



FCC RADIO TEST REPORT

FCC ID : UZ7MC330L
Equipment : Mobile Computer
Brand Name : Zebra
Model name : MC330L
Applicant : Zebra Technologies Corporation
1 Zebra Plaza, Holtsville, NY 11742
Manufacturer : Zebra Technologies Corporation
1 Zebra Plaza, Holtsville, NY 11742
Standard : FCC Part 15 Subpart E §15.407

The product was received on Aug. 12, 2019 and testing was started from Aug. 16, 2019 and completed on Nov. 08, 2019. We, SPORTON INTERNATIONAL INC., EMC & Wireless Communications Laboratory, would like to declare that the tested sample has been evaluated in accordance with the test procedures and has been in compliance with the applicable technical standards.

The report must not be used by the client to claim product certification, approval, or endorsement by TAF or any agency of government.

The test results in this report apply exclusively to the tested model / sample. Without written approval of SPORTON INTERNATIONAL INC. EMC & Wireless Communications Laboratory, the test report shall not be reproduced except in full.

Louis Wu

Approved by: Louis Wu

SPORTON INTERNATIONAL INC. EMC & Wireless Communications Laboratory

No. 52, Huaya 1st Rd., Guishan Dist., Taoyuan City, Taiwan (R.O.C.)



Table of Contents

History of this test report..... 3

Summary of Test Result..... 4

1 General Description 5

 1.1 Product Feature of Equipment Under Test..... 5

 1.2 Product Specification of Equipment Under Test..... 9

 1.3 Modification of EUT 10

 1.4 Testing Location 11

 1.5 Applicable Standards..... 11

2 Test Configuration of Equipment Under Test 12

 2.1 Carrier Frequency and Channel 12

 2.2 Test Mode..... 13

 2.3 Connection Diagram of Test System..... 19

 2.4 Support Unit used in test configuration and system 20

 2.5 EUT Operation Test Setup 21

 2.6 Measurement Results Explanation Example..... 21

3 Test Result 22

 3.1 6dB and 26dB and 99% Occupied Bandwidth Measurement 22

 3.2 Maximum Conducted Output Power Measurement 28

 3.3 Power Spectral Density Measurement 32

 3.4 Unwanted Emissions Measurement 38

 3.5 AC Conducted Emission Measurement..... 44

 3.6 Automatically Discontinue Transmission 46

 3.7 Antenna Requirements 47

4 List of Measuring Equipment..... 49

5 Uncertainty of Evaluation 51

Appendix A. AC Conducted Emission Test Result

Appendix B. Radiated Spurious Emission

Appendix C. Radiated Spurious Emission Plots

Appendix D. Duty Cycle Plots

Appendix E. Setup Photographs



History of this test report

Report No.	Version	Description	Issued Date
FR981244F	01	Initial issue of report	Nov. 29, 2019



Summary of Test Result

Report Clause	Ref Std. Clause	Test Items	Result (PASS/FAIL)	Remark
3.1	15.403 (i)	6dB & 26dB Bandwidth	Pass	-
3.1	2.1049	99% Occupied Bandwidth	Reporting only	-
3.2	15.407 (a)	Maximum Conducted Output Power	Pass	-
3.3	15.407 (a)	Power Spectral Density	Pass	-
3.4	15.407(b)	Unwanted Emissions	Pass	Under limit 3.62 dB at 43.580 MHz
3.5	15.207	AC Conducted Emission	Pass	Under limit 12.66 dB at 0.152 MHz
3.6	15.407 (c)	Automatically Discontinue Transmission	Pass	-
3.7	15.203 & 15.407 (a)	Antenna Requirement	Pass	-

Declaration of Conformity:

The test results with all measurement uncertainty excluded are presented in accordance with the regulation limits or requirements declared by manufacturers.

Comments and Explanations:

The declared of product specification for EUT presented in the report are provided by the manufacturer, and the manufacturer takes all the responsibilities for the accuracy of product specification.

Reviewed by: Wii Chang

Report Producer: Lucy Wu



1 General Description

1.1 Product Feature of Equipment Under Test

Product Feature	
Equipment	Mobile Computer
Brand Name	Zebra
Model Name	MC330L
FCC ID	UZ7MC330L
EUT supports Radios application	NFC WLAN 11a/b/g/n HT20/HT40 WLAN 11ac VHT20/VHT40/VHT80 Bluetooth BR/EDR/LE
HW Version	DV
SW Version_Gun	Android Version 9
SW Version_Brick	Android Version 9
SW Version_Rotate	Android Version 9
FW Version_Gun	Terminal Version: 02-11-08.00-PG-U00-PLT
FW Version_Brick	Terminal Version: 02-11-08.00-PG-U00-PLT
FW Version_Rotate	Terminal Version: 02-11-08.00-PG-U00-PLT
MFD_Gun	01AUG19
MFD_Brick	02AUG19
MFD_Rotate	27JUL19
EUT Stage	Identical Prototype

Remark: The above EUT's information was declared by manufacturer.



Specification of Accessories				
Adapter	Brand Name	Zebra	Part Number	PWR-WUA5V12W0US
U cable	Brand Name	Symbol	Model Name	CBL-MC33-USBCHG-01
MC32 1X battery (Inventus)	Brand Name	Symbol	Model Number	82-000011-01
MC32 2X battery (Inventus)	Brand Name	Symbol	Model Number	82-000012-02
MC32 2X battery (TWS)	Brand Name	Symbol	Model Number	82-000012-02
MC33 1X battery (Inventus)	Brand Name	Zebra	Model Number	BT-000338
MC33 2X battery (Inventus)	Brand Name	Zebra	Model Number	BT-000337
MC33 2X battery (TWS)	Brand Name	Zebra	Model Number	BT-000337A
MC33 7000mA 2X (Inventus)	Brand Name	Zebra	Model Number	BT-000375
Holster for MC3XXX Gun configuration	Brand Name	Zebra	Model Number	SG-MC3021212-01R
Rigid holster for MC3XXX Gun configuration	Brand Name	Zebra	Model Number	SG-MC33-RDHLST-01
Holster for MC3XXXX Brick configuration	Brand Name	Zebra	Model Number	11-69293-01R
Rigid holster for MC3XXX Brick configuration	Brand Name	Zebra	Model Number	SG-MC33-RDHLST-01
Lanyard for MC3XXX Brick Configuration	Brand Name	Zebra	Model Number	SG-MC33-LNYDB-01
Protective boot for MC3XXX straight shooter	Brand Name	Zebra	Model Number	SG-MC33-RBTG-01
Protective boot for MC3XXX Turret Cup of Rotate configuration	Brand Name	Zebra	Model Number	SG-MC33-RBTRT-01
Protective boot for MC3XXX Rotate configuration	Brand Name	Zebra	Model Number	SG-MC33-RBTRD-01

**<Sample Information>**

Organization / Function / Group	SKU1	SKU2	SKU3	SKU4	SKU5
Phase	DV	DV	DV	DV	DV
Configuration					
Form Factor	Gun	Gun	Gun - Amazon	Gun China	Rotate
Scanner	SE965	SE4850 new 20-4850-IM001R	SE4770	SE4720	SE965
Keypad	Numeric (29Key)	Function Numeric (47Key)	AlphaNum (47Key)	Function Numeric (38Key)	Numeric (47Key)
Tier	Base	Base	Base	Base	Base
NFC	Yes	Yes	Yes	Yes	Yes
Camera	NA	NA	NA	NA	No
Audio Jack (NA)	NA	NA	NA	NA	No
Back Hsg	Gun 18D	Gun 18D	Gun 18D	Gun 18D	Rotate Head
Screen Protector	No	Yes	Yes	No	No
RFID Tag	Yes	Yes	Yes	Yes	No
Hand strap	No	Yes	Yes	No	No
USB Charge cable in box	No	No	No	Yes	No
Wal wart adaptor	No	No	No	Yes	No
PCB	Tripod	Tripod	Tripod	Tripod	Tripod
DRAM/eMMC	4/32 GB MLC	4/32 GB MLC	4/32 GB MLC	4/16 GB MLC	4/32 GB MLC
DRAM/eMMC Mfr main source	Hynix/Hynix	Hynix/Hynix	Hynix/Hynix	Hynix/Hynix	Hynix/Hynix



Organization / Function / Group	SKU6	SKU7	SKU8	SKU9	SKU10
Phase	DV	DV	DV	DV	DV
Configuration					
Form Factor	Straight (S)	Straight (S)	Straight (S) China	Straight (L)	Straight(45)
Scanner	SE965	SE4770	SE4720	SE4850 new 20-4850-IM001R	SE4770
Keypad	AlphaNum (47Key)	Function Numeric (38Key)	Function Numeric (38Key)	Numeric (29Key)	Function Numeric (38Key)
Tier	Base + Camera	Base + Camera	Base	Base + Camera	Base + Camera
NFC	Yes	Yes	Yes	Yes	Yes
Camera	Yes	Yes	No	Yes	Yes
Audio Jack (NA)	No	No	No	No	No
Back Hsg	22 Deg ST	22 Deg ST	22 Deg ST	18 deg ST	45 deg ST
Screen Protector	No	No	No	Yes	Yes
RFID Tag	No	No	No	No	No
Hand strap	Yes	No	No	No	Yes
USB Charge cable in box	No	No	Yes	No	No
Wal wart adaptor	No	No	Yes	No	No
PCB	Tripod	Tripod	Tripod	Tripod	Tripod
DRAM/eMMC	4/32 GB MLC	4/32 GB MLC	4/16 GB MLC	4/32 GB MLC	4/32 GB MLC
DRAM/eMMC Mfr main source	Hynix/Hynix	Hynix/Hynix	Hynix/Hynix	Hynix/Hynix	Hynix/Hynix



1.2 Product Specification of Equipment Under Test

Standards-related Product Specification	
Tx/Rx Channel Frequency Range	5745 MHz ~ 5825 MHz
Maximum Output Power to Antenna <CDD Modes>	<p><Ant. 1> 802.11a : 17.40 dBm / 0.0550 W 802.11n HT20 : 17.30 dBm / 0.0537 W 802.11n HT40 : 17.30 dBm / 0.0537 W 802.11ac VHT20: 17.40 dBm / 0.0550 W 802.11ac VHT40: 17.40 dBm / 0.0550 W 802.11ac VHT80: 17.40 dBm / 0.0550 W</p> <p><Ant. 2> 802.11a : 17.40 dBm / 0.0550 W 802.11n HT20 : 17.30 dBm / 0.0537 W 802.11n HT40 : 17.20 dBm / 0.0525 W 802.11ac VHT20: 17.40 dBm / 0.0550 W 802.11ac VHT40: 17.30 dBm / 0.0537 W 802.11ac VHT80: 17.40 dBm / 0.0550 W</p> <p>MIMO <Ant. 1 + 2> 802.11a : 20.91 dBm / 0.1233 W 802.11n HT20 : 20.71 dBm / 0.1178 W 802.11n HT40 : 20.86 dBm / 0.1219 W 802.11ac VHT20: 20.76 dBm / 0.1191 W 802.11ac VHT40: 20.91 dBm / 0.1233 W 802.11ac VHT80: 20.96 dBm / 0.1247 W</p>
Maximum Output Power <TXBF Modes>	<p>MIMO <Ant. 1 + 2> 802.11ac VHT20: 20.41 dBm / 0.1099 W 802.11ac VHT40: 20.18 dBm / 0.1042 W 802.11ac VHT80: 20.40 dBm / 0.1096 W</p>
99% Occupied Bandwidth <CDD Modes>	<p><Ant. 1> 802.11a : 16.88 MHz 802.11ac VHT20 : 18.08 MHz 802.11ac VHT40 : 36.76 MHz 802.11ac VHT80 : 76.24 MHz</p> <p><Ant. 2> 802.11a : 16.83 MHz 802.11n HT20 : 18.03 MHz 802.11n HT40 : 36.76 MHz 802.11ac VHT80 : 76.12 MHz</p> <p>MIMO <Ant. 1> 802.11a : 16.93 MHz 802.11ac VHT20 : 18.08 MHz 802.11ac VHT40 : 36.66 MHz 802.11ac VHT80 : 76.24 MHz</p> <p>MIMO <Ant. 2> 802.11a : 16.73 MHz 802.11n HT20 : 17.93 MHz 802.11n HT40 : 36.46 MHz 802.11ac VHT80 : 76.00 MHz</p>



Standards-related Product Specification													
99% Occupied Bandwidth <TXBF Modes>	MIMO <Ant. 1> 802.11ac VHT20 : 17.78 MHz 802.11ac VHT40 : 36.96 MHz 802.11ac VHT80 : 77.08 MHz MIMO <Ant. 2> 802.11ac VHT20 : 19.63 MHz 802.11ac VHT40 : 36.76 MHz 802.11ac VHT80 : 76.72 MHz												
Antenna Gain / Gain	Ant. 1: PIFA Antenna with gain 4.76 dBi Ant. 2: PIFA Antenna with gain 4.71 dBi												
Type of Modulation	802.11a/n : OFDM (BPSK / QPSK / 16QAM / 64QAM) 802.11ac : OFDM (BPSK / QPSK / 16QAM / 64QAM / 256QAM)												
Antenna Function Description	<table border="1"> <thead> <tr> <th></th> <th>Ant. 1</th> <th>Ant. 2</th> </tr> </thead> <tbody> <tr> <td>802.11 a/n/ac</td> <td>V</td> <td>V</td> </tr> <tr> <td>802.11 a/n/ac MIMO</td> <td>V</td> <td>V</td> </tr> <tr> <td>802.11ac TXBF</td> <td>V</td> <td>V</td> </tr> </tbody> </table>		Ant. 1	Ant. 2	802.11 a/n/ac	V	V	802.11 a/n/ac MIMO	V	V	802.11ac TXBF	V	V
	Ant. 1	Ant. 2											
802.11 a/n/ac	V	V											
802.11 a/n/ac MIMO	V	V											
802.11ac TXBF	V	V											

Note: MIMO Ant. 1+2 is a calculated result from sum of the power MIMO Ant. 1 and MIMO Ant. 2.

1.3 Modification of EUT

No modifications are made to the EUT during all test items.



1.4 Testing Location

Test Site	SPORTON INTERNATIONAL INC. EMC & Wireless Communications Laboratory	
Test Site Location	No.52, Huaya 1st Rd., Guishan Dist., Taoyuan City, Taiwan (R.O.C.) TEL: +886-3-327-3456 FAX: +886-3-328-4978	
Test Site No.	Sporton Site No.	
	TH05-HY	CO05-HY

Note: The test site complies with ANSI C63.4 2014 requirement.

Test Site	SPORTON INTERNATIONAL INC. EMC & Wireless Communications Laboratory	
Test Site Location	No.58, Aly. 75, Ln. 564, Wenhua 3rd, Rd., Guishan Dist., Taoyuan City, Taiwan (R.O.C.) TEL: +886-3-327-0868 FAX: +886-3-327-0855	
Test Site No.	Sporton Site No.	
	03CH12-HY	

Note: The test site complies with ANSI C63.4 2014 requirement.

FCC designation No.: TW1190 and TW0007

1.5 Applicable Standards

According to the specifications of the manufacturer, the EUT must comply with the requirements of the following standards:

- ♦ FCC Part 15 Subpart E
- ♦ FCC KDB 789033 D02 General UNII Test Procedures New Rules v02r01.
- ♦ FCC KDB 414788 D01 Radiated Test Site v01r01.
- ♦ FCC KDB 662911 D01 Multiple Transmitter Output v02r01.
- ♦ ANSI C63.10-2013

Remark:

1. All test items were verified and recorded according to the standards and without any deviation during the test.
2. This EUT has also been tested and complied with the requirements of FCC Part 15, Subpart B, recorded in a separate test report.



2 Test Configuration of Equipment Under Test

- a. The EUT has been associated with peripherals and configuration operated in a manner tended to maximize its emission characteristics in a typical application. Frequency range investigated: conduction emission (150 kHz to 30 MHz), radiation emission (9 kHz to the 10th harmonic of the highest fundamental frequency or to 40 GHz, whichever is lower). For radiated measurement, pre-scanned in three orthogonal panels, X, Y, Z. The worst cases (CDD Mode: X plane for Ant. 1 and Ant. 2, Z plane for MIMO Ant. 1+2; TXBF Mode: Y plane) were recorded in this report.
- b. AC power line Conducted Emission was tested under maximum output power.

2.1 Carrier Frequency and Channel

Frequency Band	Channel	Freq. (MHz)	Channel	Freq. (MHz)
5725-5850 MHz Band 4 (U-NII-3)	149	5745	157	5785
	151*	5755	159*	5795
	153	5765	161	5805
	155#	5775	165	5825

Note:

- 1. The above Frequency and Channel in "*" were 802.11n HT40 and 802.11ac VHT40.
- 2. The above Frequency and Channel in "#n" were 802.11ac VHT80.



2.2 Test Mode

Final test modes are considering the modulation and worse data rates as below table.

Single Mode

Modulation	Data Rate
802.11a	6 Mbps
802.11n HT20 (Covered by VHT20)	MCS0
802.11n HT40 (Covered by VHT40)	MCS0
802.11ac VHT20	MCS0
802.11ac VHT40	MCS0
802.11ac VHT80	MCS0

MIMO Mode

Modulation	Data Rate
802.11a	6 Mbps
802.11n HT20 (Covered by VHT20)	MCS0
802.11n HT40 (Covered by VHT40)	MCS0
802.11ac VHT20	MCS0
802.11ac VHT40	MCS0
802.11ac VHT80	MCS0

TXBF Mode

Modulation	Data Rate
802.11ac VHT20	MCS0
802.11ac VHT40	MCS0
802.11ac VHT80	MCS6

Test Cases	
AC Conducted Emission	Mode 1 :Keypad (47) + WLAN (5GHz) Link + Bluetooth Link + Color Bar + MC33 7000mA 2X (Inventus) + USB Cable (Data Link with Notebook) (eMMC to Notebook) for SKU 5
Remark:	
<ol style="list-style-type: none"> Data Linking with Notebook means data application transferred mode between EUT and Notebook. For Radiated Test Cases, the tests were performed with MC33 2X battery (Inventus) and SKU 5. 	



Ch. #		Band IV : 5725-5850 MHz			
		802.11a	802.11ac VHT20	802.11ac VHT40	802.11ac VHT80
L	Low	149	149	151	-
M	Middle	157	157	-	155
H	High	165	165	159	-

<CDD Mode>
<Ant. 1>

802.11a RF Output Power (dBm)										
Power vs. Channel			Power vs Data Rate							
Channel	Frequency (MHz)	Data Rate (bps)	channel	Data Rate (bps)						
		6M		9M	12M	18M	24M	36M	48M	54M
Duty Cycle (%)		95.81		94.40	92.70	89.90	87.10	82.30	78.10	76.30
CH 149	5745	17.40	CH 149	17.30	17.30	17.20	17.30	17.10	17.10	17.20
CH 157	5785	17.40								
CH 165	5825	17.40								

802.11n HT20 RF Output Power (dBm)										
Power vs. Channel			Power vs Data Rate							
Channel	Frequency (MHz)	MCS Index	channel	MCS Index						
		MCS0		MCS1	MCS2	MCS3	MCS4	MCS5	MCS6	MCS7
Duty Cycle (%)		95.05		92.30	89.30	86.60	81.90	77.90	76.20	74.80
CH 149	5745	17.20	CH 157	17.00	17.10	17.10	17.00	17.00	17.00	17.00
CH 157	5785	17.30								
CH 165	5825	17.20								

802.11n HT40 RF Output Power (dBm)										
Power vs. Channel			Power vs Data Rate							
Channel	Frequency (MHz)	MCS Index	channel	MCS Index						
		MCS0		MCS1	MCS2	MCS3	MCS4	MCS5	MCS6	MCS7
Duty Cycle (%)		92.20		86.20	81.40	77.40	71.00	66.70	64.90	63.00
CH 151	5755	17.30	CH 151	17.10	17.10	17.10	17.10	17.10	17.10	17.10
CH 159	5795	17.30								

802.11ac VHT20 RF Output Power (dBm)											
Power vs. Channel			Power vs Data Rate								
Channel	Frequency (MHz)	MCS Index	channel	MCS Index							
		MCS0		MCS1	MCS2	MCS3	MCS4	MCS5	MCS6	MCS7	MCS8
Duty Cycle (%)		95.07		92.30	89.40	86.70	81.90	78.30	76.40	75.00	72.30
CH 149	5745	17.30	CH 157	17.10	17.20	17.20	17.10	17.10	17.10	17.10	17.10
CH 157	5785	17.40									
CH 165	5825	17.30									



802.11ac VHT40 RF Output Power (dBm)												
Power vs. Channel			Power vs Data Rate									
Channel	Frequency (MHz)	MCS Index	channel	MCS Index								
		MCS0		MCS1	MCS2	MCS3	MCS4	MCS5	MCS6	MCS7	MCS8	MCS9
Duty Cycle (%)		91.39		86.30	81.40	77.60	71.40	67.20	65.40	63.60	60.70	59.80
CH 151	5755	17.40	CH 151	17.20	17.20	17.20	17.20	17.20	17.10	17.20	17.10	17.10
CH 159	5795	17.40										

802.11ac VHT80 RF Output Power (dBm)												
Power vs. Channel			Power vs Data Rate									
Channel	Frequency (MHz)	MCS Index	channel	MCS Index								
		MCS0		MCS1	MCS2	MCS3	MCS4	MCS5	MCS6	MCS7	MCS8	MCS9
Duty Cycle (%)		89.09		76.60	70.70	66.10	59.80	56.10	54.10	53.00	50.40	49.30
CH155	5775	17.40	CH155	17.20	17.20	17.20	17.20	17.20	17.20	17.20	17.20	17.20

<Ant. 2>

802.11a RF Output Power (dBm)										
Power vs. Channel			Power vs Data Rate							
Channel	Frequency (MHz)	Data Rate (bps)	channel	Data Rate (bps)						
		6M		9M	12M	18M	24M	36M	48M	54M
Duty Cycle (%)		95.83		94.40	92.80	89.80	87.20	82.50	78.20	76.50
CH 149	5745	17.30	CH 157	17.20	17.20	17.00	17.30	17.00	17.10	17.00
CH 157	5785	17.40								
CH 165	5825	17.40								

802.11n HT20 RF Output Power (dBm)										
Power vs. Channel			Power vs Data Rate							
Channel	Frequency (MHz)	MCS Index	channel	MCS Index						
		MCS0		MCS1	MCS2	MCS3	MCS4	MCS5	MCS6	MCS7
Duty Cycle (%)		95.54		92.30	89.30	86.70	81.90	77.80	76.30	75.00
CH 149	5745	17.20	CH 157	17.00	17.20	17.20	17.00	17.00	17.00	17.00
CH 157	5785	17.30								
CH 165	5825	17.30								

802.11n HT40 RF Output Power (dBm)										
Power vs. Channel			Power vs Data Rate							
Channel	Frequency (MHz)	MCS Index	channel	MCS Index						
		MCS0		MCS1	MCS2	MCS3	MCS4	MCS5	MCS6	MCS7
Duty Cycle (%)		91.79		86.20	81.40	77.40	71.00	66.70	64.90	63.00
CH 151	5755	17.20	CH 151	86.20	81.40	77.40	71.00	66.70	64.90	63.00
CH 159	5795	17.10								



802.11ac VHT20 RF Output Power (dBm)											
Power vs. Channel			Power vs Data Rate								
Channel	Frequency (MHz)	MCS Index	channel	MCS Index							
		MCS0		MCS1	MCS2	MCS3	MCS4	MCS5	MCS6	MCS7	MCS8
Duty Cycle (%)		95.54		92.30	89.40	86.70	82.10	78.30	76.50	75.10	72.40
CH 149	5745	17.30	CH 157	17.10	17.30	17.30	17.10	17.10	17.10	17.10	17.10
CH 157	5785	17.40									
CH 165	5825	17.40									

802.11ac VHT40 RF Output Power (dBm)												
Power vs. Channel			Power vs Data Rate									
Channel	Frequency (MHz)	MCS Index	channel	MCS Index								
		MCS0		MCS1	MCS2	MCS3	MCS4	MCS5	MCS6	MCS7	MCS8	MCS9
Duty Cycle (%)		91.39		86.20	81.40	77.60	71.50	67.20	65.60	63.70	60.80	59.60
CH 151	5755	17.30	CH 151	17.20	17.10	17.10	17.20	17.20	17.20	17.20	17.20	17.20
CH 159	5795	17.20										

802.11ac VHT80 RF Output Power (dBm)												
Power vs. Channel			Power vs Data Rate									
Channel	Frequency (MHz)	MCS Index	channel	MCS Index								
		MCS0		MCS1	MCS2	MCS3	MCS4	MCS5	MCS6	MCS7	MCS8	MCS9
Duty Cycle (%)		90.18		76.50	70.70	66.00	59.50	-56.00	53.90	53.00	50.40	49.20
CH155	5775	17.40	CH155	17.10	17.20	17.10	17.10	17.10	17.10	17.10	17.10	17.10

MIMO <Ant. 1+2>

802.11a RF Output Power (dBm)										
Power vs. Channel			Power vs Data Rate							
Channel	Frequency (MHz)	Data Rate (bps)	channel	Data Rate (bps)						
		6M		9M	12M	18M	24M	36M	48M	54M
CH 149	5745	20.91	CH 149	20.81	20.71	20.61	20.81	20.71	20.81	20.71
CH 157	5785	20.66								
CH 165	5825	20.76								

802.11n HT20 RF Output Power (dBm)										
Power vs. Channel			Power vs Data Rate							
Channel	Frequency (MHz)	MCS Index	channel	MCS Index						
		MCS0		MCS1	MCS2	MCS3	MCS4	MCS5	MCS6	MCS7
CH 149	5745	20.71	CH 149	20.56	20.27	20.26	20.46	20.51	20.56	20.51
CH 157	5785	20.66								
CH 165	5825	20.66								



802.11n HT40 RF Output Power (dBm)											
Power vs. Channel			Power vs Data Rate								
Channel	Frequency (MHz)	MCS Index	channel	MCS Index							
		MCS0		MCS1	MCS2	MCS3	MCS4	MCS5	MCS6	MCS7	
CH 151	5755	20.86	CH 151	20.76	20.76	20.76	20.76	20.76	20.71	20.71	20.66
CH 159	5795	20.71									

802.11ac VHT20 RF Output Power (dBm)											
Power vs. Channel			Power vs Data Rate								
Channel	Frequency (MHz)	MCS Index	channel	MCS Index							
		MCS0		MCS1	MCS2	MCS3	MCS4	MCS5	MCS6	MCS7	MCS8
CH 149	5745	20.76	CH 149	20.66	20.37	20.36	20.56	20.61	20.66	20.61	20.61
CH 157	5785	20.71									
CH 165	5825	20.71									

802.11ac VHT40 RF Output Power (dBm)												
Power vs. Channel			Power vs Data Rate									
Channel	Frequency (MHz)	MCS Index	channel	MCS Index								
		MCS0		MCS1	MCS2	MCS3	MCS4	MCS5	MCS6	MCS7	MCS8	MCS9
CH 151	5755	20.91	CH 151	20.86	20.81	20.81	20.76	20.71	20.71	20.66	20.66	20.66
CH 159	5795	20.76										

802.11ac VHT80 RF Output Power (dBm)												
Power vs. Channel			Power vs Data Rate									
Channel	Frequency (MHz)	MCS Index	channel	MCS Index								
		MCS0		MCS1	MCS2	MCS3	MCS4	MCS5	MCS6	MCS7	MCS8	MCS9
CH155	5775	20.96	CH155	20.81	20.86	20.76	20.81	20.66	20.71	20.76	20.76	20.76



<TXBF Mode>

MIMO <Ant. 1+2>

802.11ac VHT20 RF Output Power (dBm)											
Power vs. Channel			Power vs Data Rate								
Channel	Frequency (MHz)	MCS Index	channel	MCS Index							
		MCS0		MCS1	MCS2	MCS3	MCS4	MCS5	MCS6	MCS7	MCS8
CH 149	5745	20.41	CH 149	20.00	19.93	20.05	20.07	19.90	20.12	20.27	20.27
CH 157	5785	20.32									
CH 165	5825	20.41									

802.11ac VHT40 RF Output Power (dBm)												
Power vs. Channel			Power vs Data Rate									
Channel	Frequency (MHz)	MCS Index	channel	MCS Index								
		MCS0		MCS1	MCS2	MCS3	MCS4	MCS5	MCS6	MCS7	MCS8	MCS9
CH 151	5755	20.18	CH 151	19.87	19.87	19.98	19.91	19.81	19.81	19.94	20.13	19.87
CH 159	5795	20.14										

802.11ac VHT80 RF Output Power (dBm)												
Power vs. Channel			Power vs Data Rate									
Channel	Frequency (MHz)	MCS Index	channel	MCS Index								
		MCS0		MCS1	MCS2	MCS3	MCS4	MCS5	MCS6	MCS7	MCS8	MCS9
CH155	5775	20.24	CH155	20.07	19.80	19.95	20.18	20.01	20.40	19.97	20.08	20.18

2.3 Connection Diagram of Test System

< WLAN Tx CDD Mode>

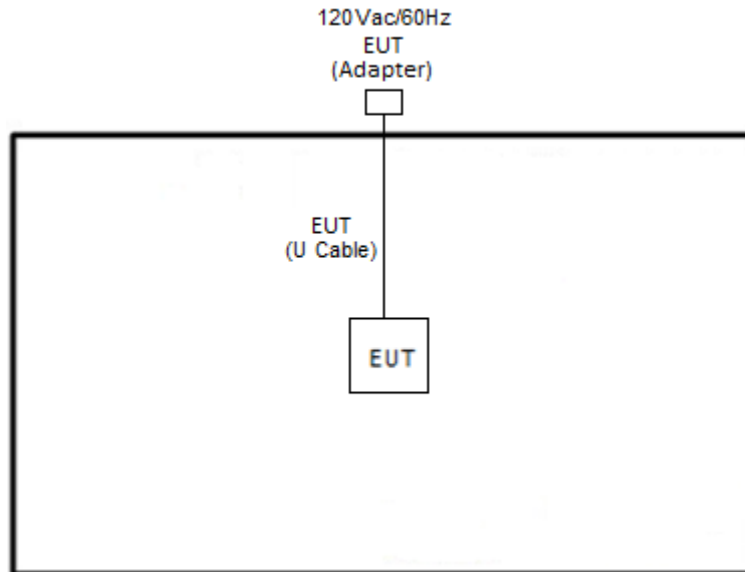

< WLAN TXBF Mode>

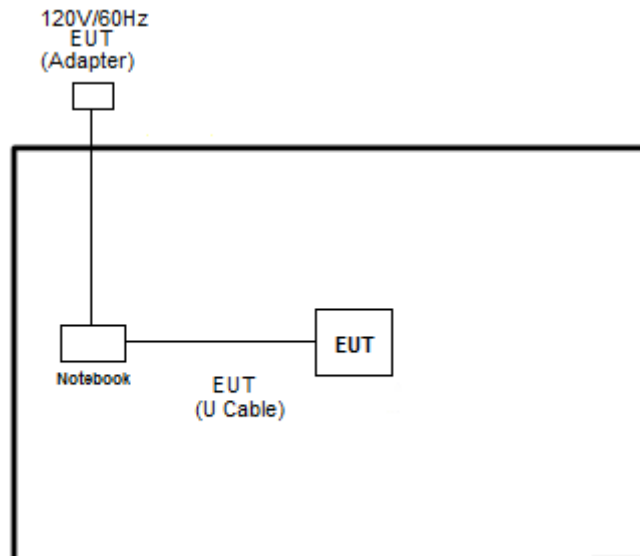

<For AC Conducted Emission Mode>

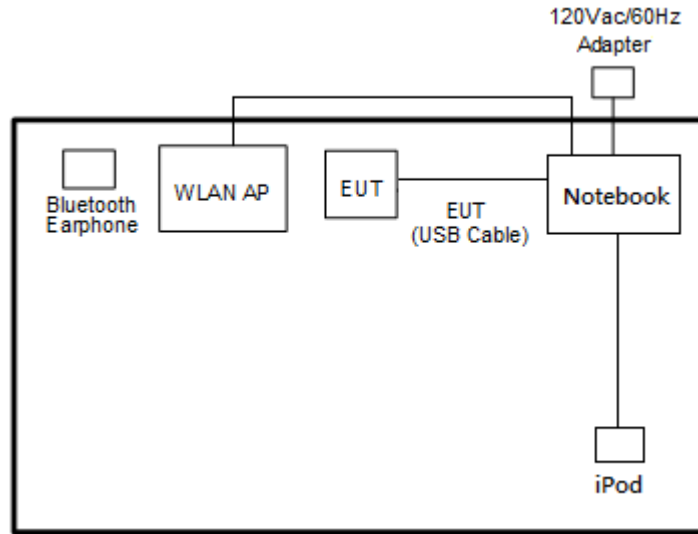

2.4 Support Unit used in test configuration and system

Item	Equipment	Trade Name	Model Name	FCC ID	Data Cable	Power Cord
1.	Bluetooth Earphone	Sony Ericsson	MW600	PY7DDA-2029	N/A	N/A
2.	WLAN AP	ASUS	RT-AC66U B1	N/A	N/A	Unshielded, 1.8m
3.	Notebook	DELL	Latitude E5570	FCC DoC	N/A	AC I/P: Unshielded, 1.2 m DC O/P: Shielded, 1.8 m
4.	Notebook	ASUS	P2430U	N/A	N/A	N/A
5.	Notebook	Lenovo	E330	N/A	N/A	N/A
6.	iPod	Apple	A1285	FCC DoC	Shielded, 1.0 m	N/A
7.	SD Card	SanDisk	MicroSD HC	FCC DoC	N/A	N/A



2.5 EUT Operation Test Setup

The RF test items, utility “QRCT V 3.0.298.0)” was installed in Notebook which was programmed in order to make the EUT get into the engineering modes to provide channel selection, power level, data rate and the application type and for continuous transmitting signals.

For TXBF mode, the modulation modes and data rates manipulated by the command lines in the engineering program made the EUT link to another EUT by power under the normal operation. The “adb” software tool was used to enable the EUT to transmit signals continuously.

2.6 Measurement Results Explanation Example

For all conducted test items:

The offset level is set in the spectrum analyzer to compensate the RF cable loss and attenuator factor between EUT conducted output port and spectrum analyzer. With the offset compensation, the spectrum analyzer reading level is exactly the EUT RF output level.

Example :

The spectrum analyzer offset is derived from RF cable loss and attenuator factor.

Offset = RF cable loss + attenuator factor.

Following shows an offset computation example with cable loss 4.2 dB and 10dB attenuator.

$$\begin{aligned} \text{Offset(dB)} &= \text{RF cable loss(dB)} + \text{attenuator factor(dB)}. \\ &= 4.2 + 10 = 14.2 \text{ (dB)} \end{aligned}$$

3 Test Result

3.1 6dB and 26dB and 99% Occupied Bandwidth Measurement

3.1.1 Description of 6dB and 26dB and 99% Occupied Bandwidth

The minimum 6 dB bandwidth shall be at least 500 kHz.

26dB and 99% Occupied bandwidth are reporting only.

3.1.2 Measuring Instruments

See list of measuring equipment of this test report.

3.1.3 Test Procedures

1. The testing follows FCC KDB 789033 D02 General UNII Test Procedures New Rules v02r01. Section C) Emission bandwidth for the band 5.725-5.85GHz
2. Set RBW = 100kHz.
3. Set the VBW $\geq 3 \times$ RBW.
4. Detector = Peak.
5. Trace mode = max hold
6. Measure the maximum width of the emission that is 6 dB down from the peak of the emission.
7. Measure and record the results in the test report.

3.1.4 Test Setup

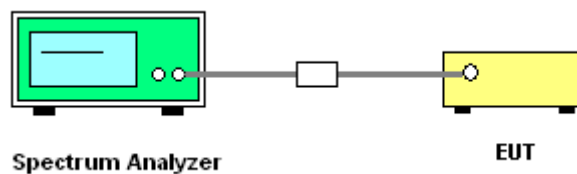



3.1.5 Test Result of 6dB and 26dB and 99% Occupied Bandwidth

Test Engineer :	Luffy Lin , Richard Qiu	Temperature :	21~25°C
		Relative Humidity :	51~54%

<CDD Mode>

Band IV													
Mod.	Data Rate	NTX	CH.	Freq. (MHz)	99% Bandwidth (MHz)		26dB Bandwidth (MHz)		6 dB Bandwidth (MHz)		6 dB Bandwidth Min. Limit (MHz)	Pass/Fail	
					Ant 1	Ant 2	Ant 1	Ant 2	Ant 1	Ant 2			
11a	6Mbps	1	149	5745	16.83	16.78	24.73	24.78	15.53	15.58	0.5	Pass	
11a	6Mbps	1	157	5785	16.88	16.78	25.32	24.78	15.28	15.58	0.5	Pass	
11a	6Mbps	1	165	5825	16.83	16.83	25.03	25.07	16.28	15.48	0.5	Pass	
VHT20	MCS0	1	149	5745	18.03	18.03	26.37	25.87	16.53	16.53	0.5	Pass	
VHT20	MCS0	1	157	5785	18.08	18.03	26.92	26.32	16.78	16.78	0.5	Pass	
VHT20	MCS0	1	165	5825	18.03	18.03	26.07	26.17	16.78	16.73	0.5	Pass	
VHT40	MCS0	1	151	5755	36.76	36.66	42.35	42.35	35.46	35.60	0.5	Pass	
VHT40	MCS0	1	159	5795	36.66	36.76	41.99	41.90	35.06	35.42	0.5	Pass	
VHT80	MCS0	1	155	5775	76.24	76.12	84.56	84.24	75.13	75.13	0.5	Pass	
11a	6Mbps	2	149	5745	16.93	16.68	25.07	24.93	15.13	15.63	0.5	Pass	
11a	6Mbps	2	157	5785	16.93	16.68	25.42	24.68	15.28	15.68	0.5	Pass	
11a	6Mbps	2	165	5825	16.78	16.73	25.22	24.28	15.08	15.63	0.5	Pass	
VHT20	MCS0	2	149	5745	18.08	17.93	26.37	25.57	15.93	16.48	0.5	Pass	
VHT20	MCS0	2	157	5785	18.08	17.88	26.67	25.42	16.53	16.53	0.5	Pass	
VHT20	MCS0	2	165	5825	17.98	17.93	26.27	25.37	15.13	16.78	0.5	Pass	
VHT40	MCS0	2	151	5755	36.66	36.46	42.62	42.17	35.56	35.24	0.5	Pass	
VHT40	MCS0	2	159	5795	36.66	36.46	41.90	42.26	35.69	35.24	0.5	Pass	
VHT80	MCS0	2	155	5775	76.24	76.00	84.56	84.24	75.13	75.13	0.5	Pass	

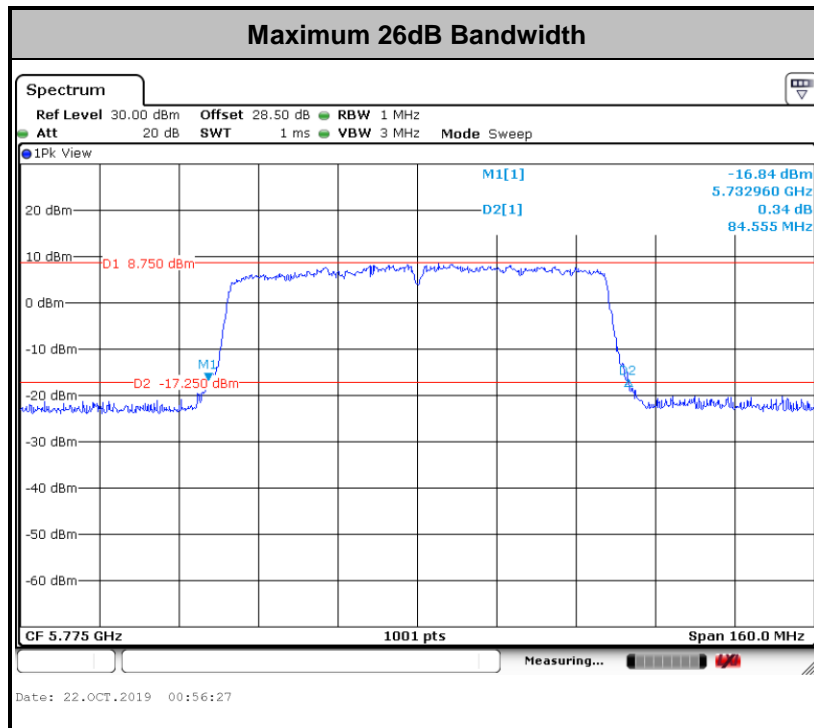
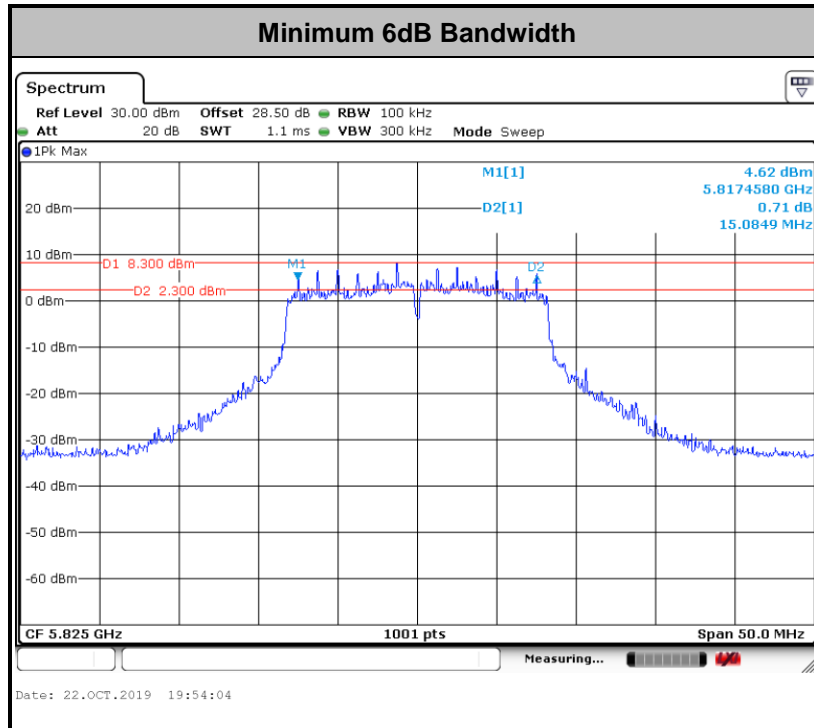

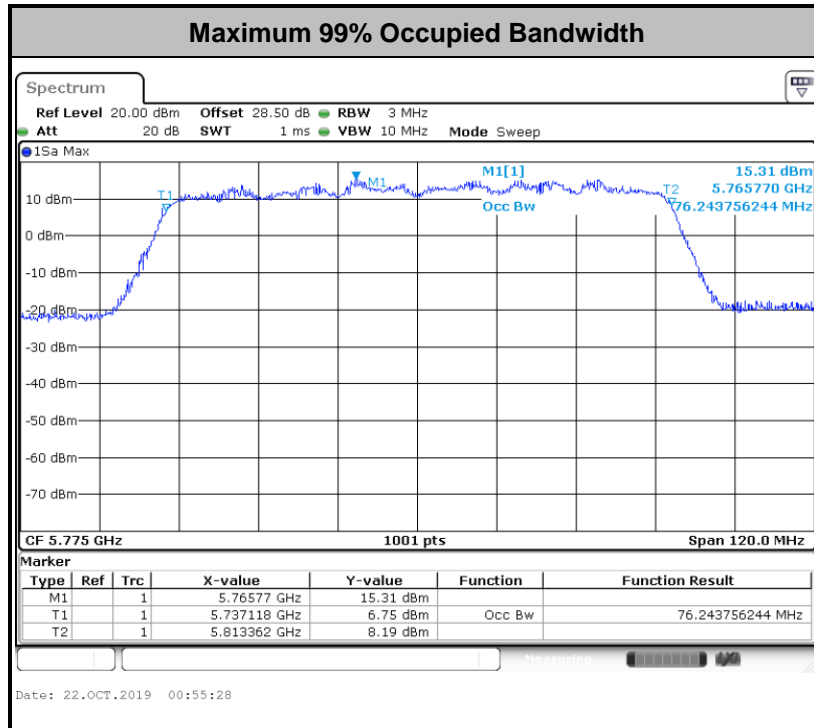

Note: The occupied channel bandwidth is maintained within the band of operation for all of the modulations.



Test Engineer :	Kai Liao	Temperature :	21~25°C
		Relative Humidity :	51~54%

<TXBF Mode>

Band IV												
Mod.	Data Rate	NTX	CH.	Freq. (MHz)	99% Bandwidth (MHz)		26dB Bandwidth (MHz)		6 dB Bandwidth (MHz)		6 dB Bandwidth Min. Limit (MHz)	Pass/Fail
					Ant 1	Ant 2	Ant 1	Ant 2	Ant 1	Ant 2		
VHT20	MCS0	2	149	5775	17.78	19.38	23.68	29.07	15.13	17.63	0.5	Pass
VHT20	MCS0	2	157	5785	17.78	19.58	24.28	28.92	15.13	17.53	0.5	Pass
VHT20	MCS0	2	165	5825	17.73	19.63	23.93	28.62	15.13	17.63	0.5	Pass
VHT40	MCS0	2	151	5755	36.96	36.66	41.63	42.80	35.06	36.23	0.5	Pass
VHT40	MCS0	2	159	5795	36.86	36.76	41.45	42.26	35.66	36.23	0.5	Pass
VHT80	MCS6	2	155	5775	77.08	76.72	84.40	83.76	75.44	75.04	0.5	Pass

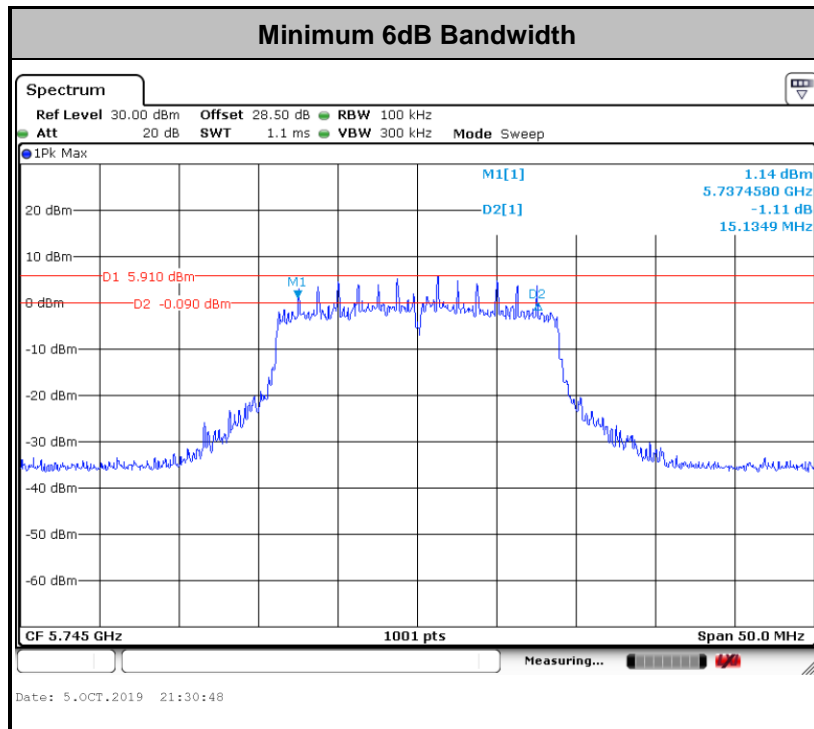

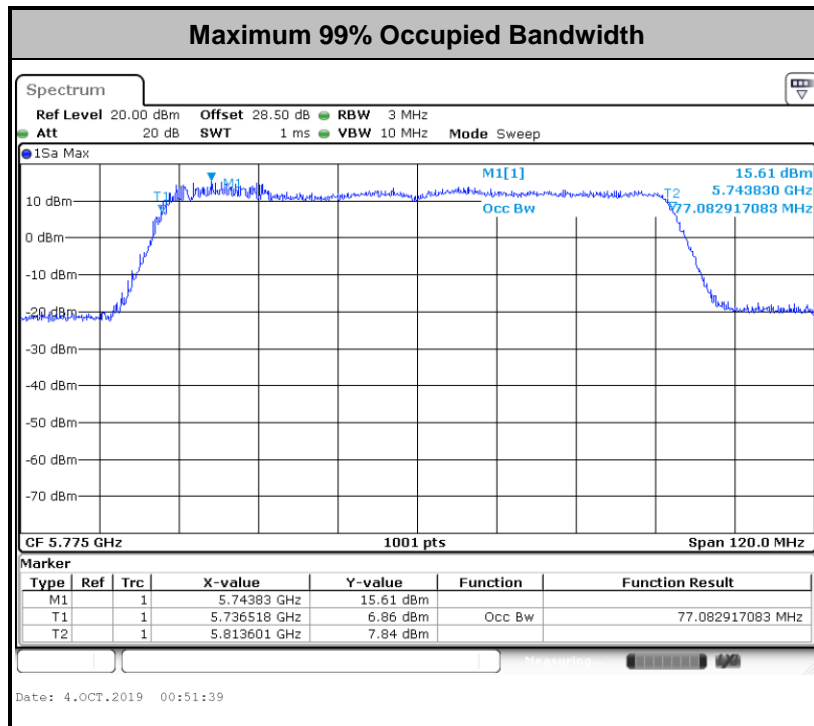
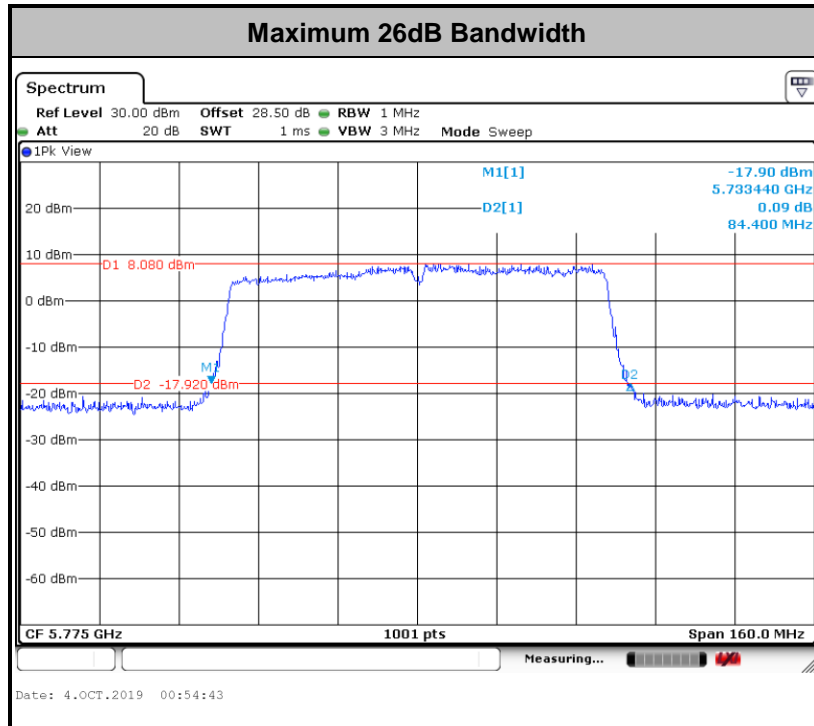

Note: The occupied channel bandwidth is maintained within the band of operation for all of the modulations.

3.2 Maximum Conducted Output Power Measurement

3.2.1 Limit of Maximum Conducted Output Power

For the band 5.725–5.85 GHz, the maximum conducted output power over the frequency band of operation shall not exceed 1 W.

If transmitting antennas of directional gain greater than 6 dBi are used, the peak output power shall be reduced by the amount in dB that the directional gain of the antenna exceeds 6 dBi.

3.2.2 Measuring Instruments

See list of measuring equipment of this test report.

3.2.3 Test Procedures

The testing follows Method PM-G of FCC KDB 789033 D02 General UNII Test Procedures New Rules v02r01.

Method PM-G (Measurement using a gated RF average power meter):

1. Measurement is performed using a wideband RF power meter.
2. The EUT is configured to transmit at its maximum power control level.
3. Measure the average power of the transmitter
4. Since the measurement is made only during the ON time of the transmitter, no duty cycle correction factor is required.

3.2.4 Test Setup

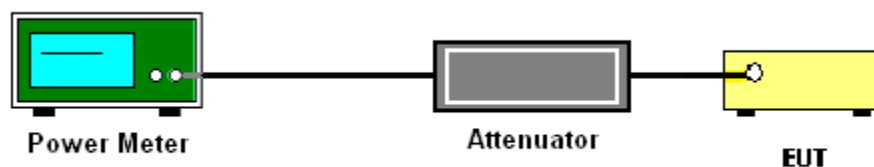



3.2.5 Test Result of Maximum Conducted Output Power

Test Engineer :	Luffy Lin , Richard Qiu	Temperature :	21~25°C
		Relative Humidity :	51~54%

<CDD Mode>

Band IV												
Mod.	Data Rate	NTX	CH.	Freq. (MHz)	Average Conducted Power (dBm)			FCC Conducted Power Limit (dBm)		DG (dBi)		Pass/Fail
					Ant 1	Ant 2	SUM	Ant 1	Ant 2	Ant 1	Ant 2	
11a	6Mbps	1	149	5745	17.40	17.30		30.00	30.00	4.76	4.71	Pass
11a	6Mbps	1	157	5785	17.40	17.40		30.00	30.00	4.76	4.71	Pass
11a	6Mbps	1	165	5825	17.40	17.40		30.00	30.00	4.76	4.71	Pass
HT20	MCS0	1	149	5745	17.20	17.20		30.00	30.00	4.76	4.71	Pass
HT20	MCS0	1	157	5785	17.30	17.30		30.00	30.00	4.76	4.71	Pass
HT20	MCS0	1	165	5825	17.20	17.30		30.00	30.00	4.76	4.71	Pass
HT40	MCS0	1	151	5755	17.30	17.20		30.00	30.00	4.76	4.71	Pass
HT40	MCS0	1	159	5795	17.30	17.10		30.00	30.00	4.76	4.71	Pass
VHT20	MCS0	1	149	5745	17.30	17.30		30.00	30.00	4.76	4.71	Pass
VHT20	MCS0	1	157	5785	17.40	17.40		30.00	30.00	4.76	4.71	Pass
VHT20	MCS0	1	165	5825	17.30	17.40		30.00	30.00	4.76	4.71	Pass
VHT40	MCS0	1	151	5755	17.40	17.30		30.00	30.00	4.76	4.71	Pass
VHT40	MCS0	1	159	5795	17.40	17.20		30.00	30.00	4.76	4.71	Pass
VHT80	MCS0	1	155	5775	17.40	17.40		30.00	30.00	4.76	4.71	Pass



Band IV												
Mod.	Data Rate	NTX	CH.	Freq. (MHz)	Average Conducted Power (dBm)			FCC Conducted Power Limit (dBm)		DG (dBi)		Pass/Fail
					Ant 1	Ant 2	SUM	Ant 1	Ant 2	Ant 1	Ant 2	
11a	6Mbps	2	149	5745	17.90	17.90	20.91	30.00		4.76	Pass	
11a	6Mbps	2	157	5785	17.70	17.60	20.66	30.00		4.76	Pass	
11a	6Mbps	2	165	5825	17.90	17.60	20.76	30.00		4.76	Pass	
HT20	MCS0	2	149	5745	17.70	17.70	20.71	30.00		4.76	Pass	
HT20	MCS0	2	157	5785	17.70	17.60	20.66	30.00		4.76	Pass	
HT20	MCS0	2	165	5825	17.70	17.60	20.66	30.00		4.76	Pass	
HT40	MCS0	2	151	5755	17.90	17.80	20.86	30.00		4.76	Pass	
HT40	MCS0	2	159	5795	17.80	17.60	20.71	30.00		4.76	Pass	
VHT20	MCS0	2	149	5745	17.80	17.70	20.76	30.00		4.76	Pass	
VHT20	MCS0	2	157	5785	17.70	17.70	20.71	30.00		4.76	Pass	
VHT20	MCS0	2	165	5825	17.80	17.60	20.71	30.00		4.76	Pass	
VHT40	MCS0	2	151	5755	17.90	17.90	20.91	30.00		4.76	Pass	
VHT40	MCS0	2	159	5795	17.80	17.70	20.76	30.00		4.76	Pass	
VHT80	MCS0	2	155	5775	18.00	17.90	20.96	30.00		4.76	Pass	



Test Engineer :	Kai Liao	Temperature :	21~25°C
		Relative Humidity :	51~54%

<TXBF Mode>

Band IV												
Mod.	Data Rate	NTX	CH.	Freq. (MHz)	Average Conducted Power (dBm)			FCC Conducted Power Limit (dBm)		DG (dBi)		Pass/Fail
					Ant 1	Ant 2	SUM	Ant 1	Ant 2	Ant 1	Ant 2	
VHT20	MCS0	2	149	5745	16.70	18.00	20.41	28.25	28.25	7.75	7.75	Pass
VHT20	MCS0	2	157	5785	16.50	18.00	20.32	28.25	28.25	7.75	7.75	Pass
VHT20	MCS0	2	165	5825	16.70	18.00	20.41	28.25	28.25	7.75	7.75	Pass
VHT40	MCS0	2	151	5755	16.30	17.90	20.18	28.25	28.25	7.75	7.75	Pass
VHT40	MCS0	2	159	5795	16.20	17.90	20.14	28.25	28.25	7.75	7.75	Pass
VHT80	MCS6	2	155	5775	16.40	18.20	20.40	28.25	28.25	7.75	7.75	Pass



3.3 Power Spectral Density Measurement

3.3.1 Limit of Power Spectral Density

For the band 5.725–5.85 GHz, the maximum power spectral density shall not exceed 30 dBm in any 500-kHz band.

If transmitting antennas of directional gain greater than 6 dBi are used, the peak output power shall be reduced by the amount in dB that the directional gain of the antenna exceeds 6 dBi.

3.3.2 Measuring Instruments

See list of measuring equipment of this test report.

3.3.3 Test Procedures

The testing follows FCC KDB 789033 D02 General UNII Test Procedures New Rules v02r01. Section F) Maximum power spectral density.

Method SA-3

(power averaging (rms) detection with max hold):

- Set span to encompass the entire emission bandwidth (EBW) of the signal.
 - Set RBW = 300 kHz.
 - Set VBW \geq 1 MHz.
 - Number of points in sweep \geq 2 Span / RBW.
 - Sweep time \leq (number of points in sweep) \times T, when duty cycle is less than 98 percent where T is the minimum transmission duration over which the transmitter is on and is transmitting at its maximum power control level for the tested mode of operation.
 - Detector = power averaging (rms).
 - Trace mode = max hold.
 - Allow max hold to run for at least 60 seconds, or longer as needed to allow the trace to stabilize.
1. The RF output of EUT was connected to the spectrum analyzer by a low loss cable.
 2. Each plot has already offset with cable loss, and attenuator loss. Measure the PPSD and record it.

3. For MIMO mode, calculation method follows FCC KDB 662911 D01 Multiple Transmitter Output v02r01.

Method (c): Measure and add $10 \log(N_{ANT})$ dB.

With this technique, spectrum measurements are performed at each output of the device, but rather than summing the spectra or the spectral peaks across the outputs, the quantity $10 \log(N_{ANT})$ dB is added to each spectrum value before comparing to the emission limit. The addition of $10 \log(N_{ANT})$ dB serves to apportion the emission limit among the N_{ANT} outputs so that each output is permitted to contribute no more than $1/N_{ANT}^{th}$ of the PSD limit.

3.3.4 Test Setup

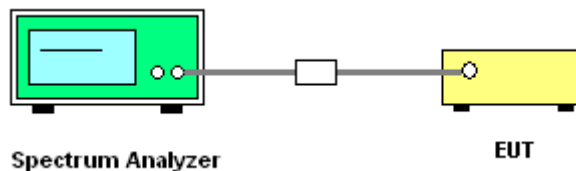



3.3.5 Test Result of Power Spectral Density

Test Engineer :	Luffy Lin , Richard Qiu	Temperature :	21~25°C
		Relative Humidity :	51~54%

<CDD Mode>

Band IV															
Mod.	Data Rate	NTX	CH.	Freq. (MHz)	10log (500kHz /RBW) Factor (dB)		Average Power Density (dBm/500kHz)			Average PSD Limit (dBm/500kHz)		DG (dBi)		Pass /Fail	
					Ant 1	Ant 2	Ant 1	Ant 2	SUM	Ant 1	Ant 2	Ant 1	Ant 2		
					11a	6Mbps	1	149	5745	2.22	2.22	7.04	7.82		
11a	6Mbps	1	157	5785	2.22	2.22	7.56	7.13		30.00	30.00	4.76	4.71	Pass	
11a	6Mbps	1	165	5825	2.22	2.22	7.23	7.26		30.00	30.00	4.76	4.71	Pass	
VHT20	MCS0	1	149	5745	2.22	2.22	7.18	7.38	-	30.00	30.00	4.76	4.71	Pass	
VHT20	MCS0	1	157	5785	2.22	2.22	7.68	7.52		30.00	30.00	4.76	4.71	Pass	
VHT20	MCS0	1	165	5825	2.22	2.22	6.88	7.64		30.00	30.00	4.76	4.71	Pass	
VHT40	MCS0	1	151	5755	2.22	2.22	3.44	3.49		30.00	30.00	4.76	4.71	Pass	
VHT40	MCS0	1	159	5795	2.22	2.22	3.26	2.96		30.00	30.00	4.76	4.71	Pass	
VHT80	MCS0	1	155	5775	2.22	2.22	1.20	1.79		30.00	30.00	4.76	4.71	Pass	
11a	6Mbps	2	149	5745	2.22		7.93	7.78		10.79	28.25		7.75		Pass
11a	6Mbps	2	157	5785	2.22		7.45	8.03		11.04	28.25		7.75		Pass
11a	6Mbps	2	165	5825	2.22		7.59	7.81		10.82	28.25		7.75		Pass
VHT20	MCS0	2	149	5745	2.22		7.50	7.96	10.97	28.25		7.75		Pass	
VHT20	MCS0	2	157	5785	2.22		8.33	7.69	10.70	28.25		7.75		Pass	
VHT20	MCS0	2	165	5825	2.22		8.29	7.62	10.63	28.25		7.75		Pass	
VHT40	MCS0	2	151	5755	2.22		4.09	4.52	7.53	28.25		7.75		Pass	
VHT40	MCS0	2	159	5795	2.22		4.01	4.21	7.22	28.25		7.75		Pass	
VHT80	MCS0	2	155	5775	2.22		2.09	2.09	10.05	28.25		7.75		Pass	

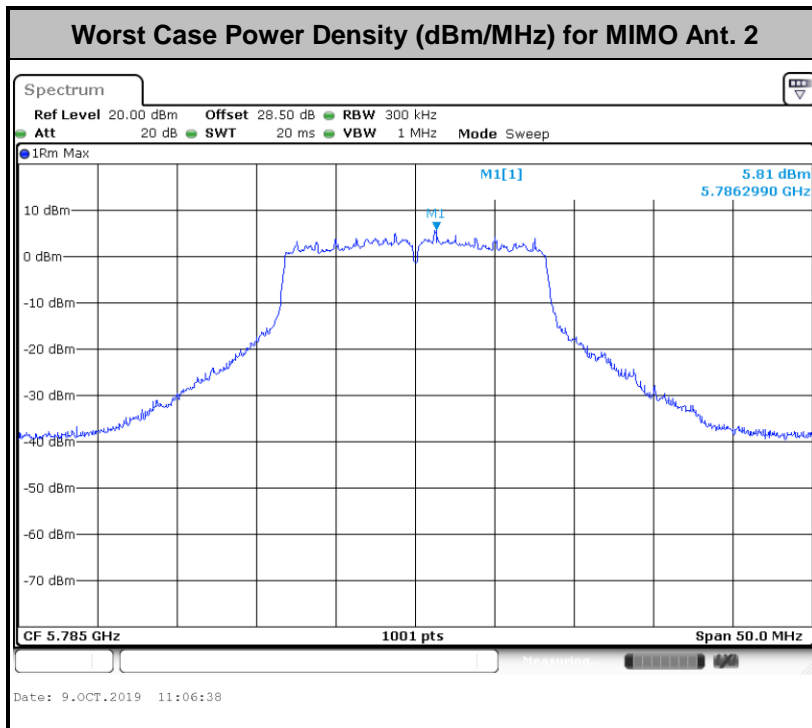
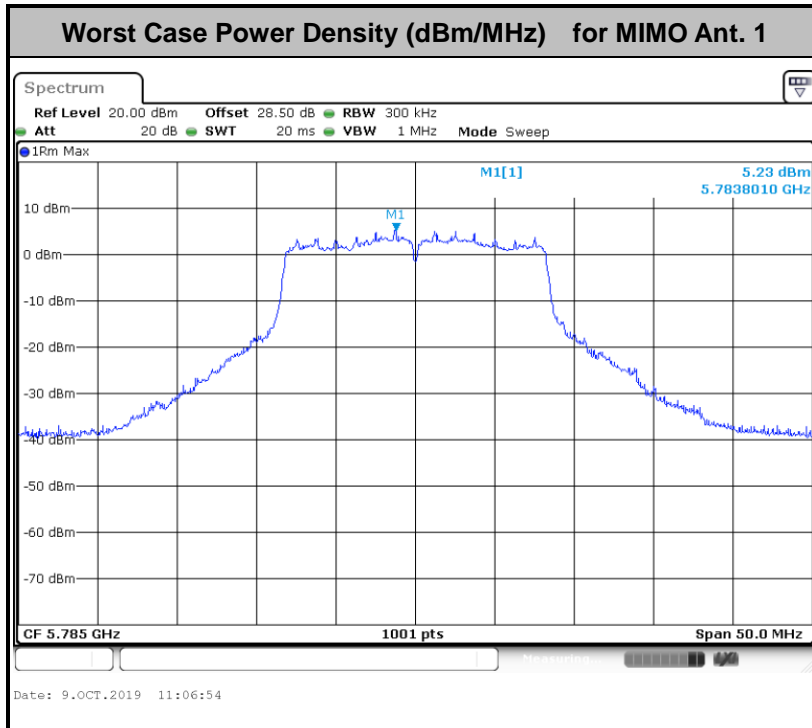



Test Engineer :	Kai Liao	Temperature :	21~25°C
		Relative Humidity :	51~54%

<TXBF Mode>

Band IV														
Mod.	Data Rate	NTX	CH.	Freq. (MHz)	10log (500kHz /RBW) Factor (dB)		Average Power Density (dBm/500kHz)			Average PSD Limit (dBm/500kHz)		DG (dBi)		Pass /Fail
					Ant 1	Ant 2	Ant 1	Ant 2	SUM	Ant 1	Ant 2	Ant 1	Ant 2	
VHT20	MCS0	2	149	5745	2.22	6.24	7.49	10.50	28.25	7.75	7.75	7.75	Pass	
VHT20	MCS0	2	157	5785	2.22	6.15	7.74	10.75	28.25	7.75	7.75	7.75	Pass	
VHT20	MCS0	2	165	5825	2.22	6.05	7.78	10.79	28.25	7.75	7.75	7.75	Pass	
VHT40	MCS0	2	151	5755	2.22	5.24	4.58	7.59	28.25	7.75	7.75	7.75	Pass	
VHT40	MCS0	2	159	5795	2.22	4.49	4.79	7.80	28.25	7.75	7.75	7.75	Pass	
VHT80	MCS6	2	155	5775	2.22	0.36	1.95	4.96	28.25	7.75	7.75	7.75	Pass	

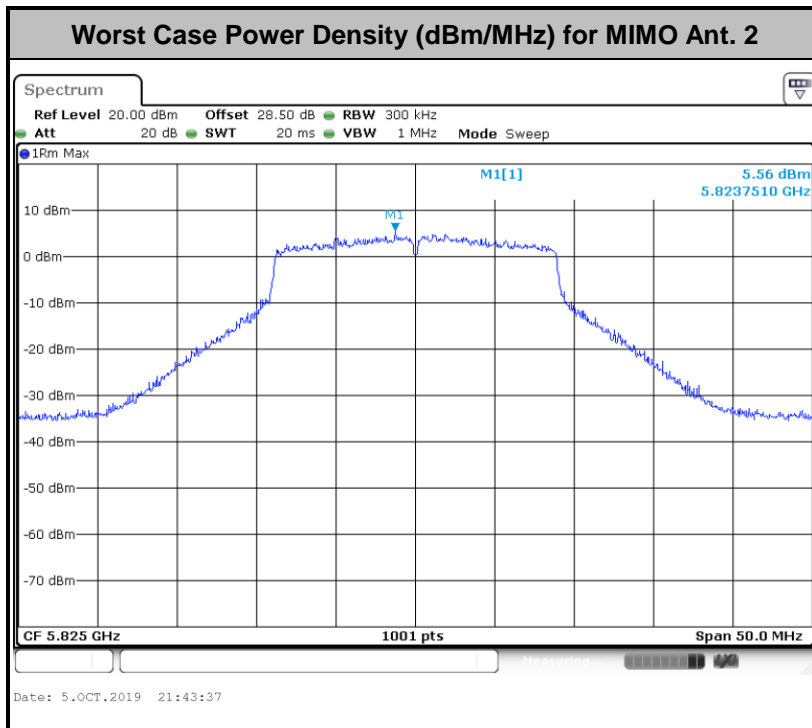
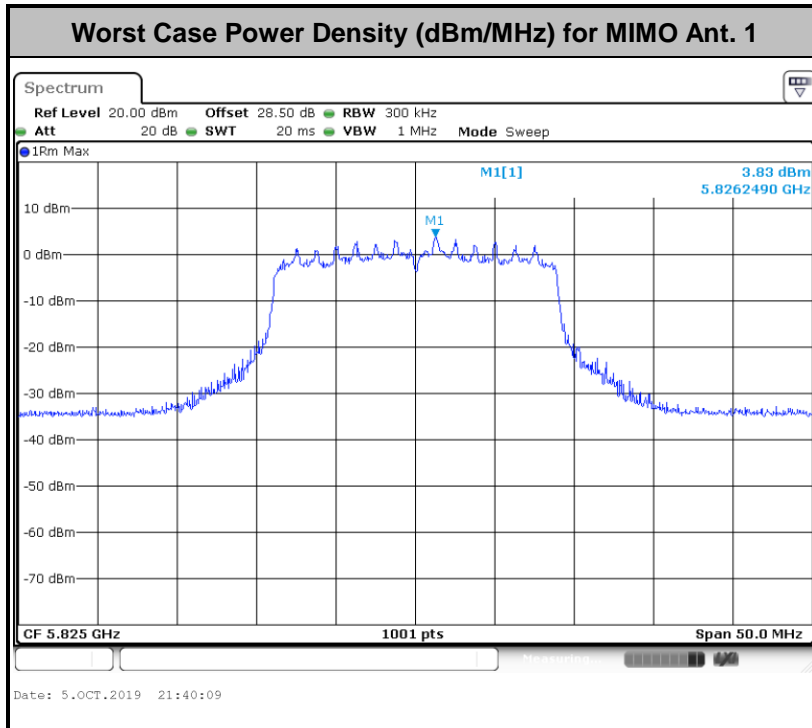



3.4 Unwanted Emissions Measurement

This section is to measure unwanted emissions through radiated measurement for band edge spurious emissions and out of band emissions measurement.

3.4.1 Limit of Unwanted Emissions

(1) For transmitters operating in the 5.725-5.85 GHz band:

15.407(b)(4)(i) All emissions shall be limited to a level of -27 dBm/MHz at 75 MHz or more above or below the band edge increasing linearly to 10 dBm/MHz at 25 MHz above or below the band edge, and from 25 MHz above or below the band edge increasing linearly to a level of 15.6 dBm/MHz at 5 MHz above or below the band edge, and from 5 MHz above or below the band edge increasing linearly to a level of 27 dBm/MHz at the band edge.

(2) Unwanted spurious emissions fallen in restricted bands shall comply with the general field strength limits as below table,

Frequency (MHz)	Field Strength (microvolts/meter)	Measurement Distance (meters)
0.009 – 0.490	2400/F(kHz)	300
0.490 – 1.705	24000/F(kHz)	30
1.705 – 30.0	30	30
30 – 88	100	3
88 – 216	150	3
216 - 960	200	3
Above 960	500	3

Note: The following formula is used to convert the EIRP to field strength.

$$E = \frac{1000000\sqrt{30P}}{3} \mu\text{V/m, where P is the eirp (Watts)}$$



EIRP (dBm)	Field Strength at 3m (dBμV/m)
- 27	68.3

(3) KDB789033 D02 v02r01 G)2)c)

- (i) Sections 15.407(b)(1-3) specifies the unwanted emissions limit for the U-NII-1 and U-NII-2 bands. As specified, emissions above 1000 MHz that are outside of the restricted bands are subject to a peak emission limit of -27 dBm/MHz.
- (ii) Section 15.407(b)(4) specifies the unwanted emissions limit for the U-NII-3 band. A band emissions mask is specified in Section 15.407(b)(4)(i). The emission limits are based on the use of a peak detector.

3.4.2 Measuring Instruments

See list of measuring equipment of this test report.

3.4.3 Test Procedures

1. The testing follows FCC KDB 789033 D02 General UNII Test Procedures New Rules v02r01. Section G) Unwanted emissions measurement.

(1) Procedure for Unwanted Emissions Measurements Below 1000MHz

- RBW = 120 kHz
- VBW = 300 kHz
- Detector = Peak
- Trace mode = max hold

(2) Procedure for Peak Unwanted Emissions Measurements Above 1000 MHz

- RBW = 1 MHz
- VBW ≥ 3 MHz
- Detector = Peak
- Sweep time = auto
- Trace mode = max hold

(3) Procedures for Average Unwanted Emissions Measurements Above 1000MHz

- RBW = 1 MHz
- VBW = 10 Hz, when duty cycle is no less than 98 percent.
- VBW ≥ 1/T, when duty cycle is less than 98 percent where T is the minimum transmission duration over which the transmitter is on and is transmitting at its maximum power control level for the tested mode of operation.



2. The EUT was placed on a turntable with 0.8 meter for frequency below 1GHz and 1.5 meter for frequency above 1GHz respectively above ground.
3. The EUT was set 3 meters from the interference receiving antenna which was mounted on the top of a variable height antenna tower.
4. The antenna is a broadband antenna and its height is adjusted between one meter and four meters above ground to find the maximum value of the field strength for both horizontal polarization and vertical polarization of the antenna.
5. For each suspected emission, the EUT was arranged to its worst case and then adjust the antenna tower (from 1 m to 4 m) and turntable (from 0 degree to 360 degrees) to find the maximum reading.
6. For testing below 1GHz, if the emission level of the EUT in peak mode was 3 dB lower than the limit specified, then peak values of EUT will be reported, otherwise, the emissions will be repeated one by one using the CISPR quasi-peak method and reported.
7. For testing above 1GHz, the emission level of the EUT in peak mode was 20dB lower than average limit (that means the emission level in average mode also complies with the limit in average mode), then peak values of EUT will be reported, otherwise, the emissions will be measured in average mode again and reported.

3.4.4 Test Setup

For radiated emissions below 30MHz

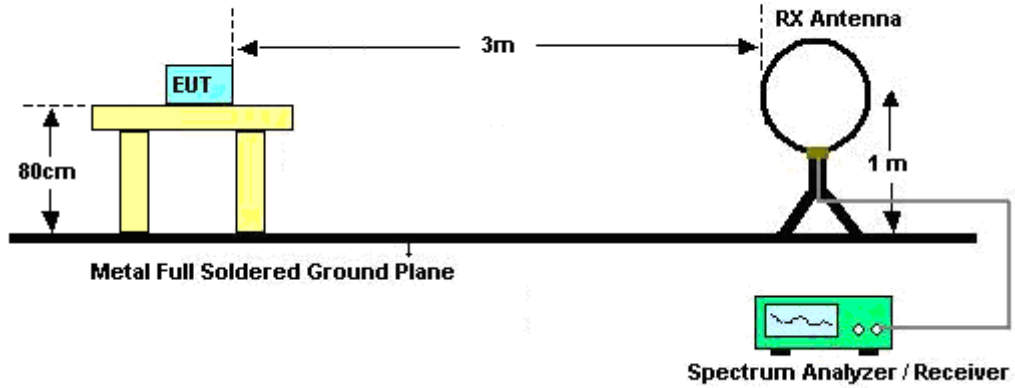

For radiated emissions from 30MHz to 1GHz

<CDD Mode>

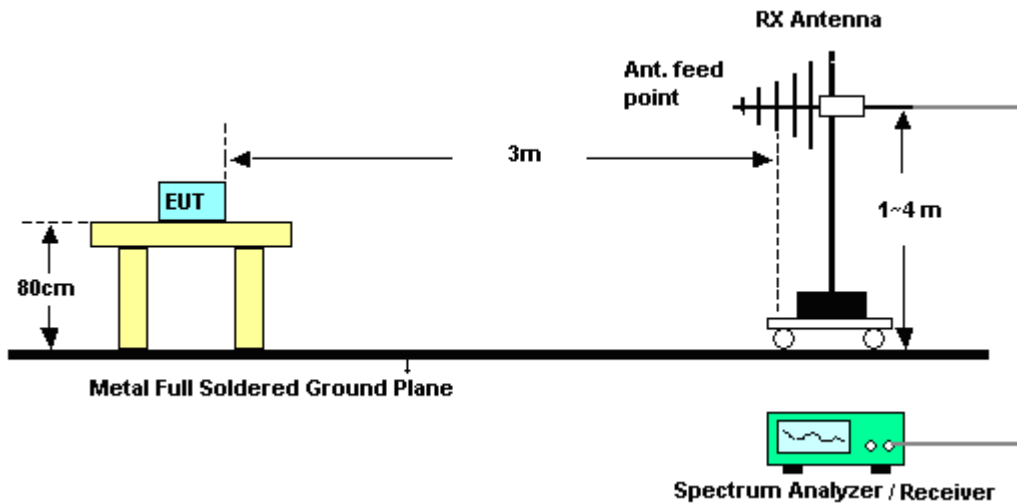

<TXBF Modes>

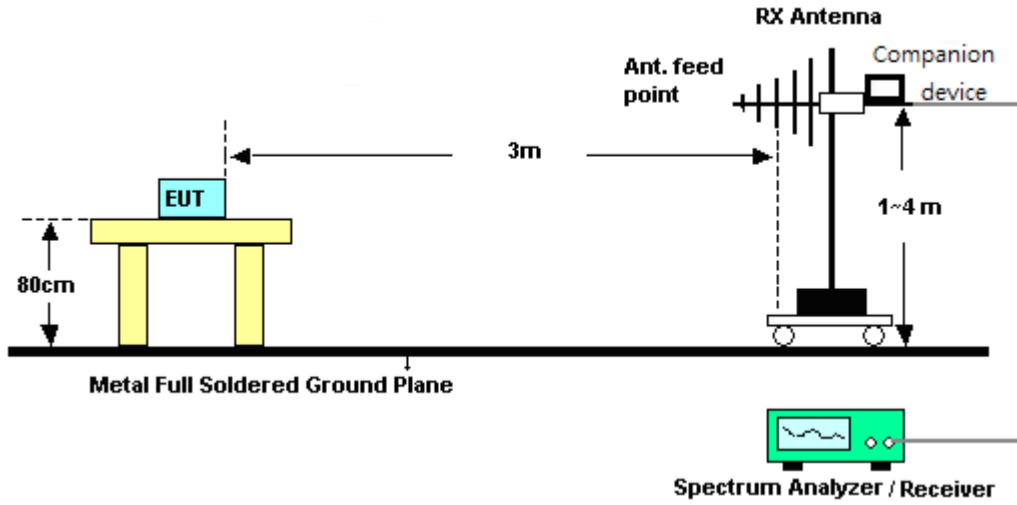

For radiated emissions above 1GHz

<CDD Mode>

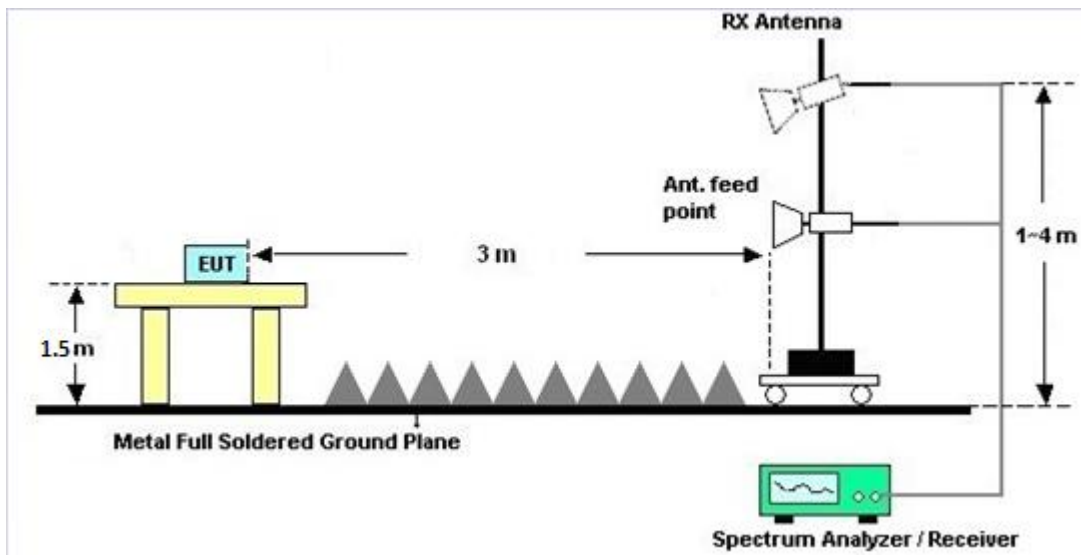

<TXBF Modes>

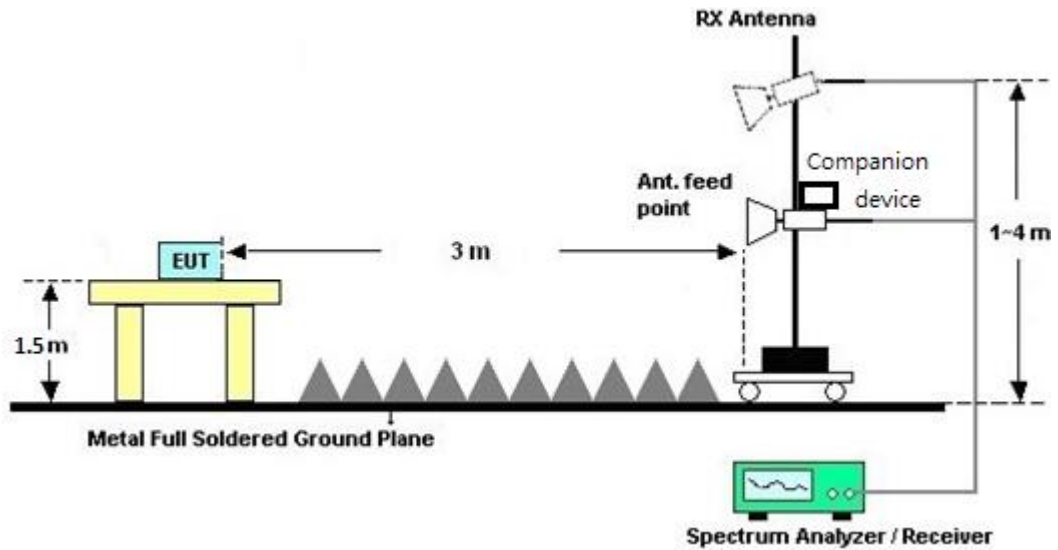

3.4.5 Test Results of Radiated Emissions (9 kHz ~ 30 MHz)

The low frequency, which started from 9 kHz to 30MHz, was pre-scanned and the result which was 20dB lower than the limit line was not reported.

There is a comparison data of both open-field test site and alternative test site - semi-Anechoic chamber according to 414788 D01 Radiated Test Site v01r01, and the result came out very similar.

3.4.6 Test Result of Radiated Band Edges

Please refer to Appendix B and C.

3.4.7 Duty Cycle

Please refer to Appendix D.

3.4.8 Test Result of Unwanted Radiated Emission (30MHz ~ 10th Harmonic)

Please refer to Appendix B and C.



3.5 AC Conducted Emission Measurement

3.5.1 Limit of AC Conducted Emission

For equipment that is designed to be connected to the public utility (AC) power line, the radio frequency voltage that is conducted back onto the AC power line on any frequency or frequencies within the band 150 kHz to 30 MHz shall not exceed the limits in the following table.

Frequency of emission (MHz)	Conducted limit (dB μ V)	
	Quasi-peak	Average
0.15-0.5	66 to 56*	56 to 46*
0.5-5	56	46
5-30	60	50

*Decreases with the logarithm of the frequency.

3.5.2 Measuring Instruments

See list of measuring equipment of this test report.

3.5.3 Test Procedures

1. The EUT was placed 0.4 meter from the conducting wall of the shielding room was kept at least 80 centimeters from any other grounded conducting surface.
2. Connect EUT to the power mains through a line impedance stabilization network (LISN).
3. All the support units are connecting to the other LISN.
4. The LISN provides 50 ohm coupling impedance for the measuring instrument.
5. The FCC states that a 50 ohm, 50 microhenry LISN should be used.
6. Both sides of AC line were checked for maximum conducted interference.
7. The frequency range from 150 kHz to 30 MHz was searched.
8. Set the test-receiver system to Peak Detect Function and specified bandwidth with Maximum Hold Mode.

3.5.4 Test Setup

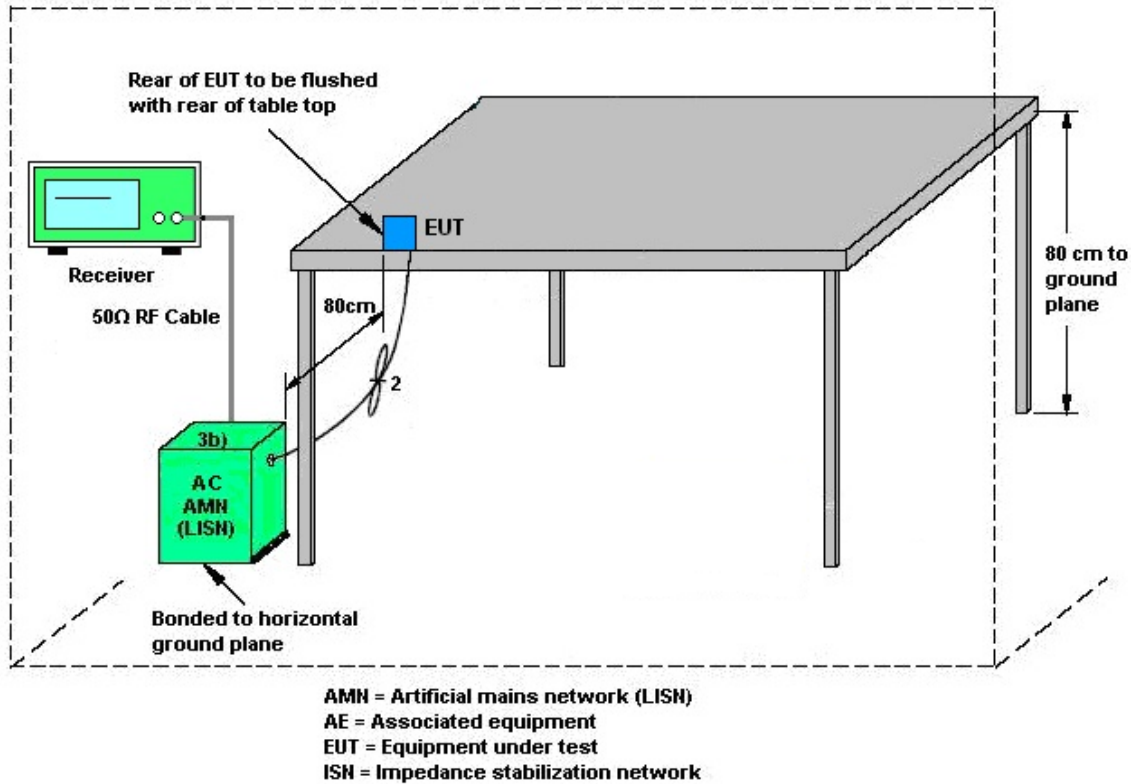

3.5.5 Test Result of AC Conducted Emission

Please refer to Appendix A.



3.6 Automatically Discontinue Transmission

3.6.1 Limit of Automatically Discontinue Transmission

The device shall automatically discontinue transmission in case of either absence of information to transmit or operational failure. These provisions are not intended to preclude the transmission of control or signaling information or the use of repetitive codes used by certain digital technologies to complete frame or burst intervals. Applicants shall include in their application for equipment authorization to describe how this requirement is met.

3.6.2 Measuring Instruments

See list of measuring equipment of this test report.

3.6.3 Test Result of Automatically Discontinue Transmission

While the EUT is not transmitting any information, the EUT can automatically discontinue transmission and become standby mode for power saving. The EUT can detect the controlling signal of ACK message transmitting from remote device and verify whether it shall resend or discontinue transmission.



3.7 Antenna Requirements

3.7.1 Standard Applicable

If transmitting antenna directional gain is greater than 6 dBi, both the peak transmit power and the peak power spectral density shall be reduced by the amount in dB that the directional gain of the antenna exceeds 6 dBi.

3.7.2 Antenna Anti-Replacement Construction

An embedded-in antenna design is used.

3.7.3 Antenna Gain

<CDD Modes >

FCC KDB 662911 D01 Multiple Transmitter Output v02r01

For CDD transmissions, directional gain is calculated as

Directional gain = GANT + Array Gain, where Array Gain is as follows.

For power spectral density (PSD) measurements on all devices,

Array Gain = 10 log(NANT/NSS=1) dB.

For power measurements on IEEE 802.11 devices,

Array Gain = 0 dB (i.e., no array gain) for NANT ≤ 4.

Directional gain may be calculated by using the formulas applicable to equal gain antennas with GANT set equal to the gain of the antenna having the highest gain;

The EUT supports CDD mode.

For power, the directional gain GANT is set equal to the antenna having the highest gain, i.e., F)2)f)i).

For PSD, the directional gain calculation is following F)2)f)ii) of KDB 662911 D01 v02r01.

The power and PSD limit should be modified if the directional gain of EUT is over 6 dBi,

The directional gain "DG" is calculated as following table.

<CDD Modes>						
			DG	DG	Power	PSD
	Ant. 1	Ant. 2	for	for	Limit	Limit
	(dBi)	(dBi)	Power	PSD	Reduction	Reduction
	(dBi)	(dBi)	(dBi)	(dBi)	(dB)	(dB)
Band IV	4.76	4.71	4.76	7.75	0.00	1.75

Power Limit Reduction = DG(Power) – 6dBi, (min = 0)

PSD Limit Reduction = DG(PSD) – 6dBi, (min = 0)

TXBF modes

FCC KDB 662911 D01 Multiple Transmitter Output v02r01

For CDD transmissions, directional gain is calculated as

$$DirectionalGain = 10 \cdot \log \left[\frac{\sum_{j=1}^{N_{SS}} \left\{ \sum_{k=1}^{N_{ANT}} g_{j,k} \right\}^2}{N_{ANT}} \right]$$

where

Each antenna is driven by no more than one spatial stream;

N_{SS} = the number of independent spatial streams of data;

N_{ANT} = the total number of antennas

$g_{j,k} = 10^{G_k / 20}$ if the k th antenna is being fed by spatial stream j , or zero if it is not;
 G_k is the gain in dBi of the k th antenna.

The EUT supports beamforming for 802.11ac modes.

The directional gain calculation is following F)2)e)ii) of KDB 662911 D01 v02r01.

The power and PSD limit should be modified if the directional gain of EUT is over 6 dBi,

The directional gain “DG” is calculated as following table.

			DG	DG	Power	PSD
			for	for	Limit	Limit
	Ant 1	Ant 2	Power	PSD	Reduction	Reduction
	(dBi)	(dBi)	(dBi)	(dBi)	(dB)	(dB)
Band IV	4.76	4.71	7.75	7.75	1.75	1.75

$Power\ Limit\ Reduction = DG(Power) - 6dBi, (min = 0)$

$PSD\ Limit\ Reduction = DG(PSD) - 6dBi, (min = 0)$



4 List of Measuring Equipment

Instrument	Manufacturer	Model No.	Serial No.	Characteristics	Calibration Date	Test Date	Due Date	Remark
AC Power Source	ChainTek	APC-1000W	N/A	N/A	N/A	Aug. 24, 2019	N/A	Conduction (CO05-HY)
EMI Test Receiver	Rohde & Schwarz	ESR3	102388	9kHz~3.6GHz	Nov. 12, 2018	Aug. 24, 2019	Nov. 11, 2019	Conduction (CO05-HY)
LISN	Rohde & Schwarz	ENV216	100080	9kHz~30MHz	Nov. 14, 2018	Aug. 24, 2019	Nov. 13, 2019	Conduction (CO05-HY)
LISN	Rohde & Schwarz	ENV216	100081	9kHz~30MHz	Nov. 09, 2018	Aug. 24, 2019	Nov. 08, 2019	Conduction (CO05-HY)
Software	Rohde & Schwarz	EMC32 V10.30	N/A	N/A	N/A	Aug. 24, 2019	N/A	Conduction (CO05-HY)
LF Cable	HUBER + SUHNER	RG-214/U	LF01	N/A	Dec. 31, 2018	Aug. 24, 2019	Dec. 30, 2019	Conduction (CO05-HY)
Pulse Limiter	Rohde & Schwarz	ESH3-Z2	100851	N/A	Dec. 31, 2018	Aug. 24, 2019	Dec. 30, 2019	Conduction (CO05-HY)
Loop Antenna	Rohde & Schwarz	HFH2-Z2	100488	9 kHz~30 MHz	Jan. 07, 2019	Sep. 07, 2019~ Oct. 14, 2019	Jan. 06, 2020	Radiation (03CH12-HY)
Bilog Antenna	TESEQ	CBL 6111D&00800 N1D01N-06	37059&01	30MHz~1GHz	Oct. 13, 2018	Sep. 07, 2019~ Oct. 11, 2019	Oct. 12, 2019	Radiation (03CH12-HY)
Bilog Antenna	TESEQ	CBL 6111D&00800 N1D01N-06	37059&01	30MHz~1GHz	Oct. 12, 2019	Oct. 12, 2019~ Oct. 14, 2019	Oct. 11, 2020	Radiation (03CH12-HY)
Horn Antenna	SCHWARZBECK	BBHA 9120D	9120D-132 8	1GHz ~ 18GHz	Nov. 09, 2018	Sep. 07, 2019~ Oct. 14, 2019	Nov. 08, 2019	Radiation (03CH12-HY)
SHF-EHF Horn Antenna	SCHWARZBECK	BBHA 9170	BBHA9170 584	18GHz ~ 40GHz	Dec. 05, 2018	Sep. 07, 2019~ Oct. 14, 2019	Dec. 04, 2019	Radiation (03CH12-HY)
Preamplifier	COM-POWER	PA-103	161075	10MHz~1GHz	Mar. 25, 2019	Sep. 07, 2019~ Oct. 14, 2019	Mar. 24, 2020	Radiation (03CH12-HY)
Preamplifier	Agilent	8449B	3008A0237 5	1GHz~26.5GHz	May 27, 2019	Sep. 07, 2019~ Oct. 14, 2019	May 26, 2020	Radiation (03CH12-HY)
Preamplifier	Jet-Power	JPA0118-55-3 03K	171000180 0054002	1GHz~18GHz	Aug. 06, 2019	Sep. 07, 2019~ Sep. 19, 2019	Aug. 05, 2020	Radiation (03CH12-HY)
Preamplifier	EMEC	EM18G40G	060715	18GHz ~ 40GHz	Dec. 06, 2018	Sep. 07, 2019~ Oct. 14, 2019	Dec. 05, 2019	Radiation (03CH12-HY)
Spectrum Analyzer	Keysight	N9010A	MY5537052 6	10Hz~44GHz	Mar. 19, 2019	Sep. 07, 2019~ Oct. 14, 2019	Mar. 18, 2020	Radiation (03CH12-HY)
Filter	Wainwright	WLKS1200-1 2SS	SN1	1.2 GHz Lowpass	Mar. 22, 2019	Sep. 07, 2019~ Sep. 19, 2019	Mar. 21, 2020	Radiation (03CH12-HY)
Filter	Wainwright	WHKX8-5872 .5-6750-1800 0-40SS	SN2	6.75GHz High Pass	Mar. 19, 2019	Sep. 07, 2019~ Oct. 14, 2019	Mar. 18, 2020	Radiation (03CH12-HY)
RF Cable	HUBER + SUHNER	SUCOFLEX 102	505134/2	30M~40GHz	Feb. 26, 2019	Sep. 07, 2019~ Oct. 14, 2019	Feb. 25, 2020	Radiation (03CH12-HY)
RF Cable	HUBER + SUHNER	SUCOFLEX 102	800740/2	30M~40GHz	Feb. 26, 2019	Sep. 07, 2019~ Oct. 14, 2019	Feb. 25, 2020	Radiation (03CH12-HY)
Antenna Mast	EMEC	AM-BS-4500- B	N/A	1m~4m	N/A	Sep. 07, 2019~ Oct. 14, 2019	N/A	Radiation (03CH12-HY)
Turn Table	EMEC	TT2000	N/A	0~360 Degree	N/A	Sep. 07, 2019~ Oct. 14, 2019	N/A	Radiation (03CH12-HY)
Software	Audix	E3 6.2009-8-24	RK-000989	N/A	N/A	Sep. 07, 2019~ Oct. 14, 2019	N/A	Radiation (03CH12-HY)



Instrument	Manufacturer	Model No.	Serial No.	Characteristics	Calibration Date	Test Date	Due Date	Remark
<For CDD Mode>								
Power Sensor	DARE	RPR3006W	13I00030S NO32	9kHz~6GHz	Dec. 03, 2018	Aug. 16, 2019~ Nov. 08, 2019	Dec. 02, 2019	Conducted (TH05-HY)
Programmable Power Supply	GW Instek	PSS-2005	EL883644	Voltage:0~20V; Current:0~5A	Oct. 16, 2018	Aug. 16, 2019~ Nov. 08, 2019	Oct. 15, 2020	Conducted (TH05-HY)
Spectrum Analyzer	Rohde & Schwarz	FSV40	101397	10Hz~40GHz	Nov. 13, 2018	Aug. 16, 2019~ Nov. 08, 2019	Nov. 12, 2019	Conducted (TH05-HY)
Switch Box & RF Cable	Burgeon	ETF-058	EC1208382	N/A	Mar. 27, 2019	Aug. 16, 2019~ Nov. 08, 2019	Mar. 26, 2020	Conducted (TH05-HY)
<For TXBF Mode>								
Power Sensor	DARE	RPR3006W	13I00030S NO32	9kHz~6GHz	Dec. 03, 2018	Aug. 16, 2019~ Nov. 08, 2019	Dec. 02, 2019	Conducted (TH05-HY)
Programmable Power Supply	GW Instek	PSS-2005	EL883644	Voltage:0~20V; Current:0~5A	Oct. 16, 2018	Aug. 16, 2019~ Nov. 08, 2019	Oct. 15, 2020	Conducted (TH05-HY)
Spectrum Analyzer	Rohde & Schwarz	FSV40	101397	10Hz~40GHz	Nov. 13, 2018	Aug. 16, 2019~ Nov. 08, 2019	Nov. 12, 2019	Conducted (TH05-HY)
Switch Box & RF Cable	Burgeon	ETF-058	EC1208382	N/A	Mar. 27, 2019	Aug. 16, 2019~ Nov. 08, 2019	Mar. 26, 2020	Conducted (TH05-HY)



5 Uncertainty of Evaluation

Uncertainty of Conducted Emission Measurement (150kHz ~ 30MHz)

Measuring Uncertainty for a Level of Confidence of 95% ($U = 2Uc(y)$)	2.2
---	-----

Uncertainty of Radiated Emission Measurement (30 MHz ~ 1000 MHz)

Measuring Uncertainty for a Level of Confidence of 95% ($U = 2Uc(y)$)	5.1
---	-----

Uncertainty of Radiated Emission Measurement (1000 MHz ~ 18000 MHz)

Measuring Uncertainty for a Level of Confidence of 95% ($U = 2Uc(y)$)	5.2
---	-----

Uncertainty of Radiated Emission Measurement (18000 MHz ~ 40000 MHz)

Measuring Uncertainty for a Level of Confidence of 95% ($U = 2Uc(y)$)	4.7
---	-----



Appendix A. AC Conducted Emission Test Results

Test Engineer :	Louis Chung	Temperature :	25.2~26.2°C
		Relative Humidity :	47.4~58.2%
Test Voltage :	120Vac / 60Hz	Phase :	Line

Full Spectrum

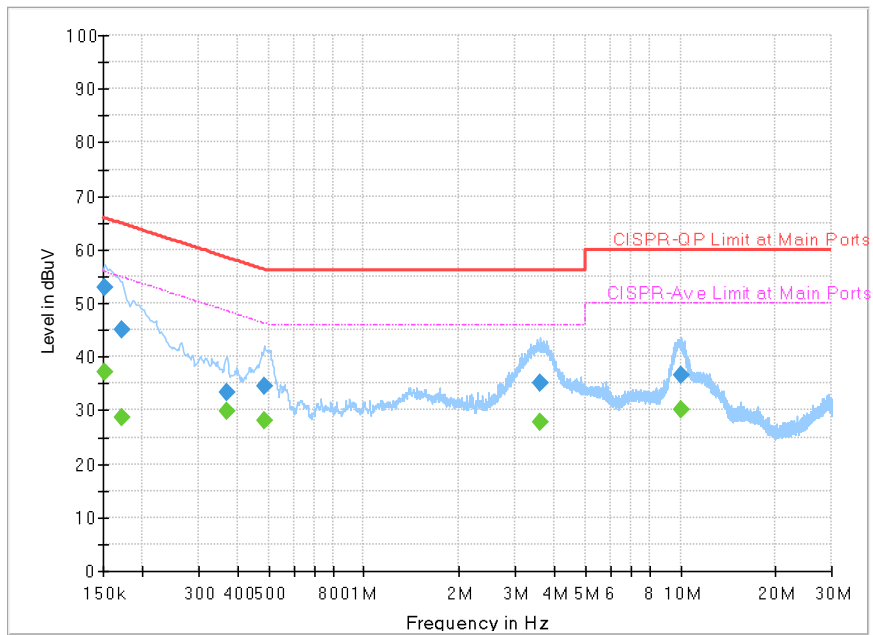

Final Result

Frequency (MHz)	QuasiPeak (dBuV)	CAverage (dBuV)	Limit (dBuV)	Margin (dB)	Line	Filter	Corr. (dB)
0.152250	---	36.99	55.88	18.89	L1	OFF	19.4
0.152250	52.85	---	65.88	13.03	L1	OFF	19.4
0.172500	---	28.51	54.84	26.33	L1	OFF	19.4
0.172500	45.16	---	64.84	19.68	L1	OFF	19.4
0.368250	---	29.79	48.54	18.75	L1	OFF	19.4
0.368250	33.44	---	58.54	25.10	L1	OFF	19.4
0.483000	---	28.11	46.29	18.18	L1	OFF	19.4
0.483000	34.62	---	56.29	21.67	L1	OFF	19.4
3.603750	---	27.71	46.00	18.29	L1	OFF	19.5
3.603750	35.23	---	56.00	20.77	L1	OFF	19.5
10.000500	---	30.17	50.00	19.83	L1	OFF	19.6
10.000500	36.42	---	60.00	23.58	L1	OFF	19.6



Test Engineer :	Louis Chung	Temperature :	25.2~26.2°C
		Relative Humidity :	47.4~58.2%
Test Voltage :	120Vac / 60Hz	Phase :	Neutral

Full Spectrum

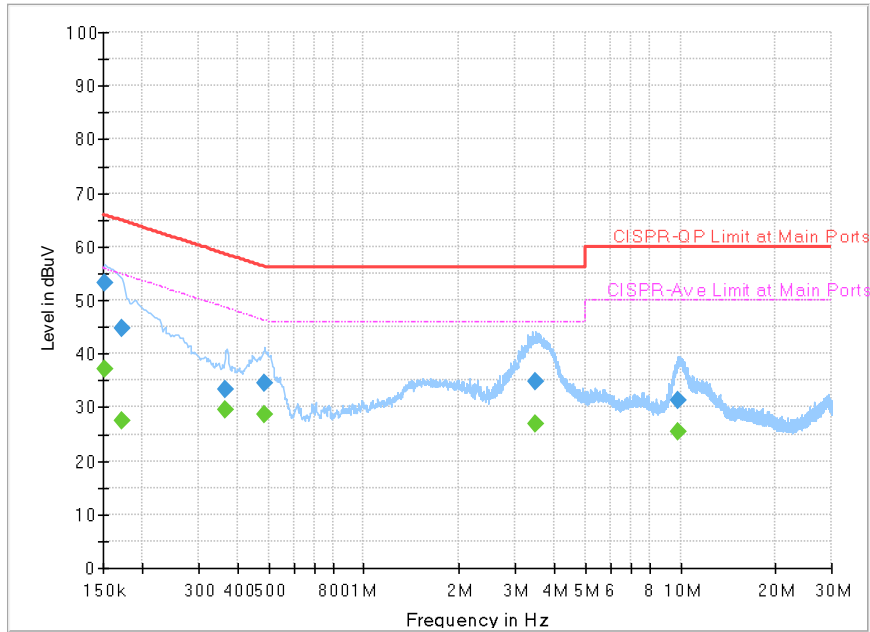

Final_Result

Frequency (MHz)	QuasiPeak (dBuV)	CAverage (dBuV)	Limit (dBuV)	Margin (dB)	Line	Filter	Corr. (dB)
0.152250	---	37.06	55.88	18.82	N	OFF	19.4
0.152250	53.22	---	65.88	12.66	N	OFF	19.4
0.172500	---	27.47	54.84	27.37	N	OFF	19.4
0.172500	44.63	---	64.84	20.21	N	OFF	19.4
0.366000	---	29.52	48.59	19.07	N	OFF	19.4
0.366000	33.29	---	58.59	25.30	N	OFF	19.4
0.485250	---	28.54	46.25	17.71	N	OFF	19.5
0.485250	34.56	---	56.25	21.69	N	OFF	19.5
3.475500	---	26.95	46.00	19.05	N	OFF	19.5
3.475500	34.76	---	56.00	21.24	N	OFF	19.5
9.858750	---	25.47	50.00	24.53	N	OFF	19.7
9.858750	31.15	---	60.00	28.85	N	OFF	19.7



Appendix B. Radiated Spurious Emission

Test Engineer :	Jack Cheng , Lance Chiang , CR Liao	Temperature :	23.1~26.4°C
		Relative Humidity :	51.8~60.9%

<CDD Mode>

Band 4 - 5725~5850MHz
WIFI 802.11a (Band Edge @ 3m)

WIFI Ant. 1	Note	Frequency (MHz)	Level (dBμV/m)	Over Limit (dB)	Limit Line (dBμV/m)	Read Level (dBμV)	Antenna Factor (dB/m)	Path Loss (dB)	Preamp Factor (dB)	Ant Pos (cm)	Table Pos (deg)	Peak Avg. (P/A)	Pol. (H/V)	
802.11a CH 149 5745MHz		5636.4	52.35	-15.85	68.2	43.62	31.73	10.45	33.45	100	236	P	H	
		5689.2	54.8	-42.44	97.24	45.84	31.94	10.48	33.46	100	236	P	H	
		5718	56.79	-53.45	110.24	47.72	32.04	10.49	33.46	100	236	P	H	
		5725	61.55	-60.65	122.2	52.46	32.05	10.5	33.46	100	236	P	H	
	*	5745	113	-	-	103.86	32.09	10.51	33.46	100	236	P	H	
	*	5745	105.55	-	-	96.41	32.09	10.51	33.46	100	236	A	H	
														H
														H
			5610	51.12	-17.08	68.2	42.35	31.78	10.44	33.45	109	296	P	V
			5660	52.4	-23.23	75.63	43.63	31.76	10.46	33.45	109	296	P	V
			5712.6	53.15	-55.58	108.73	44.09	32.03	10.49	33.46	109	296	P	V
			5725	55.67	-66.53	122.2	46.58	32.05	10.5	33.46	109	296	P	V
	*		5745	107.77	-	-	98.63	32.09	10.51	33.46	109	296	P	V
	*		5745	100.34	-	-	91.2	32.09	10.51	33.46	109	296	A	V
														V
													V	



WIFI Ant. 1	Note	Frequency (MHz)	Level (dBμV/m)	Over Limit (dB)	Limit Line (dBμV/m)	Read Level (dBμV)	Antenna Factor (dB/m)	Path Loss (dB)	Preamp Factor (dB)	Ant Pos (cm)	Table Pos (deg)	Peak Avg. (P/A)	Pol. (H/V)
		5602.6	51.99	-16.21	68.2	43.21	31.79	10.43	33.44	100	236	P	H
		5682.2	52.83	-39.24	92.07	43.92	31.89	10.48	33.46	100	236	P	H
		5717.4	53.85	-56.22	110.07	44.79	32.03	10.49	33.46	100	236	P	H
		5722.4	53.94	-62.33	116.27	44.86	32.04	10.5	33.46	100	236	P	H
	*	5785	111.83	-	-	102.6	32.17	10.53	33.47	100	236	P	H
	*	5785	104.46	-	-	95.23	32.17	10.53	33.47	100	236	A	H
		5850	54.04	-68.16	122.2	44.63	32.3	10.59	33.48	100	236	P	H
		5860.4	55.64	-53.65	109.29	46.21	32.32	10.59	33.48	100	236	P	H
		5913.2	52.78	-24.12	76.9	43.18	32.45	10.64	33.49	100	236	P	H
		5935.6	53.09	-15.11	68.2	43.38	32.54	10.66	33.49	100	236	P	H
													H
													H
802.11a													
CH 157													
5785MHz		5632.6	50.67	-17.53	68.2	41.94	31.73	10.45	33.45	100	244	P	V
		5698.2	50.27	-53.6	103.87	41.26	31.99	10.48	33.46	100	244	P	V
		5711.6	51.81	-56.64	108.45	42.76	32.02	10.49	33.46	100	244	P	V
		5723	49.89	-67.75	117.64	40.8	32.05	10.5	33.46	100	244	P	V
	*	5785	105.52	-	-	96.29	32.17	10.53	33.47	100	244	P	V
	*	5785	97.98	-	-	88.75	32.17	10.53	33.47	100	244	A	V
		5854.6	51.93	-59.78	111.71	42.51	32.31	10.59	33.48	100	244	P	V
		5860.2	51.91	-57.43	109.34	42.48	32.32	10.59	33.48	100	244	P	V
		5908	51.58	-29.16	80.74	42	32.43	10.64	33.49	100	244	P	V
		5927.4	51.94	-16.26	68.2	42.27	32.51	10.65	33.49	100	244	P	V
													V
													V



WIFI Ant. 1	Note	Frequency (MHz)	Level (dBμV/m)	Over Limit (dB)	Limit Line (dBμV/m)	Read Level (dBμV)	Antenna Factor (dB/m)	Path Loss (dB)	Preamp Factor (dB)	Ant Pos (cm)	Table Pos (deg)	Peak Avg. (P/A)	Pol. (H/V)	
802.11a CH 165 5825MHz	*	5825	110.78	-	-	101.45	32.25	10.56	33.48	100	236	P	H	
	*	5825	103.15	-	-	93.82	32.25	10.56	33.48	100	236	A	H	
		5852.8	53.36	-62.46	115.82	43.94	32.31	10.59	33.48	100	236	P	H	
		5855	54.57	-56.23	110.8	45.15	32.31	10.59	33.48	100	236	P	H	
		5884.2	53.56	-44.81	98.37	44.05	32.37	10.62	33.48	100	236	P	H	
		5925	51.77	-16.43	68.2	42.11	32.5	10.65	33.49	100	236	P	H	
														H
														H
	*	5825	106.32	-	-	96.99	32.25	10.56	33.48	108	214	P	V	
	*	5825	98.88	-	-	89.55	32.25	10.56	33.48	108	214	A	V	
		5850	51.99	-70.21	122.2	42.58	32.3	10.59	33.48	108	214	P	V	
		5857.8	52.84	-57.17	110.01	43.41	32.32	10.59	33.48	108	214	P	V	
		5876.2	51.79	-52.52	104.31	42.31	32.35	10.61	33.48	108	214	P	V	
		5946.4	52.25	-15.95	68.2	42.48	32.59	10.67	33.49	108	214	P	V	
														V
														V
													V	
Remark	1. No other spurious found. 2. All results are PASS against Peak and Average limit line.													



Band 4 5725~5850MHz
WIFI 802.11a (Harmonic @ 3m)

WIFI Ant. 1	Note	Frequency (MHz)	Level (dBμV/m)	Over Limit (dB)	Limit Line (dBμV/m)	Read Level (dBμV)	Antenna Factor (dB/m)	Path Loss (dB)	Preamp Factor (dB)	Ant Pos (cm)	Table Pos (deg)	Peak Avg. (P/A)	Pol. (H/V)	
802.11a CH 149 5745MHz		11490	47.18	-26.82	74	47.9	39.78	15.8	56.3	100	0	P	H	
		17235	48.03	-20.17	68.2	43.94	40.7	19.96	56.57	100	0	P	H	
													H	
													H	
			11490	47.14	-26.86	74	47.86	39.78	15.8	56.3	100	0	P	V
			17235	48.51	-19.69	68.2	44.42	40.7	19.96	56.57	100	0	P	V
														V
802.11a CH 157 5785MHz		11570	46.89	-27.11	74	47.67	39.66	15.86	56.3	100	0	P	H	
		17355	48.29	-19.91	68.2	43.58	41.4	20.12	56.81	100	0	P	H	
													H	
													H	
			11570	46.45	-27.55	74	47.23	39.66	15.86	56.3	100	0	P	V
			17355	48.91	-19.29	68.2	44.2	41.4	20.12	56.81	100	0	P	V
														V
802.11a CH 165 5825MHz		11650	46.56	-27.44	74	47.58	39.35	15.93	56.3	100	0	P	H	
		17475	50.02	-18.18	68.2	44.62	42.17	20.28	57.05	100	0	P	H	
													H	
													H	
			11650	45.78	-28.22	74	46.8	39.35	15.93	56.3	100	0	P	V
			17475	50.16	-18.04	68.2	44.76	42.17	20.28	57.05	100	0	P	V
														V
Remark	1. No other spurious found.													
	2. All results are PASS against Peak and Average limit line.													



Band 4 5725~5850MHz
WIFI 802.11ac VHT20 (Band Edge @ 3m)

WIFI Ant. 1	Note	Frequency (MHz)	Level (dBμV/m)	Over Limit (dB)	Limit Line (dBμV/m)	Read Level (dBμV)	Antenna Factor (dB/m)	Path Loss (dB)	Preamp Factor (dB)	Ant Pos (cm)	Table Pos (deg)	Peak Avg. (P/A)	Pol. (H/V)	
802.11ac VHT20 CH 149 5745MHz		5629.6	52.33	-15.87	68.2	43.59	31.74	10.45	33.45	100	235	P	H	
		5698.6	55.47	-48.7	104.17	46.46	31.99	10.48	33.46	100	235	P	H	
		5720	58.3	-52.5	110.8	49.22	32.04	10.5	33.46	100	235	P	H	
		5725	63.14	-59.06	122.2	54.05	32.05	10.5	33.46	100	235	P	H	
	*	5745	112.42	-	-	103.28	32.09	10.51	33.46	100	235	P	H	
	*	5745	104.93	-	-	95.79	32.09	10.51	33.46	100	235	A	H	
														H
														H
			5647.8	51.22	-16.98	68.2	42.51	31.7	10.46	33.45	102	289	P	V
			5687.4	52.53	-43.38	95.91	43.59	31.92	10.48	33.46	102	289	P	V
			5717.4	55.67	-54.4	110.07	46.61	32.03	10.49	33.46	102	289	P	V
			5724.8	56.37	-65.37	121.74	47.28	32.05	10.5	33.46	102	289	P	V
	*		5745	107.28	-	-	98.14	32.09	10.51	33.46	102	289	P	V
	*		5745	99.81	-	-	90.67	32.09	10.51	33.46	102	289	A	V
													V	
													V	



WIFI Ant. 1	Note	Frequency (MHz)	Level (dBμV/m)	Over Limit (dB)	Limit Line (dBμV/m)	Read Level (dBμV)	Antenna Factor (dB/m)	Path Loss (dB)	Preamp Factor (dB)	Ant Pos (cm)	Table Pos (deg)	Peak Avg. (P/A)	Pol. (H/V)
		5632.6	51.47	-16.73	68.2	42.74	31.73	10.45	33.45	100	233	P	H
		5689.2	52.85	-44.39	97.24	43.89	31.94	10.48	33.46	100	233	P	H
		5716	53.51	-56.17	109.68	44.45	32.03	10.49	33.46	100	233	P	H
		5722.2	54.49	-61.33	115.82	45.41	32.04	10.5	33.46	100	233	P	H
	*	5785	111.14	-	-	101.91	32.17	10.53	33.47	100	233	P	H
	*	5785	103.96	-	-	94.73	32.17	10.53	33.47	100	233	A	H
		5850	55.49	-66.71	122.2	46.08	32.3	10.59	33.48	100	233	P	H
		5857.4	54.93	-55.2	110.13	45.51	32.31	10.59	33.48	100	233	P	H
		5879.6	53.92	-47.86	101.78	44.43	32.36	10.61	33.48	100	233	P	H
		5935.2	53.28	-14.92	68.2	43.57	32.54	10.66	33.49	100	233	P	H
802.11ac													H
VHT20													H
CH 157		5606.4	50.38	-17.82	68.2	41.6	31.79	10.43	33.44	109	289	P	V
5785MHz		5661.2	52.06	-24.46	76.52	43.28	31.77	10.46	33.45	109	289	P	V
		5708.4	52.79	-54.76	107.55	43.74	32.02	10.49	33.46	109	289	P	V
		5721.2	51.64	-61.9	113.54	42.56	32.04	10.5	33.46	109	289	P	V
	*	5785	105.83	-	-	96.6	32.17	10.53	33.47	109	289	P	V
	*	5785	98.18	-	-	88.95	32.17	10.53	33.47	109	289	A	V
		5852.4	51.53	-65.2	116.73	42.12	32.3	10.59	33.48	109	289	P	V
		5859.4	52.71	-56.86	109.57	43.28	32.32	10.59	33.48	109	289	P	V
		5907.2	52.69	-28.65	81.34	43.11	32.43	10.64	33.49	109	289	P	V
		5929	51.37	-16.83	68.2	41.68	32.52	10.66	33.49	109	289	P	V
													V
													V



WIFI Ant. 1	Note	Frequency (MHz)	Level (dBμV/m)	Over Limit (dB)	Limit Line (dBμV/m)	Read Level (dBμV)	Antenna Factor (dB/m)	Path Loss (dB)	Preamp Factor (dB)	Ant Pos (cm)	Table Pos (deg)	Peak Avg. (P/A)	Pol. (H/V)	
802.11ac VHT20 CH 165 5825MHz	*	5825	110.42	-	-	101.09	32.25	10.56	33.48	103	233	P	H	
	*	5825	102.73	-	-	93.4	32.25	10.56	33.48	103	233	A	H	
		5850.8	56.71	-63.67	120.38	47.3	32.3	10.59	33.48	103	233	P	H	
		5856.2	56.03	-54.43	110.46	46.61	32.31	10.59	33.48	103	233	P	H	
		5880.4	54.74	-46.45	101.19	45.25	32.36	10.61	33.48	103	233	P	H	
		5931.6	52.09	-16.11	68.2	42.39	32.53	10.66	33.49	103	233	P	H	
														H
														H
	*	5825	105.26	-	-	95.93	32.25	10.56	33.48	100	296	296	P	V
	*	5825	97.86	-	-	88.53	32.25	10.56	33.48	100	296	296	A	V
		5850.6	53.79	-67.04	120.83	44.38	32.3	10.59	33.48	100	296	296	P	V
		5856	53.26	-57.26	110.52	43.84	32.31	10.59	33.48	100	296	296	P	V
		5892	53.24	-39.34	92.58	43.72	32.38	10.62	33.48	100	296	296	P	V
		5947.8	52.3	-15.9	68.2	42.53	32.59	10.67	33.49	100	296	296	P	V
														V
														V
Remark	1. No other spurious found. 2. All results are PASS against Peak and Average limit line.													



Band 4 5725~5850MHz
WIFI 802.11ac VHT20 (Harmonic @ 3m)

WIFI Ant. 1	Note	Frequency (MHz)	Level (dBμV/m)	Over Limit (dB)	Limit Line (dBμV/m)	Read Level (dBμV)	Antenna Factor (dB/m)	Path Loss (dB)	Preamp Factor (dB)	Ant Pos (cm)	Table Pos (deg)	Peak Avg. (P/A)	Pol. (H/V)	
802.11ac VHT20 CH 149 5745MHz		11490	46.38	-27.62	74	47.1	39.78	15.8	56.3	100	0	P	H	
		17235	48.32	-19.88	68.2	44.23	40.7	19.96	56.57	100	0	P	H	
													H	
													H	
			11490	46.84	-27.16	74	47.56	39.78	15.8	56.3	100	0	P	V
			17235	47.88	-20.32	68.2	43.79	40.7	19.96	56.57	100	0	P	V
														V
802.11ac VHT20 CH 157 5785MHz		11570	47.84	-26.16	74	48.62	39.66	15.86	56.3	100	0	P	H	
		17355	49.2	-19	68.2	44.49	41.4	20.12	56.81	100	0	P	H	
													H	
													H	
			11570	47.84	-26.16	74	48.62	39.66	15.86	56.3	100	0	P	V
			17355	48.56	-19.64	68.2	43.85	41.4	20.12	56.81	100	0	P	V
														V
802.11ac VHT20 CH 165 5825MHz		11650	46.48	-27.52	74	47.5	39.35	15.93	56.3	100	0	P	H	
		17475	50.37	-17.83	68.2	44.97	42.17	20.28	57.05	100	0	P	H	
													H	
													H	
			11650	45.29	-28.71	74	46.31	39.35	15.93	56.3	100	0	P	V
			17475	50.37	-17.83	68.2	44.97	42.17	20.28	57.05	100	0	P	V
														V
Remark	1. No other spurious found.													
	2. All results are PASS against Peak and Average limit line.													



Band 4 5725~5850MHz
WIFI 802.11ac VHT40 (Band Edge @ 3m)

WIFI Ant. 1	Note	Frequency (MHz)	Level (dBμV/m)	Over Limit (dB)	Limit Line (dBμV/m)	Read Level (dBμV)	Antenna Factor (dB/m)	Path Loss (dB)	Preamp Factor (dB)	Ant Pos (cm)	Table Pos (deg)	Peak Avg. (P/A)	Pol. (H/V)
		5600	51.63	-16.57	68.2	42.84	31.8	10.43	33.44	104	235	P	H
		5694.8	57.18	-44.19	101.37	48.19	31.97	10.48	33.46	104	235	P	H
		5713.6	65.87	-43.14	109.01	56.81	32.03	10.49	33.46	104	235	P	H
		5722.6	68.89	-47.84	116.73	59.8	32.05	10.5	33.46	104	235	P	H
	*	5755	110.57	-	-	101.41	32.11	10.52	33.47	104	235	P	H
	*	5755	102.53	-	-	93.37	32.11	10.52	33.47	104	235	A	H
		5852.8	53.88	-61.94	115.82	44.46	32.31	10.59	33.48	104	235	P	H
		5863.4	52.48	-55.97	108.45	43.03	32.33	10.6	33.48	104	235	P	H
		5881	52.07	-48.67	100.74	42.58	32.36	10.61	33.48	104	235	P	H
		5943.6	51.91	-16.29	68.2	42.16	32.57	10.67	33.49	104	235	P	H
													H
													H
802.11ac													
VHT40													
CH 151		5650	51.58	-16.62	68.2	42.87	31.7	10.46	33.45	100	292	P	V
5755MHz		5699.8	54.49	-50.56	105.05	45.47	32	10.48	33.46	100	292	P	V
		5719	62.66	-47.86	110.52	53.58	32.04	10.5	33.46	100	292	P	V
		5724.8	62.63	-59.11	121.74	53.54	32.05	10.5	33.46	100	292	P	V
	*	5755	105.56	-	-	96.4	32.11	10.52	33.47	100	292	P	V
	*	5755	97.83	-	-	88.67	32.11	10.52	33.47	100	292	A	V
		5853.6	52.78	-61.21	113.99	43.36	32.31	10.59	33.48	100	292	P	V
		5857.6	52.29	-57.78	110.07	42.86	32.32	10.59	33.48	100	292	P	V
		5917.4	52.46	-21.34	73.8	42.83	32.47	10.65	33.49	100	292	P	V
		5935.4	53.47	-14.73	68.2	43.76	32.54	10.66	33.49	100	292	P	V
													V
													V



WIFI Ant. 1	Note	Frequency (MHz)	Level (dBμV/m)	Over Limit (dB)	Limit Line (dBμV/m)	Read Level (dBμV)	Antenna Factor (dB/m)	Path Loss (dB)	Preamp Factor (dB)	Ant Pos (cm)	Table Pos (deg)	Peak Avg. (P/A)	Pol. (H/V)
		5605.8	51.32	-16.88	68.2	42.54	31.79	10.43	33.44	101	232	P	H
		5698	52.56	-51.17	103.73	43.55	31.99	10.48	33.46	101	232	P	H
		5716.4	53.97	-55.82	109.79	44.91	32.03	10.49	33.46	101	232	P	H
		5723.6	54.55	-64.46	119.01	45.46	32.05	10.5	33.46	101	232	P	H
	*	5795	109.24	-	-	99.98	32.19	10.54	33.47	101	232	P	H
	*	5795	101.51	-	-	92.25	32.19	10.54	33.47	101	232	A	H
		5850	57.07	-65.13	122.2	47.66	32.3	10.59	33.48	101	232	P	H
		5858.6	58.11	-51.68	109.79	48.68	32.32	10.59	33.48	101	232	P	H
		5876	55.14	-49.32	104.46	45.66	32.35	10.61	33.48	101	232	P	H
		5944.6	53.43	-14.77	68.2	43.67	32.58	10.67	33.49	101	232	P	H
802.11ac													H
VHT40													H
CH 159		5632.6	50.71	-17.49	68.2	41.98	31.73	10.45	33.45	106	292	P	V
5795MHz		5673.2	52.61	-32.8	85.41	43.75	31.84	10.47	33.45	106	292	P	V
		5717.4	52.09	-57.98	110.07	43.03	32.03	10.49	33.46	106	292	P	V
		5721.6	53.21	-61.24	114.45	44.13	32.04	10.5	33.46	106	292	P	V
	*	5795	105.21	-	-	95.95	32.19	10.54	33.47	106	292	P	V
	*	5795	96.87	-	-	87.61	32.19	10.54	33.47	106	292	A	V
		5853	55.07	-60.29	115.36	45.65	32.31	10.59	33.48	106	292	P	V
		5860	54.33	-55.07	109.4	44.9	32.32	10.59	33.48	106	292	P	V
		5878	54.2	-48.77	102.97	44.71	32.36	10.61	33.48	106	292	P	V
		5935	52.27	-15.93	68.2	42.56	32.54	10.66	33.49	106	292	P	V
													V
													V
Remark	1. No other spurious found. 2. All results are PASS against Peak and Average limit line.												



**Band 4 5725~5850MHz
WIFI 802.11ac VHT40 (Harmonic @ 3m)**

WIFI Ant. 1	Note	Frequency (MHz)	Level (dBμV/m)	Over Limit (dB)	Limit Line (dBμV/m)	Read Level (dBμV)	Antenna Factor (dB/m)	Path Loss (dB)	Preamp Factor (dB)	Ant Pos (cm)	Table Pos (deg)	Peak Avg. (P/A)	Pol. (H/V)	
802.11ac VHT40 CH 151 5755MHz		11510	46.69	-27.31	74	47.4	39.78	15.81	56.3	100	0	P	H	
		17265	47.99	-20.21	68.2	43.82	40.8	20	56.63	100	0	P	H	
													H	
													H	
			11510	46.63	-27.37	74	47.34	39.78	15.81	56.3	100	0	P	V
			17265	48.56	-19.64	68.2	44.39	40.8	20	56.63	100	0	P	V
														V
802.11ac VHT40 CH 159 5795MHz		11590	46.88	-27.12	74	47.68	39.62	15.88	56.3	100	0	P	H	
		17385	49.14	-19.06	68.2	44.18	41.67	20.16	56.87	100	0	P	H	
													H	
													H	
			11590	47.07	-26.93	74	47.87	39.62	15.88	56.3	100	0	P	V
			17385	49.52	-18.68	68.2	44.56	41.67	20.16	56.87	100	0	P	V
														V
Remark	1. No other spurious found.													
	2. All results are PASS against Peak and Average limit line.													



Band 4 5725~5850MHz
WIFI 802.11ac VHT80 (Band Edge @ 3m)

WIFI Ant. 1	Note	Frequency (MHz)	Level (dBμV/m)	Over Limit (dB)	Limit Line (dBμV/m)	Read Level (dBμV)	Antenna Factor (dB/m)	Path Loss (dB)	Preamp Factor (dB)	Ant Pos (cm)	Table Pos (deg)	Peak Avg. (P/A)	Pol. (H/V)
		5647.8	53	-15.2	68.2	44.29	31.7	10.46	33.45	101	237	P	H
		5698.6	62.24	-41.93	104.17	53.23	31.99	10.48	33.46	101	237	P	H
		5703.2	71.41	-34.69	106.1	62.37	32.01	10.49	33.46	101	237	P	H
		5721.2	66.95	-46.59	113.54	57.87	32.04	10.5	33.46	101	237	P	H
	*	5775	107.18	-	-	97.97	32.15	10.53	33.47	101	237	P	H
	*	5775	99.01	-	-	89.8	32.15	10.53	33.47	101	237	A	H
		5850.8	72.36	-48.02	120.38	62.95	32.3	10.59	33.48	101	237	P	H
		5863.2	67.92	-40.58	108.5	58.47	32.33	10.6	33.48	101	237	P	H
		5875.4	61.69	-43.21	104.9	52.21	32.35	10.61	33.48	101	237	P	H
		5925	51.83	-16.37	68.2	42.17	32.5	10.65	33.49	101	237	P	H
802.11ac													H
VHT80													H
CH 155		5636.6	52.06	-16.14	68.2	43.33	31.73	10.45	33.45	100	291	P	V
5775MHz		5699	64.53	-39.93	104.46	55.52	31.99	10.48	33.46	100	291	P	V
		5712.6	66.14	-42.59	108.73	57.08	32.03	10.49	33.46	100	291	P	V
		5724.6	68.16	-53.13	121.29	59.07	32.05	10.5	33.46	100	291	P	V
	*	5775	101.1	-	-	91.89	32.15	10.53	33.47	100	291	P	V
	*	5775	93.7	-	-	84.49	32.15	10.53	33.47	100	291	A	V
		5852	63.07	-54.57	117.64	53.66	32.3	10.59	33.48	100	291	P	V
		5855.6	63.97	-46.66	110.63	54.55	32.31	10.59	33.48	100	291	P	V
		5875.4	56.34	-48.56	104.9	46.86	32.35	10.61	33.48	100	291	P	V
		5934.2	52.55	-15.65	68.2	42.84	32.54	10.66	33.49	100	291	P	V
													V
													V
Remark	1. No other spurious found. 2. All results are PASS against Peak and Average limit line.												



Band 4 5725~5850MHz

WIFI 802.11ac VHT80 (Harmonic @ 3m)

WIFI Ant. 1	Note	Frequency (MHz)	Level (dBμV/m)	Over Limit (dB)	Limit Line (dBμV/m)	Read Level (dBμV)	Antenna Factor (dB/m)	Path Loss (dB)	Preamp Factor (dB)	Ant Pos (cm)	Table Pos (deg)	Peak Avg. (P/A)	Pol. (H/V)	
802.11ac VHT80 CH 155 5775MHz		11550	47.04	-26.96	74	47.79	39.7	15.85	56.3	100	0	P	H	
		17325	48.78	-19.42	68.2	44.34	41.12	20.07	56.75	100	0	P	H	
													H	
													H	
			11550	46.55	-27.45	74	47.3	39.7	15.85	56.3	100	0	P	V
			17325	48.91	-19.29	68.2	44.47	41.12	20.07	56.75	100	0	P	V
														V
													V	
Remark	1. No other spurious found. 2. All results are PASS against Peak and Average limit line.													



Emission below 1GHz

5GHz WIFI 802.11ac VHT40 (LF @ 3m)

WIFI	Note	Frequency	Level	Over	Limit	Read	Antenna	Path	Preamp	Ant	Table	Peak	Pol.	
Ant.				Limit	Line	Level	Factor	Loss	Factor	Pos	Pos	Avg.		
1		(MHz)	(dBμV/m)	(dB)	(dBμV/m)	(dBμV)	(dB/m)	(dB)	(dB)	(cm)	(deg)	(P/A)	(H/V)	
5GHz 802.11ac VHT40 LF		43.58	32.37	-7.63	40	44.33	17.45	0.97	30.38	-	-	P	H	
		110.51	30.56	-12.94	43.5	42.58	16.88	1.52	30.42	-	-	P	H	
		259.89	34.29	-11.71	46	42.69	19.65	2.16	30.21	-	-	P	H	
		478.14	35.61	-10.39	46	38.66	23.57	3.2	29.82	-	-	P	H	
		720.64	40	-6	46	38.39	27.13	3.95	29.47	100	0	P	H	
		894.27	38.29	-7.71	46	33.93	29.02	4.49	29.15	-	-	P	H	
														H
														H
														H
														H
														H
														H
														H
														H
			43.58	36.26	-3.74	40	48.22	17.45	0.97	30.38	100	82	QP	V
			43.58	41.13	1.13	40	53.09	17.45	0.97	30.38	100	82	P	V
			95.96	32.18	-11.32	43.5	45.77	15.4	1.44	30.43	-	-	P	V
			191.02	26.99	-16.51	43.5	40.53	14.84	1.95	30.33	-	-	P	V
			714.82	37.53	-8.47	46	36.12	26.97	3.93	29.49	-	-	P	V
		847.71	37.42	-8.58	46	33.25	29.04	4.35	29.22	-	-	P	V	
		901.06	38.01	-7.99	46	33.64	29.01	4.5	29.14	-	-	P	V	
													V	
													V	
													V	
													V	
													V	
Remark	1. No other spurious found. 2. All results are PASS against limit line.													



Band 4 - 5725~5850MHz
WIFI 802.11a (Band Edge @ 3m)

WIFI	Note	Frequency	Level	Over	Limit	Read	Antenna	Path	Preamp	Ant	Table	Peak	Pol.	
Ant.				Limit	Line	Level	Factor	Loss	Factor	Pos	Pos	Avg.		
2		(MHz)	(dBμV/m)	(dB)	(dBμV/m)	(dBμV)	(dB/m)	(dB)	(dB)	(cm)	(deg)	(P/A)	(H/V)	
802.11a CH 149 5745MHz		5637.4	50.99	-17.21	68.2	42.26	31.73	10.45	33.45	106	305	P	H	
		5695.4	52.9	-48.91	101.81	43.91	31.97	10.48	33.46	106	305	P	H	
		5717.4	56.9	-53.17	110.07	47.84	32.03	10.49	33.46	106	305	P	H	
		5724.2	62.42	-57.96	120.38	53.33	32.05	10.5	33.46	106	305	P	H	
	*	5745	112.75	-	-	103.61	32.09	10.51	33.46	106	305	P	H	
	*	5745	105.51	-	-	96.37	32.09	10.51	33.46	106	305	A	H	
														H
														H
			5639.6	50.98	-17.22	68.2	42.26	31.72	10.45	33.45	101	298	P	V
			5698.2	53.37	-50.5	103.87	44.36	31.99	10.48	33.46	101	298	P	V
			5718.6	53.99	-56.42	110.41	44.91	32.04	10.5	33.46	101	298	P	V
			5723.4	56.48	-62.07	118.55	47.39	32.05	10.5	33.46	101	298	P	V
	*		5745	108.51	-	-	99.37	32.09	10.51	33.46	101	298	P	V
	*		5745	101.24	-	-	92.1	32.09	10.51	33.46	101	298	A	V
														V
														V



WIFI Ant. 2	Note	Frequency (MHz)	Level (dBμV/m)	Over Limit (dB)	Limit Line (dBμV/m)	Read Level (dBμV)	Antenna Factor (dB/m)	Path Loss (dB)	Preamp Factor (dB)	Ant Pos (cm)	Table Pos (deg)	Peak Avg. (P/A)	Pol. (H/V)
		5639.8	51.06	-17.14	68.2	42.34	31.72	10.45	33.45	106	304	P	H
		5665.8	51.8	-28.13	79.93	42.99	31.79	10.47	33.45	106	304	P	H
		5719	53.88	-56.64	110.52	44.8	32.04	10.5	33.46	106	304	P	H
		5724.8	52.81	-68.93	121.74	43.72	32.05	10.5	33.46	106	304	P	H
	*	5785	112.08	-	-	102.85	32.17	10.53	33.47	106	304	P	H
	*	5785	104.88	-	-	95.65	32.17	10.53	33.47	106	304	A	H
		5854.6	52.81	-58.9	111.71	43.39	32.31	10.59	33.48	106	304	P	H
		5856.8	54.5	-55.8	110.3	45.08	32.31	10.59	33.48	106	304	P	H
		5901.6	52.68	-32.8	85.48	43.13	32.41	10.63	33.49	106	304	P	H
		5942.4	53.77	-14.43	68.2	44.02	32.57	10.67	33.49	106	304	P	H
													H
													H
802.11a													
CH 157													
5785MHz		5622.6	51.1	-17.1	68.2	42.36	31.75	10.44	33.45	104	298	P	V
		5677.4	51.65	-36.87	88.52	42.77	31.86	10.47	33.45	104	298	P	V
		5714.6	53.13	-56.16	109.29	44.07	32.03	10.49	33.46	104	298	P	V
		5722.8	53.45	-63.73	117.18	44.36	32.05	10.5	33.46	104	298	P	V
	*	5785	107.48	-	-	98.25	32.17	10.53	33.47	104	298	P	V
	*	5785	100.03	-	-	90.8	32.17	10.53	33.47	104	298	A	V
		5852.6	52.17	-64.1	116.27	42.75	32.31	10.59	33.48	104	298	P	V
		5857.4	52.04	-58.09	110.13	42.62	32.31	10.59	33.48	104	298	P	V
		5892.4	52.81	-39.48	92.29	43.29	32.38	10.62	33.48	104	298	P	V
		5942.4	52.62	-15.58	68.2	42.87	32.57	10.67	33.49	104	298	P	V
													V
													V



WiFi Ant. 2	Note	Frequency (MHz)	Level (dBµV/m)	Over Limit (dB)	Limit Line (dBµV/m)	Read Level (dBµV)	Antenna Factor (dB/m)	Path Loss (dB)	Preamp Factor (dB)	Ant Pos (cm)	Table Pos (deg)	Peak Avg. (P/A)	Pol. (H/V)	
802.11a CH 165 5825MHz	*	5825	111.73	-	-	102.4	32.25	10.56	33.48	105	307	P	H	
	*	5825	104.39	-	-	95.06	32.25	10.56	33.48	105	307	A	H	
		5850.6	56.49	-64.34	120.83	47.08	32.3	10.59	33.48	105	307	P	H	
		5871.2	55.95	-50.31	106.26	46.49	32.34	10.6	33.48	105	307	P	H	
		5889.4	55.53	-38.98	94.51	46.01	32.38	10.62	33.48	105	307	P	H	
		5944.4	52.99	-15.21	68.2	43.23	32.58	10.67	33.49	105	307	P	H	
														H
														H
	*	5825	107.06	-	-	97.73	32.25	10.56	33.48	101	298	P	V	
	*	5825	99.63	-	-	90.3	32.25	10.56	33.48	101	298	A	V	
		5850.8	53.05	-67.33	120.38	43.64	32.3	10.59	33.48	101	298	P	V	
		5856.6	53.56	-56.79	110.35	44.14	32.31	10.59	33.48	101	298	P	V	
		5881.2	53.26	-47.33	100.59	43.77	32.36	10.61	33.48	101	298	P	V	
		5926.6	52.87	-15.33	68.2	43.2	32.51	10.65	33.49	101	298	P	V	
														V
														V
													V	
Remark	1. No other spurious found. 2. All results are PASS against Peak and Average limit line.													



Band 4 5725~5850MHz

WIFI 802.11a (Harmonic @ 3m)

WIFI Ant. 2	Note	Frequency (MHz)	Level (dBμV/m)	Over Limit (dB)	Limit Line (dBμV/m)	Read Level (dBμV)	Antenna Factor (dB/m)	Path Loss (dB)	Preamp Factor (dB)	Ant Pos (cm)	Table Pos (deg)	Peak Avg. (P/A)	Pol. (H/V)
802.11a CH 149 5745MHz		11490	46.91	-27.09	74	47.63	39.78	15.8	56.3	100	0	P	H
		17235	47.69	-20.51	68.2	43.6	40.7	19.96	56.57	100	0	P	H
													H
													H
		11490	47.06	-26.94	74	47.78	39.78	15.8	56.3	100	0	P	V
		17235	47.65	-20.55	68.2	43.56	40.7	19.96	56.57	100	0	P	V
													V
													V
802.11a CH 157 5785MHz		11570	46.42	-27.58	74	47.2	39.66	15.86	56.3	100	0	P	H
		17355	49.79	-18.41	68.2	45.08	41.4	20.12	56.81	100	0	P	H
													H
													H
		11570	47.63	-26.37	74	48.41	39.66	15.86	56.3	100	0	P	V
		17355	49.11	-19.09	68.2	44.4	41.4	20.12	56.81	100	0	P	V
													V
													V
802.11a CH 165 5825MHz		11650	46.07	-27.93	74	47.09	39.35	15.93	56.3	100	0	P	H
		17475	50.09	-18.11	68.2	44.69	42.17	20.28	57.05	100	0	P	H
													H
													H
		11650	46.37	-27.63	74	47.39	39.35	15.93	56.3	100	0	P	V
		17475	49.78	-18.42	68.2	44.38	42.17	20.28	57.05	100	0	P	V
													V
													V
Remark	1. No other spurious found. 2. All results are PASS against Peak and Average limit line.												



Band 4 5725~5850MHz
WIFI 802.11ac VHT20 (Band Edge @ 3m)

WIFI Ant. 2	Note	Frequency (MHz)	Level (dBμV/m)	Over Limit (dB)	Limit Line (dBμV/m)	Read Level (dBμV)	Antenna Factor (dB/m)	Path Loss (dB)	Preamp Factor (dB)	Ant Pos (cm)	Table Pos (deg)	Peak Avg. (P/A)	Pol. (H/V)	
802.11ac VHT20 CH 149 5745MHz		5605.6	51.67	-16.53	68.2	42.89	31.79	10.43	33.44	109	305	P	H	
		5697.6	54.38	-49.05	103.43	45.37	31.99	10.48	33.46	109	305	P	H	
		5720	58.4	-52.4	110.8	49.32	32.04	10.5	33.46	109	305	P	H	
		5725	66.02	-56.18	122.2	56.93	32.05	10.5	33.46	109	305	P	H	
	*	5745	112.48	-	-	103.34	32.09	10.51	33.46	109	305	P	H	
	*	5745	105.1	-	-	95.96	32.09	10.51	33.46	109	305	A	H	
														H
														H
			5602.6	51.31	-16.89	68.2	42.53	31.79	10.43	33.44	101	299	P	V
			5688.4	53.04	-43.6	96.64	44.09	31.93	10.48	33.46	101	299	P	V
			5716.4	53.71	-56.08	109.79	44.65	32.03	10.49	33.46	101	299	P	V
			5723.8	60.93	-58.53	119.46	51.84	32.05	10.5	33.46	101	299	P	V
	*		5745	107.59	-	-	98.45	32.09	10.51	33.46	101	299	P	V
	*		5745	100.72	-	-	91.58	32.09	10.51	33.46	101	299	A	V
														V
													V	



WIFI Ant. 2	Note	Frequency (MHz)	Level (dBμV/m)	Over Limit (dB)	Limit Line (dBμV/m)	Read Level (dBμV)	Antenna Factor (dB/m)	Path Loss (dB)	Preamp Factor (dB)	Ant Pos (cm)	Table Pos (deg)	Peak Avg. (P/A)	Pol. (H/V)
		5632	53.03	-15.17	68.2	44.29	31.74	10.45	33.45	105	304	P	H
		5686.4	54.25	-40.92	95.17	45.31	31.92	10.48	33.46	105	304	P	H
		5716.4	55.21	-54.58	109.79	46.15	32.03	10.49	33.46	105	304	P	H
		5724.2	54.47	-65.91	120.38	45.38	32.05	10.5	33.46	105	304	P	H
	*	5785	112.31	-	-	103.08	32.17	10.53	33.47	105	304	P	H
	*	5785	104.56	-	-	95.33	32.17	10.53	33.47	105	304	A	H
		5854.4	54.32	-57.85	112.17	44.9	32.31	10.59	33.48	105	304	P	H
		5874.4	53.33	-52.04	105.37	43.85	32.35	10.61	33.48	105	304	P	H
		5881.4	53.07	-47.38	100.45	43.58	32.36	10.61	33.48	105	304	P	H
		5934.8	53.58	-14.62	68.2	43.87	32.54	10.66	33.49	105	304	P	H
802.11ac													H
VHT20													H
CH 157		5645	52.35	-15.85	68.2	43.64	31.71	10.45	33.45	100	299	P	V
5785MHz		5697.8	53.43	-50.15	103.58	44.42	31.99	10.48	33.46	100	299	P	V
		5713.2	54.75	-54.15	108.9	45.69	32.03	10.49	33.46	100	299	P	V
		5724.8	54.3	-67.44	121.74	45.21	32.05	10.5	33.46	100	299	P	V
	*	5785	107.3	-	-	98.07	32.17	10.53	33.47	100	299	P	V
	*	5785	99.62	-	-	90.39	32.17	10.53	33.47	100	299	A	V
		5852	50.79	-66.85	117.64	41.38	32.3	10.59	33.48	100	299	P	V
		5862.4	53.24	-55.49	108.73	43.8	32.32	10.6	33.48	100	299	P	V
		5893.6	51.68	-39.72	91.4	42.16	32.39	10.62	33.49	100	299	P	V
		5925.8	52.23	-15.97	68.2	42.57	32.5	10.65	33.49	100	299	P	V
													V
													V



WIFI Ant. 2	Note	Frequency (MHz)	Level (dBμV/m)	Over Limit (dB)	Limit Line (dBμV/m)	Read Level (dBμV)	Antenna Factor (dB/m)	Path Loss (dB)	Preamp Factor (dB)	Ant Pos (cm)	Table Pos (deg)	Peak Avg. (P/A)	Pol. (H/V)	
802.11ac VHT20 CH 165 5825MHz	*	5825	111.4	-	-	102.07	32.25	10.56	33.48	104	302	P	H	
	*	5825	103.4	-	-	94.07	32.25	10.56	33.48	104	302	A	H	
		5854.6	55.96	-55.75	111.71	46.54	32.31	10.59	33.48	104	302	P	H	
		5863.4	56.16	-52.29	108.45	46.71	32.33	10.6	33.48	104	302	P	H	
		5877.2	55.31	-48.26	103.57	45.83	32.35	10.61	33.48	104	302	P	H	
		5928.6	52.39	-15.81	68.2	42.71	32.51	10.66	33.49	104	302	P	H	
														H
														H
	*	5825	106.99	-	-	97.66	32.25	10.56	33.48	100	298	P	V	
	*	5825	99.31	-	-	89.98	32.25	10.56	33.48	100	298	A	V	
		5853	52.27	-63.09	115.36	42.85	32.31	10.59	33.48	100	298	P	V	
		5861.8	53.58	-55.31	108.89	44.14	32.32	10.6	33.48	100	298	P	V	
		5884	51.86	-46.66	98.52	42.35	32.37	10.62	33.48	100	298	P	V	
		5928	51.62	-16.58	68.2	41.94	32.51	10.66	33.49	100	298	P	V	
														V
														V
Remark	1. No other spurious found. 2. All results are PASS against Peak and Average limit line.													



Band 4 5725~5850MHz
WIFI 802.11ac VHT20 (Harmonic @ 3m)

WIFI Ant. 2	Note	Frequency (MHz)	Level (dBμV/m)	Over Limit (dB)	Limit Line (dBμV/m)	Read Level (dBμV)	Antenna Factor (dB/m)	Path Loss (dB)	Preamp Factor (dB)	Ant Pos (cm)	Table Pos (deg)	Peak Avg. (P/A)	Pol. (H/V)	
802.11ac VHT20 CH 149 5745MHz		11490	46.55	-27.45	74	47.27	39.78	15.8	56.3	100	0	P	H	
		17235	50.17	-18.03	68.2	46.08	40.7	19.96	56.57	100	0	P	H	
													H	
													H	
			11490	46.35	-27.65	74	47.07	39.78	15.8	56.3	100	0	P	V
			17235	49.42	-18.78	68.2	45.33	40.7	19.96	56.57	100	0	P	V
														V
802.11ac VHT20 CH 157 5785MHz		11570	47.33	-26.67	74	48.11	39.66	15.86	56.3	100	0	P	H	
		17355	49.95	-18.25	68.2	45.24	41.4	20.12	56.81	100	0	P	H	
													H	
													H	
			11570	46.4	-27.6	74	47.18	39.66	15.86	56.3	100	0	P	V
			17355	49.68	-18.52	68.2	44.97	41.4	20.12	56.81	100	0	P	V
														V
802.11ac VHT20 CH 165 5825MHz		11650	45.65	-28.35	74	46.67	39.35	15.93	56.3	100	0	P	H	
		17475	50.44	-17.76	68.2	45.04	42.17	20.28	57.05	100	0	P	H	
													H	
													H	
			11650	45.73	-28.27	74	46.75	39.35	15.93	56.3	100	0	P	V
			17475	49.61	-18.59	68.2	44.21	42.17	20.28	57.05	100	0	P	V
														V
Remark	1. No other spurious found.													
	2. All results are PASS against Peak and Average limit line.													



Band 4 5725~5850MHz
WIFI 802.11ac VHT40 (Band Edge @ 3m)

WIFI Ant. 2	Note	Frequency (MHz)	Level (dBμV/m)	Over Limit (dB)	Limit Line (dBμV/m)	Read Level (dBμV)	Antenna Factor (dB/m)	Path Loss (dB)	Preamp Factor (dB)	Ant Pos (cm)	Table Pos (deg)	Peak Avg. (P/A)	Pol. (H/V)
		5633.8	52.06	-16.14	68.2	43.33	31.73	10.45	33.45	102	305	P	H
		5698.8	57.7	-46.62	104.32	48.69	31.99	10.48	33.46	102	305	P	H
		5720	68.21	-42.59	110.8	59.13	32.04	10.5	33.46	102	305	P	H
		5722.8	69.49	-47.69	117.18	60.4	32.05	10.5	33.46	102	305	P	H
	*	5755	111.27	-	-	102.11	32.11	10.52	33.47	102	305	P	H
	*	5755	103.1	-	-	93.94	32.11	10.52	33.47	102	305	A	H
		5851	53.34	-66.58	119.92	43.93	32.3	10.59	33.48	102	305	P	H
		5858.4	53.75	-56.1	109.85	44.32	32.32	10.59	33.48	102	305	P	H
		5880.6	53.15	-47.89	101.04	43.66	32.36	10.61	33.48	102	305	P	H
		5945	52.31	-15.89	68.2	42.55	32.58	10.67	33.49	102	305	P	H
													H
													H
802.11ac VHT40 CH 151 5755MHz		5622.6	51.51	-16.69	68.2	42.77	31.75	10.44	33.45	100	298	P	V
		5699.4	56.87	-47.89	104.76	47.85	32	10.48	33.46	100	298	P	V
		5719	66.5	-44.02	110.52	57.42	32.04	10.5	33.46	100	298	P	V
		5722.8	64.13	-53.05	117.18	55.04	32.05	10.5	33.46	100	298	P	V
	*	5755	106.2	-	-	97.04	32.11	10.52	33.47	100	298	P	V
	*	5755	98.47	-	-	89.31	32.11	10.52	33.47	100	298	A	V
		5850	50.92	-71.28	122.2	41.51	32.3	10.59	33.48	100	298	P	V
		5874	52	-53.48	105.48	42.52	32.35	10.61	33.48	100	298	P	V
		5875.8	51.87	-52.74	104.61	42.39	32.35	10.61	33.48	100	298	P	V
		5942.8	51.42	-16.78	68.2	41.67	32.57	10.67	33.49	100	298	P	V
													V
													V



WIFI Ant. 2	Note	Frequency (MHz)	Level (dBμV/m)	Over Limit (dB)	Limit Line (dBμV/m)	Read Level (dBμV)	Antenna Factor (dB/m)	Path Loss (dB)	Preamp Factor (dB)	Ant Pos (cm)	Table Pos (deg)	Peak Avg. (P/A)	Pol. (H/V)
		5629.6	52.13	-16.07	68.2	43.39	31.74	10.45	33.45	115	302	P	H
		5697.6	54.03	-49.4	103.43	45.02	31.99	10.48	33.46	115	302	P	H
		5711.8	54.22	-54.29	108.51	45.17	32.02	10.49	33.46	115	302	P	H
		5724.4	55.71	-65.12	120.83	46.62	32.05	10.5	33.46	115	302	P	H
	*	5795	110.44	-	-	101.18	32.19	10.54	33.47	115	302	P	H
	*	5795	102.29	-	-	93.03	32.19	10.54	33.47	115	302	A	H
		5854	53.94	-59.14	113.08	44.52	32.31	10.59	33.48	115	302	P	H
		5856.2	54.84	-55.62	110.46	45.42	32.31	10.59	33.48	115	302	P	H
		5924.4	52.97	-15.67	68.64	43.31	32.5	10.65	33.49	115	302	P	H
		5949	52.44	-15.76	68.2	42.66	32.6	10.67	33.49	115	302	P	H
802.11ac													H
VHT40													H
CH 159		5612.4	50	-18.2	68.2	41.23	31.78	10.44	33.45	100	297	P	V
5795MHz		5670.2	52.38	-30.81	83.19	43.54	31.82	10.47	33.45	100	297	P	V
		5714.4	52.54	-56.69	109.23	43.48	32.03	10.49	33.46	100	297	P	V
		5723.4	51.67	-66.88	118.55	42.58	32.05	10.5	33.46	100	297	P	V
	*	5795	105.98	-	-	96.72	32.19	10.54	33.47	100	297	P	V
	*	5795	97.9	-	-	88.64	32.19	10.54	33.47	100	297	A	V
		5852.6	52.66	-63.61	116.27	43.24	32.31	10.59	33.48	100	297	P	V
		5867.6	53.11	-54.16	107.27	43.65	32.34	10.6	33.48	100	297	P	V
		5890.8	51.61	-41.86	93.47	42.09	32.38	10.62	33.48	100	297	P	V
		5948.4	50.58	-17.62	68.2	40.81	32.59	10.67	33.49	100	297	P	V
													V
													V
Remark	1. No other spurious found. 2. All results are PASS against Peak and Average limit line.												



**Band 4 5725~5850MHz
WIFI 802.11ac VHT40 (Harmonic @ 3m)**

WIFI Ant. 2	Note	Frequency (MHz)	Level (dBμV/m)	Over Limit (dB)	Limit Line (dBμV/m)	Read Level (dBμV)	Antenna Factor (dB/m)	Path Loss (dB)	Preamp Factor (dB)	Ant Pos (cm)	Table Pos (deg)	Peak Avg. (P/A)	Pol. (H/V)	
802.11ac VHT40 CH 151 5755MHz		11510	46.11	-27.89	74	46.82	39.78	15.81	56.3	100	0	P	H	
		17265	48.48	-19.72	68.2	44.31	40.8	20	56.63	100	0	P	H	
													H	
													H	
			11510	47.06	-26.94	74	47.77	39.78	15.81	56.3	100	0	P	V
			17265	47.97	-20.23	68.2	43.8	40.8	20	56.63	100	0	P	V
														V
802.11ac VHT40 CH 159 5795MHz		11590	46.47	-27.53	74	47.27	39.62	15.88	56.3	100	0	P	H	
		17385	48.87	-19.33	68.2	43.91	41.67	20.16	56.87	100	0	P	H	
													H	
													H	
			11590	47.12	-26.88	74	47.92	39.62	15.88	56.3	100	0	P	V
			17385	49.48	-18.72	68.2	44.52	41.67	20.16	56.87	100	0	P	V
														V
Remark	1. No other spurious found.													
	2. All results are PASS against Peak and Average limit line.													



Band 4 5725~5850MHz
WIFI 802.11ac VHT80 (Band Edge @ 3m)

WIFI Ant. 2	Note	Frequency (MHz)	Level (dBμV/m)	Over Limit (dB)	Limit Line (dBμV/m)	Read Level (dBμV)	Antenna Factor (dB/m)	Path Loss (dB)	Preamp Factor (dB)	Ant Pos (cm)	Table Pos (deg)	Peak Avg. (P/A)	Pol. (H/V)
		5641	53.47	-14.73	68.2	44.75	31.72	10.45	33.45	103	304	P	H
		5697.6	64.86	-38.57	103.43	55.85	31.99	10.48	33.46	103	304	P	H
		5717.2	68.11	-41.91	110.02	59.05	32.03	10.49	33.46	103	304	P	H
		5722	69.45	-45.91	115.36	60.37	32.04	10.5	33.46	103	304	P	H
	*	5775	107.5	-	-	98.29	32.15	10.53	33.47	103	304	P	H
	*	5775	98.92	-	-	89.71	32.15	10.53	33.47	103	304	A	H
		5852.8	65.29	-50.53	115.82	55.87	32.31	10.59	33.48	103	304	P	H
		5858	63.14	-46.82	109.96	53.71	32.32	10.59	33.48	103	304	P	H
		5876	56.96	-47.5	104.46	47.48	32.35	10.61	33.48	103	304	P	H
		5932.8	53.31	-14.89	68.2	43.61	32.53	10.66	33.49	103	304	P	H
													H
													H
802.11ac VHT80 CH 155 5775MHz		5647.2	51.74	-16.46	68.2	43.02	31.71	10.46	33.45	100	295	P	V
		5698.8	59.02	-45.3	104.32	50.01	31.99	10.48	33.46	100	295	P	V
		5717	63.55	-46.41	109.96	54.49	32.03	10.49	33.46	100	295	P	V
		5724.2	62.69	-57.69	120.38	53.6	32.05	10.5	33.46	100	295	P	V
	*	5775	102.86	-	-	93.65	32.15	10.53	33.47	100	295	P	V
	*	5775	95.02	-	-	85.81	32.15	10.53	33.47	100	295	A	V
		5852	59.33	-58.31	117.64	49.92	32.3	10.59	33.48	100	295	P	V
		5857	58.04	-52.2	110.24	48.62	32.31	10.59	33.48	100	295	P	V
		5875.6	53.57	-51.18	104.75	44.09	32.35	10.61	33.48	100	295	P	V
		5932	51.23	-16.97	68.2	41.53	32.53	10.66	33.49	100	295	P	V
													V
													V
Remark	1. No other spurious found. 2. All results are PASS against Peak and Average limit line.												



**Band 4 5725~5850MHz
WIFI 802.11ac VHT80 (Harmonic @ 3m)**

WIFI Ant. 2	Note	Frequency (MHz)	Level (dBμV/m)	Over Limit (dB)	Limit Line (dBμV/m)	Read Level (dBμV)	Antenna Factor (dB/m)	Path Loss (dB)	Preamp Factor (dB)	Ant Pos (cm)	Table Pos (deg)	Peak Avg. (P/A)	Pol. (H/V)	
802.11ac VHT80 CH 155 5775MHz		11550	46.72	-27.28	74	47.47	39.7	15.85	56.3	100	0	P	H	
		17325	48.99	-19.21	68.2	44.55	41.12	20.07	56.75	100	0	P	H	
													H	
													H	
			11550	46.44	-27.56	74	47.19	39.7	15.85	56.3	100	0	P	V
			17325	47.95	-20.25	68.2	43.51	41.12	20.07	56.75	100	0	P	V
														V
													V	
Remark	1. No other spurious found. 2. All results are PASS against Peak and Average limit line.													



Emission below 1GHz
5GHz WIFI 802.11a (LF @ 3m)

WIFI	Note	Frequency	Level	Over	Limit	Read	Antenna	Path	Preamp	Ant	Table	Peak	Pol.	
Ant.				Limit	Line	Level	Factor	Loss	Factor	Pos	Pos	Avg.		
2		(MHz)	(dBμV/m)	(dB)	(dBμV/m)	(dBμV)	(dB/m)	(dB)	(dB)	(cm)	(deg)	(P/A)	(H/V)	
5GHz 802.11a LF		43.58	31.43	-8.57	40	43.39	17.45	0.97	30.38	100	0	P	H	
		108.57	31.41	-12.09	43.5	43.54	16.78	1.51	30.42	-	-	P	H	
		140.58	24.5	-19	43.5	35.91	17.32	1.66	30.39	-	-	P	H	
		847.71	36.37	-9.63	46	32.2	29.04	4.35	29.22	-	-	P	H	
		889.42	36.14	-9.86	46	31.78	29.05	4.47	29.16	-	-	P	H	
		940.83	35.7	-10.3	46	29.87	30.22	4.63	29.02	-	-	P	H	
														H
														H
														H
														H
														H
														H
														H
			43.58	34.84	-5.16	40	46.8	17.45	0.97	30.38	100	79	QP	V
			43.58	41.1	1.1	40	53.06	17.45	0.97	30.38	100	79	P	V
			103.72	30.01	-13.49	43.5	42.55	16.38	1.51	30.43	-	-	P	V
			154.16	24.02	-19.48	43.5	35.66	16.99	1.74	30.37	-	-	P	V
			721.61	37.67	-8.33	46	36.03	27.16	3.95	29.47	-	-	P	V
			903.97	36.63	-9.37	46	32.18	29.07	4.51	29.13	-	-	P	V
			951.5	36.49	-9.51	46	30.24	30.58	4.66	28.99	-	-	P	V
													V	
													V	
													V	
													V	
													V	
Remark	1. No other spurious found. 2. All results are PASS against limit line.													



Band 4 - 5725~5850MHz
WIFI 802.11a (Band Edge @ 3m)

WIFI	Note	Frequency	Level	Over	Limit	Read	Antenna	Path	Preamp	Ant	Table	Peak	Pol.	
Ant.				Limit	Line	Level	Factor	Loss	Factor	Pos	Pos	Avg.		
1+2		(MHz)	(dBμV/m)	(dB)	(dBμV/m)	(dBμV)	(dB/m)	(dB)	(dB)	(cm)	(deg)	(P/A)	(H/V)	
802.11a CH 149 5745MHz		5646.8	51.53	-16.67	68.2	42.81	31.71	10.46	33.45	100	325	P	H	
		5695.4	54.41	-47.4	101.81	45.42	31.97	10.48	33.46	100	325	P	H	
		5718.6	58.66	-51.75	110.41	49.58	32.04	10.5	33.46	100	325	P	H	
		5722.4	63.32	-52.95	116.27	54.24	32.04	10.5	33.46	100	325	P	H	
	*	5745	116.74	-	-	107.6	32.09	10.51	33.46	100	325	P	H	
	*	5745	109.25	-	-	100.11	32.09	10.51	33.46	100	325	A	H	
														H
														H
			5603.4	52.33	-15.87	68.2	43.55	31.79	10.43	33.44	396	277	P	V
			5699.4	55.11	-49.65	104.76	46.09	32	10.48	33.46	396	277	P	V
			5720	55.96	-54.84	110.8	46.88	32.04	10.5	33.46	396	277	P	V
			5724.2	63.11	-57.27	120.38	54.02	32.05	10.5	33.46	396	277	P	V
	*		5745	112.25	-	-	103.11	32.09	10.51	33.46	396	277	P	V
	*		5745	104.82	-	-	95.68	32.09	10.51	33.46	396	277	A	V
														V
														V



WIFI Ant. 1+2	Note	Frequency (MHz)	Level (dBμV/m)	Over Limit (dB)	Limit Line (dBμV/m)	Read Level (dBμV)	Antenna Factor (dB/m)	Path Loss (dB)	Preamp Factor (dB)	Ant Pos (cm)	Table Pos (deg)	Peak Avg. (P/A)	Pol. (H/V)	
802.11a CH 157 5785MHz		5624.4	50.77	-17.43	68.2	42.03	31.75	10.44	33.45	121	326	P	H	
		5667	52.16	-28.66	80.82	43.34	31.8	10.47	33.45	121	326	P	H	
		5719.4	54.32	-56.31	110.63	45.24	32.04	10.5	33.46	121	326	P	H	
		5720.8	54.93	-57.69	112.62	45.85	32.04	10.5	33.46	121	326	P	H	
	*	5785	116.01	-	-	106.78	32.17	10.53	33.47	121	326	P	H	
	*	5785	108.6	-	-	99.37	32.17	10.53	33.47	121	326	A	H	
		5850.4	54.58	-66.71	121.29	45.17	32.3	10.59	33.48	121	326	P	H	
		5855.6	53.72	-56.91	110.63	44.3	32.31	10.59	33.48	121	326	P	H	
		5914	52.8	-23.51	76.31	43.19	32.46	10.64	33.49	121	326	P	H	
		5939	52.06	-16.14	68.2	42.32	32.56	10.67	33.49	121	326	P	H	
														H
														H
			5623	52.46	-15.74	68.2	43.72	31.75	10.44	33.45	400	264	P	V
			5692.8	51.69	-48.2	99.89	42.71	31.96	10.48	33.46	400	264	P	V
			5715.6	51.8	-57.77	109.57	42.74	32.03	10.49	33.46	400	264	P	V
			5722.2	53.06	-62.76	115.82	43.98	32.04	10.5	33.46	400	264	P	V
	*		5785	110.67	-	-	101.44	32.17	10.53	33.47	400	264	P	V
	*		5785	103.18	-	-	93.95	32.17	10.53	33.47	400	264	A	V
			5852.2	50.89	-66.29	117.18	41.48	32.3	10.59	33.48	400	264	P	V
			5872.6	51.9	-53.97	105.87	42.42	32.35	10.61	33.48	400	264	P	V
		5894.6	53.08	-37.58	90.66	43.55	32.39	10.63	33.49	400	264	P	V	
		5938.4	52.44	-15.76	68.2	42.72	32.55	10.66	33.49	400	264	P	V	
													V	
													V	



WiFi Ant. 1+2	Note	Frequency (MHz)	Level (dBµV/m)	Over Limit (dB)	Limit Line (dBµV/m)	Read Level (dBµV)	Antenna Factor (dB/m)	Path Loss (dB)	Preamp Factor (dB)	Ant Pos (cm)	Table Pos (deg)	Peak Avg. (P/A)	Pol. (H/V)	
802.11a CH 165 5825MHz	*	5825	115.74	-	-	106.41	32.25	10.56	33.48	121	327	P	H	
	*	5825	108.25	-	-	98.92	32.25	10.56	33.48	121	327	A	H	
		5852.6	55.16	-61.11	116.27	45.74	32.31	10.59	33.48	121	327	P	H	
		5859.8	55.5	-53.95	109.45	46.07	32.32	10.59	33.48	121	327	P	H	
		5877.4	54.49	-48.93	103.42	45.01	32.35	10.61	33.48	121	327	P	H	
		5926	52.08	-16.12	68.2	42.42	32.5	10.65	33.49	121	327	P	H	
														H
														H
	*	5825	110.05	-	-	100.72	32.25	10.56	33.48	388	265	P	V	
	*	5825	102.76	-	-	93.43	32.25	10.56	33.48	388	265	A	V	
		5851	53.65	-66.27	119.92	44.24	32.3	10.59	33.48	388	265	P	V	
		5861.8	54.36	-54.53	108.89	44.92	32.32	10.6	33.48	388	265	P	V	
		5879.2	52.93	-49.15	102.08	43.44	32.36	10.61	33.48	388	265	P	V	
		5945.8	51.49	-16.71	68.2	41.73	32.58	10.67	33.49	388	265	P	V	
														V
														V
													V	
Remark	1. No other spurious found. 2. All results are PASS against Peak and Average limit line.													



Band 4 5725~5850MHz
WIFI 802.11a (Harmonic @ 3m)

WIFI Ant. 1+2	Note	Frequency (MHz)	Level (dBµV/m)	Over Limit (dB)	Limit Line (dBµV/m)	Read Level (dBµV)	Antenna Factor (dB/m)	Path Loss (dB)	Preamp Factor (dB)	Ant Pos (cm)	Table Pos (deg)	Peak Avg. (P/A)	Pol. (H/V)
802.11a CH 149 5745MHz		11490	46.21	-27.79	74	46.93	39.78	15.8	56.3	100	0	P	H
		17235	48.23	-19.97	68.2	44.14	40.7	19.96	56.57	100	0	P	H
													H
													H
		11490	46.5	-27.5	74	47.22	39.78	15.8	56.3	100	0	P	V
		17235	47.56	-20.64	68.2	43.47	40.7	19.96	56.57	100	0	P	V
													V
													V
802.11a CH 157 5785MHz		11570	47.46	-26.54	74	48.24	39.66	15.86	56.3	100	0	P	H
		17355	49.16	-19.04	68.2	44.45	41.4	20.12	56.81	100	0	P	H
													H
													H
		11570	46.63	-27.37	74	47.41	39.66	15.86	56.3	100	0	P	V
		17355	48.64	-19.56	68.2	43.93	41.4	20.12	56.81	100	0	P	V
													V
													V
802.11a CH 165 5825MHz		11650	46.31	-27.69	74	47.33	39.35	15.93	56.3	100	0	P	H
		17475	49.54	-18.66	68.2	44.14	42.17	20.28	57.05	100	0	P	H
													H
													H
		11650	45.86	-28.14	74	46.88	39.35	15.93	56.3	100	0	P	V
		17475	49.83	-18.37	68.2	44.43	42.17	20.28	57.05	100	0	P	V
													V
													V
Remark	1. No other spurious found. 2. All results are PASS against Peak and Average limit line.												



Band 4 5725~5850MHz
WIFI 802.11ac VHT20 (Band Edge @ 3m)

WIFI Ant. 1+2	Note	Frequency (MHz)	Level (dBμV/m)	Over Limit (dB)	Limit Line (dBμV/m)	Read Level (dBμV)	Antenna Factor (dB/m)	Path Loss (dB)	Preamp Factor (dB)	Ant Pos (cm)	Table Pos (deg)	Peak Avg. (P/A)	Pol. (H/V)	
802.11ac VHT20 CH 149 5745MHz		5648.6	50.8	-17.4	68.2	42.09	31.7	10.46	33.45	100	325	P	H	
		5692.8	56.25	-43.64	99.89	47.27	31.96	10.48	33.46	100	325	P	H	
		5719.6	58.35	-52.34	110.69	49.27	32.04	10.5	33.46	100	325	P	H	
		5725	69.67	-52.53	122.2	60.58	32.05	10.5	33.46	100	325	P	H	
	*	5745	117.04	-	-	107.9	32.09	10.51	33.46	100	325	P	H	
	*	5745	109.57	-	-	100.43	32.09	10.51	33.46	100	325	A	H	
														H
														H
			5615.8	51.05	-17.15	68.2	42.29	31.77	10.44	33.45	400	278	P	V
			5692.2	54.07	-45.38	99.45	45.1	31.95	10.48	33.46	400	278	P	V
			5718	55.81	-54.43	110.24	46.74	32.04	10.49	33.46	400	278	P	V
			5725	62.27	-59.93	122.2	53.18	32.05	10.5	33.46	400	278	P	V
	*		5745	111.72	-	-	102.58	32.09	10.51	33.46	400	278	P	V
	*		5745	103.78	-	-	94.64	32.09	10.51	33.46	400	278	A	V
														V
													V	



WIFI Ant. 1+2	Note	Frequency (MHz)	Level (dBµV/m)	Over Limit (dB)	Limit Line (dBµV/m)	Read Level (dBµV)	Antenna Factor (dB/m)	Path Loss (dB)	Preamp Factor (dB)	Ant Pos (cm)	Table Pos (deg)	Peak Avg. (P/A)	Pol. (H/V)
		5640.4	51.09	-17.11	68.2	42.37	31.72	10.45	33.45	105	318	P	H
		5691.4	52.37	-46.49	98.86	43.4	31.95	10.48	33.46	105	318	P	H
		5717.2	53.93	-56.09	110.02	44.87	32.03	10.49	33.46	105	318	P	H
		5723.8	54.4	-65.06	119.46	45.31	32.05	10.5	33.46	105	318	P	H
	*	5785	116.88	-	-	107.65	32.17	10.53	33.47	105	318	P	H
	*	5785	108.96	-	-	99.73	32.17	10.53	33.47	105	318	A	H
		5853.8	55.01	-58.53	113.54	45.59	32.31	10.59	33.48	105	318	P	H
		5864.4	55.04	-53.13	108.17	45.59	32.33	10.6	33.48	105	318	P	H
		5879.6	52.96	-48.82	101.78	43.47	32.36	10.61	33.48	105	318	P	H
		5935	53.12	-15.08	68.2	43.41	32.54	10.66	33.49	105	318	P	H
802.11ac													H
VHT20													H
CH 157		5643.2	51.83	-16.37	68.2	43.12	31.71	10.45	33.45	361	272	P	V
5785MHz		5693.6	51.99	-48.49	100.48	43.01	31.96	10.48	33.46	361	272	P	V
		5702.6	53.8	-52.13	105.93	44.76	32.01	10.49	33.46	361	272	P	V
		5724.8	53.47	-68.27	121.74	44.38	32.05	10.5	33.46	361	272	P	V
	*	5785	111.52	-	-	102.29	32.17	10.53	33.47	361	272	P	V
	*	5785	103.5	-	-	94.27	32.17	10.53	33.47	361	272	A	V
		5852.8	50.46	-65.36	115.82	41.04	32.31	10.59	33.48	361	272	P	V
		5858.2	51.83	-58.07	109.9	42.4	32.32	10.59	33.48	361	272	P	V
		5917.6	51.4	-22.26	73.66	41.77	32.47	10.65	33.49	361	272	P	V
		5947.2	51.91	-16.29	68.2	42.14	32.59	10.67	33.49	361	272	P	V
													V
													V



WiFi Ant. 1+2	Note	Frequency (MHz)	Level (dBμV/m)	Over Limit (dB)	Limit Line (dBμV/m)	Read Level (dBμV)	Antenna Factor (dB/m)	Path Loss (dB)	Preamp Factor (dB)	Ant Pos (cm)	Table Pos (deg)	Peak Avg. (P/A)	Pol. (H/V)	
802.11ac VHT20 CH 165 5825MHz	*	5825	115.78	-	-	106.45	32.25	10.56	33.48	100	320	P	H	
	*	5825	108.06	-	-	98.73	32.25	10.56	33.48	100	320	A	H	
		5850	56.33	-65.87	122.2	46.92	32.3	10.59	33.48	100	320	P	H	
		5863.8	55.3	-53.03	108.33	45.85	32.33	10.6	33.48	100	320	P	H	
		5886.8	54.92	-41.52	96.44	45.41	32.37	10.62	33.48	100	320	P	H	
		5935.2	52.02	-16.18	68.2	42.31	32.54	10.66	33.49	100	320	P	H	
														H
														H
	*	5825	110.7	-	-	101.37	32.25	10.56	33.48	394	267	P	V	
	*	5825	102.76	-	-	93.43	32.25	10.56	33.48	394	267	A	V	
		5853.8	53.29	-60.25	113.54	43.87	32.31	10.59	33.48	394	267	P	V	
		5860.2	53.25	-56.09	109.34	43.82	32.32	10.59	33.48	394	267	P	V	
		5887.6	53.26	-42.59	95.85	43.74	32.38	10.62	33.48	394	267	P	V	
		5945.4	51.48	-16.72	68.2	41.72	32.58	10.67	33.49	394	267	P	V	
														V
													V	
Remark	1. No other spurious found. 2. All results are PASS against Peak and Average limit line.													



Band 4 5725~5850MHz
WIFI 802.11ac VHT20 (Harmonic @ 3m)

WIFI Ant. 1+2	Note	Frequency (MHz)	Level (dBμV/m)	Over Limit (dB)	Limit Line (dBμV/m)	Read Level (dBμV)	Antenna Factor (dB/m)	Path Loss (dB)	Preamp Factor (dB)	Ant Pos (cm)	Table Pos (deg)	Peak Avg. (P/A)	Pol. (H/V)	
802.11ac VHT20 CH 149 5745MHz		11490	47.44	-26.56	74	48.16	39.78	15.8	56.3	100	0	P	H	
		17235	48.2	-20	68.2	44.11	40.7	19.96	56.57	100	0	P	H	
													H	
													H	
			11490	46.42	-27.58	74	47.14	39.78	15.8	56.3	100	0	P	V
			17235	48.97	-19.23	68.2	44.88	40.7	19.96	56.57	100	0	P	V
														V
802.11ac VHT20 CH 157 5785MHz		11570	47.21	-26.79	74	47.99	39.66	15.86	56.3	100	0	P	H	
		17355	49.34	-18.86	68.2	44.63	41.4	20.12	56.81	100	0	P	H	
													H	
													H	
			11570	46.51	-27.49	74	47.29	39.66	15.86	56.3	100	0	P	V
			17355	51.14	-17.06	68.2	46.43	41.4	20.12	56.81	100	0	P	V
														V
802.11ac VHT20 CH 165 5825MHz		11650	46.66	-27.34	74	47.68	39.35	15.93	56.3	100	0	P	H	
		17475	49.63	-18.57	68.2	44.23	42.17	20.28	57.05	100	0	P	H	
													H	
													H	
			11650	46.4	-27.6	74	47.42	39.35	15.93	56.3	100	0	P	V
			17475	49.57	-18.63	68.2	44.17	42.17	20.28	57.05	100	0	P	V
														V
Remark	1. No other spurious found.													
	2. All results are PASS against Peak and Average limit line.													



Band 4 5725~5850MHz
WIFI 802.11ac VHT40 (Band Edge @ 3m)

WIFI Ant. 1+2	Note	Frequency (MHz)	Level (dBμV/m)	Over Limit (dB)	Limit Line (dBμV/m)	Read Level (dBμV)	Antenna Factor (dB/m)	Path Loss (dB)	Preamp Factor (dB)	Ant Pos (cm)	Table Pos (deg)	Peak Avg. (P/A)	Pol. (H/V)	
		5628.4	52.35	-15.85	68.2	43.61	31.74	10.45	33.45	100	319	P	H	
		5698.6	59.59	-44.58	104.17	50.58	31.99	10.48	33.46	100	319	P	H	
		5715	71.03	-38.37	109.4	61.97	32.03	10.49	33.46	100	319	P	H	
		5720.2	68.27	-42.99	111.26	59.19	32.04	10.5	33.46	100	319	P	H	
	*	5755	114.89	-	-	105.73	32.11	10.52	33.47	100	319	P	H	
	*	5755	106.62	-	-	97.46	32.11	10.52	33.47	100	319	A	H	
		5853.8	53.52	-60.02	113.54	44.1	32.31	10.59	33.48	100	319	P	H	
		5858.4	52.83	-57.02	109.85	43.4	32.32	10.59	33.48	100	319	P	H	
		5880.2	53.03	-48.31	101.34	43.54	32.36	10.61	33.48	100	319	P	H	
		5928.4	52.65	-15.55	68.2	42.97	32.51	10.66	33.49	100	319	P	H	
802.11ac VHT40 CH 151 5755MHz													H	
													H	
			5621.2	50.56	-17.64	68.2	41.81	31.76	10.44	33.45	152	334	P	V
			5697.2	55.16	-47.98	103.14	46.16	31.98	10.48	33.46	152	334	P	V
			5718.4	67.12	-43.23	110.35	58.04	32.04	10.5	33.46	152	334	P	V
			5721.2	68.12	-45.42	113.54	59.04	32.04	10.5	33.46	152	334	P	V
		*	5755	110.52	-	-	101.36	32.11	10.52	33.47	152	334	P	V
		*	5755	102.32	-	-	93.16	32.11	10.52	33.47	152	334	A	V
			5852	51.78	-65.86	117.64	42.37	32.3	10.59	33.48	152	334	P	V
			5864.6	52.27	-55.84	108.11	42.82	32.33	10.6	33.48	152	334	P	V
			5899.2	52.71	-34.54	87.25	43.17	32.4	10.63	33.49	152	334	P	V
			5926.8	51.05	-17.15	68.2	41.38	32.51	10.65	33.49	152	334	P	V
														V
														V



WIFI Ant. 1+2	Note	Frequency (MHz)	Level (dBµV/m)	Over Limit (dB)	Limit Line (dBµV/m)	Read Level (dBµV)	Antenna Factor (dB/m)	Path Loss (dB)	Preamp Factor (dB)	Ant Pos (cm)	Table Pos (deg)	Peak Avg. (P/A)	Pol. (H/V)
		5640.6	51.08	-17.12	68.2	42.36	31.72	10.45	33.45	100	319	P	H
		5673.8	52.83	-33.02	85.85	43.97	31.84	10.47	33.45	100	319	P	H
		5719.2	54.97	-55.61	110.58	45.89	32.04	10.5	33.46	100	319	P	H
		5722.8	53.4	-63.78	117.18	44.31	32.05	10.5	33.46	100	319	P	H
	*	5795	114.48	-	-	105.22	32.19	10.54	33.47	100	319	P	H
	*	5795	106.78	-	-	97.52	32.19	10.54	33.47	100	319	A	H
		5853.4	57.41	-57.04	114.45	47.99	32.31	10.59	33.48	100	319	P	H
		5859.4	57	-52.57	109.57	47.57	32.32	10.59	33.48	100	319	P	H
		5878.2	54.48	-48.34	102.82	44.99	32.36	10.61	33.48	100	319	P	H
		5936.2	52.4	-15.8	68.2	42.69	32.54	10.66	33.49	100	319	P	H
802.11ac													H
VHT40													H
CH 159		5613.4	49.98	-18.22	68.2	41.22	31.77	10.44	33.45	100	336	P	V
5795MHz		5692.6	51.68	-48.06	99.74	42.7	31.96	10.48	33.46	100	336	P	V
		5713	53.47	-55.37	108.84	44.41	32.03	10.49	33.46	100	336	P	V
		5723.6	53.46	-65.55	119.01	44.37	32.05	10.5	33.46	100	336	P	V
	*	5795	109.73	-	-	100.47	32.19	10.54	33.47	100	336	P	V
	*	5795	101.87	-	-	92.61	32.19	10.54	33.47	100	336	A	V
		5850	53.18	-69.02	122.2	43.77	32.3	10.59	33.48	100	336	P	V
		5863.4	54.86	-53.59	108.45	45.41	32.33	10.6	33.48	100	336	P	V
		5883.4	52.22	-46.74	98.96	42.71	32.37	10.62	33.48	100	336	P	V
		5949.6	51.67	-16.53	68.2	41.89	32.6	10.67	33.49	100	336	P	V
													V
													V
Remark	1. No other spurious found. 2. All results are PASS against Peak and Average limit line.												



**Band 4 5725~5850MHz
WIFI 802.11ac VHT40 (Harmonic @ 3m)**

WIFI Ant. 1+2	Note	Frequency (MHz)	Level (dBµV/m)	Over Limit (dB)	Limit Line (dBµV/m)	Read Level (dBµV)	Antenna Factor (dB/m)	Path Loss (dB)	Preamp Factor (dB)	Ant Pos (cm)	Table Pos (deg)	Peak Avg. (P/A)	Pol. (H/V)	
802.11ac VHT40 CH 151 5755MHz		11510	46.63	-27.37	74	47.34	39.78	15.81	56.3	100	0	P	H	
		17265	47.53	-20.67	68.2	43.36	40.8	20	56.63	100	0	P	H	
													H	
													H	
			11510	46.87	-27.13	74	47.58	39.78	15.81	56.3	100	0	P	V
			17265	48.75	-19.45	68.2	44.58	40.8	20	56.63	100	0	P	V
														V
802.11ac VHT40 CH 159 5795MHz		11590	46.59	-27.41	74	47.39	39.62	15.88	56.3	100	0	P	H	
		17385	49.38	-18.82	68.2	44.42	41.67	20.16	56.87	100	0	P	H	
													H	
													H	
			11590	46.9	-27.1	74	47.7	39.62	15.88	56.3	100	0	P	V
			17385	49.66	-18.54	68.2	44.7	41.67	20.16	56.87	100	0	P	V
														V
Remark	1. No other spurious found.													
	2. All results are PASS against Peak and Average limit line.													



Band 4 5725~5850MHz
WIFI 802.11ac VHT80 (Band Edge @ 3m)

WIFI Ant. 1+2	Note	Frequency (MHz)	Level (dBμV/m)	Over Limit (dB)	Limit Line (dBμV/m)	Read Level (dBμV)	Antenna Factor (dB/m)	Path Loss (dB)	Preamp Factor (dB)	Ant Pos (cm)	Table Pos (deg)	Peak Avg. (P/A)	Pol. (H/V)	
		5647.8	54.74	-13.46	68.2	46.03	31.7	10.46	33.45	107	318	P	H	
		5694.4	66.14	-34.93	101.07	57.15	31.97	10.48	33.46	107	318	P	H	
		5712.2	69.77	-38.85	108.62	60.72	32.02	10.49	33.46	107	318	P	H	
		5720	64.66	-46.14	110.8	55.58	32.04	10.5	33.46	107	318	P	H	
	*	5775	111.67	-	-	102.46	32.15	10.53	33.47	107	318	P	H	
	*	5775	103.76	-	-	94.55	32.15	10.53	33.47	107	318	A	H	
		5853	72.32	-43.04	115.36	62.9	32.31	10.59	33.48	107	318	P	H	
		5855.2	70.41	-40.33	110.74	60.99	32.31	10.59	33.48	107	318	P	H	
		5875.8	65.41	-39.2	104.61	55.93	32.35	10.61	33.48	107	318	P	H	
		5948.4	52.45	-15.75	68.2	42.68	32.59	10.67	33.49	107	318	P	H	
802.11ac VHT80 CH 155 5775MHz													H	
													H	
			5643.2	52.38	-15.82	68.2	43.67	31.71	10.45	33.45	141	332	P	V
			5698.4	63.75	-40.27	104.02	54.74	31.99	10.48	33.46	141	332	P	V
			5719.4	65.01	-45.62	110.63	55.93	32.04	10.5	33.46	141	332	P	V
			5721	65.33	-47.75	113.08	56.25	32.04	10.5	33.46	141	332	P	V
		*	5775	107.22	-	-	98.01	32.15	10.53	33.47	141	332	P	V
		*	5775	99.42	-	-	90.21	32.15	10.53	33.47	141	332	A	V
			5855	65.28	-45.52	110.8	55.86	32.31	10.59	33.48	141	332	P	V
			5859.2	67.18	-42.44	109.62	57.75	32.32	10.59	33.48	141	332	P	V
			5877.2	60.17	-43.4	103.57	50.69	32.35	10.61	33.48	141	332	P	V
			5944.4	51.46	-16.74	68.2	41.7	32.58	10.67	33.49	141	332	P	V
														V
														V
	Remark	1. No other spurious found. 2. All results are PASS against Peak and Average limit line.												



Band 4 5725~5850MHz

WIFI 802.11ac VHT80 (Harmonic @ 3m)

WIFI Ant. 1+2	Note	Frequency (MHz)	Level (dBμV/m)	Over Limit (dB)	Limit Line (dBμV/m)	Read Level (dBμV)	Antenna Factor (dB/m)	Path Loss (dB)	Preamp Factor (dB)	Ant Pos (cm)	Table Pos (deg)	Peak Avg. (P/A)	Pol. (H/V)	
802.11ac VHT80 CH 155 5775MHz		11550	46.83	-27.17	74	47.58	39.7	15.85	56.3	100	0	P	H	
		17325	49.08	-19.12	68.2	44.64	41.12	20.07	56.75	100	0	P	H	
													H	
													H	
			11550	47.03	-26.97	74	47.78	39.7	15.85	56.3	100	0	P	V
			17325	48.42	-19.78	68.2	43.98	41.12	20.07	56.75	100	0	P	V
														V
Remark	1. No other spurious found. 2. All results are PASS against Peak and Average limit line.													



Emission below 1GHz

5GHz WIFI 802.11ac VHT80 (LF @ 3m)

WIFI	Note	Frequency	Level	Over	Limit	Read	Antenna	Path	Preamp	Ant	Table	Peak	Pol.	
Ant.				Limit	Line	Level	Factor	Loss	Factor	Pos	Pos	Avg.		
1+2		(MHz)	(dBμV/m)	(dB)	(dBμV/m)	(dBμV)	(dB/m)	(dB)	(dB)	(cm)	(deg)	(P/A)	(H/V)	
5GHz 802.11ac VHT80 LF		43.58	32	-8	40	43.96	17.45	0.97	30.38	100	0	P	H	
		106.63	31.64	-11.86	43.5	43.88	16.67	1.51	30.42	-	-	P	H	
		140.58	24.35	-19.15	43.5	35.76	17.32	1.66	30.39	-	-	P	H	
		713.85	37.8	-8.2	46	36.42	26.94	3.93	29.49	-	-	P	H	
		819.58	34.66	-11.34	46	31.43	28.23	4.26	29.26	-	-	P	H	
		910.76	36.75	-9.25	46	32.14	29.19	4.53	29.11	-	-	P	H	
														H
														H
														H
														H
														H
														H
														H
														H
														H
														H
			43.58	36.38	-3.62	40	48.34	17.45	0.97	30.38	100	85	QP	V
			43.58	41.45	1.45	40	53.41	17.45	0.97	30.38	100	85	P	V
			96.93	30.32	-13.18	43.5	43.79	15.5	1.46	30.43	-	-	P	V
		154.16	23.62	-19.88	43.5	35.26	16.99	1.74	30.37	-	-	P	V	
		741.98	33.83	-12.17	46	31.32	27.9	4.03	29.42	-	-	P	V	
		865.17	35.44	-10.56	46	30.99	29.24	4.4	29.19	-	-	P	V	
		910.76	37.53	-8.47	46	32.92	29.19	4.53	29.11	-	-	P	V	
													V	
													V	
													V	
													V	
													V	
													V	
Remark	1. No other spurious found. 2. All results are PASS against limit line.													



<TXBF Mode>

Band 4 - 5725~5850MHz

WIFI 802.11ac VHT20 (Band Edge @ 3m)

WIFI Ant.	Note	Frequency	Level	Over Limit	Limit Line	Read Level	Antenna Factor	Path Loss	Preamp Factor	Ant Pos	Table Pos	Peak Avg.	Pol.	
1+2		(MHz)	(dBµV/m)	(dB)	(dBµV/m)	(dBµV)	(dB/m)	(dB)	(dB)	(cm)	(deg)	(P/A)	(H/V)	
802.11ac VHT20 CH 149 5745MHz		5622.8	49.7	-18.5	68.2	40.96	31.75	10.44	33.45	203	25	P	H	
		5688.2	51.41	-45.09	96.5	42.46	31.93	10.48	33.46	203	25	P	H	
		5709.8	50.95	-57	107.95	41.9	32.02	10.49	33.46	203	25	P	H	
		5724.4	53.99	-66.84	120.83	44.9	32.05	10.5	33.46	203	25	P	H	
	*	5745	106.03	-	-	96.89	32.09	10.51	33.46	203	25	P	H	
	*	5745	95.81	-	-	86.67	32.09	10.51	33.46	203	25	A	H	
														H
														H
			5641.6	51.22	-16.98	68.2	42.5	31.72	10.45	33.45	266	55	P	V
			5691.2	53.32	-45.39	98.71	44.35	31.95	10.48	33.46	266	55	P	V
			5717	56.58	-53.38	109.96	47.52	32.03	10.49	33.46	266	55	P	V
			5725	65.42	-56.78	122.2	56.33	32.05	10.5	33.46	266	55	P	V
	*		5745	113.79	-	-	104.65	32.09	10.51	33.46	266	55	P	V
	*		5745	104.64	-	-	95.5	32.09	10.51	33.46	266	55	A	V
													V	
													V	



WIFI Ant. 1+2	Note	Frequency (MHz)	Level (dBμV/m)	Over Limit (dB)	Limit Line (dBμV/m)	Read Level (dBμV)	Antenna Factor (dB/m)	Path Loss (dB)	Preamp Factor (dB)	Ant Pos (cm)	Table Pos (deg)	Peak Avg. (P/A)	Pol. (H/V)
		5644.6	50.07	-18.13	68.2	41.36	31.71	10.45	33.45	400	275	P	H
		5684.8	51.67	-42.32	93.99	42.74	31.91	10.48	33.46	400	275	P	H
		5712.2	51.73	-56.89	108.62	42.68	32.02	10.49	33.46	400	275	P	H
		5721.2	51.77	-61.77	113.54	42.69	32.04	10.5	33.46	400	275	P	H
	*	5785	110.9	-	-	101.67	32.17	10.53	33.47	400	275	P	H
	*	5785	101.24	-	-	92.01	32.17	10.53	33.47	400	275	A	H
		5854.4	52.97	-59.2	112.17	43.55	32.31	10.59	33.48	400	275	P	H
		5857.8	54.03	-55.98	110.01	44.6	32.32	10.59	33.48	400	275	P	H
		5881.2	52.94	-47.65	100.59	43.45	32.36	10.61	33.48	400	275	P	H
		5944.2	53.2	-15	68.2	43.44	32.58	10.67	33.49	400	275	P	H
802.11ac													H
VHT20													H
CH 157		5622.4	51.08	-17.12	68.2	42.33	31.76	10.44	33.45	400	8	P	V
5785MHz		5697.4	51.97	-51.31	103.28	42.97	31.98	10.48	33.46	400	8	P	V
		5717.2	52.58	-57.44	110.02	43.52	32.03	10.49	33.46	400	8	P	V
		5722	53.38	-61.98	115.36	44.3	32.04	10.5	33.46	400	8	P	V
	*	5785	116.17	-	-	106.94	32.17	10.53	33.47	400	8	P	V
	*	5785	106.86	-	-	97.63	32.17	10.53	33.47	400	8	A	V
		5850.4	53.77	-67.52	121.29	44.36	32.3	10.59	33.48	400	8	P	V
		5871.4	52.66	-53.55	106.21	43.2	32.34	10.6	33.48	400	8	P	V
		5875.6	52.59	-52.16	104.75	43.11	32.35	10.61	33.48	400	8	P	V
		5935.4	52.38	-15.82	68.2	42.67	32.54	10.66	33.49	400	8	P	V
													V
													V



WiFi Ant. 1+2	Note	Frequency (MHz)	Level (dBμV/m)	Over Limit (dB)	Limit Line (dBμV/m)	Read Level (dBμV)	Antenna Factor (dB/m)	Path Loss (dB)	Preamp Factor (dB)	Ant Pos (cm)	Table Pos (deg)	Peak Avg. (P/A)	Pol. (H/V)	
802.11ac VHT20 CH 165 5825MHz	*	5825	110.01	-	-	100.68	32.25	10.56	33.48	400	73	P	H	
	*	5825	101.16	-	-	91.83	32.25	10.56	33.48	400	73	A	H	
		5851.8	51.77	-66.33	118.1	42.36	32.3	10.59	33.48	400	73	P	H	
		5871.8	54.21	-51.88	106.09	44.75	32.34	10.6	33.48	400	73	P	H	
		5883	53.16	-46.1	99.26	43.66	32.37	10.61	33.48	400	73	P	H	
		5928.8	51.81	-16.39	68.2	42.12	32.52	10.66	33.49	400	73	P	H	
														H
														H
	*	5825	115.11	-	-	105.78	32.25	10.56	33.48	397	357	P	V	
	*	5825	106.1	-	-	96.77	32.25	10.56	33.48	397	357	A	V	
		5852.2	56.24	-60.94	117.18	46.83	32.3	10.59	33.48	397	357	P	V	
		5859.8	55.31	-54.14	109.45	45.88	32.32	10.59	33.48	397	357	P	V	
		5881.4	54.93	-45.52	100.45	45.44	32.36	10.61	33.48	397	357	P	V	
		5944.8	52.17	-16.03	68.2	42.41	32.58	10.67	33.49	397	357	P	V	
														V
													V	
Remark	1. No other spurious found. 2. All results are PASS against Peak and Average limit line.													



Band 4 5725~5850MHz
WIFI 802.11ac VHT20 (Harmonic @ 3m)

WIFI Ant. 1+2	Note	Frequency (MHz)	Level (dBµV/m)	Over Limit (dB)	Limit Line (dBµV/m)	Read Level (dBµV)	Antenna Factor (dB/m)	Path Loss (dB)	Preamp Factor (dB)	Ant Pos (cm)	Table Pos (deg)	Peak Avg. (P/A)	Pol. (H/V)	
802.11ac VHT20 CH 149 5745MHz		11490	48.5	-25.5	74	57.33	39.78	15.8	64.41	100	0	P	H	
		17235	49.75	-18.45	68.2	49.91	40.7	19.96	60.82	100	0	P	H	
													H	
													H	
			11490	47.05	-26.95	74	55.88	39.78	15.8	64.41	100	0	P	V
			17235	49.3	-18.9	68.2	49.46	40.7	19.96	60.82	100	0	P	V
														V
802.11ac VHT20 CH 157 5785MHz		11570	48.35	-25.65	74	57.22	39.66	15.86	64.39	100	0	P	H	
		17355	50.45	-17.75	68.2	49.6	41.4	20.12	60.67	100	0	P	H	
													H	
													H	
			11570	48.04	-25.96	74	56.91	39.66	15.86	64.39	100	0	P	V
			17355	50.83	-17.37	68.2	49.98	41.4	20.12	60.67	100	0	P	V
														V
802.11ac VHT20 CH 165 5825MHz		11650	47.31	-26.69	74	56.4	39.35	15.93	64.37	100	0	P	H	
		17475	51.61	-16.59	68.2	49.69	42.17	20.28	60.53	100	0	P	H	
													H	
													H	
			11650	47.2	-26.8	74	56.29	39.35	15.93	64.37	100	0	P	V
			17475	51.65	-16.55	68.2	49.73	42.17	20.28	60.53	100	0	P	V
														V
Remark	1. No other spurious found.													
	2. All results are PASS against Peak and Average limit line.													



Band 4 5725~5850MHz
WIFI 802.11ac VHT40 (Band Edge @ 3m)

WIFI Ant. 1+2	Note	Frequency (MHz)	Level (dBμV/m)	Over Limit (dB)	Limit Line (dBμV/m)	Read Level (dBμV)	Antenna Factor (dB/m)	Path Loss (dB)	Preamp Factor (dB)	Ant Pos (cm)	Table Pos (deg)	Peak Avg. (P/A)	Pol. (H/V)
		5646.2	49.74	-18.46	68.2	41.02	31.71	10.46	33.45	391	272	P	H
		5699	57.53	-46.93	104.46	48.52	31.99	10.48	33.46	391	272	P	H
		5720	66.91	-43.89	110.8	57.83	32.04	10.5	33.46	391	272	P	H
		5724.4	68.81	-52.02	120.83	59.72	32.05	10.5	33.46	391	272	P	H
	*	5755	106.37	-	-	97.21	32.11	10.52	33.47	391	272	P	H
	*	5755	98.51	-	-	89.35	32.11	10.52	33.47	391	272	A	H
		5852.8	53.25	-62.57	115.82	43.83	32.31	10.59	33.48	391	272	P	H
		5864.4	52.91	-55.26	108.17	43.46	32.33	10.6	33.48	391	272	P	H
		5902.6	52.63	-32.11	84.74	43.08	32.41	10.63	33.49	391	272	P	H
		5944.4	53.01	-15.19	68.2	43.25	32.58	10.67	33.49	391	272	P	H
802.11ac													H
VHT40													H
CH 151		5634.2	50.79	-17.41	68.2	42.06	31.73	10.45	33.45	400	358	P	V
5755MHz		5699.8	61.56	-43.49	105.05	52.54	32	10.48	33.46	400	358	P	V
		5715.2	75.68	-33.78	109.46	66.62	32.03	10.49	33.46	400	358	P	V
		5723.4	77.04	-41.51	118.55	67.95	32.05	10.5	33.46	400	358	P	V
	*	5755	112.85	-	-	103.69	32.11	10.52	33.47	400	358	P	V
	*	5755	104.89	-	-	95.73	32.11	10.52	33.47	400	358	A	V
		5851	57.12	-62.8	119.92	47.71	32.3	10.59	33.48	400	358	P	V
		5859.8	55.7	-53.75	109.45	46.27	32.32	10.59	33.48	400	358	P	V
		5888	52.13	-43.42	95.55	42.61	32.38	10.62	33.48	400	358	P	V
		5940	51.88	-16.32	68.2	42.14	32.56	10.67	33.49	400	358	P	V
													V
													V



WIFI Ant. 1+2	Note	Frequency (MHz)	Level (dBμV/m)	Over Limit (dB)	Limit Line (dBμV/m)	Read Level (dBμV)	Antenna Factor (dB/m)	Path Loss (dB)	Preamp Factor (dB)	Ant Pos (cm)	Table Pos (deg)	Peak Avg. (P/A)	Pol. (H/V)
		5621.8	49.22	-18.98	68.2	40.47	31.76	10.44	33.45	399	276	P	H
		5699.4	52.73	-52.03	104.76	43.71	32	10.48	33.46	399	276	P	H
		5715.8	54.42	-55.21	109.63	45.36	32.03	10.49	33.46	399	276	P	H
		5724.2	55.22	-65.16	120.38	46.13	32.05	10.5	33.46	399	276	P	H
	*	5795	109.86	-	-	100.6	32.19	10.54	33.47	399	276	P	H
	*	5795	101.12	-	-	91.86	32.19	10.54	33.47	399	276	A	H
		5851.2	64.55	-54.91	119.46	55.14	32.3	10.59	33.48	399	276	P	H
		5858	62.87	-47.09	109.96	53.44	32.32	10.59	33.48	399	276	P	H
		5876.8	56.68	-47.18	103.86	47.2	32.35	10.61	33.48	399	276	P	H
		5944.8	50.89	-17.31	68.2	41.13	32.58	10.67	33.49	399	276	P	H
802.11ac													H
VHT40													H
CH 159		5631	50.64	-17.56	68.2	41.9	31.74	10.45	33.45	400	352	P	V
5795MHz		5697	57.65	-45.34	102.99	48.65	31.98	10.48	33.46	400	352	P	V
		5719	58.28	-52.24	110.52	49.2	32.04	10.5	33.46	400	352	P	V
		5722.2	60.65	-55.17	115.82	51.57	32.04	10.5	33.46	400	352	P	V
	*	5795	113.35	-	-	104.09	32.19	10.54	33.47	400	352	P	V
	*	5795	105.63	-	-	96.37	32.19	10.54	33.47	400	352	A	V
		5850.6	69.4	-51.43	120.83	59.99	32.3	10.59	33.48	400	352	P	V
		5855.2	65.46	-45.28	110.74	56.04	32.31	10.59	33.48	400	352	P	V
		5877.8	58.28	-44.84	103.12	48.79	32.36	10.61	33.48	400	352	P	V
		5941.8	53.19	-15.01	68.2	43.44	32.57	10.67	33.49	400	352	P	V
													V
													V
Remark	1. No other spurious found. 2. All results are PASS against Peak and Average limit line.												



**Band 4 5725~5850MHz
WIFI 802.11ac VHT40 (Harmonic @ 3m)**

WIFI Ant. 1+2	Note	Frequency (MHz)	Level (dBµV/m)	Over Limit (dB)	Limit Line (dBµV/m)	Read Level (dBµV)	Antenna Factor (dB/m)	Path Loss (dB)	Preamp Factor (dB)	Ant Pos (cm)	Table Pos (deg)	Peak Avg. (P/A)	Pol. (H/V)	
802.11ac VHT40 CH 151 5755MHz		11510	48.27	-25.73	74	57.08	39.78	15.81	64.4	100	0	P	H	
		17265	49.2	-19	68.2	49.18	40.8	20	60.78	100	0	P	H	
													H	
													H	
			11510	47.37	-26.63	74	56.18	39.78	15.81	64.4	100	0	P	V
			17265	48.63	-19.57	68.2	48.61	40.8	20	60.78	100	0	P	V
														V
802.11ac VHT40 CH 159 5795MHz		11590	48.04	-25.96	74	56.92	39.62	15.88	64.38	100	0	P	H	
		17385	50.75	-17.45	68.2	49.56	41.67	20.16	60.64	100	0	P	H	
													H	
													H	
			11590	48.15	-25.85	74	57.03	39.62	15.88	64.38	100	0	P	V
			17385	51.15	-17.05	68.2	49.96	41.67	20.16	60.64	100	0	P	V
														V
Remark	1. No other spurious found.													
	2. All results are PASS against Peak and Average limit line.													



Band 4 5725~5850MHz
WIFI 802.11ac VHT80 (Band Edge @ 3m)

WIFI Ant. 1+2	Note	Frequency (MHz)	Level (dBμV/m)	Over Limit (dB)	Limit Line (dBμV/m)	Read Level (dBμV)	Antenna Factor (dB/m)	Path Loss (dB)	Preamp Factor (dB)	Ant Pos (cm)	Table Pos (deg)	Peak Avg. (P/A)	Pol. (H/V)	
		5649	55.01	-13.19	68.2	46.3	31.7	10.46	33.45	400	274	P	H	
		5699	71.47	-32.99	104.46	62.46	31.99	10.48	33.46	400	274	P	H	
		5709	76.43	-31.29	107.72	67.38	32.02	10.49	33.46	400	274	P	H	
		5724.8	78.38	-43.36	121.74	69.29	32.05	10.5	33.46	400	274	P	H	
	*	5775	105.07	-	-	95.86	32.15	10.53	33.47	400	274	P	H	
	*	5775	99.02	-	-	89.81	32.15	10.53	33.47	400	274	A	H	
		5852.2	75.29	-41.89	117.18	65.88	32.3	10.59	33.48	400	274	P	H	
		5860	76.12	-33.28	109.4	66.69	32.32	10.59	33.48	400	274	P	H	
		5878	67.3	-35.67	102.97	57.81	32.36	10.61	33.48	400	274	P	H	
		5927.6	52.65	-15.55	68.2	42.98	32.51	10.65	33.49	400	274	P	H	
802.11ac VHT80 CH 155 5775MHz													H	
													H	
			5644	59.52	-8.68	68.2	50.81	31.71	10.45	33.45	400	350	P	V
			5679	77.49	-12.21	89.7	68.61	31.87	10.47	33.46	400	350	P	V
			5719.2	80.39	-30.19	110.58	71.31	32.04	10.5	33.46	400	350	P	V
			5722.8	79.96	-37.22	117.18	70.87	32.05	10.5	33.46	400	350	P	V
		*	5775	110.22	-	-	101.01	32.15	10.53	33.47	400	350	P	V
		*	5775	103.73	-	-	94.52	32.15	10.53	33.47	400	350	A	V
			5850.4	78.7	-42.59	121.29	69.29	32.3	10.59	33.48	400	350	P	V
			5868.4	77.8	-29.25	107.05	68.34	32.34	10.6	33.48	400	350	P	V
			5875	72.18	-33.02	105.2	62.7	32.35	10.61	33.48	400	350	P	V
			5925.6	56.1	-12.1	68.2	46.44	32.5	10.65	33.49	400	350	P	V
														V
														V
	Remark	1. No other spurious found. 2. All results are PASS against Peak and Average limit line.												



**Band 4 5725~5850MHz
WIFI 802.11ac VHT80 (Harmonic @ 3m)**

WIFI Ant. 1+2	Note	Frequency (MHz)	Level (dBμV/m)	Over Limit (dB)	Limit Line (dBμV/m)	Read Level (dBμV)	Antenna Factor (dB/m)	Path Loss (dB)	Preamp Factor (dB)	Ant Pos (cm)	Table Pos (deg)	Peak Avg. (P/A)	Pol. (H/V)	
802.11ac VHT80 CH 155 5775MHz		11550	49.65	-24.35	74	58.49	39.7	15.85	64.39	100	0	P	H	
		17325	49.72	-18.48	68.2	49.24	41.12	20.07	60.71	100	0	P	H	
													H	
													H	
			11550	49.71	-24.29	74	58.55	39.7	15.85	64.39	100	0	P	V
			17325	50.69	-17.51	68.2	50.21	41.12	20.07	60.71	100	0	P	V
														V
														V
Remark	1. No other spurious found. 2. All results are PASS against Peak and Average limit line.													



Emission below 1GHz
WIFI 802.11ac VHT20 (LF @ 3m)

WIFI	Note	Frequency	Level	Over	Limit	Read	Antenna	Path	Preamp	Ant	Table	Peak	Pol.	
Ant.				Limit	Line	Level	Factor	Loss	Factor	Pos	Pos	Avg.		
1+2		(MHz)	(dBμV/m)	(dB)	(dBμV/m)	(dBμV)	(dB/m)	(dB)	(dB)	(cm)	(deg)	(P/A)	(H/V)	
5GHz 802.11ac VHT20 LF		94.02	29	-14.5	43.5	42.8	15.21	1.42	30.43	-	-	P	H	
		178.41	37.34	-6.16	43.5	50.68	15.12	1.88	30.34	100	0	P	H	
		192.96	32.5	-11	43.5	45.98	14.89	1.96	30.33	-	-	P	H	
		734.22	34.61	-11.39	46	32.39	27.66	4	29.44	-	-	P	H	
		889.42	36.52	-9.48	46	32.16	29.05	4.47	29.16	-	-	P	H	
		958.29	36.36	-9.64	46	29.83	30.81	4.69	28.97	-	-	P	H	
														H
														H
														H
														H
														H
														H
														H
														H
														H
			38.73	31.78	-8.22	40	41.25	19.9	0.94	30.31	100	0	P	V
			161.92	34.03	-9.47	43.5	46.13	16.48	1.78	30.36	-	-	P	V
			176.47	35.82	-7.68	43.5	49.06	15.24	1.87	30.35	-	-	P	V
		718.7	35.49	-10.51	46	33.96	27.07	3.94	29.48	-	-	P	V	
		742.95	36.73	-9.27	46	34.22	27.9	4.03	29.42	-	-	P	V	
		891.36	36.17	-9.83	46	31.81	29.04	4.47	29.15	-	-	P	V	
													V	
													V	
													V	
													V	
													V	
													V	
Remark	1. No other spurious found. 2. All results are PASS against limit line.													



Note symbol

*	Fundamental Frequency which can be ignored. However, the level of any unwanted emissions shall not exceed the level of the fundamental frequency.
!	Test result is over limit line.
P/A	Peak or Average
H/V	Horizontal or Vertical



A calculation example for radiated spurious emission is shown as below:

WIFI	Note	Frequency	Level	Over	Limit	Read	Antenna	Path	Preamp	Ant	Table	Peak	Pol.
Ant.				Limit	Line	Level	Factor	Loss	Factor	Pos	Pos	Avg.	
1+2		(MHz)	(dBμV/m)	(dB)	(dBμV/m)	(dBμV)	(dB/m)	(dB)	(dB)	(cm)	(deg)	(P/A)	(H/V)
802.11b		2390	55.45	-18.55	74	54.51	32.22	4.58	35.86	103	308	P	H
CH 01													
2412MHz		2390	43.54	-10.46	54	42.6	32.22	4.58	35.86	103	308	A	H

1. Path Loss(dB) = Cable loss(dB) + Filter loss(dB) + Attenuator loss(dB)
2. Level(dBμV/m) = Antenna Factor(dB/m) + Path Loss(dB) + Read Level(dBμV) - Preamp Factor(dB)
3. Over Limit(dB) = Level(dBμV/m) – Limit Line(dBμV/m)

For Peak Limit @ 2390MHz:

1. Level(dBμV/m)
= Antenna Factor(dB/m) + Path Loss(dB) + Read Level(dBμV) - Preamp Factor(dB)
= 32.22(dB/m) + 4.58(dB) + 54.51(dBμV) – 35.86 (dB)
= 55.45 (dBμV/m)
2. Over Limit(dB)
= Level(dBμV/m) – Limit Line(dBμV/m)
= 55.45(dBμV/m) – 74(dBμV/m)
= -18.55(dB)

For Average Limit @ 2390MHz:

1. Level(dBμV/m)
= Antenna Factor(dB/m) + Path Loss(dB) + Read Level(dBμV) - Preamp Factor(dB)
= 32.22(dB/m) + 4.58(dB) + 42.6(dBμV) – 35.86 (dB)
= 43.54 (dBμV/m)
2. Over Limit(dB) = Level(dBμV/m) – Limit Line(dBμV/m)
= 43.54(dBμV/m) – 54(dBμV/m)
= -10.46(dB)

Both peak and average measured complies with the limit line, so test result is “PASS”.



Appendix C. Radiated Spurious Emission Plots

Test Engineer :	Jack Cheng , Lance Chiang , CR Liao	Temperature :	23.1~26.4°C
		Relative Humidity :	51.8~60.9%

Note symbol

-L	Low channel location
-R	High channel location



<CDD Mode>

Band 4 - 5725~5850MHz
WIFI 802.11a (Band Edge @ 3m)

WIFI	Band 4 5725~5850MHz Band Edge @ 3m	
ANT	802.11a CH149 5745MHz	
1	Horizontal	Fundamental
Peak	<p>Site : 03CH12-HY Condition : PEAK_BED@_16-24 3m HORN_91200_1328 HORIZONTAL Detector : Peak Project : 981244 Setting : 17.5</p>	<p>Site : 03CH12-HY Condition : PEAK(FUN) 3m HORN_91200_1328 HORIZONTAL Detector : Peak Project : 981244 Setting : 17.5</p>



WIFI	Band 4 5725~5850MHz Band Edge @ 3m	
ANT	802.11a CH149 5745MHz	
1	Vertical	Fundamental
<p>Peak</p>	<p>Site : 03CH12-11Y Condition : PEAK_RE(B4)_16-24 3m HORN_91200_1328 VERTICAL Detector : Peak Project : 981244 Setting : 17.5</p>	<p>Site : 03CH12-11Y Condition : PEAK(FUNTE) 3m HORN_91200_1328 VERTICAL Detector : Peak Project : 981244 Setting : 17.5</p>



WIFI	Band 4 5725~5850MHz Band Edge @ 3m	
ANT	802.11a CH157 5785MHz	
1	Horizontal	Fundamental
<p>Peak</p>	<p>Site : 03CH12-HY Condition : PEAK_BE(B4)_16-24 3m HORN_9120D_1328 HORIZONTAL Detector : Peak Project : 981244 Setting : 17.5</p>	<p>Site : 03CH12-HY Condition : PEAK(FUNDE) 3m HORN_9120D_1328 HORIZONTAL Detector : Peak Project : 981244 Setting : 17.5</p>
<p>Peak</p>	<p>Site : 03CH12-HY Condition : PEAK_BE(B4)_16-24 3m HORN_9120D_1328 HORIZONTAL Detector : Peak Project : 981244 Setting : 17.5</p>	<p>Left blank</p>



WIFI	Band 4 5725~5850MHz Band Edge @ 3m	
ANT	802.11a CH157 5785MHz	
1	Vertical	Fundamental
<p>Peak</p>	<p>Site : 03CH12-HY Condition : PEAK_BE(B4)_16-24 3m HORN_9120D_1328 VERTICAL Detector : Peak Project : 981244 Setting : 17.5</p>	<p>Site : 03CH12-HY Condition : PEAK(UNIT) 3m HORN_9120D_1328 VERTICAL Detector : Peak Project : 981244 Setting : 17.5</p>
<p>Peak</p>	<p>Site : 03CH12-HY Condition : PEAK_BE(B4)_16-24 3m HORN_9120D_1328 VERTICAL Detector : Peak Project : 981244 Setting : 17.5</p>	<p>Left blank</p>

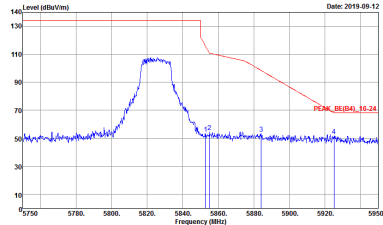
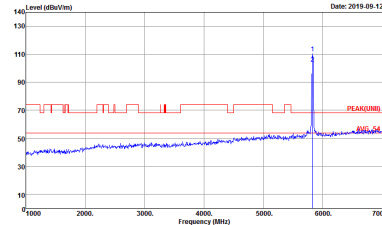

WIFI	Band 4 5725~5850MHz Band Edge @ 3m	
ANT	802.11a CH165 5825MHz	
1	Horizontal	Fundamental
Peak	 <p>Site : 03CH12-11Y Condition : PEAK_BEB(4)_16-24 3m HORN_91200_1328 HORIZONTAL Detector : Peak Project : 981244 Setting : 17.5</p>	 <p>Site : 03CH12-11Y Condition : PEAK(UNIT) 3m HORN_91200_1328 HORIZONTAL Detector : Peak Project : 981244 Setting : 17.5</p>

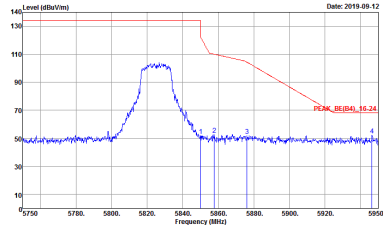
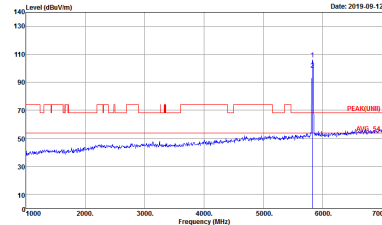

WIFI	Band 4 5725~5850MHz Band Edge @ 3m	
ANT	802.11a CH165 5825MHz	
1	Vertical	Fundamental
Peak	 <p>Site : 03CH12-11Y Condition : PEAK_BEB(4)_16-24 3m HORN_9120D_1328 VERTICAL Detector : Peak Project : 981244 Setting : 17.5</p>	 <p>Site : 03CH12-11Y Condition : PEAK(UNIT) 3m HORN_9120D_1328 VERTICAL Detector : Peak Project : 981244 Setting : 17.5</p>

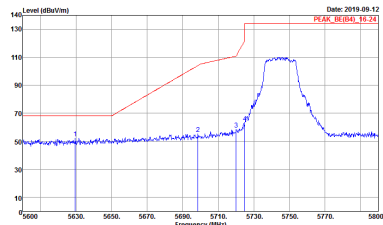
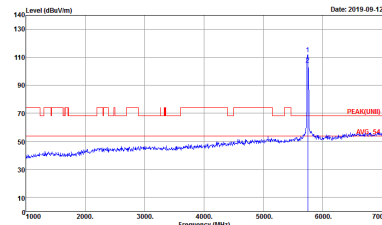

**Band 4 5725~5850MHz
WIFI 802.11ac VHT20 (Band Edge @ 3m)**

WIFI	Band 4 5725~5850MHz Band Edge @ 3m	
ANT	802.11ac VHT20 CH149 5745MHz	
1	Horizontal	Fundamental
Peak	 <p>Date: 2019-09-12 PEAK: 10.000, 10.000</p> <p>Site : 03CH12-HY Condition : PEAK_BE(B4)_16-24 3m HORN_9120D_1328 HORIZONTAL RBW:3000.000KHz VBW:3000.000KHz SWT:Auto Detector : Peak Project : 981244 Setting : 175</p>	 <p>Date: 2019-09-12 PEAK(LINE): 48.54</p> <p>Site : 03CH12-HY Condition : PEAK(LINE) 3m HORN_9120D_1328 HORIZONTAL RBW:3000.000KHz VBW:3000.000KHz SWT:Auto Detector : Peak Project : 981244 Setting : 175</p>

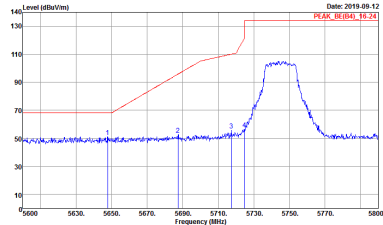
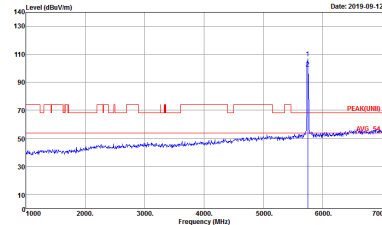

WIFI	Band 4 5725~5850MHz Band Edge @ 3m	
ANT	802.11ac VHT20 CH149 5745MHz	
1	Vertical	Fundamental
<p>Peak</p> <p>Avg.</p>	 <p>Date: 2019-09-12 PEAK RE (00_1624)</p> <p>Site : 03CH12-11Y Condition : PEAK (RE(B4)_16-24 3m HORN_9120D_1328 VERTICAL) Detector : Peak Project : 981244 Setting : 17.5</p>	 <p>Date: 2019-09-12 PEAK (0000) 005_54</p> <p>Site : 03CH12-11Y Condition : PEAK (UNITE) 3m HORN_9120D_1328 VERTICAL Detector : Peak Project : 981244 Setting : 17.5</p>

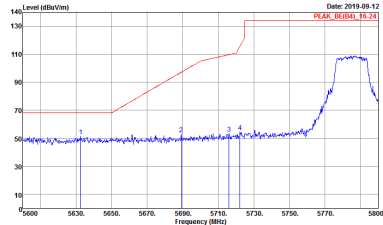
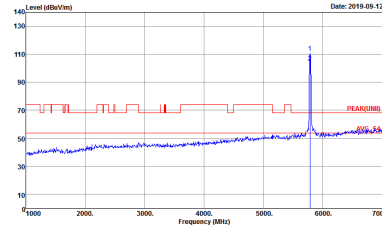
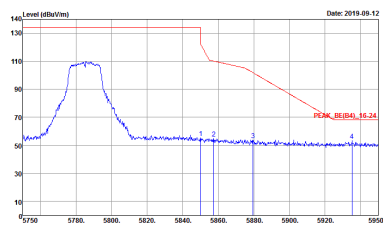

WIFI	Band 4 5725~5850MHz Band Edge @ 3m	
ANT	802.11ac VHT20 CH157 5785MHz	
1	Horizontal	Fundamental
<p>Peak</p>	 <p>Site : 03CH12-HY Condition : PEAK_BE(B4)_16-24 3m HORN_9120D_1328 HORIZONTAL Detector : Peak Project : 981244 Setting : 17.5</p>	 <p>Site : 03CH12-HY Condition : PEAK(FUNDE) 3m HORN_9120D_1328 HORIZONTAL Detector : Peak Project : 981244 Setting : 17.5</p>
<p>Peak</p>	 <p>Site : 03CH12-HY Condition : PEAK_BE(B4)_16-24 3m HORN_9120D_1328 HORIZONTAL Detector : Peak Project : 981244 Setting : 17.5</p>	<p>Left blank</p>



WIFI	Band 4 5725~5850MHz Band Edge @ 3m	
ANT	802.11ac VHT20 CH157 5785MHz	
1	Vertical	Fundamental
<p>Peak</p>	<p>Site : 03CH12-HY Condition : PEAK_BE(B4)_16-24 3m HORN_9120D_1328 VERTICAL Detector : Peak Project : 981244 Setting : 17.5</p>	<p>Site : 03CH12-HY Condition : PEAK(UNIT) 3m HORN_9120D_1328 VERTICAL Detector : Peak Project : 981244 Setting : 17.5</p>
<p>Peak</p>	<p>Site : 03CH12-HY Condition : PEAK_BE(B4)_16-24 3m HORN_9120D_1328 VERTICAL Detector : Peak Project : 981244 Setting : 17.5</p>	<p>Left blank</p>



WIFI	Band 4 5725~5850MHz Band Edge @ 3m	
ANT	802.11ac VHT20 CH165 5825MHz	
1	Horizontal	Fundamental
Peak	<p>Site : 03CH12-11Y Condition : PEAK_BE(B4)_16-24 3m HORN_9120_1328 HORIZONTAL Detector : Peak Project : 981244 Setting : 17.5</p>	<p>Site : 03CH12-11Y Condition : PEAK(FUND) 3m HORN_9120_1328 HORIZONTAL Detector : Peak Project : 981244 Setting : 17.5</p>

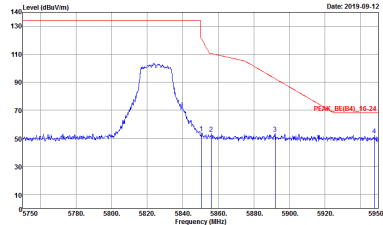
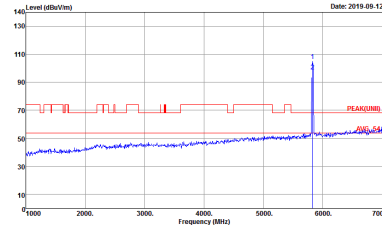

WIFI	Band 4 5725~5850MHz Band Edge @ 3m	
ANT	802.11ac VHT20 CH165 5825MHz	
1	Vertical	Fundamental
<p>Peak</p> <p>Avg.</p>	 <p>Site : 03CH12-11Y Condition : PEAK_BEB(4)_16-24 3m HORN_9120D_1328 VERTICAL Detector : Peak Project : 981244 Setting : 17.5</p>	 <p>Site : 03CH12-11Y Condition : PEAK(UNIT) 3m HORN_9120D_1328 VERTICAL Detector : Peak Project : 981244 Setting : 17.5</p>

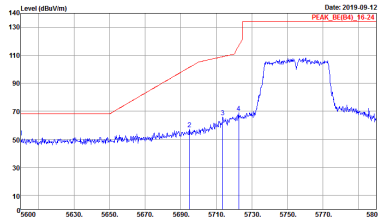
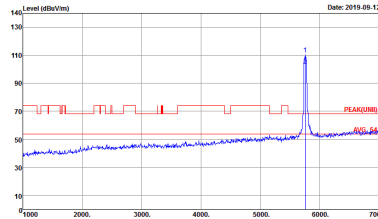
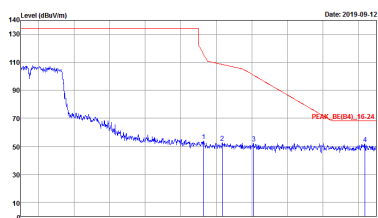

Band 4 5725~5850MHz
WIFI 802.11ac VHT40 (Band Edge @ 3m)

WIFI	Band 4 5725~5850MHz Band Edge @ 3m	
ANT	802.11ac VHT40 CH151 5755MHz	
1	Horizontal	Fundamental
<p>Peak</p>	 <p>Site : 03CH12-HY Condition : PEAK_BE(B4)_16-24 3m HORN_9120D_1328 HORIZONTAL RBW:3000.000KHz VBW:3000.000KHz SWT:Auto Detector : Peak Project : 981244 Setting : 17.5</p>	 <p>Site : 03CH12-HY Condition : PEAK(FUN) 3m HORN_9120D_1328 HORIZONTAL RBW:3000.000KHz VBW:3000.000KHz SWT:Auto Detector : Peak Project : 981244 Setting : 17.5</p>
<p>Peak</p>	 <p>Site : 03CH12-HY Condition : PEAK_BE(B4)_16-24 3m HORN_9120D_1328 HORIZONTAL RBW:3000.000KHz VBW:3000.000KHz SWT:Auto Detector : Peak Project : 981244 Setting : 17.5</p>	<p>Left blank</p>



WIFI	Band 4 5725~5850MHz Band Edge @ 3m	
ANT	802.11ac VHT40 CH151 5755MHz	
1	Vertical	Fundamental
<p>Peak</p>	<p>Site : 03CH12-HY Condition : PEAK_BE(B4)_16-24 3m HORN_9120D_1328 VERTICAL Detector : Peak Project : 981244 Setting : 17.5</p>	<p>Site : 03CH12-HY Condition : PEAK(UNIT) 3m HORN_9120D_1328 VERTICAL Detector : Peak Project : 981244 Setting : 17.5</p>
<p>Peak</p>	<p>Site : 03CH12-HY Condition : PEAK_BE(B4)_16-24 3m HORN_9120D_1328 VERTICAL Detector : Peak Project : 981244 Setting : 17.5</p>	<p>Left blank</p>



WIFI	Band 4 5725~5850MHz Band Edge @ 3m	
ANT	802.11ac VHT40 CH159 5795MHz	
1	Horizontal	Fundamental
<p>Peak</p>	<p>Site : 03CH12-HY Condition : PEAK_BE(B4)_16-24 3m HORN_9120D_1328 HORIZONTAL Detector : Peak Project : 981244 Setting : 17.5</p>	<p>Site : 03CH12-HY Condition : PEAK(UNIT) 3m HORN_9120D_1328 HORIZONTAL Detector : Peak Project : 981244 Setting : 17.5</p>
<p>Peak</p>	<p>Site : 03CH12-HY Condition : PEAK_BE(B4)_16-24 3m HORN_9120D_1328 HORIZONTAL Detector : Peak Project : 981244 Setting : 17.5</p>	<p>Left blank</p>



WIFI	Band 4 5725~5850MHz Band Edge @ 3m	
ANT	802.11ac VHT40 CH159 5795MHz	
1	Vertical	Fundamental
<p>Peak</p>	<p>Site : 03CH12-HY Condition : PEAK_BE(B4)_16-24 3m HORN_9120D_1328 VERTICAL Detector : Peak Project : 981244 Setting : 17.5</p>	<p>Site : 03CH12-HY Condition : PEAK(UNIT) 3m HORN_9120D_1328 VERTICAL Detector : Peak Project : 981244 Setting : 17.5</p>
<p>Peak</p>	<p>Site : 03CH12-HY Condition : PEAK_BE(B4)_16-24 3m HORN_9120D_1328 VERTICAL Detector : Peak Project : 981244 Setting : 17.5</p>	<p>Left blank</p>

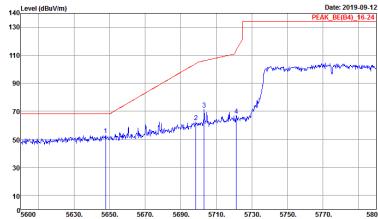
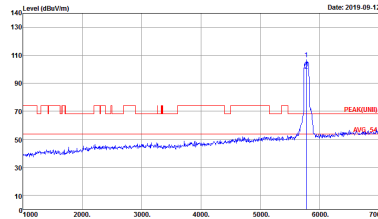
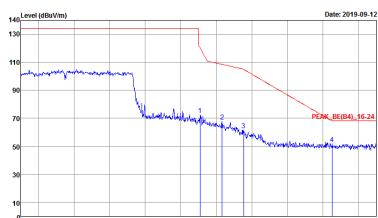

Band 4 5725~5850MHz
WIFI 802.11ac VHT80 (Band Edge @ 3m)

WIFI	Band 4 5725~5850MHz Band Edge @ 3m	
ANT	802.11ac VHT80 CH155 5775MHz	
1	Horizontal	Fundamental
<p>Peak</p>	 <p>Site : 03CH12-HY Condition : PEAK_BE(B4)_16-24 3m HORN_9120D_1328 HORIZONTAL Detector : Peak Project : 981244 Setting : 175</p>	 <p>Site : 03CH12-HY Condition : PEAK(FUN1) 3m HORN_9120D_1328 HORIZONTAL Detector : Peak Project : 981244 Setting : 175</p>
<p>Peak</p>	 <p>Site : 03CH12-HY Condition : PEAK_BE(B4)_16-24 3m HORN_9120D_1328 HORIZONTAL Detector : Peak Project : 981244 Setting : 175</p>	<p>Left blank</p>



WIFI	Band 4 5725~5850MHz Band Edge @ 3m	
ANT	802.11ac VHT80 CH155 5775MHz	
1	Vertical	Fundamental
<p>Peak</p>	<p>Site : 03CH12-HY Condition : PEAK_BE(B4)_16-24 3m HORN_9120D_1328 VERTICAL Detector : Peak Project : 981244 Setting : 17.5</p>	<p>Site : 03CH12-HY Condition : PEAK(UNIT) 3m HORN_9120D_1328 VERTICAL Detector : Peak Project : 981244 Setting : 17.5</p>
<p>Peak</p>	<p>Site : 03CH12-HY Condition : PEAK_BE(B4)_16-24 3m HORN_9120D_1328 VERTICAL Detector : Peak Project : 981244 Setting : 17.5</p>	<p>Left blank</p>



Band 4 - 5725~5850MHz
WIFI 802.11a (Harmonic @ 3m)

WIFI	Band 4 5725~5850MHz Harmonic @ 3m	
ANT	802.11a CH149 5745MHz	
1	Horizontal	Vertical
Peak Avg.	<p>Site : 03CH12-HY Condition : PEAK(LINE) 3m HORN_9120D_1328 HORIZONTAL Detector : Peak Project : 981244 Setting : 17.5</p>	<p>Site : 03CH12-HY Condition : PEAK(LINE) 3m HORN_9120D_1328 VERTICAL Detector : Peak Project : 981244 Setting : 17.5</p>

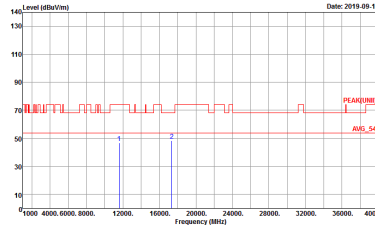
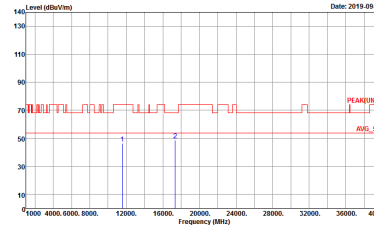

WIFI	Band 4 5725~5850MHz Harmonic @ 3m	
ANT	802.11a CH157 5785MHz	
1	Horizontal	Vertical
<p>Peak Avg.</p>	 <p>Site : 03CH12-11Y Condition : PEAK(LINE1) 3m HORN_9120D_1328 HORIZONTAL Detector : Peak Project : 981244 Setting : 175</p>	 <p>Site : 03CH12-11Y Condition : PEAK(LINE1) 3m HORN_9120D_1328 VERTICAL Detector : Peak Project : 981244 Setting : 175</p>

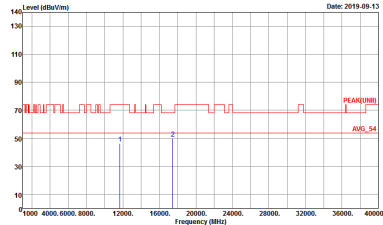
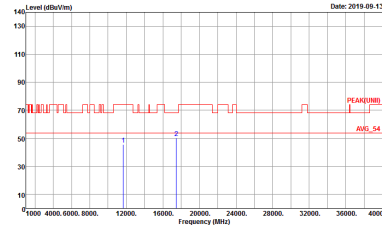

WIFI	Band 4 5725~5850MHz Harmonic @ 3m	
ANT	802.11a CH165 5825MHz	
1	Horizontal	Vertical
<p>Peak</p> <p>Avg.</p>	 <p>Site : 03CH12-11Y Condition : PEAK(100) 3m HORN_9120D_1328 HORIZONTAL Detector : Peak Project : 981244 Setting : 17.5</p>	 <p>Site : 03CH12-11Y Condition : PEAK(100) 3m HORN_9120D_1328 VERTICAL Detector : Peak Project : 981244 Setting : 17.5</p>



Band 4 5725~5850MHz
WIFI 802.11ac VHT20 (Harmonic @ 3m)

WIFI	Band 4 5725~5850MHz Harmonic @ 3m	
ANT	802.11ac VHT20 CH149 5745MHz	
1	Horizontal	Vertical
Peak Avg.	<p>Site : 03CH12-HY Condition : PEAK(UNII) 3m HORN_9120D_1328 HORIZONTAL Detector : Peak Project : 981244 Setting : 17.5</p>	<p>Site : 03CH12-HY Condition : PEAK(UNII) 3m HORN_9120D_1328 VERTICAL Detector : Peak Project : 981244 Setting : 17.5</p>



WIFI	Band 4 5725~5850MHz Harmonic @ 3m	
ANT	802.11ac VHT20 CH157 5785MHz	
1	Horizontal	Vertical
Peak Avg.	<p>Site : 03CH12-1HY Condition : PEAK(LINE1) 3m HORN_9120D_1328 HORIZONTAL Detector : Peak Project : 981244 Setting : 175</p>	<p>Site : 03CH12-1HY Condition : PEAK(LINE1) 3m HORN_9120D_1328 VERTICAL Detector : Peak Project : 981244 Setting : 175</p>

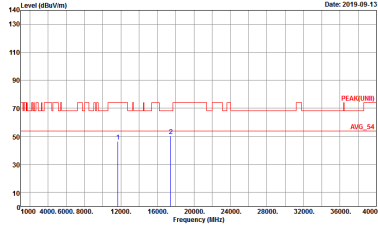
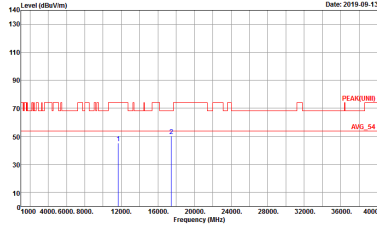

WIFI	Band 4 5725~5850MHz Harmonic @ 3m	
ANT	802.11ac VHT20 CH165 5825MHz	
1	Horizontal	Vertical
<p>Peak Avg.</p>	 <p>Site : 03CH12-11Y Condition : PEAK(LINE1) 3m HORN_9120D_1328 HORIZONTAL Detector : Peak Project : 981244 Setting : 175</p>	 <p>Site : 03CH12-11Y Condition : PEAK(LINE1) 3m HORN_9120D_1328 VERTICAL Detector : Peak Project : 981244 Setting : 175</p>



Band 4 5725~5850MHz
WIFI 802.11ac VHT40 (Harmonic @ 3m)

WIFI	Band 4 5725~5850MHz Harmonic @ 3m	
ANT	802.11ac VHT40 CH151 5755MHz	
1	Horizontal	Vertical
Peak Avg.	<p>Site : 03CH12-HY Condition : PEAK(UNII) 3m HORN_9120D_1328 HORIZONTAL Detector : Peak Project : 981244 Setting : 17.5</p>	<p>Site : 03CH12-HY Condition : PEAK(UNII) 3m HORN_9120D_1328 VERTICAL Detector : Peak Project : 981244 Setting : 17.5</p>



WIFI	Band 4 5725~5850MHz Harmonic @ 3m	
ANT	802.11ac VHT40 CH159 5795MHz	
1	Horizontal	Vertical
Peak Avg.	<p>Site : 03CH12-1HY Condition : PEAK(LINE1) 3m HORN_9120D_1328 HORIZONTAL Detector : Peak Project : 981244 Setting : 175</p>	<p>Site : 03CH12-1HY Condition : PEAK(LINE1) 3m HORN_9120D_1328 VERTICAL Detector : Peak Project : 981244 Setting : 175</p>



Band 4 5725~5850MHz
WIFI 802.11ac VHT80 (Harmonic @ 3m)

WIFI	Band 4 5725~5850MHz Harmonic @ 3m	
ANT	802.11ac VHT80 CH155 5775MHz	
1	Horizontal	Vertical
Peak Avg.	<p>Site : 03CH12-HY Condition : PEAK(UNII) 3m HORN_9120D_1328 HORIZONTAL Detector : Peak Project : 981244 Setting : 17.5</p>	<p>Site : 03CH12-HY Condition : PEAK(UNII) 3m HORN_9120D_1328 VERTICAL Detector : Peak Project : 981244 Setting : 17.5</p>



Emission below 1GHz
5GHz WIFI 802.11ac VHT40 (LF)

Table with 2 columns: Horizontal and Vertical. Each column contains a spectral plot showing Level (dBu/m) vs Frequency (MHz) from 50 to 1000 MHz. The plots show a blue signal line and a red QP peak marker. Metadata includes Site: 03CH12-HY, Condition: QP 3m BTL06_6111D_37059, Detector: Peak, Project: 981244.



Band 4 - 5725~5850MHz
WIFI 802.11a (Band Edge @ 3m)

Table with 2 columns: Horizontal and Fundamental. Contains spectral plots and technical details like Site, Condition, Detector, Project, Setting.

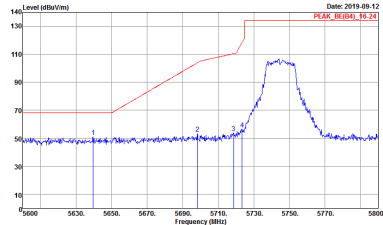
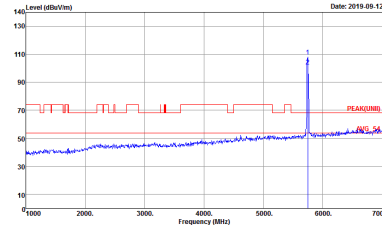

WIFI	Band 4 5725~5850MHz Band Edge @ 3m	
ANT	802.11a CH149 5745MHz	
2	Vertical	Fundamental
Peak	 <p>Site : 03CH12-11Y Condition : PEAK_RE(B4)_16-24 3m HORN_9120D_1328 VERTICAL Detector : Peak Project : 981244 Setting : 17.5</p>	 <p>Site : 03CH12-11Y Condition : PEAK_UNDE1) 3m HORN_9120D_1328 VERTICAL Detector : Peak Project : 981244 Setting : 17.5</p>



WIFI	Band 4 5725~5850MHz Band Edge @ 3m	
ANT	802.11a CH157 5785MHz	
2	Horizontal	Fundamental
<p>Peak</p>		
<p>Peak</p>		<p>Left blank</p>



WIFI	Band 4 5725~5850MHz Band Edge @ 3m	
ANT	802.11a CH157 5785MHz	
2	Vertical	Fundamental
<p>Peak</p>	<p>Site : 03CH12-HY Condition : PEAK_BE(B4)_16-24 3m HORN_9120D_1328 VERTICAL Detector : Peak Project : 981244 Setting : 17.5</p>	<p>Site : 03CH12-HY Condition : PEAK(FUNDE) 3m HORN_9120D_1328 VERTICAL Detector : Peak Project : 981244 Setting : 17.5</p>
<p>Peak</p>	<p>Site : 03CH12-HY Condition : PEAK_BE(B4)_16-24 3m HORN_9120D_1328 VERTICAL Detector : Peak Project : 981244 Setting : 17.5</p>	<p>Left blank</p>

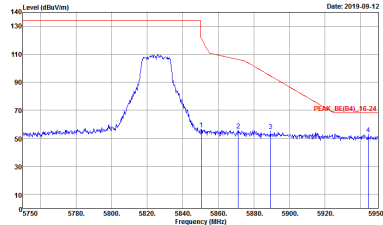
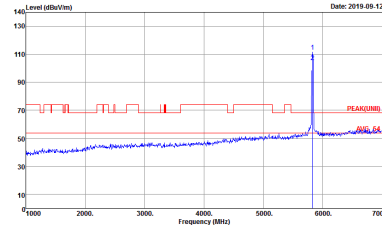

WIFI	Band 4 5725~5850MHz Band Edge @ 3m	
ANT	802.11a CH165 5825MHz	
2	Horizontal	Fundamental
Peak	 <p>Site : 03CH2-11Y Condition : PEAK_BE(B4)_16-24 3m HORN_91200_1328 HORIZONTAL Detector : Peak Project : 981244 Setting : 17.5</p>	 <p>Site : 03CH2-11Y Condition : PEAK(UNIT) 3m HORN_91200_1328 HORIZONTAL Detector : Peak Project : 981244 Setting : 17.5</p>



WIFI	Band 4 5725~5850MHz Band Edge @ 3m	
ANT	802.11a CH165 5825MHz	
2	Vertical	Fundamental
Peak	<p>Site : 03CH12-11Y Condition : PEAK_BE(B4)_16-24 3m HORN_91200_1328 VERTICAL Detector : Peak Project : 981244 Setting : 17.5</p>	<p>Site : 03CH12-11Y Condition : PEAK(FUN) 3m HORN_91200_1328 VERTICAL Detector : Peak Project : 981244 Setting : 17.5</p>

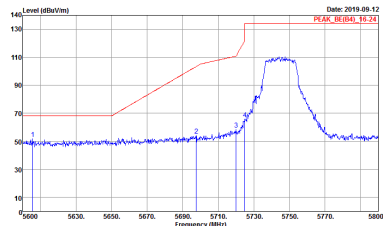
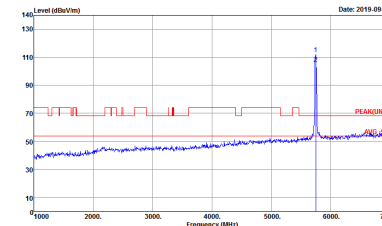

**Band 4 5725~5850MHz
WIFI 802.11ac VHT20 (Band Edge @ 3m)**

WIFI	Band 4 5725~5850MHz Band Edge @ 3m	
ANT	802.11ac VHT20 CH149 5745MHz	
2	Horizontal	Fundamental
Peak	 <p> Site : 03CH12-HY Condition : PEAK_BE(B4)_16-24 3m HORN_9120D_1328 HORIZONTAL Detector : Peak Project : 981244 Setting : 175 </p>	 <p> Site : 03CH12-HY Condition : PEAK(UN1) 3m HORN_9120D_1328 HORIZONTAL Detector : Peak Project : 981244 Setting : 175 </p>

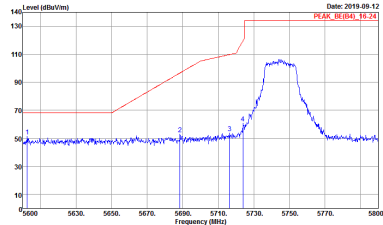
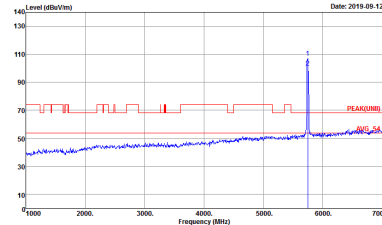

WIFI	Band 4 5725~5850MHz Band Edge @ 3m	
ANT	802.11ac VHT20 CH149 5745MHz	
2	Vertical	Fundamental
Peak Avg.	 <p>Site : 03CH12-11Y Condition : PEAK_RE(B4)_16-24 3m HORN_9120D_1328 VERTICAL Detector : Peak Project : 981244 Setting : 17.5</p>	 <p>Site : 03CH12-11Y Condition : PEAK(FUND) 3m HORN_9120D_1328 VERTICAL Detector : Peak Project : 981244 Setting : 17.5</p>



WIFI	Band 4 5725~5850MHz Band Edge @ 3m	
ANT	802.11ac VHT20 CH157 5785MHz	
2	Horizontal	Fundamental
<p>Peak</p>	<p>Site : 03CH12-HY Condition : PEAK_BE(B4)_16-24 3m HORN_9120D_1328 HORIZONTAL Detector : Peak Project : 981244 Setting : 17.5</p>	<p>Site : 03CH12-HY Condition : PEAK(FUNDE) 3m HORN_9120D_1328 HORIZONTAL Detector : Peak Project : 981244 Setting : 17.5</p>
<p>Peak</p>	<p>Site : 03CH12-HY Condition : PEAK_BE(B4)_16-24 3m HORN_9120D_1328 HORIZONTAL Detector : Peak Project : 981244 Setting : 17.5</p>	<p>Left blank</p>



WIFI	Band 4 5725~5850MHz Band Edge @ 3m	
ANT	802.11ac VHT20 CH157 5785MHz	
2	Vertical	Fundamental
Peak	<p>Site : 03CH12-HY Condition : PEAK_BE(B4)_16-24 3m HORN_9120D_1328 VERTICAL Detector : Peak Project : 981244 Setting : 17.5</p>	<p>Site : 03CH12-HY Condition : PEAK(UNIT) 3m HORN_9120D_1328 VERTICAL Detector : Peak Project : 981244 Setting : 17.5</p>
Peak	<p>Site : 03CH12-HY Condition : PEAK_BE(B4)_16-24 3m HORN_9120D_1328 VERTICAL Detector : Peak Project : 981244 Setting : 17.5</p>	Left blank

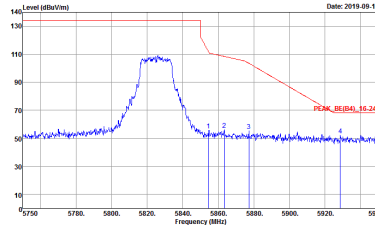
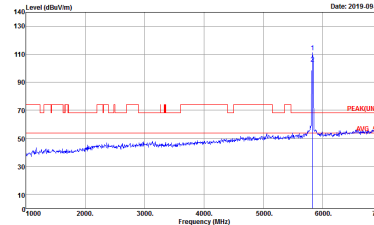

WIFI	Band 4 5725~5850MHz Band Edge @ 3m	
ANT	802.11ac VHT20 CH165 5825MHz	
2	Horizontal	Fundamental
Peak	 <p>Site : 03CH12-11Y Condition : PEAK_BEB(4)_16-24 3m HORN_91200_1328 HORIZONTAL Detector : Peak Project : 981244 Setting : 17.5</p>	 <p>Site : 03CH12-11Y Condition : PEAK(UNIT) 3m HORN_91200_1328 HORIZONTAL Detector : Peak Project : 981244 Setting : 17.5</p>

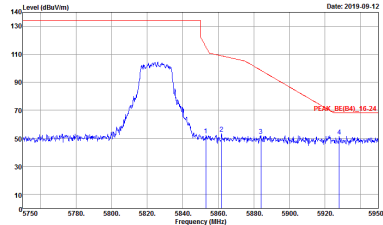
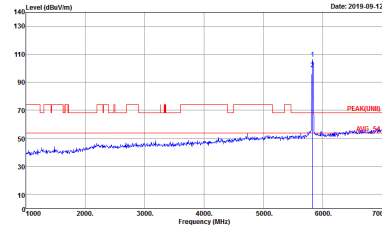

WIFI	Band 4 5725~5850MHz Band Edge @ 3m	
ANT	802.11ac VHT20 CH165 5825MHz	
2	Vertical	Fundamental
Peak Avg.	 <p>Site : 03CH12-11Y Condition : PEAK_BEB(4)_16-24 3m HORN_9120D_1328 VERTICAL Detector : Peak Project : 981244 Setting : 17.5</p>	 <p>Site : 03CH12-11Y Condition : PEAK(UNIT) 3m HORN_9120D_1328 VERTICAL Detector : Peak Project : 981244 Setting : 17.5</p>

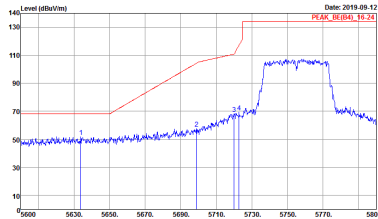
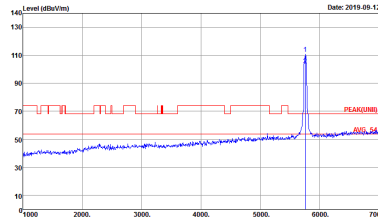
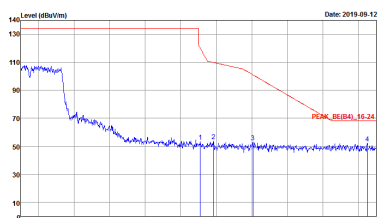

Band 4 5725~5850MHz
WIFI 802.11ac VHT40 (Band Edge @ 3m)

WIFI	Band 4 5725~5850MHz Band Edge @ 3m	
ANT	802.11ac VHT40 CH151 5755MHz	
2	Horizontal	Fundamental
<p>Peak</p>	 <p>Site : 03CH12-HY Condition : PEAK_BE(B4)_16-24 3m HORN_9120D_1328 HORIZONTAL RBW:3000.000kHz VBW:3000.000kHz SWT:Auto Detector : Peak Project : 981244 Setting : 175</p>	 <p>Site : 03CH12-HY Condition : PEAK(U001) 3m HORN_9120D_1328 HORIZONTAL RBW:3000.000kHz VBW:3000.000kHz SWT:Auto Detector : Peak Project : 981244 Setting : 175</p>
<p>Peak</p>	 <p>Site : 03CH12-HY Condition : PEAK_BE(B4)_16-24 3m HORN_9120D_1328 HORIZONTAL RBW:3000.000kHz VBW:3000.000kHz SWT:Auto Detector : Peak Project : 981244 Setting : 175</p>	<p align="center">Left blank</p>



WIFI	Band 4 5725~5850MHz Band Edge @ 3m	
ANT	802.11ac VHT40 CH151 5755MHz	
2	Vertical	Fundamental
<p>Peak</p>	<p>Site : 03CH12-HY Condition : PEAK_BE(B4)_16-24 3m HORN_9120D_1328 VERTICAL Detector : Peak Project : 981244 Setting : 17.5</p>	<p>Site : 03CH12-HY Condition : PEAK(UNIT) 3m HORN_9120D_1328 VERTICAL Detector : Peak Project : 981244 Setting : 17.5</p>
<p>Peak</p>	<p>Site : 03CH12-HY Condition : PEAK_BE(B4)_16-24 3m HORN_9120D_1328 VERTICAL Detector : Peak Project : 981244 Setting : 17.5</p>	<p>Left blank</p>



WIFI	Band 4 5725~5850MHz Band Edge @ 3m	
ANT	802.11ac VHT40 CH159 5795MHz	
2	Horizontal	Fundamental
<p>Peak</p>	<p>Site : 03CH12-HY Condition : PEAK_BE(B4)_16-24 3m HORN_9120D_1328 HORIZONTAL Detector : Peak Project : 981244 Setting : 17.5</p>	<p>Site : 03CH12-HY Condition : PEAK(UNIT) 3m HORN_9120D_1328 HORIZONTAL Detector : Peak Project : 981244 Setting : 17.5</p>
<p>Peak</p>	<p>Site : 03CH12-HY Condition : PEAK_BE(B4)_16-24 3m HORN_9120D_1328 HORIZONTAL Detector : Peak Project : 981244 Setting : 17.5</p>	<p>Left blank</p>



WIFI	Band 4 5725~5850MHz Band Edge @ 3m	
ANT	802.11ac VHT40 CH159 5795MHz	
2	Vertical	Fundamental
<p>Peak</p>	<p>Site : 03CH12-HY Condition : PEAK_BE(B4)_16-24 3m HORN_9120D_1328 VERTICAL Detector : Peak Project : 981244 Setting : 175</p>	<p>Site : 03CH12-HY Condition : PEAK(UNIT) 3m HORN_9120D_1328 VERTICAL Detector : Peak Project : 981244 Setting : 175</p>
<p>Peak</p>	<p>Site : 03CH12-HY Condition : PEAK_BE(B4)_16-24 3m HORN_9120D_1328 VERTICAL Detector : Peak Project : 981244 Setting : 175</p>	<p>Left blank</p>

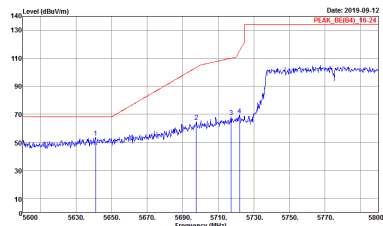
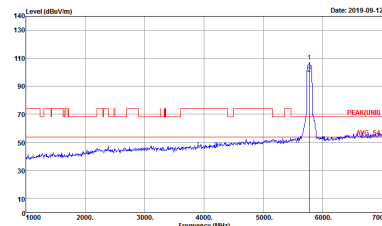
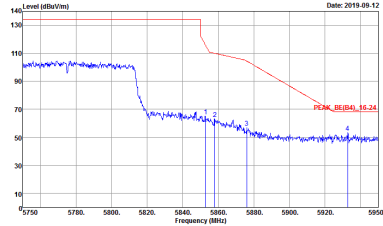

Band 4 5725~5850MHz
WIFI 802.11ac VHT80 (Band Edge @ 3m)

WIFI	Band 4 5725~5850MHz Band Edge @ 3m	
ANT	802.11ac VHT80 CH155 5775MHz	
2	Horizontal	Fundamental
<p>Peak</p>	 <p>Site : 03CH12-HY Condition : PEAK_BE(B4)_16-24 3m HORN_9120D_1328 HORIZONTAL RBW:1000.000kHz VBW:3000.000kHz SWT:Auto Detector : Peak Project : 981244 Setting : 175</p>	 <p>Site : 03CH12-HY Condition : PEAK(FUN) 3m HORN_9120D_1328 HORIZONTAL RBW:1000.000kHz VBW:3000.000kHz SWT:Auto Detector : Peak Project : 981244 Setting : 175</p>
<p>Peak</p>	 <p>Site : 03CH12-HY Condition : PEAK_BE(B4)_16-24 3m HORN_9120D_1328 HORIZONTAL RBW:1000.000kHz VBW:3000.000kHz SWT:Auto Detector : Peak Project : 981244 Setting : 175</p>	<p align="center">Left blank</p>

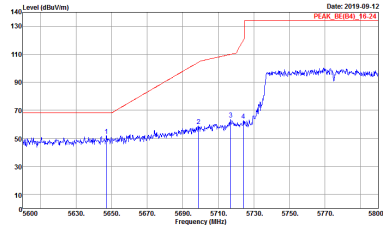
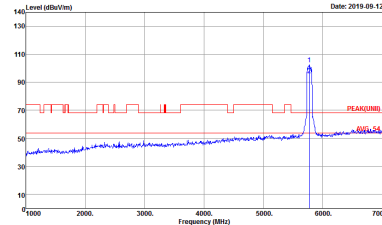
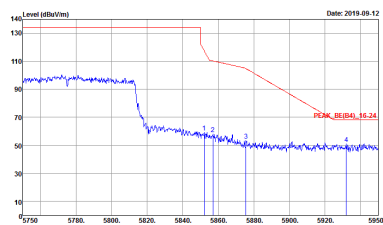

WIFI	Band 4 5725~5850MHz Band Edge @ 3m	
ANT	802.11ac VHT80 CH155 5775MHz	
2	Vertical	Fundamental
<p>Peak</p>	 <p>Site : 03CH12-HY Condition : PEAK_BE(B4)_16-24 3m HORN_9120D_1328 VERTICAL Detector : Peak Project : 981244 Setting : 17.5</p>	 <p>Site : 03CH12-HY Condition : PEAK(UNIT) 3m HORN_9120D_1328 VERTICAL Detector : Peak Project : 981244 Setting : 17.5</p>
<p>Peak</p>	 <p>Site : 03CH12-HY Condition : PEAK_BE(B4)_16-24 3m HORN_9120D_1328 VERTICAL Detector : Peak Project : 981244 Setting : 17.5</p>	<p>Left blank</p>



Band 4 - 5725~5850MHz
WIFI 802.11a (Harmonic @ 3m)

Table with 2 columns: Horizontal and Vertical. Each column contains a spectral plot of Level (dBu/m) vs Frequency (MHz) and associated test parameters like Site, Condition, Detector, Project, and Setting.

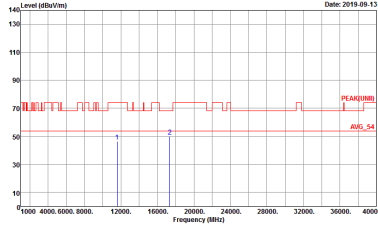
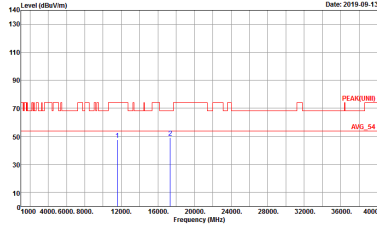

WIFI	Band 4 5725~5850MHz Harmonic @ 3m	
ANT	802.11a CH157 5785MHz	
2	Horizontal	Vertical
<p>Peak</p> <p>Avg.</p>	 <p>Site : 03CH12-11Y Condition : PEAK(LINE1) 3m HORN_9120D_1328 HORIZONTAL Detector : Peak Project : 981244 Setting : 17.5</p>	 <p>Site : 03CH12-11Y Condition : PEAK(LINE1) 3m HORN_9120D_1328 VERTICAL Detector : Peak Project : 981244 Setting : 17.5</p>

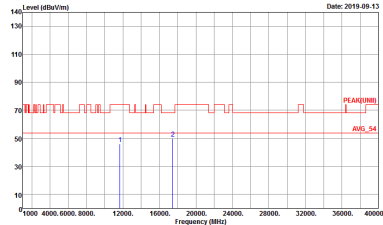
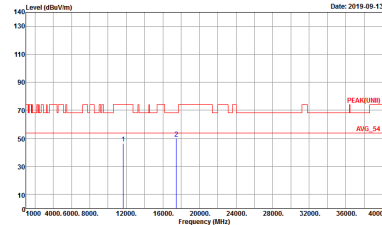

WIFI	Band 4 5725~5850MHz Harmonic @ 3m	
ANT	802.11a CH165 5825MHz	
2	Horizontal	Vertical
<p>Peak</p> <p>Avg.</p>	 <p>Site : 03CH12-1HY Condition : PEAK(LINE1) 3m HORN_9120D_1328 HORIZONTAL Detector : Peak Project : 981244 Setting : 175</p>	 <p>Site : 03CH12-1HY Condition : PEAK(LINE1) 3m HORN_9120D_1328 VERTICAL Detector : Peak Project : 981244 Setting : 175</p>



Band 4 5725~5850MHz
WIFI 802.11ac VHT20 (Harmonic @ 3m)

WIFI	Band 4 5725~5850MHz Harmonic @ 3m	
ANT	802.11ac VHT20 CH149 5745MHz	
2	Horizontal	Vertical
Peak Avg.	<p>Site : 03CH12-HY Condition : PEAK(UNII) 3m HORN_9120D_1328 HORIZONTAL Detector : Peak Project : 981244 Setting : 17.5</p>	<p>Site : 03CH12-HY Condition : PEAK(UNII) 3m HORN_9120D_1328 VERTICAL Detector : Peak Project : 981244 Setting : 17.5</p>

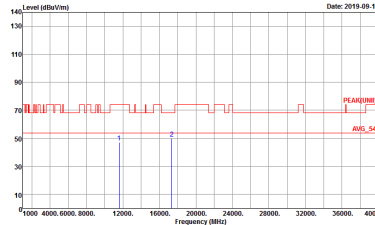
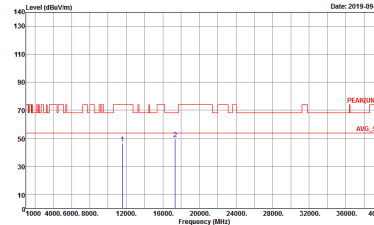

WIFI	Band 4 5725~5850MHz Harmonic @ 3m	
ANT	802.11ac VHT20 CH157 5785MHz	
2	Horizontal	Vertical
<p>Peak</p> <p>Avg.</p>	 <p>Date: 2019-09-13</p> <p>Site : 03CH12-1HY Condition : PEAK(LINE1) 3m HORN_9120D_1328 HORIZONTAL Detector : Peak Project : 981244 Setting : 17.5</p>	 <p>Date: 2019-09-13</p> <p>Site : 03CH12-1HY Condition : PEAK(LINE1) 3m HORN_9120D_1328 VERTICAL Detector : Peak Project : 981244 Setting : 17.5</p>



WIFI	Band 4 5725~5850MHz Harmonic @ 3m	
ANT	802.11ac VHT20 CH165 5825MHz	
2	Horizontal	Vertical
Peak Avg.	<p>Site : 03CH12-1HY Condition : PEAK(LINE1) 3m HORN_9120D_1328 HORIZONTAL Detector : Peak Project : 981244 Setting : 175</p>	<p>Site : 03CH12-1HY Condition : PEAK(LINE1) 3m HORN_9120D_1328 VERTICAL Detector : Peak Project : 981244 Setting : 175</p>



Band 4 5725~5850MHz
WIFI 802.11ac VHT40 (Harmonic @ 3m)

WIFI	Band 4 5725~5850MHz Harmonic @ 3m	
ANT	802.11ac VHT40 CH151 5755MHz	
2	Horizontal	Vertical
Peak Avg.	<p>Site : 03CH12-HY Condition : PEAK(UNII) 3m HORN_9120D_1328 HORIZONTAL Detector : Peak Project : 981244 Setting : 17.5</p>	<p>Site : 03CH12-HY Condition : PEAK(UNII) 3m HORN_9120D_1328 VERTICAL Detector : Peak Project : 981244 Setting : 17.5</p>

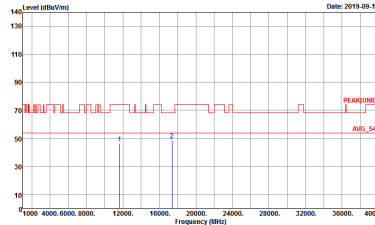
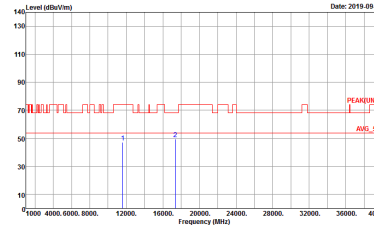

WIFI	Band 4 5725~5850MHz Harmonic @ 3m	
ANT	802.11ac VHT40 CH159 5795MHz	
2	Horizontal	Vertical
<p>Peak Avg.</p>	 <p>Site : 03CH12-11Y Condition : PEAK(LINE1) 3m HORN_9120D_1328 HORIZONTAL Detector : Peak Project : 981244 Setting : 175</p>	 <p>Site : 03CH12-11Y Condition : PEAK(LINE1) 3m HORN_9120D_1328 VERTICAL Detector : Peak Project : 981244 Setting : 175</p>



Band 4 5725~5850MHz
WIFI 802.11ac VHT80 (Harmonic @ 3m)

WIFI	Band 4 5725~5850MHz Harmonic @ 3m	
ANT	802.11ac VHT80 CH155 5775MHz	
2	Horizontal	Vertical
Peak Avg.	<p>Site : 03CH12-HY Condition : PEAK(UNII) 3m HORN_9120D_1328 HORIZONTAL Detector : Peak Project : 981244 Setting : 17.5</p>	<p>Site : 03CH12-HY Condition : PEAK(UNII) 3m HORN_9120D_1328 VERTICAL Detector : Peak Project : 981244 Setting : 17.5</p>



Emission below 1GHz
5GHz WIFI 802.11a (LF)

WIFI	5GHz 5725~5850MHz	
ANT	802.11a LF	
2	Horizontal	Vertical
QP / Peak	<p>Site : 03CH12-HY Condition : QP 3m BTL06_6111D_37059 HORIZONTAL Detector : Peak Project : 981244</p>	<p>Site : 03CH12-HY Condition : QP 3m BTL06_6111D_37059 VERTICAL Detector : Peak Project : 981244</p>



Band 4 - 5725~5850MHz
WIFI 802.11a (Band Edge @ 3m)

WIFI	Band 4 5725~5850MHz Band Edge @ 3m	
ANT	802.11a CH149 5745MHz	
1+2	Horizontal	Fundamental
Peak	<p>Site : 03CH2-HY Condition : PEAK_BED4_16-24 3m HORN_9120_1328 HORIZONTAL Detector : Peak Project : 981244 Setting : 17.5</p>	<p>Site : 03CH2-HY Condition : PEAK(UNITE) 3m HORN_9120_1328 HORIZONTAL Detector : Peak Project : 981244 Setting : 17.5</p>

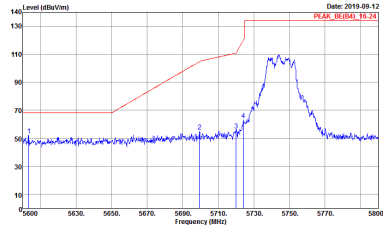
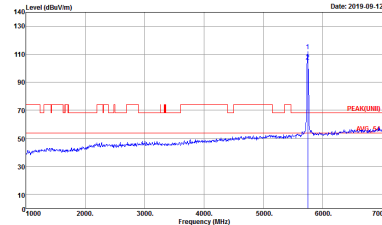

WIFI	Band 4 5725~5850MHz Band Edge @ 3m	
ANT	802.11a CH149 5745MHz	
1+2	Vertical	Fundamental
Peak	 <p>Site : 03CH12-11Y Condition : PEAK_RE(B4)_16-24 3m HORN_91200_1328 VERTICAL Detector : Peak Project : 981244 Setting : 17.5</p>	 <p>Site : 03CH12-11Y Condition : PEAK(FUNDE)_3m HORN_91200_1328 VERTICAL Detector : Peak Project : 981244 Setting : 17.5</p>



WIFI	Band 4 5725~5850MHz Band Edge @ 3m	
ANT	802.11a CH157 5785MHz	
1+2	Horizontal	Fundamental
<p>Peak</p>	<p>Site : 03CH12-HY Condition : PEAK_BE(B4)_16-24 3m HORN_9120D_1328 HORIZONTAL Detector : Peak Project : 981244 Setting : 17.5</p>	<p>Site : 03CH12-HY Condition : PEAK(FUNTE) 3m HORN_9120D_1328 HORIZONTAL Detector : Peak Project : 981244 Setting : 17.5</p>
<p>Peak</p>	<p>Site : 03CH12-HY Condition : PEAK_BE(B4)_16-24 3m HORN_9120D_1328 HORIZONTAL Detector : Peak Project : 981244 Setting : 17.5</p>	<p>Left blank</p>



WIFI	Band 4 5725~5850MHz Band Edge @ 3m	
ANT	802.11a CH157 5785MHz	
1+2	Vertical	Fundamental
Peak	<p>Site : 03CH12-HY Condition : PEAK_BE(B4)_16-24 3m HORN_9120D_1328 VERTICAL Detector : Peak Project : 981244 Setting : 17.5</p>	<p>Site : 03CH12-HY Condition : PEAK(UNIT) 3m HORN_9120D_1328 VERTICAL Detector : Peak Project : 981244 Setting : 17.5</p>
Peak	<p>Site : 03CH12-HY Condition : PEAK_BE(B4)_16-24 3m HORN_9120D_1328 VERTICAL Detector : Peak Project : 981244 Setting : 17.5</p>	Left blank

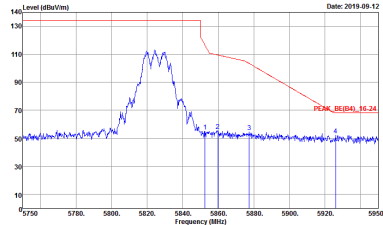
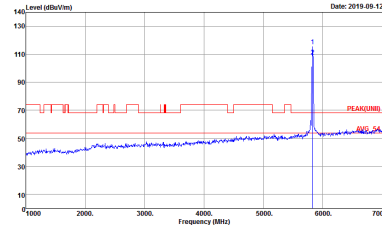

WIFI	Band 4 5725~5850MHz Band Edge @ 3m	
ANT	802.11a CH165 5825MHz	
1+2	Horizontal	Fundamental
Peak	 <p>Site : 03CHZ-HY Condition : PEAK_9E(B4)_16-24 3m HORN_91200_1328 HORIZONTAL Detector : Peak Project : 981244 Setting : 17.5</p>	 <p>Site : 03CHZ-HY Condition : PEAK(UNIT) 3m HORN_91200_1328 HORIZONTAL Detector : Peak Project : 981244 Setting : 17.5</p>

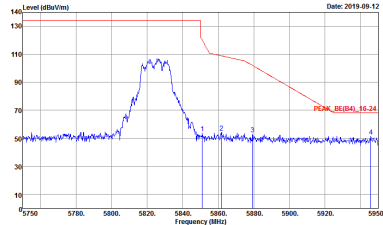
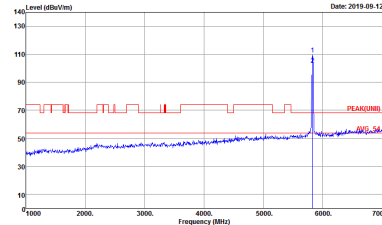

WIFI	Band 4 5725~5850MHz Band Edge @ 3m	
ANT	802.11a CH165 5825MHz	
1+2	Vertical	Fundamental
Peak	 <p>Site : 03CH12-11Y Condition : PEAK_BE(B4)_16-24 3m HORN_91200_1328 VERTICAL Detector : Peak Project : 981244 Setting : 17.5</p>	 <p>Site : 03CH12-11Y Condition : PEAK(FUND) 3m HORN_91200_1328 VERTICAL Detector : Peak Project : 981244 Setting : 17.5</p>



**Band 4 5725~5850MHz
WIFI 802.11ac VHT20 (Band Edge @ 3m)**

WIFI	Band 4 5725~5850MHz Band Edge @ 3m	
ANT	802.11ac VHT20 CH149 5745MHz	
1+2	Horizontal	Fundamental
Peak	<p> Date: 2019-09-12 PEAK: 132.00, 10.00 </p> <p> Site : 03CH12-HY Condition : PEAK_BE(B4)_16-24 3m HORN_9120D_1328 HORIZONTAL RBW:3000.000KHz VBW:3000.000KHz SWT:Auto Detector : Peak Project : 981244 Setting : 17.5 </p>	<p> Date: 2019-09-12 PEAK(UN1): 132.00, 10.00 AVG: 94 </p> <p> Site : 03CH12-HY Condition : PEAK(UN1) 3m HORN_9120D_1328 HORIZONTAL RBW:1000.000KHz VBW:3000.000KHz SWT:Auto Detector : Peak Project : 981244 Setting : 17.5 </p>

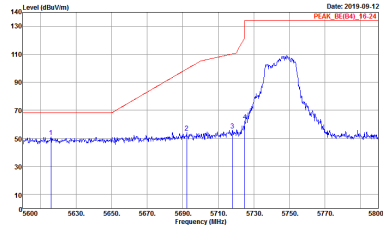
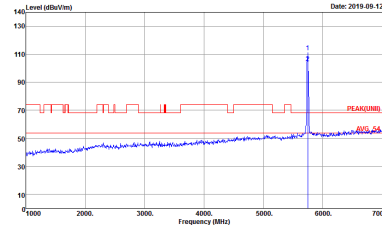

WIFI	Band 4 5725~5850MHz Band Edge @ 3m	
ANT	802.11ac VHT20 CH149 5745MHz	
1+2	Vertical	Fundamental
<p>Peak Avg.</p>	 <p>Site : 03CH12-11Y Condition : PEAK_RE(B4)_16-24 3m HORN_9120D_1328 VERTICAL Detector : Peak Project : 981244 Setting : 17.5</p>	 <p>Site : 03CH12-11Y Condition : PEAK_UNITE1 3m HORN_9120D_1328 VERTICAL Detector : Peak Project : 981244 Setting : 17.5</p>

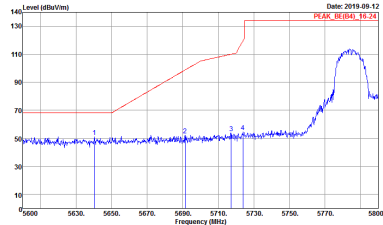
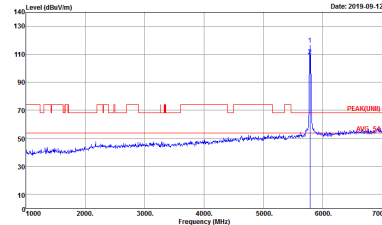
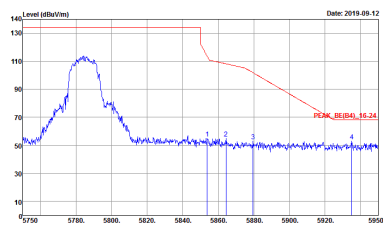

WIFI	Band 4 5725~5850MHz Band Edge @ 3m	
ANT	802.11ac VHT20 CH157 5785MHz	
1+2	Horizontal	Fundamental
<p>Peak</p>	 <p>Site : 03CH12-HY Condition : PEAK_BE(B4)_16-24 3m HORN_9120D_1328 HORIZONTAL Detector : Peak Project : 981244 Setting : 17.5</p>	 <p>Site : 03CH12-HY Condition : PEAK(UNIT) 3m HORN_9120D_1328 HORIZONTAL Detector : Peak Project : 981244 Setting : 17.5</p>
<p>Peak</p>	 <p>Site : 03CH12-HY Condition : PEAK_BE(B4)_16-24 3m HORN_9120D_1328 HORIZONTAL Detector : Peak Project : 981244 Setting : 17.5</p>	<p>Left blank</p>



WIFI	Band 4 5725~5850MHz Band Edge @ 3m	
ANT	802.11ac VHT20 CH157 5785MHz	
1+2	Vertical	Fundamental
<p>Peak</p>	<p>Site : 03CH12-HY Condition : PEAK_BE(B4)_16-24 3m HORN_9120D_1328 VERTICAL Detector : Peak Project : 981244 Setting : 17.5</p>	<p>Site : 03CH12-HY Condition : PEAK(FUNDE) 3m HORN_9120D_1328 VERTICAL Detector : Peak Project : 981244 Setting : 17.5</p>
<p>Peak</p>	<p>Site : 03CH12-HY Condition : PEAK_BE(B4)_16-24 3m HORN_9120D_1328 VERTICAL Detector : Peak Project : 981244 Setting : 17.5</p>	<p>Left blank</p>

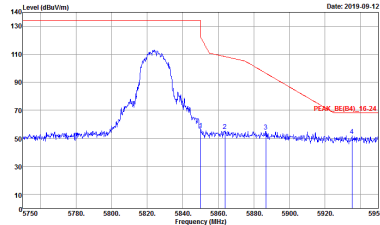
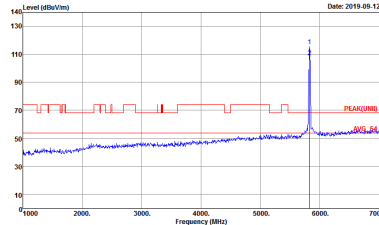

WIFI	Band 4 5725~5850MHz Band Edge @ 3m	
ANT	802.11ac VHT20 CH165 5825MHz	
1+2	Horizontal	Fundamental
Peak	 <p>Site : 03CH12-11Y Condition : PEAK_BE(B4)_16-24 3m HORN_91200_1328 HORIZONTAL Detector : Peak Project : 981244 Setting : 17.5</p>	 <p>Site : 03CH12-11Y Condition : PEAK(FUND) 3m HORN_91200_1328 HORIZONTAL Detector : Peak Project : 981244 Setting : 17.5</p>

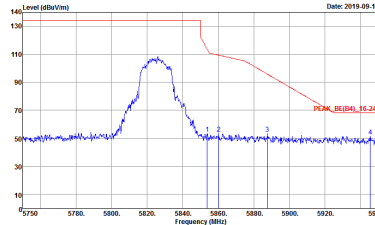
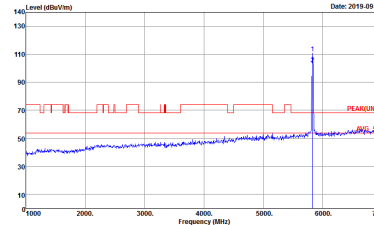

WIFI	Band 4 5725~5850MHz Band Edge @ 3m	
ANT	802.11ac VHT20 CH165 5825MHz	
1+2	Vertical	Fundamental
<p>Peak</p> <p>Avg.</p>	 <p>Site : 03CH12-11Y Condition : PEAK_BE(B4)_16-24 3m HORN_9120D_1328 VERTICAL Detector : Peak Project : 981244 Setting : 17.5</p>	 <p>Site : 03CH12-11Y Condition : PEAK(UNIT) 3m HORN_9120D_1328 VERTICAL Detector : Peak Project : 981244 Setting : 17.5</p>



Band 4 5725~5850MHz
WIFI 802.11ac VHT40 (Band Edge @ 3m)

WIFI	Band 4 5725~5850MHz Band Edge @ 3m	
ANT	802.11ac VHT40 CH151 5755MHz	
1+2	Horizontal	Fundamental
Peak	<p>Site : 03CH12-HY Condition : PEAK_BE(B4)_16-24 3m HORN_9120D_1328 HORIZONTAL Detector : Peak Project : 981244 Setting : 175</p>	<p>Site : 03CH12-HY Condition : PEAK(UN11) 3m HORN_9120D_1328 HORIZONTAL Detector : Peak Project : 981244 Setting : 175</p>
Peak	<p>Site : 03CH12-HY Condition : PEAK_BE(B4)_16-24 3m HORN_9120D_1328 HORIZONTAL Detector : Peak Project : 981244 Setting : 175</p>	Left blank



WIFI	Band 4 5725~5850MHz Band Edge @ 3m	
ANT	802.11ac VHT40 CH151 5755MHz	
1+2	Vertical	Fundamental
<p>Peak</p>	<p>Site : 03CH12-HY Condition : PEAK_BE(B4)_16-24 3m HORN_9120D_1328 VERTICAL Detector : Peak Project : 981244 Setting : 17.5</p>	<p>Site : 03CH12-HY Condition : PEAK(FUNDE) 3m HORN_9120D_1328 VERTICAL Detector : Peak Project : 981244 Setting : 17.5</p>
<p>Peak</p>	<p>Site : 03CH12-HY Condition : PEAK_BE(B4)_16-24 3m HORN_9120D_1328 VERTICAL Detector : Peak Project : 981244 Setting : 17.5</p>	<p>Left blank</p>





WIFI	Band 4 5725~5850MHz Band Edge @ 3m	
ANT	802.11ac VHT40 CH159 5795MHz	
1+2	Horizontal	Fundamental
<p>Peak</p>	<p>Site : 03CH12-HY Condition : PEAK_BE(B4)_16-24 3m HORN_9120D_1328 HORIZONTAL Detector : Peak Project : 981244 Setting : 17.5</p>	<p>Site : 03CH12-HY Condition : PEAK(UNIT) 3m HORN_9120D_1328 HORIZONTAL Detector : Peak Project : 981244 Setting : 17.5</p>
<p>Peak</p>	<p>Site : 03CH12-HY Condition : PEAK_BE(B4)_16-24 3m HORN_9120D_1328 HORIZONTAL Detector : Peak Project : 981244 Setting : 17.5</p>	<p>Left blank</p>

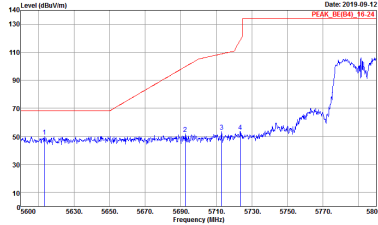
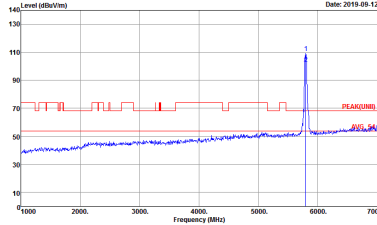
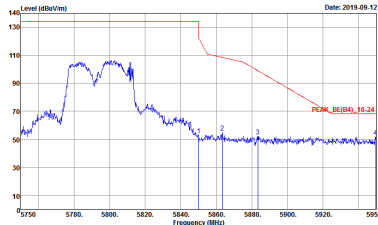

WIFI	Band 4 5725~5850MHz Band Edge @ 3m	
ANT	802.11ac VHT40 CH159 5795MHz	
1+2	Vertical	Fundamental
<p>Peak</p>	 <p>Site : 03CH12-HY Condition : PEAK_BE(B4)_16-24 3m HORN_9120D_1328 VERTICAL Detector : Peak Project : 981244 Setting : 17.5</p>	 <p>Site : 03CH12-HY Condition : PEAK(FUNTE) 3m HORN_9120D_1328 VERTICAL Detector : Peak Project : 981244 Setting : 17.5</p>
<p>Peak</p>	 <p>Site : 03CH12-HY Condition : PEAK_BE(B4)_16-24 3m HORN_9120D_1328 VERTICAL Detector : Peak Project : 981244 Setting : 17.5</p>	<p>Left blank</p>

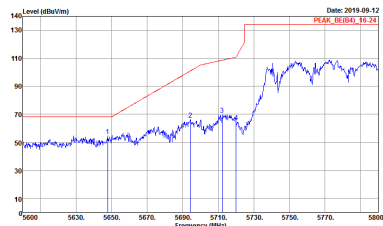
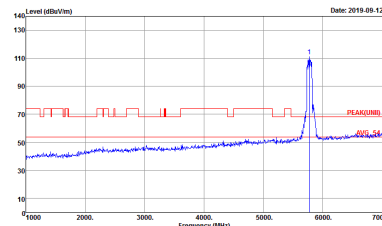

Band 4 5725~5850MHz
WIFI 802.11ac VHT80 (Band Edge @ 3m)

WIFI	Band 4 5725~5850MHz Band Edge @ 3m	
ANT	802.11ac VHT80 CH155 5775MHz	
1+2	Horizontal	Fundamental
<p>Peak</p>	 <p>Site : 03CH12-HY Condition : PEAK_BE(B4)_16-24 3m HORN_9120D_1328 HORIZONTAL Detector : Peak Project : 981244 Setting : 175</p>	 <p>Site : 03CH12-HY Condition : PEAK(FUN1) 3m HORN_9120D_1328 HORIZONTAL Detector : Peak Project : 981244 Setting : 175</p>
<p>Peak</p>	 <p>Site : 03CH12-HY Condition : PEAK_BE(B4)_16-24 3m HORN_9120D_1328 HORIZONTAL Detector : Peak Project : 981244 Setting : 175</p>	<p align="center">Left blank</p>



WIFI	Band 4 5725~5850MHz Band Edge @ 3m	
ANT	802.11ac VHT80 CH155 5775MHz	
1+2	Vertical	Fundamental
<p>Peak</p>	<p>Site : 03CH12-HY Condition : PEAK_BE(B4)_16-24 3m HORN_9120D_1328 VERTICAL Detector : Peak Project : 981244 Setting : 17.5</p>	<p>Site : 03CH12-HY Condition : PEAK(FUNDE) 3m HORN_9120D_1328 VERTICAL Detector : Peak Project : 981244 Setting : 17.5</p>
<p>Peak</p>	<p>Site : 03CH12-HY Condition : PEAK_BE(B4)_16-24 3m HORN_9120D_1328 VERTICAL Detector : Peak Project : 981244 Setting : 17.5</p>	<p>Left blank</p>



Band 4 - 5725~5850MHz
WIFI 802.11a (Harmonic @ 3m)

WIFI	Band 4 5725~5850MHz Harmonic @ 3m	
ANT	802.11a CH149 5745MHz	
1+2	Horizontal	Vertical
Peak Avg.	<p>Site : 03CH12-HY Condition : PEAK(LINE) 3m HORN_9120D_1328 HORIZONTAL Detector : Peak Project : 981244 Setting : 17.5</p>	<p>Site : 03CH12-HY Condition : PEAK(LINE) 3m HORN_9120D_1328 VERTICAL Detector : Peak Project : 981244 Setting : 17.5</p>

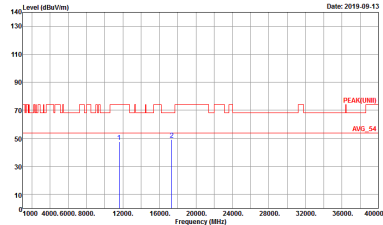
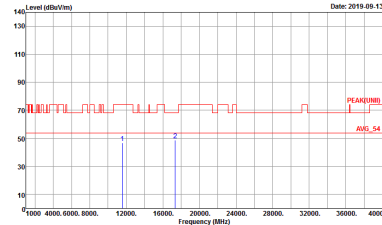

WIFI	Band 4 5725~5850MHz Harmonic @ 3m	
ANT	802.11a CH157 5785MHz	
1+2	Horizontal	Vertical
<p>Peak Avg.</p>	 <p>Site : 03CH12-1HY Condition : PEAK(LINE1) 3m HORN_9120D_1328 HORIZONTAL Detector : Peak Project : 981244 Setting : 175</p>	 <p>Site : 03CH12-1HY Condition : PEAK(LINE1) 3m HORN_9120D_1328 VERTICAL Detector : Peak Project : 981244 Setting : 175</p>

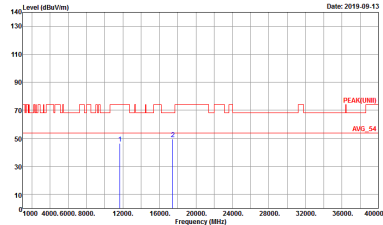
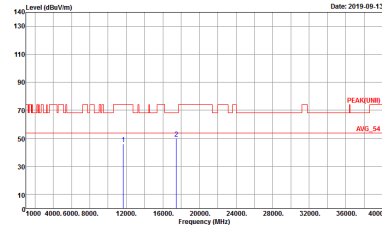

WIFI	Band 4 5725~5850MHz Harmonic @ 3m	
ANT	802.11a CH165 5825MHz	
1+2	Horizontal	Vertical
<p>Peak</p> <p>Avg.</p>	 <p>Site : 03CH12-1HY Condition : PEAK(LINE1) 3m HORN_9120D_1328 HORIZONTAL Detector : Peak Project : 981244 Setting : 17.5</p>	 <p>Site : 03CH12-1HY Condition : PEAK(LINE1) 3m HORN_9120D_1328 VERTICAL Detector : Peak Project : 981244 Setting : 17.5</p>



Band 4 5725~5850MHz
WIFI 802.11ac VHT20 (Harmonic @ 3m)

WIFI	Band 4 5725~5850MHz Harmonic @ 3m	
ANT	802.11ac VHT20 CH149 5745MHz	
1+2	Horizontal	Vertical
Peak Avg.	<p>Site : 03CH12-HY Condition : PEAK(UNII) 3m HORN_9120D_1328 HORIZONTAL Detector : Peak Project : 981244 Setting : 17.5</p>	<p>Site : 03CH12-HY Condition : PEAK(UNII) 3m HORN_9120D_1328 VERTICAL Detector : Peak Project : 981244 Setting : 17.5</p>



WIFI	Band 4 5725~5850MHz Harmonic @ 3m	
ANT	802.11ac VHT20 CH157 5785MHz	
1+2	Horizontal	Vertical
Peak Avg.	<p>Site : 03CH12-4Y Condition : PEAK(LINE1) 3m HORN_9120D_1328 HORIZONTAL Detector : Peak Project : 981244 Setting : 175</p>	<p>Site : 03CH12-4Y Condition : PEAK(LINE1) 3m HORN_9120D_1328 VERTICAL Detector : Peak Project : 981244 Setting : 175</p>



WIFI	Band 4 5725~5850MHz Harmonic @ 3m	
ANT	802.11ac VHT20 CH165 5825MHz	
1+2	Horizontal	Vertical
Peak Avg.	<p>Site : 03CH12-1HY Condition : PEAK(LINE1) 3m HORN_9120D_1328 HORIZONTAL Detector : Peak Project : 981244 Setting : 17.5</p>	<p>Site : 03CH12-1HY Condition : PEAK(LINE1) 3m HORN_9120D_1328 VERTICAL Detector : Peak Project : 981244 Setting : 17.5</p>



Band 4 5725~5850MHz
WIFI 802.11ac VHT40 (Harmonic @ 3m)

WIFI	Band 4 5725~5850MHz Harmonic @ 3m	
ANT	802.11ac VHT40 CH151 5755MHz	
1+2	Horizontal	Vertical
Peak Avg.	<p>Site : 03CH12-HY Condition : PEAK(UNII) 3m HORN_9120D_1328 HORIZONTAL Detector : Peak Project : 981244 Setting : 17.5</p>	<p>Site : 03CH12-HY Condition : PEAK(UNII) 3m HORN_9120D_1328 VERTICAL Detector : Peak Project : 981244 Setting : 17.5</p>



WIFI	Band 4 5725~5850MHz Harmonic @ 3m	
ANT	802.11ac VHT40 CH159 5795MHz	
1+2	Horizontal	Vertical
Peak Avg.	<p>Site : 03CH12-1HY Condition : PEAK(LINE1) 3m HORN_9120D_1328 HORIZONTAL Detector : Peak Project : 981244 Setting : 175</p>	<p>Site : 03CH12-1HY Condition : PEAK(LINE1) 3m HORN_9120D_1328 VERTICAL Detector : Peak Project : 981244 Setting : 175</p>



Band 4 5725~5850MHz
WIFI 802.11ac VHT80 (Harmonic @ 3m)

WIFI	Band 4 5725~5850MHz Harmonic @ 3m	
ANT	802.11ac VHT80 CH155 5775MHz	
1+2	Horizontal	Vertical
Peak Avg.	<p>Site : 03CH12-HY Condition : PEAK(UNII) 3m HORN_9120D_1328 HORIZONTAL Detector : Peak Project : 981244 Setting : 17.5</p>	<p>Site : 03CH12-HY Condition : PEAK(UNII) 3m HORN_9120D_1328 VERTICAL Detector : Peak Project : 981244 Setting : 17.5</p>

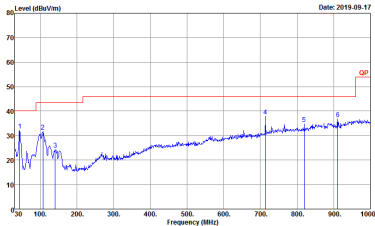
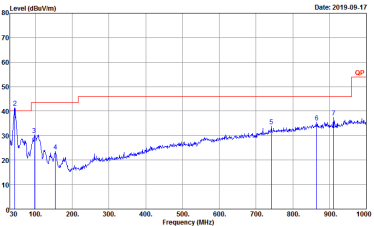

Emission below 1GHz
5GHz WIFI 802.11ac VHT80 (LF)

WIFI	5GHz 5725~5850MHz	
ANT	802.11ac VHT80 LF	
1+2	Horizontal	Vertical
<p>QP / Peak</p>	 <p>Site : 03CH12-HY Condition : QP 3m BTL06_6111D_37059 HORIZONTAL Detector : Peak Project : 981244</p>	 <p>Site : 03CH12-HY Condition : QP 3m BTL06_6111D_37059 VERTICAL Detector : Peak Project : 981244</p>



<TXBF Mode>

Band 4 - 5725~5850MHz
WIFI 802.11ac VHT20 (Band Edge @ 3m)

Table with 2 columns: Horizontal and Fundamental. It contains two spectral plots showing Level (dBm/100) vs Frequency (MHz) with associated test parameters like Site, Condition, Detector, Project, and Setting.

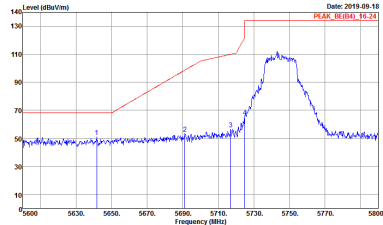
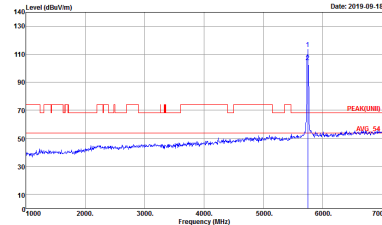

WIFI	Band 4 5725~5850MHz Band Edge @ 3m	
ANT	802.11ac VHT20 CH149 5745MHz	
1+2	Vertical	Fundamental
<p>Peak Avg.</p>	 <p>Site : 03CH12-11Y Condition : PEAK_RE(00)_16-24 3m HORN_9120D_1328 VERTICAL Detector : Peak Project : 981244 Setting : 20</p>	 <p>Site : 03CH12-11Y Condition : PEAK(0000) 3m HORN_9120D_1328 VERTICAL Detector : Peak Project : 981244 Setting : 20</p>

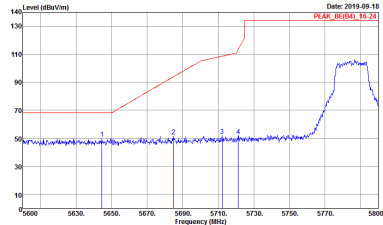
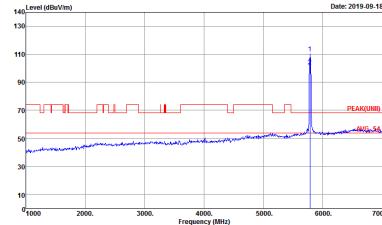
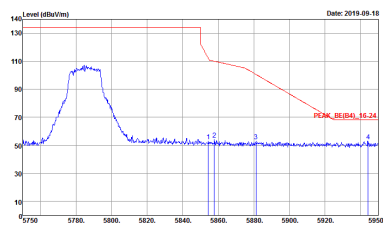

WIFI	Band 4 5725~5850MHz Band Edge @ 3m	
ANT	802.11ac VHT20 CH157 5785MHz	
1+2	Horizontal	Fundamental
<p>Peak</p>	 <p>Site : 03CH12-HY Condition : PEAK_BE(B4)_16-24 3m HORN_9120D_1328 HORIZONTAL Detector : Peak Project : 981244 Setting : 20</p>	 <p>Site : 03CH12-HY Condition : PEAK(FUNDET) 3m HORN_9120D_1328 HORIZONTAL Detector : Peak Project : 981244 Setting : 20</p>
<p>Peak</p>	 <p>Site : 03CH12-HY Condition : PEAK_BE(B4)_16-24 3m HORN_9120D_1328 HORIZONTAL Detector : Peak Project : 981244 Setting : 20</p>	<p>Left blank</p>



WIFI	Band 4 5725~5850MHz Band Edge @ 3m	
ANT	802.11ac VHT20 CH157 5785MHz	
1+2	Vertical	Fundamental
Peak	<p>Site : 03CH12-HY Condition : PEAK_BE(B4)_16-24 3m HORN_9120D_1328 VERTICAL Detector : Peak Project : 981244 Setting : 20</p>	<p>Site : 03CH12-HY Condition : PEAK(UNID) 3m HORN_9120D_1328 VERTICAL Detector : Peak Project : 981244 Setting : 20</p>
Peak	<p>Site : 03CH12-HY Condition : PEAK_BE(B4)_16-24 3m HORN_9120D_1328 VERTICAL Detector : Peak Project : 981244 Setting : 20</p>	Left blank

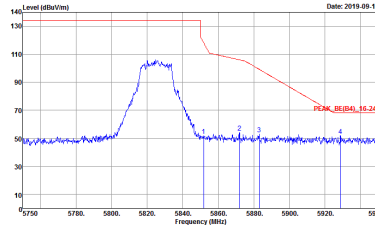
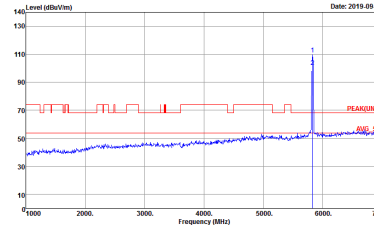

WIFI	Band 4 5725~5850MHz Band Edge @ 3m	
ANT	802.11ac VHT20 CH165 5825MHz	
1+2	Horizontal	Fundamental
<p>Peak</p>	 <p>Site : 03CH12-1HY Condition : PEAK_BE(B4)_16-24 3m HORN_91200_1328 HORIZONTAL Detector : Peak Project : 981244 Setting : 20</p>	 <p>Site : 03CH12-1HY Condition : PEAK(FUN) 3m HORN_91200_1328 HORIZONTAL Detector : Peak Project : 981244 Setting : 20</p>

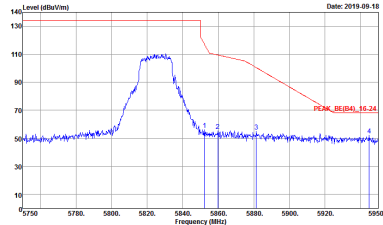
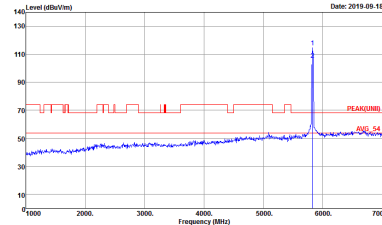

WIFI	Band 4 5725~5850MHz Band Edge @ 3m	
ANT	802.11ac VHT20 CH165 5825MHz	
1+2	Vertical	Fundamental
<p>Peak</p> <p>Avg.</p>	 <p>Site : 03CH12-1HY Condition : PEAK_BE(B4)_16-24 3m HORN_9120D_1328 VERTICAL Detector : Peak Project : 981244 Setting : 20</p>	 <p>Site : 03CH12-1HY Condition : PEAK(FUND) 3m HORN_9120D_1328 VERTICAL Detector : Peak Project : 981244 Setting : 20</p>

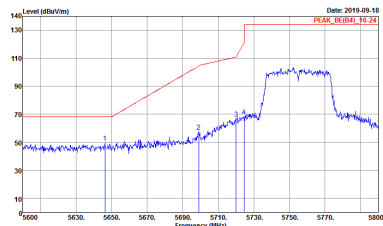
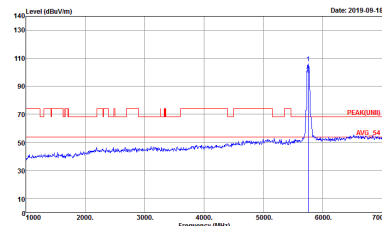
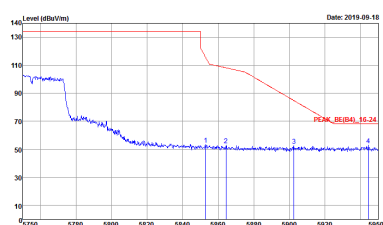

Band 4 5725~5850MHz
WIFI 802.11ac VHT40 (Band Edge @ 3m)

WIFI	Band 4 5725~5850MHz Band Edge @ 3m	
ANT	802.11ac VHT40 CH151 5755MHz	
1+2	Horizontal	Fundamental
<p>Peak</p>	 <p>Site : 03CH12-HY Condition : PEAK_BE(B4)_16-24 3m HORN_9120D_1328 HORIZONTAL RBW:3000.000KHz VBW:3000.000KHz SWT:Auto Detector : Peak Project : 981244 Setting : 20</p>	 <p>Site : 03CH12-HY Condition : PEAK(UNII) 3m HORN_9120D_1328 HORIZONTAL RBW:3000.000KHz VBW:3000.000KHz SWT:Auto Detector : Peak Project : 981244 Setting : 20</p>
<p>Peak</p>	 <p>Site : 03CH12-HY Condition : PEAK_BE(B4)_16-24 3m HORN_9120D_1328 HORIZONTAL RBW:3000.000KHz VBW:3000.000KHz SWT:Auto Detector : Peak Project : 981244 Setting : 20</p>	<p>Left blank</p>