



FCC CO-LOCATION TEST REPORT

FCC ID : UZ7MC330L
Equipment : Mobile Computer
Brand Name : Zebra
Model Name : MC330L
Applicant : Zebra Technologies Corporation
1 Zebra Plaza, Holtsville, NY 11742
Manufacturer : Zebra Technologies Corporation
1 Zebra Plaza, Holtsville, NY 11742
Standard : FCC Part 15 Subpart E §15.407

The product was received on Aug. 12, 2019 and testing was started from Nov. 14, 2019 and completed on Nov. 14, 2019. We, SPORTON INTERNATIONAL INC. EMC & Wireless Communications Laboratory, would like to declare that the tested sample has been evaluated in accordance with the test procedures and has been in compliance with the applicable technical standards.

The report must not be used by the client to claim product certification, approval, or endorsement by TAF or any agency of government.

The test results in this report apply exclusively to the tested model / sample. Without written approval of SPORTON INTERNATIONAL INC. EMC & Wireless Communications Laboratory, the test report shall not be reproduced except in full.

Approved by: Louis Wu

SPORTON INTERNATIONAL INC. EMC & Wireless Communications Laboratory
No. 52, Huaya 1st Rd., Guishan Dist., Taoyuan City, Taiwan (R.O.C.)



Table of Contents

History of this test report.....	3
Summary of Test Result.....	4
1 General Description	5
1.1 Product Feature of Equipment Under Test.....	5
1.2 Product Specification of Equipment Under Test.....	9
1.3 Modification of EUT	9
1.4 Testing Location	9
1.5 Applicable Standards.....	9
2 Test Configuration of Equipment Under Test	10
2.1 Carrier Frequency and Channel	10
2.2 Test Mode.....	10
2.3 Connection Diagram of Test System.....	10
2.4 Support Unit used in test configuration and system	11
2.5 EUT Operation Test Setup	11
3 Test Result	12
3.1 Unwanted Emissions Measurement.....	12
3.2 Antenna Requirements	16
4 List of Measuring Equipment.....	17
5 Uncertainty of Evaluation	18
Appendix A. Radiated Spurious Emission	
Appendix B. Radiated Spurious Emission Plots	
Appendix C. Duty Cycle Plots	
Appendix D. Setup Photographs	



Summary of Test Result

Report Clause	Ref Std. Clause	Test Items	Result (PASS/FAIL)	Remark
3.1	15.407(b)	Unwanted Emissions	Pass	Under limit 1.23 dB at 242483.500 MHz
3.2	15.203 15.407(a)	Antenna Requirement	Pass	-

Declaration of Conformity:

The test results with all measurement uncertainty excluded are presented in accordance with the regulation limits or requirements declared by manufacturers.

Comments and Explanations:

The declared of product specification for EUT presented in the report are provided by the manufacturer, and the manufacturer takes all the responsibilities for the accuracy of product specification.

Reviewed by: Wii Chang

Report Producer: Yimin Ho



1 General Description

1.1 Product Feature of Equipment Under Test

Product Feature	
Equipment	Mobile Computer
Brand Name	Zebra
Model Name	MC330L
FCC ID	UZ7MC330L
EUT supports Radios application	NFC WLAN 11a/b/g/n HT20/HT40 WLAN 11ac VHT20/VHT40/VHT80 Bluetooth BR/EDR/LE
HW Version	DV
SW Version_Gun	Android Version 9
SW Version_Brick	Android Version 9
SW Version_Rotate	Android Version 9
FW Version_Gun	Terminal Version: 02-11-08.00-PG-U00-PLT
FW Version_Brick	Terminal Version: 02-11-08.00-PG-U00-PLT
FW Version_Rotate	Terminal Version: 02-11-08.00-PG-U00-PLT
MFD_Gun	01AUG19
MFD_Brick	02AUG19
MFD_Rotate	27JUL19
EUT Stage	Identical Prototype

Remark: The above EUT's information was declared by manufacturer.



Specification of Accessories				
Adapter	Brand Name	Zebra	Part Number	PWR-WUA5V12W0US
U cable	Brand Name	Symbol	Model Name	CBL-MC33-USBCHG-01
MC32 1X battery (Inventus)	Brand Name	Symbol	Model Number	82-000011-01
MC32 2X battery (Inventus)	Brand Name	Symbol	Model Number	82-000012-02
MC32 2X battery (TWS)	Brand Name	Symbol	Model Number	82-000012-02
MC33 1X battery (Inventus)	Brand Name	ZEBRA	Model Number	BT-000338
MC33 2X battery (Inventus)	Brand Name	ZEBRA	Model Number	BT-000337
MC33 2X battery (TWS)	Brand Name	ZEBRA	Model Number	BT-000337A
MC33 7000mA 2X (Inventus)	Brand Name	ZEBRA	Model Number	BT-000375
Holster for MC3XXX Gun configuration	Brand Name	Zebra	Model Number	SG-MC3021212-01R
Rigid holster for MC3XXX Gun configuration	Brand Name	Zebra	Model Number	SG-MC33-RDHLST-01
Holster for MC3XXX Brick configuration	Brand Name	Zebra	Model Number	11-69293-01R
Rigid holster for MC3XXX Brick configuration	Brand Name	Zebra	Model Number	SG-MC33-RDHLST-01
Lanyard for MC3XXX Brick Configuration	Brand Name	Zebra	Model Number	SG-MC33-LNYDB-01
Protective boot for MC3XXX straight shooter	Brand Name	Zebra	Model Number	SG-MC33-RBTG-01
Protective boot for MC3XXX Turret Cup of Rotate configuration	Brand Name	Zebra	Model Number	SG-MC33-RBTRT-01
Protective boot for MC3XXX Rotate configuration	Brand Name	Zebra	Model Number	SG-MC33-RBTRD-01

**<Sample Information>**

Organization / Function / Group	SKU1	SKU2	SKU3	SKU4	SKU5
Phase	DV	DV	DV	DV	DV
Configuration					
Form Factor	Gun	Gun	Gun - Amazon	Gun China	Rotate
Scanner	SE965	SE4850 new 20-4850-IM001R	SE4770	SE4720	SE965
Keypad	Numeric (29Key)	Function Numeric (47Key)	AlphaNum (47Key)	Function Numeric (38Key)	Numeric (47Key)
Tier	Base	Base	Base	Base	Base
NFC	Yes	Yes	Yes	Yes	Yes
Camera	NA	NA	NA	NA	No
Audio Jack (NA)	NA	NA	NA	NA	No
Back Hsg	Gun 18D	Gun 18D	Gun 18D	Gun 18D	Rotate Head
Screen Protector	No	Yes	Yes	No	No
RFID Tag	Yes	Yes	Yes	Yes	No
Hand strap	No	Yes	Yes	No	No
USB Charge cable in box	No	No	No	Yes	No
Wal wart adaptor	No	No	No	Yes	No
PCB	Tripod	Tripod	Tripod	Tripod	Tripod
DRAM/eMMC	4/32 GB MLC	4/32 GB MLC	4/32 GB MLC	4/16 GB MLC	4/32 GB MLC
DRAM/eMMC Mfr main source	Hynix/Hynix	Hynix/Hynix	Hynix/Hynix	Hynix/Hynix	Hynix/Hynix



Organization / Function / Group	SKU6	SKU7	SKU8	SKU9	SKU10
Phase	DV	DV	DV	DV	DV
Configuration					
Form Factor	Straight (S)	Straight (S)	Straight (S) China	Straight (L)	Straight(45)
Scanner	SE965	SE4770	SE4720	SE4850 new 20-4850-IM001R	SE4770
Keypad	AlphaNum (47Key)	Function Numeric (38Key)	Function Numeric (38Key)	Numeric (29Key)	Function Numeric (38Key)
Tier	Base + Camera	Base + Camera	Base	Base + Camera	Base + Camera
NFC	Yes	Yes	Yes	Yes	Yes
Camera	Yes	Yes	No	Yes	Yes
Audio Jack (NA)	No	No	No	No	No
Back Hsg	22 Deg ST	22 Deg ST	22 Deg ST	18 deg ST	45 deg ST
Screen Protector	No	No	No	Yes	Yes
RFID Tag	No	No	No	No	No
Hand strap	Yes	No	No	No	Yes
USB Charge cable in box	No	No	Yes	No	No
Wal wart adaptor	No	No	Yes	No	No
PCB	Tripod	Tripod	Tripod	Tripod	Tripod
DRAM/eMMC	4/32 GB MLC	4/32 GB MLC	4/16 GB MLC	4/32 GB MLC	4/32 GB MLC
DRAM/eMMC Mfr main source	Hynix/Hynix	Hynix/Hynix	Hynix/Hynix	Hynix/Hynix	Hynix/Hynix

1.2 Product Specification of Equipment Under Test

Standards-related Product Specification	
Tx/Rx Frequency Range	2400 MHz ~ 2483.5 MHz 5260 MHz ~ 5320 MHz
Antenna Type / Gain	<2412 MHz ~ 2462 MHz> Ant. 1 : PIFA Antenna with gain 3.40 dBi <5250 MHz ~ 5350 MHz> Ant. 2 : PIFA Antenna with gain 4.41 dBi
Type of Modulation	802.11n : OFDM (BPSK / QPSK / 16QAM / 64QAM) 802.11ac: OFDM (BPSK / QPSK / 16QAM / 64QAM / 256QAM)

1.3 Modification of EUT

No modifications are made to the EUT during all test items.

1.4 Testing Location

Test Site	SPORTON INTERNATIONAL INC. EMC & Wireless Communications Laboratory
Test Site Location	No.58, Aly. 75, Ln. 564, Wenhua 3rd, Rd., Guishan Dist., Taoyuan City, Taiwan (R.O.C.) TEL: +886-3-327-0868 FAX: +886-3-327-0855
Test Site No.	Sporton Site No. 03CH12-HY

Note: The test site complies with ANSI C63.4 2014 requirement.

FCC Designation No. TW0007

1.5 Applicable Standards

According to the specifications of the manufacturer, the EUT must comply with the requirements of the following standards:

- ♦ FCC Part 15 Subpart E
- ♦ FCC KDB 789033 D02 General UNII Test Procedures New Rules v02r01.
- ♦ FCC KDB 414788 D01 Radiated Test Site v01r01.
- ♦ FCC KDB 662911 D01 Multiple Transmitter Output v02r01.
- ♦ FCC KDB Publication No. 558074 D01 DTS Meas. Guidance v05r02
- ♦ ANSI C63.10-2013

Remark:

1. All test items were verified and recorded according to the standards and without any deviation during the test.
2. This EUT has also been tested and complied with the requirements of FCC Part 15, Subpart B, recorded in a separate test report.

2 Test Configuration of Equipment Under Test

The EUT has been associated with peripherals and configuration operated in a manner tended to maximize its emission characteristics in a typical application. Frequency range investigated: radiation emission (9 kHz to the 10th harmonic of the highest fundamental frequency or to 40 GHz, whichever is lower). For radiated measurement, pre-scanned in three orthogonal panels, X, Y, Z. The worst cases (Y plane) were recorded in this report.

2.1 Carrier Frequency and Channel

2400-2483.5 MHz 802.11n HT40		5250-5350 MHz 802.11ac VHT40	
Channel	Freq. (MHz)	Channel	Freq. (MHz)
09	2452	62	5310

2.2 Test Mode

Final test modes are considering the modulation and worse data rates as below table.

<Co-Location>

Modulation	Data Rate
802.11n HT40 for Ant. 1 + 802.11ac VHT40 for Ant. 2	MCS0 + MCS0

Remark: All the tests were performed with MC33 2X battery (Inventus) and SKU 5.

2.3 Connection Diagram of Test System

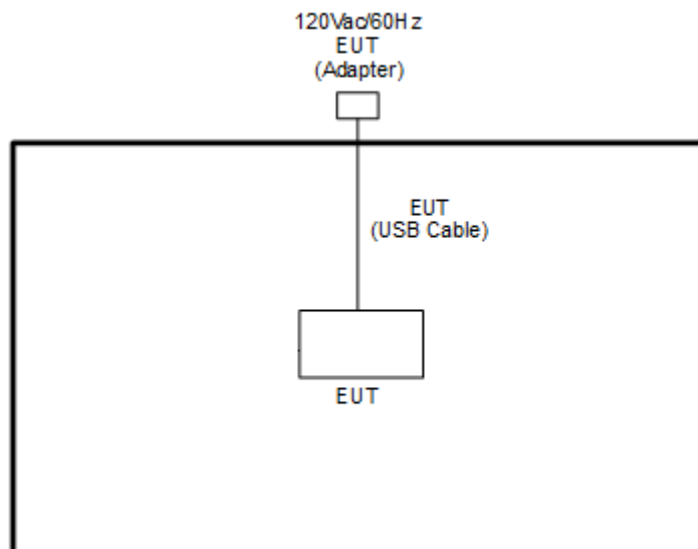



2.4 Support Unit used in test configuration and system

Item	Equipment	Trade Name	Model Name	FCC ID	Data Cable	Power Cord
1.	Notebook	Lenovo	E330	NA	N/A	AC I/P: Unshielded, 1.2m DC O/P: Shielded, 1.8m

2.5 EUT Operation Test Setup

The RF test items, utility “QRCT v3.0.298.0” was installed in Notebook which was programmed in order to make the EUT get into the engineering modes to provide channel selection, power level, data rate and the application type and for continuous transmitting signals.



3 Test Result

3.1 Unwanted Emissions Measurement

This section is to measure unwanted emissions through radiated measurement for band edge spurious emissions and out of band emissions measurement.

3.1.1 Limit of Unwanted Emissions

(1) Unwanted spurious emissions fallen in restricted bands shall comply with the general field strength limits as below table,

Frequency (MHz)	Field Strength (microvolts/meter)	Measurement Distance (meters)
0.009 – 0.490	2400/F(kHz)	300
0.490 – 1.705	24000/F(kHz)	30
1.705 – 30.0	30	30
30 – 88	100	3
88 – 216	150	3
216 - 960	200	3
Above 960	500	3

Note: The following formula is used to convert the EIRP to field strength.

$$E = \frac{1000000\sqrt{30P}}{3} \mu\text{V/m, where P is the eirp (Watts)}$$

EIRP (dBm)	Field Strength at 3m (dBμV/m)
- 27	68.3

(3) KDB789033 D02 v02r01 G)2)c)

- (i) Sections 15.407(b)(1-3) specifies the unwanted emissions limit for the U-NII-1 and U-NII-2 bands. As specified, emissions above 1000 MHz that are outside of the restricted bands are subject to a peak emission limit of -27 dBm/MHz.
- (ii) Section 15.407(b)(4) specifies the unwanted emissions limit for the U-NII-3 band. A band emissions mask is specified in Section 15.407(b)(4)(i). The emission limits are based on the use of a peak detector.

3.1.2 Measuring Instruments

See list of measuring equipment of this test report.



3.1.3 Test Procedures

1. The testing follows FCC KDB 789033 D02 General UNII Test Procedures New Rules **v02r01**.
Section G) Unwanted emissions measurement.
 - (1) Procedure for Unwanted Emissions Measurements Below 1000MHz
 - RBW = 120 kHz
 - VBW = 300 kHz
 - Detector = Peak
 - Trace mode = max hold
 - (2) Procedure for Peak Unwanted Emissions Measurements Above 1000 MHz
 - RBW = 1 MHz
 - VBW \geq 3 MHz
 - Detector = Peak
 - Sweep time = auto
 - Trace mode = max hold
 - (3) Procedures for Average Unwanted Emissions Measurements Above 1000MHz
 - RBW = 1 MHz
 - VBW = 10 Hz, when duty cycle is no less than 98 percent.
 - VBW \geq 1/T, when duty cycle is less than 98 percent where T is the minimum transmission duration over which the transmitter is on and is transmitting at its maximum power control level for the tested mode of operation.
2. The EUT was placed on a turntable with 0.8 meter for frequency below 1GHz and 1.5 meter for frequency above 1GHz respectively above ground.
3. The EUT was set 3 meters from the interference receiving antenna which was mounted on the top of a variable height antenna tower.
4. The antenna is a broadband antenna and its height is adjusted between one meter and four meters above ground to find the maximum value of the field strength for both horizontal polarization and vertical polarization of the antenna.
5. For each suspected emission, the EUT was arranged to its worst case and then adjust the antenna tower (from 1 m to 4 m) and turntable (from 0 degree to 360 degrees) to find the maximum reading.
6. For testing below 1GHz, if the emission level of the EUT in peak mode was 3 dB lower than the limit specified, then peak values of EUT will be reported, otherwise, the emissions will be repeated one by one using the CISPR quasi-peak method and reported.
7. For testing above 1GHz, the emission level of the EUT in peak mode was 20dB lower than average limit (that means the emission level in average mode also complies with the limit in average mode), then peak values of EUT will be reported, otherwise, the emissions will be measured in average mode again and reported.

3.1.4 Test Setup

For radiated emissions below 30MHz

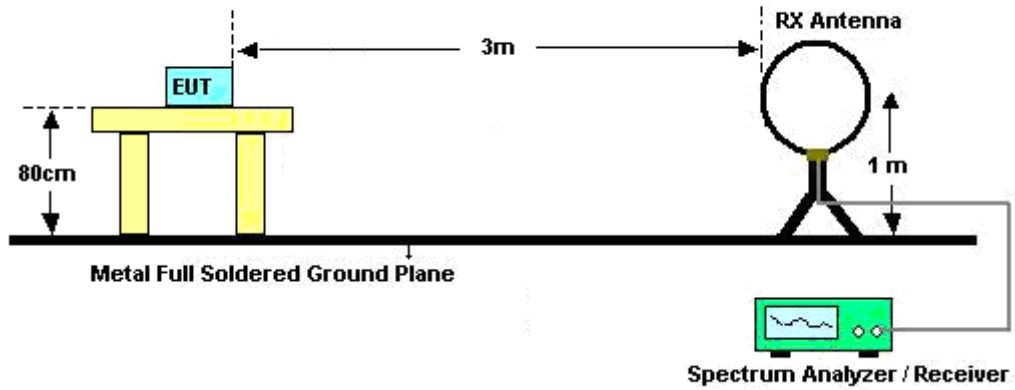

For radiated emissions from 30MHz to 1GHz

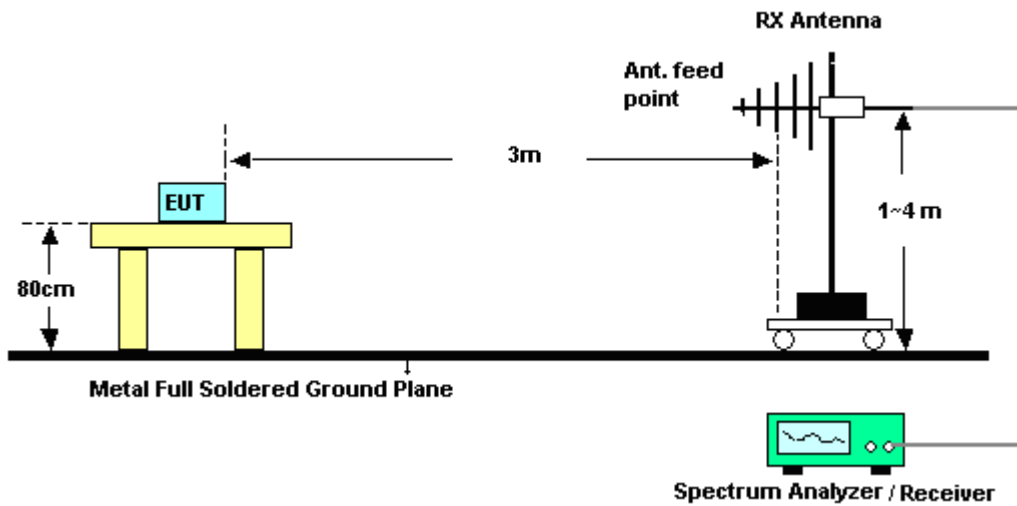

For radiated emissions above 1GHz

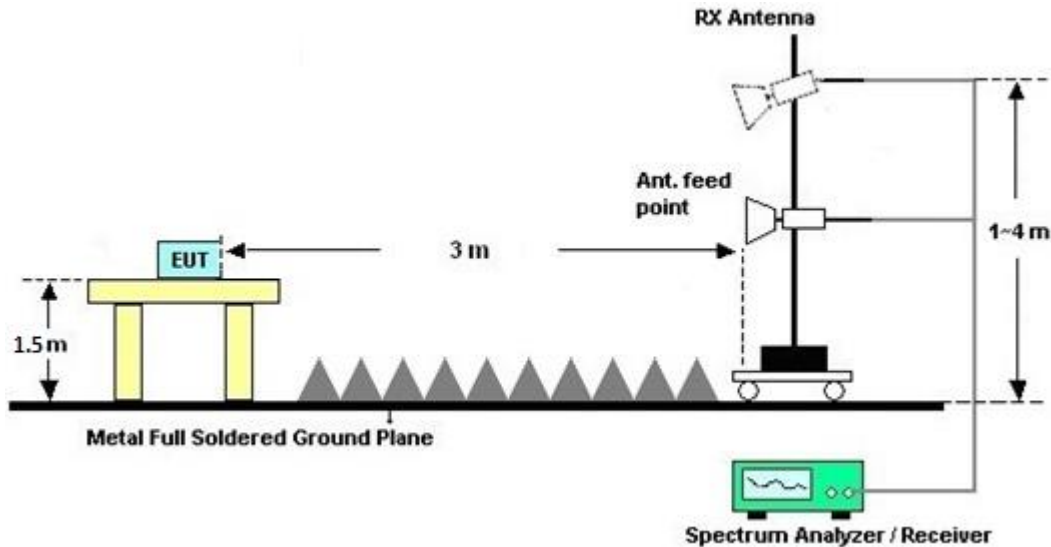

3.1.5 Test Results of Radiated Spurious Emissions (9 kHz ~ 30 MHz)

The low frequency, which started from 9 kHz to 30MHz, was pre-scanned and the result which was 20dB lower than the limit line was not reported.

There is a comparison data of both open-field test site and alternative test site - semi-Anechoic chamber according to 414788 D01 Radiated Test Site v01r01, and the result came out very similar.

3.1.6 Test Result of Radiated Spurious at Band Edges

Please refer to Appendix A and B.

3.1.7 Duty Cycle

Please refer to Appendix C.

3.1.8 Test Result of Radiated Spurious Emissions (30MHz ~ 10th Harmonic)

Please refer to Appendix A and B.



3.2 Antenna Requirements

3.2.1 Standard Applicable

If transmitting antenna directional gain is greater than 6 dBi, both the peak transmit power and the peak power spectral density shall be reduced by the amount in dB that the directional gain of the antenna exceeds 6 dBi.

3.2.2 Antenna Anti-Replacement Construction

An embedded-in antenna design is used.

3.2.3 Antenna Gain

The antenna peak gain of EUT is less than 6 dBi. Therefore, it is not necessary to reduce maximum peak output power limit.



4 List of Measuring Equipment

Instrument	Manufacturer	Model No.	Serial No.	Characteristics	Calibration Date	Test Date	Due Date	Remark
Loop Antenna	Rohde & Schwarz	HFH2-Z2	100488	9 kHz~30 MHz	Jan. 07, 2019	Nov. 14, 2019	Jan. 06, 2020	Radiation (03CH12-HY)
Bilog Antenna	TESEQ	CBL 6111D&00800 N1D01N-06	37059&01	30MHz~1GHz	Oct. 12, 2019	Nov. 14, 2019	Oct. 11, 2020	Radiation (03CH12-HY)
Horn Antenna	SCHWARZBECK	BBHA 9120D	9120D-020 37	1GHz ~ 18GHz	Oct. 28, 2019	Nov. 14, 2019	Oct. 27, 2020	Radiation (03CH12-HY)
SHF-EHF Horn Antenna	SCHWARZBECK	BBHA 9170	BBHA9170 584	18GHz ~ 40GHz	Dec. 05, 2018	Nov. 14, 2019	Dec. 04, 2019	Radiation (03CH12-HY)
Preamplifier	COM-POWER	PA-103	161075	10MHz~1GHz	Mar. 25, 2019	Nov. 14, 2019	Mar. 24, 2020	Radiation (03CH12-HY)
Preamplifier	Agilent	8449B	3008A0237 5	1GHz~26.5GHz	May. 27, 2019	Nov. 14, 2019	May 26, 2020	Radiation (03CH12-HY)
Preamplifier	MITEQ	AMF-7D-0010 1800-30-10P	1590074	1GHz~18GHz	May. 20, 2019	Nov. 14, 2019	May 19, 2020	Radiation (03CH12-HY)
Preamplifier	EMEC	EM18G40G	060715	18GHz ~ 40GHz	Dec. 06, 2018	Nov. 14, 2019	Dec. 05, 2019	Radiation (03CH12-HY)
EMI Test Receiver	Rohde & Schwarz	ESU26	100390	20Hz~26.5GHz	Dec. 26, 2018	Nov. 14, 2019	Dec. 25, 2019	Radiation (03CH12-HY)
Spectrum Analyzer	Keysight	N9010A	MY5537052 6	10Hz~44GHz	Mar. 19, 2019	Nov. 14, 2019	Mar. 18, 2020	Radiation (03CH12-HY)
Filter	Wainwright	WLKS1200-1 2SS	SN1	1.2 GHz Lowpass	Mar. 22, 2019	Nov. 14, 2019	Mar. 21, 2020	Radiation (03CH12-HY)
Filter	Wainwright	WHKX12-270 0-3000-18000 -60ST	SN2	3GHz High Pass	Jul. 15, 2019	Nov. 14, 2019	Jul. 14, 2020	Radiation (03CH12-HY)
Filter	Woken	WHKX8-5272. 5-6750-18000 -40ST	SN2	6.75G Highpass	Mar. 19, 2019	Nov. 14, 2019	Mar. 18, 2020	Radiation (03CH12-HY)
Notch Filter	Wainwright	WRCGV2400/ 2483-2390/24 93-35/10SS	SN4	2.4G	Nov. 01, 2019	Nov. 14, 2019	Oct. 31, 2020	Radiation (03CH12-HY)
Notch Filter	Wainwright	WRCJV12-51 20-5150-5350 -5380-40SS	SN6	5GBand1~2	Jul. 03, 2018	Nov. 14, 2019	Jul. 02, 2020	Radiation (03CH12-HY)
RF Cable	HUBER + SUHNER	SUCOFLEX 126E	0058/126E	30M-18G	Mar. 13, 2019	Nov. 14, 2019	Mar. 12, 2020	Radiation (03CH12-HY)
RF Cable	HUBER + SUHNER	SUCOFLEX 102	505134/2	30M~40GHz	Feb. 26, 2019	Nov. 14, 2019	Feb. 25, 2020	Radiation (03CH12-HY)
RF Cable	HUBER + SUHNER	SUCOFLEX 102	800740/2	30M~40GHz	Feb. 26, 2019	Nov. 14, 2019	Feb. 25, 2020	Radiation (03CH12-HY)
Antenna Mast	EMEC	AM-BS-4500- B	N/A	1m~4m	N/A	Nov. 14, 2019	N/A	Radiation (03CH12-HY)
Turn Table	EMEC	TT2000	N/A	0~360 Degree	N/A	Nov. 14, 2019	N/A	Radiation (03CH12-HY)
Software	Audix	E3 6.2009-8-24	RK-000989	N/A	N/A	Nov. 14, 2019	N/A	Radiation (03CH12-HY)



5 Uncertainty of Evaluation

Uncertainty of Radiated Emission Measurement (30 MHz ~ 1000 MHz)

Measuring Uncertainty for a Level of Confidence of 95% ($U = 2Uc(y)$)	5.1
---	-----

Uncertainty of Radiated Emission Measurement (1000 MHz ~ 18000 MHz)

Measuring Uncertainty for a Level of Confidence of 95% ($U = 2Uc(y)$)	5.2
---	-----

Uncertainty of Radiated Emission Measurement (18000 MHz ~ 40000 MHz)

Measuring Uncertainty for a Level of Confidence of 95% ($U = 2Uc(y)$)	4.7
---	-----



Appendix A. Radiated Spurious Emission

Test Engineer :	Jack Cheng, Lance Chiang and Chuan Chu	Temperature :	23.1~26.4°C
		Relative Humidity :	56~68%

2.4G 11n HT40_Tx_Ch09 + 5G 11ac(40)_Tx_Ch62

WIFI 802.11n HT40 (Band Edge @ 3m)

WIFI	Note	Frequency	Level	Over	Limit	Read	Antenna	Path	Preamp	Ant	Table	Peak	Pol.
Ant.				Limit	Line	Level	Factor	Loss	Factor	Pos	Pos	Avg.	
1		(MHz)	(dBμV/m)	(dB)	(dBμV/m)	(dBμV)	(dB/m)	(dB)	(dB)	(cm)	(deg)	(P/A)	(H/V)
802.11n HT40 CH 09 2452MHz		2386.02	54.84	-19.16	74	43.84	27.53	16.62	33.15	217	333	P	H
		2310	46.32	-7.68	54	35.01	27.84	16.53	33.06	217	333	A	H
	*	2452	93.02	-	-	82.17	27.4	16.68	33.23	217	333	P	H
	*	2452	85.28	-	-	74.43	27.4	16.68	33.23	217	333	A	H
		2499.37	55.14	-18.86	74	44.41	27.3	16.72	33.29	217	333	P	H
		2484.67	46.23	-7.77	54	35.46	27.33	16.71	33.27	217	333	A	H
		2328.76	55.27	-18.73	74	44.07	27.73	16.55	33.08	198	312	P	V
		2389.38	46.07	-7.93	54	35.08	27.52	16.63	33.16	198	312	A	V
	*	2452	105.88	-	-	95.03	27.4	16.68	33.23	198	312	P	V
	*	2452	97.97	-	-	87.12	27.4	16.68	33.23	198	312	A	V
		2484.46	60.91	-13.09	74	50.14	27.33	16.71	33.27	198	312	P	V
	2483.5	52.77	-1.23	54	42	27.33	16.71	33.27	198	312	A	V	
Remark	1. No other spurious found. 2. All results are PASS against Peak and Average limit line.												



WIFI 802.11ac VHT40 (Band Edge @ 3m)

WIFI Ant. 2	Note	Frequency (MHz)	Level (dBμV/m)	Over Limit (dB)	Limit Line (dBμV/m)	Read Level (dBμV)	Antenna Factor (dB/m)	Path Loss (dB)	Preamp Factor (dB)	Ant Pos (cm)	Table Pos (deg)	Peak Avg. (P/A)	Pol. (H/V)
802.11ac VHT40 CH 62 5310MHz		5087.38	50.46	-23.54	74	42.24	31.95	9.74	33.47	208	355	P	H
		5116.62	42.97	-11.03	54	34.69	31.97	9.78	33.47	208	355	A	H
	*	5310	100.88	-	-	92.99	31.3	10.04	33.45	208	355	P	H
	*	5310	93.51	-	-	85.62	31.3	10.04	33.45	208	355	A	H
		5368.08	50.86	-23.14	74	42.82	31.37	10.11	33.44	208	355	P	H
		5350.32	45.19	-8.81	54	37.24	31.3	10.09	33.44	208	355	A	H
		5109.82	51.57	-22.43	74	43.29	31.98	9.77	33.47	400	20	P	V
		5140.76	43	-11	54	34.74	31.92	9.81	33.47	400	20	A	V
	*	5310	107.83	-	-	99.94	31.3	10.04	33.45	400	20	P	V
	*	5310	100.15	-	-	92.26	31.3	10.04	33.45	400	20	A	V
		5355.12	56.55	-17.45	74	48.58	31.32	10.09	33.44	400	20	P	V
		5350.08	49.95	-4.05	54	42	31.3	10.09	33.44	400	20	A	V
Remark	1. No other spurious found. 2. All results are PASS against Peak and Average limit line.												



Co-location mode (Harmonic @ 3m)

Co-location	Note	Frequency (MHz)	Level (dBμV/m)	Over Limit (dB)	Limit Line (dBμV/m)	Read Level (dBμV)	Antenna Factor (dB/m)	Path Loss (dB)	Preamp Factor (dB)	Ant Pos (cm)	Table Pos (deg)	Peak Avg. (P/A)	Pol. (H/V)	
Co-location mode		4904	51.75	-22.25	74	44.42	31.22	9.6	33.49	100	331	P	H	
		4904	43.17	-10.83	54	35.84	31.22	9.6	33.49	100	331	A	H	
		7356	45.26	-28.74	74	59.53	36.28	13.02	63.57	100	0	P	H	
		10620	48.63	-25.37	74	57.19	39.88	15.19	63.63	100	0	P	H	
		15930	43.71	-30.29	74	49.99	37.06	18.73	62.07	100	0	P	H	
														H
														H
														H
			4904	51.58	-22.42	74	44.25	31.22	9.6	33.49	100	276	P	V
			4904	43.03	-10.97	54	35.7	31.22	9.6	33.49	100	276	A	V
			7356	44.1	-29.9	74	58.37	36.28	13.02	63.57	100	0	P	V
			10620	48.26	-25.74	74	56.82	39.88	15.19	63.63	100	0	P	V
			15930	43.4	-30.6	74	49.68	37.06	18.73	62.07	100	0	P	V
														V
													V	
													V	
Remark	1. No other spurious found. 2. All results are PASS against Peak and Average limit line.													



Emission below 1GHz

Co-location mode (LF @ 3m)

Co-location	Note	Frequency	Level	Over	Limit	Read	Antenna	Path	Preamp	Ant	Table	Peak	Pol.	
		(MHz)	(dBμV/m)	(dB)	(dBμV/m)	(dBμV)	(dB/m)	(dB)	(dB)	(cm)	(deg)	(P/A)	(H/V)	
Co-location mode		66.86	32.91	-7.09	40	50.38	11.79	1.2	30.46	-	-	P	H	
		72.68	33.6	-6.4	40	50.5	12.29	1.26	30.45	100	0	P	H	
		113.42	34.02	-9.48	43.5	45.91	17.01	1.52	30.42	-	-	P	H	
		777.87	38.69	-7.31	46	35.71	28.19	4.13	29.34	-	-	P	H	
		914.64	35.73	-10.27	46	31.02	29.27	4.54	29.1	-	-	P	H	
		950.53	36.28	-9.72	46	30	30.61	4.66	28.99	-	-	P	H	
														H
														H
														H
														H
														H
														H
														H
														H
														H
														H
														H
														H
			42.61	34.64	-5.36	40	46.02	18.02	0.96	30.36	100	353	QP	V
			42.61	42.79	2.79	40	54.17	18.02	0.96	30.36	100	353	P	V
		64.92	33.61	-6.39	40	51.23	11.65	1.19	30.46	-	-	P	V	
		113.42	34.68	-8.82	43.5	46.57	17.01	1.52	30.42	-	-	P	V	
		777.87	38.15	-7.85	46	35.17	28.19	4.13	29.34	-	-	P	V	
		882.63	34.81	-11.19	46	30.56	28.97	4.45	29.17	-	-	P	V	
		953.44	37.17	-8.83	46	30.76	30.73	4.67	28.99	-	-	P	V	
													V	
													V	
													V	
													V	
													V	
													V	
Remark	<ol style="list-style-type: none"> No other spurious found. All results are PASS against limit line. 													



Note symbol

*	Fundamental Frequency which can be ignored. However, the level of any unwanted emissions shall not exceed the level of the fundamental frequency.
!	Test result is over limit line.
P/A	Peak or Average
H/V	Horizontal or Vertical



A calculation example for radiated spurious emission is shown as below:

WIFI	Note	Frequency	Level	Over	Limit	Read	Antenna	Path	Preamp	Ant	Table	Peak	Pol.
Ant.				Limit	Line	Level	Factor	Loss	Factor	Pos	Pos	Avg.	
0		(MHz)	(dBμV/m)	(dB)	(dBμV/m)	(dBμV)	(dB/m)	(dB)	(dB)	(cm)	(deg)	(P/A)	(H/V)
802.11b		2390	55.45	-18.55	74	54.51	32.22	4.58	35.86	103	308	P	H
CH 01													
2412MHz		2390	43.54	-10.46	54	42.6	32.22	4.58	35.86	103	308	A	H

1. Path Loss(dB) = Cable loss(dB) + Filter loss(dB) + Attenuator loss(dB)
2. Level(dBμV/m) =
Antenna Factor(dB/m) + Path Loss(dB) + Read Level(dBμV) - Preamp Factor(dB)
3. Over Limit(dB) = Level(dBμV/m) – Limit Line(dBμV/m)

For Peak Limit @ 2390MHz:

1. Level(dBμV/m)
= Antenna Factor(dB/m) + Path Loss(dB) + Read Level(dBμV) - Preamp Factor(dB)
= 32.22(dB/m) + 4.58(dB) + 54.51(dBμV) – 35.86 (dB)
= 55.45 (dBμV/m)
2. Over Limit(dB)
= Level(dBμV/m) – Limit Line(dBμV/m)
= 55.45(dBμV/m) – 74(dBμV/m)
= -18.55(dB)

For Average Limit @ 2390MHz:

1. Level(dBμV/m)
= Antenna Factor(dB/m) + Path Loss(dB) + Read Level(dBμV) - Preamp Factor(dB)
= 32.22(dB/m) + 4.58(dB) + 42.6(dBμV) – 35.86 (dB)
= 43.54 (dBμV/m)
2. Over Limit(dB)
= Level(dBμV/m) – Limit Line(dBμV/m)
= 43.54(dBμV/m) – 54(dBμV/m)
= -10.46(dB)

Both peak and average measured complies with the limit line, so test result is “PASS”.



Appendix B. Radiated Spurious Emission Plots

Test Engineer :	Jack Cheng, Lance Chiang and Chuan Chu	Temperature :	23.1~26.4°C
		Relative Humidity :	56~68%

Note symbol

-L	Low channel location
-R	High channel location



2.4G 11n HT40_Tx_Ch09 + 5G 11ac(40)_Tx_Ch62

WIFI 802.11n HT40 (Band Edge @ 3m)

WIFI	2.4GHz 2400~2483.5MHz Band Edge @ 3m	
ANT	802.11n HT40 CH09 2452MHz - L	
1	Horizontal	Fundamental
Peak	<p>Site : 03CH12-HY Condition : PEAK_BE_74 3m HORN_9120D_1328 HORIZONTAL Detector : RBW:1000.000KHz VBW:3000.000KHz SWT:Auto Project : Peak Mode : 981244 2.4G WLAN Setting : 58 5G WLAN Setting : 12.5 5G WLAN Setting : 16.5</p>	<p>Site : 03CH12-HY Condition : PEAK_74 3m HORN_9120D_1328 HORIZONTAL Detector : RBW:1000.000KHz VBW:3000.000KHz SWT:Auto Project : Peak Mode : 981244 2.4G WLAN Setting : 58 5G WLAN Setting : 12.5 5G WLAN Setting : 16.5</p>
Avg.	<p>Site : 03CH12-HY Condition : AVG_BE_54 3m HORN_9120D_1328 HORIZONTAL Detector : RBW:1000.000KHz VBW:3.000KHz SWT:Auto Project : Peak Mode : 981244 2.4G WLAN Setting : 58 5G WLAN Setting : 12.5 5G WLAN Setting : 16.5</p>	<p>Site : 03CH12-HY Condition : AVG_54 3m HORN_9120D_1328 HORIZONTAL Detector : RBW:1000.000KHz VBW:3.000KHz SWT:Auto Project : Peak Mode : 981244 2.4G WLAN Setting : 58 5G WLAN Setting : 12.5 5G WLAN Setting : 16.5</p>

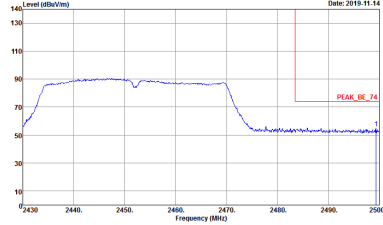
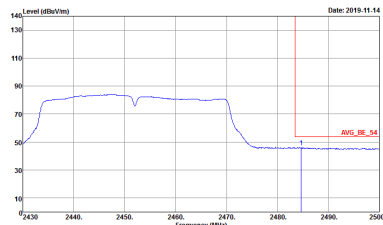

WIFI	2.4GHz 2400~2483.5MHz Band Edge @ 3m	
ANT	802.11n HT40 CH09 2452MHz - R	
1	Horizontal	Fundamental
<p>Peak</p>	 <p>Site : 03CH12-HY Condition : PEAK_BE_74 3m HORN_9120D_1328 HORIZONTAL Detector : Peak Project : 981244 Mode : 58 2.4G WLAN Setting : 12.5 5G WLAN Setting : 16.5</p>	<p>Left blank</p>
<p>Avg.</p>	 <p>Site : 03CH12-HY Condition : AVG_BE_54 3m HORN_9120D_1328 HORIZONTAL Detector : Peak Project : 981244 Mode : 58 2.4G WLAN Setting : 12.5 5G WLAN Setting : 16.5</p>	<p>Left blank</p>

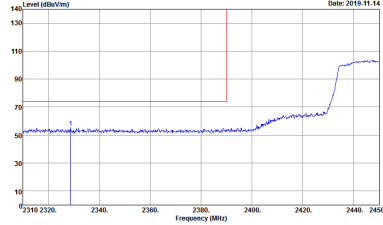
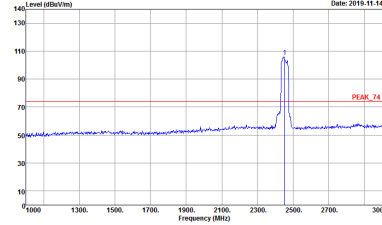
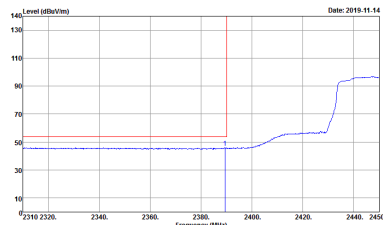
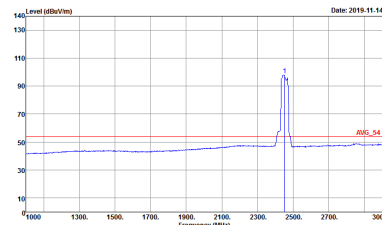

WIFI	2.4GHz 2400~2483.5MHz Band Edge @ 3m	
ANT	802.11n HT40 CH09 2452MHz - L	
1	Vertical	Fundamental
Peak	 <p>Site : 03CH12-HY Condition : PEAK_BE_74 3m HORN_9120D_1328 VERTICAL Detector : Peak Project : 981244 Mode : 58 2.4G WLAN Setting : 12.5 5G WLAN Setting : 16.5</p>	 <p>Site : 03CH12-HY Condition : PEAK_74 3m HORN_9120D_1328 VERTICAL Detector : Peak Project : 981244 Mode : 58 2.4G WLAN Setting : 12.5 5G WLAN Setting : 16.5</p>
Avg.	 <p>Site : 03CH12-HY Condition : AVG_BE_54 3m HORN_9120D_1328 VERTICAL Detector : Peak Project : 981244 Mode : 58 2.4G WLAN Setting : 12.5 5G WLAN Setting : 16.5</p>	 <p>Site : 03CH12-HY Condition : AVG_54 3m HORN_9120D_1328 VERTICAL Detector : Peak Project : 981244 Mode : 58 2.4G WLAN Setting : 12.5 5G WLAN Setting : 16.5</p>

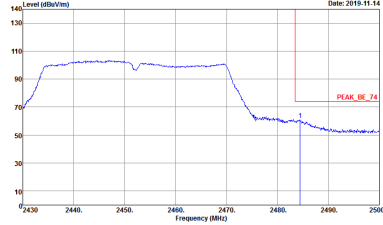
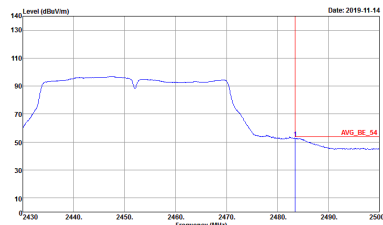

WIFI	2.4GHz 2400~2483.5MHz Band Edge @ 3m	
ANT	802.11n HT40 CH09 2452MHz - R	
1	Vertical	Fundamental
<p>Peak</p>	 <p>Site : 03CH12-HY Condition : PEAK_BE_74 3m HORN_9120D_1328 VERTICAL Detector : Peak Project : 981244 Mode : 58 2.4G WLAN Setting : 12.5 5G WLAN Setting : 16.5</p>	<p>Left blank</p>
<p>Avg.</p>	 <p>Site : 03CH12-HY Condition : AVG_BE_54 3m HORN_9120D_1328 VERTICAL Detector : Peak Project : 981244 Mode : 58 2.4G WLAN Setting : 12.5 5G WLAN Setting : 16.5</p>	<p>Left blank</p>



WIFI 802.11ac VHT40 (Band Edge @ 3m)

WIFI	Band 2 5250~5350MHz Band Edge @ 3m	
ANT	802.11ac VHT40 CH62 5310 - L	
1	Horizontal	Fundamental
Peak	<p>Site : 03CH12-HY Condition : PEAK_BE_74 3m HORN_9120D_1328 HORIZONTAL Detector : RBW:1000.000KHz VBW:3000.000KHz SWT:Auto Project : 981244 Mode : 58 2.4G WLAN Setting : 12.5 5G WLAN Setting : 16.5 : Add 2.4G Notch</p>	<p>Site : 03CH12-HY Condition : PEAK(UNIT) 3m HORN_9120D_1328 HORIZONTAL Detector : RBW:1000.000KHz VBW:3000.000KHz SWT:Auto Project : 981244 Mode : 58 2.4G WLAN Setting : 12.5 5G WLAN Setting : 16.5 : Add 2.4G Notch</p>
Avg.	<p>Site : 03CH12-HY Condition : AVG_BE_54 3m HORN_9120D_1328 HORIZONTAL Detector : Peak Project : 981244 Mode : 58 2.4G WLAN Setting : 12.5 5G WLAN Setting : 16.5 : Add 2.4G Notch</p>	Left blank

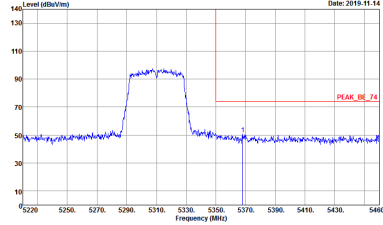
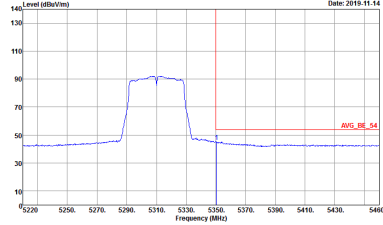

WIFI	Band 2 5250~5350MHz Band Edge @ 3m	
ANT	802.11ac VHT40 CH62 5310 - R	
1	Horizontal	Fundamental
<p>Peak</p>	 <p>Site : 03CH12-HY Condition : PEAK_BE_74 3m HORN_9120D_1328 HORIZONTAL Detector : Peak Project : 981244 Mode : 58 2.4G WLAN Setting : 12.5 5G WLAN Setting : 16.5 : Add 2.4G Notch</p>	<p>Left blank</p>
<p>Avg.</p>	 <p>Site : 03CH12-HY Condition : AVG_BE_54 3m HORN_9120D_1328 HORIZONTAL Detector : Peak Project : 981244 Mode : 58 2.4G WLAN Setting : 12.5 5G WLAN Setting : 16.5 : Add 2.4G Notch</p>	<p>Left blank</p>



WIFI	Band 2 5250~5350MHz Band Edge @ 3m	
ANT	802.11ac VHT40 CH62 5310 - L	
1	Vertical	Fundamental
Peak	<p>Site : 03CH12-HY Condition : PEAK_BE_74.3m HORN_9120D_1328 VERTICAL Detector : Peak Project : 981244 Mode : 58 2.4G WLAN Setting : 12.5 5G WLAN Setting : 16.5 : Add 2.4G Notch</p>	<p>Site : 03CH12-HY Condition : PEAK(FUNDED) 3m HORN_9120D_1328 VERTICAL Detector : Peak Project : 981244 Mode : 58 2.4G WLAN Setting : 12.5 5G WLAN Setting : 16.5 : Add 2.4G Notch</p>
Avg.	<p>Site : 03CH12-HY Condition : AVG_BE_54.3m HORN_9120D_1328 VERTICAL Detector : Peak Project : 981244 Mode : 58 2.4G WLAN Setting : 12.5 5G WLAN Setting : 16.5 : Add 2.4G Notch</p>	Left blank

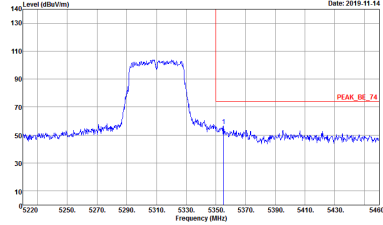
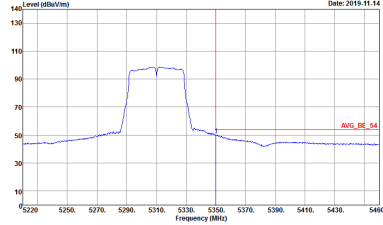

WIFI	Band 2 5250~5350MHz Band Edge @ 3m	
ANT	802.11ac VHT40 CH62 5310 - R	
1	Vertical	Fundamental
<p>Peak</p>	 <p>Site : 03CH12-HY Condition : PEAK_BE_74 3m HORN_9120D_1328 VERTICAL Detector : Peak Project : 981244 Mode : 58 2.4G WLAN Setting : 12.5 5G WLAN Setting : 16.5 : Add 2.4G Notch</p>	<p>Left blank</p>
<p>Avg.</p>	 <p>Site : 03CH12-HY Condition : AVG_BE_54 3m HORN_9120D_1328 VERTICAL Detector : Peak Project : 981244 Mode : 58 2.4G WLAN Setting : 12.5 5G WLAN Setting : 16.5 : Add 2.4G Notch</p>	<p>Left blank</p>



Emission below 1GHz

Co-location mode (LF)

Co-location mode LF		
	Horizontal	Vertical
QP / Peak	<p>Site : 03CH12-HY Condition : QP 3m BILO6_6111D_37059 HORIZONTAL Detector : Peak Project : 981244 Mode : 58 2.4G WLAN Setting : 12.5 5G WLAN Setting : 16.5</p>	<p>Site : 03CH12-HY Condition : QP 3m BILO6_6111D_37059 VERTICAL Detector : Peak Project : 981244 Mode : 58 2.4G WLAN Setting : 12.5 5G WLAN Setting : 16.5</p>



Appendix C. Duty Cycle Plots

Antenna	Band	Duty Cycle (%)	T(us)	1/T(kHz)	VBW Setting	Duty Factor (dB)
1	2.4GHz 802.11n HT40	89.27	915	1.09	3kHz	0.49
2	5GHz 802.11ac VHT40	91.39	955	1.05	3kHz	0.39

<Ant. 1>

2.4GHz 802.11n HT40

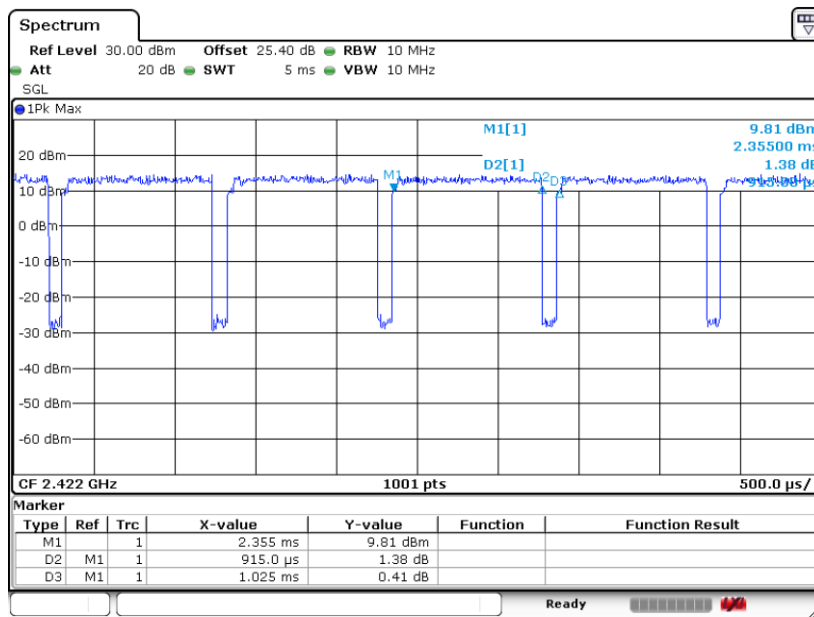

Date: 20.SEP.2019 22:07:37



<Ant. 2>

5GHz 802.11ac VHT40

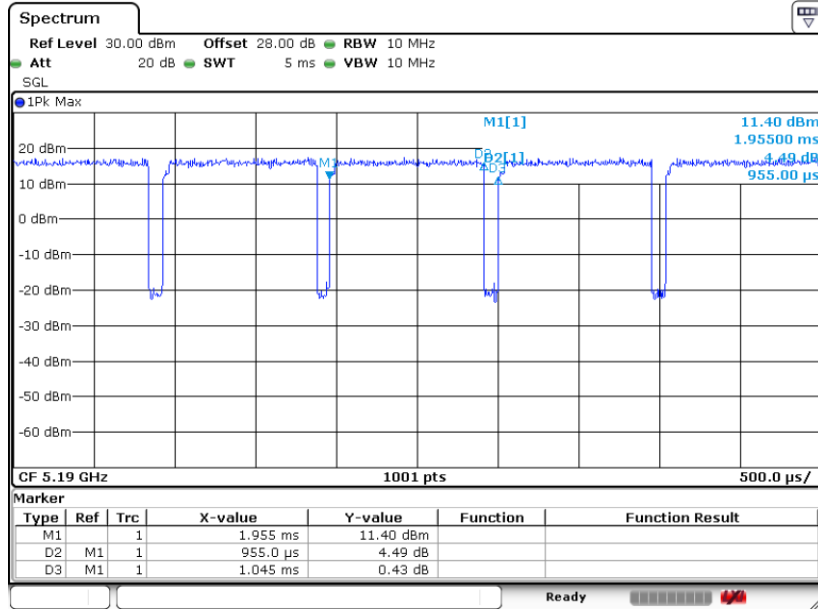

Date: 17.SEP.2019 20:20:07