

About This Guide

Introduction

This guide provides information about using the mobile computer and accessories.



NOTE: Screens and windows pictured in this guide are samples and can differ from actual screens.

Configurations

This guide covers the following configurations:

Table 1 Configurations

Configuration	Radios	Display	Memory	Data Capture Options	Operating System
MC33XX-G Standard/Premium/Premium +	WLAN: IEEE® 802.11a/b/g/n/ac/d/h/i/k/r/w WPAN: Bluetooth V4.1, V2.1 + EDR w/ Bluetooth Low Energy (BLE)	4.0" color	2 GB RAM / 16 GB Flash 4 GB RAM / 16 GB Flash 4GB RAM / 32 GB Flash	Imager or laser scanner, Interactive Sensor Technology (IST)	Android-based, Android Open-Source Project/GMS 7.1.2

Software Versions

To determine the current software versions touch > **About phone**.

- **Model**– Displays the model number.
- **Android version**– Displays the operating system version.
- **Kernel version**– Displays the kernel version number.
- **Build number**– Displays the software build number.

To determine the device serial number touch > **About phone** > **Status**.

- **Serial number** - Displays the serial number.

Chapter Descriptions

Topics covered in this guide are as follows:

- [Getting Started](#) provides information on getting the MC33XX up and running for the first time.
- [Using the MC33XX](#) provides basic instructions for using the MC33XX with Android OS, including powering on and resetting the MC33XX.
- [Applications](#) describes the applications installed on the device.
- [Data Capture](#) provides information for capturing bar code data using the internal camera and optional scan modules and Bluetooth scanner.
- [Wireless](#) provides information on the various wireless options.
- [Accessories](#) describes the available accessories and how to use them with the MC33XX.
- [Maintenance and Troubleshooting](#) includes instructions on cleaning and storing the MC33XX, and provides troubleshooting solutions for potential problems during MC33XX operation.
- [Technical Specifications](#) provides the technical specifications for the MC33XX.
- [MC33XX Keypads](#) provides keypad descriptions and special character generation tables.

Notational Conventions

The following conventions are used in this document:

- **Bold** text is used to highlight the following:
 - Dialog box, window and screen names
 - Drop-down list and list box names
 - Check box and radio button names
 - Icons on a screen
 - Key names on a keypad
 - Button names on a screen.
- Bullets (•) indicate:
 - Action items
 - Lists of alternatives
 - Lists of required steps that are not necessarily sequential.
- Sequential lists (e.g., those that describe step-by-step procedures) appear as numbered lists.

Icon Conventions

The documentation set is designed to give the reader more visual clues. The following graphic icons are used throughout the documentation set. These icons and their associated meanings are described below.

About This Guide



NOTE: NOTE contains information more important than the surrounding text, such as exceptions or preconditions. They also refer the reader elsewhere for additional information, remind the reader how to complete an action (when it is not part of the current procedure, for instance), or tell the reader where something is located on the screen. There is no warning level associated with a note.



CAUTION: The word CAUTION with the associated safety icon implies information that, if disregarded, may result in minor or moderate injury, or serious product damage.



WARNING: The word WARNING with the associated safety icon implies information that, if disregarded, could result in death or serious injury, or serious product damage.

Related Documents

- MC33XX Quick Start Guide, p/n MN-003143-01
- MC33XX Regulatory Guide, p/n MN-003144-01
- MC33XX Integrator Guide, p/n MN-003136-01

For the latest version of this guide and all guides, go to: <http://www.zebra.com/support>.

Service Information

If you have a problem with your equipment, contact Zebra Support Center for your region. Contact information is available at: <http://www.zebra.com/support>.

When contacting the Zebra Support Center, please have the following information available:

- Serial number of the unit (found on manufacturing label)
- Model number or product name (found on manufacturing label)
- Software type and version number

Figure 1 Manufacturing Label Location

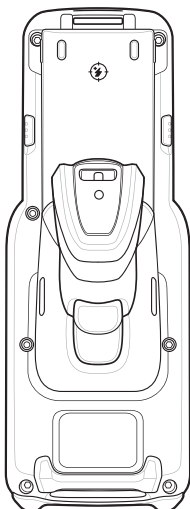

About This Guide

Zebra responds to calls by email or telephone within the time limits set forth in support agreements.

If your problem cannot be solved by the Zebra Support Center, you may need to return your equipment for servicing and will be given specific directions. Zebra is not responsible for any damages incurred during shipment if the approved shipping container is not used. Shipping the units improperly can possibly void the warranty.

If you purchased your product from a Zebra business partner, contact that business partner for support.

Provide Documentation Feedback

If you have comments, questions, or suggestions about this guide, send an email to EVM-Techdocs@zebra.com.

FOR REVIEW

Getting Started

Introduction

This chapter provides the features of the MC33XX and explains how to set it up for the first time.

MC33XX-G Features

Figure 2 Front View

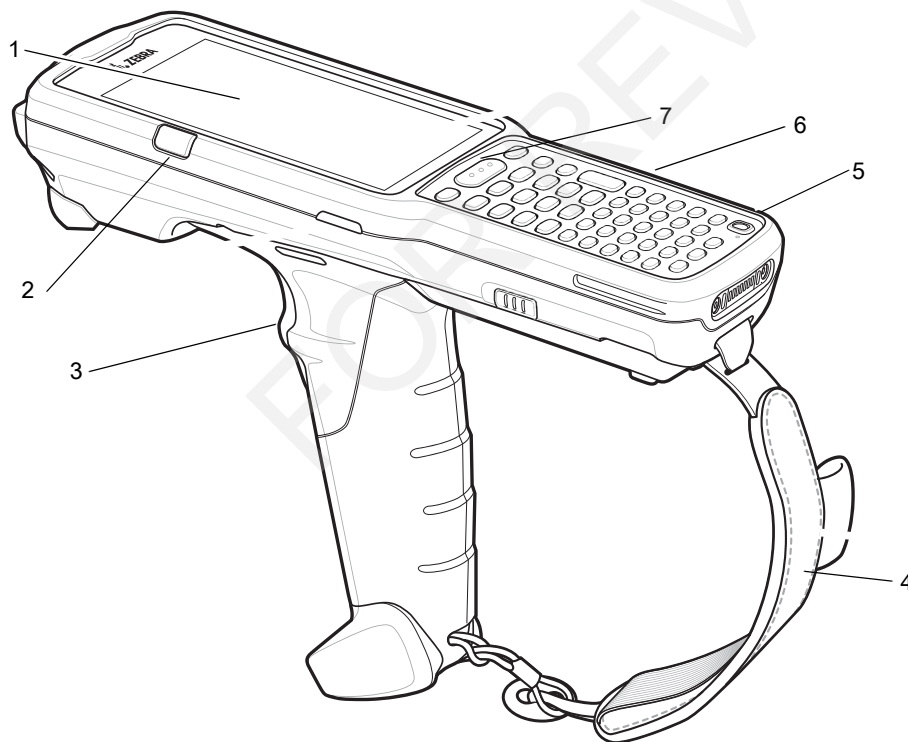

Table 2 Features - Front View

Number	Item	Function
1	Display	Displays all information needed to operate the MC33XX.
2	Charge LED	Indicates the battery charge state while charging.

Table 2 Features - Front View (Continued)

Number	Item	Function
3	Trigger	Initiates data capture when a scan application is enabled.
4	Handstrap	Use for securely holding the device.
5	Power Button	Press and hold to turn on the MC33XX. Press to turn on or off the screen. Press and hold to select one of these options: Power off - Turn off the MC33XX. Reset - Reboot the MC33XX when software stops responding. Airplane mode - Disable all wireless connections. Battery swap - Places the device in Battery Swap mode when replacing the battery. Silent mode - All notifications are disabled except for alarms.
6	Keypad	Use to enter data and navigate on screen functions.
7	Scan Button	Initiates data capture when a scan application is enabled.

Figure 3 Back View

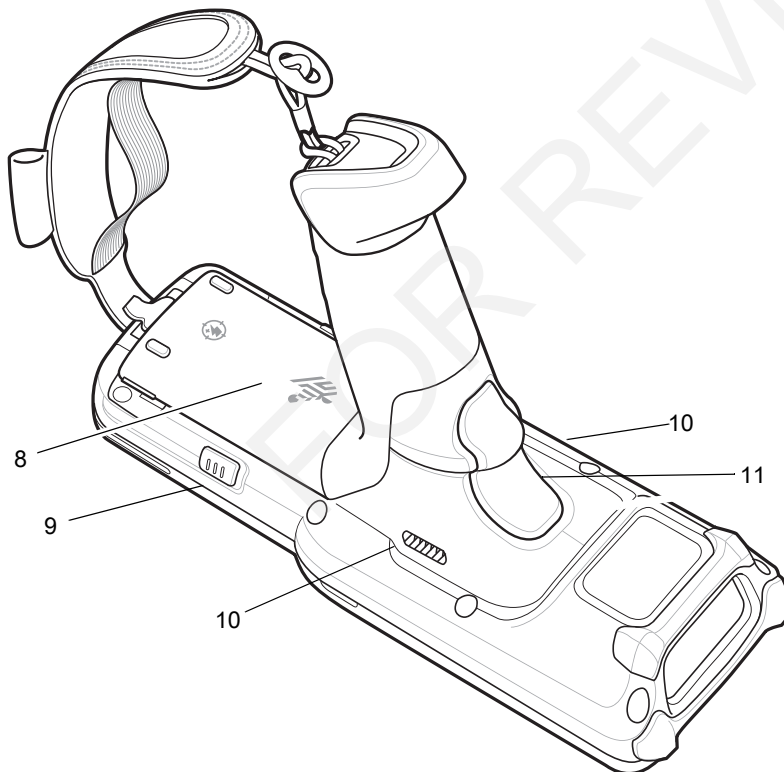

Table 3 Features - Back View

Number	Item	Function
8	Battery	Provides power for operating the device.
9	Battery Release Buttons	Release the battery from the device.
10	Speakers	Provides audio output for video and music playback.
11	Trigger	Initiates data capture when a scan application is enabled.

FOR REVIEW

Unpacking

Carefully remove all protective material from the MC33XX and save the shipping container for later storage and shipping.

Verify the following items are in the box:

- MC33XX
- Lithium-ion battery
- Quick Start Guide
- Regulatory Guide.

Inspect the equipment for damage. If any equipment is missing or damaged, contact the Zebra Support Center immediately. See [Service Information on page 12](#) for contact information.

Setup

To start using the MC33XX for the first time:

- Install a microSD card (optional)
- Install the battery
- Charge the MC33XX
- Power on the MC33XX.

Installing a microSD Card

The microSD card slot provides secondary non-volatile storage. The slot is located under the battery pack. Refer to the documentation provided with the card for more information, and follow the manufacturer's recommendations for use.



CAUTION: Follow proper electrostatic discharge (ESD) precautions to avoid damaging the microSD card. Proper ESD precautions include, but are not limited to, working on an ESD mat and ensuring that the operator is properly grounded.



NOTE: After installing the microSD card, the device will automatically reset. This ensures proper reading of the file content on the microSD card.

1. Remove the microSD card cover.

Figure 4 Remove microSD Card Cover

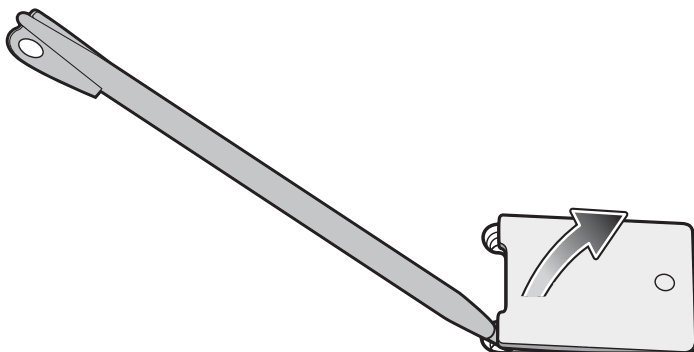

2. Slide the microSD card holder down to unlock.

Figure 5 Unlock microSD Card Holder

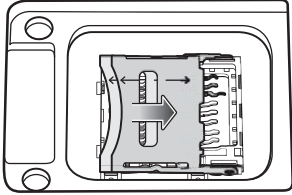

3. Lift the microSD card holder.

Figure 6 Lift microSD Card Holder

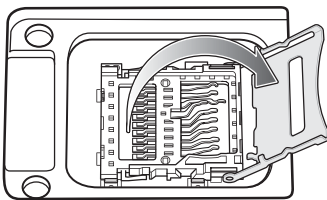

4. Place the microSD card into the contact area.

Figure 7 Install microSD Card

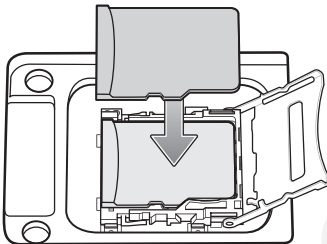

5. Close the microSD card holder and slide the microSD card holder up to lock.

Figure 8 Lock microSD Card Holder

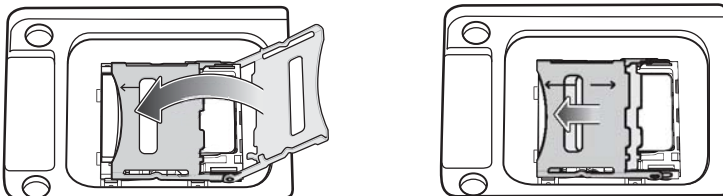

6. Replace the microSD card cover and ensure that it is installed properly.

Figure 9 Replace Cover

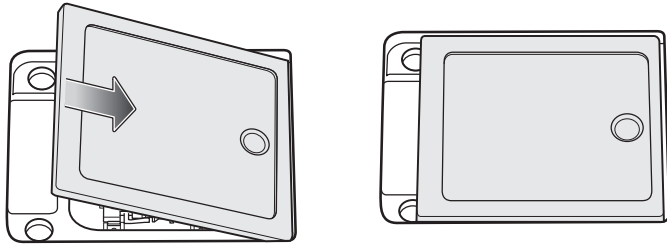

FOR REVIEW

Installing the MC33XX-G Battery

To install the battery:

1. Align the battery into the battery compartment.

Figure 10 Inserting the Battery

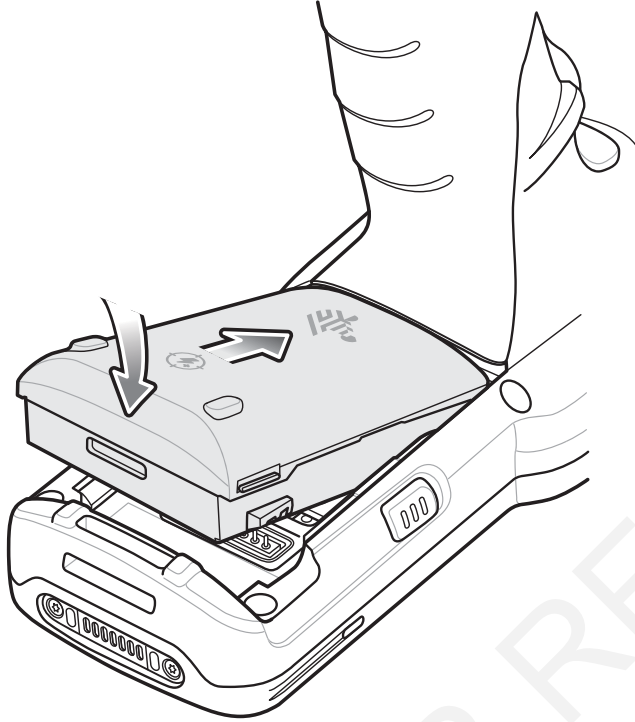

2. Rotate the bottom of the bottom into the battery compartment.
3. Press battery down firmly. Ensure that both battery release buttons on the sides of the MC33XX return to the home position.

Figure 11 Press Battery Down

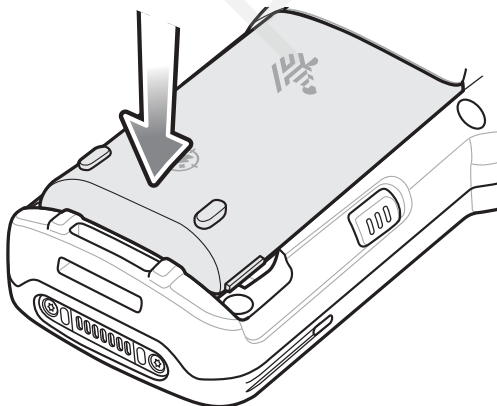

4. Press the Power button to turn on the device.

Charging the Battery



CAUTION: Ensure that you follow the guidelines for battery safety described in [Battery Safety Guidelines on page 113](#).

Use the mobile computer cradles, cables and spare battery chargers to charge the mobile computer main battery.

The main battery can be charged before insertion into the mobile computer or after it is installed. The Extended Life Battery ships from the factory in all MC33XX-G configurations. Use one of the spare battery chargers to charge the main battery (out of the mobile computer) or one of the cradles to charge the main battery while it is installed in the mobile computer.

Before using the mobile computer for the first time, fully charge the main battery until the amber Charge LED Indicator remains lit (see [LED Charge Indicators on page 21](#) for charge status indications). The Standard Battery fully charges in less than five hours and the Extended Life Battery fully charges in less than eight hours.

The MC33XX retains data in memory for at least five minutes when the mobile computer's main battery is removed or fully discharged.

When the main battery reaches a very low battery state, the battery retains data in memory for at least 36 hours.

Batteries must be charged within the 0° to +40° C (32° to 104° F) ambient temperature range.

The following accessories can be used to charge batteries:

- Cradles (and a power supply):
 - Single Slot Serial/USB Cradle with Battery Adapter
 - Four Slot Cradles.
- Cables (and a power supply):
 - USB Client Charge Cable
 - Serial (RS232) Charge Cable.
- Spare Battery Chargers (and a power supply):
 - Four Slot Spare Battery Charger
 - Universal Battery Charger (UBC) Adapter with Battery Adapter.

To charge the mobile computer using the cradles:

1. Insert the mobile computer into a cradle. See [Accessories](#) for accessory setup.
2. The mobile computer starts to charge automatically. The amber Charge LED Indicator indicates the charge status. See the table below for charging indications.



To charge the mobile computer using the cables:

1. Connect the MC33XX Communication/Charge Cable to the appropriate power source and connect to the mobile computer. See [Accessories](#) for accessory setup.
2. The mobile computer starts to charge automatically. The amber Charge LED Indicator indicates the charge status.

Table 4 LED Charge Indicators

Status	Indications
<ul style="list-style-type: none"> Off 	<ul style="list-style-type: none"> MC33XX is not charging. MC33XX is not inserted correctly in the cradle. MC33XX is not connected to a power source. Charger or cradle is not powered.
<ul style="list-style-type: none"> Slow Blinking Amber 	<ul style="list-style-type: none"> MC33XX is charging.
<ul style="list-style-type: none"> Solid Amber 	<ul style="list-style-type: none"> Charging complete. Note: When the battery is initially inserted in the mobile computer, the amber LED flashes once if the battery power is low.
<ul style="list-style-type: none"> Fast Blinking Amber 	<ul style="list-style-type: none"> Charging error, e.g.: <ul style="list-style-type: none"> Temperature is too low or too high. Charging has gone on too long without completion (typically eight hours).

Charging Temperature

Charge batteries in ambient temperatures from 0 °C to 40 °C (32 °F to 104 °F) or up to 45 °C (113 °F) as reported by the battery. To view the battery temperature, touch the **Battery Info** icon on the Home screen or touch  >  **About device** > **Battery Information**.

Note that charging is intelligently controlled by the MC33N0. To accomplish this, for small periods of time, the MC33N0 or accessory alternately enables and disables battery charging to keep the battery at acceptable temperatures. The MC33XX or accessory indicates when charging is disabled due to abnormal temperatures via its LED.

Charging Spare Batteries

See [Accessories](#) for information on using accessories to charge spare batteries.

Google Account Setup



NOTE: The MC33XX has to be connected to the internet in-order to set up a Google account.

The first time the MC33XX starts, the Setup Wizard displays. Follow the on-screen instructions to set up a Google account, configure Google Wallet for purchasing items from the Play Store, entering your personal information, and enabling backup/restore features.

Replacing the MC33XX-G Battery

1. Press the Power button until the menu appears.
2. Touch **Battery swap**. Wait for the Scan LED to light red and then turn off.
3. Push in the two Battery Release buttons.
The battery ejects slightly.

Figure 12 Release Battery

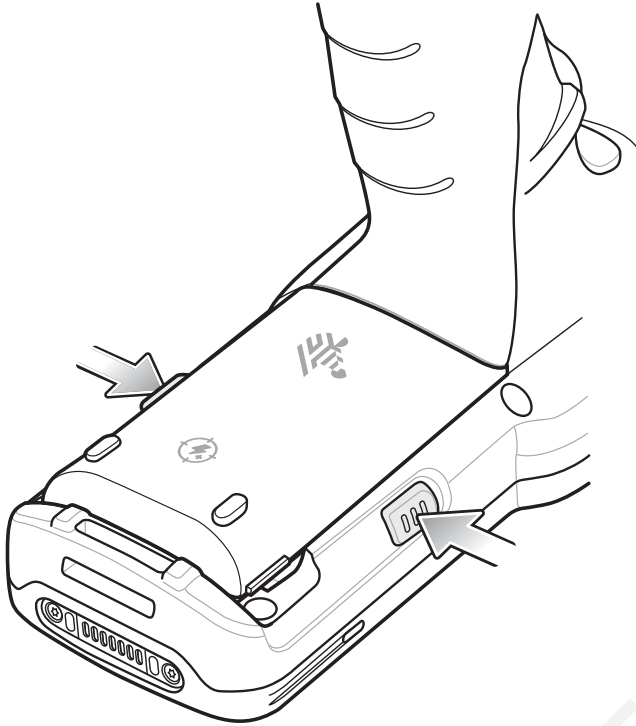

4. Remove the battery from the battery compartment.

Figure 13 Remove Battery



5. Align the battery into the battery compartment.

Figure 14 Inserting the Battery

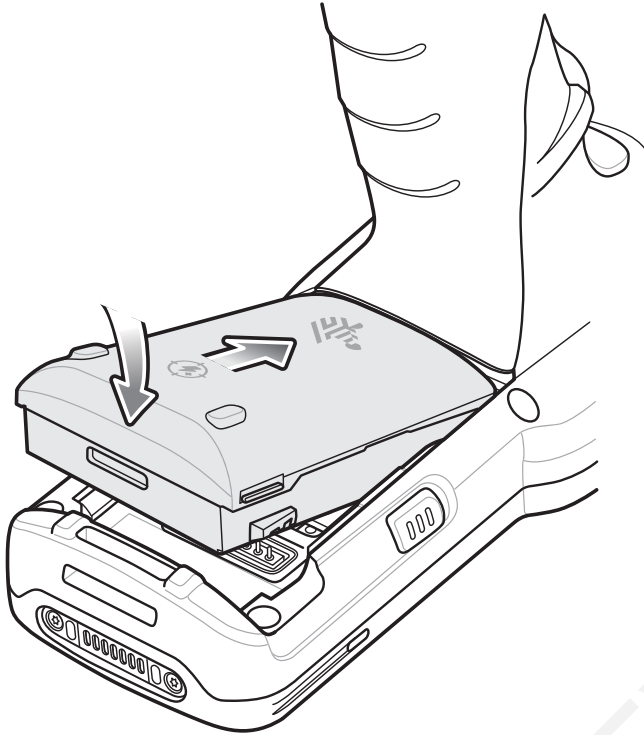

6. Rotate the bottom of the bottom into the battery compartment.
7. Press battery down firmly. Ensure that both battery release buttons on the sides of the MC33XX return to the home position.

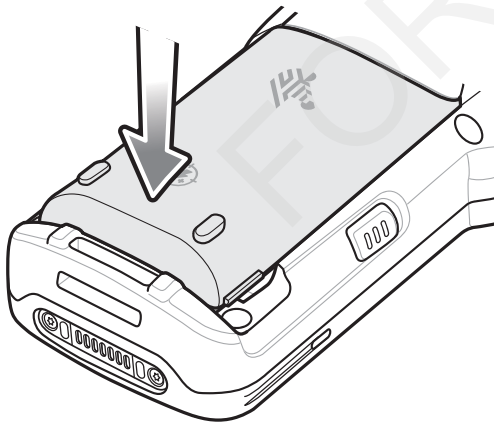

Figure 15 Press Battery Down



8. Press the Power button to turn on the device.

Accessing Device Settings

Throughout this guide, the user can access device:

1. Swipe down with two fingers from the status bar to open the quick access panel and then touch .
2. On the Home screen, swipe up from the bottom of the screen and touch .

Battery Management



NOTE: Prior to checking the battery charge level, remove the MC33XX from any AC power source (cradle or cable).

To check the charge status of the main battery, touch  >  **About phone** > **Status**.

Battery status indicates that the battery is discharging and **Battery level** lists the battery charge (as a percentage of fully charged).

Monitor Battery Usage

The **Battery** screen lists which applications consume the most battery power. Also use it to turn off applications that were downloaded if they are consuming too much power.



Touch  >  **Battery** or swipe down with two fingers from the status bar to open the quick access panel and then touch .

Figure 16 Battery Screen



The **Battery** screen lists the applications using the battery. The discharge graph at the top of the screen shows the rate of the battery discharge since last charged (short periods of time when connected to a charger are shown as thin green lines at the bottom of the chart), and how long it has been running on battery power.

Touch an application in the **Battery** screen to display details about its power consumption. Different applications display different information. Some applications include buttons that open screens with settings to adjust power use.

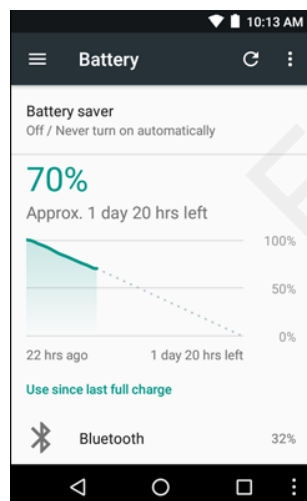
Low Battery Notification

When the battery charge drops below 11% (Extended Capacity Battery), the MC33XX displays a notice to connect the MC33XX to power. The user should charge the battery using one of the charging accessories.

Figure 17 Low Battery Notification Screen

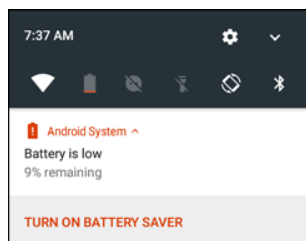

When the battery charge drops below 8% (Extended Capacity Battery), the MC33XX goes into critical suspend mode to save data. The screen turns off. If the Power button is pressed, the Right LED flashes amber.

The user must replace the battery or charge the MC33XX using one of the charging accessories to retain data.

Battery Optimization

Observe the following battery saving tips:

- Leave the MC33XX connected to AC power at all times when not in use.
- Disable DataWedge Launcher profile. Refer to the MC33XX Mobile Computer Integrator Guide for instructions.
- Set the screen to turn off after a short period of non-use. See [Changing the Screen Timeout Setting on page 27](#).
- Set the MC33XX to turn off when not in use. See [Scheduled Power On and Off on page 50](#).
- Reduce the screen brightness. See [Setting the Screen Brightness on page 26](#).
- Turn off all wireless radios when not in use.
- Turn off automatic syncing for Email, Calendar, Contacts, and other applications.
- Minimize use of applications that keep the MC33XX from suspending, for example, music and video applications.

Turning Off the Radios

To turn off all the radios:

1. Press the Power button until the menu appears.
2. Touch **Airplane mode**. The airplane icon  appears in the Status bar indicating that all the radios are off.

Using a Bluetooth Headset

You can use a Bluetooth headset for audio communication when an audio enabled application is used. See [Bluetooth on page 84](#) for information on connecting a Bluetooth device to the mobile computer. Ensure that the mobile computer's volume is set appropriately before putting the headset on. When a Bluetooth headset is connected the speaker is muted.





NOTE: If the mobile computer goes into suspend mode the Bluetooth connection is disabled and the mobile computer automatically switches to speakerphone mode.

Real-Time Clock Backup

The MC33XX provides a Real-time Clock (RTC) backup feature. After boot-up, the device saves the system time in a file in persistent storage. When the device re-boots, it compares the system time to the time saved in a file. If the system time is not the latest, it restores the time from the file.

Setting the Date and Time

The user is only required to set the time zone or set the date and time when not connected to a wireless network.

1. Swipe down with two fingers from the status bar to open the quick access panel and then touch .
2. Touch  **Date & time**.
3. Touch **Automatic date & time** to disable automatic date and time synchronization.
4. Touch **Set date**.
5. In the calendar, set today's date.
6. Touch **OK**.
7. Touch **Set time**.
8. Touch the green circle, drag to the current hour and then release.
9. Touch the green circle, drag to the current minute and then release.
10. Touch **AM** or **PM**.
11. Touch **OK**.
12. Touch **Automatic time zone** to disable automatic date and time synchronization.
13. Touch **Select time zone**.
14. Select the current time zone from the list.
15. Touch .

Display Setting

Use Display settings to change the screen brightness, change the background image, enable screen rotation, set sleep time and change font size.

Setting the Screen Brightness



To manually set the screen brightness:

1. Swipe down with two fingers from the status bar to open the quick access panel.
2. Slide the icon to adjust the screen brightness level.

Figure 18 Brightness Slider



To let the MC33XX automatically adjust the screen brightness using the built-in light sensor:



1. Swipe down with two fingers from the status bar to open the quick access panel and then touch .
2. Touch  **Display**.
3. Touch **Brightness Level**.
4. Touch **Adaptive brightness** to automatically adjust the brightness.
5. Touch .

Night Light

To make it easier to look at the screen in dim light, reduce the screen's blue color. Set Night Light to turn on automatically from sunset to sunrise, or at other times.

Changing the Screen Timeout Setting

To set the screen sleep time:

1. Swipe down with two fingers from the status bar to open the quick access panel and then touch .
2. Touch  **Display**.
3. Touch **Sleep**
4. Select one of the sleep values.
 - **15 seconds**
 - **30 seconds**
 - **1 minute** (default)
 - **2 minutes**
 - **5 minutes**
 - **10 minutes**
 - **30 minutes**
5. Touch .

Setting Font Size

To set the size of the font in system applications:



1. Swipe down with two fingers from the status bar to open the quick access panel and then touch .
2. Touch  **Display**.
3. Touch **Font Size**.



Figure 19 Font Settings

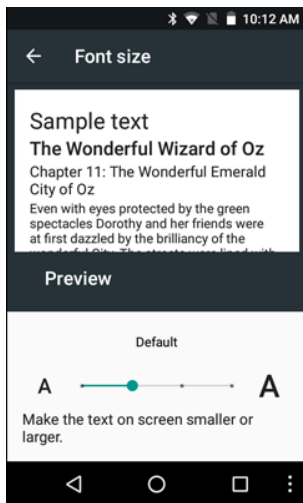

4. Select one of the font size values.
 - **Small**
 - **Default** (default)
 - **Large**
 - **Largest.**
5. Touch .

Setting Screen Rotation

By default, screen rotation is disabled. To enable screen rotation:

1. Swipe down with two fingers from the status bar to open the quick access panel and then touch .
2. Touch  **Display**.
3. Touch **When device is rotated** and select **Rotate the contents of the screen** to set the MC33XX to automatically switch orientation when the MC33XX is rotated.
4. Touch .

General Sound Setting

Use the **Sounds** settings to configure media and alarm volumes.



1. Swipe down with two fingers from the status bar to open the quick access panel and then touch .
2. Touch  **Sounds**.

Figure 20 Sound Screen

- **Media volume** - Controls the music, games and media volume.
- **Alarm volume** - Controls the alarm clock volume.
- **Notification volume** -

- **Do not disturb** - Mutes the MC33XX so that it does not make sounds or vibrate when you do not want it to.
 - **Priority only allows** - Use to set priorities.
 - **Alarms** - Disabled.
 - **Reminders and Events** - Switch on or off.
 - **Messages and Calls** - Choose from anyone, starred contacts, any contact, or none. To star contacts, use the Contacts app.
 - **Repeat callers** - Choose whether to let the MC33XX ring if the same person calls again within 15 minutes.
 - **Automatic rules** - To automatically silence the MC33XX during certain times, like at night or on weekends. Touch a default rule Weekend or Weeknight. Or, to make your own rule, tap Add rule and then Time rule.
 - **Block visual disturbances**
 - **Block when screen is on** - option pertains to notifications you receive when you are actively using the device. If you would like to disable the banner like notifications when Do not Disturb is enabled, turn this option On. This will also prevent you from peeking at notifications.
 - **Block when screen is off** - option pertains to notifications you receive when you are not using your device i.e. the display is asleep. If you want to prevent the display from waking up when a new notification is received, turn this option On. This will additionally disable the LED light alerts your phone sends you when you have new notifications.
 - **Default notification ringtone** - Touch to select a sound to play for all system notifications.
 - **Default alarm ringtone** - Touch to select a sound to play for alarms.
 - **Other sounds**
 - **Screen locking sounds** - play a sound when locking and unlocking the screen (default – enabled)
 - **Charging sounds** - Not applicable.
 - **Touch sounds** - Play a sound when making screen selections (default – enabled).
 - **Vibrate on tap** - Device vibrates when making screen selections (default – disabled).

Wake-Up Sources

By default the MC33XX wakes from suspend mode when the user presses the power button. The MC33XX can be configured to wake when the user presses the Gun Trigger or the Center Trigger.



1. Swipe down with two fingers from the status bar to open the quick access panel and then touch .
2. Touch  **Wake-Up Sources**.

Figure 21 Wake-Up Sources



3. Touch **GUN_TRIGGER** checkbox. A check appears in the checkbox.
4. Touch **CENTER_TRIGGER** checkbox. A check appears in the checkbox.
5. Touch .

FOR REVIEW

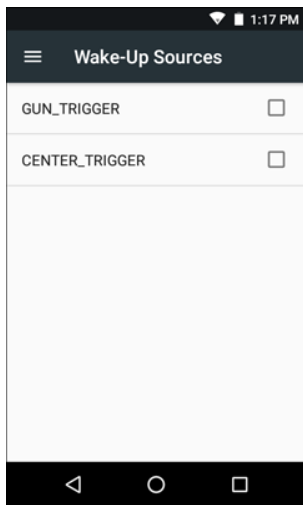
Using the MC33XX

Introduction

This chapter describes the screens, status and notification icons, and controls on the MC33XX, and provides basic instructions for using the MC33XX.

Google Mobile Services



NOTE This section only applies to MC33XX devices with Google Mobile Services (GMS) software.

The MC33XX with GMS contains applications and services that provide additional functionality to the MC33XX.

GMS includes:

- **Applications** - GMS adds a variety of Google applications and associated widgets including Chrome, Gmail, Drive and Maps.
- **Services:**
 - **Speech to Text** - Allows for free format speech to text, in many languages for both connected and disconnected network. Launch by touching the microphone icon on the keyboard.
 - **TalkBack Service** - Provides spoken feedback on various parts of the user interface. To enable, go to Settings > Accessibility.
 - **Network Location Provider** - Adds a location provider which uses mobile network tower information and Wi-Fi access point information to provide a location without using GPS. To enable, go to Settings > Location access.
 - **Widevine DRM** - Enables the digital rights management so that protected content can be played. Enable via DRM Info from the Play Store.
 - **Google Cloud Messaging** - Allows the sending of data from your server to your MC33XX and also to receive messages from devices on the same connection.
 - **Backup and Restore** - Allows the users settings and applications to be backed up to a Google server and subsequently restored from that server after a factory reset.
- **Google accounts** - Create and use a Google account to synchronize mail, files, music, photos, contacts and calendar events.

Home Screen

The Home screen displays when the MC33XX turns on. Depending upon the configuration, the Home screen might appear different. Contact your system administrator for more information.

After a suspend or screen time-out, the Home screen displays with the lock sliders. Touch the screen and slide up to unlock.  For screen locking information see [Un-Locking the Screen on page 48](#).

Figure 22 Home Screen



NOTE: The Home screen icons can be configured by the user and may look different than shown.

The Home screen consists of the following:

Table 5 Home Screen Items

Item	Description
1 — Status Bar	Displays the time, status icons (right side), and notification icons (left side). For more information see on page 32 and Managing Notifications on page 35 .
2 — Widgets	Launches stand-alone applications that run on the Home screen. See Application Shortcuts and Widgets on page 37 for more information.
3 — Shortcut Icons	Opens applications installed on the MC33XX. See Application Shortcuts and Widgets on page 37 for more information.
4 — Folder	Contains apps.
5 — Settings Icon	Opens the Settings window.
6 — Back	Displays the previous screen.

Table 5 Home Screen Items (Continued)

Item	Description
7 — Home	Displays the Home screen.
8 — Recent Button	Displays recently used applications.
9 — All Apps Icon	Opens the APPS window.

The Home screen provides four additional screens for placement of widgets and shortcuts. Swipe the screen left or right to view the additional screens.

Setting Home Screen Rotation

By default the Home screen rotation is disabled. To enable Home screen rotation:



1. Touch and hold anywhere on the Home screen until the options appear.
2. Touch .
3. Touch **Allow Home screen rotation** switch.
4. Touch .
5. Rotate the device.

Figure 23 Rotated Home Screen

Status Bar

The Status bar displays the notification icons (left side), time and status icons (right side).

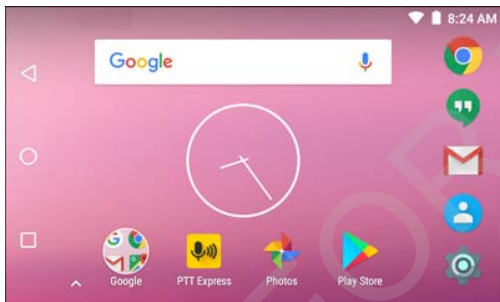

NOTE: Some status icons may not appear in the Status Bar if there are too many icons to display.

Figure 24 Notification and Status Icons

If there are more notifications than can fit in the Status bar,  displays indicating that more notifications exist. Open the Notifications panel to view all notifications and status.

Status Icons

Table 6 Status Icons



















Icon	Description
	Indicates that all sounds except media and alarms are silenced.
	Indicates that the Orange key is locked.
	Indicates that the Blue key is pressed.
A	Indicates that the ALT key is pressed.
C	Indicates that the CTRL key is pressed.
	Indicates that the Shift key is pressed.
	Indicates that the Shift key is locked.
	Indicates that the Alarm is active.
	Indicates that the main battery is fully charged.
	Indicates that the main battery is partially drained.
	Indicates that the main battery charge is low.
	Indicates that the main battery charge is very low.
	Indicates that the main battery is charging.
	Indicates that all sounds except media and alarms are silenced and vibrate mode is active.
	Indicates that the Airplane Mode is active. All radios are turned off.
	Indicates that Bluetooth is on.
	Indicates that the MC33XX is connected to a Bluetooth device.
	Connected to a Wi-Fi network.
	Not connected to a Wi-Fi network or no Wi-Fi signal.

Table 6 Status Icons (Continued)

Icon	Description
	Connected to an Ethernet network.
	Portable Wi-Fi Hotspot is active.

Notification Icons

Table 7 Notification Icons



















Icon	Description
	Indicates that the internal storage disc is almost full.
	Screenshot captured.
	Error capturing screenshot.
	Indicates the status of the PTT Express Voice Client. For a complete list of PTT Express notification icons see Table 11 on page 65
	Indicates that DataWedge application is running on the device.
	Indicates that more notifications are available for viewing.
	Indicates that data is syncing.
	Indicates an upcoming event.
	Indicates that an open Wi-Fi network is available.
	Indicates that a song is playing.
	Indicates that a problem with sign-in or sync has occurred.
	Indicates that the MC33XX is uploading data.
	Indicates that the MC33XX is downloading data when animated and download is complete when static.
	Indicates that USB tethering is active.
	Indicates that the MC33XX is connected to or disconnected from virtual private network (VPN).
	Preparing Internal Storage.

Table 7 Notification Icons (Continued)

Icon	Description
	Indicates that USB debugging is enabled on the MC33XX.
	Indicates the status of the PTT Express Voice Client. See Notification Icons for complete list of PTT Express notification icons.
	Indicates that RxLogger application is running.
	Indicates a Bluetooth scanner is connected to the MC33XX.

Managing Notifications

Notification icons report the arrival of new messages, calendar events, and alarms, as well as ongoing events. When a notification occurs, an icon appears in the Status bar with a brief description. See [Notification Icons on page 34](#) for a list of possible notification icons and their description. Open the **Notifications** panel to view a list of all the notifications.

To open the Notification panel drag the Status bar down from the top of the screen.

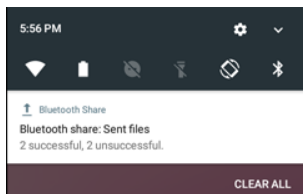
Figure 25 Notification Panel

To respond to a notification, open the Notifications Panel and then touch a notification. The Notifications Panel closes and the subsequent activity is dependent on the notification.

To clear all notifications, open the Notifications Panel and then touch **CLEAR ALL**. All event-based notifications disappear. Ongoing notifications remain in the list.

To close the Notification Panel, swipe the Notifications Panel up.

Setting Application Notifications

To change notification settings for a specific app:

1. Swipe down with two fingers from the status bar to open the quick access panel and then touch .
2. Touch **Notifications**.
3. Select an app.
4. Select an available option:
 - **Block all**
 - **Show silently**
 - **On the lock screen**
 - **Override Do Not Disturb.**





IMPORTANT In the notification, slide the notification slightly left or right and touch .

Viewing Notification Settings for All Apps

1. Swipe down with two fingers from the status bar to open the quick access panel and then touch .
2. Touch **Notifications**.
3. Touch down-arrow next to **All apps**.
4. To see all the apps currently set to a specific setting, touch that setting.

Controlling Lock Screen Notifications

To control notification content on the lock screen:

1. Swipe down with two fingers from the status bar to open the quick access panel and then touch .
2. Touch **Notifications** > .
3. Touch **On the lock screen**.
4. Select **Show all notification content** to or select **Don't show notifications at all**.

Quick Access Panel

Use Quick Settings to get to frequently used settings, like turning on airplane mode. To open the Quick Settings bar, swipe down once from the top of an unlocked screen.

Figure 26 Quick Settings Bar



To see the full Quick Settings panel:

- If the MC33XX is locked, swipe down once.
- If the MC33XX is unlocked, swipe down once with 2 fingers, or twice with one finger.
- If the Quick Settings bar is open, touch the Down arrow.

Figure 27 Full Quick Settings

Available setting tiles:

- Display brightness: Slide to lower or increase the brightness of the screen.
- Wi-Fi network: Turn Wi-Fi on or off. To open Wi-Fi settings, touch the Wi-Fi network name.
- Battery Power - Indicates percentage of battery power remaining. Touch to view battery usage.
- Do not disturb: Control how and when to receive notifications.
- Flashlight: Turn camera flash on or off.
- Auto-rotate: Lock the device's orientation in portrait or landscape mode or set to automatically rotate.
- Bluetooth settings: Turn Bluetooth on or off. To open Bluetooth settings, touch the **Bluetooth**.
- Airplane mode: Turn airplane mode on or off. Airplane mode means device will not connect to Wi-Fi or Bluetooth.

- Location - Turn locationing on or off.
- Hotspot - Turn mobile hotspot on or off.
- Invert colors - Invert the display colors.
- Data Saver - Turn on to prevent some apps from sending or receiving data in the background.
- Night Light - Tint the screen amber to make it easier to look at the screen in dim light. Set Night Light to turn on automatically from sunset to sunrise, or at other times.
- Nearby - Helps find and interact with services and devices close to the device.



Edit Icons on Quick Settings

The first several setting tiles become the Quick Settings bar.



To move a setting tile:

1. Touch and drag a setting tile to another location.
2. Release the tile.
3. Touch  to save tiles and return to quick settings.

To add a setting tile:

1. Open Quick Settings.
2. Touch .
3. Slide Quick Settings panel up to reveal additional tiles.
4. Touch and drag a setting tile from the **Drag to add tiles** area to the main area.
5. Release the tile.
6. Touch  to save tiles and return to quick settings.

To remove a setting tile:

1. Open Quick Settings.
2. Touch .
3. Touch and drag a setting tile to the **Drag here to remove** area.
4. Release the tile.
5. Touch  to save tiles and return to quick settings.

Application Shortcuts and Widgets

Application shortcuts placed on the Home screen allow quick and easy access to applications. Widgets are self-contained applications placed on the Home screen to access frequently used features.

Adding an Application to the Home Screen

1. Go to the desired Home screen.
2. Swipe up from the bottom of the screen.
3. Scroll through the list to find the application icon.
4. Touch and hold the icon until the Home screen appears.
5. Position the icon on the screen and then release.

Adding a Widget to the Home Screen

To add a widget to the Home screen:

1. Go to the desired Home screen.
2. Touch and hold until the menu appears.
3. Touch **WIDGETS**.
4. Scroll through the list to find the widget.
5. Touch and hold the widget until the Home screen appears.
6. Position the widget on the screen and then release.

Moving Items on the Home Screen

1. Touch and hold the item until it floats on the screen.
2. Drag the item to a new location. Pause at the edge of the screen to drag the item onto an adjacent Home screen.
3. Lift finger to place the item on the Home screen.

Removing an Application Shortcut or Widget from the Home Screen

1. Go to the desired Home screen.
2. Touch and hold the application shortcut or widget icon until it floats on the screen.
3. Drag the icon to **Remove** on the top of the screen and then release.

Folders

Use Folders to organize similar applications together. Tap the folder to open and display items in the folder.

Creating Folders

To create a folder, there must be at least two app icons on the Home screen.

1. Go to the desired Home screen.
2. Touch and hold on one application icon.
3. Drag the icon and stack on top of another icon.
4. Lift and release.

Naming Folders

To name a folder:

1. Touch the folder.

Figure 28 Open Folder

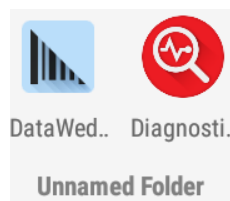



2. Touch the title area and enter a folder name using the keyboard.
3. Touch  on the keyboard.
4. Touch anywhere on the Home screen to close the folder. The folder name appears under the folder.

Figure 29 Renamed Folder



Removing Folders

To remove a folder:

1. Touch and hold the folder icon until it enlarges.
2. Drag the folder to  **Remove** and release.

Home Screen Wallpaper

To change the Home screen wallpaper.

1. Touch and hold on the screen until the menu appears.
2. Touch **WALLPAPERS**.
3. Touch **My photos** to select a photo from Gallery or select one of the pre-installed photos.
4. Touch **Save wallpaper**.

Using the Touchscreen

Use the multi-tap sensitive screen to operate the device.

- **Tap** - Tap to:
 - select items on the screen
 - type letters and symbols using the on-screen keyboard
 - press on-screen buttons.
- **Tap and Hold** - Tap and hold:
 - an item on the Home screen to move it to a new location or to the trash.
 - an item in Apps to create a shortcut on the Home screen.
 - the Home screen to open a menu for customizing the Home screen.
 - an empty area on the Home screen until the menu appears.
- **Drag** - Tap and hold an item for a moment and then move finger on the screen until reaching the new position.

- **Swipe**- Move finger up and down or left and right on the screen to:
 - unlock the screen
 - view additional Home screens
 - view additional application icons in the Launcher window
 - view more information on an application's screen.
- **Double-tap** - Tap twice on a web page, map, or other screen to zoom in and out.
- **Pinch** - In some applications, zoom in and out by placing two fingers on the screen and pinching them together (to zoom out) or spreading them apart (to zoom in).

On-screen Keyboards



Use the on-screen keyboard to enter text in a text field.

Editing Text

Edit entered text and use menu commands to cut, copy, and paste text within or across applications. Some applications do not support editing some or all of the text they display; others may offer their own way to select text.

Entering Numbers, Symbols and Special Characters

To enter numbers and symbols:

- Touch and hold one of the top-row keys until a menu appears then select a number. Keys with alternate characters display an ellipsis (...) below the character.
- Touch and hold the Shift key with one finger, touch one or more capital letters or symbols to enter them, and then lift both fingers to return to the lowercase keyboard.
- Touch  to switch to the numbers and symbols keyboard.
- Touch the  key on the numbers and symbols keyboard to view additional symbols.

To enter special characters, touch and hold a number or symbol key to open a menu of additional symbols.

- A larger version of the key displays briefly over the keyboard.
- Keys with alternate characters display an ellipsis (...) below the character.

Hiding On-Screen Keyboard

On devices with keypads, the user can hide the on-screen keyboard.

Touch in a text field to display the on-screen keyboard. Touch  at the bottom right corner of the screen.

Figure 30 Hide Keyboard Option

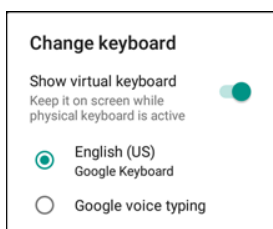

Touch the **Show virtual keyboard** switch to off. The on-screen keyboard automatically disappears.

To show the on-screen keyboard, Touch in a text field. Touch at the bottom right corner of the screen. Touch the **Show virtual keyboard** switch to on. The keyboard re-appears.

Switching Language Keyboards

The user can enable multiple language keyboards. The available language codes appear on the space bar.

Figure 31 Keyboard with Multiple Languages

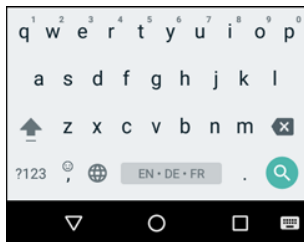

To switch between language keyboard, touch at the bottom right corner of the screen.

Figure 32 Change Keyboard Option

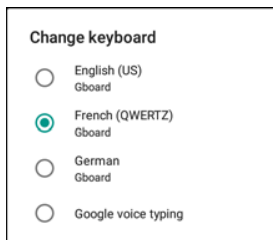

Select one of the keyboard languages. The keyboard automatically changes to the selected language.

Configuring the Keyboard

To configure the keyboard, refer to the Keyboard Settings section in the MC33XX Mobile Computer Integrator Guide.

Do Not Disturb Feature

This mode mutes the MC33XX so that it does not make sounds or vibrate.

For example, use Do Not Disturb to:

- Automatically limit sounds at night or during events
- Mute interruptions other than alarms
- Get alerted to messages only from favorite contacts.

Limit Sounds and Vibrations

Mute the MC33XX completely, or let through the important alarms or important calls.

Total Silence

To completely mute the MC33XX so that it does not make a sound or vibrate, choose **Total silence**.

In Total silence mode:

- Alarms do not make noise.
- MC33XX does not vibrate or make sounds when receiving a message, or notification.
- Sounds from music, videos, games, and other media are muted.



NOTE: The user will not hear alarms in Total silence mode.

1. Swipe down with two fingers from the status bar to open the quick access panel.
2. Touch **Do not disturb > Total silence**.
3. Choose **Until you turn it off** or select a time period.
4. Touch **Done**.

When Total Silence is on,  appears in the quick access panel and the Status Bar.

To turn off Total Silence, open quick access panel and touch **Total silence**.

Alarms Only

To mute the MC33XX so that the user hears alarms, choose **Alarms only**. This option does not mute sounds from music, videos, games, or other media.

1. Swipe down with two fingers from the status bar to open the quick access panel.
2. Touch **Do not disturb > Alarms only**.
3. Choose **Until you turn it off** or select a time period.
4. Tap **Done**.

When Alarms Only is on,  appears in the quick access panel and the Status Bar.

To turn off Alarms Only, open quick access panel and touch **Alarms only**.





NOTE: To quickly turn on Alarms Only, with the screen on, press and hold the Volume Down button until the volume is all the way down. Then, press Volume Down again to turn on Alarms Only.

To turn off Alarms Only, press either the Volume Up or Volume Down button and the touch **END NOW** in the alert message. Then, press Volume Up again to turn on Alarms Only.

Priority Notifications Only

To only be interrupted by important notifications, choose Priority Only. This option does not mute sounds from music, videos, games, or other media.

Before turning on Priority Only mode, set the notification priorities:

1. Swipe down with two fingers from the status bar to open the quick access panel and then touch .
2. Touch  **Sounds and notifications > Do not disturb > Priority only allows**.
3. Set priorities.
 - **Alarms:** Disabled by default.

- **Reminders and Events:** Switch on or off.
- **Messages and Calls:** Choose **From anyone**, **From contacts only**, **From starred contacts only**, or **none**. To star contacts, use the **Contacts** app.
- **Repeat callers:** Choose whether to let the MC33XX ring if the same person calls again within 15 minutes.

After setting notification priorities, turn on Priority only mode to limit interruptions. The priority notifications make a sound or vibrate based on the current ringer volume, but other notifications will be silenced.

1. Swipe down with two fingers from the status bar to open the quick access panel.
2. Touch **Do not disturb > Priority only**.
3. Choose **Until you turn it off** or select a time period.
4. Tap **Done**.



When Priority Only is on,  appears in the quick access panel and the Status Bar.

To turn off Priority Only, open quick access panel and touch **Priority only**.

Automatically Block Sounds and Vibrations



Silence Sounds During Certain Times

To automatically silence the MC33XX during certain times, like at night or on weekends, set the time rules.

1. Swipe down with two fingers from the status bar to open the quick access panel and then touch .
2. Touch  **Sound & notification > Do not disturb > Automatic rules**.
3. Touch a default **Weekend** or **Weeknight**. Or, to make a new rule, touch **Add rule** and then **Time rule**.
4. Edit the new rule:
 - **Rule name:** Name the rule.
 - **Days, Start time,** and **End time:** Set the rule's schedule.
 - **Do not disturb:** Choose whether the rule uses **Alarms only**, **Priority only**, or **Total silence**.
5. Touch the On/Off text or switch at the top to turn on the rule.

Silence Sounds During Events and Meetings

To automatically silence the MC33XX during events or meetings, set an event rules.

1. Swipe down with two fingers from the status bar to open the quick access panel and then touch .
2. Touch  **Sound & notification > Do not disturb > Automatic rules**.
3. To edit the default rule, touch **Event**. Or, to create a new rule, touch **Add rule > Event rule**.
4. Edit the rule settings.
 - **During events for:** Select which Google Calendar events the rule uses.
 - **Where reply is:** Options: **Yes, Maybe, or Not replied, Yes or Maybe, or Yes**.
 - **Do not disturb:** Choose whether the rule uses **Priority only**, **Alarms only**, or **Total silence**.
5. Touch the On/Off switch at the top to turn on the rule.

Turn Sounds Back On

When the MC33XX is in Do Not Disturb mode, Alarms or Priority only  or Total silence  display.

To turn off Do Not Disturb, either:

- In the quick access panel, touch **Alarms only**, **Priority only**, or **Total silence**.
- Press the Volume Down button and touch **End Now**.

Override Do Not Disturb for Specific Apps

To let through notifications from specific apps:

1. Open **Settings > Sounds**.
2. Touch an app.
3. Touch **Override Do Not Disturb**.

Applications

The **APPS** screen displays icons for all installed applications. The table below lists the applications installed on the MC33XX. Refer to the MC33XX Integrator Guide for information on installing and uninstalling applications.

Table 8 Applications









Icon	Description
	AppGallery - Provides links to utilities and demonstration applications that can be installed on the MC33XX.
	Battery Manager – Displays battery information, including charge level, status, health and wear level.
	Battery Swap – Use to place device in Battery Swap mode when replacing the battery.
	Bluetooth Pairing – Use to pair a Bluetooth Imager with the MC33XX by scanning a bar code.
	Calculator - Provides the basic and scientific arithmetic functions.
	Calendar - Use to manage events and appointments.
	Chrome - Use to access the Internet or intranet.
	Chromium - An open-source web browser project started by Google, which provides the source code for the proprietary Google Chrome browser.

Table 8 Applications (Continued)















Icon	Description
	Clock - Use to schedule alarms for appointments or as a wake-up.
	Contacts - Use to manage contact information. See Contacts on page 57 for more information.
	DataWedge - Enables data capture using the scanner or imager.
	Device Central - Displays detailed information about the MC33XX and supported peripherals. See Device Central for more information.
	Diagnostic Tool - Use to diagnose the MC33XX. See Diagnostic Tool for more information.
	Downloads - lists all downloads files.
	Drive - Upload photos, videos, documents, and other files to personal storage site.
	DWDemo - Provides a way to demonstrate the data capture features using the Linear Imager. See DataWedge Demonstration on page 62 for more information.
	Email - Use to send and receive email.
	File Browser - Organize and manage files on the MC33XX. See File Browser on page 56 for more information.
	Gmail - Use to send and receive email using a Google email account.
	Google - Launches Google search application.
	Hangouts - Use to communicate with friends using text messages and photos.
	Maps - Use to see your location on a map (with public transit, traffic or satellite overlays). Search for any business or place of interest. Provides turn-by-turn navigation with voice guidance and traffic-avoidance and alternate routes, for drivers, cyclists, walkers and users of public transportation.
	MSRN - Use verify authenticity of the paired Snap-on MSR and to provision the Snap-on MSR.

Table 8 Applications (Continued)





















Icon	Description
	Music - Play music stored on the microSD card and internal memory.
	Notes - Use to take and save notes.
	Photos – Use to sync photos with Google account.
	Play Movies & TV – View movies and video on your device.
	Play Music – Use to listen to music.
	Play Store – Download music, movies, books, and Android apps and games from the Google Play Store.
	PTT Express – Use to launch the PTT Express client for Voice over IP (VoIP) communication.
	RxLogger – Use to diagnose device and application issues. See RxLogger on page 67 for more information.
	RxLogger Utility – Use to monitor data from log files on the MC33XX while RxLogger is running.
	Search - Use the Google search engine to search the Internet and the MC33XX.
	Settings - Use to configure the MC33XX.
	SimulScan - Use to demonstrate the document capture feature of the MC33XX.
	SMARTMU - A diagnostic intelligent app. Use to diagnose surrounding area and display network stats, such as coverage hole detection, or AP in vicinity.
	Sound Recorder - Use to record audio.
	StageNow - Allows the MC33XX to stage a device for initial use by initiating the deployment of settings, firmware and software.
	TechDocs - Opens the on-device User Guide for the MC33XX.

Table 8 Applications (Continued)

Icon	Description
	Videos - Use to view videos on the MC33XX.
	Voice Search - Use to perform searches by asking questions.
	YouTube - Use to view videos on the YouTube web site.
	Velocity - Opens the Wavelink terminal emulation application.

Accessing Applications

All applications installed on the device are accessed using the **APPS** window.

1. On the Home screen, swipe up from the bottom of the screen.

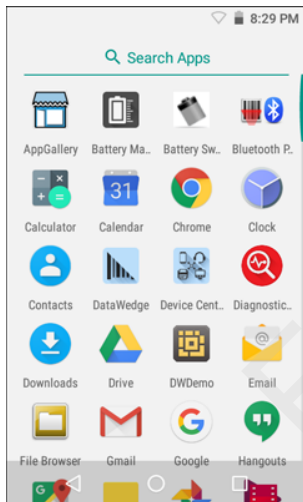
Figure 33 APPS Window Example

2. Slide the **APPS** window up or down to view more application icons. Touch an icon to open the application. See [Application Shortcuts and Widgets on page 37](#) for information on creating a shortcut on the Home screen.

Switching Between Recent Applications



1. Touch . A window appears on the screen with icons of recently used applications.

Figure 34 Recently Used Applications

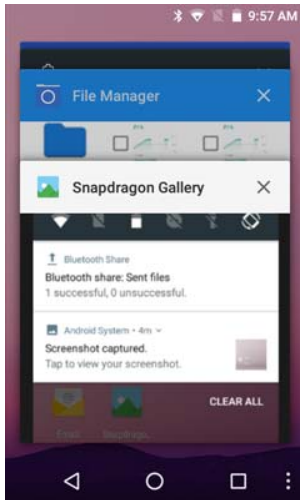

2. Slide the window up and down to view all recently used applications.
3. Swipe left or right to remove application from the list and force close the application.
4. Touch an icon to open it or touch  to return to the current screen.

Un-Locking the Screen

Use the Lock screen to protect access to data on the MC33XX. Some email accounts require locking the screen. Refer to the mc33xx Integrator Guide for information on setting up the locking feature.

When locked, a pattern, PIN or password is required to unlock the device. Press the Power button to lock the screen. The device also locks after a pre-defined time-out.

Press and release the Power button to wake the device. The Lock screen displays. Swipe the screen up to unlock. If the Pattern screen unlock feature is enabled, the Pattern screen appears instead of the Lock screen. If the PIN or Password screen unlock feature is enabled, enter the PIN or password after unlocking the screen.

Figure 35 Lock Screen (AOSP & GMS)

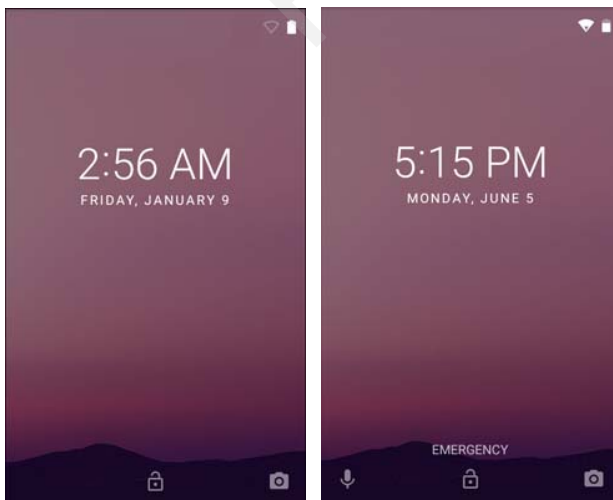

Figure 36 PIN Screen

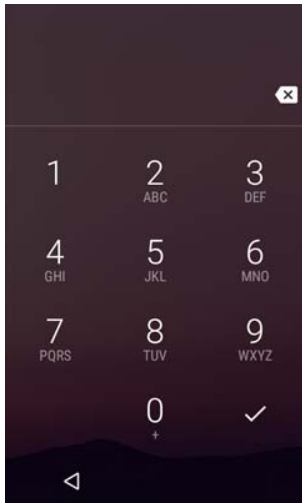
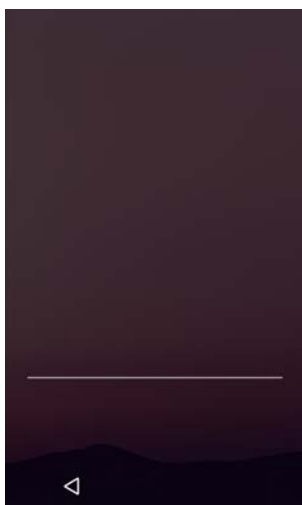

Figure 37 Pattern Screen



Figure 38 Password Screen



Scheduled Power On and Off

The user can set the MC33XX to turn on or off at a specific time. This can save battery power when the MC33XX is not in use.

To set the power on and off schedule:



1. Swipe down with two fingers from the status bar to open the quick access panel and then touch .
2. Touch  **Scheduled power on and off**.

Figure 39 Scheduled Power On and Off



3. In the **Scheduled power on** section, touch the on/off switch.

Figure 40 Set Power Schedule

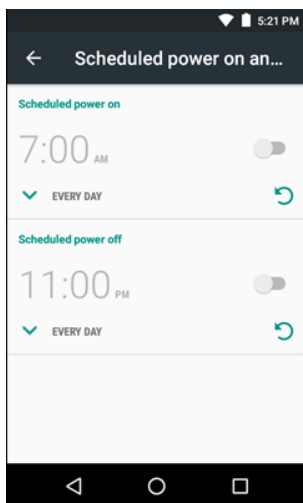
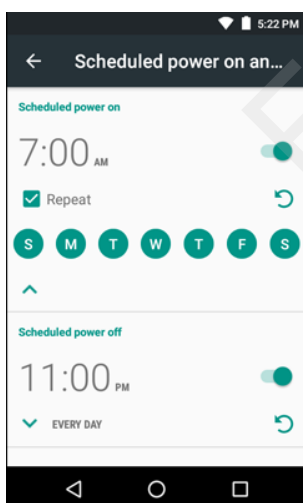

4. Touch the time.
5. Use the clock dialog box to set the power on time and touch **Done**. by default, the power on time occurs everyday.
6. Touch the day circles disable power on for a specific day.

7. Deselect the **Repeat** checkbox to disable daily repeating and set the MC33XX power on at the next set time.
8. Repeat for scheduled power off settings.
9. Touch .

When the MC33XX starts automatic power off, a dialog box appears.

Figure 41 Power Off

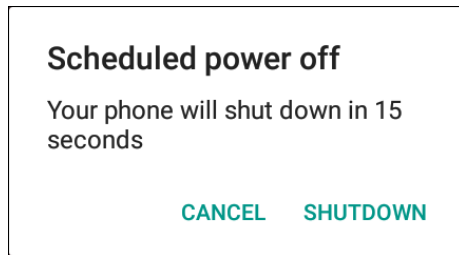

Touch **Shutdown** to power off, Cancel to not power off or the device powers off automatically after a 20 seconds.

Resetting the Device

There are two reset functions, soft reset and hard reset.

Performing a Soft Reset

Perform a soft reset if applications stop responding.

1. Press and hold the Power button until the menu appears.
2. Touch **Reset**.
3. The device reboots.

Performing a Hard Reset



CAUTION: Performing a hard reset with a microSD card installed in the MC33XX may cause damage or data corruption to the micro SD card.

All un-saved data is lost after performing a hard reset.

Perform a Hard Reset if the device stops responding. To perform a Hard Reset:

1. Simultaneously press the Power button, 1 and 9 keys.
2. The device reboots.

Suspend Mode

The MC33XX goes into suspend mode when the user presses the Power button or after a period of inactivity (set in the Display settings window).

To wake the MC33XX from Suspend mode, press the Power button. The Lock screen displays. Swipe the screen up to unlock. If the Pattern screen unlock feature is enabled, the Pattern screen appears instead of the Lock

screen. If the PIN or Password screen unlock feature is enabled, enter the PIN or Password after unlocking the screen.



NOTE: If the user enters the PIN, password or pattern incorrectly five times, they must wait 30 seconds before trying again.

If the user forgets the PIN, password or pattern contact the system administrator.

Figure 42 Lock Screen

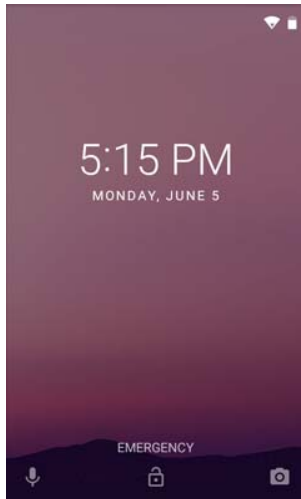

Transferring Files with a Host Computer via USB

Connect the MC33XX to a host computer using the USB Charging cable or the 1-Slot USB cradle to transfer files between the MC33XX and the host computer. See [Accessories](#) for more information.

When connecting the MC33XX to a host computer, follow the host computer's instructions for connecting and disconnecting USB devices, to avoid damaging or corrupting files.

Transferring Files using Media Transfer Protocol



NOTE Use Media Transfer Protocol (MTP) to copy files between the MC33XX (internal memory or microSD card) and the host computer.

1. Connect the Rugged Charge/USB Cable to the MC33XX or place the MC33XX into the 1-Slot USB/Charge Only Cradle. See [Accessories](#) for setup information.
2. Pull down the Notification panel and touch **USB charging this device**.

Figure 43 Use USB Dialog Box

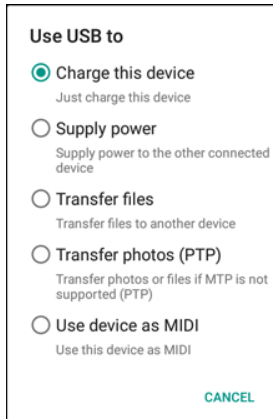

3. Touch **Transfer files**.
4. On the host computer, open a file explorer application.
5. Locate the **MC33XX** as a portable device.
6. Open the **SD card** or the **Internal storage** folder.
7. Copy files to and from the MC33XX or delete files as required.

Transferring Files using Photo Transfer Protocol



NOTE Use Photo Transfer Protocol (PTP) to copy photos from either the microSD card or internal memory to the host computer.

1. Connect the USB Cable to the MC33XX or place the MC33XX into the 1-Slot Ethernet Cradle. See [Accessories](#) for setup information.
2. Pull down the Notification panel and touch **USB charging this device**.

Figure 44 Use USB Dialog Box

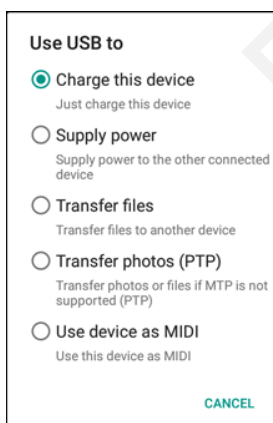

3. Touch **Transfer photos (PTP)**.
4. On the host computer, open a file explorer application.
5. Open the **SD card** or the **Internal storage** folder.
6. Copy or delete photos as required.

Disconnect from the Host Computer



CAUTION Carefully follow the host computer's instructions to unmount the microSD card and disconnect USB devices correctly to avoid losing information.

1. On the host computer, unmount the device.
2. Remove the USB cable from the device or remove the device from the cradle.

FOR REVIEW

Applications

Introduction

This section describes the applications installed on the device.

Battery Manager

The Battery Manager provides detailed information about the battery.

To open **Battery Manager**, swipe up from the bottom of the Home screen and touch .

Figure 45 Battery Manager Screen



Battery level - Indicate the current battery charge level.

Time since charging- Indicates the amount of time since the device began charging. Displays when the MC33XX is on AC power.

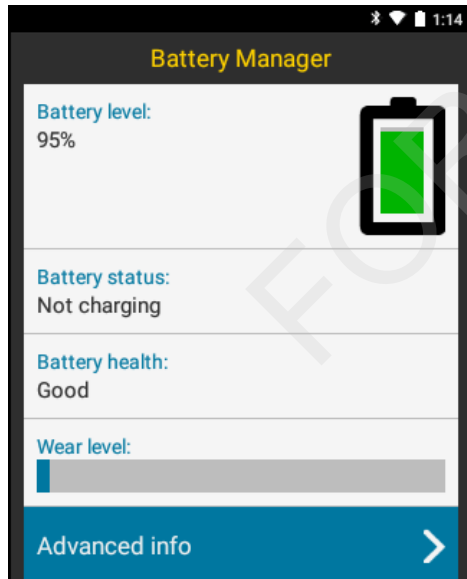
Battery status

- **Not charging** - Indicates that the MC33XX is not connected to AC power.
- **Charging over AC** - Indicates that the MC33XX is connected to AC power and charging.

Battery health - Indicates the health of the battery.

Wear level - Indicates the health of the battery in graphical form.

Advanced info - Tap to view additional battery information.

File Browser

Use the **File Browser** application to view and manage files on the device.



To open **File Browser**, swipe up from the bottom of the Home screen and touch .

Figure 46 File Browser Screen

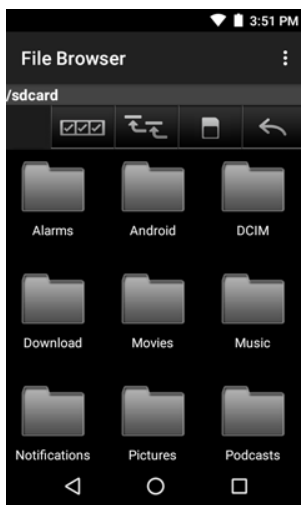

The address bar indicates the current folder path. Touch the current folder path to manually enter a path and folder name.

Use  to select multiple files/folder.

Use  to view the internal storage root folder.

Use  to view the microSD card root folder.

Use  to view the previous folder or to exit the application.

Touch and hold an item to perform an operation on that item. Select one of the options from the **File Operations** menu:

- **Information** - View detailed information about the file or folder.
- **Move** - Move the file or folder to a new location.
- **Copy** - Copy the select file.
- **Delete** - Delete the selected file.
- **Rename** - Rename the select file.
- **Open as** - Open the selected file as a specific file type.
- **Share** - Share the file with other devices.

Touch  to open menu options:

- **New Folder** - Create a new folder.
- **Search** - Search for a specific file on the device.
- **Sort** - Select the sort order of the files by name, type, size or date.
- **Refresh** - Refresh the current folder.
- **List View** - Change the folder to display item is a list.
- **Grid View** - Change the folder to display item is a grid.
- **Change Size** - Change the size of the icons.
- **About File Browser** - Displays the app version.

Contacts

Use the **Contacts** application to manage contacts.



From a Home or Apps screen, touch . Contacts opens to the main list of contacts. View contacts in three ways at the top of the screen: Groups, All contacts, and Favorites. Touch the tabs to change how to view the contacts. Swipe up or down to scroll through the lists.

Figure 47 Contacts Screen



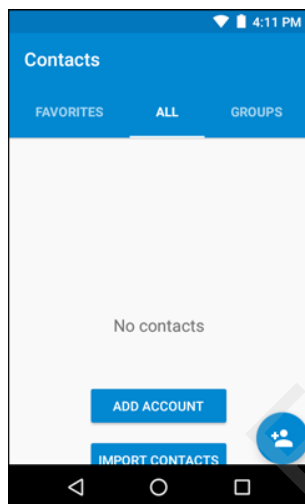

Adding Contacts

1. In the **Contacts** application, touch .
2. If there are more than one account with contacts, touch the one to use.
3. Type the contact's name and other information. Touch a field to start typing, and swipe down to view all categories.
4. To open a menu with preset labels, such as Home or Work for an email address, touch the label to the right of the contact information. Or to create your own label, touch **Custom** in the menu.
5. Touch .

Editing Contacts

1. In the **Contacts** application, touch a contact name to edit.

2. Touch .
3. Edit the contact information.
4. Touch .

Deleting Contacts

1. In the **Contacts** application, touch a contact name to delete.
2. Touch .
3. Touch **Delete**.
4. Touch **Delete** to confirm.

Photos



NOTE: The device supports the following image formats: jpeg, gif, png and bmp.

The device supports the following video formats: H.263, H.264 and MPEG4 Simple Profile.

Use Photos to:

- view photos
- play videos
- perform basic editing of photos
- set photos as wallpaper
- set photos as a contact photo
- share photos and videos.

Photos presents all photos and videos stored on the microSD card and internal memory.

To open the **Photos** application, swipe up from the bottom of the Home screen and touch .

By default, Photos open to the **Photos** view.

- Touch an album to open it and view its contents. The photos and videos in the album are displayed in chronological order.
- Touch a photo or video in an album to view it.
- Press  to return to the main screen.

Working with Albums

Albums are groups of images and videos in folders. Touch an album to open it. The photos and videos are listed in a chronologically ordered grid. The name of the album displays at the top of the screen.

Swipe up to scroll images across the screen.

Deleting an Album

To delete an album and its contents:

1. Touch an album to open it.
2. Touch  > **Delete device folder**.
3. In the delete folder dialog box, touch **Delete**.

Working with Photos

Use Photos to view photos on the internal memory and the microSD card.

Viewing and Browsing Photos

To view a photo:

1. Touch an album to open it.
2. Touch a photo.

Figure 48 Photo Example



- Swipe left or right to view the next or previous photo in the album.
- Turn the device to view the photo in upright (portrait) or sideways (landscape) orientation. The photo is displayed (but not saved) in the new orientation.
- Touch the photo to view the controls.
- Pinch two fingers together or spread them apart to zoom in or out.
- Drag the photo to view parts that are not in view.

Cropping a Photo



1. Touch a photo to view the controls.
2. Touch  > . The cropping tool appears.
3. Use the cropping tool to select the portion of the photo to crop.
 - Drag from the inside of the cropping tool to move it.
 - Drag an edge of the cropping tool to resize it to any proportion.

Figure 49 Cropping Tool



4. Touch **DONE**.
5. Touch **SAVE** to save a copy of the cropped photo. The original version is retained.

Setting a Photo as a Contact Icon

1. Touch the photo to open it.
2. Touch .
3. Touch **Use as**.
4. Touch **Contact photo**.
5. In the **Contacts** application, touch a contact.
6. Touch the white box and crop the photo accordingly.
7. Touch **Done**.

Share a Photo

1. Touch an album to open it.
2. Touch a photo to open it.
3. Touch .
4. Touch the application to use to share the selected photo. The application selected opens with the photo attached to a new message.

Deleting a Photo

1. Touch a photo to open it.
2. Touch .
3. Touch **Move to Trash** to delete the photo.

Working with Videos

Use Photos to view videos and share videos.

Watching Videos

1. Touch an album to open it.
2. Touch a video. The video automatically starts playing.
3. Touch the screen to view the playback controls.

Sharing a Video

1. Touch an album to open it.
2. Touch a video to open it.
3. Touch . The Share menu appears.
4. Touch the application to use to share the selected video. The application selected opens with the video attached to a new message.

Deleting a Video

1. Touch an album to open it.
2. Touch a video to open it.
3. Touch .
4. Touch **Move to trash** to delete the video.

FOR REVIEW

DataWedge Demonstration



NOTE See the MC33XX Mobile Computer Integrator Guide for information on DataWedge configuration.

Use **DataWedge Demonstration** to demonstrate data capture functionality.

Figure 50 DataWedge Demonstration Window

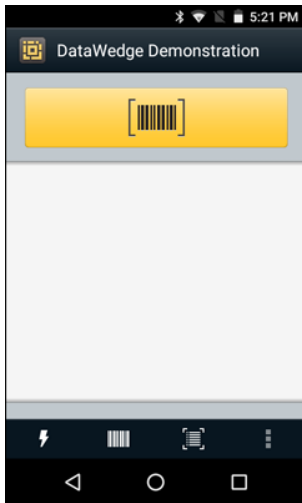
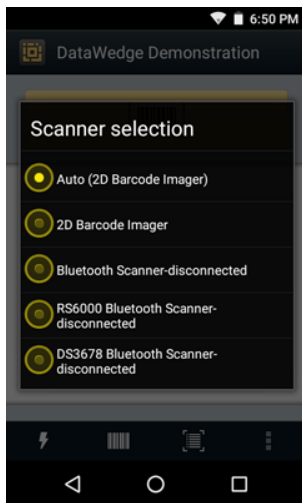

Table 9 DataWedge Demonstration Icons

Feature	Icon	Description
Illumination		Indicates imager illumination is off. Touch to turn illumination on.
		Indicates imager illumination is on. Touch to turn illumination off.
Data Capture		Indicates that the data capture function is through the internal imager.
		Indicates that an RS6000 Bluetooth imager is not connected to the MC33XX.
		Indicates that an RS6000 Bluetooth imager is connected to the MC33XX.
Scan Mode		Indicates imager is in picklist mode. Touch to change to normal scan mode.
		Indicates imager is in normal scan mode. Touch to change to picklist mode.
Menu		Opens a menu to view the application information or to set the application DataWedge profile.

Touch the Data Capture icon to select the data capture mode.

Figure 51 Data Capture Options Menu



Select a scanner to use. See [Data Capture](#) for configuring scanner options.

Either press the programmable button or touch the yellow scan button to enable data capture. The captured data appears in the text field below the yellow button.

Sound Recorder

Use **Sound Recorder** to record audio messages.

Recordings are saved on the microSD card (if installed) or the Internal Storage and available in the Music application playlist titled "Audio Recordings."

Figure 52 Sound Recorder Application

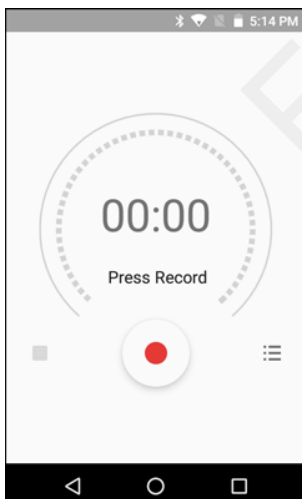

PTT Express Voice Client



NOTE: PTT Express Voice Client creates Push-To-Talk (PTT) communication capability between disparate enterprise devices. Leveraging existing Wireless Local Area Network (WLAN) infrastructure, PTT Express delivers simple PTT communication without the need of a voice communication server.

- **Group Call:** Press and hold the Talk button (yellow Scan button on the MC33XX-G keypad) to start communicating with other voice client users.
- **Private Response:** Press and release and then press and hold the Talk button to respond to the originator of the last broadcast or to make a Private Response.

PTT Audible Indicators

The following tones provide helpful cues when using the voice client.

- **Talk Tone:** Double chirp. Plays when the Talk button is depressed. This is a prompt for the user to start talking.
- **Access Tone:** Single beep. Plays when another user just finished a broadcast or response. The user is now able to initiate a Group Broadcast or Private Response.
- **Busy Tone:** Continuous tone. Plays when the Talk button is depressed and another user is already communicating on the same talkgroup. Plays after the maximum allowed talk time is reached (60 seconds).
- **Network Tone:**
 - Three increasing pitch beeps. Plays when PTT Express has acquired the WLAN connection and the service is enabled.
 - Three decreasing pitch beeps. Plays when PTT Express has lost the WLAN connection or the service is disabled.

Figure 53 PTT Express Default User Interface

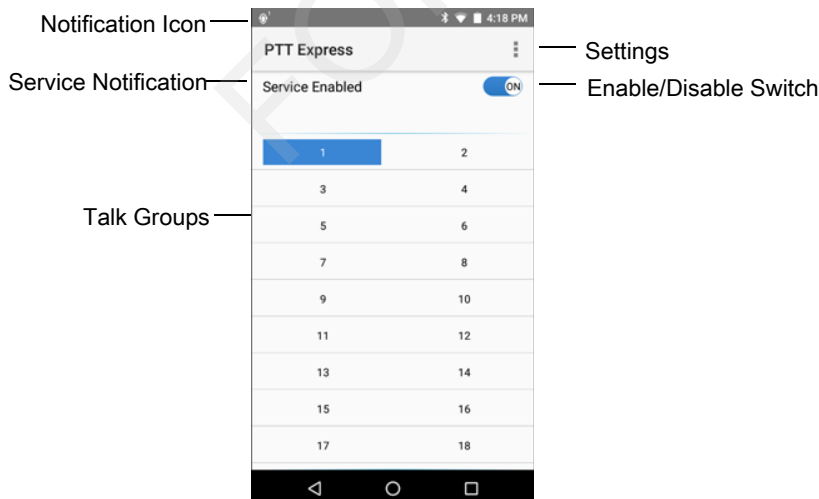









Table 10 PTT Express Default user Interface Descriptions

Item	Description
Notification Icon	Indicates the current state of the PTT Express client.
Service Indication	Indicates the status of the PTT Express client. Options: Service Enabled , Service Disabled or Service Unavailable .
Talk Group	Lists all 32 Talk Groups available for PTT communication.
Settings	Opens the PTT Express Settings screen.
Enable/Disable Switch	Turns the PTT service on and off.

Notification Icons

Indicates the current state of the PTT Express Voice Client.

Table 11 PTT Express Default Notification Icons

Icon	Description
	Indicates that PTT Express Voice client is disabled.
	Indicates that PTT Express Voice client is enabled but not connected to a WLAN.
	Indicates that PTT Express Voice client is enabled, connected to a WLAN and listening on the Talk Group indicated by the number next to the icon.
	Indicates that PTT Express Voice client is enabled, connected to a WLAN and communicating on the Talk Group indicated by the number next to the icon.
	Indicates that PTT Express Voice client is enabled, connected to a WLAN and in a private response.
	Indicates that PTT Express Voice client is enabled and muted.
	Indicates that the PTT Express Voice client is enabled but it is not able to communicate due to a VoIP telephony call is in progress.

Enabling PTT Communication

1. Swipe up from the bottom of the Home screen and touch .
2. Slide the **Enable/Disable Switch** to the **ON** position. The button changes to an **ON** button.

Selecting a Talk Group

One of 32 Talk Groups can be selected by PTT Express users. However, only one talk group may be enabled at a time on the device. Touch one of the 32 Talk Groups. The selected Talk Group is highlighted.

PTT Communication



NOTE: This section describes the default PTT Express client configuration. See the PTT Express V1.2 User Guide for detailed information on using the client.

PTT communication may be established as a Group Call. When PTT Express is enabled, the yellow Scan button or another key on the keypad can be assigned for PTT communication.

Creating a Group Call



1. Press and hold the Scan button and listen for the talk tone to play.
If a busy tone is heard, release the button and wait a moment before making another attempt. Ensure that PTT Express and the WLAN are enabled.
2. Start talking after the talk tone is heard.
If the user holds the button for more than 60 seconds (default), the call is dropped allowing others to make Group calls. The user should release the button when finished talking to allow others to make calls.
3. Release the button when finished talking.

Responding with a Private Response

The Private Response can only be initiated once a Group Call has been established. The initial Private Response is made to the originator of the Group Call.

1. Wait until an access tone is heard.
2. Press and release and then press and hold the Talk button and listen for the talk tone to play.
3. If a busy tone is heard, release the button and wait a moment before making another attempt. Ensure that PTT Express and the WLAN are enabled.
4. Start talking after the talk tone plays.
5. Release the button when finished talking.

Disabling PTT Express Voice Client Communication

1. Swipeup from the bottom of the Home screen and touch .
2. Slide the **Enable/Disable Switch** to the **OFF** position. The button changes to **OFF**.
3. Touch .

RxLogger

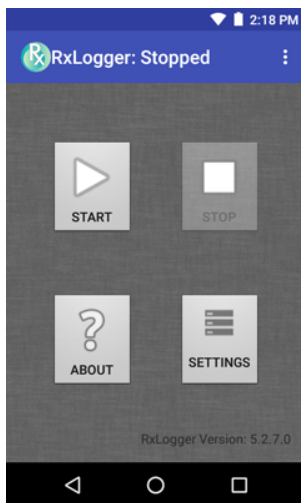

RxLogger is a comprehensive diagnostic tool that provides application and system metrics. It allows for custom plug-ins to be created and work seamlessly with this tool. RxLogger is used to diagnose device and application issues. Its information tracking includes the following: CPU load, memory load, memory snapshots, battery consumption, power states, wireless logging, cellular logging, TCP dumps, Bluetooth logging, GPS logging, logcat, FTP push/pull, ANR dumps, etc. All logs and files generated are saved onto flash storage on the device (internal or external).

Figure 54 RxLogger





Enabling Logging

To enable RxLogger:

1. Swipe up from the bottom of the Home screen and touch .
2. Touch **START**. RxLogger begins collecting data.
3. Touch .

Disabling Logging

To disable RxLogger:

1. Swipe up from the bottom of the Home screen and touch .
2. Touch **STOP**. RxLogger stops collecting data.
3. Touch .

RxLogger Utility

RxLogger Utility is a data monitoring application for viewing logs in the MC33XX while RxLogger is running. The user can access the logs and RxLogger Utility features in the App View or the Overlay View.

In the App View the user views logs in the RxLogger Utility.

Figure 55 RxLogger Utility App View

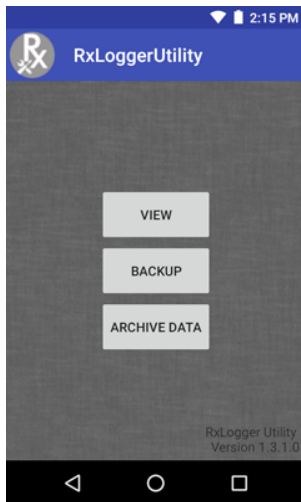

Refer to the MC33XX Mobile Computer Integrator Guide for detailed information about using RxLogger Utility.

Diagnostic Tool

The **Diagnostic Tool** is a utility that determines the health of the MC33XX. Use the Diagnostic Tool to troubleshoot the device and determine issues.

1. Swipe up from the bottom of the Home screen and touch .

Figure 56 Diagnostic Tool



2. Touch **Run Test**. The app tests all enabled subsystems (by default only the Battery and System tests are enabled). See [Settings on page 71](#) to enable subsystem tests.

Figure 57 Test Passed Screen

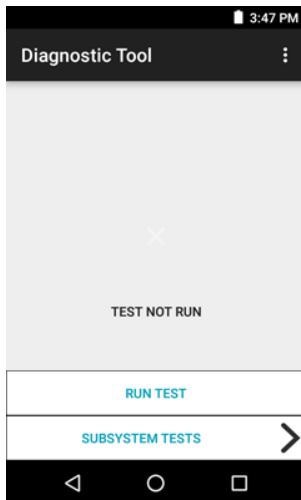
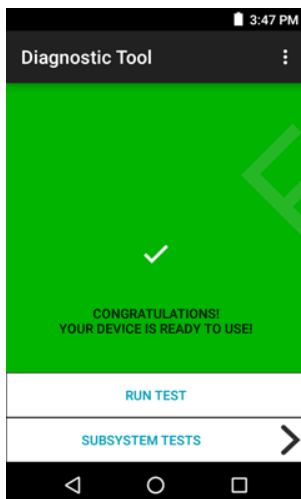
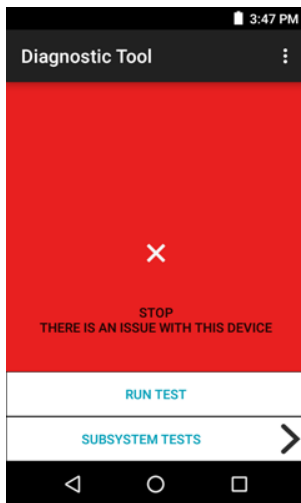

Figure 58 Test Failed Screen



3. To view each individual subsystem test, touch **Subsystem Tests**.

Figure 59 Subsystem Screen

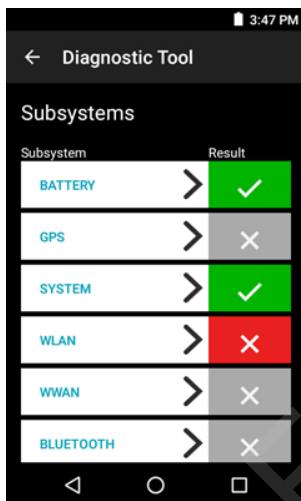



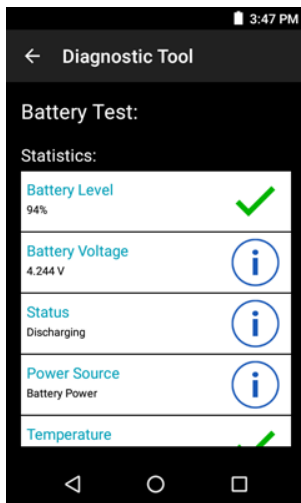

Table 12 Subsystem Test Result Indicators

Status Icon	Description
	Indicates test passed.
	Indicates test failed.
	Indicates test not supported or not enabled.

4. Touch one of the subsystems to view details.

Figure 60 Battery Subsystem Details



Settings

By default only the Battery and System tests are enabled. To enable other tests:

1. Touch **Settings**.
2. Touch to the left of the test name. A green box with a checkmark appears.
3. Touch **SAVE**.
4. Touch **Yes** to confirm.
5. Touch **Back**.

Battery Test Information

The Battery Test obtains the following information:

- **Battery Level** - Indicates the current battery charge level.
- **Battery Voltage** - Indicates the current battery voltage.
- **Status** - Indicates if the battery is charging (on AC power) or discharging (on battery power).
- **Power Source** - Indicates whether the device is receiving power from the battery or from an external source.
- **Temperature** - Indicates the current battery temperature.
- **Charge Cycles** - Not applicable.
- **Backup Battery Voltage** - Indicates backup battery voltage.
- **Manufacture Date** - Not applicable (Displays the manufacture date of the battery).

GPS Test Information

Not supported on the MC33XX.

System Test Information

Use the System Test to determine if the CPU or memory loads are too high, there are too many processes running on the device, or that storage on the device is almost full. The System Test obtains the following information:

- **CPU Load** - Indicates the amount of CPU being used.
- **Free Physical Memory** - Indicates the amount of RAM available.
- **Free Storage** - Indicates the amount of internal Flash memory available.
- **Process Count** - Indicates the number of processes currently running.

WLAN Test Information

If the WiFi radio is not present or disabled the test may be skipped. Use this information to determine if the device's WLAN configuration is correct or whether there is any connection with an access point or network. The WLAN Test obtains the following information:

- **WLAN Enabled** - Indicates if the WLAN radio is enabled or disabled.
- **WLAN Status** - Indicates the current status of association with the access point.
- **ESSID** - Displays the name of the wireless network.
- **BSSID** - Displays the MAC address of the connected access point.
- **MAC Address** - Displays the device's MAC address.
- **Signal** - Indicates the strength of the Wi-Fi signal (in dBm).
- **IP Address** - Displays the IP address of the device.

WWAN Test Information

Not supported on the MC33XX.

Bluetooth Test Information

The Bluetooth Test obtains the following information:

- **Enabled** - Indicates if the Bluetooth radio is enabled or disabled.
- **Status** - Indicates if the device is paired to another Bluetooth device.
- **Connectable/Discoverable** - Indicates if the device is discoverable or connectable.
- **Address** - Displays the Bluetooth radio MAC address.
- **Name** - Displays the Bluetooth name for the device.

Device Central

Device Central displays detailed information about the MC33XX and connected peripherals and supports the following Zebra devices:

- RS6000 Bluetooth Ring Scanner
- RS5000 Corded Ring Scanner
- HS3100 Bluetooth Headset

Device Central features include:

- Discovering and pairing with supported peripherals via Bluetooth or corded connection.
- Paging a connected RS6000 Ring Scanners.
- Updating the firmware of supported ring scanners.
- Displaying the connection status of peripherals.
- Displaying information for a connected peripheral in the notification bar.

Figure 61 Device Central Screen

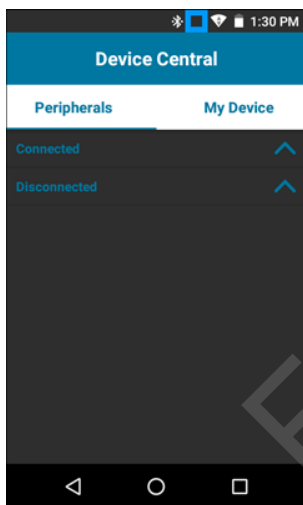

Device Central Tabs

- **Peripherals** Tab - displays all currently connected and previously connected peripherals. Connected peripherals display the length of time (in minutes) that they have been connected. When an RS6000 is connected the **Page** button displays. See [Paging an RS6000 Ring Scanner on page 74](#).

Touch the peripheral information to display the **Device Details** screen.

- **Device Details** - displays detailed device information for the selected peripheral.
- **My Device** Tab - displays information about the MC33XX and the current version of Device Central.
 - **Device Details** - displays the **About device** screen.
 - **Device Battery Details** - displays the **Battery** screen.

Paging an RS6000 Ring Scanner

Use the **Page** button to easily locate the currently connected RS6000 Ring Scanner:

1. With the RS6000 Ring Scanner connected, touch swipe up from the bottom of the Home screen and select



NOTE The RS6000 Ring Scanner must be within 10 m (32 ft) of the MC33XX.

2. Under the RS6000 peripheral information, touch **Page** to begin paging the RS6000. The paged RS6000 beeps and vibrates.

To stop paging, press the scan trigger of the RS6000. On a triggerless RS6000, stop paging by resetting the RS6000. See [Resetting the Device on page 51](#).

FOR REVIEW

Data Capture

Introduction

This chapter provides information for capturing bar code data using the internal camera and optional scan modules and Bluetooth scanner.

The MC33XX offers the following data capture options:

- imager.
- laser scanner.
- RS507 Hands-free imager.
- RS6000 Bluetooth Ring Scanner.



NOTE: DataWedge is installed and enabled on the MC33XX by default.

By default, the good decode beep is set to system volume (Music and Media). The good decode beep can be set to another sound (Notifications or Alarms) and the volume can be independently controlled. See the DataWedge section in the MC33XX Integrator Guide for more information.

Imager

The device with an integrated imager has the following features:

- Omnidirectional reading of a variety of bar code symbologies, including the most popular linear, postal, PDF417, and 2D matrix code types.
- Advanced intuitive laser aiming cross-hair for easy point-and-shoot operation.

The module uses digital camera technology to take a digital picture of a bar code, stores the resulting image in its memory, and executes state-of-the-art software decoding algorithms to extract the data from the image.

Operational Modes

The device with an integrated imager supports two modes of operation, listed below. Activate each mode by pressing a scan button.

- **Decode Mode:** In this mode, the device attempts to locate and decode enabled bar codes within its field of view. The imager remains in this mode as long as the user holds the scan button, or until it decodes a bar code.



NOTE: To enable Pick List Mode, configure in DataWedge.

- **Pick List Mode:** This mode allows the user to selectively decode a bar code when more than one bar code is in the device's field of view. To accomplish this, move the aiming crosshair over the required bar code to decode only this bar code. This feature is ideal for pick lists containing multiple bar codes and manufacturing or transport labels containing more than one bar code type (either 1D or 2D).

Laser Scanner

The MC33XX with laser scanner has the following features:

- Reading of a variety of bar code symbologies, including the most popular linear, postal, and 1-D code types.
- Intuitive aiming for easy point-and-shoot operation.

RS507 Hands-Free Imager

The RS507 Hands-free Imager is a wearable bar code scan solution for both 1D and 2D bar code symbologies. The scanner supports Simple Serial Interface (SSI) and Bluetooth Human Interface Device (HID) connection to the device where the scanner emulates a keyboard.

Figure 62 RS507 Hands-Free Imager

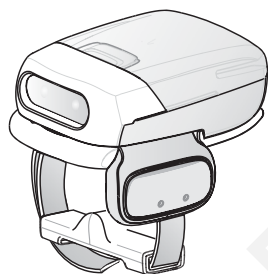

Refer to the RS507 Hands-free Imager Product Reference Guide for more information.

RS6000 Bluetooth Ring Scanner

The RS6000 Bluetooth Ring Scanner is a wearable barcode scan solution for both 1D and 2D barcode symbologies.

Figure 63 RS6000 Bluetooth Ring Scanner

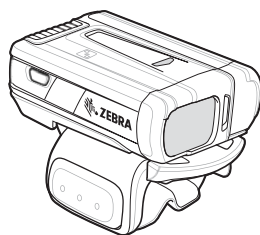

Refer to the RS6000 Bluetooth Ring Scanner Product Reference Guide for more information.

Scanning Considerations

Typically, scanning is a simple matter of aim, scan, and decode where a few quick trial efforts master it. However, consider the following to optimize scanning performance:

- Range
 - Any scanning device decodes well over a particular working range — minimum and maximum distances from the bar code. This range varies according to bar code density and scanning device optics.
Scanning within range brings quick and constant decodes; scanning too close or too far away prevents decodes. Move the scanner closer and farther away to find the right working range for the bar codes being scanned.
- Angle
 - Scan angle is important for promoting quick decodes. When laser beams reflect directly back into the scanner from the bar code, this specular reflection can “blind” the scanner.
To avoid this, scan the bar code so that the beam does not bounce directly back. But do not scan at too sharp an angle; the scanner needs to collect scattered reflections from the scan to make a successful decode. Practice quickly shows what tolerances to work within.
- Hold the device farther away for larger symbols.
- Move the device closer for symbols with bars that are close together.



NOTE: Scanning procedures depend on the application and device configuration. An application may use different scanning procedures from those described.

Bar Code Capture with Imager

To capture bar code data:

1. Ensure that an application is open on the device and a text field is in focus (text cursor in text field).
2. Point the top of the device at a bar code.

Figure 64 Bar Code Scanning – MC33XX-G

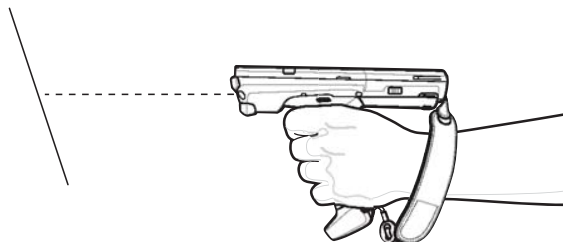

3. Press and hold the Scan button or Trigger.
The red laser aiming pattern turns on to assist in aiming.
4. Ensure the bar code is within the area formed by the cross-hairs in the aiming pattern. The aiming dot is used for increased visibility in bright lighting conditions.

The Scan LEDs light green and a beep sounds, by default, to indicate the bar code was decoded successfully. Note that when the device is in Pick List Mode, the device does not decode the bar code until the center of the crosshair touches the bar code.

Figure 65 Aiming Pattern

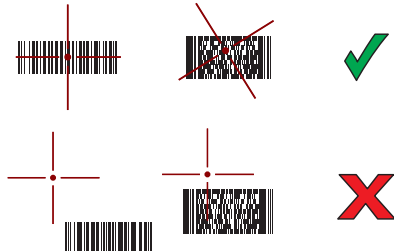

Figure 66 Pick List Mode with Multiple Bar Codes in Aiming Pattern



5. Release the scan button or Trigger.
6. The bar code content data appears in the text field.

Bar Code Capture with RS507 Hands-Free Imager

Pair the RS507 with the MC33XX. See [Pairing the RS507/RS6000 Hands-Free Imager Using SSI on page 82](#) or [Pairing the RS507/RS6000 Hands-Free Imager Bluetooth HID on page 83](#).

1. Ensure that an application is open on the device and a text field is in focus (text cursor in text field).
2. Point the RS507 at a bar code.

Figure 67 Bar Code Scanning with RS507

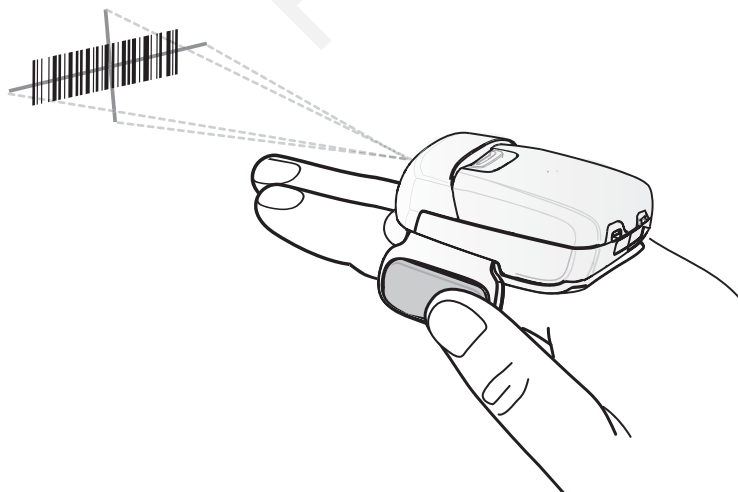

3. Press and hold the trigger.

The red laser aiming pattern turns on to assist in aiming. Ensure the bar code is within the area formed by the cross-hairs in the aiming pattern. The aiming dot is used for increased visibility in bright lighting conditions.

The RS507 LEDs light green, a beep sounds to indicate the bar code was decoded successfully. Note that when the RS507 is in Pick List Mode, the RS507 does not decode the bar code until the center of the crosshair touches the bar code.

Figure 68 Aiming Pattern

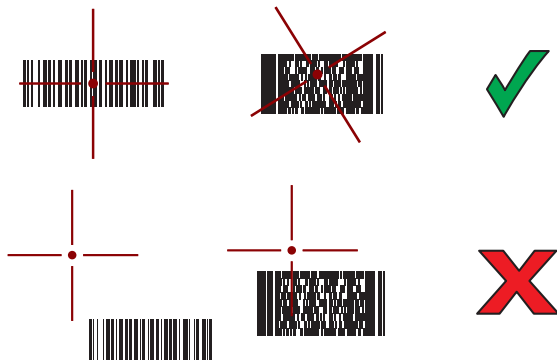

Figure 69 Pick List Mode with Multiple Bar Codes in Aiming Pattern



4. The captured data appears in the text field.

Barcode Capture with RS6000 Bluetooth Ring Scanner

To read a barcode, a scan-enabled application is required. The MC33XX contains the **DataWedge** application that allows the user to enable the scanner to decode barcode data and display the barcode content. See [DataWedge Demonstration on page 68](#) for more information on launching DataWedge.

Pair the RS6000 with the MC33XX. See [Pairing Using Simple Serial Interface on page 88](#) or [Pairing Using Bluetooth Human Interface Device on page 88](#) for more information.

1. Ensure that an application is open on the device and a text field is in focus (text cursor in text field).
2. Point the RS6000 at a barcode.

Figure 70 Barcode Scanning with RS6000

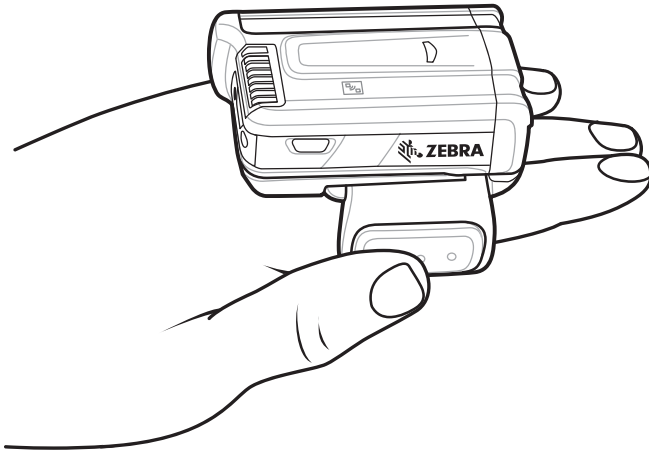

3. Press and hold the trigger.

The red laser aiming pattern turns on to assist in aiming. Ensure the barcode is within the area formed by the cross-hairs in the aiming pattern. The aiming dot is used for increased visibility in bright lighting conditions.

The RS6000 LEDs light green, a beep sounds to indicate the barcode was decoded successfully. Note that when the RS6000 is in Pick List Mode, the RS6000 does not decode the barcode until the center of the crosshair touches the barcode.

Figure 71 Aiming Pattern

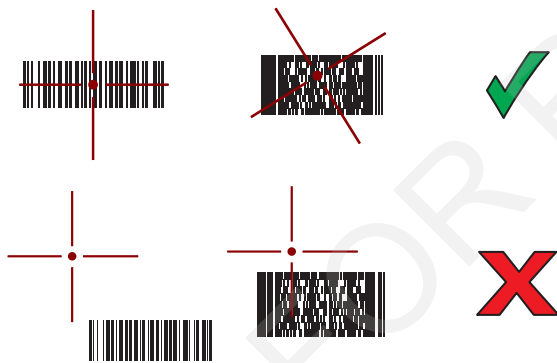

Figure 72 Pick List Mode with Multiple barcodes in Aiming Pattern



4. The captured data appears in the text field.

Pairing the RS507/RS6000 Hands-Free Imager

To connect the RS507 or RS6000 imagers to the MC33XX, use one of the following methods:

- Near Field Communication (NFC) (RS6000 only)
- Simple Serial Interface (SSI)
- Bluetooth Human Interface Device (HID) Mode.

Pairing Using Near Field Communication



NOTE: NFC is supported on the premium and premium + configurations of the device and only with the RS6000.

The MC33XX provides the ability to pair the RS6000 using NFC.

1. Ensure that the RS6000 is in SSI mode. Refer to the RS6000 User Guide for more information.
2. Ensure that NFC is enabled on the MC33XX.
3. Align the NFC icon on the RS6000 with the NFC icon on the back of the MC33XX.

The Status LED blinks blue indicating that the RS6000 is attempting to establish connection with the MC33XX. When connection is established, the Status LED turns off and the RS6000 emits a single string of low/high beeps.

A notification appears on the MC33XX screen.



The  icon appears in the Status bar.

Figure 73 Align NFC Antennas

The MC33XX pairs with the RS6000 and  appears in the Status bar.



NOTE: Not all Zebra devices support NFC readers and the Tap-to-Pair feature.

Pairing in HID Mode Using Near Field Communication

The MC33XX provides the ability to pair the RS6000 in HID Mode using NFC.



NOTE: NFC is supported on the premium and premium + configurations of the device and only with the RS6000.

1. Ensure that NFC is enabled on the MC33XX.
2. Ensure that Bluetooth is enabled on both devices.

3. Ensure that the Bluetooth device to discover is in discoverable mode.
4. Ensure that the two devices are within 10 meters (32.8 feet) of one another.
5. Place the RS6000 in Human Interface Device (HID) mode. If the RS6000 is already in HID mode, skip to step 6.
 - a. Remove the battery from the RS6000.
 - b. Press and hold the Restore key.
 - c. Install the battery onto the RS6000.
 - d. Keep holding the Restore key for about five seconds until a chirp is heard and the Scan LEDs flash green.
 - e. Scan the barcode below to place the RS6000 in HID mode.

Figure 74 Bluetooth HID Barcode

6. Remove the battery from the RS6000.
7. Re-install the battery into the RS6000.
8. Align the NFC icon on the RS6000 with the NFC icon on the MC33XX.

The Status LED blinks blue indicating that the RS6000 is attempting to establish connection with the MC33XX. When connection is established, the Status LED turns off and the RS6000 emits a single string of low/high beeps.

A notification appears on the MC33XX screen.



The  icon appears in the Status bar.

Figure 75 Align NFC Antennas

The MC33XX pairs with the RS6000 and  appears in the Status bar.



NOTE: Not all Zebra devices support NFC readers and the Tap-to-Pair feature.

Pairing the RS507/RS6000 Hands-Free Imager Using SSI

An RS507/RS6000 Hands-free Imager can be used with the device to capture bar code data.



1. Ensure that the two devices are within 10 meters (32.8 feet) of one another.
2. Install the battery into the RS507/RS6000.
3. On the MC33XX, swipe up from the bottom of the Home screen and touch .

Figure 76 Bluetooth Pairing Utility

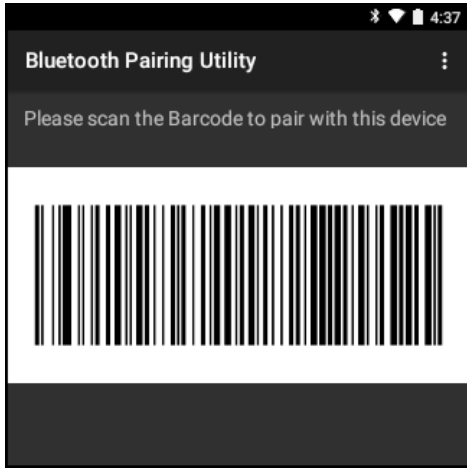

4. Using the RS507/RS6000, scan the bar code on the screen.
The RS507/RS6000 emits a high/low/high/low beeps. The Scan LED flashes green indicating that the RS507/RS6000 is attempting to establish connection with the MC33XX. When connection is established, the Scan LED turns off and the RS507/RS6000 emits one string of low/high beeps.
5. On the MC33XX, touch .

Pairing the RS507/RS6000 Hands-Free Imager Bluetooth HID



An RS507/RS6000 Hands-free Imager can be used with the device to capture bar code data.

1. Ensure that Bluetooth is enabled on both devices.
2. Ensure that the Bluetooth device to discover is in discoverable mode.
3. Ensure that the two devices are within 10 meters (32.8 feet) of one another.
4. Place the RS507/RS6000 in Human Interface Device (HID) mode. If the RS507/RS6000 is already in HID mode, skip to step 5.
 - a. Remove the battery from the RS507/RS6000.
 - b. Press and hold the Restore key.
 - c. Install the battery onto the RS507/RS6000.
 - d. Keep holding the Restore key for about five seconds until a chirp is heard and the Scan LEDs flash green.
 - e. Scan the bar code below to place the RS507 in HID mode.

Figure 77 RS507//RS6000 Bluetooth HID Bar Code



5. Remove the battery from the RS507/RS6000.
6. Re-install the battery into the RS507/RS6000.

7. On the MC33XX, touch .
8. Touch  **Bluetooth**.
9. Touch **SCAN FOR DEVICES**. The device begins searching for discoverable Bluetooth devices in the area and displays them under **AVAILABLE DEVICES**.
10. Scroll through the list and select RS507/RS6000.



The device connects to the RS507/RS6000 and **Connected** appears below the device name. The Bluetooth device is added to the **Bluetooth devices** list and a trusted (“paired”) connection is established.

DataWedge



DataWedge is a utility that adds advanced barcode scanning capability to any application without writing code. It runs in the background and handles the interface to built-in barcode scanners. The captured barcode data is converted to keystrokes and sent to the target application as if it was typed on the keypad.

To configure DataWedge refer to the MC33XX Integrator Guide.

Enabling DataWedge

1. Swipe up from the bottom of the Home screen.
2. Touch .
3. Touch .
4. Touch **Settings**.
5. Touch the **DataWedge enabled** checkbox. A blue checkmark appears in the checkbox indicating that DataWedge is enabled.
6. Touch

Disabling DataWedge

1. Swipe up from the bottom of the Home screen.
2. Touch .
3. Touch .
4. Touch **Settings**.
5. Touch the **DataWedge enabled** checkbox. The blue checkmark disappears from the checkbox indicating that DataWedge is disabled.
6. Touch

Wireless

Introduction

This section provides information on the wireless features:

- Wireless Local Area Network (WLAN)
- Bluetooth
- Near Field Communications (NFC)

Wireless Local Area Networks

Wireless local area networks (WLANs) allow the MC33XX to communicate wirelessly inside a building. Before using the MC33XX on a WLAN, the facility must be set up with the required hardware to run the WLAN (sometimes known as infrastructure). The infrastructure and the MC33XX must both be properly configured to enable this communication.

Refer to the documentation provided with the infrastructure (access points (APs), access ports, switches, Radius servers, etc.) for instructions on how to set up the infrastructure.

Once the infrastructure is set up to enforce the chosen WLAN security scheme, use the **Wireless & networks** settings to configure the MC33XX to match the security scheme.

The MC33XX supports the following WLAN security options:

- Open
- Wireless Equivalent Privacy (WEP)
- Wi-Fi Protected Access (WPA)/WPA2 Personal (PSK)
- Extensible Authentication Protocol (EAP)
 - LEAP
 - FAST - with Microsoft Challenge-Handshake Authentication Protocol version 2 (MSCHAPv2) and Generic Token Card (GTC) authentication.
 - Protected Extensible Authentication Protocol (PEAP) - with MSCHAPv2 and GTC authentication.
 - Transport Layer Security (TLS)
 - TTLS - with Password Authentication Protocol (PAP), MSCHAP and MSCHAPv2 authentication.

The **Status** bar displays icons that indicate Wi-Fi network availability and Wi-Fi status. See [Status Bar on page 33](#) for more information.



NOTE: Turn off Wi-Fi when not using it, to extend the life of the battery.

Scan and Connect to a Wi-Fi Network

1. Swipe down with two fingers from the status bar to open the quick access panel.
2. Touch **WLAN** to open the **WLAN** screen. The MC33XX searches for WLANs in the area and lists them.

Figure 73 WLAN Screen

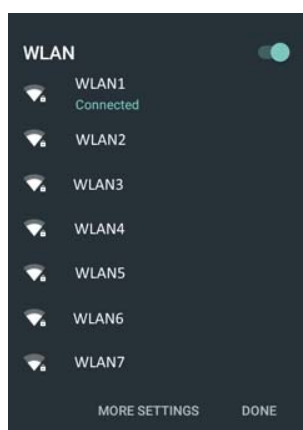



3. Scroll through the list and select the desired WLAN network.
4. For open networks, touch profile once or press and hold and then select **Connect to network** or for secure networks enter the required password or other credentials then touch **Connect**. See the system administrator for more information.

The MC33XX obtains a network address and other required information from the network using the dynamic host configuration protocol (DHCP) protocol. To configure the MC33XX with a fixed internet protocol (IP) address, refer to the MC33XX Integrator Guide..

5. In the Wi-Fi setting field, **Connected** appears indicating that the MC33XX is connected to the WLAN.

Remove a Wi-Fi Network

To remove a remembered or connected network:

1. Swipe down with two fingers from the status bar to open the quick access panel and then touch .
2. Touch  **Wi-Fi**.
3. In the **Wi-Fi** list, touch and hold the name of the network.
4. In the menu, touch **Forget network**.
5. Touch .

Bluetooth

Bluetooth-equipped devices can communicate without wires, using frequency-hopping spread spectrum (FHSS) radio frequency (RF) to transmit and receive data in the 2.4 GHz Industry Scientific and Medical (ISM) band (802.15.1). Bluetooth wireless technology is specifically designed for short-range (10 meters (32.8 feet)) communication and low power consumption.

Devices with Bluetooth capabilities can exchange information (e.g., files, appointments, and tasks) with other Bluetooth enabled devices such as printers, access points, and other mobile devices.

The MC33XX supports Bluetooth Low Energy. Bluetooth Low Energy is targeted at applications in the healthcare, fitness, security, and home entertainment industries. It provides reduced power consumption and cost while maintaining standard Bluetooth range.

Adaptive Frequency Hopping

Adaptive Frequency Hopping (AFH) is a method of avoiding fixed frequency interferers, and can be used with Bluetooth voice. All devices in the piconet (Bluetooth network) must be AFH-capable in order for AFH to work. There is no AFH when connecting and discovering devices. Avoid making Bluetooth connections and discoveries during critical 802.11b communications. AFH for Bluetooth consists of four main sections:

- Channel Classification - A method of detecting an interference on a channel-by-channel basis, or pre-defined channel mask.
- Link Management - Coordinates and distributes the AFH information to the rest of the Bluetooth network.
- Hop Sequence Modification - Avoids interference by selectively reducing the number of hopping channels.
- Channel Maintenance - A method for periodically re-evaluating the channels.

When AFH is enabled, the Bluetooth radio “hops around” (instead of through) the 802.11b high-rate channels. AFH coexistence allows Enterprise devices to operate in any infrastructure.

The Bluetooth radio in this device operates as a Class 2 device power class. The maximum output power is 2.5 mW and the expected range is 10 meters (32.8 ft.). A definition of ranges based on power class is difficult to obtain due to power and device differences, and whether one measures open space or closed office space.



NOTE: It is not recommended to perform Bluetooth wireless technology inquiry when high rate 802.11b operation is required.

Security

The current Bluetooth specification defines security at the link level. Application-level security is not specified. This allows application developers to define security mechanisms tailored to their specific need. Link-level security occurs between devices, not users, while application-level security can be implemented on a per-user basis. The Bluetooth specification defines security algorithms and procedures required to authenticate devices, and if needed, encrypt the data flowing on the link between the devices. Device authentication is a mandatory feature of Bluetooth while link encryption is optional.

Pairing of Bluetooth devices is accomplished by creating an initialization key used to authenticate the devices and create a link key for them. Entering a common personal identification number (PIN) in the devices being paired generates the initialization key. The PIN is never sent over the air. By default, the Bluetooth stack responds with no key when a key is requested (it is up to user to respond to the key request event). Authentication of Bluetooth devices is based-upon a challenge-response transaction. Bluetooth allows for a PIN or passkey used to create other 128-bit keys used for security and encryption. The encryption key is derived from the link key used to

authenticate the pairing devices. Also worthy of note is the limited range and fast frequency hopping of the Bluetooth radios that makes long-distance eavesdropping difficult.

Recommendations are:

- Perform pairing in a secure environment
- Keep PIN codes private and do not store the PIN codes in the device
- Implement application-level security.

Bluetooth Profiles

The MC33XX supports the following Bluetooth services:

- Service Discovery Protocol (SDP) - Handles the search for known and specific services as well as general services.
- Serial Port Profile (SPP) - Allows use of RFCOMM protocol to emulate serial cable connection between two Bluetooth peer devices. For example, connecting the device to a printer.
- Object Push Profile (OPP) - Allows the device to push and pull objects to and from a push server.
- Advanced Audio Distribution Profile (A2DP) - Allows the device to stream stereo-quality audio to a wireless headset or wireless stereo speakers.
- Audio/Video Remote Control Profile (AVRCP) - Allows the device to control A/V equipment to which a user has access. It may be used in concert with A2DP.
- Personal Area Network (PAN) - Allows the use of Bluetooth Network Encapsulation Protocol to provide L3 networking capabilities over a Bluetooth link. Only PANU role is supported.
- Human Interface Device Profile (HID) - Allows Bluetooth keyboards, pointing devices, gaming devices and remote monitoring devices to connect to the device.
- Headset Profile (HSP) - Allows a hands-free device, such as a Bluetooth headset, to place and receive calls on the device.
- Hands-Free Profile (HFP) - Allows car hands-free kits to communicate with the device in the car.
- Phone Book Access Profile (PBAP) - Allows exchange of Phone Book Objects between a car kit and a mobile device to allow the car kit to display the name of the incoming caller; allow the car kit to download the phone book so the user can initiate a call from the car display.
- Symbol Serial Interface (SSI) - Allows for communication with Bluetooth Imager.
- File Transfer Profile (FTP) - Provides the capability to browse, manipulate and transfer files in file system of another system. Uses GOEP as a basis.
- Generic Attribute Profile (GATT) - Provides profile discovery and description services for Bluetooth Low Energy protocol. It defines how attributes are grouped together into sets to form services.
- HID Over GATT Profile (HOGP) - Defines the procedures and features used by Bluetooth low energy HID Devices using GATT and Bluetooth HID Hosts using GATT.
- Scan Parameters Profile (ScPP) - Provides devices with information to assist them in managing their connection idle timeout and advertising parameters to optimize for power consumption and/or reconnection latency.

Bluetooth Power States

The Bluetooth radio is off by default.

- **Suspend** - When the MC33XX goes into suspend mode, the Bluetooth radio stays on.

- **Airplane Mode** - When the MC33XX is placed in Airplane Mode, the Bluetooth radio turns off. When Airplane mode is disabled, the Bluetooth radio returns to the prior state. When in Airplane Mode, the Bluetooth radio can be turned back on if desired.

Bluetooth Radio Power

Turn off the Bluetooth radio to save power or if entering an area with radio restrictions (e.g., an airplane). When the radio is off, other Bluetooth devices cannot see or connect to the device. Turn on the Bluetooth radio to exchange information with other Bluetooth devices (within range). Communicate only with Bluetooth radios in close proximity.



NOTE: To achieve the best battery life turn off radios when not in use.

Enabling Bluetooth

1. Swipe down with two fingers from the status bar to open the quick access panel.
2. Touch  to turn Bluetooth on.
3. Touch **Done**.
4. Touch .

Disabling Bluetooth

1. Swipe down with two fingers from the status bar to open the quick access panel.
2. Touch  **Bluetooth**.
3. Touch the slider switch to turn off Bluetooth. Touch .

Discovering Bluetooth Device(s)

The MC33XX can receive information from discovered devices without pairing. However, once paired, the MC33XX and a paired device exchange information automatically when the Bluetooth radio is on. To find Bluetooth devices in the area:

1. Ensure that Bluetooth is enabled on both devices.
2. Ensure that the Bluetooth device to discover is in discoverable mode.
3. Ensure that the two devices are within 10 meters (32.8 feet) of one another.
4. TSwipe down with two fingers from the status bar to open the quick access panel.
5. Touch  **Bluetooth**.
6. Touch **More Settings**. The **Bluetooth** screen appears.

The MC33XX begins searching for discoverable Bluetooth devices in the area and displays them under **Available devices**.

7. Scroll through the list and select a device. The **Bluetooth pairing request** dialog box appears.



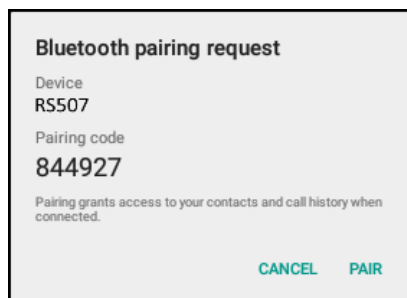

Figure 74 Bluetooth Pairing



8. Enter a PIN in the text box and touch **OK**. Enter the same PIN on the other device.
9. For Simple Pairing, touch **Pair** on both devices.
10. The Bluetooth device is added to the **Bluetooth devices** list and a trusted (“paired”) connection is established.



Changing the Bluetooth Name

By default, the MC33XX has a generic Bluetooth name that is visible to other devices when connected.

1. Swipe down with two fingers from the status bar to open the quick access panel and then touch .
2. Touch  **Bluetooth**.
3. If Bluetooth is not on, slide the switch to the **ON** position.
4. Touch .
5. Touch **Rename this device**.
6. Enter a name and touch **Rename**.
7. Press .





Connecting to a Bluetooth Device

Once paired, connect to a Bluetooth device.

1. Swipe down with two fingers from the status bar to open the quick access panel and then touch .
2. Touch  **Bluetooth**.
3. If Bluetooth is not on, slide the switch to the **ON** position.
4. In the **Paired Devices** list, touch an unconnected Bluetooth device.
When connected, CONNECTED appears below the device name.





Selecting Profiles on the Bluetooth Device

Some Bluetooth devices have multiple profiles. To select a profile:

1. Swipe down with two fingers from the status bar to open the quick access panel and then touch .
2. Touch  **Bluetooth**.
3. In the **Paired Devices** list, touch  next to the device name.
4. Under **PROFILES**, check or uncheck a profile to allow the device to use that profile.
5. Touch .

Unpairing a Bluetooth Device

To unpair a Bluetooth device and erase all pairing information:

1. Touch  >  **Bluetooth**.
2. In the **Paired Devices** list, touch  next to the device name.
3. Touch **FORGET**.
4. Touch .

Near Field Communications

NFC/HF RFID is a short-range wireless connectivity technology standard that enables secure transaction between a reader and a contactless smartcard. The technology is based on ISO/IEC 14443 type A and B (proximity) and ISO/IEC 15693 (vicinity) standards, using the HF 13.56 MHz unlicensed band. The MC33XX supports 3 operating modes:

- Reader mode
- Peer-to-Peer communication
- Card Emulation mode.

Using NFC, the MC33XX can:

- Read contactless cards such as contactless tickets, ID cards and ePassport.
- Read and write information to contactless cards such as SmartPosters and tickets, as well as devices with NFC interface such as vending machines.
- Read information from supported medical sensors.
- Pair with supported Bluetooth devices such as printers and headsets.
- Exchange data with another NFC device.
- Emulate contactless card such as payment, ticket or SmartPoster.

The MC33XX NFC antenna is uniquely positioned to read NFC cards from the top of the device while being held in the user's hand.

Reading NFC Cards

1. Launch an NFC enabled application.
2. Hold device as shown.

Figure 75 Reading Cards

3. Move the MC33XX close to the NFC card until the MC33XX detects the card.
4. Hold the card steadily until the transaction is complete (usually indicated by the application).

Sharing Information Using NFC

You can beam content like a web page, contact cards, pictures, YouTube links or location information from your screen to another device by bringing the devices together back to back.

Make sure both devices are unlocked, support NFC, and have both NFC and Android Beam turned on.

1. Open a screen that contains a web page, video, photo or contact.
2. Move the back of the MC33XX toward the back of the other device.

Figure 76 Sharing Data Using NFC

When the devices connect, you hear a sound, the image on the screen reduces in size, the message Touch to beam appears.

3. Touch anywhere on the screen.
The transfer begins.

Maintenance and Troubleshooting

Introduction

This chapter includes instructions on cleaning and storing the device, and provides troubleshooting solutions for potential problems during operation.

Maintaining the MC33XX

For trouble-free service, observe the following tips when using the MC33XX:

- Do not scratch the screen of the MC33XX. When working with the MC33XX, use a stylus or plastic-tipped pens intended for use with a touch-sensitive screen. Never use an actual pen or pencil or other sharp object on the surface of the MC33XX screen.
- The touch-sensitive screen of the MC33XX is glass. Do not drop the MC33XX or subject it to strong impact.
- Protect the MC33XX from temperature extremes. Do not leave it on the dashboard of a car on a hot day, and keep it away from heat sources.
- Do not store or use the MC33XX in any location that is dusty, damp, or wet.
- Use a soft lens cloth to clean the MC33XX. If the surface of the MC33XX screen becomes soiled, clean it with a soft cloth moistened with a diluted window-cleaning solution.
- Periodically replace the rechargeable battery to ensure maximum battery life and product performance. Battery life depends on individual usage patterns.
- A screen protector is applied to the MC33XX. Zebra recommends using this to minimize wear and tear. Screen protectors enhance the usability and durability of touch screen displays. Benefits include:
 - Protection from scratches and gouges
 - Durable writing and touch surface with tactile feel
 - Abrasion and chemical resistance
 - Glare reduction
 - Keeping the device's screen looking new
 - Quick and easy installation.

Battery Safety Guidelines



WARNING: Failure to follow these guidelines may result in fire, explosion, or other hazard.

- The area in which the units are charged should be clear of debris and combustible materials or chemicals. Particular care should be taken where the device is charged in a non commercial environment.
- Follow battery usage, storage, and charging guidelines found in this guide.
- Improper battery use may result in a fire, explosion, or other hazard.
- To charge the mobile device battery, the battery and charger temperatures must be between +32 °F and +104 °F (0 °C and +40 °C)
- Do not use incompatible batteries and chargers. Use of an incompatible battery or charger may present a risk of fire, explosion, leakage, or other hazard. If you have any questions about the compatibility of a battery or a charger, contact Zebra Customer Support Center.
- Do not disassemble or open, crush, bend or deform, puncture, or shred.
- Severe impact from dropping any battery-operated device on a hard surface could cause the battery to overheat.
- Do not short circuit a battery or allow metallic or conductive objects to contact the battery terminals.
- Do not modify or remanufacture, attempt to insert foreign objects into the battery, immerse or expose to water or other liquids, or expose to fire, explosion, or other hazard.
- Do not leave or store the equipment in or near areas that might get very hot, such as in a parked vehicle or near a radiator or other heat source. Do not place battery into a microwave oven or dryer.
- Battery usage by children should be supervised.
- Please follow local regulations to properly dispose of used re-chargeable batteries.
- Do not dispose of batteries in fire.
- Seek medical advice immediately if a battery has been swallowed.
- In the event of a battery leak, do not allow the liquid to come in contact with the skin or eyes. If contact has been made, wash the affected area with large amounts of water and seek medical advice.
- If you suspect damage to your equipment or battery, contact Zebra Customer Support to arrange for inspection.

Cleaning Instructions



CAUTION: Always wear eye protection.

Read warning label on compressed air and alcohol product before using.

If you have to use any other solution for medical reasons please contact the Global Customer Support Center for more information.



WARNING: Avoid exposing this product to contact with hot oil or other flammable liquids. If such exposure occurs, unplug the device and clean the product immediately in accordance with these guidelines.

Approved Cleanser Active Ingredients

100% of the active ingredients in any cleaner must consist of one or some combination of the following: isopropyl alcohol, bleach/sodium hypochlorite, hydrogen peroxide or mild dish soap.

Harmful Ingredients

The following chemicals are known to damage the plastics on the device and should not come in contact with the device: ammonia solutions, compounds of amines or ammonia; acetone; ketones; ethers; aromatic and chlorinated hydrocarbons; aqueous or alcoholic alkaline solutions; ethanolamine; toluene; trichloroethylene; benzene; carbonic acid and TB-lysoform.

Cleaning Instructions

Do not apply liquid directly to the device. Dampen a soft cloth or use pre-moistened wipes. Do not wrap the device in the cloth or wipe, but gently wipe the unit. Be careful not to let liquid pool around the display window or other places. Allow the unit to air dry before use.

Special Cleaning Notes

Many vinyl gloves contain phthalate additives, which are often not recommended for medical use and are known to be harmful to the housing of the device. The device should not be handled while wearing vinyl gloves containing phthalates, or before hands are washed to remove contaminant residue after gloves are removed. If products containing any of the harmful ingredients listed above are used prior to handling the device, such as hand sanitizer that contain ethanolamine, hands must be completely dry before handling the device to prevent damage to the plastics.

Cleaning Materials Required

- Alcohol wipes
- Lens tissue
- Cotton-tipped applicators
- Isopropyl alcohol
- Can of compressed air with a tube.

Cleaning Frequency

The cleaning frequency is up to the customer's discretion due to the varied environments in which the mobile devices are used. They may be cleaned as frequently as required, but it is advisable to clean the camera window periodically when used in dirty environments to ensure optimum performance.

Cleaning the MC33XX

Housing

Using the alcohol wipes, wipe the housing including buttons.

Display

The display can be wiped down with the alcohol wipes, but care should be taken not to allow any pooling of liquid around the edges of the display. Immediately dry the display with a soft, non-abrasive cloth to prevent streaking.

Exit Window

Wipe the camera and exit window periodically with a lens tissue or other material suitable for cleaning optical material such as eyeglasses.

Connector Cleaning

To clean the connectors:

1. Remove the main battery from mobile computer.
2. Dip the cotton portion of the cotton-tipped applicator in isopropyl alcohol.
3. Rub the cotton portion of the cotton-tipped applicator back-and-forth across the connector. Do not leave any cotton residue on the connector.
4. Repeat at least three times.
5. Use the cotton-tipped applicator dipped in alcohol to remove any grease and dirt near the connector area.
6. Use a dry cotton-tipped applicator and repeat steps 4 through 6.



CAUTION: Do not point nozzle at yourself and others, ensure the nozzle or tube is away from your face.

7. Spray compressed air on the connector area by pointing the tube/nozzle about ½ inch away from the surface.
8. Inspect the area for any grease or dirt, repeat if required.

Cleaning Cradle Connectors

To clean the connectors on a cradle:

1. Remove the DC power cable from the cradle.
2. Dip the cotton portion of the cotton-tipped applicator in isopropyl alcohol.
3. Rub the cotton portion of the cotton-tipped applicator along the pins of the connector. Slowly move the applicator back-and-forth from one side of the connector to the other. Do not leave any cotton residue on the connector.
4. All sides of the connector should also be rubbed with the cotton-tipped applicator.



CAUTION: Do not point nozzle at yourself and others, ensure the nozzle or tube is away from your face.

5. Spray compressed air in the connector area by pointing the tube/nozzle about ½ inch away from the surface.
6. Remove any lint left by the cotton-tipped applicator.
7. If grease and other dirt can be found on other areas of the cradle, use a lint-free cloth and alcohol to remove.
8. Allow at least 10 to 30 minutes (depending on ambient temperature and humidity) for the alcohol to air dry before applying power to cradle.

If the temperature is low and humidity is high, longer drying time is required. Warm temperature and dry humidity requires less drying time.

Troubleshooting the MC33XX

Table 16 Troubleshooting the MC33XX

Problem	Cause	Solution
Mobile computer does not turn on.	Main battery not charged.	Charge or replace the main battery.
	Main battery not installed properly.	Ensure the battery is installed properly.
	MC33XX not responding.	Perform a soft reset. If the mobile computer still does not turn on, perform a hard reset. For more information see Resetting the Device on page 55 .
Battery did not charge.	Battery failed.	Replace battery. If the mobile computer still does not operate, try a soft reset, then a hard reset. See Resetting the Device on page 55 .
	Mobile computer removed from cradle while battery was charging.	Insert mobile computer in cradle and begin charging. The Extended Life Battery requires up to eight hours to recharge fully.
	Extreme battery temperature.	Battery does not charge if ambient temperature is below 32 °F (0 °C) or above 104 °F (40 °C).
Cannot see characters on screen.	Mobile computer not powered on.	Press the Power button.
During data communication, no data was transmitted, or transmitted data was incomplete.	Mobile computer removed from cradle or unplugged from host computer during communication.	Replace the mobile computer in the cradle, or reattach the cable and re-transmit.
	Incorrect cable configuration.	See the system administrator or refer to the MC33XX Integrator Guide.

Table 16 Troubleshooting the MC33XX (Continued)





Problem	Cause	Solution
Mobile computer does not emit sound.	Volume setting is low or turned off.	Click on the speaker icon to increase the volume.
MC33XX turns itself off.	MC33XX is inactive.	The mobile computer turns off after a period of inactivity. This period can be set from 15 seconds to 30 minutes.
	Battery is depleted.	Recharge or replace the battery.
A message appears stating that the mobile computer memory is full.	Too many applications installed on the mobile computer.	Remove user-installed applications on the MC33XX to recover memory. Select  >  Apps . Select the unused programs and touch Uninstall .
The MC33XX does not decode when reading bar code.	DataWedge is not enabled.	Ensure that DataWedge is enabled and configured properly. Refer to the MC33XX Integrator Guide for more information.
	Unreadable bar code.	Ensure the symbol is not defaced.
	Distance between the MC33XX and bar code is incorrect.	Place the MC33XX within proper scanning range.
	MC33XX is not programmed for the bar code type.	Program the MC33XX to accept the type of bar code being scanned. Refer to the MC33XX Integrator Guide for DataWedge configuration.
	MC33XX is not programmed to generate a beep.	If the MC33XX does not beep on a good decode, set the application to generate a beep on good decode.
MC33XX cannot find any Bluetooth devices nearby.	Too far from other Bluetooth devices.	Move closer to the other Bluetooth device(s), within a range of 10 meters (32.8 feet).
	The Bluetooth device(s) nearby are not turned on.	Turn on the Bluetooth device(s) to find.
	The Bluetooth device(s) are not in discoverable mode.	Set the Bluetooth device(s) to discoverable mode. If needed, refer to the device's user documentation for help.

Table 16 Troubleshooting the MC33XX (Continued)

Problem	Cause	Solution
Cannot connect to WLAN.	Access Point (AP) does not broadcast country code.	Disable 802.11d feature. Touch  > Wi-Fi >  > Advanced . Deselect the Enable 802.11d checkbox.
When trying to open File Browser or other applications, the application automatically closes.	The Internal Memory is full.	Connect the MC33XX to a host computer and delete files from Internal Memory using the host computer.

FOR REVIEW

Technical Specifications

Introduction

The following sections provide technical specification for the device.

MC33XX Technical Specifications

The following table summarizes the MC33XX's intended operating environment and technical hardware specifications.

Table 17 MC33XX Technical Specifications

Item	Description
Physical Characteristics	
Dimensions	MC33XX-G: 7.96 in L x 2.94 in W x 6.45 in D (202.6 mm L x 74.7 mm W x 163.9 mm H)
Weight	MC33XX-G (with extended battery) - 17.8 oz (505 g)
Display	4.0 inch capacitive; WVGA; color
Imager Window	Corning® Gorilla® Glass
Touch Panel	Corning® Gorilla® Glass touch panel w/air gap
Backlight	LED backlight
Battery	Standard: Rechargeable Lithium-Ion 2740 mAh minimum (3.7V) Extended Life: Rechargeable Lithium-Ion 5200 mAh minimum (3.7V)
Expansion Slot	User accessible microSD slot. Supports up to 32 GB microSDHC.
Network Connections	USB 2.0 High Speed (host and client), WLAN and Bluetooth
Notification	Side LEDs and audible tone

Specifications

Table 17 MC33XX Technical Specifications (Continued)

Item	Description
Keypad Options	29-key Numeric 38-key FunctionNumeric (calculator-style integrated numeric keypad) 47-key Alpha-Numeric (calculator-style integrated numeric keypad)
Voice	PTT Voice Support (Internal Speaker)
Audio	Speaker
Performance Characteristics	
CPU	Qualcomm 8056 1.8 GHz hexa-core 64 bit with power optimization
Operating System	Android-based AOSP (7.1.2); GMS - select configurations
Memory	2GB RAM, 16 GB Flash (Standard). 4 GB RAM, 16 GB Flash (Premium). 4 GB RAM, 32 GB Flash (premium +).
Output Power (USB)	USB: 5 VDC @ 500 mA max.
User Environment	
Operating Temperature	-20°C to 50°C (-4°F to 122°F)
Storage Temperature	-40 °C to 70 °C (-40 °F to 158 °F) without battery
Charging Temperature	0 °C to 40 °C (32 °F to 104 °F)
Humidity	5% to 95% RH non-condensing
Drop Specification	Multiple 5 ft./1.5 m drops to concrete over the entire operating temperature range.
Tumble Specification	500 drops 3.2 ft / 1 m Tumbles (1000 hits)
Sealing	IP54
Vibration	5 Hz to 2 KHz
Thermal Shock	-40 °C to 70 °C (-40 °F to 158 °F)
Electrostatic Discharge (ESD)	±20kVdc air discharge, ± 10kVdc contact discharge
Wireless LAN Data Communications	
Wireless Local Area Network (WLAN) radio	IEEE® 802.11a/b/g/n/ac/d/h/i/k/r/w
Data Rates Supported	2.4 GHz: 144 Mbps 5 GHz: 867 Mbps
Operating Channels	Chan 36 - 165 (5 GHz), Chan 1 - 13 (2.4 GHz); actual operating channels/frequencies depend on regulatory rules and certification agency.

Specifications

Table 17 MC33XX Technical Specifications (Continued)

Item	Description
Security and Encryption	<p>Security Modes: WPA and WPA2 (Personal or Enterprise)</p> <p>Encryption: WEP40/WEP104, TKIP and AES</p> <p>Authentication: EAP-TLS; EAP-TTLS (MSCHAP, MSCHAPv2, PAP); PEAP (MSCHAPv2, EAP-GTC); LEAP; EAP-FAST (MSCHAPv2, EAP-GTC).</p> <p>Authentication: TLS; TTLS (MSCHAP, MSCHAPv2 or PAP; PEAP (MSCHAPv2, GTC); LEAP; FAST (MSCHAPv2, GTC).</p> <p>Other: Wi-Fi, CCXv4 certified, and supports IPv6 FIPS 140-2 certified</p>
Certifications	802.11n/ac, WMM-PS, WMM-AC, PMF, Voice Enterprise, Wi-Fi Direct, WPS
Fast Roam	PMKID/OKC/CCKM/802.11r
Wireless PAN Data	
Bluetooth	V4.1, V2.1 + EDR w/ Bluetooth Low Energy (BLE)
Data Capture	
Laser scanner Imager	<p>Captures 1D bar codes.</p> <p>Captures 1D and 2D bar codes.</p>
Scanning	MC33XX-G: SE965 1D, SE4750 SR 2D, SE4850 ERI
NFC	Premium/Premium +
Laser Scanner (SE965) Specifications	
Optical Resolution	0.005 in. minimum element width
Roll	Condition: 20 mil Code 39 at 10 in. ± 35° from vertical
Pitch Angle	Condition: 20 mil Code 39 at 10 in. ± 65° from normal
Skew Tolerance	Condition: 20 mil Code 39 at 10 in. ± 40° from normal
Ambient Light	<p>Tolerant to typical artificial indoor and natural outdoor (direct sunlight) lighting conditions.</p> <p>Fluorescent, Incandescent, Mercury Vapor, Sodium Vapor, LED: 450 ft. Candles (4,844 Lux)</p> <p>Sunlight: 10,000 Ft Candles (107,640 Lux)</p> <p>Note: LED lighting with high AC ripple content can impact scanning performance.</p>
Scan Repetition Rate	104 (± 14) scans/sec (bidirectional)

Specifications

Table 17 MC33XX Technical Specifications (Continued)

Item	Description
Scan Angle	Wide (Default): 47° (typical) Medium: 35° (typical) Narrow: 10° (typical)
2D Imager Engine (SE4750) Specifications	
Field of View	Horizontal - 48.0° Vertical - 36.7°
Image Resolution	1280 horizontal X 960 vertical pixels
Roll	360°
Pitch Angle	+/- 60° from normal
Skew Tolerance	+/- 60° from normal
Ambient Light	Sunlight: 10,000 ft. candles (107,639 lux)
Focal Distance	From front of engine: 17.7 cm (7.0 in.)
Laser Aiming Element	Visible Laser Diode (VLD): 655 nm +/- 10 nm Central Dot Optical Power: 0.6 mW (typical) Pattern Angle: 48.0° horizontal, 38.0° vertical
Illumination System	LEDs: Warm white LED Pattern Angle: 80° at 505 intensity
2D Extended Range Imager Engine (SE4850) Specifications	
Field of View	Near camera: Horizontal - 32.0°, Vertical 20° Far camera: Horizontal - 12°, Vertical - 7.6°
Image Resolution	1280 horizontal X 800 vertical pixels
Roll	360°
Pitch Angle	+/- 60° from normal
Skew Tolerance	+/- 60° from normal
Ambient Light	Sunlight: 10,000 ft. candles (107,639 lux)
Laser Aiming Element	Laser Wavelength: 655 nm Central Dot Optical Power: 0.6 mW (Class 2 IEC60825:2014)
Illumination System	LEDs: Hyper Red 660nm
Supported Symbolologies	

Specifications

Table 17 MC33XX Technical Specifications (Continued)

Item	Description
1D	Chinese 2 of 5, Codabar, Code 11, Code 128, Code 39, Code 93, Discrete 2 of 5, EAN-8, EAN-13, GS1 DataBar, GS1 DataBar Expanded, GS1 DataBar Limited, Interleaved 2 of 5, Korean 2 of 5, MSI, TLC 39, Matrix 2 of 5, Trioptic, UPCA, UPCE, UPCE1, Web Code.
2D	Australian Postal, Aztec, Canadian Postal, Composite AB, Composite C, Data Matrix, Dutch Postal, Japan Postal, Maxicode, Micro PDF, Micro QR, PDF, QR Code, UK Postal, US Planet, US Postnet, US4State, US4State FICS.

FOR REVIEW

MC33XX Keypads

Introduction

The MC33XX offers three types of keypad configurations: 29 key, 38 key and 47 key.

MC33XX 29-Key Keypad





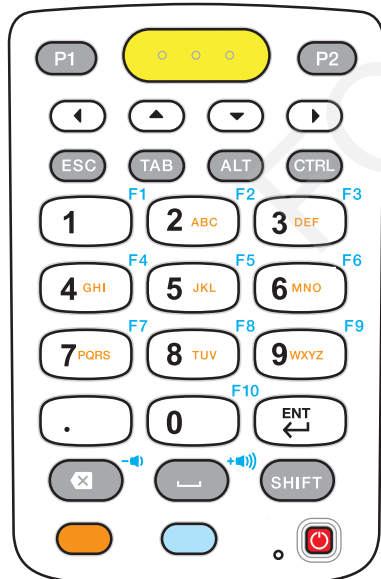



The 29-key keypad contains a Power button, application keys, scroll keys and function keys. The keypad is color-coded to indicate the alternate function key (blue) values and the alternate ALPHA key (orange) values. Note that keypad functions can be changed by an application so the mobile computer keypad may not function as described. See the tables below for key and button descriptions and keypad alternate functions.

Figure 79 29-Key Keypad Configuration



Keypads

Table 15 29-Key Keypad Descriptions

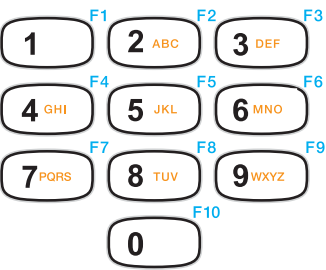
Key	Description
Power (red) 	Powers the mobile computer screen on and off (resume and suspend).
Program 1 	Unassigned application key.
Program 2 	Unassigned application key.
Scan (yellow) 	Used in scanning applications, press to scan a bar code. This key has the same function as activating the side mounted scan buttons.
Scroll Keys 	Moves up,down, left, or right from one item to another. Increases/decreases specified values.
ESC 	Produces the ESC function.
TAB 	Produces the TAB function.
ALT 	Produces the ALT function.
CTRL 	Press and release the CTRL key to activate the keypad alternate CTRL functions. The C icon appears in the Status bar. A Press and release the CTRL key two times to return to the default keypad functions.
Numeric/Alpha/Special Function 	Numeric, alpha or special function keys. Numeric by default. Produces a special function when the blue function key is activated. Produces alpha values when the orange alpha key is activated. In Alpha state, produces the lower case alphabetic characters on the key. Each key press produces the next alphabetic character in sequence. For example, press and release the alpha key and then press the 4 key once to produce the letter 'g'; press and release the alpha key and then press the 4 key three times to produce the letter 'i'. When the SHIFT key is pressed in Alpha state, the upper case alphabetic characters on the key are produced. For example, press and release the alpha key, press and hold the SHIFT key and then press the 4 key once to produce the letter 'G'; press and release the alpha key, press and hold the SHIFT key and then press the 4 key three times to produce the letter 'I'.

Keypads

Table 15 29-Key Keypad Descriptions (Continued)











Key	Description
Period/Decimal Point 	Produces a period for alpha entries and a decimal point for numeric entries by default.
Enter 	Executes a selected item or function.
BKSP 	Backspace function by default. Decreases volume when the blue function key is activated.
SPACE 	Space function by default. Increases volume when the blue function key is activated.
Shift 	Press and release the SHIFT key to activate the keypad alternate SHIFT functions. The  icon appears on the Status bar. Press and release the SHIFT key again to return to the default keypad functions.
Orange 	Press the orange alpha key to access the alternate alpha characters (shown on the keypad in orange). The  icon appears on the Status bar. Press and release the orange alpha key again to return to the default keypad functions.
Blue 	Press and release the blue function key to activate the keypad alternate functions (shown on the keypad in blue). The  icon appears on the Status bar. Press and release the blue function key again to return to the default keypad functions.

Table 16 29-key Keypad Input Modes

Key	Numeric State		Orange Key (Alpha Lowercase State)				Orange Key + Shift Key (Alpha Uppercase State)			
		SHIFT + Key	1st Press	2nd Press	3rd Press	4th Press	1st Press	2nd Press	3rd Press	4th Press
1	1	!	*							
2	2	@	a	b	c		A	B	C	
3	3	#	d	e	f		D	E	F	
4	4	\$	g	h	i		G	H	I	
5	5	%	j	k	l		J	K	L	
6	6	^	m	n	o		M	N	O	
7	7	&	p	q	r	s	P	Q	R	S

Table 16 29-key Keypad Input Modes (Continued)

Key	Numeric State		Orange Key (Alpha Lowercase State)				Orange Key + Shift Key (Alpha Uppercase State)			
		SHIFT + Key	1st Press	2nd Press	3rd Press	4th Press	1st Press	2nd Press	3rd Press	4th Press
8	8	*	t	u	v		T	U	V	
9	9	(w	x	y	z	W	X	Y	Z
0	0)	0				0			
.	.	>	.				.			

NOTE: An application can change the key functions. The keypad may not function exactly as described.

MC33XX 38-Key Keypad





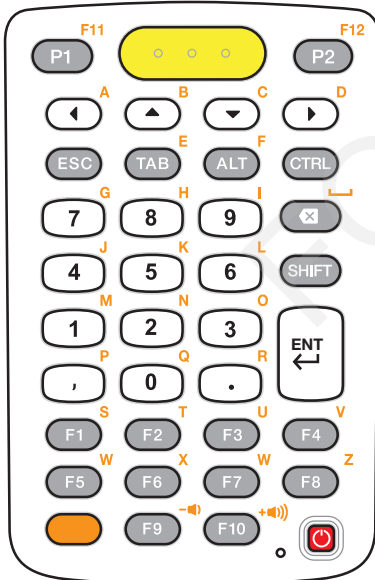









The 38-key keypad contains a Power button, application keys, scroll keys and function keys. The keypad is color-coded to indicate the alternate function key (blue) values. Note that keypad functions can be changed by an application so the mobile computer keypad may not function as described. The tables below provide key and button descriptions and keypad alternate functions.

Figure 80 38-Key Keypad Android Configuration



Keypads

Table 17 38-Key Keypad Descriptions

Key	Description
Power (red) 	Powers the mobile computer screen on and off (resume and suspend).
Program 1 	Unassigned application key.
Program 2 	Opens a menu with items that affect the current screen or application. Unassigned application key.
Scan (yellow) 	Used in scanning applications, press to scan a bar code. This key has the same function as activating the side mounted scan buttons.
Scroll 	Moves up,down, left, or right from one item to another.
Orange 	Press the orange alpha key to access the alternate alpha characters (shown on the keypad in orange). The  icon appears on the Status bar. Press and release the orange alpha key again to return to the default keypad functions.
CTRL 	Press and release the CTRL key to activate the keypad alternate CTRL functions. The  icon appears on the Status bar. Press and release the CTRL key again to return to the default keypad functions. Press and release the blue FUNC key and then the CTRL key to activate the ALT functions. The  icon appears on the Status bar. Press and release the CTRL key two times to return to the default keypad functions.
ESC 	Produces the ESC function.
TAB 	Produces the TAB function.
ALT 	Produces the ALT function.
CTRL 	Produces the CTRL function.

Keypads

Table 17 38-Key Keypad Descriptions (Continued)







Key	Description
<p>Numeric/Alpha/Special Function</p> 	<p>Press for the default numeric value. Produces alpha values when the orange alpha key is activated.</p>
<p>BKSP</p> 	<p>Backspace function by default. Decreases brightness when the blue FUNC key is activated.</p>
<p>Shift</p> 	<p>Press and release the SHIFT key to activate the keypad alternate SHIFT functions. The  icon appears on the Status bar. Press and release the SHIFT key again to return to the default keypad functions.</p>
<p>Enter</p> 	<p>Executes a selected item or function.</p>
<p>Period</p> 	<p>Produces a period for alpha entries and a decimal point for numeric entries.</p>
<p>Comma</p> 	<p>Produces a comma by default.</p>
<p>F1 - F10</p> 	<p>Special function keys by default.</p>

Table 18 38-key Keypad Input Modes

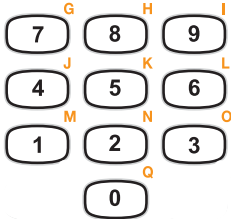
Key	Normal	SHIFT + Key	Orange + Key	Orange + SHIFT + Key	Blue + Key
Right Arrow			a	A	
Up Arrow			b	B	

Keypads

Table 18 38-key Keypad Input Modes (Continued)

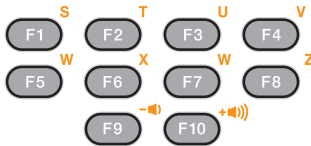
Key	Normal	SHIFT + Key	Orange + Key	Orange + SHIFT + Key	Blue + Key
Down Arrow			c	C	
Left Arrow			d	D	Tab
CTRL			e	E	Ctrl
ESC			f	F	
7	7	&	g	G	-
8	8	*	h	H	=
9	9	(l	l	/
BKSP	Backspace	Backspace	Space	Space	Backspace
4	4	\$	j	J	[
5	5	%	k	K]
6	6	^	l	L	;
1	1	!	m	M	'
2	2	@	n	N	'
3	3	#	o	O	\
,	,	<	p	P	,
0	0)	q	Q	0
.	.	>	r	R	-
F1			s	S	F11
F2			t	T	F12
F3			u	U	F13
F4			v	V	F14
F5			w	W	
F6			x	X	Increase Brightness
F7			y	Y	Increase Volume
F8			z	Z	
F9					Decrease Brightness
F10			*		Decrease Volume

NOTE: An application can change the key functions. The keypad may not function exactly as described.

MC33XX 47-Key Keypad

The 47-key keypad contains a Power button, application keys, scroll keys and function keys. The keypad is color-coded to indicate the alternate function key (blue) values. Note, that keypad functions can be changed by an application so the mobile computer keypad may not function as described. The tables below provide key and button descriptions and keypad alternate functions.

Figure 81 47-Key Keypad Android Configuration

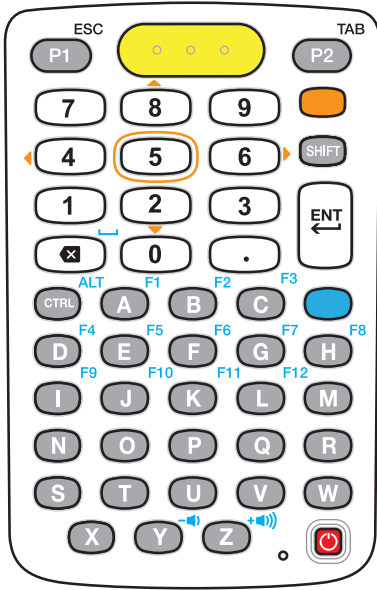





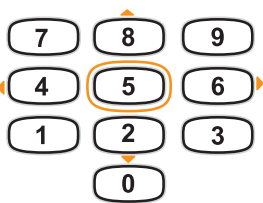











Table 19 47-Key Keypad Descriptions

Key	Description
Power (red) 	Powers the mobile computer screen on and off (resume and suspend).
Program 1/ESC 	Unassigned application key. With the Shift key activated, P1 produces the ESC function.
Program 2/TAB 	Unassigned application key. With the Shift key activated, P2 produces the TAB function.
Scan (yellow) 	Used in scanning applications, press to scan a bar code.

Keypads

Table 19 47-Key Keypad Descriptions (Continued)

Key	Description
Orange 	Press the orange key to access the alternate navigation and selection functions. The  icon appears on the Status bar. Press and release the orange key again to return to the default keypad functions.
Numeric/Scroll/Select 	Numeric, scroll, select keys. Numeric by default. With the orange key activated, the 2, 4, 6, and 8 keys produce scroll functions and the 5 key produces a select function.
Shift 	Press and release the SHIFT key to momentarily activate the keypad alternate SHIFT functions. The  icon appears on the Status bar. Press and release the SHIFT key a second time to lock the keypad into the Shift-Lock mode. The  icon appears on the Status bar. Press and release the SHIFT key again to return to the default keypad functions.
Enter 	Executes a selected item or function.
Backspace/Space 	Backspace function by default. Produces the Space function when the blue function key is activated.
Period 	Produces a period for alpha entries and a decimal point for numeric entries.
CTRL 	Press and release the CTRL key to activate the keypad alternate CTRL functions. The  icon appears on the Status bar. Press and release the CTRL key again to return to the default keypad functions. Press and release the blue function key and then the CTRL key to activate the ALT functions. The  icon appears on the Status bar. Press and release the CTRL key two times to return to the default keypad functions.

Keypads

Table 19 47-Key Keypad Descriptions (Continued)

Key	Description
<p>Alpha/Special Function</p>	Alpha by default. Special function by default when the blue function key is activated.
<p>Blue</p>	Press and release the blue function function key to activate the keypad alternate functions (shown on the keypad in blue). The icon appears on the Status bar. Press and release the blue function function key again to return to the default keypad functions.

Table 20 47-key Keypad Input Modes

Key	Normal	SHIFT + Key	Blue + Key
A	a	A	F1
B	b	B	F2
C	c	C	F3
D	d	D	F4
E	e	E	F5
F	f	F	F6
G	g	G	F7
H	h	H	F8
I	i	I	F9
J	j	J	F10
K	k	K	F11
L	l	L	F12
M	m	M	
N	n	N	
O	o	O	
P	p	P	
Q	q	Q	
R	r	R	

Keypads

Table 20 47-key Keypad Input Modes (Continued)

Key	Normal	SHIFT + Key	Blue + Key
S	s	S	
T	t	T	
U	u	U	
V	v	V	
W	w	W	
X	x	X	
Y	y	Y	Decrease Volume
Z	z	Z	Increase Volume
Backspace	Backspace	Delete	Space
1	1	!	
2	2	@	
3	3	#	
4	4	\$	
5	5	%	
6	6	^	
7	7	&	
8	8	*	
9	9	(
0	0)	
NOTE: An application can change the key functions. The keypad may not function exactly as described.			