



FCC RF Test Report

APPLICANT : Zebra Technologies Corporation
EQUIPMENT : Mobile Computer
BRAND NAME : Zebra
MODEL NAME : MC330K
FCC ID : UZ7MC330K
STANDARD : FCC Part 15 Subpart C §15.247
CLASSIFICATION : (DTS) Digital Transmission System

The product was received on Sep. 01, 2017 and testing was completed on Oct. 24, 2017. We, SPORTON INTERNATIONAL INC., would like to declare that the tested sample has been evaluated in accordance with the test procedures and has been in compliance with the applicable technical standards.

The test results in this report apply exclusively to the tested model / sample. Without written approval of SPORTON INTERNATIONAL INC., the test report shall not be reproduced except in full.

Reviewed by: Joseph Lin / Supervisor

Approved by: Jones Tsai / Manager



SPORTON INTERNATIONAL INC.

No. 52, Hwa Ya 1st Rd., Hwa Ya Technology Park, Kwei-Shan District, Tao Yuan City, Taiwan, R.O.C.

SPORTON INTERNATIONAL INC.

TEL : 886-3-327-3456

FAX : 886-3-328-4978

FCC ID : UZ7MC330K

Page Number : 1 of 141

Report Issued Date : Nov. 02, 2017

Report Version : Rev. 01

Report Template No.: BU5-FR15CWLAC MA Version 2.0



TABLE OF CONTENTS

REVISION HISTORY..... 3

SUMMARY OF TEST RESULT 4

1 GENERAL DESCRIPTION 5

 1.1 Applicant 5

 1.2 Manufacturer 5

 1.3 Product Feature of Equipment Under Test..... 5

 1.4 Product Specification of Equipment Under Test..... 7

 1.5 Modification of EUT 8

 1.6 Testing Location 9

 1.7 Applicable Standards..... 9

2 TEST CONFIGURATION OF EQUIPMENT UNDER TEST 10

 2.1 Carrier Frequency and Channel 10

 2.2 Test Mode 11

 2.3 Connection Diagram of Test System 19

 2.4 Support Unit used in test configuration and system 21

 2.5 EUT Operation Test Setup 21

 2.6 Measurement Results Explanation Example..... 22

3 TEST RESULT 23

 3.1 6dB and 99% Bandwidth Measurement 23

 3.2 Output Power Measurement..... 27

 3.3 Power Spectral Density Measurement 34

 3.4 Conducted Band Edges and Spurious Emission Measurement 42

 3.5 Radiated Band Edges and Spurious Emission Measurement 131

 3.6 AC Conducted Emission Measurement..... 136

 3.7 Antenna Requirements 138

4 LIST OF MEASURING EQUIPMENT 140

5 UNCERTAINTY OF EVALUATION 141

APPENDIX A. AC CONDUCTED EMISSION TEST RESULT

APPENDIX B. RADIATED SPURIOUS EMISSION

APPENDIX C. RADIATED SPURIOUS EMISSION PLOTS

APPENDIX D. DUTY CYCLE PLOTS

APPENDIX E. SETUP PHOTOGRAPHS



REVISION HISTORY

REPORT NO.	VERSION	DESCRIPTION	ISSUED DATE
FR790120C	Rev. 01	Initial issue of report	Nov. 02, 2017



SUMMARY OF TEST RESULT

Report Section	FCC Rule	Description	Limit	Result	Remark
3.1	15.247(a)(2)	6dB Bandwidth	$\geq 0.5\text{MHz}$	Pass	-
3.1	-	99% Bandwidth	-	Pass	-
3.2	15.247(b)	Power Output Measurement	$\leq 30\text{dBm}$	Pass	-
3.3	15.247(e)	Power Spectral Density	$\leq 8\text{dBm}/3\text{kHz}$	Pass	-
3.4	15.247(d)	Conducted Band Edges	$\leq 20\text{dBc}$	Pass	-
		Conducted Spurious Emission		Pass	-
3.5	15.247(d)	Radiated Band Edges and Radiated Spurious Emission	15.209(a) & 15.247(d)	Pass	Under limit 1.03 dB at 2389.660 MHz
3.6	15.207	AC Conducted Emission	15.207(a)	Pass	Under limit 8.20 dB at 13.558 MHz
3.7	15.203 & 15.247(b)	Antenna Requirement	N/A	Pass	-



1 General Description

1.1 Applicant

Zebra Technologies Corporation
1 Zebra Plaza, Holtsville, NY 11742

1.2 Manufacturer

Zebra Technologies Corporation
1 Zebra Plaza, Holtsville, NY 11742

1.3 Product Feature of Equipment Under Test

Product Feature	
Equipment	Mobile Computer
Brand Name	Zebra
Model Name	MC330K
FCC ID	UZ7MC330K
EUT supports Radios application	NFC WLAN 11a/b/g/n HT20/HT40 WLAN 11ac VHT20/VHT40/VHT80 Bluetooth BR/EDR/LE
HW Version	EV1b
SW Version	Android Version 7.1.2
FW Version	W10: Aug 4 2017 12:57:11 version 7.35.205.8 (r) FWID 01-895bc792
Fusion Version	Fusion_BA_2.10.0.0.007_N-0809201717-N
MFD	30AUG17
EUT Stage	Engineering Sample

Remark: The above EUT's information was declared by manufacturer. Please refer to the specifications or user's manual for more detailed description.



<SKU List>

Premium+					
SKU	Type-scanner	Camera	Audio Jack	NFC	Speaker
1	GUN-SE4850	X	X	V	V
2	GUN-SE4750	X	X	V	V
3	GUN-SE965	X	X	V	V
4	Brick-SE4850	V	V	V	V
5	Brick-SE4750	V	V	V	V
6	Brick-SE965	V	V	V	V
7	Rotate	V	V	V	V

Premium					
SKU	Type-scanner	Camera	Audio Jack	NFC	Speaker
8	Brick-SE4850	X	V	V	V
9	Brick-SE4750	X	V	V	V
10	Brick-SE965	X	V	V	V
11	Rotate	X	V	V	V

Specification of Accessories				
Sentry 1X Battery	Brand Name	Zebra	Part Number	BT-000338-01
Sentry 2X Battery	Brand Name	Zebra	Part Number	BT-000337-01
MC32 1X Battery	Brand Name	Symbol	Part Number	82-000011-01
MC32 2X Battery	Brand Name	Symbol	Part Number	82-000012-02
Wall wart power supply(18W)	Brand Name	Zebra	Part Number	PWR-WUA5V12W0US
Charge Cable for Wall wart power supply	Brand Name	Zebra	Part Number	PWRS-14000-249R
HS2100 Earphone	Brand Name	Symbol	Part Number	HS2100-OTH
Quick Disconnect cable for HS2100 Headset	Brand Name	Symbol	Part Number	CBL-HS2100-QDC1-01
RCH51 Earphone	Brand Name	Symbol	Part Number	RCH51
Cable for RCH51 earphone	Brand Name	Symbol	Part Number	25-124411-02R
U cable	Brand Name	Symbol	Part Number	CBL-MC33-USBCHG-01
Gun Holster MC3000	Brand Name	Symbol	Model Name	SG-MC3021212-01R
Holster MC30XX	Brand Name	Symbol	Model Name	11-69293-01R



1.4 Product Specification of Equipment Under Test

Standards-related Product Specification	
Tx/Rx Channel Frequency Range	2412 MHz ~ 2462 MHz
Maximum Average Output Power to antenna <CDD Mode>	<Ant. 1> 802.11b : 18.33 dBm (0.0681 W) 802.11g : 17.48 dBm (0.0560 W) 802.11n HT20 : 17.49 dBm (0.0561 W) 802.11n HT40 : 16.59 dBm (0.0456 W) <Ant. 2> 802.11b : 18.30 dBm (0.0676 W) 802.11g : 17.21 dBm (0.0526 W) 802.11n HT20 : 17.25 dBm (0.0531 W) 802.11n HT40 : 16.29 dBm (0.0426 W) <MIMO Ant. 1 + 2> 802.11b : 21.26 dBm (0.1337 W) 802.11g : 20.24 dBm (0.1057 W) 802.11n HT20 : 20.19 dBm (0.1045 W) 802.11n HT40 : 17.82 dBm (0.0605 W)
Maximum Average Output Power to antenna <TXBF Mode>	<MIMO Ant. 1 + 2> 802.11n HT20 : 21.46 dBm (0.1400 W) 802.11n HT40 : 19.76 dBm (0.0946 W)
99% Occupied Bandwidth <CDD Mode>	802.11b : 12.00MHz 802.11g : 18.65MHz 802.11n HT20 : 19.40MHz 802.11n HT40 : 36.80MHz
99% Occupied Bandwidth <TXBF Mode>	802.11n HT20 : 19.60MHz 802.11n HT40 : 36.80MHz



Standards-related Product Specification			
Type of Modulation	802.11b : DSSS (DBPSK / DQPSK / CCK)		
	802.11a/g/n : OFDM (BPSK / QPSK / 16QAM / 64QAM)		
Antenna Type / Gain	802.11ac : OFDM (BPSK / QPSK / 16QAM / 64QAM / 256QAM)		
Antenna Function Description	<Ant. 1>PIFA Antenna with gain 3.86 dBi		
	<Ant. 2>PIFA Antenna with gain 3.63 dBi		
		Ant. 1	Ant. 2
	802.11 b/g/n	V	V
802.11 b/g/n MIMO	V	V	
802.11 n TXBF	V	V	

Note: MIMO Ant. 1+2 is a calculated result from sum of the power MIMO Ant. 1 and MIMO Ant. 2.

1.5 Modification of EUT

No modifications are made to the EUT during all test items.



1.6 Testing Location

Sporton Lab is accredited to ISO 17025 by Taiwan Accreditation Foundation (TAF code : 1190) and the FCC designation No. TW0007 under the FCC 2.948(e) by Mutual Recognition Agreement (MRA) in FCC Test.

Test Site	SPORTON INTERNATIONAL INC.	
Test Site Location	No. 52, Hwa Ya 1 st Rd., Hwa Ya Technology Park, Kwei-Shan District, Tao Yuan City, Taiwan, R.O.C. TEL: +886-3-327-3456 FAX: +886-3-328-4978	
Test Site No.	Sporton Site No.	
	TH05-HY	CO05-HY

Note: The test site complies with ANSI C63.4 2014 requirement.

Test Site	SPORTON INTERNATIONAL INC.	
Test Site Location	No.58, Aly. 75, Ln. 564, Wenhua 3rd Rd. Guishan Dist, Taoyuan City, Taiwan (R.O.C.) TEL: +886-3-327-0868 FAX: +886-3-327-0855	
Test Site No.	Sporton Site No.	
	03CH12-HY	

Note: The test site complies with ANSI C63.4 2014 requirement.

1.7 Applicable Standards

According to the specifications of the manufacturer, the EUT must comply with the requirements of the following standards:

- ♦ FCC Part 15 Subpart C §15.247
- ♦ FCC KDB Publication No. 558074 D01 DTS Meas. Guidance v04
- ♦ FCC KDB 662911 D01 Multiple Transmitter Output v02r01.
- ♦ ANSI C63.10-2013

Remark:

1. All test items were verified and recorded according to the standards and without any deviation during the test.
2. This EUT has also been tested and complied with the requirements of FCC Part 15, Subpart B, recorded in a separate test report.



2 Test Configuration of Equipment Under Test

- a. The EUT has been associated with peripherals and configuration operated in a manner tended to maximize its emission characteristics in a typical application. Frequency range investigated: conduction emission (150 kHz to 30 MHz), radiation emission (9 kHz to the 10th harmonic of the highest fundamental frequency or to 40 GHz, whichever is lower). For radiated measurement, pre-scanned in three orthogonal panels, X, Y, Z. The worst cases (Y Plane) were recorded in this report.

- b. AC power line Conducted Emission was tested under maximum output power.

2.1 Carrier Frequency and Channel

Frequency Band	Channel	Freq. (MHz)	Channel	Freq. (MHz)
2400-2483.5 MHz	1	2412	7	2442
	2	2417	8	2447
	3	2422	9	2452
	4	2427	10	2457
	5	2432	11	2462
	6	2437		



2.2 Test Mode

Final test mode of conducted test items and radiated spurious emissions are considering the modulation and worse data rates as below table.

Single Antenna

Modulation	Data Rate
802.11b	1 Mbps
802.11g	6 Mbps
802.11n HT20	MCS0
802.11n HT40	MCS0

MIMO Antenna

Modulation	Data Rate
802.11b	1 Mbps
802.11g	6 Mbps
802.11n HT20	MCS0
802.11n HT40	MCS0

TXBF Antenna

Modulation	Data Rate
802.11n HT20	MCS0
802.11n HT40	MCS0



<CDD Modes>

<Ant. 1>

802.11b mode		
Power vs. Channel		
Channel	Frequency (MHz)	Data Rate (bps)
		1M
Duty Cycle (%)		99.33
CH 01	2412	18.30
CH 02	2417	18.13
CH 06	2437	18.33
CH 10	2457	18.26
CH 11	2462	18.32

802.11g mode		
Power vs. Channel		
Channel	Frequency (MHz)	Data Rate (bps)
		6M
Duty Cycle (%)		96.05
CH 01	2412	13.49
CH 02	2417	17.07
CH 06	2437	17.43
CH 10	2457	17.48
CH 11	2462	13.47

802.11n HT20 mode		
Power vs. Channel		
Channel	Frequency (MHz)	MCS Index
		MCS0
Duty Cycle (%)		94.52
CH 01	2412	11.26
CH 02	2417	17.16
CH 06	2437	17.27
CH 10	2457	17.49
CH 11	2462	12.25



802.11n HT40 mode		
Power vs. Channel		
Channel	Frequency (MHz)	MCS Index
		MCS0
Duty Cycle (%)		95.58
CH 03	2422	12.69
CH 06	2437	16.59
CH 09	2452	14.40



<Ant. 2>

802.11b mode		
Power vs. Channel		
Channel	Frequency (MHz)	Data Rate (bps)
		1M
Duty Cycle (%)		99.33
CH 01	2412	18.26
CH 02	2417	18.23
CH 06	2437	18.25
CH 10	2457	18.24
CH 11	2462	18.30

802.11g mode		
Power vs. Channel		
Channel	Frequency (MHz)	Data Rate (bps)
		6M
Duty Cycle (%)		96.05
CH 01	2412	13.33
CH 02	2417	16.77
CH 06	2437	17.21
CH 10	2457	17.13
CH 11	2462	13.23

802.11n HT20 mode		
Power vs. Channel		
Channel	Frequency (MHz)	MCS Index
		MCS0
Duty Cycle (%)		94.52
CH 01	2412	11.22
CH 02	2417	16.80
CH 06	2437	17.25
CH 10	2457	17.04
CH 11	2462	11.61



802.11n HT40 mode		
Power vs. Channel		
Channel	Frequency (MHz)	MCS Index
		MCS0
Duty Cycle (%)		95.58
CH 03	2422	12.54
CH 06	2437	16.29
CH 09	2452	14.18



MIMO<Ant. 1 + 2>

802.11b mode		
Power vs. Channel		
Channel	Frequency (MHz)	Data Rate (bps)
		1M
CH 01	2412	20.70
CH 02	2417	21.26
CH 06	2437	21.26
CH 10	2457	21.02
CH 11	2462	20.70

802.11g mode		
Power vs. Channel		
Channel	Frequency (MHz)	Data Rate (bps)
		6M
CH 01	2412	16.77
CH 02	2417	20.24
CH 06	2437	20.24
CH 10	2457	18.58
CH 11	2462	18.09

802.11n HT20 mode		
Power vs. Channel		
Channel	Frequency (MHz)	MCS Index
		MCS0
CH 01	2412	14.92
CH 02	2417	20.19
CH 06	2437	20.19
CH 10	2457	18.00
CH 11	2462	16.99



802.11n HT40 mode		
Power vs. Channel		
Channel	Frequency (MHz)	MCS Index
		MCS0
CH 03	2422	11.83
CH 06	2437	17.82
CH 09	2452	12.88



<TXBF Mode>

MIMO<Ant. 1 + 2>

802.11n HT20 mode		
Power vs. Channel		
Channel	Frequency (MHz)	MCS Index
		MCS0
CH 01	2412	16.51
CH 02	2417	21.46
CH 06	2437	21.46
CH 10	2457	21.06
CH 11	2462	17.66

802.11n HT40 mode		
Power vs. Channel		
Channel	Frequency (MHz)	MCS Index
		MCS0
CH 03	2422	15.81
CH 06	2437	19.76
CH 09	2452	19.31

Test Cases	
AC Conducted Emission	Mode 1: MP3 play + WLAN (5GHz) Link + Bluetooth Link + NFC On + Sentry 2X + PWR-WUA5V12W0US (LV6) + RCH51(5) + USB link with adapter + Keypad (38) + SKU 5

Remark: For radiated test cases, the test was performed with SKU 7, Keypad (47), MC32 1X Battery, RCH51 Earphone, USB Link with Adapter, PWR-WUA5V12W0US(LV6).

2.3 Connection Diagram of Test System

<WLAN Tx Mode>

<CDD Mode>

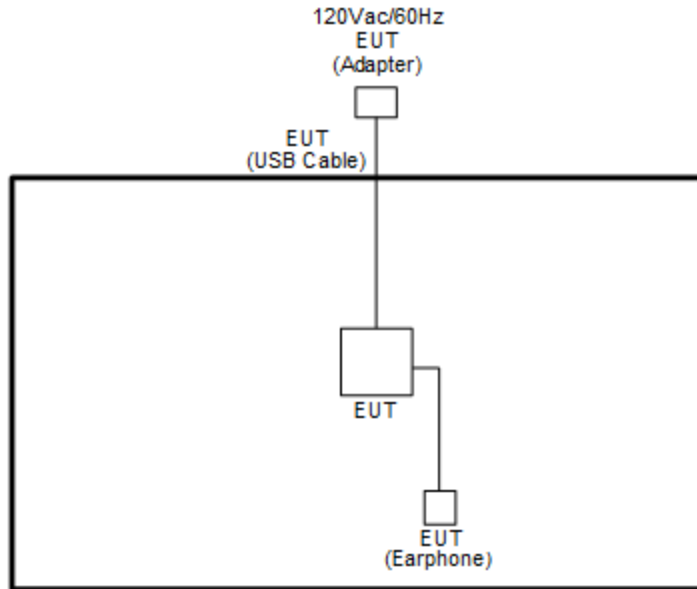

<TXBF Mode>

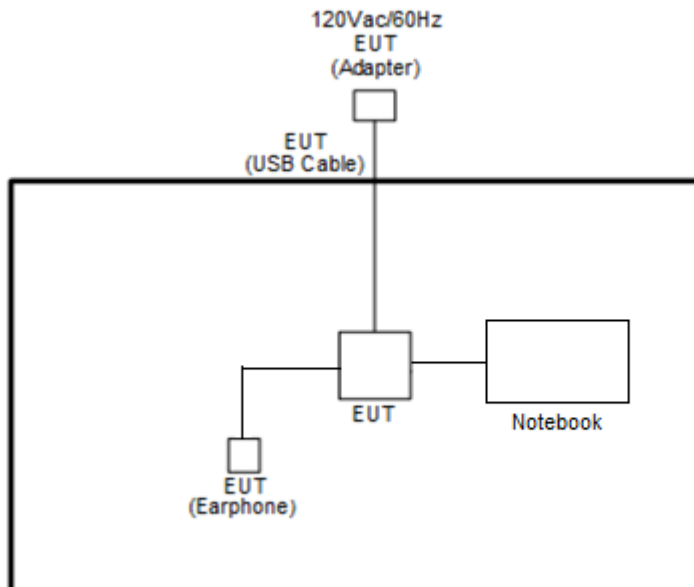

<AC Conducted Emission Mode>

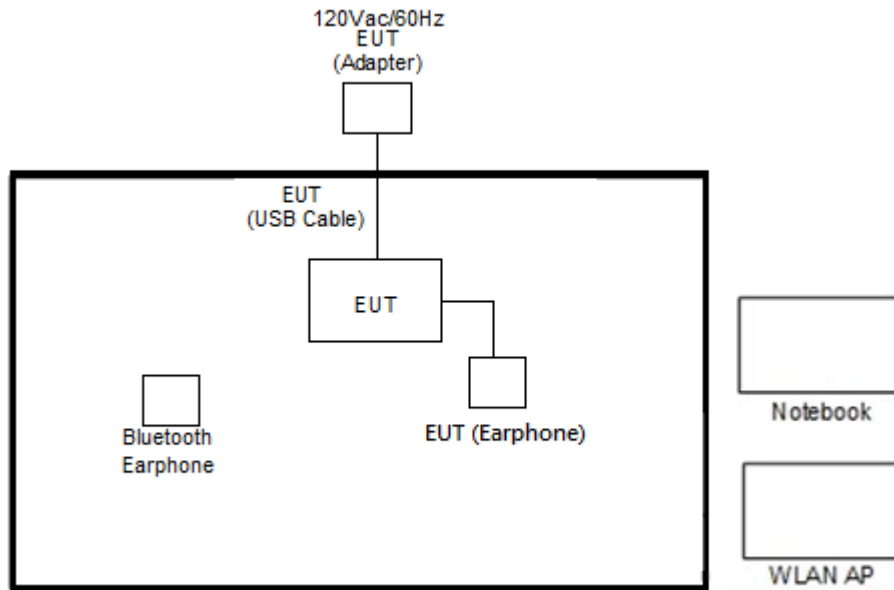



2.4 Support Unit used in test configuration and system

Item	Equipment	Trade Name	Model Name	FCC ID	Data Cable	Power Cord
1.	Bluetooth Earphone	Sony Ericsson	MW600	PY7DDA-2029	N/A	N/A
2.	WLAN AP	ASUS	RT-AC66U	MSQ-RTAC66U	N/A	Unshielded, 1.8m
3.	Notebook	DELL	Latitude E6320	FCC DoC/ Contains FCC ID: QDS-BRCM1054	N/A	AC I/P: Unshielded, 1.2 m DC O/P: Shielded, 1.8 m
4.	Notebook-40(Tx)	Lenovo	E335	N/A	N/A	AC I/P: Unshielded, 1.2 m DC O/P: Shielded, 1.8 m
5.	Notebook-53(Rx)	ASUS	K42J	N/A	N/A	AC I/P: Unshielded, 1.2 m DC O/P: Shielded, 1.8 m
6.	SD Card	SanDisk	MicroSD HC	FCC DoC	N/A	N/A

2.5 EUT Operation Test Setup

The RF test items, programmed RF utility, “Wi-Fi RF Test” installed in the notebook make the EUT provide functions like channel selection and power level for continuous transmitting and receiving signals.

For WLAN MIMO TXBF modes, the EUT was tested under normal operation and link to another device with power, modulation modes and data rates controlled by engineer mode command lines. The CMD software tool was used to make EUT continuous transmitting signals.



2.6 Measurement Results Explanation Example

For all conducted test items:

The offset level is set in the spectrum analyzer to compensate the RF cable loss and attenuator factor between EUT conducted output port and spectrum analyzer. With the offset compensation, the spectrum analyzer reading level is exactly the EUT RF output level.

Example:

The spectrum analyzer offset is derived from RF cable loss and attenuator factor.

Offset = RF cable loss + attenuator factor.

Following shows an offset computation example with cable loss 4.2 dB and 10dB attenuator.

$$\begin{aligned} \text{Offset(dB)} &= \text{RF cable loss(dB)} + \text{attenuator factor(dB)}. \\ &= 4.2 + 10 = 14.2 \text{ (dB)} \end{aligned}$$

3 Test Result

3.1 6dB and 99% Bandwidth Measurement

3.1.1 Limit of 6dB and 99% Bandwidth

The minimum 6 dB bandwidth shall be at least 500 kHz.

3.1.2 Measuring Instruments

The measuring equipment is listed in the section 4 of this test report.

3.1.3 Test Procedures

1. The testing follows FCC KDB Publication No. 558074 DTS D01 Meas. Guidance v04.
2. The RF output of EUT was connected to the spectrum analyzer by RF cable and attenuator. The path loss was compensated to the results for each measurement.
3. Set to the maximum power setting and enable the EUT transmit continuously.
4. Make the measurement with the spectrum analyzer's resolution bandwidth (RBW) = 100 kHz. Set the Video bandwidth (VBW) = 300 kHz. In order to make an accurate measurement. The 6 dB bandwidth must be greater than 500 kHz.
5. For 99% Bandwidth Measurement, the spectrum analyzer's resolution bandwidth (RBW) = 1MHz and set the Video bandwidth (VBW) = 3MHz.
6. Measure and record the results in the test report.

3.1.4 Test Setup

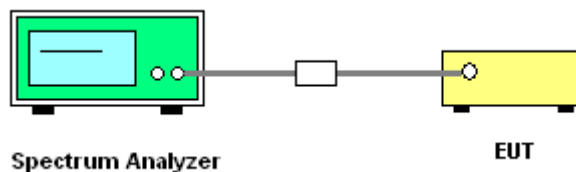



3.1.5 Test Result of 6dB and 99% Occupied Bandwidth

<CDD Mode>

2.4GHz Band										
Mod.	Data Rate	NTX	CH.	Freq. (MHz)	99% Occupied BW (MHz)		6dB BW (MHz)		6dB BW Limit (MHz)	Pass/Fail
					Ant 1	Ant 2	Ant 1	Ant 2		
11b	1Mbps	1	1	2412	11.95	11.95	8.56	9.00	0.50	Pass
11b	1Mbps	1	2	2417	11.80	12.00	8.52	8.52	0.50	Pass
11b	1Mbps	1	6	2437	11.85	11.85	8.58	8.56	0.50	Pass
11b	1Mbps	1	10	2457	11.85	12.00	8.52	9.04	0.50	Pass
11b	1Mbps	1	11	2462	11.85	11.95	8.52	9.04	0.50	Pass
11g	6Mbps	1	1	2412	18.30	18.20	16.32	15.48	0.50	Pass
11g	6Mbps	1	2	2417	18.30	18.35	16.32	16.28	0.50	Pass
11g	6Mbps	1	6	2437	18.40	18.20	16.32	16.28	0.50	Pass
11g	6Mbps	1	10	2457	17.25	18.65	16.06	16.32	0.50	Pass
11g	6Mbps	1	11	2462	18.35	17.20	16.00	16.28	0.50	Pass
HT20	MCS0	1	1	2412	19.20	17.80	17.56	15.10	0.50	Pass
HT20	MCS0	1	2	2417	19.10	19.05	17.52	17.52	0.50	Pass
HT20	MCS0	1	6	2437	16.20	18.95	17.56	17.54	0.50	Pass
HT20	MCS0	1	10	2457	19.15	19.40	17.28	17.56	0.50	Pass
HT20	MCS0	1	11	2462	19.10	18.00	17.16	17.56	0.50	Pass
HT40	MCS0	1	3	2422	36.70	36.70	35.76	35.92	0.50	Pass
HT40	MCS0	1	6	2437	36.80	36.60	36.36	35.04	0.50	Pass
HT40	MCS0	1	9	2452	36.50	36.60	35.76	36.28	0.50	Pass
11b	1Mbps	2	1	2412	11.85	11.85	9.00	8.52	0.50	Pass
11b	1Mbps	2	2	2417	11.80	11.90	8.50	9.04	0.50	Pass
11b	1Mbps	2	6	2437	11.85	11.90	9.00	9.04	0.50	Pass
11b	1Mbps	2	10	2457	11.80	11.95	8.52	8.52	0.50	Pass
11b	1Mbps	2	11	2462	11.80	11.90	8.54	9.00	0.50	Pass



2.4GHz Band										
Mod.	Data Rate	NTX	CH.	Freq. (MHz)	99% Occupied BW (MHz)		6dB BW (MHz)		6dB BW Limit (MHz)	Pass/Fail
					Ant 1	Ant 2	Ant 1	Ant 2		
11g	6Mbps	2	1	2412	18.00	17.85	16.32	16.32	0.50	Pass
11g	6Mbps	2	2	2417	18.30	18.15	16.28	16.36	0.50	Pass
11g	6Mbps	2	6	2437	18.65	18.10	16.32	16.32	0.50	Pass
11g	6Mbps	2	10	2457	18.25	18.25	16.08	16.32	0.50	Pass
11g	6Mbps	2	11	2462	18.45	18.20	16.08	16.32	0.50	Pass
HT20	MCS0	2	1	2412	19.00	18.70	17.56	17.56	0.50	Pass
HT20	MCS0	2	2	2417	19.00	19.00	17.52	17.56	0.50	Pass
HT20	MCS0	2	6	2437	19.15	18.70	17.60	17.56	0.50	Pass
HT20	MCS0	2	10	2457	19.00	18.95	17.52	17.60	0.50	Pass
HT20	MCS0	2	11	2462	18.95	18.80	17.16	17.56	0.50	Pass
HT40	MCS0	2	3	2422	36.70	36.70	36.32	35.72	0.50	Pass
HT40	MCS0	2	6	2437	36.70	36.60	36.32	36.27	0.50	Pass
HT40	MCS0	2	9	2452	36.50	36.70	35.76	35.84	0.50	Pass

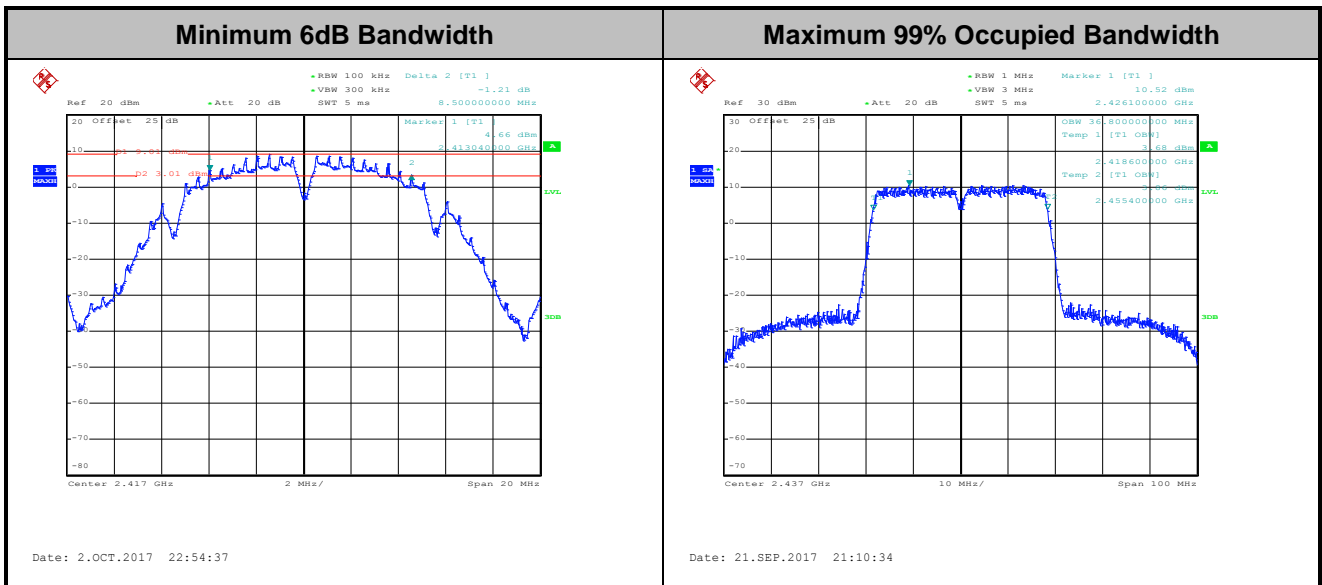

Note : The occupied channel bandwidth is maintained within the band of operation for all of the modulations.



<TXBF Mode>

2.4GHz Band										
Mod.	Data Rate	NTX	CH.	Freq. (MHz)	99% Occupied BW (MHz)		6dB BW (MHz)		6dB BW Limit (MHz)	Pass/Fail
					Ant 1	Ant 2	Ant 1	Ant 2		
HT20	MCS0	2	1	2412	19.30	19.10	17.64	17.56	0.50	Pass
HT20	MCS0	2	2	2417	19.10	19.25	17.16	17.56	0.50	Pass
HT20	MCS0	2	6	2437	19.60	19.10	17.16	16.88	0.50	Pass
HT20	MCS0	2	10	2457	19.05	19.25	17.18	17.56	0.50	Pass
HT20	MCS0	2	11	2462	19.10	19.10	17.29	17.52	0.50	Pass
HT40	MCS0	2	3	2422	36.50	36.80	35.08	35.08	0.50	Pass
HT40	MCS0	2	6	2437	36.60	36.30	33.76	33.76	0.50	Pass
HT40	MCS0	2	9	2452	36.30	36.60	35.04	35.04	0.50	Pass

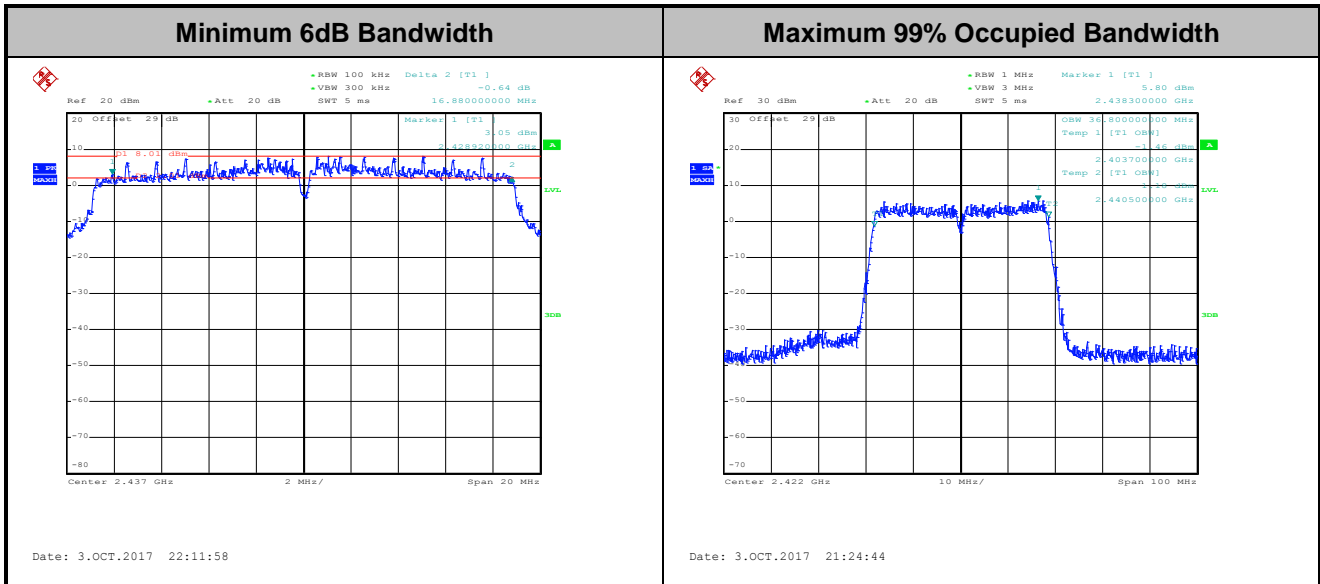

Note : The occupied channel bandwidth is maintained within the band of operation for all of the modulations.



3.2 Output Power Measurement

3.2.1 Limit of Output Power

For systems using digital modulation in the 2400-2483.5MHz, the limit for output power is 30dBm. If transmitting antenna with directional gain greater than 6dBi is used, the output power from the intentional radiator shall be reduced below the above stated value by the amount in dB that the directional gain of the antenna exceeds 6 dBi. In case of point-to-point operation, the limit has to be reduced by 1dB for every 3dB that the directional gain of the antenna exceeds 6dBi.

3.2.2 Measuring Instruments

The measuring equipment is listed in the section 4 of this test report.

3.2.3 Test Procedures

CDD Modes

1. The testing follows the Measurement Procedure of FCC KDB No. 558074 DTS D01 Meas. Guidance v04 section 9.2.3.1 Method AVGPM.
2. The RF output of EUT was connected to the power meter by RF cable and attenuator. The path loss was compensated to the results for each measurement.
3. Set to the maximum power setting and enable the EUT transmit continuously.
4. Measure the conducted output power and record the results in the test report.
5. For MIMO mode, calculation method follows FCC KDB 662911 D01 Multiple Transmitter Output v02r01.

TXBF Modes

1. The testing follows the Measurement Procedure of FCC KDB No. 558074 DTS D01 Meas. Guidance v04 section 9.2.3.2 Method AVGPM-G.
2. The RF output of EUT was connected to the power meter by RF cable and attenuator. The path loss was compensated to the results for each measurement.
3. Set to the maximum power setting and enable the EUT transmit continuously.
4. Measure the conducted output power and record the results in the test report.
5. For MIMO mode, calculation method follows FCC KDB 662911 D01 Multiple Transmitter Output v02r01.

3.2.4 Test Setup

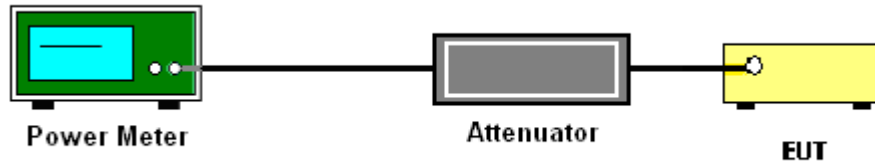



3.2.5 Test Result of Peak Output Power (Reporting Only)

<CDD Modes>

2.4GHz Band												
Mod.	Data Rate	NTX	CH.	Freq. (MHz)	Peak Conducted Power (dBm)			DG (dBi)		EIRP Power (dBm)		
					Ant 1	Ant 2	SUM	Ant 1	Ant 2	Ant 1	Ant 2	
11b	1Mbps	1	1	2412	21.38	21.56		3.86	3.63	25.24	25.19	
11b	1Mbps	1	2	2417	21.17	21.43		3.86	3.63	25.03	25.06	
11b	1Mbps	1	6	2437	21.46	21.46		3.86	3.63	25.32	25.09	
11b	1Mbps	1	10	2457	21.56	21.89		3.86	3.63	25.42	25.52	
11b	1Mbps	1	11	2462	21.44	21.66		3.86	3.63	25.30	25.29	
11g	6Mbps	1	1	2412	20.40	20.16		3.86	3.63	24.26	23.79	
11g	6Mbps	1	2	2417	23.16	22.91		3.86	3.63	27.02	26.54	
11g	6Mbps	1	6	2437	23.65	23.51		3.86	3.63	27.51	27.14	
11g	6Mbps	1	10	2457	23.77	23.11		3.86	3.63	27.63	26.74	
11g	6Mbps	1	11	2462	20.31	20.01		3.86	3.63	24.17	23.64	
HT20	MCS0	1	1	2412	18.51	17.53		3.86	3.63	22.37	21.16	
HT20	MCS0	1	2	2417	23.41	23.20		3.86	3.63	27.27	26.83	
HT20	MCS0	1	6	2437	23.58	23.53		3.86	3.63	27.44	27.16	
HT20	MCS0	1	10	2457	23.83	23.05		3.86	3.63	27.69	26.68	
HT20	MCS0	1	11	2462	19.43	19.40		3.86	3.63	23.29	23.03	
HT40	MCS0	1	3	2422	20.25	20.17		3.86	3.63	24.11	23.80	
HT40	MCS0	1	6	2437	23.34	22.76		3.86	3.63	27.20	26.39	
HT40	MCS0	1	9	2452	21.63	21.42		3.86	3.63	25.49	25.05	
11b	1Mbps	2	1	2412	20.76	20.92	23.85	3.86		27.71		
11b	1Mbps	2	2	2417	21.36	20.60	24.44	3.86		28.30		
11b	1Mbps	2	6	2437	21.24	21.61	24.44	3.86		28.30		
11b	1Mbps	2	10	2457	21.71	20.48	24.15	3.86		28.01		
11b	1Mbps	2	11	2462	21.34	20.45	23.93	3.86		27.79		



2.4GHz Band											
Mod.	Data Rate	NTX	CH.	Freq. (MHz)	Peak Conducted Power (dBm)			DG (dBi)		EIRP Power (dBm)	
					Ant 1	Ant 2	SUM	Ant 1	Ant 2	Ant 1	Ant 2
11g	6Mbps	2	1	2412	20.47	20.52	23.51	3.86		27.37	
11g	6Mbps	2	2	2417	23.34	22.94	26.19	3.86		30.05	
11g	6Mbps	2	6	2437	23.31	23.05	26.19	3.86		30.05	
11g	6Mbps	2	10	2457	22.41	21.65	25.06	3.86		28.92	
11g	6Mbps	2	11	2462	21.78	21.25	24.53	3.86		28.39	
HT20	MCS0	2	1	2412	19.31	18.84	22.09	3.86		25.95	
HT20	MCS0	2	2	2417	23.27	23.17	26.27	3.86		30.13	
HT20	MCS0	2	6	2437	23.41	23.10	26.27	3.86		30.13	
HT20	MCS0	2	10	2457	22.13	21.41	24.80	3.86		28.66	
HT20	MCS0	2	11	2462	21.54	20.96	24.27	3.86		28.13	
HT40	MCS0	2	3	2422	16.11	15.60	18.87	3.86		22.73	
HT40	MCS0	2	6	2437	21.97	21.57	24.78	3.86		28.64	
HT40	MCS0	2	9	2452	17.20	16.51	19.88	3.86		23.74	



3.2.6 Test Result of Average output Power

<CDD Mode>

2.4GHz Band																		
Mod.	Data Rate	NTX	CH.	Freq. (MHz)	Duty Factor (dB)		Average Conducted Power (dBm)			Conducted Power Limit (dBm)		DG (dBi)		EIRP Power (dBm)		EIRP Power Limit (dBm)		Pass /Fail
					Ant 1	Ant 2	Ant 1	Ant 2	SUM	Ant 1	Ant 2	Ant 1	Ant 2	Ant 1	Ant 2	Ant 1	Ant 2	
11b	1Mbps	1	1	2412	0.03	0.03	18.30	18.26		30.00	30.00	3.86	3.63	22.16	21.89	36.00	36.00	Pass
11b	1Mbps	1	2	2417	0.03	0.03	18.13	18.23		30.00	30.00	3.86	3.63	21.99	21.86	36.00	36.00	Pass
11b	1Mbps	1	6	2437	0.03	0.03	18.33	18.25		30.00	30.00	3.86	3.63	22.19	21.88	36.00	36.00	Pass
11b	1Mbps	1	10	2457	0.03	0.03	18.26	18.24		30.00	30.00	3.86	3.63	22.12	21.87	36.00	36.00	Pass
11b	1Mbps	1	11	2462	0.03	0.03	18.32	18.30		30.00	30.00	3.86	3.63	22.18	21.93	36.00	36.00	Pass
11g	6Mbps	1	1	2412	0.17	0.17	13.49	13.33		30.00	30.00	3.86	3.63	17.35	16.96	36.00	36.00	Pass
11g	6Mbps	1	2	2417	0.17	0.17	17.07	16.77		30.00	30.00	3.86	3.63	20.93	20.40	36.00	36.00	Pass
11g	6Mbps	1	6	2437	0.17	0.17	17.43	17.21		30.00	30.00	3.86	3.63	21.29	20.84	36.00	36.00	Pass
11g	6Mbps	1	10	2457	0.17	0.17	17.48	17.13		30.00	30.00	3.86	3.63	21.34	20.76	36.00	36.00	Pass
11g	6Mbps	1	11	2462	0.17	0.17	13.47	13.23		30.00	30.00	3.86	3.63	17.33	16.86	36.00	36.00	Pass
HT20	MCS0	1	1	2412	0.24	0.24	11.26	11.22		30.00	30.00	3.86	3.63	15.12	14.85	36.00	36.00	Pass
HT20	MCS0	1	2	2417	0.24	0.24	17.16	16.80		30.00	30.00	3.86	3.63	21.02	20.43	36.00	36.00	Pass
HT20	MCS0	1	6	2437	0.24	0.24	17.27	17.25		30.00	30.00	3.86	3.63	21.13	20.88	36.00	36.00	Pass
HT20	MCS0	1	10	2457	0.24	0.24	17.49	17.04		30.00	30.00	3.86	3.63	21.35	20.67	36.00	36.00	Pass
HT20	MCS0	1	11	2462	0.24	0.24	12.25	11.61		30.00	30.00	3.86	3.63	16.11	15.24	36.00	36.00	Pass
HT40	MCS0	1	3	2422	0.20	0.20	12.69	12.54		30.00	30.00	3.86	3.63	16.55	16.17	36.00	36.00	Pass
HT40	MCS0	1	6	2437	0.20	0.20	16.59	16.29		30.00	30.00	3.86	3.63	20.45	19.92	36.00	36.00	Pass
HT40	MCS0	1	9	2452	0.20	0.20	14.40	14.18		30.00	30.00	3.86	3.63	18.26	17.81	36.00	36.00	Pass
11b	1Mbps	2	1	2412	0.02	0.03	17.66	17.72	20.70	30.00		3.86		24.56		36.00		Pass
11b	1Mbps	2	2	2417	0.02	0.03	18.29	17.37	21.26	30.00		3.86		25.12		36.00		Pass
11b	1Mbps	2	6	2437	0.02	0.03	18.09	18.41	21.26	30.00		3.86		25.12		36.00		Pass
11b	1Mbps	2	10	2457	0.02	0.03	18.63	17.28	21.02	30.00		3.86		24.88		36.00		Pass
11b	1Mbps	2	11	2462	0.02	0.03	18.11	17.23	20.70	30.00		3.86		24.56		36.00		Pass



2.4GHz Band																		
Mod.	Data Rate	NTX	CH.	Freq. (MHz)	Duty Factor (dB)		Average Conducted Power (dBm)			Conducted Power Limit (dBm)		DG (dBi)		EIRP Power (dBm)		EIRP Power Limit (dBm)		Pass /Fail
					Ant 1	Ant 2	Ant 1	Ant 2	SUM	Ant 1	Ant 2	Ant 1	Ant 2	Ant 1	Ant 2	Ant 1	Ant 2	
11g	6Mbps	2	1	2412	0.23	0.23	13.85	13.66	16.77	30.00	3.86	20.63	36.00	Pass				
11g	6Mbps	2	2	2417	0.23	0.23	17.25	16.95	20.24	30.00	3.86	24.10	36.00	Pass				
11g	6Mbps	2	6	2437	0.23	0.23	17.29	17.16	20.24	30.00	3.86	24.10	36.00	Pass				
11g	6Mbps	2	10	2457	0.23	0.23	15.83	15.29	18.58	30.00	3.86	22.44	36.00	Pass				
11g	6Mbps	2	11	2462	0.23	0.23	15.37	14.76	18.09	30.00	3.86	21.95	36.00	Pass				
HT20	MCS0	2	1	2412	0.24	0.24	11.96	11.84	14.92	30.00	3.86	18.78	36.00	Pass				
HT20	MCS0	2	2	2417	0.24	0.24	16.96	16.87	20.19	30.00	3.86	24.05	36.00	Pass				
HT20	MCS0	2	6	2437	0.24	0.24	17.34	17.01	20.19	30.00	3.86	24.05	36.00	Pass				
HT20	MCS0	2	10	2457	0.24	0.24	15.21	14.74	18.00	30.00	3.86	21.86	36.00	Pass				
HT20	MCS0	2	11	2462	0.24	0.24	14.13	13.82	16.99	30.00	3.86	20.85	36.00	Pass				
HT40	MCS0	2	3	2422	0.20	0.20	9.16	8.46	11.83	30.00	3.86	15.69	36.00	Pass				
HT40	MCS0	2	6	2437	0.20	0.20	14.92	14.70	17.82	30.00	3.86	21.68	36.00	Pass				
HT40	MCS0	2	9	2452	0.20	0.20	10.14	9.58	12.88	30.00	3.86	16.74	36.00	Pass				



<TXBF Mode>

2.4GHz Band																		
Mod.	Data Rate	NTX	CH.	Freq. (MHz)	Duty Factor (dB)		Average Conducted Power (dBm)			Conducted Power Limit (dBm)		DG (dBi)		EIRP Power (dBm)		EIRP Power Limit (dBm)		Pass /Fail
					Ant 1	Ant 2	Ant 1	Ant 2	SUM	Ant 1	Ant 2	Ant 1	Ant 2	Ant 1	Ant 2	Ant 1	Ant 2	
HT20	MCS0	2	1	2412	0.00	0.00	13.40	13.60	16.51	30.00		6.76		23.27		36.00		Pass
HT20	MCS0	2	2	2417	0.00	0.00	18.60	18.30	21.46	30.00		6.76		28.22		36.00		Pass
HT20	MCS0	2	6	2437	0.00	0.00	18.50	18.40	21.46	30.00		6.76		28.22		36.00		Pass
HT20	MCS0	2	10	2457	0.00	0.00	18.20	17.90	21.06	30.00		6.76		27.82		36.00		Pass
HT20	MCS0	2	11	2462	0.00	0.00	14.80	14.50	17.66	30.00		6.76		24.42		36.00		Pass
HT40	MCS0	2	3	2422	0.00	0.00	12.70	12.90	15.81	30.00		6.76		22.57		36.00		Pass
HT40	MCS0	2	6	2437	0.00	0.00	16.80	16.70	19.76	30.00		6.76		26.52		36.00		Pass
HT40	MCS0	2	9	2452	0.00	0.00	16.10	16.50	19.31	30.00		6.76		26.07		36.00		Pass



3.3 Power Spectral Density Measurement

3.3.1 Limit of Power Spectral Density

The peak power spectral density shall not be greater than 8dBm in any 3kHz band at any time interval of continuous transmission.

3.3.2 Measuring Instruments

The measuring equipment is listed in the section 4 of this test report.



3.3.3 Test Procedures

CDD Modes

Method AVGPSD-2

1. The testing follows Measurement Procedure 10.2 Method PKPSD of FCC KDB Publication No. 558074 D01 DTS Meas. Guidance v04
2. The RF output of EUT was connected to the spectrum analyzer by RF cable and attenuator. The path loss was compensated to the results for each measurement.
3. Set to the maximum power setting and enable the EUT transmit continuously.
4. Make the measurement with the spectrum analyzer's resolution bandwidth (RBW) = 10 kHz. Video bandwidth VBW = 30 kHz In order to make an accurate measurement, set the span to 1.5 times DTS Channel Bandwidth. (6dB BW)
5. Number of points in sweep ≥ 2 Span / RBW. (This ensures that bin-to-bin spacing is \leq RBW/2, so that narrowband signals are not lost between frequency bins).
6. Detector = RMS, Sweep time = auto couple.
7. Trace average at least 100 traces in power averaging mode.
8. Add $10 \log(1/x)$, where x is the duty cycle, to the measured power in order to compute the average power during the actual transmission times. For example, add $10 \log(1/0.25) = 6$ dB if the duty cycle is 25 percent.
9. Measure and record the results in the test report. For MIMO mode, calculation method follows FCC KDB 662911 D01 Multiple Transmitter Output v02r01.
Method (c): Measure and add $10 \log(N_{ANT})$ dB.

With this technique, spectrum measurements are performed at each output of the device, but rather than summing the spectra or the spectral peaks across the outputs, the quantity $10 \log(N_{ANT})$ dB is added to each spectrum value before comparing to the emission limit. The addition of $10 \log(N_{ANT})$ dB serves to apportion the emission limit among the N_{ANT} outputs so that each output is permitted to contribute no more than $1/N_{ANT}^{\text{th}}$ of the PSD limit .

TXBF Modes**Method AVGPSD-3**

1. The testing follows Measurement Procedure 10.7 Method AVGPSD-3 of FCC KDB Publication No. 558074 D01 DTS Meas. Guidance v04.
2. The RF output of EUT was connected to the spectrum analyzer by RF cable and attenuator. The path loss was compensated to the results for each measurement.
3. Set to the maximum power setting and enable the EUT transmit continuously.
4. Make the measurement with the spectrum analyzer's resolution bandwidth (RBW) = 10 kHz. Video bandwidth VBW = 30 kHz In order to make an accurate measurement, set the span to 1.5 times DTS Channel Bandwidth. (6dB BW).
5. Number of points in sweep ≥ 2 Span / RBW. (This ensures that bin-to-bin spacing is \leq RBW/2, so that narrowband signals are not lost between frequency bins).
6. Detector = RMS, Sweep time = auto couple.
7. Trace mode = max hold.
8. Allow max hold to run for at least 60 seconds, or longer as needed to allow the trace to stabilize.
9. Measure and record the results in the test report. For MIMO mode, calculation method follows FCC KDB 662911 D01 Multiple Transmitter Output v02r01.

Method (c): Measure and add $10 \log(N_{\text{ANT}})$ dB.

With this technique, spectrum measurements are performed at each output of the device, but rather than summing the spectra or the spectral peaks across the outputs, the quantity $10 \log(N_{\text{ANT}})$ dB is added to each spectrum value before comparing to the emission limit. The addition of $10 \log(N_{\text{ANT}})$ dB serves to apportion the emission limit among the N_{ANT} outputs so that each output is permitted to contribute no more than $1/N_{\text{ANT}}^{\text{th}}$ of the PSD limit .

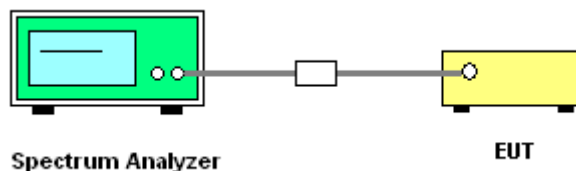
3.3.4 Test Setup



3.3.5 Test Result of Power Spectral Density

<CDD Mode>

2.4GHz Band												
Mod.	Data Rate	NTX	CH.	Freq. (MHz)	Average PSD (dBm/3kHz)			DG (dBi)		Average PSD Limit (dBm/3kHz)		Pass/Fail
					Ant 1	Ant 2	Worse + 3.01	Ant 1	Ant 2	Ant 1	Ant 2	
11b	1Mbps	1	1	2412	-8.51	-8.52		3.86	3.63	8.00	8.00	Pass
11b	1Mbps	1	2	2417	-8.41	-8.18		3.86	3.63	8.00	8.00	Pass
11b	1Mbps	1	6	2437	-8.36	-8.63		3.86	3.63	8.00	8.00	Pass
11b	1Mbps	1	10	2457	-8.18	-8.08		3.86	3.63	8.00	8.00	Pass
11b	1Mbps	1	11	2462	-8.32	-8.69		3.86	3.63	8.00	8.00	Pass
11g	6Mbps	1	1	2412	-13.79	-13.08		3.86	3.63	8.00	8.00	Pass
11g	6Mbps	1	2	2417	-10.11	-10.14		3.86	3.63	8.00	8.00	Pass
11g	6Mbps	1	6	2437	-9.56	-9.73		3.86	3.63	8.00	8.00	Pass
11g	6Mbps	1	10	2457	-9.53	-9.76		3.86	3.63	8.00	8.00	Pass
11g	6Mbps	1	11	2462	-12.72	-13.65		3.86	3.63	8.00	8.00	Pass
HT20	MCS0	1	1	2412	-17.56	-17.58		3.86	3.63	8.00	8.00	Pass
HT20	MCS0	1	2	2417	-11.50	-11.23		3.86	3.63	8.00	8.00	Pass
HT20	MCS0	1	6	2437	-11.82	-11.52		3.86	3.63	8.00	8.00	Pass
HT20	MCS0	1	10	2457	-11.90	-11.74		3.86	3.63	8.00	8.00	Pass
HT20	MCS0	1	11	2462	-16.69	-17.34		3.86	3.63	8.00	8.00	Pass
HT40	MCS0	1	3	2422	-18.20	-18.44		3.86	3.63	8.00	8.00	Pass
HT40	MCS0	1	6	2437	-14.78	-14.48		3.86	3.63	8.00	8.00	Pass
HT40	MCS0	1	9	2452	-16.88	-17.06		3.86	3.63	8.00	8.00	Pass
11b	1Mbps	2	1	2412	-8.62	-9.05	-5.61	6.76		7.24		Pass
11b	1Mbps	2	2	2417	-8.25	-8.65	-5.24	6.76		7.24		Pass
11b	1Mbps	2	6	2437	-8.39	-8.23	-5.22	6.76		7.24		Pass
11b	1Mbps	2	10	2457	-8.15	-8.88	-5.14	6.76		7.24		Pass
11b	1Mbps	2	11	2462	-8.80	-9.58	-5.79	6.76		7.24		Pass



2.4GHz Band												
Mod.	Data Rate	NTX	CH.	Freq. (MHz)	Average PSD (dBm/3kHz)			DG (dBi)		Average PSD Limit (dBm/3kHz)		Pass/Fail
					Ant 1	Ant 2	Worse + 3.01	Ant 1	Ant 2	Ant 1	Ant 2	
11g	6Mbps	2	1	2412	-13.43	-12.92	-9.91	6.76	6.76	7.24	7.24	Pass
11g	6Mbps	2	2	2417	-10.07	-9.97	-6.96	6.76	6.76	7.24	7.24	Pass
11g	6Mbps	2	6	2437	-9.38	-9.94	-6.37	6.76	6.76	7.24	7.24	Pass
11g	6Mbps	2	10	2457	-10.41	-11.60	-7.40	6.76	6.76	7.24	7.24	Pass
11g	6Mbps	2	11	2462	-11.28	-12.35	-8.27	6.76	6.76	7.24	7.24	Pass
HT20	MCS0	2	1	2412	-16.53	-17.08	-13.52	6.76	6.76	7.24	7.24	Pass
HT20	MCS0	2	2	2417	-11.21	-11.81	-8.20	6.76	6.76	7.24	7.24	Pass
HT20	MCS0	2	6	2437	-10.62	-11.66	-7.61	6.76	6.76	7.24	7.24	Pass
HT20	MCS0	2	10	2457	-13.06	-13.85	-10.05	6.76	6.76	7.24	7.24	Pass
HT20	MCS0	2	11	2462	-14.60	-14.30	-11.29	6.76	6.76	7.24	7.24	Pass
HT40	MCS0	2	3	2422	-22.23	-22.51	-19.22	6.76	6.76	7.24	7.24	Pass
HT40	MCS0	2	6	2437	-16.43	-16.30	-13.29	6.76	6.76	7.24	7.24	Pass
HT40	MCS0	2	9	2452	-21.50	-21.35	-18.34	6.76	6.76	7.24	7.24	Pass

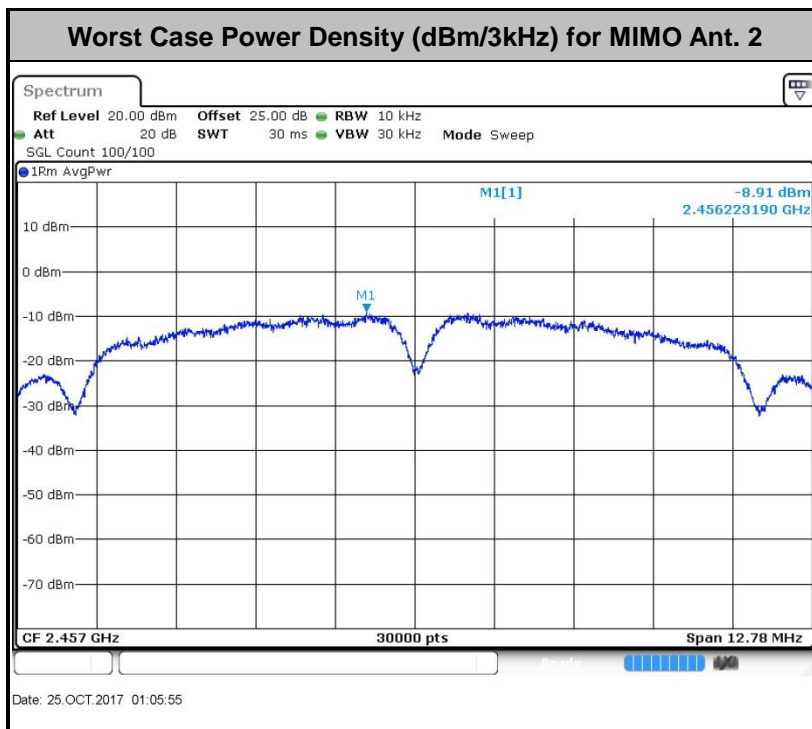
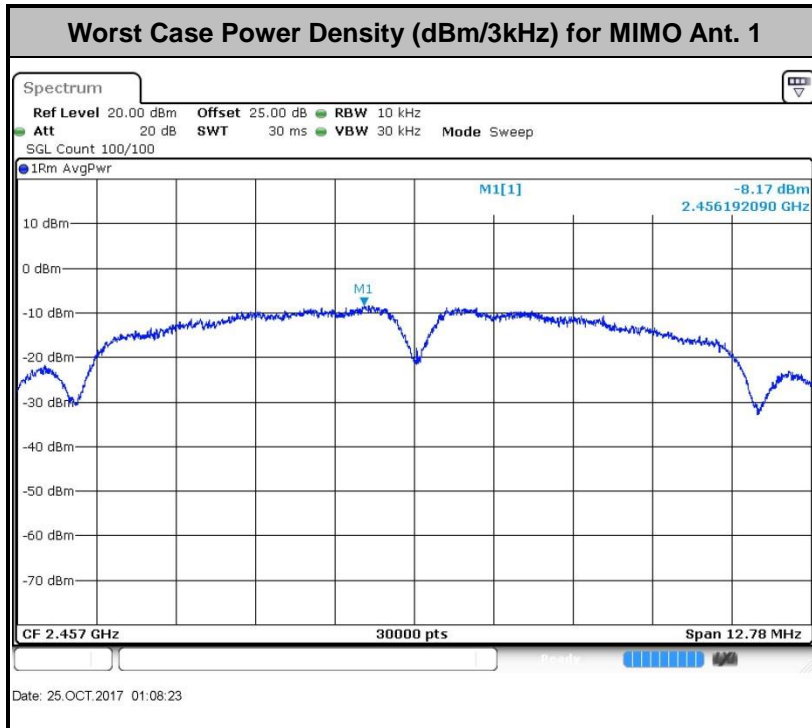

Note: Average Power Density (dB) = Measured value+ Duty Factor



<TXBF Mode>

2.4GHz Band												
Mod.	Data Rate	NTX	CH.	Freq. (MHz)	Average PSD (dBm/3kHz)			DG (dBi)		Average PSD Limit (dBm/3kHz)		Pass/Fail
					Ant 1	Ant 2	Worse + 3.01	Ant 1	Ant 2	Ant 1	Ant 2	
HT20	MCS0	2	1	2412	-6.82	-7.10	-3.81	6.76		7.24		Pass
HT20	MCS0	2	2	2417	-2.21	-2.68	0.80	6.76		7.24		Pass
HT20	MCS0	2	6	2437	-1.54	-1.53	1.48	6.76		7.24		Pass
HT20	MCS0	2	10	2457	-2.17	-3.56	0.84	6.76		7.24		Pass
HT20	MCS0	2	11	2462	-5.49	-6.87	-2.48	6.76		7.24		Pass
HT40	MCS0	2	3	2422	-8.03	-8.54	-5.02	6.76		7.24		Pass
HT40	MCS0	2	6	2437	-4.38	-4.11	-1.10	6.76		7.24		Pass
HT40	MCS0	2	9	2452	-5.14	-5.30	-2.13	6.76		7.24		Pass

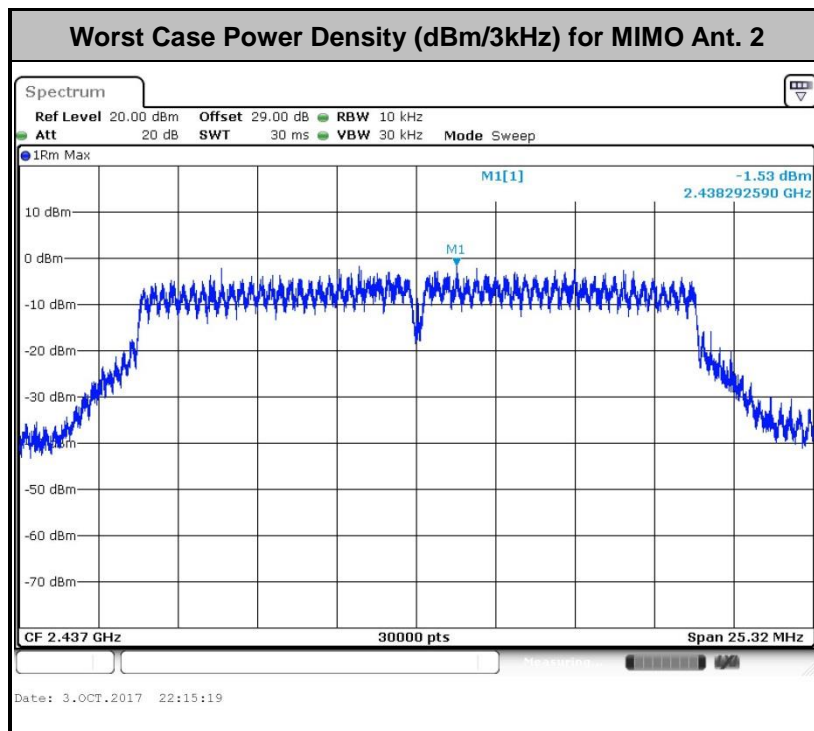
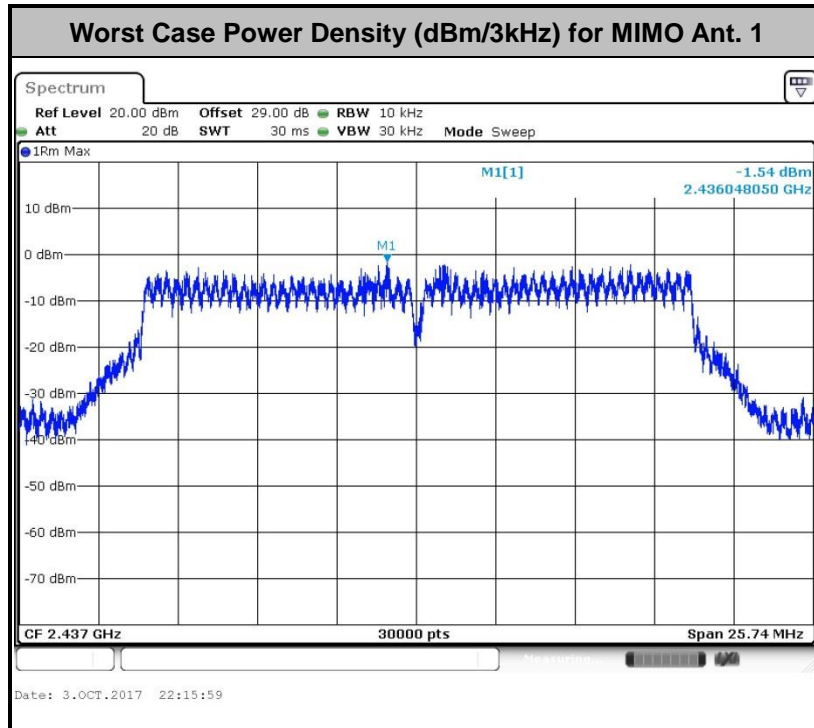

Note: Average Power Density (dB) = Measured value+ Duty Factor

3.4 Conducted Band Edges and Spurious Emission Measurement

3.4.1 Limit of Conducted Band Edges and Spurious Emission Measurement

In any 100 kHz bandwidth outside of the authorized frequency band, the emissions which fall in the non-restricted bands shall be attenuated at least 20 dB / 30dB relative to the maximum PSD level in 100 kHz by RF conducted measurement and radiated emissions which fall in the restricted bands, as defined in Section 15.205(a), must also comply with the radiated emission limits specified in Section 15.209(a).

3.4.2 Measuring Instruments

The measuring equipment is listed in the section 4 of this test report.

3.4.3 Test Procedures

1. The testing follows FCC KDB Publication No. 558074 D01 DTS Meas. Guidance v04.
2. The RF output of EUT was connected to the spectrum analyzer by RF cable and attenuator. The path loss was compensated to the results for each measurement.
3. Set to the maximum power setting and enable the EUT transmit continuously.
4. Set RBW = 100 kHz, VBW=300 kHz, Peak Detector. Unwanted Emissions measured in any 100 kHz bandwidth outside of the authorized frequency band shall be attenuated by at least 20 dB relative to the maximum in-band peak PSD level in 100 kHz when maximum peak conducted output power procedure is used. If the transmitter complies with the conducted power limits based on the use of RMS averaging over a time interval, the attenuation required under this paragraph shall be 30 dB instead of 20 dB per 15.247(d).
5. Measure and record the results in the test report.
6. The RF fundamental frequency should be excluded against the limit line in the operating frequency band.

3.4.4 Test Setup

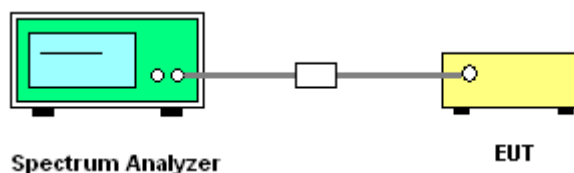



3.4.5 Test Result of Conducted Band Edges and Spurious Emission

<CDD Mode>

Number of TX = 1, Ant. 1 (Measured)

Number of TX	1	Ant. :	1
Test Mode :	802.11b	Temperature :	21~25°C
Test Band :	2.4GHz Low	Relative Humidity :	51~54%
Test Channel :	01	Test Engineer :	Kai Liao

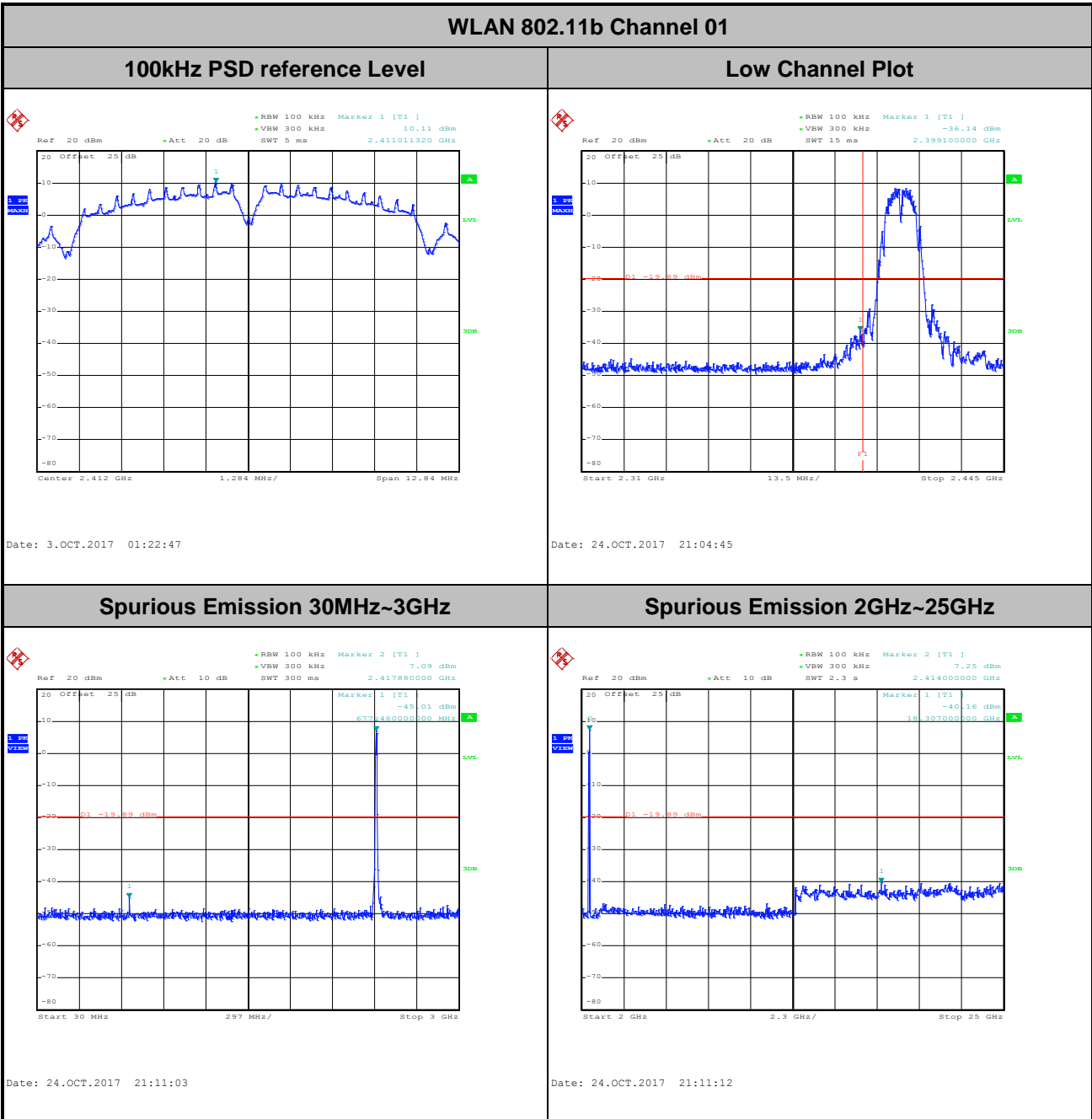



Number of TX	1	Ant. :	1
Test Mode :	802.11b	Temperature :	21~25°C
Test Band :	2.4GHz Low	Relative Humidity :	51~54%
Test Channel :	02	Test Engineer :	Kai Liao

WLAN 802.11b Channel 02

100kHz PSD reference Level

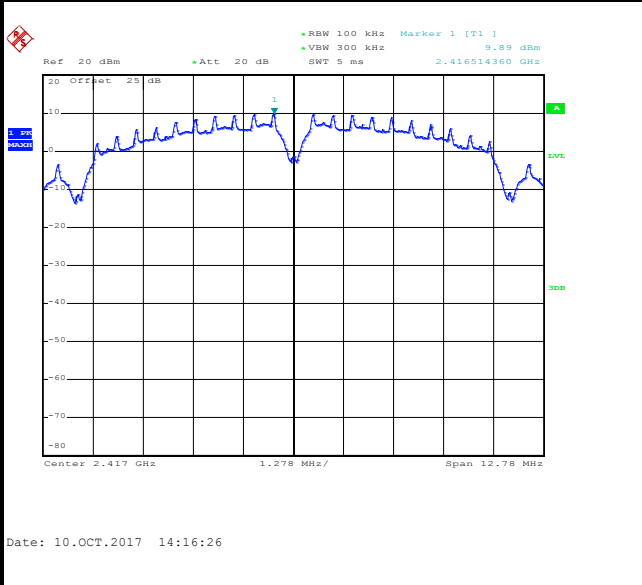

Low Channel Plot

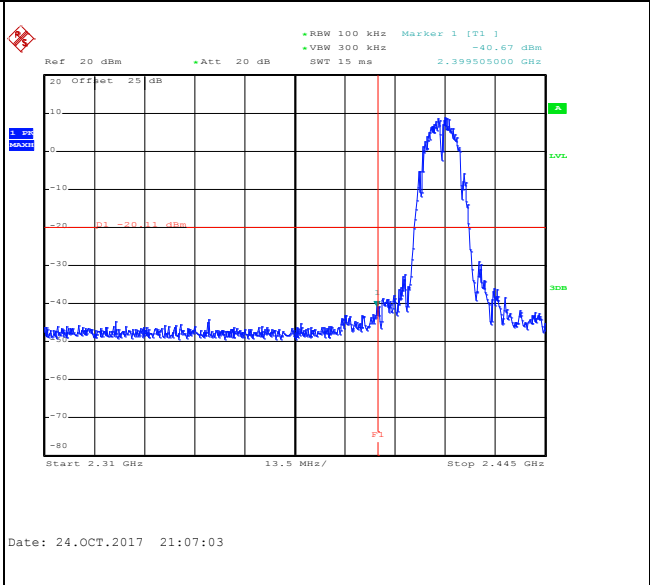

Spurious Emission 30MHz~3GHz

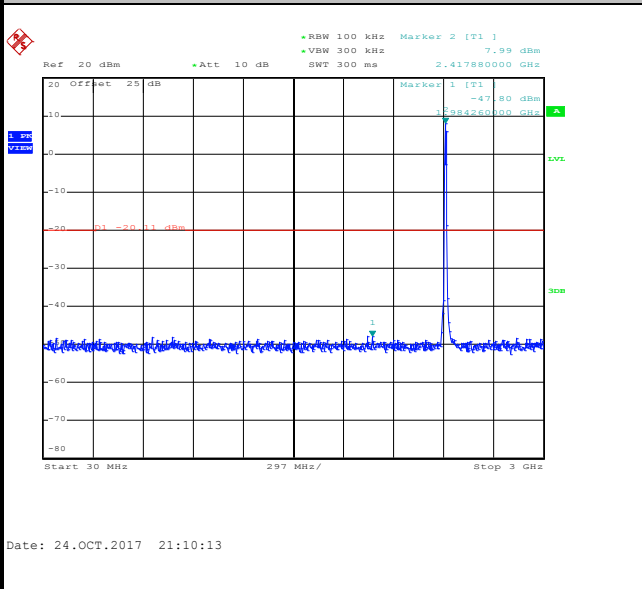

Spurious Emission 2GHz~25GHz

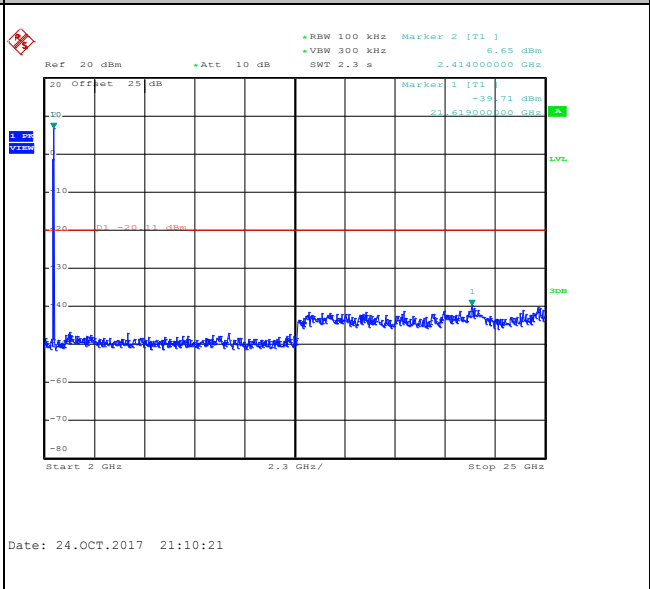



Number of TX :	1	Ant. :	1
Test Mode :	802.11b	Temperature :	21~25°C
Test Band :	2.4GHz Mid	Relative Humidity :	51~54%
Test Channel :	06	Test Engineer :	Kai Liao

WLAN 802.11b Channel 06

100kHz PSD reference Level

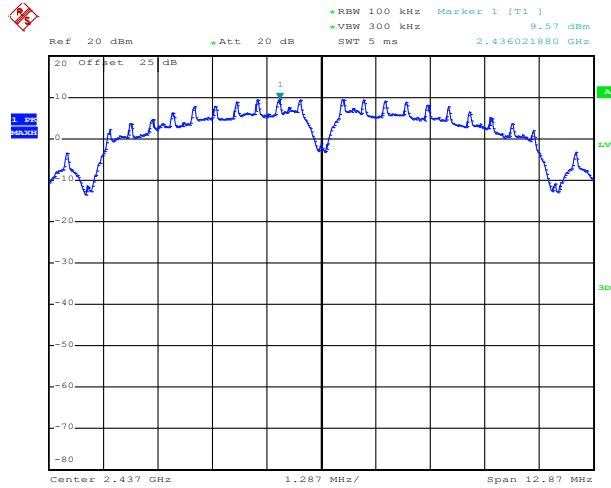

Date: 3.OCT.2017 01:27:24

Spurious Emission 30MHz~3GHz

Spurious Emission 2GHz~25GHz

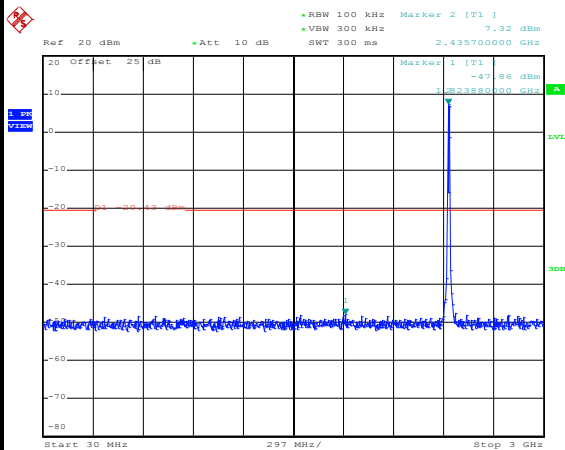

Date: 24.OCT.2017 21:19:00

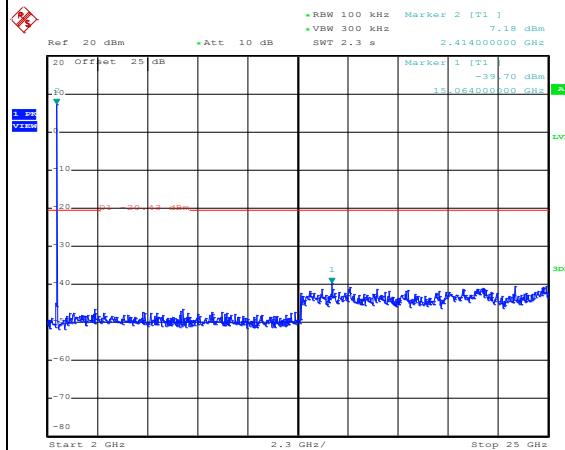

Date: 24.OCT.2017 21:19:08



Number of TX :	1	Ant. :	1
Test Mode :	802.11b	Temperature :	21~25°C
Test Band :	2.4GHz High	Relative Humidity :	51~54%
Test Channel :	10	Test Engineer :	Kai Liao

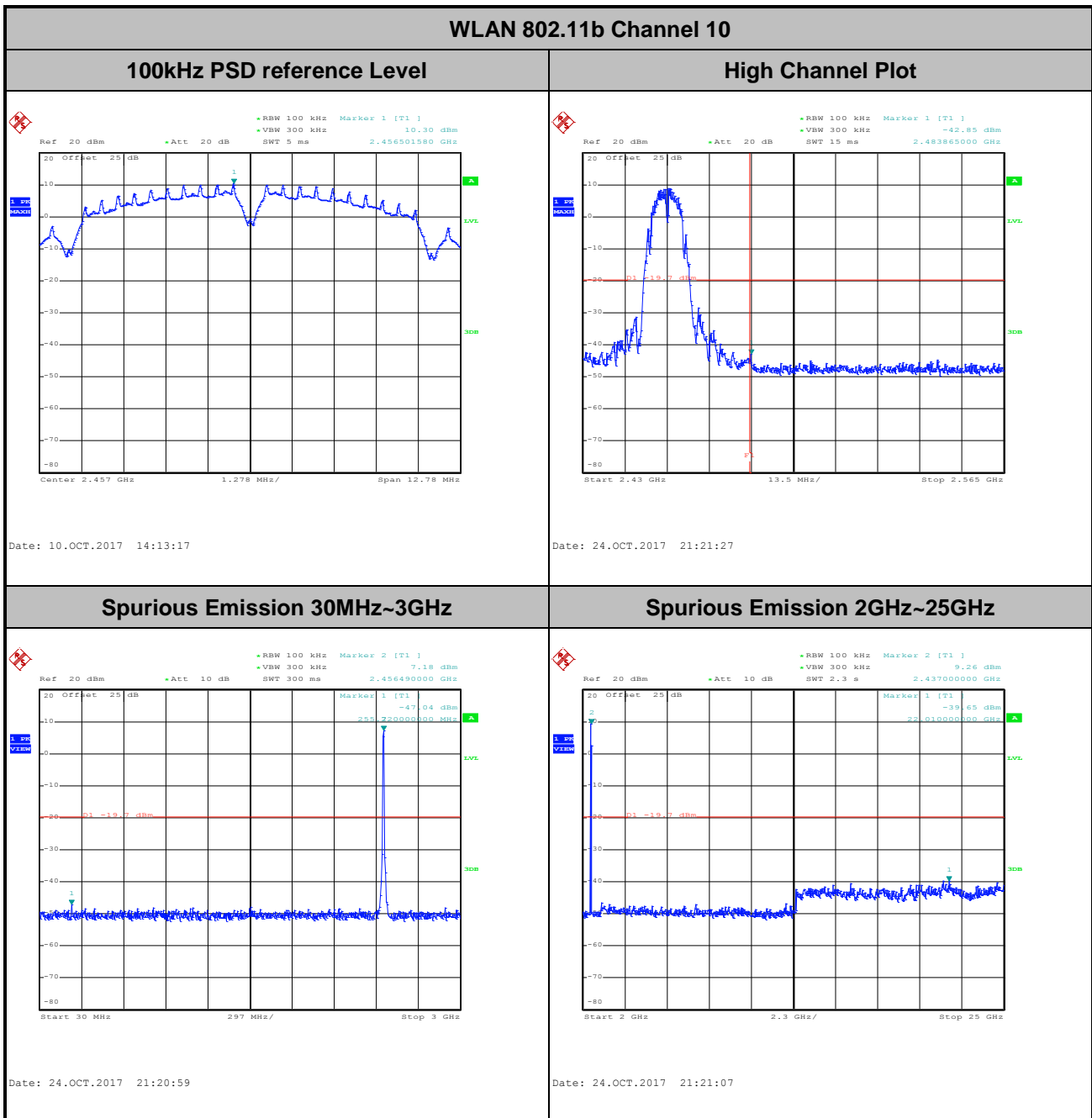



Number of TX :	1	Ant. :	1
Test Mode :	802.11b	Temperature :	21~25°C
Test Band :	2.4GHz High	Relative Humidity :	51~54%
Test Channel :	11	Test Engineer :	Kai Liao

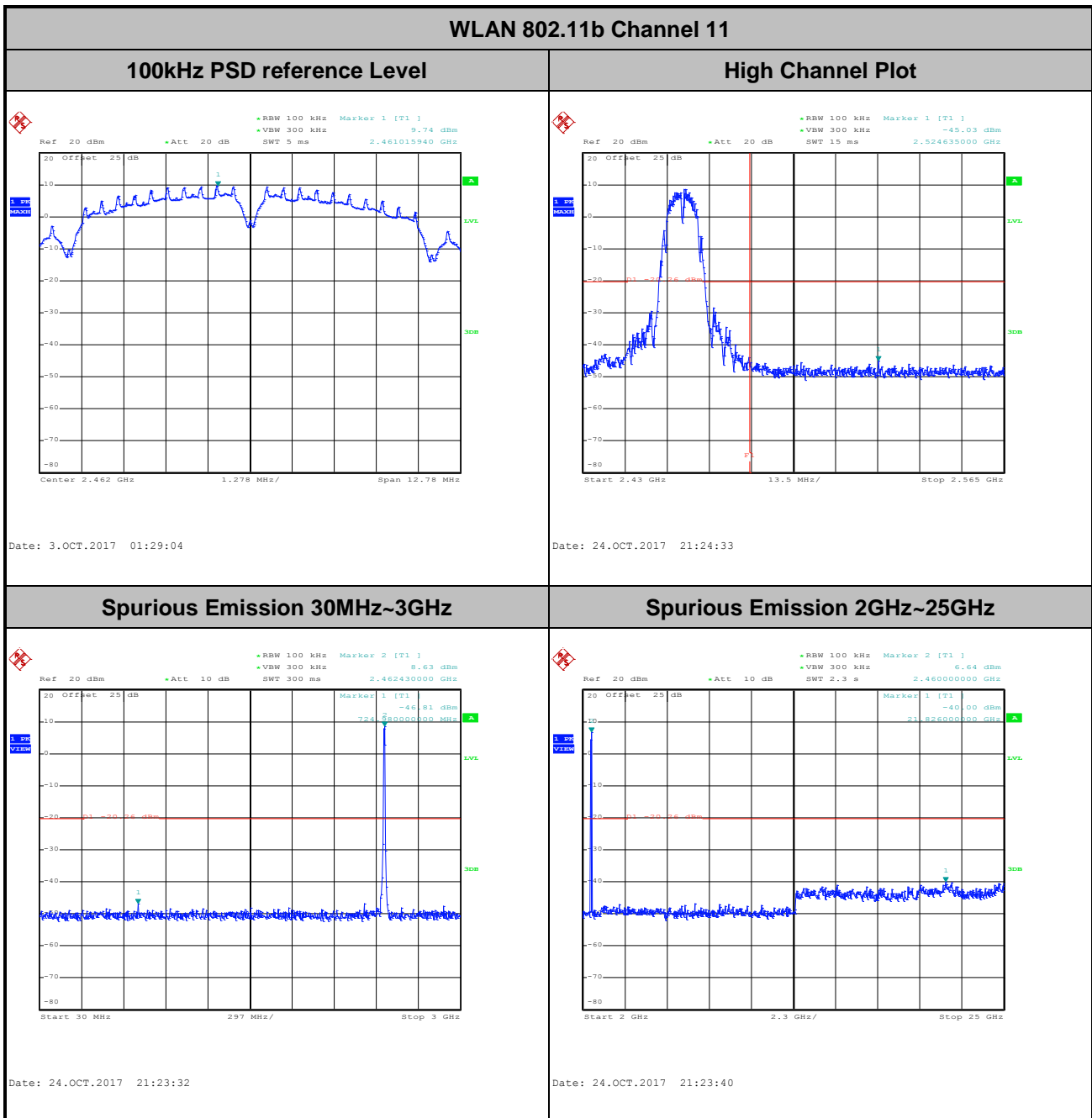



Number of TX :	1	Ant. :	1
Test Mode :	802.11g	Temperature :	21~25°C
Test Band :	2.4GHz Low	Relative Humidity :	51~54%
Test Channel :	01	Test Engineer :	Kai Liao

WLAN 802.11g Channel 01

100kHz PSD reference Level

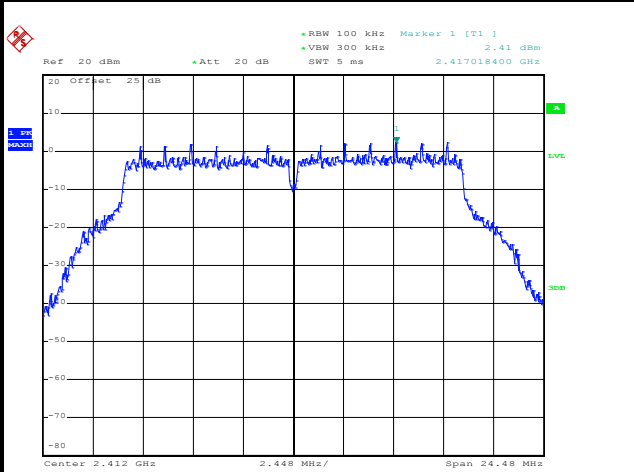

Date: 10.OCT.2017 13:33:35

Low Channel Plot

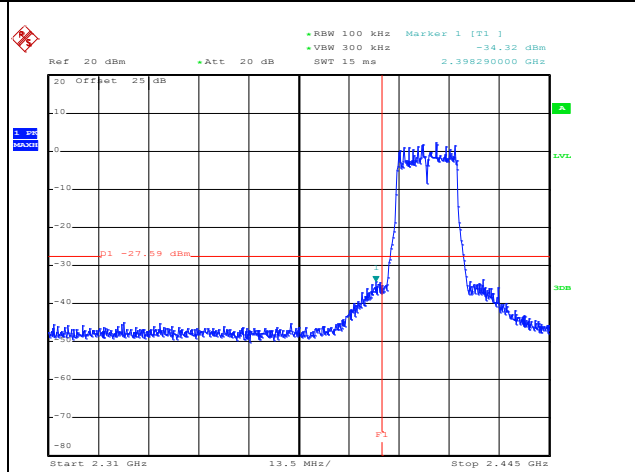

Date: 24.OCT.2017 22:26:35

Spurious Emission 30MHz~3GHz

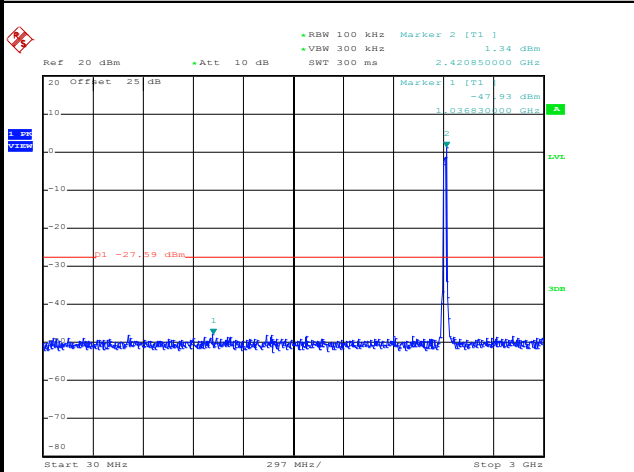

Date: 24.OCT.2017 22:26:01

Spurious Emission 2GHz~25GHz

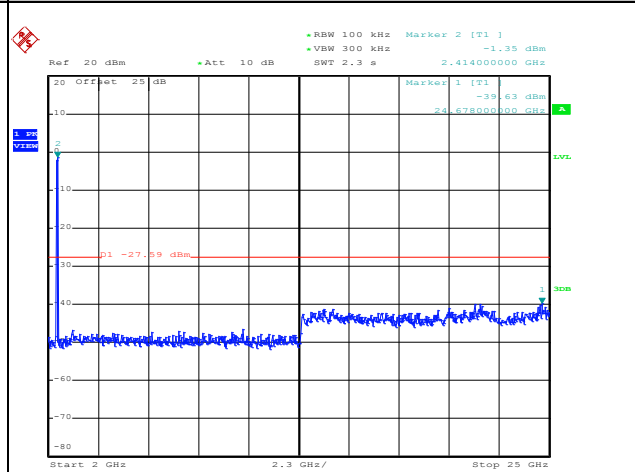

Date: 24.OCT.2017 22:26:10



Number of TX :	1	Ant. :	1
Test Mode :	802.11g	Temperature :	21~25°C
Test Band :	2.4GHz Low	Relative Humidity :	51~54%
Test Channel :	02	Test Engineer :	Kai Liao

WLAN 802.11g Channel 02

100kHz PSD reference Level

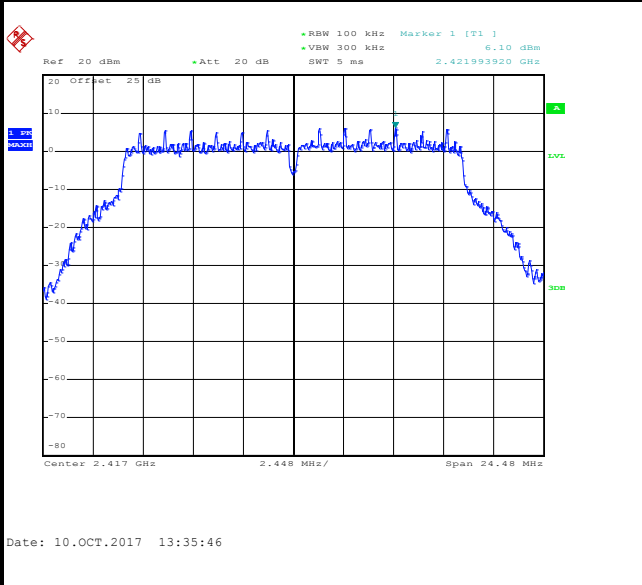

Low Channel Plot

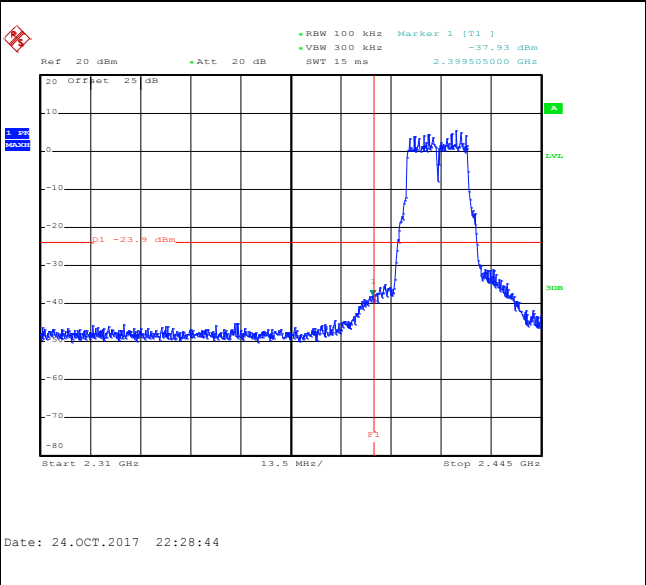

Spurious Emission 30MHz~3GHz

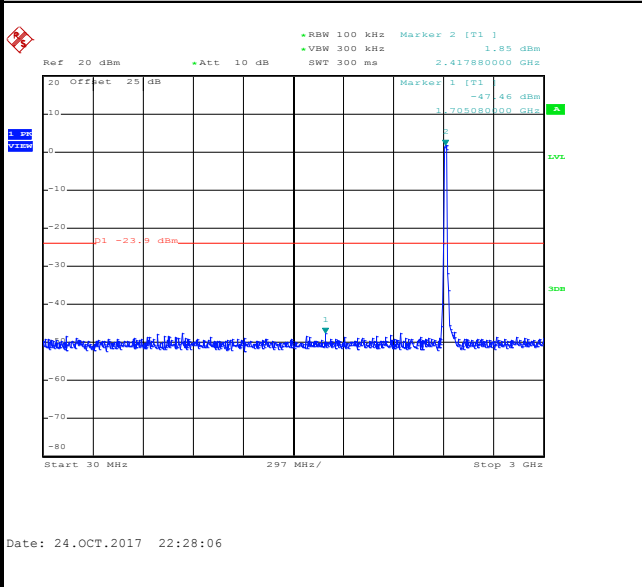

Spurious Emission 2GHz~25GHz

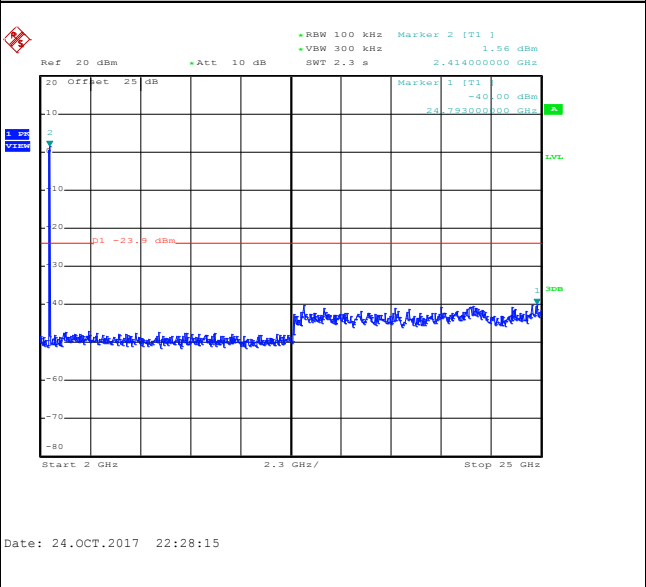



Number of TX :	1	Ant. :	1
Test Mode :	802.11g	Temperature :	21~25°C
Test Band :	2.4GHz Mid	Relative Humidity :	51~54%
Test Channel :	06	Test Engineer :	Kai Liao

WLAN 802.11g Channel 06

100kHz PSD reference Level

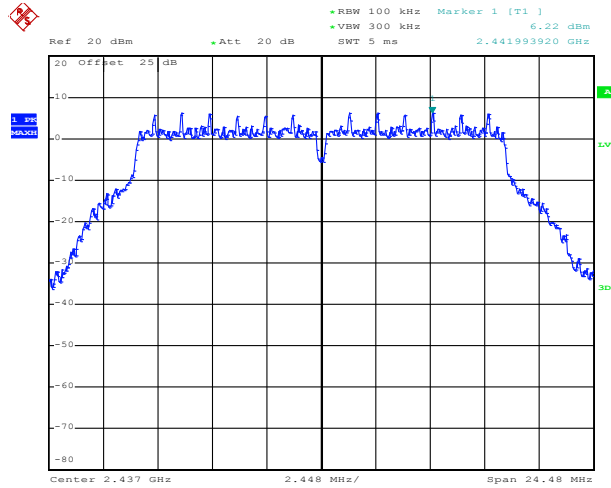

Date: 10.OCT.2017 13:39:41

Spurious Emission 30MHz~3GHz

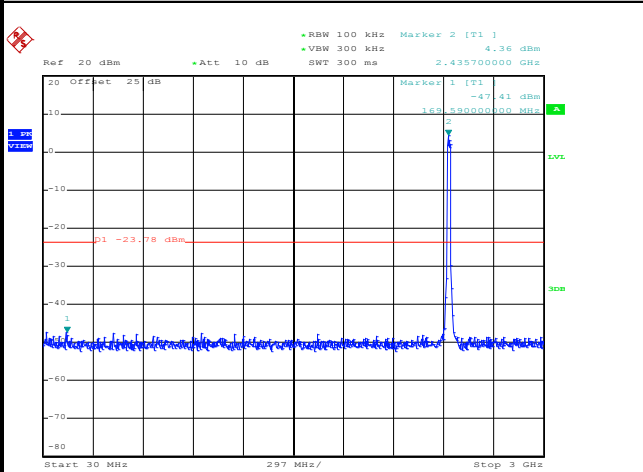

Date: 24.OCT.2017 22:30:26

Spurious Emission 2GHz~25GHz

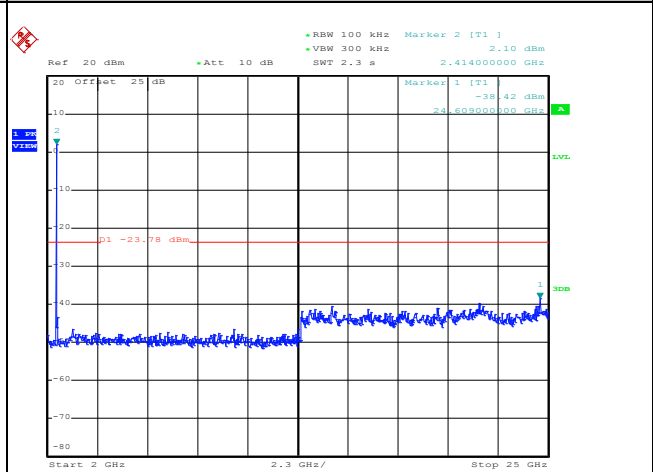

Date: 24.OCT.2017 22:30:34



Number of TX :	1	Ant. :	1
Test Mode :	802.11g	Temperature :	21~25°C
Test Band :	2.4GHz High	Relative Humidity :	51~54%
Test Channel :	10	Test Engineer :	Kai Liao

WLAN 802.11g Channel 10

100kHz PSD reference Level

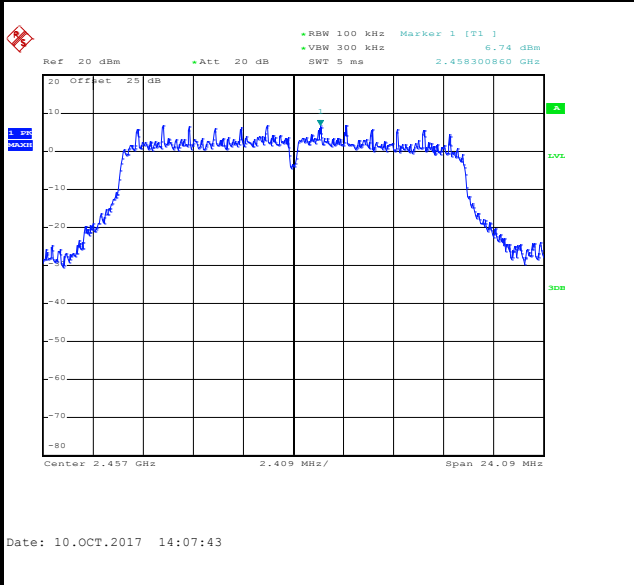

High Channel Plot

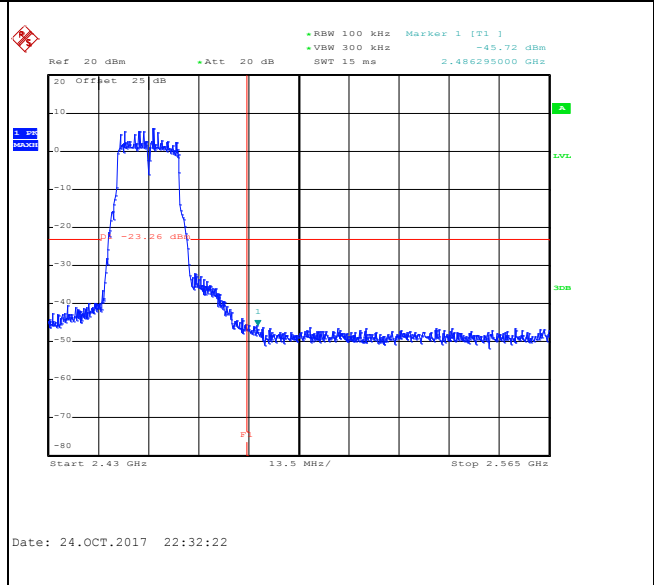

Spurious Emission 30MHz~3GHz

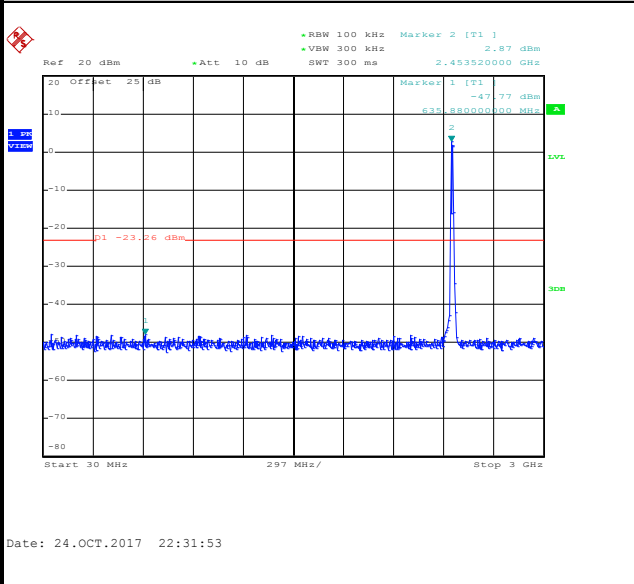

Spurious Emission 2GHz~25GHz

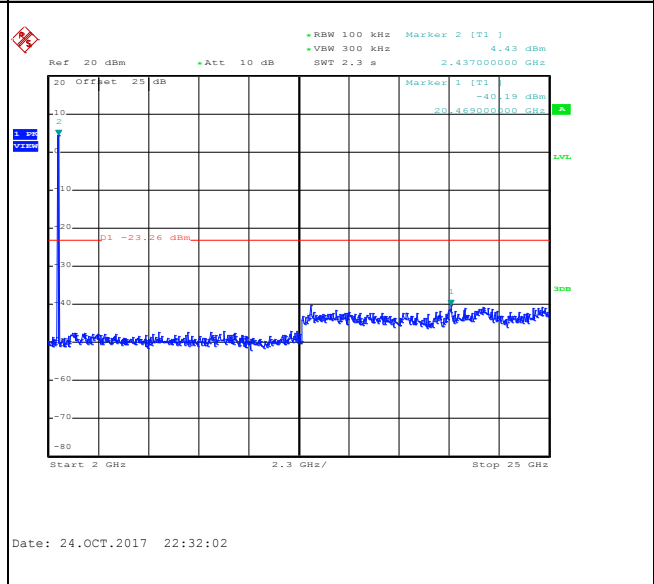



Number of TX :	1	Ant. :	1
Test Mode :	802.11g	Temperature :	21~25°C
Test Band :	2.4GHz High	Relative Humidity :	51~54%
Test Channel :	11	Test Engineer :	Kai Liao

WLAN 802.11g Channel 11

100kHz PSD reference Level

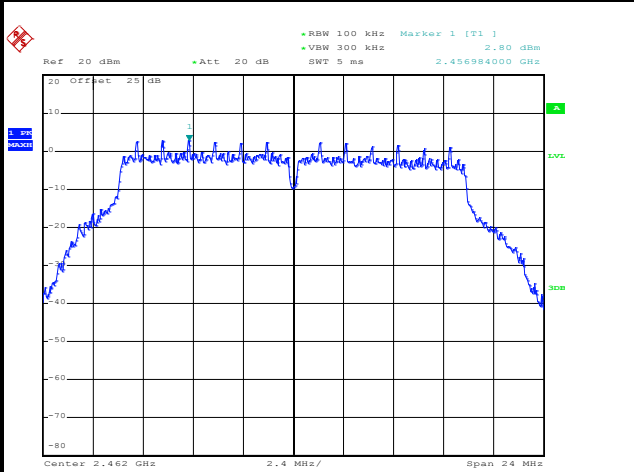

Date: 10.OCT.2017 13:45:52

High Channel Plot

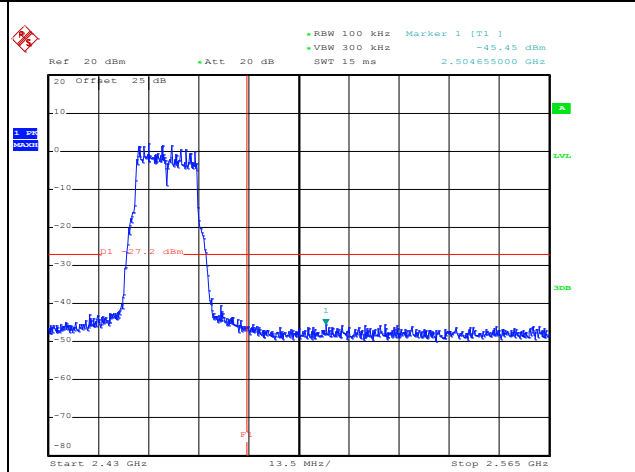

Date: 24.OCT.2017 22:34:33

Spurious Emission 30MHz~3GHz

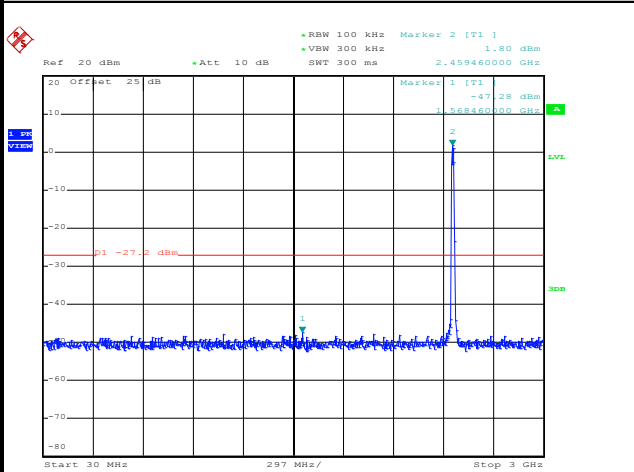

Date: 24.OCT.2017 22:34:54

Spurious Emission 2GHz~25GHz

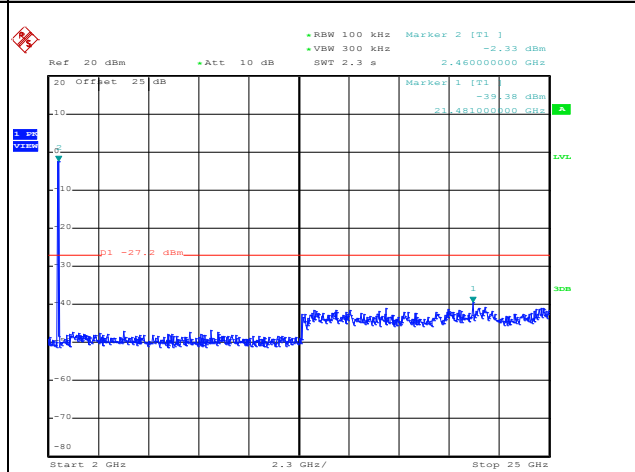

Date: 24.OCT.2017 22:35:02



Number of TX	1	Ant. :	1
Test Mode :	802.11n HT20	Temperature :	21~25°C
Test Band :	2.4GHz Low	Relative Humidity :	51~54%
Test Channel :	01	Test Engineer :	Kai Liao

WLAN 802.11n HT20 Channel 01

100kHz PSD reference Level

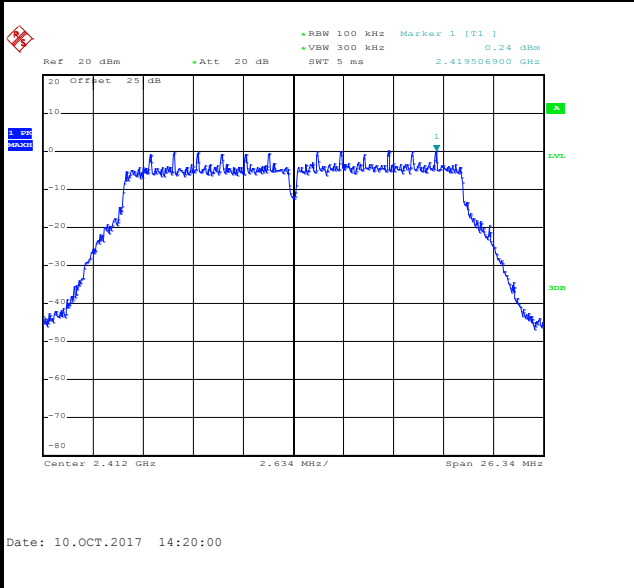

Low Channel Plot

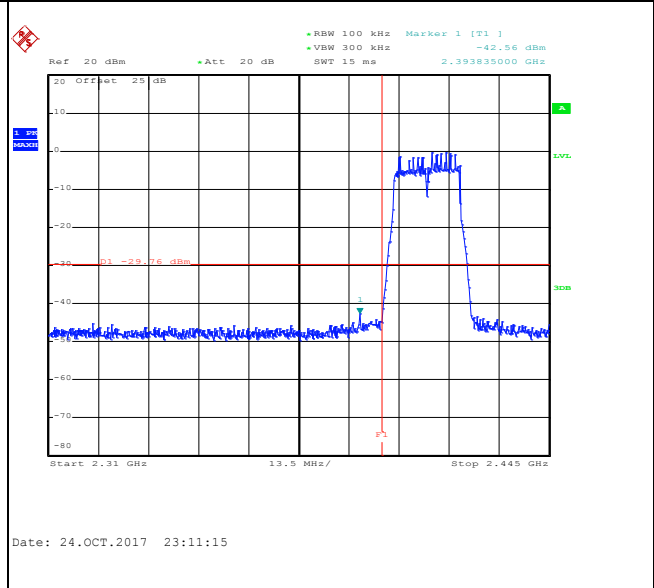

Spurious Emission 30MHz~3GHz

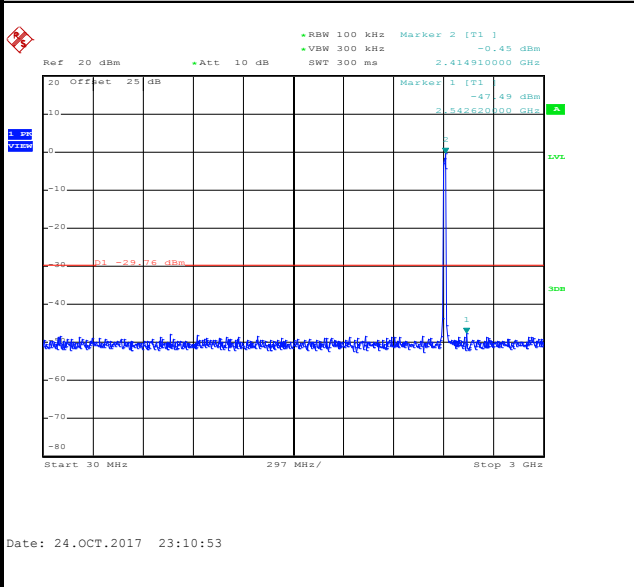

Spurious Emission 2GHz~25GHz

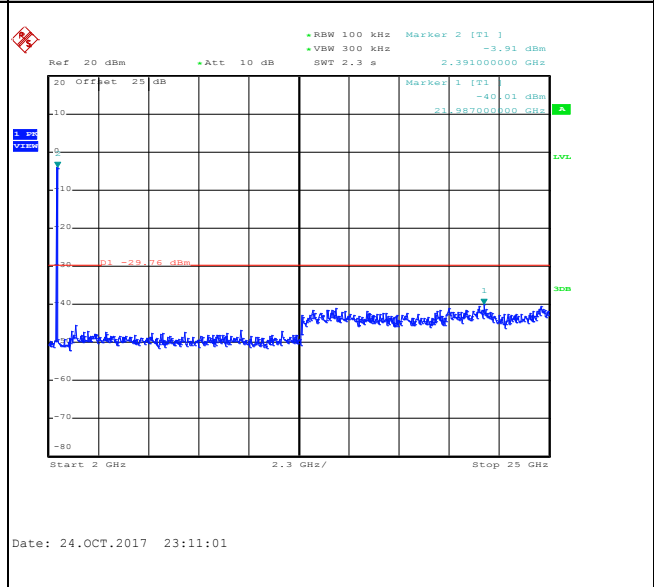



Number of TX	1	Ant. :	1
Test Mode :	802.11n HT20	Temperature :	21~25°C
Test Band :	2.4GHz Low	Relative Humidity :	51~54%
Test Channel :	02	Test Engineer :	Kai Liao

WLAN 802.11n HT20 Channel 02

100kHz PSD reference Level

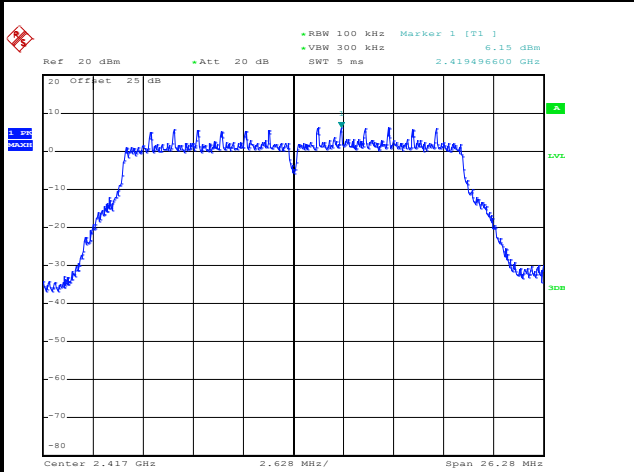

Date: 10.OCT.2017 14:22:34

Low Channel Plot

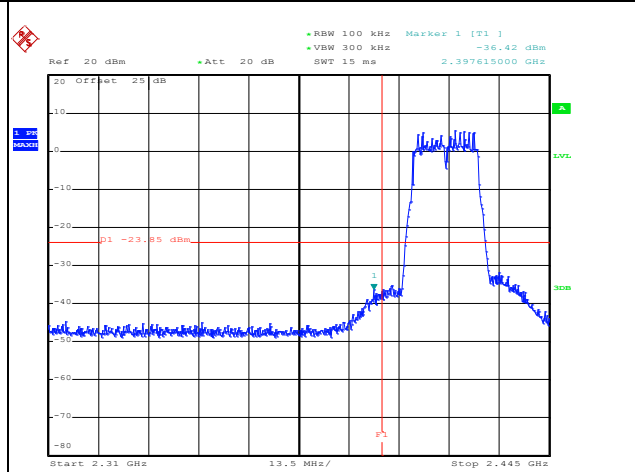

Date: 24.OCT.2017 23:13:19

Spurious Emission 30MHz~3GHz

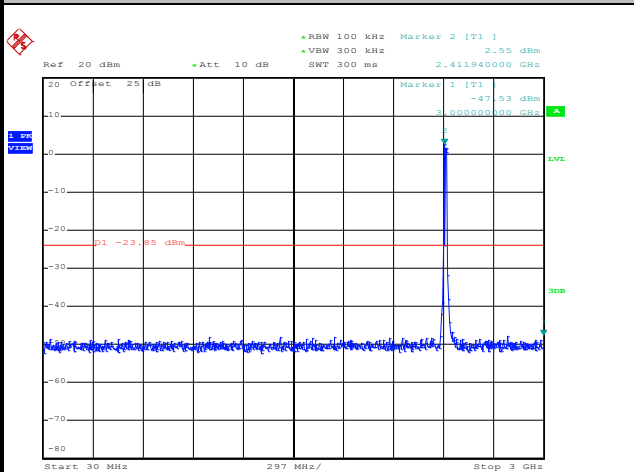

Date: 24.OCT.2017 23:12:51

Spurious Emission 2GHz~25GHz

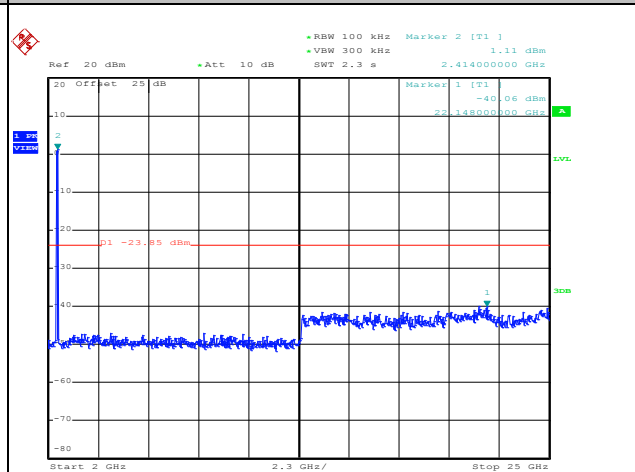

Date: 24.OCT.2017 23:13:00



Number of TX :	1	Ant. :	1
Test Mode :	802.11n HT20	Temperature :	21~25°C
Test Band :	2.4GHz Mid	Relative Humidity :	51~54%
Test Channel :	06	Test Engineer :	Kai Liao

WLAN 802.11n HT20 Channel 06

100kHz PSD reference Level

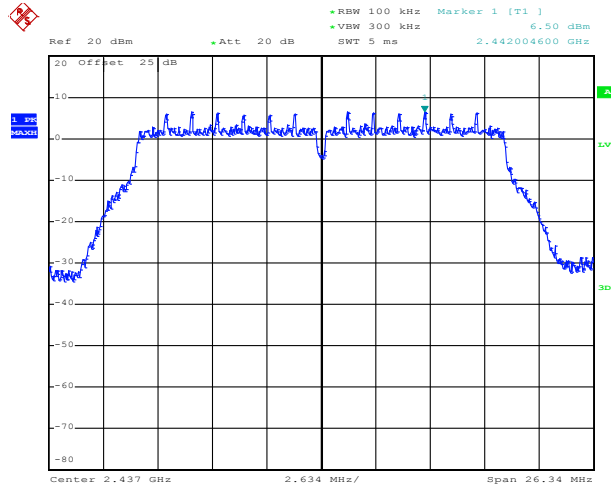

Date: 10.OCT.2017 14:26:47

Spurious Emission 30MHz~3GHz

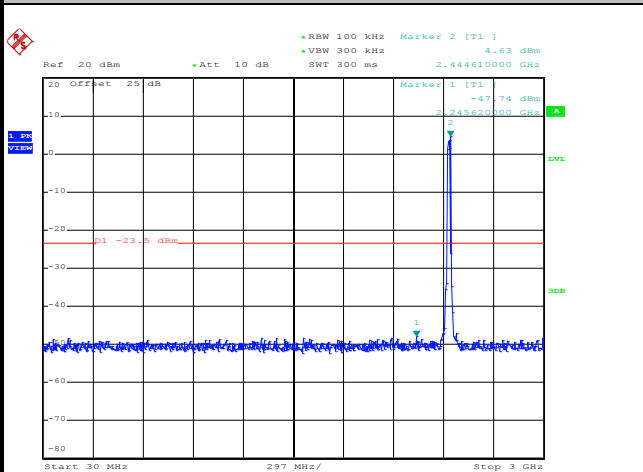

Date: 24.OCT.2017 23:14:50

Spurious Emission 2GHz~25GHz

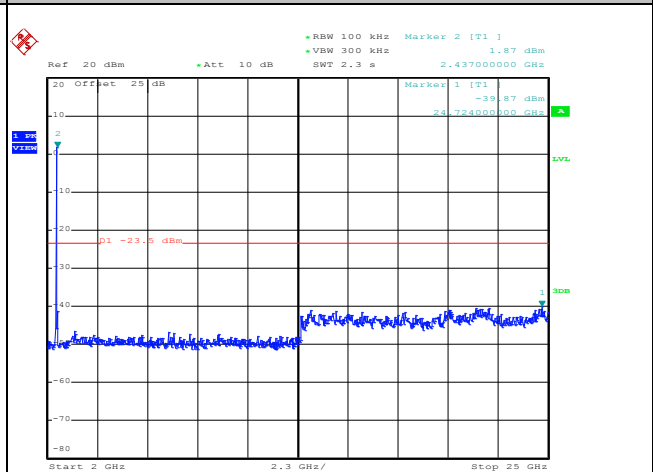

Date: 24.OCT.2017 23:14:58



Number of TX :	1	Ant. :	1
Test Mode :	802.11n HT20	Temperature :	21~25°C
Test Band :	2.4GHz High	Relative Humidity :	51~54%
Test Channel :	10	Test Engineer :	Kai Liao

WLAN 802.11n HT20 Channel 10

100kHz PSD reference Level

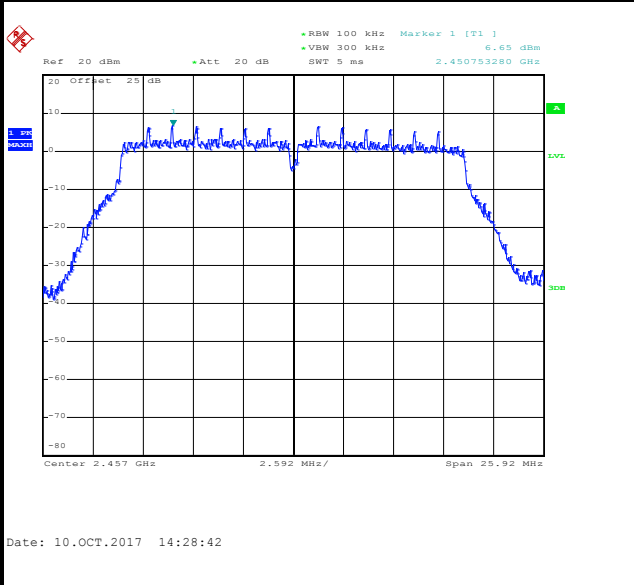

High Channel Plot

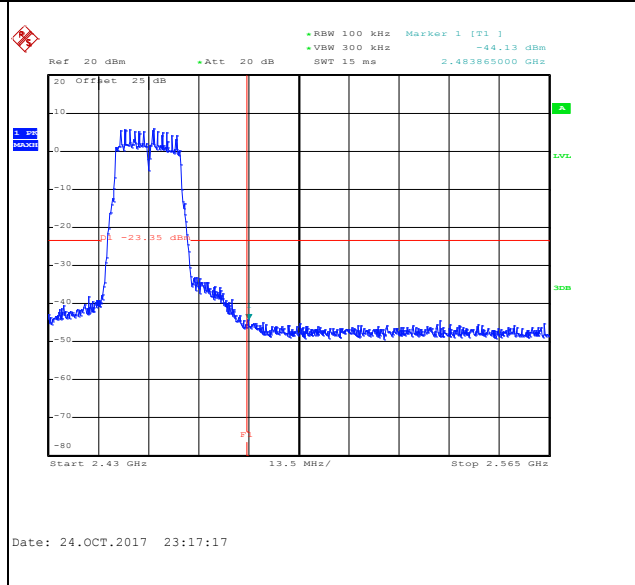

Spurious Emission 30MHz~3GHz

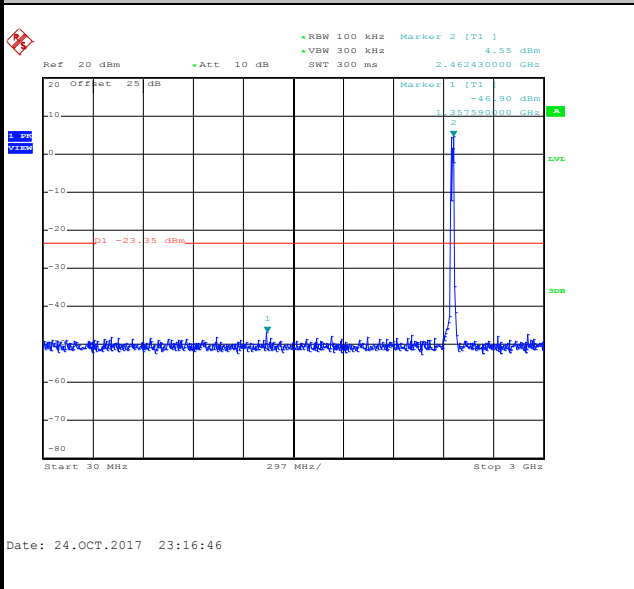

Spurious Emission 2GHz~25GHz

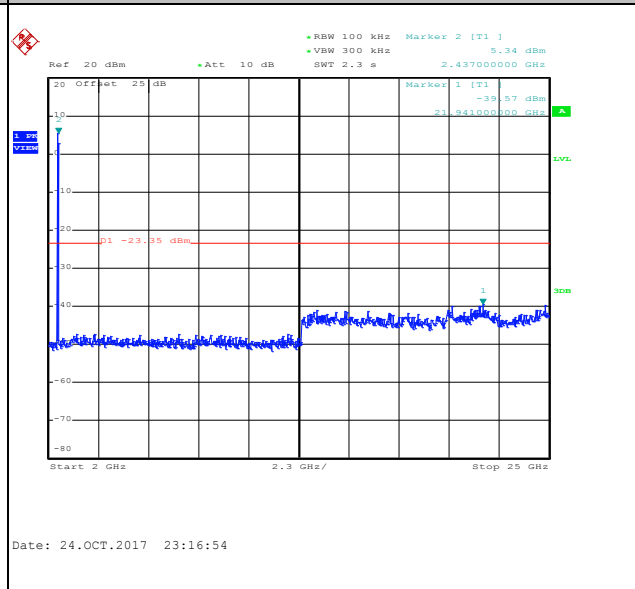



Number of TX :	1	Ant. :	1
Test Mode :	802.11n HT20	Temperature :	21~25°C
Test Band :	2.4GHz High	Relative Humidity :	51~54%
Test Channel :	11	Test Engineer :	Kai Liao

WLAN 802.11n HT20 Channel 11

100kHz PSD reference Level

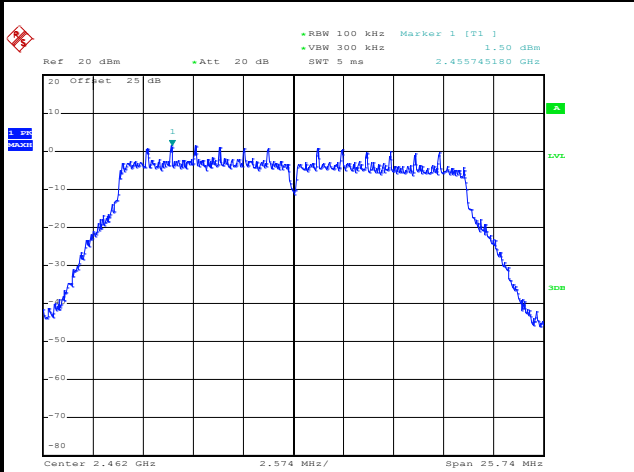

Date: 10.OCT.2017 14:31:19

High Channel Plot

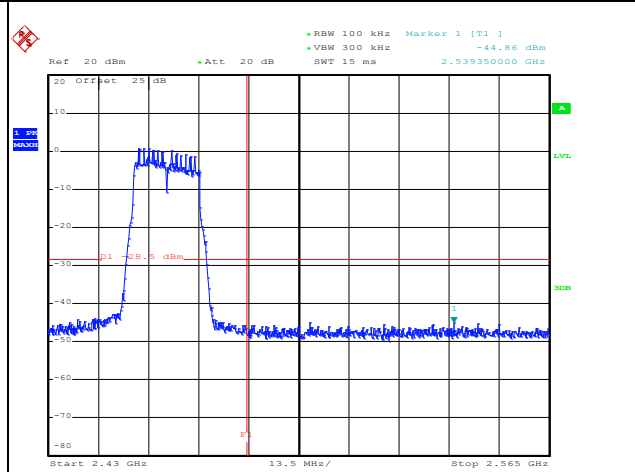

Date: 24.OCT.2017 23:19:03

Spurious Emission 30MHz~3GHz

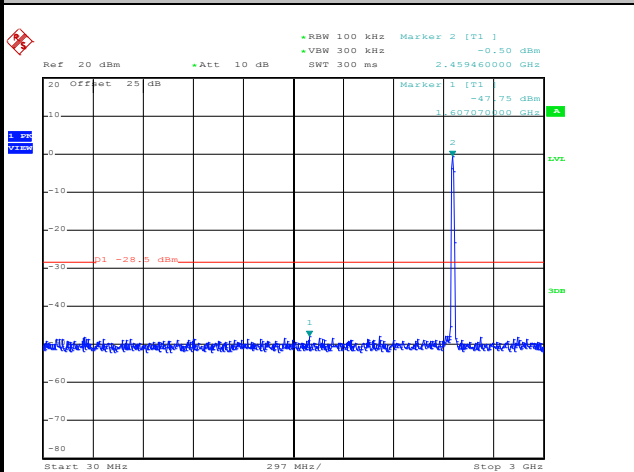

Date: 24.OCT.2017 23:18:38

Spurious Emission 2GHz~25GHz

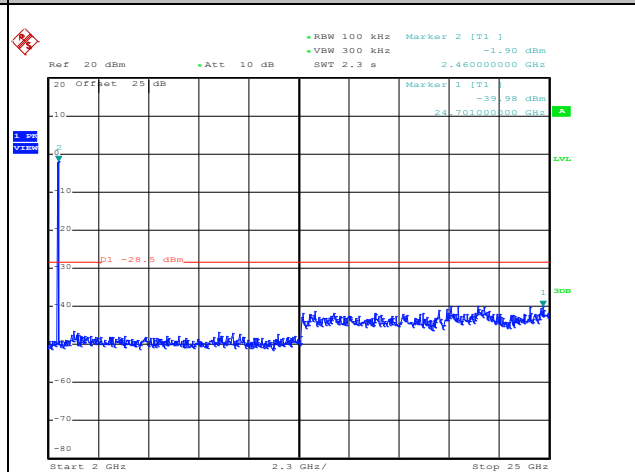

Date: 24.OCT.2017 23:18:47



Number of TX :	1	Ant. :	1
Test Mode :	802.11n HT40	Temperature :	21~25°C
Test Band :	2.4GHz Low	Relative Humidity :	51~54%
Test Channel :	03	Test Engineer :	Kai Liao

WLAN 802.11n HT40 Channel 03

100kHz PSD reference Level

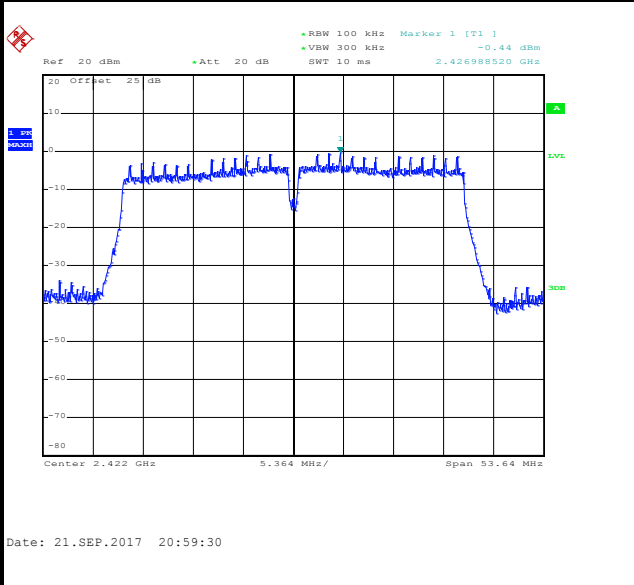

Low Channel Plot

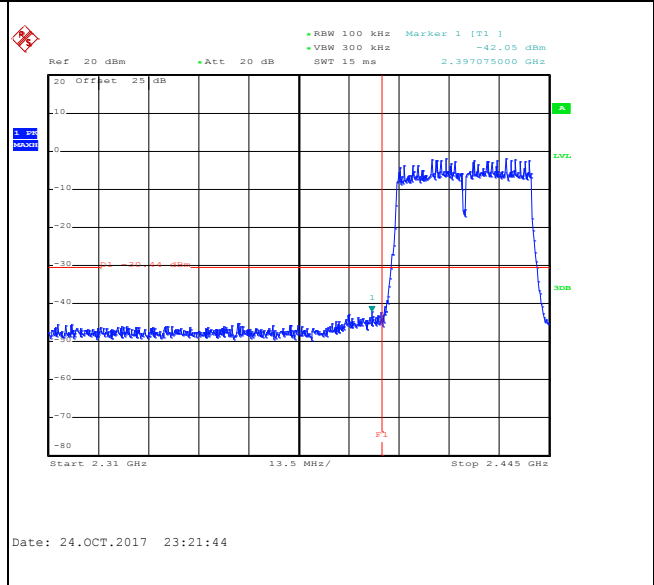

Spurious Emission 30MHz~3GHz

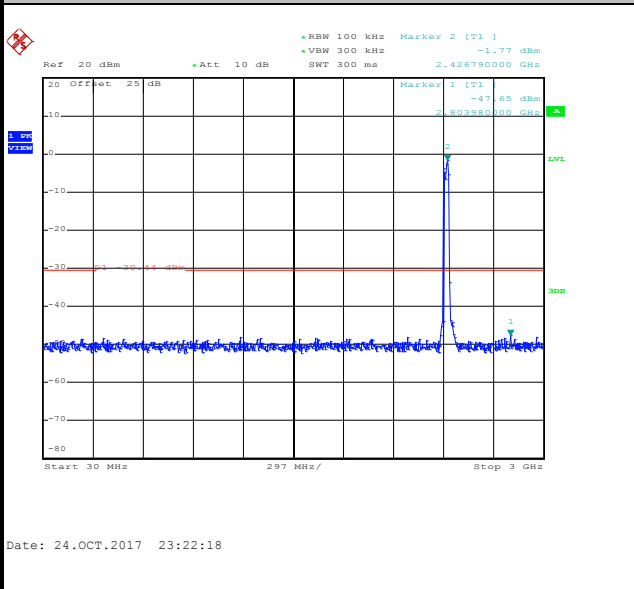

Spurious Emission 2GHz~25GHz

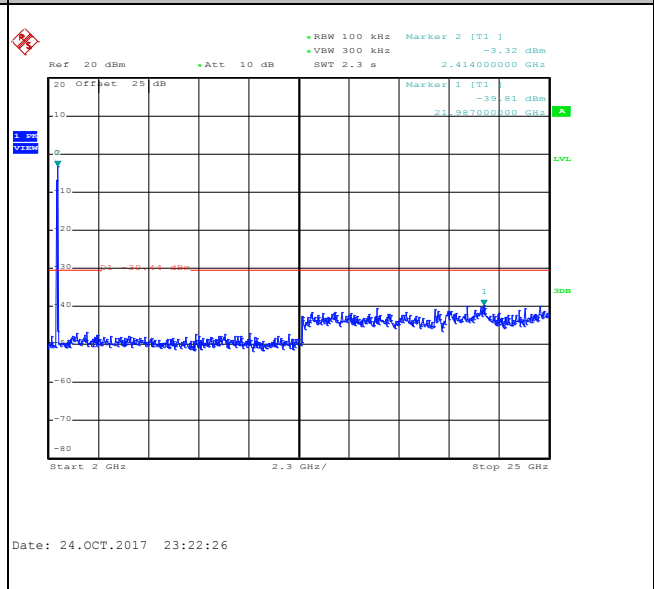



Number of TX :	1	Ant. :	1
Test Mode :	802.11n HT40	Temperature :	21~25°C
Test Band :	2.4GHz Mid	Relative Humidity :	51~54%
Test Channel :	06	Test Engineer :	Kai Liao

WLAN 802.11n HT40 Channel 06

100kHz PSD reference Level

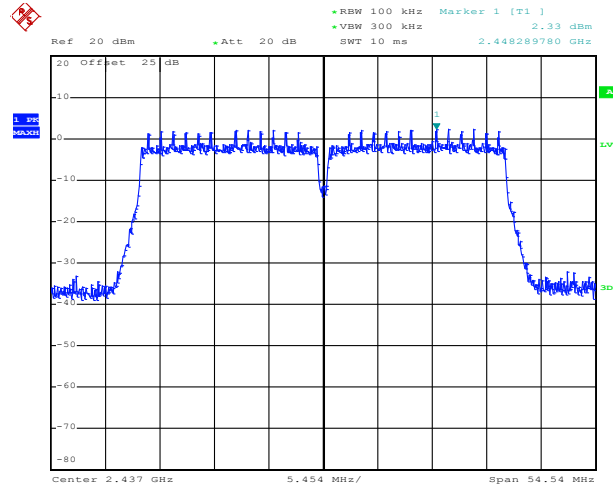

Date: 21.SEP.2017 21:09:38

Spurious Emission 30MHz~3GHz

Spurious Emission 2GHz~25GHz

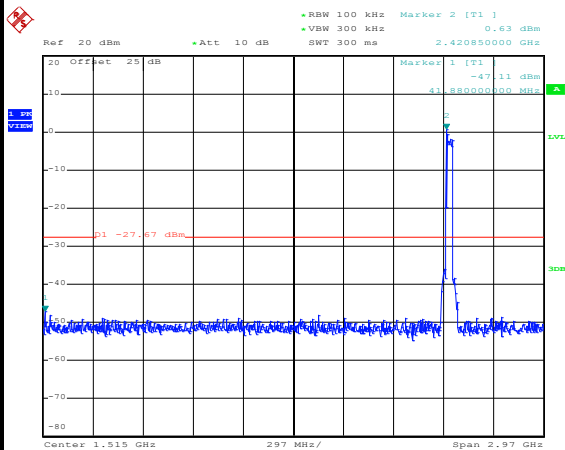

Date: 25.OCT.2017 01:34:21

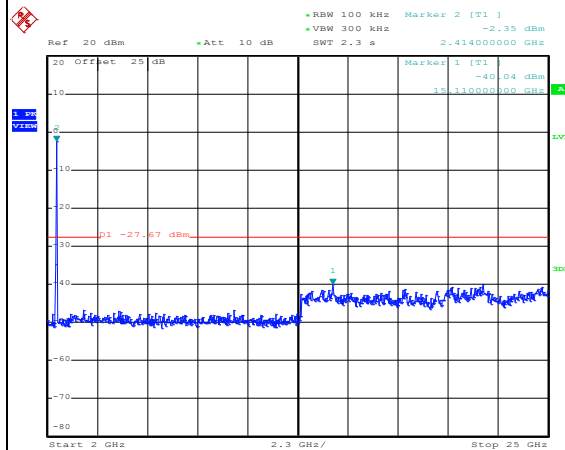

Date: 25.OCT.2017 01:34:30



Number of TX :	1	Ant. :	1
Test Mode :	802.11n HT40	Temperature :	21~25°C
Test Band :	2.4GHz High	Relative Humidity :	51~54%
Test Channel :	09	Test Engineer :	Kai Liao

WLAN 802.11n HT40 Channel 09

100kHz PSD reference Level

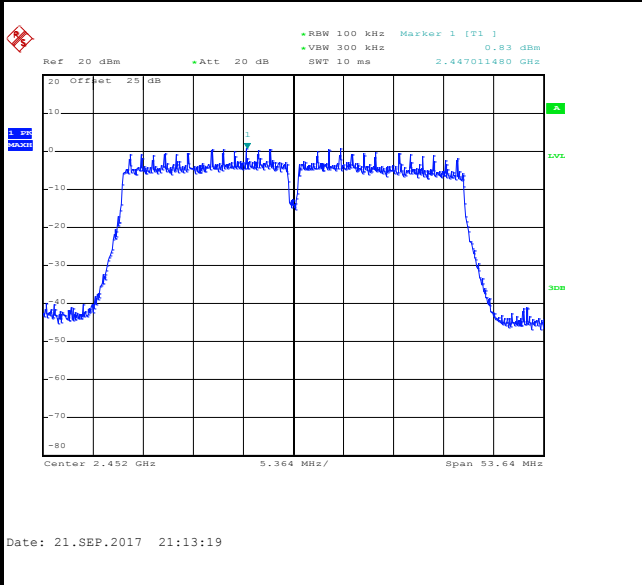

High Channel Plot

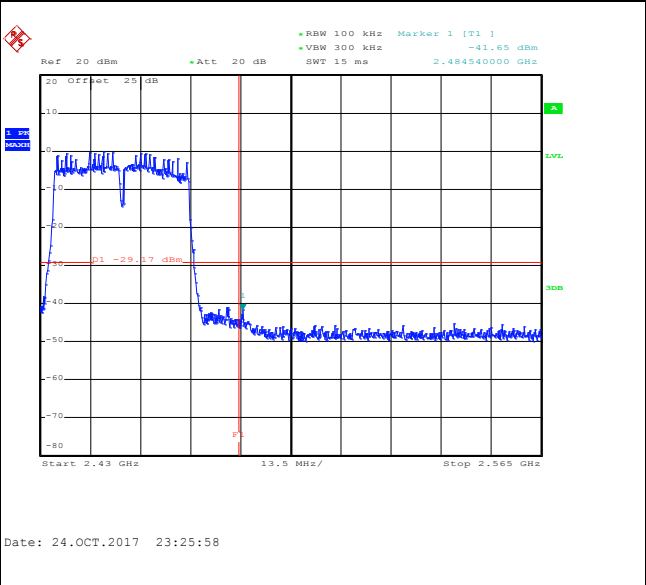

Spurious Emission 30MHz~3GHz

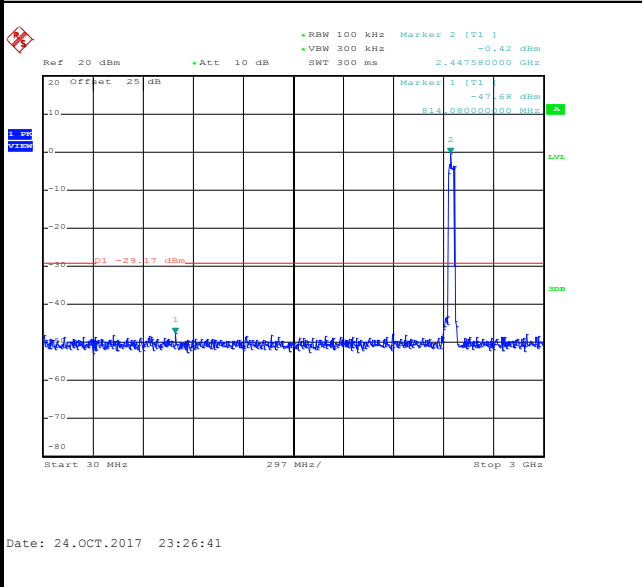

Spurious Emission 2GHz~25GHz

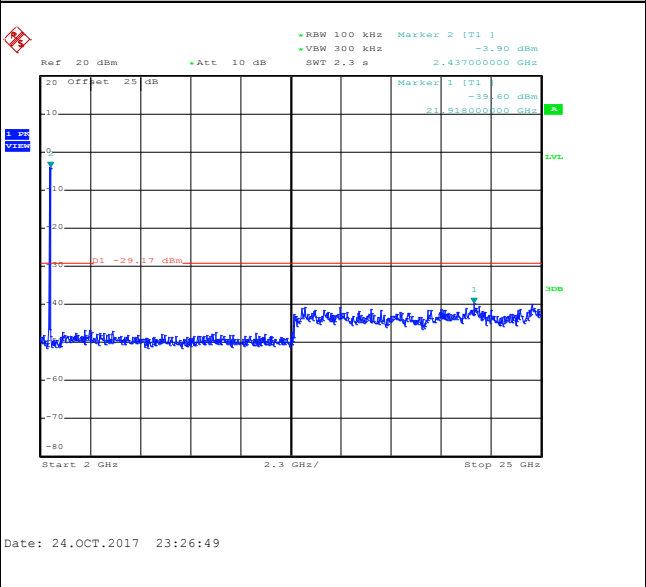



Number of TX = 1, Ant. 2 (Measured)

Number of TX	1	Ant. :	2
Test Mode :	802.11b	Temperature :	21~25°C
Test Band :	2.4GHz Low	Relative Humidity :	51~54%
Test Channel :	01	Test Engineer :	Kai Liao

WLAN 802.11b Channel 01

100kHz PSD reference Level

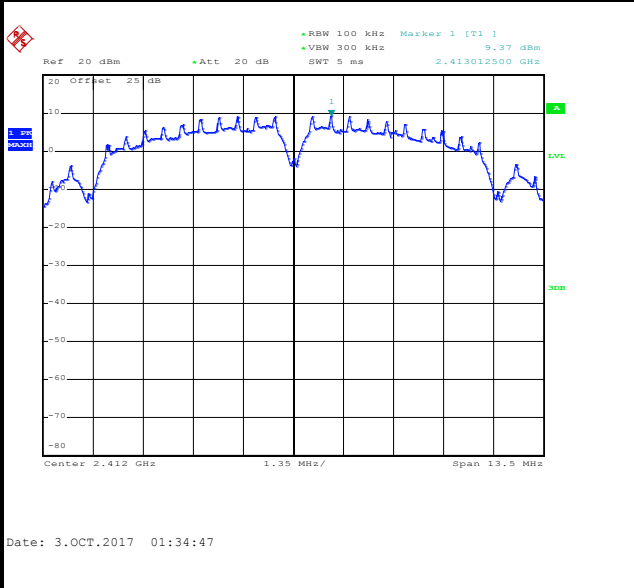

Low Channel Plot

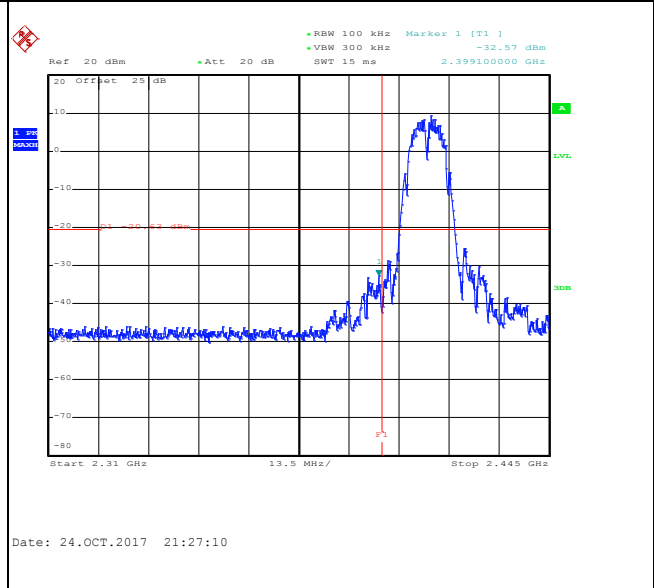

Spurious Emission 30MHz~3GHz

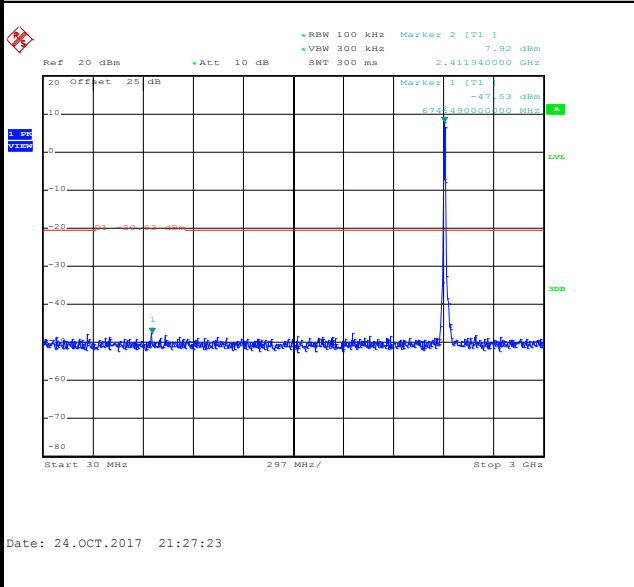

Spurious Emission 2GHz~25GHz

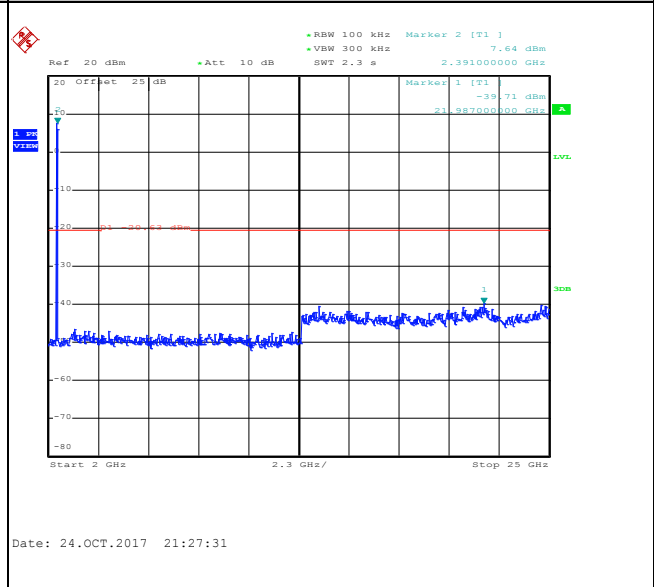



Number of TX	1	Ant. :	2
Test Mode :	802.11b	Temperature :	21~25°C
Test Band :	2.4GHz Low	Relative Humidity :	51~54%
Test Channel :	02	Test Engineer :	Kai Liao

WLAN 802.11b Channel 02

100kHz PSD reference Level

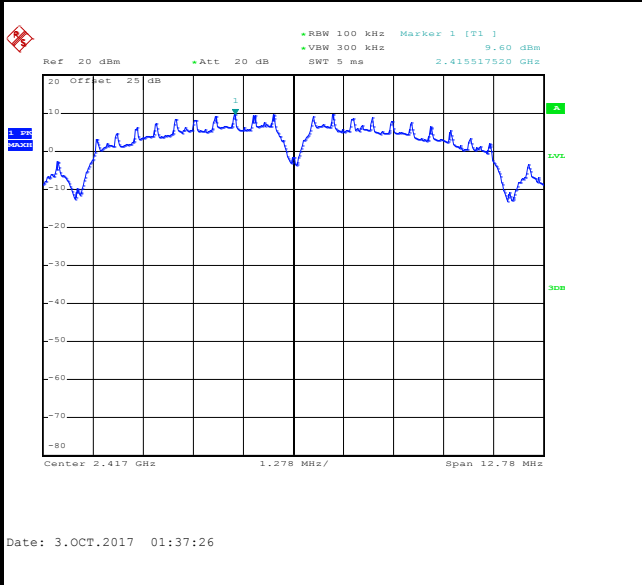

Low Channel Plot

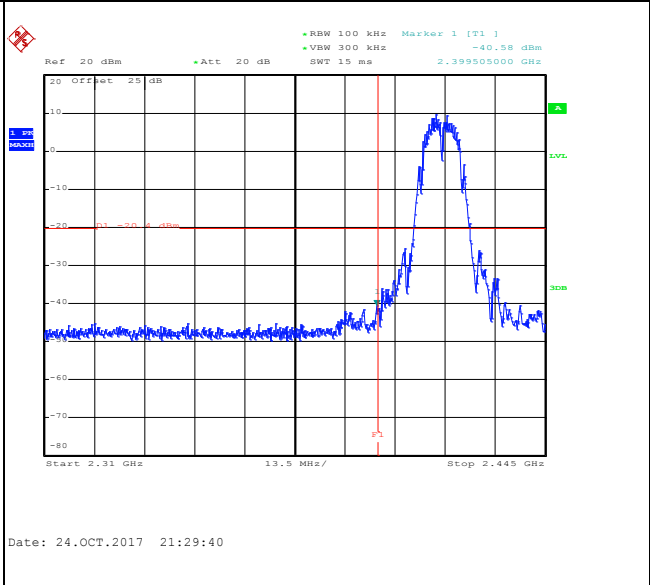

Spurious Emission 30MHz~3GHz

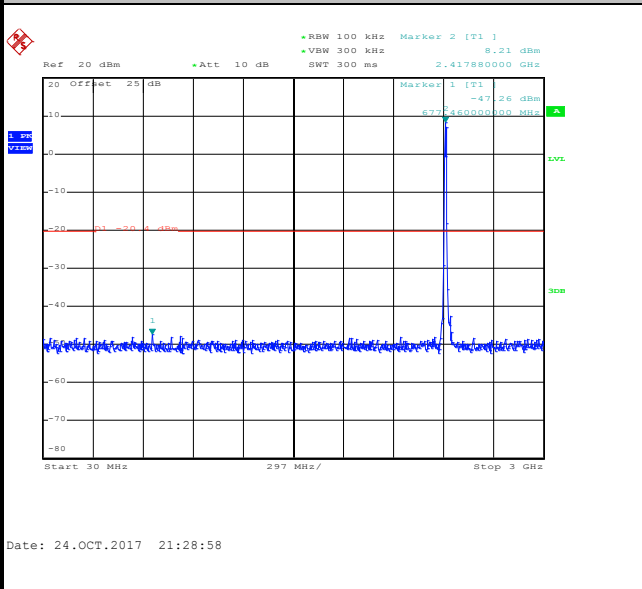

Spurious Emission 2GHz~25GHz

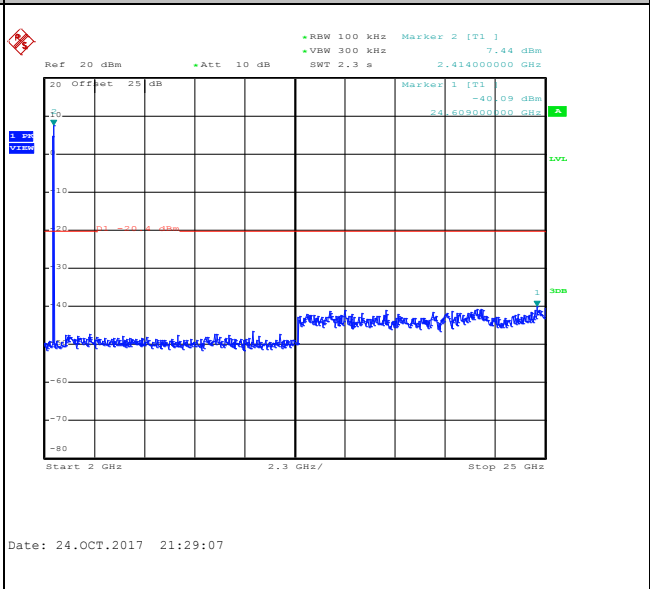



Number of TX :	1	Ant. :	2
Test Mode :	802.11b	Temperature :	21~25°C
Test Band :	2.4GHz Mid	Relative Humidity :	51~54%
Test Channel :	06	Test Engineer :	Kai Liao

WLAN 802.11b Channel 06

100kHz PSD reference Level

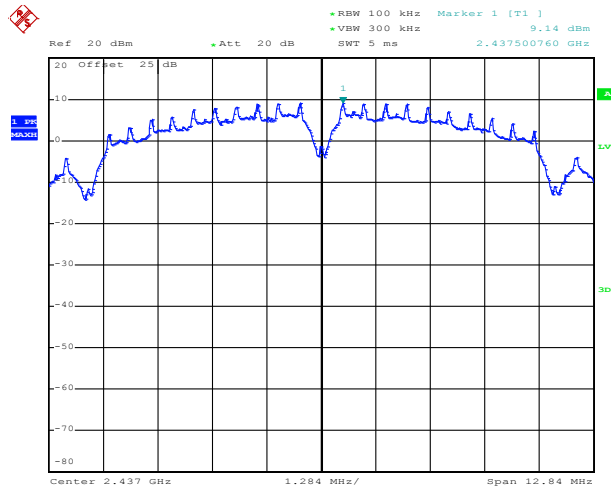

Date: 3.OCT.2017 01:39:11

Spurious Emission 30MHz~3GHz

Spurious Emission 2GHz~25GHz

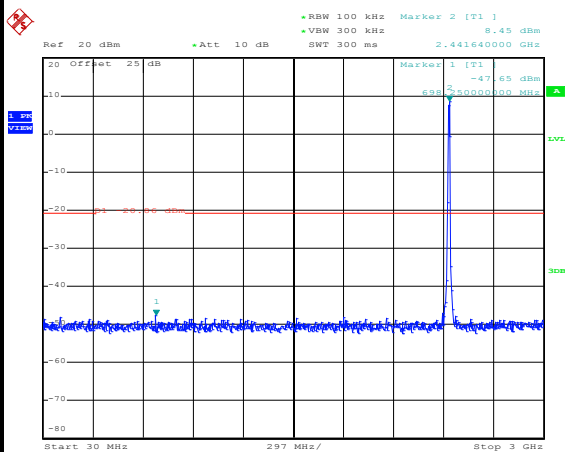

Date: 24.OCT.2017 21:31:36

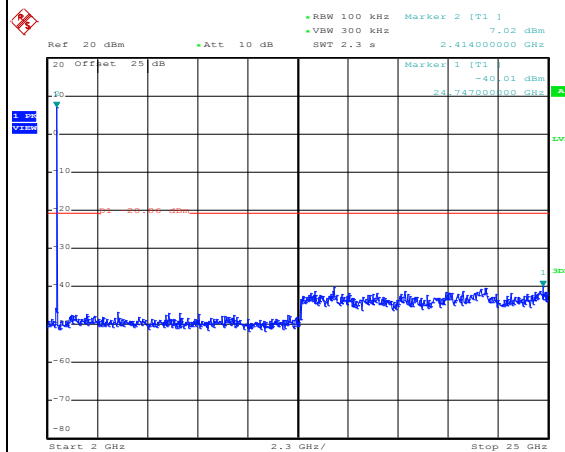

Date: 24.OCT.2017 21:31:44



Number of TX :	1	Ant. :	2
Test Mode :	802.11b	Temperature :	21~25°C
Test Band :	2.4GHz High	Relative Humidity :	51~54%
Test Channel :	10	Test Engineer :	Kai Liao

WLAN 802.11b Channel 10

100kHz PSD reference Level

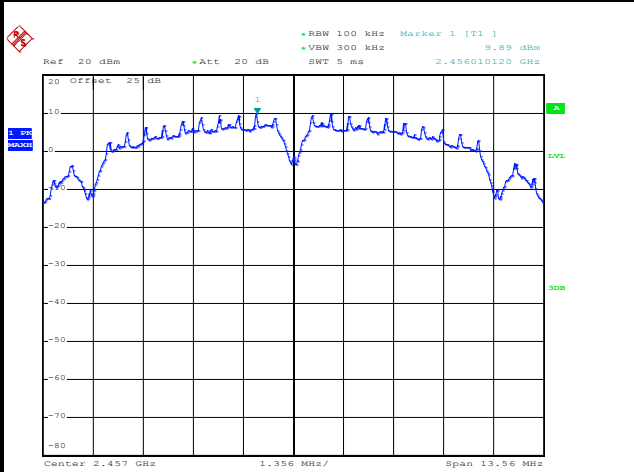

Date: 3.OCT.2017 01:42:01

High Channel Plot

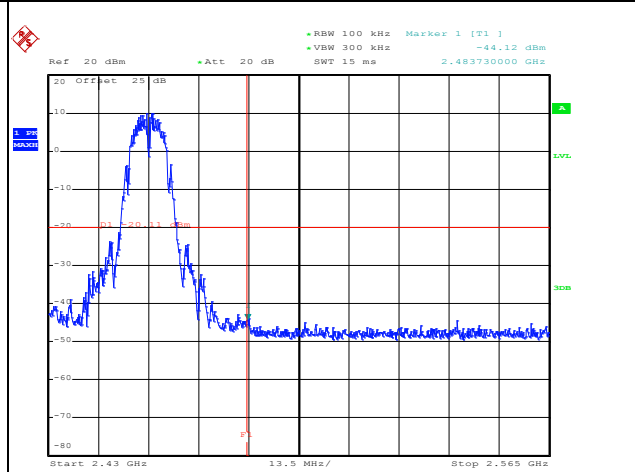

Date: 24.OCT.2017 21:33:52

Spurious Emission 30MHz~3GHz

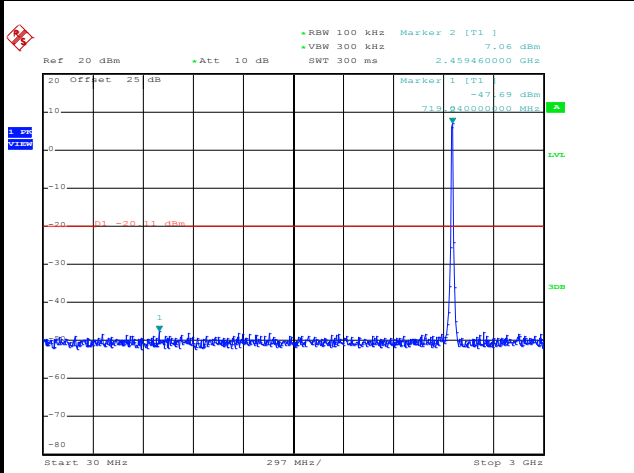

Date: 24.OCT.2017 21:33:13

Spurious Emission 2GHz~25GHz

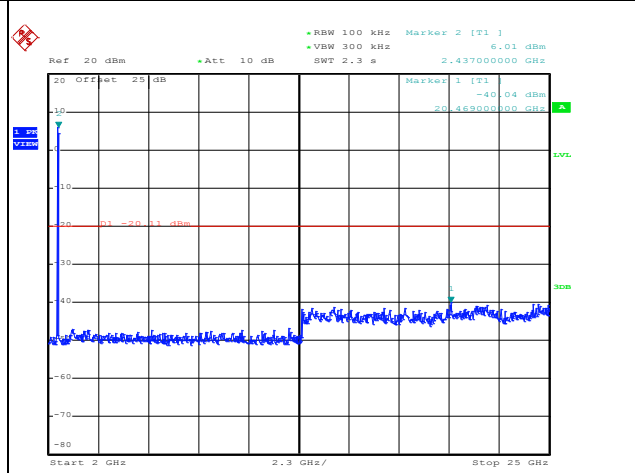

Date: 24.OCT.2017 21:33:22



Number of TX :	1	Ant. :	2
Test Mode :	802.11b	Temperature :	21~25°C
Test Band :	2.4GHz High	Relative Humidity :	51~54%
Test Channel :	11	Test Engineer :	Kai Liao

WLAN 802.11b Channel 11

100kHz PSD reference Level

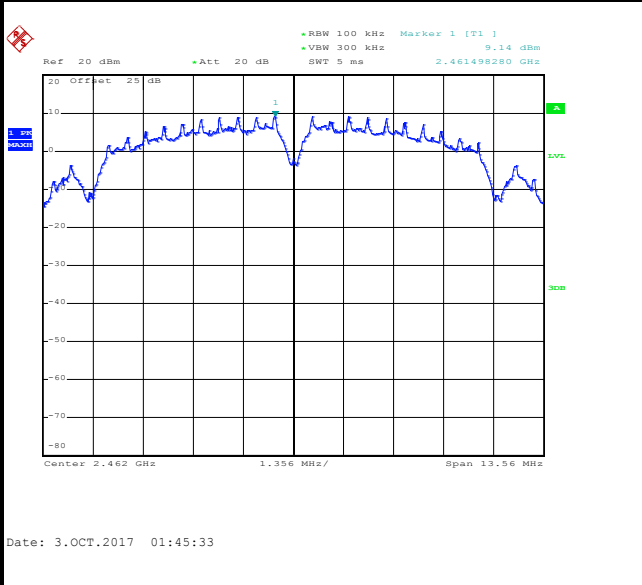

High Channel Plot

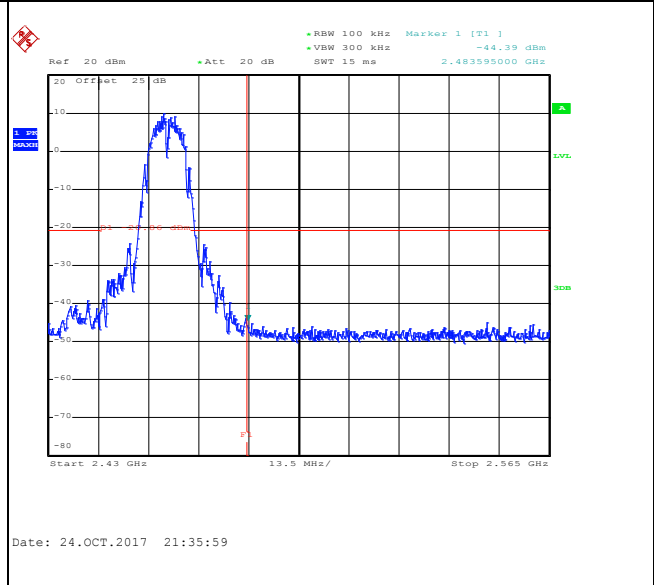

Spurious Emission 30MHz~3GHz

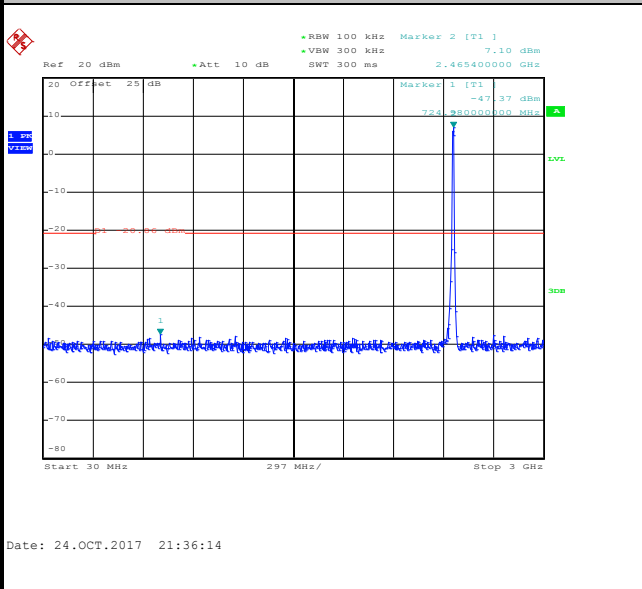

Spurious Emission 2GHz~25GHz

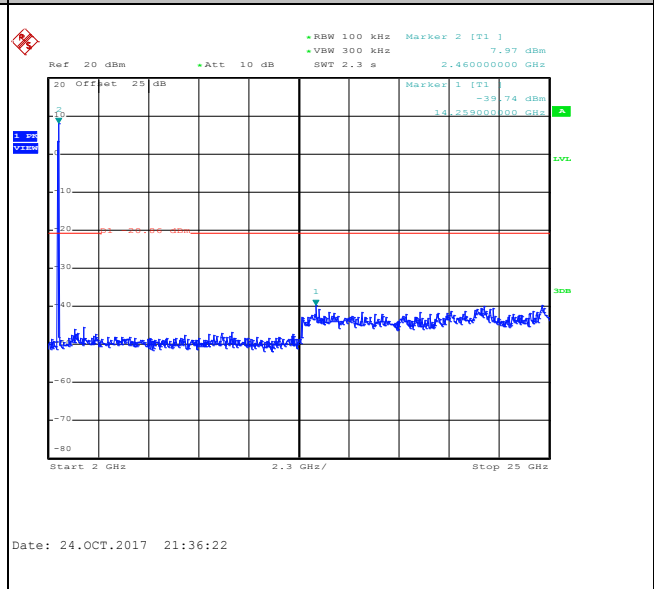



Number of TX :	1	Ant. :	2
Test Mode :	802.11g	Temperature :	21~25°C
Test Band :	2.4GHz Low	Relative Humidity :	51~54%
Test Channel :	01	Test Engineer :	Kai Liao

WLAN 802.11g Channel 01

100kHz PSD reference Level

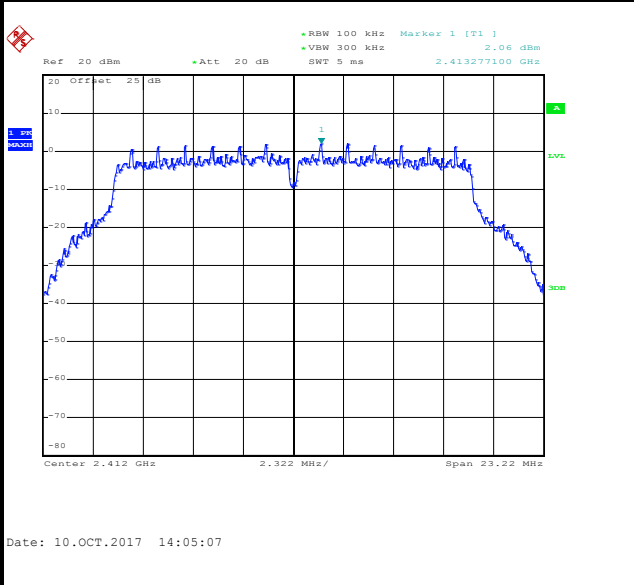

Low Channel Plot

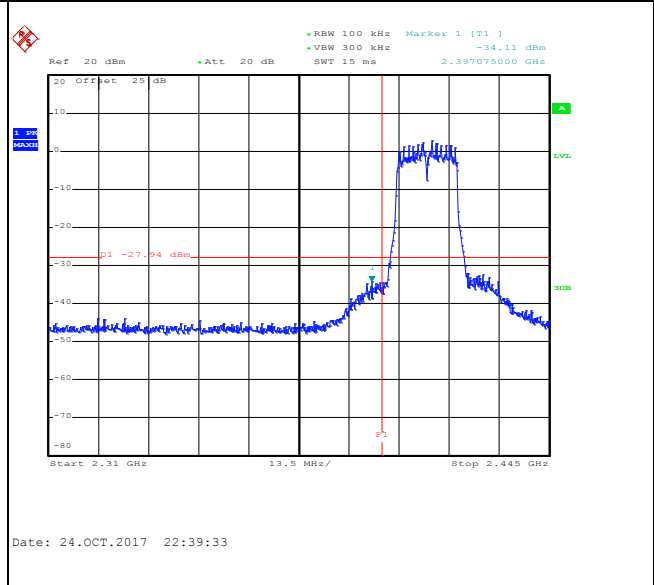

Spurious Emission 30MHz~3GHz

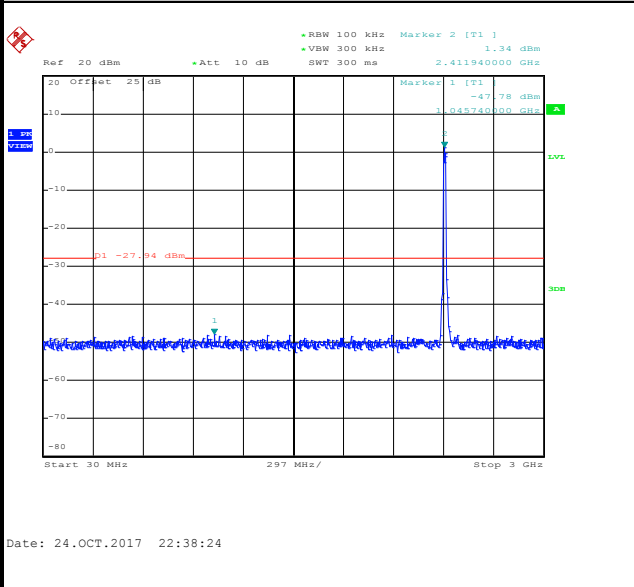

Spurious Emission 2GHz~25GHz

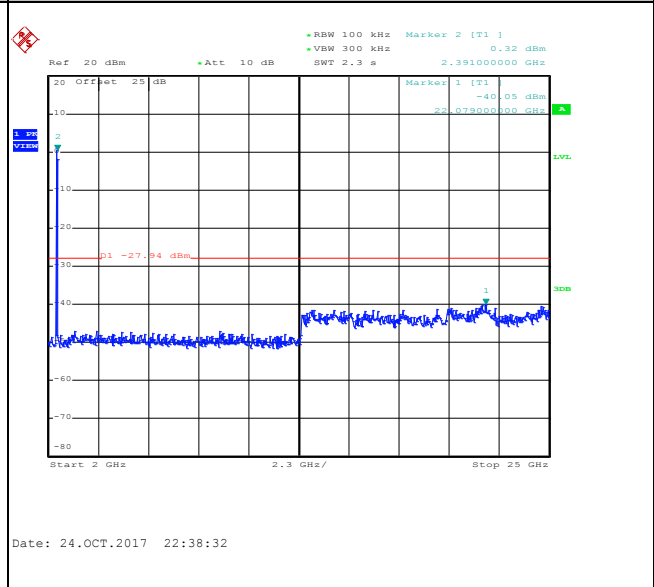



Number of TX :	1	Ant. :	2
Test Mode :	802.11g	Temperature :	21~25°C
Test Band :	2.4GHz Low	Relative Humidity :	51~54%
Test Channel :	02	Test Engineer :	Kai Liao

WLAN 802.11g Channel 02

100kHz PSD reference Level

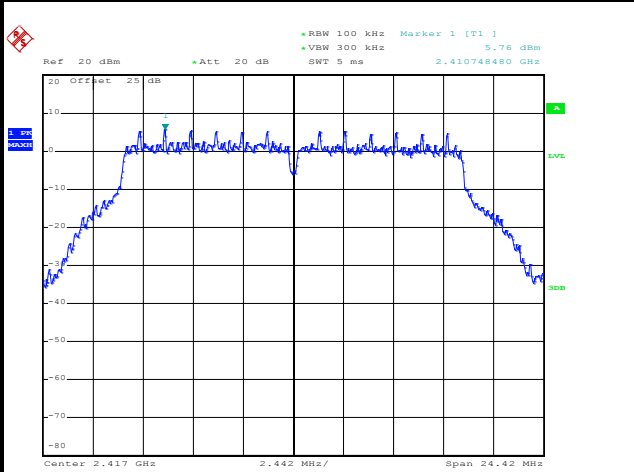

Date: 10.OCT.2017 14:01:51

Low Channel Plot

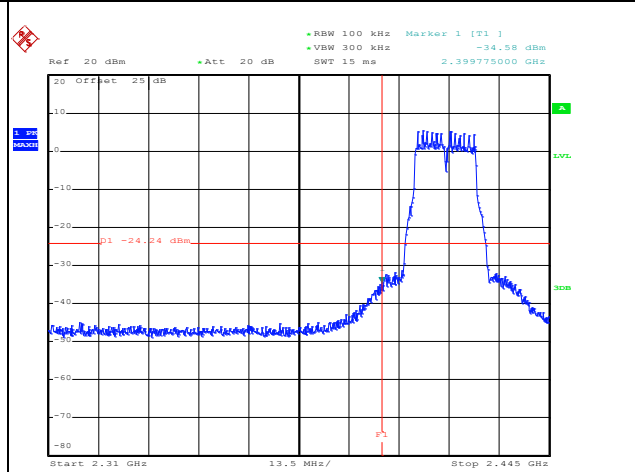

Date: 24.OCT.2017 22:47:18

Spurious Emission 30MHz~3GHz

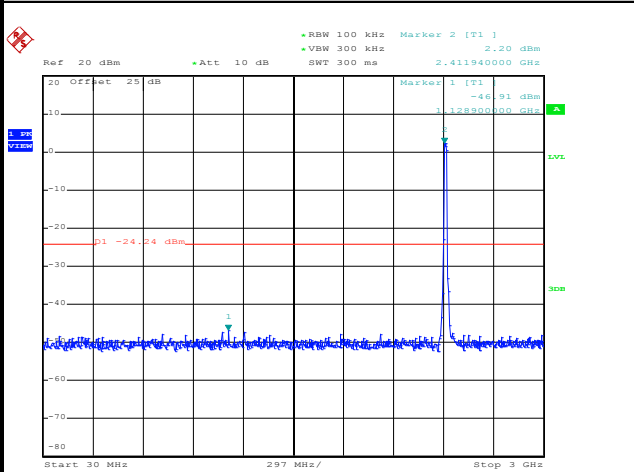

Date: 24.OCT.2017 22:46:23

Spurious Emission 2GHz~25GHz

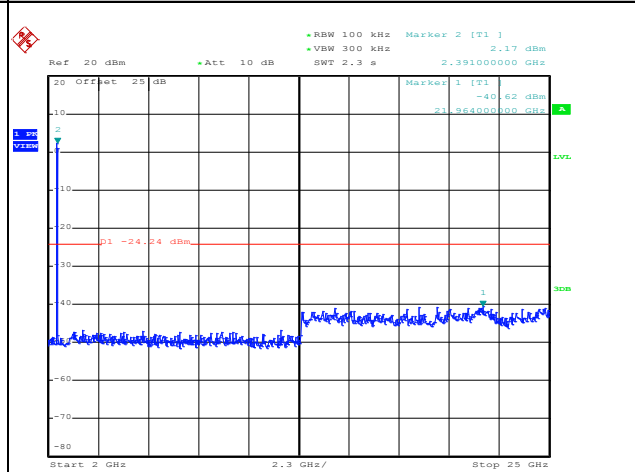

Date: 24.OCT.2017 22:46:32



Number of TX :	1	Ant. :	2
Test Mode :	802.11g	Temperature :	21~25°C
Test Band :	2.4GHz Mid	Relative Humidity :	51~54%
Test Channel :	06	Test Engineer :	Kai Liao

WLAN 802.11g Channel 06

100kHz PSD reference Level

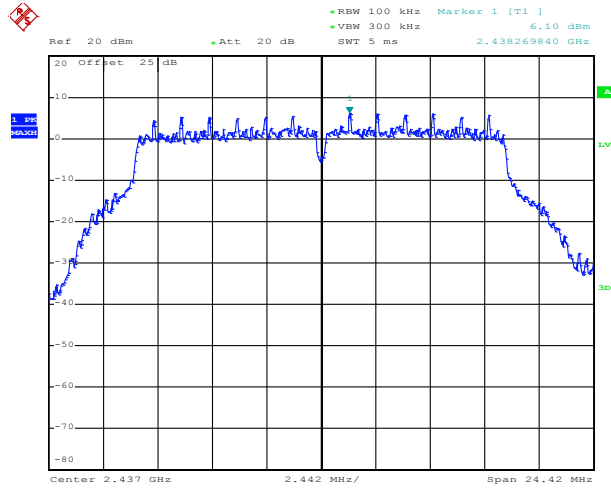

Date: 10.OCT.2017 13:52:27

Spurious Emission 30MHz~3GHz

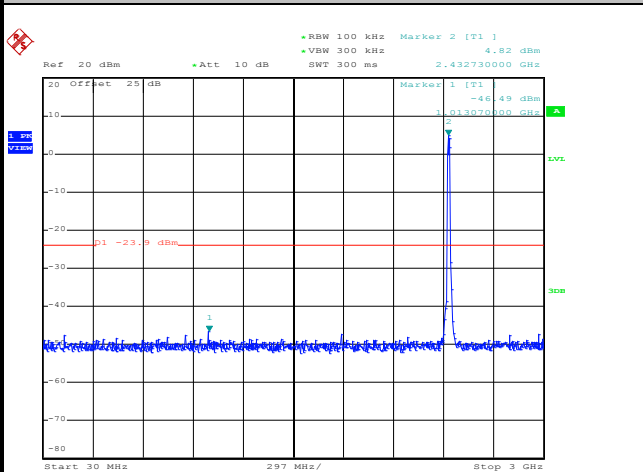

Date: 24.OCT.2017 22:49:27

Spurious Emission 2GHz~25GHz

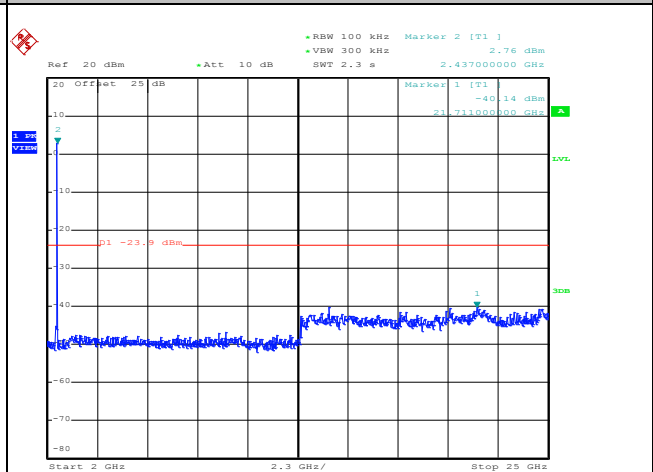

Date: 24.OCT.2017 22:49:35



Number of TX :	1	Ant. :	2
Test Mode :	802.11g	Temperature :	21~25°C
Test Band :	2.4GHz High	Relative Humidity :	51~54%
Test Channel :	10	Test Engineer :	Kai Liao

WLAN 802.11g Channel 10

100kHz PSD reference Level

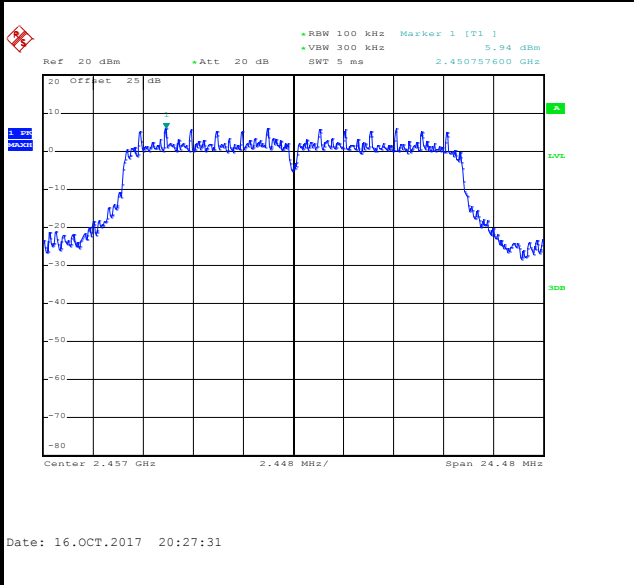

High Channel Plot

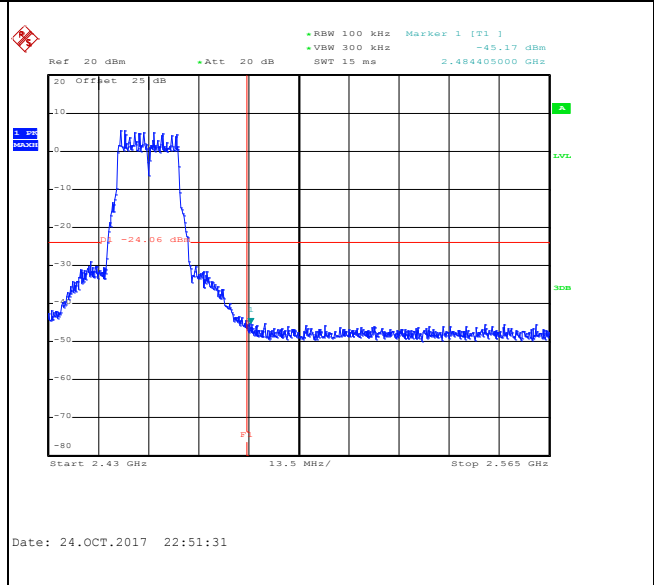

Spurious Emission 30MHz~3GHz

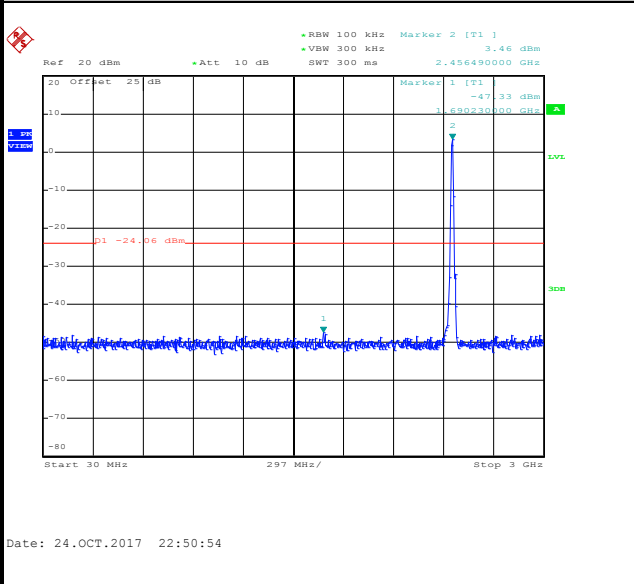

Spurious Emission 2GHz~25GHz

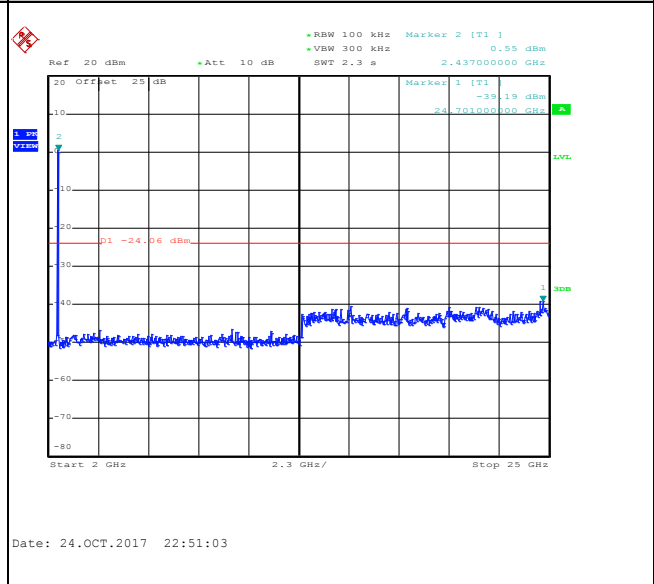



Number of TX :	1	Ant. :	2
Test Mode :	802.11g	Temperature :	21~25°C
Test Band :	2.4GHz High	Relative Humidity :	51~54%
Test Channel :	11	Test Engineer :	Kai Liao

WLAN 802.11g Channel 11

100kHz PSD reference Level

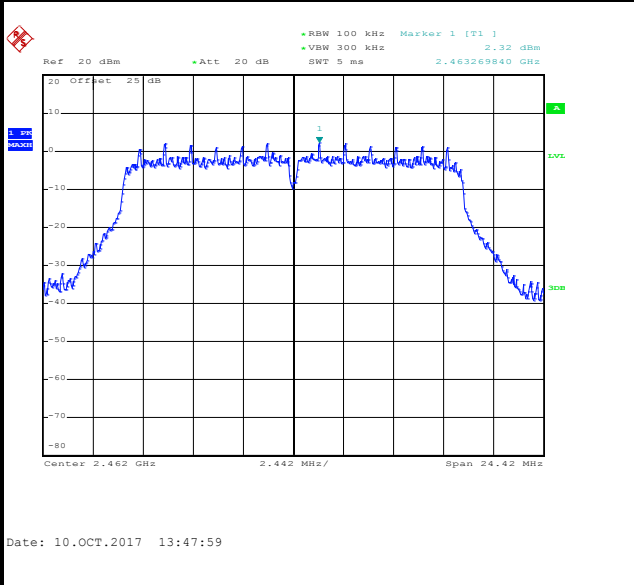

High Channel Plot

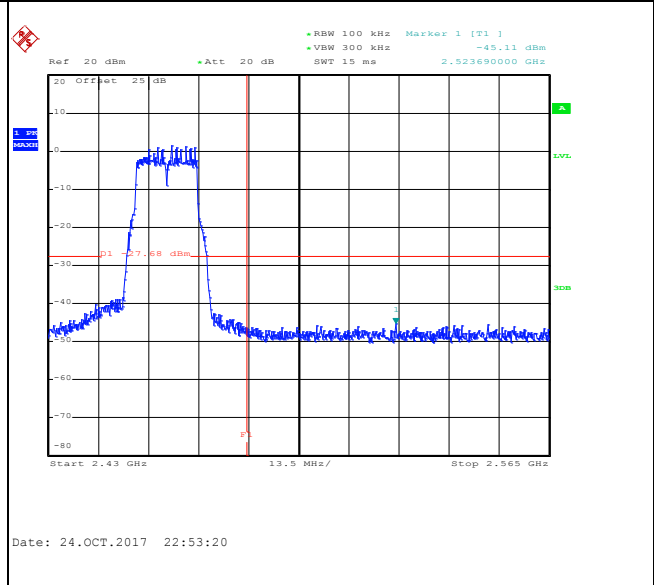

Spurious Emission 30MHz~3GHz

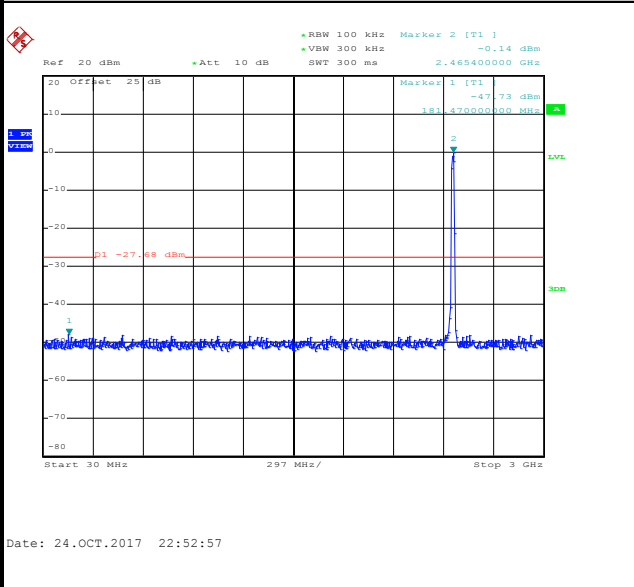

Spurious Emission 2GHz~25GHz

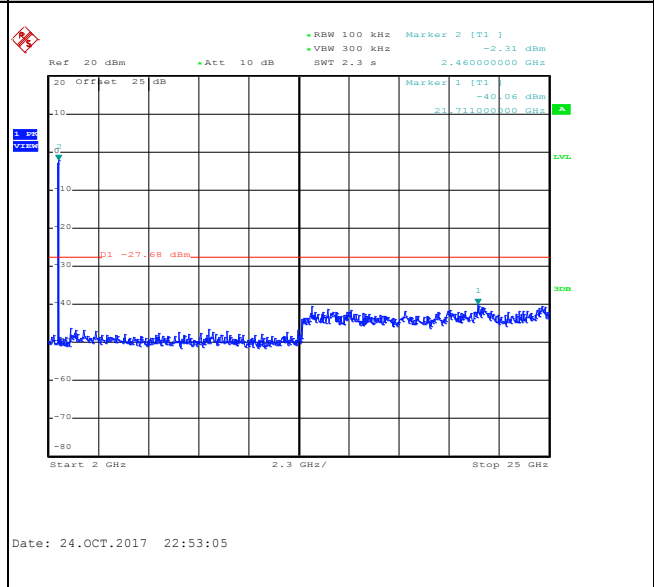



Number of TX	1	Ant. :	2
Test Mode :	802.11n HT20	Temperature :	21~25°C
Test Band :	2.4GHz Low	Relative Humidity :	51~54%
Test Channel :	01	Test Engineer :	Kai Liao

WLAN 802.11n HT20 Channel 01

100kHz PSD reference Level

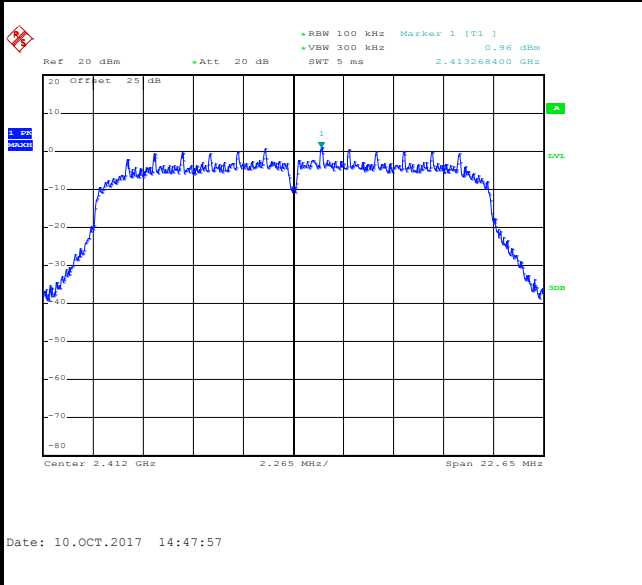

Low Channel Plot

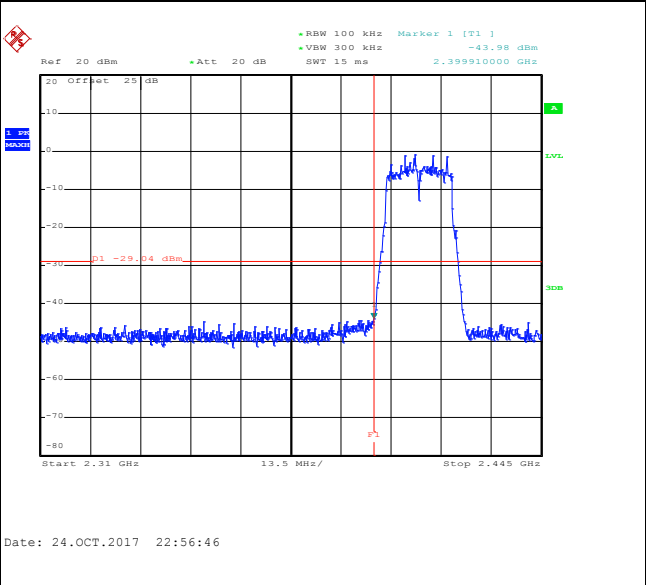

Spurious Emission 30MHz~3GHz

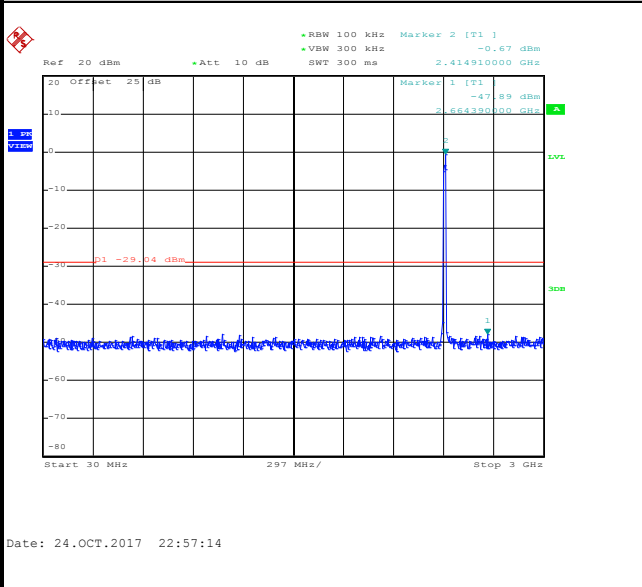

Spurious Emission 2GHz~25GHz

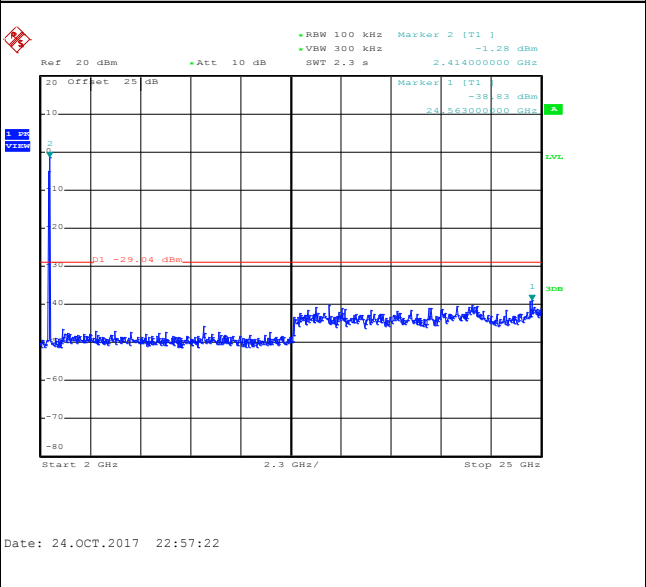



Number of TX	1	Ant. :	2
Test Mode :	802.11n HT20	Temperature :	21~25°C
Test Band :	2.4GHz Low	Relative Humidity :	51~54%
Test Channel :	02	Test Engineer :	Kai Liao

WLAN 802.11n HT20 Channel 02

100kHz PSD reference Level

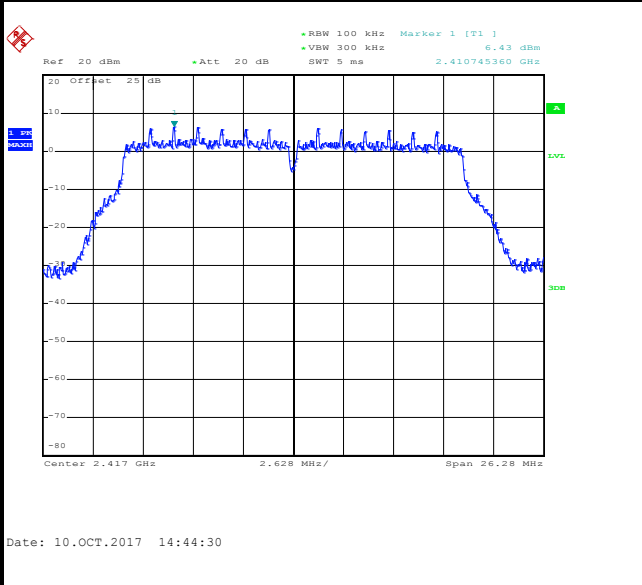

Low Channel Plot

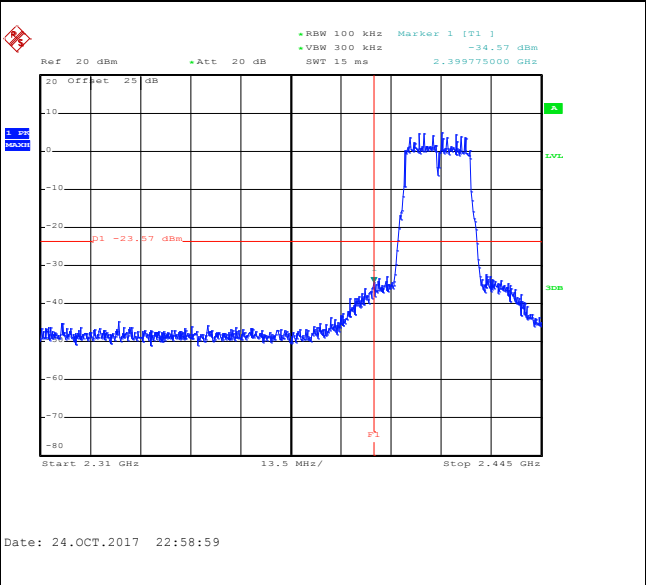

Spurious Emission 30MHz~3GHz

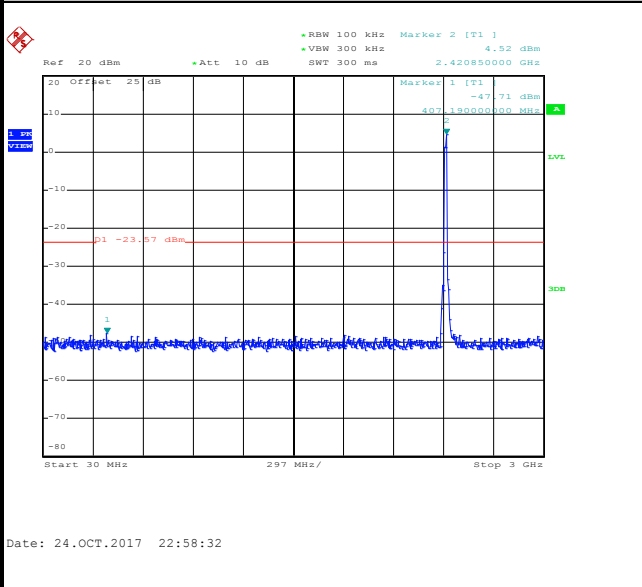

Spurious Emission 2GHz~25GHz

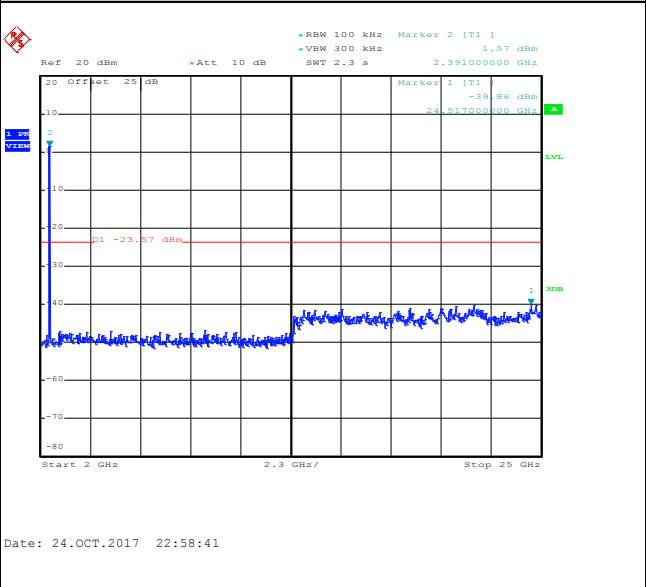



Number of TX :	1	Ant. :	2
Test Mode :	802.11n HT20	Temperature :	21~25°C
Test Band :	2.4GHz Mid	Relative Humidity :	51~54%
Test Channel :	06	Test Engineer :	Kai Liao

WLAN 802.11n HT20 Channel 06

100kHz PSD reference Level

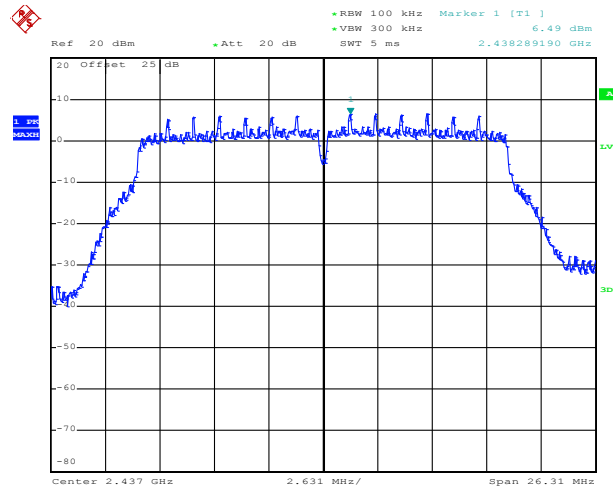

Date: 10.OCT.2017 14:41:46

Spurious Emission 30MHz~3GHz

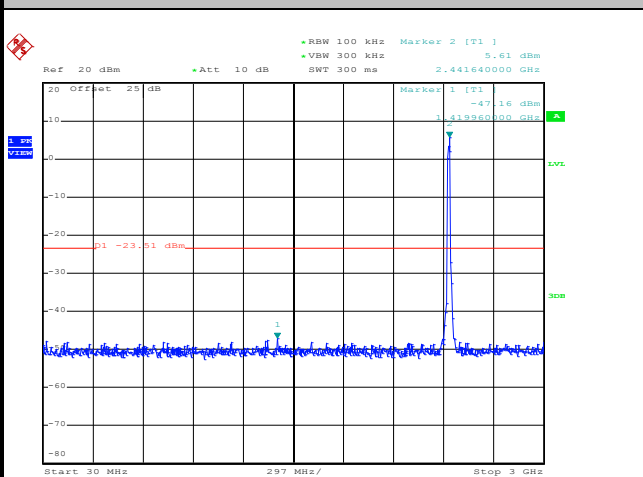

Date: 24.OCT.2017 23:00:48

Spurious Emission 2GHz~25GHz

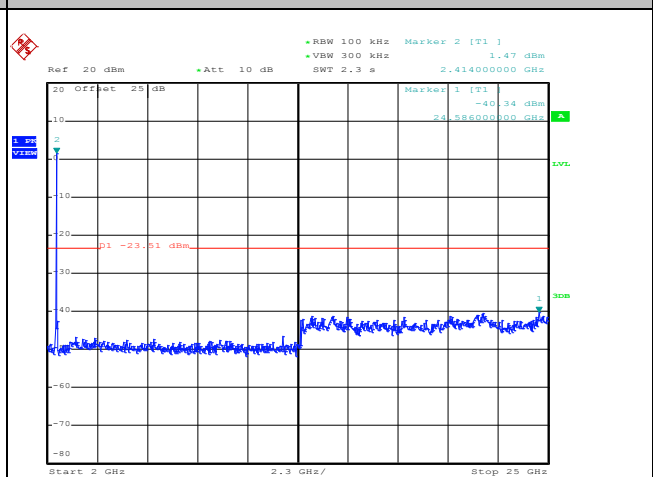

Date: 24.OCT.2017 23:00:57



Number of TX :	1	Ant. :	2
Test Mode :	802.11n HT20	Temperature :	21~25°C
Test Band :	2.4GHz High	Relative Humidity :	51~54%
Test Channel :	10	Test Engineer :	Kai Liao

WLAN 802.11n HT20 Channel 10

100kHz PSD reference Level

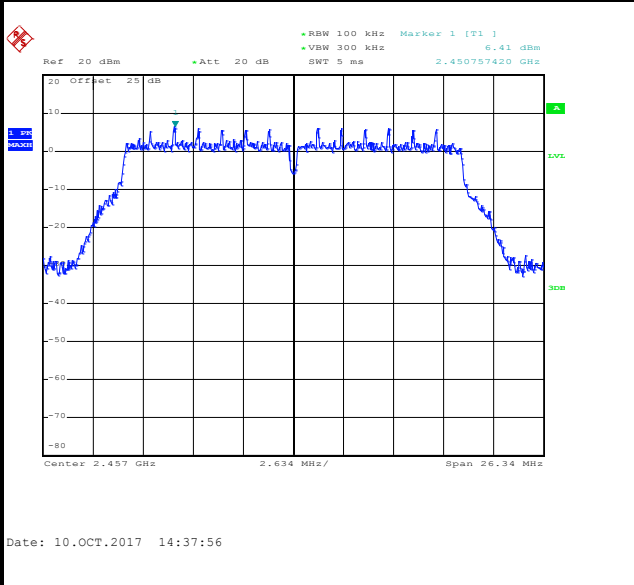

High Channel Plot

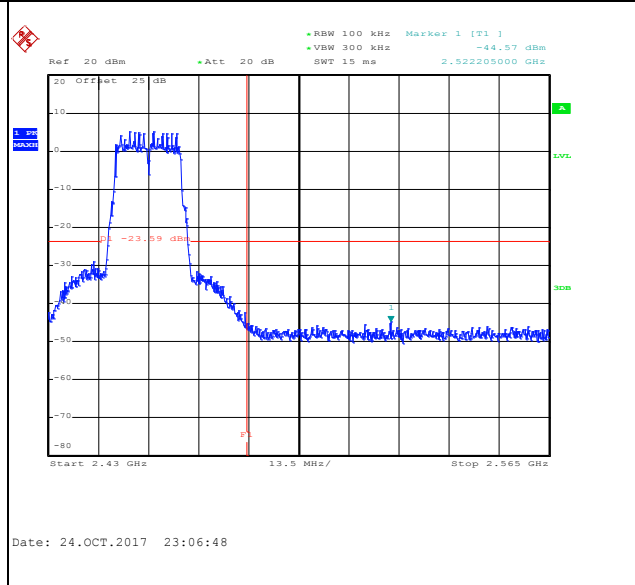

Spurious Emission 30MHz~3GHz

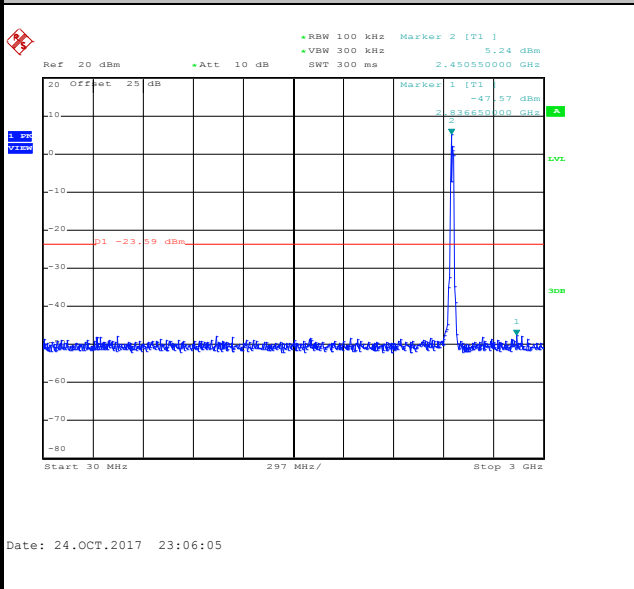

Spurious Emission 2GHz~25GHz

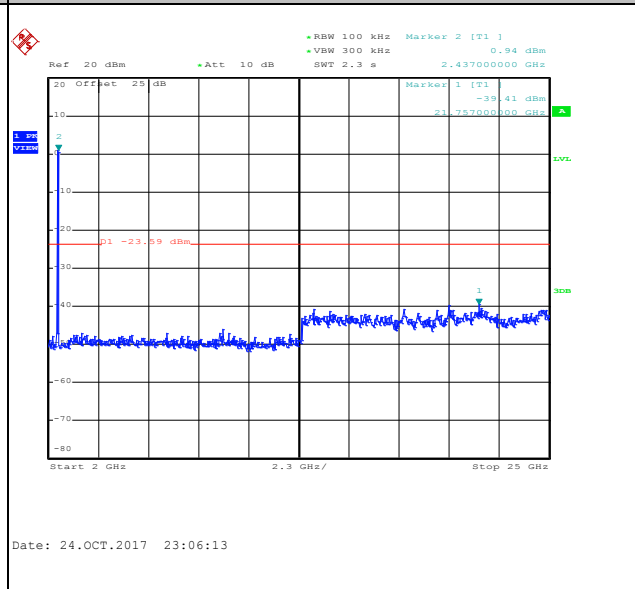



Number of TX :	1	Ant. :	2
Test Mode :	802.11n HT20	Temperature :	21~25°C
Test Band :	2.4GHz High	Relative Humidity :	51~54%
Test Channel :	11	Test Engineer :	Kai Liao

WLAN 802.11n HT20 Channel 11

100kHz PSD reference Level

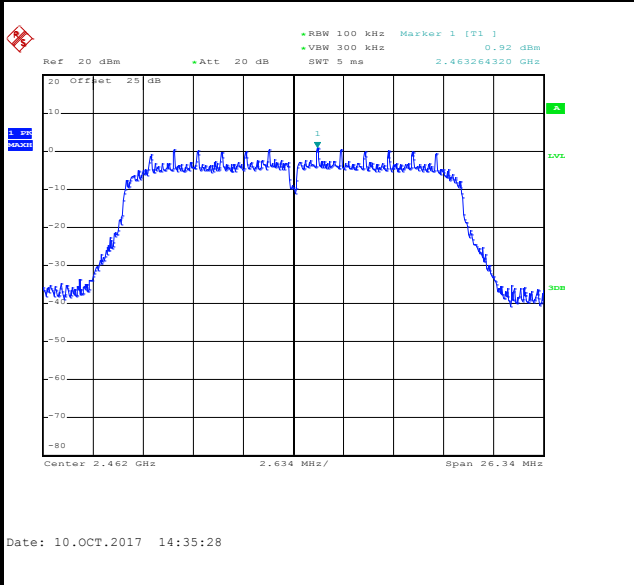

High Channel Plot

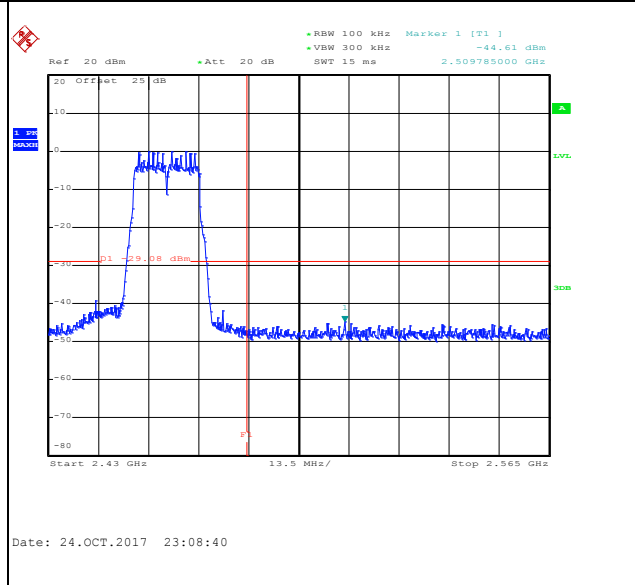

Spurious Emission 30MHz~3GHz

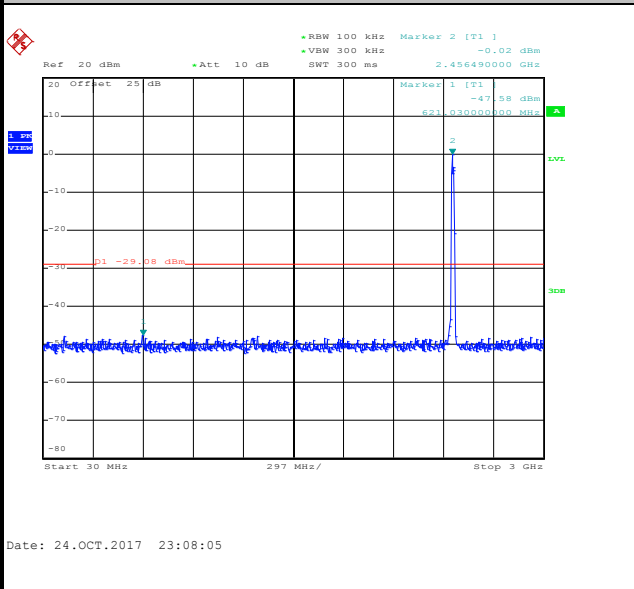

Spurious Emission 2GHz~25GHz

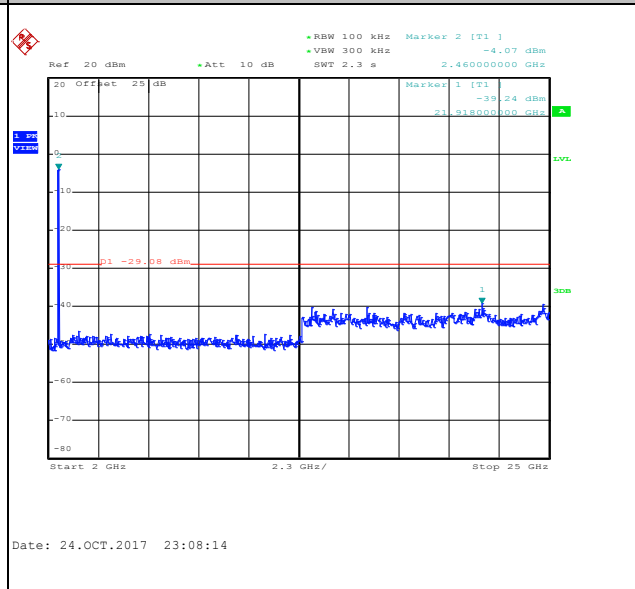



Number of TX :	1	Ant. :	2
Test Mode :	802.11n HT40	Temperature :	21~25°C
Test Band :	2.4GHz Low	Relative Humidity :	51~54%
Test Channel :	03	Test Engineer :	Kai Liao

WLAN 802.11n HT40 Channel 03

100kHz PSD reference Level

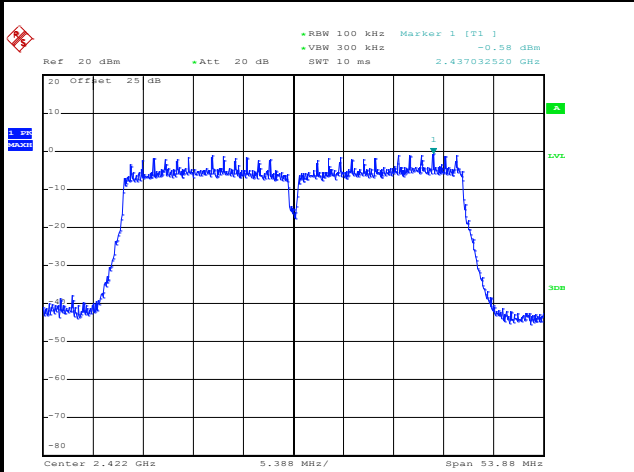

Date: 21.SEP.2017 21:28:07

Low Channel Plot

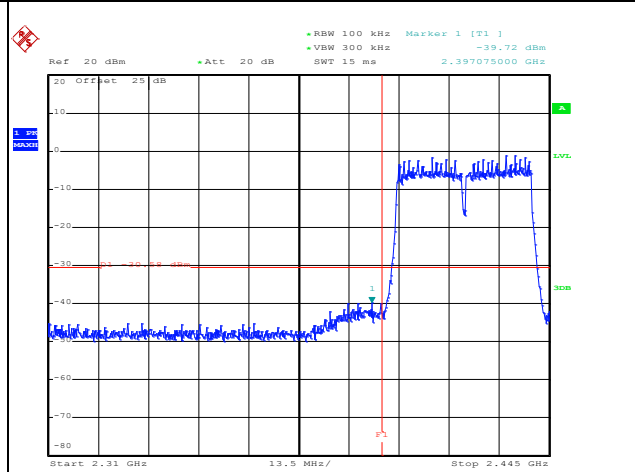

Date: 24.OCT.2017 23:33:23

Spurious Emission 30MHz~3GHz

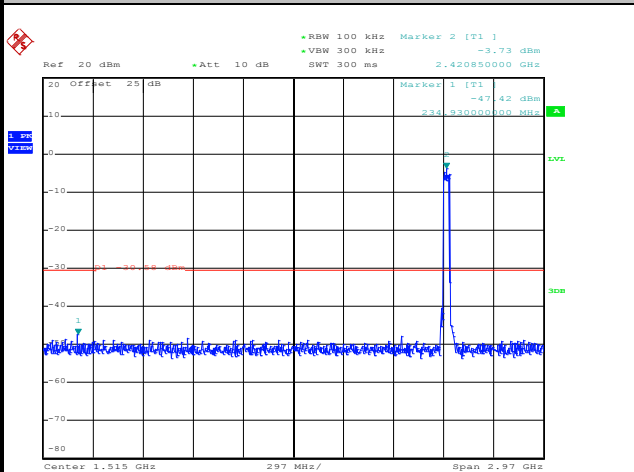

Date: 24.OCT.2017 23:33:02

Spurious Emission 2GHz~25GHz

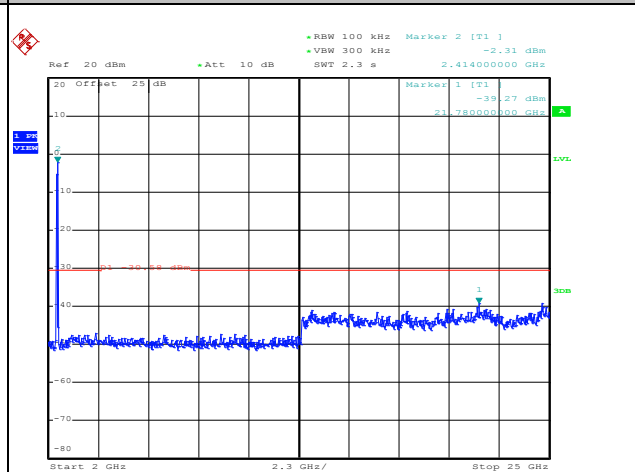

Date: 24.OCT.2017 23:33:11



Number of TX :	1	Ant. :	2
Test Mode :	802.11n HT40	Temperature :	21~25°C
Test Band :	2.4GHz Mid	Relative Humidity :	51~54%
Test Channel :	06	Test Engineer :	Kai Liao

WLAN 802.11n HT40 Channel 06

100kHz PSD reference Level

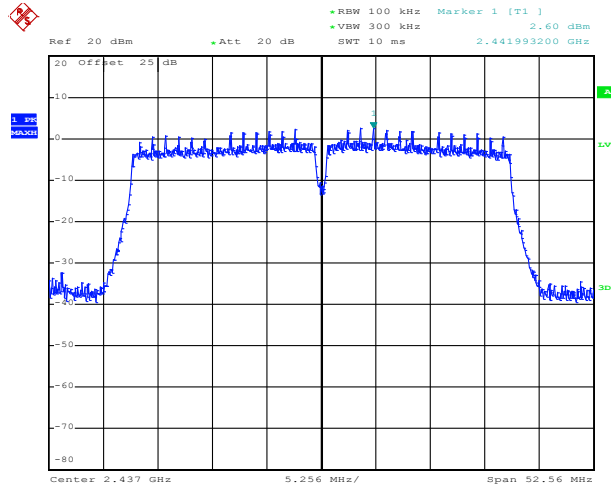

Date: 21.SEP.2017 21:25:39

Spurious Emission 30MHz~3GHz

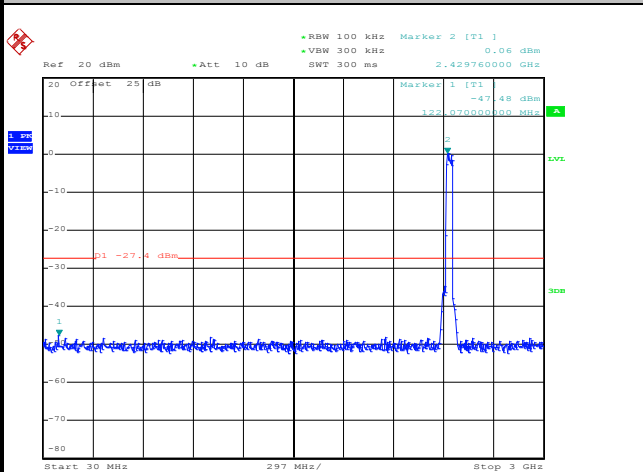

Date: 24.OCT.2017 23:31:51

Spurious Emission 2GHz~25GHz

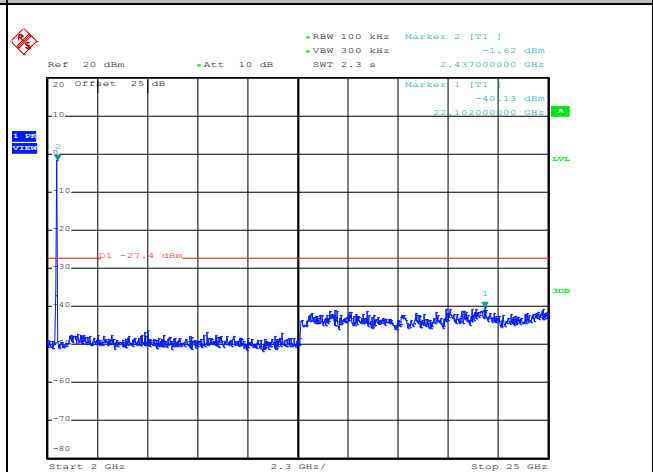

Date: 24.OCT.2017 23:32:00



Number of TX :	1	Ant. :	2
Test Mode :	802.11n HT40	Temperature :	21~25°C
Test Band :	2.4GHz High	Relative Humidity :	51~54%
Test Channel :	09	Test Engineer :	Kai Liao

WLAN 802.11n HT40 Channel 09

100kHz PSD reference Level

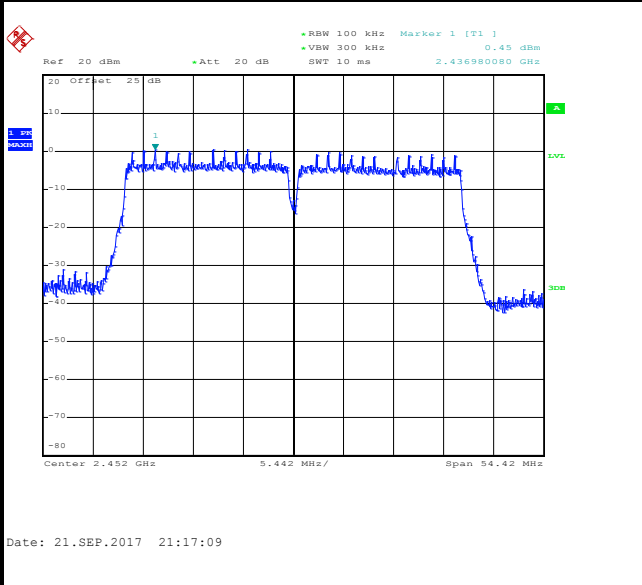

High Channel Plot

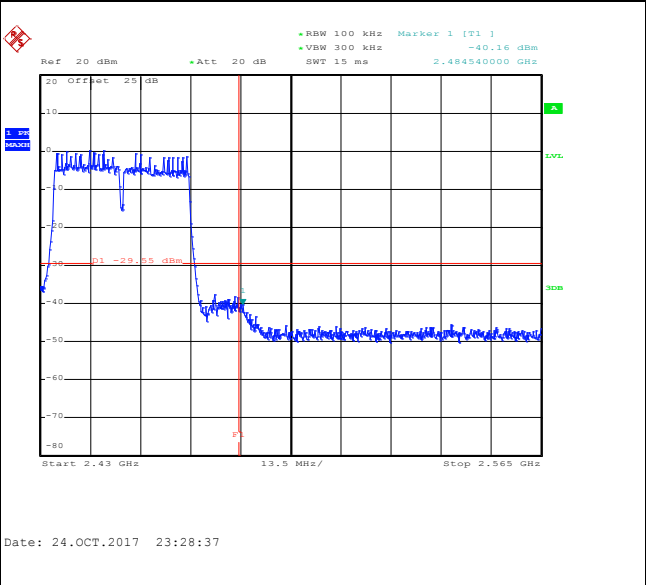

Spurious Emission 30MHz~3GHz

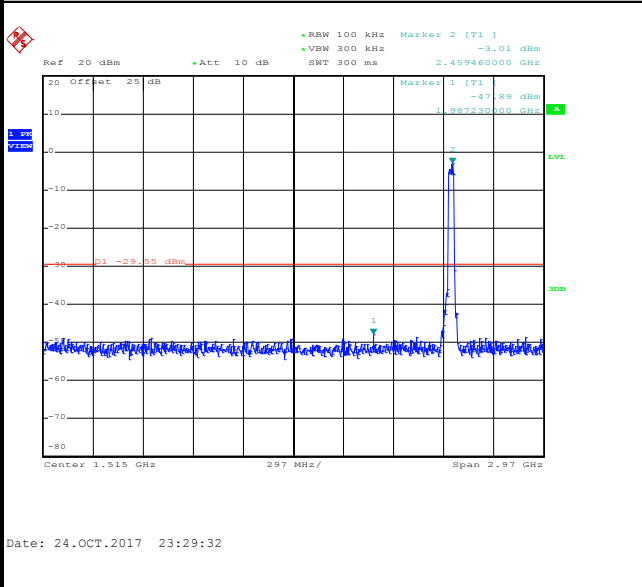

Spurious Emission 2GHz~25GHz

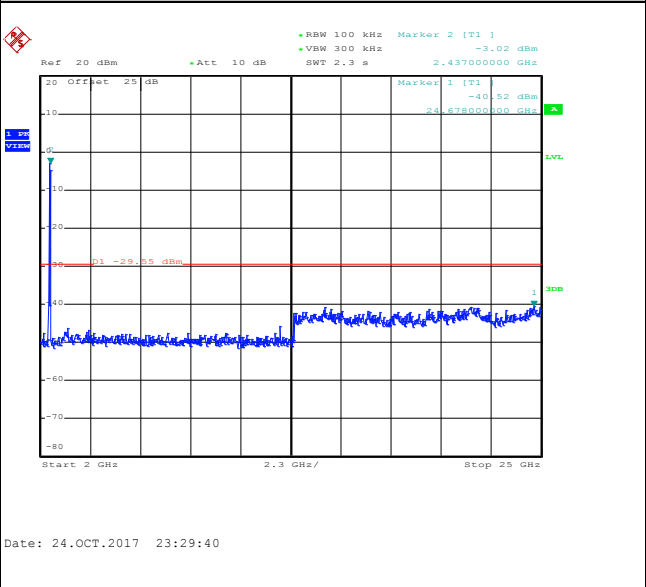



Number of TX = 2, Ant. 1 (Measured)

Number of TX	2	Ant. :	1
Test Mode :	802.11b	Temperature :	21~25°C
Test Band :	2.4GHz Low	Relative Humidity :	51~54%
Test Channel :	01	Test Engineer :	Kai Liao

WLAN 802.11b Channel 01

100kHz PSD reference Level

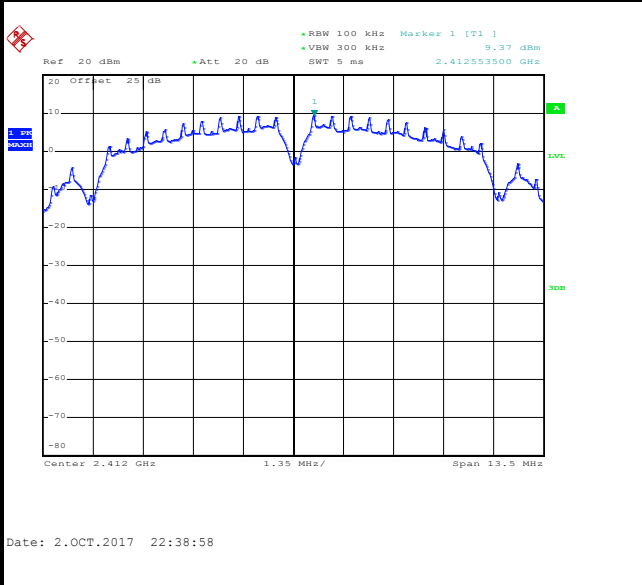

Low Channel Plot

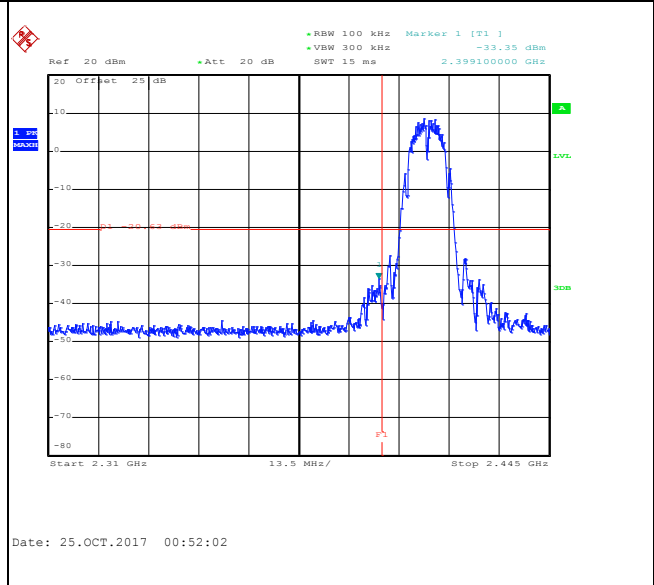

Spurious Emission 30MHz~3GHz

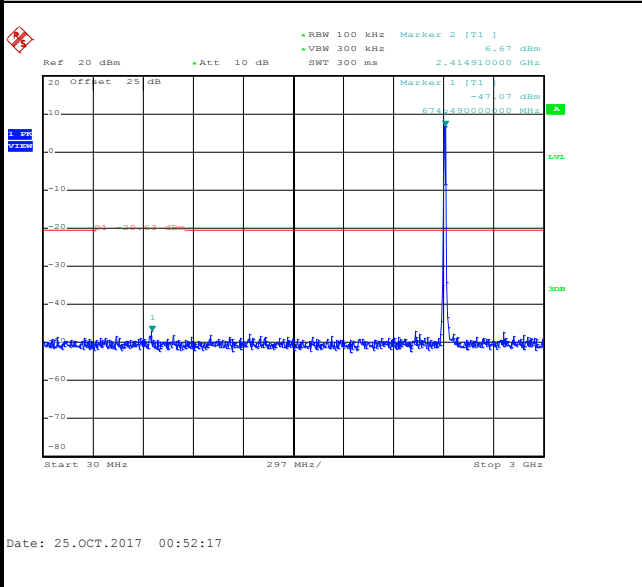

Spurious Emission 2GHz~25GHz

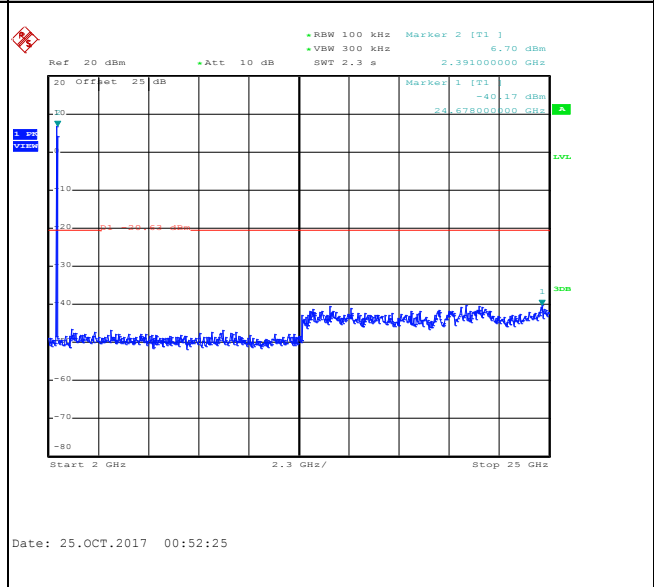



Number of TX	2	Ant. :	1
Test Mode :	802.11b	Temperature :	21~25°C
Test Band :	2.4GHz Low	Relative Humidity :	51~54%
Test Channel :	02	Test Engineer :	Kai Liao

WLAN 802.11b Channel 02

100kHz PSD reference Level

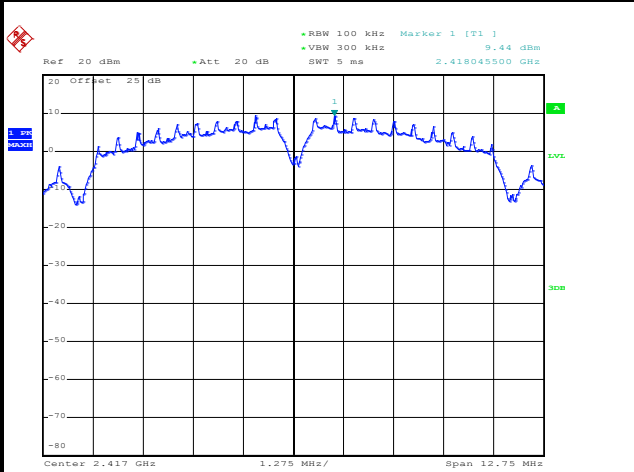

Date: 2.OCT.2017 22:55:42

Low Channel Plot

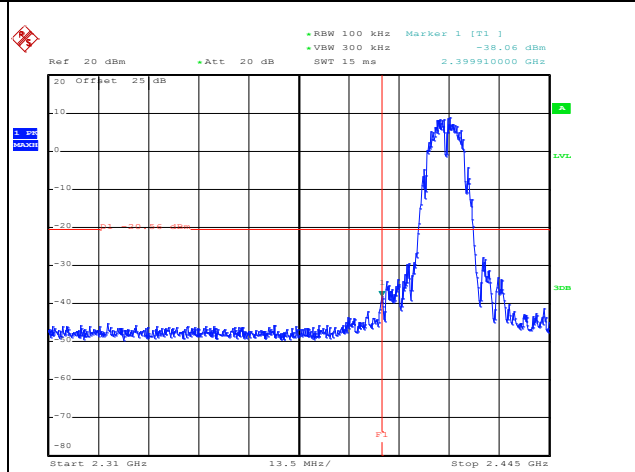

Date: 25.OCT.2017 01:03:19

Spurious Emission 30MHz~3GHz

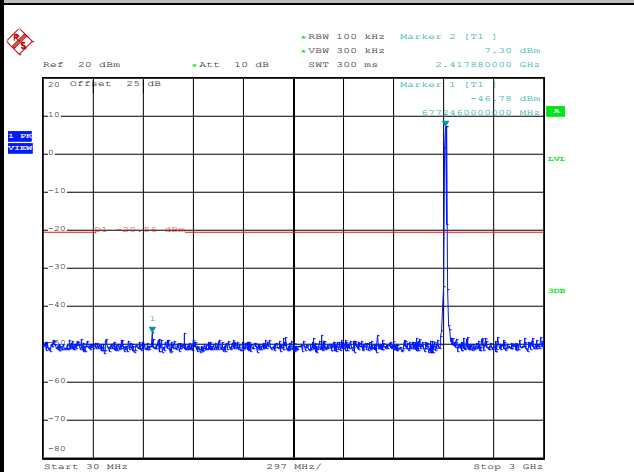

Date: 25.OCT.2017 01:02:45

Spurious Emission 2GHz~25GHz

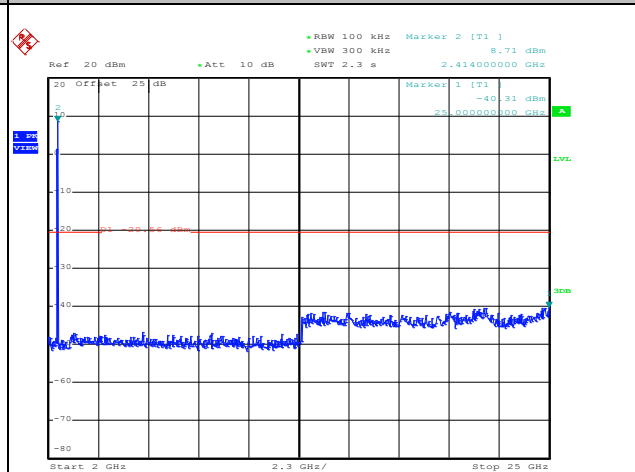

Date: 25.OCT.2017 01:02:53



Number of TX :	2	Ant. :	1
Test Mode :	802.11b	Temperature :	21~25°C
Test Band :	2.4GHz Mid	Relative Humidity :	51~54%
Test Channel :	06	Test Engineer :	Kai Liao

WLAN 802.11b Channel 06

100kHz PSD reference Level

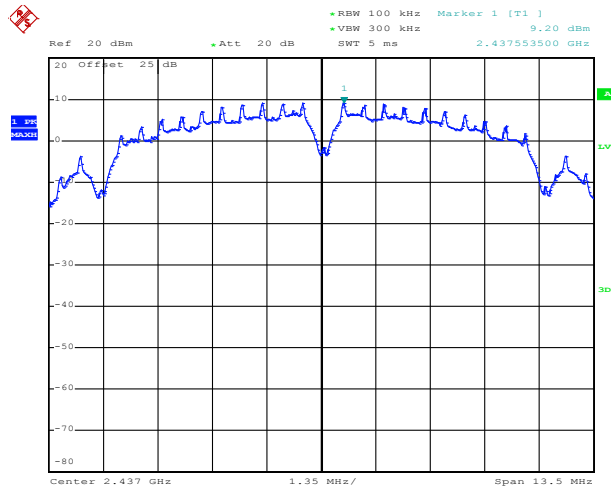

Date: 2.OCT.2017 23:25:28

Spurious Emission 30MHz~3GHz

Spurious Emission 2GHz~25GHz

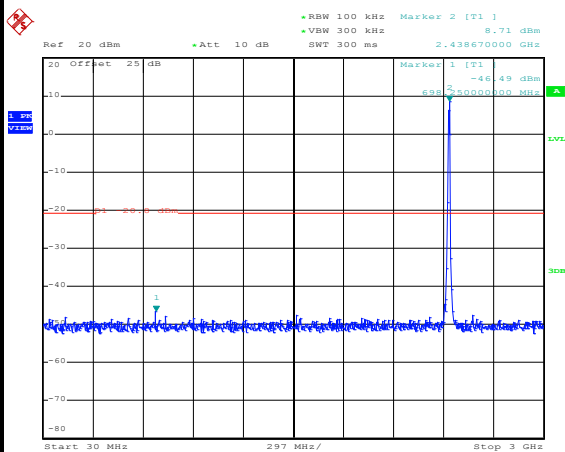

Date: 25.OCT.2017 01:04:34

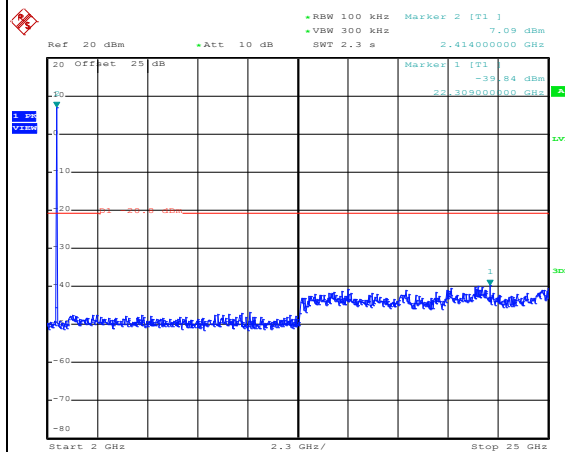

Date: 25.OCT.2017 01:04:42



Number of TX :	2	Ant. :	1
Test Mode :	802.11b	Temperature :	21~25°C
Test Band :	2.4GHz High	Relative Humidity :	51~54%
Test Channel :	10	Test Engineer :	Kai Liao

WLAN 802.11b Channel 10

100kHz PSD reference Level

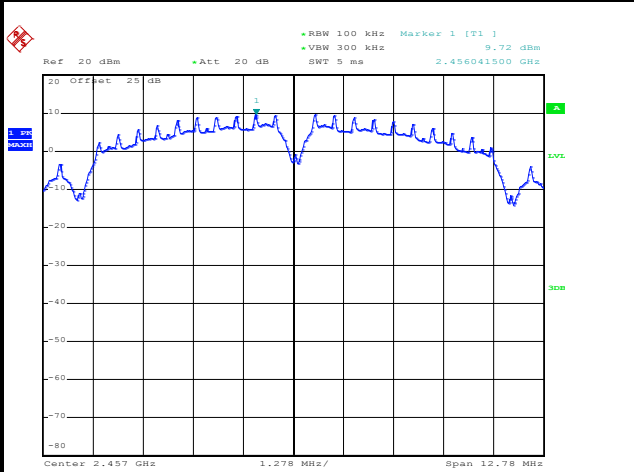

Date: 2.OCT.2017 23:28:46

High Channel Plot

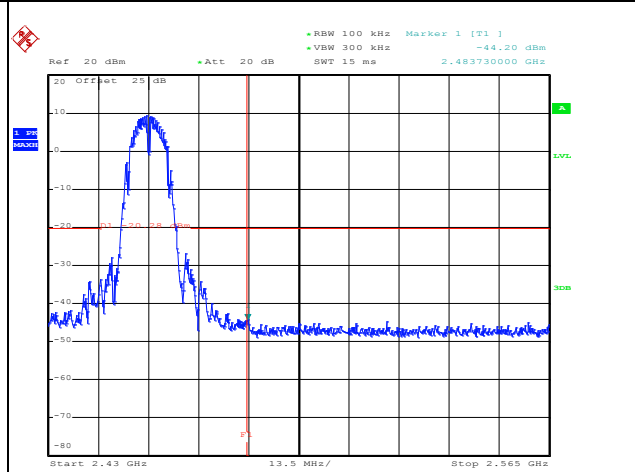

Date: 25.OCT.2017 01:11:52

Spurious Emission 30MHz~3GHz

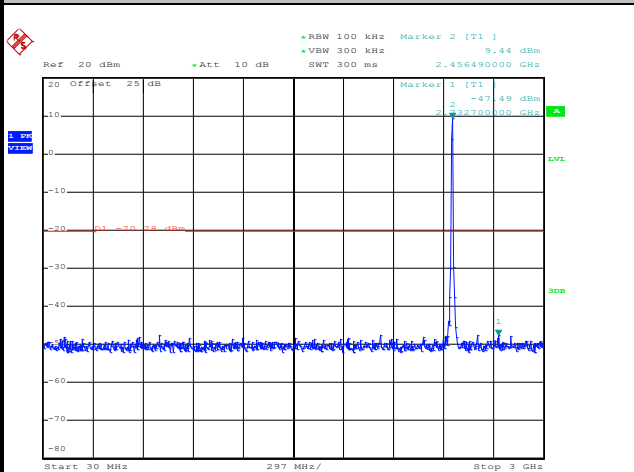

Date: 25.OCT.2017 01:10:52

Spurious Emission 2GHz~25GHz

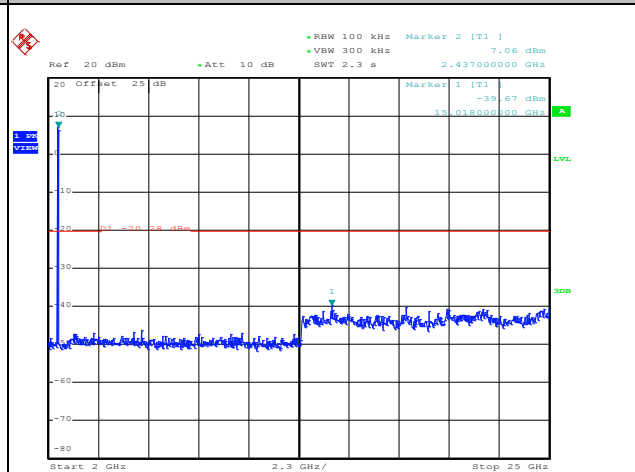

Date: 25.OCT.2017 01:11:01



Number of TX :	2	Ant. :	1
Test Mode :	802.11b	Temperature :	21~25°C
Test Band :	2.4GHz High	Relative Humidity :	51~54%
Test Channel :	11	Test Engineer :	Kai Liao

WLAN 802.11b Channel 11

100kHz PSD reference Level

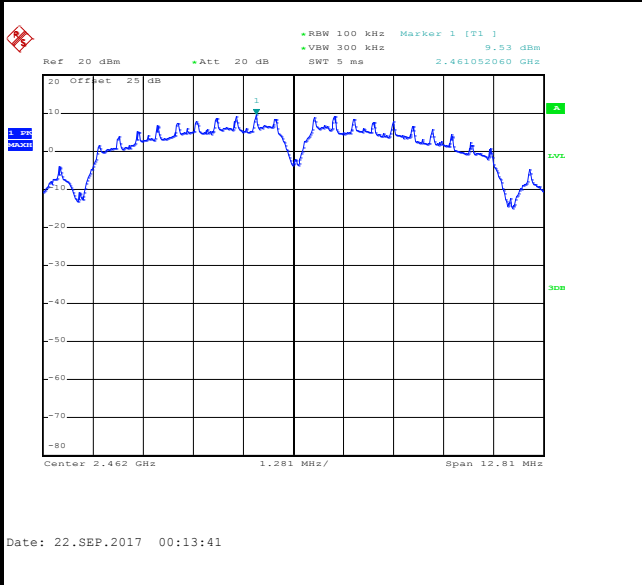

High Channel Plot

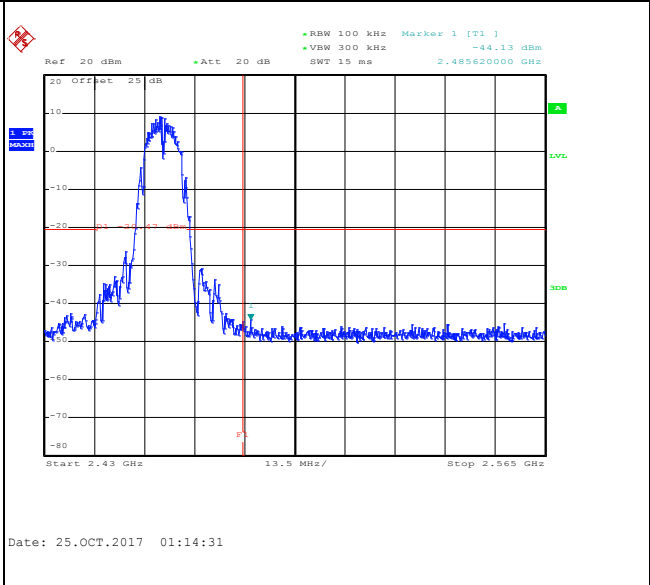

Spurious Emission 30MHz~3GHz

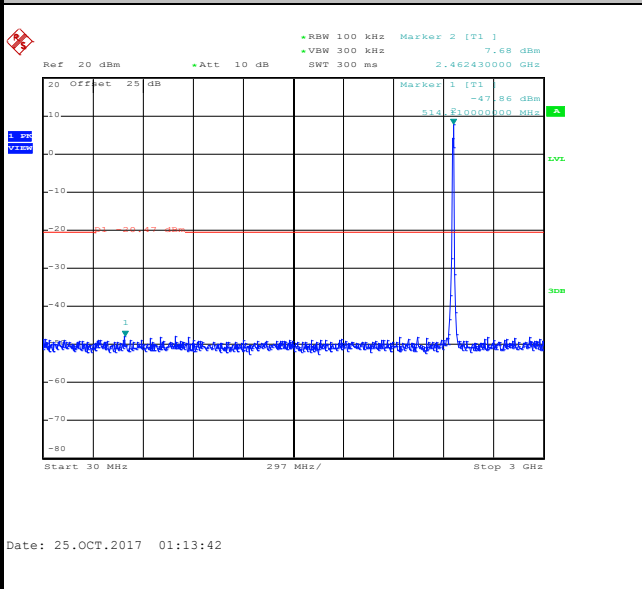

Spurious Emission 2GHz~25GHz

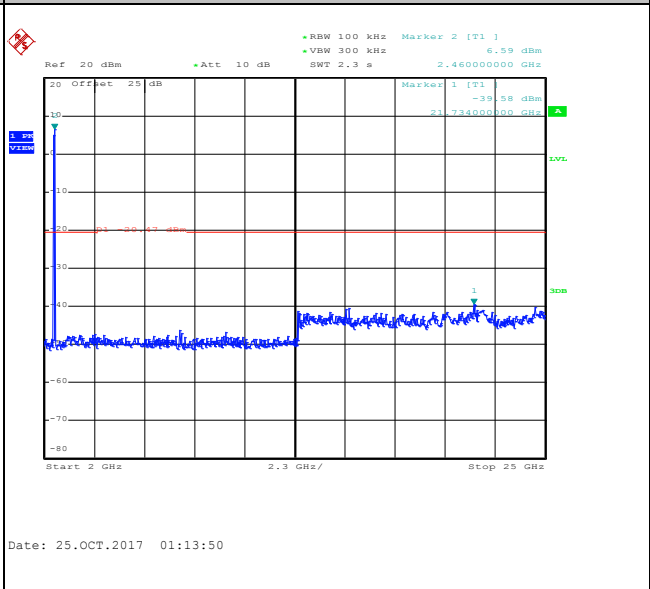



Number of TX :	2	Ant. :	1
Test Mode :	802.11g	Temperature :	21~25°C
Test Band :	2.4GHz Low	Relative Humidity :	51~54%
Test Channel :	01	Test Engineer :	Kai Liao

WLAN 802.11g Channel 01

100kHz PSD reference Level

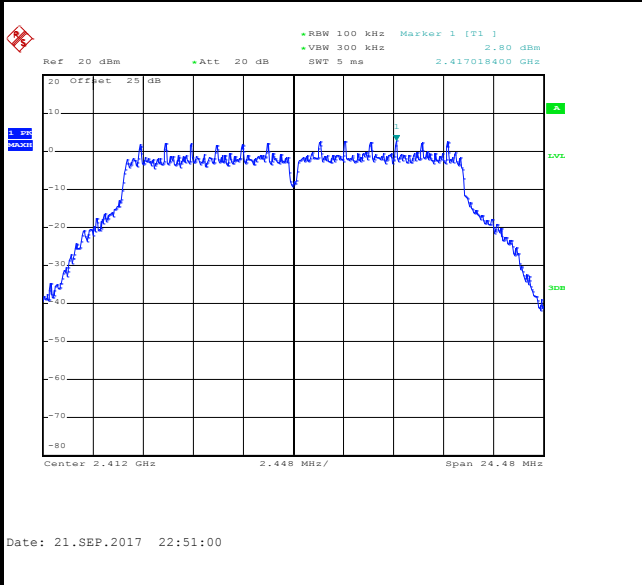

Low Channel Plot

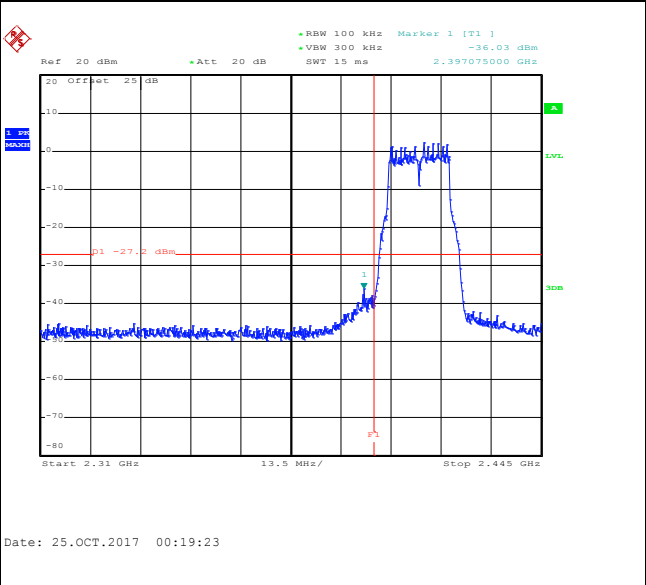

Spurious Emission 30MHz~3GHz

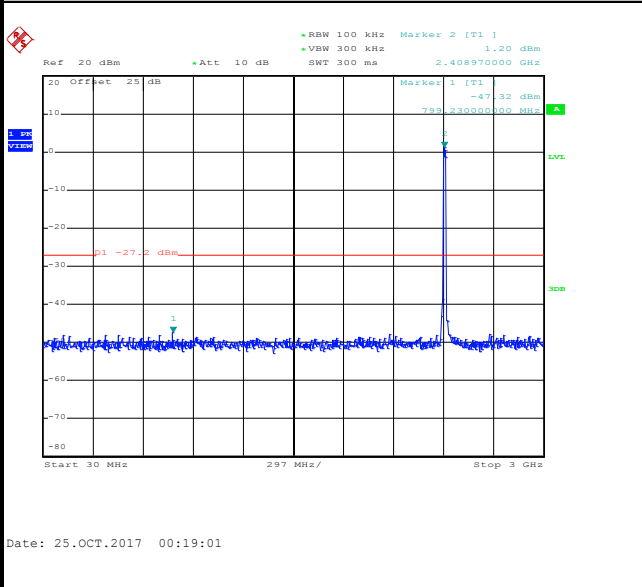

Spurious Emission 2GHz~25GHz

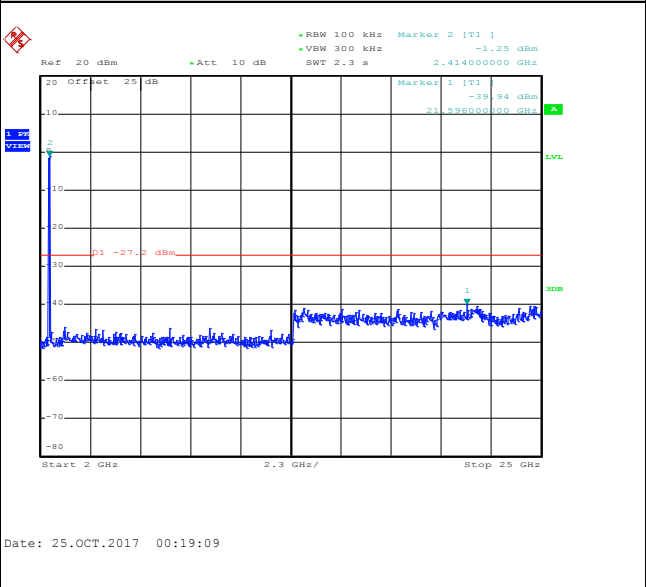



Number of TX :	2	Ant. :	1
Test Mode :	802.11g	Temperature :	21~25°C
Test Band :	2.4GHz Low	Relative Humidity :	51~54%
Test Channel :	02	Test Engineer :	Kai Liao

WLAN 802.11g Channel 02

100kHz PSD reference Level

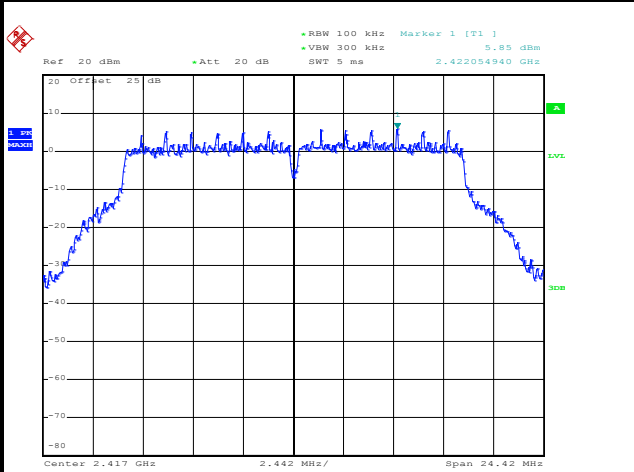

Date: 2.OCT.2017 23:57:55

Low Channel Plot

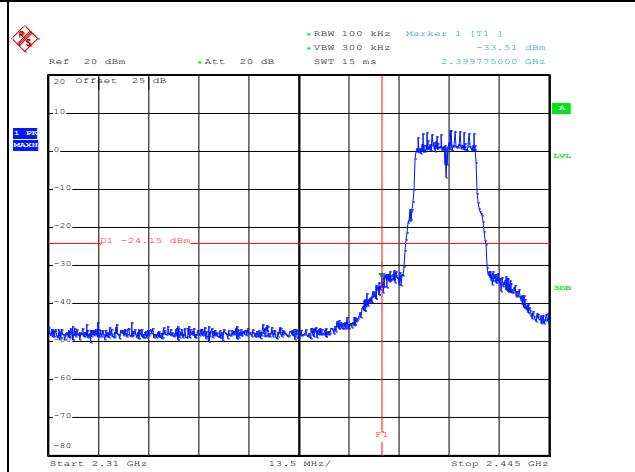

Date: 25.OCT.2017 00:28:29

Spurious Emission 30MHz~3GHz

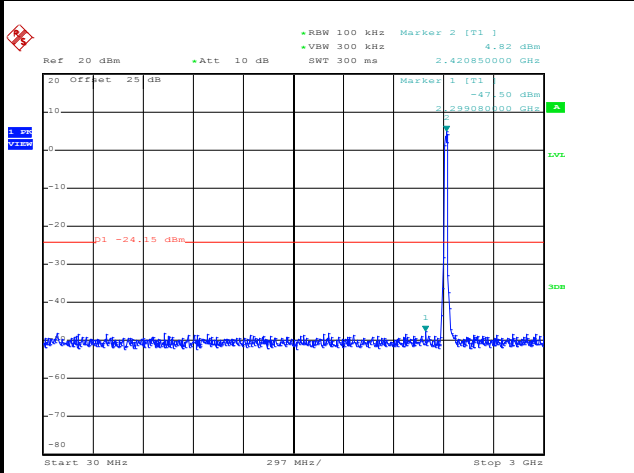

Date: 25.OCT.2017 00:27:57

Spurious Emission 2GHz~25GHz

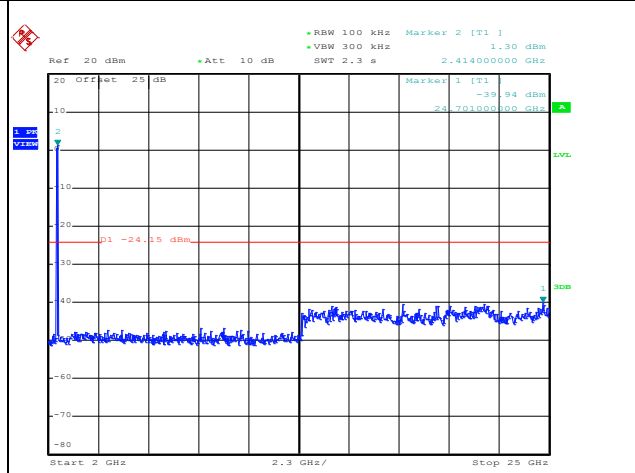

Date: 25.OCT.2017 00:28:06



Number of TX :	2	Ant. :	1
Test Mode :	802.11g	Temperature :	21~25°C
Test Band :	2.4GHz Mid	Relative Humidity :	51~54%
Test Channel :	06	Test Engineer :	Kai Liao

WLAN 802.11g Channel 06

100kHz PSD reference Level

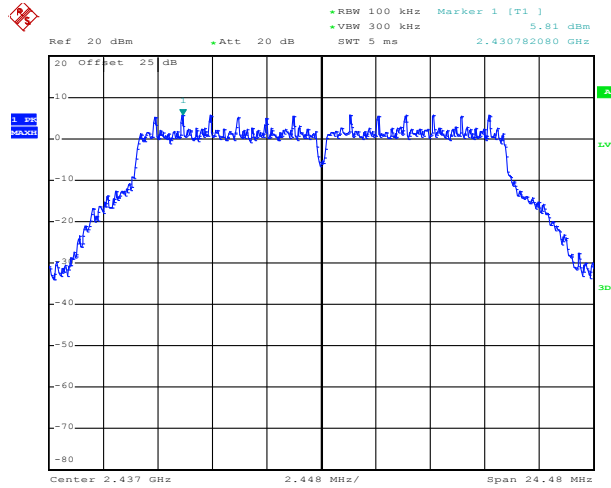

Date: 3.OCT.2017 00:48:17

Spurious Emission 30MHz~3GHz

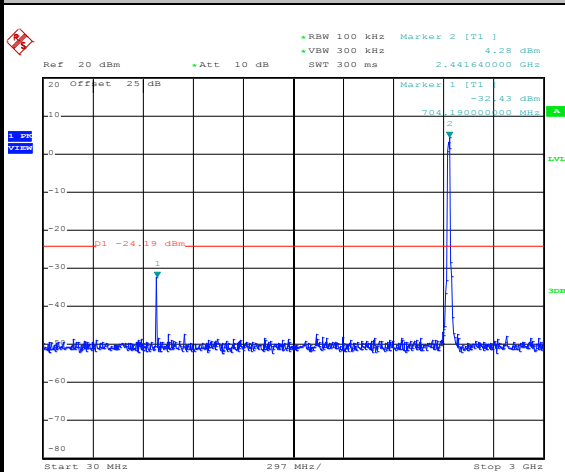

Date: 25.OCT.2017 00:30:14

Spurious Emission 2GHz~25GHz

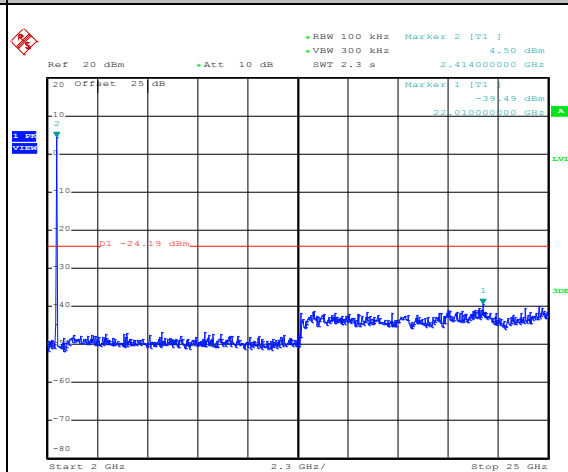

Date: 25.OCT.2017 00:30:22



Number of TX :	2	Ant. :	1
Test Mode :	802.11g	Temperature :	21~25°C
Test Band :	2.4GHz High	Relative Humidity :	51~54%
Test Channel :	10	Test Engineer :	Kai Liao

WLAN 802.11g Channel 10

100kHz PSD reference Level

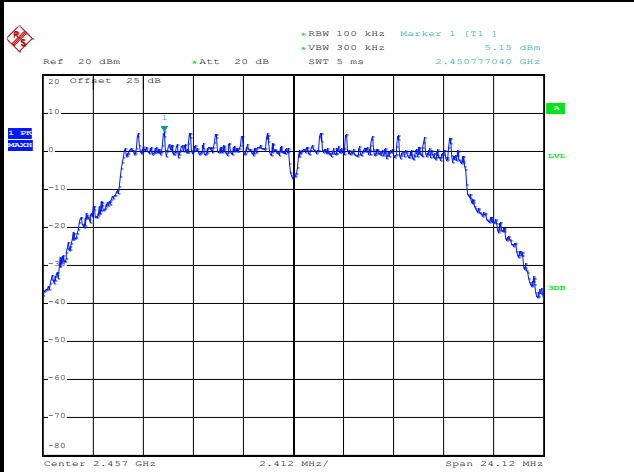

Date: 21.SEP.2017 23:59:53

High Channel Plot

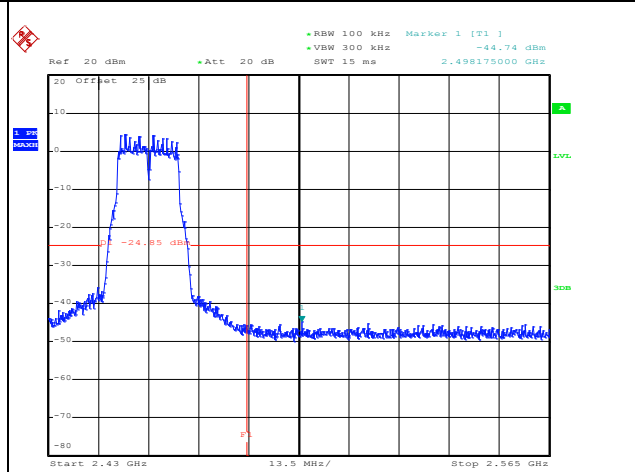

Date: 25.OCT.2017 00:37:28

Spurious Emission 30MHz~3GHz

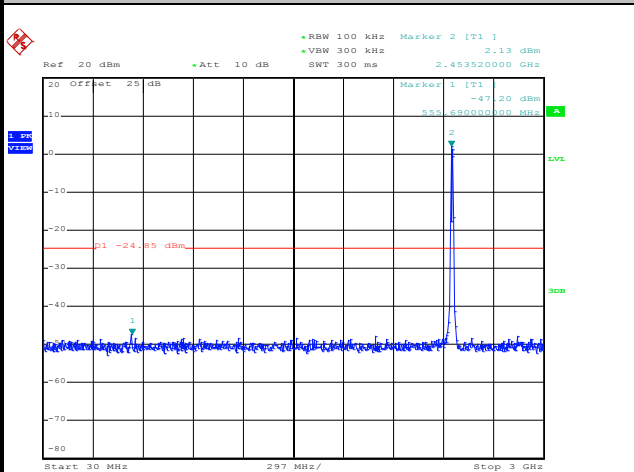

Date: 25.OCT.2017 00:37:00

Spurious Emission 2GHz~25GHz

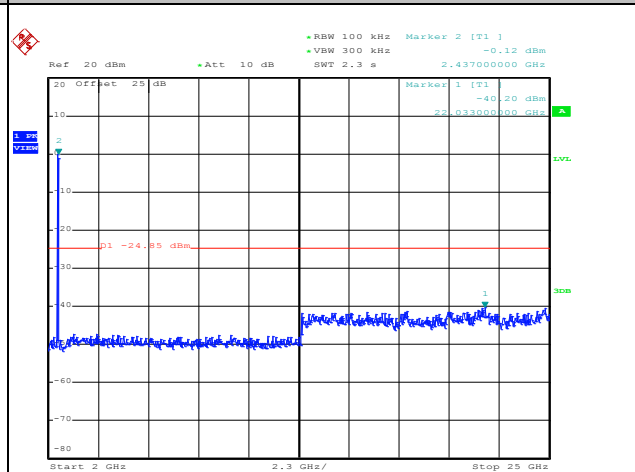

Date: 25.OCT.2017 00:37:09



Number of TX :	2	Ant. :	1
Test Mode :	802.11g	Temperature :	21~25°C
Test Band :	2.4GHz High	Relative Humidity :	51~54%
Test Channel :	11	Test Engineer :	Kai Liao

WLAN 802.11g Channel 11

100kHz PSD reference Level

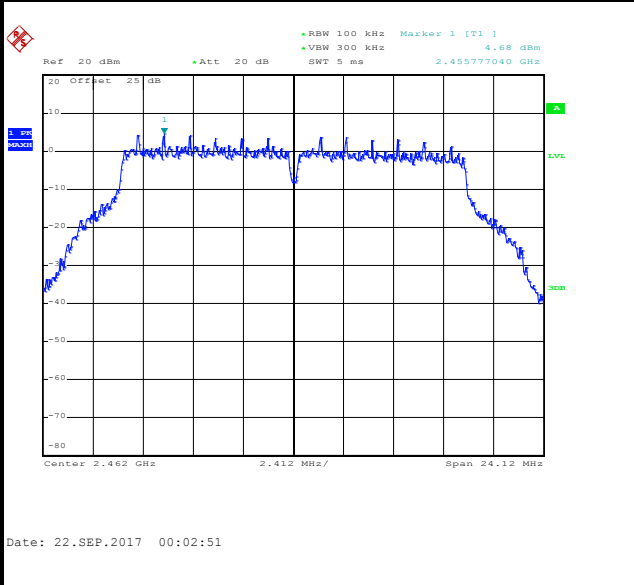

High Channel Plot

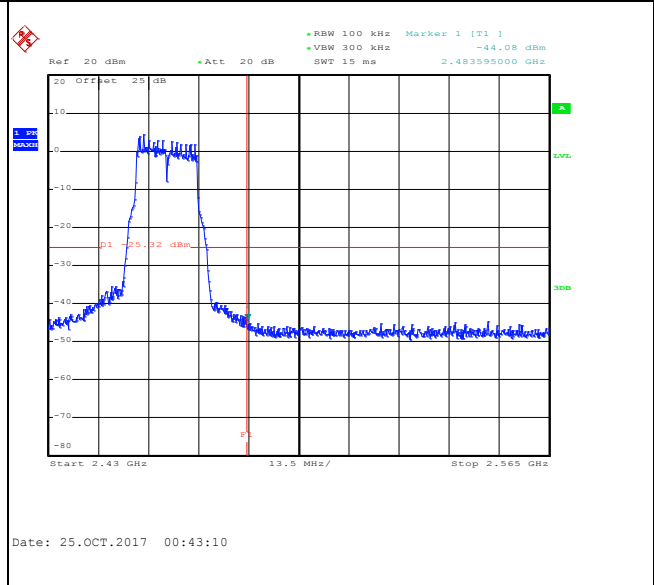

Spurious Emission 30MHz~3GHz

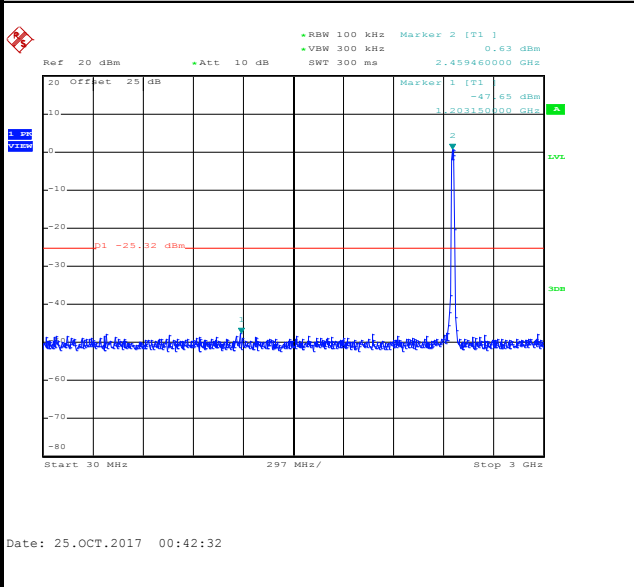

Spurious Emission 2GHz~25GHz

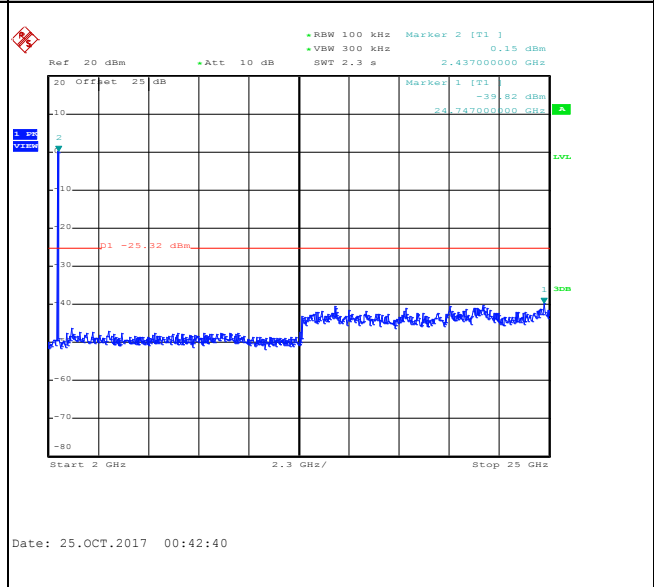



Number of TX :	2	Ant. :	1
Test Mode :	802.11n HT20	Temperature :	21~25°C
Test Band :	2.4GHz Low	Relative Humidity :	51~54%
Test Channel :	01	Test Engineer :	Kai Liao

WLAN 802.11n HT20 Channel 01

100kHz PSD reference Level

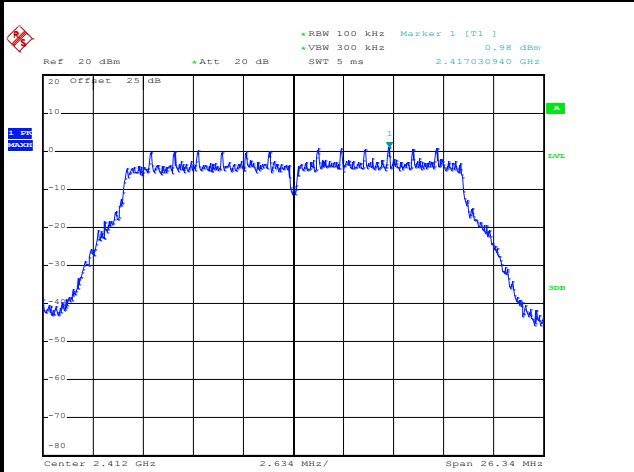

Date: 21.SEP.2017 22:47:36

Low Channel Plot

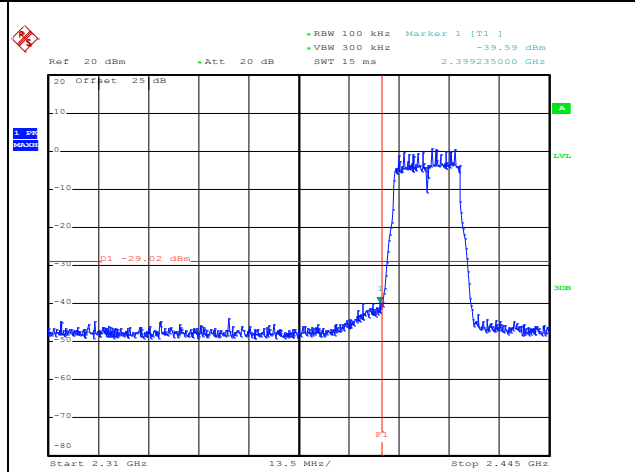

Date: 24.OCT.2017 23:54:38

Spurious Emission 30MHz~3GHz

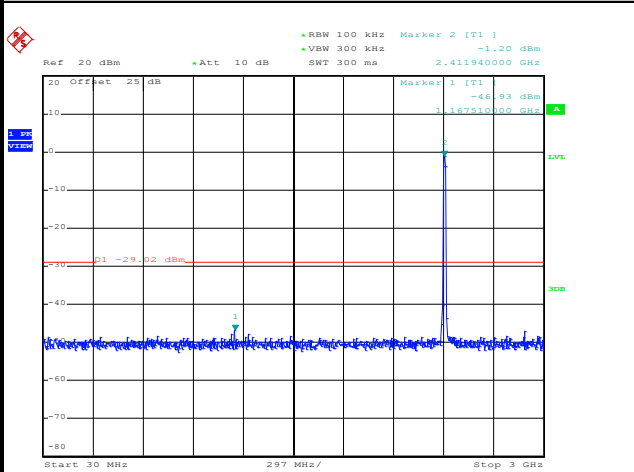

Date: 24.OCT.2017 23:54:53

Spurious Emission 2GHz~25GHz

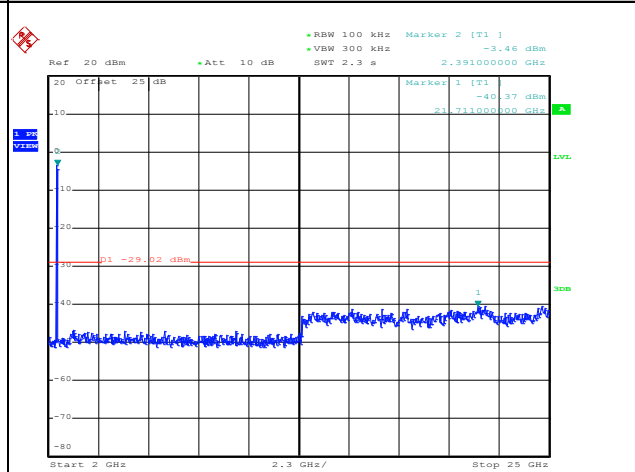

Date: 24.OCT.2017 23:55:02



Number of TX :	2	Ant. :	1
Test Mode :	802.11n HT20	Temperature :	21~25°C
Test Band :	2.4GHz Low	Relative Humidity :	51~54%
Test Channel :	02	Test Engineer :	Kai Liao

WLAN 802.11n HT20 Channel 02

100kHz PSD reference Level

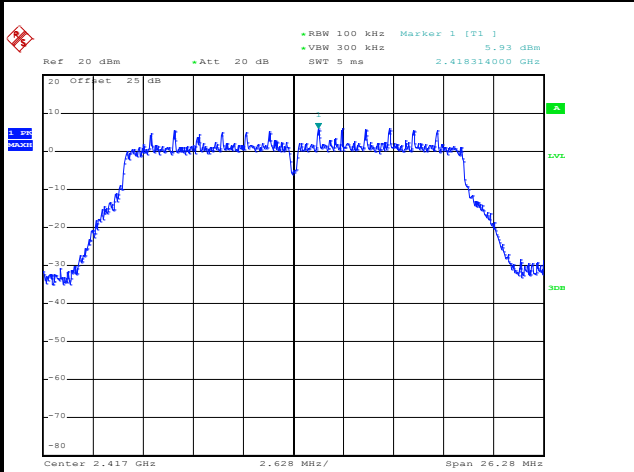

Date: 3.OCT.2017 01:12:00

Low Channel Plot

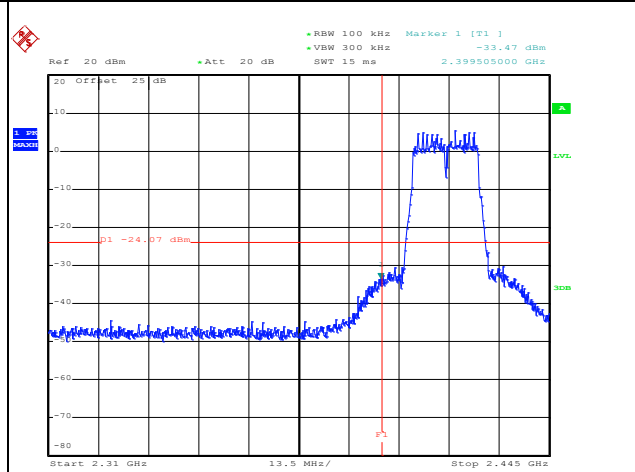

Date: 24.OCT.2017 23:59:43

Spurious Emission 30MHz~3GHz

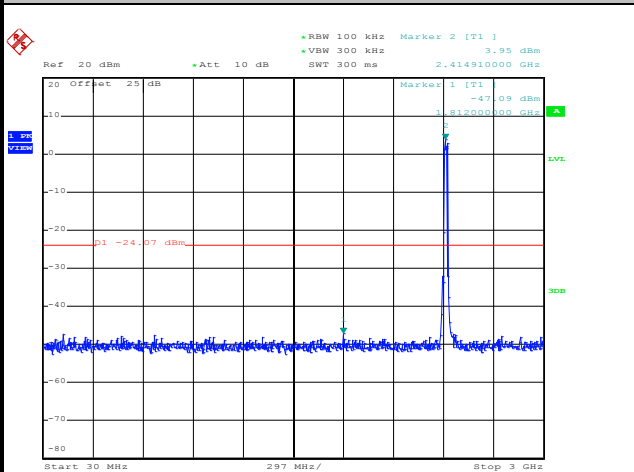

Date: 24.OCT.2017 23:59:20

Spurious Emission 2GHz~25GHz

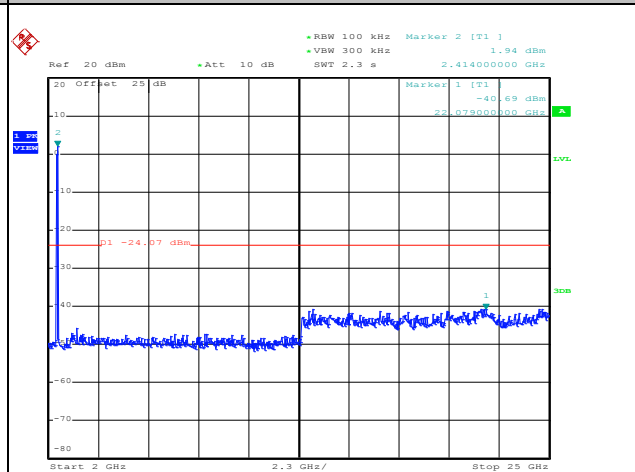

Date: 24.OCT.2017 23:59:28



Number of TX :	2	Ant. :	1
Test Mode :	802.11n HT20	Temperature :	21~25°C
Test Band :	2.4GHz Mid	Relative Humidity :	51~54%
Test Channel :	06	Test Engineer :	Kai Liao

WLAN 802.11n HT20 Channel 06

100kHz PSD reference Level

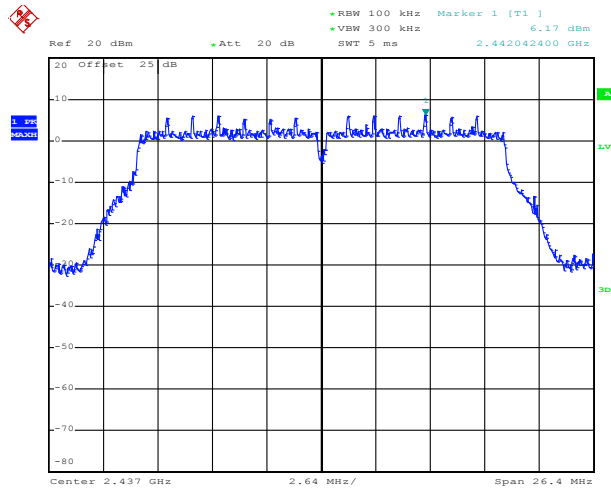

Date: 3.OCT.2017 00:58:22

Spurious Emission 30MHz~3GHz

Spurious Emission 2GHz~25GHz

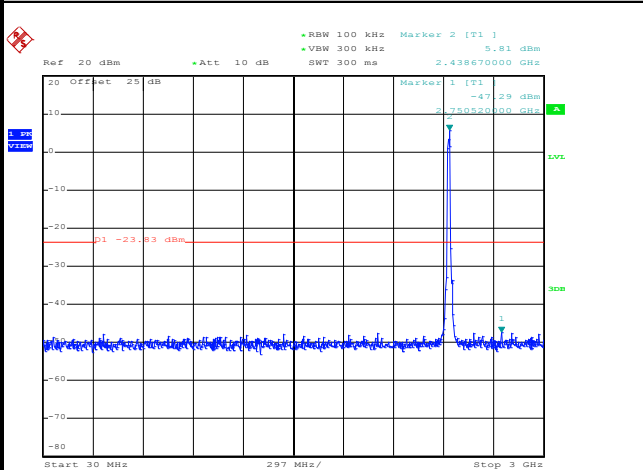

Date: 25.OCT.2017 00:00:56

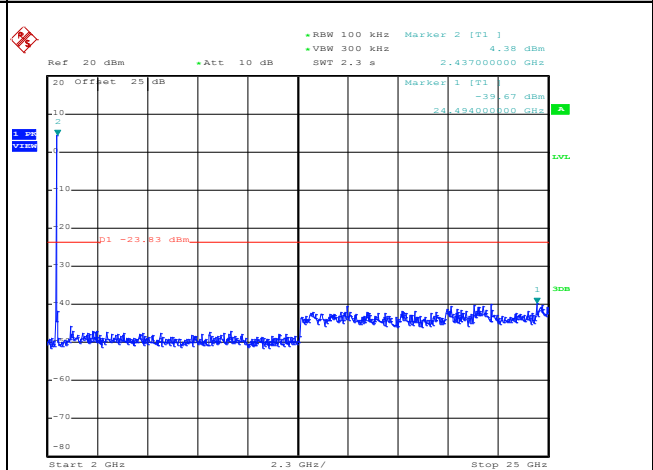

Date: 25.OCT.2017 00:01:05



Number of TX :	2	Ant. :	1
Test Mode :	802.11n HT20	Temperature :	21~25°C
Test Band :	2.4GHz High	Relative Humidity :	51~54%
Test Channel :	10	Test Engineer :	Kai Liao

WLAN 802.11n HT20 Channel 10

100kHz PSD reference Level

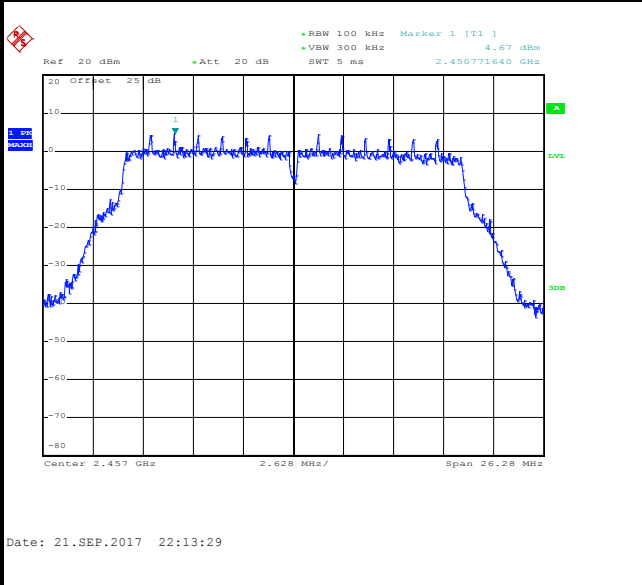

High Channel Plot

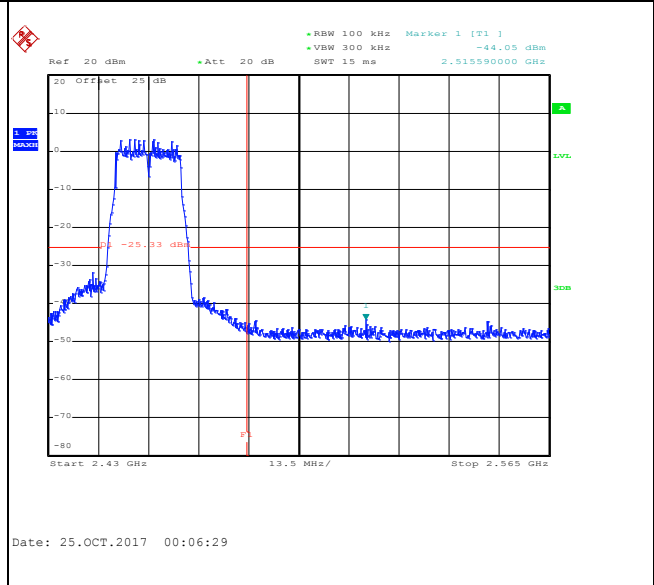

Spurious Emission 30MHz~3GHz

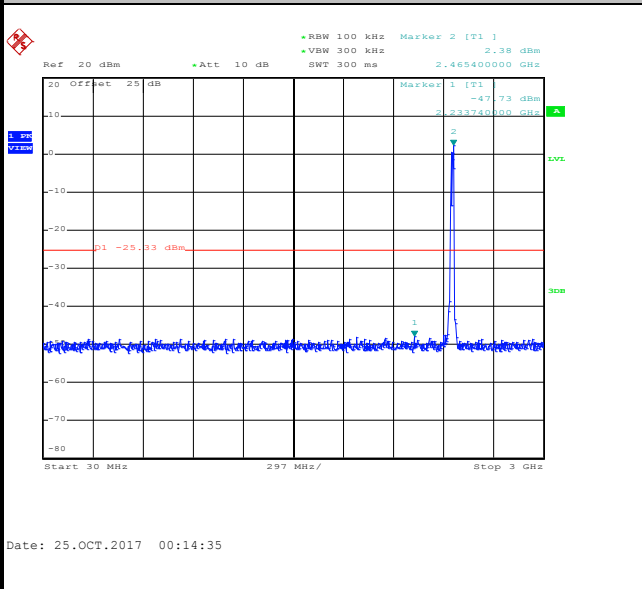

Spurious Emission 2GHz~25GHz

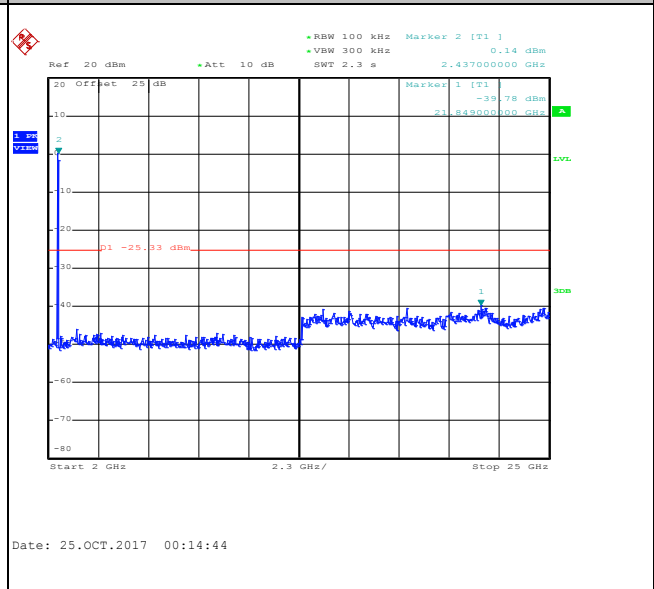



Number of TX :	2	Ant. :	1
Test Mode :	802.11n HT20	Temperature :	21~25°C
Test Band :	2.4GHz High	Relative Humidity :	51~54%
Test Channel :	11	Test Engineer :	Kai Liao

WLAN 802.11n HT20 Channel 11

100kHz PSD reference Level



High Channel Plot

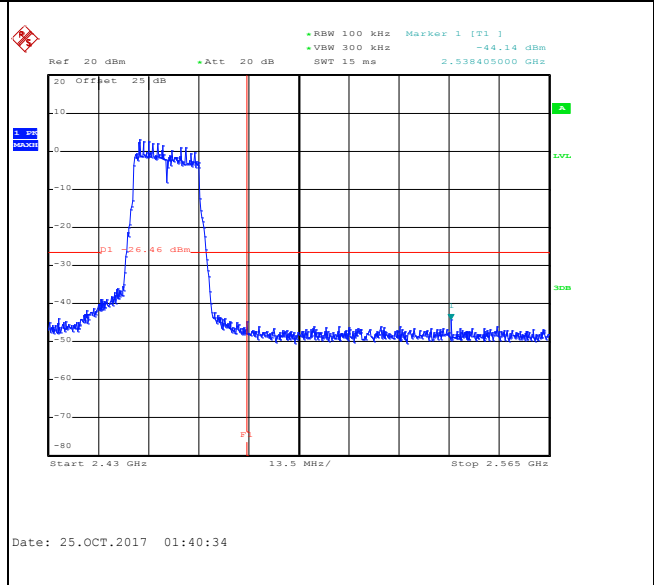

Spurious Emission 30MHz~3GHz

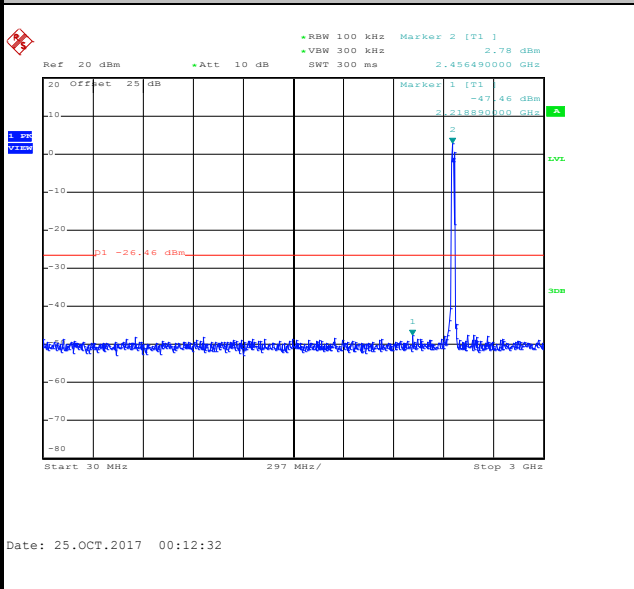

Spurious Emission 2GHz~25GHz

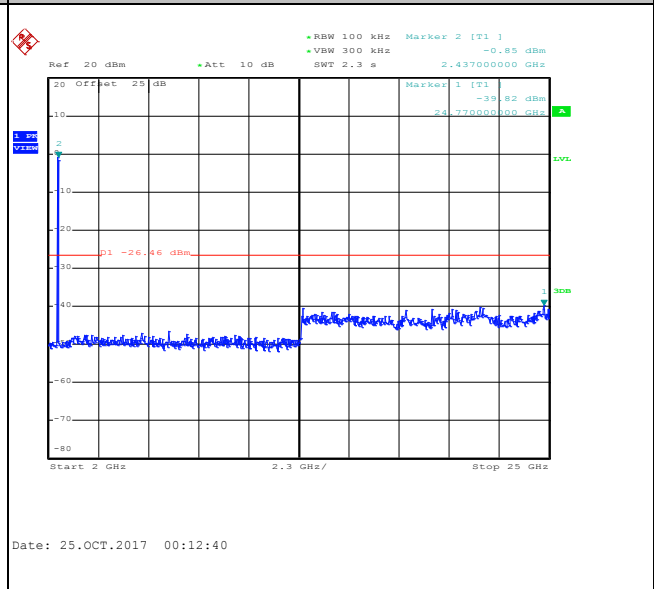



Number of TX :	2	Ant. :	1
Test Mode :	802.11n HT40	Temperature :	21~25°C
Test Band :	2.4GHz Low	Relative Humidity :	51~54%
Test Channel :	03	Test Engineer :	Kai Liao

WLAN 802.11n HT40 Channel 03

100kHz PSD reference Level

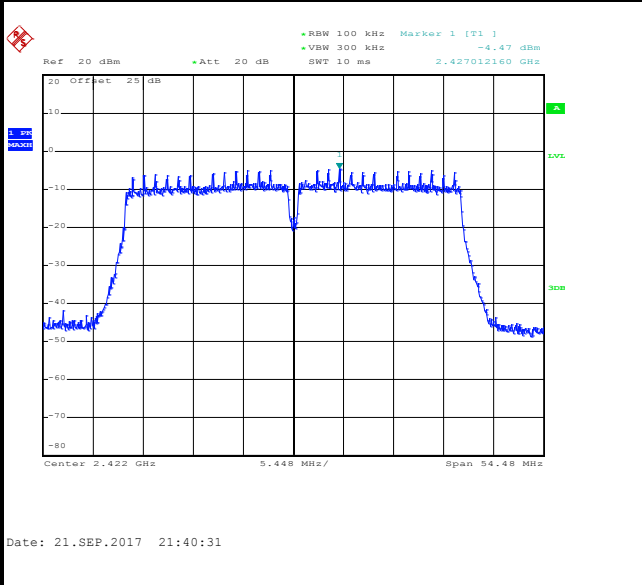

Low Channel Plot

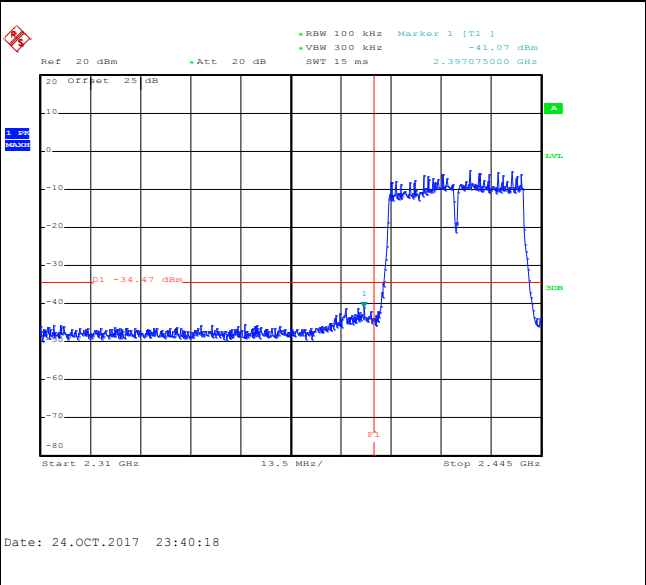

Spurious Emission 30MHz~3GHz

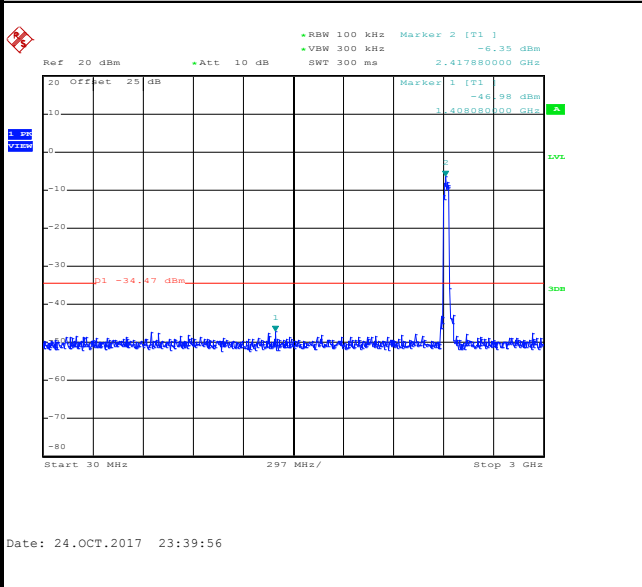

Spurious Emission 2GHz~25GHz

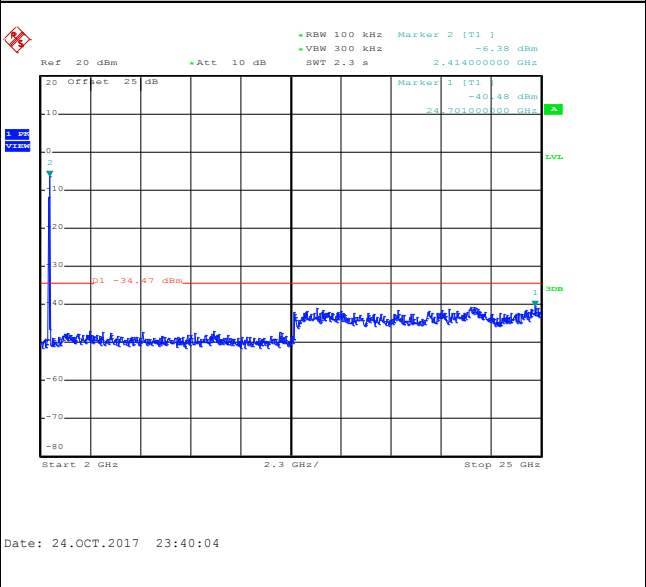



Number of TX :	2	Ant. :	1
Test Mode :	802.11n HT40	Temperature :	21~25°C
Test Band :	2.4GHz Mid	Relative Humidity :	51~54%
Test Channel :	06	Test Engineer :	Kai Liao

WLAN 802.11n HT40 Channel 06

100kHz PSD reference Level

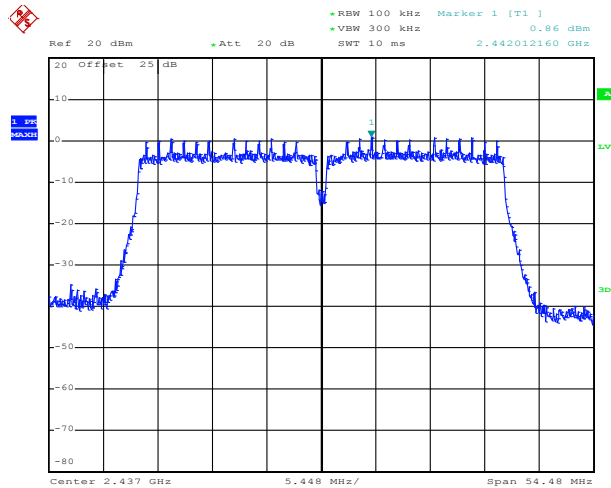

Date: 21.SEP.2017 21:55:38

Spurious Emission 30MHz~3GHz

Spurious Emission 2GHz~25GHz

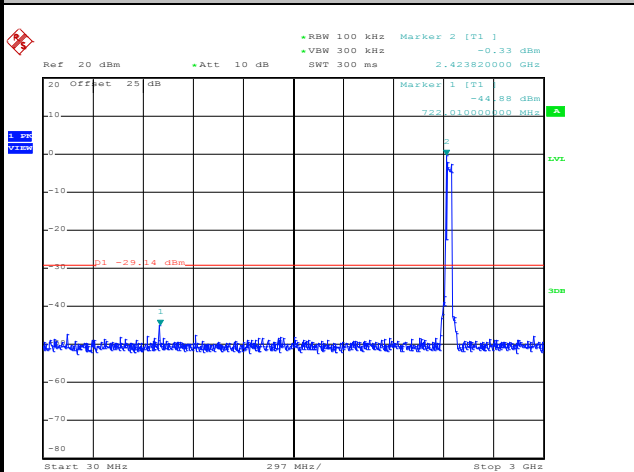

Date: 24.OCT.2017 23:45:54

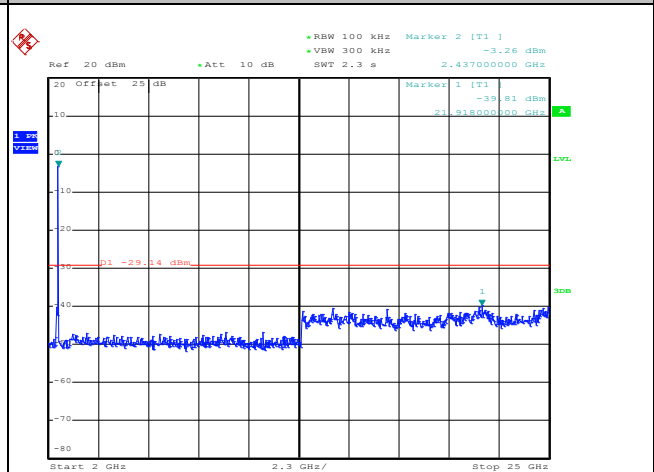

Date: 24.OCT.2017 23:46:03



Number of TX :	2	Ant. :	1
Test Mode :	802.11n HT40	Temperature :	21~25°C
Test Band :	2.4GHz High	Relative Humidity :	51~54%
Test Channel :	09	Test Engineer :	Kai Liao

WLAN 802.11n HT40 Channel 09

100kHz PSD reference Level

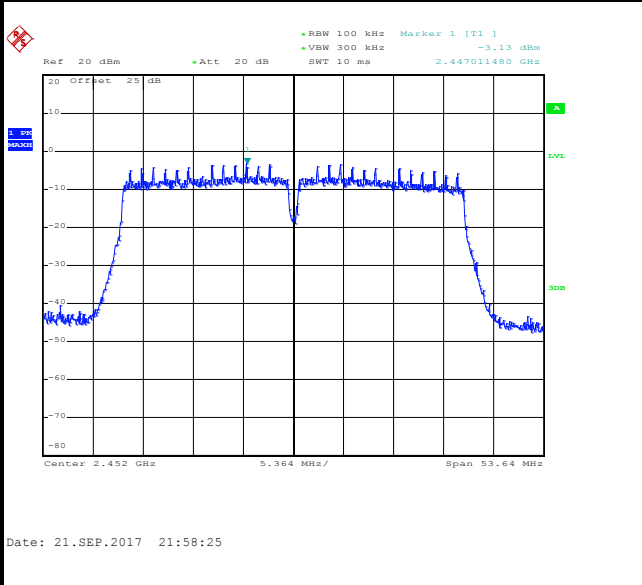

High Channel Plot

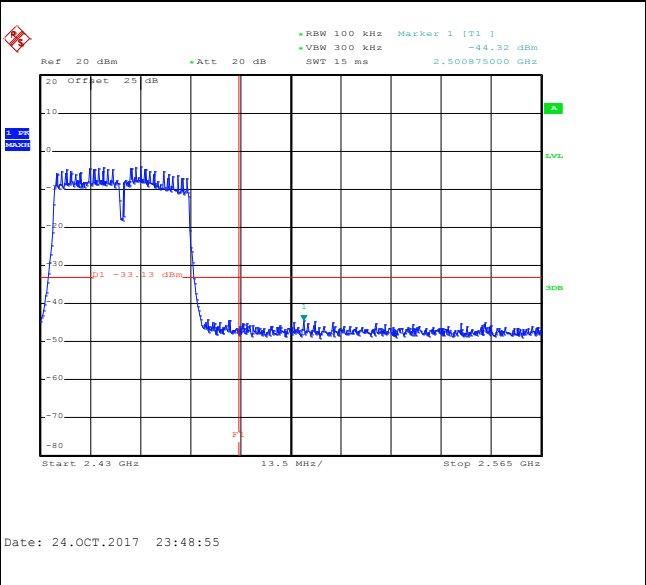

Spurious Emission 30MHz~3GHz

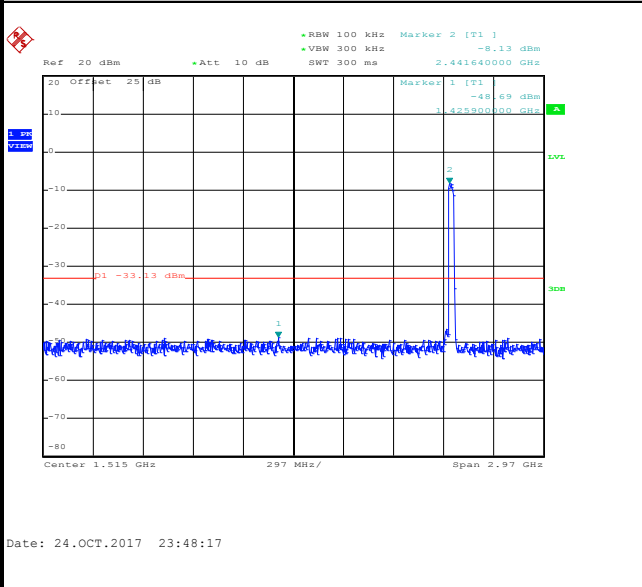

Spurious Emission 2GHz~25GHz

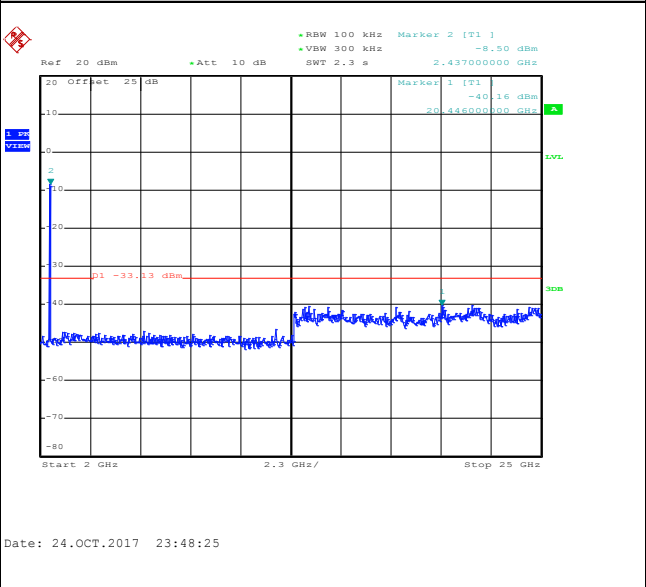



Number of TX = 2, Ant. 2 (Measured)

Number of TX :	2	Ant. :	2
Test Mode :	802.11b	Temperature :	21~25°C
Test Band :	2.4GHz Low	Relative Humidity :	51~54%
Test Channel :	01	Test Engineer :	Kai Liao

WLAN 802.11b Channel 01

100kHz PSD reference Level

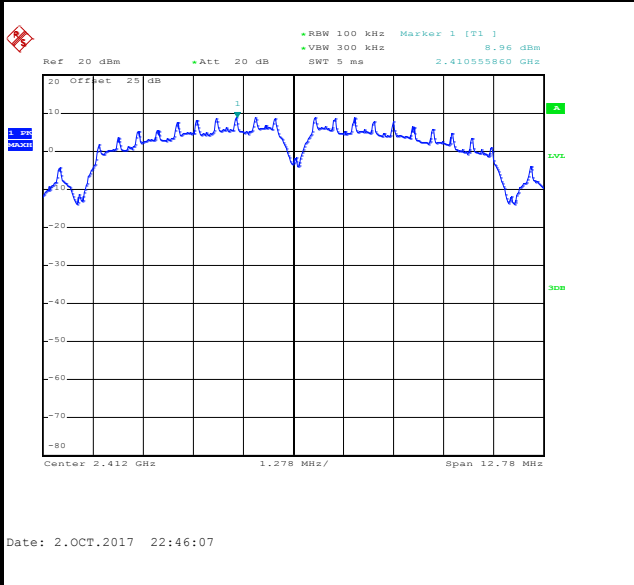

Low Channel Plot

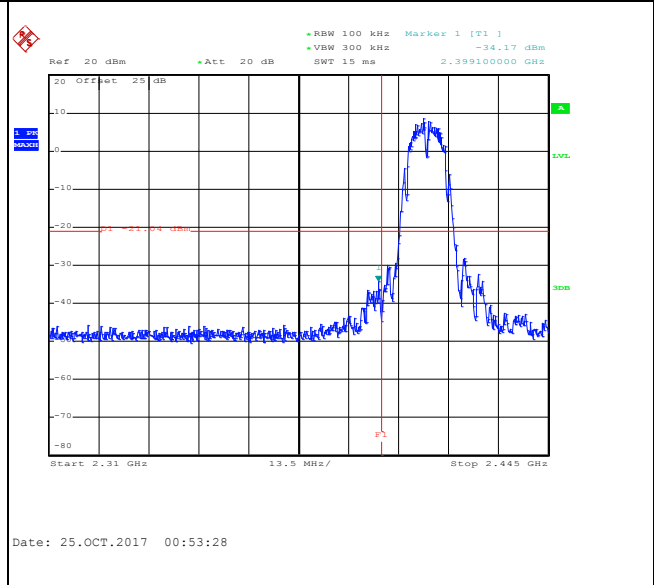

Spurious Emission 30MHz~3GHz

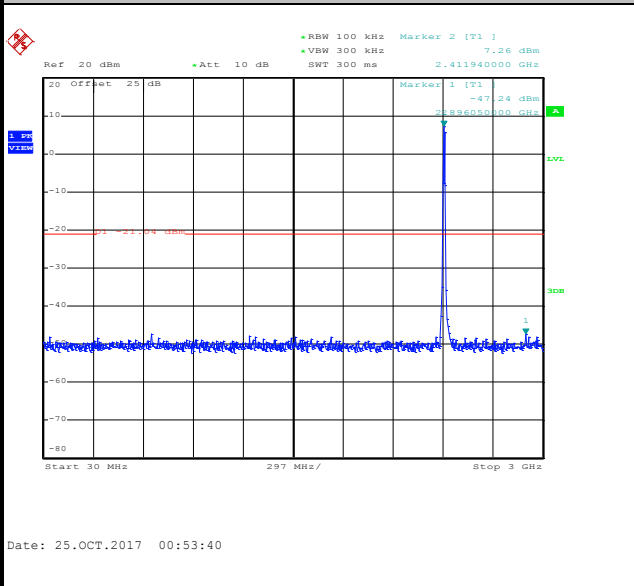

Spurious Emission 2GHz~25GHz

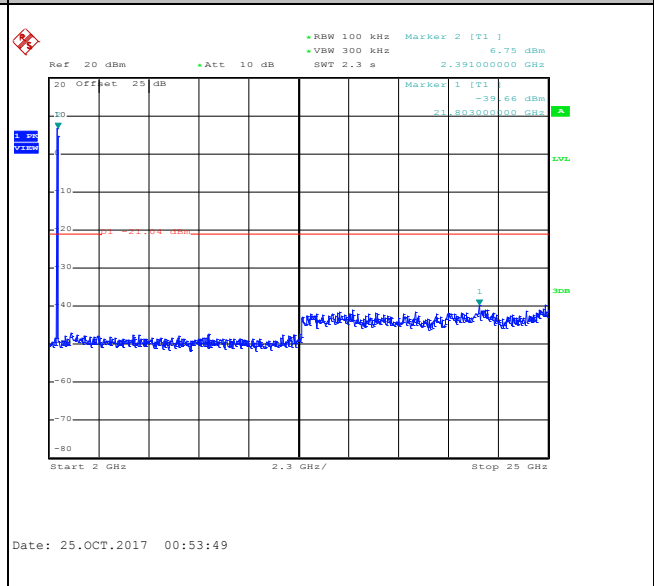



Number of TX :	2	Ant. :	2
Test Mode :	802.11b	Temperature :	21~25°C
Test Band :	2.4GHz Low	Relative Humidity :	51~54%
Test Channel :	02	Test Engineer :	Kai Liao

WLAN 802.11b Channel 02

100kHz PSD reference Level

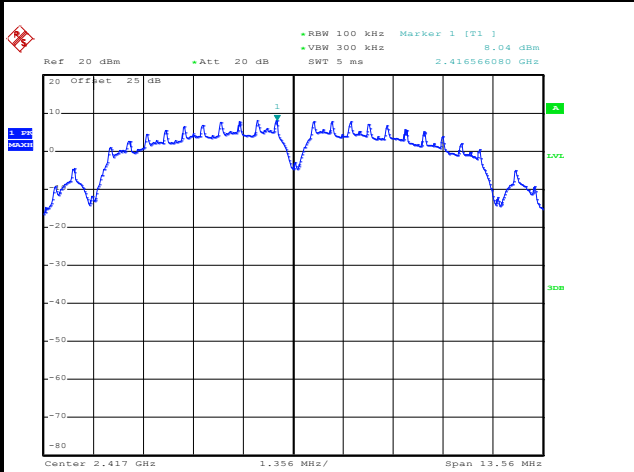

Date: 2.OCT.2017 23:15:56

Low Channel Plot

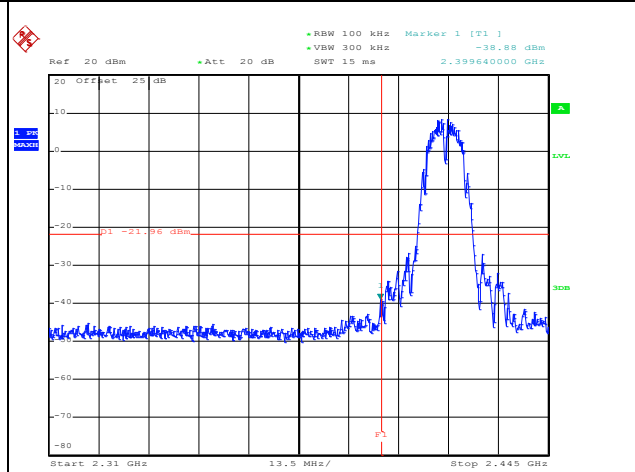

Date: 25.OCT.2017 00:55:36

Spurious Emission 30MHz~3GHz

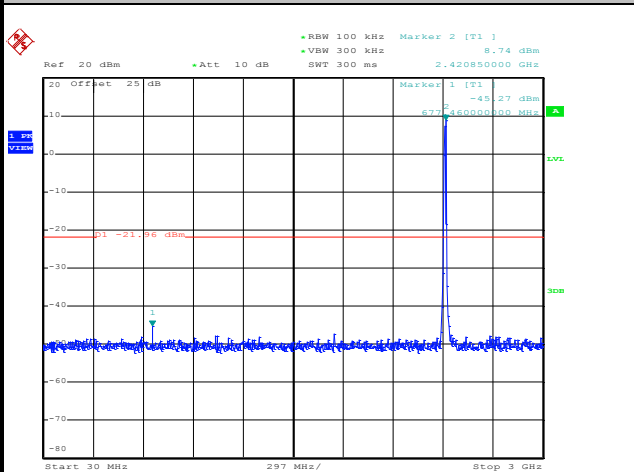

Date: 25.OCT.2017 00:55:04

Spurious Emission 2GHz~25GHz

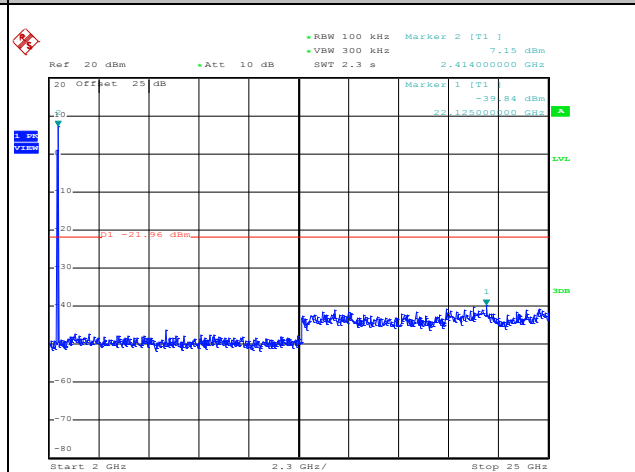

Date: 25.OCT.2017 00:55:12



Number of TX :	2	Ant. :	2
Test Mode :	802.11b	Temperature :	21~25°C
Test Band :	2.4GHz Mid	Relative Humidity :	51~54%
Test Channel :	06	Test Engineer :	Kai Liao

WLAN 802.11b Channel 06

100kHz PSD reference Level

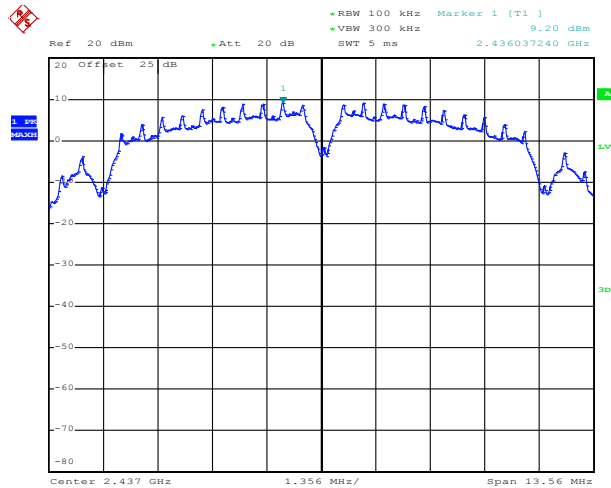

Date: 2.OCT.2017 23:23:25

Spurious Emission 30MHz~3GHz

Spurious Emission 2GHz~25GHz

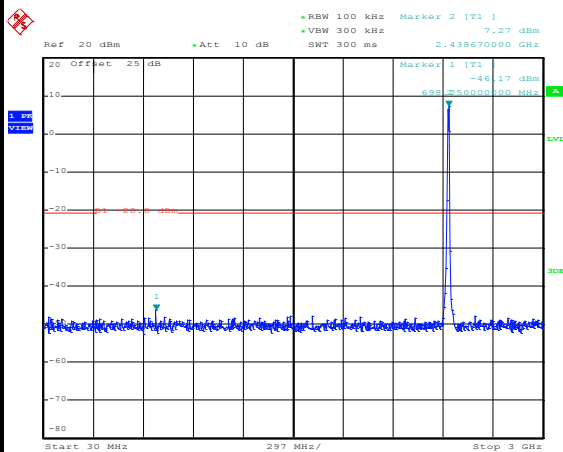

Date: 25.OCT.2017 01:06:49

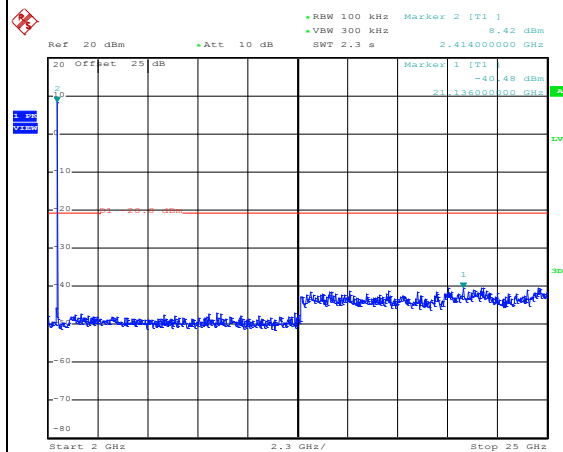

Date: 25.OCT.2017 01:06:57



Number of TX :	2	Ant. :	2
Test Mode :	802.11b	Temperature :	21~25°C
Test Band :	2.4GHz High	Relative Humidity :	51~54%
Test Channel :	10	Test Engineer :	Kai Liao

WLAN 802.11b Channel 10

100kHz PSD reference Level

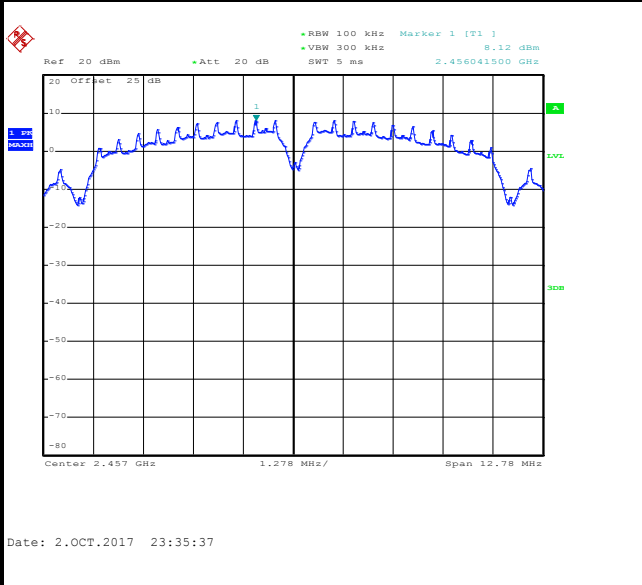

High Channel Plot

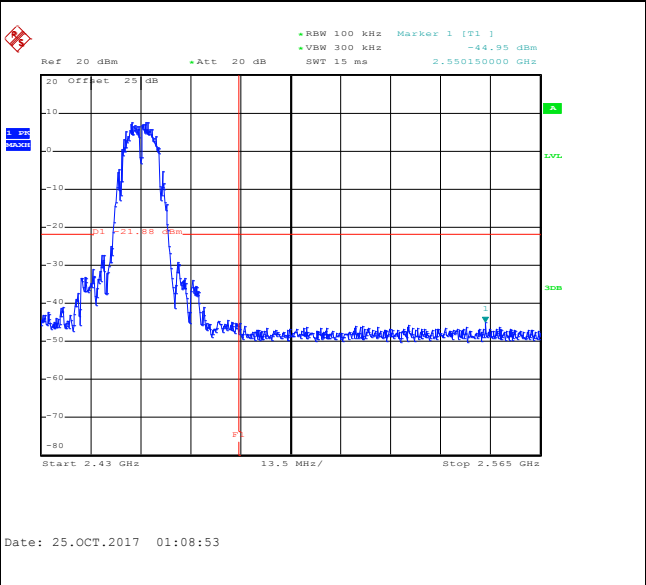

Spurious Emission 30MHz~3GHz

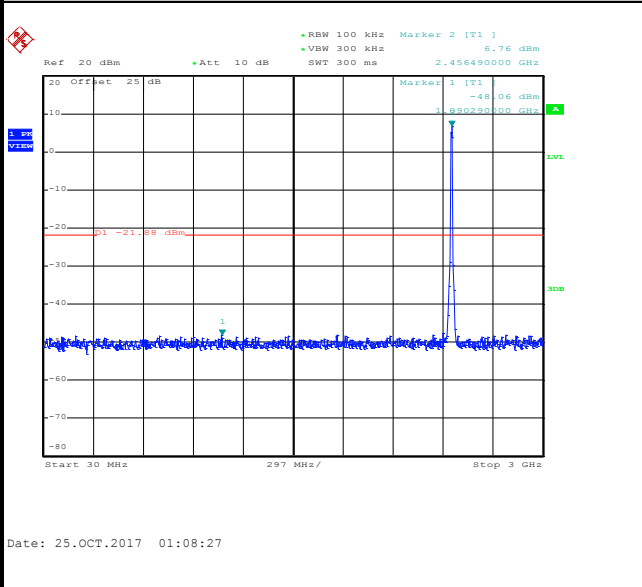

Spurious Emission 2GHz~25GHz

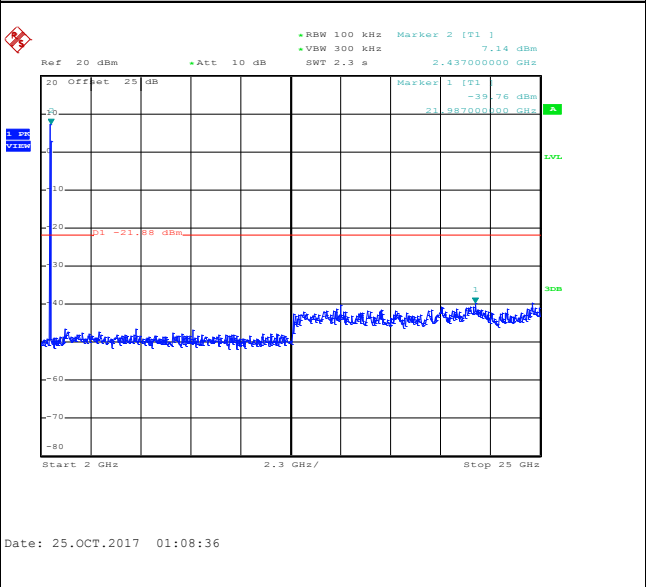



Number of TX :	2	Ant. :	2
Test Mode :	802.11b	Temperature :	21~25°C
Test Band :	2.4GHz High	Relative Humidity :	51~54%
Test Channel :	11	Test Engineer :	Kai Liao

WLAN 802.11b Channel 11

100kHz PSD reference Level

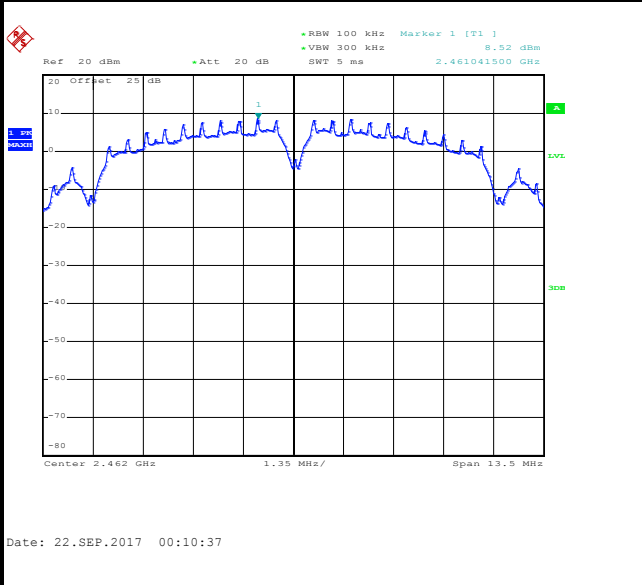

High Channel Plot

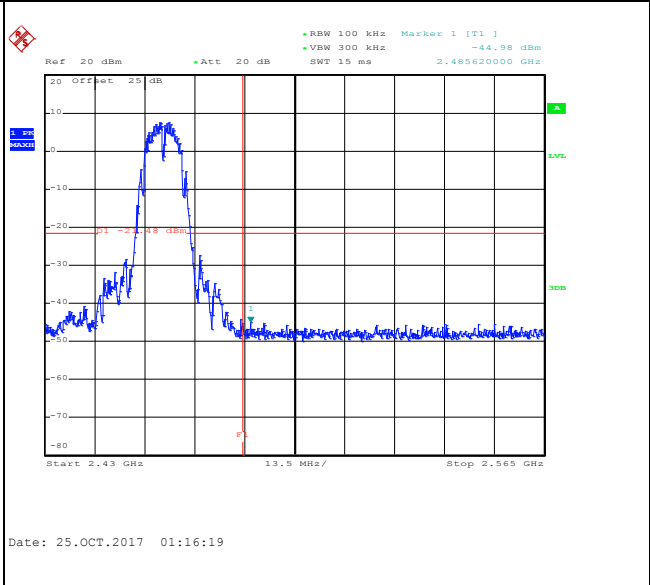

Spurious Emission 30MHz~3GHz

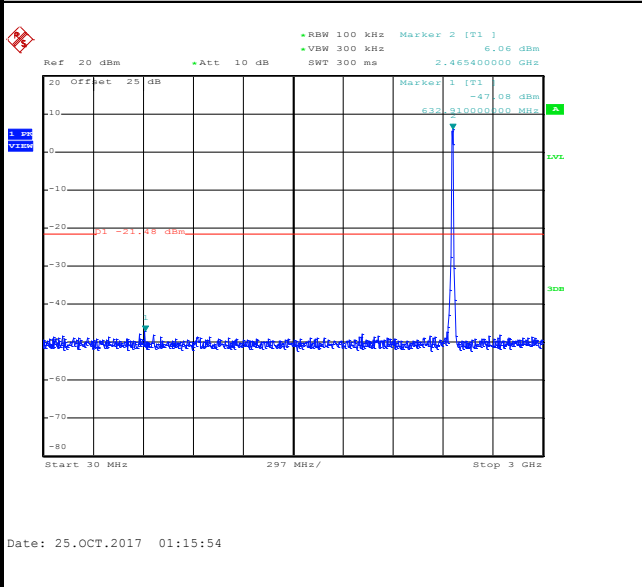

Spurious Emission 2GHz~25GHz

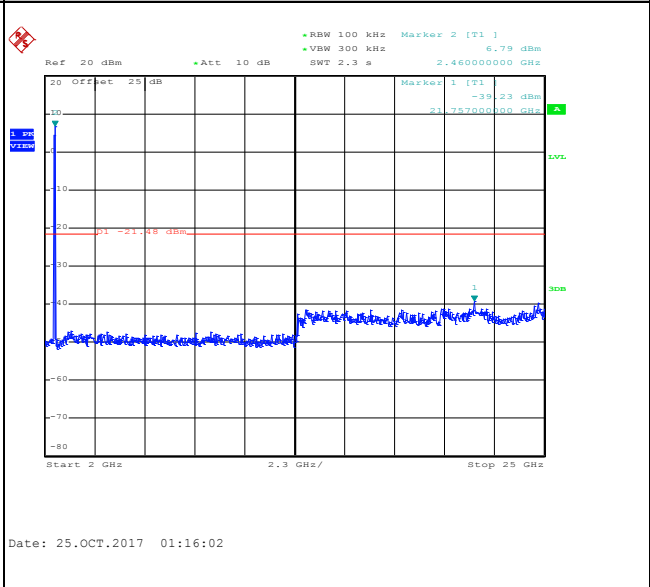



Number of TX :	2	Ant. :	2
Test Mode :	802.11g	Temperature :	21~25°C
Test Band :	2.4GHz Low	Relative Humidity :	51~54%
Test Channel :	01	Test Engineer :	Kai Liao

WLAN 802.11g Channel 01

100kHz PSD reference Level

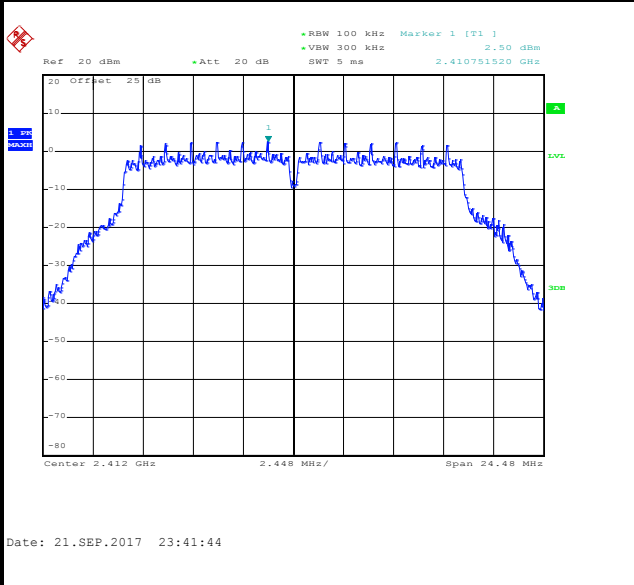

Low Channel Plot

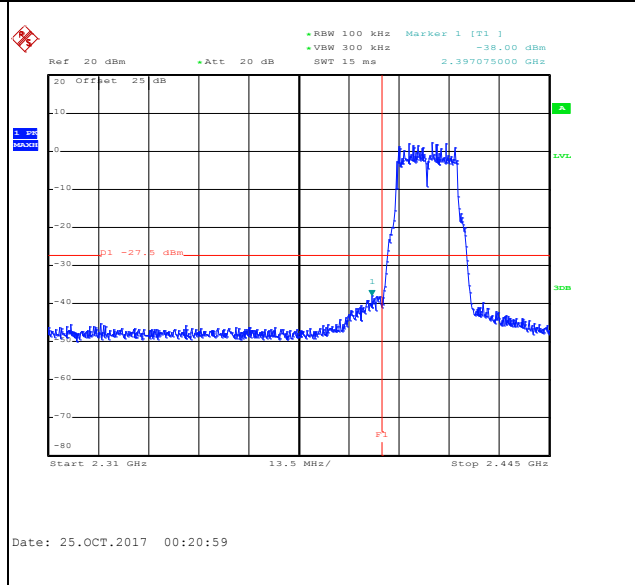

Spurious Emission 30MHz~3GHz

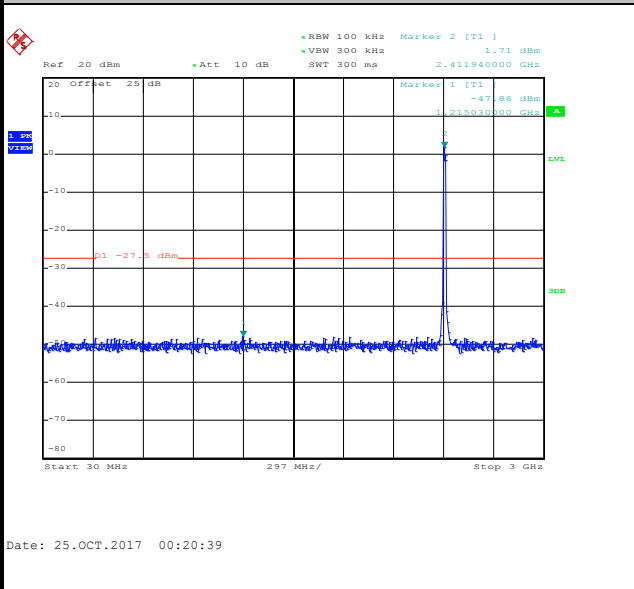

Spurious Emission 2GHz~25GHz

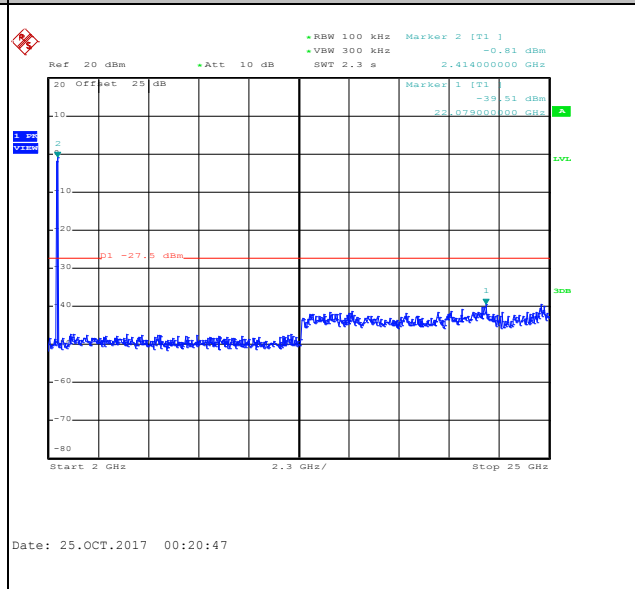



Number of TX :	2	Ant. :	2
Test Mode :	802.11g	Temperature :	21~25°C
Test Band :	2.4GHz Low	Relative Humidity :	51~54%
Test Channel :	02	Test Engineer :	Kai Liao

WLAN 802.11g Channel 02

100kHz PSD reference Level

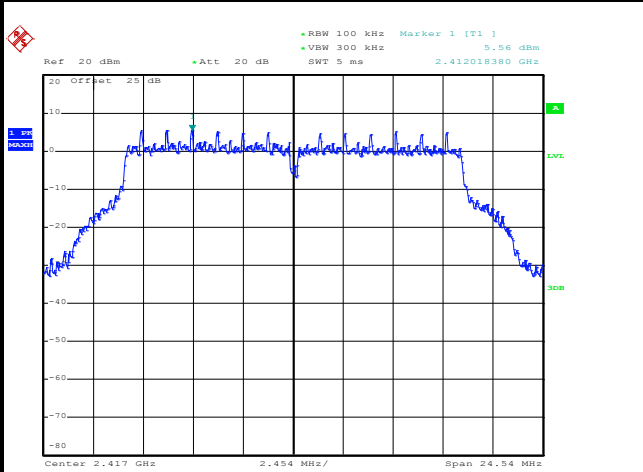

Date: 2.OCT.2017 23:53:17

Low Channel Plot

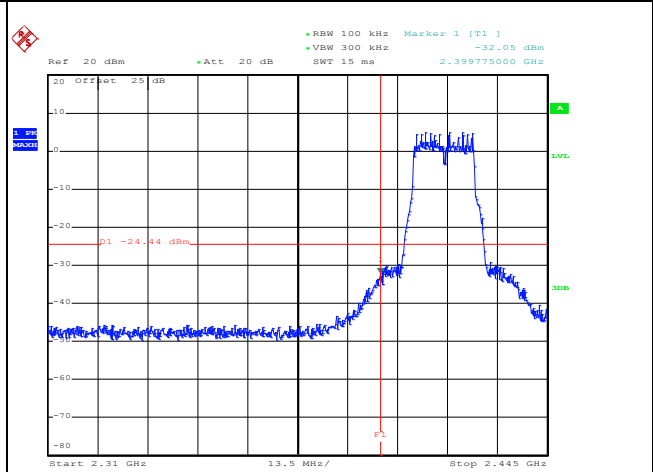

Date: 25.OCT.2017 00:23:01

Spurious Emission 30MHz~3GHz

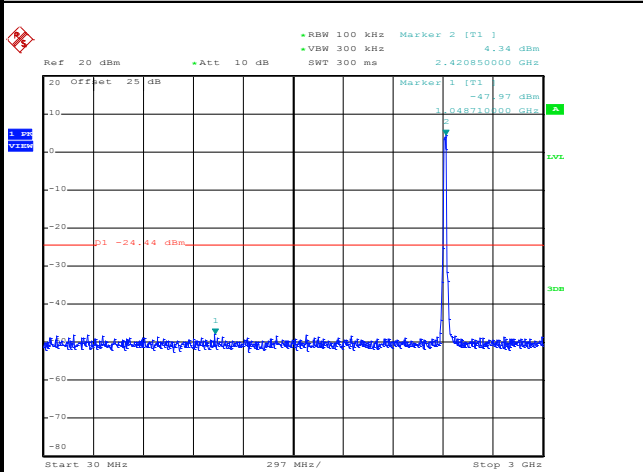

Date: 25.OCT.2017 00:22:27

Spurious Emission 2GHz~25GHz

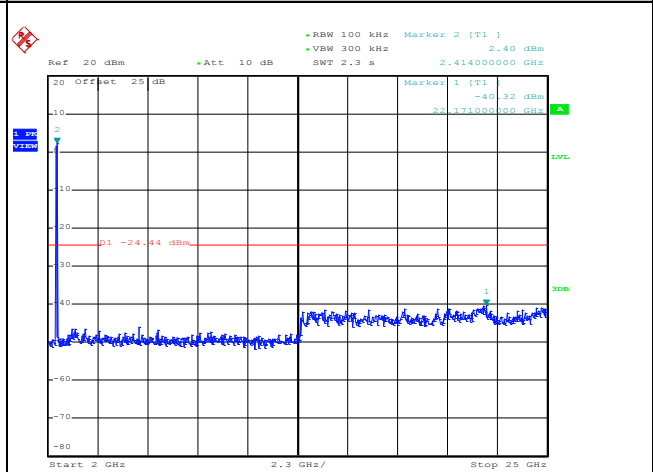

Date: 25.OCT.2017 00:22:35



Number of TX :	2	Ant. :	2
Test Mode :	802.11g	Temperature :	21~25°C
Test Band :	2.4GHz Mid	Relative Humidity :	51~54%
Test Channel :	06	Test Engineer :	Kai Liao

WLAN 802.11g Channel 06

100kHz PSD reference Level

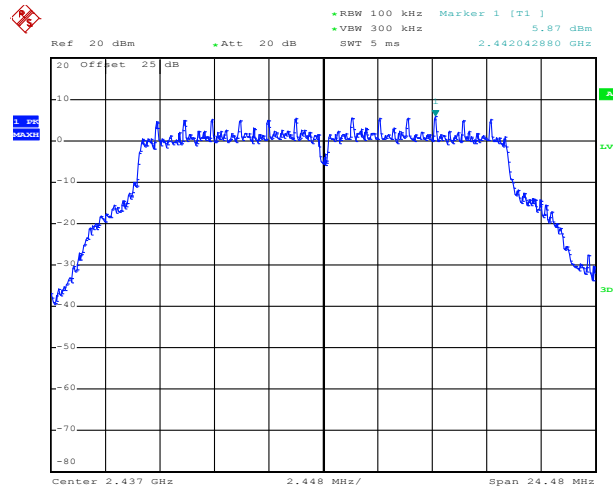

Date: 3.OCT.2017 00:51:39

Spurious Emission 30MHz~3GHz

Spurious Emission 2GHz~25GHz

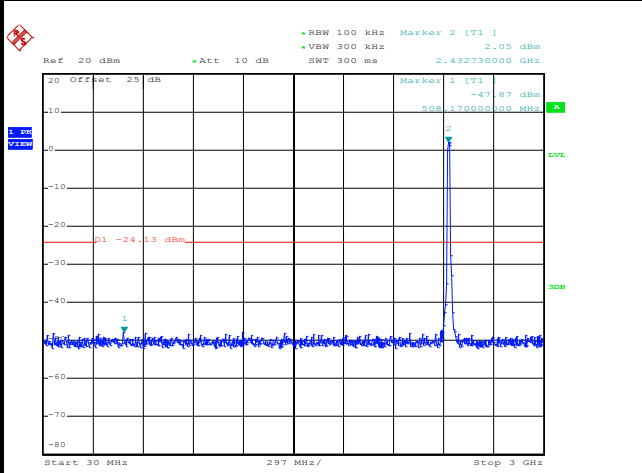

Date: 25.OCT.2017 00:32:20

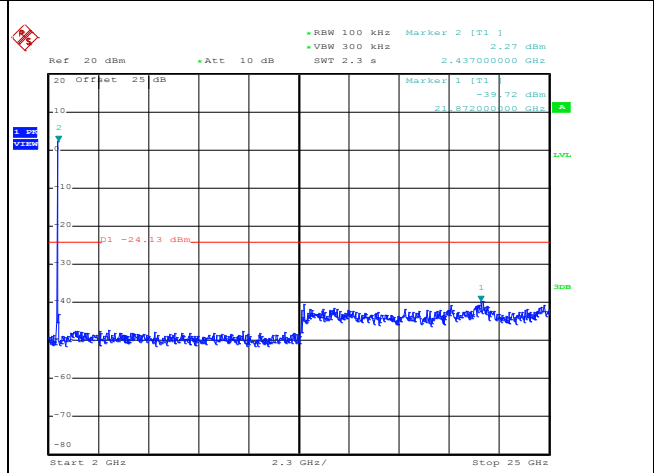

Date: 25.OCT.2017 00:32:29



Number of TX :	2	Ant. :	2
Test Mode :	802.11g	Temperature :	21~25°C
Test Band :	2.4GHz High	Relative Humidity :	51~54%
Test Channel :	10	Test Engineer :	Kai Liao

WLAN 802.11g Channel 10

100kHz PSD reference Level

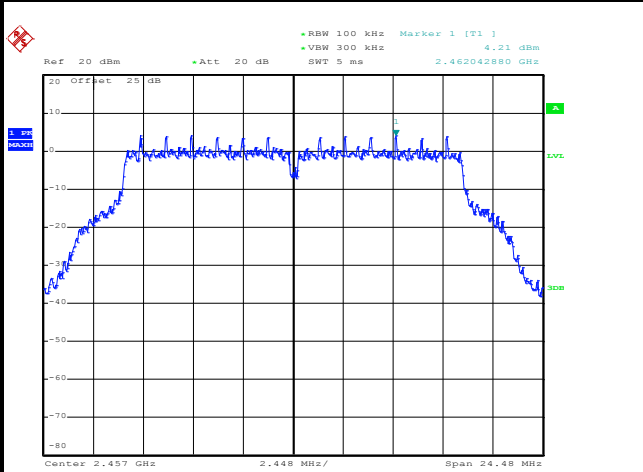

Date: 21.SEP.2017 23:56:23

High Channel Plot

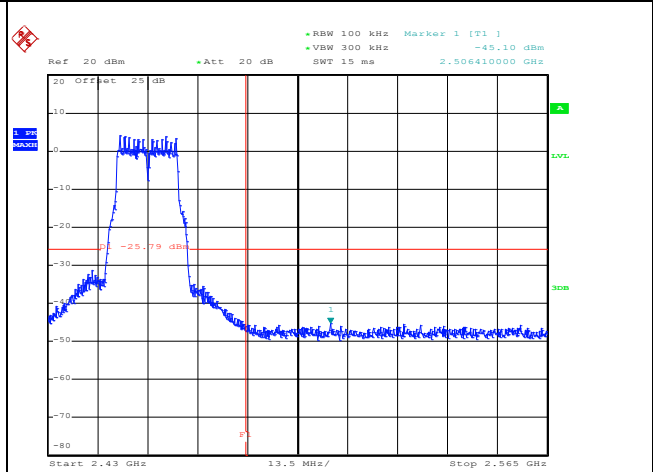

Date: 25.OCT.2017 00:34:41

Spurious Emission 30MHz~3GHz

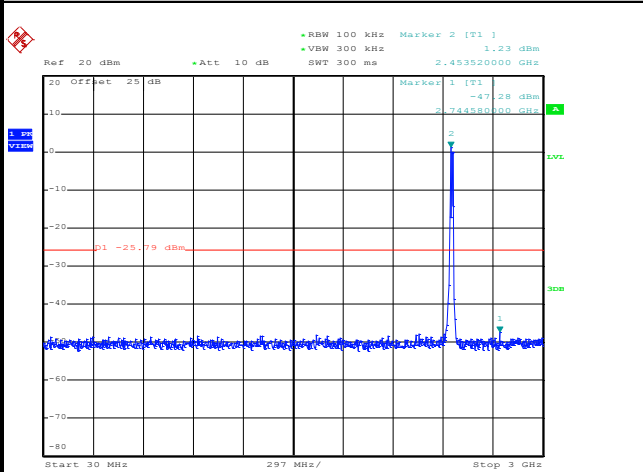

Date: 25.OCT.2017 00:34:14

Spurious Emission 2GHz~25GHz

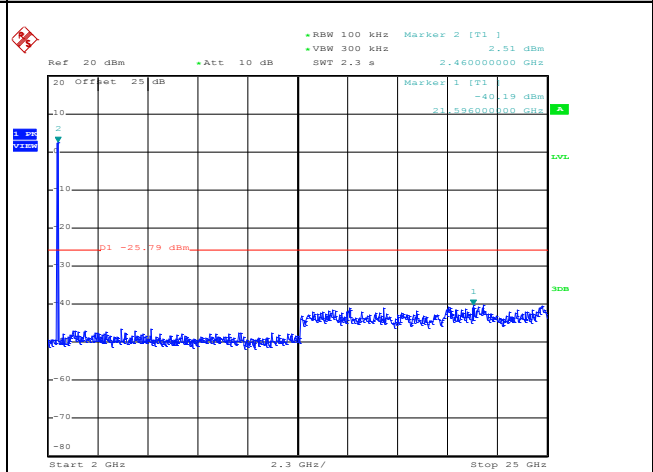

Date: 25.OCT.2017 00:34:22



Number of TX :	2	Ant. :	2
Test Mode :	802.11g	Temperature :	21~25°C
Test Band :	2.4GHz High	Relative Humidity :	51~54%
Test Channel :	11	Test Engineer :	Kai Liao

WLAN 802.11g Channel 11

100kHz PSD reference Level

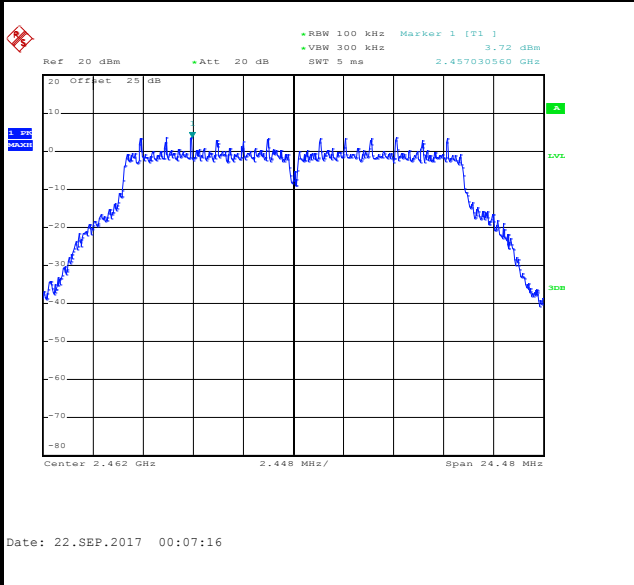

High Channel Plot

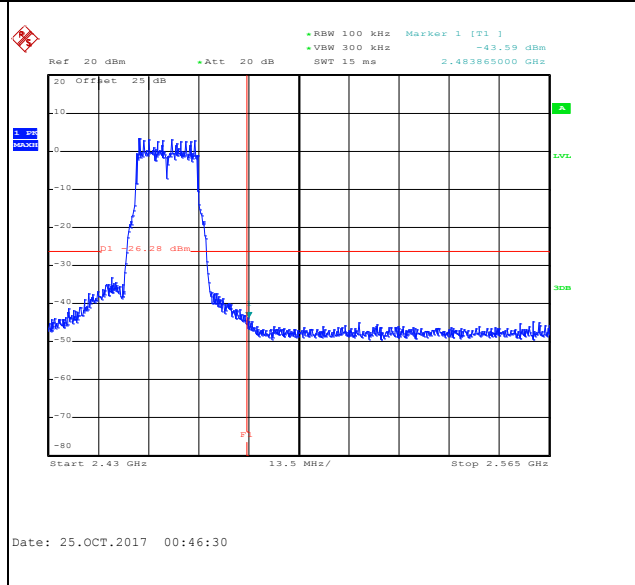

Spurious Emission 30MHz~3GHz

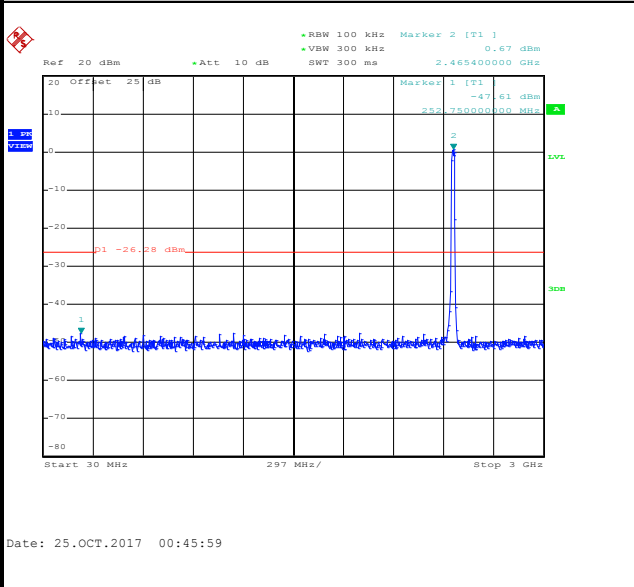

Spurious Emission 2GHz~25GHz

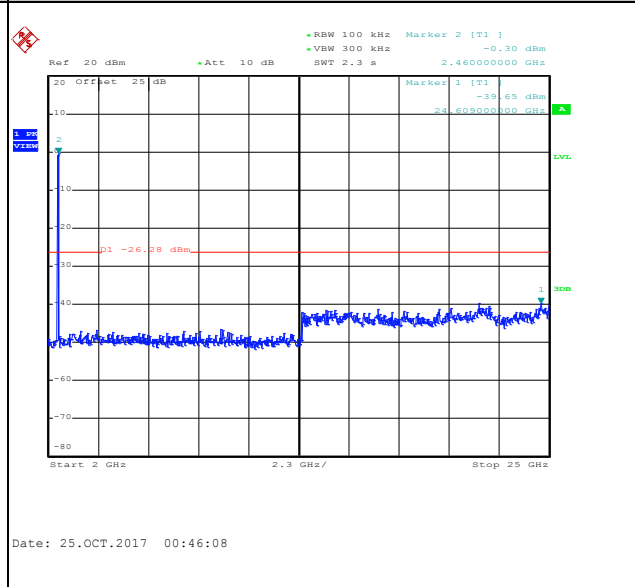



Number of TX :	2	Ant. :	2
Test Mode :	802.11n HT20	Temperature :	21~25°C
Test Band :	2.4GHz Low	Relative Humidity :	51~54%
Test Channel :	01	Test Engineer :	Kai Liao

WLAN 802.11n HT20 Channel 01

100kHz PSD reference Level

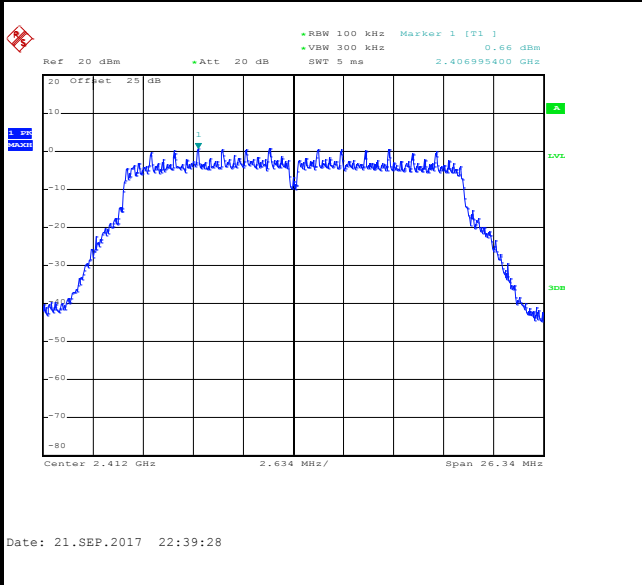

Low Channel Plot

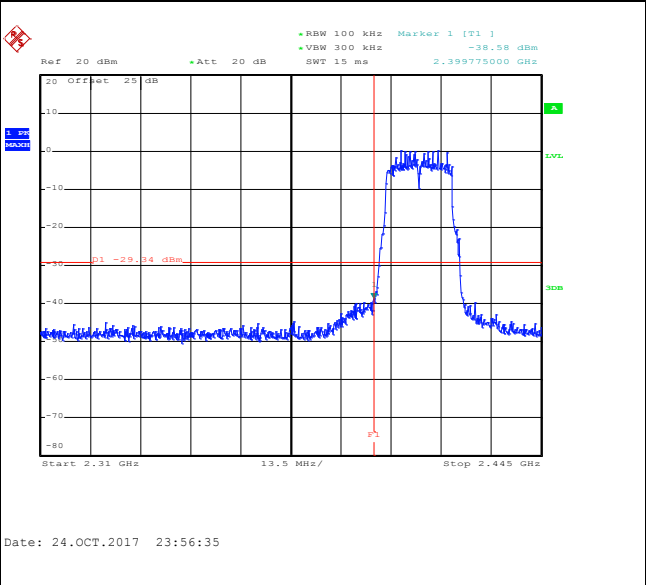

Spurious Emission 30MHz~3GHz

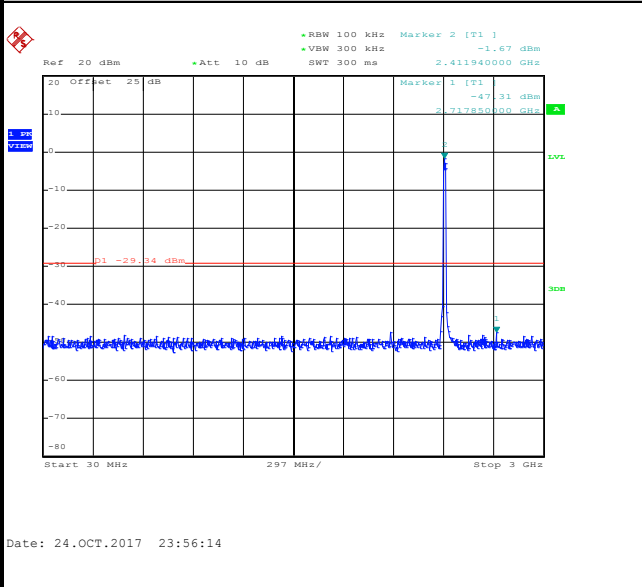

Spurious Emission 2GHz~25GHz

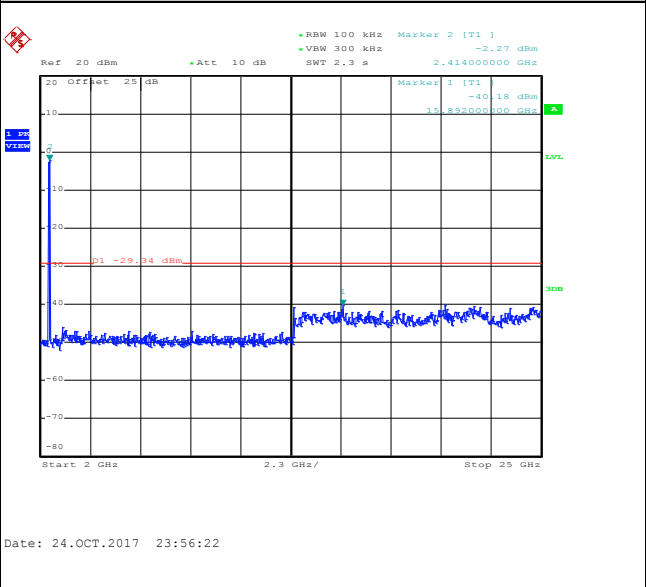



Number of TX :	2	Ant. :	2
Test Mode :	802.11n HT20	Temperature :	21~25°C
Test Band :	2.4GHz Low	Relative Humidity :	51~54%
Test Channel :	02	Test Engineer :	Kai Liao

WLAN 802.11n HT20 Channel 02

100kHz PSD reference Level

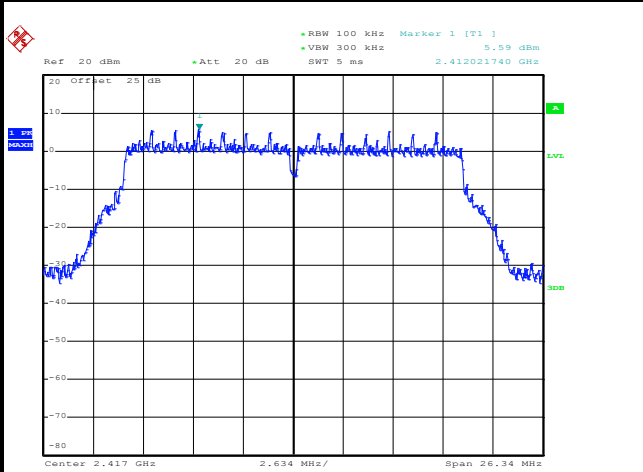

Date: 3.OCT.2017 01:04:03

Low Channel Plot

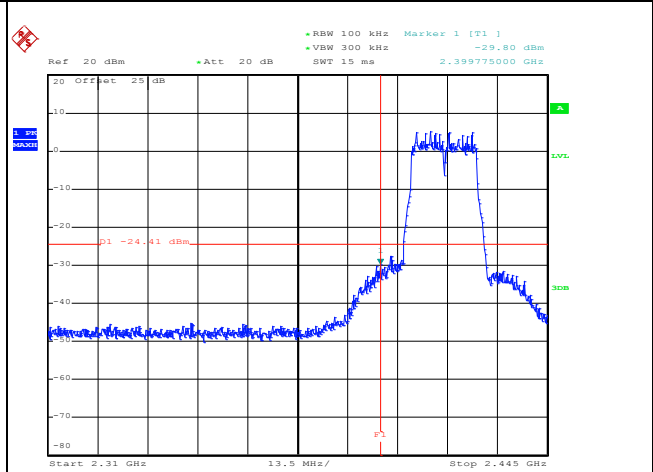

Date: 24.OCT.2017 23:58:02

Spurious Emission 30MHz~3GHz

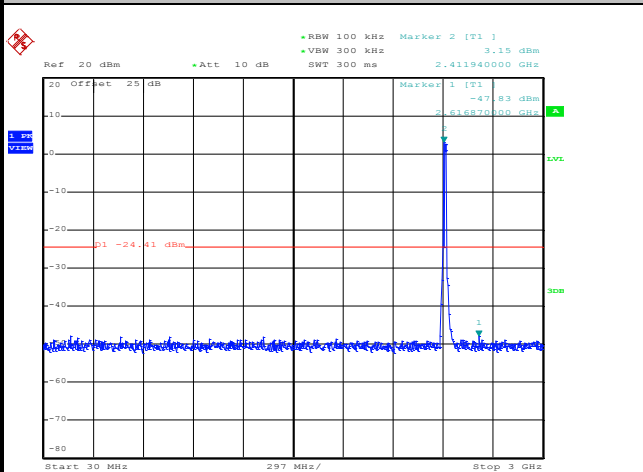

Date: 24.OCT.2017 23:57:33

Spurious Emission 2GHz~25GHz

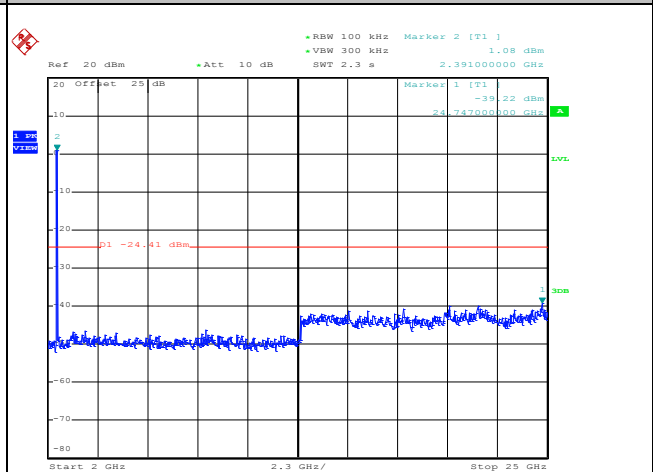

Date: 24.OCT.2017 23:57:41



Number of TX :	2	Ant. :	2
Test Mode :	802.11n HT20	Temperature :	21~25°C
Test Band :	2.4GHz Mid	Relative Humidity :	51~54%
Test Channel :	06	Test Engineer :	Kai Liao

WLAN 802.11n HT20 Channel 06

100kHz PSD reference Level

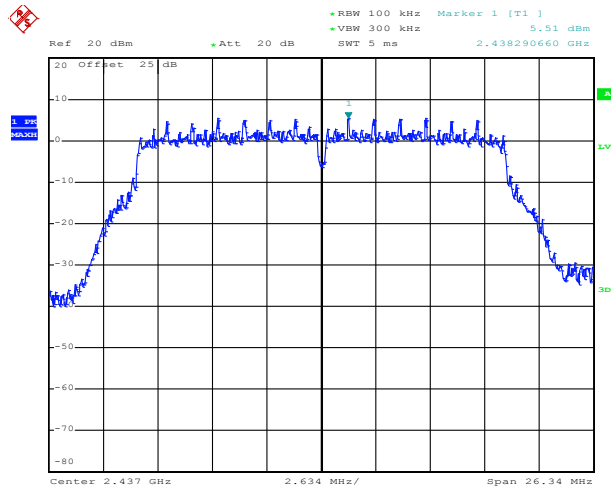

Date: 3.OCT.2017 01:01:11

Spurious Emission 30MHz~3GHz

Spurious Emission 2GHz~25GHz

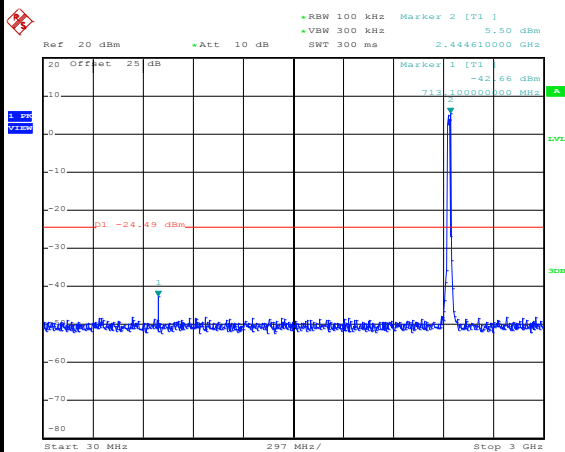

Date: 25.OCT.2017 00:02:12

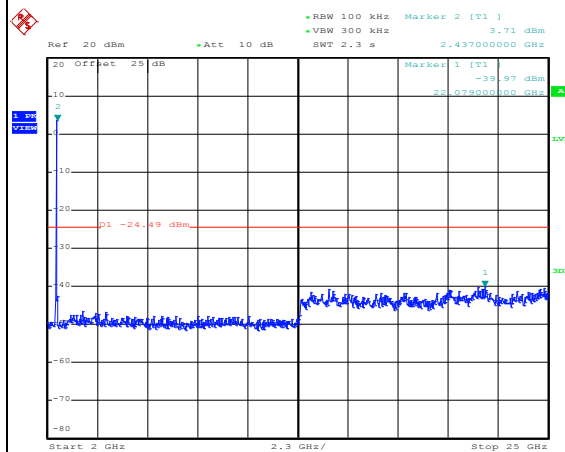

Date: 25.OCT.2017 00:02:20



Number of TX :	2	Ant. :	2
Test Mode :	802.11n HT20	Temperature :	21~25°C
Test Band :	2.4GHz High	Relative Humidity :	51~54%
Test Channel :	10	Test Engineer :	Kai Liao

WLAN 802.11n HT20 Channel 10

100kHz PSD reference Level

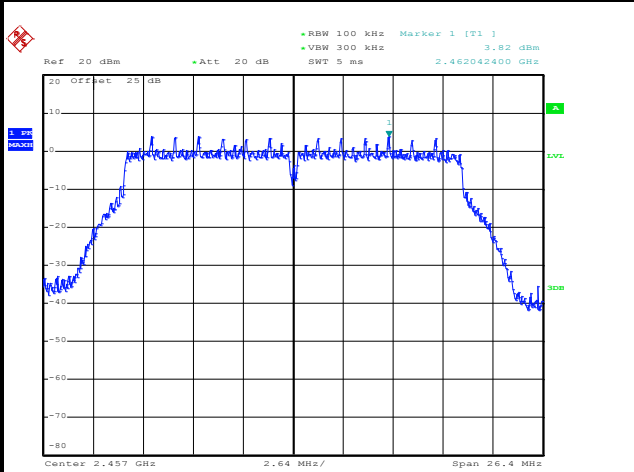

Date: 21.SEP.2017 22:25:38

High Channel Plot

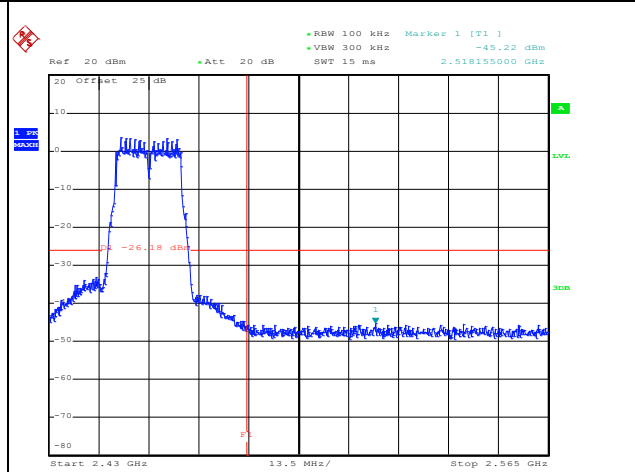

Date: 25.OCT.2017 00:04:38

Spurious Emission 30MHz~3GHz

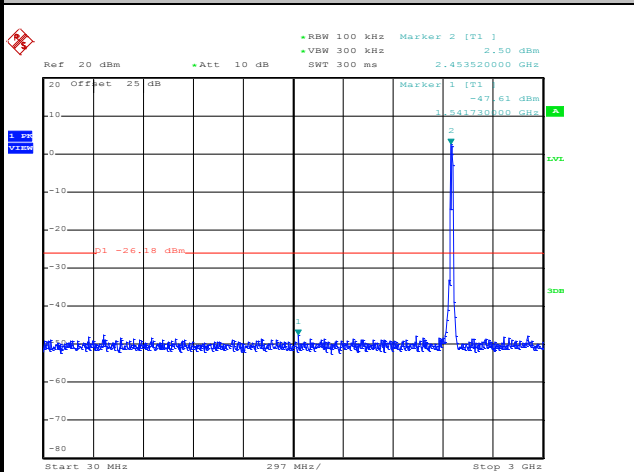

Date: 25.OCT.2017 00:04:07

Spurious Emission 2GHz~25GHz

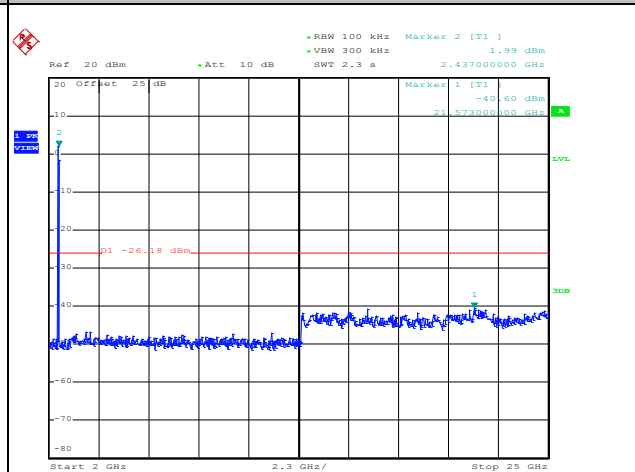

Date: 25.OCT.2017 00:04:16