



FCC RF Test Report

APPLICANT : Zebra Technologies Corporation
EQUIPMENT : Mobile Computer
BRAND NAME : Zebra
MODEL NAME : MC330K
FCC ID : UZ7MC330K
STANDARD : FCC Part 15 Subpart E §15.407
CLASSIFICATION : (NII) Unlicensed National Information Infrastructure

The product was received on Sep. 01, 2017 and testing was completed on Oct. 18, 2017. We, SPORTON INTERNATIONAL INC., would like to declare that the tested sample has been evaluated in accordance with the test procedures and has been in compliance with the applicable technical standards.

The test results in this report apply exclusively to the tested model / sample. Without written approval of SPORTON INTERNATIONAL INC., the test report shall not be reproduced except in full.

Reviewed by: Joseph Lin / Supervisor

Approved by: Jones Tsai / Manager



Testing Laboratory
1190

SPORTON INTERNATIONAL INC.

No. 52, Hwa Ya 1st Rd., Hwa Ya Technology Park, Kwei-Shan District, Tao Yuan City, Taiwan, R.O.C.



TABLE OF CONTENTS

REVISION HISTORY..... 3

SUMMARY OF TEST RESULT 4

1 GENERAL DESCRIPTION 5

 1.1 Applicant 5

 1.2 Manufacturer 5

 1.3 Product Feature of Equipment Under Test..... 5

 1.4 Product Specification of Equipment Under Test..... 7

 1.5 Modification of EUT 8

 1.6 Testing Location 9

 1.7 Applicable Standards 9

2 TEST CONFIGURATION OF EQUIPMENT UNDER TEST 10

 2.1 Carrier Frequency and Channel 10

 2.2 Test Mode 11

 2.3 Connection Diagram of Test System..... 20

 2.4 Support Unit used in test configuration and system 21

 2.5 EUT Operation Test Setup 22

 2.6 Measurement Results Explanation Example..... 22

3 TEST RESULT..... 23

 3.1 6dB and 26dB and 99% Occupied Bandwidth Measurement 23

 3.2 Maximum Conducted Output Power Measurement 29

 3.3 Power Spectral Density Measurement 33

 3.4 Unwanted Emissions Measurement 39

 3.5 AC Conducted Emission Measurement..... 45

 3.6 Frequency Stability Measurement 47

 3.7 Automatically Discontinue Transmission 49

 3.8 Antenna Requirements 50

4 LIST OF MEASURING EQUIPMENT 52

5 UNCERTAINTY OF EVALUATION 53

APPENDIX A. AC CONDUCTED EMISSION TEST RESULT

APPENDIX B. RADIATED SPURIOUS EMISSION

APPENDIX C. RADIATED SPURIOUS EMISSION PLOTS

APPENDIX D. DUTY CYCLE PLOTS

APPENDIX E. SETUP PHOTOGRAPHS



REVISION HISTORY

REPORT NO.	VERSION	DESCRIPTION	ISSUED DATE
FR790120F	Rev. 01	Initial issue of report	Nov. 02, 2017



SUMMARY OF TEST RESULT

Report Section	FCC Rule	Description	Limit	Result	Remark
3.1	15.403(i)	6dB, 26dB and 99% Occupied Bandwidth	> 500kHz	Pass	-
3.2	15.407(a)	Maximum Conducted Output Power	≤ 30 dBm	Pass	-
3.3	15.407(a)	Power Spectral Density	≤ 30 dBm/500kHz	Pass	-
3.4	15.407(b)	Unwanted Emissions	15.407(b)(4)(i) & 15.209(a)	Pass	Under limit 1.21 dB at 5649.200 MHz
3.5	15.207	AC Conducted Emission	15.207(a)	Pass	Under limit 8.00 dB at 13.558 MHz
3.6	15.407(g)	Frequency Stability	Within Operation Band	Pass	-
3.7	15.407(c)	Automatically Discontinue Transmission	Discontinue Transmission	Pass	-
3.8	15.203 & 15.407(a)	Antenna Requirement	N/A	Pass	-



1 General Description

1.1 Applicant

Zebra Technologies Corporation
1 Zebra Plaza, Holtsville, NY 11742

1.2 Manufacturer

Zebra Technologies Corporation
1 Zebra Plaza, Holtsville, NY 11742

1.3 Product Feature of Equipment Under Test

Product Feature	
Equipment	Mobile Computer
Brand Name	Zebra
Model Name	MC330K
FCC ID	UZ7MC330K
EUT supports Radios application	NFC WLAN 11a/b/g/n HT20/HT40 WLAN 11ac VHT20/VHT40/VHT80 Bluetooth BR/EDR/LE
HW Version	EV1b
SW Version	Android Version 7.1.2
FW Version	W10: Aug 4 2017 12:57:11 version 7.35.205.8 (r) FWID 01-895bc792
MFD	30AUG17
EUT Stage	Engineering Sample

Remark:

1. The above EUT's information was declared by manufacturer. Please refer to the specifications or user's manual for more detailed description.
2. AC Conducted Emission tests are performed on SKU 5, and Radiated Spurious Emission tests are performed on SKU 7.



<SKU list>

Premium+					
SKU	Type-scanner	camera	Audio Jack	NFC	Speaker
1	GUN-SE4850	X	X	V	V
2	GUN-SE4750	X	X	V	V
3	GUN-SE965	X	X	V	V
4	Brick-SE4850	V	V	V	V
5	Brick-SE4750	V	V	V	V
6	Brick-SE965	V	V	V	V
7	Rotate	V	V	V	V

Premium					
SKU	Type-scanner	camera	Audio Jack	NFC	Speaker
8	Brick-SE4850	X	V	V	V
9	Brick-SE4750	X	V	V	V
10	Brick-SE965	X	V	V	V
11	Rotate	X	V	V	V

Specification of Accessories				
Sentry 1X Battery	Brand Name	Zebra	Part Number	BT-000338-01
Sentry 2X Battery	Brand Name	Zebra	Part Number	BT-000337-01
MC32 1X Battery	Brand Name	Symbol	Part Number	82-000011-01
MC32 2X Battery	Brand Name	Symbol	Part Number	82-000012-02
Wall wart power supply(18W)	Brand Name	Zebra	Part Number	PWR-WUA5V12W0US
Charge Cable for Wall wart power supply	Brand Name	Zebra	Part Number	PWRS-14000-249R
HS2100 Earphone	Brand Name	Symbol	Part Number	HS2100-OTH
Quick Disconnect cable for HS2100 Headset	Brand Name	Symbol	Part Number	CBL-HS2100-QDC1-01
RCH51 Earphone	Brand Name	Symbol	Part Number	RCH51
Cable for RCH51 earphone	Brand Name	Symbol	Part Number	25-124411-02R
U cable	Brand Name	Symbol	Part Number	CBL-MC33-USBCHG-01
Gun Holster MC3000	Brand Name	Symbol	Model Name	SG-MC3021212-01R
Holster MC30XX	Brand Name	Symbol	Model Name	11-69293-01R



1.4 Product Specification of Equipment Under Test

Standards-related Product Specification	
Tx/Rx Channel Frequency Range	5745 MHz ~ 5825 MHz
Maximum Output Power <CDD Modes>	<p><5745 MHz ~ 5825 MHz></p> <p><Ant. 1> 802.11a : 17.44 dBm / 0.0555 W 802.11n HT20 : 17.48 dBm / 0.056 W 802.11n HT40 : 16.89 dBm / 0.0489 W 802.11ac VHT20: 17.49 dBm / 0.0561 W 802.11ac VHT40: 16.90 dBm / 0.0490 W 802.11ac VHT80: 14.96 dBm / 0.0313 W</p> <p><Ant. 2> 802.11a : 17.22 dBm / 0.0527 W 802.11n HT20 : 17.21 dBm / 0.0526 W 802.11n HT40 : 16.80 dBm / 0.0479 W 802.11ac VHT20: 17.25 dBm / 0.0531 W 802.11ac VHT40: 16.89 dBm / 0.0489 W 802.11ac VHT80: 14.88 dBm / 0.0308 W</p> <p>MIMO <Ant. 1 + 2> 802.11a : 20.00 dBm / 0.1000 W 802.11n HT20 : 20.21 dBm / 0.1050 W 802.11n HT40 : 19.74 dBm / 0.0942 W 802.11ac VHT20: 20.25 dBm / 0.1059 W 802.11ac VHT40: 19.84 dBm / 0.0964 W 802.11ac VHT80: 18.64 dBm / 0.0731 W</p>
Maximum Output Power <TXBF Modes>	<p><5745 MHz ~ 5825 MHz></p> <p><Ant. 1> 802.11n HT20 : 17.70 dBm / 0.0589 W 802.11n HT40 : 16.40 dBm / 0.0437 W 802.11ac VHT20: 17.80 dBm / 0.0603 W 802.11ac VHT40: 16.60 dBm / 0.0457 W 802.11ac VHT80: 15.70 dBm / 0.0372 W</p> <p><Ant. 2> 802.11n HT20 : 17.20 dBm / 0.0525 W 802.11n HT40 : 16.70 dBm / 0.0468 W 802.11ac VHT20: 17.30 dBm / 0.0537 W 802.11ac VHT40: 16.90 dBm / 0.0490 W 802.11ac VHT80: 16.10 dBm / 0.0407 W</p> <p>MIMO <Ant. 1 + 2> 802.11n HT20 : 20.31 dBm / 0.1074 W 802.11n HT40 : 19.51 dBm / 0.0893 W 802.11ac VHT20: 20.37 dBm / 0.1089 W 802.11ac VHT40: 19.76 dBm / 0.0778 W 802.11ac VHT80: 18.91 dBm / 0.0731 W</p>



Standards-related Product Specification													
99% Occupied Bandwidth <CDD Modes>	802.11a : 20.40 MHz 802.11ac VHT20 : 20.45 MHz 802.11ac VHT40 : 46.10 MHz 802.11ac VHT80 : 76.32 MHz												
99% Occupied Bandwidth <TXBF Modes>	802.11ac VHT20 : 19.80 MHz 802.11ac VHT40 : 37.70 MHz 802.11ac VHT80 : 75.96 MHz												
Type of Modulation	802.11a : OFDM (BPSK / QPSK / 16QAM / 64QAM) 802.11ac : OFDM (BPSK / QPSK / 16QAM / 64QAM / 256QAM)												
Antenna Type / Gain	<Ant. 1> : PIFA Antenna with gain 5.31 dBi <Ant. 2> : PIFA Antenna with gain 4.85 dBi												
Antenna Function Description	<table border="1"> <thead> <tr> <th></th> <th>Ant. 1</th> <th>Ant. 2</th> </tr> </thead> <tbody> <tr> <td>802.11 a/n/ac</td> <td>V</td> <td>V</td> </tr> <tr> <td>802.11 a/n/ac MIMO</td> <td>V</td> <td>V</td> </tr> <tr> <td>802.11n/ac TXBF</td> <td>V</td> <td>V</td> </tr> </tbody> </table>		Ant. 1	Ant. 2	802.11 a/n/ac	V	V	802.11 a/n/ac MIMO	V	V	802.11n/ac TXBF	V	V
	Ant. 1	Ant. 2											
802.11 a/n/ac	V	V											
802.11 a/n/ac MIMO	V	V											
802.11n/ac TXBF	V	V											

Note: MIMO Ant. 1+2 is a calculated result from sum of the power MIMO Ant. 1 and MIMO Ant. 2.

1.5 Modification of EUT

No modifications are made to the EUT during all test items.



1.6 Testing Location

Sporton Lab is accredited to ISO 17025 by Taiwan Accreditation Foundation (TAF code : 1190) and the FCC designation No. TW1190 under the FCC 2.948(e) by Mutual Recognition Agreement (MRA) in FCC Test.

Test Site	SPORTON INTERNATIONAL INC.		
Test Site Location	No. 52, Hwa Ya 1 st Rd., Hwa Ya Technology Park, Kwei-Shan District, Tao Yuan City, Taiwan, R.O.C. TEL: +886-3-327-3456 FAX: +886-3-328-4978		
Test Site No.	Sporton Site No.		
	TH05-HY	CO05-HY	03CH07-HY

Note: The test site complies with ANSI C63.4 2014 requirement.

1.7 Applicable Standards

According to the specifications of the manufacturer, the EUT must comply with the requirements of the following standards:

- ♦ FCC Part 15 Subpart E
- ♦ FCC KDB 789033 D02 General UNII Test Procedures New Rules v01r04.
- ♦ FCC KDB 662911 D01 Multiple Transmitter Output v02r01.
- ♦ ANSI C63.10-2013

Remark:

1. All test items were verified and recorded according to the standards and without any deviation during the test.
2. This EUT has also been tested and complied with the requirements of FCC Part 15, Subpart B, recorded in a separate test report.



2 Test Configuration of Equipment Under Test

- a. The EUT has been associated with peripherals and configuration operated in a manner tended to maximize its emission characteristics in a typical application. Frequency range investigated: conduction emission (150 kHz to 30 MHz), radiation emission (9 kHz to the 10th harmonic of the highest fundamental frequency or to 40 GHz, whichever is lower). For radiated measurement, pre-scanned in three orthogonal panels, X, Y, Z. The worst cases (X plane for SISO and Z plane for MIMO) were recorded in this report.
- b. AC power line Conducted Emission was tested under maximum output power.

2.1 Carrier Frequency and Channel

Frequency Band	Channel	Freq. (MHz)	Channel	Freq. (MHz)
5725-5850 MHz Band 4 (U-NII-3)	149	5745	157	5785
	151*	5755	159*	5795
	153	5765	161	5805
	155#	5775	165	5825

Note:

1. The above Frequency and Channel in "*" were 802.11n HT40 and 802.11ac VHT40.
2. The above Frequency and Channel in "#n" were 802.11ac VHT80.



2.2 Test Mode

Final test mode of conducted test items and radiated spurious emissions are considering the modulation and worse data rates as below table.

Single Antenna

Modulation	Data Rate
802.11a	6 Mbps
802.11n HT20	MCS0
802.11n HT40	MCS0
802.11ac VHT20	MCS0
802.11ac VHT40	MCS0
802.11ac VHT80	MCS0

MIMO Antenna

Modulation	Data Rate
802.11a	6 Mbps
802.11n HT20	MCS0
802.11n HT40	MCS0
802.11ac VHT20	MCS0
802.11ac VHT40	MCS0
802.11ac VHT80	MCS0

TXBF Antenna

Modulation	Data Rate
802.11n HT20	MCS0
802.11n HT40	MCS0
802.11ac VHT20	MCS0
802.11ac VHT40	MCS0
802.11ac VHT80	MCS0



<CDD Mode>

<Antenna 1>

802.11a mode		
Power vs. Channel		
Channel	Frequency (MHz)	Data Rate (bps)
		6M
Duty Cycle (%)		96.05
CH 149	5745	17.44
CH 157	5785	17.11
CH 165	5825	17.03

802.11n HT20 mode		
Power vs. Channel		
Channel	Frequency (MHz)	Data Rate (bps)
		MCS0
Duty Cycle (%)		94.52
CH 149	5745	17.35
CH 157	5785	17.07
CH 165	5825	17.48

802.11n HT40 mode		
Power vs. Channel		
Channel	Frequency (MHz)	Data Rate (bps)
		MCS0
Duty Cycle (%)		90.63
CH 151	5755	16.83
CH 159	5795	16.89



802.11ac VHT20 mode		
Power vs. Channel		
Channel	Frequency (MHz)	Data Rate (bps)
		MCS0
Duty Cycle (%)		95.89
CH 149	5745	17.36
CH 157	5785	17.47
CH 165	5825	17.49

802.11ac VHT40 mode		
Power vs. Channel		
Channel	Frequency (MHz)	Data Rate (bps)
		MCS0
Duty Cycle (%)		92.31
CH 151	5755	16.85
CH 159	5795	16.90

802.11ac VHT80 mode		
Power vs. Channel		
Channel	Frequency (MHz)	Data Rate (bps)
		MCS0
Duty Cycle (%)		85.46
CH 155	5755	14.96



<Antenna 2>

802.11a mode		
Power vs. Channel		
Channel	Frequency (MHz)	Data Rate (bps)
		6M
Duty Cycle (%)		96.05
CH 149	5745	17.22
CH 157	5785	17.22
CH 165	5825	17.17

802.11n HT20 mode		
Power vs. Channel		
Channel	Frequency (MHz)	Data Rate (bps)
		MCS0
Duty Cycle (%)		94.52
CH 149	5745	17.14
CH 157	5785	17.21
CH 165	5825	17.19

802.11n HT40 mode		
Power vs. Channel		
Channel	Frequency (MHz)	Data Rate (bps)
		MCS0
Duty Cycle (%)		91.27
CH 151	5755	16.78
CH 159	5795	16.80



802.11ac VHT20 mode		
Power vs. Channel		
Channel	Frequency (MHz)	Data Rate (bps)
		MCS0
Duty Cycle (%)		95.89
CH 149	5745	17.18
CH 157	5785	17.25
CH 165	5825	17.18

802.11ac VHT40 mode		
Power vs. Channel		
Channel	Frequency (MHz)	Data Rate (bps)
		MCS0
Duty Cycle (%)		92.19
CH 151	5755	16.84
CH 159	5795	16.89

802.11ac VHT80 mode		
Power vs. Channel		
Channel	Frequency (MHz)	Data Rate (bps)
		MCS0
Duty Cycle (%)		85.19
CH 155	5755	14.88



MIMO < Antenna 1+2>

802.11a mode		
Power vs. Channel		
Channel	Frequency (MHz)	Data Rate (bps)
		6M
CH 149	5745	20.00
CH 157	5785	19.70
CH 165	5825	19.55

802.11n HT20 mode		
Power vs. Channel		
Channel	Frequency (MHz)	Data Rate (bps)
		MCS0
CH 149	5745	20.21
CH 157	5785	19.80
CH 165	5825	19.79

802.11n HT40 mode		
Power vs. Channel		
Channel	Frequency (MHz)	Data Rate (bps)
		MCS0
CH 151	5755	19.74
CH 159	5795	19.58

802.11ac VHT20 mode		
Power vs. Channel		
Channel	Frequency (MHz)	Data Rate (bps)
		MCS0
CH 149	5745	20.25
CH 157	5785	19.96
CH 165	5825	19.84



802.11ac VHT40 mode		
Power vs. Channel		
Channel	Frequency (MHz)	Data Rate (bps)
		MCS0
CH 151	5755	19.84
CH 159	5795	19.71

802.11ac VHT80 mode		
Power vs. Channel		
Channel	Frequency (MHz)	Data Rate (bps)
		MCS0
CH 155	5755	18.64



<TXBF Mode>

MIMO <Antenna 1+2>

802.11n HT20 mode		
Power vs. Channel		
Channel	Frequency (MHz)	Data Rate (bps)
		6M
CH 149	5745	20.31
CH 157	5785	20.22
CH 165	5825	20.15

802.11n HT40 mode		
Power vs. Channel		
Channel	Frequency (MHz)	Data Rate (bps)
		MCS0
CH 151	5755	19.51
CH 159	5795	19.47

802.11ac VHT20 mode		
Power vs. Channel		
Channel	Frequency (MHz)	Data Rate (bps)
		MCS0
CH 149	5745	20.36
CH 157	5785	20.37
CH 165	5825	20.30

802.11ac VHT40 mode		
Power vs. Channel		
Channel	Frequency (MHz)	Data Rate (bps)
		MCS0
CH 151	5755	19.61
CH 159	5795	19.76



802.11ac VHT80 mode		
Power vs. Channel		
Channel	Frequency (MHz)	Data Rate (bps)
		6M
CH 155	5755	18.91

AC Conducted Emission	Mode 1 : MP3 Play + WLAN (5GHz) Link + Bluetooth Link + NFC On + Sentry 2X + PWR-WUA5V12W0US + RCH51 + USB Link with Adapter + Keypad (38) + SKU 5
Remark: For Radiated Test Cases, The tests were performance with SKU 7.	

2.3 Connection Diagram of Test System.

<CDD Mode>

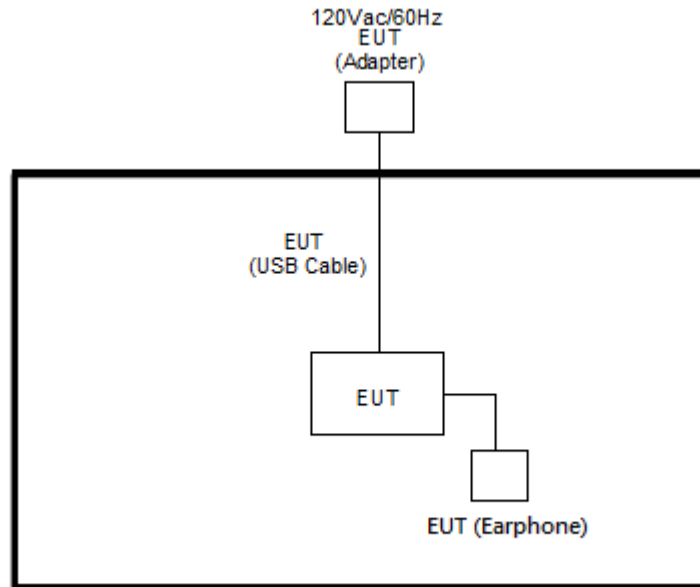

<TXBF Mode>

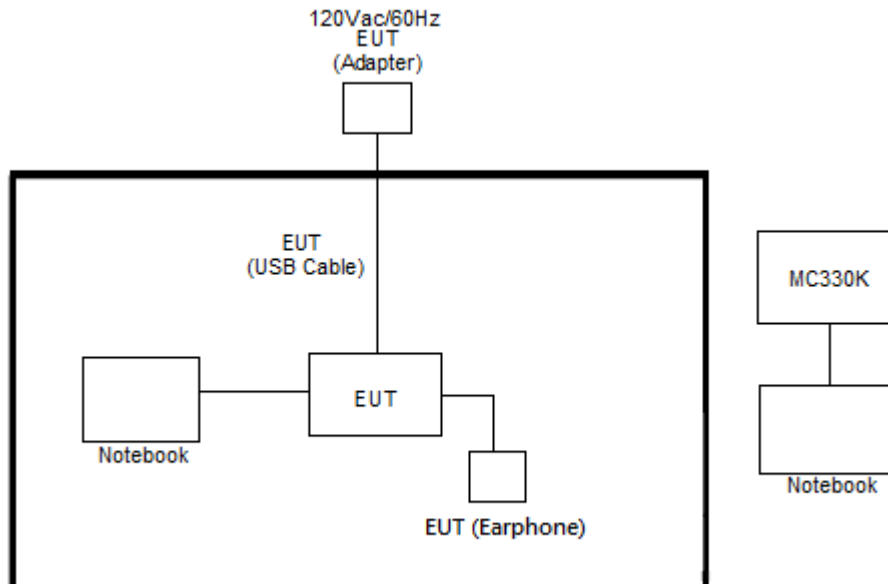

<AC Conducted Emission Mode>

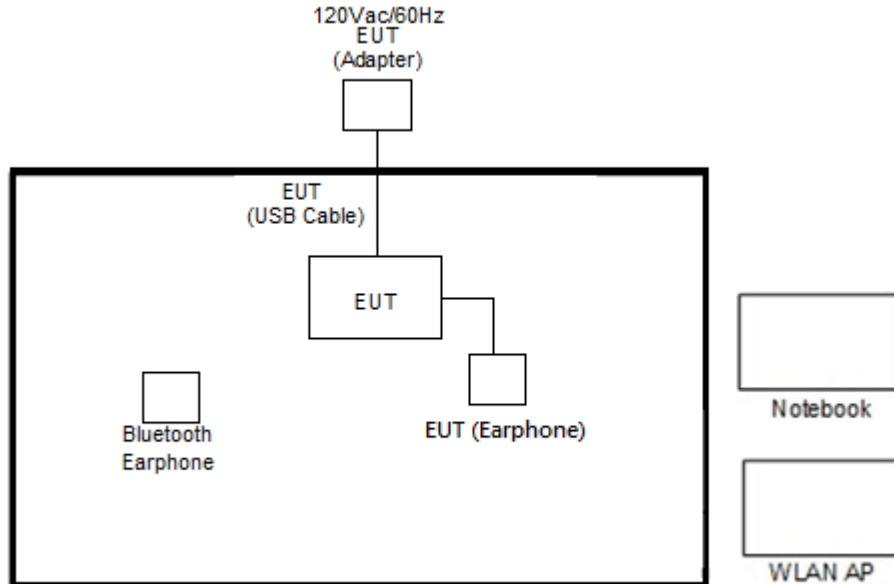

2.4 Support Unit used in test configuration and system

Item	Equipment	Trade Name	Model Name	FCC ID	Data Cable	Power Cord
1.	Bluetooth Earphone	Sony Ericsson	MW600	PY700A2029	N/A	Unshielded,1.8m
2.	WLAN AP	ASUS	RT-AC66U	MSQ-RTAC66U	N/A	Unshielded,1.8m
3.	Notebook	DELL	Latitude E6320	FCC DoC	N/A	AC I/P: Unshielded, 1.2 m DC O/P: Shielded, 1.8 m
4.	SD Card	SanDisk	MicroSD HC	FCC DoC	N/A	N/A



2.5 EUT Operation Test Setup

The RF test items, programmed RF utility, “ADB” installed in the notebook make the EUT provide functions like channel selection and power level for continuous transmitting signals

2.6 Measurement Results Explanation Example

For all conducted test items:

The offset level is set in the spectrum analyzer to compensate the RF cable loss and attenuator factor between EUT conducted output port and spectrum analyzer. With the offset compensation, the spectrum analyzer reading level is exactly the EUT RF output level.

Example :

The spectrum analyzer offset is derived from RF cable loss and attenuator factor.

Offset = RF cable loss + attenuator factor.

Following shows an offset computation example with cable loss 4.2 dB and 10dB attenuator.

$$\begin{aligned} \text{Offset(dB)} &= \text{RF cable loss(dB)} + \text{attenuator factor(dB)}. \\ &= 4.2 + 10 = 14.2 \text{ (dB)} \end{aligned}$$

3 Test Result

3.1 6dB and 26dB and 99% Occupied Bandwidth Measurement

3.1.1 Description of 6dB and 26dB and 99% Occupied Bandwidth

The minimum 6 dB bandwidth shall be at least 500 kHz.

26dB and 99% Occupied bandwidth are reporting only.

3.1.2 Measuring Instruments

The measuring equipment is listed in the section 4 of this test report.

3.1.3 Test Procedures

1. The testing follows FCC KDB 789033 D02 General UNII Test Procedures New Rules v01r04.
Section C) Emission bandwidth for the band 5.725-5.85GHz
2. Set RBW = 100kHz.
3. Set the VBW $\geq 3 \times$ RBW.
4. Detector = Peak.
5. Trace mode = max hold
6. Measure the maximum width of the emission that is 6 dB down from the peak of the emission.
7. Measure and record the results in the test report.

3.1.4 Test Setup

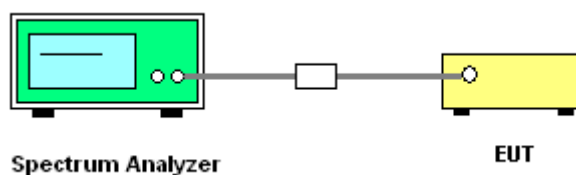



3.1.5 Test Result of 6dB Bandwidth

<CDD Mode>

Band IV													
Mod.	Data Rate	NTX	CH.	Freq. (MHz)	99% Bandwidth (MHz)		26dB Bandwidth (MHz)		6 dB Bandwidth (MHz)		6 dB Bandwidth Min. Limit (MHz)		Pass/Fail
					Ant 1	Ant 2	Ant 1	Ant 2	Ant 1	Ant 2	Ant 1	Ant 2	
11a	6Mbps	1	149	5745	18.65	20.10	33.30	39.80	16.32	16.32	0.5	0.5	Pass
11a	6Mbps	1	157	5785	18.65	20.35	33.60	41.50	16.32	16.32	0.5	0.5	Pass
11a	6Mbps	1	165	5825	18.65	20.40	30.50	41.90	16.32	16.30	0.5	0.5	Pass
VHT20	MCS0	1	149	5745	19.50	20.30	45.70	45.38	16.04	17.56	0.5	0.5	Pass
VHT20	MCS0	1	157	5785	19.70	20.35	45.10	44.09	17.54	17.56	0.5	0.5	Pass
VHT20	MCS0	1	165	5825	19.65	20.45	39.65	45.60	17.54	17.56	0.5	0.5	Pass
VHT40	MCS0	1	151	5755	37.50	45.20	83.91	94.37	36.23	36.32	0.5	0.5	Pass
VHT40	MCS0	1	159	5795	37.70	46.10	93.74	96.47	36.28	36.23	0.5	0.5	Pass
VHT80	MCS0	1	155	5775	75.84	76.08	107.16	102.04	75.28	75.80	0.5	0.5	Pass
11a	6Mbps	2	149	5745	19.05	19.30	38.84	39.12	16.30	16.32	0.5		Pass
11a	6Mbps	2	157	5785	19.05	18.45	37.08	34.92	16.28	16.30	0.5		Pass
11a	6Mbps	2	165	5825	19.25	18.50	36.84	27.16	16.32	16.32	0.5		Pass
VHT20	MCS0	2	149	5745	19.60	19.85	43.44	44.48	17.54	17.56	0.5		Pass
VHT20	MCS0	2	157	5785	20.00	19.25	44.40	39.53	17.56	17.58	0.5		Pass
VHT20	MCS0	2	165	5825	20.00	19.20	45.84	23.22	17.56	17.56	0.5		Pass
VHT40	MCS0	2	151	5755	37.30	44.10	83.13	97.05	36.28	36.27	0.5		Pass
VHT40	MCS0	2	159	5795	39.80	37.40	90.58	78.95	36.35	36.23	0.5		Pass
VHT80	MCS0	2	155	5775	75.96	76.32	110.88	159.99	75.82	75.12	0.5		Pass

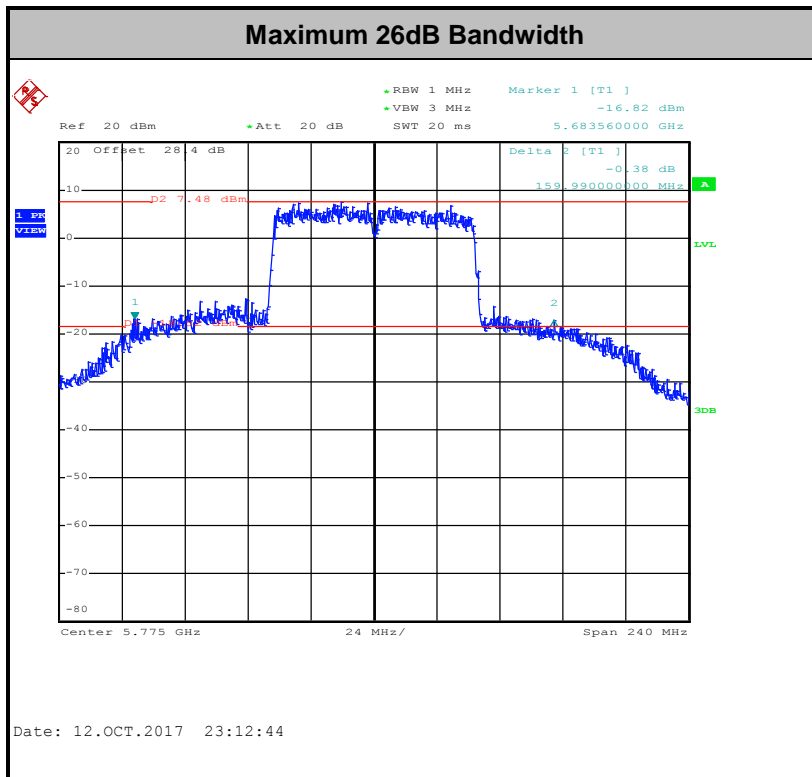
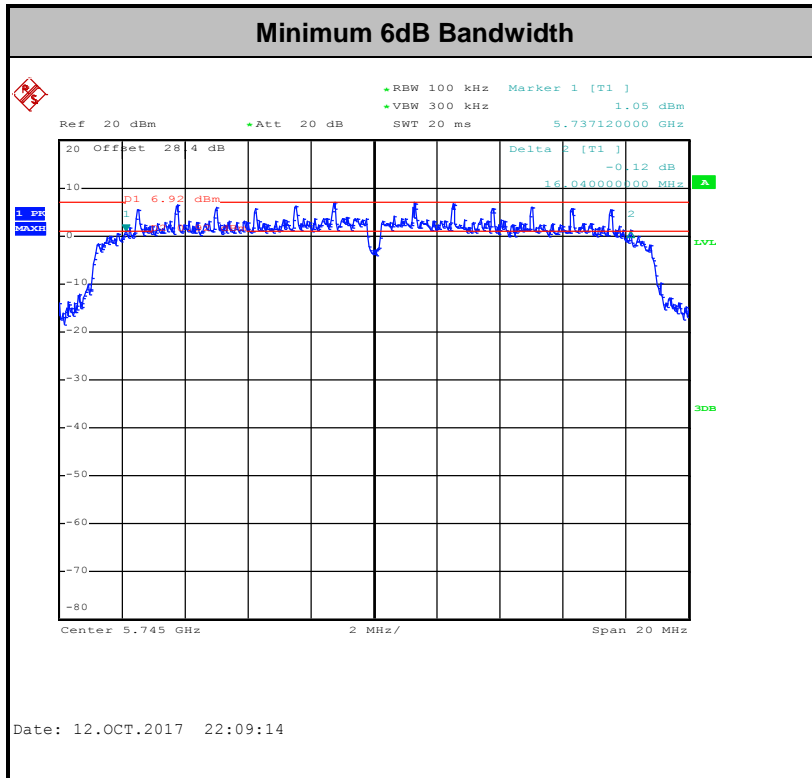

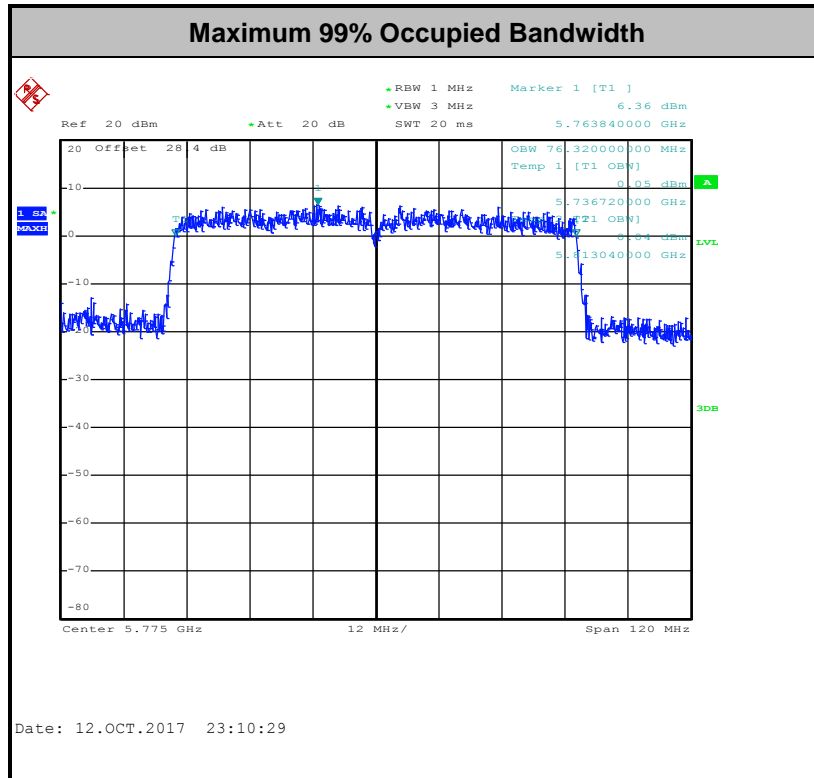

Note: The occupied channel bandwidth is maintained within the band of operation for all of the modulations.



<TXBF Mode>

Band IV													
Mod.	Data Rate	NTX	CH.	Freq. (MHz)	99% Bandwidth (MHz)		26dB Bandwidth (MHz)		6 dB Bandwidth (MHz)		6 dB Bandwidth Min. Limit (MHz)		Pass/Fail
					Ant 1	Ant 2	Ant 1	Ant 2	Ant 1	Ant 2	Ant 1	Ant 2	
VHT20	MCS0	2	149	5745	19.20	19.05	33.50	38.50	17.56	17.56	0.5	0.5	Pass
VHT20	MCS0	2	157	5785	19.50	19.55	36.60	45.61	17.56	17.54	0.5	0.5	Pass
VHT20	MCS0	2	165	5825	19.80	19.10	41.10	27.10	17.56	17.58	0.5	0.5	Pass
VHT40	MCS0	2	151	5755	37.20	37.70	70.49	85.12	36.28	36.32	0.5	0.5	Pass
VHT40	MCS0	2	159	5795	37.10	37.30	81.51	92.91	36.32	36.08	0.5	0.5	Pass
VHT80	MCS0	2	155	5775	75.96	75.96	116.10	117.44	75.28	75.68	0.5	0.5	Pass

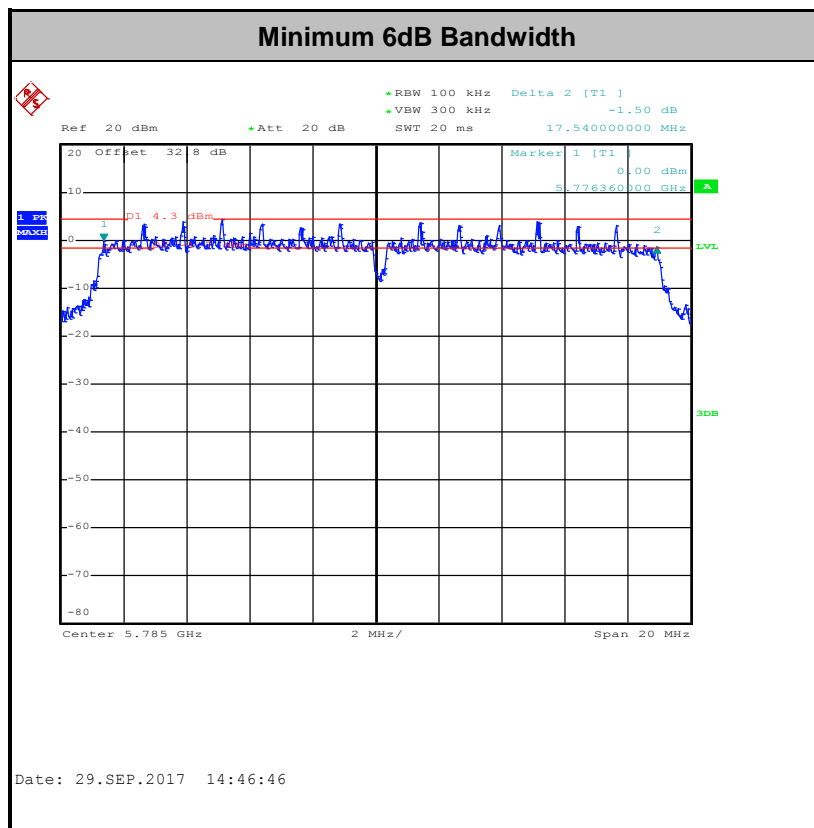

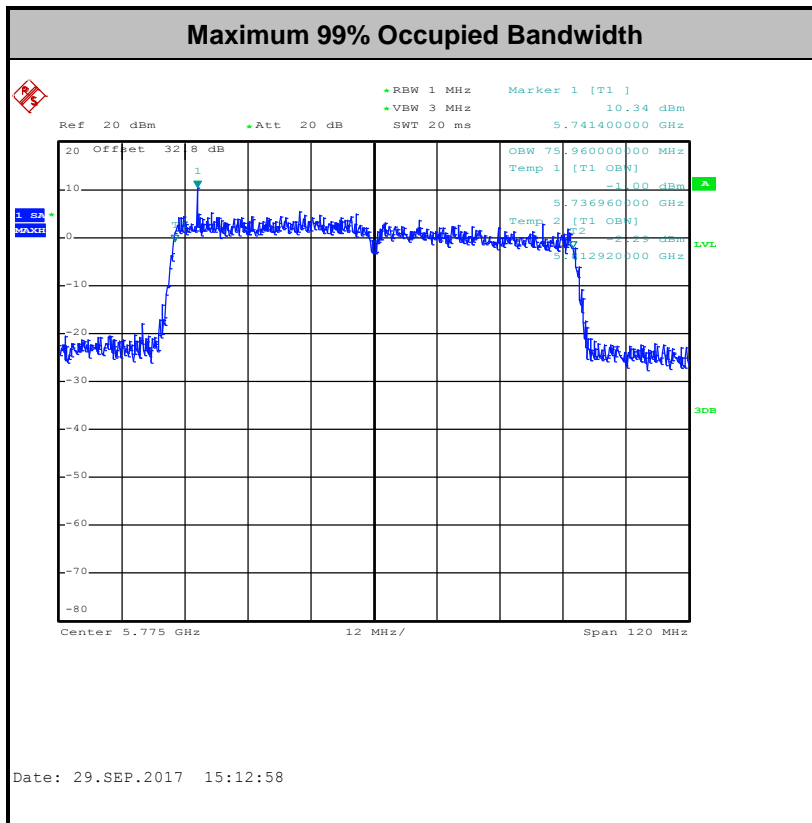
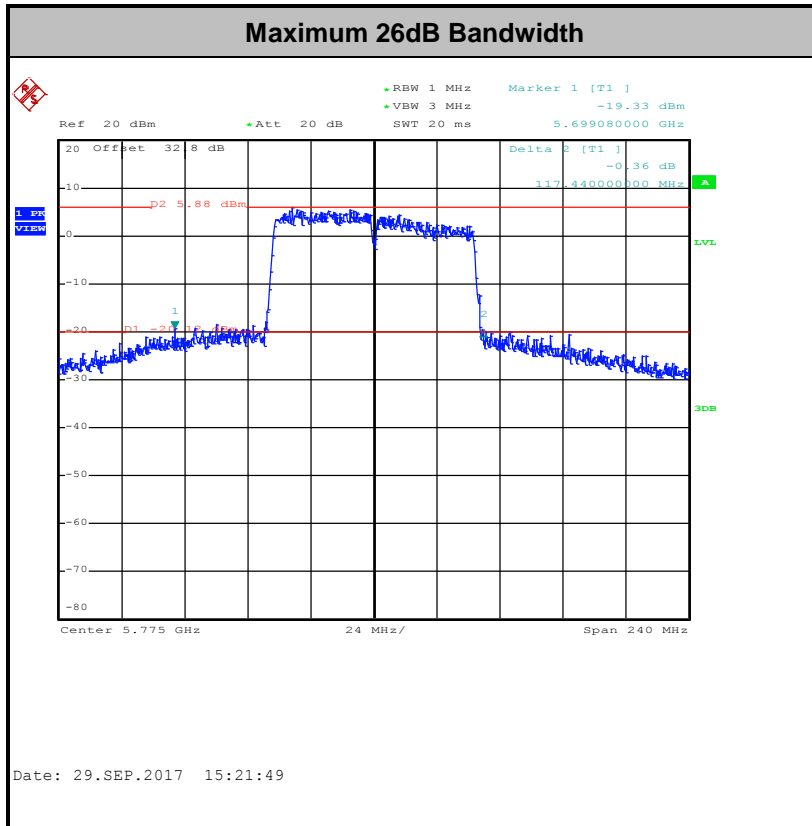

Note: The occupied channel bandwidth is maintained within the band of operation for all of the modulations.



3.2 Maximum Conducted Output Power Measurement

3.2.1 Limit of Maximum Conducted Output Power

For the band 5.725–5.85 GHz, the maximum conducted output power over the frequency band of operation shall not exceed 1 W.

If transmitting antennas of directional gain greater than 6 dBi are used, the peak output power shall be reduced by the amount in dB that the directional gain of the antenna exceeds 6 dBi.

3.2.2 Measuring Instruments

The measuring equipment is listed in the section 4 of this test report.

3.2.3 Test Procedures

CDD modes

The testing follows Method PM of FCC KDB 789033 D02 General UNII Test Procedures New Rules v01r04.

Method PM (Measurement using an RF average power meter):

1. Measurement is performed using a wideband RF power meter.
2. The EUT is configured to transmit continuously with a consistent duty cycle at its maximum power control level.
3. Measure the average power of the transmitter, and the average power is corrected with duty factor, $10 \log(1/x)$, where x is the duty cycle.

TXBF modes

The testing follows Method PM-G of FCC KDB 789033 D02 General UNII Test Procedures New Rules v01r04 for TXBF modes.

Method PM-G (Measurement using a gated RF average power meter):

1. Measurement is performed using a wideband RF power meter.
2. The EUT is configured to transmit at its maximum power control level.
3. Measure the average power of the transmitter
4. Since the measurement is made only during the ON time of the transmitter, no duty cycle correction factor is required.

3.2.4 Test Setup

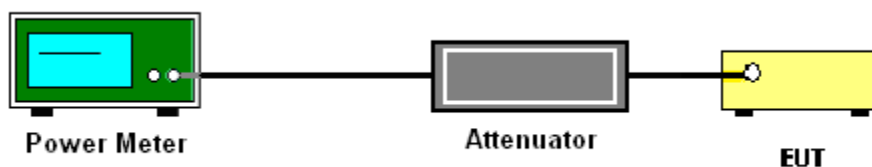



3.2.5 Test Result of Maximum Conducted Output Power

<CDD Mode>

Band IV														
Mod.	Data Rate	NTX	CH.	Freq. (MHz)	Duty Factor (dB)		Average Conducted Power (dBm)			FCC Conducted Power Limit (dBm)		DG (dBi)		Pass/Fail
					Ant 1	Ant 2	Ant 1	Ant 2	SUM	Ant 1	Ant 2	Ant 1	Ant 2	
11a	6Mbps	1	149	5745	0.17	0.17	17.44	17.22	-	30.00	30.00	5.31	4.85	Pass
11a	6Mbps	1	157	5785	0.17	0.17	17.11	17.22	-	30.00	30.00	5.31	4.85	Pass
11a	6Mbps	1	165	5825	0.17	0.17	17.03	17.17	-	30.00	30.00	5.31	4.85	Pass
HT20	MCS0	1	149	5745	0.24	0.00	17.35	17.14	-	30.00	30.00	5.31	4.85	Pass
HT20	MCS0	1	157	5785	0.24	0.00	17.07	17.21	-	30.00	30.00	5.31	4.85	Pass
HT20	MCS0	1	165	5825	0.24	0.00	17.48	17.19	-	30.00	30.00	5.31	4.85	Pass
HT40	MCS0	1	151	5755	0.43	0.40	16.83	16.78	-	30.00	30.00	5.31	4.85	Pass
HT40	MCS0	1	159	5795	0.43	0.40	16.89	16.80	-	30.00	30.00	5.31	4.85	Pass
VHT20	MCS0	1	149	5745	0.18	0.18	17.36	17.18	-	30.00	30.00	5.31	4.85	Pass
VHT20	MCS0	1	157	5785	0.18	0.18	17.47	17.25	-	30.00	30.00	5.31	4.85	Pass
VHT20	MCS0	1	165	5825	0.18	0.18	17.49	17.18	-	30.00	30.00	5.31	4.85	Pass
VHT40	MCS0	1	151	5755	0.35	0.35	16.85	16.84	-	30.00	30.00	5.31	4.85	Pass
VHT40	MCS0	1	159	5795	0.35	0.35	16.90	16.89	-	30.00	30.00	5.31	4.85	Pass
VHT80	MCS0	1	155	5775	0.68	0.70	14.96	14.88	-	30.00	30.00	5.31	4.85	Pass
11a	6Mbps	2	149	5745	0.23	0.23	17.31	16.63	20.00	30.00		5.31		Pass
11a	6Mbps	2	157	5785	0.23	0.23	17.43	15.80	19.70	30.00		5.31		Pass
11a	6Mbps	2	165	5825	0.23	0.23	17.57	15.19	19.55	30.00		5.31		Pass
HT20	MCS0	2	149	5745	0.24	0.24	17.54	16.82	20.21	30.00		5.31		Pass
HT20	MCS0	2	157	5785	0.24	0.24	17.54	15.86	19.80	30.00		5.31		Pass
HT20	MCS0	2	165	5825	0.24	0.24	17.76	15.50	19.79	30.00		5.31		Pass
HT40	MCS0	2	151	5755	0.35	0.36	16.98	16.46	19.74	30.00		5.31		Pass
HT40	MCS0	2	159	5795	0.35	0.36	17.17	15.86	19.58	30.00		5.31		Pass
VHT20	MCS0	2	149	5745	0.24	0.21	17.60	16.84	20.25	30.00		5.31		Pass
VHT20	MCS0	2	157	5785	0.24	0.21	17.58	16.21	19.96	30.00		5.31		Pass
VHT20	MCS0	2	165	5825	0.24	0.21	17.74	15.67	19.84	30.00		5.31		Pass
VHT40	MCS0	2	151	5755	0.35	0.35	16.97	16.68	19.84	30.00		5.31		Pass
VHT40	MCS0	2	159	5795	0.35	0.35	17.12	16.23	19.71	30.00		5.31		Pass
VHT80	MCS0	2	155	5775	0.70	0.68	15.73	15.52	18.64	30.00		5.31		Pass



<TXBF Mode>

Mod.	Data Rate	NTX	CH.	Freq. (MHz)	Average Conducted Power (dBm)			FCC Conducted Power Limit (dBm)		DG (dBi)		Pass/Fail
					Ant 1	Ant 2	SUM	Ant 1	Ant 2	Ant 1	Ant 2	
HT20	MCS0	2	149	5745	17.40	17.20	20.31	27.91		8.09		Pass
HT20	MCS0	2	157	5785	17.50	16.90	20.22	27.91		8.09		Pass
HT20	MCS0	2	165	5825	17.70	16.50	20.15	27.91		8.09		Pass
HT40	MCS0	2	151	5755	16.40	16.60	19.51	27.91		8.09		Pass
HT40	MCS0	2	159	5795	16.20	16.70	19.47	27.91		8.09		Pass
VHT20	MCS0	2	149	5745	17.40	17.30	20.36	27.91		8.09		Pass
VHT20	MCS0	2	157	5785	17.70	17.00	20.37	27.91		8.09		Pass
VHT20	MCS0	2	165	5825	17.80	16.70	20.30	27.91		8.09		Pass
VHT40	MCS0	2	151	5755	16.50	16.70	19.61	27.91		8.09		Pass
VHT40	MCS0	2	159	5795	16.60	16.90	19.76	27.91		8.09		Pass
VHT80	MCS0	2	155	5775	15.70	16.10	18.91	27.91		8.09		Pass



3.3 Power Spectral Density Measurement

3.3.1 Limit of Power Spectral Density

For the band 5.725–5.85 GHz, the maximum power spectral density shall not exceed 30 dBm in any 500-kHz band.

If transmitting antennas of directional gain greater than 6 dBi are used, the peak output power shall be reduced by the amount in dB that the directional gain of the antenna exceeds 6 dBi.

3.3.2 Measuring Instruments

The measuring equipment is listed in the section 4 of this test report.

3.3.3 Test Procedures

The testing follows FCC KDB 789033 D02 General UNII Test Procedures New Rules v01r04. Section F) Maximum power spectral density.

CDD modes

Method SA-2

(trace averaging across on and off times of the EUT transmissions, followed by duty cycle correction).

- Measure the duty cycle.
- Set span to encompass the entire emission bandwidth (EBW) of the signal.
- Set RBW = 300 kHz.
- Set VBW \geq 1 MHz.
- Number of points in sweep \geq 2 Span / RBW.
- Sweep time = auto.
- Detector = RMS
- Trace average at least 100 traces in power averaging mode.
- Add $10 \log(500\text{kHz}/\text{RBW})$ to the test result.
- Add $10 \log(1/x)$, where x is the duty cycle, to the measured power in order to compute the average power during the actual transmission times. For example, add $10 \log(1/0.25) = 6$ dB if the duty cycle is 25 percent.

TXBF modes**# Method SA-3 #**

(power averaging (rms) detection with max hold):

- Set span to encompass the entire emission bandwidth (EBW) of the signal.
 - Set RBW = 300 kHz.
 - Set VBW \geq 1 MHz.
 - Number of points in sweep \geq 2 Span / RBW.
 - Sweep time \leq (number of points in sweep) \times T, when duty cycle is less than 98 percent where T is the minimum transmission duration over which the transmitter is on and is transmitting at its maximum power control level for the tested mode of operation.
 - Detector = power averaging (rms).
 - Trace mode = max hold.
 - Allow max hold to run for at least 60 seconds, or longer as needed to allow the trace to stabilize.
1. The RF output of EUT was connected to the spectrum analyzer by a low loss cable.
 2. Each plot has already offset with cable loss, and attenuator loss. Measure the PPSD and record it.
 3. For MIMO mode, calculation method follows FCC KDB 662911 D01 Multiple Transmitter Output v02r01.

Method (c): Measure and add $10 \log(N_{ANT})$ dB.

With this technique, spectrum measurements are performed at each output of the device, but rather than summing the spectra or the spectral peaks across the outputs, the quantity $10 \log(N_{ANT})$ dB is added to each spectrum value before comparing to the emission limit. The addition of $10 \log(N_{ANT})$ dB serves to apportion the emission limit among the N_{ANT} outputs so that each output is permitted to contribute no more than $1/N_{ANT}^{th}$ of the PSD limit.

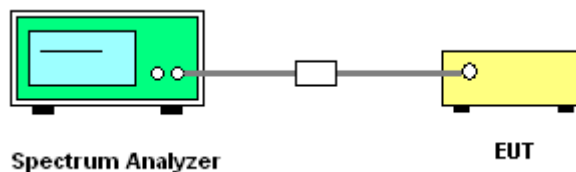
3.3.4 Test Setup



3.3.5 Test Result of Power Spectral Density

<CDD Mode>

Band IV																
Mod.	Data Rate	NTX	CH.	Freq. (MHz)	Duty Factor (dB)		10log (500kHz /RBW) Factor (dB)		Average Power Density (dBm/500kHz)			Average PSD Limit (dBm/500kHz)		DG (dBi)		Pass /Fail
					Ant 1	Ant 2	Ant 1	Ant 2	Ant 1	Ant 2	SUM	Ant 1	Ant 2	Ant 1	Ant 2	
11a	6Mbps	1	149	5745	0.17	0.17	2.22	2.22	3.06	2.65	-	30.00	30.00	5.31	4.85	Pass
11a	6Mbps	1	157	5785	0.17	0.17	2.22	2.22	2.50	2.86	-	30.00	30.00	5.31	4.85	Pass
11a	6Mbps	1	165	5825	0.17	0.17	2.22	2.22	2.55	2.82	-	30.00	30.00	5.31	4.85	Pass
VHT20	MCS0	1	149	5745	0.18	0.18	2.22	2.22	2.92	2.77	-	30.00	30.00	5.31	4.85	Pass
VHT20	MCS0	1	157	5785	0.18	0.18	2.22	2.22	2.79	2.41	-	30.00	30.00	5.31	4.85	Pass
VHT20	MCS0	1	165	5825	0.18	0.18	2.22	2.22	3.61	2.62	-	30.00	30.00	5.31	4.85	Pass
VHT40	MCS0	1	151	5755	0.35	0.35	2.22	2.22	-0.53	-0.51	-	30.00	30.00	5.31	4.85	Pass
VHT40	MCS0	1	159	5795	0.35	0.35	2.22	2.22	-0.79	-0.72	-	30.00	30.00	5.31	4.85	Pass
VHT80	MCS0	1	155	5775	0.68	0.70	2.22	2.22	-4.19	-4.79	-	30.00	30.00	5.31	4.85	Pass
11a	6Mbps	2	149	5745	0.23	0.23	2.22	2.22	2.13	-0.66	5.14	27.91	27.91	8.09	8.09	Pass
11a	6Mbps	2	157	5785	0.23	0.23	2.22	2.22	1.79	-1.81	4.80	27.91	27.91	8.09	8.09	Pass
11a	6Mbps	2	165	5825	0.23	0.23	2.22	2.22	0.18	-2.57	3.19	27.91	27.91	8.09	8.09	Pass
VHT20	MCS0	2	149	5745	0.24	0.21	2.22	2.22	2.05	-0.95	5.06	27.91	27.91	8.09	8.09	Pass
VHT20	MCS0	2	157	5785	0.24	0.21	2.22	2.22	1.44	-1.86	4.45	27.91	27.91	8.09	8.09	Pass
VHT20	MCS0	2	165	5825	0.24	0.21	2.22	2.22	-0.03	-2.39	2.98	27.91	27.91	8.09	8.09	Pass
VHT40	MCS0	2	151	5755	0.35	0.35	2.22	2.22	-0.45	-2.90	2.56	27.91	27.91	8.09	8.09	Pass
VHT40	MCS0	2	159	5795	0.35	0.35	2.22	2.22	-2.61	-4.61	0.62	27.91	27.91	8.09	8.09	Pass
VHT80	MCS0	2	155	5775	0.70	0.68	2.22	2.22	-5.39	-7.35	-2.12	27.91	27.91	8.09	8.09	Pass



Worst Case Power Density (dBm/300kHz) MIMO ant.1+2(1)

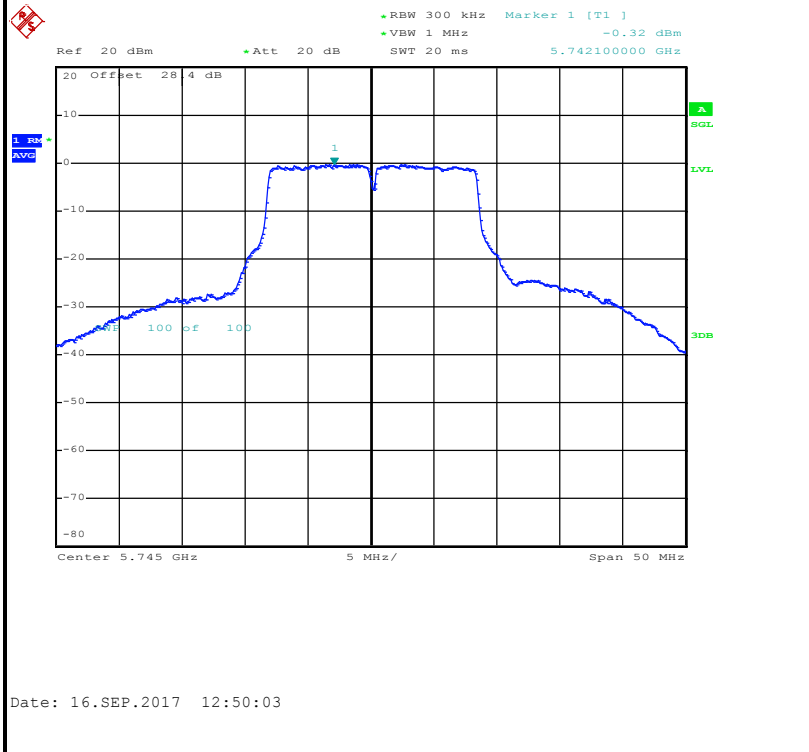

Worst Case Power Density (dBm/300kHz) MIMO ant.1+2(2)

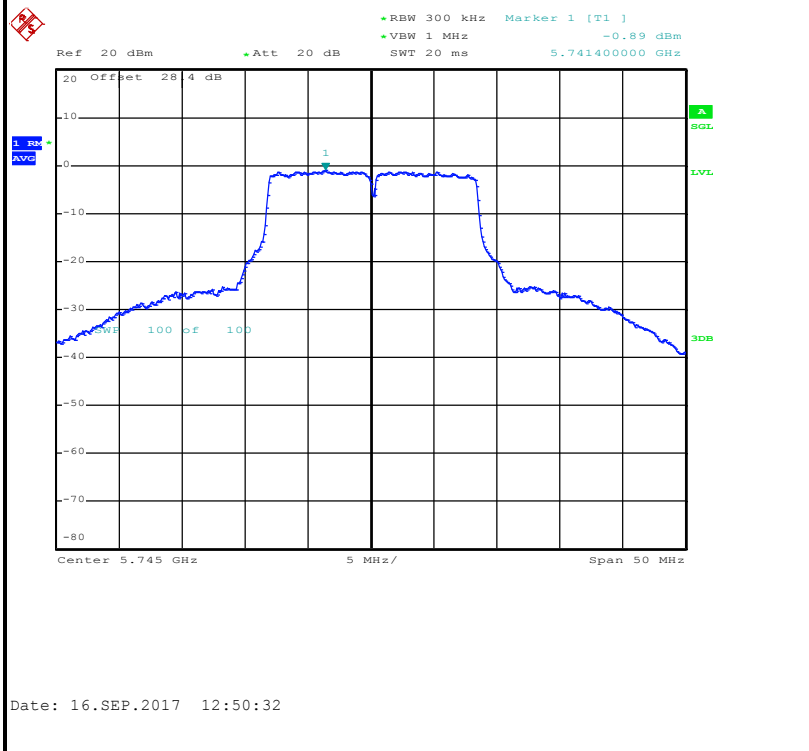



<TXBF Mode>

Band IV																
Mod.	Data Rate	NTX	CH.	Freq. (MHz)	Duty Factor (dB)		10log (500kHz /RBW) Factor (dB)		Average Power Density (dBm/500kHz)			Average PSD Limit (dBm/500kHz)		DG (dBi)		Pass /Fail
					Ant 1	Ant 2	Ant 1	Ant 2	Ant 1	Ant 2	SUM	Ant 1	Ant 2	Ant 1	Ant 2	
VHT20	MCS0	2	149	5745	0.00	0.00	2.22	5.72	3.20	8.73	27.91	8.09	Pass			
VHT20	MCS0	2	157	5785	0.00	0.00	2.22	6.49	2.82	9.50	27.91	8.09	Pass			
VHT20	MCS0	2	165	5825	0.00	0.00	2.22	6.40	1.87	9.41	27.91	8.09	Pass			
VHT40	MCS0	2	151	5755	0.00	0.00	2.22	1.97	-0.37	4.98	27.91	8.09	Pass			
VHT40	MCS0	2	159	5795	0.00	0.00	2.22	1.81	-1.23	4.82	27.91	8.09	Pass			
VHT80	MCS0	2	155	5775	0.00	0.00	2.22	-2.43	-4.74	0.58	27.91	8.09	Pass			



Worst Case Power Density (dBm/300kHz) MIMO ant.1+2(1)

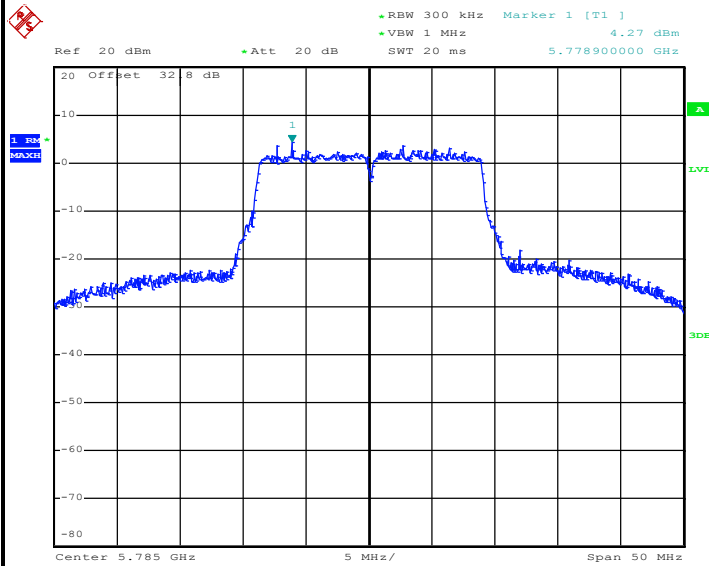

Date: 29.SEP.2017 14:36:12

Worst Case Power Density (dBm/300kHz) MIMO ant.1+2(2)

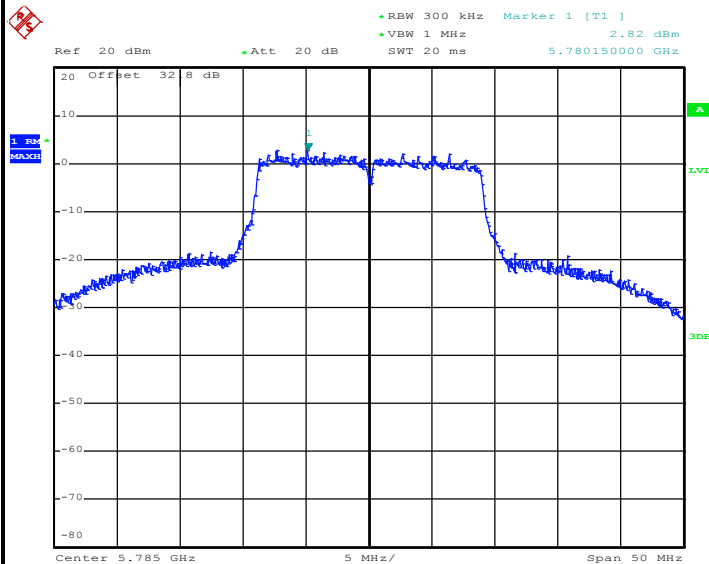

Date: 29.SEP.2017 14:35:58



3.4 Unwanted Emissions Measurement

This section is to measure unwanted emissions through radiated measurement for band edge spurious emissions and out of band emissions measurement.

3.4.1 Limit of Unwanted Emissions

- (1) For transmitters operating in the 5.725-5.85 GHz band:
15.407(b)(4)(i) All emissions shall be limited to a level of -27 dBm/MHz at 75 MHz or more above or below the band edge increasing linearly to 10 dBm/MHz at 25 MHz above or below the band edge, and from 25 MHz above or below the band edge increasing linearly to a level of 15.6 dBm/MHz at 5 MHz above or below the band edge, and from 5 MHz above or below the band edge increasing linearly to a level of 27 dBm/MHz at the band edge.
- (2) Unwanted spurious emissions fallen in restricted bands per FCC Part15.205 shall comply with the general field strength limits set forth in § 15.209 as below table,

Frequency (MHz)	Field Strength (microvolts/meter)	Measurement Distance (meters)
0.009 – 0.490	2400/F(kHz)	300
0.490 – 1.705	24000/F(kHz)	30
1.705 – 30.0	30	30
30 – 88	100	3
88 – 216	150	3
216 - 960	200	3
Above 960	500	3

Note: The following formula is used to convert the EIRP to field strength.

$$E = \frac{1000000\sqrt{30P}}{3} \mu\text{V/m, where P is the eirp (Watts)}$$



EIRP (dBm)	Field Strength at 3m (dBµV/m)
-17	78.3
- 27	68.3

(3) KDB789033 D02 v01r04 G)2)c)

- (i) Section 15.407(b)(1-3) specifies the unwanted emissions limit for the U-NII-1 and 2 bands. As specified, emissions above 1000 MHz that are outside of the restricted bands are subject to a peak emission limit of -27 dBm/MHz. However, an out-of-band emission that complies with both the average and peak limits of Section 15.209 is not required to satisfy the -27 dBm/MHz dBm/MHz peak emission limit.
- (ii) Section 15.407(b)(4) specifies the unwanted emissions limit for the U-NII-3 band. A band emissions mask is specified in Section 15.407(b)(4)(i). An alternative to the band emissions mask is specified in Section 15.407(b)(4)(ii). The alternative limits are based on the highest antenna gain specified in the filing. There are also marketing and importation restrictions for the alternative limit.

Note 3: An out-of-band emission that complies with both the average and peak limits of Section 15.209 is not required to satisfy the -27 dBm/MHz peak emission limit.

Note 4: Only devices with antenna gains of 10 dBi or less may be approved using the emission limits specified in Section 15.247(d) till March 2, 2018; all other devices operating in this band must use the mask specified in Section 15.407(b)(4)(i).

3.4.2 Measuring Instruments

The measuring equipment is listed in the section 4 of this test report.



3.4.3 Test Procedures

1. The testing follows FCC KDB 789033 D02 General UNII Test Procedures New Rules v01r04. Section G) Unwanted emissions measurement.

(1) Procedure for Unwanted Emissions Measurements Below 1000MHz

- RBW = 120 kHz
- VBW = 300 kHz
- Detector = Peak
- Trace mode = max hold

(2) Procedure for Peak Unwanted Emissions Measurements Above 1000 MHz

- RBW = 1 MHz
- VBW \geq 3 MHz
- Detector = Peak
- Sweep time = auto
- Trace mode = max hold

(3) Procedures for Average Unwanted Emissions Measurements Above 1000MHz

- RBW = 1 MHz
- VBW = 10 Hz, when duty cycle is no less than 98 percent.
- VBW \geq 1/T, when duty cycle is less than 98 percent where T is the minimum transmission duration over which the transmitter is on and is transmitting at its maximum power control level for the tested mode of operation.



2. The EUT was placed on a turntable with 0.8 meter for frequency below 1GHz and 1.5 meter for frequency above 1GHz respectively above ground.
3. The EUT was set 3 meters from the interference receiving antenna which was mounted on the top of a variable height antenna tower.
4. The antenna is a broadband antenna and its height is adjusted between one meter and four meters above ground to find the maximum value of the field strength for both horizontal polarization and vertical polarization of the antenna.
5. For each suspected emission, the EUT was arranged to its worst case and then adjust the antenna tower (from 1 m to 4 m) and turntable (from 0 degree to 360 degrees) to find the maximum reading.
6. For testing below 1GHz, if the emission level of the EUT in peak mode was 3 dB lower than the limit specified, then peak values of EUT will be reported, otherwise, the emissions will be repeated one by one using the CISPR quasi-peak method and reported.
7. For testing above 1GHz, the emission level of the EUT in peak mode was 20dB lower than average limit (that means the emission level in average mode also complies with the limit in average mode), then peak values of EUT will be reported, otherwise, the emissions will be measured in average mode again and reported.

3.4.4 Test Setup

For radiated emissions below 30MHz

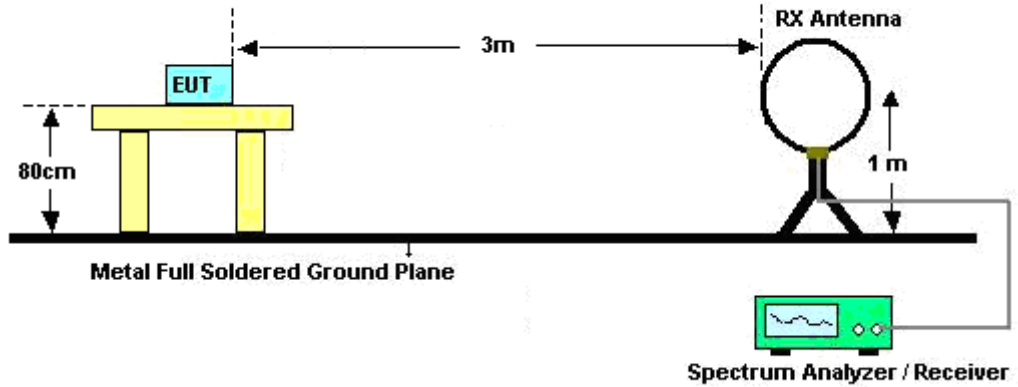

For radiated emissions from 30MHz to 1GHz

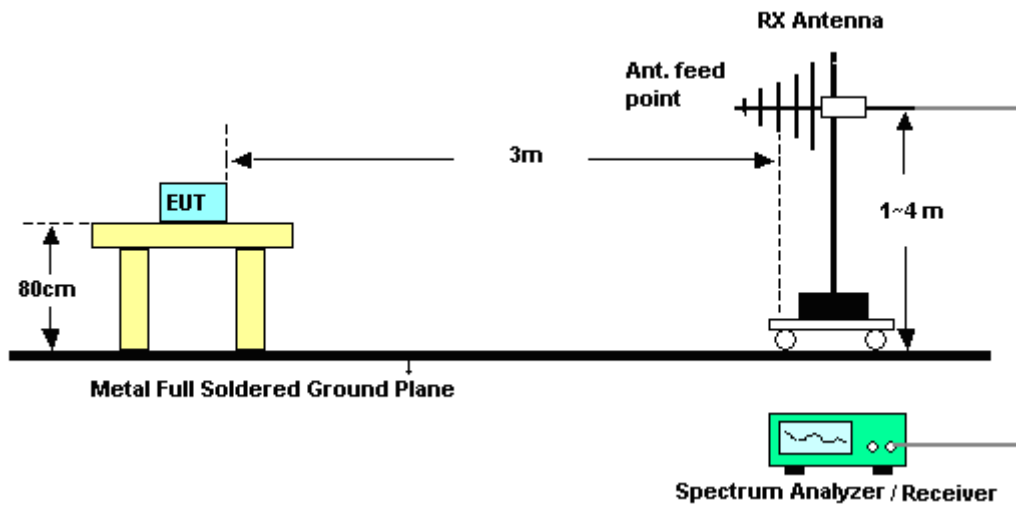

For radiated emissions above 1GHz

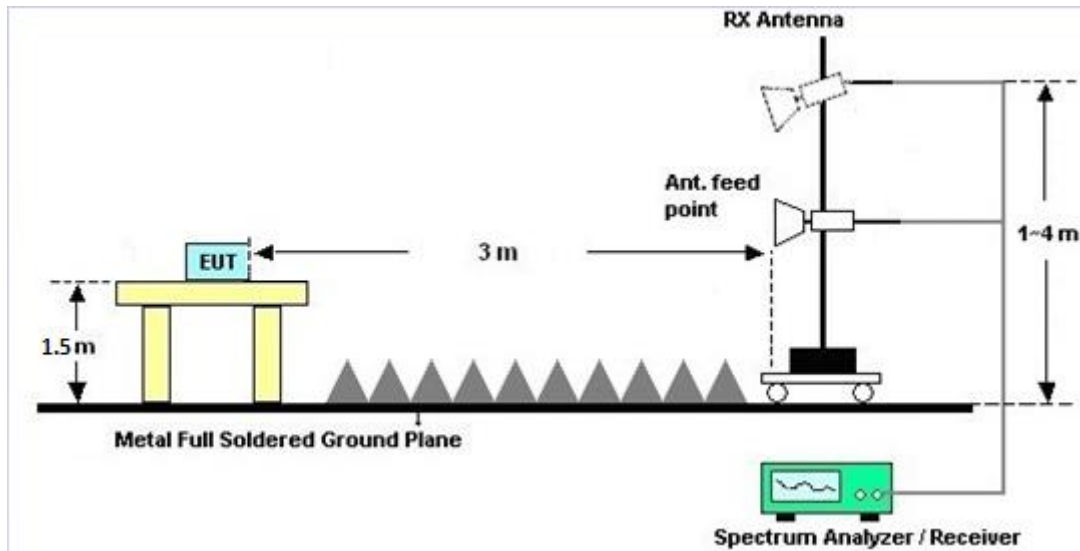

3.4.5 Test Results of Radiated Emissions (9 kHz ~ 30 MHz)

The low frequency, which started from 9 kHz to 30MHz, was pre-scanned and the result which was 20dB lower than the limit line was not reported.

3.4.6 Test Result of Radiated Band Edges

Please refer to Appendix B and C.

3.4.7 Duty Cycle

Please refer to Appendix D.

3.4.8 Test Result of Unwanted Radiated Emission (30MHz ~ 10th Harmonic)

Please refer to Appendix B and C.



3.5 AC Conducted Emission Measurement

3.5.1 Limit of AC Conducted Emission

For equipment that is designed to be connected to the public utility (AC) power line, the radio frequency voltage that is conducted back onto the AC power line on any frequency or frequencies within the band 150 kHz to 30 MHz shall not exceed the limits in the following table.

Frequency of emission (MHz)	Conducted limit (dB μ V)	
	Quasi-peak	Average
0.15-0.5	66 to 56*	56 to 46*
0.5-5	56	46
5-30	60	50

*Decreases with the logarithm of the frequency.

3.5.2 Measuring Instruments

The measuring equipment is listed in the section 4 of this test report.

3.5.3 Test Procedures

1. The EUT was placed 0.4 meter from the conducting wall of the shielding room was kept at least 80 centimeters from any other grounded conducting surface.
2. Connect EUT to the power mains through a line impedance stabilization network (LISN).
3. All the support units are connecting to the other LISN.
4. The LISN provides 50 ohm coupling impedance for the measuring instrument.
5. The FCC states that a 50 ohm, 50 microhenry LISN should be used.
6. Both sides of AC line were checked for maximum conducted interference.
7. The frequency range from 150 kHz to 30 MHz was searched.
8. Set the test-receiver system to Peak Detect Function and specified bandwidth with Maximum Hold Mode.

3.5.4 Test Setup

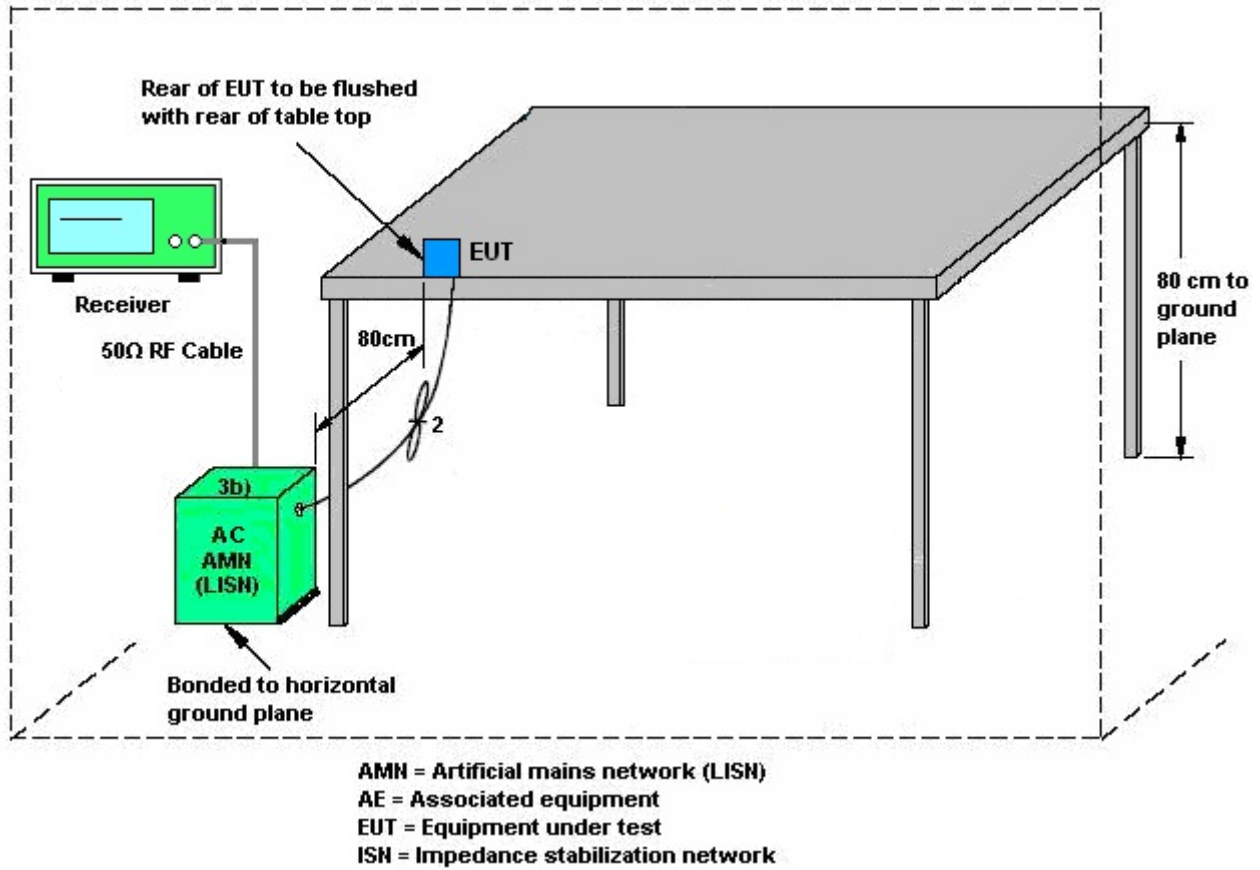

3.5.5 Test Result of AC Conducted Emission

Please refer to Appendix A.

3.6 Frequency Stability Measurement

3.6.1 Limit of Frequency Stability

Manufacturers of U-NII devices are responsible for ensuring frequency stability such that an emission is maintained within the band of operation under all conditions of normal operation as specified in the user's manual.

3.6.2 Measuring Instruments

The measuring equipment is listed in the section 4 of this test report.

3.6.3 Test Procedures

1. To ensure emission at the band edge is maintained within the authorized band, those values shall be measured by radiation emissions at upper and lower frequency points, and finally compensated by frequency deviation as procedures below.
2. The EUT was operated at the maximum output power, and connected to the spectrum analyzer, which is set to maximum hold function and peak detector. The peak value of the power envelope was measured and noted. The upper and lower frequency points were respectively measured relatively 10dB lower than the measured peak value.
3. The frequency deviation was calculated by adding the upper frequency point and the lower frequency point divided by two. Those detailed values of frequency deviation are provided in table below.

3.6.4 Test Setup





3.6.5 Test Result of Frequency Stability

Band IV									
Mod.	Data Rate	NTX	CH.	Freq. (MHz)	Center Frequency (MHz)	Frequency Deviation (MHz)	Frequency Stability (ppm)	Temperature (°C)	Voltage (V)
11a	6Mbps	1	149	5745	5745.050	0.050	8.70	50	3.8
11a	6Mbps	1	149	5745	5745.000	0.000	0.00	-30	3.8
11a	6Mbps	1	149	5745	5745.050	0.050	8.70	20	4.2
11a	6Mbps	1	149	5745	5745.050	0.050	8.70	20	3.6
11a	6Mbps	1	149	5745	5745.050	0.050	8.70	20	3.8



3.7 Automatically Discontinue Transmission

3.7.1 Limit of Automatically Discontinue Transmission

The device shall automatically discontinue transmission in case of either absence of information to transmit or operational failure. These provisions are not intended to preclude the transmission of control or signaling information or the use of repetitive codes used by certain digital technologies to complete frame or burst intervals. Applicants shall include in their application for equipment authorization to describe how this requirement is met.

3.7.2 Measuring Instruments

The measuring equipment is listed in the section 4 of this test report.

3.7.3 Test Result of Automatically Discontinue Transmission

While the EUT is not transmitting any information, the EUT can automatically discontinue transmission and become standby mode for power saving. The EUT can detect the controlling signal of ACK message transmitting from remote device and verify whether it shall resend or discontinue transmission.



3.8 Antenna Requirements

3.8.1 Standard Applicable

If transmitting antenna directional gain is greater than 6 dBi, both the peak transmit power and the peak power spectral density shall be reduced by the amount in dB that the directional gain of the antenna exceeds 6 dBi.

3.8.2 Antenna Anti-Replacement Construction

An embedded-in antenna design is used.

3.8.3 Antenna Gain

CDD modes

FCC KDB 662911 D01 Multiple Transmitter Output **v02r01**

For CDD transmissions, directional gain is calculated as

Directional gain = $G_{ANT} + \text{Array Gain}$, where Array Gain is as follows.

For power spectral density (PSD) measurements on all devices,

Array Gain = $10 \log(N_{ANT}/N_{SS}=1)$ dB.

For power measurements on IEEE 802.11 devices,

Array Gain = 0 dB (i.e., no array gain) for $N_{ANT} \leq 4$.

Directional gain may be calculated by using the formulas applicable to equal gain antennas with G_{ANT} set equal to the gain of the antenna having the highest gain;

The EUT supports CDD mode.

For power, the directional gain G_{ANT} is set equal to the antenna having the highest gain, i.e., F)2)f)i).

For PSD, the directional gain calculation is following F)2)f)ii) of KDB 662911 D01 **v02r01**.

The power and PSD limit should be modified if the directional gain of EUT is over 6 dBi,

The directional gain "DG" is calculated as following table.

			DG	DG	Power	PSD
			for	for	Limit	Limit
	Ant 1	Ant 2	Power	PSD	Reduction	Reduction
	(dBi)	(dBi)	(dBi)	(dBi)	(dB)	(dB)
Band IV	5.31	4.85	5.31	8.09	0.00	2.09

Power limit reduction = Composite gain – 6dBi, (min = 0)

PSD limit reduction = Composite gain + PSD Array gain – 6dBi, (min = 0)

TXBF modes

FCC KDB 662911 D01 Multiple Transmitter Output **v02r01**

For CDD transmissions, directional gain is calculated as

$$DirectionalGain = 10 \cdot \log \left[\frac{\sum_{j=1}^{N_{SS}} \left\{ \sum_{k=1}^{N_{ANT}} g_{j,k} \right\}^2}{N_{ANT}} \right]$$

where

Each antenna is driven by no more than one spatial stream;

N_{SS} = the number of independent spatial streams of data;

N_{ANT} = the total number of antennas

$g_{j,k} = 10^{G_k / 20}$ if the k th antenna is being fed by spatial stream j , or zero if it is not;
 G_k is the gain in dBi of the k th antenna.

The EUT supports beamforming for 802.11ac modes.

The directional gain calculation is following F)2)e)ii) of KDB 662911 D01 **v02r01**.

The power and PSD limit should be modified if the directional gain of EUT is over 6 dBi,

The directional gain “DG” is calculated as following table.

			DG	DG	Power	PSD
			for	for	Limit	Limit
	Ant 1	Ant 2	Power	PSD	Reduction	Reduction
	(dBi)	(dBi)	(dBi)	(dBi)	(dB)	(dB)
Band IV	5.31	4.85	8.09	8.09	2.09	2.09

Power Limit Reduction = $DG(\text{Power}) - 6\text{dBi}$, (min = 0)

PSD Limit Reduction = $DG(\text{PSD}) - 6\text{dBi}$, (min = 0)



4 List of Measuring Equipment

Instrument	Manufacturer	Model No.	Serial No.	Characteristics	Calibration Date	Test Date	Due Date	Remark
Power Meter	Anritsu	ML2495A	1132003	N/A	Aug. 09, 2017	Sep. 04, 2017 ~ Oct. 17, 2017	Aug. 08, 2018	Conducted (TH05-HY)
Power Sensor	Anritsu	MA2411B	1126017	300MHz~40GHz	Aug. 09, 2017	Sep. 04, 2017 ~ Oct. 17, 2017	Aug. 08, 2018	Conducted (TH05-HY)
Spectrum Analyzer	Rohde & Schwarz	FSP40	100057	9kHz-40GHz	Nov. 25, 2016	Sep. 04, 2017 ~ Oct. 17, 2017	Nov. 24, 2017	Conducted (TH05-HY)
Temperature Chamber	ESPEC	SU-241	92003713	-30°C ~95°C	Jun. 05, 2017	Sep. 04, 2017 ~ Oct. 17, 2017	Jun. 04, 2018	Conducted (TH05-HY)
Programmable Power Supply	GW Instek	PSS-2005	EL890089	1V~20V 0.5A~5A	Jan. 12, 2017	Sep. 04, 2017 ~ Oct. 17, 2017	Jan. 11, 2018	Conducted (TH05-HY)
Power Sensor	DARE	RPR3006W	16I000054S NO13	10MHz~6GHz	Dec. 22, 2016	Sep. 20, 2017 ~ Oct. 18, 2017	Dec. 21, 2017	Conducted (TH05-HY)
Spectrum Analyzer	Rohde & Schwarz	FSP40	100057	9kHz-40GHz	Nov. 25, 2016	Sep. 20, 2017 ~ Oct. 18, 2017	Nov. 24, 2017	Conducted (TH05-HY)
Programmable Power Supply	GW Instek	PSS-2005	EL890089	1V~20V 0.5A~5A	Jan. 12, 2017	Sep. 20, 2017 ~ Oct. 18, 2017	Jan. 11, 2018	Conducted (TH05-HY)
AC Power Source	ChainTek	APC-1000W	N/A	N/A	N/A	Sep. 24, 2017	N/A	Conduction (CO05-HY)
EMI Test Receiver	Rohde & Schwarz	ESCI 7	100724	9kHz~7GHz	Sep. 20, 2017	Sep. 24, 2017	Sep. 19, 2018	Conduction (CO05-HY)
LISN	Rohde & Schwarz	ENV216	100080	9kHz~30MHz	Nov. 29, 2016	Sep. 24, 2017	Nov. 28, 2017	Conduction (CO05-HY)
Bilog Antenna	TESEQ	CBL 6111D&00800 N1D01N-06	35419&03	30MHz to 1GHz	Jan. 07, 2017	Sep. 06, 2017 ~ Oct. 16, 2017	Jan. 06, 2018	Radiation (03CH07-HY)
Double Ridge Horn Antenna	ESCO	3117	00075962	1GHz ~ 18GHz	Aug. 23, 2017	Sep. 06, 2017 ~ Oct. 16, 2017	Aug. 22, 2018	Radiation (03CH07-HY)
Loop Antenna	Rohde & Schwarz	HFH2-Z2	100315	9 kHz~30 MHz	May 15, 2017	Sep. 06, 2017 ~ Oct. 16, 2017	May 14, 2019	Radiation (03CH07-HY)
Preamplifier	MITEQ	AMF-7D-0010 1800-30-10P	1590075	1GHz ~ 18GHz	Apr. 25, 2017	Sep. 06, 2017 ~ Oct. 16, 2017	Apr. 24, 2018	Radiation (03CH07-HY)
Preamplifier	COM-POWER	PA-103A	161241	10MHz-1GHz	Mar. 14, 2017	Sep. 06, 2017 ~ Oct. 16, 2017	Mar. 13, 2018	Radiation (03CH07-HY)
Preamplifier	Agilent	8449B	3008A02375	1GHz~26.5GHz	Dec. 21, 2016	Sep. 06, 2017 ~ Oct. 16, 2017	Dec. 20, 2017	Radiation (03CH07-HY)
Antenna Mast	Max-Full	MFA520BS	N/A	1m~4m	N/A	Sep. 06, 2017 ~ Oct. 16, 2017	N/A	Radiation (03CH07-HY)
Turn Table	ChainTek	Chaintek 3000	N/A	0~360 Degree	N/A	Sep. 06, 2017 ~ Oct. 16, 2017	N/A	Radiation (03CH07-HY)
Amplifier	MITEQ	TTA1840-35-HG	1871923	18GHz~40GHz, VSWR : 2.5:1 max	Jul. 18, 2017	Sep. 06, 2017 ~ Oct. 16, 2017	Jul. 17, 2018	Radiation (03CH07-HY)
EMI Test Receiver	Agilent	N9038A(MXE)	MY53290053	20Hz to 26.5GHz	Jan. 12, 2017	Sep. 06, 2017 ~ Oct. 16, 2017	Jan. 11, 2018	Radiation (03CH07-HY)
SHF-EHF Horn Antenna	SCHWARZBECK	BBHA 9170	BBHA91705 84	18GHz- 40GHz	Nov. 08, 2016	Sep. 06, 2017 ~ Oct. 16, 2017	Nov. 07, 2017	Radiation (03CH07-HY)
Spectrum Analyzer	Agilent	N9010A	MY53470118	10Hz~44GHz	Apr. 17, 2017	Sep. 06, 2017 ~ Oct. 16, 2017	Apr. 16, 2018	Radiation (03CH07-HY)



5 Uncertainty of Evaluation

Uncertainty of Conducted Emission Measurement (150kHz ~ 30MHz)

Measuring Uncertainty for a Level of Confidence of 95% ($U = 2Uc(y)$)	2.70
---	------

Uncertainty of Radiated Emission Measurement (30 MHz ~ 1000 MHz)

Measuring Uncertainty for a Level of Confidence of 95% ($U = 2Uc(y)$)	5.70
---	------

Uncertainty of Radiated Emission Measurement (1000 MHz ~ 18000 MHz)

Measuring Uncertainty for a Level of Confidence of 95% ($U = 2Uc(y)$)	5.50
---	------

Uncertainty of Radiated Emission Measurement (18000 MHz ~ 40000 MHz)

Measuring Uncertainty for a Level of Confidence of 95% ($U = 2Uc(y)$)	5.20
---	------



Appendix A. AC Conducted Emission Test Results

Test Engineer :	Arthur Hsieh	Temperature :	21~24°C
		Relative Humidity :	51~55%

ENV216 Auto Test FCC Power Bar - L

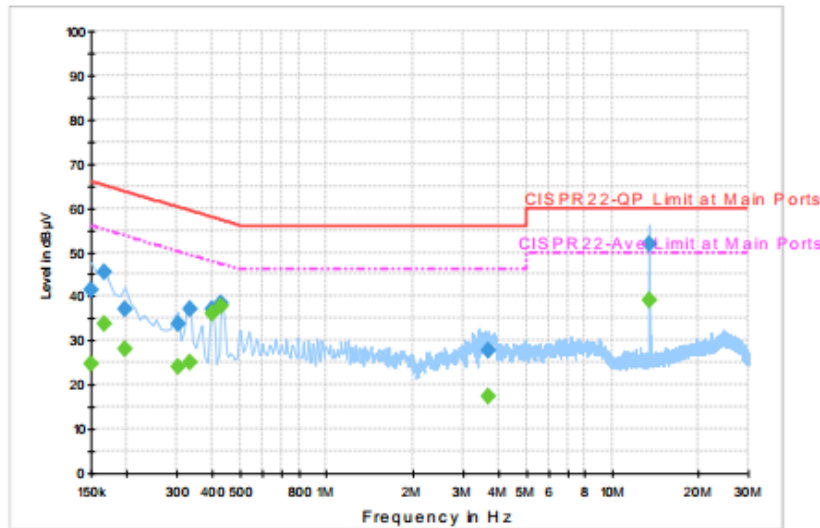

Final Result 1

Frequency (MHz)	QuasiPeak (dBµV)	Filter	Line	Corr. (dB)	Margin (dB)	Limit (dBµV)
0.150000	41.6	Off	L1	19.6	24.4	66.0
0.166000	45.4	Off	L1	19.6	19.8	65.2
0.198000	37.1	Off	L1	19.6	26.6	63.7
0.302000	33.7	Off	L1	19.6	26.5	60.2
0.334000	37.0	Off	L1	19.6	22.4	59.4
0.398000	37.0	Off	L1	19.6	20.9	57.9
0.430000	38.6	Off	L1	19.6	18.7	57.3
3.686000	27.8	Off	L1	19.7	28.2	56.0
13.558000	51.9	Off	L1	20.2	8.1	60.0

Final Result 2

Frequency (MHz)	Average (dBµV)	Filter	Line	Corr. (dB)	Margin (dB)	Limit (dBµV)
0.150000	24.7	Off	L1	19.6	31.3	56.0
0.166000	33.9	Off	L1	19.6	21.3	55.2
0.198000	28.1	Off	L1	19.6	25.6	53.7
0.302000	24.0	Off	L1	19.6	26.2	50.2
0.334000	25.2	Off	L1	19.6	24.2	49.4
0.398000	36.2	Off	L1	19.6	11.7	47.9
0.430000	37.8	Off	L1	19.6	9.5	47.3
3.686000	17.4	Off	L1	19.7	28.6	46.0
13.558000	39.2	Off	L1	20.2	10.8	50.0



ENV216 Auto Test FCC Power Bar - N

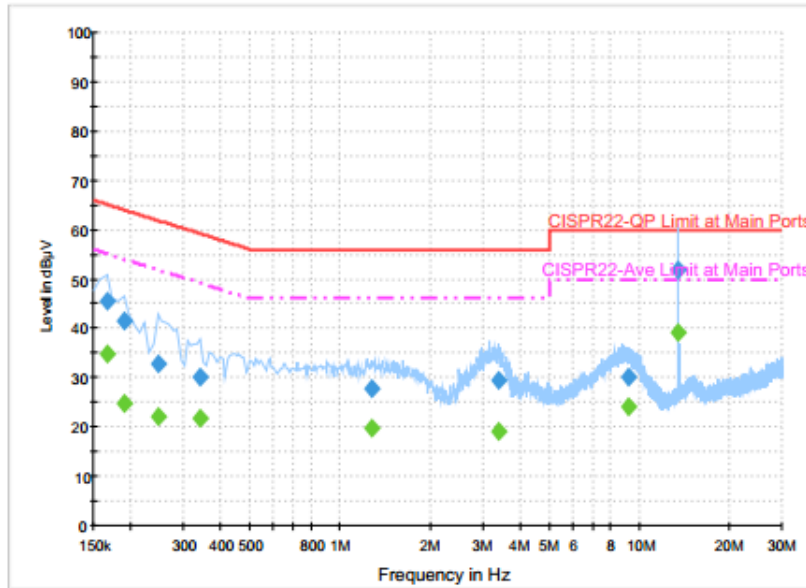

Final Result 1

Frequency (MHz)	QuasiPeak (dBµV)	Filter	Line	Corr. (dB)	Margin (dB)	Limit (dBµV)
0.166000	45.5	Off	N	19.5	19.7	65.2
0.190000	41.4	Off	N	19.5	22.6	64.0
0.246000	32.9	Off	N	19.5	29.0	61.9
0.342000	30.2	Off	N	19.5	29.0	59.2
1.278000	27.7	Off	N	19.6	28.3	56.0
3.382000	29.3	Off	N	19.6	26.7	56.0
9.222000	30.2	Off	N	20.0	29.8	60.0
13.558000	52.0	Off	N	20.3	8.0	60.0

Final Result 2

Frequency (MHz)	Average (dBµV)	Filter	Line	Corr. (dB)	Margin (dB)	Limit (dBµV)
0.166000	34.8	Off	N	19.5	20.4	55.2
0.190000	24.7	Off	N	19.5	29.3	54.0
0.246000	22.1	Off	N	19.5	29.8	51.9
0.342000	21.8	Off	N	19.5	27.4	49.2
1.278000	19.6	Off	N	19.6	26.4	46.0
3.382000	19.1	Off	N	19.6	26.9	46.0
9.222000	24.0	Off	N	20.0	26.0	50.0
13.558000	39.2	Off	N	20.3	10.8	50.0



Appendix B. Radiated Spurious Emission

Test Engineer :	Jesse Wang / Stand Hsieh / James Chiu	Temperature :	22~27°C
		Relative Humidity :	52~58%

<CDD Mode>

Band 4 - 5725~5850MHz

WIFI 802.11a (Band Edge @ 3m)

WIFI Ant. 1	Note	Frequency (MHz)	Level (dBμV/m)	Over Limit (dB)	Limit Line (dBμV/m)	Read Level (dBμV)	Antenna Factor (dB/m)	Cable Loss (dB)	Preamp Factor (dB)	Ant Pos (cm)	Table Pos (deg)	Peak Avg. (P/A)	Pol. (H/V)	
802.11a CH 149 5745MHz		5633.4	54.42	-13.78	68.2	41.85	35.09	12.61	35.13	100	227	P	H	
		5699.6	67.07	-37.84	104.91	54.37	35.17	12.67	35.14	100	227	P	H	
		5719.4	77.47	-33.16	110.63	64.67	35.21	12.73	35.14	100	227	P	H	
		5724.8	84.26	-37.48	121.74	71.46	35.21	12.73	35.14	100	227	P	H	
	*	5745	114.34	-	-	101.46	35.24	12.79	35.15	100	227	P	H	
	*	5745	106.85	-	-	93.97	35.24	12.79	35.15	100	227	A	H	
														H
														H
			5633.8	53.87	-14.33	68.2	41.3	35.09	12.61	35.13	100	299	P	V
			5698.4	63.19	-40.83	104.02	50.49	35.17	12.67	35.14	100	299	P	V
			5719.2	73.79	-36.79	110.58	60.99	35.21	12.73	35.14	100	299	P	V
			5724.4	80.81	-40.02	120.83	68.01	35.21	12.73	35.14	100	299	P	V
	*		5745	109.34	-	-	96.46	35.24	12.79	35.15	100	299	P	V
	*		5745	101.93	-	-	89.05	35.24	12.79	35.15	100	299	A	V
														V
														V



WIFI Ant. 1	Note	Frequency (MHz)	Level (dBμV/m)	Over Limit (dB)	Limit Line (dBμV/m)	Read Level (dBμV)	Antenna Factor (dB/m)	Cable Loss (dB)	Preamp Factor (dB)	Ant Pos (cm)	Table Pos (deg)	Peak Avg. (P/A)	Pol. (H/V)
		5616.4	54.22	-13.98	68.2	41.71	35.07	12.56	35.12	100	228	P	H
		5681.8	55.74	-36.03	91.77	43.07	35.14	12.67	35.14	100	228	P	H
		5715.4	56.93	-52.58	109.51	44.15	35.19	12.73	35.14	100	228	P	H
		5722	59.13	-56.23	115.36	46.33	35.21	12.73	35.14	100	228	P	H
	*	5785	111.68	-	-	98.7	35.29	12.85	35.16	100	228	P	H
	*	5785	104.41	-	-	91.43	35.29	12.85	35.16	100	228	A	H
		5850.8	53.71	-66.67	120.38	40.56	35.38	12.94	35.17	100	228	P	H
		5855.8	52.75	-57.83	110.58	39.57	35.41	12.94	35.17	100	228	P	H
		5898	51.43	-36.71	88.14	38.14	35.46	13.02	35.19	100	228	P	H
		5938	51.41	-16.79	68.2	38	35.5	13.11	35.2	100	228	P	H
													H
													H
802.11a													
CH 157													
5785MHz		5613.2	52.61	-15.59	68.2	40.13	35.04	12.56	35.12	100	218	P	V
		5659.8	54.27	-21.21	75.48	41.67	35.12	12.61	35.13	100	218	P	V
		5715	54	-55.4	109.4	41.22	35.19	12.73	35.14	100	218	P	V
		5722.2	55.23	-60.59	115.82	42.43	35.21	12.73	35.14	100	218	P	V
	*	5785	108.05	-	-	95.07	35.29	12.85	35.16	100	218	P	V
	*	5785	100.82	-	-	87.84	35.29	12.85	35.16	100	218	A	V
		5854	53.81	-59.27	113.08	40.63	35.41	12.94	35.17	100	218	P	V
		5862.8	52.13	-56.48	108.61	38.88	35.41	13.02	35.18	100	218	P	V
		5900.6	51.48	-34.74	86.22	38.1	35.46	13.11	35.19	100	218	P	V
		5940	51.08	-17.12	68.2	37.64	35.53	13.11	35.2	100	218	P	V
													V
													V



WiFi Ant. 1	Note	Frequency (MHz)	Level (dBμV/m)	Over Limit (dB)	Limit Line (dBμV/m)	Read Level (dBμV)	Antenna Factor (dB/m)	Cable Loss (dB)	Preamp Factor (dB)	Ant Pos (cm)	Table Pos (deg)	Peak Avg. (P/A)	Pol. (H/V)	
802.11a CH 165 5825MHz	*	5825	109.41	-	-	96.28	35.36	12.94	35.17	100	232	P	H	
	*	5825	102.14	-	-	89.01	35.36	12.94	35.17	100	232	A	H	
		5851.4	66.93	-52.08	119.01	53.78	35.38	12.94	35.17	100	232	P	H	
		5855	62.33	-48.47	110.8	49.15	35.41	12.94	35.17	100	232	P	H	
		5875.8	53.72	-50.89	104.61	40.45	35.43	13.02	35.18	100	232	P	H	
		5938.2	51.29	-16.91	68.2	37.88	35.5	13.11	35.2	100	232	P	H	
														H
														H
	*	5825	107.41	-	-	94.28	35.36	12.94	35.17	106	66	P	V	
	*	5825	100.18	-	-	87.05	35.36	12.94	35.17	106	66	A	V	
		5851.6	63.63	-54.92	118.55	50.48	35.38	12.94	35.17	106	66	P	V	
		5856	59.14	-51.38	110.52	45.96	35.41	12.94	35.17	106	66	P	V	
		5898.4	52.06	-35.79	87.85	38.77	35.46	13.02	35.19	106	66	P	V	
		5935.2	51.47	-16.73	68.2	38.06	35.5	13.11	35.2	106	66	P	V	
														V
														V
														V
	Remark	1. No other spurious found. 2. All results are PASS against Peak and Average limit line.												



Band 4 5725~5850MHz
WIFI 802.11a (Harmonic @ 3m)

WIFI Ant. 1	Note	Frequency (MHz)	Level (dBμV/m)	Over Limit (dB)	Limit Line (dBμV/m)	Read Level (dBμV)	Antenna Factor (dB/m)	Cable Loss (dB)	Preamp Factor (dB)	Ant Pos (cm)	Table Pos (deg)	Peak Avg. (P/A)	Pol. (H/V)	
802.11a CH 149 5745MHz		11490	46.11	-27.89	74	45.3	39.27	18.88	57.34	100	0	P	H	
		17235	55.97	-12.23	68.2	45.96	42.43	23.38	55.8	100	0	P	H	
													H	
													H	
			11490	46.27	-27.73	74	45.46	39.27	18.88	57.34	100	0	P	V
			17235	56.1	-12.1	68.2	46.09	42.43	23.38	55.8	100	0	P	V
														V
802.11a CH 157 5785MHz		11570	46.1	-27.9	74	45.14	39.2	18.95	57.19	100	0	P	H	
		17355	58.68	-9.52	68.2	48.79	42.24	23.45	55.8	100	0	P	H	
													H	
													H	
			11570	45.94	-28.06	74	44.98	39.2	18.95	57.19	100	0	P	V
			17355	57.83	-10.37	68.2	47.94	42.24	23.45	55.8	100	0	P	V
														V
802.11a CH 165 5825MHz		11650	47.15	-26.85	74	46.09	39.11	19.03	57.08	100	0	P	H	
		17475	54.34	-13.86	68.2	44.57	42.05	23.52	55.8	100	0	P	H	
													H	
													H	
			11650	46.39	-27.61	74	45.33	39.11	19.03	57.08	100	0	P	V
			17475	56.39	-11.81	68.2	46.62	42.05	23.52	55.8	100	0	P	V
														V
Remark	1. No other spurious found.													
	2. All results are PASS against Peak and Average limit line.													



Band 4 5725~5850MHz
WIFI 802.11ac VHT20 (Band Edge @ 3m)

WIFI Ant. 1	Note	Frequency (MHz)	Level (dBμV/m)	Over Limit (dB)	Limit Line (dBμV/m)	Read Level (dBμV)	Antenna Factor (dB/m)	Cable Loss (dB)	Preamp Factor (dB)	Ant Pos (cm)	Table Pos (deg)	Peak Avg. (P/A)	Pol. (H/V)	
802.11ac VHT20 CH 149 5745MHz		5639.8	54.7	-13.5	68.2	42.13	35.09	12.61	35.13	100	229	P	H	
		5695.6	71.76	-30.2	101.96	59.06	35.17	12.67	35.14	100	229	P	H	
		5720	79.48	-31.32	110.8	66.68	35.21	12.73	35.14	100	229	P	H	
		5725	83.22	-38.98	122.2	70.42	35.21	12.73	35.14	100	229	P	H	
	*	5745	113.37	-	-	100.49	35.24	12.79	35.15	100	229	P	H	
	*	5745	105.72	-	-	92.84	35.24	12.79	35.15	100	229	A	H	
														H
														H
			5620.4	53.07	-15.13	68.2	40.51	35.07	12.61	35.12	100	299	P	V
			5696.4	64.83	-37.72	102.55	52.13	35.17	12.67	35.14	100	299	P	V
			5720	75.72	-35.08	110.8	62.92	35.21	12.73	35.14	100	299	P	V
			5723.8	83.49	-35.97	119.46	70.69	35.21	12.73	35.14	100	299	P	V
		*	5745	109.52	-	-	96.64	35.24	12.79	35.15	100	299	P	V
		*	5745	101.79	-	-	88.91	35.24	12.79	35.15	100	299	A	V
													V	
													V	



WIFI Ant. 1	Note	Frequency (MHz)	Level (dBμV/m)	Over Limit (dB)	Limit Line (dBμV/m)	Read Level (dBμV)	Antenna Factor (dB/m)	Cable Loss (dB)	Preamp Factor (dB)	Ant Pos (cm)	Table Pos (deg)	Peak Avg. (P/A)	Pol. (H/V)
		5630.6	53.68	-14.52	68.2	41.13	35.07	12.61	35.13	100	227	P	H
		5693.6	55.95	-44.53	100.48	43.25	35.17	12.67	35.14	100	227	P	H
		5718	57.65	-52.59	110.24	44.85	35.21	12.73	35.14	100	227	P	H
		5724.6	58.47	-62.82	121.29	45.67	35.21	12.73	35.14	100	227	P	H
	*	5785	111.69	-	-	98.71	35.29	12.85	35.16	100	227	P	H
	*	5785	104.14	-	-	91.16	35.29	12.85	35.16	100	227	A	H
		5850.8	53.78	-66.6	120.38	40.63	35.38	12.94	35.17	100	227	P	H
		5870	53.98	-52.62	106.6	40.73	35.41	13.02	35.18	100	227	P	H
		5910	51.68	-27.59	79.27	38.28	35.48	13.11	35.19	100	227	P	H
		5934	51.3	-16.9	68.2	37.88	35.5	13.11	35.19	100	227	P	H
802.11ac													H
VHT20													H
CH 157		5605	52.46	-15.74	68.2	39.98	35.04	12.56	35.12	100	305	P	V
5785MHz		5671.6	53.2	-31.02	84.22	40.52	35.14	12.67	35.13	100	305	P	V
		5718.6	54.87	-55.54	110.41	42.07	35.21	12.73	35.14	100	305	P	V
		5722	55.65	-59.71	115.36	42.85	35.21	12.73	35.14	100	305	P	V
	*	5785	107.56	-	-	94.58	35.29	12.85	35.16	100	305	P	V
	*	5785	99.89	-	-	86.91	35.29	12.85	35.16	100	305	A	V
		5851.4	52.87	-66.14	119.01	39.72	35.38	12.94	35.17	100	305	P	V
		5862.2	51.49	-57.29	108.78	38.24	35.41	13.02	35.18	100	305	P	V
		5897	52.49	-36.39	88.88	39.2	35.46	13.02	35.19	100	305	P	V
		5928.8	50.74	-17.46	68.2	37.32	35.5	13.11	35.19	100	305	P	V
													V
													V



WIFI Ant. 1	Note	Frequency (MHz)	Level (dBμV/m)	Over Limit (dB)	Limit Line (dBμV/m)	Read Level (dBμV)	Antenna Factor (dB/m)	Cable Loss (dB)	Preamp Factor (dB)	Ant Pos (cm)	Table Pos (deg)	Peak Avg. (P/A)	Pol. (H/V)	
802.11ac VHT20 CH 165 5825MHz	*	5825	110.23	-	-	97.1	35.36	12.94	35.17	100	224	P	H	
	*	5825	102.17	-	-	89.04	35.36	12.94	35.17	100	224	A	H	
		5850.2	74.1	-47.64	121.74	60.95	35.38	12.94	35.17	100	224	P	H	
		5855.4	65.22	-45.47	110.69	52.04	35.41	12.94	35.17	100	224	P	H	
		5875	56.25	-48.95	105.2	42.98	35.43	13.02	35.18	100	224	P	H	
		5942.2	52.48	-15.72	68.2	38.95	35.53	13.2	35.2	100	224	P	H	
														H
														H
	*	5825	107.84	-	-	94.71	35.36	12.94	35.17	100	224	P	V	
	*	5825	100.23	-	-	87.1	35.36	12.94	35.17	100	224	A	V	
		5850	69.55	-52.65	122.2	56.4	35.38	12.94	35.17	100	224	P	V	
		5855.2	62.66	-48.08	110.74	49.48	35.41	12.94	35.17	100	224	P	V	
		5879.6	55.33	-46.45	101.78	42.06	35.43	13.02	35.18	100	224	P	V	
		5931.8	51.38	-16.82	68.2	37.96	35.5	13.11	35.19	100	224	P	V	
														V
													V	
Remark	1. No other spurious found. 2. All results are PASS against Peak and Average limit line.													



Band 4 5725~5850MHz
WIFI 802.11ac VHT20 (Harmonic @ 3m)

WIFI Ant. 1	Note	Frequency (MHz)	Level (dBμV/m)	Over Limit (dB)	Limit Line (dBμV/m)	Read Level (dBμV)	Antenna Factor (dB/m)	Cable Loss (dB)	Preamp Factor (dB)	Ant Pos (cm)	Table Pos (deg)	Peak Avg. (P/A)	Pol. (H/V)	
802.11ac VHT20 CH 149 5745MHz		11490	44.92	-29.08	74	45	38.38	18.88	57.34	100	0	P	H	
		17235	56.23	-11.97	68.2	46.88	41.77	23.38	55.8	100	0	P	H	
													H	
													H	
			11490	44.78	-29.22	74	44.86	38.38	18.88	57.34	100	0	P	V
			17235	58.36	-9.84	68.2	49.01	41.77	23.38	55.8	100	0	P	V
														V
802.11ac VHT20 CH 157 5785MHz		11570	45.82	-28.18	74	45.6	38.46	18.95	57.19	100	0	P	H	
		17355	56.63	-11.57	68.2	47.37	41.61	23.45	55.8	100	0	P	H	
													H	
													H	
			11570	45.03	-28.97	74	44.81	38.46	18.95	57.19	100	0	P	V
			17355	58.26	-9.94	68.2	49	41.61	23.45	55.8	100	0	P	V
														V
802.11ac VHT20 CH 165 5825MHz		11650	45.92	-28.08	74	45.46	38.51	19.03	57.08	100	0	P	H	
		17475	54.58	-13.62	68.2	45.41	41.45	23.52	55.8	100	0	P	H	
													H	
													H	
			11650	46.36	-27.64	74	45.9	38.51	19.03	57.08	100	0	P	V
			17475	55.14	-13.06	68.2	45.97	41.45	23.52	55.8	100	0	P	V
														V
Remark	1. No other spurious found.													
	2. All results are PASS against Peak and Average limit line.													



Band 4 5725~5850MHz
WIFI 802.11ac VHT40 (Band Edge @ 3m)

WIFI Ant. 1	Note	Frequency (MHz)	Level (dBμV/m)	Over Limit (dB)	Limit Line (dBμV/m)	Read Level (dBμV)	Antenna Factor (dB/m)	Cable Loss (dB)	Preamp Factor (dB)	Ant Pos (cm)	Table Pos (deg)	Peak Avg. (P/A)	Pol. (H/V)
		5637.2	61.1	-7.1	68.2	48.53	35.09	12.61	35.13	100	227	P	H
		5697.6	74.66	-28.77	103.43	61.96	35.17	12.67	35.14	100	227	P	H
		5719	83.63	-26.89	110.52	70.83	35.21	12.73	35.14	100	227	P	H
		5720.4	83.3	-28.41	111.71	70.5	35.21	12.73	35.14	100	227	P	H
	*	5755	110.32	-	-	97.42	35.26	12.79	35.15	100	227	P	H
	*	5755	102.52	-	-	89.62	35.26	12.79	35.15	100	227	A	H
		5850.2	56.51	-65.23	121.74	43.36	35.38	12.94	35.17	100	227	P	H
		5862	54.86	-53.98	108.84	41.61	35.41	13.02	35.18	100	227	P	H
		5888	53.09	-42.46	95.55	39.8	35.46	13.02	35.19	100	227	P	H
		5925.8	51.205	-16.95	68.2	37.83	35.5	13.11	35.19	100	227	P	H
													H
													H
802.11ac													
VHT40													
CH 151		5643.4	56.62	-11.58	68.2	44.05	35.09	12.61	35.13	100	299	P	V
5755MHz		5698.4	72.28	-31.74	104.02	59.58	35.17	12.67	35.14	100	299	P	V
		5719	80.58	-29.94	110.52	67.78	35.21	12.73	35.14	100	299	P	V
		5722.6	80.96	-35.77	116.73	68.16	35.21	12.73	35.14	100	299	P	V
	*	5755	106.57	-	-	93.67	35.26	12.79	35.15	100	299	P	V
	*	5755	98.43	-	-	85.53	35.26	12.79	35.15	100	299	A	V
		5850.2	53.63	-68.11	121.74	40.48	35.38	12.94	35.17	100	299	P	V
		5857.2	53.56	-56.62	110.18	40.38	35.41	12.94	35.17	100	299	P	V
		5882.8	51.43	-47.98	99.41	38.16	35.43	13.02	35.18	100	299	P	V
		5949.2	51.85	-16.35	68.2	38.32	35.53	13.2	35.2	100	299	P	V
													V
													V



WIFI Ant. 1	Note	Frequency (MHz)	Level (dBμV/m)	Over Limit (dB)	Limit Line (dBμV/m)	Read Level (dBμV)	Antenna Factor (dB/m)	Cable Loss (dB)	Preamp Factor (dB)	Ant Pos (cm)	Table Pos (deg)	Peak Avg. (P/A)	Pol. (H/V)
		5629.6	56.37	-11.83	68.2	43.82	35.07	12.61	35.13	100	226	P	H
		5699.2	62.78	-41.83	104.61	50.08	35.17	12.67	35.14	100	226	P	H
		5716.4	66.92	-42.87	109.79	54.14	35.19	12.73	35.14	100	226	P	H
		5721.8	67.1	-47.8	114.9	54.3	35.21	12.73	35.14	100	226	P	H
	*	5795	108.3	-	-	95.3	35.31	12.85	35.16	100	226	P	H
	*	5795	100.71	-	-	87.71	35.31	12.85	35.16	100	226	A	H
		5851	65.57	-54.35	119.92	52.42	35.38	12.94	35.17	100	226	P	H
		5856.8	64.02	-46.28	110.3	50.84	35.41	12.94	35.17	100	226	P	H
		5877.4	61.36	-42.06	103.42	48.09	35.43	13.02	35.18	100	226	P	H
		5941.4	52.93	-15.27	68.2	39.4	35.53	13.2	35.2	100	226	P	H
802.11ac													H
VHT40													H
CH 159		5649.8	54.27	-13.93	68.2	41.67	35.12	12.61	35.13	105	304	P	V
5795MHz		5688.6	58.61	-38.18	96.79	45.91	35.17	12.67	35.14	105	304	P	V
		5719.2	63.99	-46.59	110.58	51.19	35.21	12.73	35.14	105	304	P	V
		5724.6	63.61	-57.68	121.29	50.81	35.21	12.73	35.14	105	304	P	V
	*	5795	104.89	-	-	91.89	35.31	12.85	35.16	105	304	P	V
	*	5795	97.3	-	-	84.3	35.31	12.85	35.16	105	304	A	V
		5852.6	61.05	-55.22	116.27	47.9	35.38	12.94	35.17	105	304	P	V
		5855	60.05	-50.75	110.8	46.87	35.41	12.94	35.17	105	304	P	V
		5877.2	56.55	-47.02	103.57	43.28	35.43	13.02	35.18	105	304	P	V
		5931.6	52.16	-16.04	68.2	38.74	35.5	13.11	35.19	105	304	P	V
													V
													V
Remark	1. No other spurious found. 2. All results are PASS against Peak and Average limit line.												



Band 4 5725~5850MHz
WIFI 802.11ac VHT40 (Harmonic @ 3m)

WIFI Ant. 1	Note	Frequency (MHz)	Level (dBμV/m)	Over Limit (dB)	Limit Line (dBμV/m)	Read Level (dBμV)	Antenna Factor (dB/m)	Cable Loss (dB)	Preamp Factor (dB)	Ant Pos (cm)	Table Pos (deg)	Peak Avg. (P/A)	Pol. (H/V)	
802.11ac VHT40 CH 151 5755MHz		11510	46.12	-27.88	74	46.1	38.4	18.92	57.3	100	0	P	H	
		17265	52.95	-15.25	68.2	43.62	41.73	23.4	55.8	100	0	P	H	
													H	
													H	
			11510	45.82	-28.18	74	45.8	38.4	18.92	57.3	100	0	P	V
			17265	53.02	-15.18	68.2	43.69	41.73	23.4	55.8	100	0	P	V
														V
802.11ac VHT40 CH 159 5795MHz		11590	45.28	-28.72	74	44.98	38.47	18.99	57.16	100	0	P	H	
		17385	53.38	-14.82	68.2	44.15	41.56	23.47	55.8	100	0	P	H	
													H	
													H	
			11590	44.79	-29.21	74	44.49	38.47	18.99	57.16	100	0	P	V
			17385	53.47	-14.73	68.2	44.24	41.56	23.47	55.8	100	0	P	V
														V
Remark	1. No other spurious found.													
	2. All results are PASS against Peak and Average limit line.													



Band 4 5725~5850MHz
WIFI 802.11ac VHT80 (Band Edge @ 3m)

WIFI Ant. 1	Note	Frequency (MHz)	Level (dBμV/m)	Over Limit (dB)	Limit Line (dBμV/m)	Read Level (dBμV)	Antenna Factor (dB/m)	Cable Loss (dB)	Preamp Factor (dB)	Ant Pos (cm)	Table Pos (deg)	Peak Avg. (P/A)	Pol. (H/V)
		5649	65.67	-2.53	68.2	53.1	35.09	12.61	35.13	100	227	P	H
		5690.8	76.29	-22.13	98.42	63.59	35.17	12.67	35.14	100	227	P	H
		5717.4	76.16	-33.91	110.07	63.38	35.19	12.73	35.14	100	227	P	H
		5722	76.61	-38.75	115.36	63.81	35.21	12.73	35.14	100	227	P	H
	*	5775	104.72	-	-	91.8	35.29	12.79	35.16	100	227	P	H
	*	5775	96.52	-	-	83.6	35.29	12.79	35.16	100	227	A	H
		5851.2	70.21	-49.25	119.46	57.06	35.38	12.94	35.17	100	227	P	H
		5859.8	68.48	-40.97	109.45	55.31	35.41	12.94	35.18	100	227	P	H
		5876.8	64.04	-39.82	103.86	50.77	35.43	13.02	35.18	100	227	P	H
		5929	53.12	-15.08	68.2	39.7	35.5	13.11	35.19	100	227	P	H
802.11ac													H
VHT80													H
CH 155		5649.4	61.4	-6.8	68.2	48.83	35.09	12.61	35.13	100	300	P	V
5775MHz		5697.4	70.64	-32.64	103.28	57.94	35.17	12.67	35.14	100	300	P	V
		5706	72.29	-34.59	106.88	59.51	35.19	12.73	35.14	100	300	P	V
		5723.6	73.09	-45.92	119.01	60.29	35.21	12.73	35.14	100	300	P	V
	*	5775	99.82	-	-	86.9	35.29	12.79	35.16	100	300	P	V
	*	5775	92.52	-	-	79.6	35.29	12.79	35.16	100	300	A	V
		5851.4	65.5	-53.51	119.01	52.35	35.38	12.94	35.17	100	300	P	V
		5859.8	63.35	-46.1	109.45	50.18	35.41	12.94	35.18	100	300	P	V
		5875.8	57.24	-47.37	104.61	43.97	35.43	13.02	35.18	100	300	P	V
		5933.8	52.47	-15.73	68.2	39.05	35.5	13.11	35.19	100	300	P	V
													V
													V
Remark	1. No other spurious found. 2. All results are PASS against limit line.												



Band 4 5725~5850MHz
WIFI 802.11ac VHT80 (Band Edge @ 3m)

WIFI Ant. 1	Note	Frequency (MHz)	Level (dBμV/m)	Over Limit (dB)	Limit Line (dBμV/m)	Read Level (dBμV)	Antenna Factor (dB/m)	Cable Loss (dB)	Preamp Factor (dB)	Ant Pos (cm)	Table Pos (deg)	Peak Avg. (P/A)	Pol. (H/V)	
802.11ac VHT80 CH 155 5775MHz		11550	45.83	-28.17	74	45.66	38.44	18.95	57.22	100	0	P	H	
		17325	51.43	-16.77	68.2	42.14	41.66	23.43	55.8	100	0	P	H	
													H	
													H	
			11550	45.86	-28.14	74	45.69	38.44	18.95	57.22	100	0	P	V
			17325	51.46	-16.74	68.2	42.17	41.66	23.43	55.8	100	0	P	V
														V
														V
Remark	1. No other spurious found. 2. All results are PASS against Peak and Average limit line.													



Emission below 1GHz

5GHz WIFI 802.11ac VHT80 (LF @ 3m)

WIFI Ant. 1	Note	Frequency (MHz)	Level (dBμV/m)	Over Limit (dB)	Limit Line (dBμV/m)	Read Level (dBμV)	Antenna Factor (dB/m)	Cable Loss (dB)	Preamp Factor (dB)	Ant Pos (cm)	Table Pos (deg)	Peak Avg. (P/A)	Pol. (H/V)	
5GHz 802.11ac VHT80 LF		30	27.34	-12.66	40	32.26	24.72	1.71	31.35			P	H	
		143.67	27.72	-15.78	43.5	39.41	17.2	2.62	31.51			P	H	
		281.37	31.54	-14.46	46	40.82	18.77	3.28	31.33			P	H	
		303.5	29.21	-16.79	46	37.82	19.25	3.43	31.29			P	H	
		392.4	29.18	-16.82	46	35.05	21.45	3.82	31.14			P	H	
		958.7	35.08	-10.92	46	29.29	30.9	5.4	30.51	100	88	P	H	
														H
														H
														H
														H
														H
														H
														H
														H
														H
			35.94	31.37	-8.63	40	39.51	21.58	1.71	31.43			P	V
			76.71	31.79	-8.21	40	48.5	12.76	2.11	31.58	100	69	P	V
			122.34	33.87	-9.63	43.5	45.59	17.48	2.34	31.54			P	V
			773.9	31.83	-14.17	46	29.51	28.05	4.88	30.61			P	V
			891.5	33.74	-12.26	46	30.03	28.97	5.27	30.53			P	V
		957.3	35.48	-10.52	46	29.73	30.86	5.4	30.51			P	V	
													V	
													V	
													V	
													V	
													V	
													V	
Remark	1. No other spurious found. 2. All results are PASS against limit line.													



Band 4 5725~5850MHz
WIFI 802.11ac VHT80 (Band Edge @ 3m)

WIFI Ant. 2	Note	Frequency (MHz)	Level (dBμV/m)	Over Limit (dB)	Limit Line (dBμV/m)	Read Level (dBμV)	Antenna Factor (dB/m)	Cable Loss (dB)	Preamp Factor (dB)	Ant Pos (cm)	Table Pos (deg)	Peak Avg. (P/A)	Pol. (H/V)
		5648.2	65.32	-2.88	68.2	52.75	35.09	12.61	35.13	100	302	P	H
		5696.6	78.6	-24.09	102.69	65.9	35.17	12.67	35.14	100	302	P	H
		5719.8	81.58	-29.16	110.74	68.78	35.21	12.73	35.14	100	302	P	H
		5723.8	79.93	-39.53	119.46	67.13	35.21	12.73	35.14	100	302	P	H
	*	5775	103.3	-	-	90.38	35.29	12.79	35.16	100	302	P	H
	*	5775	95.2	-	-	82.28	35.29	12.79	35.16	100	302	A	H
		5850	72.39	-49.81	122.2	59.24	35.38	12.94	35.17	100	302	P	H
		5859.8	71.99	-37.46	109.45	58.82	35.41	12.94	35.18	100	302	P	H
		5876	64.62	-39.84	104.46	51.35	35.43	13.02	35.18	100	302	P	H
		5927	53.85	-14.35	68.2	40.43	35.5	13.11	35.19	100	302	P	H
802.11ac													H
VHT80													H
CH 155		5649.2	61.82	-6.38	68.2	49.25	35.09	12.61	35.13	100	303	P	V
5775MHz		5697.8	75.49	-28.09	103.58	62.79	35.17	12.67	35.14	100	303	P	V
		5719.6	78.03	-32.66	110.69	65.23	35.21	12.73	35.14	100	303	P	V
		5721.4	78.55	-35.44	113.99	65.75	35.21	12.73	35.14	100	303	P	V
	*	5775	101.52	-	-	88.6	35.29	12.79	35.16	100	303	P	V
	*	5775	94.62	-	-	81.7	35.29	12.79	35.16	100	303	A	V
		5854.6	70.72	-40.99	111.71	57.54	35.41	12.94	35.17	100	303	P	V
		5857.4	68.77	-41.36	110.13	55.59	35.41	12.94	35.17	100	303	P	V
		5875.4	63.65	-41.25	104.9	50.38	35.43	13.02	35.18	100	303	P	V
		5936.6	51.77	-16.43	68.2	38.36	35.5	13.11	35.2	100	303	P	V
													V
													V
Remark	1. No other spurious found. 2. All results are PASS against Peak and Average limit line.												



Band 4 5725~5850MHz

WIFI 802.11ac VHT80 (Harmonic @ 3m)

WIFI Ant. 2	Note	Frequency (MHz)	Level (dBμV/m)	Over Limit (dB)	Limit Line (dBμV/m)	Read Level (dBμV)	Antenna Factor (dB/m)	Cable Loss (dB)	Preamp Factor (dB)	Ant Pos (cm)	Table Pos (deg)	Peak Avg. (P/A)	Pol. (H/V)	
802.11ac VHT80 CH 155 5775MHz		11550	46.07	-27.93	74	45.11	39.23	18.95	57.22	100	0	P	H	
		17325	50.86	-17.34	68.2	40.94	42.29	23.43	55.8	100	0	P	H	
													H	
													H	
			11550	46.39	-27.61	74	45.43	39.23	18.95	57.22	100	0	P	V
			17325	50.75	-17.45	68.2	40.83	42.29	23.43	55.8	100	0	P	V
														V
Remark	1. No other spurious found.													
	2. All results are PASS against Peak and Average limit line.													



Emission below 1GHz

5GHz WIFI 802.11n HT40 (LF @ 3m)

WIFI Ant. 2	Note	Frequency (MHz)	Level (dBμV/m)	Over Limit (dB)	Limit Line (dBμV/m)	Read Level (dBμV)	Antenna Factor (dB/m)	Cable Loss (dB)	Preamp Factor (dB)	Ant Pos (cm)	Table Pos (deg)	Peak Avg. (P/A)	Pol. (H/V)	
5GHz 802.11n HT40 LF		30.27	25.76	-14.24	40	30.68	24.72	1.71	31.35			P	H	
		126.93	30.65	-12.85	43.5	42.34	17.5	2.34	31.53			P	H	
		288.12	30.17	-15.83	46	39.27	18.94	3.28	31.32			P	H	
		863.5	32.97	-13.03	46	29.14	29.11	5.27	30.55			P	H	
		939.8	33.4	-12.6	46	28.59	30	5.33	30.52			P	H	
		956.6	34.91	-11.09	46	29.21	30.81	5.4	30.51	100	68	P	H	
														H
														H
														H
														H
														H
														H
														H
														H
														H
			77.25	31.35	-8.65	40	47.92	12.9	2.11	31.58	100	201	P	V
			123.15	31.86	-11.64	43.5	43.57	17.48	2.34	31.53			P	V
			290.55	24.96	-21.04	46	33.98	19.01	3.28	31.31			P	V
			921.6	33.65	-12.35	46	29.55	29.29	5.33	30.52			P	V
			947.5	34.41	-11.59	46	29.15	30.38	5.4	30.52			P	V
		953.8	34.67	-11.33	46	29.11	30.67	5.4	30.51			P	V	
													V	
													V	
													V	
													V	
													V	
													V	
													V	
Remark	1. No other spurious found. 2. All results are PASS against limit line.													



Band 4 - 5725~5850MHz
WIFI 802.11a (Band Edge @ 3m)

WIFI Ant.	Note	Frequency	Level	Over Limit	Limit Line	Read Level	Antenna Factor	Cable Loss	Preamp Factor	Ant Pos	Table Pos	Peak Avg.	Pol.	
1+2		(MHz)	(dBµV/m)	(dB)	(dBµV/m)	(dBµV)	(dB/m)	(dB)	(dB)	(cm)	(deg)	(P/A)	(H/V)	
802.11a CH 149 5745MHz		5643	55.36	-12.84	68.2	42.79	35.09	12.61	35.13	100	308	P	H	
		5695.2	67.42	-34.24	101.66	54.72	35.17	12.67	35.14	100	308	P	H	
		5720	79.77	-31.03	110.8	66.97	35.21	12.73	35.14	100	308	P	H	
		5723.6	83.36	-35.65	119.01	70.56	35.21	12.73	35.14	100	308	P	H	
	*	5745	114.58	-	-	101.7	35.24	12.79	35.15	100	308	P	H	
	*	5745	107.28	-	-	94.4	35.24	12.79	35.15	100	308	A	H	
														H
														H
			5632.2	53.31	-14.89	68.2	40.76	35.07	12.61	35.13	100	240	P	V
			5698.6	64.04	-40.13	104.17	51.34	35.17	12.67	35.14	100	240	P	V
			5720	75.05	-35.75	110.8	62.25	35.21	12.73	35.14	100	240	P	V
			5722	79.07	-36.29	115.36	66.27	35.21	12.73	35.14	100	240	P	V
	*		5745	110.48	-	-	97.6	35.24	12.79	35.15	100	240	P	V
	*		5745	103.48	-	-	90.6	35.24	12.79	35.15	100	240	A	V
														V
													V	



WIFI Ant. 1+2	Note	Frequency (MHz)	Level (dBμV/m)	Over Limit (dB)	Limit Line (dBμV/m)	Read Level (dBμV)	Antenna Factor (dB/m)	Cable Loss (dB)	Preamp Factor (dB)	Ant Pos (cm)	Table Pos (deg)	Peak Avg. (P/A)	Pol. (H/V)	
802.11a CH 157 5785MHz		5640.8	54.17	-14.03	68.2	41.6	35.09	12.61	35.13	100	314	P	H	
		5662.8	54.48	-23.22	77.7	41.82	35.12	12.67	35.13	100	314	P	H	
		5708	57.58	-49.86	107.44	44.8	35.19	12.73	35.14	100	314	P	H	
		5722.2	58.37	-57.45	115.82	45.57	35.21	12.73	35.14	100	314	P	H	
	*	5785	113.17	-	-	100.19	35.29	12.85	35.16	100	314	P	H	
	*	5785	106.47	-	-	93.49	35.29	12.85	35.16	100	314	A	H	
		5852.2	53.69	-63.49	117.18	40.54	35.38	12.94	35.17	100	314	P	H	
		5869.4	51.77	-55	106.77	38.52	35.41	13.02	35.18	100	314	P	H	
		5876.6	51.51	-52.5	104.01	38.24	35.43	13.02	35.18	100	314	P	H	
		5949.2	50.79	-17.41	68.2	37.26	35.53	13.2	35.2	100	314	P	H	
														H
														H
			5645.2	53.03	-15.17	68.2	40.46	35.09	12.61	35.13	100	241	P	V
			5682.2	53.61	-38.46	92.07	40.94	35.14	12.67	35.14	100	241	P	V
			5718.6	54.37	-56.04	110.41	41.57	35.21	12.73	35.14	100	241	P	V
			5722.8	54.88	-62.3	117.18	42.08	35.21	12.73	35.14	100	241	P	V
	*		5785	110.27	-	-	97.29	35.29	12.85	35.16	100	241	P	V
	*		5785	103.17	-	-	90.19	35.29	12.85	35.16	100	241	A	V
			5851	52.15	-67.77	119.92	39	35.38	12.94	35.17	100	241	P	V
			5856.2	51.95	-58.51	110.46	38.77	35.41	12.94	35.17	100	241	P	V
		5898.8	51.18	-36.37	87.55	37.89	35.46	13.02	35.19	100	241	P	V	
		5949.2	50.68	-17.52	68.2	37.15	35.53	13.2	35.2	100	241	P	V	
													V	
													V	



WiFi Ant. 1+2	Note	Frequency (MHz)	Level (dBμV/m)	Over Limit (dB)	Limit Line (dBμV/m)	Read Level (dBμV)	Antenna Factor (dB/m)	Cable Loss (dB)	Preamp Factor (dB)	Ant Pos (cm)	Table Pos (deg)	Peak Avg. (P/A)	Pol. (H/V)	
802.11a CH 165 5825MHz	*	5825	111.83	-	-	98.7	35.36	12.94	35.17	100	317	P	H	
	*	5825	104.33	-	-	91.2	35.36	12.94	35.17	100	317	A	H	
		5851.6	71.8	-46.75	118.55	58.65	35.38	12.94	35.17	100	317	P	H	
		5857.4	69.93	-40.2	110.13	56.75	35.41	12.94	35.17	100	317	P	H	
		5877.8	57.62	-45.5	103.12	44.35	35.43	13.02	35.18	100	317	P	H	
		5927	52.07	-16.13	68.2	38.65	35.5	13.11	35.19	100	317	P	H	
														H
														H
	*	5825	109.13	-	-	96	35.36	12.94	35.17	100	240	240	P	V
	*	5825	101.53	-	-	88.4	35.36	12.94	35.17	100	240	240	A	V
		5851.4	67.76	-51.25	119.01	54.61	35.38	12.94	35.17	100	240	240	P	V
		5856.8	68.11	-42.19	110.3	54.93	35.41	12.94	35.17	100	240	240	P	V
		5880.6	54.59	-46.45	101.04	41.32	35.43	13.02	35.18	100	240	240	P	V
		5935.2	51.25	-16.95	68.2	37.84	35.5	13.11	35.2	100	240	240	P	V
														V
														V
														V
Remark	1. No other spurious found. 2. All results are PASS against Peak and Average limit line.													



Band 4 5725~5850MHz
WIFI 802.11a (Harmonic @ 3m)

WIFI Ant. 1+2	Note	Frequency (MHz)	Level (dBμV/m)	Over Limit (dB)	Limit Line (dBμV/m)	Read Level (dBμV)	Antenna Factor (dB/m)	Cable Loss (dB)	Preamp Factor (dB)	Ant Pos (cm)	Table Pos (deg)	Peak Avg. (P/A)	Pol. (H/V)	
802.11a CH 149 5745MHz		11490	47.02	-26.98	74	47.1	38.38	18.88	57.34	100	0	P	H	
		17235	62.2	-6	68.2	52.85	41.77	23.38	55.8	100	0	P	H	
													H	
													H	
			11490	46.57	-27.43	74	46.65	38.38	18.88	57.34	100	0	P	V
			17235	58.54	-9.66	68.2	49.19	41.77	23.38	55.8	100	0	P	V
														V
802.11a CH 157 5785MHz		11570	45.83	-28.17	74	45.61	38.46	18.95	57.19	100	0	P	H	
		17355	58.41	-9.79	68.2	49.15	41.61	23.45	55.8	100	0	P	H	
													H	
													H	
			11570	45.03	-28.97	74	44.81	38.46	18.95	57.19	100	0	P	V
			17355	54.28	-13.92	68.2	45.02	41.61	23.45	55.8	100	0	P	V
														V
802.11a CH 165 5825MHz		11650	46.46	-27.54	74	46	38.51	19.03	57.08	100	0	P	H	
		17475	56.33	-11.87	68.2	47.16	41.45	23.52	55.8	100	0	P	H	
													H	
													H	
			11650	46.28	-27.72	74	45.82	38.51	19.03	57.08	100	0	P	V
			17475	54.17	-14.03	68.2	45	41.45	23.52	55.8	100	0	P	V
														V
Remark	1. No other spurious found.													
	2. All results are PASS against Peak and Average limit line.													



Band 4 5725~5850MHz
WIFI 802.11ac VHT20 (Band Edge @ 3m)

WIFI Ant. 1+2	Note	Frequency (MHz)	Level (dBμV/m)	Over Limit (dB)	Limit Line (dBμV/m)	Read Level (dBμV)	Antenna Factor (dB/m)	Cable Loss (dB)	Preamp Factor (dB)	Ant Pos (cm)	Table Pos (deg)	Peak Avg. (P/A)	Pol. (H/V)	
802.11ac VHT20 CH 149 5745MHz		5646.4	54.82	-13.38	68.2	42.25	35.09	12.61	35.13	100	315	P	H	
		5696.6	69.4	-33.29	102.69	56.7	35.17	12.67	35.14	100	315	P	H	
		5718.8	80.86	-29.6	110.46	68.06	35.21	12.73	35.14	100	315	P	H	
		5724.2	84.77	-35.61	120.38	71.97	35.21	12.73	35.14	100	315	P	H	
	*	5745	114.5	-	-	101.62	35.24	12.79	35.15	100	315	P	H	
	*	5745	106.84	-	-	93.96	35.24	12.79	35.15	100	315	A	H	
														H
														H
			5631	52.92	-15.28	68.2	40.37	35.07	12.61	35.13	376	262	P	V
			5698.4	70.83	-33.19	104.02	58.13	35.17	12.67	35.14	376	262	P	V
			5720	78.35	-32.45	110.8	65.55	35.21	12.73	35.14	376	262	P	V
			5723.8	85.55	-33.91	119.46	72.75	35.21	12.73	35.14	376	262	P	V
		*	5745	112.87	-	-	99.99	35.24	12.79	35.15	376	262	P	V
		*	5745	104.85	-	-	91.97	35.24	12.79	35.15	376	262	A	V
													V	
													V	



WIFI Ant. 1+2	Note	Frequency (MHz)	Level (dBμV/m)	Over Limit (dB)	Limit Line (dBμV/m)	Read Level (dBμV)	Antenna Factor (dB/m)	Cable Loss (dB)	Preamp Factor (dB)	Ant Pos (cm)	Table Pos (deg)	Peak Avg. (P/A)	Pol. (H/V)
		5600.4	54.17	-14.03	68.2	41.68	35.04	12.56	35.11	100	319	P	H
		5692.8	56.35	-43.54	99.89	43.65	35.17	12.67	35.14	100	319	P	H
		5718.6	57.6	-52.81	110.41	44.8	35.21	12.73	35.14	100	319	P	H
		5724.6	59.15	-62.14	121.29	46.35	35.21	12.73	35.14	100	319	P	H
	*	5785	112.44	-	-	99.46	35.29	12.85	35.16	100	319	P	H
	*	5785	105.41	-	-	92.43	35.29	12.85	35.16	100	319	A	H
		5852	53.64	-64	117.64	40.49	35.38	12.94	35.17	100	319	P	H
		5857.6	53.66	-56.41	110.07	40.48	35.41	12.94	35.17	100	319	P	H
		5904.4	52.24	-31.17	83.41	38.86	35.46	13.11	35.19	100	319	P	H
		5938	51.24	-16.96	68.2	37.83	35.5	13.11	35.2	100	319	P	H
802.11ac													H
VHT20													H
CH 157		5640.8	52.87	-15.33	68.2	40.3	35.09	12.61	35.13	100	245	P	V
5785MHz		5657.6	53.22	-20.63	73.85	40.62	35.12	12.61	35.13	100	245	P	V
		5716	55.02	-54.66	109.68	42.24	35.19	12.73	35.14	100	245	P	V
		5725	55.29	-66.91	122.2	42.49	35.21	12.73	35.14	100	245	P	V
	*	5785	110.02	-	-	97.04	35.29	12.85	35.16	100	245	P	V
	*	5785	102.33	-	-	89.35	35.29	12.85	35.16	100	245	A	V
		5850	51.81	-70.39	122.2	38.66	35.38	12.94	35.17	100	245	P	V
		5856	52.48	-58.04	110.52	39.3	35.41	12.94	35.17	100	245	P	V
		5889.4	51.5	-43.01	94.51	38.21	35.46	13.02	35.19	100	245	P	V
		5932.2	51.87	-16.33	68.2	38.45	35.5	13.11	35.19	100	245	P	V
													V
													V



WIFI Ant. 1+2	Note	Frequency (MHz)	Level (dBμV/m)	Over Limit (dB)	Limit Line (dBμV/m)	Read Level (dBμV)	Antenna Factor (dB/m)	Cable Loss (dB)	Preamp Factor (dB)	Ant Pos (cm)	Table Pos (deg)	Peak Avg. (P/A)	Pol. (H/V)	
802.11ac VHT20 CH 165 5825MHz	*	5825	111.73	-	-	98.6	35.36	12.94	35.17	100	327	P	H	
	*	5825	103.66	-	-	90.53	35.36	12.94	35.17	100	327	A	H	
		5851.6	74.22	-44.33	118.55	61.07	35.38	12.94	35.17	100	327	P	H	
		5858.8	68.95	-40.78	109.73	55.78	35.41	12.94	35.18	100	327	P	H	
		5876.6	56.89	-47.12	104.01	43.62	35.43	13.02	35.18	100	327	P	H	
		5929	51.34	-16.86	68.2	37.92	35.5	13.11	35.19	100	327	P	H	
														H
														H
	*	5825	108.56	-	-	95.43	35.36	12.94	35.17	100	241	241	P	V
	*	5825	101.27	-	-	88.14	35.36	12.94	35.17	100	241	241	A	V
		5850.4	71.04	-50.25	121.29	57.89	35.38	12.94	35.17	100	241	241	P	V
		5860.8	68.54	-40.63	109.17	55.29	35.41	13.02	35.18	100	241	241	P	V
		5875.4	56.05	-48.85	104.9	42.78	35.43	13.02	35.18	100	241	241	P	V
		5941.2	51.28	-16.92	68.2	37.75	35.53	13.2	35.2	100	241	241	P	V
														V
													V	
Remark	1. No other spurious found. 2. All results are PASS against Peak and Average limit line.													



Band 4 5725~5850MHz
WIFI 802.11ac VHT20 (Harmonic @ 3m)

WIFI Ant. 1+2	Note	Frequency (MHz)	Level (dBμV/m)	Over Limit (dB)	Limit Line (dBμV/m)	Read Level (dBμV)	Antenna Factor (dB/m)	Cable Loss (dB)	Preamp Factor (dB)	Ant Pos (cm)	Table Pos (deg)	Peak Avg. (P/A)	Pol. (H/V)	
802.11ac VHT20 CH 149 5745MHz		11490	46.43	-27.57	74	46.51	38.38	18.88	57.34	100	0	P	H	
		17235	61.84	-6.36	68.2	52.49	41.77	23.38	55.8	100	0	P	H	
													H	
													H	
			11490	47.15	-26.85	74	47.23	38.38	18.88	57.34	100	0	P	V
			17235	55.78	-12.42	68.2	46.43	41.77	23.38	55.8	100	0	P	V
														V
802.11ac VHT20 CH 157 5785MHz		11570	46.22	-27.78	74	46	38.46	18.95	57.19	100	0	P	H	
		17355	57.5	-10.7	68.2	48.24	41.61	23.45	55.8	100	0	P	H	
													H	
													H	
			11570	46.12	-27.88	74	45.9	38.46	18.95	57.19	100	0	P	V
			17355	52.9	-15.3	68.2	43.64	41.61	23.45	55.8	100	0	P	V
														V
802.11ac VHT20 CH 165 5825MHz		11650	46.08	-27.92	74	45.62	38.51	19.03	57.08	100	0	P	H	
		17475	53.56	-14.64	68.2	44.39	41.45	23.52	55.8	100	0	P	H	
													H	
													H	
			11650	45.58	-28.42	74	45.12	38.51	19.03	57.08	100	0	P	V
			17475	50.62	-17.58	68.2	41.45	41.45	23.52	55.8	100	0	P	V
														V
Remark	1. No other spurious found.													
	2. All results are PASS against Peak and Average limit line.													



Band 4 5725~5850MHz
WIFI 802.11ac VHT40 (Band Edge @ 3m)

WIFI Ant. 1+2	Note	Frequency (MHz)	Level (dBμV/m)	Over Limit (dB)	Limit Line (dBμV/m)	Read Level (dBμV)	Antenna Factor (dB/m)	Cable Loss (dB)	Preamp Factor (dB)	Ant Pos (cm)	Table Pos (deg)	Peak Avg. (P/A)	Pol. (H/V)	
802.11ac VHT40 CH 151 5755MHz		5648.8	64.75	-3.45	68.2	52.18	35.09	12.61	35.13	100	318	P	H	
		5697.2	77.55	-25.59	103.14	64.85	35.17	12.67	35.14	100	318	P	H	
		5719	89.1	-21.42	110.52	76.3	35.21	12.73	35.14	100	318	P	H	
		5724.2	88.74	-31.64	120.38	75.94	35.21	12.73	35.14	100	318	P	H	
	*	5755	111.7	-	-	98.8	35.26	12.79	35.15	100	318	P	H	
	*	5755	104.25	-	-	91.35	35.26	12.79	35.15	100	318	A	H	
		5853.6	58.63	-55.36	113.99	45.45	35.41	12.94	35.17	100	318	P	H	
		5867.8	56.43	-50.78	107.21	43.18	35.41	13.02	35.18	100	318	P	H	
		5878	52.62	-50.35	102.97	39.35	35.43	13.02	35.18	100	318	P	H	
		5940.2	50.96	-17.24	68.2	37.43	35.53	13.2	35.2	100	318	P	H	
														H
														H
			5648.6	61.02	-7.18	68.2	48.45	35.09	12.61	35.13	100	254	P	V
			5697.6	74.27	-29.16	103.43	61.57	35.17	12.67	35.14	100	254	P	V
			5717.6	84.38	-25.75	110.13	71.58	35.21	12.73	35.14	100	254	P	V
			5721.4	84.99	-29	113.99	72.19	35.21	12.73	35.14	100	254	P	V
	*		5755	107.83	-	-	94.93	35.26	12.79	35.15	100	254	P	V
	*		5755	100.61	-	-	87.71	35.26	12.79	35.15	100	254	A	V
			5851.2	53.56	-65.9	119.46	40.41	35.38	12.94	35.17	100	254	P	V
			5860	53.56	-55.84	109.4	40.39	35.41	12.94	35.18	100	254	P	V
		5875	52.45	-52.75	105.2	39.18	35.43	13.02	35.18	100	254	P	V	
		5947.6	52.2	-16	68.2	38.67	35.53	13.2	35.2	100	254	P	V	
													V	
													V	



WIFI Ant. 1+2	Note	Frequency (MHz)	Level (dBμV/m)	Over Limit (dB)	Limit Line (dBμV/m)	Read Level (dBμV)	Antenna Factor (dB/m)	Cable Loss (dB)	Preamp Factor (dB)	Ant Pos (cm)	Table Pos (deg)	Peak Avg. (P/A)	Pol. (H/V)
		5638.4	56.59	-11.61	68.2	44.02	35.09	12.61	35.13	100	319	P	H
		5699	64.99	-39.47	104.46	52.29	35.17	12.67	35.14	100	319	P	H
		5719	70.89	-39.63	110.52	58.09	35.21	12.73	35.14	100	319	P	H
		5723.6	70.09	-48.92	119.01	57.29	35.21	12.73	35.14	100	319	P	H
	*	5795	109.82	-	-	96.82	35.31	12.85	35.16	100	319	P	H
	*	5795	102.98	-	-	89.98	35.31	12.85	35.16	100	319	A	H
		5854.4	66.57	-45.6	112.17	53.39	35.41	12.94	35.17	100	319	P	H
		5861.4	65.52	-43.49	109.01	52.27	35.41	13.02	35.18	100	319	P	H
		5876	59.96	-44.5	104.46	46.69	35.43	13.02	35.18	100	319	P	H
		5943.6	51.93	-16.27	68.2	38.4	35.53	13.2	35.2	100	319	P	H
802.11ac													H
VHT40													H
CH 159		5634.8	53.33	-14.87	68.2	40.76	35.09	12.61	35.13	100	242	P	V
5795MHz		5697.8	60.53	-43.05	103.58	47.83	35.17	12.67	35.14	100	242	P	V
		5717.8	67.1	-43.08	110.18	54.3	35.21	12.73	35.14	100	242	P	V
		5721	68.14	-44.94	113.08	55.34	35.21	12.73	35.14	100	242	P	V
	*	5795	106.97	-	-	93.97	35.31	12.85	35.16	100	242	P	V
	*	5795	99.51	-	-	86.51	35.31	12.85	35.16	100	242	A	V
		5851.6	64.22	-54.33	118.55	51.07	35.38	12.94	35.17	100	242	P	V
		5856.4	62.52	-47.89	110.41	49.34	35.41	12.94	35.17	100	242	P	V
		5876	59.13	-45.33	104.46	45.86	35.43	13.02	35.18	100	242	P	V
		5941	51.18	-17.02	68.2	37.65	35.53	13.2	35.2	100	242	P	V
													V
													V
Remark	<ol style="list-style-type: none"> No other spurious found. All results are PASS against Peak and Average limit line. 												



Band 4 5725~5850MHz
WIFI 802.11ac VHT40 (Harmonic @ 3m)

WIFI Ant. 1+2	Note	Frequency (MHz)	Level (dBμV/m)	Over Limit (dB)	Limit Line (dBμV/m)	Read Level (dBμV)	Antenna Factor (dB/m)	Cable Loss (dB)	Preamp Factor (dB)	Ant Pos (cm)	Table Pos (deg)	Peak Avg. (P/A)	Pol. (H/V)	
802.11ac VHT40 CH 151 5755MHz		11510	45.83	-28.17	74	45.81	38.4	18.92	57.3	100	0	P	H	
		17265	59.75	-8.45	68.2	50.42	41.73	23.4	55.8	100	0	P	H	
													H	
													H	
			11510	46.73	-27.27	74	46.71	38.4	18.92	57.3	100	0	P	V
			17265	53.96	-14.24	68.2	44.63	41.73	23.4	55.8	100	0	P	V
														V
802.11ac VHT40 CH 159 5795MHz		11590	45	-29	74	44.7	38.47	18.99	57.16	100	0	P	H	
		17385	56.35	-11.85	68.2	47.12	41.56	23.47	55.8	100	0	P	H	
													H	
													H	
			11590	46.4	-27.6	74	46.1	38.47	18.99	57.16	100	0	P	V
			17385	53.71	-14.49	68.2	44.48	41.56	23.47	55.8	100	0	P	V
														V
Remark	1. No other spurious found.													
	2. All results are PASS against Peak and Average limit line.													



Band 4 5725~5850MHz
WIFI 802.11ac VHT80 (Band Edge @ 3m)

WIFI Ant. 1+2	Note	Frequency (MHz)	Level (dBμV/m)	Over Limit (dB)	Limit Line (dBμV/m)	Read Level (dBμV)	Antenna Factor (dB/m)	Cable Loss (dB)	Preamp Factor (dB)	Ant Pos (cm)	Table Pos (deg)	Peak Avg. (P/A)	Pol. (H/V)	
802.11ac VHT80 CH 155 5775MHz		5649.2	66.99	-1.21	68.2	54.42	35.09	12.61	35.13	100	326	P	H	
		5692.6	78.02	-21.72	99.74	65.32	35.17	12.67	35.14	100	326	P	H	
		5706	78.63	-28.25	106.88	65.85	35.19	12.73	35.14	100	326	P	H	
		5723.4	79.99	-38.56	118.55	67.19	35.21	12.73	35.14	100	326	P	H	
	*	5775	105.59	-	-	92.67	35.29	12.79	35.16	100	326	P	H	
	*	5775	98.93	-	-	86.01	35.29	12.79	35.16	100	326	A	H	
		5851	71.59	-48.33	119.92	58.44	35.38	12.94	35.17	100	326	P	H	
		5871.4	69.83	-36.38	106.21	56.56	35.43	13.02	35.18	100	326	P	H	
		5875.6	63.4	-41.35	104.75	50.13	35.43	13.02	35.18	100	326	P	H	
		5931.4	53.05	-15.15	68.2	39.63	35.5	13.11	35.19	100	326	P	H	
														H
														H
			5646.2	64.99	-3.21	68.2	52.42	35.09	12.61	35.13	100	242	P	V
			5691	76.05	-22.51	98.56	63.35	35.17	12.67	35.14	100	242	P	V
			5711.2	76.92	-31.42	108.34	64.14	35.19	12.73	35.14	100	242	P	V
			5723.6	78.39	-40.62	119.01	65.59	35.21	12.73	35.14	100	242	P	V
	*		5775	103.61	-	-	90.69	35.29	12.79	35.16	100	242	P	V
	*		5775	96.41	-	-	83.49	35.29	12.79	35.16	100	242	A	V
			5851.6	69.94	-48.61	118.55	56.79	35.38	12.94	35.17	100	242	P	V
			5871.2	68.87	-37.39	106.26	55.6	35.43	13.02	35.18	100	242	P	V
		5875	62.9	-42.3	105.2	49.63	35.43	13.02	35.18	100	242	P	V	
		5925.2	52.92	-15.28	68.2	39.5	35.5	13.11	35.19	100	242	P	V	
													V	
													V	
Remark	1. No other spurious found. 2. All results are PASS against Peak and Average limit line.													



Band 4 5725~5850MHz
WIFI 802.11ac VHT80 (Harmonic @ 3m)

WIFI Ant. 1+2	Note	Frequency (MHz)	Level (dBμV/m)	Over Limit (dB)	Limit Line (dBμV/m)	Read Level (dBμV)	Antenna Factor (dB/m)	Cable Loss (dB)	Preamp Factor (dB)	Ant Pos (cm)	Table Pos (deg)	Peak Avg. (P/A)	Pol. (H/V)	
802.11ac VHT80 CH 155 5775MHz		11550	45.95	-28.05	74	45.78	38.44	18.95	57.22	100	0	P	H	
		17325	52.78	-15.42	68.2	43.49	41.66	23.43	55.8	100	0	P	H	
													H	
													H	
			11550	45.97	-28.03	74	45.8	38.44	18.95	57.22	100	0	P	V
			17325	51.94	-16.26	68.2	42.65	41.66	23.43	55.8	100	0	P	V
														V
Remark	1. No other spurious found.													
	2. All results are PASS against Peak and Average limit line.													



Emission below 1GHz

5GHz WIFI 802.11ac VHT80 (LF @ 3m)

WIFI Ant. 1+2	Note	Frequency (MHz)	Level (dBμV/m)	Over Limit (dB)	Limit Line (dBμV/m)	Read Level (dBμV)	Antenna Factor (dB/m)	Cable Loss (dB)	Preamp Factor (dB)	Ant Pos (cm)	Table Pos (deg)	Peak Avg. (P/A)	Pol. (H/V)	
5GHz 802.11ac VHT80 LF		30	26.7	-13.3	40	31.62	24.72	1.71	31.35			P	H	
		124.5	30.53	-12.97	43.5	42.23	17.49	2.34	31.53			P	H	
		138.54	35.43	-8.07	43.5	47.33	17.28	2.34	31.52	100	29	P	H	
		309.8	29.27	-16.73	46	37.83	19.29	3.43	31.28			P	H	
		910.4	34.44	-11.56	46	30.54	29.09	5.33	30.52			P	H	
		977.6	35.61	-18.39	54	29.89	30.83	5.4	30.51			P	H	
														H
														H
														H
														H
														H
														H
														H
														H
														H
			32.97	30.76	-9.24	40	37.28	23.16	1.71	31.39			P	V
			76.98	32.53	-7.47	40	49.24	12.76	2.11	31.58	100	71	P	V
			123.96	33.31	-10.19	43.5	45.01	17.49	2.34	31.53			P	V
			846.7	31.68	-14.32	46	28.17	28.87	5.2	30.56			P	V
			926.5	33.13	-12.87	46	28.84	29.48	5.33	30.52			P	V
		986	35.09	-18.91	54	29.41	30.65	5.54	30.51			P	V	
													V	
													V	
													V	
													V	
													V	
													V	
Remark	1. No other spurious found. 2. All results are PASS against limit line.													



<TXBF Mode>

Band 4 - 5725~5850MHz

WIFI 802.11ac VHT20 (Band Edge @ 3m)

WIFI Ant.	Note	Frequency	Level	Over Limit	Limit Line	Read Level	Antenna Factor	Cable Loss	Preamp Factor	Ant Pos	Table Pos	Peak Avg.	Pol.		
1+2		(MHz)	(dBμV/m)	(dB)	(dBμV/m)	(dBμV)	(dB/m)	(dB)	(dB)	(cm)	(deg)	(P/A)	(H/V)		
802.11ac VHT20 CH 149 5745MHz		5623	56.21	-11.99	68.2	43.65	35.07	12.61	35.12	100	316	P	H		
		5700	63.73	-41.47	105.2	51.03	35.17	12.67	35.14	100	316	P	H		
		5720	73.33	-37.47	110.8	60.53	35.21	12.73	35.14	100	316	P	H		
		5724	78.27	-41.65	119.92	65.47	35.21	12.73	35.14	100	316	P	H		
	*	5745	116.18	-	-	103.3	35.24	12.79	35.15	100	316	P	H		
	*	5745	109.21	-	-	96.33	35.24	12.79	35.15	100	316	A	H		
														H	
															H
			5630.2	53.33	-14.87	68.2	40.78	35.07	12.61	35.13	376	268	P	V	
			5698	59.16	-44.57	103.73	46.46	35.17	12.67	35.14	376	268	P	V	
			5718.4	65.5	-44.85	110.35	52.7	35.21	12.73	35.14	376	268	P	V	
			5723	70.91	-46.73	117.64	58.11	35.21	12.73	35.14	376	268	P	V	
	*		5745	112.48	-	-	99.6	35.24	12.79	35.15	376	268	P	V	
	*		5745	107.06	-	-	94.18	35.24	12.79	35.15	376	268	A	V	
													V		
													V		



WIFI Ant. 1+2	Note	Frequency (MHz)	Level (dBμV/m)	Over Limit (dB)	Limit Line (dBμV/m)	Read Level (dBμV)	Antenna Factor (dB/m)	Cable Loss (dB)	Preamp Factor (dB)	Ant Pos (cm)	Table Pos (deg)	Peak Avg. (P/A)	Pol. (H/V)
		5609.6	53.52	-14.68	68.2	41.04	35.04	12.56	35.12	265	328	P	H
		5699.2	55.6	-49.01	104.61	42.9	35.17	12.67	35.14	265	328	P	H
		5718.8	58.43	-52.03	110.46	45.63	35.21	12.73	35.14	265	328	P	H
		5725	58.65	-63.55	122.2	45.85	35.21	12.73	35.14	265	328	P	H
	*	5785	113.67	-	-	100.69	35.29	12.85	35.16	265	328	P	H
	*	5785	107.16	-	-	94.18	35.29	12.85	35.16	265	328	A	H
		5850	53.39	-68.81	122.2	40.24	35.38	12.94	35.17	265	328	P	H
		5857.2	52.77	-57.41	110.18	39.59	35.41	12.94	35.17	265	328	P	H
		5876.6	51.93	-52.08	104.01	38.66	35.43	13.02	35.18	265	328	P	H
		5948.8	51.7	-16.5	68.2	38.17	35.53	13.2	35.2	265	328	P	H
802.11ac													H
VHT20													H
CH 157		5630.4	52.68	-15.52	68.2	40.13	35.07	12.61	35.13	100	63	P	V
5785MHz		5681.8	52.58	-39.19	91.77	39.91	35.14	12.67	35.14	100	63	P	V
		5718.6	54.13	-56.28	110.41	41.33	35.21	12.73	35.14	100	63	P	V
		5720.6	53.49	-58.68	112.17	40.69	35.21	12.73	35.14	100	63	P	V
	*	5785	104.7	-	-	91.72	35.29	12.85	35.16	100	63	P	V
	*	5785	99.18	-	-	86.2	35.29	12.85	35.16	100	63	A	V
		5854.8	52	-59.26	111.26	38.82	35.41	12.94	35.17	100	63	P	V
		5868.8	51.52	-55.41	106.93	38.27	35.41	13.02	35.18	100	63	P	V
		5887.6	51.94	-43.91	95.85	38.65	35.46	13.02	35.19	100	63	P	V
		5942	51.88	-16.32	68.2	38.35	35.53	13.2	35.2	100	63	P	V
													V
													V



WIFI Ant. 1+2	Note	Frequency (MHz)	Level (dBμV/m)	Over Limit (dB)	Limit Line (dBμV/m)	Read Level (dBμV)	Antenna Factor (dB/m)	Cable Loss (dB)	Preamp Factor (dB)	Ant Pos (cm)	Table Pos (deg)	Peak Avg. (P/A)	Pol. (H/V)	
802.11ac VHT20 CH 165 5825MHz	*	5825	110.15	-	-	97.02	35.36	12.94	35.17	300	329	P	H	
	*	5825	105.44	-	-	92.31	35.36	12.94	35.17	300	329	A	H	
		5850	73.41	-48.79	122.2	60.26	35.38	12.94	35.17	300	329	P	H	
		5855	64.83	-45.97	110.8	51.65	35.41	12.94	35.17	300	329	P	H	
		5875.8	54.94	-49.67	104.61	41.67	35.43	13.02	35.18	300	329	P	H	
		5937.8	51.53	-16.67	68.2	38.12	35.5	13.11	35.2	300	329	P	H	
														H
														H
	*	5825	108.58	-	-	95.45	35.36	12.94	35.17	300	257	257	P	V
	*	5825	104.3	-	-	91.17	35.36	12.94	35.17	300	257	257	A	V
		5850	71.95	-50.25	122.2	58.8	35.38	12.94	35.17	300	257	257	P	V
		5859.6	61.17	-48.34	109.51	48	35.41	12.94	35.18	300	257	257	P	V
		5882.2	53.65	-46.2	99.85	40.38	35.43	13.02	35.18	300	257	257	P	V
		5945.6	51.38	-16.82	68.2	37.85	35.53	13.2	35.2	300	257	257	P	V
														V
														V
Remark	1. No other spurious found. 2. All results are PASS against Peak and Average limit line.													



Band 4 5725~5850MHz
WIFI 802.11ac VHT20 (Harmonic @ 3m)

WIFI Ant. 1+2	Note	Frequency (MHz)	Level (dBμV/m)	Over Limit (dB)	Limit Line (dBμV/m)	Read Level (dBμV)	Antenna Factor (dB/m)	Cable Loss (dB)	Preamp Factor (dB)	Ant Pos (cm)	Table Pos (deg)	Peak Avg. (P/A)	Pol. (H/V)	
802.11ac VHT20 CH 149 5745MHz		11490	45.44	-28.56	74	45.52	38.38	18.88	57.34	100	0	P	H	
		17235	61.81	-6.39	68.2	52.46	41.77	23.38	55.8	100	0	P	H	
													H	
													H	
			11490	45.77	-28.23	74	45.85	38.38	18.88	57.34	100	0	P	V
			17235	58.89	-9.31	68.2	49.54	41.77	23.38	55.8	100	0	P	V
														V
802.11ac VHT20 CH 157 5785MHz		11570	45.68	-28.32	74	45.46	38.46	18.95	57.19			P	H	
		17355	60.56	-7.64	68.2	51.3	41.61	23.45	55.8	100	0	P	H	
													H	
													H	
			11570	45.39	-28.61	74	45.17	38.46	18.95	57.19			P	V
			17355	57.24	-10.96	68.2	47.98	41.61	23.45	55.8	100	0	P	V
														V
802.11ac VHT20 CH 165 5825MHz		11650	45.14	-28.86	74	44.68	38.51	19.03	57.08	100	0	P	H	
		17475	58.7	-9.5	68.2	49.53	41.45	23.52	55.8	100	0	P	H	
													H	
													H	
			11650	45.66	-28.34	74	45.2	38.51	19.03	57.08	100	0	P	V
			17475	53.9	-14.3	68.2	44.73	41.45	23.52	55.8	100	0	P	V
														V
Remark	1. No other spurious found.													
	2. All results are PASS against Peak and Average limit line.													



Band 4 5725~5850MHz
WIFI 802.11ac VHT40 (Band Edge @ 3m)

WIFI Ant. 1+2	Note	Frequency (MHz)	Level (dBμV/m)	Over Limit (dB)	Limit Line (dBμV/m)	Read Level (dBμV)	Antenna Factor (dB/m)	Cable Loss (dB)	Preamp Factor (dB)	Ant Pos (cm)	Table Pos (deg)	Peak Avg. (P/A)	Pol. (H/V)	
802.11ac VHT40 CH 151 5755MHz		5641.8	59.07	-9.13	68.2	46.5	35.09	12.61	35.13	100	314	P	H	
		5698	70.07	-33.66	103.73	57.37	35.17	12.67	35.14	100	314	P	H	
		5709.8	81.79	-26.16	107.95	69.01	35.19	12.73	35.14	100	314	P	H	
		5725	83.6	-38.6	122.2	70.8	35.21	12.73	35.14	100	314	P	H	
	*	5755	108.71	-	-	95.81	35.26	12.79	35.15	100	314	P	H	
	*	5755	100.92	-	-	88.02	35.26	12.79	35.15	100	314	A	H	
		5853.4	54.79	-59.66	114.45	41.64	35.38	12.94	35.17	100	314	P	H	
		5856	53.38	-57.14	110.52	40.2	35.41	12.94	35.17	100	314	P	H	
		5901.6	52.08	-33.4	85.48	38.7	35.46	13.11	35.19	100	314	P	H	
		5932.2	51.8	-16.4	68.2	38.38	35.5	13.11	35.19	100	314	P	H	
														H
														H
			5624.6	53.5	-14.7	68.2	40.94	35.07	12.61	35.12	353	63	P	V
			5695.4	59.06	-42.75	101.81	46.36	35.17	12.67	35.14	353	63	P	V
			5716	70.72	-38.96	109.68	57.94	35.19	12.73	35.14	353	63	P	V
			5721	72.97	-40.11	113.08	60.17	35.21	12.73	35.14	353	63	P	V
	*		5755	104.19	-	-	91.29	35.26	12.79	35.15	353	63	P	V
	*		5755	97.49	-	-	84.59	35.26	12.79	35.15	353	63	A	V
			5851	51.8	-68.12	119.92	38.65	35.38	12.94	35.17	353	63	P	V
			5858	51.59	-58.37	109.96	38.42	35.41	12.94	35.18	353	63	P	V
		5899.2	52.33	-34.92	87.25	39.04	35.46	13.02	35.19	353	63	P	V	
		5938.6	51.44	-16.76	68.2	38	35.53	13.11	35.2	353	63	P	V	
													V	
													V	



WIFI Ant. 1+2	Note	Frequency (MHz)	Level (dBμV/m)	Over Limit (dB)	Limit Line (dBμV/m)	Read Level (dBμV)	Antenna Factor (dB/m)	Cable Loss (dB)	Preamp Factor (dB)	Ant Pos (cm)	Table Pos (deg)	Peak Avg. (P/A)	Pol. (H/V)
		5649.2	57.76	-10.44	68.2	45.19	35.09	12.61	35.13	100	317	P	H
		5696.2	63.28	-39.12	102.4	50.58	35.17	12.67	35.14	100	317	P	H
		5718.4	68.35	-42	110.35	55.55	35.21	12.73	35.14	100	317	P	H
		5724.4	69.21	-51.62	120.83	56.41	35.21	12.73	35.14	100	317	P	H
	*	5795	108.3	-	-	95.3	35.31	12.85	35.16	100	317	P	H
	*	5795	101.38	-	-	88.38	35.31	12.85	35.16	100	317	A	H
		5850	61.82	-60.38	122.2	48.67	35.38	12.94	35.17	100	317	P	H
		5868.6	62.64	-44.35	106.99	49.39	35.41	13.02	35.18	100	317	P	H
		5875.8	59.03	-45.58	104.61	45.76	35.43	13.02	35.18	100	317	P	H
		5948.2	52.41	-15.79	68.2	38.88	35.53	13.2	35.2	100	317	P	H
802.11ac													H
VHT40													H
CH 159		5648.8	53.41	-14.79	68.2	40.84	35.09	12.61	35.13	100	8	P	V
5795MHz		5696.8	54.45	-48.39	102.84	41.75	35.17	12.67	35.14	100	8	P	V
		5718.8	57.92	-52.54	110.46	45.12	35.21	12.73	35.14	100	8	P	V
		5724	59.73	-60.19	119.92	46.93	35.21	12.73	35.14	100	8	P	V
	*	5795	102.18	-	-	89.18	35.31	12.85	35.16	100	8	P	V
	*	5795	95.27	-	-	82.27	35.31	12.85	35.16	100	8	A	V
		5850	55.86	-66.34	122.2	42.71	35.38	12.94	35.17	100	8	P	V
		5856.6	55.55	-54.8	110.35	42.37	35.41	12.94	35.17	100	8	P	V
		5889.4	52.83	-41.68	94.51	39.54	35.46	13.02	35.19	100	8	P	V
		5926.2	51.09	-17.11	68.2	37.67	35.5	13.11	35.19	100	8	P	V
													V
													V
Remark	<ol style="list-style-type: none"> No other spurious found. All results are PASS against Peak and Average limit line. 												



Band 4 5725~5850MHz
WIFI 802.11ac VHT40 (Harmonic @ 3m)

WIFI Ant. 1+2	Note	Frequency (MHz)	Level (dBμV/m)	Over Limit (dB)	Limit Line (dBμV/m)	Read Level (dBμV)	Antenna Factor (dB/m)	Cable Loss (dB)	Preamp Factor (dB)	Ant Pos (cm)	Table Pos (deg)	Peak Avg. (P/A)	Pol. (H/V)	
802.11ac VHT40 CH 151 5755MHz		11510	44.81	-29.19	74	44.79	38.4	18.92	57.3	100	0	P	H	
		17265	50.73	-17.47	68.2	41.4	41.73	23.4	55.8	100	0	P	H	
													H	
													H	
			11510	45.15	-28.85	74	45.13	38.4	18.92	57.3	100	0	P	V
			17265	50.13	-18.07	68.2	40.8	41.73	23.4	55.8	100	0	P	V
														V
802.11ac VHT40 CH 159 5795MHz		11590	44.33	-29.67	74	44.03	38.47	18.99	57.16	100	0	P	H	
		17385	51.03	-17.17	68.2	41.8	41.56	23.47	55.8	100	0	P	H	
													H	
													H	
			11590	45.72	-28.28	74	45.42	38.47	18.99	57.16	100	0	P	V
			17385	50.38	-17.82	68.2	41.15	41.56	23.47	55.8	100	0	P	V
														V
Remark	1. No other spurious found.													
	2. All results are PASS against Peak and Average limit line.													



Band 4 5725~5850MHz
WIFI 802.11ac VHT80 (Band Edge @ 3m)

WIFI Ant. 1+2	Note	Frequency (MHz)	Level (dBμV/m)	Over Limit (dB)	Limit Line (dBμV/m)	Read Level (dBμV)	Antenna Factor (dB/m)	Cable Loss (dB)	Preamp Factor (dB)	Ant Pos (cm)	Table Pos (deg)	Peak Avg. (P/A)	Pol. (H/V)	
802.11ac VHT80 CH 155 5775MHz		5647	62.79	-5.41	68.2	50.22	35.09	12.61	35.13	100	330	P	H	
		5683.2	74.75	-18.05	92.8	62.08	35.14	12.67	35.14	100	330	P	H	
		5718.2	75.89	-34.41	110.3	63.09	35.21	12.73	35.14	100	330	P	H	
		5722.8	74	-43.18	117.18	61.2	35.21	12.73	35.14	100	330	P	H	
	*	5775	108.9	-	-	95.98	35.29	12.79	35.16	100	330	P	H	
	*	5775	97.67	-	-	84.75	35.29	12.79	35.16	100	330	A	H	
		5853.6	67.26	-46.73	113.99	54.08	35.41	12.94	35.17	100	330	P	H	
		5868	68.64	-38.52	107.16	55.39	35.41	13.02	35.18	100	330	P	H	
		5876.4	64.38	-39.78	104.16	51.11	35.43	13.02	35.18	100	330	P	H	
		5944.6	53.28	-14.92	68.2	39.75	35.53	13.2	35.2	100	330	P	H	
														H
														H
			5632.6	55.45	-12.75	68.2	42.88	35.09	12.61	35.13	100	62	P	V
			5685.8	66.61	-28.11	94.72	53.91	35.17	12.67	35.14	100	62	P	V
			5701	66.88	-38.6	105.48	54.1	35.19	12.73	35.14	100	62	P	V
			5724.8	67.56	-54.18	121.74	54.76	35.21	12.73	35.14	100	62	P	V
	*		5775	98.36	-	-	85.44	35.29	12.79	35.16	100	62	P	V
	*		5775	91.57	-	-	78.65	35.29	12.79	35.16	100	62	A	V
			5853.8	63.76	-49.78	113.54	50.58	35.41	12.94	35.17	100	62	P	V
			5862.8	61.46	-47.15	108.61	48.21	35.41	13.02	35.18	100	62	P	V
		5875	56.77	-48.43	105.2	43.5	35.43	13.02	35.18	100	62	P	V	
		5944.8	51.18	-17.02	68.2	37.65	35.53	13.2	35.2	100	62	P	V	
													V	
													V	
Remark	3. No other spurious found. 4. All results are PASS against Peak and Average limit line.													



Band 4 5725~5850MHz

WIFI 802.11ac VHT80 (Harmonic @ 3m)

WIFI Ant. 1+2	Note	Frequency (MHz)	Level (dBμV/m)	Over Limit (dB)	Limit Line (dBμV/m)	Read Level (dBμV)	Antenna Factor (dB/m)	Cable Loss (dB)	Preamp Factor (dB)	Ant Pos (cm)	Table Pos (deg)	Peak Avg. (P/A)	Pol. (H/V)	
802.11ac VHT80 CH 155 5775MHz		11550	43.88	-30.12	74	43.71	38.44	18.95	57.22	100	0	P	H	
		17325	51.97	-16.23	68.2	42.68	41.66	23.43	55.8	100	0	P	H	
													H	
													H	
			11550	46.01	-27.99	74	45.84	38.44	18.95	57.22	100	0	P	V
			17325	50.73	-17.47	68.2	41.44	41.66	23.43	55.8	100	0	P	V
														V
Remark	1. No other spurious found.													
	2. All results are PASS against Peak and Average limit line.													



Emission below 1GHz
WIFI 802.11ac VHT80 (LF @ 3m)

WIFI	Note	Frequency	Level	Over	Limit	Read	Antenna	Cable	Preamp	Ant	Table	Peak	Pol.	
Ant.				Limit	Line	Level	Factor	Loss	Factor	Pos	Pos	Avg.		
1+2		(MHz)	(dBμV/m)	(dB)	(dBμV/m)	(dBμV)	(dB/m)	(dB)	(dB)	(cm)	(deg)	(P/A)	(H/V)	
802.11ac VHT80 LF		30	26.89	-13.11	40	31.81	24.72	1.71	31.35			P	H	
		144.48	29.07	-14.43	43.5	40.77	17.19	2.62	31.51			P	H	
		290.55	30.45	-15.55	46	39.47	19.01	3.28	31.31			P	H	
		885.2	33.07	-12.93	46	29.33	29	5.27	30.53			P	H	
		932.1	33.78	-12.22	46	29.27	29.7	5.33	30.52			P	H	
		955.9	34.52	-11.48	46	28.82	30.81	5.4	30.51	100	76	P	H	
													H	
													H	
													H	
													H	
													H	
													H	
			76.98	31.02	-8.98	40	47.73	12.76	2.11	31.58	100	177	P	V
			125.31	32.06	-11.44	43.5	43.75	17.5	2.34	31.53			P	V
			229.8	31.46	-14.54	46	43.69	16.15	3.03	31.41			P	V
			899.9	33.51	-12.49	46	29.84	28.92	5.27	30.52			P	V
			930	34.72	-11.28	46	30.29	29.62	5.33	30.52			P	V
			958.7	35.15	-10.85	46	29.36	30.9	5.4	30.51			P	V
													V	
													V	
												V		
												V		
												V		
												V		
Remark	1. No other spurious found. 2. All results are PASS against limit line.													



Note symbol

*	Fundamental Frequency which can be ignored. However, the level of any unwanted emissions shall not exceed the level of the fundamental frequency.
!	Test result is over limit line.
P/A	P eak or A verage
H/V	H orizontal or V ertical



A calculation example for radiated spurious emission is shown as below:

WIFI	Note	Frequency	Level	Over	Limit	Read	Antenna	Cable	Preamp	Ant	Table	Peak	Pol.
Ant.				Limit	Line	Level	Factor	Loss	Factor	Pos	Pos	Avg.	
1+2		(MHz)	(dBμV/m)	(dB)	(dBμV/m)	(dBμV)	(dB/m)	(dB)	(dB)	(cm)	(deg)	(P/A)	(H/V)
802.11b		2390	55.45	-18.55	74	54.51	32.22	4.58	35.86	103	308	P	H
CH 01													
2412MHz		2390	43.54	-10.46	54	42.6	32.22	4.58	35.86	103	308	A	H

- Level(dBμV/m) =
Antenna Factor(dB/m) + Cable Loss(dB) + Read Level(dBμV) - Preamp Factor(dB)
- Over Limit(dB) = Level(dBμV/m) – Limit Line(dBμV/m)

For Peak Limit @ 2390MHz:

- Level(dBμV/m)
= Antenna Factor(dB/m) + Cable Loss(dB) + Read Level(dBμV) - Preamp Factor(dB)
= 32.22(dB/m) + 4.58(dB) + 54.51(dBμV) – 35.86 (dB)
= 55.45 (dBμV/m)
- Over Limit(dB)
= Level(dBμV/m) – Limit Line(dBμV/m)
= 55.45(dBμV/m) – 74(dBμV/m)
= -18.55(dB)

For Average Limit @ 2390MHz:

- Level(dBμV/m)
= Antenna Factor(dB/m) + Cable Loss(dB) + Read Level(dBμV) - Preamp Factor(dB)
= 32.22(dB/m) + 4.58(dB) + 42.6(dBμV) – 35.86 (dB)
= 43.54 (dBμV/m)
- Over Limit(dB)
= Level(dBμV/m) – Limit Line(dBμV/m)
= 43.54(dBμV/m) – 54(dBμV/m)
= -10.46(dB)

Both peak and average measured complies with the limit line, so test result is “PASS”



Appendix C. Radiated Spurious Emission Plots

Test Engineer :	Jesse Wang / Stand Hsieh / James Chiu	Temperature :	22~27°C
		Relative Humidity :	52~58%

Note symbol

-L	Low channel location
-R	High channel location



<CDD Mode>

Band 4 - 5725~5850MHz
WIFI 802.11a (Band Edge @ 3m)

WIFI	Band 4 5725~5850MHz Band Edge @ 3m	
ANT	802.11a CH149 5745MHz	
1	Horizontal	Fundamental
Peak	<p> Site : 03CH07-HY Condition : PEAK_BE(B4)_16-24 3m HF_ANT_00075962 HORIZONTAL Detector : Peak Project : 790120 Mode : 59 Power Setting : 19 </p>	<p> Site : 03CH07-HY Condition : PEAK(LINII) 3m HF_ANT_00075962 HORIZONTAL Detector : Peak Project : 790120 Mode : 59 Power Setting : 19 </p>



WIFI	Band 4 5725~5850MHz Band Edge @ 3m	
ANT	802.11a CH149 5745MHz	
1	Vertical	Fundamental
Peak	<p>Site : 03CH07-HY Condition : PEAK_BE(B4)_16-24 3m HF_ANT_00075962 VERTICAL Detector : Peak Project : 790120 Mode : 59 Power Setting : 19</p>	<p>Site : 03CH07-HY Condition : PEAK(LINII) 3m HF_ANT_00075962 VERTICAL Detector : Peak Project : 790120 Mode : 59 Power Setting : 19</p>



WIFI	Band 4 5725~5850MHz Band Edge @ 3m	
ANT	802.11a CH157 5785MHz	
1	Horizontal	Fundamental
Peak	<p>Site : 03CH07-HY Condition : PEAK_BE(B4)_16-24 3m HF_ANT_00075962 HORIZONTAL Detector : Peak Project : 790120 Mode : 60 Power Setting : 19</p>	<p>Site : 03CH07-HY Condition : PEAK(LINII) 3m HF_ANT_00075962 HORIZONTAL Detector : Peak Project : 790120 Mode : 60 Power Setting : 19</p>
Peak	<p>Site : 03CH07-HY Condition : PEAK_BE(B4)_16-24 3m HF_ANT_00075962 HORIZONTAL Detector : Peak Project : 790120 Mode : 60 Power Setting : 19</p>	Left blank



WIFI	Band 4 5725~5850MHz Band Edge @ 3m	
ANT	802.11a CH157 5785MHz	
1	Vertical	Fundamental
Peak	<p>Site : 03CH07-HY Condition : PEAK_BE(B4)_16-24 3m HF_ANT_00075962 VERTICAL Detector : Peak Project : 790120 Mode : 60 Power Setting : 19</p>	<p>Site : 03CH07-HY Condition : PEAK(UNI) 3m HF_ANT_00075962 VERTICAL Detector : Peak Project : 790120 Mode : 60 Power Setting : 19</p>
Peak	<p>Site : 03CH07-HY Condition : PEAK_BE(B4)_16-24 3m HF_ANT_00075962 VERTICAL Detector : Peak Project : 790120 Mode : 60 Power Setting : 19</p>	Left blank



WIFI	Band 4 5725~5850MHz Band Edge @ 3m	
ANT	802.11a CH165 5825MHz	
1	Horizontal	Fundamental
<p>Peak</p>	<p>Site : 03CH07-HY Condition : PEAK_BE(B4)_16-24 3m HF_ANT_00075962 HORIZONTAL RBW:1000.000KHz VBW:3000.000KHz SWT:Auto Detector : Peak Project : 790120 Mode : 61 Power Setting : 19</p>	<p>Site : 03CH07-HY Condition : PEAK(LINII) 3m HF_ANT_00075962 HORIZONTAL RBW:1000.000KHz VBW:3000.000KHz SWT:Auto Detector : Peak Project : 790120 Mode : 61 Power Setting : 19</p>



WIFI	Band 4 5725~5850MHz Band Edge @ 3m	
ANT	802.11a CH165 5825MHz	
1	Vertical	Fundamental
Peak	<p>Site : 03CH07-HY Condition : PEAK_BE(B4)_16-24 3m HF_ANT_00075962 VERTICAL RBW:1000.000KHz VBW:3000.000KHz SWT:Auto Detector : Peak Project : 790120 Mode : 61 Power Setting : 19</p>	<p>Site : 03CH07-HY Condition : PEAK(LINII) 3m HF_ANT_00075962 VERTICAL RBW:1000.000KHz VBW:3000.000KHz SWT:Auto Detector : Peak Project : 790120 Mode : 61 Power Setting : 19</p>



**Band 4 5725~5850MHz
WIFI 802.11ac VHT20 (Band Edge @ 3m)**

WIFI	Band 4 5725~5850MHz Band Edge @ 3m	
ANT	802.11ac VHT20 CH149 5745MHz	
1	Horizontal	Fundamental
Peak	<p> Site : 03CH07-HY Condition : PEAK_BE(B4)_16-24 3m HF_ANT_00075962 HORIZONTAL Detector : Peak Project : 790120 Mode : 73 Power Setting : 19 </p>	<p> Site : 03CH07-HY Condition : PEAK(LIN)1 3m HF_ANT_00075962 HORIZONTAL Detector : Peak Project : 790120 Mode : 73 Power Setting : 19 </p>

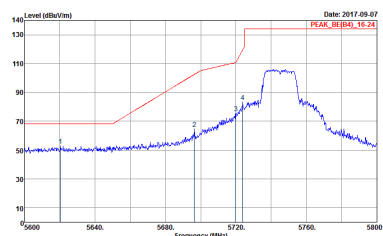
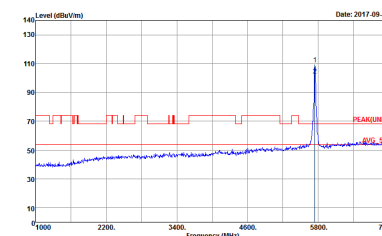

WIFI	Band 4 5725~5850MHz Band Edge @ 3m	
ANT	802.11ac VHT20 CH149 5745MHz	
1	Vertical	Fundamental
<p>Peak</p> <p>Avg.</p>	 <p>Site : 03CH07-HY Condition : PEAK_BE(4)_16-24 3m HF_ANT_00075962 VERTICAL Detector : Peak Project : 790120 Mode : 73 Power Setting : 19</p>	 <p>Site : 03CH07-HY Condition : PEAK(UNII) 3m HF_ANT_00075962 VERTICAL Detector : Peak Project : 790120 Mode : 73 Power Setting : 19</p>



WIFI	Band 4 5725~5850MHz Band Edge @ 3m	
ANT	802.11ac VHT20 CH157 5785MHz	
1	Horizontal	Fundamental
Peak	<p>Site : 03CH07-HY Condition : PEAK_BE(B4)_16-24 3m HF_ANT_00075962 HORIZONTAL Detector : Peak Project : 790120 Mode : 74 Power Setting : 19.5</p>	<p>Site : 03CH07-HY Condition : PEAK(UNII) 3m HF_ANT_00075962 HORIZONTAL Detector : Peak Project : 790120 Mode : 74 Power Setting : 19.5</p>
Peak	<p>Site : 03CH07-HY Condition : PEAK_BE(B4)_16-24 3m HF_ANT_00075962 HORIZONTAL Detector : Peak Project : 790120 Mode : 74 Power Setting : 19.5</p>	Left blank



WIFI	Band 4 5725~5850MHz Band Edge @ 3m	
ANT	802.11ac VHT20 CH157 5785MHz	
1	Vertical	Fundamental
Peak	<p>Site : 03CH07-HY Condition : PEAK_BE(B4)_16-24 3m HF_ANT_00075962 VERTICAL Detector : Peak Project : 790120 Mode : 74 Power Setting : 19.5</p>	<p>Site : 03CH07-HY Condition : PEAK(UNII) 3m HF_ANT_00075962 VERTICAL Detector : Peak Project : 790120 Mode : 74 Power Setting : 19.5</p>
Peak	<p>Site : 03CH07-HY Condition : PEAK_BE(B4)_16-24 3m HF_ANT_00075962 VERTICAL Detector : Peak Project : 790120 Mode : 74 Power Setting : 19.5</p>	Left blank



WIFI	Band 4 5725~5850MHz Band Edge @ 3m	
ANT	802.11ac VHT20 CH165 5825MHz	
1	Horizontal	Fundamental
Peak	<p>Site : 03CH07-HY Condition : PEAK_BE(B4)_16-24 3m HF_ANT_00075962 HORIZONTAL RBW:1000.000KHz VBW:3000.000KHz SWT:Auto Detector : Peak Project : 790120 Mode : 75 Power Setting : 19.5</p>	<p>Site : 03CH07-HY Condition : PEAK(UNI) 3m HF_ANT_00075962 HORIZONTAL RBW:1000.000KHz VBW:3000.000KHz SWT:Auto Detector : Peak Project : 790120 Mode : 75 Power Setting : 19.5</p>



WIFI	Band 4 5725~5850MHz Band Edge @ 3m	
ANT	802.11ac VHT20 CH165 5825MHz	
1	Vertical	Fundamental
Peak Avg.	<p>Site : 03CH07-HY Condition : PEAK_BE(B4)_16-24 3m HF_ANT_00075962 VERTICAL RBW:1000.000KHz VBW:3000.000KHz SWT:Auto Detector : Peak Project : 790120 Mode : 75 Power Setting : 19.5</p>	<p>Site : 03CH07-HY Condition : PEAK(LINII) 3m HF_ANT_00075962 VERTICAL RBW:1000.000KHz VBW:3000.000KHz SWT:Auto Detector : Peak Project : 790120 Mode : 75 Power Setting : 19.5</p>



**Band 4 5725~5850MHz
WIFI 802.11ac VHT40 (Band Edge @ 3m)**

WIFI	Band 4 5725~5850MHz Band Edge @ 3m	
ANT	802.11ac VHT40 CH151 5755MHz	
1	Horizontal	Fundamental
Peak	<p>Site : 03CH07-HY Condition : PEAK_BE(B4)_16-24 3m HF_ANT_00075962 HORIZONTAL Detector : Peak Project : 790120 Mode : 85 Power Setting : 17.5</p>	<p>Site : 03CH07-HY Condition : PEAK(LIN1) 3m HF_ANT_00075962 HORIZONTAL Detector : Peak Project : 790120 Mode : 85 Power Setting : 17.5</p>
	<p>Site : 03CH07-HY Condition : PEAK_BE(B4)_16-24 3m HF_ANT_00075962 HORIZONTAL Detector : Peak Project : 790120 Mode : 85 Power Setting : 17.5</p>	Left blank



WIFI	Band 4 5725~5850MHz Band Edge @ 3m	
ANT	802.11ac VHT40 CH151 5755MHz	
1	Vertical	Fundamental
Peak	<p>Site : 03CH07-HY Condition : PEAK_BE(B4)_16-24 3m HF_ANT_00075962 VERTICAL Detector : Peak Project : 790120 Mode : 85 Power Setting : 17.5</p>	<p>Site : 03CH07-HY Condition : PEAK(UNII) 3m HF_ANT_00075962 VERTICAL Detector : Peak Project : 790120 Mode : 85 Power Setting : 17.5</p>
Peak	<p>Site : 03CH07-HY Condition : PEAK_BE(B4)_16-24 3m HF_ANT_00075962 VERTICAL Detector : Peak Project : 790120 Mode : 85 Power Setting : 17.5</p>	Left blank



WIFI	Band 4 5725~5850MHz Band Edge @ 3m	
ANT	802.11ac VHT40 CH159 5795MHz	
1	Horizontal	Fundamental
Peak	<p>Site : 03CH07-HY Condition : PEAK_BE(84)_16-24 3m HF_ANT_00075962 HORIZONTAL Detector : Peak Project : 790120 Mode : 86 Power Setting : 18</p>	<p>Site : 03CH07-HY Condition : PEAK(LINII) 3m HF_ANT_00075962 HORIZONTAL Detector : Peak Project : 790120 Mode : 86 Power Setting : 18</p>
Peak	<p>Site : 03CH07-HY Condition : PEAK_BE(84)_16-24 3m HF_ANT_00075962 HORIZONTAL Detector : Peak Project : 790120 Mode : 86 Power Setting : 18</p>	Left blank



WIFI	Band 4 5725~5850MHz Band Edge @ 3m	
ANT	802.11ac VHT40 CH159 5795MHz	
1	Vertical	Fundamental
Peak	<p>Site : 03CH07-HY Condition : PEAK_BE(B4)_16-24 3m HF_ANT_00075962 VERTICAL Detector : Peak Project : 790120 Mode : 86 Power Setting : 18</p>	<p>Site : 03CH07-HY Condition : PEAK(LINII) 3m HF_ANT_00075962 VERTICAL Detector : Peak Project : 790120 Mode : 86 Power Setting : 18</p>
Peak	<p>Site : 03CH07-HY Condition : PEAK_BE(B4)_16-24 3m HF_ANT_00075962 VERTICAL Detector : Peak Project : 790120 Mode : 86 Power Setting : 18</p>	Left blank



**Band 4 5725~5850MHz
WIFI 802.11ac VHT80 (Band Edge @ 3m)**

WIFI	Band 4 5725~5850MHz Band Edge @ 3m	
ANT	802.11ac VHT80 CH155 5775MHz	
1	Horizontal	Fundamental
Peak	<p>Site : 03CH07-HY Condition : PEAK_BE(B4)_16-24 3m HF_ANT_00075962 HORIZONTAL Detector : Peak Project : 790120 Mode : 93 Power Setting : 17</p>	<p>Site : 03CH07-HY Condition : PEAK(UNIT) 3m HF_ANT_00075962 HORIZONTAL Detector : Peak Project : 790120 Mode : 93 Power Setting : 17</p>
	<p>Site : 03CH07-HY Condition : PEAK_BE(B4)_16-24 3m HF_ANT_00075962 HORIZONTAL Detector : Peak Project : 790120 Mode : 93 Power Setting : 17</p>	Left blank



WIFI	Band 4 5725~5850MHz Band Edge @ 3m	
ANT	802.11ac VHT80 CH155 5775MHz	
1	Vertical	Fundamental
Peak	<p>Site : 03CH07-HY Condition : PEAK_BE(B4)_16-24 3m HF_ANT_00075962 VERTICAL Detector : Peak Project : 790120 Mode : 93 Power Setting : 17</p>	<p>Site : 03CH07-HY Condition : PEAK(UNI) 3m HF_ANT_00075962 VERTICAL Detector : Peak Project : 790120 Mode : 93 Power Setting : 17</p>
Peak	<p>Site : 03CH07-HY Condition : PEAK_BE(B4)_16-24 3m HF_ANT_00075962 VERTICAL Detector : Peak Project : 790120 Mode : 93 Power Setting : 17</p>	Left blank



Band 4 - 5725~5850MHz
WIFI 802.11a (Harmonic @ 3m)

WIFI	Band 4 5725~5850MHz Harmonic @ 3m	
ANT	802.11a CH149 5745MHz	
1	Horizontal	Vertical
Peak Avg.	<p>Site : 03CH07-11Y Condition : PEAK(LINII) 3m SHF-EHF_131029 HORIZONTAL Detector : Peak Project : 790120 Mode : 59 Power Setting : 19</p>	<p>Site : 03CH07-11Y Condition : PEAK(LINII) 3m SHF-EHF_131029 VERTICAL Detector : Peak Project : 790120 Mode : 59 Power Setting : 19</p>

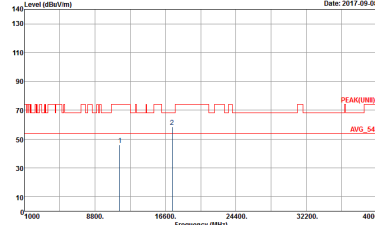
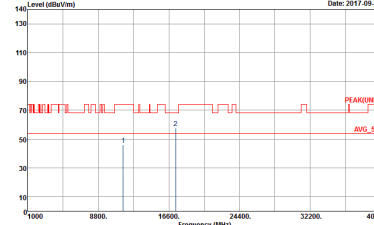

WIFI	Band 4 5725~5850MHz Harmonic @ 3m	
ANT	802.11a CH157 5785MHz	
1	Horizontal	Vertical
<p>Peak</p> <p>Avg.</p>	 <p>Site : 03CH07-4Y Condition : PEAK(UNII) 3m SHF-EHF_131029 HORIZONTAL RBW:1000.000KHz VBW:3000.000KHz SWT:Auto Detector : Peak Project : 790120 Mode : 60 Power Setting : 19</p>	 <p>Site : 03CH07-4Y Condition : PEAK(UNII) 3m SHF-EHF_131029 VERTICAL RBW:1000.000KHz VBW:3000.000KHz SWT:Auto Detector : Peak Project : 790120 Mode : 60 Power Setting : 19</p>



WIFI	Band 4 5725~5850MHz Harmonic @ 3m	
ANT	802.11a CH165 5825MHz	
1	Horizontal	Vertical
<p>Peak</p> <p>Avg.</p>	<p>Site : 03CH07-HY Condition : PEAK(UNII) 3m SHF-EHF_131029 HORIZONTAL Detector : Peak Project : 790120 Mode : 61 Power Setting : 19</p>	<p>Site : 03CH07-HY Condition : PEAK(UNII) 3m SHF-EHF_131029 VERTICAL Detector : Peak Project : 790120 Mode : 61 Power Setting : 19</p>



**Band 4 5725~5850MHz
WIFI 802.11ac VHT20 (Harmonic @ 3m)**

WIFI	Band 4 5725~5850MHz Harmonic @ 3m	
ANT	802.11ac VHT20 CH149 5745MHz	
1	Horizontal	Vertical
Peak Avg.	<p>Site : 03CH07-HY Condition : PEAK(UNII) 3m HF_ANT_00075962 HORIZONTAL Detector : Peak Project : 790120 Mode : 73 Power Setting : 19</p>	<p>Site : 03CH07-HY Condition : PEAK(UNII) 3m SHF-EHF_131029 VERTICAL Detector : Peak Project : 790120 Mode : 73 Power Setting : 19</p>



WIFI	Band 4 5725~5850MHz Harmonic @ 3m	
ANT	802.11ac VHT20 CH157 5785MHz	
1	Horizontal	Vertical
Peak Avg.	<p>Site : 03CH07-HY Condition : PEAK(UNII) 3m SHF-EHF_131029 HORIZONTAL Detector : Peak Project : 790120 Mode : 74 Power Setting : 19.5</p>	<p>Site : 03CH07-HY Condition : PEAK(UNII) 3m SHF-EHF_131029 VERTICAL Detector : Peak Project : 790120 Mode : 74 Power Setting : 19.5</p>



WIFI	Band 4 5725~5850MHz Harmonic @ 3m	
ANT	802.11ac VHT20 CH165 5825MHz	
1	Horizontal	Vertical
Peak Avg.	<p>Site : 03CH07-4HY Condition : PEAK(UNII) 3m SHF-EHF_131029 HORIZONTAL Detector : Peak Project : 790120 Mode : 75 Power Setting : 19.5</p>	<p>Site : 03CH07-4HY Condition : PEAK(UNII) 3m SHF-EHF_131029 VERTICAL Detector : Peak Project : 790120 Mode : 75 Power Setting : 19.5</p>

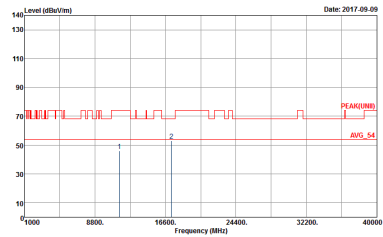
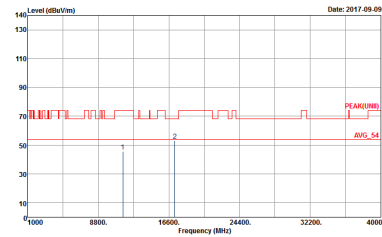

**Band 4 5725~5850MHz
WIFI 802.11ac VHT40 (Harmonic @ 3m)**

WIFI	Band 4 5725~5850MHz Harmonic @ 3m	
ANT	802.11ac VHT40 CH151 5755MHz	
1	Horizontal	Vertical
<p>Peak Avg.</p>	 <p>Site : 03CH07-HY Condition : PEAK(UNII) 3m SHF-EHF_131029 HORIZONTAL Detector : Peak Project : 790120 Mode : 85 Power Setting : 17.5</p>	 <p>Site : 03CH07-HY Condition : PEAK(UNII) 3m SHF-EHF_131029 VERTICAL Detector : Peak Project : 790120 Mode : 85 Power Setting : 17.5</p>

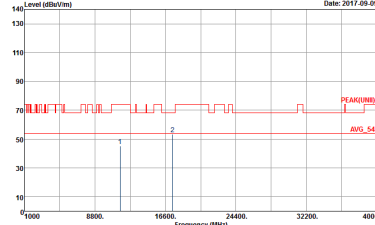
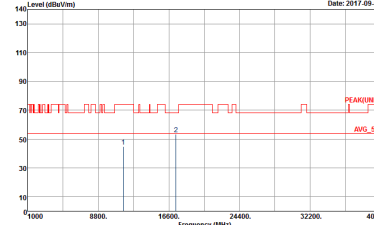

WIFI	Band 4 5725~5850MHz Harmonic @ 3m	
ANT	802.11ac VHT40 CH159 5795MHz	
1	Horizontal	Vertical
Peak Avg.	 <p>Site : 03CH07-HY Condition : PEAK(UNII) 3m SHF-EHF_131029 HORIZONTAL Detector : Peak Project : F90120 Mode : 80 Power Setting : 18</p>	 <p>Site : 03CH07-HY Condition : PEAK(UNII) 3m SHF-EHF_131029 VERTICAL Detector : Peak Project : F90120 Mode : 80 Power Setting : 18</p>

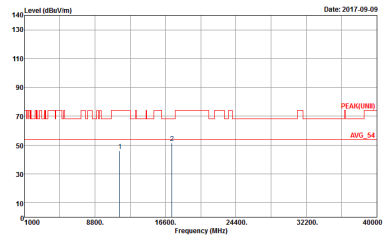
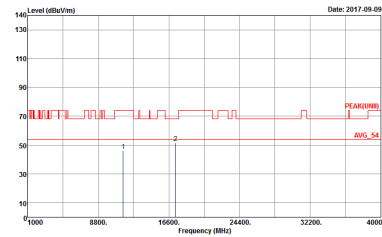

**Band 4 5725~5850MHz
WIFI 802.11ac VHT80 (Harmonic @ 3m)**

WIFI	Band 4 5725~5850MHz Harmonic @ 3m	
ANT	802.11ac VHT80 CH155 5775MHz	
1	Horizontal	Vertical
<p>Peak Avg.</p>	 <p>Site : 03CH07-HY Condition : PEAK(UNII) 3m SHF-EHF_131029 HORIZONTAL Detector : Peak Project : 790120 Mode : 93 Power Setting : 17</p>	 <p>Site : 03CH07-HY Condition : PEAK(UNII) 3m SHF-EHF_131029 VERTICAL Detector : Peak Project : 790120 Mode : 93 Power Setting : 17</p>



Emission below 1GHz
5GHz WIFI 802.11ac VHT80 (LF)

WIFI	5GHz 5725-5850MHz	
ANT	802.11ac VHT80 LF	
1	Horizontal	Vertical
QP / Peak	<p>Site : 03CH07-11Y Condition : QP 3m LF-ANT-35419(6) HORIZONTAL Detector : Peak Project : 790120 Mode : 128</p>	<p>Site : 03CH07-11Y Condition : QP 3m LF-ANT-35419(6) VERTICAL Detector : Peak Project : 790120 Mode : 128</p>



**Band 4 5725~5850MHz
WIFI 802.11ac VHT80 (Band Edge @ 3m)**

WIFI	Band 4 5725~5850MHz Band Edge @ 3m	
ANT	802.11ac VHT80 CH155 5775MHz	
2	Horizontal	Fundamental
Peak	<p>Date: 2017-09-08 PEAK_BE(B4)_16-24</p> <p>Site : 03CH07-HY Condition : PEAK_BE(B4)_16-24 3m HF_ANT_00075962 HORIZONTAL RBW:3000.000kHz VBW:3000.000kHz SWT:Auto Detector : Peak Project : 790120 Mode : 94 Power Setting : 18.5</p>	<p>Date: 2017-09-08 PEAK(UMB) AVG_54</p> <p>Site : 03CH07-HY Condition : PEAK(UMB)_3m HF_ANT_00075962 HORIZONTAL RBW:1000.000kHz VBW:3000.000kHz SWT:Auto Detector : Peak Project : 790120 Mode : 94 Power Setting : 18.5</p>
Peak	<p>Date: 2017-09-08 PEAK_BE(B4)_16-24</p> <p>Site : 03CH07-HY Condition : PEAK_BE(B4)_16-24 3m HF_ANT_00075962 HORIZONTAL RBW:1000.000kHz VBW:3000.000kHz SWT:Auto Detector : Peak Project : 790120 Mode : 94 Power Setting : 18.5</p>	Left blank



WIFI	Band 4 5725~5850MHz Band Edge @ 3m	
ANT	802.11ac VHT80 CH155 5775MHz	
2	Vertical	Fundamental
Peak	<p>Site : 03CH07-HY Condition : PEAK_BE(B4)_16-24 3m HF_ANT_00075962 VERTICAL Detector : Peak Project : 790120 Mode : 94 Power Setting : 18.5</p>	<p>Site : 03CH07-HY Condition : PEAK(U)B 3m HF_ANT_00075962 VERTICAL Detector : Peak Project : 790120 Mode : 94 Power Setting : 18.5</p>
Peak	<p>Site : 03CH07-HY Condition : PEAK_BE(B4)_16-24 3m HF_ANT_00075962 VERTICAL Detector : Peak Project : 790120 Mode : 94 Power Setting : 18.5</p>	Left blank



**Band 4 5725~5850MHz
WIFI 802.11ac VHT80 (Harmonic @ 3m)**

WIFI	Band 4 5725~5850MHz Harmonic @ 3m	
ANT	802.11ac VHT80 CH155 5775MHz	
2	Horizontal	Vertical
Peak Avg.	<p>Site : 03CH07-HY Condition : PEAK(UNII) 3m SHF-EHF_131029 HORIZONTAL Detector : Peak Project : 790120 Mode : 94 Power Setting : 18.5</p>	<p>Site : 03CH07-HY Condition : PEAK(UNII) 3m SHF-EHF_131029 VERTICAL Detector : Peak Project : 790120 Mode : 94 Power Setting : 18.5</p>



Emission below 1GHz
5GHz WIFI 802.11ac VHT80 (LF)

WIFI	5GHz 5725-5850MHz	
ANT	802.11ac VHT80 LF	
2	Horizontal	Vertical
QP / Peak	<p>Site : 03CH07-11Y Condition : QP 3m LF-ANT-35419(6) HORIZONTAL Detector : Peak Project : 790120 Mode : 129</p>	<p>Site : 03CH07-11Y Condition : QP 3m LF-ANT-35419(6) VERTICAL Detector : Peak Project : 790120 Mode : 129</p>



Band 4 - 5725~5850MHz
WIFI 802.11a (Band Edge @ 3m)

WIFI	Band 4 5725~5850MHz Band Edge @ 3m	
ANT	802.11a CH149 5745MHz	
1+2	Horizontal	Fundamental
Peak	<p> Site : 03CH07-HY Condition : PEAK_BE(B4)_16-24 3m HF_ANT_00075962 HORIZONTAL Detector : Peak Project : 790120 Mode : 17 Power Setting : 20 </p>	<p> Site : 03CH07-HY Condition : PEAK(LINII) 3m HF_ANT_00075962 HORIZONTAL Detector : Peak Project : 790120 Mode : 17 Power Setting : 20 </p>

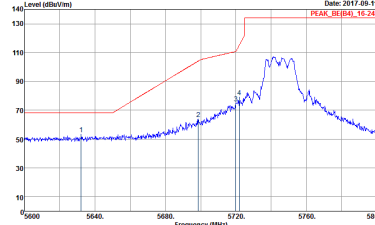
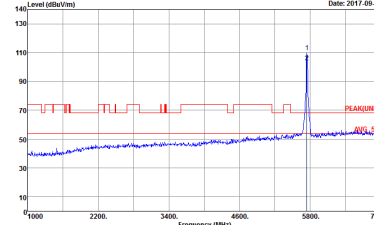

WIFI	Band 4 5725~5850MHz Band Edge @ 3m	
ANT	802.11a CH149 5745MHz	
1+2	Vertical	Fundamental
<p>Peak</p>	 <p>Site : 03CH07-HY Condition : PEAK_BE(B4)_16-24 3m HF_ANT_00075962 VERTICAL Detector : Peak Project : 790120 Mode : 17 Power Setting : 20</p>	 <p>Site : 03CH07-HY Condition : PEAK(LINII) 3m HF_ANT_00075962 VERTICAL Detector : Peak Project : 790120 Mode : 17 Power Setting : 20</p>



WIFI	Band 4 5725~5850MHz Band Edge @ 3m	
ANT	802.11a CH157 5785MHz	
1+2	Horizontal	Fundamental
Peak	<p>Site : 03CH07-HY Condition : PEAK_BE(B4)_16-24 3m HF_ANT_00075962 HORIZONTAL Detector : Peak Project : 790120 Mode : 18 Power Setting : 20</p>	<p>Site : 03CH07-HY Condition : PEAK(FUN) 3m HF_ANT_00075962 HORIZONTAL Detector : Peak Project : 790120 Mode : 18 Power Setting : 20</p>
Peak	<p>Site : 03CH07-HY Condition : PEAK_BE(B4)_16-24 3m HF_ANT_00075962 HORIZONTAL Detector : Peak Project : 790120 Mode : 18 Power Setting : 20</p>	Left blank



WIFI	Band 4 5725~5850MHz Band Edge @ 3m	
ANT	802.11a CH157 5785MHz	
1+2	Vertical	Fundamental
Peak	<p>Site : 03CH07-HY Condition : PEAK_BE(B4)_16-24 3m HF_ANT_00075962 VERTICAL Detector : Peak Project : 790120 Mode : 18 Power Setting : 20</p>	<p>Site : 03CH07-HY Condition : PEAK(LINII) 3m HF_ANT_00075962 VERTICAL Detector : Peak Project : 790120 Mode : 18 Power Setting : 20</p>
Peak	<p>Site : 03CH07-HY Condition : PEAK_BE(B4)_16-24 3m HF_ANT_00075962 VERTICAL Detector : Peak Project : 790120 Mode : 18 Power Setting : 20</p>	Left blank

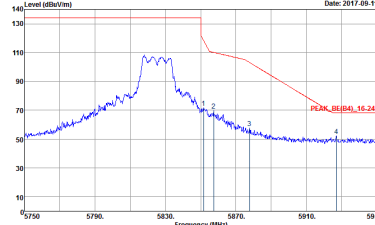
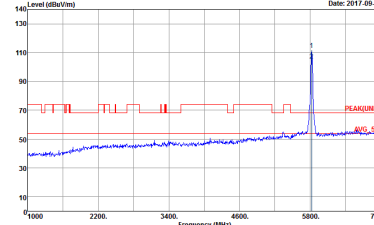

WIFI	Band 4 5725~5850MHz Band Edge @ 3m	
ANT	802.11a CH165 5825MHz	
1+2	Horizontal	Fundamental
Peak	 <p>Site : 03CH07-HY Condition : PEAK_BE(B4)_16-24 3m HF_ANT_00075962 HORIZONTAL Detector : Peak Project : 790120 Mode : 19 Power Setting : 20</p>	 <p>Site : 03CH07-HY Condition : PEAK(UNI) 3m HF_ANT_00075962 HORIZONTAL Detector : Peak Project : 790120 Mode : 19 Power Setting : 20</p>



WIFI	Band 4 5725~5850MHz Band Edge @ 3m	
ANT	802.11a CH165 5825MHz	
1+2	Vertical	Fundamental
Peak	<p>Site : 03CH07-HY Condition : PEAK_BE(B4)_16-24 3m HF_ANT_00075962 VERTICAL RBW:1000.000KHz VBW:3000.000KHz SWT:Auto Detector : Peak Project : 790120 Mode : 19 Power Setting : 20</p>	<p>Site : 03CH07-HY Condition : PEAK(LINII) 3m HF_ANT_00075962 VERTICAL RBW:1000.000KHz VBW:3000.000KHz SWT:Auto Detector : Peak Project : 790120 Mode : 19 Power Setting : 20</p>



Band 4 5725~5850MHz
WIFI 802.11ac VHT20 (Band Edge @ 3m)

WIFI	Band 4 5725~5850MHz Band Edge @ 3m	
ANT	802.11ac VHT20 CH149 5745MHz	
1+2	Horizontal	Fundamental
Peak	<p>Site : 03CH07-HY Condition : PEAK_BE(B4)_16-24 3m HF_ANT_00075962 HORIZONTAL Detector : Peak Project : 790120 Mode : 30 Power Setting : 20</p>	<p>Site : 03CH07-HY Condition : PEAK(LIN)I 3m HF_ANT_00075962 HORIZONTAL Detector : Peak Project : 790120 Mode : 30 Power Setting : 20</p>

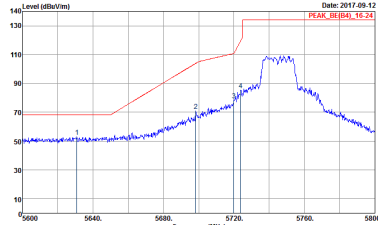
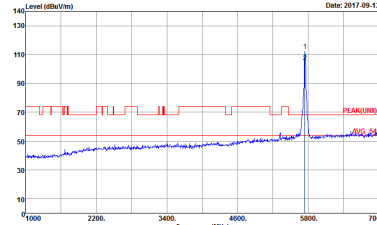

WIFI	Band 4 5725~5850MHz Band Edge @ 3m	
ANT	802.11ac VHT20 CH149 5745MHz	
1+2	Vertical	Fundamental
<p>Peak Avg.</p>	 <p>Site : 03CH07-HY Condition : PEAK_BE(B4)_16-24 3m HF_ANT_00075962 VERTICAL RBW:1000.000KHz VBW:3000.000KHz SWT:Auto Detector : Peak Project : 790120 Mode : 30 Power Setting : 20</p>	 <p>Site : 03CH07-HY Condition : PEAK(LINII) 3m HF_ANT_00075962 VERTICAL RBW:1000.000KHz VBW:3000.000KHz SWT:Auto Detector : Peak Project : 790120 Mode : 30 Power Setting : 20</p>



WIFI	Band 4 5725~5850MHz Band Edge @ 3m	
ANT	802.11ac VHT20 CH157 5785MHz	
1+2	Horizontal	Fundamental
Peak	<p>Site : 03CH07-HY Condition : PEAK_BE(B4)_16-24 3m HF_ANT_00075962 HORIZONTAL Detector : Peak Project : 790120 Mode : 31 Power Setting : 20</p>	<p>Site : 03CH07-HY Condition : PEAK(UNII) 3m HF_ANT_00075962 HORIZONTAL Detector : Peak Project : 790120 Mode : 31 Power Setting : 20</p>
Peak	<p>Site : 03CH07-HY Condition : PEAK_BE(B4)_16-24 3m HF_ANT_00075962 HORIZONTAL Detector : Peak Project : 790120 Mode : 31 Power Setting : 20</p>	Left blank



WIFI	Band 4 5725~5850MHz Band Edge @ 3m	
ANT	802.11ac VHT20 CH157 5785MHz	
1+2	Vertical	Fundamental
Peak	<p>Site : 03CH07-HY Condition : PEAK_BE(B4)_16-24 3m HF_ANT_00075962 VERTICAL Detector : Peak Project : 790120 Mode : 31 Power Setting : 20</p>	<p>Site : 03CH07-HY Condition : PEAK(UNII) 3m HF_ANT_00075962 VERTICAL Detector : Peak Project : 790120 Mode : 31 Power Setting : 20</p>
Peak	<p>Site : 03CH07-HY Condition : PEAK_BE(B4)_16-24 3m HF_ANT_00075962 VERTICAL Detector : Peak Project : 790120 Mode : 31 Power Setting : 20</p>	Left blank

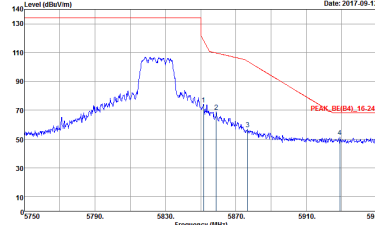
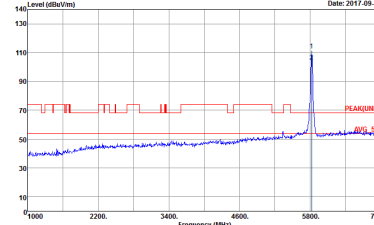

WIFI	Band 4 5725~5850MHz Band Edge @ 3m	
ANT	802.11ac VHT20 CH165 5825MHz	
1+2	Horizontal	Fundamental
Peak	 <p>Site : 03CH07-HY Condition : PEAK_BE(B4)_16-24 3m HF_ANT_00075962 HORIZONTAL Detector : Peak Project : 790120 Mode : 32 Power Setting : 20</p>	 <p>Site : 03CH07-HY Condition : PEAK(LINII) 3m HF_ANT_00075962 HORIZONTAL Detector : Peak Project : 790120 Mode : 32 Power Setting : 20</p>

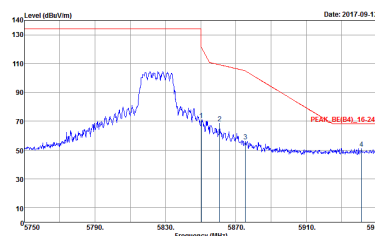
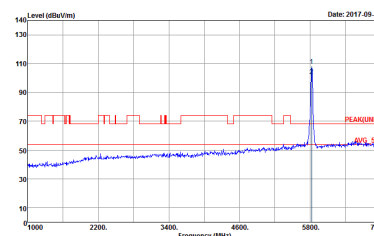

WIFI	Band 4 5725~5850MHz Band Edge @ 3m	
ANT	802.11ac VHT20 CH165 5825MHz	
1+2	Vertical	Fundamental
Peak Avg.	 <p>Site : 03CH07-HY Condition : PEAK_BE(B4)_16-24 3m HF_ANT_00075962 VERTICAL RBW:1000.000KHz VBW:3000.000KHz SWT:Auto Detector : Peak Project : 790120 Mode : 32 Power Setting : 20</p>	 <p>Site : 03CH07-HY Condition : PEAK(LINII) 3m HF_ANT_00075962 VERTICAL RBW:1000.000KHz VBW:3000.000KHz SWT:Auto Detector : Peak Project : 790120 Mode : 32 Power Setting : 20</p>



Band 4 5725~5850MHz
WIFI 802.11ac VHT40 (Band Edge @ 3m)

WIFI	Band 4 5725~5850MHz Band Edge @ 3m	
ANT	802.11ac VHT40 CH151 5755MHz	
1+2	Horizontal	Fundamental
Peak	<p>Site : 03CH07-HY Condition : PEAK_BE(B4)_16-24 3m HF_ANT_00075962 HORIZONTAL Detector : Peak Project : 790120 Mode : 41 Power Setting : 20</p>	<p>Site : 03CH07-HY Condition : PEAK(UMB) 3m HF_ANT_00075962 HORIZONTAL Detector : Peak Project : 790120 Mode : 41 Power Setting : 20</p>
Peak	<p>Site : 03CH07-HY Condition : PEAK_BE(B4)_16-24 3m HF_ANT_00075962 HORIZONTAL Detector : Peak Project : 790120 Mode : 41 Power Setting : 20</p>	Left blank



WIFI	Band 4 5725~5850MHz Band Edge @ 3m	
ANT	802.11ac VHT40 CH151 5755MHz	
1+2	Vertical	Fundamental
Peak	<p>Site : 03CH07-HY Condition : PEAK_BE(B4)_16-24 3m HF_ANT_00075962 VERTICAL Detector : Peak Project : 790120 Mode : 41 Power Setting : 20</p>	<p>Site : 03CH07-HY Condition : PEAK(UNI) 3m HF_ANT_00075962 VERTICAL Detector : Peak Project : 790120 Mode : 41 Power Setting : 20</p>
Peak	<p>Site : 03CH07-HY Condition : PEAK_BE(B4)_16-24 3m HF_ANT_00075962 VERTICAL Detector : Peak Project : 790120 Mode : 41 Power Setting : 20</p>	Left blank



WIFI	Band 4 5725~5850MHz Band Edge @ 3m	
ANT	802.11ac VHT40 CH159 5795MHz	
1+2	Horizontal	Fundamental
Peak	<p>Site : 03CH07-HY Condition : PEAK_BE(B4)_16-24 3m HF_ANT_00075962 HORIZONTAL Detector : Peak Project : 790120 Mode : 42 Power Setting : 20</p>	<p>Site : 03CH07-HY Condition : PEAK(UNI) 3m HF_ANT_00075962 HORIZONTAL Detector : Peak Project : 790120 Mode : 42 Power Setting : 20</p>
Peak	<p>Site : 03CH07-HY Condition : PEAK_BE(B4)_16-24 3m HF_ANT_00075962 HORIZONTAL Detector : Peak Project : 790120 Mode : 42 Power Setting : 20</p>	Left blank

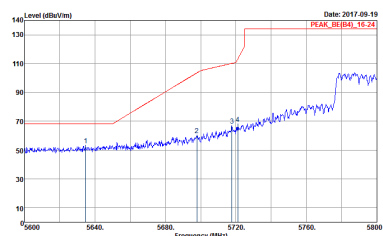
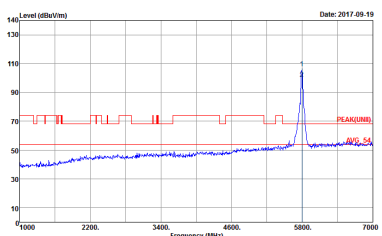
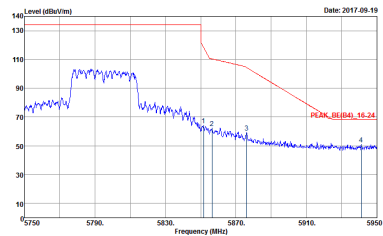

WIFI	Band 4 5725~5850MHz Band Edge @ 3m	
ANT	802.11ac VHT40 CH159 5795MHz	
1+2	Vertical	Fundamental
<p>Peak</p>	 <p>Site : 03CH07-HY Condition : PEAK_BE(84)_16-24 3m HF_ANT_00075962 VERTICAL Detector : Peak Project : 790120 Mode : 42 Power Setting : 18</p>	 <p>Site : 03CH07-HY Condition : PEAK(UB) 3m HF_ANT_00075962 VERTICAL Detector : Peak Project : 790120 Mode : 42 Power Setting : 18</p>
<p>Peak</p>	 <p>Site : 03CH07-HY Condition : PEAK_BE(84)_16-24 3m HF_ANT_00075962 VERTICAL Detector : Peak Project : 790120 Mode : 42 Power Setting : 18</p>	<p>Left blank</p>



**Band 4 5725~5850MHz
WIFI 802.11ac VHT80 (Band Edge @ 3m)**

WIFI	Band 4 5725~5850MHz Band Edge @ 3m	
ANT	802.11ac VHT80 CH155 5775MHz	
1+2	Horizontal	Fundamental
Peak	<p>Site : 03CH07-HY Condition : PEAK_BE(B4)_16-24 3m HF_ANT_00075962 HORIZONTAL Detector : Peak Project : 790120 Mode : 48 Power Setting : 17.5</p>	<p>Site : 03CH07-HY Condition : PEAK(UNIT) 3m HF_ANT_00075962 HORIZONTAL Detector : Peak Project : 790120 Mode : 48 Power Setting : 17.5</p>
Peak	<p>Site : 03CH07-HY Condition : PEAK_BE(B4)_16-24 3m HF_ANT_00075962 HORIZONTAL Detector : Peak Project : 790120 Mode : 48 Power Setting : 17.5</p>	Left blank

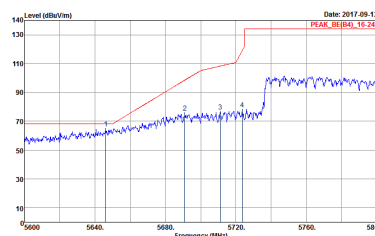
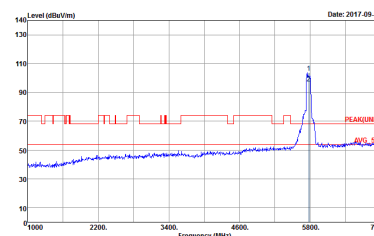
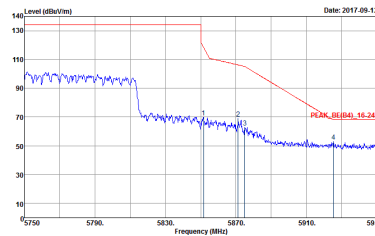

WIFI	Band 4 5725~5850MHz Band Edge @ 3m	
ANT	802.11ac VHT80 CH155 5775MHz	
1+2	Vertical	Fundamental
Peak	 <p>Date: 2017-09-12 PEAK_BE(B4)_16-24</p> <p>Site : 03CH07-HY Condition : PEAK_BE(B4)_16-24 3m HF_ANT_00075962 VERTICAL Detector : Peak Project : 790120 Mode : 48 Power Setting : 17.5</p>	 <p>Date: 2017-09-12 PEAK(BB)_16-24</p> <p>Site : 03CH07-HY Condition : PEAK(UNII) 3m HF_ANT_00075962 VERTICAL Detector : Peak Project : 790120 Mode : 48 Power Setting : 17.5</p>
Peak	 <p>Date: 2017-09-12 PEAK_BE(B4)_16-24</p> <p>Site : 03CH07-HY Condition : PEAK_BE(B4)_16-24 3m HF_ANT_00075962 VERTICAL Detector : Peak Project : 790120 Mode : 48 Power Setting : 17.5</p>	Left blank



Band 4 - 5725~5850MHz
WIFI 802.11a (Harmonic @ 3m)

WIFI	Band 4 5725~5850MHz Harmonic @ 3m	
ANT	802.11a CH149 5745MHz	
1+2	Horizontal	Vertical
Peak Avg.	<p>Site : 03CH07-11Y Condition : PEAK(LINII) 3m SHF-EHF_131029 HORIZONTAL Detector : Peak Project : 790120 Mode : 17 Power Setting : 20</p>	<p>Site : 03CH07-11Y Condition : PEAK(LINII) 3m SHF-EHF_131029 VERTICAL Detector : Peak Project : 790120 Mode : 17 Power Setting : 20</p>

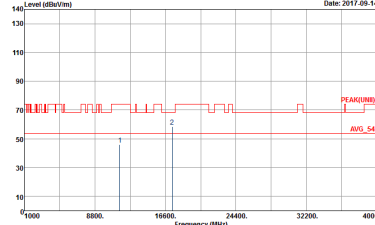
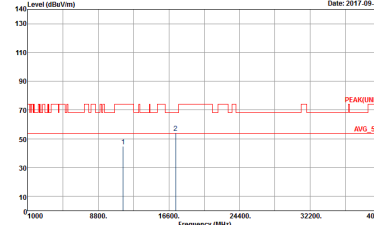

WIFI	Band 4 5725~5850MHz Harmonic @ 3m	
ANT	802.11a CH157 5785MHz	
1+2	Horizontal	Vertical
Peak Avg.	 <p>Site : 03CH07-HY Condition : PEAK(UNIT) 3m SHF-EHF_131029 HORIZONTAL Detector : Peak Project : 790120 Mode : 18 Power Setting : 20</p>	 <p>Site : 03CH07-HY Condition : PEAK(UNIT) 3m SHF-EHF_131029 VERTICAL Detector : Peak Project : 790120 Mode : 18 Power Setting : 20</p>

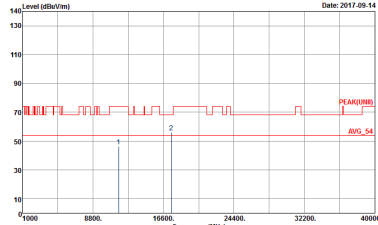
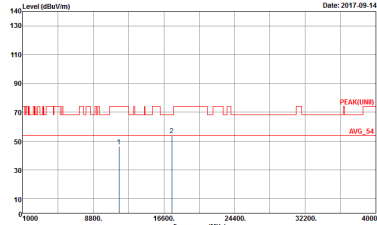

WIFI	Band 4 5725~5850MHz Harmonic @ 3m	
ANT	802.11a CH165 5825MHz	
1+2	Horizontal	Vertical
Peak Avg.	 <p>Site : 03CH07-HY Condition : PEAK(UNII) 3m SHF-EHF_131029 HORIZONTAL Detector : Peak Project : 790120 Mode : 19 Power Setting : 20</p>	 <p>Site : 03CH07-HY Condition : PEAK(UNII) 3m SHF-EHF_131029 VERTICAL Detector : Peak Project : 790120 Mode : 19 Power Setting : 20</p>



**Band 4 5725~5850MHz
WIFI 802.11ac VHT20 (Harmonic @ 3m)**

WIFI	Band 4 5725~5850MHz Harmonic @ 3m	
ANT	802.11ac VHT20 CH149 5745MHz	
1+2	Horizontal	Vertical
Peak Avg.	<p>Site : 03CH07-HY Condition : PEAK(UNII) 3m SHF-EHF_131029 HORIZONTAL Detector : Peak Project : 790120 Mode : 30 Power Setting : 20</p>	<p>Site : 03CH07-HY Condition : PEAK(UNII) 3m SHF-EHF_131029 VERTICAL Detector : Peak Project : 790120 Mode : 30 Power Setting : 20</p>

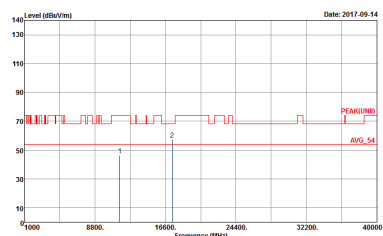
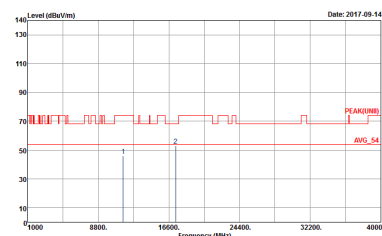

WIFI	Band 4 5725~5850MHz Harmonic @ 3m	
ANT	802.11ac VHT20 CH157 5785MHz	
1+2	Horizontal	Vertical
Peak Avg.	 <p>Site : 03CH07-HY Condition : PEAK(UNII) 3m SHF-EHF_131029 HORIZONTAL Detector : Peak Project : 790120 Mode : 31 Power Setting : 20</p>	 <p>Site : 03CH07-HY Condition : PEAK(UNII) 3m SHF-EHF_131029 VERTICAL Detector : Peak Project : 790120 Mode : 31 Power Setting : 20</p>

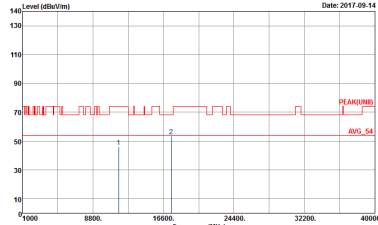
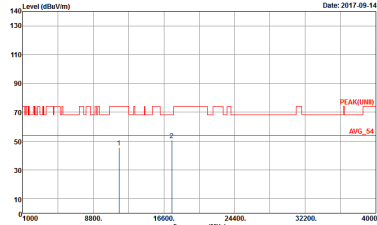

WIFI	Band 4 5725~5850MHz Harmonic @ 3m	
ANT	802.11ac VHT20 CH165 5825MHz	
1+2	Horizontal	Vertical
Peak Avg.	 <p>Site : 03CH07-HY Condition : PEAK(UNII) 3m SHF-EHF_131029 HORIZONTAL Detector : Peak Project : 790120 Mode : 32 Power Setting : 20</p>	 <p>Site : 03CH07-HY Condition : PEAK(UNII) 3m SHF-EHF_131029 VERTICAL Detector : Peak Project : 790120 Mode : 32 Power Setting : 20</p>



**Band 4 5725~5850MHz
WIFI 802.11ac VHT40 (Harmonic @ 3m)**

WIFI	Band 4 5725~5850MHz Harmonic @ 3m	
ANT	802.11ac VHT40 CH151 5755MHz	
1+2	Horizontal	Vertical
Peak Avg.	<p>Site : 03CH07-HY Condition : PEAK(UM) 3m SHF-EHF_131029 HORIZONTAL Detector : Peak Project : 790120 Mode : 41 Power Setting : 18</p>	<p>Site : 03CH07-HY Condition : PEAK(UM) 3m SHF-EHF_131029 VERTICAL Detector : Peak Project : 790120 Mode : 41 Power Setting : 18</p>



WIFI	Band 4 5725~5850MHz Harmonic @ 3m	
ANT	802.11ac VHT40 CH159 5795MHz	
1+2	Horizontal	Vertical
Peak Avg.		



**Band 4 5725~5850MHz
WIFI 802.11ac VHT80 (Harmonic @ 3m)**

WIFI	Band 4 5725~5850MHz Harmonic @ 3m	
ANT	802.11ac VHT80 CH155 5775MHz	
1+2	Horizontal	Vertical
Peak Avg.	<p>Site : 03CH07-HY Condition : PEAK(UNII) 3m SHF-EHF_131029 HORIZONTAL Detector : Peak Project : 790120 Mode : 48 Power Setting : 17.5</p>	<p>Site : 03CH07-HY Condition : PEAK(UNII) 3m SHF-EHF_131029 VERTICAL Detector : Peak Project : 790120 Mode : 48 Power Setting : 17.5</p>



Emission below 1GHz
5GHz WIFI 802.11ac VHT80 (LF)

WIFI	5GHz 5725-5850MHz	
ANT	802.11ac VHT80 LF	
1+2	Horizontal	Vertical
QP / Peak	<p>Site : 03CH07-11Y Condition : QP 3m LF-ANT-35419(6) HORIZONTAL Detector : Peak Project : 790120 Mode : 125</p>	<p>Site : 03CH07-11Y Condition : QP 3m LF-ANT-35419(6) VERTICAL Detector : Peak Project : 790120 Mode : 125</p>



<TXBF Mode>

Band 4 - 5725~5850MHz

WIFI 802.11ac VHT20 (Band Edge @ 3m)

WIFI	Band 4 5725~5850MHz Band Edge @ 3m	
ANT	802.11ac VHT20 CH149 5745MHz	
1+2	Horizontal	Fundamental
Peak	<p> Site : 03CH07-HY Condition : PEAK_BE(B4)_16-24 3m HF_ANT_00075962 HORIZONTAL Detector : Peak Project : 790120 Mode : 105 Power Setting : 18.5 </p>	<p> Site : 03CH07-HY Condition : PEAK(LINII) 3m HF_ANT_00075962 HORIZONTAL Detector : Peak Project : 790120 Mode : 105 Power Setting : 18.5 </p>

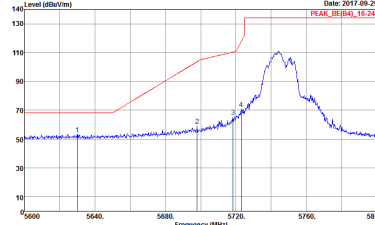
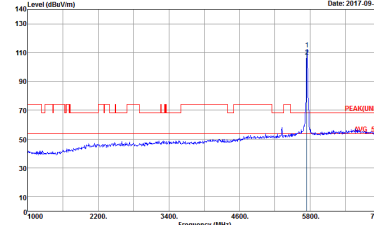

WIFI	Band 4 5725~5850MHz Band Edge @ 3m	
ANT	802.11ac VHT20 CH149 5745MHz	
1+2	Vertical	Fundamental
<p>Peak</p> <p>Avg.</p>	 <p>Site : 03CH07-HY Condition : PEAK_8E(84)_16-24 3m HF_ANT_00075962 VERTICAL RBW:1000.000KHz VBW:3000.000KHz SWT:Auto Detector : Peak Project : 790120 Mode : 105 Power Setting : 18.5</p>	 <p>Site : 03CH07-HY Condition : PEAK(UNII) 3m HF_ANT_00075962 VERTICAL RBW:1000.000KHz VBW:3000.000KHz SWT:Auto Detector : Peak Project : 790120 Mode : 105 Power Setting : 18.5</p>

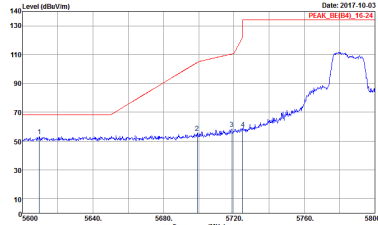
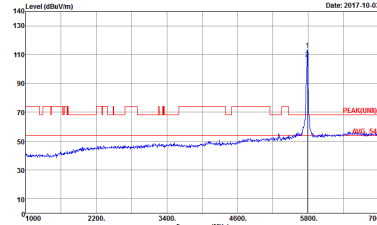
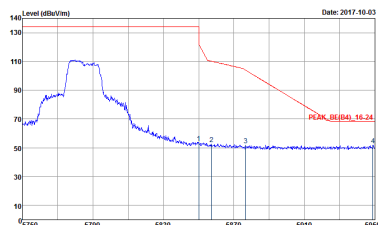

WIFI	Band 4 5725~5850MHz Band Edge @ 3m	
ANT	802.11ac VHT20 CH157 5785MHz	
1+2	Horizontal	Fundamental
Peak	 <p>Site : 03CH07-HY Condition : PEAK_BE(B4)_16-24 3m HF_ANT_00075962 HORIZONTAL Detector : Peak Project : 790120 Mode : 106 Power Setting : 19</p>	 <p>Site : 03CH07-HY Condition : PEAK(UNII) 3m HF_ANT_00075962 HORIZONTAL Detector : Peak Project : 790120 Mode : 106 Power Setting : 19</p>
Peak	 <p>Site : 03CH07-HY Condition : PEAK_BE(B4)_16-24 3m HF_ANT_00075962 HORIZONTAL Detector : Peak Project : 790120 Mode : 106 Power Setting : 19</p>	Left blank



WIFI	Band 4 5725~5850MHz Band Edge @ 3m	
ANT	802.11ac VHT20 CH157 5785MHz	
1+2	Vertical	Fundamental
Peak	<p>Site : 03CH07-HY Condition : PEAK_BE(B4)_16-24 3m HF_ANT_00075962 VERTICAL Detector : Peak Project : 790120 Mode : 106 Power Setting : 19</p>	<p>Site : 03CH07-HY Condition : PEAK(UNI) 3m HF_ANT_00075962 VERTICAL Detector : Peak Project : 790120 Mode : 106 Power Setting : 19</p>
Peak	<p>Site : 03CH07-HY Condition : PEAK_BE(B4)_16-24 3m HF_ANT_00075962 VERTICAL Detector : Peak Project : 790120 Mode : 106 Power Setting : 19</p>	Left blank

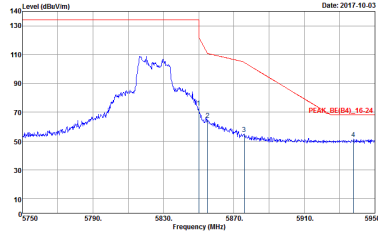
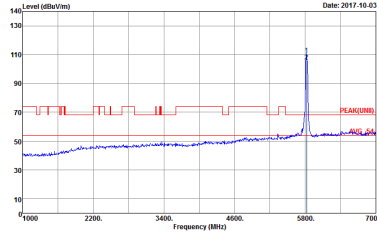

WIFI	Band 4 5725~5850MHz Band Edge @ 3m	
ANT	802.11ac VHT20 CH165 5825MHz	
1+2	Horizontal	Fundamental
Peak	 <p>Site : 03CH07-HY Condition : PEAK_BE(B4)_16-24 3m HF_ANT_00075962 HORIZONTAL RBW:1000.000KHz VBW:3000.000KHz SWT:Auto Detector : Peak Project : 790120 Mode : 107 Power Setting : 19.5</p>	 <p>Site : 03CH07-HY Condition : PEAK(LINII) 3m HF_ANT_00075962 HORIZONTAL RBW:1000.000KHz VBW:3000.000KHz SWT:Auto Detector : Peak Project : 790120 Mode : 107 Power Setting : 19.5</p>



WIFI	Band 4 5725~5850MHz Band Edge @ 3m	
ANT	802.11ac VHT20 CH165 5825MHz	
1+2	Vertical	Fundamental
Peak Avg.	<p>Site : 03CH07-HY Condition : PEAK_BE(B4)_16-24 3m HF_ANT_00075962 VERTICAL RBW:1000.000KHz VBW:3000.000KHz SWT:Auto Detector : Peak Project : 790120 Mode : 107 Power Setting : 19.5</p>	<p>Site : 03CH07-HY Condition : PEAK(LINII) 3m HF_ANT_00075962 VERTICAL RBW:1000.000KHz VBW:3000.000KHz SWT:Auto Detector : Peak Project : 790120 Mode : 107 Power Setting : 19.5</p>

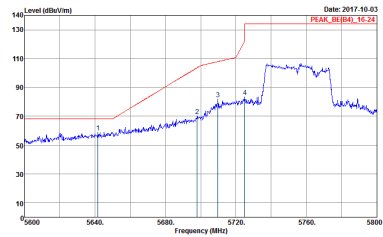
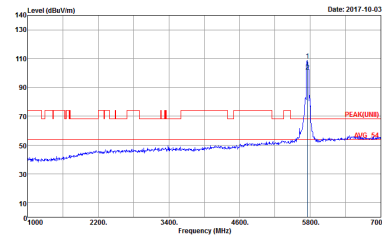
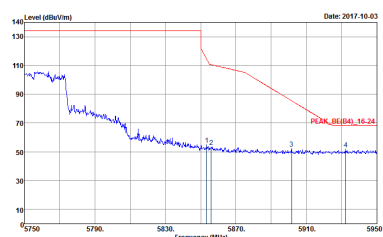

**Band 4 5725~5850MHz
WIFI 802.11ac VHT40 (Band Edge @ 3m)**

WIFI	Band 4 5725~5850MHz Band Edge @ 3m	
ANT	802.11ac VHT40 CH151 5755MHz	
1+2	Horizontal	Fundamental
<p>Peak</p>	 <p>Site : 03CH07-HY Condition : PEAK_BE(B4)_16-24 3m HF_ANT_00075962 HORIZONTAL Detector : Peak Project : 790120 Mode : 116 Power Setting : 17</p>	 <p>Site : 03CH07-HY Condition : PEAK(LIN)I 3m HF_ANT_00075962 HORIZONTAL Detector : Peak Project : 790120 Mode : 116 Power Setting : 17</p>
<p>Peak</p>	 <p>Site : 03CH07-HY Condition : PEAK_BE(B4)_16-24 3m HF_ANT_00075962 HORIZONTAL Detector : Peak Project : 790120 Mode : 116 Power Setting : 17</p>	<p align="center">Left blank</p>

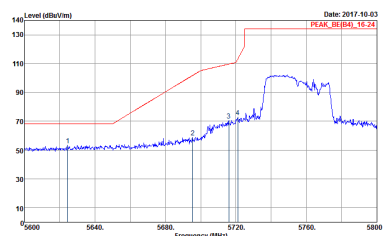
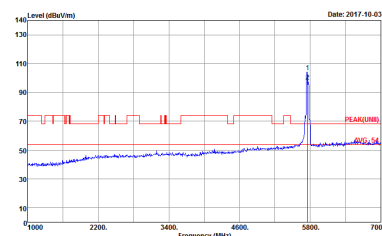
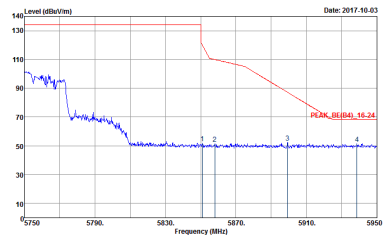

WIFI	Band 4 5725~5850MHz Band Edge @ 3m	
ANT	802.11ac VHT40 CH151 5755MHz	
1+2	Vertical	Fundamental
Peak	 <p>Site : 03CH07-HY Condition : PEAK_BE(B4)_16-24 3m HF_ANT_00075962 VERTICAL Detector : Peak Project : 790120 Mode : 116 Power Setting : 17</p>	 <p>Site : 03CH07-HY Condition : PEAK(UNI) 3m HF_ANT_00075962 VERTICAL Detector : Peak Project : 790120 Mode : 116 Power Setting : 17</p>
Peak	 <p>Site : 03CH07-HY Condition : PEAK_BE(B4)_16-24 3m HF_ANT_00075962 VERTICAL Detector : Peak Project : 790120 Mode : 116 Power Setting : 17</p>	Left blank



WIFI	Band 4 5725~5850MHz Band Edge @ 3m	
ANT	802.11ac VHT40 CH159 5795MHz	
1+2	Horizontal	Fundamental
Peak	<p>Site : 03CH07-HY Condition : PEAK_BE(B4)_16-24 3m HF_ANT_00075962 HORIZONTAL Detector : Peak Project : 790120 Mode : 117 Power Setting : 17.5</p>	<p>Site : 03CH07-HY Condition : PEAK(LINII) 3m HF_ANT_00075962 HORIZONTAL Detector : Peak Project : 790120 Mode : 117 Power Setting : 17.5</p>
Peak	<p>Site : 03CH07-HY Condition : PEAK_BE(B4)_16-24 3m HF_ANT_00075962 HORIZONTAL Detector : Peak Project : 790120 Mode : 117 Power Setting : 17.5</p>	Left blank



WIFI	Band 4 5725~5850MHz Band Edge @ 3m	
ANT	802.11ac VHT40 CH159 5795MHz	
1+2	Vertical	Fundamental
Peak	<p>Site : 03CH07-HY Condition : PEAK_BE(B4)_16-24 3m HF_ANT_00075962 VERTICAL Detector : Peak Project : 790120 Mode : 117 Power Setting : 17.5</p>	<p>Site : 03CH07-HY Condition : PEAK(UNI) 3m HF_ANT_00075962 VERTICAL Detector : Peak Project : 790120 Mode : 117 Power Setting : 17.5</p>
Peak	<p>Site : 03CH07-HY Condition : PEAK_BE(B4)_16-24 3m HF_ANT_00075962 VERTICAL Detector : Peak Project : 790120 Mode : 117 Power Setting : 17.5</p>	Left blank



**Band 4 5725~5850MHz
WIFI 802.11ac VHT80 (Band Edge @ 3m)**

WIFI	Band 4 5725~5850MHz Band Edge @ 3m	
ANT	802.11ac VHT80 CH155 5775MHz	
1+2	Horizontal	Fundamental
Peak	<p>Site : 03CH07-HY Condition : PEAK_BE(B4)_16-24 3m HF_ANT_00075962 HORIZONTAL Detector : Peak Project : 790120 Mode : 123 Power Setting : 16.5</p>	<p>Site : 03CH07-HY Condition : PEAK(LINE) 3m HF_ANT_00075962 HORIZONTAL Detector : Peak Project : 790120 Mode : 123 Power Setting : 16.5</p>
	<p>Site : 03CH07-HY Condition : PEAK_BE(B4)_16-24 3m HF_ANT_00075962 HORIZONTAL Detector : Peak Project : 790120 Mode : 123 Power Setting : 16.5</p>	Left blank



WIFI	Band 4 5725~5850MHz Band Edge @ 3m	
ANT	802.11ac VHT80 CH155 5775MHz	
1+2	Vertical	Fundamental
Peak	<p>Site : 03CH07-HY Condition : PEAK_BE(B4)_16-24 3m HF_ANT_00075962 VERTICAL Detector : Peak Project : 790120 Mode : 123 Power Setting : 16.5</p>	<p>Site : 03CH07-HY Condition : PEAK(FUN) 3m HF_ANT_00075962 VERTICAL Detector : Peak Project : 790120 Mode : 123 Power Setting : 16.5</p>
Peak	<p>Site : 03CH07-HY Condition : PEAK_BE(B4)_16-24 3m HF_ANT_00075962 VERTICAL Detector : Peak Project : 790120 Mode : 123 Power Setting : 16.5</p>	Left blank



Band 4 - 5725~5850MHz
WIFI 802.11ac VHT20 (Harmonic @ 3m)

Table with 3 columns: WIFI (Band 4 5725~5850MHz Harmonic @ 3m), ANT (802.11ac VHT20 CH149 5745MHz), and 1+2 (Horizontal and Vertical). It contains two spectral plots showing Level (dBuV/m) vs Frequency (MHz) with Peak and Avg. values.

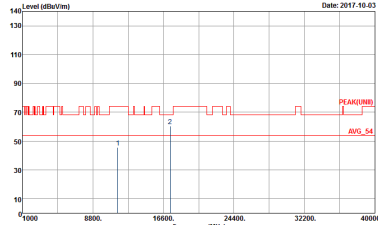
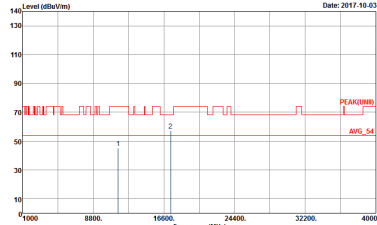

WIFI	Band 4 5725~5850MHz Harmonic @ 3m	
ANT	802.11ac VHT20 CH157 5785MHz	
1+2	Horizontal	Vertical
Peak Avg.	 <p>Site : 03CH07-4Y Condition : PEAK(UNII) 3m SHF-EHF_131029 HORIZONTAL Detector : Peak Project : 790120 Mode : 100 Power Setting : 19</p>	 <p>Site : 03CH07-4Y Condition : PEAK(UNII) 3m SHF-EHF_131029 VERTICAL Detector : Peak Project : 790120 Mode : 100 Power Setting : 19</p>

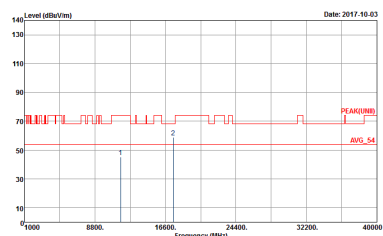
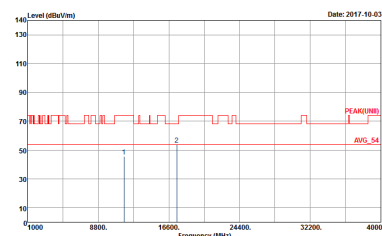

WIFI	Band 4 5725~5850MHz Harmonic @ 3m	
ANT	802.11ac VHT20 CH165 5825MHz	
1+2	Horizontal	Vertical
Peak Avg.	 <p>Site : 03CH07-HY Condition : PEAK(UNII) 3m SHF-EHF_131029 HORIZONTAL Detector : Peak Project : 790120 Mode : 107 Power Setting : 19.5</p>	 <p>Site : 03CH07-HY Condition : PEAK(UNII) 3m SHF-EHF_131029 VERTICAL Detector : Peak Project : 790120 Mode : 107 Power Setting : 19.5</p>



**Band 4 5725~5850MHz
WIFI 802.11ac VHT40 (Harmonic @ 3m)**

WIFI	Band 4 5725~5850MHz Harmonic @ 3m	
ANT	802.11ac VHT40 CH151 5755MHz	
1+2	Horizontal	Vertical
Peak Avg.	<p>Site : 03CH07-HY Condition : PEAK(UNII) 3m SHF-EHF_131029 HORIZONTAL Detector : Peak Project : 790120 Mode : 116 Power Setting : 17</p>	<p>Site : 03CH07-HY Condition : PEAK(UNII) 3m SHF-EHF_131029 VERTICAL Detector : Peak Project : 790120 Mode : 116 Power Setting : 17</p>



WIFI	Band 4 5725~5850MHz Harmonic @ 3m	
ANT	802.11ac VHT40 CH159 5795MHz	
1+2	Horizontal	Vertical
Peak Avg.	<p>Site : 03CH07-HY Condition : PEAK(UNII) 3m SHF-EHF_131029 HORIZONTAL Detector : Peak Project : 790120 Mode : 117 Power Setting : 17.5</p>	<p>Site : 03CH07-HY Condition : PEAK(UNII) 3m SHF-EHF_131029 VERTICAL Detector : Peak Project : 790120 Mode : 117 Power Setting : 17.5</p>



**Band 4 5725~5850MHz
WIFI 802.11ac VHT80 (Harmonic @ 3m)**

WIFI	Band 4 5725~5850MHz Harmonic @ 3m	
ANT	802.11ac VHT80 CH155 5775MHz	
1+2	Horizontal	Vertical
Peak Avg.	<p>Site : 03CH07-HY Condition : PEAK(UNII) 3m SHF-EHF_131029 HORIZONTAL Detector : Peak Project : 790120 Mode : 123 Power Setting : 16.5</p>	<p>Site : 03CH07-HY Condition : PEAK(UNII) 3m SHF-EHF_131029 VERTICAL Detector : Peak Project : 790120 Mode : 123 Power Setting : 16.5</p>



Emission below 1GHz
5GHz WIFI 802.11ac VHT80 (LF)

Table with 2 columns: Horizontal and Vertical. Each column contains a spectral plot of Level (dBuV/m) vs Frequency (MHz) from 50 to 1000 MHz. The plots show a red line for the limit and a blue line for the actual emission. A 'QP' peak is marked at the end of the spectrum. Metadata for both plots includes Site: 03CH07-11Y, Condition: QP 3m LF-ANT-35419(6), Detector: Peak, Project: 790120, and Mode: 131.

Appendix D. Duty Cycle Plots

Antenna	Band	Duty Cycle(%)	T(us)	1/T(kHz)	VBW Setting
0	802.11a	96.053	730	1.37	3kHz
0	5GHz 802.11n HT20	94.521	690	1.45	3kHz
0	5GHz 802.11n HT40	90.625	348	2.87	3kHz
1	802.11a	96.053	730	1.37	3kHz
1	5GHz 802.11n HT20	94.521	690	1.45	3kHz
1	5GHz 802.11n HT40	91.27	345	2.90	3kHz
1+2	5GHz 802.11a for Ant 1	94.74	720	1.39	3kHz
1+2	5GHz 802.11a for Ant 2	94.81	730	1.37	3kHz
1+2	5GHz 802.11n HT20 for Ant 1	94.52	690	1.45	3kHz
1+2	5GHz 802.11n HT20 for Ant 2	94.52	690	1.45	3kHz
1+2	5GHz 802.11n HT40 for Ant 1	92.19	354	2.82	3kHz
1+2	5GHz 802.11n HT40 for Ant 2	92.06	348	2.87	3kHz
0	5GHz 802.11ac VHT20	95.89	700	1.43	3kHz
0	5GHz 802.11ac VHT40	92.308	360	2.77	3kHz
0	5GHz 802.11ac VHT80	85.455	188	5.32	10kHz
1	5GHz 802.11ac VHT20	95.89	700	1.42	3kHz
1	5GHz 802.11ac VHT40	92.187	354	2.82	3kHz
1	5GHz 802.11ac VHT80	85.185	184	5.43	10kHz
1+2	5GHz 802.11ac VHT20 for Ant 1	94.6	700	1.43	3kHz
1+2	5GHz 802.11ac VHT20 for Ant 2	95.24	700	1.43	3kHz
1+2	5GHz 802.11ac VHT40 for Ant 1	92.31	360	2.78	3kHz
1+2	5GHz 802.11ac VHT40 for Ant 2	92.31	360	2.78	3kHz
1+2	5GHz 802.11ac VHT80 for Ant 1	85.19	184	5.43	10kHz
1+2	5GHz 802.11ac VHT80 for Ant 2	85.46	188	5.32	10kHz



SISO <Ant. 1>

802.11a

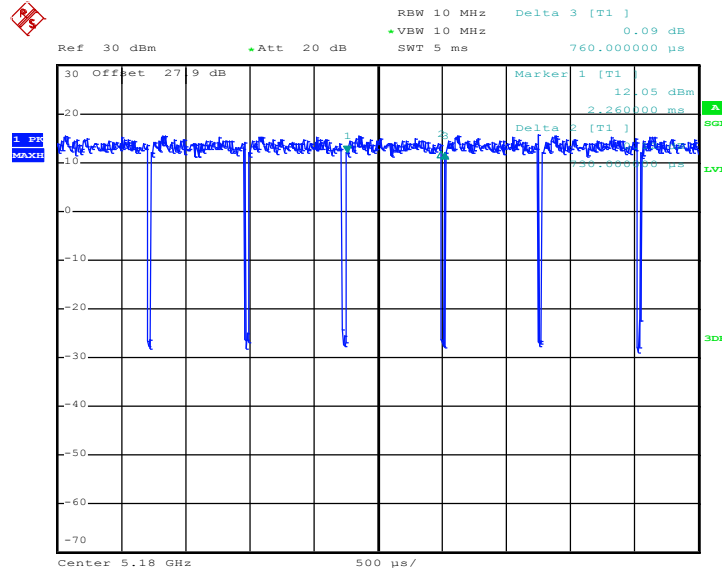

Date: 4.SEP.2017 22:14:43

802.11n HT20

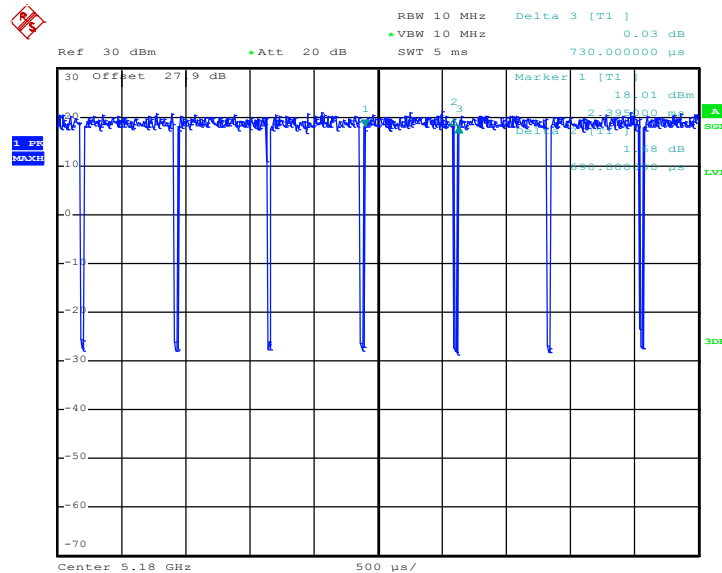

Date: 4.SEP.2017 22:19:23



802.11n HT40

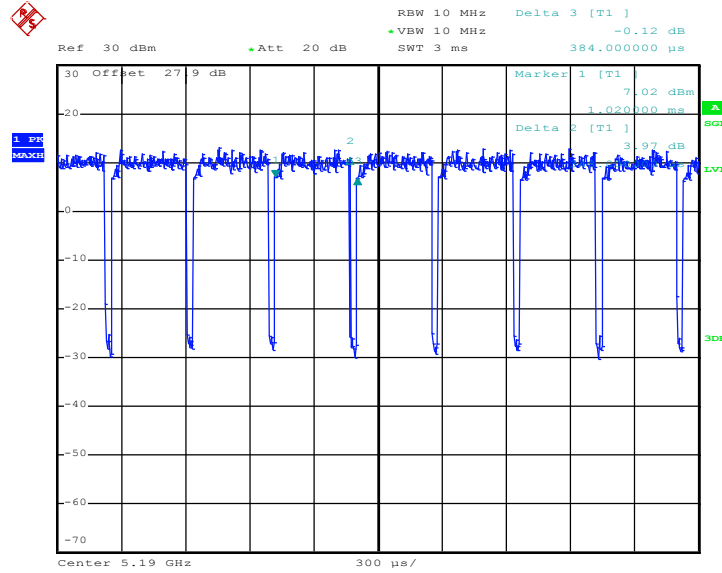

Date: 4.SEP.2017 22:28:20

802.11ac VHT20

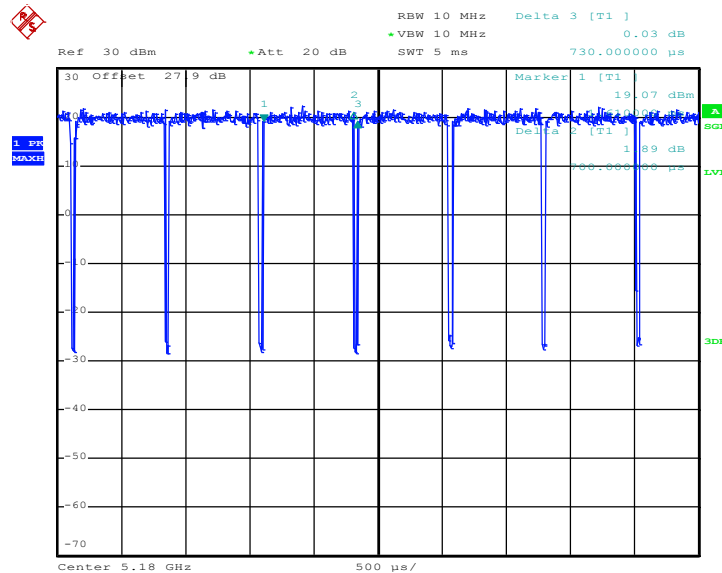

Date: 4.SEP.2017 22:23:16



802.11ac VHT40

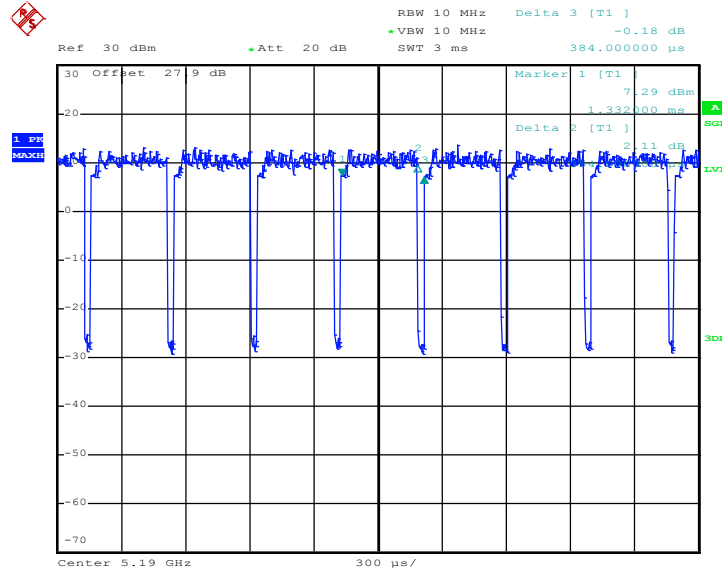

Date: 4.SEP.2017 22:31:59

802.11ac VHT80

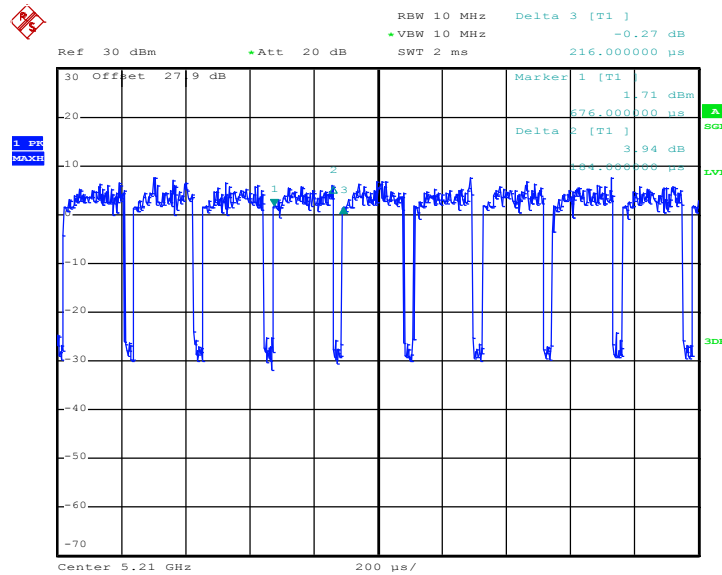

Date: 4.SEP.2017 22:36:04



SISO <Ant. 2>

802.11a

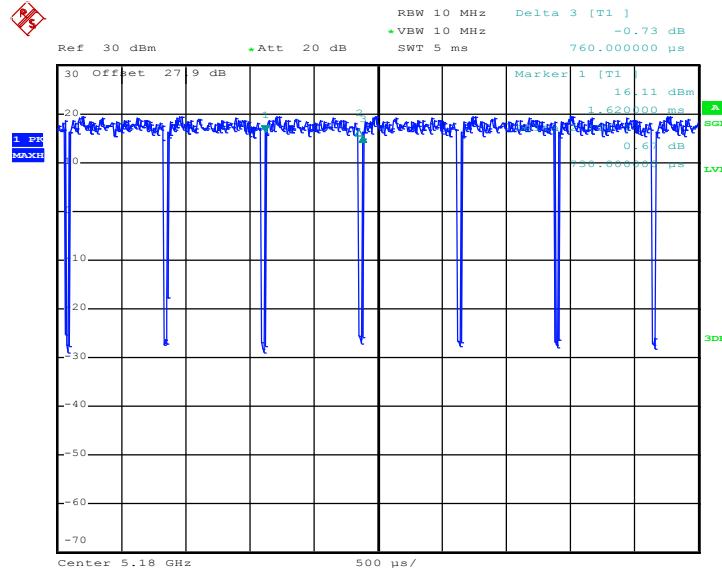

Date: 4.SEP.2017 22:16:06

802.11n HT20

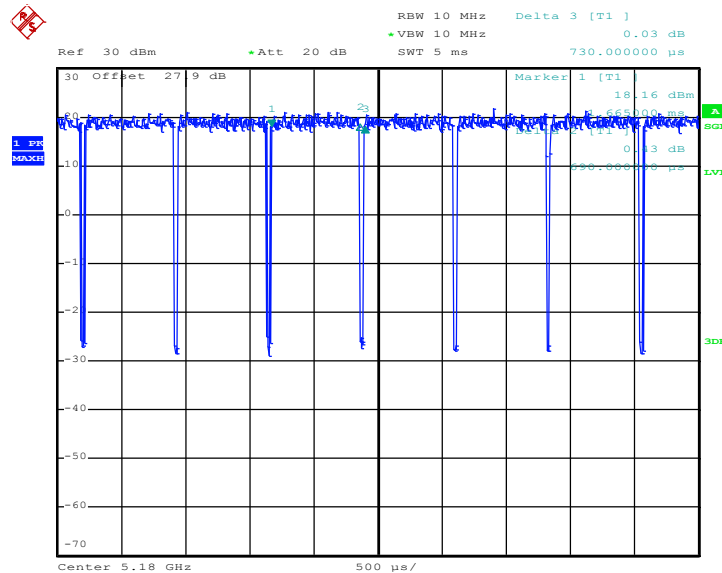

Date: 4.SEP.2017 22:17:48



802.11n HT40

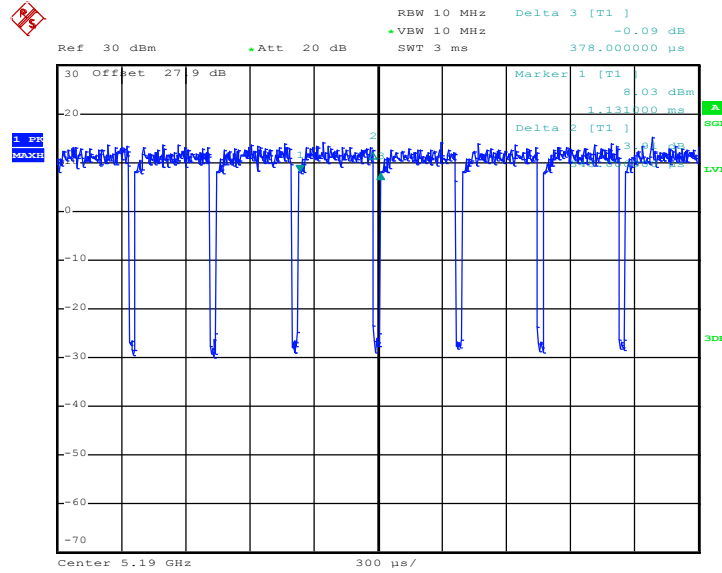

Date: 4.SEP.2017 22:25:21

802.11ac VHT20

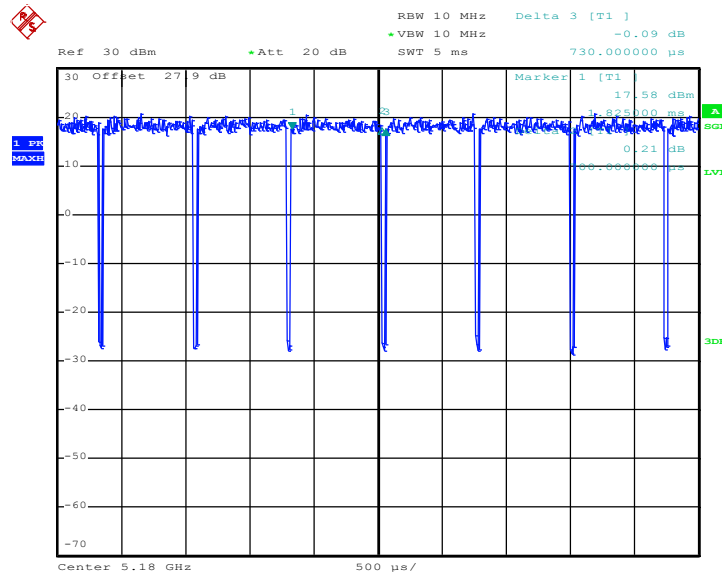

Date: 4.SEP.2017 22:22:21



802.11ac VHT40

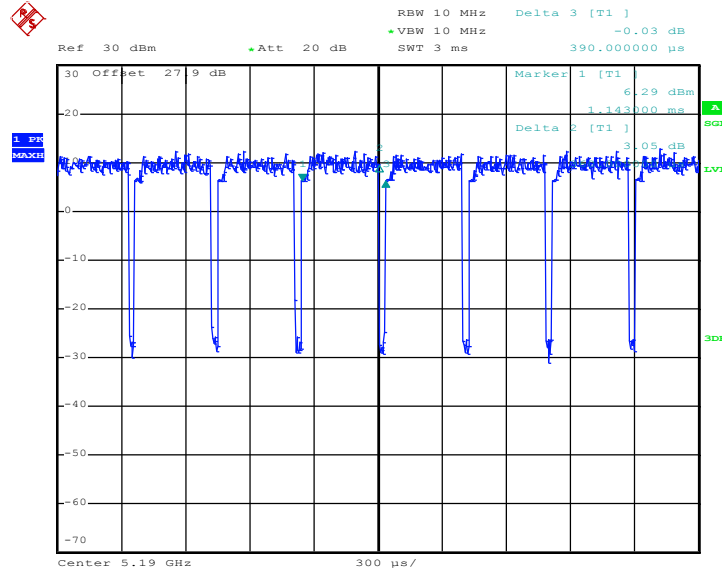

Date: 4.SEP.2017 22:30:17

802.11ac VHT80

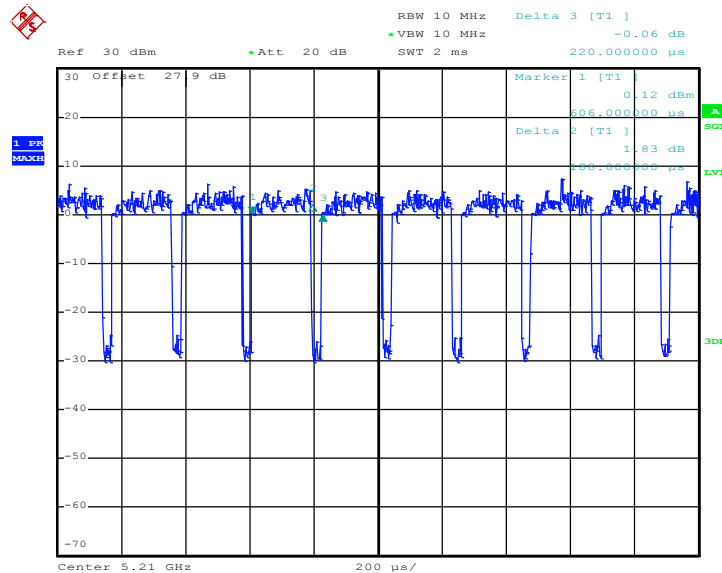

Date: 4.SEP.2017 22:33:48



MIMO <Ant. 1+2(1)>

802.11a

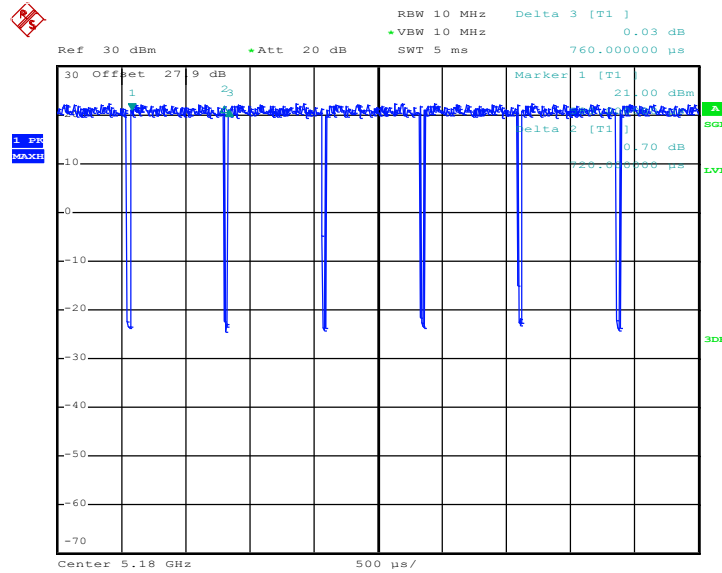

Date: 6.SEP.2017 00:21:08

802.11n HT20

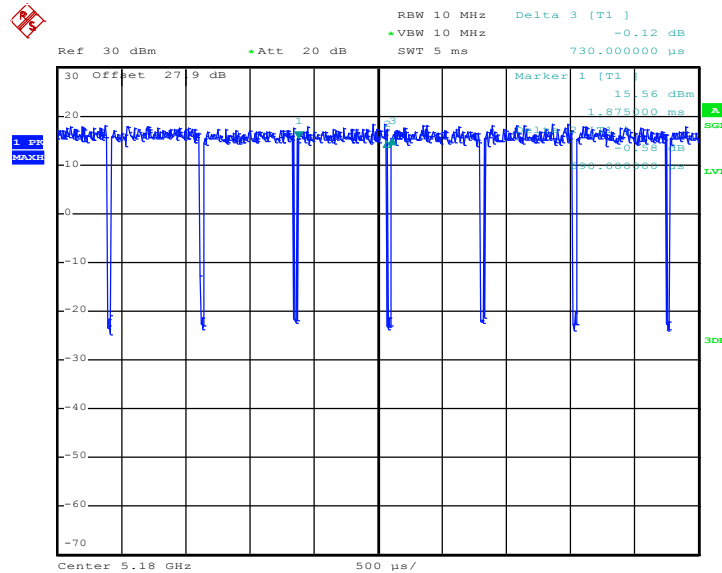

Date: 6.SEP.2017 00:27:39



802.11n HT40

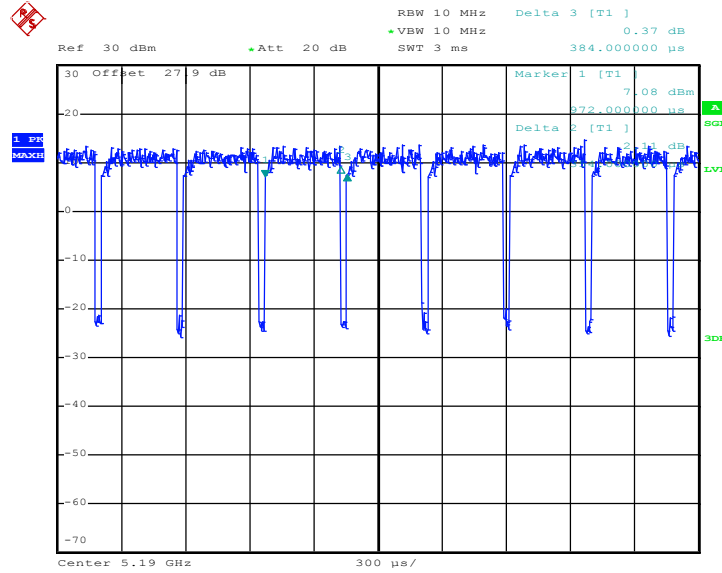

Date: 6.SEP.2017 00:31:16

802.11ac VHT20

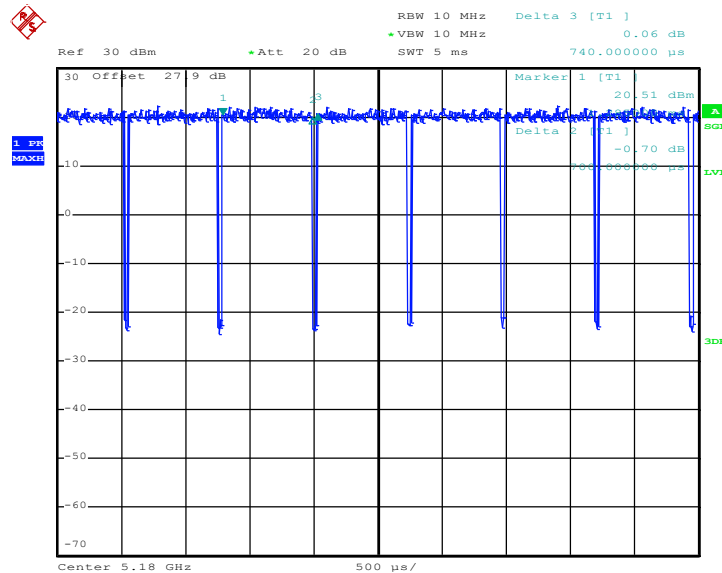

Date: 6.SEP.2017 00:25:13



802.11ac VHT40

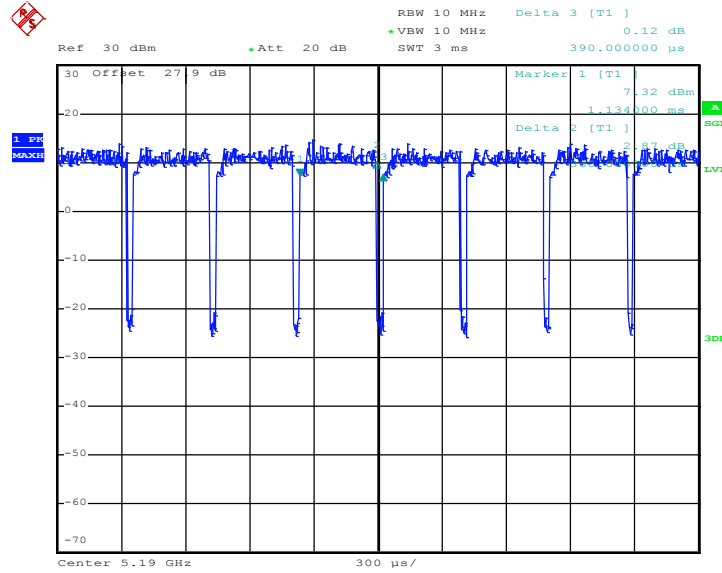

Date: 6.SEP.2017 00:30:15

802.11ac VHT80

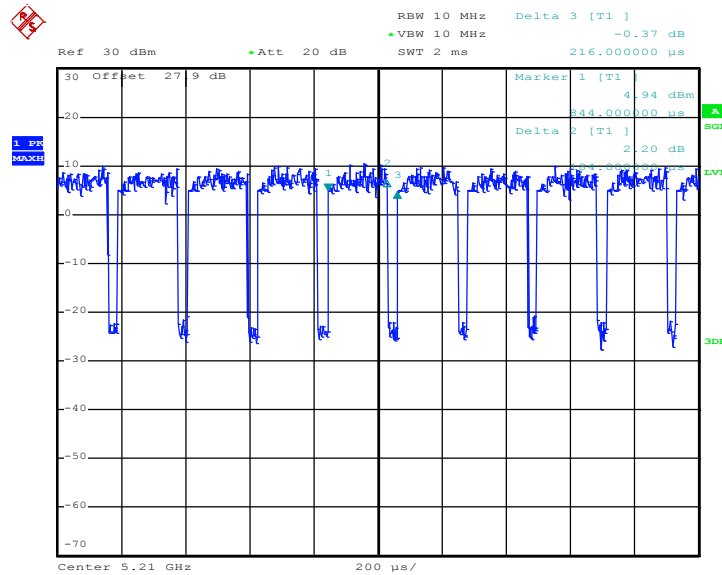

Date: 6.SEP.2017 01:25:05



MIMO <Ant. 1+2(2)>

802.11a

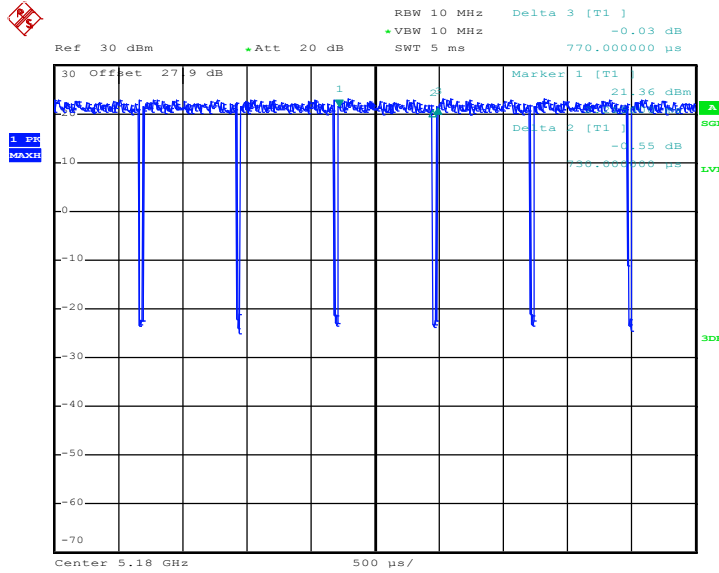

Date: 6.SEP.2017 00:21:49

802.11n HT20

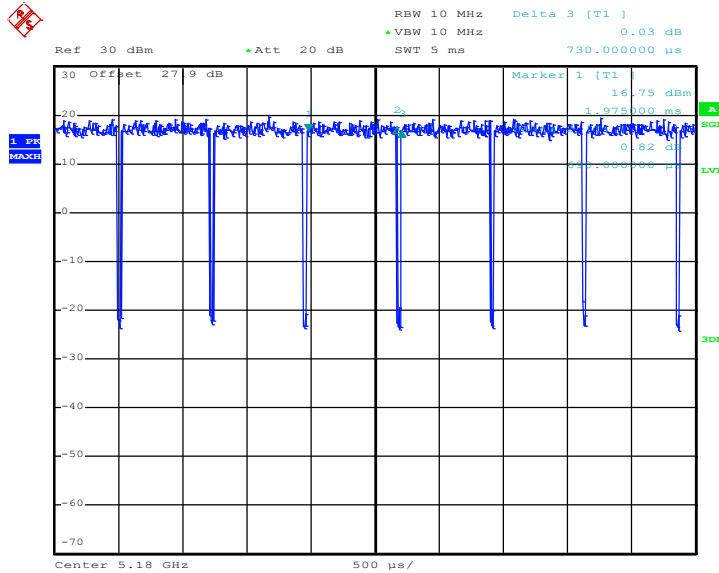

Date: 6.SEP.2017 00:28:07



802.11n HT40

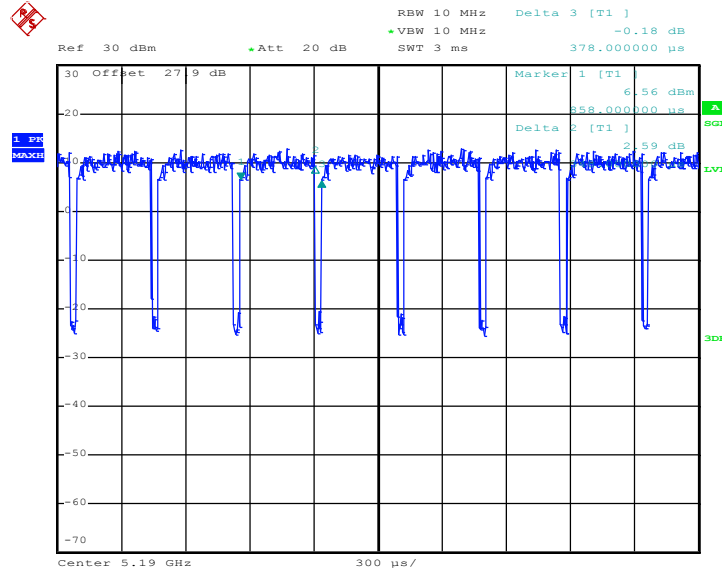

Date: 6.SEP.2017 00:32:19

802.11ac VHT20

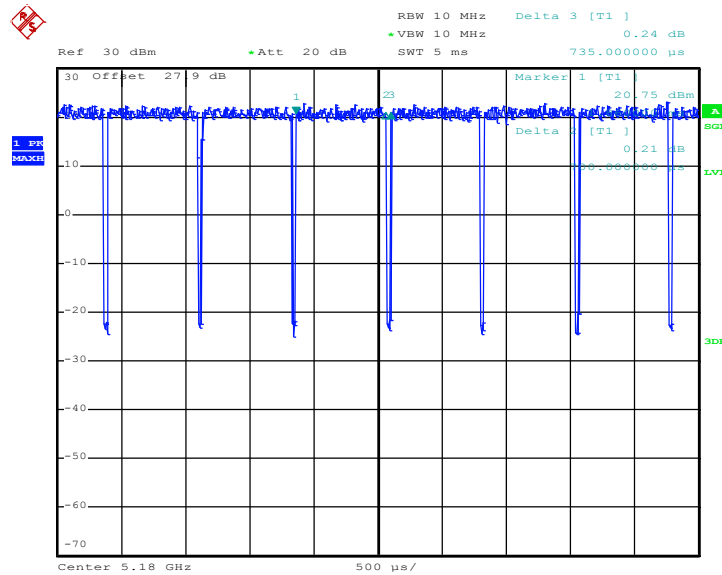

Date: 6.SEP.2017 00:26:20



802.11ac VHT40

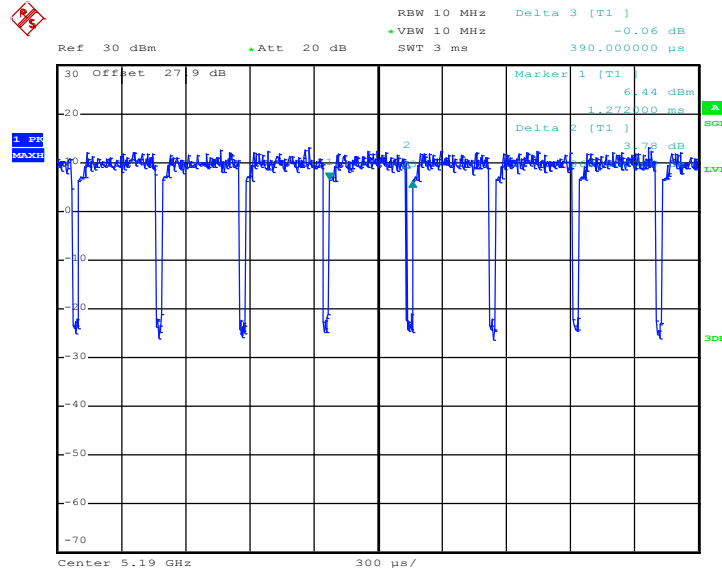

Date: 6.SEP.2017 00:29:45

802.11ac VHT80

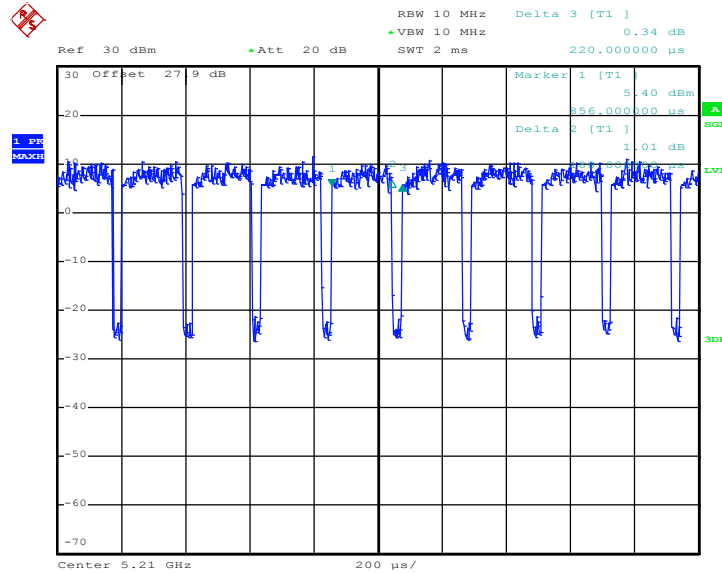

Date: 6.SEP.2017 01:25:36