



# FCC TEST REPORT

**REPORT NO.:** RF980827H06

**MODEL NO.:** MC3100

**RECEIVED:** July 29, 2009

**TESTED:** Aug. 31 to Sep. 03, 2009

**ISSUED:** Sep. 18, 2009

**APPLICANT:** Motorola Inc.

**ADDRESS:** One Motorola Plaza  
Holtsville NY 11742-1300  
USA

**ISSUED BY:** Bureau Veritas Consumer Products Services  
(H.K.) Ltd., Taoyuan Branch

**LAB LOCATION:** No. 81-1, Lu Liao Keng, 9th Ling, Wu Lung  
Tsuen, Chung Lin Hsiang, Hsin Chu Hsien 307,  
Taiwan

This test report consists of 80 pages in total. It may be duplicated completely for legal use with the approval of the applicant. It should not be reproduced except in full, without the written approval of our laboratory. The client should not use it to claim product endorsement by TAF or any government agencies. The test results in the report only apply to the tested sample.



## TABLE OF CONTENTS

|       |  |    |
|-------|--|----|
| 1     | CERTIFICATION.....                                       | 4  |
| 2     | SUMMARY OF TEST RESULTS.....                             | 5  |
| 2.1   | MEASUREMENT UNCERTAINTY .....                            | 6  |
| 3     | GENERAL INFORMATION.....                                 | 7  |
| 3.1   | GENERAL DESCRIPTION OF EUT.....                          | 7  |
| 3.2   | DESCRIPTION OF TEST MODES.....                           | 11 |
| 3.3   | TEST MODE APPLICABILITY AND TESTED CHANNEL DETAIL: ..... | 12 |
| 3.4   | GENERAL DESCRIPTION OF APPLIED STANDARDS.....            | 14 |
| 3.5   | DESCRIPTION OF SUPPORT UNITS .....                       | 15 |
| 3.6   | CONFIGURATION OF SYSTEM UNDER TEST .....                 | 16 |
| 4     | TEST PROCEDURES AND RESULTS.....                         | 19 |
| 4.1   | CONDUCTED EMISSION MEASUREMENT.....                      | 19 |
| 4.1.1 | LIMITS OF CONDUCTED EMISSION MEASUREMENT .....           | 19 |
| 4.1.2 | TEST INSTRUMENTS .....                                   | 19 |
| 4.1.3 | TEST PROCEDURES.....                                     | 20 |
| 4.1.4 | TEST SETUP .....   | 20 |
| 4.1.5 | EUT OPERATING CONDITIONS.....                            | 21 |
| 4.1.6 | TEST RESULTS .....                                       | 22 |
| 4.2   | NUMBER OF HOPPING FREQUENCY USED.....                    | 28 |
| 4.2.1 | LIMIT OF HOPPING FREQUENCY USED.....                     | 28 |
| 4.2.2 | TEST INSTRUMENTS .....                                   | 28 |
| 4.2.3 | TEST PROCEDURES.....                                     | 28 |
| 4.2.4 | DEVIATION FROM TEST STANDARD .....                       | 28 |
| 4.2.5 | TEST SETUP .....   | 29 |
| 4.2.6 | TEST RESULTS .....                                       | 29 |
| 4.3   | DWELL TIME ON EACH CHANNEL .....                         | 33 |
| 4.3.1 | LIMIT OF DWELL TIME USED .....                           | 33 |
| 4.3.2 | TEST INSTRUMENTS .....                                   | 33 |
| 4.3.3 | TEST PROCEDURES.....                                     | 33 |
| 4.3.4 | DEVIATION FROM TEST STANDARD .....                       | 34 |
| 4.3.5 | TEST SETUP .....   | 34 |
| 4.3.6 | TEST RESULTS .....                                       | 34 |
| 4.4   | CHANNEL BANDWIDTH.....                                   | 38 |
| 4.4.1 | LIMITS OF CHANNEL BANDWIDTH .....                        | 38 |
| 4.4.2 | TEST INSTRUMENTS .....                                   | 38 |
| 4.4.3 | TEST PROCEDURE .....                                     | 38 |
| 4.4.4 | DEVIATION FROM TEST STANDARD .....                       | 38 |
| 4.4.5 | TEST SETUP .....   | 39 |
| 4.4.6 | EUT OPERATING CONDITION.....                             | 39 |
| 4.4.7 | TEST RESULTS .....                                       | 40 |
| 4.5   | HOPPING CHANNEL SEPARATION .....                         | 46 |
| 4.5.1 | LIMIT OF HOPPING CHANNEL SEPARATION.....                 | 46 |
| 4.5.2 | TEST INSTRUMENTS .....                                   | 46 |



|       |  |    |
|-------|--|----|
| 4.5.3 | TEST PROCEDURES.....   | 46 |
| 4.5.4 | DEVIATION FROM TEST STANDARD .....   | 47 |
| 4.5.5 | TEST SETUP .....   | 47 |
| 4.5.6 | TEST RESULTS .....   | 48 |
| 4.6   | MAXIMUM PEAK OUTPUT POWER .....  | 54 |
| 4.6.1 | LIMITS OF MAXIMUM PEAK OUTPUT POWER MEASUREMENT .....                                    | 54 |
| 4.6.2 | INSTRUMENTS.....   | 54 |
| 4.6.3 | TEST PROCEDURES.....   | 54 |
| 4.6.4 | DEVIATION FROM TEST STANDARD .....   | 54 |
| 4.6.5 | TEST SETUP .....   | 55 |
| 4.6.6 | EUT OPERATING CONDITION.....   | 55 |
| 4.6.7 | TEST RESULTS .....   | 56 |
| 4.7   | RADIATED EMISSION MEASUREMENT.....   | 62 |
| 4.7.1 | LIMITS OF RADIATED EMISSION MEASUREMENT .....  | 62 |
| 4.7.2 | TEST INSTRUMENTS .....   | 63 |
| 4.7.3 | TEST PROCEDURES.....   | 64 |
| 4.7.4 | DEVIATION FROM TEST STANDARD .....   | 64 |
| 4.7.5 | TEST SETUP .....   | 65 |
| 4.7.6 | TEST RESULTS .....   | 66 |
| 4.8   | CONDUCTED OUT-BAND EMISSION MEASUREMENT .....  | 73 |
| 4.8.1 | LIMITS OF CONDUCTED OUT-BAND EMISSION MEASUREMENT .....                                  | 73 |
| 4.8.2 | TEST INSTRUMENTS .....   | 73 |
| 4.8.3 | TEST PROCEDURE .....   | 73 |
| 4.8.4 | DEVIATION FROM TEST STANDARD .....   | 73 |
| 4.8.5 | EUT OPERATING CONDITION.....   | 73 |
| 4.8.6 | TEST RESULTS .....   | 74 |
| 4.9   | ANTENNA REQUIREMENT .....  | 78 |
| 4.9.1 | STANDARD APPLICABLE .....  | 78 |
| 4.9.2 | ANTENNA CONNECTED CONSTRUCTION.....  | 78 |
| 5     | INFORMATION ON THE TESTING LABORATORIES .....  | 79 |
| 6     | APPENDIX A - MODIFICATIONS RECORDERS FOR ENGINEERING CHANGES TO THE EUT BY THE LAB ..... | 80 |



# 1 CERTIFICATION

**PRODUCT :** Mobile Computer  
**BRAND NAME :** MOTOROLA  
**MODEL NO. :** MC3100  
**APPLICANT :** Motorola Inc.  
**TESTED DATE :** Aug. 31 to Sep. 03, 2009  
**TEST SAMPLE :** ENGINEERING SAMPLE  
**STANDARDS :** 47 CFR Part 15, Subpart C (Section 15.247),  
ANSI C63.4-2003

The above equipment has been tested by **Bureau Veritas Consumer Products Services (H.K.) Ltd., Taoyuan Branch**, and found compliance with the requirement of the above standards. The test record, data evaluation & Equipment Under Test (EUT) configurations represented herein are true and accurate accounts of the measurements of the sample's EMC characteristics under the conditions specified in this report.

**PREPARED BY :** Carol Liao , **DATE:** Sep. 18, 2009  
( Carol Liao, Specialist )

**TECHNICAL ACCEPTANCE :** Hank Chung , **DATE:** Sep. 18, 2009  
Responsible for RF ( Hank Chung, Deputy Manager )

**APPROVED BY :** May Chen , **DATE:** Sep. 18, 2009  
(May Chen, Deputy Manager )

## 2 SUMMARY OF TEST RESULTS

The EUT has been tested according to the following specifications:

| <b>APPLIED STANDARD: 47 CFR Part 15, Subpart C</b> |  |               |  |
|--|--|---------------|--|
| <b>Standard Section</b>                            | <b>Test Type and Limit</b>   | <b>Result</b> | <b>REMARK</b>  |
| 15.207   | AC Power Conducted Emission  | PASS          | Meet the requirement of limit Minimum passing margin is -13.21dB at 0.162MHz |
| 15.247(a)(1)(I)-(ii)                               | Number of Hopping Frequency Used Spec.: At least 15 channels   | PASS          | Meet the requirement of limit  |
| 15.247(a)(1)(ii)                                   | Dwell Time on Each Channel Spec.: Max. 0.4 second within 31.6 second                                   | PASS          | Meet the requirement of limit  |
| 15.247(a)(1)(I)-(ii)                               | Hopping Channel Separation Spec. : Min. 25 kHz or two-thirds of 20 dB bandwidth, which ever is greater | PASS          | Meet the requirement of limit  |
| 15.247(a)(2)                                       | Spectrum Bandwidth of a Frequency Hopping Sequence Spread Spectrum System                              | PASS          | Meet the requirement of limit  |
| 15.247(b)  | Maximum Peak Output Power Spec.: max. 125mW  | PASS          | Meet the requirement of limit  |
| 15.247(c)  | Transmitter Radiated Emissions Spec.: Table 15.209   | PASS          | Meet the requirement of limit Minimum passing margin is -9.18dB at 40.12MHz  |
| 15.247(c)  | Conducted Out-Band Emissions Measurement   | PASS          | Meet the requirement of limit  |

## 2.1 MEASUREMENT UNCERTAINTY

Where relevant, the following measurement uncertainty levels have been estimated for tests performed on the EUT as specified in CISPR 16-4-2:

This uncertainty represents an expanded uncertainty expressed at approximately the 95% confidence level using a coverage factor of  $k=2$ .

| <b>Measurement</b>                | <b>Value</b> |
|-----------------------------------|--------------|
| Conducted emissions               | 2.44 dB      |
| Radiated emissions (30MHz-1GHz)   | 3.94 dB      |
| Radiated emissions (1GHz ~18GHz)  | 2.49 dB      |
| Radiated emissions (18GHz ~20GHz) | 2.70 dB      |

### 3 GENERAL INFORMATION

#### 3.1 GENERAL DESCRIPTION OF EUT

|                              |  |
|------------------------------|--|
| <b>PRODUCT</b>               | Mobile Computer  |
| <b>MODEL NO.</b>             | MC3100   |
| <b>FCC ID</b>                | UZ7MC3100  |
| <b>POWER SUPPLY</b>          | DC 12V to cradle,<br>DC 5.4V from power adapter or<br>DC 3.7V from battery   |
| <b>MODULATION TYPE</b>       | GFSK, $\pi/4$ – DQPSK, 8DPSK   |
| <b>MODULATION TECHNOLOGY</b> | FHSS   |
| <b>TRANSFER RATE</b>         | DH 1, DH 3, DH 5   |
| <b>FREQUENCY RANGE</b>       | 2402MHz ~ 2480MHz  |
| <b>NUMBER OF CHANNEL</b>     | 79   |
| <b>MAXIMUM OUTPUT POWER</b>  | GFSK: 1.445 mW<br>8DPSK: 2.449 mW<br>$\pi/4$ – DQPSK: 2.265 mW   |
| <b>ANTENNA TYPE</b>          | Please see note 2  |
| <b>DATA CABLE</b>            | RS232 Cable x 1 (Part No.: 25-67866-03R)<br>USB Cable x 1 (Part No.: 25-67868-03R)<br>(only for test, not for sale together) |
| <b>I/O PORTS</b>             | USB port x 1, SD slot port x 1, Audio port x 1   |
| <b>ASSOCIATED DEVICES</b>    | Battery x 1 for MC3100 (S) (Model No.: 82-127909-02)<br>Battery x 1 for MC3100(R) (Model No.: 82-127912-01)                  |

#### NOTE:

1. There are several types of MC3100 with identical Bluetooth module (BT2.1+EDR).
2. The EUT was pre-tested under the following modes:

| Test Mode     | Description      |
|---------------|------------------|
| Mode A        | X-Y plane        |
| Mode B        | Z-X plane        |
| <b>Mode C</b> | <b>Z-Y plane</b> |

From the above modes, the worst emission level was found in **Mode C**. Therefore only the test data of the modes were recorded in this report individually.



3. There are two antennas provided to this EUT, please refer to the following table:

| No. | Brand    | Model    | Antenna Type | Gain (dBi) | Connector Type | Frequency range (MHz) | Cable Loss(dB) | Cable Length |
|-----|----------|----------|--------------|------------|----------------|-----------------------|----------------|--------------|
| 1   | Motorola | Rot type | PIFA         | 3.08       | Hirose U.FL    | 2400~2480             | 0.1~0.15       | 35 ± 0.5mm   |
| 2   | Motorola | Str type | PIFA         | 2.481      | Hirose U.FL    | 2400~2480             | 0.1~0.15       | 35 ± 0.5mm   |

4. EUT Configuration:

|             | Straight type | Rotating type     |
|-------------|---------------|-------------------|
|             | Type1         | Type2             |
| OS          | WIN CE        | WIN CE            |
| CPU         | 624MHZ        | 624MHZ            |
| RAM         | 128MB         | 128MB             |
| Flash       | 256MB         | 256MB             |
| Keypad      | 48keys        | 28keys            |
| Battery     | (MOTOROLA)    | (MOTOROLA)        |
| Scan Engine | 2D imaging    | 1D laser scanning |
| BT          | V             | V                 |



5. The EUT could be supplied with the a charger, power adapter and Li-ion battery as below:

|   |  |
|---|--|
| <b>Cradle 1 (1-slot) (only for test, not for sale together)</b> |  |
| Brand:  | SYMBOL   |
| Part No.:   | CRD3000-1001RR   |
| Input power :   | +12V-----3.3A  |
| I/O Ports:  | USB Port x 1<br>RJ-45(console) Port x 1  |
| Associated devices:   | USB cable x 1 (Part No.: 25-68596-01R)<br>(1.6m, Unshielded without core)<br>RJ-45(console) cable x 1 (Part No.: 25-63852-01R)<br>(1.8m, Unshielded without core)<br>Adapter x 1 (Part No.: 50-14000-148R) |
| <b>Cradle 2 (4-slot) (only for test, not for sale together)</b> |  |
| Brand:  | SYMBOL   |
| Part No.:   | CRD3000-4001ER   |
| Input power :   | +12V-----9A  |
| I/O Ports:  | RJ-45(LAN) Port x 2  |
| Associated devices:   | Power cable x 2 (Part No.: 50-16002-042R)<br>(1.8m, Shielded with two cores)<br>Adapter x 2 (Part No.: 50-14000-241R)  |
| <b>Adapter 1 (only for Cradle 1 use, not for sale together)</b> |  |
| Brand:  | HIPRO  |
| Model No.:  | HP-O2040D43  |
| Part No.:   | 50-14000-148R  |
| Input power :   | 100-240V, 50-60Hz, 1.5A  |
| Output power :  | +12V-----3.33A<br>DC output cable (1.8m, Unshielded)   |
| <b>Adapter 2 (only for Cradle 2 use, not for sale together)</b> |  |
| Brand:  | SYMBOL   |
| Model No.:  | SYM04-1  |
| Part No.:   | 50-14000-241R  |
| Input power :   | 100-120/200-240V, 50-60Hz, 3.0/1.5A  |
| Output power :  | +12V-----9.0A  |

|   |  |
|---|--|
| <b>Adapter 3 (only for test, not for sale together)</b> |  |
| Brand:  | DELTA  |
| Model No.:  | ADP-16GB A   |
| Part No.:   | 50-14000-147   |
| Input power :   | 100-240V, 50-60Hz, 0.4A  |
| Output power :  | +5.4V----3.0A<br>DC output cable (1.8m, Unshielded, with one core) |
| <b>Adapter 4 (only for test, not for sale together)</b> |  |
| Brand:  | MOTOROLA   |
| Model No.:  | EADP-16BB A  |
| Part No.:   | 50-14000-249R  |
| Input power :   | 100-240V, 50-60Hz, 0.4A  |
| Output power :  | +5.4V----3.0A<br>DC output cable (1.8m, Unshielded)                |

6. The above EUT information was declared by the manufacturer and for more detailed features description, please refer to the manufacturer's specifications or User's Manual.

### 3.2 DESCRIPTION OF TEST MODES

Seventy-nine channels are provided to this EUT.

| Channel | Freq. (MHz) | Channel | Freq. (MHz) | Channel | Freq. (MHz) | Channel | Freq. (MHz) |
|---------|-------------|---------|-------------|---------|-------------|---------|-------------|
| 0       | 2402        | 20      | 2422        | 40      | 2442        | 60      | 2462        |
| 1       | 2403        | 21      | 2423        | 41      | 2443        | 61      | 2463        |
| 2       | 2404        | 22      | 2424        | 42      | 2444        | 62      | 2464        |
| 3       | 2405        | 23      | 2425        | 43      | 2445        | 63      | 2465        |
| 4       | 2406        | 24      | 2426        | 44      | 2446        | 64      | 2466        |
| 5       | 2407        | 25      | 2427        | 45      | 2447        | 65      | 2467        |
| 6       | 2408        | 26      | 2428        | 46      | 2448        | 66      | 2468        |
| 7       | 2409        | 27      | 2429        | 47      | 2449        | 67      | 2469        |
| 8       | 2410        | 28      | 2430        | 48      | 2450        | 68      | 2470        |
| 9       | 2411        | 29      | 2431        | 49      | 2451        | 69      | 2471        |
| 10      | 2412        | 30      | 2432        | 50      | 2452        | 70      | 2472        |
| 11      | 2413        | 31      | 2433        | 51      | 2453        | 71      | 2473        |
| 12      | 2414        | 32      | 2434        | 52      | 2454        | 72      | 2474        |
| 13      | 2415        | 33      | 2435        | 53      | 2455        | 73      | 2475        |
| 14      | 2416        | 34      | 2436        | 54      | 2456        | 74      | 2476        |
| 15      | 2417        | 35      | 2437        | 55      | 2457        | 75      | 2477        |
| 16      | 2418        | 36      | 2438        | 56      | 2458        | 76      | 2478        |
| 17      | 2419        | 37      | 2439        | 57      | 2459        | 77      | 2479        |
| 18      | 2420        | 38      | 2440        | 58      | 2460        | 78      | 2480        |
| 19      | 2421        | 39      | 2441        | 59      | 2461        |         |             |

### 3.3 TEST MODE APPLICABILITY AND TESTED CHANNEL DETAIL:

The device has several types and different accessory, therefore the worst case base on investigation by different combination for each test item and its data was recorded in this report.

| EUT CONFIGURE MODE | APPLICABLE TO |         |                    |      | DESCRIPTION  |
|--------------------|---------------|---------|--------------------|------|--|
|                    | PLC           | RE < 1G | RE <sup>≥</sup> 1G | APCM |  |
| A                  | √             |         | √                  | √    | USB Mode: Type2 MC3100+Battery+Adapter(motorola)                                       |
| B                  | √             |         |                    |      | cradle mode: (1-slot)Type2 MC3100+Battery+Adapter                                      |
| C                  | √             | √       |                    |      | cradle mode: (4-slot) 2*(Type2 MC3100+Battery)<br>+2*( Type2_2 MC3190+Battery)+Adapter |

Where **PLC**: Power Line Conducted Emission

**RE < 1G**: Radiated Emission below 1GHz

**RE <sup>≥</sup> 1G**: Radiated Emission above 1GHz

**APCM**: Antenna Port Conducted Measurement

#### **Power Line Conducted Emission Test:**

- Pre-Scan has been conducted to determine the worst-case mode from all possible combinations between available modulations, data rates and antenna ports (if EUT with antenna diversity architecture).
- Following channel(s) was (were) selected for the final test as listed below.

| Available Channel | Tested Channel | Modulation Technology | Modulation Type | Packet Type | EUT CONFIGURE MODE |
|-------------------|----------------|-----------------------|-----------------|-------------|--------------------|
| 0 to 78           | 78             | FHSS                  | 8DPSK           | DH5         | A, B, C            |

#### **Radiated Emission Test (Below 1 GHz):**

- Pre-Scan has been conducted to determine the worst-case mode from all possible combinations between available modulations, data rates and antenna ports (if EUT with antenna diversity architecture).
- Following channel(s) was (were) selected for the final test as listed below.

| Available Channel | Tested Channel | Modulation Technology | Modulation Type | Packet Type | EUT CONFIGURE MODE |
|-------------------|----------------|-----------------------|-----------------|-------------|--------------------|
| 0 to 78           | 0              | FHSS                  | 8DPSK           | DH5         | C                  |

**Radiated Emission Test (Above 1 GHz):**

- Pre-Scan has been conducted to determine the worst-case mode from all possible combinations between available modulations, data rates and antenna ports (if EUT with antenna diversity architecture).
- Following channel(s) was (were) selected for the final test as listed below.

| Available Channel | Tested Channel | Modulation Technology | Modulation Type | Packet Type | EUT CONFIGURE MODE |
|-------------------|----------------|-----------------------|-----------------|-------------|--------------------|
| 0 to 78           | 0, 39, 78      | FHSS                  | GFSK            | DH5         | A                  |
| 0 to 78           | 0, 39, 78      | FHSS                  | 8DPSK           | DH5         | A                  |

**Conducted Out-Band Measurement:**

- Pre-Scan has been conducted to determine the worst-case mode from all possible combinations between available modulations, data rates and antenna ports (if EUT with antenna diversity architecture).
- Following channel(s) was (were) selected for the final test as listed below.

| Available Channel | Tested Channel | Modulation Technology | Modulation Type | Packet Type | EUT CONFIGURE MODE |
|-------------------|----------------|-----------------------|-----------------|-------------|--------------------|
| 0 to 78           | 0, 78          | FHSS                  | GFSK            | DH5         | A                  |
| 0 to 78           | 0, 78          | FHSS                  | 8DPSK           | DH5         | A                  |

**Antenna Port Conducted Measurement:**

- Pre-Scan has been conducted to determine the worst-case mode from all possible combinations between available modulations, data rates and antenna ports (if EUT with antenna diversity architecture).
- Following channel(s) was (were) selected for the final test as listed below.

| Available Channel | Tested Channel | Modulation Technology | Modulation Type | Packet Type | EUT CONFIGURE MODE |
|-------------------|----------------|-----------------------|-----------------|-------------|--------------------|
| 0 to 78           | 0, 39, 78      | FHSS                  | GFSK            | DH5         | A                  |
| 0 to 78           | 0, 39, 78      | FHSS                  | 8DPSK           | DH5         | A                  |
| 0 to 78           | 0, 39, 78      | FHSS                  | $\pi/4$ -DQPSK  | DH5         | A                  |



### **3.4 GENERAL DESCRIPTION OF APPLIED STANDARDS**

The EUT is a Mobile Computer. According to the specifications of the manufacturer, it must comply with the requirements of the following standards:

**FCC Part 15, Subpart C. (15.247)**

**ANSI C63.4 : 2003**

All test items have been performed and recorded as per the above standards.

**NOTE:** The EUT is also considered as a kind of computer peripheral, because the connection to computer is necessary for typical use. It has been verified to comply with the requirements of FCC Part 15, Subpart B, Class B (DoC). The test report has been issued separately.

### 3.5 DESCRIPTION OF SUPPORT UNITS

The EUT has been tested as an independent unit together with other necessary accessories or support units. The following support units or accessories were used to form a representative test configuration during the tests.

| NO. | PRODUCT           | BRAND     | MODEL NO.    | SERIAL NO.                   | FCC ID          |
|-----|-------------------|-----------|--------------|------------------------------|-----------------|
| 1   | NOTEBOOK COMPUTER | DELL      | PP19L        | CN-OHC416-7016<br>6-5CA-0448 | PIW632500516610 |
| 2   | NOTEBOOK COMPUTER | DELL      | PP17L        | CN-ONF743-48643<br>-7AV-0124 | FCC DoC         |
| 3   | EARPHONE          | SYMBOL    | NA           | NA                           | NA              |
| 4   | SD CARD           | Transcend | NA           | NA                           | NA              |
| 5   | BETTERY           | SYMBOL    | 55-060112-05 | N/A                          | NA              |
| 6   | IPOD              | APPLE     | A1137        | 6U6078FMUPR                  | FCC DOC         |
| 7   | MOBILE COMPUTER   | MOTOROLA  | MC3190       | N/A                          | UZ7MC3190       |

| No. | Signal cable description  |
|-----|---|
| 1   | NA  |
| 2   | NA  |
| 3   | 1.3 m wrapped unshielded wire, terminated via drain wire, with 3.5 mm phone plug, w/o core. |
| 4   | NA  |
| 5   | NA  |
| 6   | 1.2 m foil shielded wire, USB connector, w/o core.  |
| 7   | NA  |

Note: 1. All power cords of the above support units are unshielded (1.8m).

### 3.6 CONFIGURATION OF SYSTEM UNDER TEST

For USB Mode:

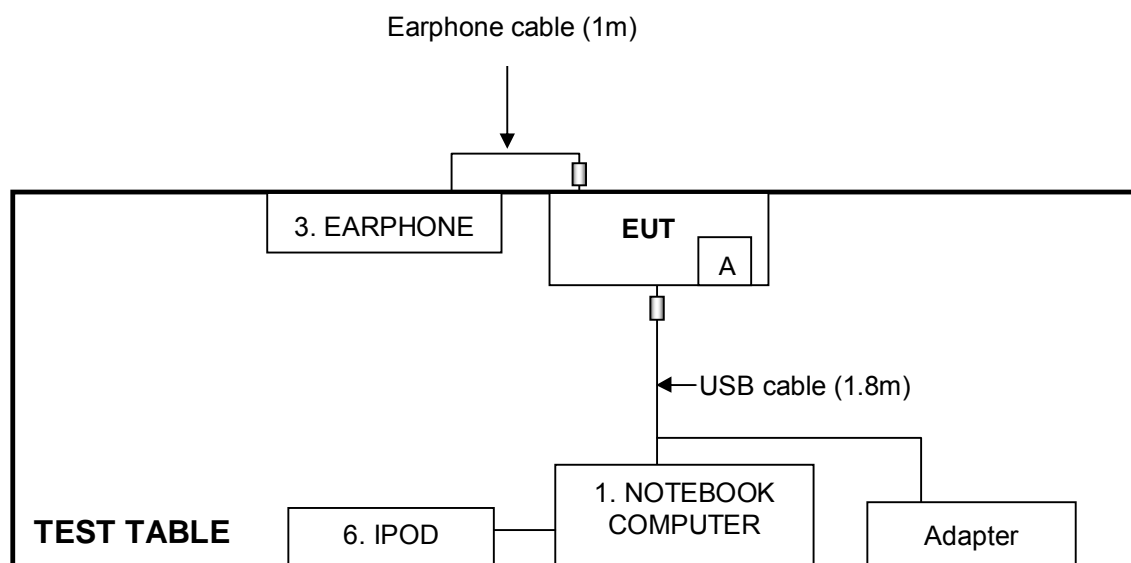

**NOTE:** 1. Item A is the SD Card (Support unit 4).



**For Cradle (1 Slot) Mode:**

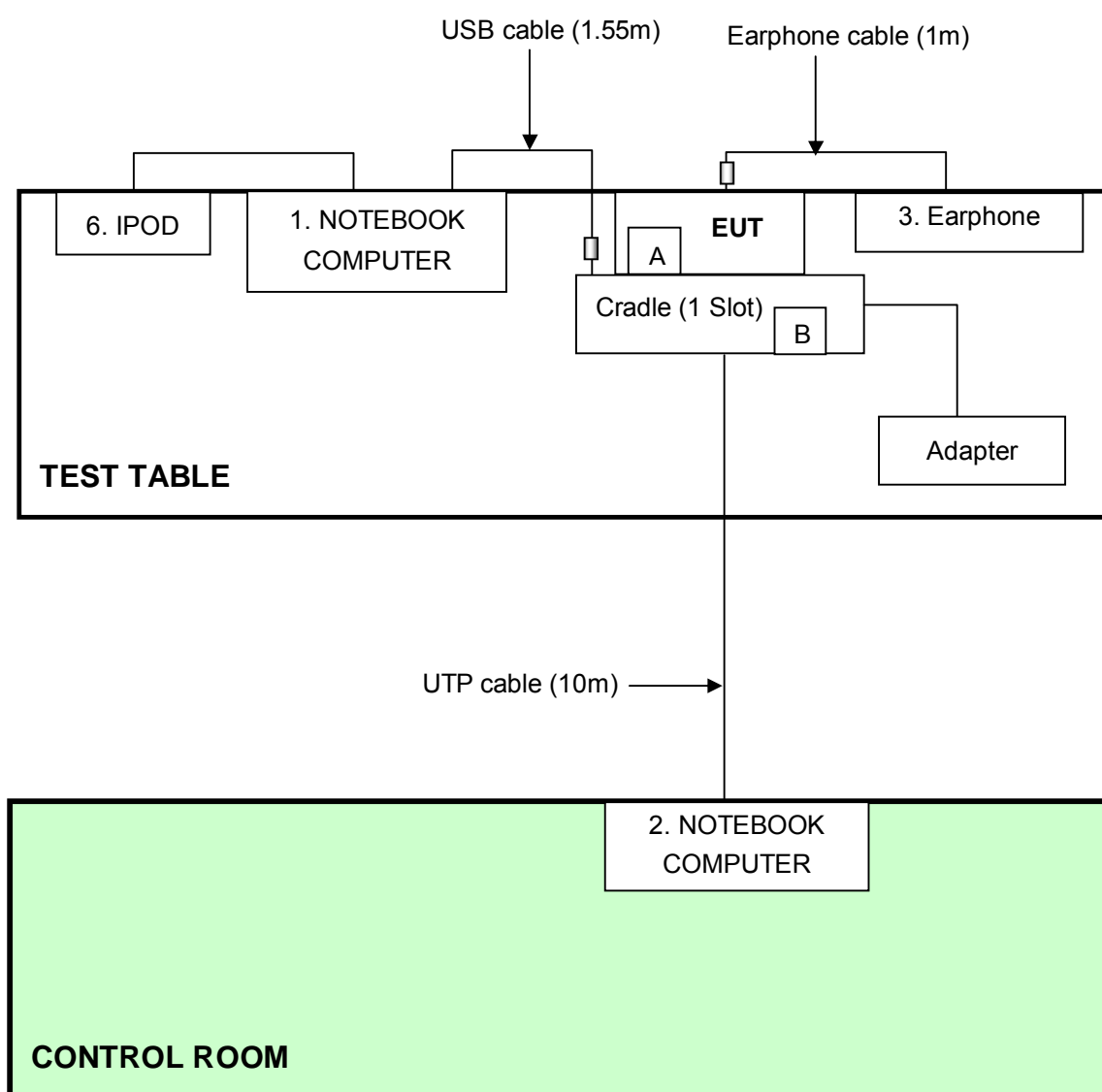

**NOTE:** 1. Item A is the SD Card (Support unit 4).  
 2. Item B is the Battery (Support unit 5).

**For Cradle (4 Slot) Mode:**

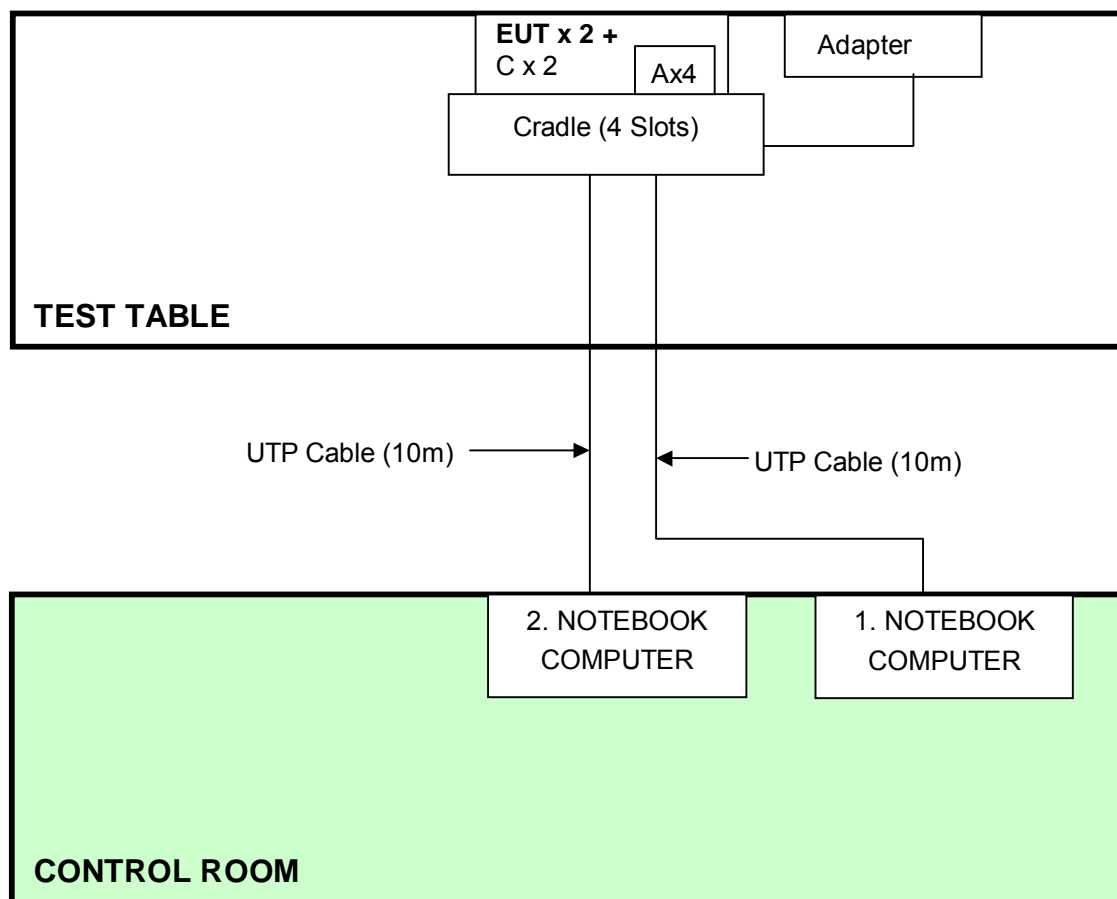

**NOTE:** 1. Item A is the SD Card (Support unit 4).  
 2. Item C is the Mobile Computer (Support unit 7).

## 4 TEST PROCEDURES AND RESULTS

### 4.1 CONDUCTED EMISSION MEASUREMENT

#### 4.1.1 LIMITS OF CONDUCTED EMISSION MEASUREMENT

| FREQUENCY OF EMISSION (MHz) | CONDUCTED LIMIT (dB $\mu$ V) |          |
|-----------------------------|------------------------------|----------|
|                             | Quasi-peak                   | Average  |
| 0.15-0.5                    | 66 to 56                     | 56 to 46 |
| 0.5-5                       | 56                           | 46       |
| 5-30                        | 60                           | 50       |

**NOTE:**

1. The lower limit shall apply at the transition frequencies.
2. All emanations from a class B digital device or system, including any network of conductors and apparatus connected thereto, shall not exceed the level of field strengths specified above.

#### 4.1.2 TEST INSTRUMENTS

| DESCRIPTION & MANUFACTURER                            | MODEL NO.             | SERIAL NO. | CALIBRATED DATE | CALIBRATED UNTIL |
|---|-----------------------|------------|-----------------|------------------|
| Test Receiver   | ESCS 30               | 100375     | Mar. 23, 2009   | Mar. 22, 2010    |
| Line-Impedance Stabilization Network (for Peripheral) | ENV-216               | 100071     | Nov. 26, 2008   | Nov. 25, 2009    |
| Line-Impedance Stabilization Network (for EUT)        | ESH3-Z5               | 848773/004 | Nov. 05, 2008   | Nov. 04, 2009    |
| RF Cable (JYEBAO)                                     | 5DFB                  | COBCAB-001 | Aug. 15, 2009   | Aug. 14, 2010    |
| 50 ohms Terminator                                    | 50                    | 3          | Nov. 05, 2008   | Nov. 04, 2009    |
| Software  | BV<br>ADT_Cond_V7.3.7 | NA         | NA              | NA               |

**Note:**

1. The calibration interval of the above test instruments is 12 months and the calibrations are traceable to NML/ROC and NIST/USA.
2. The test was performed in Shielded Room No. B.
3. The VCCI Con B Registration No. is C-2193.

#### 4.1.3 TEST PROCEDURES

- a. The EUT/HOST was placed 0.4 meters from the conducting wall of the shielded room with EUT/HOST being connected to the power mains through a line impedance stabilization network (LISN). Other support units were connected to the power mains through another LISN. The two LISNs provide 50 ohm/ 50uH of coupling impedance for the measuring instrument.
- b. Both lines of the power mains connected to the EUT/HOST were checked for maximum conducted interference.
- c. The frequency range from 150 kHz to 30 MHz was searched. Emission levels over 10dB under the prescribed limits could not be reported

#### 4.1.4 TEST SETUP

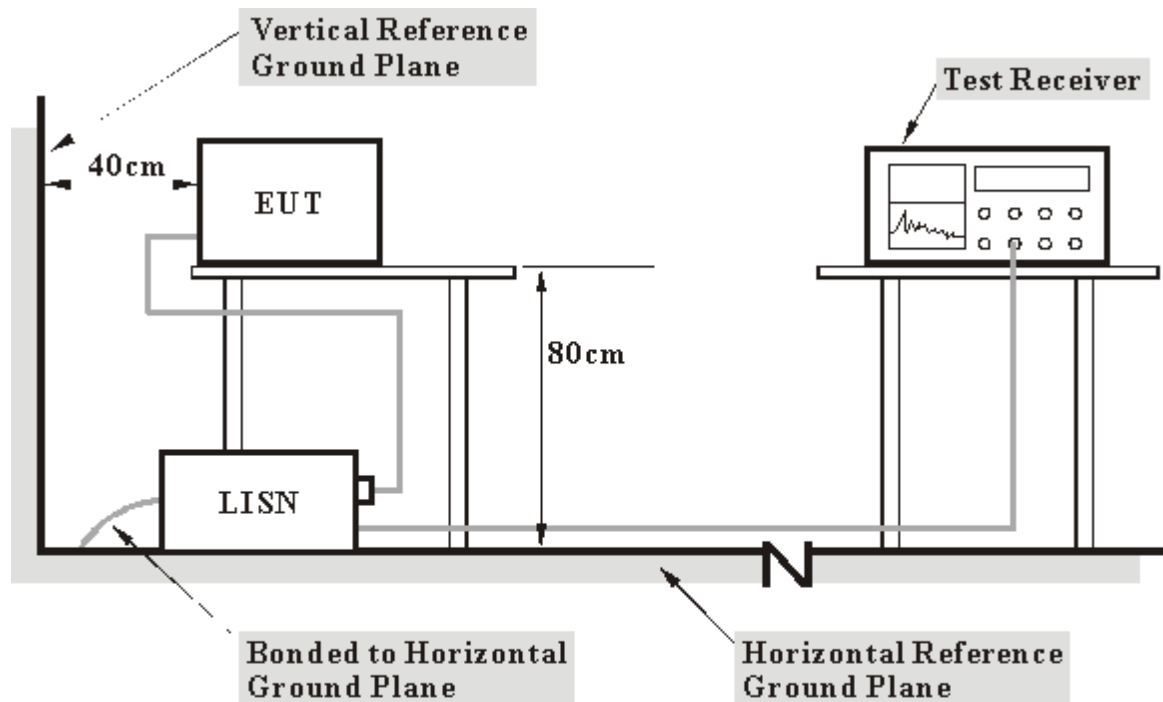

- Note:**
1. Support units were connected to second LISN.
  2. Both of LISNs (AMN) 80 cm from EUT and at the least 80 cm from other units and other metal planes support units.

For the actual test configuration, please refer to the related item – Photographs of the Test Configuration.

#### 4.1.5 EUT OPERATING CONDITIONS

**For USB Mode:**

1. Set the EUT under charger condition via USB charging cable.
2. EUT runs the test program "BTRegTest ver3.5.exe" to transmission/receiving condition continuously.

**For Cradle Mode:**

1. Set the EUT under charger condition via cradle.
2. EUT runs the test program "BTRegTest ver3.5.exe" to transmission/receiving condition continuously.

#### 4.1.6 TEST RESULTS

##### For USB Mode

|                                 |                           |                      |          |
|---------------------------------|---------------------------|----------------------|----------|
| <b>INPUT POWER (SYSTEM)</b>     | 120Vac, 60 Hz             | <b>6DB BANDWIDTH</b> | 9 kHz    |
| <b>ENVIRONMENTAL CONDITIONS</b> | 25 deg. C, 66%RH, 965 hPa | <b>PHASE</b>         | Line (L) |
| <b>TESTED BY</b>                | Wen Yu                    |                      |          |

| No | Freq. [MHz] | Corr. Factor (dB) | Reading Value |     | Emission Level |     | Limit     |       | Margin |     |
|----|-------------|-------------------|---------------|-----|----------------|-----|-----------|-------|--------|-----|
|    |             |                   | [dB (uV)]     |     | [dB (uV)]      |     | [dB (uV)] |       | (dB)   |     |
|    |             |                   | Q.P.          | AV. | Q.P.           | AV. | Q.P.      | AV.   | Q.P.   | AV. |
| 1  | 0.150       | 0.17              | 48.12         | -   | 48.29          | -   | 66.00     | 56.00 | -17.71 | -   |
| 2  | 0.177       | 0.18              | 43.24         | -   | 43.42          | -   | 64.61     | 54.61 | -21.19 | -   |
| 3  | 0.502       | 0.23              | 33.59         | -   | 33.82          | -   | 56.00     | 46.00 | -22.18 | -   |
| 4  | 4.402       | 0.65              | 32.74         | -   | 33.39          | -   | 56.00     | 46.00 | -22.61 | -   |
| 5  | 6.180       | 0.76              | 36.88         | -   | 37.64          | -   | 60.00     | 50.00 | -22.36 | -   |
| 6  | 15.492      | 1.19              | 39.13         | -   | 40.32          | -   | 60.00     | 50.00 | -19.68 | -   |

- REMARKS:**
1. Q.P. and AV. are abbreviations of quasi-peak and average individually.
  2. "-": The Quasi-peak reading value also meets average limit and measurement with the average detector is unnecessary.
  3. The emission levels of other frequencies were very low against the limit.
  4. Margin value = Emission level - Limit value
  5. Correction factor = Insertion loss + Cable loss
  6. Emission Level = Correction Factor + Reading Value.

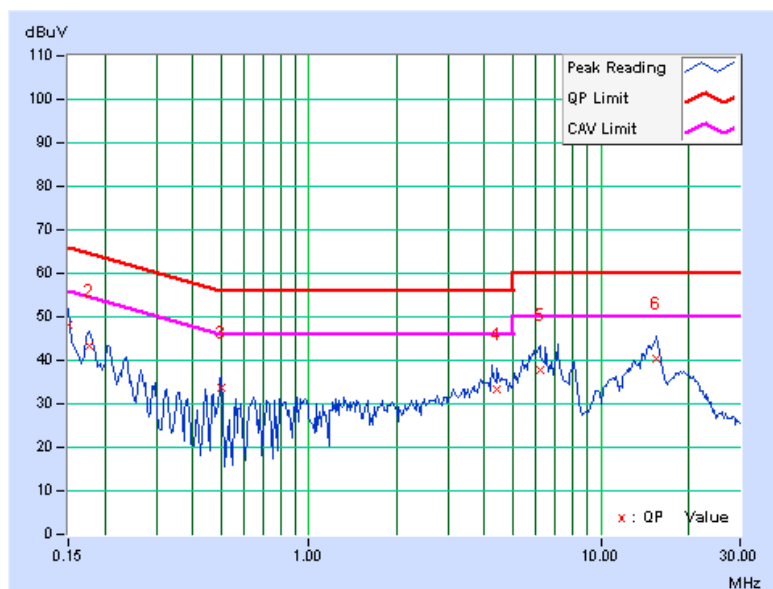



A D T

|                                 |                              |                      |             |
|---------------------------------|------------------------------|----------------------|-------------|
| <b>INPUT POWER (SYSTEM)</b>     | 120Vac, 60 Hz                | <b>6dB BANDWIDTH</b> | 9 kHz       |
| <b>ENVIRONMENTAL CONDITIONS</b> | 25 deg. C, 66%RH,<br>965 hPa | <b>PHASE</b>         | Neutral (N) |
| <b>TESTED BY</b>                | Frank Liu                    |                      |             |

| No | Freq.<br>[MHz] | Corr.<br>Factor<br>(dB) | Reading Value |     | Emission Level |     | Limit     |       | Margin |     |
|----|----------------|-------------------------|---------------|-----|----------------|-----|-----------|-------|--------|-----|
|    |                |                         | [dB (uV)]     |     | [dB (uV)]      |     | [dB (uV)] |       | (dB)   |     |
|    |                |                         | Q.P.          | AV. | Q.P.           | AV. | Q.P.      | AV.   | Q.P.   | AV. |
| 1  | 0.150          | 0.10                    | 48.01         | -   | 48.11          | -   | 66.00     | 56.00 | -17.89 | -   |
| 2  | 0.177          | 0.11                    | 42.55         | -   | 42.66          | -   | 64.61     | 54.61 | -21.95 | -   |
| 3  | 0.502          | 0.17                    | 33.27         | -   | 33.44          | -   | 56.00     | 46.00 | -22.56 | -   |
| 4  | 4.523          | 0.58                    | 32.51         | -   | 33.09          | -   | 56.00     | 46.00 | -22.91 | -   |
| 5  | 6.199          | 0.66                    | 36.84         | -   | 37.50          | -   | 60.00     | 50.00 | -22.50 | -   |
| 6  | 15.426         | 0.98                    | 38.42         | -   | 39.40          | -   | 60.00     | 50.00 | -20.60 | -   |

- REMARKS:**
1. Q.P. and AV. are abbreviations of quasi-peak and average individually.
  2. "-": The Quasi-peak reading value also meets average limit and measurement with the average detector is unnecessary.
  3. The emission levels of other frequencies were very low against the limit.
  4. Margin value = Emission level - Limit value
  5. Correction factor = Insertion loss + Cable loss
  6. Emission Level = Correction Factor + Reading Value.

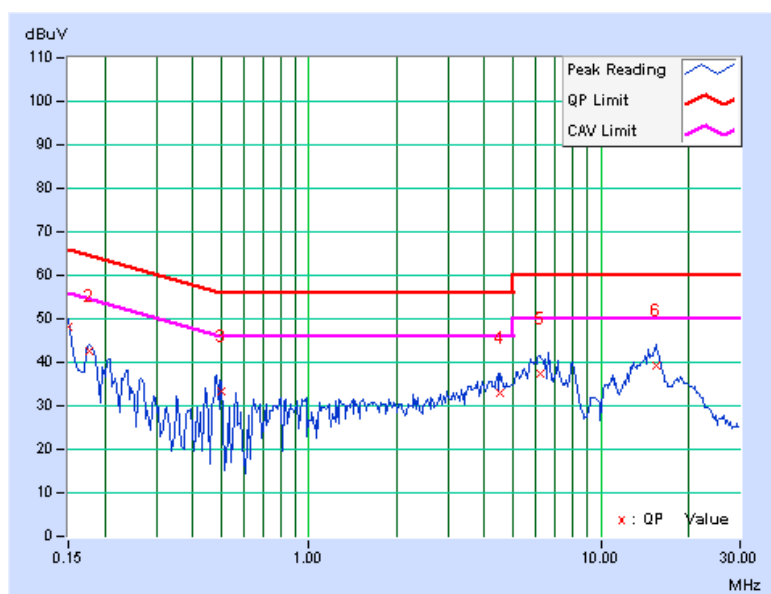



A D T

**For Cradle (1 Slot) Mode**

|                                 |                              |                      |          |
|---------------------------------|------------------------------|----------------------|----------|
| <b>INPUT POWER (SYSTEM)</b>     | 120Vac, 60 Hz                | <b>6DB BANDWIDTH</b> | 9 kHz    |
| <b>ENVIRONMENTAL CONDITIONS</b> | 25 deg. C, 66%RH,<br>965 hPa | <b>PHASE</b>         | Line (L) |
| <b>TESTED BY</b>                | Frank Liu                    |                      |          |

| No | Freq.<br>[MHz] | Corr.<br>Factor<br>(dB) | Reading Value |     | Emission Level |     | Limit     |       | Margin |     |
|----|----------------|-------------------------|---------------|-----|----------------|-----|-----------|-------|--------|-----|
|    |                |                         | [dB (uV)]     |     | [dB (uV)]      |     | [dB (uV)] |       | (dB)   |     |
|    |                |                         | Q.P.          | AV. | Q.P.           | AV. | Q.P.      | AV.   | Q.P.   | AV. |
| 1  | 0.205          | 0.18                    | 45.67         | -   | 45.85          | -   | 63.42     | 53.42 | -17.57 | -   |
| 2  | 0.306          | 0.19                    | 36.57         | -   | 36.76          | -   | 60.07     | 50.07 | -23.32 | -   |
| 3  | 0.412          | 0.19                    | 37.67         | -   | 37.86          | -   | 57.61     | 47.61 | -19.75 | -   |
| 4  | 0.615          | 0.28                    | 38.24         | -   | 38.52          | -   | 56.00     | 46.00 | -17.48 | -   |
| 5  | 0.884          | 0.39                    | 33.67         | -   | 34.06          | -   | 56.00     | 46.00 | -21.94 | -   |
| 6  | 1.300          | 0.47                    | 33.42         | -   | 33.89          | -   | 56.00     | 46.00 | -22.11 | -   |

- REMARKS:**
1. Q.P. and AV. are abbreviations of quasi-peak and average individually.
  2. "-": The Quasi-peak reading value also meets average limit and measurement with the average detector is unnecessary.
  3. The emission levels of other frequencies were very low against the limit.
  4. Margin value = Emission level - Limit value
  5. Correction factor = Insertion loss + Cable loss
  6. Emission Level = Correction Factor + Reading Value.

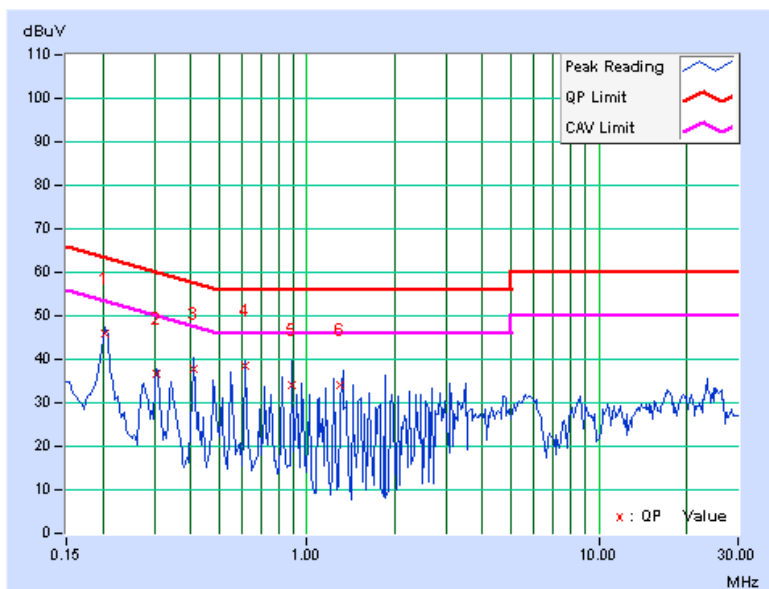





A D T

|                                 |                              |                      |             |
|---------------------------------|------------------------------|----------------------|-------------|
| <b>INPUT POWER (SYSTEM)</b>     | 120Vac, 60 Hz                | <b>6dB BANDWIDTH</b> | 9 kHz       |
| <b>ENVIRONMENTAL CONDITIONS</b> | 25 deg. C, 66%RH,<br>965 hPa | <b>PHASE</b>         | Neutral (N) |
| <b>TESTED BY</b>                | Frank Liu                    |                      |             |

| No | Freq.<br>[MHz] | Corr.<br>Factor<br>(dB) | Reading Value |     | Emission Level |     | Limit     |       | Margin |     |
|----|----------------|-------------------------|---------------|-----|----------------|-----|-----------|-------|--------|-----|
|    |                |                         | [dB (uV)]     |     | [dB (uV)]      |     | [dB (uV)] |       | (dB)   |     |
|    |                |                         | Q.P.          | AV. | Q.P.           | AV. | Q.P.      | AV.   | Q.P.   | AV. |
| 1  | 0.205          | 0.11                    | 45.64         | -   | 45.75          | -   | 63.42     | 53.42 | -17.67 | -   |
| 2  | 0.306          | 0.12                    | 36.84         | -   | 36.96          | -   | 60.07     | 50.07 | -23.11 | -   |
| 3  | 0.408          | 0.13                    | 32.65         | -   | 32.78          | -   | 57.69     | 47.69 | -24.91 | -   |
| 4  | 0.615          | 0.21                    | 31.96         | -   | 32.17          | -   | 56.00     | 46.00 | -23.83 | -   |
| 5  | 0.822          | 0.28                    | 34.84         | -   | 35.12          | -   | 56.00     | 46.00 | -20.88 | -   |
| 6  | 0.924          | 0.32                    | 29.66         | -   | 29.98          | -   | 56.00     | 46.00 | -26.02 | -   |

- REMARKS:**
1. Q.P. and AV. are abbreviations of quasi-peak and average individually.
  2. "-": The Quasi-peak reading value also meets average limit and measurement with the average detector is unnecessary.
  3. The emission levels of other frequencies were very low against the limit.
  4. Margin value = Emission level - Limit value
  5. Correction factor = Insertion loss + Cable loss
  6. Emission Level = Correction Factor + Reading Value.

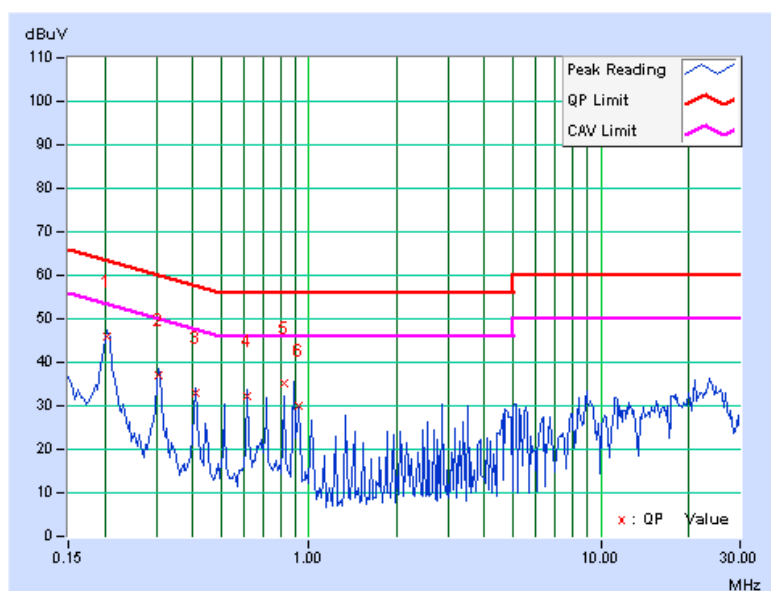



A D T

**For Cradle (4 Slot) Mode**

|                                 |                              |                      |          |
|---------------------------------|------------------------------|----------------------|----------|
| <b>INPUT POWER (SYSTEM)</b>     | 120Vac, 60 Hz                | <b>6DB BANDWIDTH</b> | 9 kHz    |
| <b>ENVIRONMENTAL CONDITIONS</b> | 25 deg. C, 66%RH,<br>965 hPa | <b>PHASE</b>         | Line (L) |
| <b>TESTED BY</b>                | Frank Liu                    |                      |          |

| No | Freq.<br>[MHz] | Corr.<br>Factor<br>(dB) | Reading Value |     | Emission Level |     | Limit        |              | Margin        |     |
|----|----------------|-------------------------|---------------|-----|----------------|-----|--------------|--------------|---------------|-----|
|    |                |                         | [dB (uV)]     |     | [dB (uV)]      |     | [dB (uV)]    |              | (dB)          |     |
|    |                |                         | Q.P.          | AV. | Q.P.           | AV. | Q.P.         | AV.          | Q.P.          | AV. |
| 1  | 0.150          | 0.17                    | 50.44         | -   | 50.61          | -   | 66.00        | 56.00        | -15.39        | -   |
| 2  | <b>0.162</b>   | <b>0.17</b>             | <b>51.99</b>  | -   | <b>52.16</b>   | -   | <b>65.38</b> | <b>55.38</b> | <b>-13.21</b> | -   |
| 3  | 0.173          | 0.17                    | 43.34         | -   | 43.51          | -   | 64.79        | 54.79        | -21.28        | -   |
| 4  | 0.227          | 0.18                    | 39.26         | -   | 39.44          | -   | 62.56        | 52.56        | -23.12        | -   |
| 5  | 0.295          | 0.18                    | 32.27         | -   | 32.45          | -   | 60.40        | 50.40        | -27.94        | -   |
| 6  | 0.748          | 0.33                    | 27.29         | -   | 27.62          | -   | 56.00        | 46.00        | -28.38        | -   |

- REMARKS:**
1. Q.P. and AV. are abbreviations of quasi-peak and average individually.
  2. "-": The Quasi-peak reading value also meets average limit and measurement with the average detector is unnecessary.
  3. The emission levels of other frequencies were very low against the limit.
  4. Margin value = Emission level - Limit value
  5. Correction factor = Insertion loss + Cable loss
  6. Emission Level = Correction Factor + Reading Value.

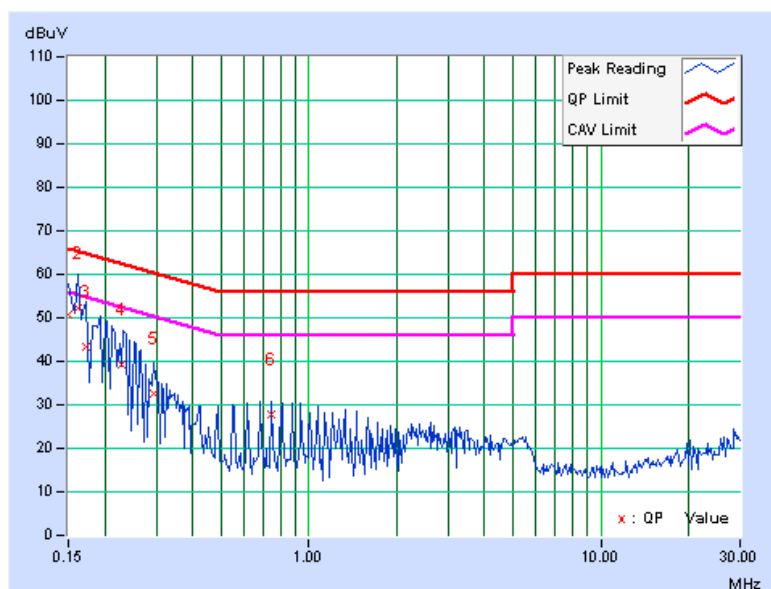



A D T

|                                 |                              |                      |             |
|---------------------------------|------------------------------|----------------------|-------------|
| <b>INPUT POWER (SYSTEM)</b>     | 120Vac, 60 Hz                | <b>6dB BANDWIDTH</b> | 9 kHz       |
| <b>ENVIRONMENTAL CONDITIONS</b> | 25 deg. C, 66%RH,<br>965 hPa | <b>PHASE</b>         | Neutral (N) |
| <b>TESTED BY</b>                | Frank Liu                    |                      |             |

| No | Freq.<br>[MHz] | Corr.<br>Factor<br>(dB) | Reading Value |     | Emission Level |     | Limit     |       | Margin |     |
|----|----------------|-------------------------|---------------|-----|----------------|-----|-----------|-------|--------|-----|
|    |                |                         | [dB (uV)]     |     | [dB (uV)]      |     | [dB (uV)] |       | (dB)   |     |
|    |                |                         | Q.P.          | AV. | Q.P.           | AV. | Q.P.      | AV.   | Q.P.   | AV. |
| 1  | 0.159          | 0.10                    | 51.84         | -   | 51.94          | -   | 65.51     | 55.51 | -13.57 | -   |
| 2  | 0.227          | 0.11                    | 40.73         | -   | 40.84          | -   | 62.56     | 52.56 | -21.72 | -   |
| 3  | 0.228          | 0.11                    | 40.26         | -   | 40.37          | -   | 62.52     | 52.52 | -22.15 | -   |
| 4  | 0.291          | 0.12                    | 35.74         | -   | 35.86          | -   | 60.51     | 50.51 | -24.65 | -   |
| 5  | 0.619          | 0.21                    | 27.83         | -   | 28.04          | -   | 56.00     | 46.00 | -27.96 | -   |
| 6  | 0.748          | 0.26                    | 28.66         | -   | 28.92          | -   | 56.00     | 46.00 | -27.08 | -   |

- REMARKS:**
1. Q.P. and AV. are abbreviations of quasi-peak and average individually.
  2. "-": The Quasi-peak reading value also meets average limit and measurement with the average detector is unnecessary.
  3. The emission levels of other frequencies were very low against the limit.
  4. Margin value = Emission level - Limit value
  5. Correction factor = Insertion loss + Cable loss
  6. Emission Level = Correction Factor + Reading Value.

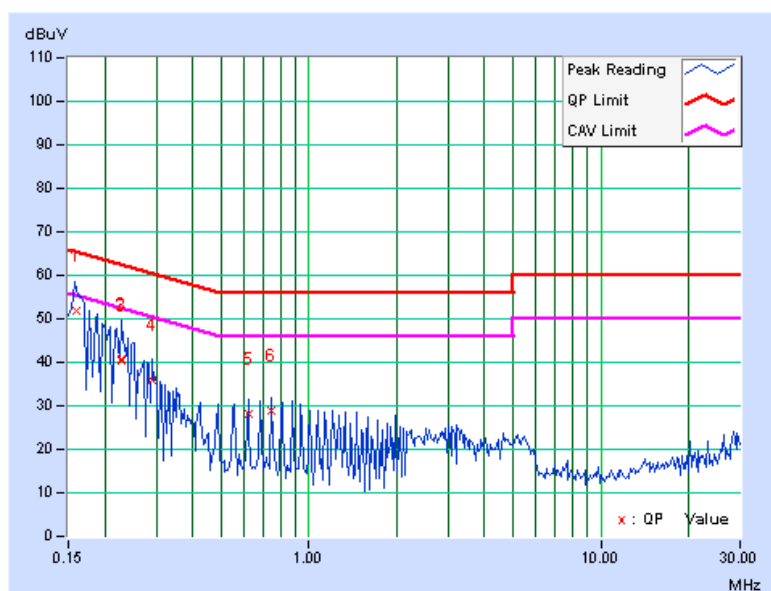

## 4.2 NUMBER OF HOPPING FREQUENCY USED

### 4.2.1 LIMIT OF HOPPING FREQUENCY USED

At least 15 hopping frequencies, and should be equally spaced.

### 4.2.2 TEST INSTRUMENTS

| DESCRIPTION & MANUFACTURER | MODEL NO. | SERIAL NO. | CALIBRATED DATE | CALIBRATED UNTIL |
|----------------------------|-----------|------------|-----------------|------------------|
| R&S SPECTRUM ANALYZER      | FSP40     | 100037     | Aug. 09, 2009   | Aug. 08, 2010    |

**NOTE:**

1. The calibration interval of the above test instruments is 12 months and the calibrations are traceable to NML/ROC and NIST/USA.

### 4.2.3 TEST PROCEDURES

1. Check the calibration of the measuring instrument (SA) using either an internal calibrator or a known signal from an external generator.
2. Turn on the EUT and connect its antenna terminal to measurement via a low loss cable. Then set it to any one measured frequency within its operating range and make sure the instrument is operated in its linear range.
3. Set the SA on MaxHold Mode, and then keep the EUT in hopping mode. Record all the signals from each channel until each one has been recorded.
4. Set the SA on View mode and then plot the result on SA screen.
5. Repeat above procedures until all frequencies measured were complete.

### 4.2.4 DEVIATION FROM TEST STANDARD

No deviation

#### 4.2.5 TEST SETUP



#### 4.2.6 TEST RESULTS

There are 79 hopping frequencies in the hopping mode. Please refer to next pages for the test result. On the plots, it shows that the hopping frequencies are equally spaced.



A D T

For GFSK :

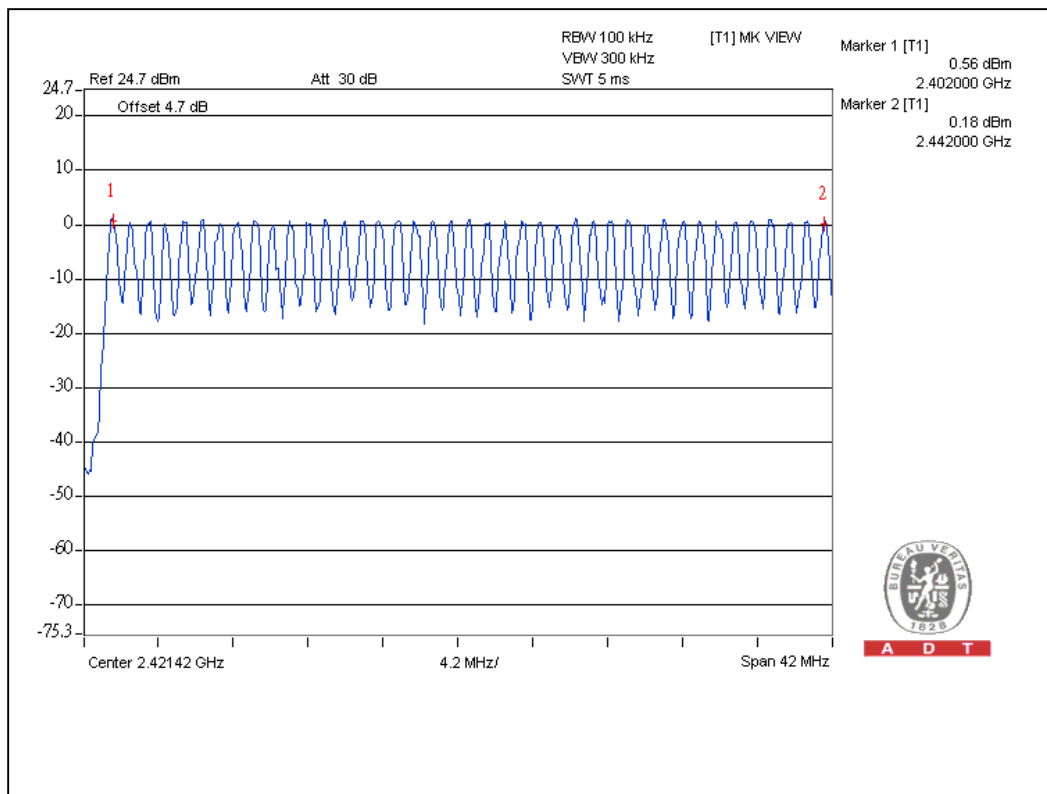

A D T

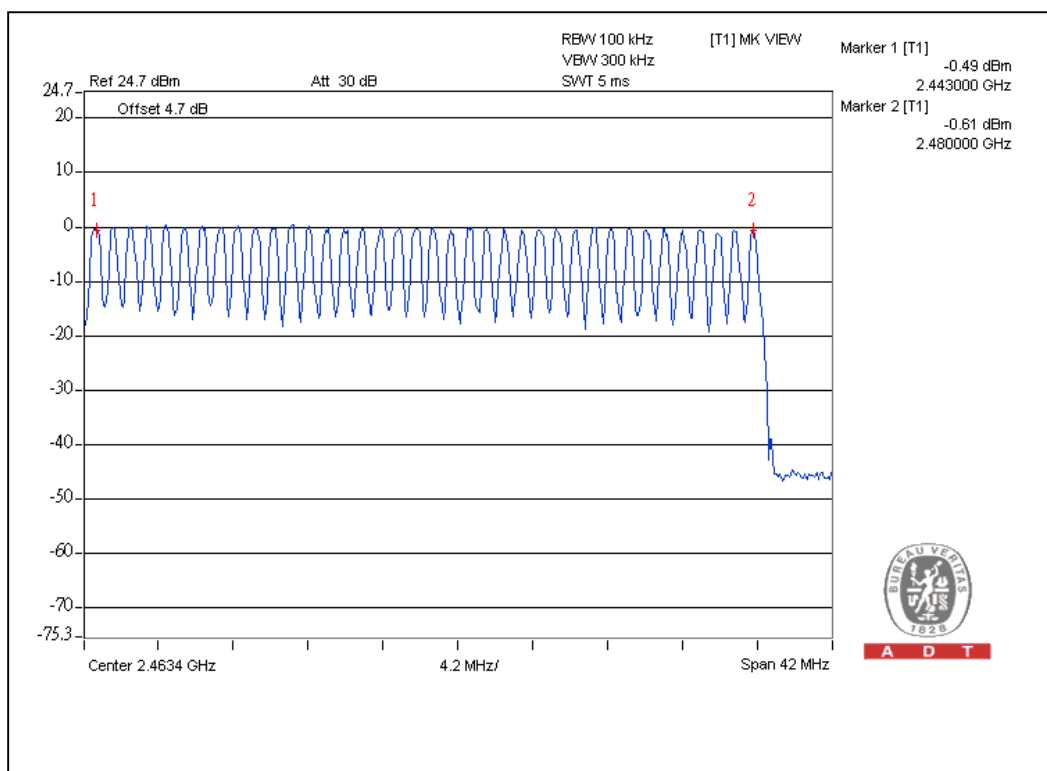

A D T



A D T

For 8DPSK :

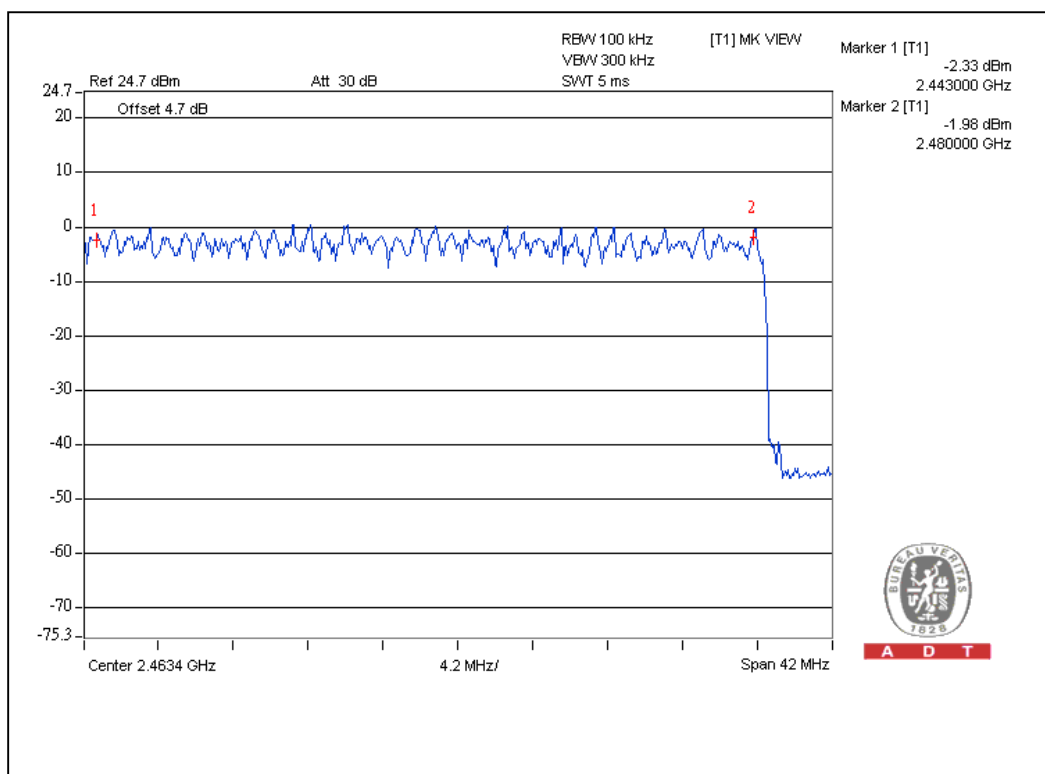
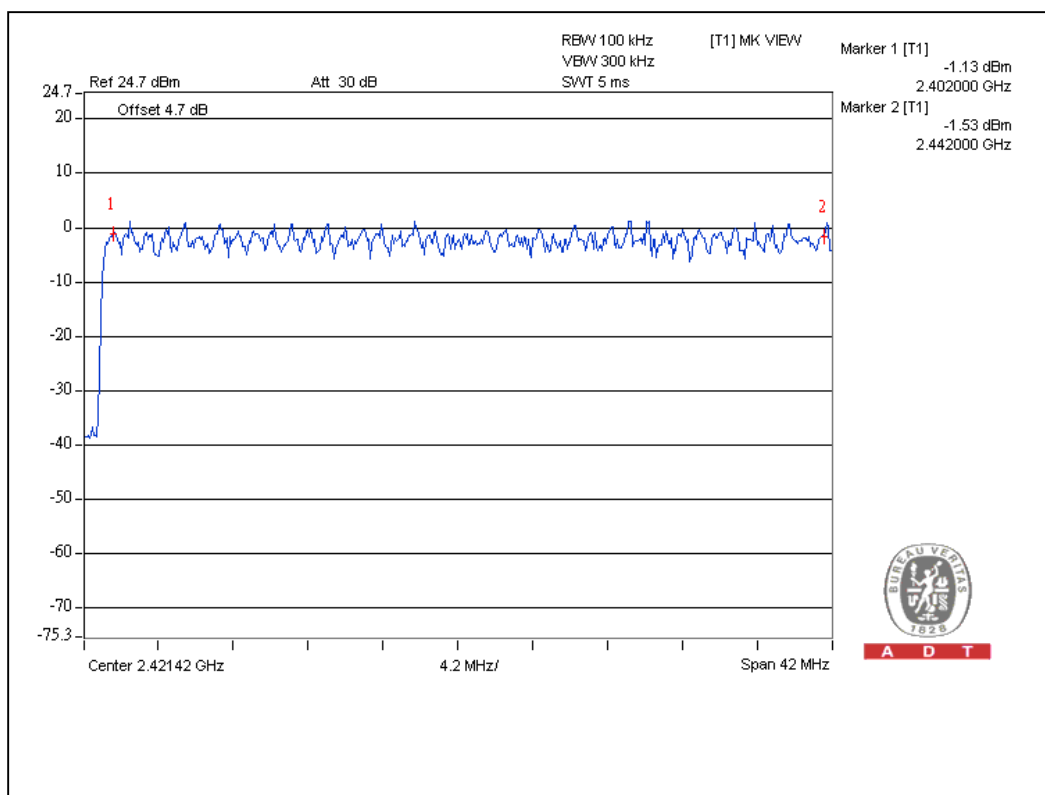



A D T

For  $\pi/4$ -DQPSK :

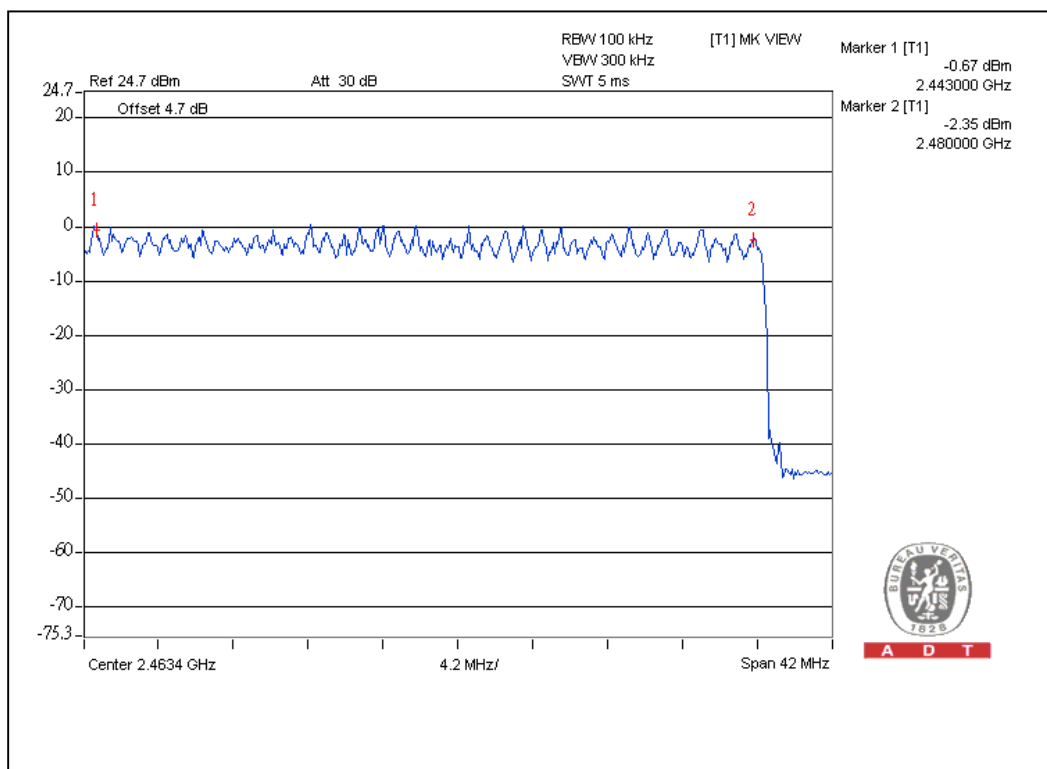
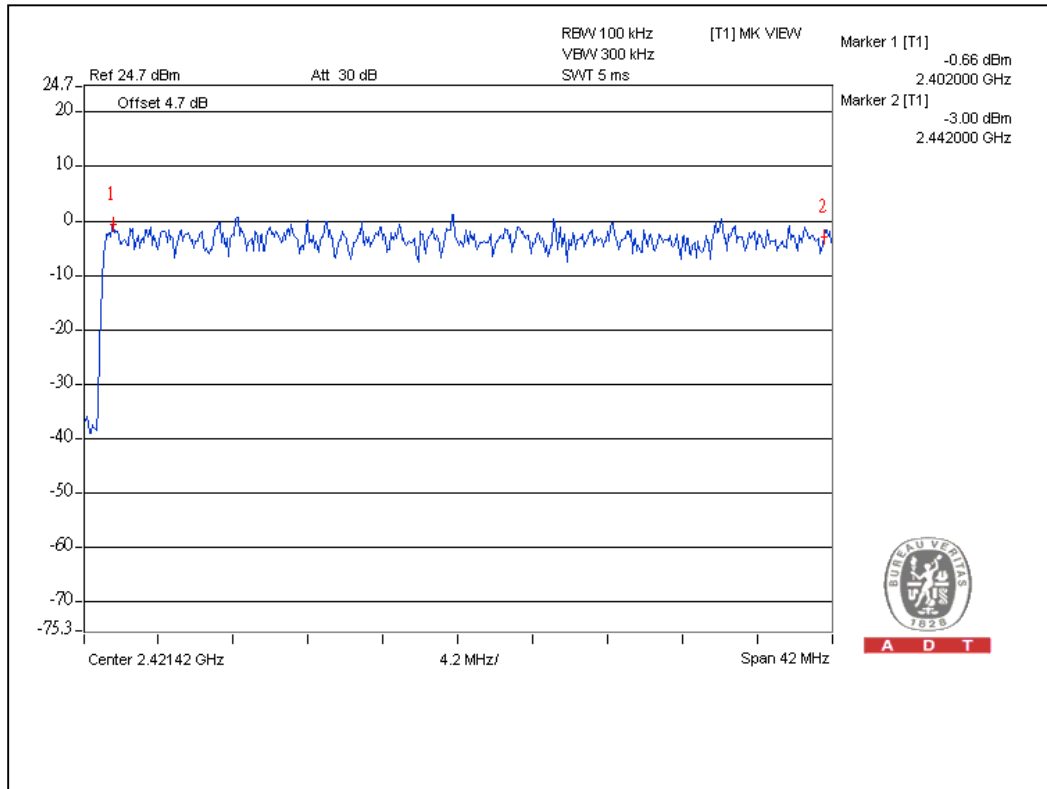



### 4.3 DWELL TIME ON EACH CHANNEL

#### 4.3.1 LIMIT OF DWELL TIME USED

For FHSS, the average time of occupancy on any frequency shall not be greater than 0.4 seconds within a 31.6 second period. For hybrid systems, the average time of occupancy on any frequency should not exceed 0.4 seconds within a time period in seconds equal to the number of hopping frequencies employed multiplied by 0.4.

#### 4.3.2 TEST INSTRUMENTS

| DESCRIPTION & MANUFACTURER | MODEL NO. | SERIAL NO. | CALIBRATED DATE | CALIBRATED UNTIL |
|----------------------------|-----------|------------|-----------------|------------------|
| R&S SPECTRUM ANALYZER      | FSP40     | 100037     | Aug. 09, 2009   | Aug. 08, 2010    |

**NOTE:**

1. The calibration interval of the above test instruments is 12 months and the calibrations are traceable to NML/ROC and NIST/USA.

#### 4.3.3 TEST PROCEDURES

1. Check the calibration of the measuring instrument (SA) using either an internal calibrator or a known signal from an external generator.
2. Turn on the EUT and connect its antenna terminal to measurement via a low loss cable. Then set it to any one measured frequency within its operating range and make sure the instrument is operated in its linear range.
3. Adjust the center frequency of SA on any frequency be measured and set SA to zero span mode. And then, set RBW and VBW of spectrum analyzer to proper value.
4. Measure the time duration of one transmission on the measured frequency. And then plot the result with time difference of this time duration.
5. Repeat above procedures until all frequencies measured were complete.

#### 4.3.4 DEVIATION FROM TEST STANDARD

No deviation

#### 4.3.5 TEST SETUP

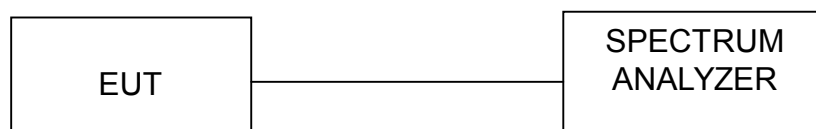

#### 4.3.6 TEST RESULTS

| Mode | Number of transmission in a 31.6 (79Hopping*0.4) | Length of transmission time (msec) | Result (msec) | Limit (msec) |
|------|--|------------------------------------|---------------|--------------|
| DH1  | 51 (times / 5 sec) *6.32=322.32 times            | 0.6                                | 193.4         | 400          |
| DH3  | 22 (times / 5 sec) *6.32=139.04 times            | 1.776                              | 246.9         | 400          |
| DH5  | 17 (times / 5 sec) *6.32=107.44 times            | 3.05                               | 327.7         | 400          |

Test plots of the transmitting time slot are shown on next three pages.



A D T

# DH1

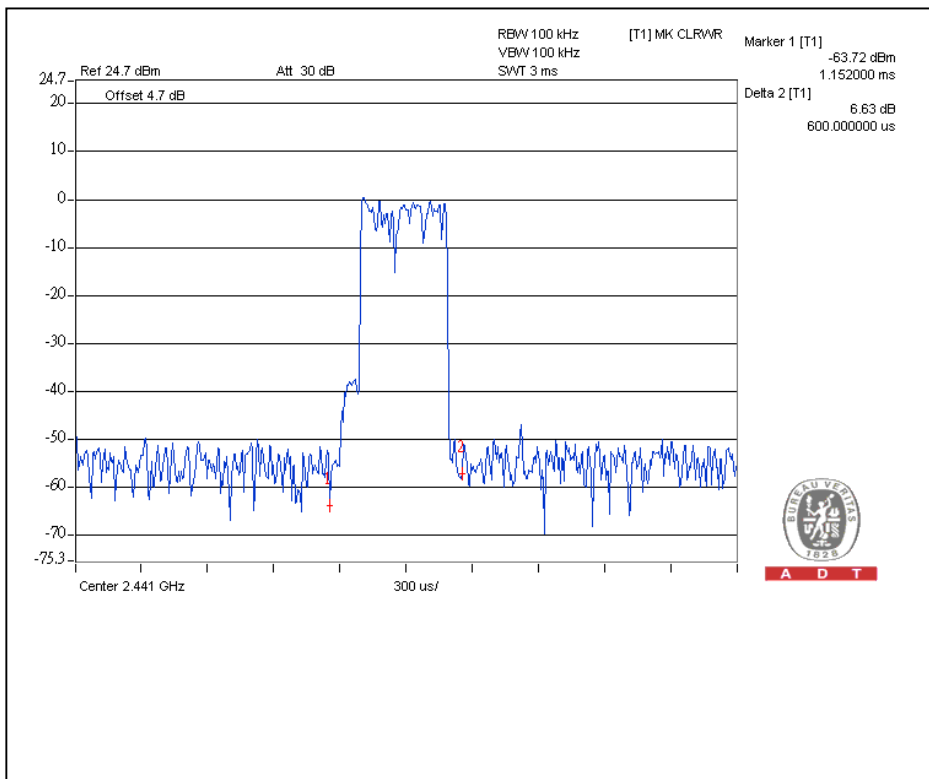
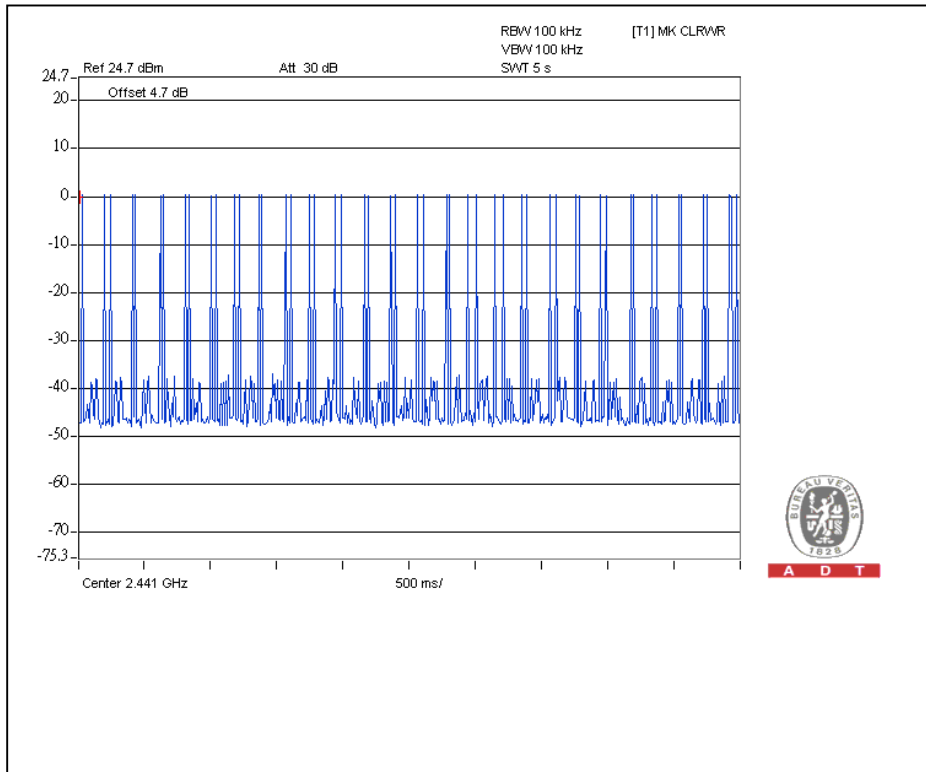



A D T

### DH3

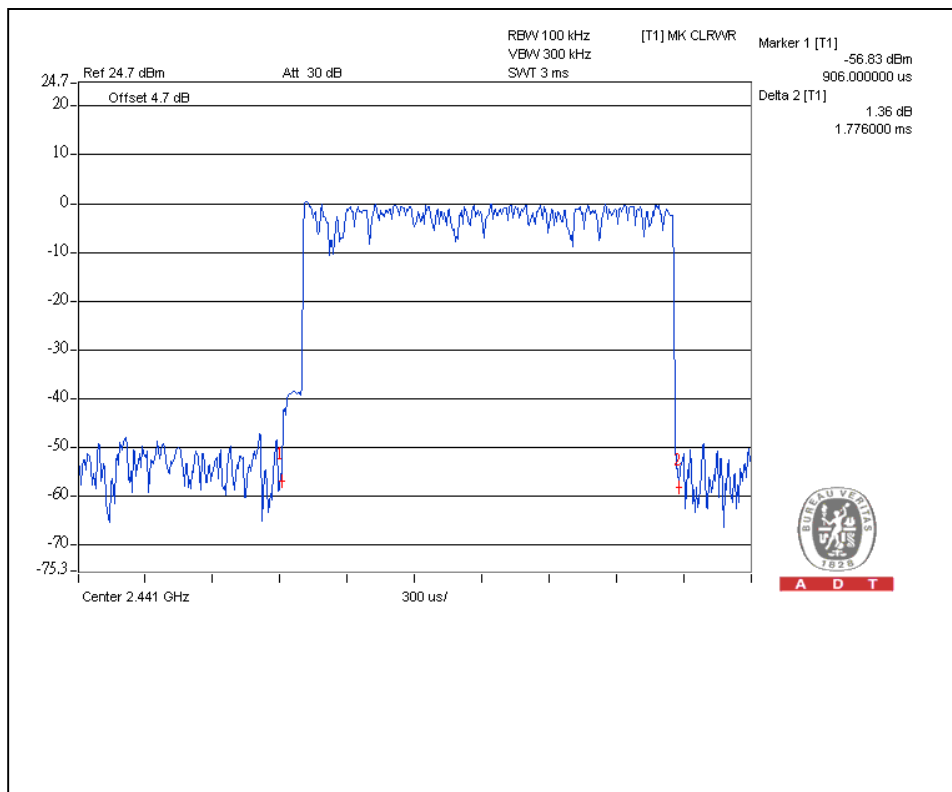
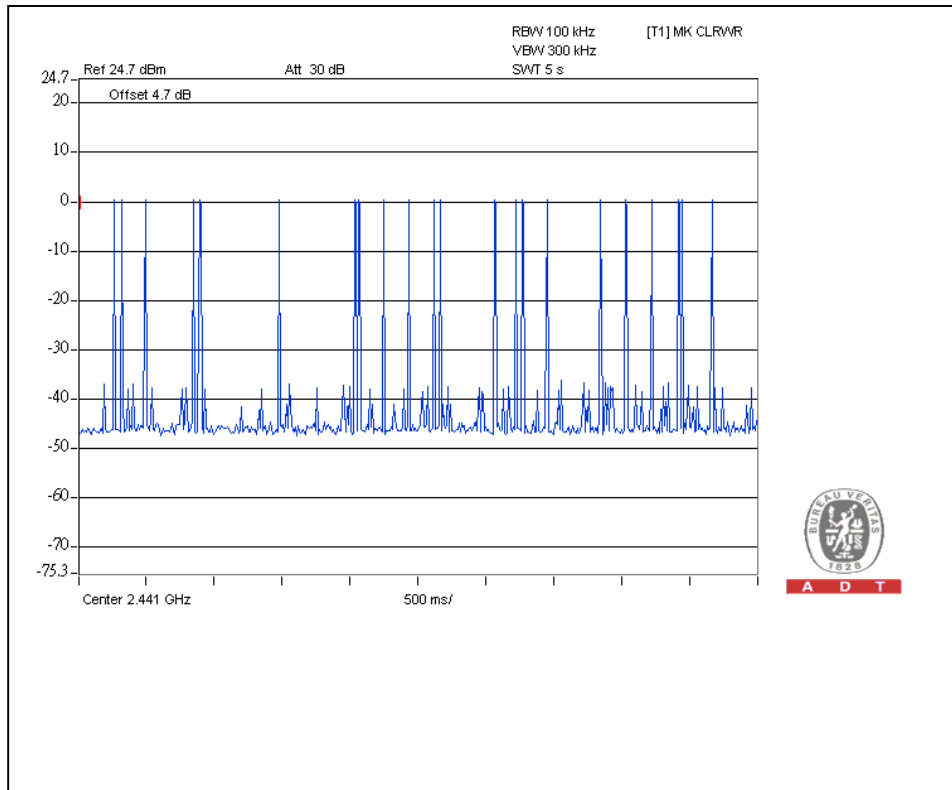



A D T

# DH5

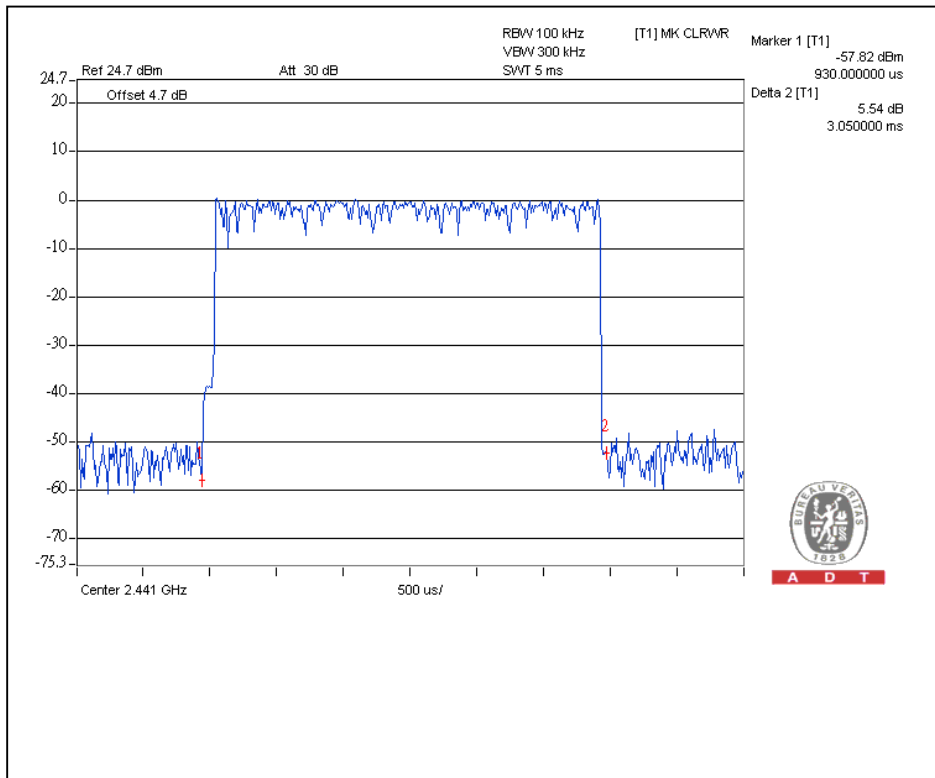
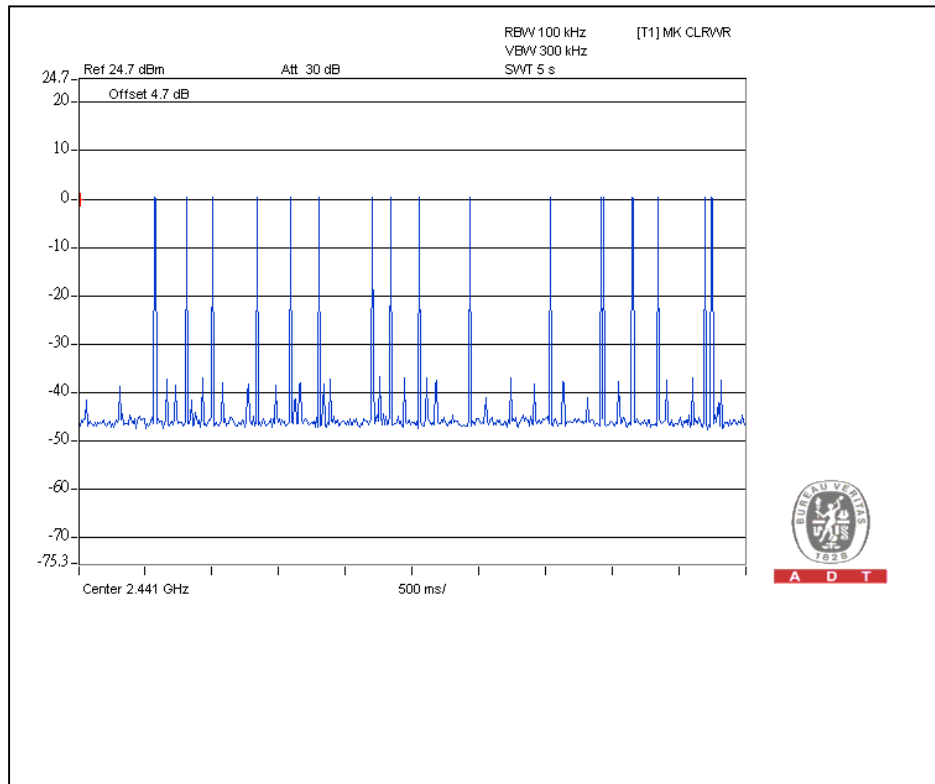

## 4.4 CHANNEL BANDWIDTH

### 4.4.1 LIMITS OF CHANNEL BANDWIDTH

For frequency hopping system operating in the 2400-2483.5MHz, If the two-thirds 20dB bandwidth of hopping channel is greater than 25kHz, two-thirds 20dB bandwidth of hopping channel shall be a minimum limit for the hopping channel separation.

### 4.4.2 TEST INSTRUMENTS

| DESCRIPTION & MANUFACTURER | MODEL NO. | SERIAL NO. | CALIBRATED DATE | CALIBRATED UNTIL |
|----------------------------|-----------|------------|-----------------|------------------|
| R&S SPECTRUM ANALYZER      | FSP40     | 100037     | Aug. 09, 2009   | Aug. 08, 2010    |

**NOTE:**

- 1.The calibration interval of the above test instruments is 12 months and the calibrations are traceable to NML/ROC and NIST/USA.

### 4.4.3 TEST PROCEDURE

1. Check the calibration of the measuring instrument using either an internal calibrator or a known signal from an external generator.
2. Turn on the EUT and connect it to measurement instrument. Then set it to any one convenient frequency within its operating range. Set a reference level on the measuring instrument equal to the highest peak value.
3. Measure the frequency difference of two frequencies that were attenuated 20dB from the reference level. Record the frequency difference as the emission bandwidth.
4. Repeat above procedures until all frequencies measured were complete.

### 4.4.4 DEVIATION FROM TEST STANDARD

No deviation

#### 4.4.5 TEST SETUP

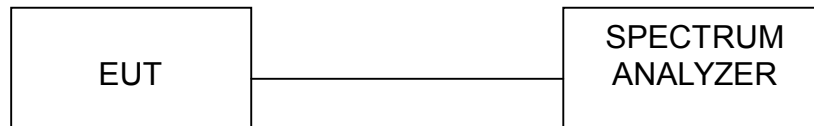

#### 4.4.6 EUT OPERATING CONDITION

The software provided by client enabled the EUT to transmit and receive data at lowest, middle and highest channel frequencies individually.



A D T

#### 4.4.7 TEST RESULTS

|                                 |                          |                             |               |
|---------------------------------|--------------------------|-----------------------------|---------------|
| <b>MODULATION TYPE</b>          | GFSK                     | <b>INPUT POWER (SYSTEM)</b> | 120Vac, 60 Hz |
| <b>ENVIRONMENTAL CONDITIONS</b> | 25deg. C, 60%RH, 965 hPa | <b>TESTED BY</b>            | Wen Yu        |

| <b>CHANNEL</b> | <b>CHANNEL FREQUENCY (MHz)</b> | <b>20dB BANDWIDTH (kHz)</b> |
|----------------|--------------------------------|-----------------------------|
| 0              | 2402                           | 968                         |
| 39             | 2441                           | 1016                        |
| 78             | 2480                           | 1003                        |

#### Channel 0

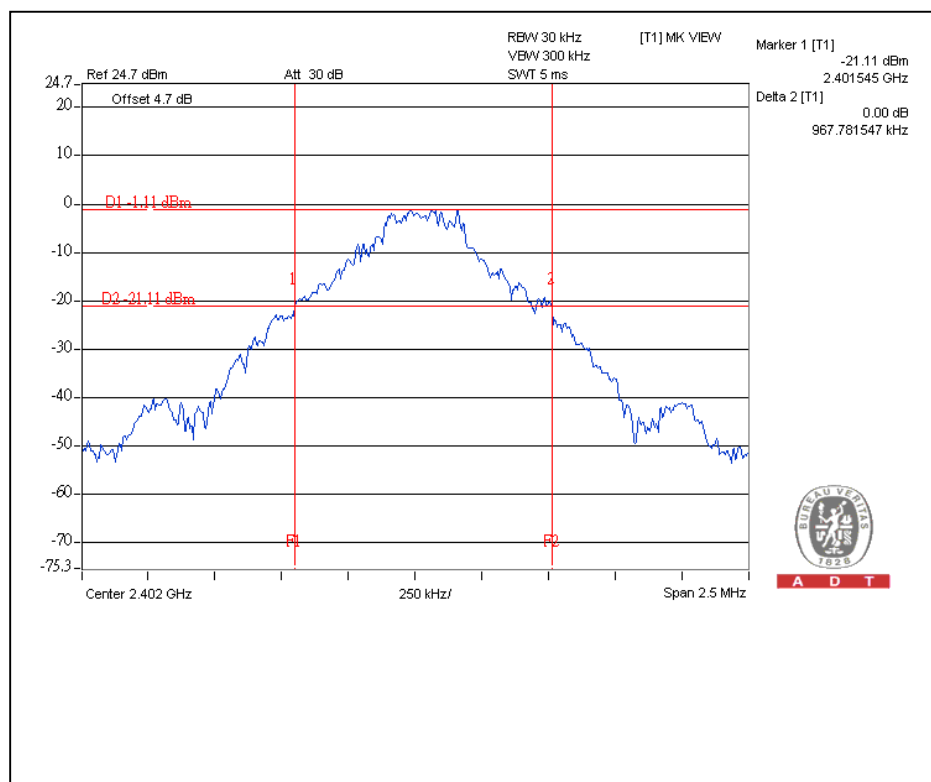





A D T

### Channel 39

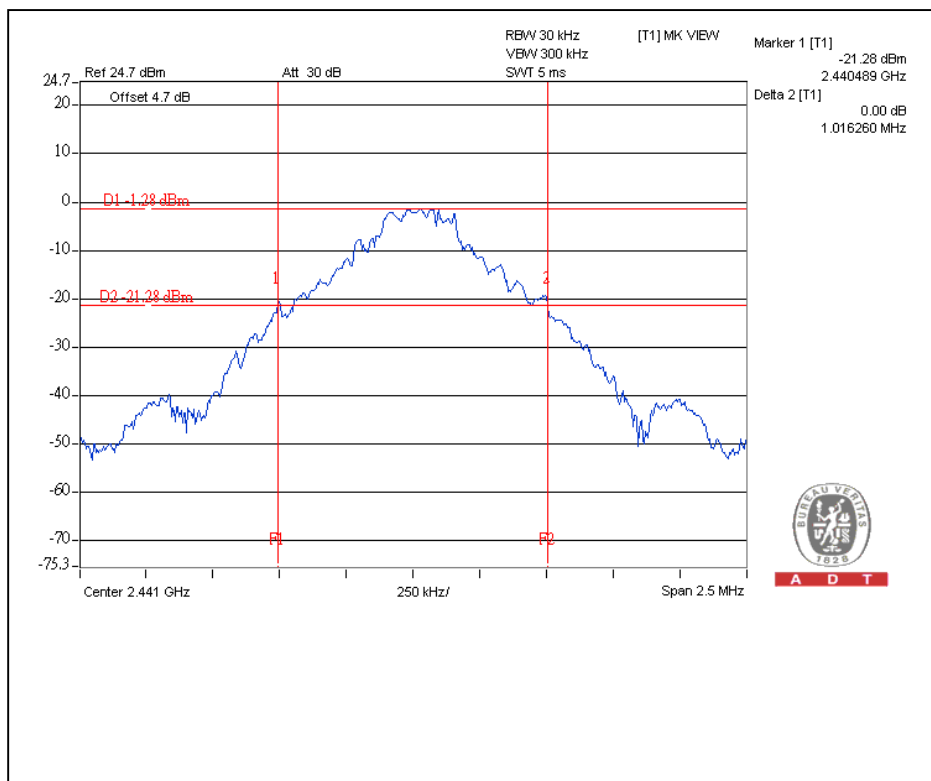

### Channel 78

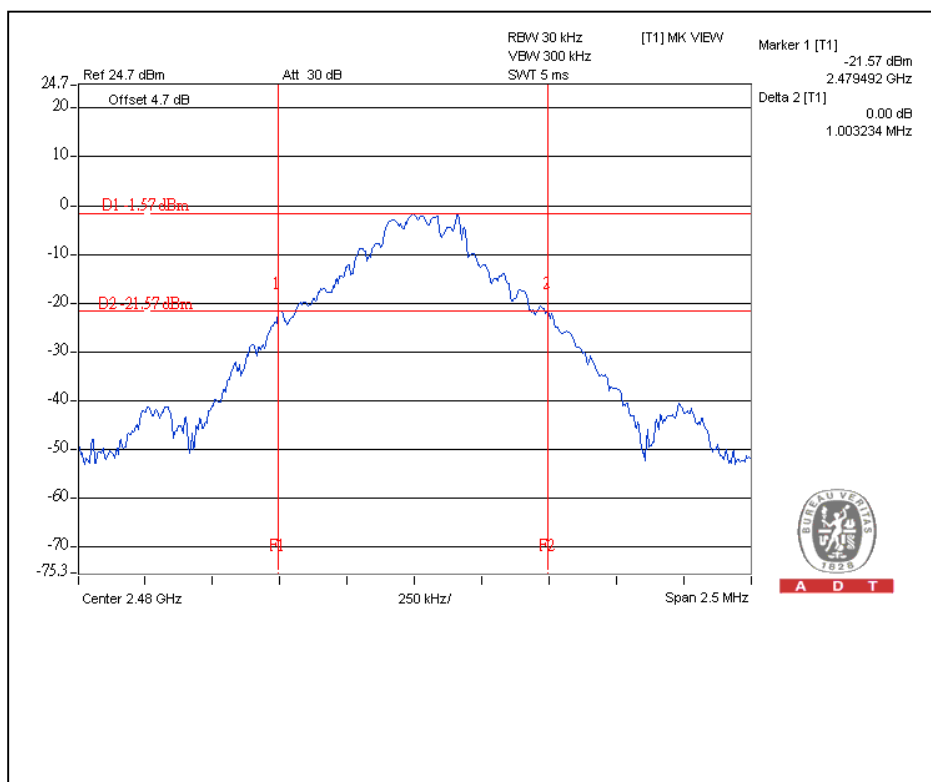



A D T

|                                 |                          |                             |               |
|---------------------------------|--------------------------|-----------------------------|---------------|
| <b>MODULATION TYPE</b>          | 8DPSK                    | <b>INPUT POWER (SYSTEM)</b> | 120Vac, 60 Hz |
| <b>ENVIRONMENTAL CONDITIONS</b> | 25deg. C, 60%RH, 965 hPa | <b>TESTED BY</b>            | Wen Yu        |

| <b>CHANNEL</b> | <b>CHANNEL FREQUENCY (MHz)</b> | <b>20dB BANDWIDTH (kHz)</b> |
|----------------|--------------------------------|-----------------------------|
| 0              | 2402                           | 1320                        |
| 39             | 2441                           | 1300                        |
| 78             | 2480                           | 1311                        |

### Channel 0

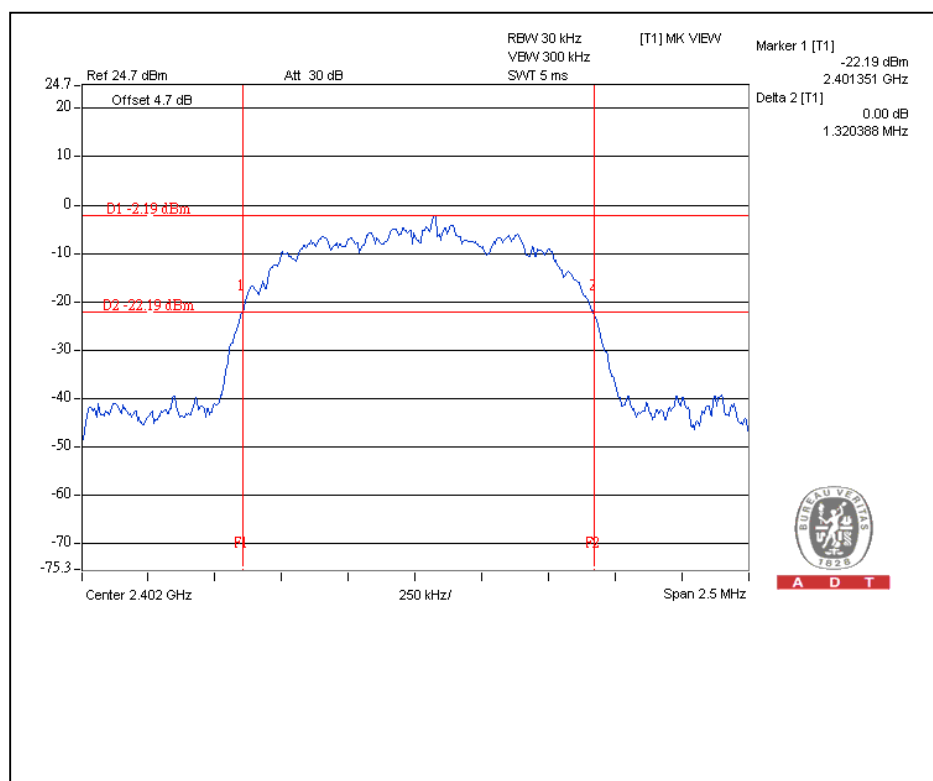



A D T

### Channel 39

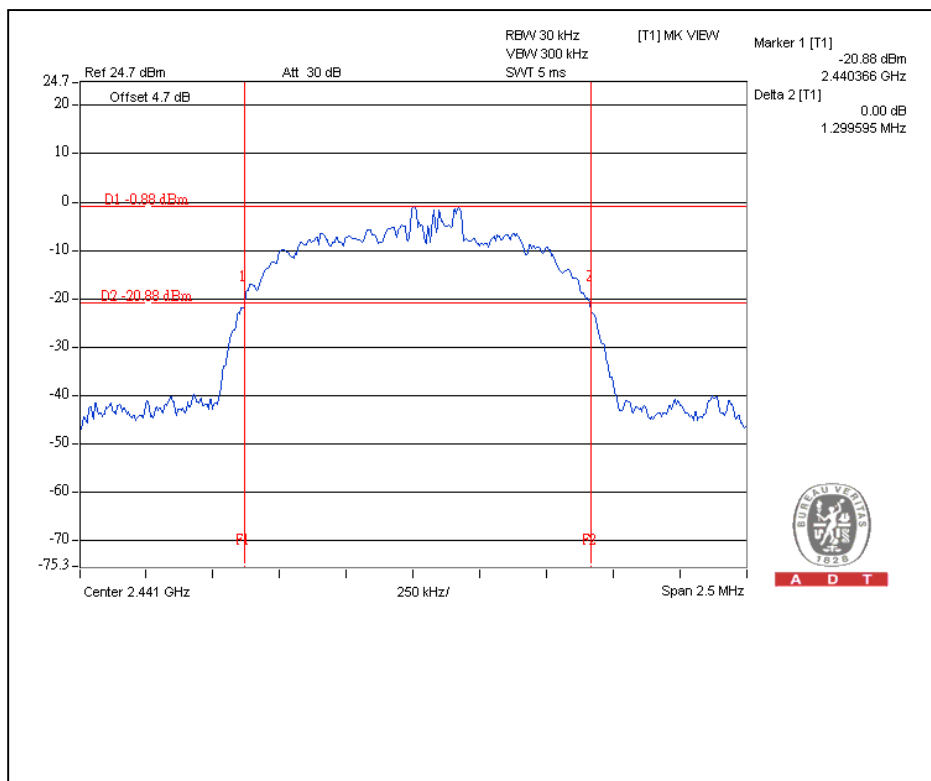

### Channel 78

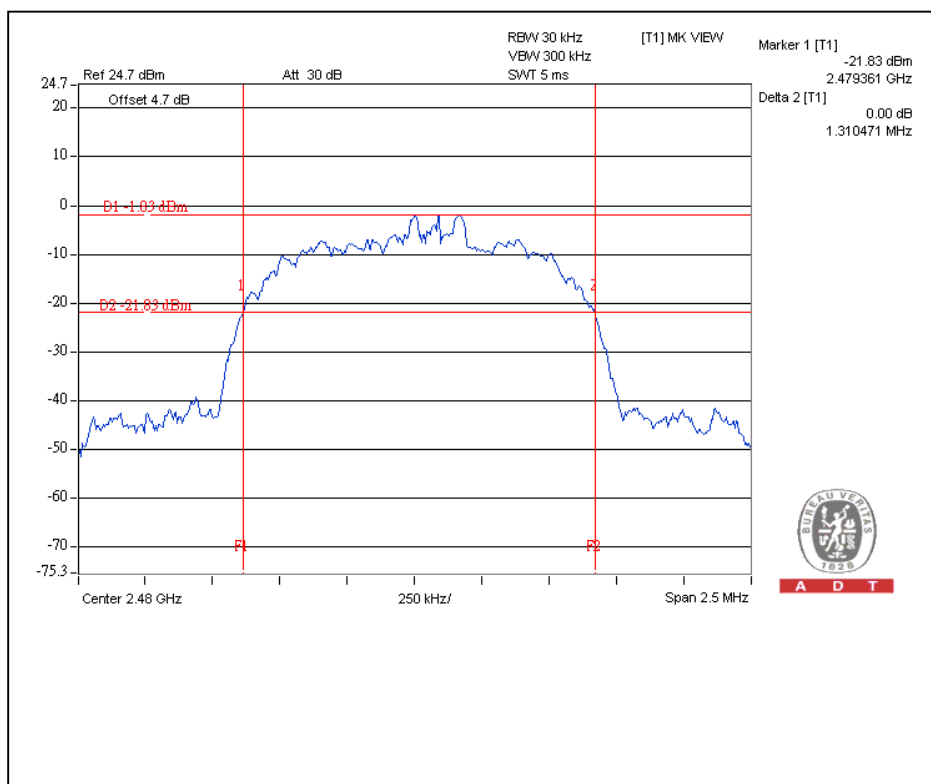



A D T

|                                 |                          |                             |               |
|---------------------------------|--------------------------|-----------------------------|---------------|
| <b>MODULATION TYPE</b>          | $\pi/4$ -DQPSK           | <b>INPUT POWER (SYSTEM)</b> | 120Vac, 60 Hz |
| <b>ENVIRONMENTAL CONDITIONS</b> | 25deg. C, 60%RH, 965 hPa | <b>TESTED BY</b>            | Wen Yu        |

| CHANNEL | CHANNEL FREQUENCY (MHz) | 20dB BANDWIDTH (kHz) |
|---------|-------------------------|----------------------|
| 0       | 2402                    | 1316                 |
| 39      | 2441                    | 1313                 |
| 78      | 2480                    | 1322                 |

### Channel 0

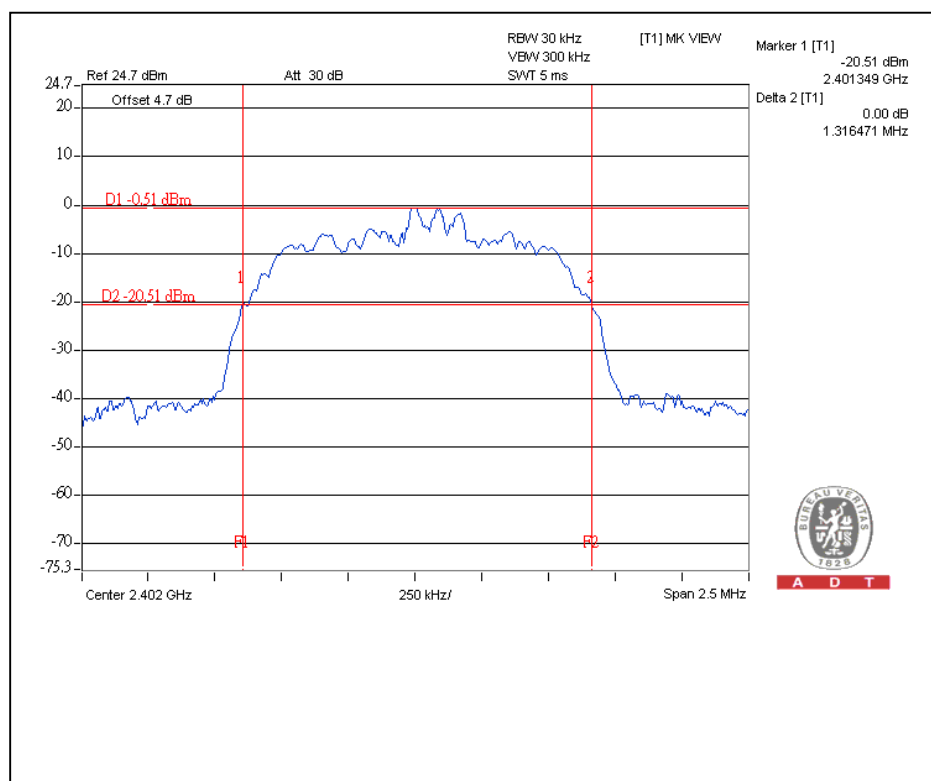



A D T

### Channel 39

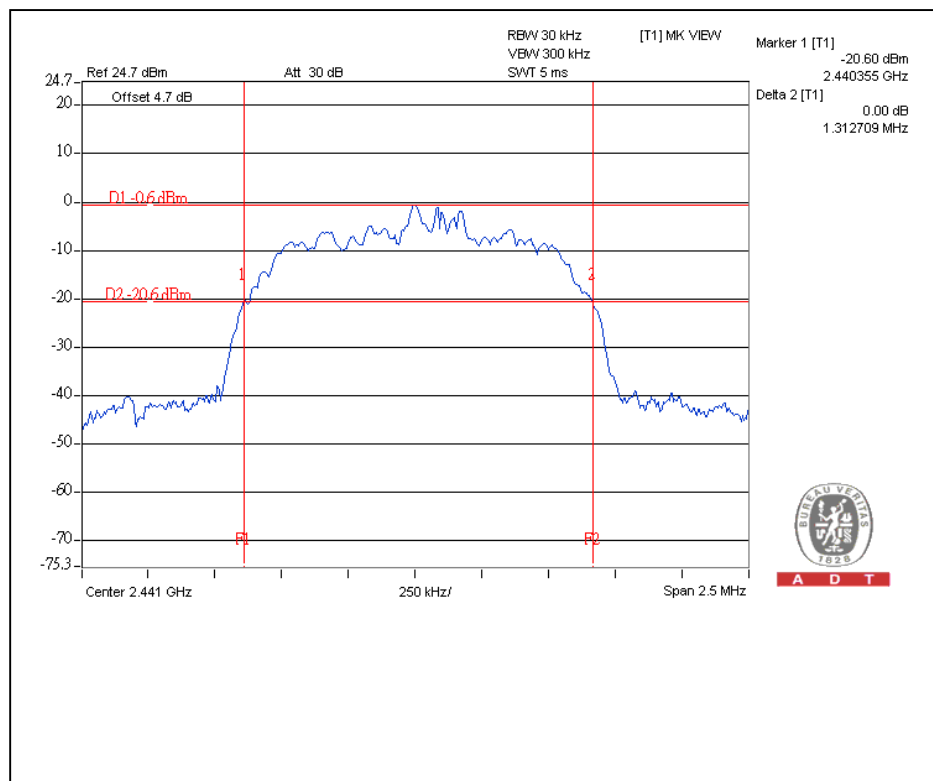

### Channel 78

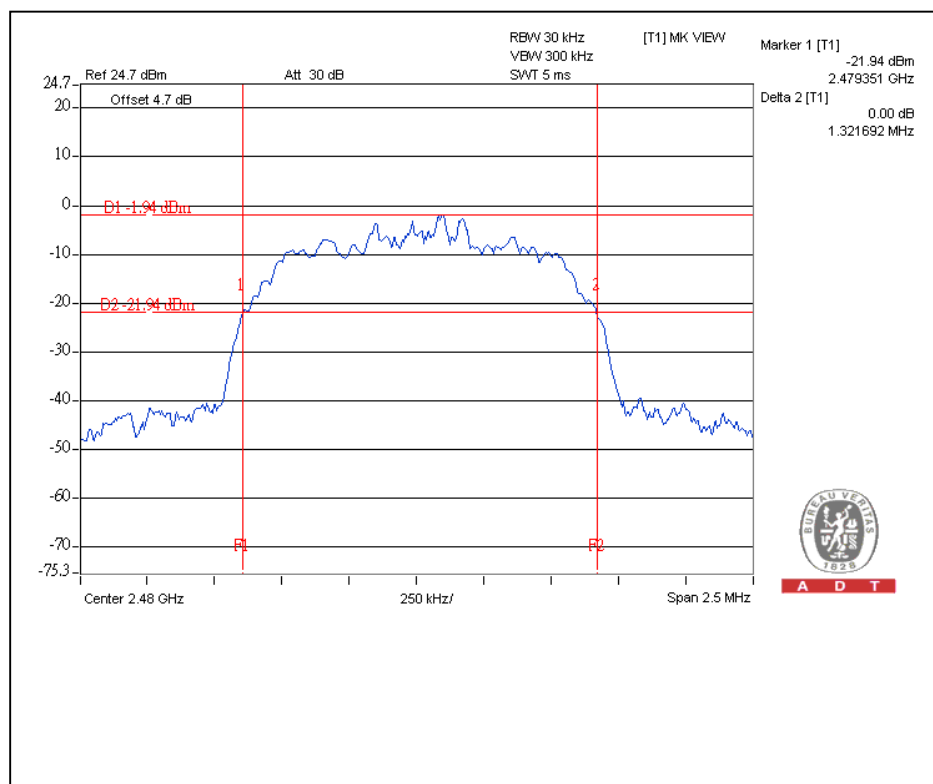



## 4.5 HOPPING CHANNEL SEPARATION

### 4.5.1 LIMIT OF HOPPING CHANNEL SEPARATION

At least 25 kHz or two-thirds of 20dB hopping channel bandwidth (whichever is greater).

### 4.5.2 TEST INSTRUMENTS

| DESCRIPTION & MANUFACTURER | MODEL NO. | SERIAL NO. | CALIBRATED DATE | CALIBRATED UNTIL |
|----------------------------|-----------|------------|-----------------|------------------|
| R&S SPECTRUM ANALYZER      | FSP40     | 100037     | Aug. 09, 2009   | Aug. 08, 2010    |

**NOTE:**

1. The calibration interval of the above test instruments is 12 months and the calibrations are traceable to NML/ROC and NIST/USA.

### 4.5.3 TEST PROCEDURES

1. Check the calibration of the measuring instrument using either an internal calibrator or a known signal from an external generator.
2. Turn on the EUT and connect it to measurement instrument. Then set it to any one convenient frequency within its operating range.
3. By using the MaxHold function record the separation of two adjacent channels.
4. Measure the frequency difference of these two adjacent channels by SA MARK function. And then plot the result on SA screen.
5. Repeat above procedures until all frequencies measured were complete.

#### 4.5.4 DEVIATION FROM TEST STANDARD

No deviation

#### 4.5.5 TEST SETUP

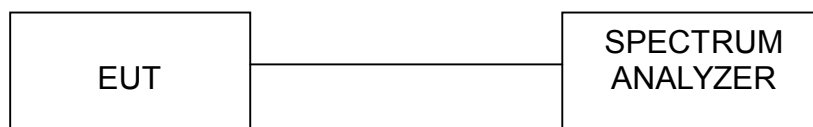



A D T

### 4.5.6 TEST RESULTS

|                                 |                          |                             |               |
|---------------------------------|--------------------------|-----------------------------|---------------|
| <b>MODULATION TYPE</b>          | GFSK                     | <b>INPUT POWER (SYSTEM)</b> | 120Vac, 60 Hz |
| <b>ENVIRONMENTAL CONDITIONS</b> | 25deg. C, 60%RH, 965 hPa | <b>TESTED BY</b>            | Wen Yu        |

| Channel | Frequency (MHz) | Adjacent Channel Separation (kHz) | Minimum Limit (kHz) | Pass / Fail |
|---------|-----------------|-----------------------------------|---------------------|-------------|
| 0       | 2402            | 1004                              | 645                 | PASS        |
| 39      | 2441            | 1001                              | 677                 | PASS        |
| 78      | 2480            | 1000                              | 669                 | PASS        |

The minimum limit is two-thirds of 20dB bandwidth. Test results please refer to next two pages.

### Channel 0

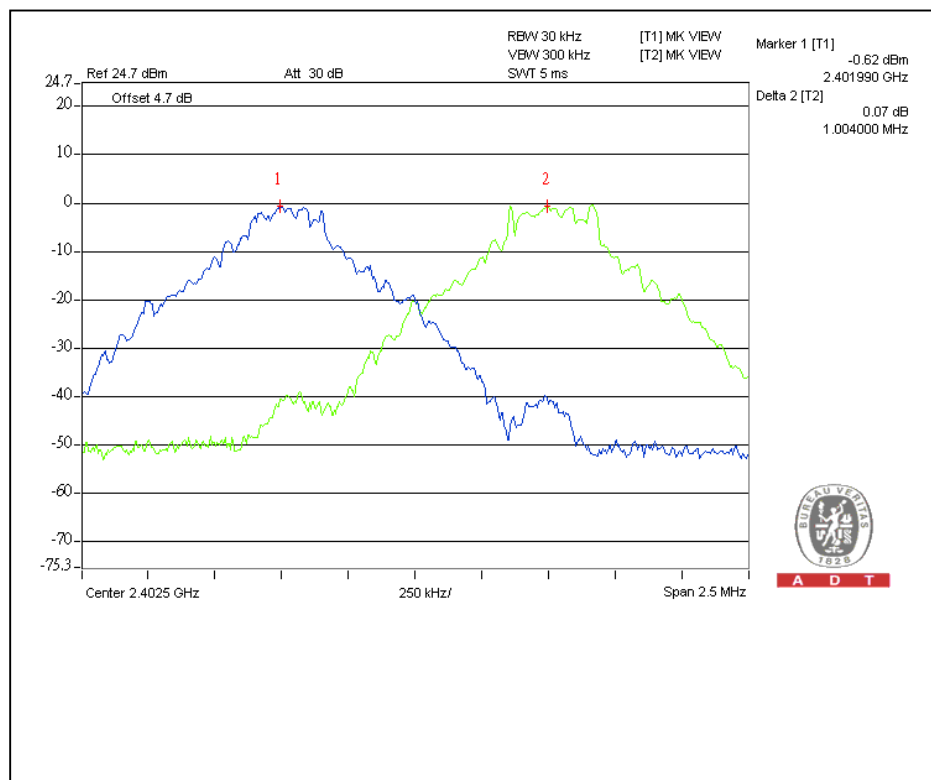





A D T

### Channel 39

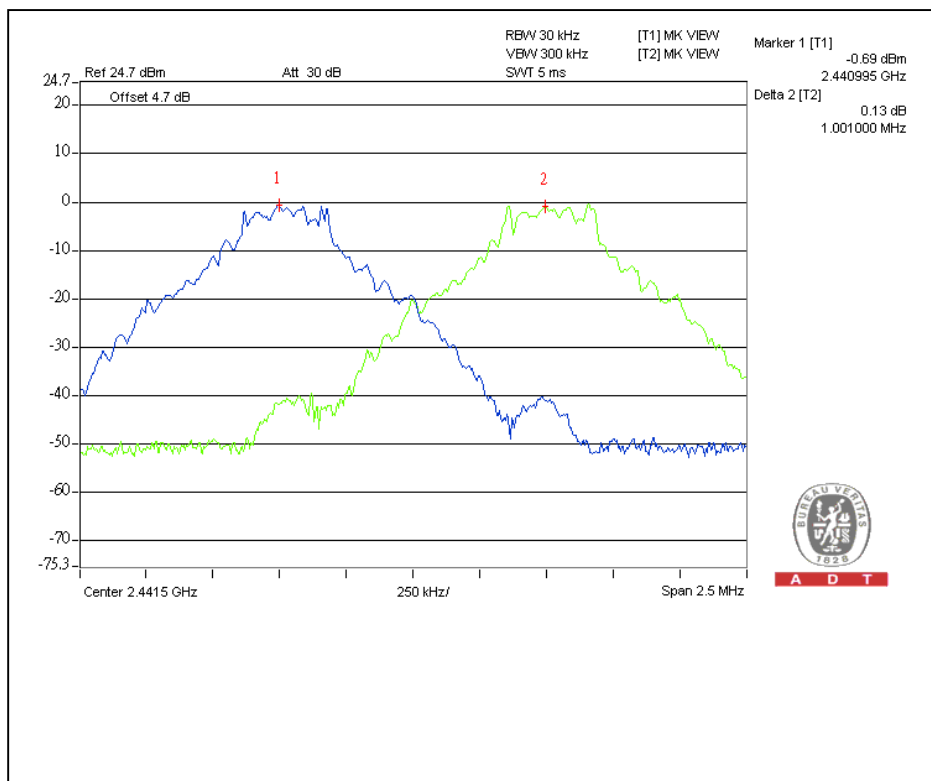

### Channel 78

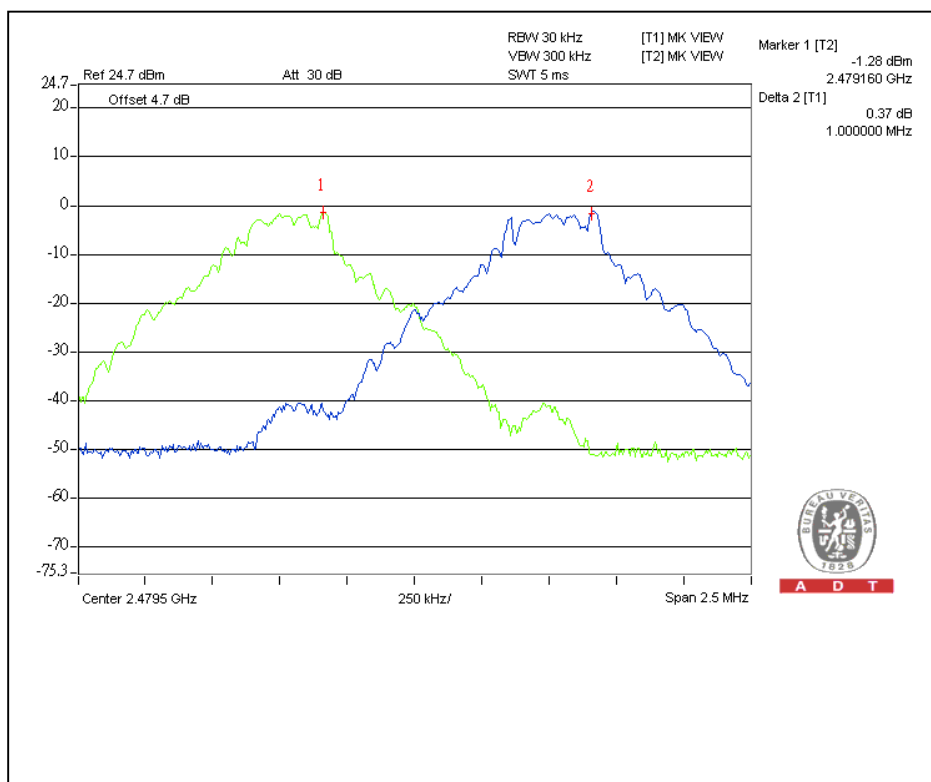



A D T

|                                 |                          |                             |               |
|---------------------------------|--------------------------|-----------------------------|---------------|
| <b>MODULATION TYPE</b>          | 8DPSK                    | <b>INPUT POWER (SYSTEM)</b> | 120Vac, 60 Hz |
| <b>ENVIRONMENTAL CONDITIONS</b> | 25deg. C, 60%RH, 965 hPa | <b>TESTED BY</b>            | Wen Yu        |

| Channel | Frequency (MHz) | Adjacent Channel Separation (kHz) | Minimum Limit (kHz) | Pass / Fail |
|---------|-----------------|-----------------------------------|---------------------|-------------|
| 0       | 2402            | 1005                              | 880                 | PASS        |
| 39      | 2441            | 1006                              | 867                 | PASS        |
| 78      | 2480            | 1001                              | 874                 | PASS        |

The minimum limit is two-thirds of 20dB bandwidth. Test results please refer to next two pages.

### Channel 0

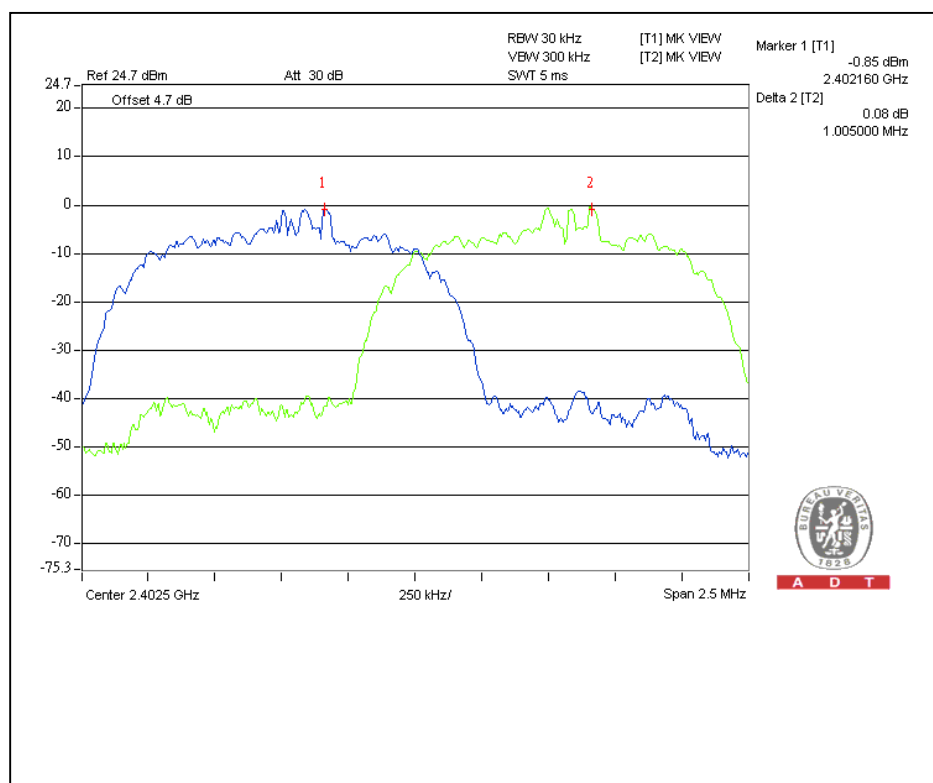



A D T

### Channel 39

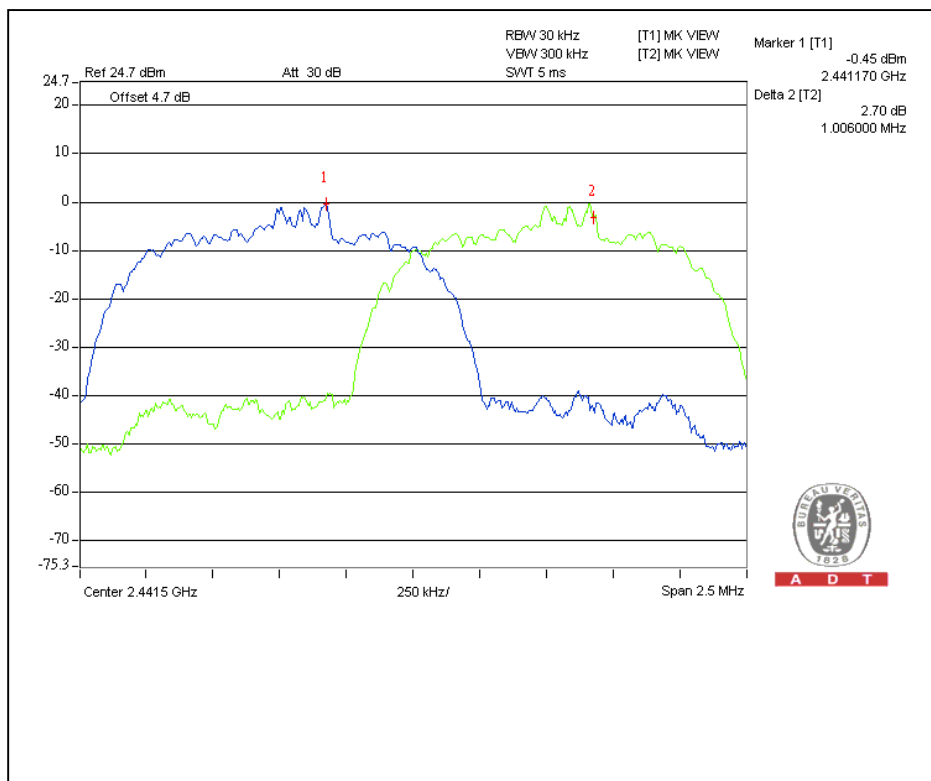

### Channel 78

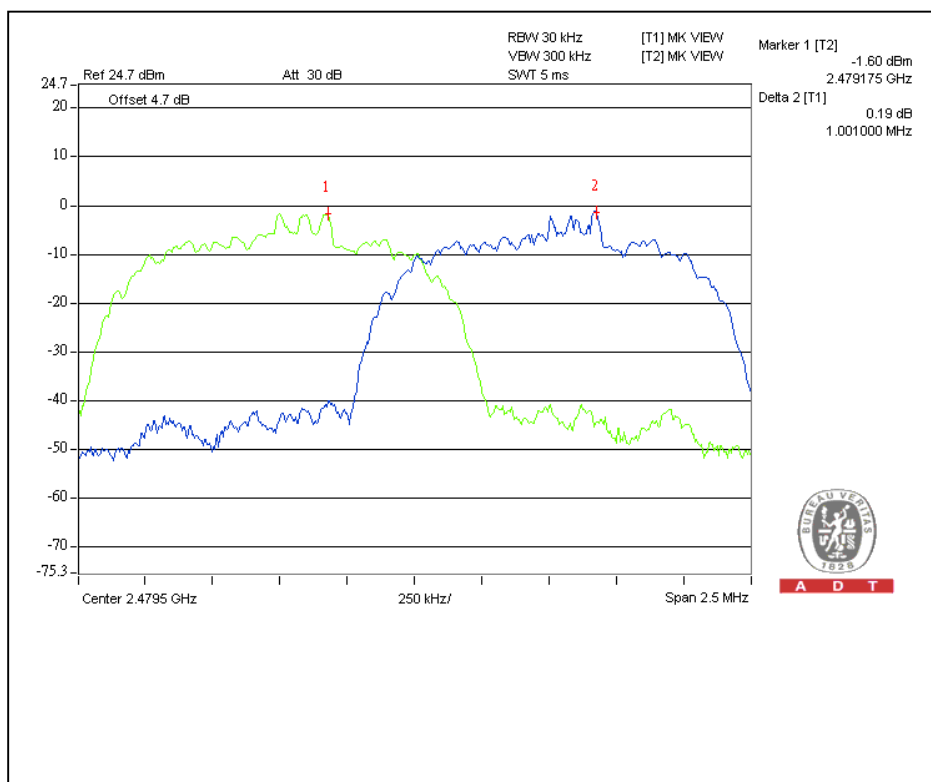



A D T

|                                 |                          |                             |               |
|---------------------------------|--------------------------|-----------------------------|---------------|
| <b>MODULATION TYPE</b>          | $\pi/4$ -DQPSK           | <b>INPUT POWER (SYSTEM)</b> | 120Vac, 60 Hz |
| <b>ENVIRONMENTAL CONDITIONS</b> | 25deg. C, 60%RH, 965 hPa | <b>TESTED BY</b>            | Wen Yu        |

| Channel | Frequency (MHz) | Adjacent Channel Separation (kHz) | Minimum Limit (kHz) | Pass / Fail |
|---------|-----------------|-----------------------------------|---------------------|-------------|
| 0       | 2402            | 1001                              | 877                 | PASS        |
| 39      | 2441            | 1004                              | 875                 | PASS        |
| 78      | 2480            | 1005                              | 881                 | PASS        |

The minimum limit is two-thirds of 20dB bandwidth. Test results please refer to next two pages.

### Channel 0

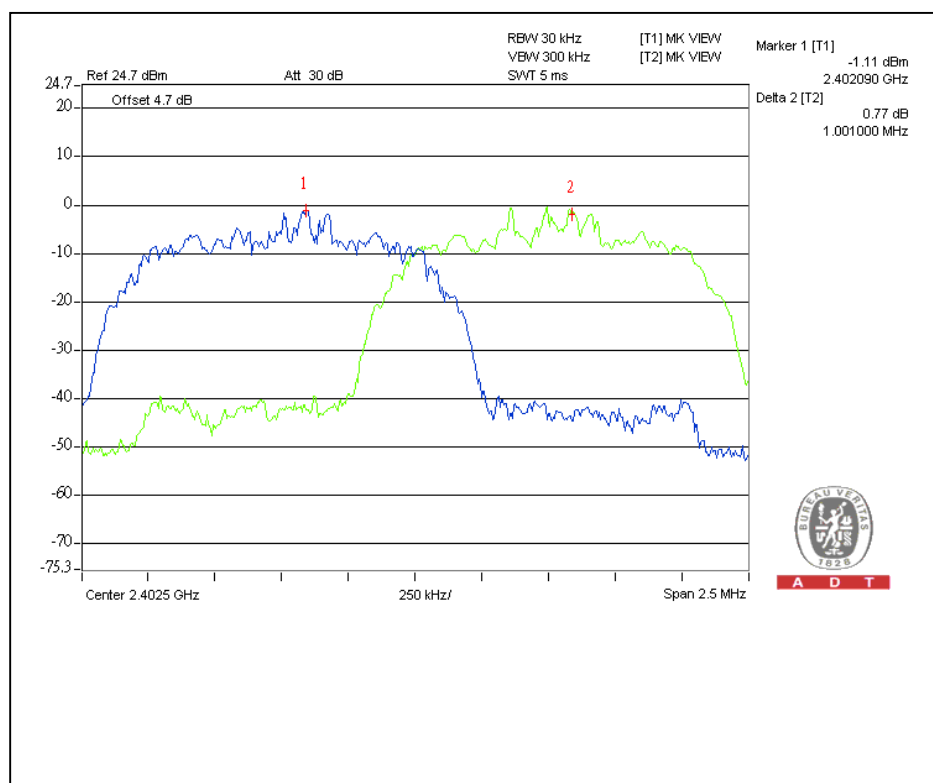



A D T

### Channel 39

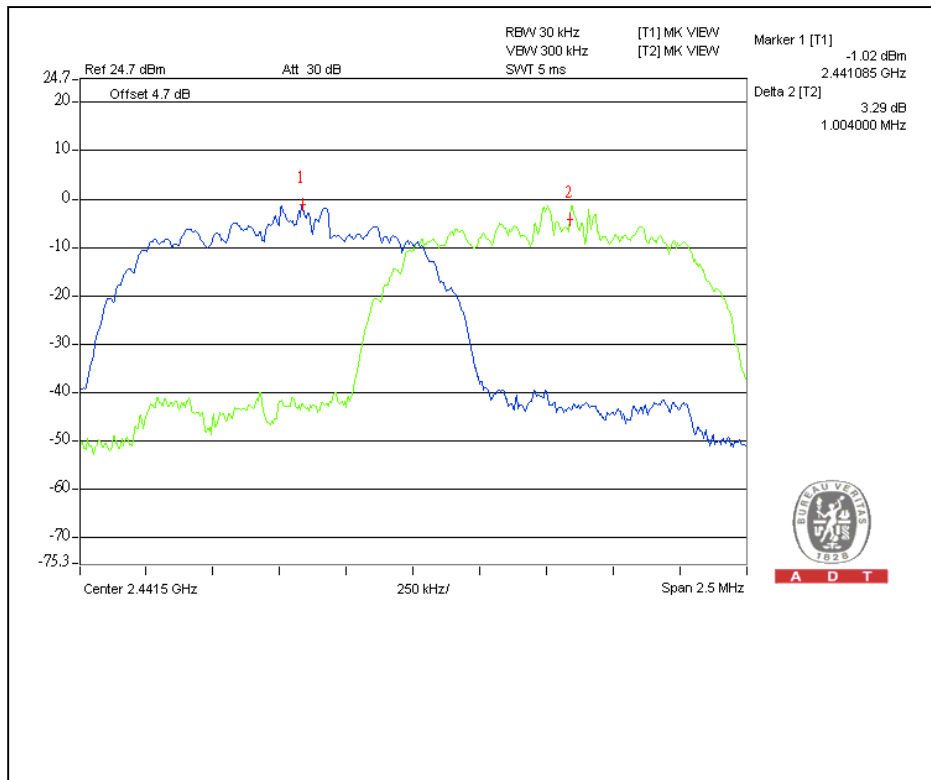

### Channel 78

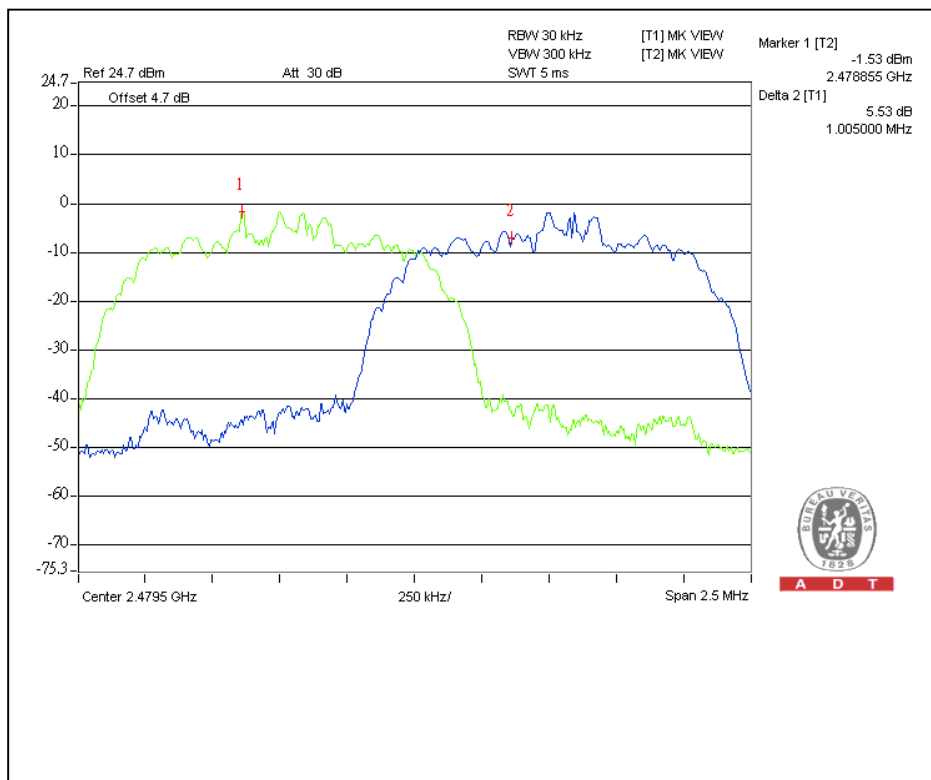

## 4.6 MAXIMUM PEAK OUTPUT POWER

### 4.6.1 LIMITS OF MAXIMUM PEAK OUTPUT POWER MEASUREMENT

The Maximum Peak Output Power Limit is 125mW.

### 4.6.2 INSTRUMENTS

| DESCRIPTION & MANUFACTURER | MODEL NO. | SERIAL NO. | CALIBRATED DATE | CALIBRATED UNTIL |
|----------------------------|-----------|------------|-----------------|------------------|
| R&S SPECTRUM ANALYZER      | FSP40     | 100037     | Aug. 09, 2009   | Aug. 08, 2010    |

**NOTE:**

1. The calibration interval of the above test instruments is 12 months and the calibrations are traceable to NML/ROC and NIST/USA.

### 4.6.3 TEST PROCEDURES

1. Check the calibration of the measuring instrument using either an internal calibrator or a known signal from an external generator.
2. Turn on the EUT and connect it to measurement instrument. Then set it to any one convenient frequency within its operating range. Set a reference level on the measuring instrument equal to the highest peak value.
3. The center frequency of the spectrum analyzer is set to the fundamental frequency and using 3 MHz RBW and 3 MHz VBW.
4. Measure the captured power within the band and recording the plot.
5. Repeat above procedures until all frequencies measured were complete.

### 4.6.4 DEVIATION FROM TEST STANDARD

No deviation

#### 4.6.5 TEST SETUP

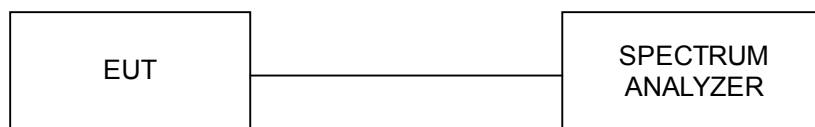

For the actual test configuration, please refer to the related Item – Photographs of the Test Configuration.

#### 4.6.6 EUT OPERATING CONDITION

The software provided by client enabled the EUT to transmit and receive data at lowest, middle and highest channel frequencies individually.



A D T

### 4.6.7 TEST RESULTS

|                                 |                          |                             |               |
|---------------------------------|--------------------------|-----------------------------|---------------|
| <b>MODULATION TYPE</b>          | GFSK                     | <b>INPUT POWER (SYSTEM)</b> | 120Vac, 60 Hz |
| <b>ENVIRONMENTAL CONDITIONS</b> | 25deg. C, 60%RH, 965 hPa | <b>TESTED BY</b>            | Wen Yu        |

| CHANNEL | CHANNEL FREQUENCY (MHz) | PEAK POWER OUTPUT (mW) | PEAK POWER OUTPUT (dBm) | PEAK POWER LIMIT (mW) | PASS/FAIL |
|---------|-------------------------|------------------------|-------------------------|-----------------------|-----------|
| 0       | 2402                    | 1.445                  | 1.60                    | 125                   | PASS      |
| 39      | 2441                    | 1.426                  | 1.54                    | 125                   | PASS      |
| 78      | 2480                    | 1.219                  | 0.86                    | 125                   | PASS      |

### Channel 0

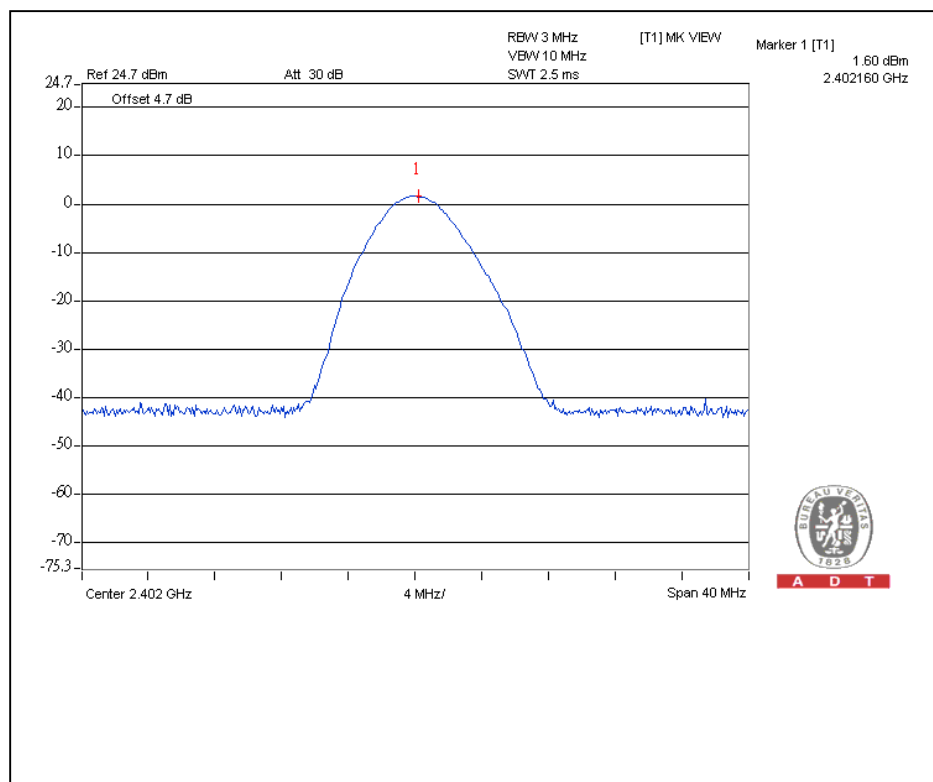





A D T

### Channel 39

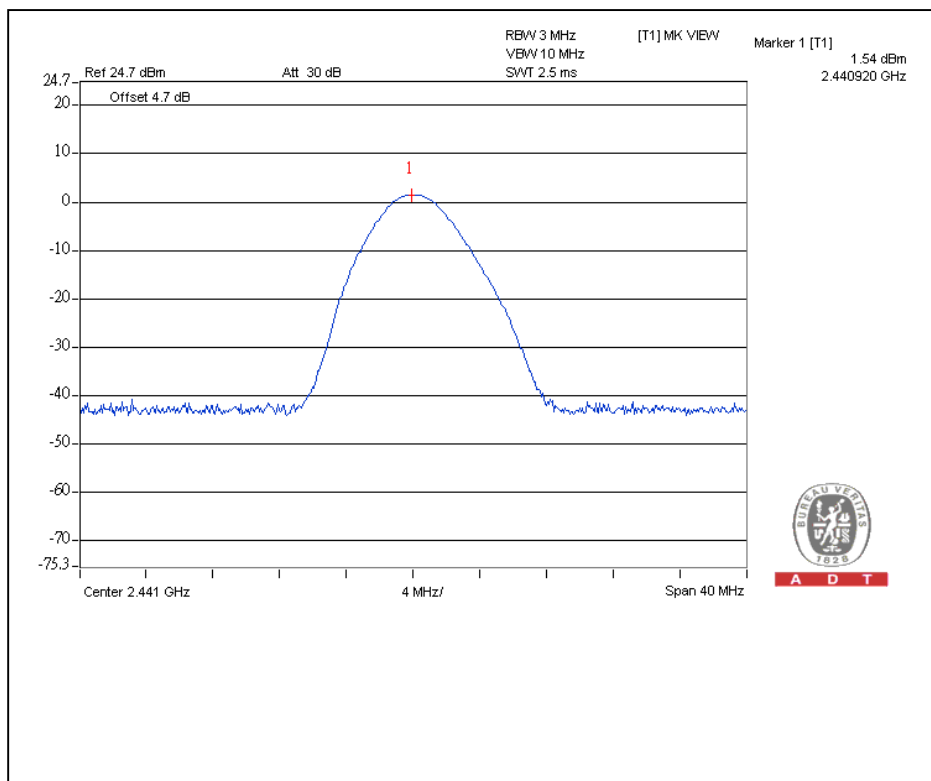

### Channel 78

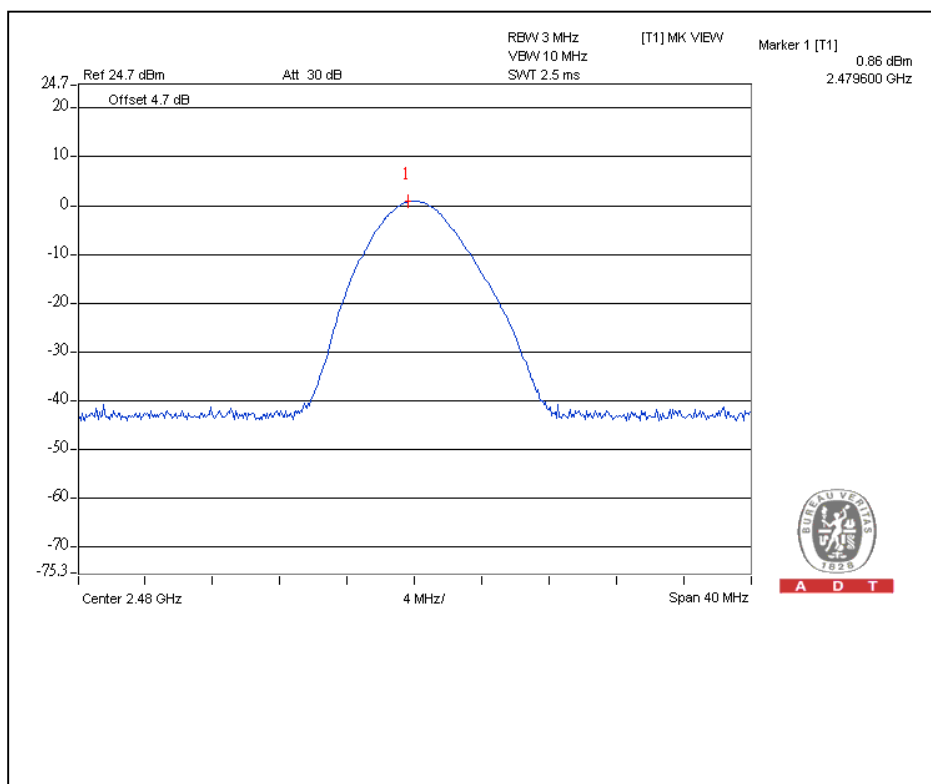



A D T

|                                 |                          |                             |               |
|---------------------------------|--------------------------|-----------------------------|---------------|
| <b>MODULATION TYPE</b>          | 8DPSK                    | <b>INPUT POWER (SYSTEM)</b> | 120Vac, 60 Hz |
| <b>ENVIRONMENTAL CONDITIONS</b> | 25deg. C, 60%RH, 965 hPa | <b>TESTED BY</b>            | Wen Yu        |

| CHANNEL | CHANNEL FREQUENCY (MHz) | PEAK POWER OUTPUT (mW) | PEAK POWER OUTPUT (dBm) | PEAK POWER LIMIT (mW) | PASS/FAIL |
|---------|-------------------------|------------------------|-------------------------|-----------------------|-----------|
| 0       | 2402                    | 2.449                  | 3.89                    | 125                   | PASS      |
| 39      | 2441                    | 2.410                  | 3.82                    | 125                   | PASS      |
| 78      | 2480                    | 2.051                  | 3.12                    | 125                   | PASS      |

### Channel 0

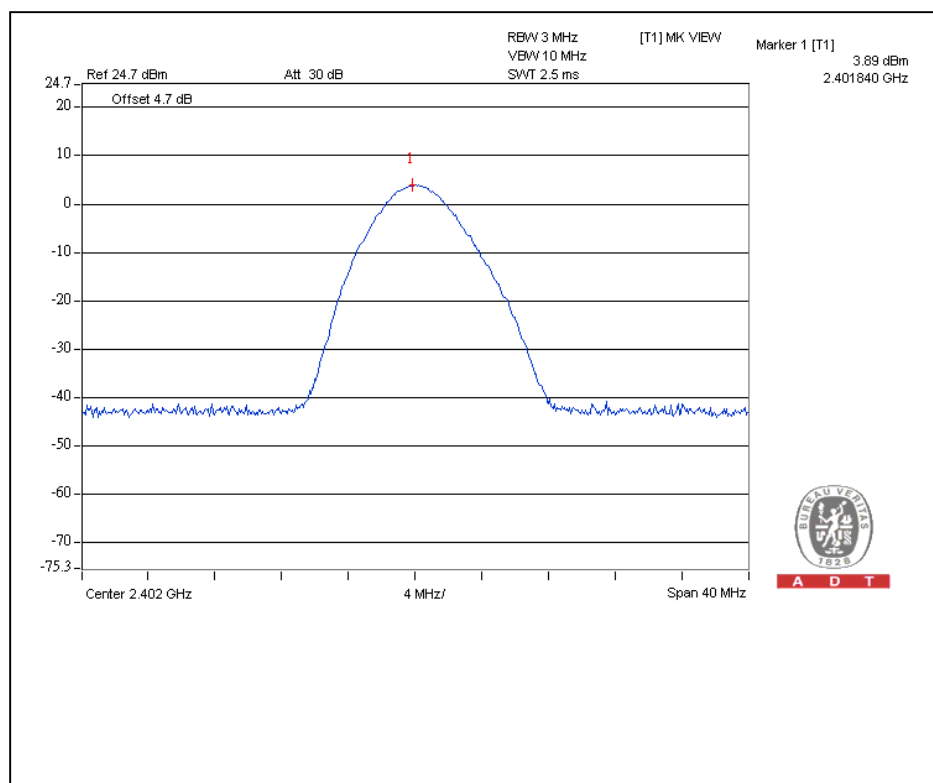



A D T

### Channel 39

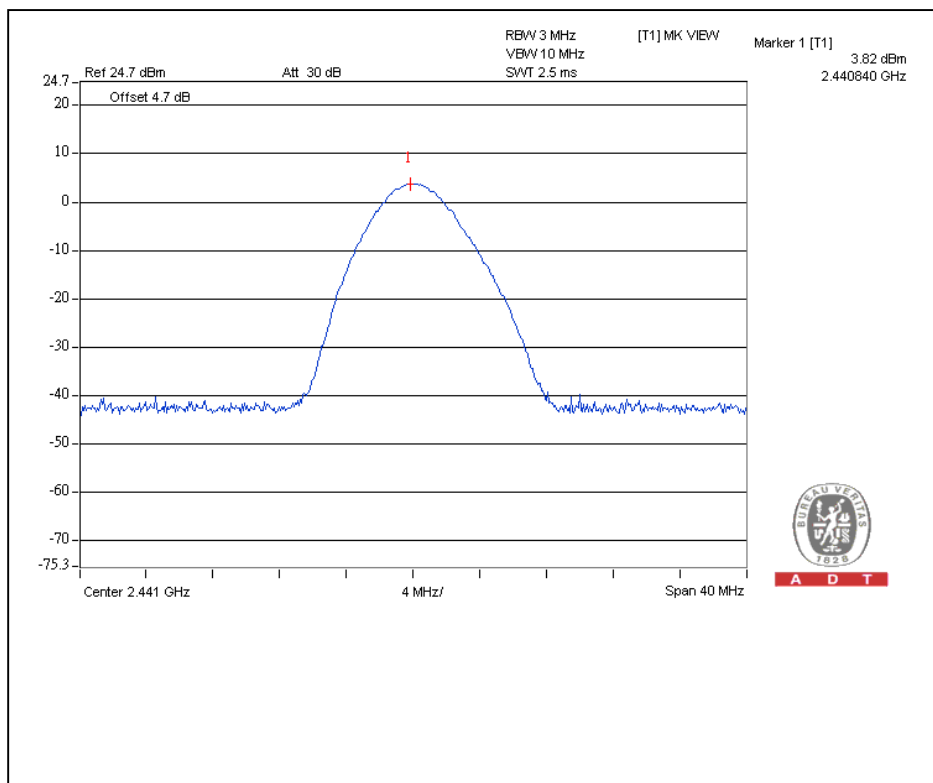

### Channel 78

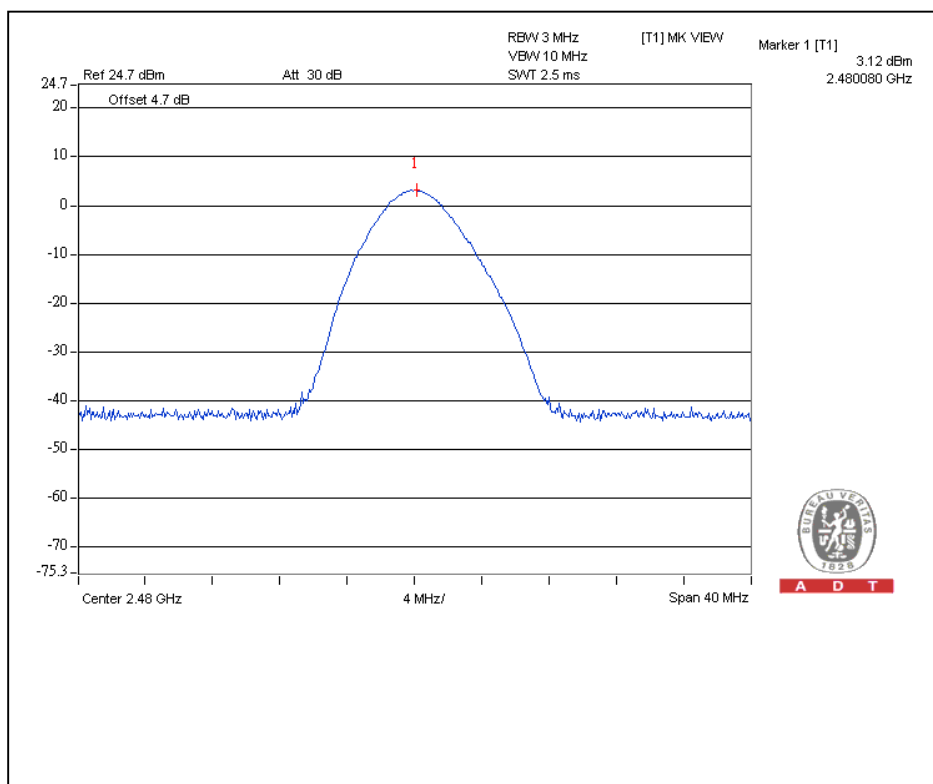



A D T

|                                 |                          |                             |               |
|---------------------------------|--------------------------|-----------------------------|---------------|
| <b>MODULATION TYPE</b>          | $\pi/4$ -DQPSK           | <b>INPUT POWER (SYSTEM)</b> | 120Vac, 60 Hz |
| <b>ENVIRONMENTAL CONDITIONS</b> | 25deg. C, 60%RH, 965 hPa | <b>TESTED BY</b>            | Wen Yu        |

| CHANNEL | CHANNEL FREQUENCY (MHz) | PEAK POWER OUTPUT (mW) | PEAK POWER OUTPUT (dBm) | PEAK POWER LIMIT (mW) | PASS/FAIL |
|---------|-------------------------|------------------------|-------------------------|-----------------------|-----------|
| 0       | 2402                    | 2.265                  | 3.55                    | 125                   | PASS      |
| 39      | 2441                    | 2.143                  | 3.31                    | 125                   | PASS      |
| 78      | 2480                    | 1.928                  | 2.85                    | 125                   | PASS      |

### Channel 0

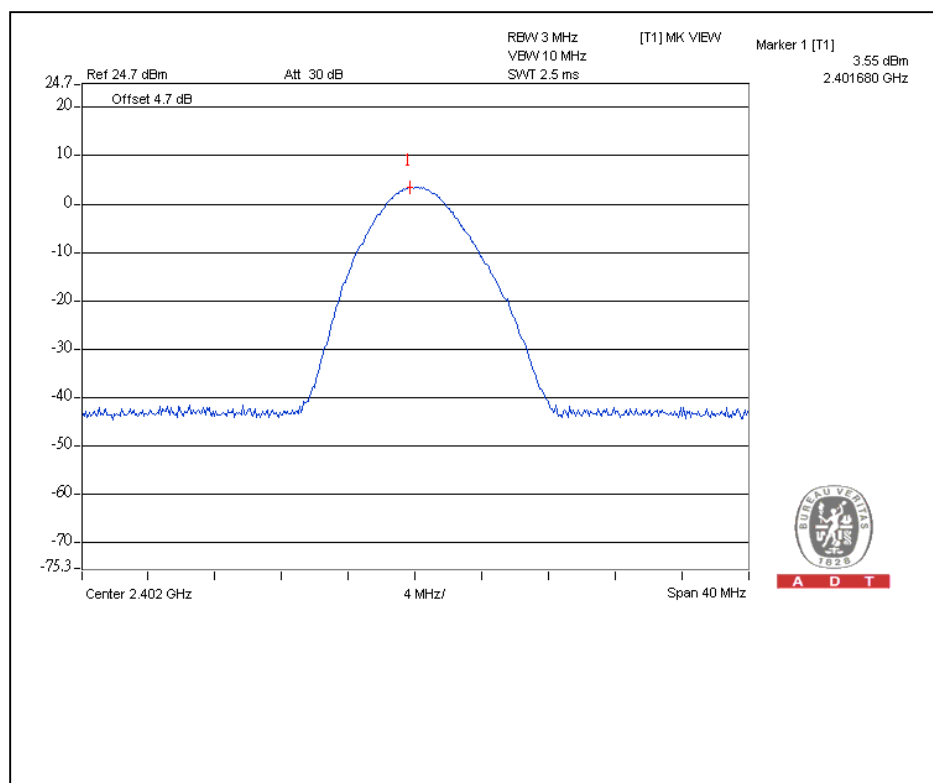



A D T

### Channel 39

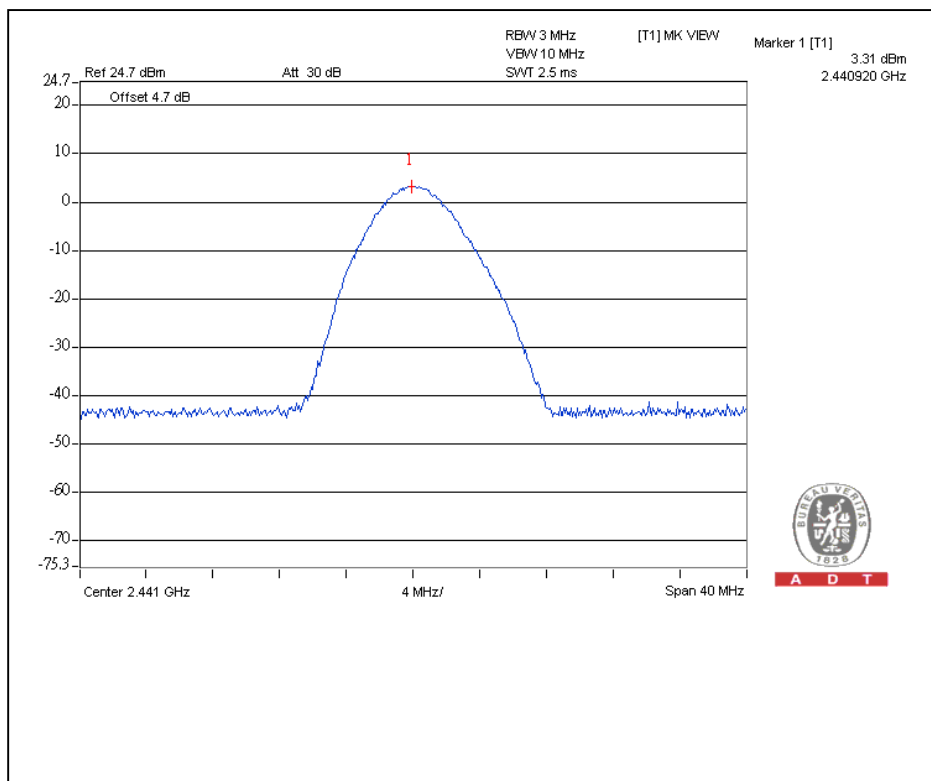

### Channel 78

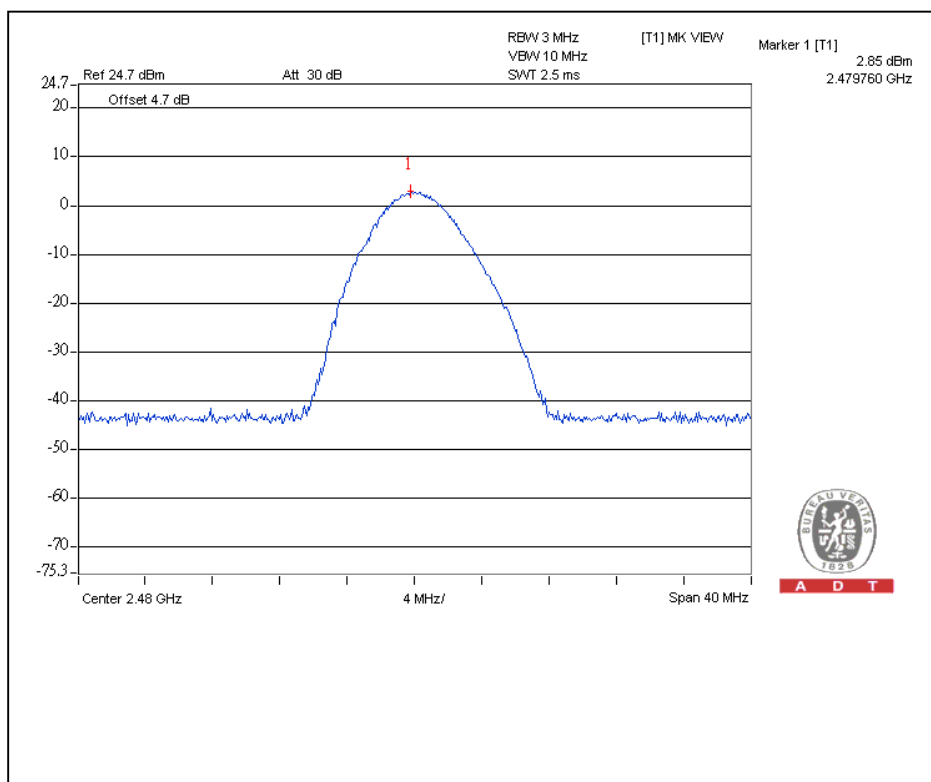

## 4.7 RADIATED EMISSION MEASUREMENT

### 4.7.1 LIMITS OF RADIATED EMISSION MEASUREMENT

Emissions radiated outside of the specified bands, shall be according to the general radiated limits in 15.209 as following:

| Frequencies (MHz) | Field strength (microvolts/meter) | Measurement distance (meters) |
|-------------------|-----------------------------------|-------------------------------|
| 0.009-0.490       | 2400/F(kHz)                       | 300                           |
| 0.490-1.705       | 24000/F(kHz)                      | 30                            |
| 1.705-30.0        | 30                                | 30                            |
| 30-88             | 100                               | 3                             |
| 88-216            | 150                               | 3                             |
| 216-960           | 200                               | 3                             |
| Above 960         | 500                               | 3                             |

As shown in 15.35(b), for frequencies above 1000MHz, the field strength limits are based on average detector, however, the peak field strength of any emission shall not exceed the maximum permitted average limits, specified above by more than 20dB under any condition of modulation.



A D T

#### 4.7.2 TEST INSTRUMENTS

| DESCRIPTION & MANUFACTURER           | MODEL NO.                | SERIAL NO.      | CALIBRATED DATE | CALIBRATED UNTIL |
|--------------------------------------|--------------------------|-----------------|-----------------|------------------|
| ROHDE & SCHWARZ Spectrum Analyzer    | FSP40                    | 100036          | Dec. 09, 2008   | Dec. 08, 2009    |
| Agilent PSA Spectrum Analyzer        | E4446A                   | MY46180622      | Apr. 24 , 2009  | Apr. 23 , 2010   |
| HP Pre_Amplifier                     | 8449B                    | 3008A01923      | Nov. 10, 2008   | Nov. 09, 2009    |
| ROHDE & SCHWARZ Test Receiver        | ESCS30                   | 847124/029      | Sep. 09, 2008   | Sep. 08, 2009    |
| SCHWARZBECK TRILOG Broadband Antenna | VULB 9168                | 138             | April 29, 2009  | April 28, 2010   |
| Schwarzbeck Horn_Antenna             | BBHA9120                 | D124            | Dec. 09, 2008   | Dec. 08, 2009    |
| Schwarzbeck Horn_Antenna             | BBHA 9170                | BBHA9170153     | Jan. 22, 2009   | Jan. 21, 2010    |
| RF Switches                          | EMH-011                  | 08009           | Oct. 07, 2008   | Oct. 06, 2009    |
| RF CABLE (Chaintek)                  | Sucoflex 106             | 28077           | Aug. 15, 2009   | Aug. 14, 2010    |
| RF Cable                             | 8DFB                     | STCCAB-30M-1GHz | Oct. 07, 2008   | Oct. 06, 2009    |
| Software                             | ADT_Radiated_V7.6.15.9.2 | NA              | NA              | NA               |
| CT Antenna Tower & Turn Table        | NA                       | NA              | NA              | NA               |

Note: 1. The calibration interval of the above test instruments is 12 months and the calibrations are traceable to NML/ROC and NIST/USA.

2. The horn antenna, HP preamplifier (model: 8449B) and Spectrum Analyzer (model: FSP40) are used only for the measurement of emission frequency above 1GHz if tested.

3. The test was performed in Open Site No. C.

4. The FCC Site Registration No. is 656396.

5. The VCCI Site Registration No. is R-1626.

6. The CANADA Site Registration No. is IC 7450G-3.

#### 4.7.3 TEST PROCEDURES

- a. The EUT was placed on the top of a rotating table 0.8 meters above the ground at a 10 meter open area test site. The table was rotated 360 degrees to determine the position of the highest radiation.
- b. The EUT was set 3 meters away from the interference-receiving antenna, which was mounted on the top of a variable-height antenna tower.
- c. The antenna is a broadband antenna, and its height is varied from one meter to four meters above the ground to determine the maximum value of the field strength. Both horizontal and vertical polarizations of the antenna are set to make the measurement.
- d. For each suspected emission, the EUT was arranged to its worst case and then the antenna was tuned to heights from 1 meter to 4 meters and the rotatable table was turned from 0 degrees to 360 degrees to find the maximum reading.
- e. The test-receiver system was set to Peak Detect Function and Specified Bandwidth with Maximum Hold Mode.
- f. If the emission level of the EUT in peak mode was 10 dB lower than the limit specified, then testing could be stopped and the peak values of the EUT would be reported. Otherwise the emissions that did not have 10 dB margin would be re-tested one by one using peak, quasi-peak or average method as specified and then reported in a data sheet.

**NOTE:**

1. The resolution bandwidth and video bandwidth of test receiver/spectrum analyzer is 120kHz for Peak detection (PK) and Quasi-peak detection (QP) at frequency below 1GHz.
2. The resolution bandwidth is 1MHz and video bandwidth of test receiver/spectrum analyzer is 3MHz for Peak detection at frequency above 1GHz.

#### 4.7.4 DEVIATION FROM TEST STANDARD

No deviation



#### 4.7.5 TEST SETUP

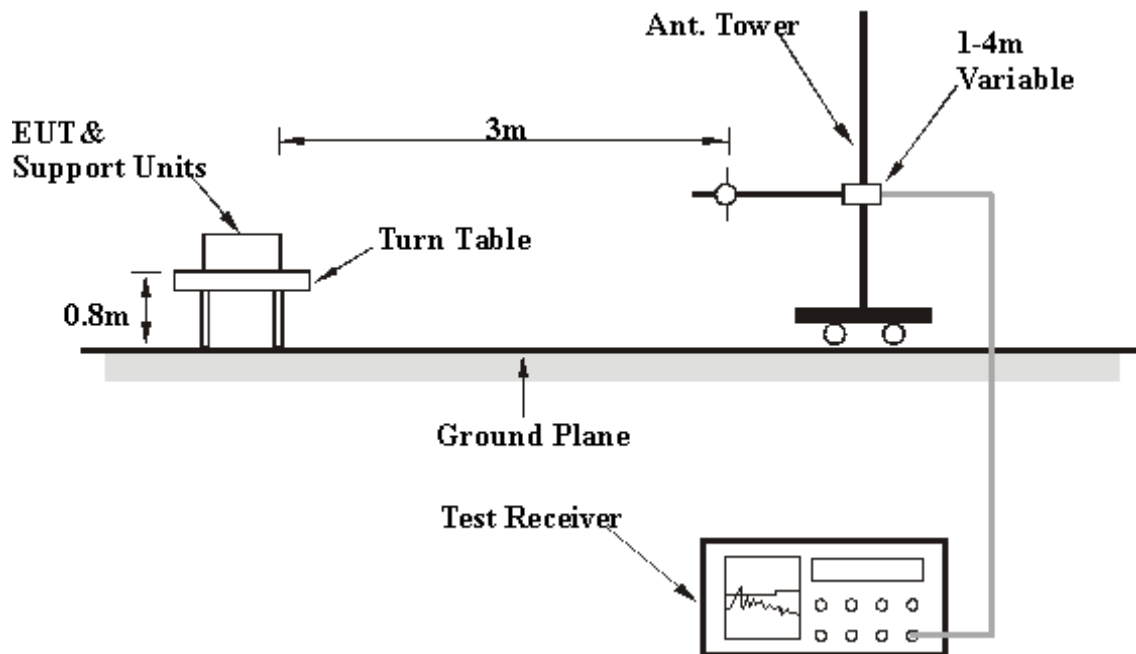

For the actual test configuration, please refer to the related item – Photographs of the Test Configuration.

## 4.7.6 TEST RESULTS

### BELOW 1GHz WORST-CASE DATA : 8DPSK MODULATION

| EUT TEST CONDITION       |                               | MEASUREMENT DETAIL |               |
|--------------------------|-------------------------------|--------------------|---------------|
| CHANNEL                  | Channel 0                     | FREQUENCY RANGE    | Below 1000MHz |
| INPUT POWER (SYSTEM)     | 120Vac, 60 Hz                 | DETECTOR FUNCTION  | Quasi-Peak    |
| ENVIRONMENTAL CONDITIONS | 29.0deg. C, 55.0%RH<br>965hPa | TESTED BY          | Frank Liu     |

| ANTENNA POLARITY & TEST DISTANCE: HORIZONTAL AT 3 M |             |                         |                |             |                    |                      |                  |                          |
|---|-------------|-------------------------|----------------|-------------|--------------------|----------------------|------------------|--------------------------|
| NO.   | FREQ. (MHz) | EMISSION LEVEL (dBuV/m) | LIMIT (dBuV/m) | MARGIN (dB) | ANTENNA HEIGHT (m) | TABLE ANGLE (Degree) | RAW VALUE (dBuV) | CORRECTION FACTOR (dB/m) |
| 1   | 38.64       | 28.91 QP                | 40.00          | -11.09      | 1.00 H             | 214                  | 14.62            | 14.29                    |
| 2   | 75.44       | 26.32 QP                | 40.00          | -13.68      | 1.00 H             | 254                  | 14.32            | 12.00                    |
| 3   | 125.00      | 25.46 QP                | 43.50          | -18.04      | 1.00 H             | 21                   | 12.39            | 13.07                    |
| 4   | 250.00      | 30.69 QP                | 46.00          | -15.31      | 1.00 H             | 87                   | 16.44            | 14.25                    |
| 5   | 375.00      | 32.11 QP                | 46.00          | -13.89      | 1.10 H             | 241                  | 13.30            | 18.81                    |
| 6   | 500.00      | 28.93 QP                | 46.00          | -17.07      | 1.23 H             | 247                  | 6.44             | 22.49                    |
| ANTENNA POLARITY & TEST DISTANCE: VERTICAL AT 3 M   |             |                         |                |             |                    |                      |                  |                          |
| NO.   | FREQ. (MHz) | EMISSION LEVEL (dBuV/m) | LIMIT (dBuV/m) | MARGIN (dB) | ANTENNA HEIGHT (m) | TABLE ANGLE (Degree) | RAW VALUE (dBuV) | CORRECTION FACTOR (dB/m) |
| 1   | 40.12       | 30.82 QP                | 40.00          | -9.18       | 1.00 V             | 31                   | 16.24            | 14.58                    |
| 2   | 80.21       | 24.50 QP                | 40.00          | -15.50      | 1.00 V             | 54                   | 13.66            | 10.84                    |
| 3   | 125.00      | 24.52 QP                | 43.50          | -18.98      | 1.00 V             | 221                  | 11.45            | 13.07                    |
| 4   | 250.00      | 26.80 QP                | 46.00          | -19.20      | 1.00 V             | 324                  | 12.55            | 14.25                    |
| 5   | 375.00      | 31.59 QP                | 46.00          | -14.41      | 1.10 V             | 118                  | 12.78            | 18.81                    |
| 6   | 500.00      | 30.84 QP                | 46.00          | -15.16      | 1.23 V             | 142                  | 8.35             | 22.49                    |

- REMARKS:**
1. Emission level (dBuV/m) = Raw Value (dBuV) + Correction Factor (dB/m).
  2. Correction Factor (dB/m) = Antenna Factor (dB/m) + Cable Factor (dB).
  3. The other emission levels were very low against the limit.
  4. Margin value = Emission level – Limit value.



A D T

ABOVE 1GHz WORST-CASE DATA : GFSK MODULATION

| EUT TEST CONDITION       |                               | MEASUREMENT DETAIL |                           |
|--------------------------|-------------------------------|--------------------|---------------------------|
| CHANNEL                  | Channel 0                     | FREQUENCY RANGE    | 1 ~ 25GHz                 |
| INPUT POWER (SYSTEM)     | 120Vac, 60 Hz                 | DETECTOR FUNCTION  | Peak (PK)<br>Average (AV) |
| ENVIRONMENTAL CONDITIONS | 37.0deg. C, 55.0%RH<br>965hPa | TESTED BY          | Eric Lee                  |

| ANTENNA POLARITY & TEST DISTANCE: HORIZONTAL AT 3 M |             |                         |                |             |                    |                      |                  |                          |
|---|-------------|-------------------------|----------------|-------------|--------------------|----------------------|------------------|--------------------------|
| NO.   | FREQ. (MHz) | EMISSION LEVEL (dBuV/m) | LIMIT (dBuV/m) | MARGIN (dB) | ANTENNA HEIGHT (m) | TABLE ANGLE (Degree) | RAW VALUE (dBuV) | CORRECTION FACTOR (dB/m) |
| 1   | 2385.61     | 55.46 PK                | 74.00          | -18.54      | 1.70 H             | 279                  | 25.19            | 30.27                    |
| 2   | 2385.61     | 25.46 AV                | 54.00          | -28.54      | 1.70 H             | 279                  | -4.81            | 30.27                    |
| 3   | *2402.00    | 99.28 PK                |                |             | 1.79 H             | 279                  | 68.95            | 30.33                    |
| 4   | *2402.00    | 69.28 AV                |                |             | 1.79 H             | 279                  | 38.95            | 30.33                    |
| 5   | 4804.00     | 42.78 PK                | 74.00          | -31.22      | 1.11 H             | 48                   | 6.05             | 36.73                    |
| 6   | 4804.00     | 12.78 AV                | 54.00          | -41.22      | 1.11 H             | 48                   | -23.95           | 36.73                    |

| ANTENNA POLARITY & TEST DISTANCE: VERTICAL AT 3 M |             |                         |                |             |                    |                      |                  |                          |
|---|-------------|-------------------------|----------------|-------------|--------------------|----------------------|------------------|--------------------------|
| NO.   | FREQ. (MHz) | EMISSION LEVEL (dBuV/m) | LIMIT (dBuV/m) | MARGIN (dB) | ANTENNA HEIGHT (m) | TABLE ANGLE (Degree) | RAW VALUE (dBuV) | CORRECTION FACTOR (dB/m) |
| 1   | 2373.01     | 55.57 PK                | 74.00          | -18.43      | 1.49 V             | 244                  | 25.35            | 30.22                    |
| 2   | 2373.01     | 25.57 AV                | 54.00          | -28.43      | 1.49 V             | 244                  | -4.65            | 30.22                    |
| 3   | *2402.00    | 92.51 PK                |                |             | 1.50 V             | 263                  | 62.18            | 30.33                    |
| 4   | *2402.00    | 62.51 AV                |                |             | 1.50 V             | 263                  | 32.18            | 30.33                    |
| 5   | 4804.00     | 43.72 PK                | 74.00          | -30.28      | 1.38 V             | 78                   | 6.99             | 36.73                    |
| 6   | 4804.00     | 13.72 AV                | 54.00          | -40.28      | 1.38 V             | 78                   | -23.01           | 36.73                    |

- REMARKS:**
1. Emission level (dBuV/m) = Raw Value (dBuV) + Correction Factor (dB/m).
  2. Correction Factor (dB/m) = Antenna Factor (dB/m) + Cable Factor (dB).
  3. The other emission levels were very low against the limit.
  4. Margin value = Emission level – Limit value.
  5. “ \* “: Fundamental frequency.
  6. The DH5 packet was the worse case duty cycle for a transmit dwell time on a channel, based upon bluetooth theory the transmitter is on 0.625 \* 5 per 296.25 ms per channel. Therefore, the duty cycle correlation factor be equal to:  $20\log(3.125 / 100) = -30.1$  dB.
  7. Average value = peak reading +  $20\log(\text{duty cycle})$ .



A D T

| EUT TEST CONDITION       |                               | MEASUREMENT DETAIL |                           |
|--------------------------|-------------------------------|--------------------|---------------------------|
| CHANNEL                  | Channel 39                    | FREQUENCY RANGE    | 1 ~ 25GHz                 |
| INPUT POWER (SYSTEM)     | 120Vac, 60 Hz                 | DETECTOR FUNCTION  | Peak (PK)<br>Average (AV) |
| ENVIRONMENTAL CONDITIONS | 37.0deg. C, 55.0%RH<br>965hPa | TESTED BY          | Eric Lee                  |

**ANTENNA POLARITY & TEST DISTANCE: HORIZONTAL AT 3 M**

| NO. | FREQ. (MHz) | EMISSION LEVEL (dBuV/m) | LIMIT (dBuV/m) | MARGIN (dB) | ANTENNA HEIGHT (m) | TABLE ANGLE (Degree) | RAW VALUE (dBuV) | CORRECTION FACTOR (dB/m) |
|-----|-------------|-------------------------|----------------|-------------|--------------------|----------------------|------------------|--------------------------|
| 1   | *2441.00    | 99.54 PK                |                |             | 1.63 H             | 282                  | 69.07            | 30.47                    |
| 2   | *2441.00    | 69.54 AV                |                |             | 1.63 H             | 282                  | 39.07            | 30.47                    |
| 3   | 4882.00     | 43.58 PK                | 74.00          | -30.42      | 1.60 H             | 82                   | 6.64             | 36.94                    |
| 4   | 4882.00     | 13.58 AV                | 54.00          | -40.42      | 1.60 H             | 82                   | -23.36           | 36.94                    |
| 5   | 7323.00     | 51.98 PK                | 74.00          | -22.02      | 1.47 H             | 194                  | 8.85             | 43.13                    |
| 6   | 7323.00     | 21.98 AV                | 54.00          | -32.02      | 1.47 H             | 194                  | -21.15           | 43.13                    |

**ANTENNA POLARITY & TEST DISTANCE: VERTICAL AT 3 M**

| NO. | FREQ. (MHz) | EMISSION LEVEL (dBuV/m) | LIMIT (dBuV/m) | MARGIN (dB) | ANTENNA HEIGHT (m) | TABLE ANGLE (Degree) | RAW VALUE (dBuV) | CORRECTION FACTOR (dB/m) |
|-----|-------------|-------------------------|----------------|-------------|--------------------|----------------------|------------------|--------------------------|
| 1   | *2441.00    | 93.48 PK                |                |             | 1.42 V             | 257                  | 63.01            | 30.47                    |
| 2   | *2441.00    | 63.48 AV                |                |             | 1.42 V             | 257                  | 33.01            | 30.47                    |
| 3   | 4882.00     | 44.69 PK                | 74.00          | -29.31      | 1.29 V             | 316                  | 7.75             | 36.94                    |
| 4   | 4882.00     | 14.69 AV                | 54.00          | -39.31      | 1.29 V             | 316                  | -22.25           | 36.94                    |
| 5   | 7323.00     | 51.28 PK                | 74.00          | -22.72      | 1.34 V             | 200                  | 8.15             | 43.13                    |
| 6   | 7323.00     | 21.28 AV                | 54.00          | -32.72      | 1.34 V             | 200                  | -21.85           | 43.13                    |

- REMARKS:**
1. Emission level (dBuV/m) = Raw Value (dBuV) + Correction Factor (dB/m).
  2. Correction Factor (dB/m) = Antenna Factor (dB/m) + Cable Factor (dB).
  3. The other emission levels were very low against the limit.
  4. Margin value = Emission level – Limit value.
  5. “ \* “: Fundamental frequency.
  6. The DH5 packet was the worse case duty cycle for a transmit dwell time on a channel, based upon bluetooth theory the transmitter is on 0.625 \* 5 per 296.25 ms per channel. Therefore, the duty cycle correlation factor be equal to:  $20\log(3.125 / 100) = -30.1$  dB.
  7. Average value = peak reading +  $20\log(\text{duty cycle})$ .



A D T

| EUT TEST CONDITION       |                               | MEASUREMENT DETAIL |                           |
|--------------------------|-------------------------------|--------------------|---------------------------|
| CHANNEL                  | Channel 78                    | FREQUENCY RANGE    | 1 ~ 25GHz                 |
| INPUT POWER (SYSTEM)     | 120Vac, 60 Hz                 | DETECTOR FUNCTION  | Peak (PK)<br>Average (AV) |
| ENVIRONMENTAL CONDITIONS | 37.0deg. C, 55.0%RH<br>965hPa | TESTED BY          | Eric Lee                  |

**ANTENNA POLARITY & TEST DISTANCE: HORIZONTAL AT 3 M**

| NO. | FREQ. (MHz) | EMISSION LEVEL (dBuV/m) | LIMIT (dBuV/m) | MARGIN (dB) | ANTENNA HEIGHT (m) | TABLE ANGLE (Degree) | RAW VALUE (dBuV) | CORRECTION FACTOR (dB/m) |
|-----|-------------|-------------------------|----------------|-------------|--------------------|----------------------|------------------|--------------------------|
| 1   | *2480.00    | 101.99 PK               |                |             | 1.58 H             | 272                  | 71.37            | 30.62                    |
| 2   | *2480.00    | 71.99 AV                |                |             | 1.58 H             | 272                  | 41.37            | 30.62                    |
| 3   | 2484.86     | 55.75 PK                | 74.00          | -18.25      | 1.59 H             | 269                  | 25.12            | 30.63                    |
| 4   | 2484.86     | 25.75 AV                | 54.00          | -28.25      | 1.59 H             | 269                  | -4.88            | 30.63                    |
| 5   | 4960.00     | 43.69 PK                | 74.00          | -30.31      | 1.48 H             | 69                   | 6.54             | 37.15                    |
| 6   | 4960.00     | 13.69 AV                | 54.00          | -40.31      | 1.48 H             | 69                   | -23.46           | 37.15                    |
| 7   | 7440.00     | 52.71 PK                | 74.00          | -21.29      | 1.52 H             | 360                  | 9.59             | 43.12                    |
| 8   | 7440.00     | 22.71 AV                | 54.00          | -31.29      | 1.52 H             | 360                  | -20.41           | 43.12                    |

**ANTENNA POLARITY & TEST DISTANCE: VERTICAL AT 3 M**

| NO. | FREQ. (MHz) | EMISSION LEVEL (dBuV/m) | LIMIT (dBuV/m) | MARGIN (dB) | ANTENNA HEIGHT (m) | TABLE ANGLE (Degree) | RAW VALUE (dBuV) | CORRECTION FACTOR (dB/m) |
|-----|-------------|-------------------------|----------------|-------------|--------------------|----------------------|------------------|--------------------------|
| 1   | *2480.00    | 94.87 PK                |                |             | 1.39 V             | 248                  | 64.25            | 30.62                    |
| 2   | *2480.00    | 64.87 AV                |                |             | 1.39 V             | 248                  | 34.25            | 30.62                    |
| 3   | 2483.74     | 55.57 PK                | 74.00          | -18.43      | 1.38 V             | 251                  | 24.94            | 30.63                    |
| 4   | 2483.74     | 25.57 AV                | 54.00          | -28.43      | 1.38 V             | 251                  | -5.06            | 30.63                    |
| 5   | 4960.00     | 43.36 PK                | 74.00          | -30.64      | 1.28 V             | 14                   | 6.21             | 37.15                    |
| 6   | 4960.00     | 13.36 AV                | 54.00          | -40.64      | 1.28 V             | 14                   | -23.79           | 37.15                    |
| 7   | 7440.00     | 51.01 PK                | 74.00          | -22.99      | 1.33 V             | 28                   | 7.89             | 43.12                    |
| 8   | 7440.00     | 21.01 AV                | 54.00          | -32.99      | 1.33 V             | 28                   | -22.11           | 43.12                    |

- REMARKS:**
- Emission level (dBuV/m) = Raw Value (dBuV) + Correction Factor (dB/m).
  - Correction Factor (dB/m) = Antenna Factor (dB/m) + Cable Factor (dB).
  - The other emission levels were very low against the limit.
  - Margin value = Emission level – Limit value.
  - \* \* \*: Fundamental frequency.
  - The DH5 packet was the worse case duty cycle for a transmit dwell time on a channel, based upon bluetooth theory the transmitter is on 0.625 \* 5 per 296.25 ms per channel. Therefore, the duty cycle correlation factor be equal to:  $20\log(3.125 / 100) = -30.1$  dB.
  - Average value = peak reading +  $20\log(\text{duty cycle})$ .

**ABOVE 1GHZ WORST-CASE DATA : 8DPSK MODULATION**

| EUT TEST CONDITION       |                               | MEASUREMENT DETAIL |                           |
|--------------------------|-------------------------------|--------------------|---------------------------|
| CHANNEL                  | Channel 0                     | FREQUENCY RANGE    | 1 ~ 25GHz                 |
| INPUT POWER (SYSTEM)     | 120Vac, 60 Hz                 | DETECTOR FUNCTION  | Peak (PK)<br>Average (AV) |
| ENVIRONMENTAL CONDITIONS | 37.0deg. C, 55.0%RH<br>965hPa | TESTED BY          | Eric Lee                  |

| ANTENNA POLARITY & TEST DISTANCE: HORIZONTAL AT 3 M |             |                         |                |             |                    |                      |                  |                          |
|---|-------------|-------------------------|----------------|-------------|--------------------|----------------------|------------------|--------------------------|
| NO.   | FREQ. (MHz) | EMISSION LEVEL (dBuV/m) | LIMIT (dBuV/m) | MARGIN (dB) | ANTENNA HEIGHT (m) | TABLE ANGLE (Degree) | RAW VALUE (dBuV) | CORRECTION FACTOR (dB/m) |
| 1   | 2384.20     | 54.89 PK                | 74.00          | -19.11      | 1.43 H             | 208                  | 24.63            | 30.26                    |
| 2   | 2384.20     | 24.89 AV                | 54.00          | -29.11      | 1.43 H             | 208                  | -5.37            | 30.26                    |
| 3   | *2402.00    | 104.92 PK               |                |             | 1.43 H             | 208                  | 74.59            | 30.33                    |
| 4   | *2402.00    | 74.92 AV                |                |             | 1.43 H             | 208                  | 44.59            | 30.33                    |
| 5   | 4804.00     | 42.19 PK                | 74.00          | -31.81      | 1.40 H             | 296                  | 5.46             | 36.73                    |
| 6   | 4804.00     | 12.19 AV                | 54.00          | -41.81      | 1.40 H             | 296                  | -24.54           | 36.73                    |
| ANTENNA POLARITY & TEST DISTANCE: VERTICAL AT 3 M   |             |                         |                |             |                    |                      |                  |                          |
| NO.   | FREQ. (MHz) | EMISSION LEVEL (dBuV/m) | LIMIT (dBuV/m) | MARGIN (dB) | ANTENNA HEIGHT (m) | TABLE ANGLE (Degree) | RAW VALUE (dBuV) | CORRECTION FACTOR (dB/m) |
| 1   | 2362.70     | 54.22 PK                | 74.00          | -19.78      | 1.69 V             | 268                  | 24.04            | 30.18                    |
| 2   | 2362.70     | 24.22 AV                | 54.00          | -29.78      | 1.69 V             | 268                  | -5.96            | 30.18                    |
| 3   | *2402.00    | 95.98 PK                |                |             | 1.69 V             | 262                  | 65.65            | 30.33                    |
| 4   | *2402.00    | 65.98 AV                |                |             | 1.69 V             | 262                  | 35.65            | 30.33                    |
| 5   | 4804.00     | 42.08 PK                | 74.00          | -31.92      | 1.39 V             | 246                  | 5.35             | 36.73                    |
| 6   | 4804.00     | 12.08 AV                | 54.00          | -41.92      | 1.39 V             | 246                  | -24.65           | 36.73                    |

- REMARKS:**
- Emission level (dBuV/m) = Raw Value (dBuV) + Correction Factor (dB/m).
  - Correction Factor (dB/m) = Antenna Factor (dB/m) + Cable Factor (dB).
  - The other emission levels were very low against the limit.
  - Margin value = Emission level – Limit value.
  - “ \* ”: Fundamental frequency.
  - The DH5 packet was the worse case duty cycle for a transmit dwell time on a channel, based upon bluetooth theory the transmitter is on 0.625 \* 5 per 296.25 ms per channel. Therefore, the duty cycle correlation factor be equal to:  $20\log(3.125 / 100) = -30.1$  dB.
  - Average value = peak reading +  $20\log(\text{duty cycle})$ .



A D T

| EUT TEST CONDITION       |                               | MEASUREMENT DETAIL |                           |
|--------------------------|-------------------------------|--------------------|---------------------------|
| CHANNEL                  | Channel 39                    | FREQUENCY RANGE    | 1 ~ 25GHz                 |
| INPUT POWER (SYSTEM)     | 120Vac, 60 Hz                 | DETECTOR FUNCTION  | Peak (PK)<br>Average (AV) |
| ENVIRONMENTAL CONDITIONS | 37.0deg. C, 55.0%RH<br>965hPa | TESTED BY          | Eric Lee                  |

**ANTENNA POLARITY & TEST DISTANCE: HORIZONTAL AT 3 M**

| NO. | FREQ. (MHz) | EMISSION LEVEL (dBuV/m) | LIMIT (dBuV/m) | MARGIN (dB) | ANTENNA HEIGHT (m) | TABLE ANGLE (Degree) | RAW VALUE (dBuV) | CORRECTION FACTOR (dB/m) |
|-----|-------------|-------------------------|----------------|-------------|--------------------|----------------------|------------------|--------------------------|
| 1   | *2441.00    | 104.46 PK               |                |             | 1.40 H             | 281                  | 73.99            | 30.47                    |
| 2   | *2441.00    | 74.46 AV                |                |             | 1.40 H             | 281                  | 43.99            | 30.47                    |
| 3   | 4882.00     | 43.08 PK                | 74.00          | -30.92      | 1.38 H             | 287                  | 6.14             | 36.94                    |
| 4   | 4882.00     | 13.08 AV                | 54.00          | -40.92      | 1.38 H             | 287                  | -23.86           | 36.94                    |
| 5   | 7323.00     | 52.33 PK                | 74.00          | -21.67      | 1.26 H             | 84                   | 9.20             | 43.13                    |
| 6   | 7323.00     | 22.33 AV                | 54.00          | -31.67      | 1.26 H             | 84                   | -20.80           | 43.13                    |

**ANTENNA POLARITY & TEST DISTANCE: VERTICAL AT 3 M**

| NO. | FREQ. (MHz) | EMISSION LEVEL (dBuV/m) | LIMIT (dBuV/m) | MARGIN (dB) | ANTENNA HEIGHT (m) | TABLE ANGLE (Degree) | RAW VALUE (dBuV) | CORRECTION FACTOR (dB/m) |
|-----|-------------|-------------------------|----------------|-------------|--------------------|----------------------|------------------|--------------------------|
| 1   | *2441.00    | 95.59 PK                |                |             | 1.63 V             | 271                  | 65.12            | 30.47                    |
| 2   | *2441.00    | 65.59 AV                |                |             | 1.63 V             | 271                  | 35.12            | 30.47                    |
| 3   | 4882.00     | 42.44 PK                | 74.00          | -31.56      | 1.41 V             | 250                  | 5.50             | 36.94                    |
| 4   | 4882.00     | 12.44 AV                | 54.00          | -41.56      | 1.41 V             | 250                  | -24.50           | 36.94                    |
| 5   | 7323.00     | 51.69 PK                | 74.00          | -22.31      | 1.50 V             | 169                  | 8.56             | 43.13                    |
| 6   | 7323.00     | 21.69 AV                | 54.00          | -32.31      | 1.50 V             | 169                  | -21.44           | 43.13                    |

- REMARKS:**
- Emission level (dBuV/m) = Raw Value (dBuV) + Correction Factor (dB/m).
  - Correction Factor (dB/m) = Antenna Factor (dB/m) + Cable Factor (dB).
  - The other emission levels were very low against the limit.
  - Margin value = Emission level – Limit value.
  - \* \* \*: Fundamental frequency.
  - The DH5 packet was the worse case duty cycle for a transmit dwell time on a channel, based upon bluetooth theory the transmitter is on 0.625 \* 5 per 296.25 ms per channel. Therefore, the duty cycle correlation factor be equal to:  $20\log(3.125 / 100) = -30.1$  dB.
  - Average value = peak reading +  $20\log(\text{duty cycle})$ .



A D T

| EUT TEST CONDITION       |                               | MEASUREMENT DETAIL |                           |
|--------------------------|-------------------------------|--------------------|---------------------------|
| CHANNEL                  | Channel 78                    | FREQUENCY RANGE    | 1 ~ 25GHz                 |
| INPUT POWER (SYSTEM)     | 120Vac, 60 Hz                 | DETECTOR FUNCTION  | Peak (PK)<br>Average (AV) |
| ENVIRONMENTAL CONDITIONS | 37.0deg. C, 55.0%RH<br>965hPa | TESTED BY          | Eric Lee                  |

| ANTENNA POLARITY & TEST DISTANCE: HORIZONTAL AT 3 M |             |                         |                |             |                    |                      |                  |                          |
|---|-------------|-------------------------|----------------|-------------|--------------------|----------------------|------------------|--------------------------|
| NO.   | FREQ. (MHz) | EMISSION LEVEL (dBuV/m) | LIMIT (dBuV/m) | MARGIN (dB) | ANTENNA HEIGHT (m) | TABLE ANGLE (Degree) | RAW VALUE (dBuV) | CORRECTION FACTOR (dB/m) |
| 1   | *2480.00    | 104.45 PK               |                |             | 1.35 H             | 285                  | 73.83            | 30.62                    |
| 2   | *2480.00    | 74.45 AV                |                |             | 1.35 H             | 285                  | 43.83            | 30.62                    |
| 3   | 2483.97     | 55.65 PK                | 74.00          | -18.35      | 1.36 H             | 288                  | 25.02            | 30.63                    |
| 4   | 2483.97     | 25.65 AV                | 54.00          | -28.35      | 1.36 H             | 288                  | -4.98            | 30.63                    |
| 5   | 4960.00     | 43.47 PK                | 74.00          | -30.53      | 1.29 H             | 68                   | 6.32             | 37.15                    |
| 6   | 4960.00     | 13.47 AV                | 54.00          | -40.53      | 1.29 H             | 68                   | -23.68           | 37.15                    |
| 7   | 7440.00     | 51.98 PK                | 74.00          | -22.02      | 1.57 H             | 172                  | 8.86             | 43.12                    |
| 8   | 7440.00     | 21.98 AV                | 54.00          | -32.02      | 1.57 H             | 172                  | -21.14           | 43.12                    |
| ANTENNA POLARITY & TEST DISTANCE: VERTICAL AT 3 M   |             |                         |                |             |                    |                      |                  |                          |
| NO.   | FREQ. (MHz) | EMISSION LEVEL (dBuV/m) | LIMIT (dBuV/m) | MARGIN (dB) | ANTENNA HEIGHT (m) | TABLE ANGLE (Degree) | RAW VALUE (dBuV) | CORRECTION FACTOR (dB/m) |
| 1   | *2480.00    | 95.51 PK                |                |             | 1.58 V             | 269                  | 64.89            | 30.62                    |
| 2   | *2480.00    | 65.51 AV                |                |             | 1.58 V             | 269                  | 34.89            | 30.62                    |
| 3   | 2484.48     | 55.66 PK                | 74.00          | -18.34      | 1.53 V             | 283                  | 25.03            | 30.63                    |
| 4   | 2484.48     | 25.66 AV                | 54.00          | -28.34      | 1.53 V             | 283                  | -4.97            | 30.63                    |
| 5   | 4960.00     | 43.22 PK                | 74.00          | -30.78      | 1.38 V             | 243                  | 6.07             | 37.15                    |
| 6   | 4960.00     | 13.22 AV                | 54.00          | -40.78      | 1.38 V             | 243                  | -23.93           | 37.15                    |
| 7   | 7440.00     | 51.72 PK                | 74.00          | -22.28      | 1.59 V             | 188                  | 8.60             | 43.12                    |
| 8   | 7440.00     | 21.72 AV                | 54.00          | -32.28      | 1.59 V             | 188                  | -21.40           | 43.12                    |

- REMARKS:**
- Emission level (dBuV/m) = Raw Value (dBuV) + Correction Factor (dB/m).
  - Correction Factor (dB/m) = Antenna Factor (dB/m) + Cable Factor (dB).
  - The other emission levels were very low against the limit.
  - Margin value = Emission level – Limit value.
  - \* \* \*: Fundamental frequency.
  - The DH5 packet was the worse case duty cycle for a transmit dwell time on a channel, based upon bluetooth theory the transmitter is on 0.625 \* 5 per 296.25 ms per channel. Therefore, the duty cycle correlation factor be equal to:  $20\log(3.125 / 100) = -30.1$  dB.
  - Average value = peak reading +  $20\log(\text{duty cycle})$ .



## 4.8 CONDUCTED OUT-BAND EMISSION MEASUREMENT

### 4.8.1 LIMITS OF CONDUCTED OUT-BAND EMISSION MEASUREMENT

Below  $-20\text{dB}$  of the highest emission level of operating band (in 100kHz RBW).

### 4.8.2 TEST INSTRUMENTS

| DESCRIPTION & MANUFACTURER | MODEL NO. | SERIAL NO. | CALIBRATED DATE | CALIBRATED UNTIL |
|----------------------------|-----------|------------|-----------------|------------------|
| R&S SPECTRUM ANALYZER      | FSP40     | 100037     | Aug. 09, 2009   | Aug. 08, 2010    |

#### NOTE:

1. The calibration interval of the above test instruments is 12 months and the calibrations are traceable to NML/ROC and NIST/USA.

### 4.8.3 TEST PROCEDURE

The transmitter output was connected to the spectrum analyzer via a low lose cable. Set RBW a of spectrum analyzer to 100 kHz and VBW of spectrum analyzer to 300 kHz with suitable frequency span including 100 MHz bandwidth from band edge. The band edges was measured and recorded.

### 4.8.4 DEVIATION FROM TEST STANDARD

No deviation

### 4.8.5 EUT OPERATING CONDITION

The software provided by client enabled the EUT to transmit and receive data at lowest, middle and highest channel frequencies individually.

### 4.8.6 TEST RESULTS

Emissions radiated outside of the specified frequency bands, please refer pages form 67 to 73 for met the requirement of the general radiated emission limits in § 15.209.

#### For GFSK MODULATION TYPE:

CH0

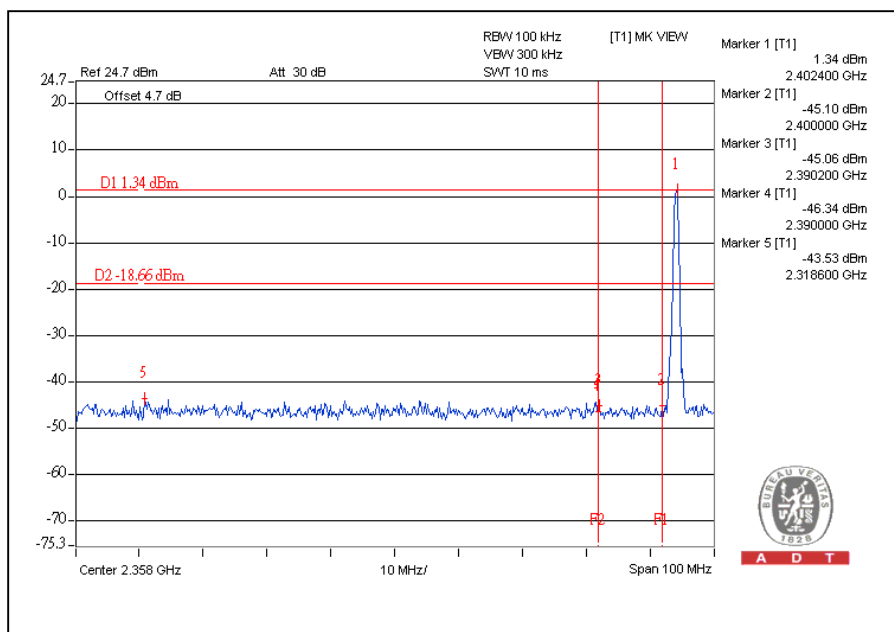

CH78

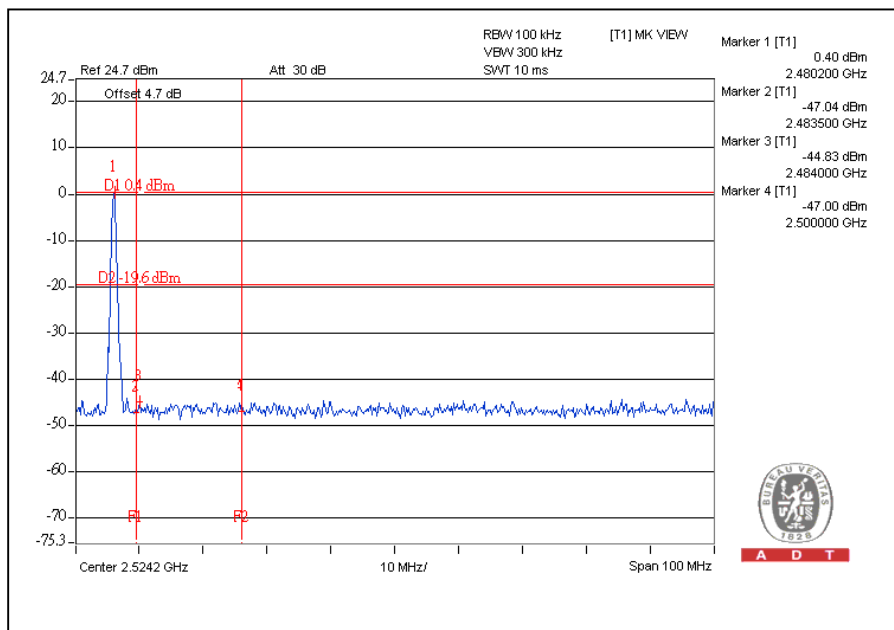



A D T

### CH0

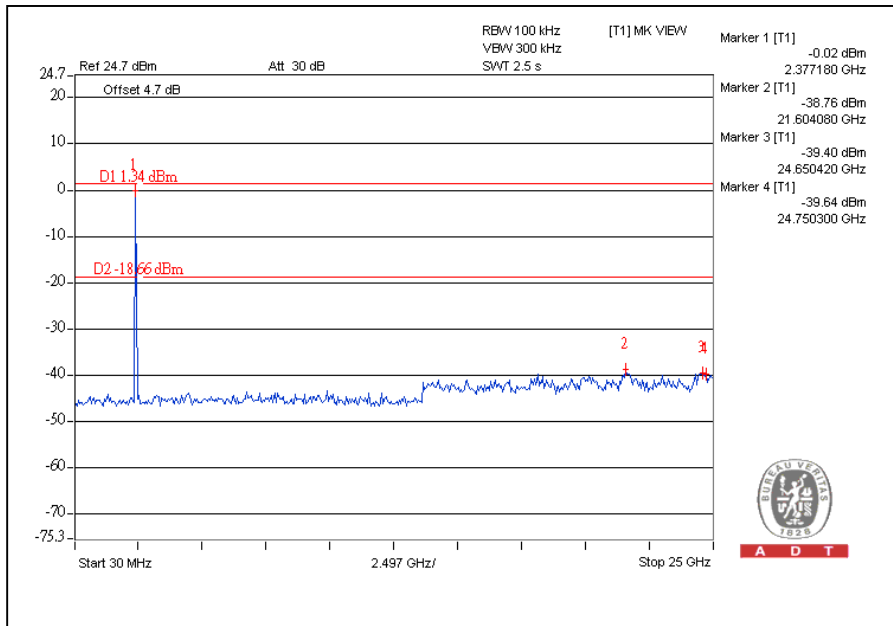

### CH78

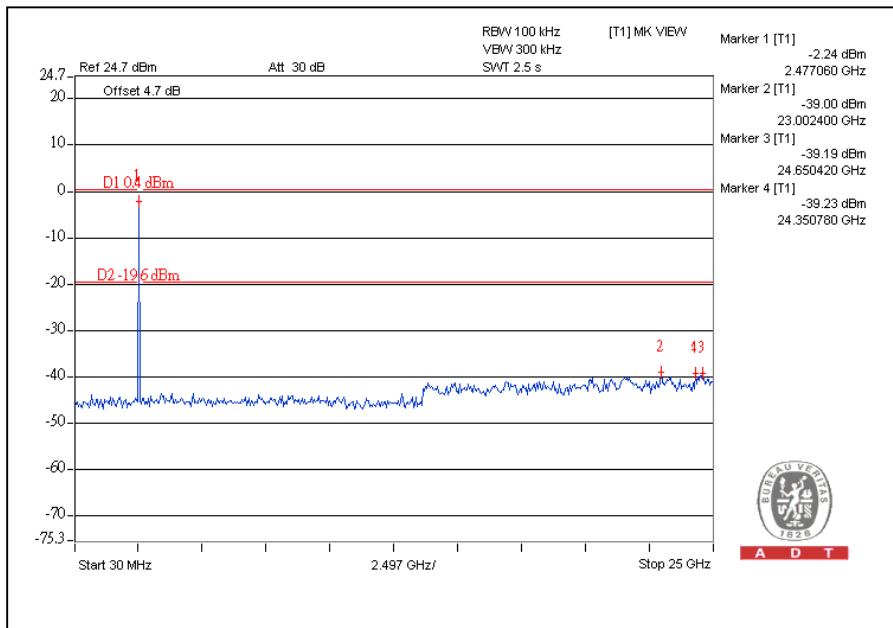



A D T

### FOR 8DPSK MODULATION TYPE:

CH0

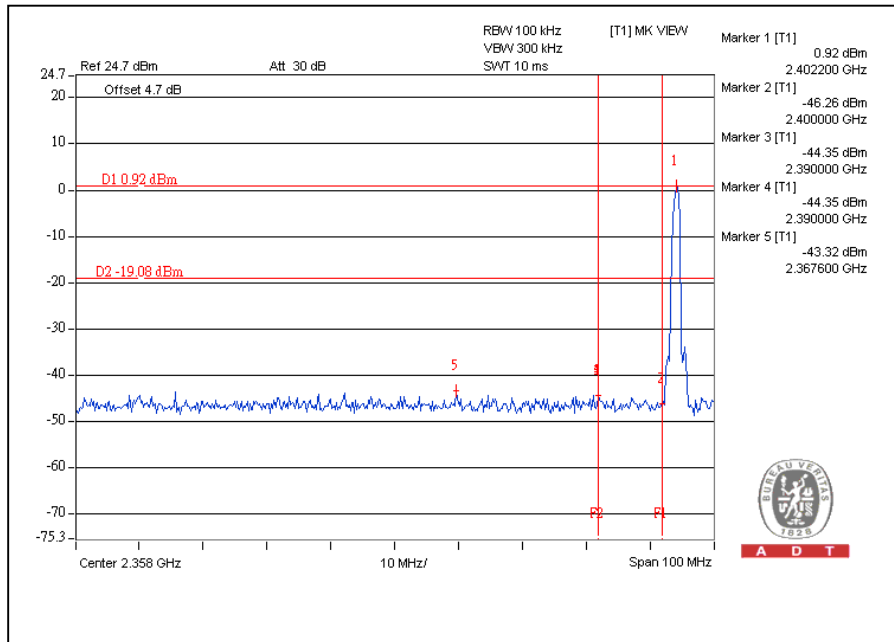

A D T

CH78

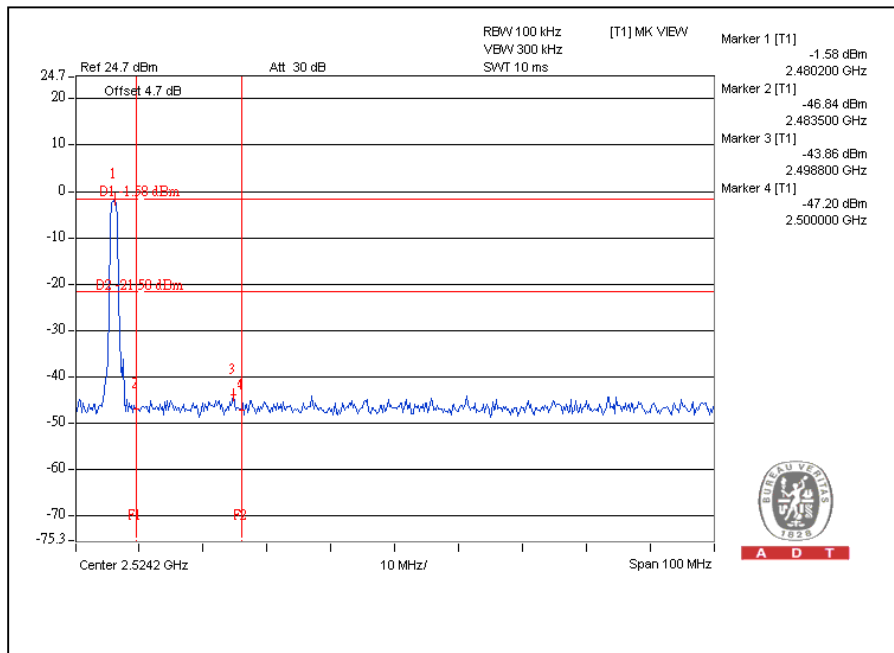

A D T



A D T

### CH0

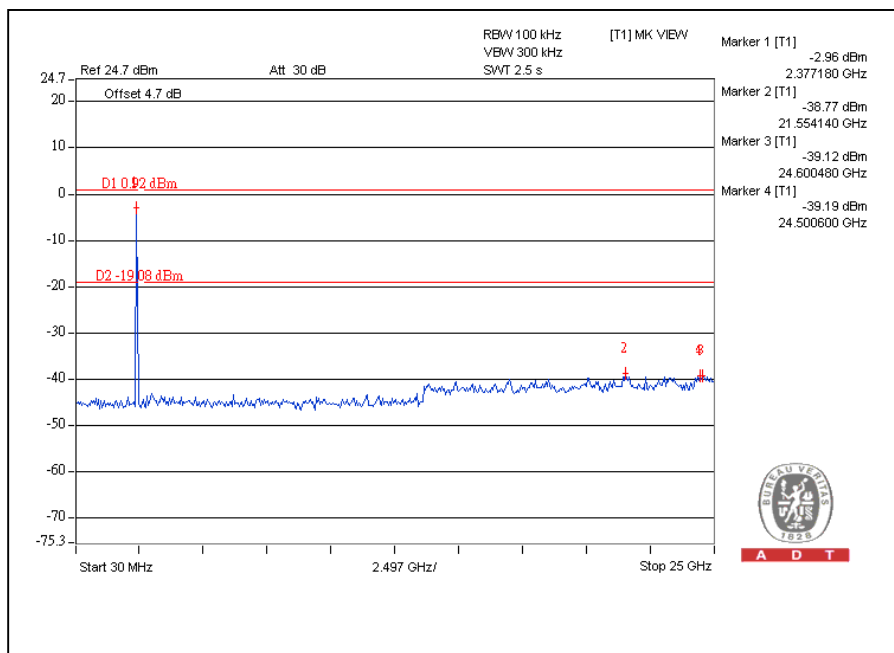

### CH78

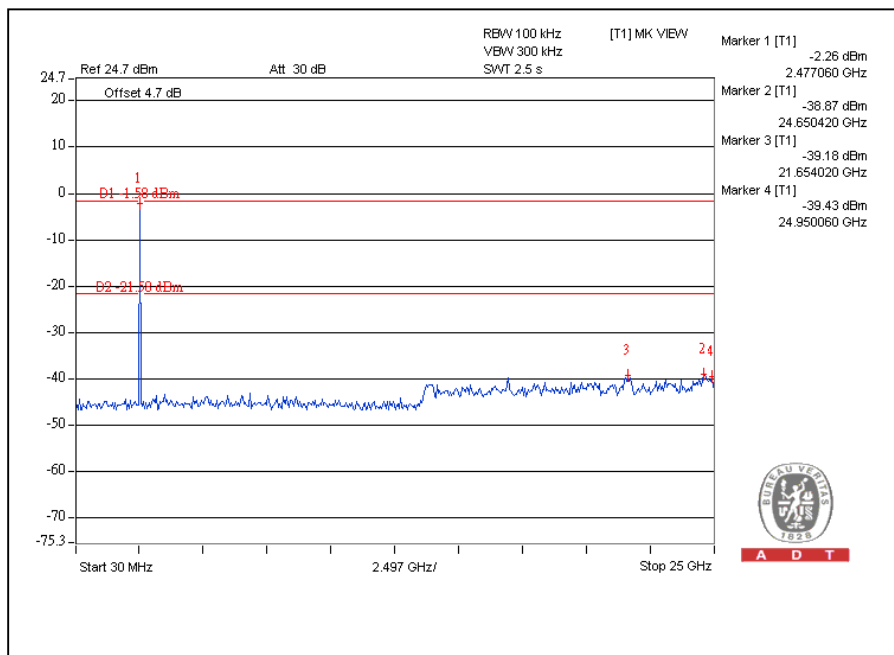

## 4.9 ANTENNA REQUIREMENT

### 4.9.1 STANDARD APPLICABLE

For intentional device, according to FCC 47 CFR Section 15.203, an intentional radiator shall be designed to ensure that no antenna other than that furnished by the responsible party shall be used with the device.

And according to FCC 47 CFR Section 15.247 (b), if transmitting antennas of directional gain greater than 6 dBi are used, the power shall be reduced by the amount in dB that the directional gain of the antenna exceeds 6 dBi.

### 4.9.2 ANTENNA CONNECTED CONSTRUCTION

There are two antennas provided to this EUT, please refer to the following table:

| No. | Brand    | Model    | Antenna Type | Gain (dBi) | Connector Type | Frequency range (MHz) | Cable Loss(dB) | Cable Length |
|-----|----------|----------|--------------|------------|----------------|-----------------------|----------------|--------------|
| 1   | Motorola | Rot type | PIFA         | 3.08       | Hirose U.FL    | 2400~2480             | 0.1~0.15       | 35 ± 0.5mm   |
| 2   | Motorola | Str type | PIFA         | 2.481      | Hirose U.FL    | 2400~2480             | 0.1~0.15       | 35 ± 0.5mm   |



## 5 INFORMATION ON THE TESTING LABORATORIES

We, Bureau Veritas Consumer Products Services (H.K.) Ltd., Taoyuan Branch, were founded in 1988 to provide our best service in EMC, Radio, Telecom and Safety consultation. Our laboratories are accredited and approved by the following approval agencies according to ISO/IEC 17025:

|                    |                      |
|--------------------|----------------------|
| <b>USA</b>         | FCC, NVLAP           |
| <b>Germany</b>     | TUV Rheinland        |
| <b>Japan</b>       | VCCI                 |
| <b>Norway</b>      | NEMKO                |
| <b>Canada</b>      | INDUSTRY CANADA, CSA |
| <b>R.O.C.</b>      | TAF, BSMI, NCC       |
| <b>Netherlands</b> | Telefication         |
| <b>Singapore</b>   | GOST-ASIA (MOU)      |
| <b>Russia</b>      | CERTIS (MOU)         |

Copies of accreditation certificates of our laboratories obtained from approval agencies can be downloaded from our web site: [www.adt.com.tw/index.5/phtml](http://www.adt.com.tw/index.5/phtml).

If you have any comments, please feel free to contact us at the following:

**Linko EMC/RF Lab:**

Tel: 886-2-26052180

Fax: 886-2-26052943

**Hsin Chu EMC/RF Lab:**

Tel: 886-3-5935343

Fax: 886-3-5935342

**Hwa Ya EMC/RF/Safety/Telecom Lab:**

Tel: 886-3-3183232

Fax: 886-3-3185050

**Email:** [service@adt.com.tw](mailto:service@adt.com.tw)

**Web Site:** [www.adt.com.tw](http://www.adt.com.tw)

The address and road map of all our labs can be found in our web site also.

## **6 APPENDIX A - MODIFICATIONS RECORDERS FOR ENGINEERING CHANGES TO THE EUT BY THE LAB**

No any modifications are made to the EUT by the lab during the test.

**--- END ---**