



FCC RADIO TEST REPORT

FCC ID : UZ7MC27AK
Equipment : Mobile computer
Brand Name : Zebra
Model Name : MC27AK
Applicant : Zebra Technologies Corporation
1 Zebra Plaza, Holtsville, NY 11742
Manufacturer : Zebra Technologies Corporation
1 Zebra Plaza, Holtsville, NY 11742
Standard : FCC Part 15 Subpart C §15.247

The product was received on Jul. 07, 2020 and testing was started from Aug. 03, 2020 and completed on Aug. 26, 2020. We, SPORTON INTERNATIONAL INC., EMC & Wireless Communications Laboratory, would like to declare that the tested sample has been evaluated in accordance with the test procedures and has been in compliance with the applicable technical standards.

The test results in this report apply exclusively to the tested model / sample. Without written approval of SPORTON INTERNATIONAL INC. EMC & Wireless Communications Laboratory, the test report shall not be reproduced except in full.

Louis Wu

Approved by: Louis Wu

SPORTON INTERNATIONAL INC. EMC & Wireless Communications Laboratory

No. 52, Huaya 1st Rd., Guishan Dist., Taoyuan City, Taiwan (R.O.C.)



Table of Contents

History of this test report.....	3
Summary of Test Result.....	4
1 General Description	5
1.1 Product Feature of Equipment Under Test.....	5
1.2 Product Specification of Equipment Under Test.....	6
1.3 Modification of EUT	6
1.4 Testing Location	6
1.5 Applicable Standards.....	7
2 Test Configuration of Equipment Under Test	8
2.1 Carrier Frequency and Channel	8
2.2 Test Mode.....	8
2.3 Connection Diagram of Test System.....	12
2.4 Support Unit used in test configuration and system	13
2.5 EUT Operation Test Setup	13
2.6 Measurement Results Explanation Example.....	13
3 Test Result	14
3.1 6dB and 99% Bandwidth Measurement	14
3.2 Output Power Measurement.....	16
3.3 Power Spectral Density Measurement	19
3.4 Conducted Band Edges and Spurious Emission Measurement	21
3.5 Radiated Band Edges and Spurious Emission Measurement	34
3.6 AC Conducted Emission Measurement.....	38
3.7 Antenna Requirements	40
4 List of Measuring Equipment.....	41
5 Uncertainty of Evaluation	43
Appendix A. AC Conducted Emission Test Result	
Appendix B. Radiated Spurious Emission	
Appendix C. Radiated Spurious Emission Plots	
Appendix D. Duty Cycle Plots	
Appendix E. Setup Photographs	



History of this test report

Report No.	Version	Description	Issued Date
FR052917-01C	01	Initial issue of report	Oct. 20, 2020



Summary of Test Result

Report Clause	Ref Std. Clause	Test Items	Result (PASS/FAIL)	Remark
3.1	15.247(a)(2)	6dB Bandwidth	Pass	-
3.1	2.1049	99% Occupied Bandwidth	Reporting only	-
3.2	15.247(b)	Power Output Measurement	Pass	-
3.3	15.247(e)	Power Spectral Density	Pass	-
3.4	15.247(d)	Conducted Band Edges	Pass	-
		Conducted Spurious Emission	Pass	-
3.5	15.247(d)	Radiated Band Edges and Radiated Spurious Emission	Pass	Under limit 1.08 dB at 2483.530 MHz
3.6	15.207	AC Conducted Emission	Pass	Under limit 14.58 dB at 0.500 MHz
3.7	15.203 & 15.247(b)	Antenna Requirement	Pass	-

Declaration of Conformity:

The test results with all measurement uncertainty excluded are presented in accordance with the regulation limits or requirements declared by manufacturers.

Comments and Explanations:

The declared of product specification for EUT presented in the report are provided by the manufacturer, and the manufacturer takes all the responsibilities for the accuracy of product specification.

Reviewed by: Wii Chang

Report Producer: Yimin Ho



1 General Description

1.1 Product Feature of Equipment Under Test

Product Feature	
Equipment	Mobile computer
Brand Name	Zebra
Model Name	MC27AK
FCC ID	UZ7MC27AK
EUT supports Radios application	WCDMA/HSPA/LTE/NFC/GNSS WLAN 11a/b/g/n HT20/HT40 WLAN 11ac VHT20/VHT40/VHT80 Bluetooth BR/EDR/LE
HW Version	EV
SW Version	10-11-31.00-QG-U00-PRD-HEL-04
OS Version	Android 10
MFD	23JUN20
EUT Stage	Engineering Sample

Remark: The above EUT's information was declared by manufacturer.

Specification of Accessories				
AC Adapter	Brand Name	Zebra	Part Number	PWR-WUA5V12W0US
Battery	Brand Name	Zebra	Part Number	BT-000418-10
USB Cable (TypeA plug to TypeC plug)	Brand Name	Zebra	Part Number	CBL-TC2X-USBC-01
Trigger Handle	Brand Name	Zebra	Part Number	TRG-MC2X-SNP1-01
Holster	Brand Name	Zebra	Part Number	SG-MC2X-HLSTR-01
Holster	Brand Name	Zebra	Part Number	SG-MC3021212-01R



1.2 Product Specification of Equipment Under Test

Product Specification subjective to this standard	
Tx/Rx Channel Frequency Range	2412 MHz ~ 2462 MHz
Maximum (Peak) Output Power to antenna	802.11b : 23.27 dBm (0.2123 W) 802.11g : 24.60 dBm (0.2884 W) 802.11n HT20 : 24.49 dBm (0.2812 W) 802.11n HT40 : 22.70 dBm (0.1862 W) 802.11ac VHT20 : 24.50 dBm (0.2818 W) 802.11ac VHT40 : 22.71 dBm (0.1866 W)
Maximum (Average) Output Power to antenna	802.11b : 21.40 dBm (0.1380 W) 802.11g : 21.30 dBm (0.1349 W) 802.11n HT20 : 21.10 dBm (0.1288 W) 802.11n HT40 : 16.90 dBm (0.0490 W) 802.11ac VHT20 : 21.20 dBm (0.1318 W) 802.11ac VHT40 : 17.00 dBm (0.0501 W)
99% Occupied Bandwidth	802.11b : 13.79 MHz 802.11g : 17.08 MHz 802.11ac VHT20 : 18.18 MHz 802.11ac VHT40 : 36.46 MHz
Antenna Type / Gain	PIFA Antenna with gain 2.31 dBi
Type of Modulation	802.11b : DSSS (DBPSK / DQPSK / CCK) 802.11g/n : OFDM (BPSK / QPSK / 16QAM / 64QAM) 802.11ac: OFDM (BPSK / QPSK / 16QAM / 64QAM / 256QAM)

1.3 Modification of EUT

No modifications are made to the EUT during all test items.

1.4 Testing Location

Test Site	SPORTON INTERNATIONAL INC. EMC & Wireless Communications Laboratory		
Test Site Location	No.52, Huaya 1st Rd., Guishan Dist., Taoyuan City, Taiwan (R.O.C.) TEL: +886-3-327-3456 FAX: +886-3-328-4978		
Test Site No.	Sporton Site No.		
	TH05-HY	CO05-HY	03CH07-HY

Note: The test site complies with ANSI C63.4 2014 requirement.

FCC designation No.: TW1190



1.5 Applicable Standards

According to the specifications of the manufacturer, the EUT must comply with the requirements of the following standards:

- ♦ FCC Part 15 Subpart C §15.247
- ♦ FCC KDB Publication No. 558074 D01 DTS Meas. Guidance v05r02
- ♦ FCC KDB 414788 D01 Radiated Test Site v01r01.
- ♦ ANSI C63.10-2013

Remark:

1. All test items were verified and recorded according to the standards and without any deviation during the test.
2. The TAF code is not including all the FCC KDB listed without accreditation.
3. This EUT has also been tested and complied with the requirements of FCC Part 15, Subpart B, recorded in a separate test report.

2 Test Configuration of Equipment Under Test

- a. The EUT has been associated with peripherals and configuration operated in a manner tended to maximize its emission characteristics in a typical application. Frequency range investigated: conduction emission (150 kHz to 30 MHz), radiation emission (9 kHz to the 10th harmonic of the highest fundamental frequency or to 40 GHz, whichever is lower). For radiated measurement, pre-scanned in three orthogonal panels, X, Y, Z. The worst cases (X plane) were recorded in this report.
- b. AC power line Conducted Emission was tested under maximum output power.

2.1 Carrier Frequency and Channel

Frequency Band	Channel	Freq. (MHz)	Channel	Freq. (MHz)
2400-2483.5 MHz	1	2412	7	2442
	2	2417	8	2447
	3	2422	9	2452
	4	2427	10	2457
	5	2432	11	2462
	6	2437		

2.2 Test Mode

Final test modes are considering the modulation and worse data rates as below table.

Modulation	Data Rate
802.11b	1 Mbps
802.11g	6 Mbps
802.11n HT20 (Covered by VHT20)	MCS0
802.11n HT40 (Covered by VHT40)	MCS0
802.11ac VHT20	MCS0
802.11ac VHT40	MCS0

Test Cases	
AC Conducted Emission	Mode 1 : WLAN (2.4GHz) Link + Bluetooth Link + NFC On + Battery + USB Cable (Charging from AC Adapter)



Ch. #	2400-2483.5 MHz			
	802.11b	802.11g	802.11ac VHT20	802.11ac VHT40
Low	01	01	01	03
Middle	06	06	06	06
High	11	11	11	09

Remark: For radiation spurious emission, the final modulation and the worst data rate was reference the max RF conducted power.

802.11b RF Peak Output Power (dBm)						
Power vs. Channel			Power vs Data Rate			
Channel	Frequency (MHz)	Data Rate (bps)	Channel	Data Rate (bps)		
		1M		2M	5.5M	11M
CH 01	2412	23.10	CH 11	22.94	22.82	22.80
CH 06	2437	23.06				
CH 11	2462	23.27				

802.11g RF Peak Output Power (dBm)										
Power vs. Channel			Power vs Data Rate							
Channel	Frequency (MHz)	Data Rate (bps)	Channel	Data Rate (bps)						
		6M		9Mbps	12Mbps	18Mbps	24Mbps	36Mbps	48Mbps	54Mbps
CH 01	2412	22.60	CH 06	24.42	24.35	24.55	24.54	24.58	24.59	24.57
CH 06	2437	24.60								
CH 11	2462	22.72								

802.11n HT20 RF Peak Output Power (dBm)										
Power vs. Channel			Power vs Data Rate							
Channel	Frequency (MHz)	MCS Index	Channel	MCS Index						
		MCS 0		MCS 1	MCS 2	MCS 3	MCS 4	MCS 5	MCS 6	MCS 7
CH 01	2412	21.70	CH 06	24.46	24.44	24.43	24.48	24.47	24.47	24.48
CH 06	2437	24.49								
CH 11	2462	22.24								

802.11n HT40 RF Peak Output Power (dBm)										
Power vs. Channel			Power vs Data Rate							
Channel	Frequency (MHz)	MCS Index	Channel	MCS Index						
		MCS 0		MCS 1	MCS 2	MCS 3	MCS 4	MCS 5	MCS 6	MCS 7
CH 03	2422	20.70	CH 06	22.69	22.68	22.64	22.69	22.68	22.69	22.68
CH 06	2437	22.70								
CH 09	2452	22.21								



802.11ac VHT20 RF Peak Output Power (dBm)												
Power vs. Channel			Power vs Data Rate									
Channel	Frequency (MHz)	MCS Index	Channel	MCS Index								
		MCS 0		MCS 1	MCS 2	MCS 3	MCS 4	MCS 5	MCS 6	MCS 7	MCS 8	
CH 01	2412	21.71	CH 06	24.47	24.45	24.44	24.49	24.48	24.48	24.49	24.47	
CH 06	2437	24.50										
CH 11	2462	22.25										

802.11ac VHT40 RF Peak Output Power (dBm)												
Power vs. Channel			Power vs Data Rate									
Channel	Frequency (MHz)	MCS Index	Channel	MCS Index								
		MCS 0		MCS 1	MCS 2	MCS 3	MCS 4	MCS 5	MCS 6	MCS 7	MCS 8	MCS 9
CH 03	2422	20.71	CH 06	22.70	22.68	22.65	22.70	22.69	22.70	22.69	22.69	22.68
CH 06	2437	22.71										
CH 09	2452	22.22										

802.11b RF Avg Output Power (dBm)						
Power vs. Channel			Power vs Data Rate			
Channel	Frequency (MHz)	Data Rate (bps)	Channel	Data Rate (bps)		
		1M		2M	5.5M	11M
CH 01	2412	21.30	CH 11	21.00	21.00	21.00
CH 06	2437	21.20				
CH 11	2462	21.40				

802.11g RF Avg Output Power (dBm)										
Power vs. Channel			Power vs Data Rate							
Channel	Frequency (MHz)	Data Rate (bps)	Channel	Data Rate (bps)						
		6M		9Mbps	12Mbps	18Mbps	24Mbps	36Mbps	48Mbps	54Mbps
CH 01	2412	18.50	CH 06	20.90	20.90	20.90	20.70	20.40	20.50	20.40
CH 06	2437	21.30								
CH 11	2462	18.70								

802.11n HT20 RF Avg Output Power (dBm)										
Power vs. Channel			Power vs Data Rate							
Channel	Frequency (MHz)	MCS Index	Channel	MCS Index						
		MCS 0		MCS 1	MCS 2	MCS 3	MCS 4	MCS 5	MCS 6	MCS 7
CH 01	2412	17.20	CH 06	20.70	20.80	20.70	20.40	20.50	20.50	20.50
CH 06	2437	21.10								
CH 11	2462	17.90								



802.11n HT40 RF Avg Output Power (dBm)										
Power vs. Channel			Power vs Data Rate							
Channel	Frequency (MHz)	MCS Index	Channel	MCS Index						
		MCS 0		MCS 1	MCS 2	MCS 3	MCS 4	MCS 5	MCS 6	MCS 7
CH 03	2422	14.70	CH 06	16.60	16.60	16.50	16.10	16.10	16.10	16.00
CH 06	2437	16.90								
CH 09	2452	16.50								

802.11ac VHT20 RF Avg Output Power (dBm)											
Power vs. Channel			Power vs Data Rate								
Channel	Frequency (MHz)	MCS Index	Channel	MCS Index							
		MCS 0		MCS 1	MCS 2	MCS 3	MCS 4	MCS 5	MCS 6	MCS 7	MCS 8
CH 01	2412	17.30	CH 06	20.80	20.90	20.80	20.50	20.60	20.60	20.60	20.60
CH 06	2437	21.20									
CH 11	2462	18.00									

802.11ac VHT40 RF Avg Output Power (dBm)												
Power vs. Channel			Power vs Data Rate									
Channel	Frequency (MHz)	MCS Index	Channel	MCS Index								
		MCS 0		MCS 1	MCS 2	MCS 3	MCS 4	MCS 5	MCS 6	MCS 7	MCS 8	MCS 9
CH 03	2422	14.80	CH 06	16.60	16.60	16.50	16.10	16.10	16.10	16.00	16.10	16.10
CH 06	2437	17.00										
CH 09	2452	16.60										

2.3 Connection Diagram of Test System

<AC Conducted Emission Mode>

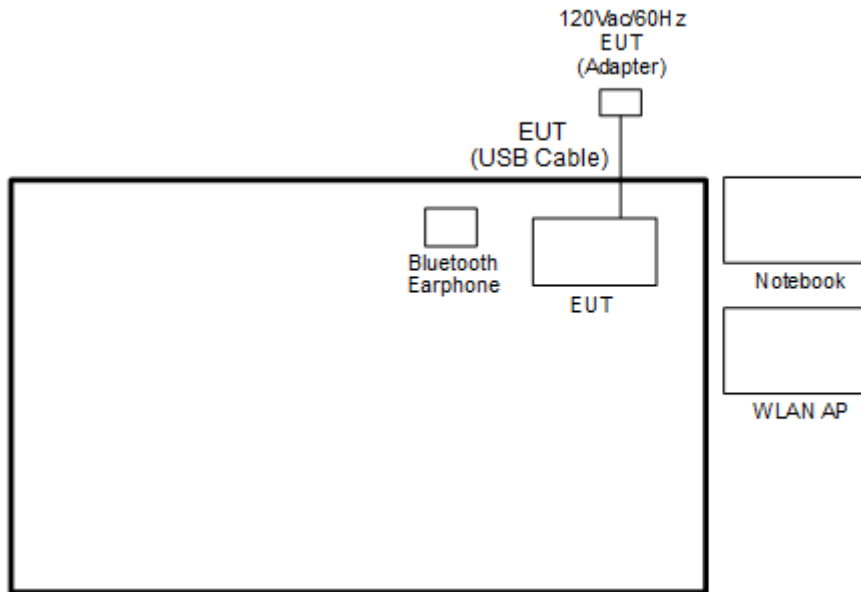

<WLAN Tx Mode>

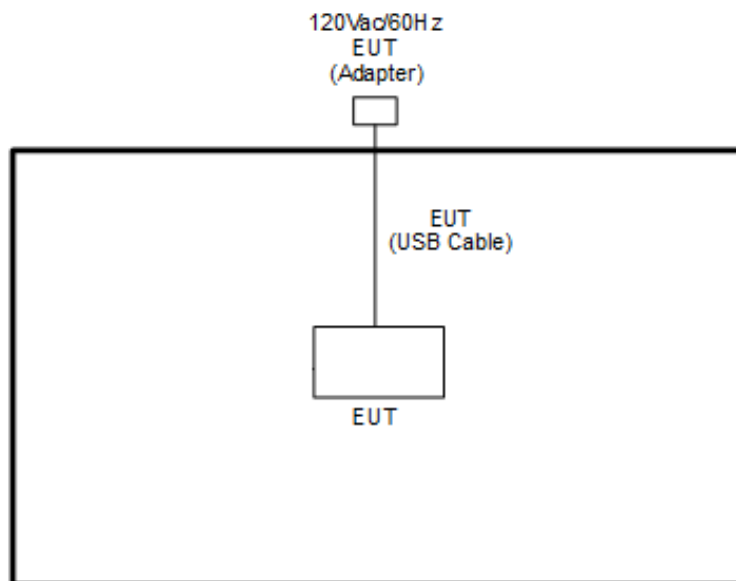

2.4 Support Unit used in test configuration and system

Item	Equipment	Brand Name	Model Name	FCC ID	Data Cable	Power Cord
1.	Bluetooth Earphone	Sony Ericsson	MW600	PY7DDA-2029	N/A	N/A
2.	WLAN AP	ASUS	RT-AC66U	MSQ-RTAC66U	N/A	Unshielded, 1.8 m
3.	Notebook	DELL	Latitude 3400	FCC DoC	N/A	AC I/P: Unshielded, 1.2 m DC O/P: Shielded, 1.8 m
4.	SD Card	SanDisk	MicroSD HC	FCC DoC	N/A	N/A

2.5 EUT Operation Test Setup

The RF test items, utility “QRCT v4.0.00067.0” was installed in Notebook which was programmed in order to make the EUT get into the engineering modes to provide channel selection, power level, data rate and the application type and for continuous transmitting signals.

2.6 Measurement Results Explanation Example

For all conducted test items:

The offset level is set in the spectrum analyzer to compensate the RF cable loss and attenuator factor between EUT conducted output port and spectrum analyzer. With the offset compensation, the spectrum analyzer reading level is exactly the EUT RF output level.

Example:

The spectrum analyzer offset is derived from RF cable loss and attenuator factor.

Offset = RF cable loss + attenuator factor.

Following shows an offset computation example with cable loss 4.2 dB and 10dB attenuator.

$$\begin{aligned} \text{Offset(dB)} &= \text{RF cable loss(dB)} + \text{attenuator factor(dB)}. \\ &= 4.2 + 10 = 14.2 \text{ (dB)} \end{aligned}$$

3 Test Result

3.1 6dB and 99% Bandwidth Measurement

3.1.1 Limit of 6dB and 99% Bandwidth

The minimum 6 dB bandwidth shall be at least 500 kHz.

3.1.2 Measuring Instruments

See list of measuring equipment of this test report.

3.1.3 Test Procedures

1. The testing follows the ANSI C63.10 Section 6.9.3 (OBW) and 11.8.1 (6dB BW).
2. The RF output of EUT was connected to the spectrum analyzer by RF cable and attenuator. The path loss was compensated to the results for each measurement.
3. Set to the maximum power setting and enable the EUT transmit continuously.
4. Make the measurement with the spectrum analyzer's resolution bandwidth (RBW) = 100 kHz. Set the Video bandwidth (VBW) = 300 kHz. In order to make an accurate measurement. The 6 dB bandwidth must be greater than 500 kHz.
5. For 99% Bandwidth Measurement, the spectrum analyzer's resolution bandwidth (RBW) is set 1-5% of the emission bandwidth and set the Video bandwidth (VBW) $\geq 3 * RBW$.
6. Measure and record the results in the test report.

3.1.4 Test Setup





3.1.5 Test Result of 6dB and 99% Occupied Bandwidth

Test Engineer :	Ryan Lin / Tommy Lee	Temperature :	21.2~24.1°C
		Relative Humidity :	47.2~57.8%

2.4GHz Band Single Antenna										
Mod.	Data Rate	NTX	CH.	Freq. (MHz)	99% Occupied BW (MHz)		6dB BW (MHz)		6dB BW Limit (MHz)	Pass/Fail
					Ant1	Ant2	Ant1	Ant2		
11b	1Mbps	1	1	2412	13.74	-	8.08	-	0.50	Pass
11b	1Mbps	1	6	2437	13.74	-	9.06	-	0.50	Pass
11b	1Mbps	1	11	2462	13.79	-	9.06	-	0.50	Pass
11g	6Mbps	1	1	2412	16.83	-	16.30	-	0.50	Pass
11g	6Mbps	1	6	2437	17.08	-	15.54	-	0.50	Pass
11g	6Mbps	1	11	2462	16.73	-	15.70	-	0.50	Pass
VHT20	MCS0	1	1	2412	17.93	-	16.90	-	0.50	Pass
VHT20	MCS0	1	6	2437	18.18	-	16.92	-	0.50	Pass
VHT20	MCS0	1	11	2462	17.98	-	16.42	-	0.50	Pass
VHT40	MCS0	1	3	2422	36.46	-	35.72	-	0.50	Pass
VHT40	MCS0	1	6	2437	36.46	-	35.72	-	0.50	Pass
VHT40	MCS0	1	9	2452	36.36	-	35.16	-	0.50	Pass

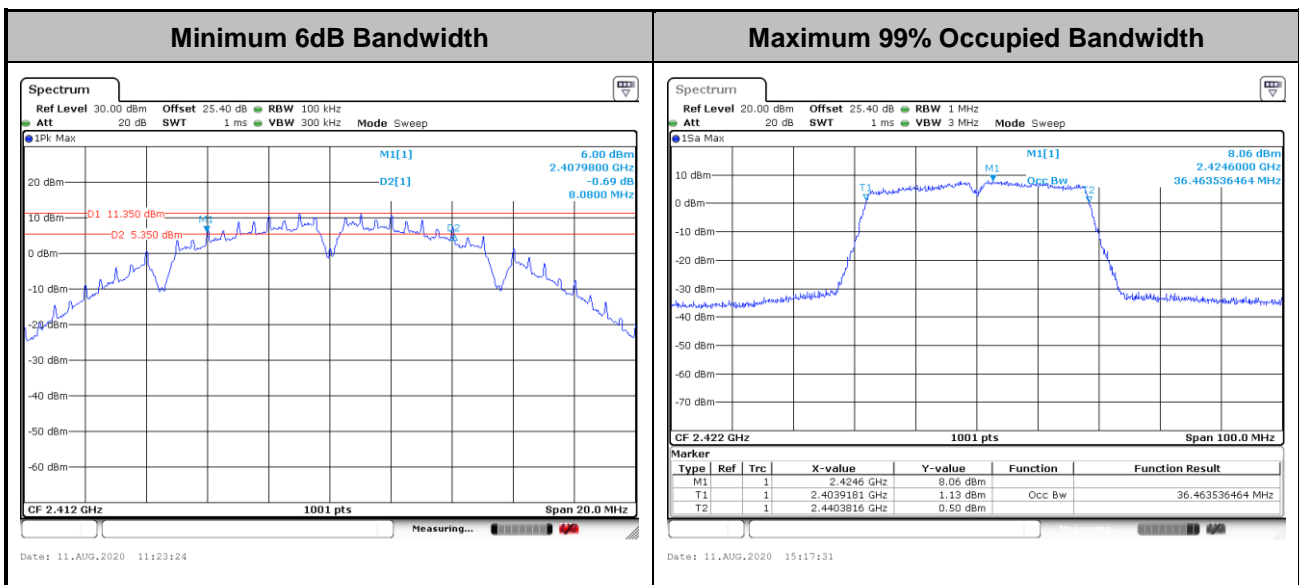

Note: The occupied channel bandwidth is maintained within the band of operation for all of the modulations.

3.2 Output Power Measurement

3.2.1 Limit of Output Power

For systems using digital modulation in the 2400-2483.5MHz, the limit for output power is 30dBm. If transmitting antenna with directional gain greater than 6dBi is used, the peak output power from the intentional radiator shall be reduced below the above stated value by the amount in dB that the directional gain of the antenna exceeds 6 dBi. In case of point-to-point operation, the limit has to be reduced by 1dB for every 3dB that the directional gain of the antenna exceeds 6dBi.

3.2.2 Measuring Instruments

See list of measuring equipment of this test report.

3.2.3 Test Procedures

1. For Peak Power, the testing follows ANSI C63.10 Section 11.9.1.3 PKPM1
2. For Average Power, the testing follows ANSI C63.10 Section 11.9.2.3.2 Method AVGPM-G
3. The RF output of EUT was connected to the power meter by RF cable and attenuator. The path loss was compensated to the results for each measurement.
4. Set to the maximum power setting and enable the EUT transmit continuously.
5. Measure the conducted output power and record the results in the test report.

3.2.4 Test Setup

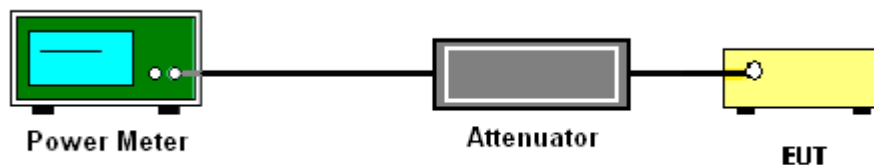



3.2.5 Test Result of Peak Output Power

Test Engineer :	Ryan Lin / Tommy Lee	Temperature :	21.2~24.1°C
		Relative Humidity :	47.2~57.8%

2.4GHz Band Single Antenna																
Mod.	Data Rate	NTX	CH.	Freq. (MHz)	Peak Conducted Power (dBm)			Conducted Power Limit (dBm)		DG (dBi)		EIRP Power (dBm)		EIRP Power Limit (dBm)		Pass /Fail
					Ant1	Ant2	SUM	Ant1	Ant2	Ant1	Ant2	Ant1	Ant2	Ant1	Ant2	
11b	1Mbps	1	1	2412	23.10	-		30.00	-	2.31	-	25.41	-	36.00	-	Pass
11b	1Mbps	1	6	2437	23.06	-		30.00	-	2.31	-	25.37	-	36.00	-	Pass
11b	1Mbps	1	11	2462	23.27	-		30.00	-	2.31	-	25.58	-	36.00	-	Pass
11g	6Mbps	1	1	2412	22.60	-		30.00	-	2.31	-	24.91	-	36.00	-	Pass
11g	6Mbps	1	6	2437	24.60	-		30.00	-	2.31	-	26.91	-	36.00	-	Pass
11g	6Mbps	1	11	2462	22.72	-		30.00	-	2.31	-	25.03	-	36.00	-	Pass
HT20	MCS0	1	1	2412	21.70	-		30.00	-	2.31	-	24.01	-	36.00	-	Pass
HT20	MCS0	1	6	2437	24.49	-		30.00	-	2.31	-	26.80	-	36.00	-	Pass
HT20	MCS0	1	11	2462	22.24	-		30.00	-	2.31	-	24.55	-	36.00	-	Pass
HT40	MCS0	1	3	2422	20.70	-		30.00	-	2.31	-	23.01	-	36.00	-	Pass
HT40	MCS0	1	6	2437	22.70	-		30.00	-	2.31	-	25.01	-	36.00	-	Pass
HT40	MCS0	1	9	2452	22.21	-		30.00	-	2.31	-	24.52	-	36.00	-	Pass
VHT20	MCS0	1	1	2412	21.71	-		30.00	-	2.31	-	24.02	-	36.00	-	Pass
VHT20	MCS0	1	6	2437	24.50	-		30.00	-	2.31	-	26.81	-	36.00	-	Pass
VHT20	MCS0	1	11	2462	22.25	-		30.00	-	2.31	-	24.56	-	36.00	-	Pass
VHT40	MCS0	1	3	2422	20.71	-		30.00	-	2.31	-	23.02	-	36.00	-	Pass
VHT40	MCS0	1	6	2437	22.71	-		30.00	-	2.31	-	25.02	-	36.00	-	Pass
VHT40	MCS0	1	9	2452	22.22	-		30.00	-	2.31	-	24.53	-	36.00	-	Pass



3.2.6 Test Result of Average Output Power (Reporting Only)

Test Engineer :	Ryan Lin / Tommy Lee	Temperature :	21.2~24.1°C
		Relative Humidity :	47.2~57.8%

2.4GHz Band Single Antenna											
Mod.	Data Rate	NTX	CH.	Freq. (MHz)	Average Conducted Power (dBm)			DG (dBi)		EIRP Power (dBm)	
					Ant1	Ant2	SUM	Ant1	Ant2	Ant1	Ant2
11b	1Mbps	1	1	2412	21.30	-		2.31	-	23.61	-
11b	1Mbps	1	6	2437	21.20	-		2.31	-	23.51	-
11b	1Mbps	1	11	2462	21.40	-		2.31	-	23.71	-
11g	6Mbps	1	1	2412	18.50	-		2.31	-	20.81	-
11g	6Mbps	1	6	2437	21.30	-		2.31	-	23.61	-
11g	6Mbps	1	11	2462	18.70	-		2.31	-	21.01	-
HT20	MCS0	1	1	2412	17.20	-		2.31	-	19.51	-
HT20	MCS0	1	6	2437	21.10	-		2.31	-	23.41	-
HT20	MCS0	1	11	2462	17.90	-		2.31	-	20.21	-
HT40	MCS0	1	3	2422	14.70	-		2.31	-	17.01	-
HT40	MCS0	1	6	2437	16.90	-		2.31	-	19.21	-
HT40	MCS0	1	9	2452	16.50	-		2.31	-	18.81	-
VHT20	MCS0	1	1	2412	17.30	-		2.31	-	19.61	-
VHT20	MCS0	1	6	2437	21.20	-		2.31	-	23.51	-
VHT20	MCS0	1	11	2462	18.00	-		2.31	-	20.31	-
VHT40	MCS0	1	3	2422	14.80	-		2.31	-	17.11	-
VHT40	MCS0	1	6	2437	17.00	-		2.31	-	19.31	-
VHT40	MCS0	1	9	2452	16.60	-		2.31	-	18.91	-

3.3 Power Spectral Density Measurement

3.3.1 Limit of Power Spectral Density

The peak power spectral density shall not be greater than 8dBm in any 3kHz band at any time interval of continuous transmission.

3.3.2 Measuring Instruments

See list of measuring equipment of this test report.

3.3.3 Test Procedures

1. The testing follows the ANSI C63.10 Section 11.10.2 Method PKPSD.
2. The RF output of EUT was connected to the spectrum analyzer by RF cable and attenuator. The path loss was compensated to the results for each measurement.
3. Set to the maximum power setting and enable the EUT transmit continuously.
4. Make the measurement with the spectrum analyzer's resolution bandwidth (RBW) = 3 kHz. Video bandwidth VBW = 10 kHz In order to make an accurate measurement, set the span to 1.5 times DTS Channel Bandwidth. (6dB BW)
5. Detector = peak, Sweep time = auto couple, Trace mode = max hold, Allow trace to fully stabilize. Use the peak marker function to determine the maximum power level.
6. Measure and record the results in the test report.

3.3.4 Test Setup

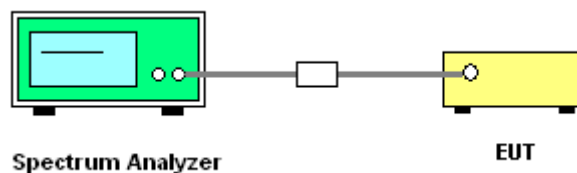



3.3.5 Test Result of Power Spectral Density

Test Engineer :	Ryan Lin / Tommy Lee	Temperature :	21.2~24.1°C
		Relative Humidity :	47.2~57.8%

2.4GHz Band Single Antenna											
Mod.	Data Rate	NTX	CH.	Freq. (MHz)	Peak PSD (dBm/3kHz)		DG (dBi)		Peak PSD Limit (dBm/3kHz)		Pass/Fail
					Ant1	Ant2	Ant1	Ant2	Ant1	Ant2	
11b	1Mbps	1	1	2412	-1.99	-	2.31	-	8.00	-	Pass
11b	1Mbps	1	6	2437	-2.07	-	2.31	-	8.00	-	Pass
11b	1Mbps	1	11	2462	-2.00	-	2.31	-	8.00	-	Pass
11g	6Mbps	1	1	2412	-8.48	-	2.31	-	8.00	-	Pass
11g	6Mbps	1	6	2437	-6.45	-	2.31	-	8.00	-	Pass
11g	6Mbps	1	11	2462	-9.85	-	2.31	-	8.00	-	Pass
VHT20	MCS0	1	1	2412	-8.04	-	2.31	-	8.00	-	Pass
VHT20	MCS0	1	6	2437	-5.92	-	2.31	-	8.00	-	Pass
VHT20	MCS0	1	11	2462	-8.66	-	2.31	-	8.00	-	Pass
VHT40	MCS0	1	3	2422	-11.37	-	2.31	-	8.00	-	Pass
VHT40	MCS0	1	6	2437	-8.63	-	2.31	-	8.00	-	Pass
VHT40	MCS0	1	9	2452	-11.50	-	2.31	-	8.00	-	Pass

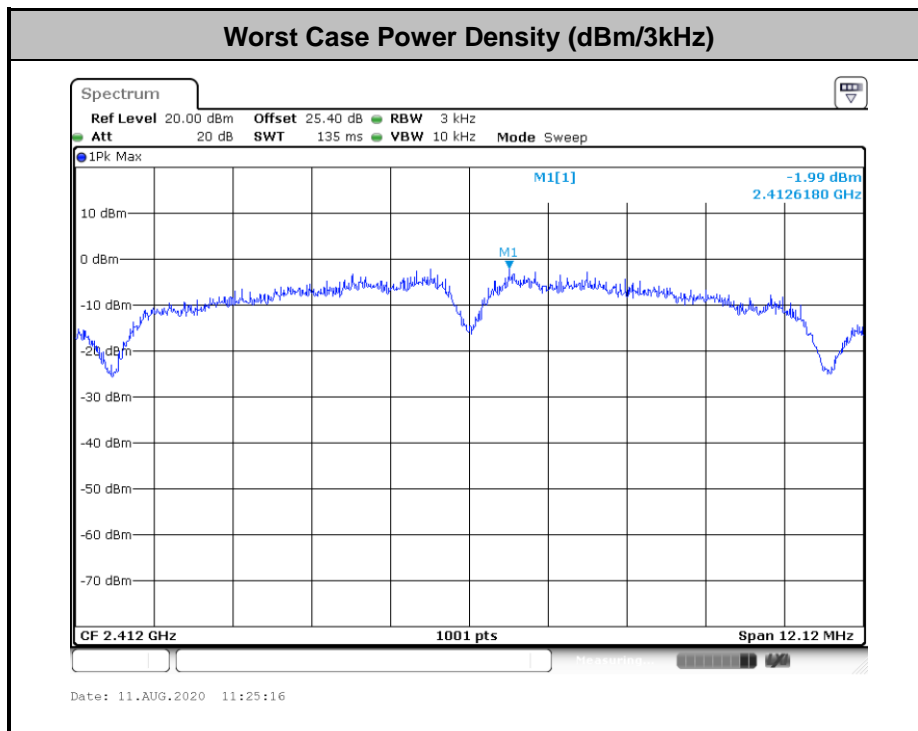

3.4 Conducted Band Edges and Spurious Emission Measurement

3.4.1 Limit of Conducted Band Edges and Spurious Emission Measurement

In any 100 kHz bandwidth outside of the authorized frequency band, the emissions which fall in the non-restricted bands shall be attenuated at least 20 dB / 30dB relative to the maximum PSD level in 100 kHz by RF conducted measurement.

3.4.2 Measuring Instruments

See list of measuring equipment of this test report.

3.4.3 Test Procedures

1. The testing follows the ANSI C63.10 Section 11.11.3 Emission level measurement.
2. The RF output of EUT was connected to the spectrum analyzer by RF cable and attenuator. The path loss was compensated to the results for each measurement.
3. Set to the maximum power setting and enable the EUT transmit continuously.
4. Set RBW = 100 kHz, VBW=300 kHz, Peak Detector. Unwanted Emissions measured in any 100 kHz bandwidth outside of the authorized frequency band shall be attenuated by at least 20 dB relative to the maximum in-band peak PSD level in 100 kHz when maximum peak conducted output power procedure is used. If the transmitter complies with the conducted power limits based on the use of RMS averaging over a time interval, the attenuation required under this paragraph shall be 30 dB instead of 20 dB per 15.247(d).
5. Measure and record the results in the test report.
6. The RF fundamental frequency should be excluded against the limit line in the operating frequency band.

3.4.4 Test Setup

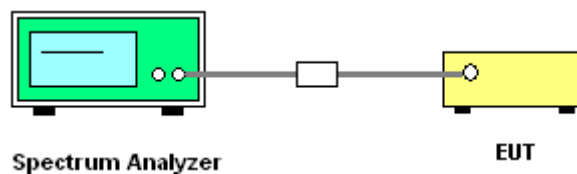



3.4.5 Test Result of Conducted Band Edges and Spurious Emission

Test Engineer :	Ryan Lin / Tommy Lee	Temperature :	21.2~24.1°C
		Relative Humidity :	47.2~57.8%

Number of TX = 1, Ant. 1 (Measured)

Test Mode :	802.11b	Test Channel :	01
-------------	---------	----------------	----

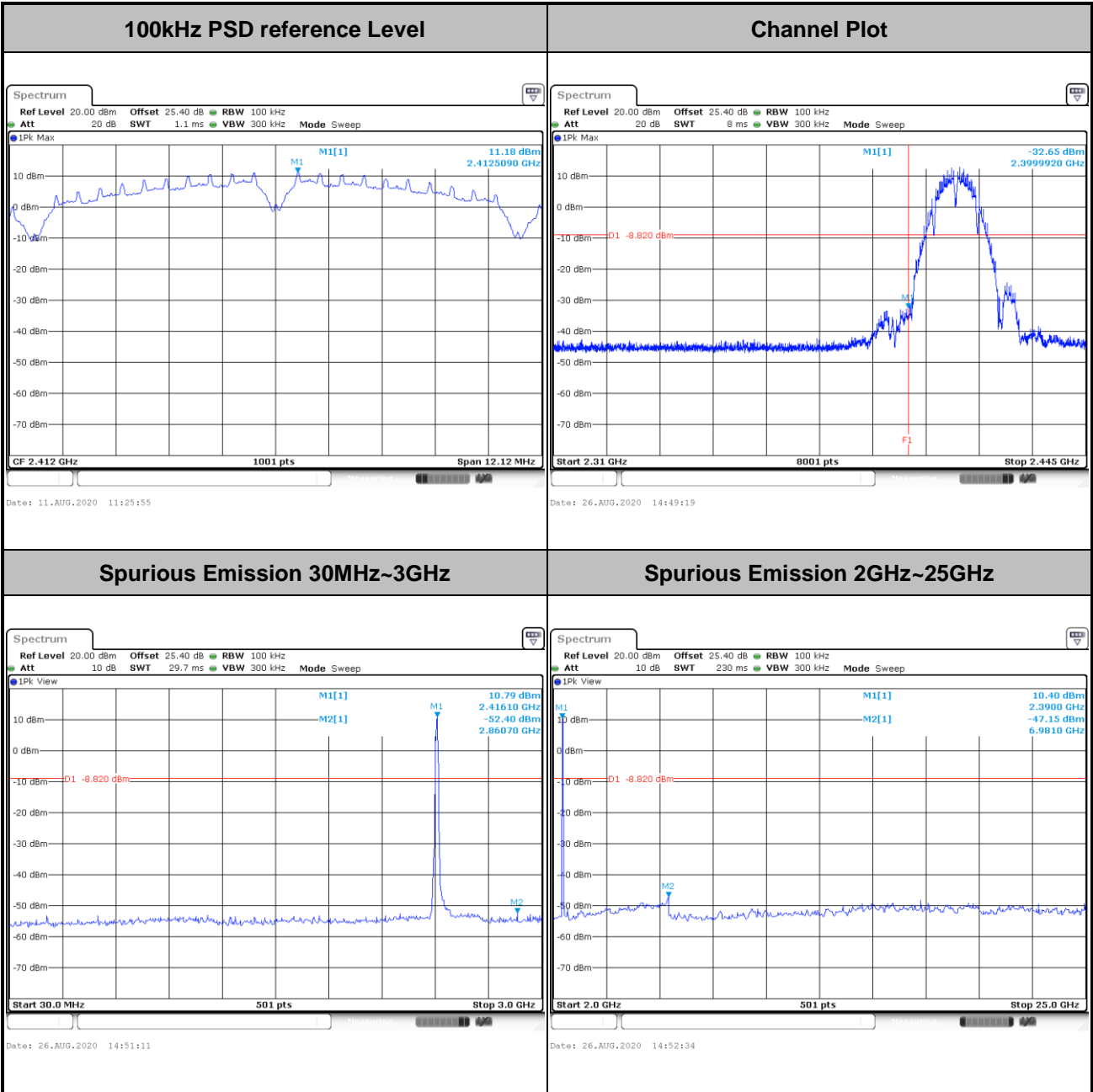



Test Mode :	802.11b	Test Channel :	06
-------------	---------	----------------	----

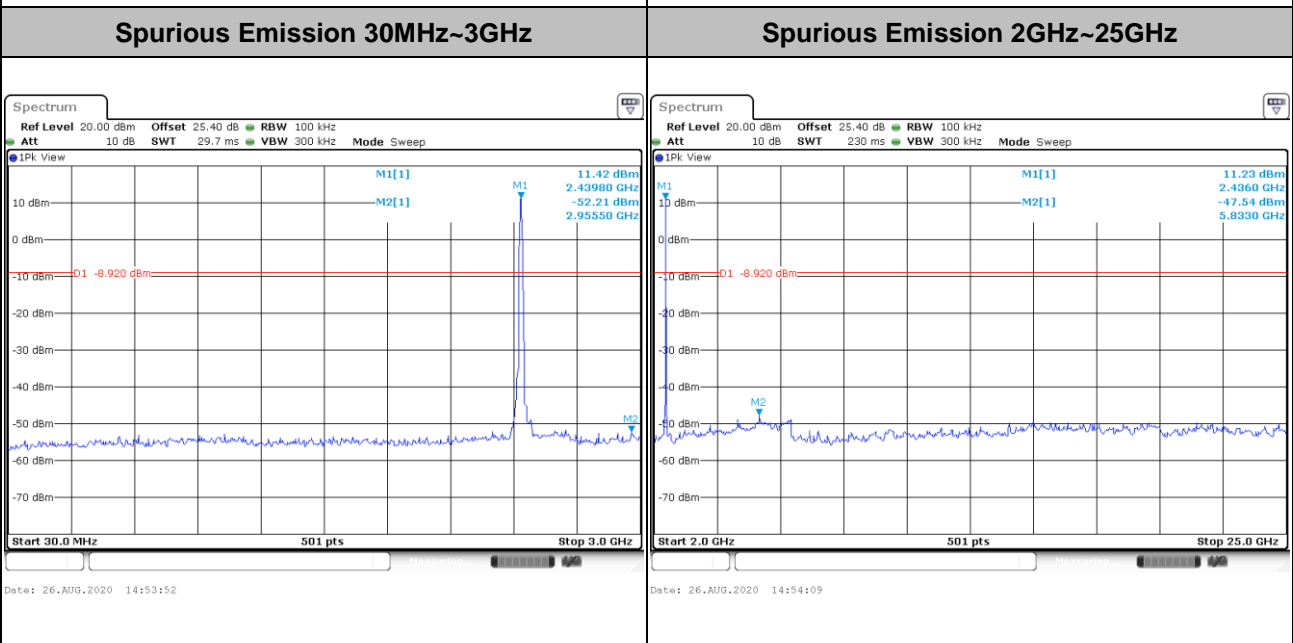
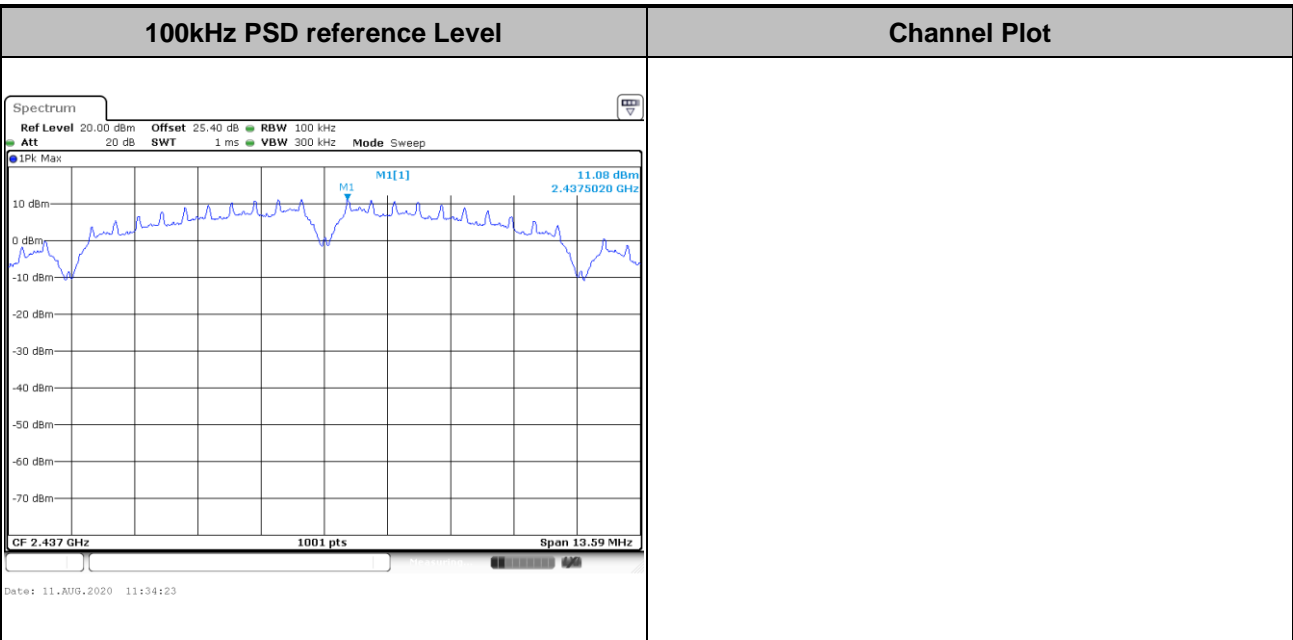



Test Mode :	802.11b	Test Channel :	11
-------------	---------	----------------	----

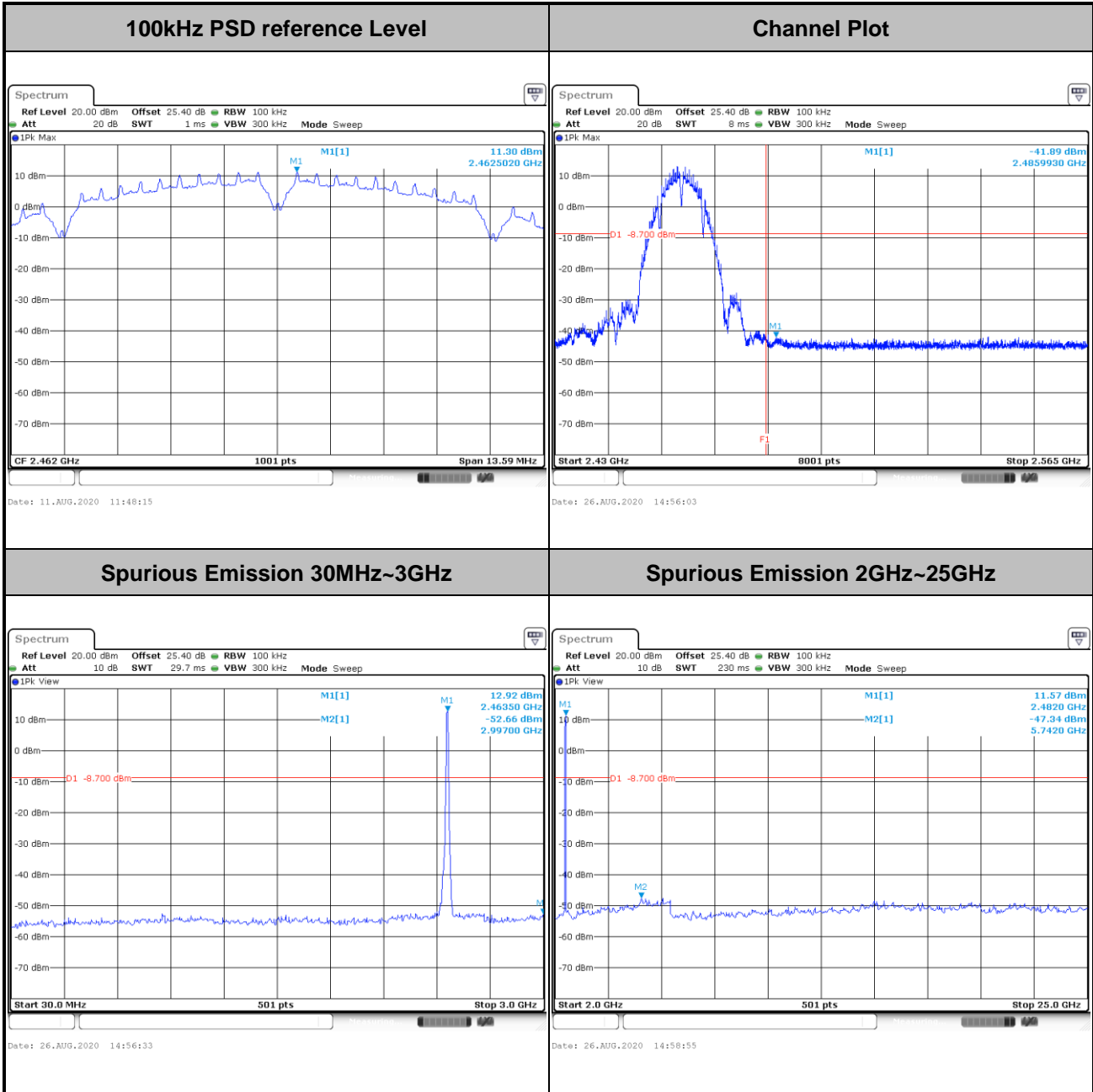



Test Mode :	802.11g	Test Channel :	01
-------------	---------	----------------	----

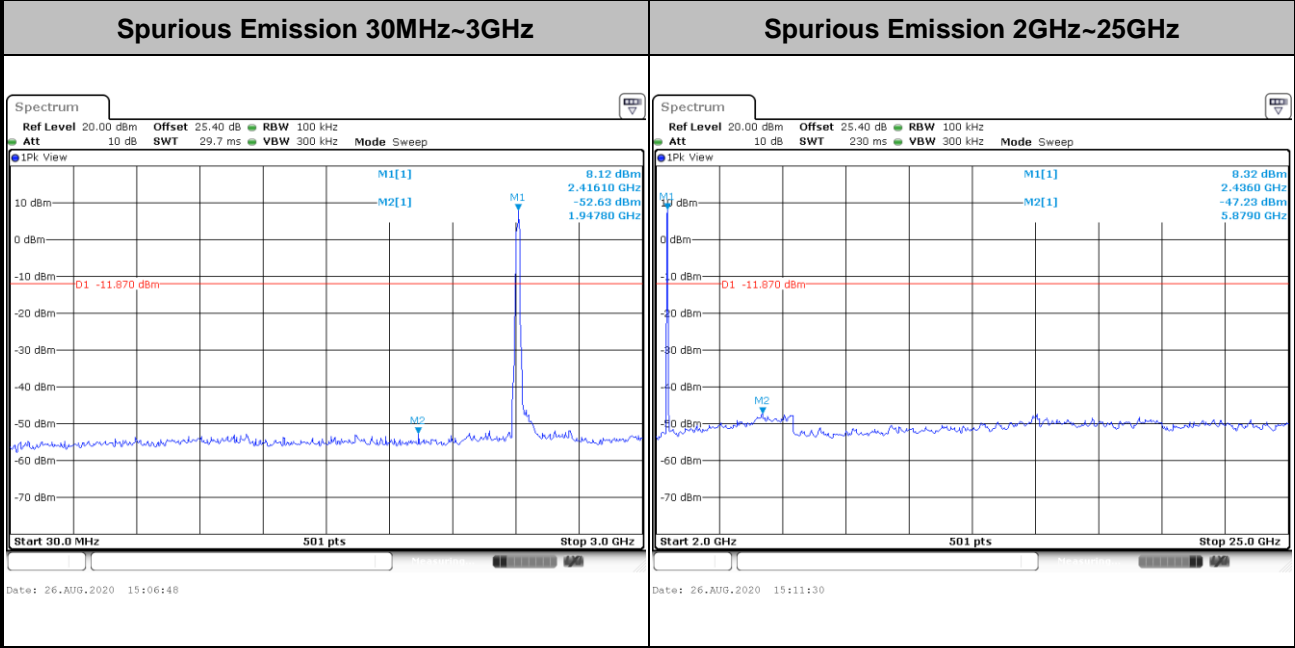
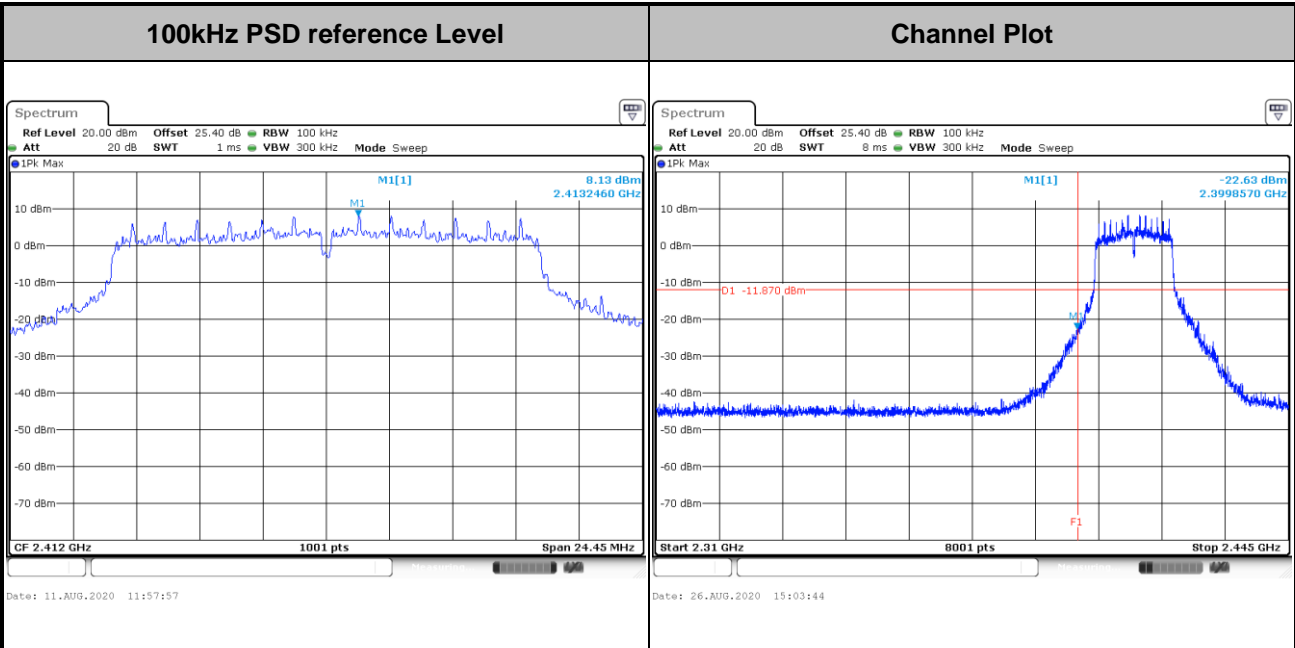



Test Mode :	802.11g	Test Channel :	06
-------------	---------	----------------	----

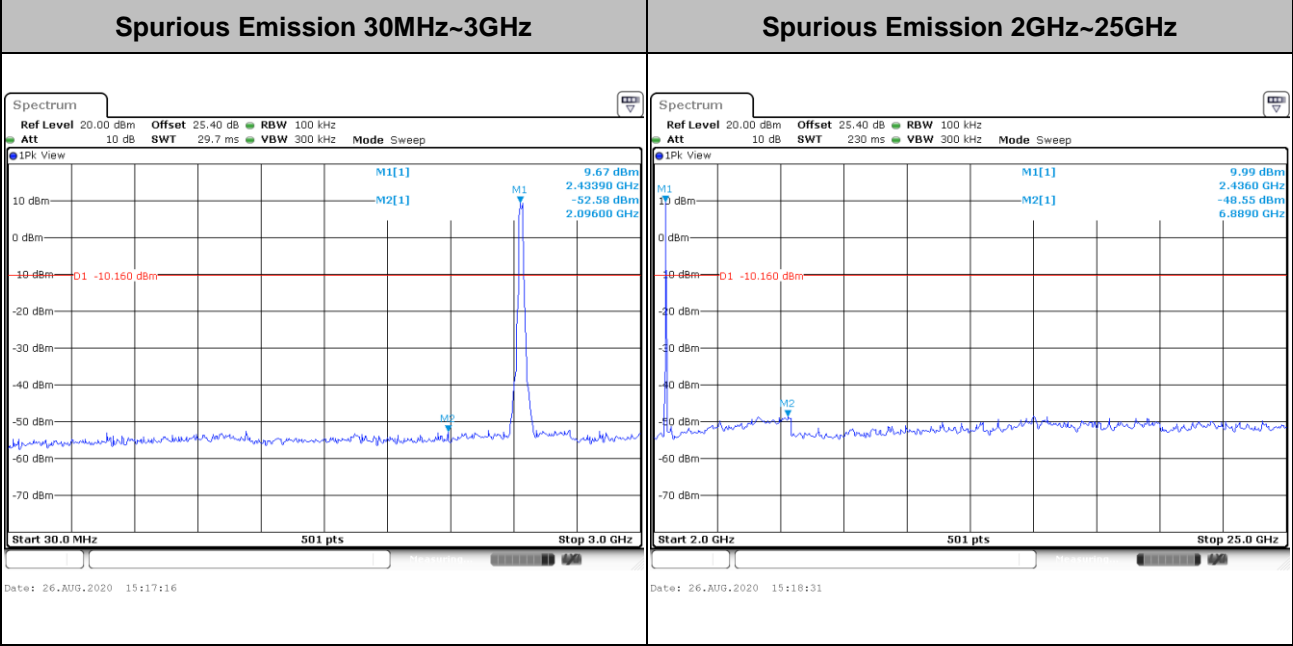
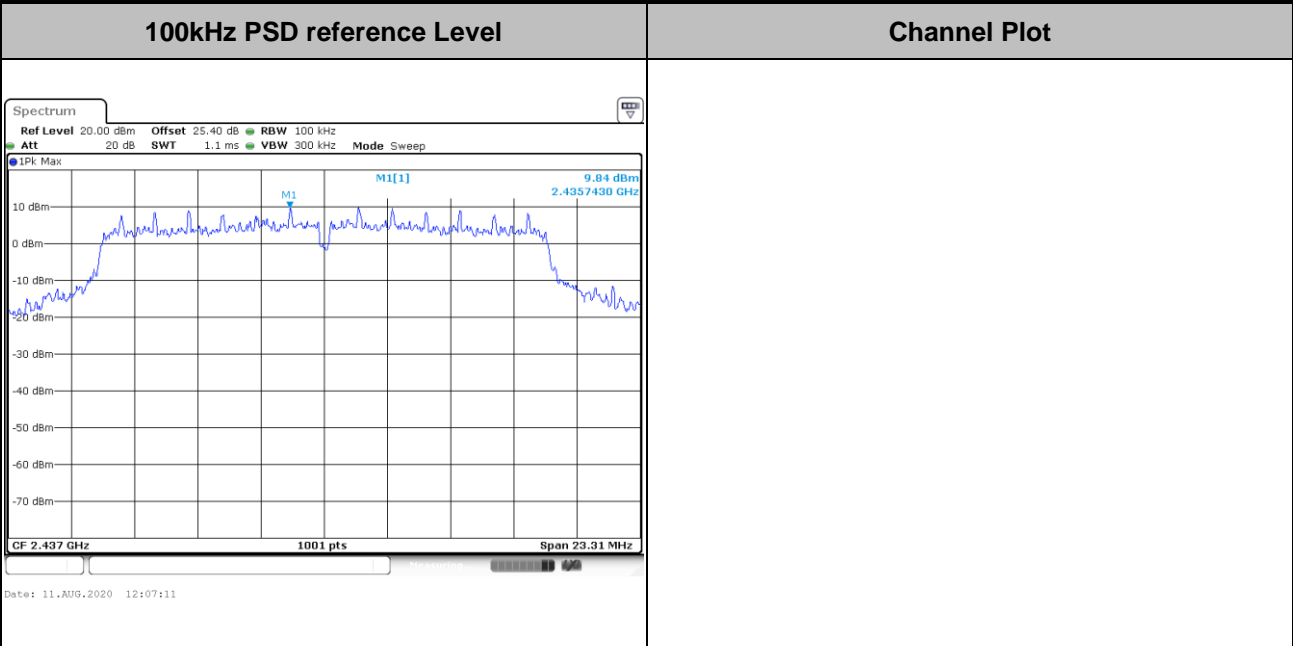



Test Mode :	802.11g	Test Channel :	11
-------------	---------	----------------	----

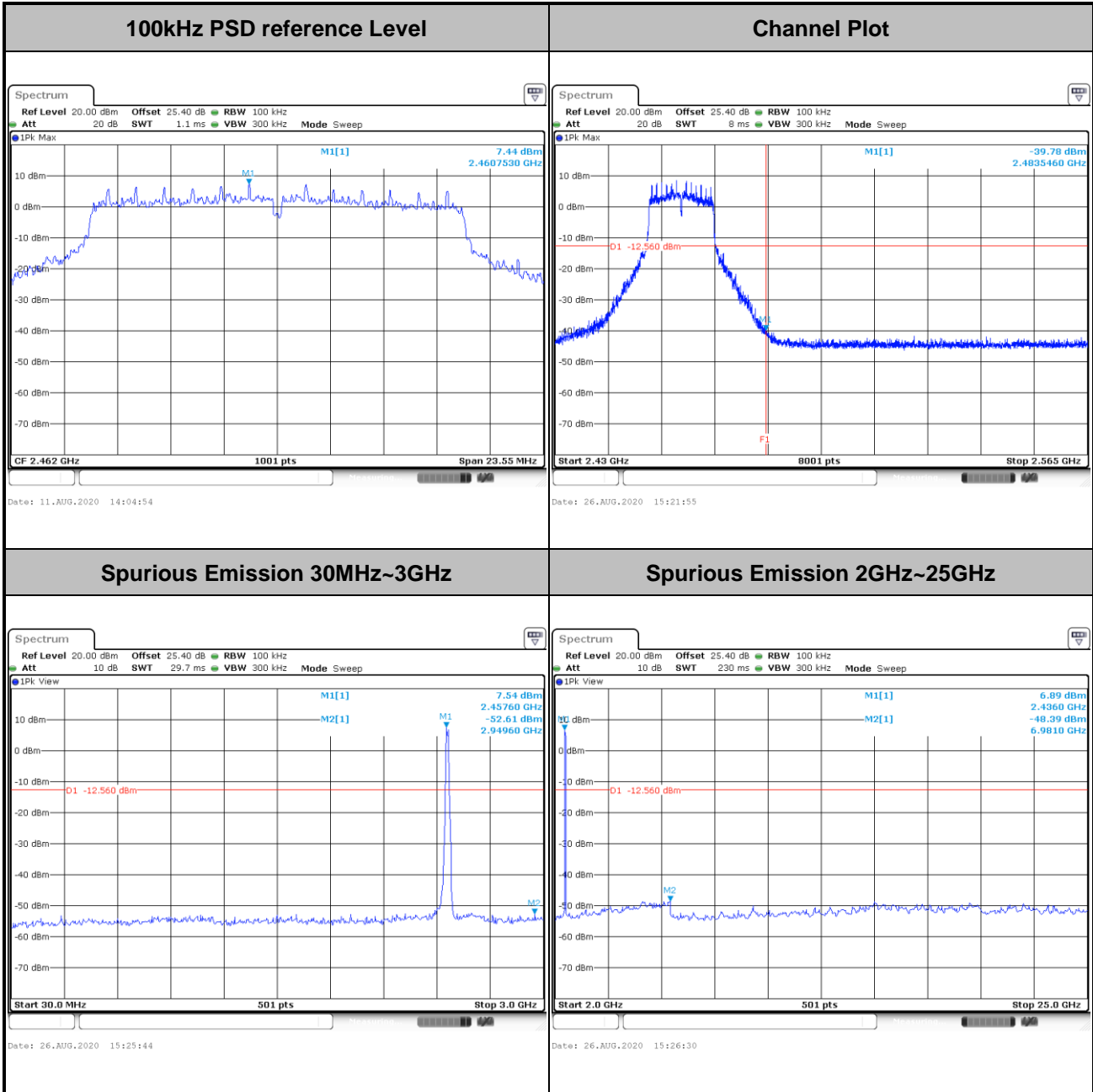



Test Mode :	802.11ac VHT20	Test Channel :	01
-------------	----------------	----------------	----

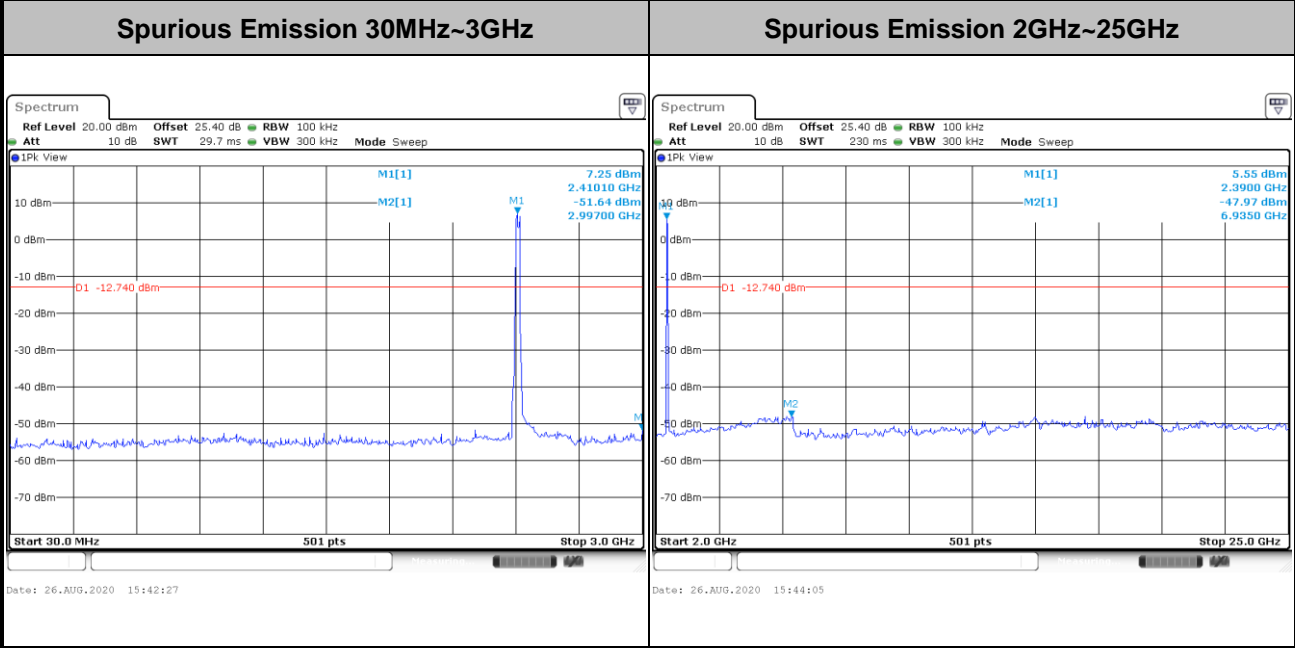
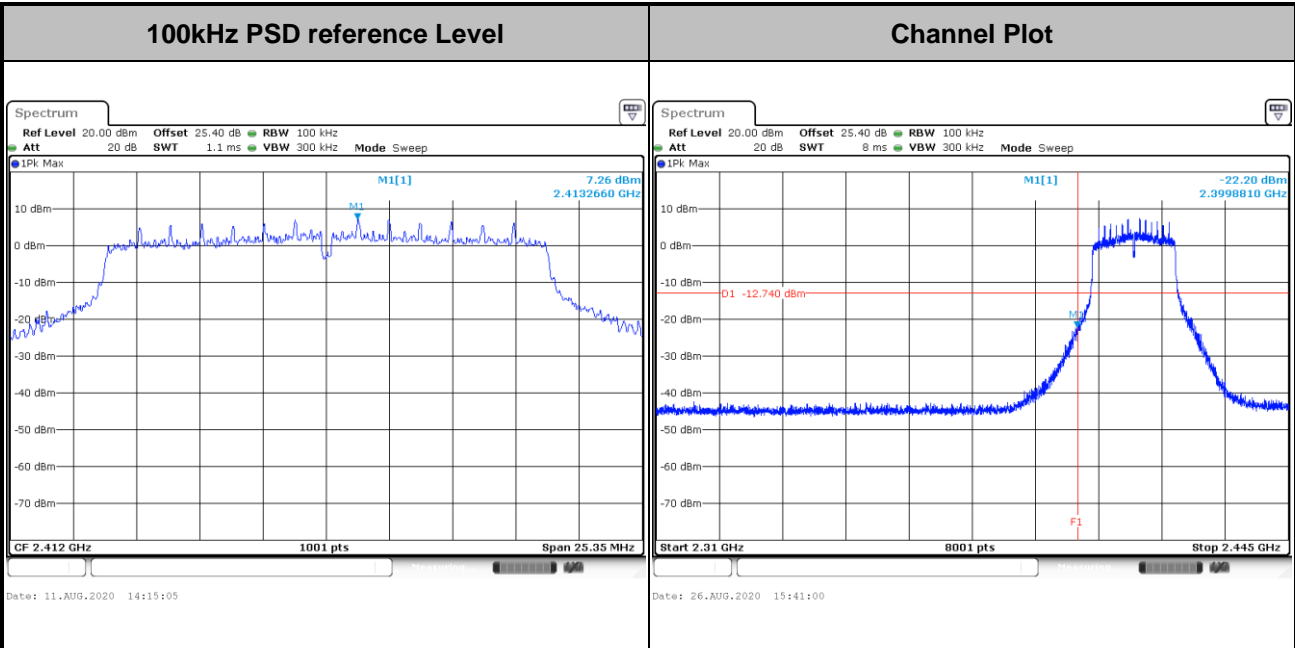



Test Mode :	802.11ac VHT20	Test Channel :	06
-------------	----------------	----------------	----

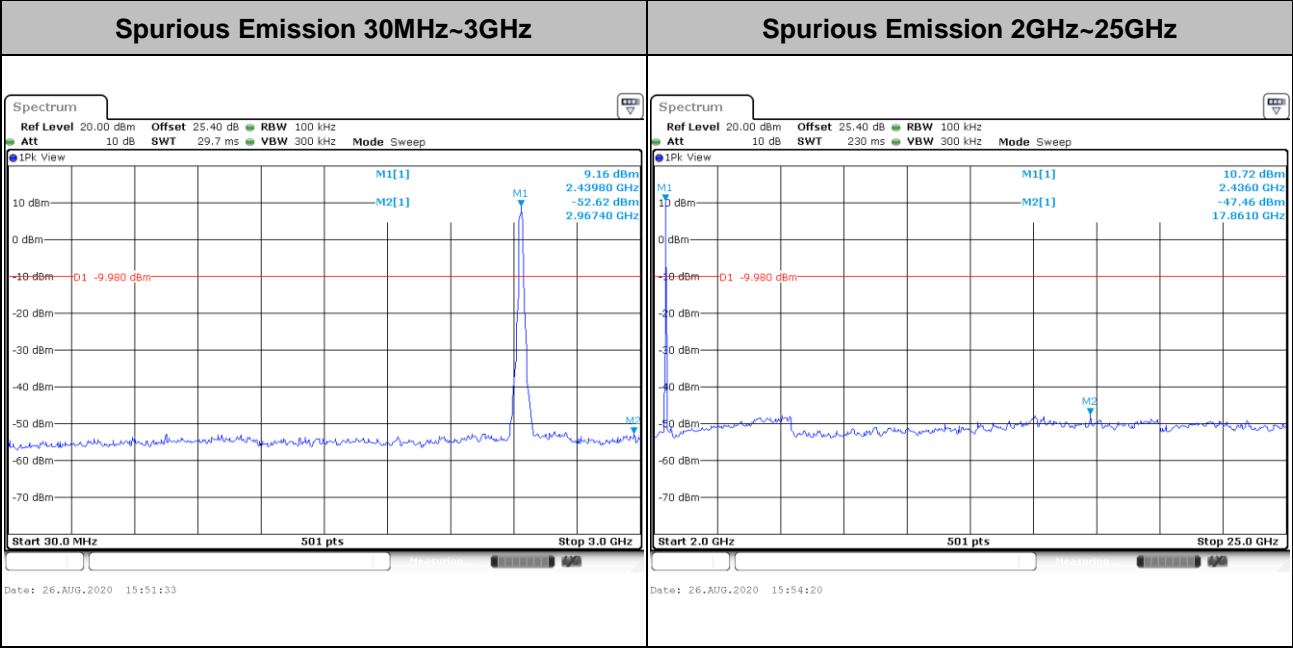
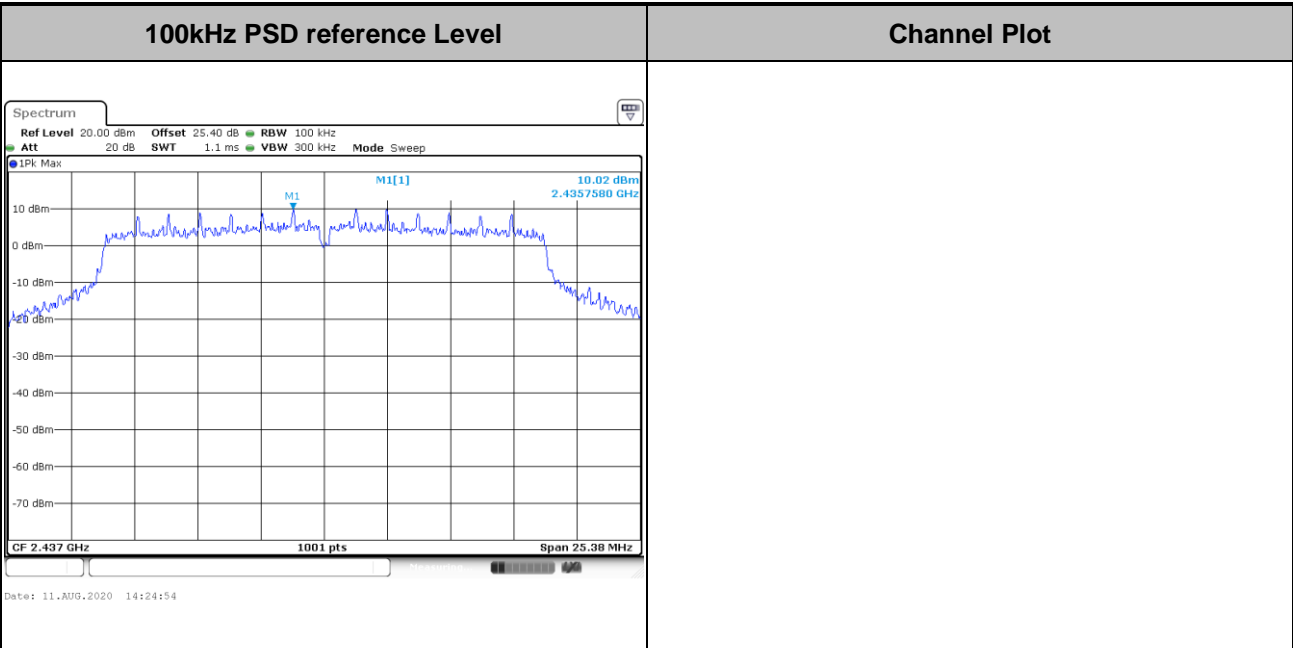



Test Mode :	802.11ac VHT20	Test Channel :	11
-------------	----------------	----------------	----

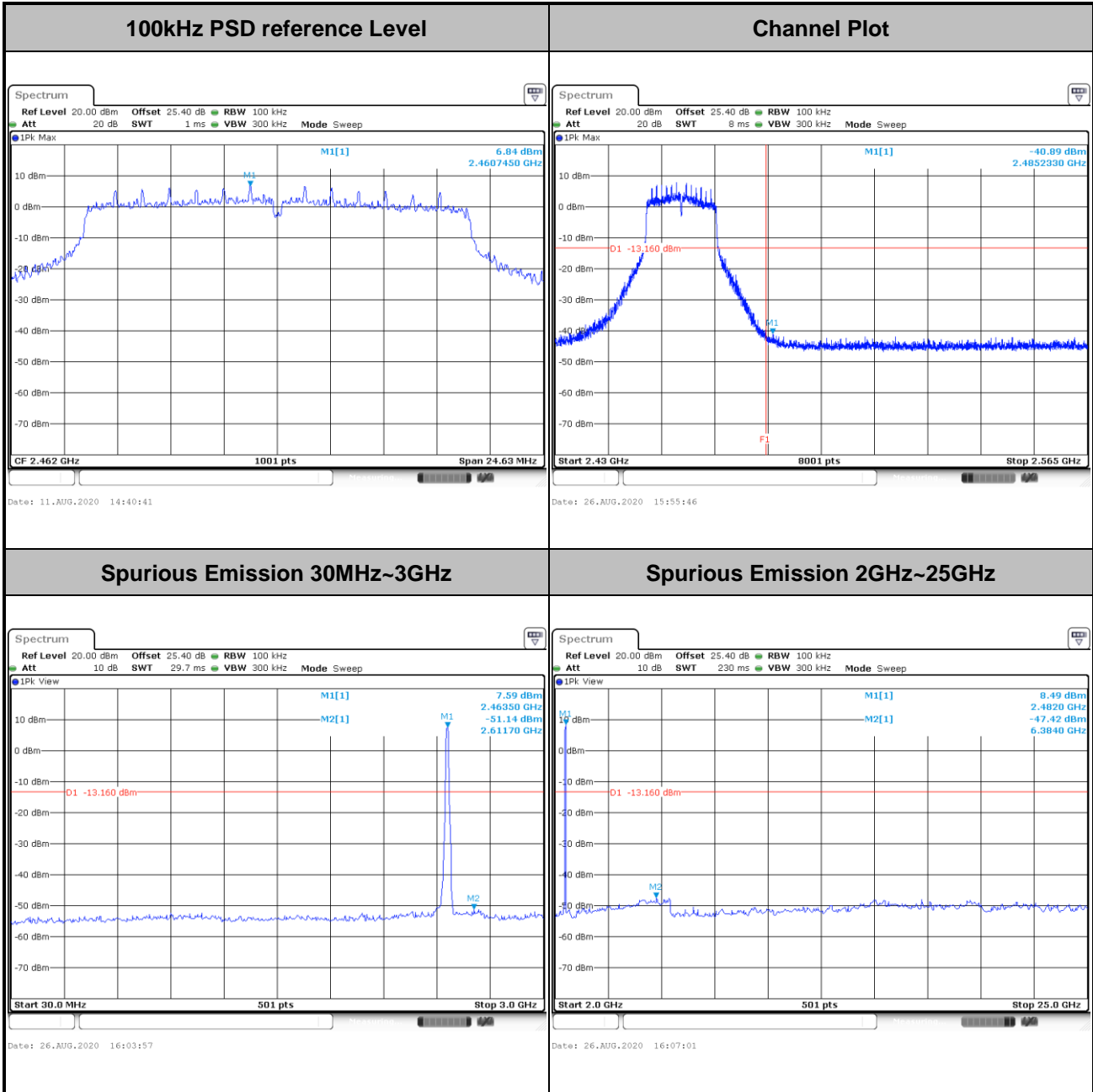



Test Mode :	802.11ac VHT40	Test Channel :	03
-------------	----------------	----------------	----

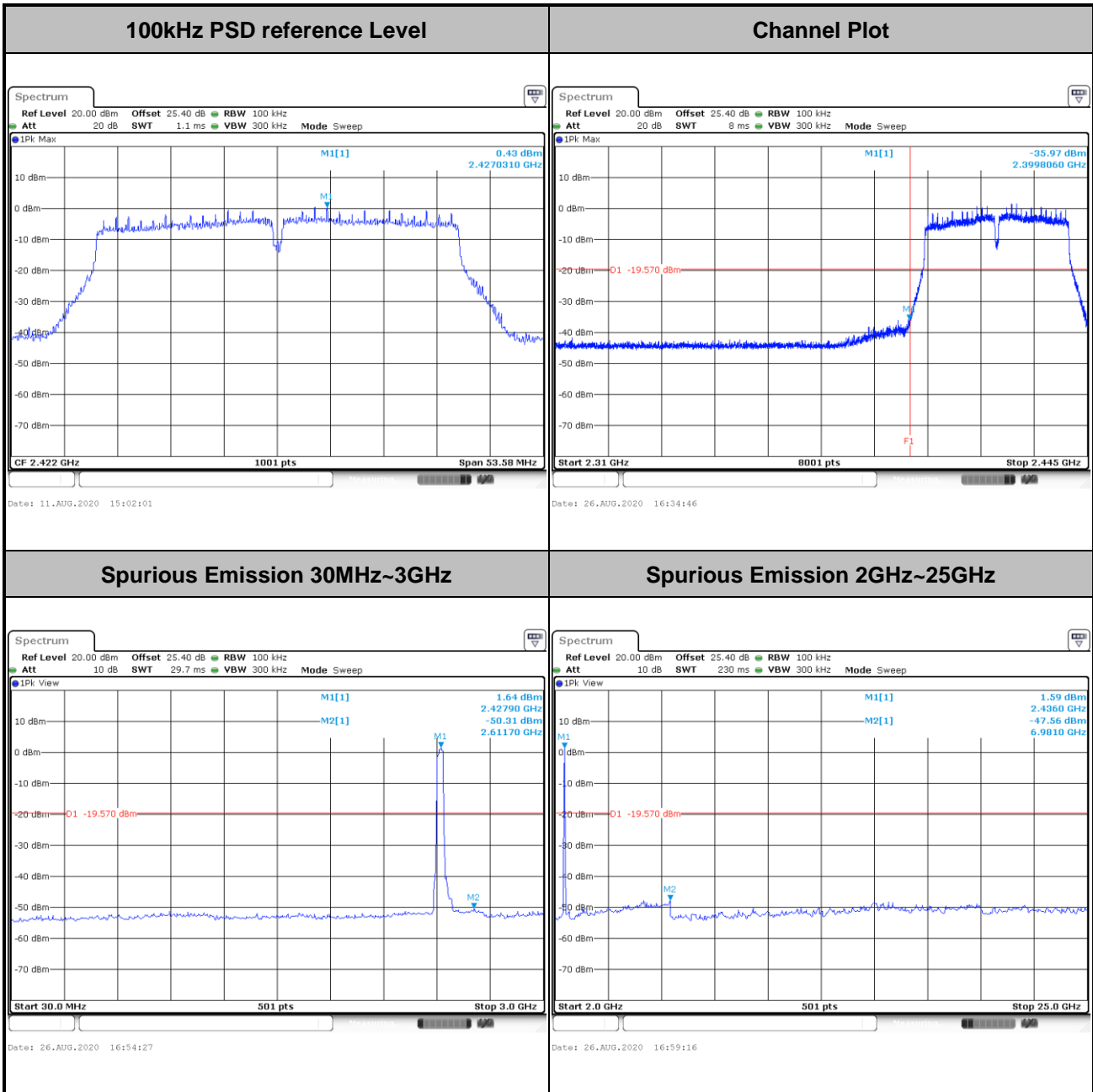



Test Mode :	802.11ac VHT40	Test Channel :	06
-------------	----------------	----------------	----

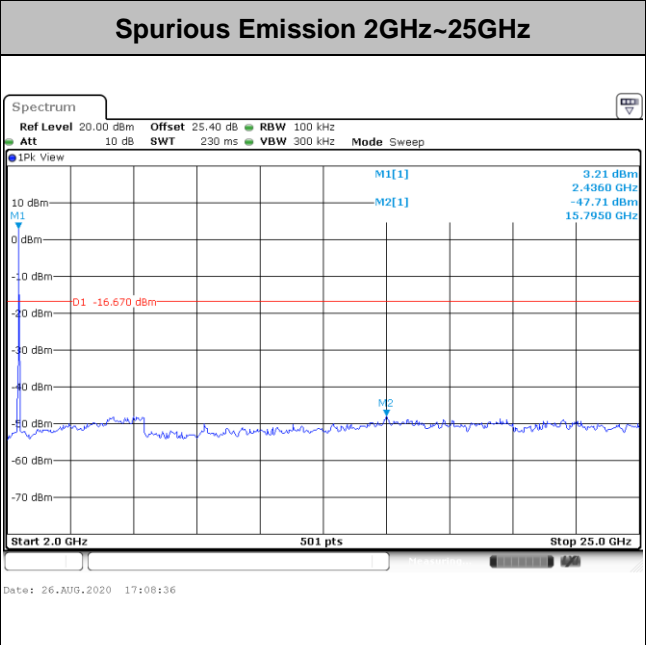
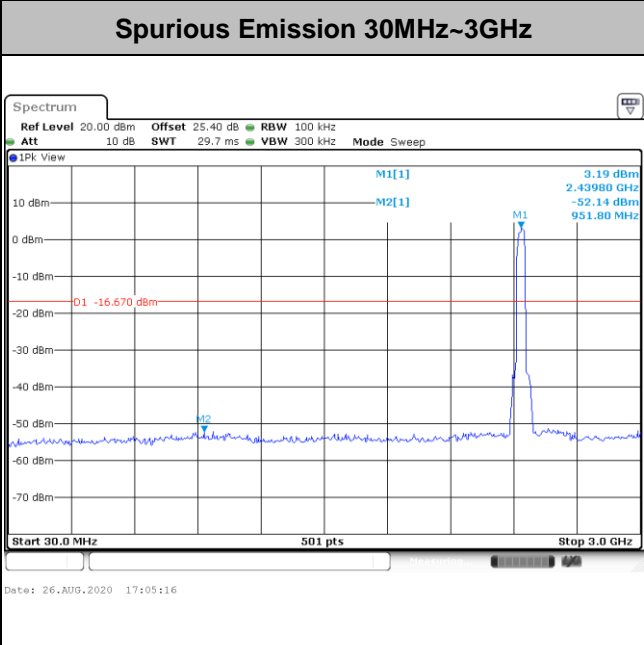
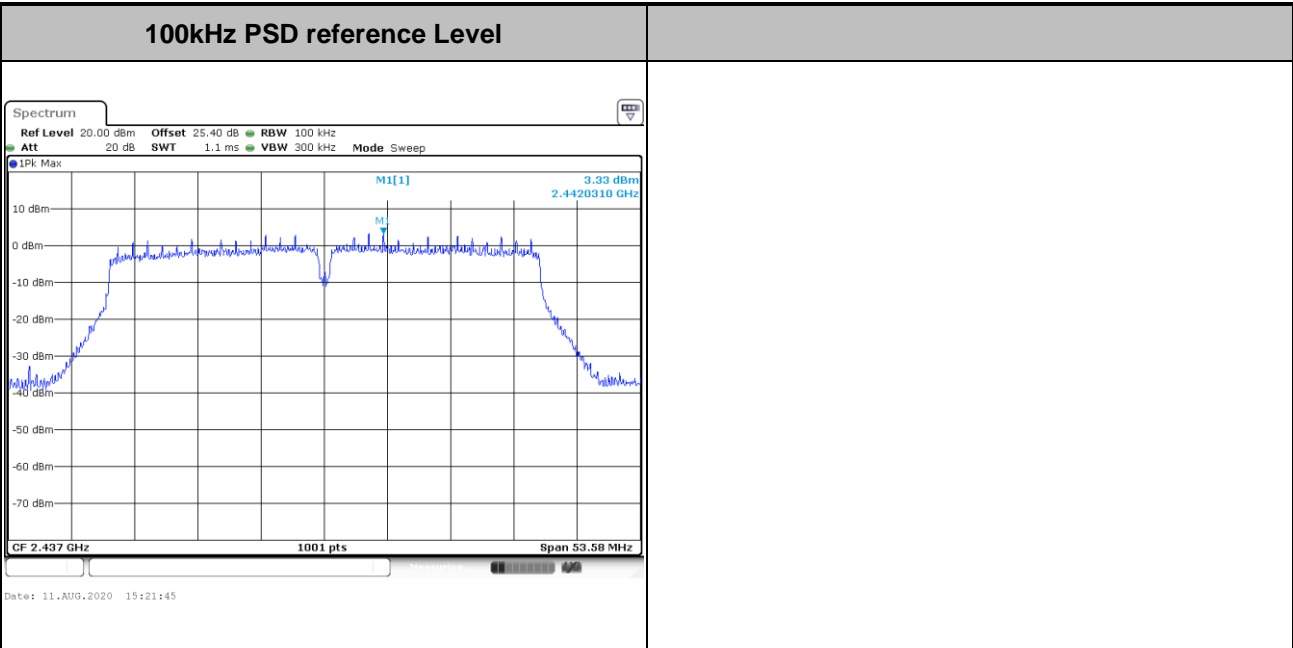



Test Mode :	802.11ac VHT40	Test Channel :	09
-------------	----------------	----------------	----

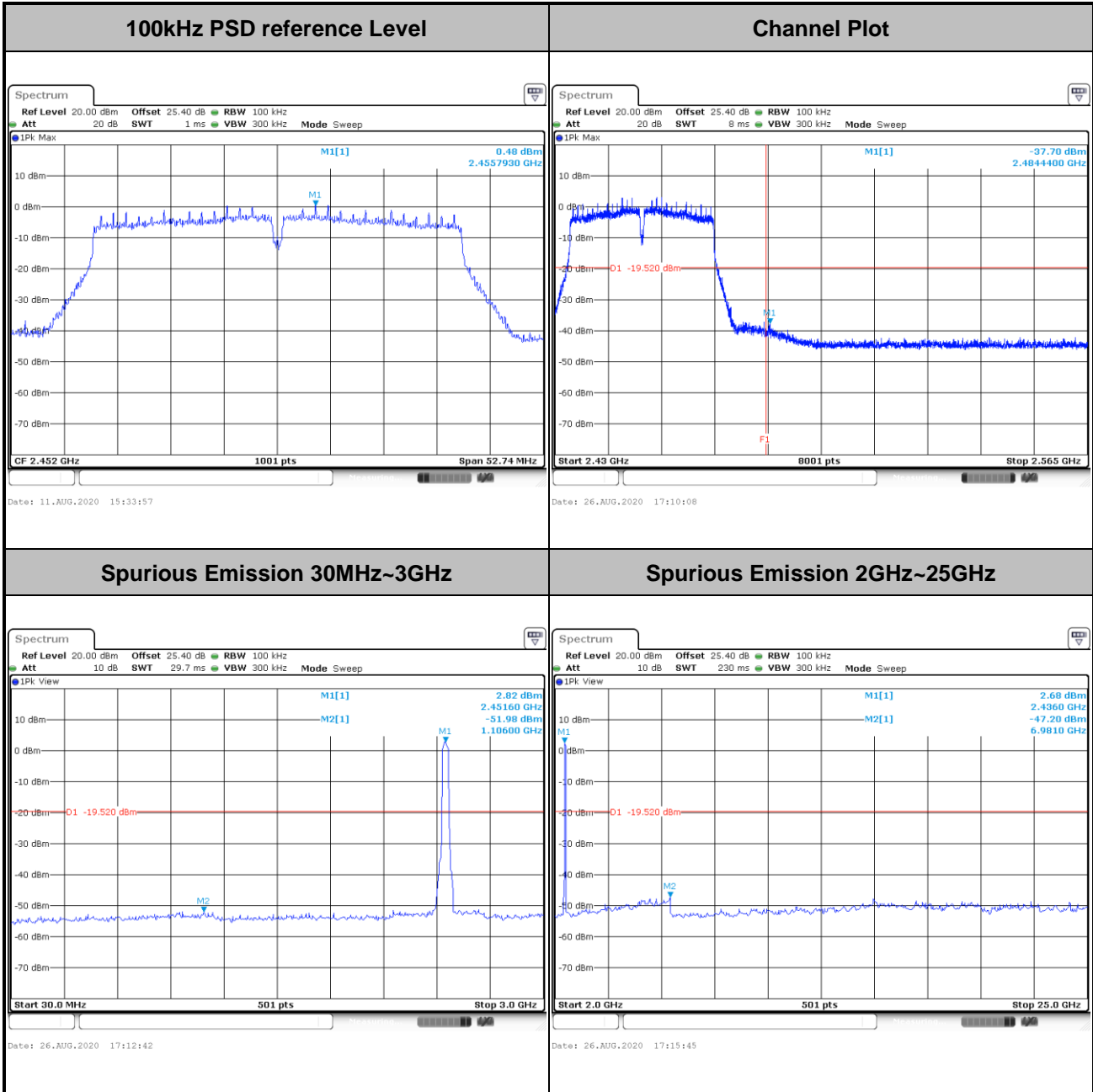



3.5 Radiated Band Edges and Spurious Emission Measurement

3.5.1 Limit of Radiated band edge and Spurious Emission Measurement

In any 100 kHz bandwidth outside the intentional radiator frequency band, all harmonics/spurious must be at least 20 dB below the highest emission level within the authorized band. If the output power of this device was measured by spectrum analyzer, the attenuation under this paragraph shall be 30 dB instead of 20 dB. In addition, radiated emissions which fall in the restricted bands must also comply with the limits as below.

Frequency (MHz)	Field Strength (microvolts/meter)	Measurement Distance (meters)
0.009 – 0.490	2400/F(kHz)	300
0.490 – 1.705	24000/F(kHz)	30
1.705 – 30.0	30	30
30 – 88	100	3
88 – 216	150	3
216 - 960	200	3
Above 960	500	3

3.5.2 Measuring Instruments

See list of measuring equipment of this test report.



3.5.3 Test Procedures

1. The testing follows the ANSI C63.10 Section 11.12.1 Radiated emission measurements.
2. The EUT was arranged to its worst case and then tune the antenna tower (from 1 m to 4 m) and turntable (from 0 degree to 360 degrees) to find the maximum reading. A pre-amp and a high pass filter are used for the test in order to get better signal level.
3. The EUT was placed on a turntable with 0.8 meter for frequency below 1GHz and 1.5 meter for frequency above 1GHz respectively above ground.
4. The EUT was set 3 meters from the interference receiving antenna, which was mounted on the top of a variable height antenna tower.
5. Corrected Reading: Antenna Factor + Cable Loss + Read Level - Preamp Factor = Level
6. For testing below 1GHz, if the emission level of the EUT in peak mode was 3 dB lower than the limit specified, then peak values of EUT will be reported, otherwise, the emissions will be repeated one by one using the CISPR quasi-peak method and reported.
7. For testing above 1GHz, the emission level of the EUT in peak mode was 20dB lower than average limit (that means the emission level in average mode also complies with the limit in average mode), then peak values of EUT will be reported, otherwise, the emissions will be measured in average mode again and reported.
8. Use the following spectrum analyzer settings:
 - (1) Span shall wide enough to fully capture the emission being measured;
 - (2) Set RBW=100 kHz for $f < 1$ GHz; $VBW \geq RBW$; Sweep = auto; Detector function = peak; Trace = max hold;
 - (3) Set RBW = 1 MHz, VBW= 3MHz for $f \geq 1$ GHz for peak measurement.
For average measurement:
 - $VBW = 10$ Hz, when duty cycle is no less than 98 percent.
 - $VBW \geq 1/T$, when duty cycle is less than 98 percent where T is the minimum transmission duration over which the transmitter is on and is transmitting at its maximum power control level for the tested mode of operation.

3.5.4 Test Setup

For radiated emissions below 30MHz

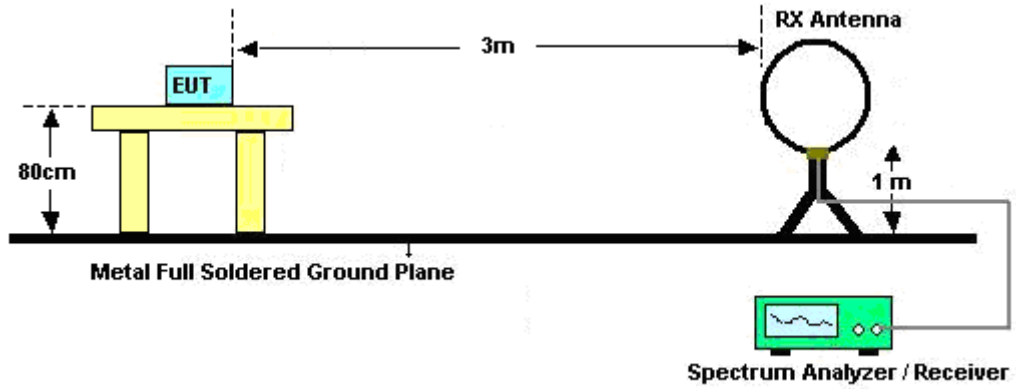

For radiated emissions from 30MHz to 1GHz

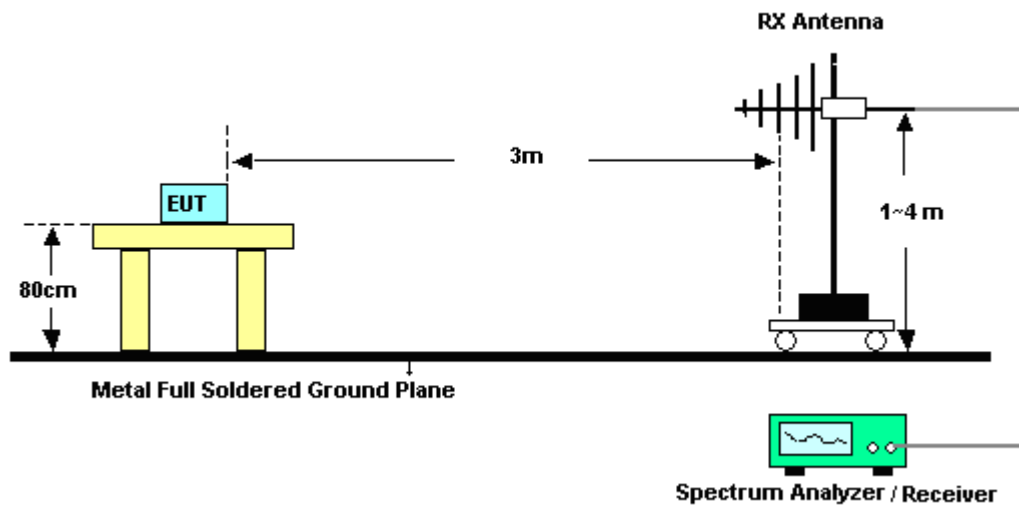

For radiated emissions above 1GHz

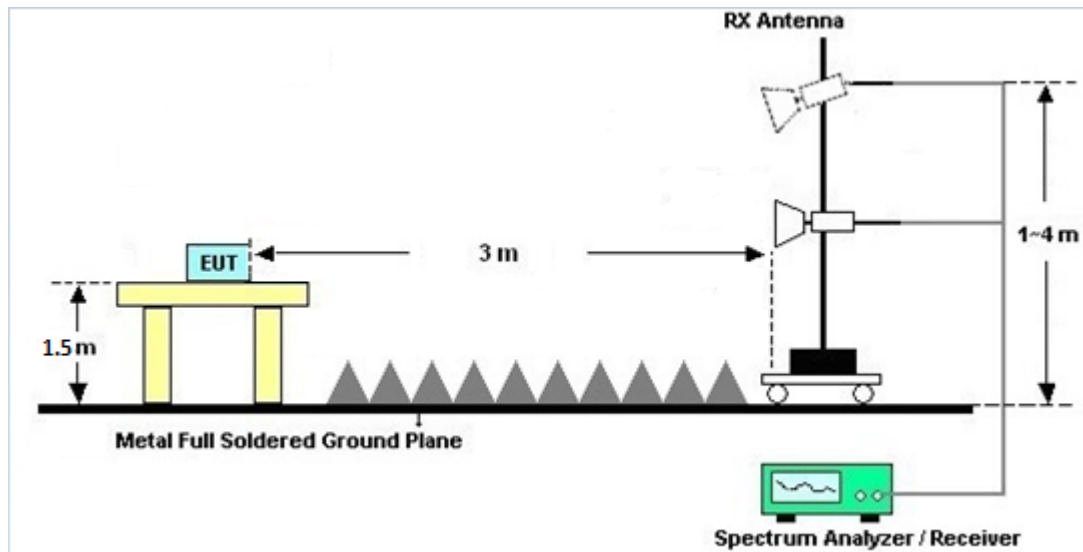

3.5.5 Test Results of Radiated Spurious Emissions (9kHz ~ 30MHz)

The low frequency, which started from 9 kHz to 30MHz, was pre-scanned and the result which was 20dB lower than the limit line was not reported.

There is a comparison data of both open-field test site and alternative test site - semi-Anechoic chamber according to 414788 D01 Radiated Test Site v01r01, and the result came out very similar.

3.5.6 Test Result of Radiated Spurious at Band Edges

Please refer to Appendix B and C.

3.5.7 Duty Cycle

Please refer to Appendix D.

3.5.8 Test Result of Radiated Spurious Emission (30MHz ~ 10th Harmonic)

Please refer to Appendix B and C.



3.6 AC Conducted Emission Measurement

3.6.1 Limit of AC Conducted Emission

For equipment that is designed to be connected to the public utility (AC) power line, the radio frequency voltage that is conducted back onto the AC power line on any frequency or frequencies within the band 150 kHz to 30 MHz shall not exceed the limits in the following table.

Frequency of Emission (MHz)	Conducted Limit (dBµV)	
	Quasi-Peak	Average
0.15-0.5	66 to 56*	56 to 46*
0.5-5	56	46
5-30	60	50

*Decreases with the logarithm of the frequency.

3.6.2 Measuring Instruments

See list of measuring equipment of this test report.

3.6.3 Test Procedures

1. The EUT was placed 0.4 meter from the conducting wall of the shielding room, and it was kept at least 80 centimeters from any other grounded conducting surface.
2. Connect EUT to the power mains through a line impedance stabilization network (LISN).
3. All the support units are connecting to the other LISN.
4. The LISN provides 50 ohm coupling impedance for the measuring instrument.
5. The FCC states that a 50 ohm, 50 microhenry LISN should be used.
6. Both sides of AC line were checked for maximum conducted interference.
7. The frequency range from 150 kHz to 30 MHz was searched.
8. Set the test-receiver system to Peak Detect Function and specified bandwidth (IF bandwidth = 9kHz) with Maximum Hold Mode.

3.6.4 Test Setup



3.6.5 Test Result of AC Conducted Emission

Please refer to Appendix A.



3.7 Antenna Requirements

3.7.1 Standard Applicable

If directional gain of transmitting Antennas is greater than 6dBi, the power shall be reduced by the same level in dB comparing to gain minus 6dBi. The use of a permanently attached Antenna or of an Antenna that uses a unique coupling to the intentional radiator shall be considered sufficient to comply with the rule.

3.7.2 Antenna Anti-Replacement Construction

An embedded-in antenna design is used.

3.7.3 Antenna Gain

The antenna peak gain of EUT is less than 6 dBi. Therefore, it is not necessary to reduce maximum peak output power limit.



4 List of Measuring Equipment

Instrument	Brand Name	Model No.	Serial No.	Characteristics	Calibration Date	Test Date	Due Date	Remark
Bilog Antenna	TESEQ	CBL 6111D & 00800N1D01N-06	35419 & 03	30MHz~1GHz	Apr. 29, 2020	Aug. 08, 2020~ Aug. 19, 2020	Apr. 28, 2021	Radiation (03CH07-HY)
Double Ridge Horn Antenna	ESCO	3117	00075962	1GHz ~ 18GHz	Dec. 06, 2019	Aug. 08, 2020~ Aug. 19, 2020	Dec. 05, 2020	Radiation (03CH07-HY)
EMI Test Receiver	Agilent	N9038A (MXE)	MY5329005 3	20Hz~26.5GHz	May 21, 2020	Aug. 08, 2020~ Aug. 19, 2020	May 20, 2021	Radiation (03CH07-HY)
Loop Antenna	Rohde & Schwarz	HFH2-Z2	100315	9 kHz~30 MHz	Dec. 26, 2019	Aug. 08, 2020~ Aug. 19, 2020	Dec. 25, 2020	Radiation (03CH07-HY)
Preamplifier	MITEQ	AMF-7D-00101 800-30-10P	1590075	1GHz~18GHz	Apr. 23, 2020	Aug. 08, 2020~ Aug. 19, 2020	Apr. 22, 2021	Radiation (03CH07-HY)
Preamplifier	COM-POWER	PA-103A	161241	10MHz~1GHz	May 19, 2020	Aug. 08, 2020~ Aug. 19, 2020	May 18, 2021	Radiation (03CH07-HY)
Preamplifier	Agilent	8449B	3008A0236 2	1GHz~26.5GHz	Nov. 01, 2019	Aug. 08, 2020~ Aug. 19, 2020	Oct. 31, 2020	Radiation (03CH07-HY)
Filter	Microwave	H3G018G1	SN477219	3GHz High Pass Filter	Nov. 01, 2019	Aug. 08, 2020~ Aug. 19, 2020	Oct. 31, 2020	Radiation (03CH07-HY)
RF Cable	HUBER + SUHNER	SUCOFLEX 102	MY2858/2,8 01606/2	18GHz~40GHz	Feb. 25, 2020	Aug. 08, 2020~ Aug. 19, 2020	Feb. 24, 2021	Radiation (03CH07-HY)
RF Cable	HUBER + SUHNER	SUCOFLEX 126	532078/126 E	30MHz~18GHz	N/A	Aug. 08, 2020~ Aug. 19, 2020	N/A	Radiation (03CH07-HY)
RF Cable	HUBER + SUHNER	SUCOFLEX 104	MY24971/4, MY28655/4	9kHz~30MHz	Feb. 25, 2020	Aug. 08, 2020~ Aug. 19, 2020	Feb. 24, 2021	Radiation (03CH07-HY)
RF Cable	HUBER + SUHNER	SUCOFLEX 104	MY28655/4, MY24971/4, MY15682/4	30MHz~1GHz	Feb. 25, 2020	Aug. 08, 2020~ Aug. 19, 2020	Feb. 24, 2021	Radiation (03CH07-HY)
RF Cable	HUBER + SUHNER	SUCOFLEX 104	MY28655/4, MY24971/4, MY15682/4	1GHz~18GHz	Feb. 25, 2020	Aug. 08, 2020~ Aug. 19, 2020	Feb. 24, 2021	Radiation (03CH07-HY)
Controller	ChainTek	Chaintek 3000	N/A	Control Turn table	N/A	Aug. 08, 2020~ Aug. 19, 2020	N/A	Radiation (03CH07-HY)
Controller	Max-Full	MF7802	MF7802083 68	Control Ant Mast	N/A	Aug. 08, 2020~ Aug. 19, 2020	N/A	Radiation (03CH07-HY)
Antenna Mast	Max-Full	MFA520BS	N/A	1m~4m	N/A	Aug. 08, 2020~ Aug. 19, 2020	N/A	Radiation (03CH07-HY)
Turn Table	ChainTek	Chaintek 3000	N/A	0~360 Degree	N/A	Aug. 08, 2020~ Aug. 19, 2020	N/A	Radiation (03CH07-HY)
Attenuator	HONOVA	5910 SMA-50-005-19 -NE	ATT-36	N/A	Nov. 01, 2019	Aug. 08, 2020~ Aug. 19, 2020	Oct. 31, 2020	Radiation (03CH07-HY)
USB Data Logger	TECPEL	TR-32	HE17XB24 95	N/A	N/A	Aug. 08, 2020~ Aug. 19, 2020	N/A	Radiation (03CH07-HY)
SHF-EHF Horn Antenna	SCHWARZBECK	BBHA 9170	BBHA9170 251	18GHz~40GHz	Nov. 26, 2019	Aug. 08, 2020~ Aug. 19, 2020	Nov. 25, 2020	Radiation (03CH07-HY)
Spectrum Analyzer	Agilent	N9030A	MY5235027 6	3Hz~44GHz	Jun. 09, 2020	Aug. 08, 2020~ Aug. 19, 2020	Jun. 08, 2021	Radiation (03CH07-HY)



Instrument	Brand Name	Model No.	Serial No.	Characteristics	Calibration Date	Test Date	Due Date	Remark
Filter	Wainwright	WHKX8-5872.5 -6750-18000-40 ST	SN7	6.75GHz High Pass Filter	Aug. 22, 2019	Aug. 08, 2020~ Aug. 19, 2020	Aug. 21, 2020	Radiation (03CH07-HY)
Preamplifier	EMEC	EM18G40G	0600789	18-40GHz	N/A	Aug. 08, 2020~ Aug. 19, 2020	N/A	Radiation (03CH07-HY)
Software	Audix	E3 6.2009-8-24	805040046 56H	N/A	N/A	Aug. 08, 2020~ Aug. 19, 2020	N/A	Radiation (03CH07-HY)
Hygrometer	Testo	608-H1	34893241	N/A	Mar. 02, 2020	Aug. 03, 2020~ Aug. 26, 2020	Mar. 01, 2021	Conducted (TH05-HY)
Power Sensor	DARE	RPR3006W	16100054S NO10	10MHz~6GHz	Dec. 23, 2019	Aug. 03, 2020~ Aug. 26, 2020	Dec. 22, 2020	Conducted (TH05-HY)
Signal Analyzer	Rohde & Schwarz	FSV40	101397	10Hz~40GHz	Nov. 15, 2019	Aug. 03, 2020~ Aug. 26, 2020	Nov. 14, 2020	Conducted (TH05-HY)
Spectrum Analyzer	Rohde & Schwarz	FSP40	100055	9kHz-40GHz	Dec. 30, 2019	Aug. 03, 2020~ Aug. 26, 2020	Dec. 29, 2020	Conducted (TH05-HY)
Switch Box & RF Cable	EM Electronics	EMSW18SE	SW200302	N/A	Mar. 17, 2020	Aug. 03, 2020~ Aug. 26, 2020	Mar. 16, 2021	Conducted (TH05-HY)
AC Power Source	ChainTek	APC-1000W	N/A	N/A	N/A	Aug. 12, 2020	N/A	Conduction (CO05-HY)
EMI Test Receiver	Rohde & Schwarz	ESR3	102388	9kHz~3.6GHz	Nov. 15, 2019	Aug. 12, 2020	Nov. 14, 2020	Conduction (CO05-HY)
Hygrometer	Testo	608-H1	34913912	N/A	Nov. 07, 2019	Aug. 12, 2020	Nov. 06, 2020	Conduction (CO05-HY)
LISN	Rohde & Schwarz	ENV216	100081	9kHz~30MHz	Nov. 15, 2019	Aug. 12, 2020	Nov. 14, 2020	Conduction (CO05-HY)
Software	Rohde & Schwarz	EMC32 V10.30	N/A	N/A	N/A	Aug. 12, 2020	N/A	Conduction (CO05-HY)
LF Cable	HUBER + SUHNER	RG-214/U	LF01	N/A	Jan. 02, 2020	Aug. 12, 2020	Jan. 01, 2021	Conduction (CO05-HY)
Pulse Limiter	Rohde & Schwarz	ESH3-Z2	100851	N/A	Jan. 02, 2020	Aug. 12, 2020	Jan. 01, 2021	Conduction (CO05-HY)



5 Uncertainty of Evaluation

Uncertainty of Conducted Emission Measurement (150kHz ~ 30MHz)

Measuring Uncertainty for a Level of Confidence of 95% ($U = 2Uc(y)$)	2.3
---	-----

Uncertainty of Radiated Emission Measurement (30 MHz ~ 1000 MHz)

Measuring Uncertainty for a Level of Confidence of 95% ($U = 2Uc(y)$)	4.7
---	-----

Uncertainty of Radiated Emission Measurement (1000 MHz ~ 18000 MHz)

Measuring Uncertainty for a Level of Confidence of 95% ($U = 2Uc(y)$)	5.3
---	-----

Uncertainty of Radiated Emission Measurement (18000 MHz ~ 40000 MHz)

Measuring Uncertainty for a Level of Confidence of 95% ($U = 2Uc(y)$)	5.0
---	-----



Appendix A. AC Conducted Emission Test Results

Test Engineer :	Howard Huang	Temperature :	23~25°C
		Relative Humidity :	40~43%

EUT Information

Report NO : 052917-01
 Test Mode : Mode 1
 Test Voltage : 120Vac/60Hz
 Phase : Line

Full Spectrum

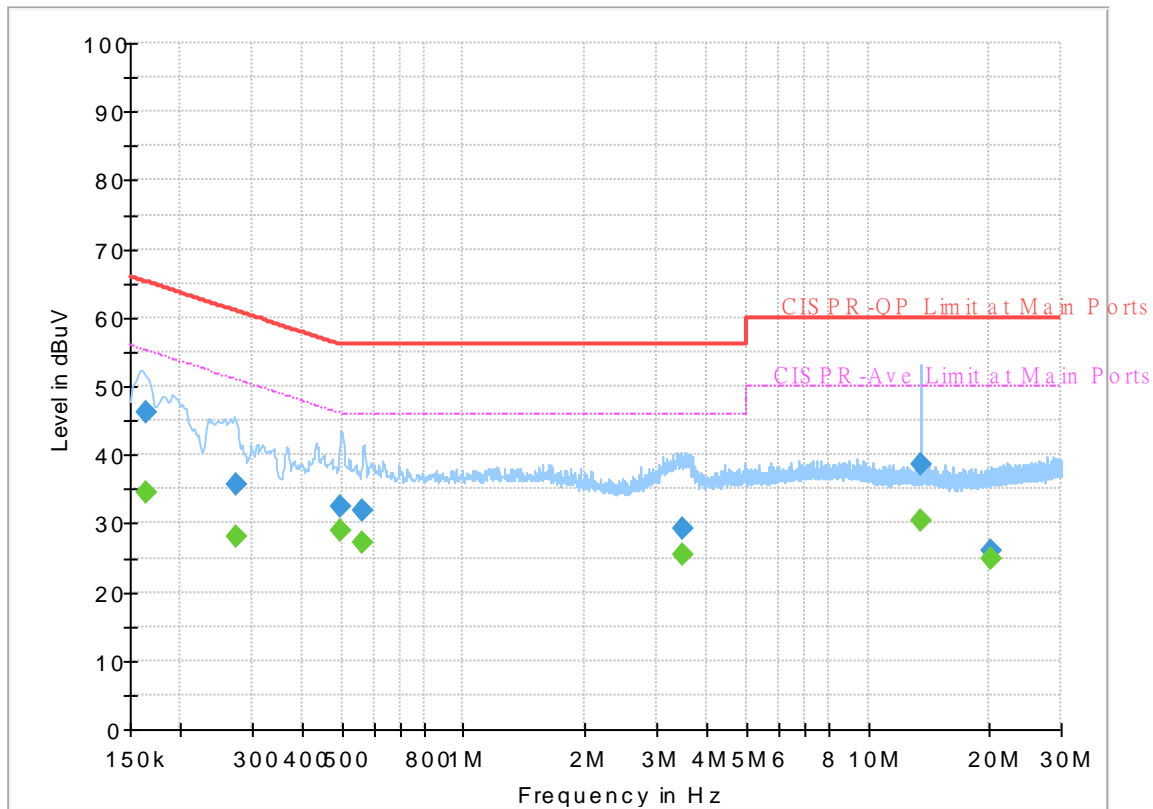

Final_Result

Frequency (MHz)	QuasiPeak (dBuV)	CAverage (dBuV)	Limit (dBuV)	Margin (dB)	Line	Filter	Corr. (dB)
0.163500	---	34.56	55.28	20.72	L1	OFF	19.6
0.163500	46.19	---	65.28	19.09	L1	OFF	19.6
0.274290	---	28.03	50.99	22.96	L1	OFF	19.6
0.274290	35.55	---	60.99	25.44	L1	OFF	19.6
0.494250	---	28.80	46.10	17.30	L1	OFF	19.6
0.494250	32.44	---	56.10	23.66	L1	OFF	19.6
0.562470	---	27.27	46.00	18.73	L1	OFF	19.6
0.562470	31.77	---	56.00	24.23	L1	OFF	19.6
3.500250	---	25.58	46.00	20.42	L1	OFF	19.7
3.500250	29.19	---	56.00	26.81	L1	OFF	19.7
13.560000	---	30.44	50.00	19.56	L1	OFF	20.2
13.560000	38.48	---	60.00	21.52	L1	OFF	20.2
20.091750	---	24.94	50.00	25.06	L1	OFF	20.4
20.091750	26.00	---	60.00	34.00	L1	OFF	20.4

EUT Information

Report NO : 052917-01
 Test Mode : Mode 1
 Test Voltage : 120Vac/60Hz
 Phase : Neutral

Full Spectrum

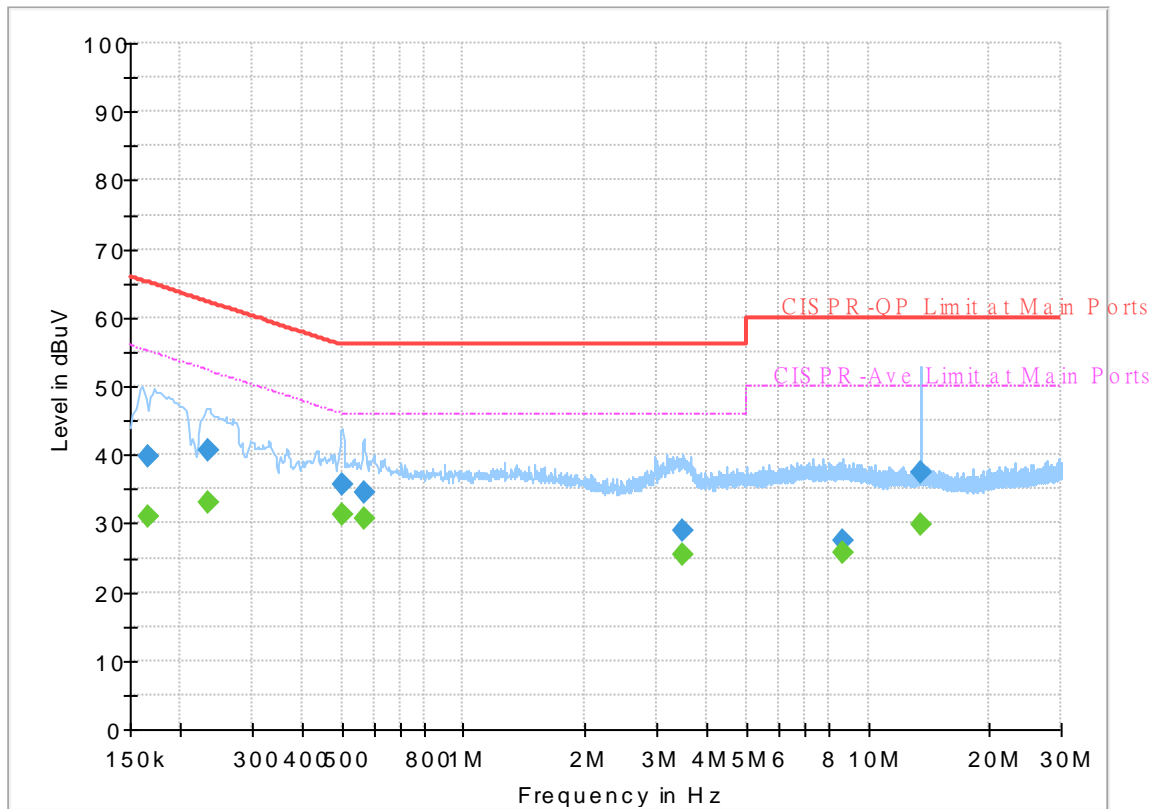

Final_Result

Frequency (MHz)	QuasiPeak (dBuV)	CAverage (dBuV)	Limit (dBuV)	Margin (dB)	Line	Filter	Corr. (dB)
0.165750	---	30.90	55.17	24.27	N	OFF	19.5
0.165750	39.63	---	65.17	25.54	N	OFF	19.5
0.235140	---	33.17	52.27	19.10	N	OFF	19.5
0.235140	40.69	---	62.27	21.58	N	OFF	19.5
0.499650	---	31.43	46.01	14.58	N	OFF	19.5
0.499650	35.64	---	56.01	20.37	N	OFF	19.5
0.569220	---	30.61	46.00	15.39	N	OFF	19.5
0.569220	34.56	---	56.00	21.44	N	OFF	19.5
3.483690	---	25.40	46.00	20.60	N	OFF	19.6
3.483690	28.98	---	56.00	27.02	N	OFF	19.6
8.656440	---	25.88	50.00	24.12	N	OFF	19.8
8.656440	27.46	---	60.00	32.54	N	OFF	19.8
13.560000	---	29.74	50.00	20.26	N	OFF	19.9
13.560000	37.36	---	60.00	22.64	N	OFF	19.9



Appendix B. Radiated Spurious Emission

Test Engineer :	Jesse Wang, Stan Hsieh and Ken Wu	Temperature :	22~23°C
		Relative Humidity :	51~59%

2.4GHz 2400~2483.5MHz

WIFI 802.11b (Band Edge @ 3m)

WIFI	Note	Frequency	Level	Over	Limit	Read	Antenna	Path	Preamp	Ant	Table	Peak	Pol.	
Ant.				Limit	Line	Level	Factor	Loss	Factor	Pos	Pos	Avg.		
1		(MHz)	(dBμV/m)	(dB)	(dBμV/m)	(dBμV)	(dB/m)	(dB)	(dB)	(cm)	(deg)	(P/A)	(H/V)	
802.11b CH 01 2412MHz		2387.385	54.92	-19.08	74	40.37	31.8	17.98	35.23	240	74	P	H	
		2387.385	45.93	-8.07	54	31.38	31.8	17.98	35.23	240	74	A	H	
	*	2412	111.68	-	-	97.04	31.87	18.02	35.25	240	74	P	H	
	*	2412	108.5	-	-	93.86	31.87	18.02	35.25	240	74	A	H	
													H	
														H
			2385.075	53.33	-20.67	74	38.76	31.83	17.97	35.23	248	17	P	V
			2387.28	43.68	-10.32	54	29.13	31.8	17.98	35.23	248	17	A	V
	*		2412	106.5	-	-	91.86	31.87	18.02	35.25	248	17	P	V
	*		2412	103.49	-	-	88.85	31.87	18.02	35.25	248	17	A	V
														V
														V
802.11b CH 06 2437MHz		2386.02	53.15	-20.85	74	38.6	31.8	17.98	35.23	265	77	P	H	
		2389.94	42.82	-11.18	54	28.27	31.8	17.98	35.23	265	77	A	H	
	*	2437	111.56	-	-	96.77	32	18.05	35.26	265	77	P	H	
	*	2437	108.56	-	-	93.77	32	18.05	35.26	265	77	A	H	
			2486.35	55.26	-18.74	74	40.35	32.07	18.13	35.29	265	77	P	H
			2485.93	44.8	-9.2	54	29.9	32.07	18.12	35.29	265	77	A	H
			2374.12	53.12	-20.88	74	38.56	31.83	17.95	35.22	217	18	P	V
			2389.1	42.53	-11.47	54	27.98	31.8	17.98	35.23	217	18	A	V
	*		2437	106.21	-	-	91.42	32	18.05	35.26	217	18	P	V
	*		2437	102.76	-	-	87.97	32	18.05	35.26	217	18	A	V
			2487.33	53.67	-20.33	74	38.76	32.07	18.13	35.29	217	18	P	V
			2483.55	43.37	-10.63	54	28.47	32.07	18.12	35.29	217	18	A	V



802.11b CH 11 2462MHz	*	2462	111.9	-	-	97.06	32.03	18.09	35.28	260	74	P	H
	*	2462	108.31	-	-	93.47	32.03	18.09	35.28	260	74	A	H
		2490	54.39	-19.61	74	39.45	32.1	18.13	35.29	260	74	P	H
		2483.52	46.33	-7.67	54	31.43	32.07	18.12	35.29	260	74	A	H
													H
													H
	*	2462	106.95	-	-	92.11	32.03	18.09	35.28	197	15	P	V
	*	2462	103.66	-	-	88.82	32.03	18.09	35.28	197	15	A	V
		2483.72	54.07	-19.93	74	39.17	32.07	18.12	35.29	197	15	P	V
		2483.52	43.97	-10.03	54	29.07	32.07	18.12	35.29	197	15	A	V
													V
													V
Remark	1. No other spurious found. 2. All results are PASS against Peak and Average limit line.												



2.4GHz 2400~2483.5MHz

WIFI 802.11b (Harmonic @ 3m)

WIFI Ant. 1	Note	Frequency (MHz)	Level (dBμV/m)	Over Limit (dB)	Limit Line (dBμV/m)	Read Level (dBμV)	Antenna Factor (dB/m)	Path Loss (dB)	Preamp Factor (dB)	Ant Pos (cm)	Table Pos (deg)	Peak Avg. (P/A)	Pol. (H/V)
802.11b CH 01 2412MHz		4824	39.85	-34.15	74	52.7	34.05	11.99	58.89	100	0	P	H
													H
													H
													H
		4824	40.66	-33.34	74	53.51	34.05	11.99	58.89	100	0	P	V
													V
													V
802.11b CH 06 2437MHz		4874	40.98	-33.02	74	53.58	34.1	12.06	58.76	100	0	P	H
		7311	42.48	-31.52	74	49.77	35.6	14.58	57.47	100	0	P	H
													H
													H
		4874	40.98	-33.02	74	53.58	34.1	12.06	58.76	100	0	P	V
		7311	42.71	-31.29	74	50	35.6	14.58	57.47	100	0	P	V
													V
802.11b CH 11 2462MHz		4924	40.14	-33.86	74	52.42	34.23	12.13	58.64	100	0	P	H
		7386	42.26	-31.74	74	49.56	35.6	14.64	57.54	100	0	P	H
													H
													H
		4924	40.41	-33.59	74	52.69	34.23	12.13	58.64	100	0	P	V
		7386	41.84	-32.16	74	49.14	35.6	14.64	57.54	100	0	P	V
													V
Remark	1. No other spurious found.												
	2. All results are PASS against Peak and Average limit line.												



2.4GHz 2400~2483.5MHz

WIFI 802.11g (Band Edge @ 3m)

WIFI Ant. 1	Note	Frequency (MHz)	Level (dBμV/m)	Over Limit (dB)	Limit Line (dBμV/m)	Read Level (dBμV)	Antenna Factor (dB/m)	Path Loss (dB)	Preamp Factor (dB)	Ant Pos (cm)	Table Pos (deg)	Peak Avg. (P/A)	Pol. (H/V)	
802.11g CH 01 2412MHz		2389.59	62.43	-11.57	74	47.88	31.8	17.98	35.23	113	75	P	H	
		2390	52.45	-1.55	54	37.9	31.8	17.98	35.23	113	75	A	H	
	*	2412	111.87	-	-	97.23	31.87	18.02	35.25	113	75	P	H	
	*	2412	104.21	-	-	89.57	31.87	18.02	35.25	113	75	A	H	
													H	
														H
			2389.275	56.08	-17.92	74	41.53	31.8	17.98	35.23	398	129	P	V
			2390	46.99	-7.01	54	32.44	31.8	17.98	35.23	398	129	A	V
	*		2412	106.38	-	-	91.74	31.87	18.02	35.25	398	129	P	V
	*		2412	99.03	-	-	84.39	31.87	18.02	35.25	398	129	A	V
														V
														V
802.11g CH 06 2437MHz		2333.1	53.31	-20.69	74	38.77	31.87	17.87	35.2	264	77	P	H	
		2389.94	43.17	-10.83	54	28.62	31.8	17.98	35.23	264	77	A	H	
	*	2437	113.46	-	-	98.67	32	18.05	35.26	264	77	P	H	
	*	2437	105.32	-	-	90.53	32	18.05	35.26	264	77	A	H	
			2485.37	54.5	-19.5	74	39.6	32.07	18.12	35.29	264	77	P	H
			2483.5	45.52	-8.48	54	30.62	32.07	18.12	35.29	264	77	A	H
			2315.04	52.92	-21.08	74	38.44	31.83	17.84	35.19	312	18	P	V
			2389.66	42.74	-11.26	54	28.19	31.8	17.98	35.23	312	18	A	V
	*		2437	110.41	-	-	95.62	32	18.05	35.26	312	18	P	V
	*		2437	102.43	-	-	87.64	32	18.05	35.26	312	18	A	V
			2485.44	54.7	-19.3	74	39.8	32.07	18.12	35.29	312	18	P	V
			2483.5	44.24	-9.76	54	29.34	32.07	18.12	35.29	312	18	A	V



802.11g CH 11 2462MHz	*	2462	111.46	-	-	96.62	32.03	18.09	35.28	122	82	P	H
	*	2462	102.78	-	-	87.94	32.03	18.09	35.28	122	82	A	H
		2483.56	64.09	-9.91	74	49.19	32.07	18.12	35.29	122	82	P	H
		2483.52	52.46	-1.54	54	37.56	32.07	18.12	35.29	122	82	A	H
													H
													H
	*	2462	106.25	-	-	91.41	32.03	18.09	35.28	100	122	P	V
	*	2462	98.59	-	-	83.75	32.03	18.09	35.28	100	122	A	V
		2484.24	60.2	-13.8	74	45.3	32.07	18.12	35.29	100	122	P	V
		2483.52	50.08	-3.92	54	35.18	32.07	18.12	35.29	100	122	A	V
													V
													V
Remark	1. No other spurious found. 2. All results are PASS against Peak and Average limit line.												



2.4GHz 2400~2483.5MHz

WIFI 802.11g (Harmonic @ 3m)

WIFI Ant. 1	Note	Frequency (MHz)	Level (dBμV/m)	Over Limit (dB)	Limit Line (dBμV/m)	Read Level (dBμV)	Antenna Factor (dB/m)	Path Loss (dB)	Preamp Factor (dB)	Ant Pos (cm)	Table Pos (deg)	Peak Avg. (P/A)	Pol. (H/V)	
802.11g CH 01 2412MHz		4824	40.45	-33.55	74	53.3	34.05	11.99	58.89	100	0	P	H	
													H	
													H	
													H	
			4824	39.54	-34.46	74	52.39	34.05	11.99	58.89	100	0	P	V
														V
														V
802.11g CH 06 2437MHz		4874	40.85	-33.15	74	53.45	34.1	12.06	58.76	100	0	P	H	
		7311	42.18	-31.82	74	49.47	35.6	14.58	57.47	100	0	P	H	
													H	
													H	
			4874	40.17	-33.83	74	52.77	34.1	12.06	58.76	100	0	P	V
			7311	43.66	-30.34	74	50.95	35.6	14.58	57.47	100	0	P	V
														V
802.11g CH 11 2462MHz		4924	40.5	-33.5	74	52.78	34.23	12.13	58.64	100	0	P	H	
		7386	40.52	-33.48	74	47.82	35.6	14.64	57.54	100	0	P	H	
													H	
													H	
			4924	40.57	-33.43	74	52.85	34.23	12.13	58.64	100	0	P	V
			7386	40.47	-33.53	74	47.77	35.6	14.64	57.54	100	0	P	V
														V
Remark	1. No other spurious found.													
	2. All results are PASS against Peak and Average limit line.													



2.4GHz 2400~2483.5MHz

WIFI 802.11ac VHT20 (Band Edge @ 3m)

WIFI Ant. 1	Note	Frequency (MHz)	Level (dBμV/m)	Over Limit (dB)	Limit Line (dBμV/m)	Read Level (dBμV)	Antenna Factor (dB/m)	Path Loss (dB)	Preamp Factor (dB)	Ant Pos (cm)	Table Pos (deg)	Peak Avg. (P/A)	Pol. (H/V)	
802.11ac VHT20 CH 01 2412MHz		2390	62.77	-11.23	74	48.22	31.8	17.98	35.23	154	88	P	H	
		2390	51.71	-2.29	54	37.16	31.8	17.98	35.23	154	88	A	H	
	*	2412	110.01	-	-	95.37	31.87	18.02	35.25	154	88	P	H	
	*	2412	102.9	-	-	88.26	31.87	18.02	35.25	154	88	A	H	
													H	
														H
			2389.38	57.83	-16.17	74	43.28	31.8	17.98	35.23	156	19	P	V
			2390	46.59	-7.41	54	32.04	31.8	17.98	35.23	156	19	A	V
		*	2412	105.27	-	-	90.63	31.87	18.02	35.25	156	19	P	V
		*	2412	97.3	-	-	82.66	31.87	18.02	35.25	156	19	A	V
802.11ac VHT20 CH 06 2437MHz		2380	53.21	-20.79	74	38.64	31.83	17.97	35.23	109	73	P	H	
		2389.94	44.12	-9.88	54	29.57	31.8	17.98	35.23	109	73	A	H	
		*	2437	113.67	-	-	98.88	32	18.05	35.26	109	73	P	H
		*	2437	105.97	-	-	91.18	32	18.05	35.26	109	73	A	H
			2488.03	55.73	-18.27	74	40.79	32.1	18.13	35.29	109	73	P	H
			2483.97	46.43	-7.57	54	31.53	32.07	18.12	35.29	109	73	P	H
			2389.52	53.52	-20.48	74	38.97	31.8	17.98	35.23	397	117	P	V
			2389.8	42.78	-11.22	54	28.23	31.8	17.98	35.23	397	117	A	V
		*	2437	109.7	-	-	94.91	32	18.05	35.26	397	117	P	V
		*	2437	101.7	-	-	86.91	32	18.05	35.26	397	117	A	V
		2487.05	55.21	-18.79	74	40.3	32.07	18.13	35.29	397	117	P	V	
		2498.6	43.11	-10.89	54	28.17	32.1	18.14	35.3	397	117	A	V	



802.11ac VHT20 CH 11 2462MHz	*	2462	110.98	-	-	96.14	32.03	18.09	35.28	106	80	P	H
	*	2462	102.39	-	-	87.55	32.03	18.09	35.28	106	80	A	H
		2483.72	62.14	-11.86	74	47.24	32.07	18.12	35.29	106	80	P	H
		2483.52	51.48	-2.52	54	36.58	32.07	18.12	35.29	106	80	A	H
													H
													H
	*	2462	105.55	-	-	90.71	32.03	18.09	35.28	100	132	P	V
	*	2462	97.59	-	-	82.75	32.03	18.09	35.28	100	132	A	V
		2483.68	59.51	-14.49	74	44.61	32.07	18.12	35.29	100	132	P	V
		2483.52	48.88	-5.12	54	33.98	32.07	18.12	35.29	100	132	A	V
													V
													V
Remark	1. No other spurious found. 2. All results are PASS against Peak and Average limit line.												



2.4GHz 2400~2483.5MHz

WIFI 802.11ac VHT20 (Harmonic @ 3m)

WIFI Ant. 1	Note	Frequency (MHz)	Level (dBµV/m)	Over Limit (dB)	Limit Line (dBµV/m)	Read Level (dBµV)	Antenna Factor (dB/m)	Path Loss (dB)	Preamp Factor (dB)	Ant Pos (cm)	Table Pos (deg)	Peak Avg. (P/A)	Pol. (H/V)	
802.11ac VHT20 CH 01 2412MHz		4824	40.7	-33.3	74	53.55	34.05	11.99	58.89	100	0	P	H	
													H	
													H	
													H	
			4824	40.1	-33.9	74	52.95	34.05	11.99	58.89	100	0	P	V
														V
														V
802.11ac VHT20 CH 06 2437MHz		4874	40.11	-33.89	74	52.71	34.1	12.06	58.76	100	0	P	H	
		7311	43.7	-30.3	74	50.99	35.6	14.58	57.47	100	0	P	H	
													H	
													H	
			4874	40.36	-33.64	74	52.96	34.1	12.06	58.76	100	0	P	V
			7311	44.41	-29.59	74	51.7	35.6	14.58	57.47	100	0	P	V
														V
802.11ac VHT20 CH 11 2462MHz		4924	39.97	-34.03	74	52.25	34.23	12.13	58.64	100	0	P	H	
		7386	41.68	-32.32	74	48.98	35.6	14.64	57.54	100	0	P	H	
													H	
													H	
			4924	40.84	-33.16	74	53.12	34.23	12.13	58.64	100	0	P	V
			7386	41.94	-32.06	74	49.24	35.6	14.64	57.54	100	0	P	V
														V
Remark	1. No other spurious found.													
	2. All results are PASS against Peak and Average limit line.													



2.4GHz 2400~2483.5MHz

WIFI 802.11ac VHT40 (Band Edge @ 3m)

WIFI Ant. 1	Note	Frequency (MHz)	Level (dBμV/m)	Over Limit (dB)	Limit Line (dBμV/m)	Read Level (dBμV)	Antenna Factor (dB/m)	Path Loss (dB)	Preamp Factor (dB)	Ant Pos (cm)	Table Pos (deg)	Peak Avg. (P/A)	Pol. (H/V)
802.11ac VHT40 CH 03 2422MHz		2389.2	61.12	-12.88	74	46.57	31.8	17.98	35.23	107	84	P	H
		2389.35	52.17	-1.83	54	37.62	31.8	17.98	35.23	107	84	A	H
	*	2422	104.38	-	-	89.67	31.93	18.03	35.25	107	84	P	H
	*	2422	96.15	-	-	81.44	31.93	18.03	35.25	107	84	A	H
		2483.98	55.01	-18.99	74	40.11	32.07	18.12	35.29	107	84	P	H
		2485.69	45.89	-8.11	54	30.99	32.07	18.12	35.29	107	84	A	H
		2389.95	57.42	-16.58	74	42.87	31.8	17.98	35.23	100	124	P	V
		2389.5	49.59	-4.41	54	35.04	31.8	17.98	35.23	100	124	A	V
	*	2422	101.46	-	-	86.75	31.93	18.03	35.25	100	124	P	V
	*	2422	93.24	-	-	78.53	31.93	18.03	35.25	100	124	A	V
		2493.97	54.01	-19.99	74	39.07	32.1	18.14	35.3	100	124	P	V
		2486.59	45.14	-8.86	54	30.23	32.07	18.13	35.29	100	124	A	V
802.11ac VHT40 CH 06 2437MHz		2388	57.59	-16.41	74	43.04	31.8	17.98	35.23	130	70	P	H
		2389.95	48.06	-5.94	54	33.51	31.8	17.98	35.23	130	70	A	H
	*	2437	107.6	-	-	92.81	32	18.05	35.26	130	70	P	H
	*	2437	99.67	-	-	84.88	32	18.05	35.26	130	70	A	H
		2483.62	62.58	-11.42	74	47.68	32.07	18.12	35.29	130	70	P	H
		2484.52	52.08	-1.92	54	37.18	32.07	18.12	35.29	130	70	A	H
		2314.65	54.61	-19.39	74	40.13	31.83	17.84	35.19	100	119	P	V
		2389.95	46.34	-7.66	54	31.79	31.8	17.98	35.23	100	119	A	V
	*	2437	103.74	-	-	88.95	32	18.05	35.26	100	119	P	V
	*	2437	96.48	-	-	81.69	32	18.05	35.26	100	119	A	V
	2483.53	59.27	-14.73	74	44.37	32.07	18.12	35.29	100	119	P	V	
	2483.71	49.81	-4.19	54	34.91	32.07	18.12	35.29	100	119	A	V	



802.11ac VHT40 CH 09 2452MHz		2337.9	53.82	-20.18	74	39.24	31.9	17.88	35.2	100	80	P	H
		2389.95	44.66	-9.34	54	30.11	31.8	17.98	35.23	100	80	A	H
	*	2452	105.95	-	-	91.14	32	18.08	35.27	100	80	P	H
	*	2452	98.47	-	-	83.66	32	18.08	35.27	100	80	A	H
		2484.07	60.12	-13.88	74	45.22	32.07	18.12	35.29	100	80	P	H
		2483.53	52.92	-1.08	54	38.02	32.07	18.12	35.29	100	80	P	H
		2347.5	53.82	-20.18	74	39.23	31.9	17.9	35.21	100	132	P	V
		2386.5	44.41	-9.59	54	29.86	31.8	17.98	35.23	100	132	A	V
	*	2452	102.75	-	-	87.94	32	18.08	35.27	100	132	P	V
	*	2452	94.74	-	-	79.93	32	18.08	35.27	100	132	A	V
		2484.7	58.82	-15.18	74	43.92	32.07	18.12	35.29	100	132	P	V
		2483.53	50.22	-3.78	54	35.32	32.07	18.12	35.29	100	132	A	V

Remark	1. No other spurious found. 2. All results are PASS against Peak and Average limit line.
---------------	---



2.4GHz 2400~2483.5MHz

WIFI 802.11ac VHT40 (Harmonic @ 3m)

WIFI Ant. 1	Note	Frequency (MHz)	Level (dBµV/m)	Over Limit (dB)	Limit Line (dBµV/m)	Read Level (dBµV)	Antenna Factor (dB/m)	Path Loss (dB)	Preamp Factor (dB)	Ant Pos (cm)	Table Pos (deg)	Peak Avg. (P/A)	Pol. (H/V)
802.11ac VHT40 CH 03 2422MHz		4844	39.79	-34.21	74	52.51	34.1	12.02	58.84	100	0	P	H
		7266	41.28	-32.72	74	48.56	35.6	14.55	57.43	100	0	P	H
													H
													H
		4844	40.41	-33.59	74	53.13	34.1	12.02	58.84	100	0	P	V
		7266	40.83	-33.17	74	48.11	35.6	14.55	57.43	100	0	P	V
													V
802.11ac VHT40 CH 06 2437MHz		4874	40.07	-33.93	74	52.67	34.1	12.06	58.76	100	0	P	H
		7311	42.55	-31.45	74	49.84	35.6	14.58	57.47	100	0	P	H
													H
													H
		4874	40.39	-33.61	74	52.99	34.1	12.06	58.76	100	0	P	V
		7311	43.09	-30.91	74	50.38	35.6	14.58	57.47	100	0	P	V
													V
802.11ac VHT40 CH 09 2452MHz		4904	40.52	-33.48	74	52.93	34.17	12.11	58.69	100	0	P	H
		7356	41.04	-32.96	74	48.44	35.5	14.61	57.51	100	0	P	H
													H
													H
		4904	40.45	-33.55	74	52.86	34.17	12.11	58.69	100	0	P	V
		7356	41.76	-32.24	74	49.16	35.5	14.61	57.51	100	0	P	V
													V
Remark	1. No other spurious found.												
	2. All results are PASS against Peak and Average limit line.												



Emission below 1GHz

2.4GHz WIFI 802.11ac VHT40 (LF)

WIFI	Note	Frequency	Level	Over	Limit	Read	Antenna	Path	Preamp	Ant	Table	Peak	Pol.	
Ant.				Limit	Line	Level	Factor	Loss	Factor	Pos	Pos	Avg.		
1		(MHz)	(dBμV/m)	(dB)	(dBμV/m)	(dBμV)	(dB/m)	(dB)	(dB)	(cm)	(deg)	(P/A)	(H/V)	
2.4GHz 802.11ac VHT40 LF		30	22.07	-17.93	40	26.83	24.32	0.93	30.01	-	-	P	H	
		129.63	27.51	-15.99	43.5	38.08	17.48	1.91	29.96	-	-	P	H	
		146.37	24.37	-19.13	43.5	35	17.29	2.03	29.95	-	-	P	H	
		863.5	33.66	-12.34	46	28.94	28.88	5	29.16	100	0	P	H	
		913.9	33.06	-12.94	46	27.94	28.87	5.16	28.91	-	-	P	H	
		954.5	33.16	-12.84	46	26.08	30.48	5.27	28.67	-	-	P	H	
														H
														H
														H
														H
														H
														H
														H
														H
														H
														H
			30	31.05	-8.95	40	35.81	24.32	0.93	30.01	100	0	P	V
			38.1	28.22	-11.78	40	36.71	20.47	1.04	30	-	-	P	V
		53.76	27.88	-12.12	40	43.49	13.14	1.24	29.99	-	-	P	V	
		916	32.19	-13.81	46	27	28.93	5.16	28.9	-	-	P	V	
		934.2	32.49	-13.51	46	26.69	29.37	5.22	28.79	-	-	P	V	
		953.1	33.03	-12.97	46	26.02	30.42	5.27	28.68	-	-	P	V	
													V	
													V	
													V	
													V	
													V	
													V	
													V	
Remark	1. No other spurious found. 2. All results are PASS against limit line.													



Note symbol

*	Fundamental Frequency which can be ignored. However, the level of any unwanted emissions shall not exceed the level of the fundamental frequency.
!	Test result is over limit line.
P/A	Peak or Average
H/V	Horizontal or Vertical



A calculation example for radiated spurious emission is shown as below:

WIFI	Note	Frequency	Level	Over	Limit	Read	Antenna	Path	Preamp	Ant	Table	Peak	Pol.
Ant.				Limit	Line	Level	Factor	Loss	Factor	Pos	Pos	Avg.	
1		(MHz)	(dBμV/m)	(dB)	(dBμV/m)	(dBμV)	(dB/m)	(dB)	(dB)	(cm)	(deg)	(P/A)	(H/V)
802.11b		2390	55.45	-18.55	74	54.51	32.22	4.58	35.86	103	308	P	H
CH 01													
2412MHz		2390	43.54	-10.46	54	42.6	32.22	4.58	35.86	103	308	A	H

1. Path Loss(dB) = Cable loss(dB) + Filter loss(dB) + Attenuator loss(dB)
2. Level(dBμV/m) =
Antenna Factor(dB/m) + Path Loss(dB) + Read Level(dBμV) - Preamp Factor(dB)
3. Over Limit(dB) = Level(dBμV/m) – Limit Line(dBμV/m)

For Peak Limit @ 2390MHz:

1. Level(dBμV/m)
= Antenna Factor(dB/m) + Path Loss(dB) + Read Level(dBμV) - Preamp Factor(dB)
= 32.22(dB/m) + 4.58(dB) + 54.51(dBμV) – 35.86 (dB)
= 55.45 (dBμV/m)
2. Over Limit(dB)
= Level(dBμV/m) – Limit Line(dBμV/m)
= 55.45(dBμV/m) – 74(dBμV/m)
= -18.55(dB)

For Average Limit @ 2390MHz:

1. Level(dBμV/m)
= Antenna Factor(dB/m) + Path Loss(dB) + Read Level(dBμV) - Preamp Factor(dB)
= 32.22(dB/m) + 4.58(dB) + 42.6(dBμV) – 35.86 (dB)
= 43.54 (dBμV/m)
2. Over Limit(dB)
= Level(dBμV/m) – Limit Line(dBμV/m)
= 43.54(dBμV/m) – 54(dBμV/m)
= -10.46(dB)

Both peak and average measured complies with the limit line, so test result is “PASS”.



Appendix C. Radiated Spurious Emission Plots

Test Engineer :	Jesse Wang, Stan Hsieh and Ken Wu	Temperature :	22~23°C
		Relative Humidity :	51~59%

Note symbol

-L	Low channel location
-R	High channel location



2.4GHz 2400~2483.5MHz
WIFI 802.11b (Band Edge @ 3m)

WIFI	2.4GHz 2400~2483.5MHz Band Edge @ 3m	
ANT	802.11b CH01 2412MHz	
1	Horizontal	Fundamental
Peak	<p>Site : 03CH07-HY Condition : PEAK_8E_3m HF_ANT_00075962 HORIZONTAL Detector : Peak Project : 052917-01 Mode : 10</p>	<p>Site : 03CH07-HY Condition : PEAK_8E_3m HF_ANT_00075962 HORIZONTAL Detector : Peak Project : 052917-01 Mode : 10</p>
Avg.	<p>Site : 03CH07-HY Condition : AVG_54_3m HF_ANT_00075962 HORIZONTAL Detector : Peak Project : 052917-01 Mode : 10</p>	<p>Site : 03CH07-HY Condition : AVG_54_3m HF_ANT_00075962 HORIZONTAL Detector : Peak Project : 052917-01 Mode : 10</p>

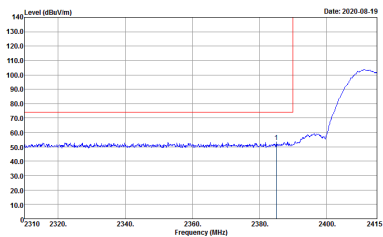
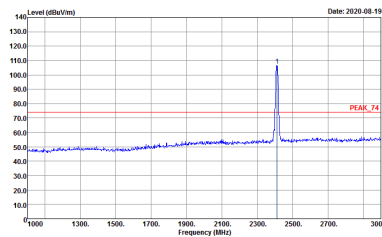
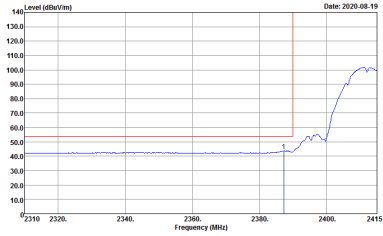
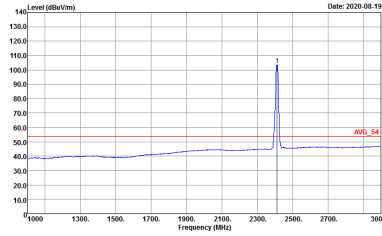

WIFI	2.4GHz 2400~2483.5MHz Band Edge @ 3m	
ANT	802.11b CH01 2412MHz	
1	Vertical	Fundamental
Peak	 <p>Date: 2020-08-19</p> <p>Site : 03CH07-HY Condition : PEAK_BE_74 3m HF_ANT_00075962 VERTICAL RBW:1000.000kHz VBW:3000.000kHz SWT:Auto Detector : Peak Project : 052917-01 Mode : 10</p>	 <p>Date: 2020-08-19</p> <p>Site : 03CH07-HY Condition : PEAK_74 3m HF_ANT_00075962 VERTICAL RBW:1000.000kHz VBW:3000.000kHz SWT:Auto Detector : Peak Project : 052917-01 Mode : 10</p>
Avg.	 <p>Date: 2020-08-19</p> <p>Site : 03CH07-HY Condition : AVG_BE_34 3m HF_ANT_00075962 VERTICAL RBW:1000.000kHz VBW:3000.000kHz SWT:Auto Detector : Peak Project : 052917-01 Mode : 10</p>	 <p>Date: 2020-08-19</p> <p>Site : 03CH07-HY Condition : AVG_34 3m HF_ANT_00075962 VERTICAL RBW:1000.000kHz VBW:3000.000kHz SWT:Auto Detector : Peak Project : 052917-01 Mode : 10</p>

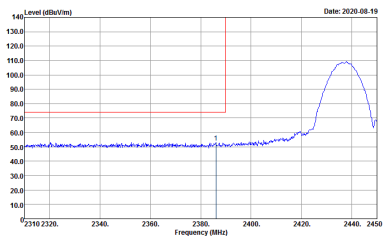
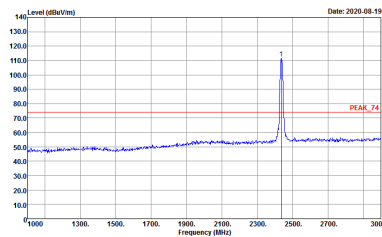
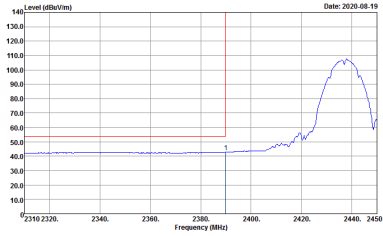
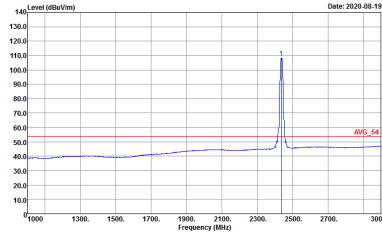

WIFI	2.4GHz 2400~2483.5MHz Band Edge @ 3m	
ANT	802.11b CH06 2437MHz - L	
1	Horizontal	Fundamental
Peak	 <p>Date: 2020-08-19</p> <p>Site : 03CH07-HY Condition : PEAK_BE_74 3m HF_ANT_00075962 HORIZONTAL RBW:1000.000kHz VBW:3000.000kHz SWT:Auto Detector : Peak Project : 052917-01 Mode : 11</p>	 <p>Date: 2020-08-19</p> <p>Site : 03CH07-HY Condition : PEAK_74 3m HF_ANT_00075962 HORIZONTAL RBW:1000.000kHz VBW:3000.000kHz SWT:Auto Detector : Peak Project : 052917-01 Mode : 11</p>
Avg.	 <p>Date: 2020-08-19</p> <p>Site : 03CH07-HY Condition : AVG_BE_34 3m HF_ANT_00075962 HORIZONTAL RBW:1000.000kHz VBW:0.010kHz SWT:Auto Detector : Peak Project : 052917-01 Mode : 11</p>	 <p>Date: 2020-08-19</p> <p>Site : 03CH07-HY Condition : AVG_34 3m HF_ANT_00075962 HORIZONTAL RBW:1000.000kHz VBW:0.010kHz SWT:Auto Detector : Peak Project : 052917-01 Mode : 11</p>



WIFI	2.4GHz 2400~2483.5MHz Band Edge @ 3m	
ANT	802.11b CH06 2437MHz - R	
1	Horizontal	Fundamental
Peak	<p>Site : 03CH07-01 Condition : PEAK_BE_74 3m HF_ANT_00070962 HORIZONTAL Detector : Peak Project : 052917-01 Mode : 11</p>	Left blank
Avg.	<p>Site : 03CH07-01 Condition : AVG_BE_54 3m HF_ANT_00070962 HORIZONTAL Detector : Peak Project : 052917-01 Mode : 11</p>	Left blank



WIFI	2.4GHz 2400~2483.5MHz Band Edge @ 3m	
ANT	802.11b CH06 2437MHz - L	
1	Vertical	Fundamental
Peak	<p>Site : 03CH07-HY Condition : PEAK_BE_74 3m HF_ANT_00075962 VERTICAL Detector : Peak Project : 052917-01 Mode : 11</p>	<p>Site : 03CH07-HY Condition : PEAK_74 3m HF_ANT_00075962 VERTICAL Detector : Peak Project : 052917-01 Mode : 11</p>
Avg.	<p>Site : 03CH07-HY Condition : AVG_BE_34 3m HF_ANT_00075962 VERTICAL Detector : Peak Project : 052917-01 Mode : 11</p>	<p>Site : 03CH07-HY Condition : AVG_34 3m HF_ANT_00075962 VERTICAL Detector : Peak Project : 052917-01 Mode : 11</p>

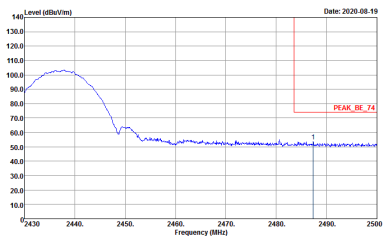
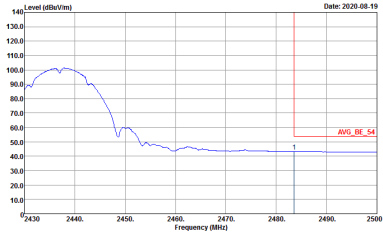

WIFI	2.4GHz 2400~2483.5MHz Band Edge @ 3m	
ANT	802.11b CH06 2437MHz - R	
1	Vertical	Fundamental
<p>Peak</p>	 <p>Site : 03CH07-01 Condition : PEAK_BE_74 3m HF_ANT_00070962 VERTICAL Detector : Peak Project : 052917-01 Mode : 11</p>	<p>Left blank</p>
<p>Avg.</p>	 <p>Site : 03CH07-01 Condition : AVG_BE_54 3m HF_ANT_00070962 VERTICAL Detector : Peak Project : 052917-01 Mode : 11</p>	<p>Left blank</p>

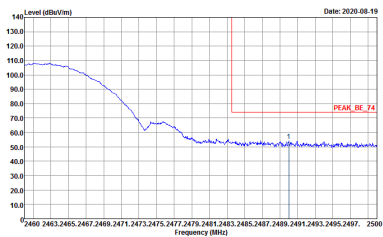
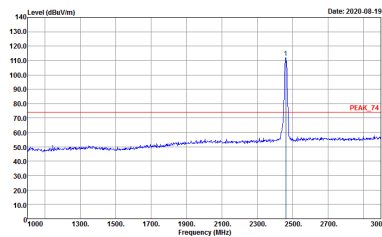
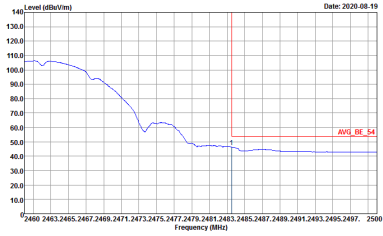
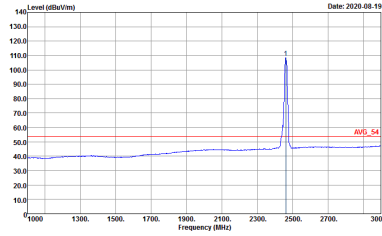

WIFI	2.4GHz 2400~2483.5MHz Band Edge @ 3m	
ANT	802.11b CH11 2462MHz	
1	Horizontal	Fundamental
Peak	 <p>Date: 2020-08-19</p> <p>Site : 03CH07-HY Condition : PEAK_BE_74 3m HF_ANT_00075962 HORIZONTAL RBW:1000.000kHz VBW:3000.000kHz SWT:Auto Detector : Peak Project : 052917-01 Mode : 12</p>	 <p>Date: 2020-08-19</p> <p>Site : 03CH07-HY Condition : PEAK_74 3m HF_ANT_00075962 HORIZONTAL RBW:1000.000kHz VBW:3000.000kHz SWT:Auto Detector : Peak Project : 052917-01 Mode : 12</p>
Avg.	 <p>Date: 2020-08-19</p> <p>Site : 03CH07-HY Condition : AVG_BE_54 3m HF_ANT_00075962 HORIZONTAL RBW:1000.000kHz VBW:3000.000kHz SWT:Auto Detector : Peak Project : 052917-01 Mode : 12</p>	 <p>Date: 2020-08-19</p> <p>Site : 03CH07-HY Condition : AVG_54 3m HF_ANT_00075962 HORIZONTAL RBW:1000.000kHz VBW:3000.000kHz SWT:Auto Detector : Peak Project : 052917-01 Mode : 12</p>

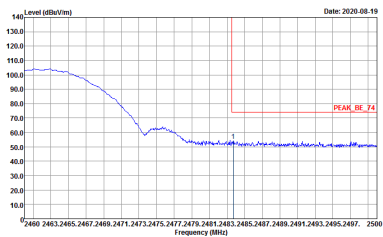
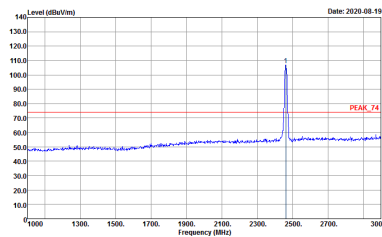
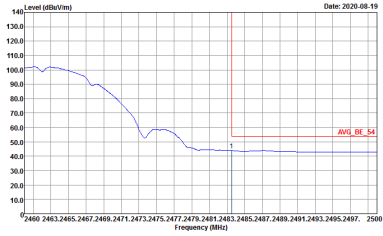
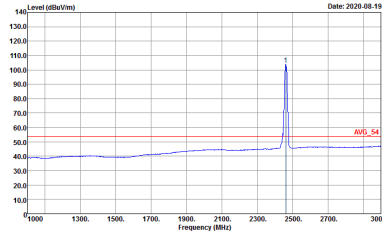

WIFI	2.4GHz 2400~2483.5MHz Band Edge @ 3m	
ANT	802.11b CH11 2462MHz	
1	Vertical	Fundamental
Peak	 <p>Date: 2020-08-19</p> <p>Level (dBm/Vm)</p> <p>Frequency (MHz)</p> <p>PEAK_BE_74</p> <p>Site : 03CH07-HY Condition : PEAK_BE_74 3m HF_ANT_00075962 VERTICAL RBW:1000.000kHz VBW:3000.000kHz SWT:Auto Detector : Peak Project : 052917-01 Mode : 12</p>	 <p>Date: 2020-08-19</p> <p>Level (dBm/Vm)</p> <p>Frequency (MHz)</p> <p>PEAK_74</p> <p>Site : 03CH07-HY Condition : PEAK_74 3m HF_ANT_00075962 VERTICAL RBW:1000.000kHz VBW:3000.000kHz SWT:Auto Detector : Peak Project : 052917-01 Mode : 12</p>
Avg.	 <p>Date: 2020-08-19</p> <p>Level (dBm/Vm)</p> <p>Frequency (MHz)</p> <p>AVG_BE_54</p> <p>Site : 03CH07-HY Condition : AVG_BE_54 3m HF_ANT_00075962 VERTICAL RBW:1000.000kHz VBW:3000.000kHz SWT:Auto Detector : Peak Project : 052917-01 Mode : 12</p>	 <p>Date: 2020-08-19</p> <p>Level (dBm/Vm)</p> <p>Frequency (MHz)</p> <p>AVG_54</p> <p>Site : 03CH07-HY Condition : AVG_54 3m HF_ANT_00075962 VERTICAL RBW:1000.000kHz VBW:3000.000kHz SWT:Auto Detector : Peak Project : 052917-01 Mode : 12</p>

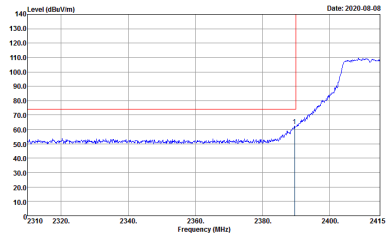
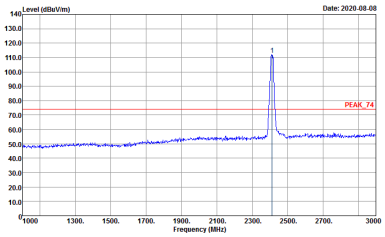
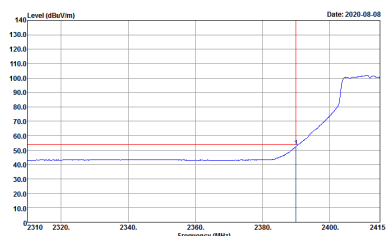
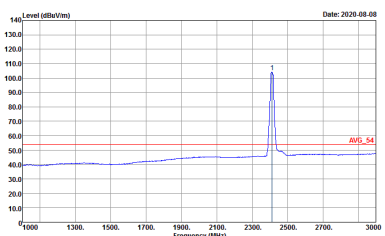

2.4GHz 2400~2483.5MHz
WIFI 802.11g (Band Edge @ 3m)

WIFI	2.4GHz 2400~2483.5MHz Band Edge @ 3m	
ANT	802.11g CH01 2412MHz	
1	Horizontal	Fundamental
Peak	 <p>Site : 03CH07-HY Condition : PEAK_BE_74 3m HF_ANT_00075962 HORIZONTAL Detector : Peak Project : 052917-01 Mode : 13</p>	 <p>Site : 03CH07-HY Condition : PEAK_74 3m HF_ANT_00075962 HORIZONTAL Detector : Peak Project : 052917-01 Mode : 13</p>
Avg.	 <p>Site : 03CH07-HY Condition : AVG_BE_54 3m HF_ANT_00075962 HORIZONTAL Detector : Peak Project : 052917-01 Mode : 13</p>	 <p>Site : 03CH07-HY Condition : AVG_54 3m HF_ANT_00075962 HORIZONTAL Detector : Peak Project : 052917-01 Mode : 13</p>

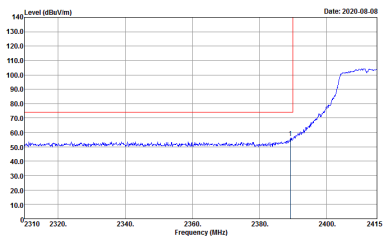
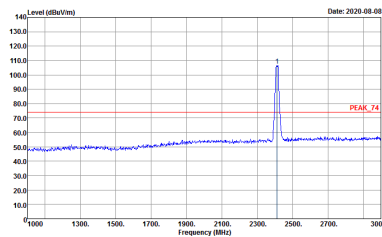
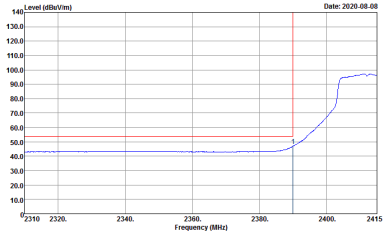
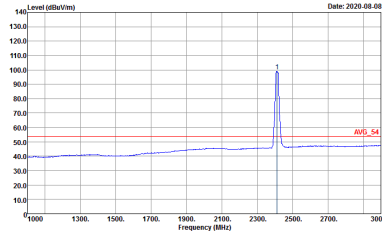

WIFI	2.4GHz 2400~2483.5MHz Band Edge @ 3m	
ANT	802.11g CH01 2412MHz	
1	Vertical	Fundamental
Peak	 <p>Site : 03CH07-HY Condition : PEAK_BE_74 3m HF_ANT_00075962 VERTICAL RBW:1000.000kHz VBW:3000.000kHz SWT:Auto Detector : Peak Project : 052917-01 Mode : 13</p>	 <p>Site : 03CH07-HY Condition : PEAK_74 3m HF_ANT_00075962 VERTICAL RBW:1000.000kHz VBW:3000.000kHz SWT:Auto Detector : Peak Project : 052917-01 Mode : 13</p>
Avg.	 <p>Site : 03CH07-HY Condition : AVG_BE_54 3m HF_ANT_00075962 VERTICAL RBW:1000.000kHz VBW:3000.000kHz SWT:Auto Detector : Peak Project : 052917-01 Mode : 13</p>	 <p>Site : 03CH07-HY Condition : AVG_54 3m HF_ANT_00075962 VERTICAL RBW:1000.000kHz VBW:3000.000kHz SWT:Auto Detector : Peak Project : 052917-01 Mode : 13</p>

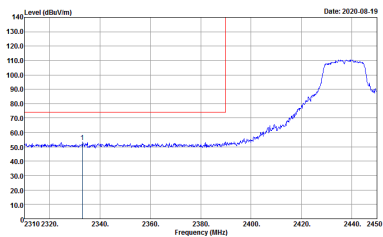
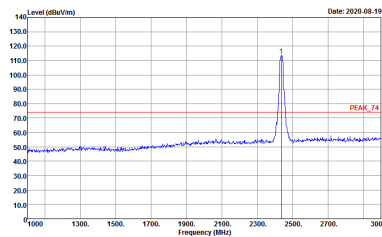
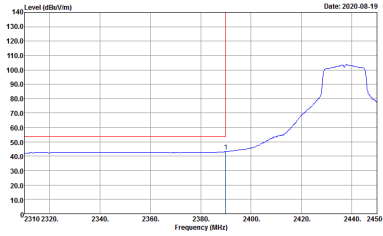
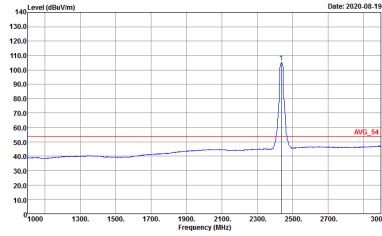

WIFI	2.4GHz 2400~2483.5MHz Band Edge @ 3m	
ANT	802.11g CH06 2437MHz - L	
1	Horizontal	Fundamental
Peak	 <p>Date: 2020-08-19</p> <p>Site : 03CH07-HY Condition : PEAK_BE_74 3m HF_ANT_00075962 HORIZONTAL RBW:1000.000kHz VBW:3000.000kHz SWT:Auto Detector : Peak Project : 052917-01 Mode : 14</p>	 <p>Date: 2020-08-19</p> <p>Site : 03CH07-HY Condition : PEAK_74 3m HF_ANT_00075962 HORIZONTAL RBW:1000.000kHz VBW:3000.000kHz SWT:Auto Detector : Peak Project : 052917-01 Mode : 14</p>
Avg.	 <p>Date: 2020-08-19</p> <p>Site : 03CH07-HY Condition : AVG_BE_34 3m HF_ANT_00075962 HORIZONTAL RBW:1000.000kHz VBW:0.010kHz SWT:Auto Detector : Peak Project : 052917-01 Mode : 14</p>	 <p>Date: 2020-08-19</p> <p>Site : 03CH07-HY Condition : AVG_34 3m HF_ANT_00075962 HORIZONTAL RBW:1000.000kHz VBW:0.010kHz SWT:Auto Detector : Peak Project : 052917-01 Mode : 14</p>



WIFI	2.4GHz 2400~2483.5MHz Band Edge @ 3m	
ANT	802.11g CH06 2437MHz - R	
1	Horizontal	Fundamental
Peak	<p>Site : 03CH07-HY Condition : PEAK_BE_74 3m HF_ANT_00070962 HORIZONTAL Detector : Peak Project : 052917-01 Mode : 14</p>	Left blank
Avg.	<p>Site : 03CH07-HY Condition : AVG_BE_54 3m HF_ANT_00070962 HORIZONTAL Detector : Peak Project : 052917-01 Mode : 14</p>	Left blank



WIFI	2.4GHz 2400~2483.5MHz Band Edge @ 3m	
ANT	802.11g CH06 2437MHz - L	
1	Vertical	Fundamental
Peak	<p>Site : 03CH07-HY Condition : PEAK_BE_74 3m HF_ANT_00075962 VERTICAL Detector : Peak Project : 052917-01 Mode : 14</p>	<p>Site : 03CH07-HY Condition : PEAK_74 3m HF_ANT_00075962 VERTICAL Detector : Peak Project : 052917-01 Mode : 14</p>
Avg.	<p>Site : 03CH07-HY Condition : AVG_BE_34 3m HF_ANT_00075962 VERTICAL Detector : Peak Project : 052917-01 Mode : 14</p>	<p>Site : 03CH07-HY Condition : AVG_34 3m HF_ANT_00075962 VERTICAL Detector : Peak Project : 052917-01 Mode : 14</p>

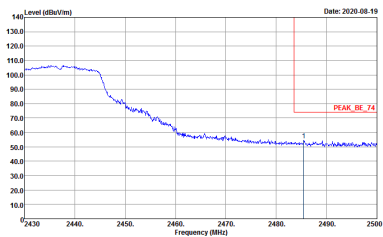
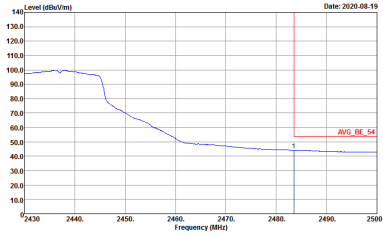

WIFI	2.4GHz 2400~2483.5MHz Band Edge @ 3m	
ANT	802.11g CH06 2437MHz - R	
1	Vertical	Fundamental
<p>Peak</p>	 <p>Date: 2020-08-19</p> <p>Site : 03CH07-01 Condition : PEAK_BE_74 3m HF_ANT_00070962 VERTICAL Detector : Peak Project : 052917-01 Mode : 14</p>	<p>Left Blank</p>
<p>Avg.</p>	 <p>Date: 2020-08-19</p> <p>Site : 03CH07-01 Condition : AVG_BE_54 3m HF_ANT_00070962 VERTICAL Detector : Peak Project : 052917-01 Mode : 14</p>	<p>Left Blank</p>

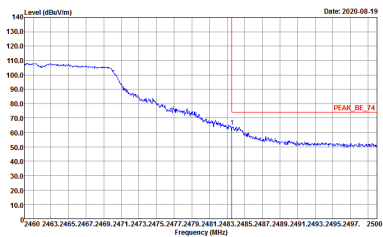
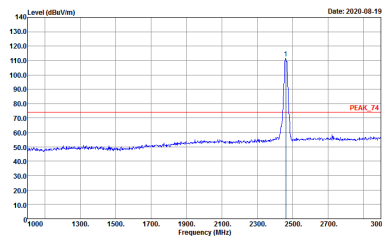
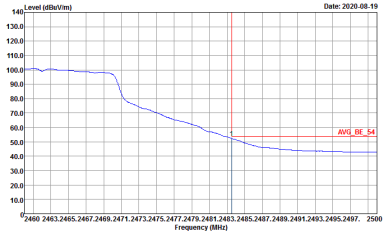
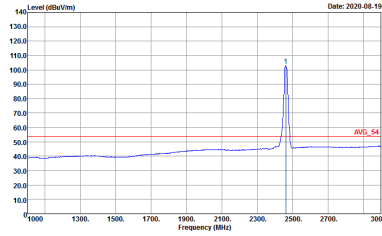

WIFI	2.4GHz 2400~2483.5MHz Band Edge @ 3m	
ANT	802.11g CH11 2462MHz	
1	Horizontal	Fundamental
Peak	 <p>Date: 2020-08-19</p> <p>Level (dBm/Vm)</p> <p>Frequency (MHz)</p> <p>PEAK_BE_74</p> <p>Site : 03CH07-HY Condition : PEAK_BE_74 3m HF_ANT_00075962 HORIZONTAL RBW:1000.000kHz VBW:3000.000kHz SWT:Auto Detector : Peak Project : 052917-01 Mode : 15</p>	 <p>Date: 2020-08-19</p> <p>Level (dBm/Vm)</p> <p>Frequency (MHz)</p> <p>PEAK_74</p> <p>Site : 03CH07-HY Condition : PEAK_74 3m HF_ANT_00075962 HORIZONTAL RBW:1000.000kHz VBW:3000.000kHz SWT:Auto Detector : Peak Project : 052917-01 Mode : 15</p>
Avg.	 <p>Date: 2020-08-19</p> <p>Level (dBm/Vm)</p> <p>Frequency (MHz)</p> <p>AVG_BE_54</p> <p>Site : 03CH07-HY Condition : AVG_BE_54 3m HF_ANT_00075962 HORIZONTAL RBW:1000.000kHz VBW:3000.000kHz SWT:Auto Detector : Peak Project : 052917-01 Mode : 15</p>	 <p>Date: 2020-08-19</p> <p>Level (dBm/Vm)</p> <p>Frequency (MHz)</p> <p>AVG_54</p> <p>Site : 03CH07-HY Condition : AVG_54 3m HF_ANT_00075962 HORIZONTAL RBW:1000.000kHz VBW:3000.000kHz SWT:Auto Detector : Peak Project : 052917-01 Mode : 15</p>

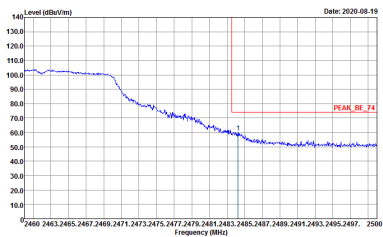
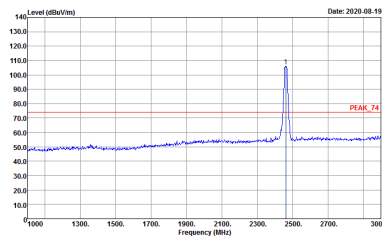
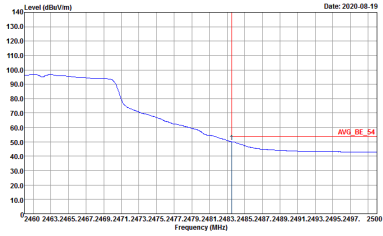
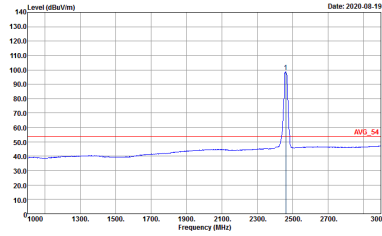

WIFI	2.4GHz 2400~2483.5MHz Band Edge @ 3m	
ANT	802.11g CH11 2462MHz	
1	Vertical	Fundamental
Peak	 <p>Date: 2020-08-19</p> <p>Level (dBm/Vm)</p> <p>Frequency (MHz)</p> <p>PEAK_BE_74</p> <p>Site : 03CH07-HY Condition : PEAK_BE_74 3m HF_ANT_00075962 VERTICAL RBW:1000.000kHz VBW:3000.000kHz SWT:Auto Detector : Peak Project : 052917-01 Mode : 15</p>	 <p>Date: 2020-08-19</p> <p>Level (dBm/Vm)</p> <p>Frequency (MHz)</p> <p>PEAK_74</p> <p>Site : 03CH07-HY Condition : PEAK_74 3m HF_ANT_00075962 VERTICAL RBW:1000.000kHz VBW:3000.000kHz SWT:Auto Detector : Peak Project : 052917-01 Mode : 15</p>
Avg.	 <p>Date: 2020-08-19</p> <p>Level (dBm/Vm)</p> <p>Frequency (MHz)</p> <p>AVG_BE_54</p> <p>Site : 03CH07-HY Condition : AVG_BE_54 3m HF_ANT_00075962 VERTICAL RBW:1000.000kHz VBW:3000.000kHz SWT:Auto Detector : Peak Project : 052917-01 Mode : 15</p>	 <p>Date: 2020-08-19</p> <p>Level (dBm/Vm)</p> <p>Frequency (MHz)</p> <p>AVG_54</p> <p>Site : 03CH07-HY Condition : AVG_54 3m HF_ANT_00075962 VERTICAL RBW:1000.000kHz VBW:3000.000kHz SWT:Auto Detector : Peak Project : 052917-01 Mode : 15</p>



2.4GHz 2400~2483.5MHz

WIFI 802.11ac VHT20 (Band Edge @ 3m)

WIFI	2.4GHz 2400~2483.5MHz Band Edge @ 3m	
ANT	802.11ac VHT20 CH01 2412MHz	
1	Horizontal	Fundamental
Peak	<p>Site : 03CH07-HY Condition : PEAK_BE_74 3m HF_ANT_00075962 HORIZONTAL Detector : Peak Project : 052917-01 Mode : 16</p>	<p>Site : 03CH07-HY Condition : PEAK_74 3m HF_ANT_00075962 HORIZONTAL Detector : Peak Project : 052917-01 Mode : 16</p>
Avg.	<p>Site : 03CH07-HY Condition : AVG_BE_54 3m HF_ANT_00075962 HORIZONTAL Detector : Peak Project : 052917-01 Mode : 16</p>	<p>Site : 03CH07-HY Condition : AVG_54 3m HF_ANT_00075962 HORIZONTAL Detector : Peak Project : 052917-01 Mode : 16</p>

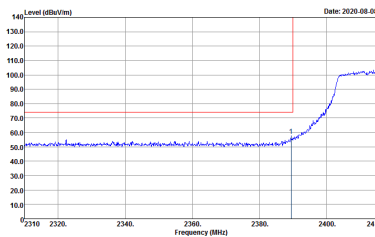
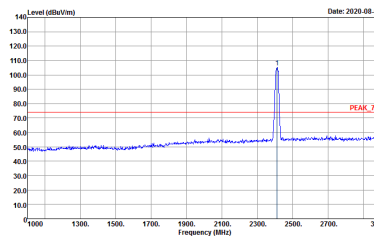
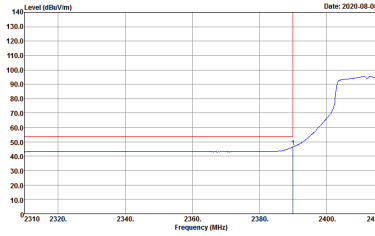
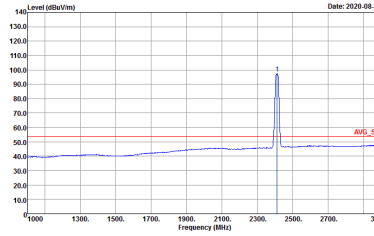

WIFI	2.4GHz 2400~2483.5MHz Band Edge @ 3m	
ANT	802.11ac VHT20 CH01 2412MHz	
1	Vertical	Fundamental
Peak	 <p>Site : 03CH07-HY Condition : PEAK_BE_74 3m HF_ANT_00075962 VERTICAL RBW:1000.000kHz VBW:3000.000kHz SWT:Auto Detector : Peak Project : 052917-01 Mode : 16</p>	 <p>Site : 03CH07-HY Condition : PEAK_74 3m HF_ANT_00075962 VERTICAL RBW:1000.000kHz VBW:3000.000kHz SWT:Auto Detector : Peak Project : 052917-01 Mode : 16</p>
Avg.	 <p>Site : 03CH07-HY Condition : AVG_BE_54 3m HF_ANT_00075962 VERTICAL RBW:1000.000kHz VBW:0.010kHz SWT:Auto Detector : Peak Project : 052917-01 Mode : 16</p>	 <p>Site : 03CH07-HY Condition : AVG_54 3m HF_ANT_00075962 VERTICAL RBW:1000.000kHz VBW:0.010kHz SWT:Auto Detector : Peak Project : 052917-01 Mode : 16</p>

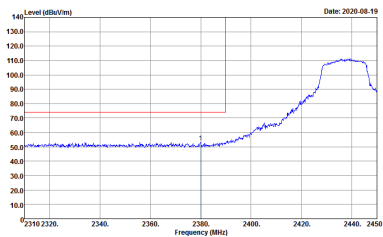
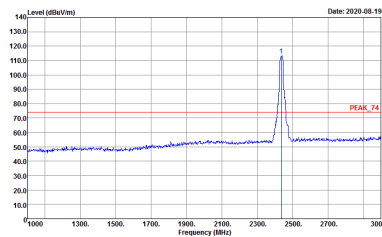
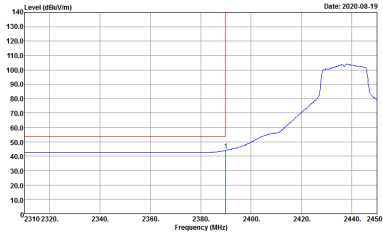
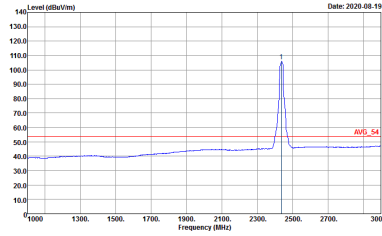

WIFI	2.4GHz 2400~2483.5MHz Band Edge @ 3m	
ANT	802.11ac VHT20 CH06 2437MHz - L	
1	Horizontal	Fundamental
Peak	 <p>Date: 2020-08-19</p> <p>Site : 03CH07-HY Condition : PEAK_BE_74 3m HF_ANT_00075962 HORIZONTAL RBW:1000.000kHz VBW:3000.000kHz SWT:Auto Detector : Peak Project : 052917-01 Mode : 17</p>	 <p>Date: 2020-08-19</p> <p>Site : 03CH07-HY Condition : PEAK_74 3m HF_ANT_00075962 HORIZONTAL RBW:1000.000kHz VBW:3000.000kHz SWT:Auto Detector : Peak Project : 052917-01 Mode : 17</p>
Avg.	 <p>Date: 2020-08-19</p> <p>Site : 03CH07-HY Condition : AVG_BE_34 3m HF_ANT_00075962 HORIZONTAL RBW:1000.000kHz VBW:3000.000kHz SWT:Auto Detector : Peak Project : 052917-01 Mode : 17</p>	 <p>Date: 2020-08-19</p> <p>Site : 03CH07-HY Condition : AVG_34 3m HF_ANT_00075962 HORIZONTAL RBW:1000.000kHz VBW:3000.000kHz SWT:Auto Detector : Peak Project : 052917-01 Mode : 17</p>



WIFI	2.4GHz 2400~2483.5MHz Band Edge @ 3m	
ANT	802.11ac VH20 CH06 2437MHz - R	
1	Horizontal	Fundamental
Peak	<p>Site : 03CH07-HY Condition : PEAK_BE_74 3m HF_ANT_00070962 HORIZONTAL Detector : Peak Project : 052917-01 Mode : 17</p>	Left blank
Avg.	<p>Site : 03CH07-HY Condition : AVG_BE_54 3m HF_ANT_00070962 HORIZONTAL Detector : Peak Project : 052917-01 Mode : 17</p>	Left blank

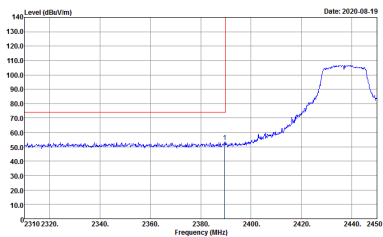
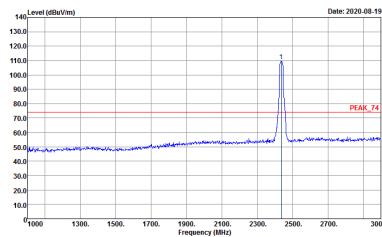
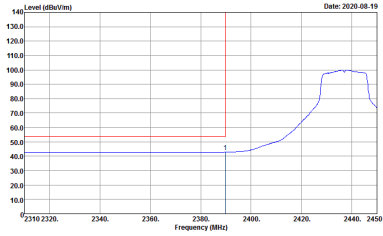
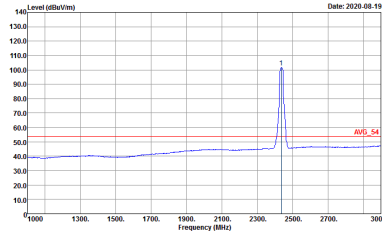

WIFI	2.4GHz 2400~2483.5MHz Band Edge @ 3m	
ANT	802.11ac VH20 CH06 2437MHz - L	
1	Vertical	Fundamental
Peak	 <p>Date: 2020-08-19</p> <p>Site : 03CH07-HY Condition : PEAK_BE_74 3m HF_ANT_00075962 VERTICAL RBW:1000.000kHz VBW:3000.000kHz SWT:Auto Detector : Peak Project : 052917-01 Mode : 17</p>	 <p>Date: 2020-08-19</p> <p>Site : 03CH07-HY Condition : PEAK_74 3m HF_ANT_00075962 VERTICAL RBW:1000.000kHz VBW:3000.000kHz SWT:Auto Detector : Peak Project : 052917-01 Mode : 17</p>
Avg.	 <p>Date: 2020-08-19</p> <p>Site : 03CH07-HY Condition : AVG_BE_34 3m HF_ANT_00075962 VERTICAL RBW:1000.000kHz VBW:0.0100kHz SWT:Auto Detector : Peak Project : 052917-01 Mode : 17</p>	 <p>Date: 2020-08-19</p> <p>Site : 03CH07-HY Condition : AVG_34 3m HF_ANT_00075962 VERTICAL RBW:1000.000kHz VBW:0.0100kHz SWT:Auto Detector : Peak Project : 052917-01 Mode : 17</p>

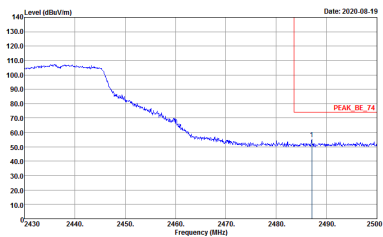
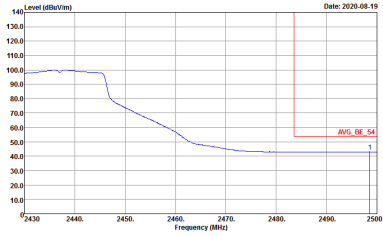

WIFI	2.4GHz 2400~2483.5MHz Band Edge @ 3m	
ANT	802.11ac VH20 CH06 2437MHz - R	
1	Vertical	Fundamental
<p>Peak</p>	 <p>Date: 2020-08-19</p> <p>Site : 03CH07-01 Condition : PEAK_BE_74 3m HF_ANT_00070962 VERTICAL Detector : Peak Project : 052917-01 Mode : 17</p>	<p>Left blank</p>
<p>Avg.</p>	 <p>Date: 2020-08-19</p> <p>Site : 03CH07-01 Condition : AVG_BE_54 3m HF_ANT_00070962 VERTICAL Detector : Peak Project : 052917-01 Mode : 17</p>	<p>Left blank</p>

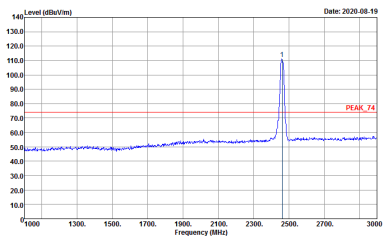
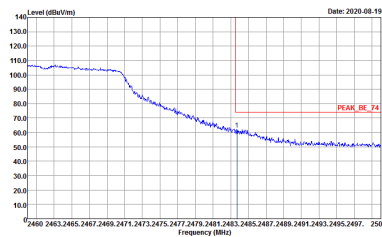
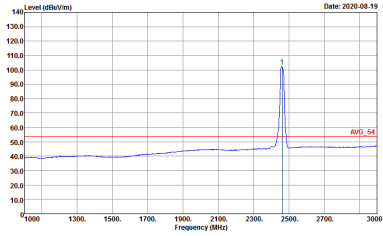
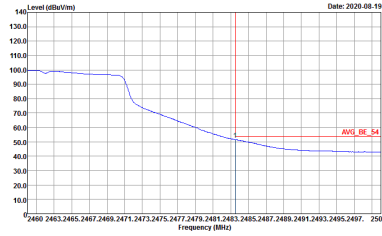

WIFI	2.4GHz 2400~2483.5MHz Band Edge @ 3m	
ANT	802.11ac VH20 CH11 2462MHz	
1	Horizontal	Fundamental
Peak	 <p>Date: 2020-08-19</p> <p>Level (dBm/Vm)</p> <p>Frequency (MHz)</p> <p>PEAK_74</p> <p>Site : 03CH07-HY Condition : PEAK_74 3m HF_ANT_00075962 HORIZONTAL RBW:1000.000kHz VBW:3000.000kHz SWT:Auto Detector : Peak Project : 052917-01 Mode : 18</p>	 <p>Date: 2020-08-19</p> <p>Level (dBm/Vm)</p> <p>Frequency (MHz)</p> <p>PEAK_BE_74</p> <p>Site : 03CH07-HY Condition : PEAK_BE_74 3m HF_ANT_00075962 HORIZONTAL RBW:1000.000kHz VBW:3000.000kHz SWT:Auto Detector : Peak Project : 052917-01 Mode : 18</p>
Avg.	 <p>Date: 2020-08-19</p> <p>Level (dBm/Vm)</p> <p>Frequency (MHz)</p> <p>AVG_54</p> <p>Site : 03CH07-HY Condition : AVG_54 3m HF_ANT_00075962 HORIZONTAL RBW:1000.000kHz VBW:3000.000kHz SWT:Auto Detector : Peak Project : 052917-01 Mode : 18</p>	 <p>Date: 2020-08-19</p> <p>Level (dBm/Vm)</p> <p>Frequency (MHz)</p> <p>AVG_BE_54</p> <p>Site : 03CH07-HY Condition : AVG_BE_54 3m HF_ANT_00075962 HORIZONTAL RBW:1000.000kHz VBW:3000.000kHz SWT:Auto Detector : Peak Project : 052917-01 Mode : 18</p>



WIFI	2.4GHz 2400~2483.5MHz Band Edge @ 3m	
ANT	802.11ac VH20 CH11 2462MHz	
1	Vertical	Fundamental
Peak	<p>Site : 03CH07-HY Condition : PEAK_24.3m HF_ANT_00075962 VERTICAL RBW:1000.000kHz VBW:3000.000kHz SWT:Auto Detector : Peak Project : 052917-01 Mode : 18</p>	<p>Site : 03CH07-HY Condition : PEAK_BE_24.3m HF_ANT_00075962 VERTICAL RBW:1000.000kHz VBW:3000.000kHz SWT:Auto Detector : Peak Project : 052917-01 Mode : 18</p>
Avg.	<p>Site : 03CH07-HY Condition : AVG_24.3m HF_ANT_00075962 VERTICAL RBW:1000.000kHz VBW:3000.000kHz SWT:Auto Detector : Peak Project : 052917-01 Mode : 18</p>	<p>Site : 03CH07-HY Condition : AVG_BE_24.3m HF_ANT_00075962 VERTICAL RBW:1000.000kHz VBW:3000.000kHz SWT:Auto Detector : Peak Project : 052917-01 Mode : 18</p>



2.4GHz 2400~2483.5MHz

WIFI 802.11ac VHT40 (Band Edge @ 3m)

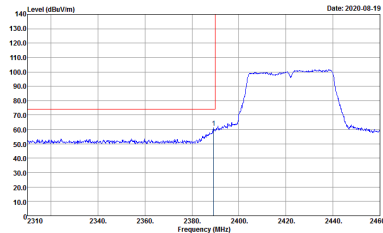
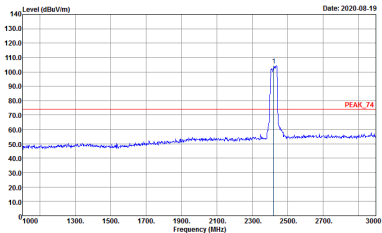
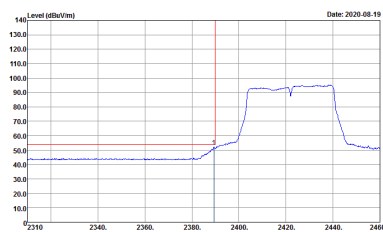
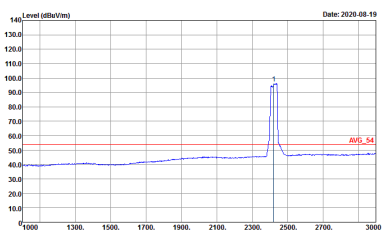
WIFI	2.4GHz 2400~2483.5MHz Band Edge @ 3m	
ANT	802.11ac VH40 CH03 2422MHz - L	
1	Horizontal	Fundamental
Peak	 <p>Site : 03CH07-HY Condition : PEAK_BE_34 3m HF ANT_00075962 HORIZONTAL Detector : Peak Project : 052917-01 Mode : 19</p>	 <p>Site : 03CH07-HY Condition : PEAK_34 3m HF ANT_00075962 HORIZONTAL Detector : Peak Project : 052917-01 Mode : 19</p>
Avg.	 <p>Site : 03CH07-HY Condition : AVG_BE_34 3m HF ANT_00075962 HORIZONTAL Detector : Peak Project : 052917-01 Mode : 19</p>	 <p>Site : 03CH07-HY Condition : AVG_34 3m HF ANT_00075962 HORIZONTAL Detector : Peak Project : 052917-01 Mode : 19</p>



WIFI	2.4GHz 2400~2483.5MHz Band Edge @ 3m	
ANT	802.11ac VH40 CH03 2422MHz - R	
1	Horizontal	Fundamental
Peak	<p>Site : 03CH07-01 Condition : PEAK_BE_74 3m HF_ANT_00070962 HORIZONTAL Detector : Peak Project : 052917-01 Mode : 19</p>	Left blank
Avg.	<p>Site : 03CH07-01 Condition : AVG_BE_54 3m HF_ANT_00070962 HORIZONTAL Detector : Peak Project : 052917-01 Mode : 19</p>	Left blank

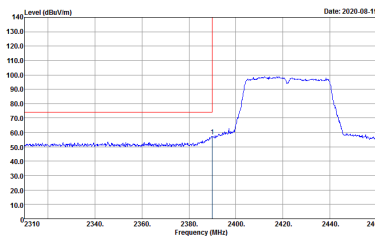
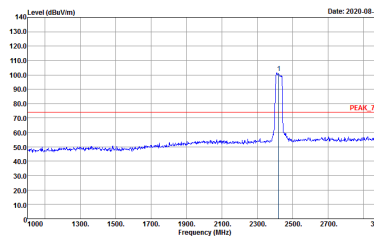
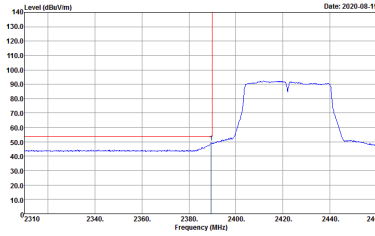
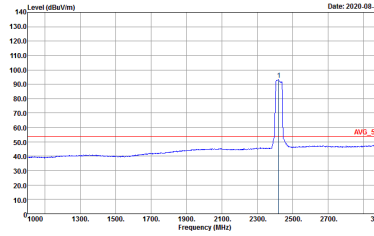

WIFI	2.4GHz 2400~2483.5MHz Band Edge @ 3m	
ANT	802.11ac VH40 CH03 2422MHz - L	
1	Vertical	Fundamental
Peak	 <p>Site : 03CH07-HY Condition : PEAK_BE_74 3m HF_ANT_00075962 VERTICAL Detector : Peak Project : 052917-01 Mode : 19</p>	 <p>Site : 03CH07-HY Condition : PEAK_74 3m HF_ANT_00075962 VERTICAL Detector : Peak Project : 052917-01 Mode : 19</p>
Avg.	 <p>Site : 03CH07-HY Condition : AVG_BE_34 3m HF_ANT_00075962 VERTICAL Detector : Peak Project : 052917-01 Mode : 19</p>	 <p>Site : 03CH07-HY Condition : AVG_34 3m HF_ANT_00075962 VERTICAL Detector : Peak Project : 052917-01 Mode : 19</p>

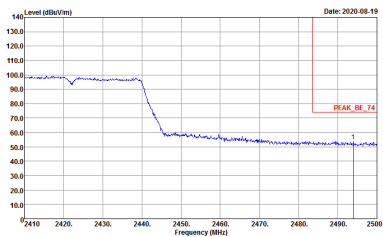
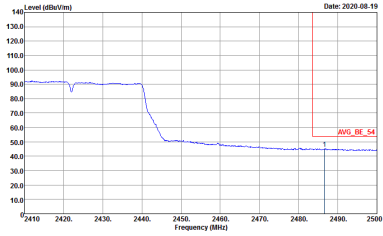

WIFI	2.4GHz 2400~2483.5MHz Band Edge @ 3m	
ANT	802.11ac VH40 CH03 2422MHz - R	
1	Vertical	Fundamental
<p>Peak</p>	 <p>Date: 2020-08-19</p> <p>Site : 03CH07-01 Condition : PEAK_BE_74 3m HF_ANT_00070962 VERTICAL Detector : Peak Project : 052917-01 Mode : 19 Setting : 13.5</p>	<p>Left blank</p>
<p>Avg.</p>	 <p>Date: 2020-08-19</p> <p>Site : 03CH07-01 Condition : AVG_BE_54 3m HF_ANT_00070962 VERTICAL Detector : Peak Project : 052917-01 Mode : 19 Setting : 13.5</p>	<p>Left blank</p>

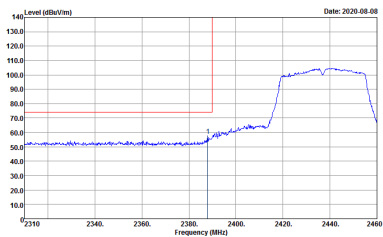
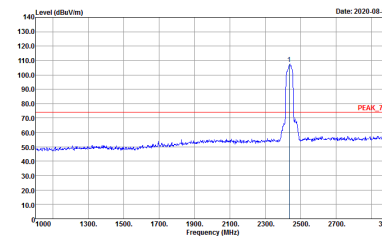
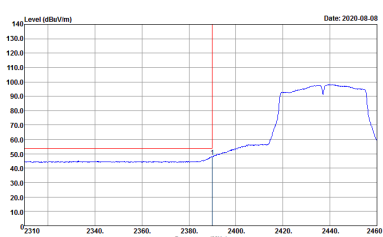
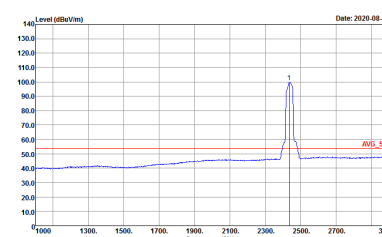

WIFI	2.4GHz 2400~2483.5MHz Band Edge @ 3m	
ANT	802.11ac VH40 CH06 2437MHz - L	
1	Horizontal	Fundamental
Peak	 <p>Site : 03CH07-HY Condition : PEAK_BE_74 3m HF_ANT_00075962 HORIZONTAL Detector : Peak Project : 052917-01 Mode : 20</p>	 <p>Site : 03CH07-HY Condition : PEAK_74 3m HF_ANT_00075962 HORIZONTAL Detector : Peak Project : 052917-01 Mode : 20</p>
Avg.	 <p>Site : 03CH07-HY Condition : AVG_BE_54 3m HF_ANT_00075962 HORIZONTAL Detector : Peak Project : 052917-01 Mode : 20</p>	 <p>Site : 03CH07-HY Condition : AVG_54 3m HF_ANT_00075962 HORIZONTAL Detector : Peak Project : 052917-01 Mode : 20</p>

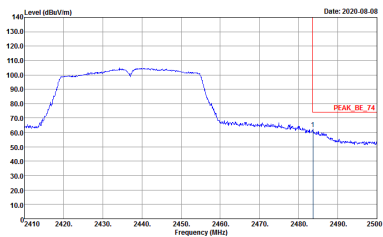
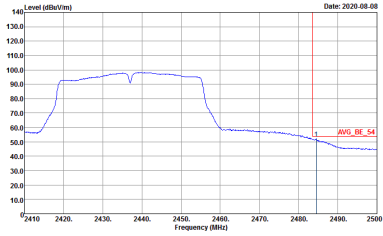

WIFI	2.4GHz 2400~2483.5MHz Band Edge @ 3m	
ANT	802.11ac VH40 CH06 2437MHz - R	
1	Horizontal	Fundamental
<p>Peak</p>	 <p>Site : 03CH07-HY Condition : PEAK_BE_74 3m HF_ANT_00075962 HORIZONTAL Detector : Peak Project : 052917-01 Mode : Z0</p>	<p>Left blank</p>
<p>Avg.</p>	 <p>Site : 03CH07-HY Condition : AVG_BE_54 3m HF_ANT_00075962 HORIZONTAL Detector : Peak Project : 052917-01 Mode : Z0</p>	<p>Left blank</p>

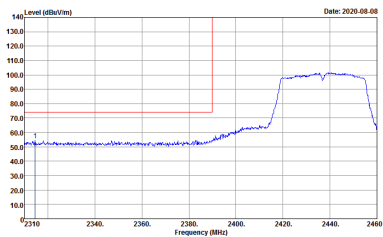
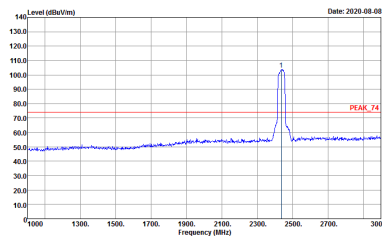
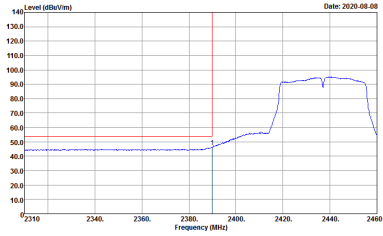
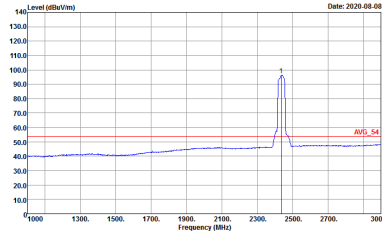

WIFI	2.4GHz 2400~2483.5MHz Band Edge @ 3m	
ANT	802.11ac VH40 CH06 2437MHz - L	
1	Vertical	Fundamental
Peak	 <p>Site : 03CH07-HY Condition : PEAK_BE_74 3m HF_ANT_00075962 VERTICAL RBW:1000.000kHz VBW:3000.000kHz SWT:Auto Detector : Peak Project : 052917-01 Mode : 20</p>	 <p>Site : 03CH07-HY Condition : PEAK_74 3m HF_ANT_00075962 VERTICAL RBW:1000.000kHz VBW:3000.000kHz SWT:Auto Detector : Peak Project : 052917-01 Mode : 20</p>
	 <p>Site : 03CH07-HY Condition : AVG_BE_54 3m HF_ANT_00075962 VERTICAL RBW:1000.000kHz VBW:3.000kHz SWT:Auto Detector : Peak Project : 052917-01 Mode : 20</p>	 <p>Site : 03CH07-HY Condition : AVG_54 3m HF_ANT_00075962 VERTICAL RBW:1000.000kHz VBW:3.000kHz SWT:Auto Detector : Peak Project : 052917-01 Mode : 20</p>



WIFI	2.4GHz 2400~2483.5MHz Band Edge @ 3m	
ANT	802.11ac VH40 CH06 2437MHz - R	
1	Vertical	Fundamental
Peak	<p>Site : 03CH07-HY Condition : PEAK_BE_74 3m HF_ANT_00075962 VERTICAL Detector : RBW:1000.000kHz VBW:3000.000kHz SWT:Auto Project : 052917-01 Mode : Z0</p>	Left blank
Avg.	<p>Site : 03CH07-HY Condition : AVG_BE_54 3m HF_ANT_00075962 VERTICAL Detector : RBW:1000.000kHz VBW:3.000kHz SWT:Auto Project : 052917-01 Mode : Z0</p>	Left blank

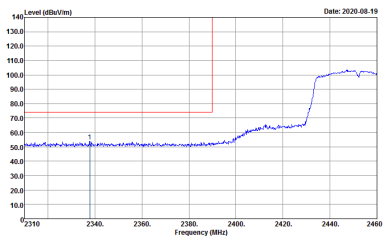
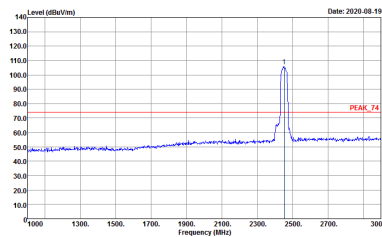
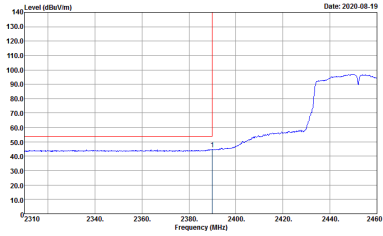
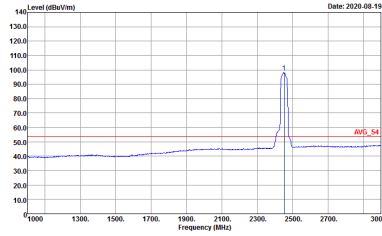

WIFI	2.4GHz 2400~2483.5MHz Band Edge @ 3m	
ANT	802.11ac VH40 CH09 2452MHz - L	
1	Horizontal	Fundamental
Peak	 <p>Date: 2020-08-19</p> <p>Site : 03CH07-HY Condition : PEAK_BE_74 3m HF_ANT_00075962 HORIZONTAL RBW:1000.000kHz VBW:3000.000kHz SWT:Auto Detector : Peak Project : 052917-01 Mode : 21</p>	 <p>Date: 2020-08-19</p> <p>Site : 03CH07-HY Condition : PEAK_74 3m HF_ANT_00075962 HORIZONTAL RBW:1000.000kHz VBW:3000.000kHz SWT:Auto Detector : Peak Project : 052917-01 Mode : 21</p>
Avg.	 <p>Date: 2020-08-19</p> <p>Site : 03CH07-HY Condition : AVG_BE_34 3m HF_ANT_00075962 HORIZONTAL RBW:1000.000kHz VBW:3.000kHz SWT:Auto Detector : Peak Project : 052917-01 Mode : 21</p>	 <p>Date: 2020-08-19</p> <p>Site : 03CH07-HY Condition : AVG_34 3m HF_ANT_00075962 HORIZONTAL RBW:1000.000kHz VBW:3.000kHz SWT:Auto Detector : Peak Project : 052917-01 Mode : 21</p>

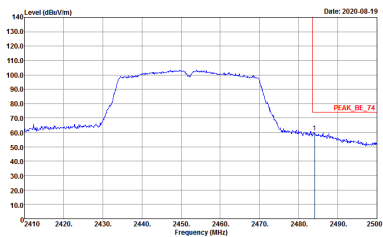
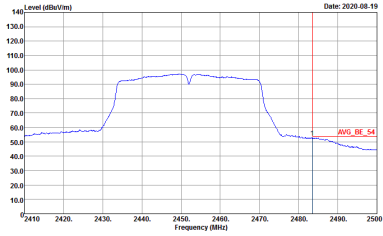

WIFI	2.4GHz 2400~2483.5MHz Band Edge @ 3m	
ANT	802.11ac VH40 CH09 2452MHz - R	
1	Horizontal	Fundamental
Peak	 <p>Date: 2020-08-19</p> <p>Site : 03CH07-01 Condition : PEAK_BE_74 3m HF_ANT_00070962 HORIZONTAL Detector : Peak Project : 052917-01 Mode : Z1</p>	Left blank
Avg.	 <p>Date: 2020-08-19</p> <p>Site : 03CH07-01 Condition : AVG_BE_34 3m HF_ANT_00070962 HORIZONTAL Detector : Peak Project : 052917-01 Mode : Z1</p>	Left blank

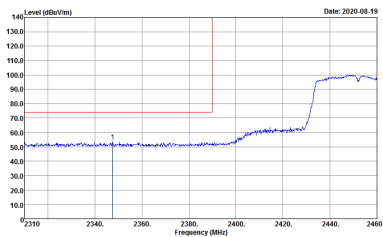
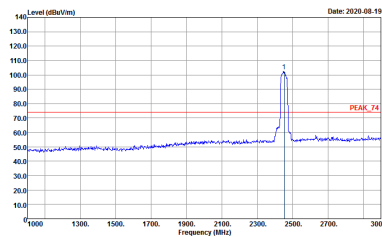
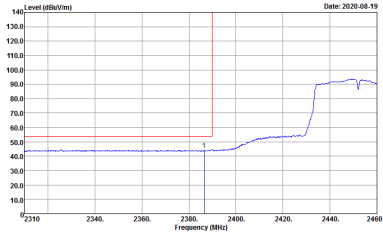
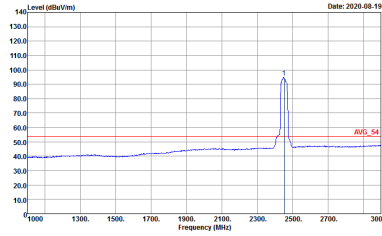

WIFI	2.4GHz 2400~2483.5MHz Band Edge @ 3m	
ANT	802.11ac VH40 CH09 2452MHz - L	
1	Vertical	Fundamental
Peak	 <p>Date: 2020.08.19</p> <p>Site : 03CH07-HY Condition : PEAK_BE_74 3m HF_ANT_00075962 VERTICAL RBW:1000.000kHz VBW:3000.000kHz SWT:Auto Detector : Peak Project : 052917-01 Mode : 21</p>	 <p>Date: 2020.08.19</p> <p>Site : 03CH07-HY Condition : PEAK_74 3m HF_ANT_00075962 VERTICAL RBW:1000.000kHz VBW:3000.000kHz SWT:Auto Detector : Peak Project : 052917-01 Mode : 21</p>
Avg.	 <p>Date: 2020.08.19</p> <p>Site : 03CH07-HY Condition : AVG_BE_34 3m HF_ANT_00075962 VERTICAL RBW:1000.000kHz VBW:3.000kHz SWT:Auto Detector : Peak Project : 052917-01 Mode : 21</p>	 <p>Date: 2020.08.19</p> <p>Site : 03CH07-HY Condition : AVG_34 3m HF_ANT_00075962 VERTICAL RBW:1000.000kHz VBW:3.000kHz SWT:Auto Detector : Peak Project : 052917-01 Mode : 21</p>

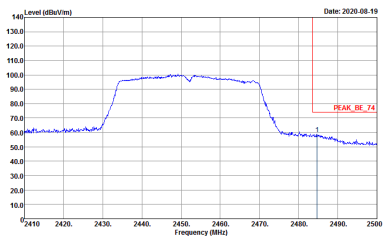
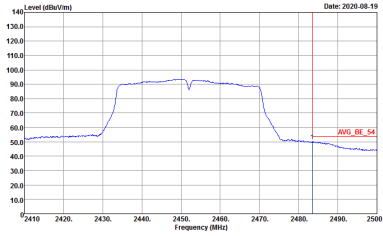

WIFI	2.4GHz 2400~2483.5MHz Band Edge @ 3m	
ANT	802.11ac VH40 CH09 2452MHz - R	
1	Vertical	Fundamental
Peak	 <p>Date: 2020-08-19</p> <p>Site : 03CH07-01 Condition : PEAK_BE_74 3m HF_ANT_00070962 VERTICAL RBW:1000.000kHz VBW:3000.000kHz SWF:Auto Detector : Peak Project : 052917-01 Mode : Z1</p>	Left blank
Avg.	 <p>Date: 2020-08-19</p> <p>Site : 03CH07-01 Condition : AVG_BE_54 3m HF_ANT_00070962 VERTICAL RBW:1000.000kHz VBW:3.000kHz SWF:Auto Detector : Peak Project : 052917-01 Mode : Z1</p>	Left blank



2.4GHz 2400~2483.5MHz

WIFI 802.11b (Harmonic @ 3m)

WIFI	2.4GHz 2400~2483.5MHz Harmonic @ 3m	
ANT	802.11b CH01 2412MHz	
1	Horizontal	Vertical
<p>Peak</p> <p>Avg.</p>	<p>Site : 09CH07-HY Condition : PEAK_74 3m HF_ANT_00075962 HORIZONTAL Detector : Peak Project : 052917-01 Mode : 10</p>	<p>Site : 09CH07-HY Condition : PEAK_74 3m HF_ANT_00075962 VERTICAL Detector : Peak Project : 052917-01 Mode : 10</p>

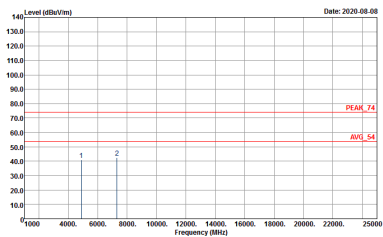
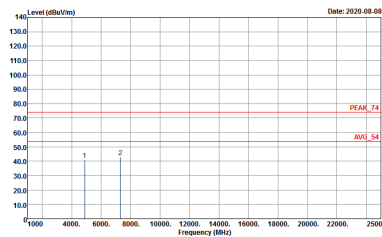

WIFI	2.4GHz 2400~2483.5MHz Harmonic @ 3m	
ANT	802.11b CH06 2437MHz	
1	Horizontal	Vertical
<p>Peak</p> <p>Avg.</p>	 <p>Site : ESCH07-HY Condition : PEAK_74 3m HE_ANT_00075962 HORIZONTAL Detector : Peak Project : 052917-01 Mode : 11</p>	 <p>Site : ESCH07-HY Condition : PEAK_74 3m HE_ANT_00075962 VERTICAL Detector : Peak Project : 052917-01 Mode : 11</p>

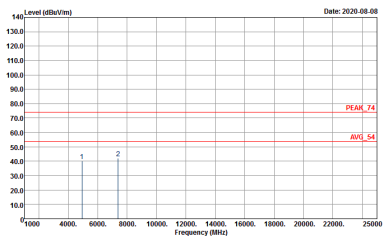
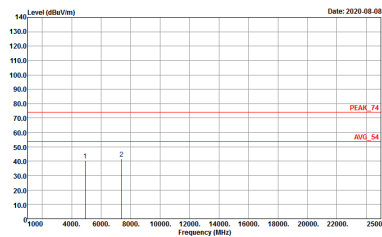

WIFI	2.4GHz 2400~2483.5MHz Harmonic @ 3m	
ANT	802.11b CH11 2462MHz	
1	Horizontal	Vertical
<p>Peak</p> <p>Avg.</p>	 <p>Site : ESCH07-HY Condition : PEAK_74 3m HE_ANT_00075962 HORIZONTAL Detector : Peak Project : 052917-01 Mode : 12</p>	 <p>Site : ESCH07-HY Condition : PEAK_74 3m HE_ANT_00075962 VERTICAL Detector : Peak Project : 052917-01 Mode : 12</p>



2.4GHz 2400~2483.5MHz

WIFI 802.11g (Harmonic @ 3m)

WIFI	2.4GHz 2400~2483.5MHz Harmonic @ 3m	
ANT	802.11g CH01 2412MHz	
1	Horizontal	Vertical
<p>Peak</p> <p>Avg.</p>	<p>Site : 09CH07-HY Condition : PEAK_74 3m HF_ANT_00075962 HORIZONTAL Detector : Peak Project : 052917-01 Mode : 13</p>	<p>Site : 09CH07-HY Condition : PEAK_74 3m HF_ANT_00075962 VERTICAL Detector : Peak Project : 052917-01 Mode : 13</p>

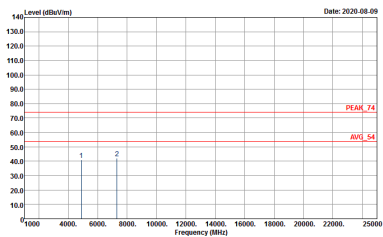
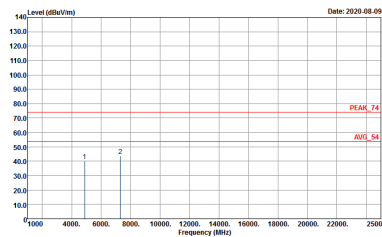

WIFI	2.4GHz 2400~2483.5MHz Harmonic @ 3m	
ANT	802.11g CH06 2437MHz	
1	Horizontal	Vertical
<p>Peak</p> <p>Avg.</p>	 <p>Site : ESCH07-HY Condition : PEAK_74 3m HE_ANT_00075962 HORIZONTAL Detector : Peak Project : 052917-01 Mode : 14</p>	 <p>Site : ESCH07-HY Condition : PEAK_74 3m HE_ANT_00075962 VERTICAL Detector : Peak Project : 052917-01 Mode : 14</p>

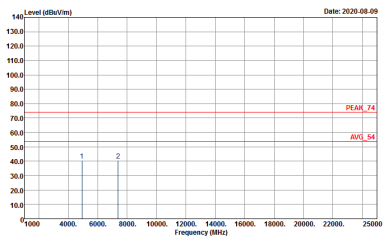
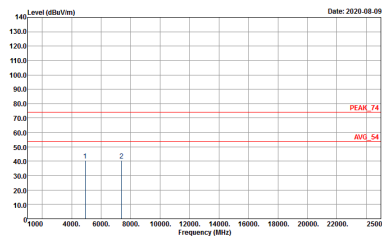

WIFI	2.4GHz 2400~2483.5MHz Harmonic @ 3m	
ANT	802.11g CH11 2462MHz	
1	Horizontal	Vertical
<p>Peak</p> <p>Avg.</p>	 <p>Site : E3CH07-HY Condition : PEAK_74 3m HE_ANT_00075962 HORIZONTAL Detector : Peak Project : 052917-01 Mode : 15</p>	 <p>Site : E3CH07-HY Condition : PEAK_74 3m HE_ANT_00075962 VERTICAL Detector : Peak Project : 052917-01 Mode : 15</p>



2.4GHz 2400~2483.5MHz

WIFI 802.11ac VHT20 (Harmonic @ 3m)

WIFI	2.4GHz 2400~2483.5MHz Harmonic @ 3m	
ANT	802.11ac VHT20 CH01 2412MHz	
1	Horizontal	Vertical
Peak Avg.		



WIFI	2.4GHz 2400~2483.5MHz Harmonic @ 3m	
ANT	802.11ac VHT20 CH06 2437MHz	
1	Horizontal	Vertical
Peak Avg.	<p>Site : E3CH07-HY Condition : PEAK_74 3m HE_ANT_00075962 HORIZONTAL Detector : Peak Project : 052917-01 Mode : 17</p>	<p>Site : E3CH07-HY Condition : PEAK_74 3m HE_ANT_00075962 VERTICAL Detector : Peak Project : 052917-01 Mode : 17</p>



WIFI	2.4GHz 2400~2483.5MHz Harmonic @ 3m	
ANT	802.11ac VHT20 CH11 2462MHz	
1	Horizontal	Vertical
<p>Peak</p> <p>Avg.</p>	<p>Site : ESCH07-HY Condition : PEAK_74 3m HE_ANT_00075962 HORIZONTAL Detector : Peak Project : 052917-01 Mode : 18</p>	<p>Site : ESCH07-HY Condition : PEAK_74 3m HE_ANT_00075962 VERTICAL Detector : Peak Project : 052917-01 Mode : 18</p>



2.4GHz 2400~2483.5MHz

WIFI 802.11ac VHT40 (Harmonic @ 3m)

WIFI	2.4GHz 2400~2483.5MHz Harmonic @ 3m																																																																																					
ANT	802.11ac VHT40 CH03 2422MHz																																																																																					
1	Horizontal	Vertical																																																																																				
Peak Avg.	<p>Site : 03CH07-HY Condition : PEAK_74.3m HF_ANT_00075962 HORIZONTAL Detector : Peak Project : 052917-01 Mode : 19</p> <table border="1"> <thead> <tr> <th>Freq</th> <th>Level</th> <th>Over</th> <th>Limit</th> <th>ReadAntenna</th> <th>Cable</th> <th>Preamp</th> <th>A/Pos</th> <th>T/Pos</th> <th>Remark</th> </tr> <tr> <th>MHz</th> <th>dBuV/m</th> <th>dB</th> <th>dBuV/m</th> <th>dBuV</th> <th>dB/m</th> <th>dB</th> <th>dB</th> <th>cm</th> <th>deg</th> </tr> </thead> <tbody> <tr> <td>1</td> <td>4844.00</td> <td>39.79</td> <td>-34.21</td> <td>74.00</td> <td>52.51</td> <td>34.10</td> <td>11.21</td> <td>58.84</td> <td>100</td> <td>0 Peak</td> </tr> <tr> <td>2</td> <td>7266.00</td> <td>41.26</td> <td>-32.72</td> <td>74.00</td> <td>48.56</td> <td>35.60</td> <td>13.64</td> <td>57.43</td> <td>100</td> <td>0 Peak</td> </tr> </tbody> </table>	Freq	Level	Over	Limit	ReadAntenna	Cable	Preamp	A/Pos	T/Pos	Remark	MHz	dBuV/m	dB	dBuV/m	dBuV	dB/m	dB	dB	cm	deg	1	4844.00	39.79	-34.21	74.00	52.51	34.10	11.21	58.84	100	0 Peak	2	7266.00	41.26	-32.72	74.00	48.56	35.60	13.64	57.43	100	0 Peak	<p>Site : 03CH07-HY Condition : PEAK_74.3m HF_ANT_00075962 VERTICAL Detector : Peak Project : 052917-01 Mode : 19</p> <table border="1"> <thead> <tr> <th>Freq</th> <th>Level</th> <th>Over</th> <th>Limit</th> <th>ReadAntenna</th> <th>Cable</th> <th>Preamp</th> <th>A/Pos</th> <th>T/Pos</th> <th>Remark</th> </tr> <tr> <th>MHz</th> <th>dBuV/m</th> <th>dB</th> <th>dBuV/m</th> <th>dBuV</th> <th>dB/m</th> <th>dB</th> <th>dB</th> <th>cm</th> <th>deg</th> </tr> </thead> <tbody> <tr> <td>1</td> <td>4844.00</td> <td>40.41</td> <td>-33.59</td> <td>74.00</td> <td>53.13</td> <td>34.10</td> <td>11.21</td> <td>58.84</td> <td>100</td> <td>0 Peak</td> </tr> <tr> <td>2</td> <td>7266.00</td> <td>40.83</td> <td>-33.17</td> <td>74.00</td> <td>48.11</td> <td>35.60</td> <td>13.64</td> <td>57.43</td> <td>100</td> <td>0 Peak</td> </tr> </tbody> </table>	Freq	Level	Over	Limit	ReadAntenna	Cable	Preamp	A/Pos	T/Pos	Remark	MHz	dBuV/m	dB	dBuV/m	dBuV	dB/m	dB	dB	cm	deg	1	4844.00	40.41	-33.59	74.00	53.13	34.10	11.21	58.84	100	0 Peak	2	7266.00	40.83	-33.17	74.00	48.11	35.60	13.64	57.43	100	0 Peak
	Freq	Level	Over	Limit	ReadAntenna	Cable	Preamp	A/Pos	T/Pos	Remark																																																																												
MHz	dBuV/m	dB	dBuV/m	dBuV	dB/m	dB	dB	cm	deg																																																																													
1	4844.00	39.79	-34.21	74.00	52.51	34.10	11.21	58.84	100	0 Peak																																																																												
2	7266.00	41.26	-32.72	74.00	48.56	35.60	13.64	57.43	100	0 Peak																																																																												
Freq	Level	Over	Limit	ReadAntenna	Cable	Preamp	A/Pos	T/Pos	Remark																																																																													
MHz	dBuV/m	dB	dBuV/m	dBuV	dB/m	dB	dB	cm	deg																																																																													
1	4844.00	40.41	-33.59	74.00	53.13	34.10	11.21	58.84	100	0 Peak																																																																												
2	7266.00	40.83	-33.17	74.00	48.11	35.60	13.64	57.43	100	0 Peak																																																																												

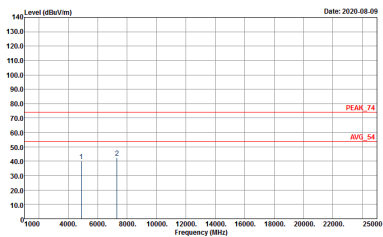
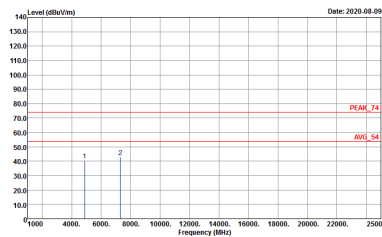

WIFI	2.4GHz 2400~2483.5MHz Harmonic @ 3m	
ANT	802.11ac VHT40 CH06 2437MHz	
1	Horizontal	Vertical
<p>Peak</p> <p>Avg.</p>	 <p>Site : ESCH07-HY Condition : PEAK_74 3m HE_ANT_00075962 HORIZONTAL Detector : Peak Project : 052917-01 Mode : 20</p>	 <p>Site : ESCH07-HY Condition : PEAK_74 3m HE_ANT_00075962 VERTICAL Detector : Peak Project : 052917-01 Mode : 20</p>

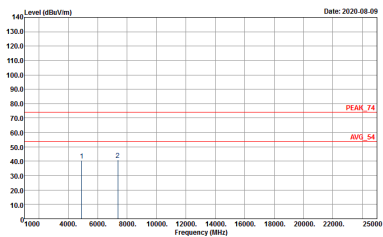
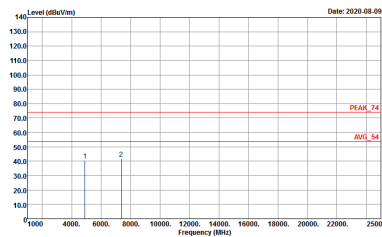

WIFI	2.4GHz 2400~2483.5MHz Harmonic @ 3m	
ANT	802.11ac VHT40 CH09 2452MHz	
1	Horizontal	Vertical
<p>Peak</p> <p>Avg.</p>	 <p>Site : ESCH07-HY Condition : PEAK_74 3m HE_ANT_00075962 HORIZONTAL Detector : Peak Project : 052917-01 Mode : 21</p>	 <p>Site : ESCH07-HY Condition : PEAK_74 3m HE_ANT_00075962 VERTICAL Detector : Peak Project : 052917-01 Mode : 21</p>



Emission below 1GHz
2.4GHz WIFI 802.11ac VHT40 (LF)

WIFI	2.4GHz 2400~2483.5MHz	
ANT	802.11ac VHT40 LF	
1	Horizontal	Vertical
QP / Peak	<p>Site : 03C1627-4H Condition : QP 3m LF-ANT-35419(6) HORIZONTAL Detector : Peak Project : 052917-01 Mode : 24</p>	<p>Site : 03C1627-4H Condition : QP 3m LF-ANT-35419(6) VERTICAL Detector : Peak Project : 052917-01 Mode : 24</p>



Appendix D. Duty Cycle Plots

Band	Duty Cycle(%)	T(us)	1/T(kHz)	VBW Setting	Duty Factor(dB)
802.11b	99.28	-	-	10Hz	0.03
802.11g	98.33	-	-	10Hz	0.07
2.4GHz 802.11ac VHT20	98.22	-	-	10Hz	0.08
2.4GHz 802.11ac VHT40	95.02	955	1.05	3kHz	0.22

