



FCC RADIO TEST REPORT

FCC ID : UZ7MC27AK
Equipment : Mobile computer
Brand Name : Zebra
Model Name : MC27AK
Applicant : Zebra Technologies Corporation
1 Zebra Plaza, Holtsville, NY 11742
Manufacturer : Zebra Technologies Corporation
1 Zebra Plaza, Holtsville, NY 11742
Standard : FCC Part 15 Subpart E §15.407

The product was received on Jul. 07, 2020 and testing was started from Aug. 03, 2020 and completed on Aug. 29, 2020. We, SPORTON INTERNATIONAL INC., EMC & Wireless Communications Laboratory, would like to declare that the tested sample has been evaluated in accordance with the test procedures and has been in compliance with the applicable technical standards.

The test results in this report apply exclusively to the tested model / sample. Without written approval of SPORTON INTERNATIONAL INC. EMC & Wireless Communications Laboratory, the test report shall not be reproduced except in full.

Louis Wu

Approved by: Louis Wu

SPORTON INTERNATIONAL INC. EMC & Wireless Communications Laboratory
No. 52, Huaya 1st Rd., Guishan Dist., Taoyuan City, Taiwan (R.O.C.)



Table of Contents

| | |
|---|-----------|
| History of this test report..... | 3 |
| Summary of Test Result..... | 4 |
| 1 General Description | 5 |
| 1.1 Product Feature of Equipment Under Test..... | 5 |
| 1.2 Product Specification of Equipment Under Test..... | 5 |
| 1.3 Modification of EUT | 6 |
| 1.4 Testing Location | 6 |
| 1.5 Applicable Standards..... | 6 |
| 2 Test Configuration of Equipment Under Test | 7 |
| 2.1 Carrier Frequency and Channel | 7 |
| 2.2 Test Mode..... | 8 |
| 2.3 Connection Diagram of Test System..... | 10 |
| 2.4 Support Unit used in test configuration and system | 11 |
| 2.5 EUT Operation Test Setup | 11 |
| 2.6 Measurement Results Explanation Example..... | 11 |
| 3 Test Result | 12 |
| 3.1 6dB and 26dB and 99% Occupied Bandwidth Measurement | 12 |
| 3.2 Maximum Conducted Output Power Measurement | 15 |
| 3.3 Power Spectral Density Measurement | 17 |
| 3.4 Unwanted Emissions Measurement..... | 19 |
| 3.5 AC Conducted Emission Measurement..... | 23 |
| 3.6 Automatically Discontinue Transmission | 25 |
| 3.7 Antenna Requirements..... | 26 |
| 4 List of Measuring Equipment..... | 27 |
| 5 Uncertainty of Evaluation..... | 29 |
| Appendix A. AC Conducted Emission Test Result | |
| Appendix B. Radiated Spurious Emission | |
| Appendix C. Radiated Spurious Emission Plots | |
| Appendix D. Duty Cycle Plots | |
| Appendix E. Setup Photographs | |



History of this test report

| Report No. | Version | Description | Issued Date |
|--------------|---------|-------------------------|---------------|
| FR052917-01F | 01 | Initial issue of report | Oct. 20, 2020 |
| | | | |
| | | | |
| | | | |
| | | | |
| | | | |
| | | | |
| | | | |
| | | | |
| | | | |
| | | | |
| | | | |
| | | | |
| | | | |
| | | | |
| | | | |



Summary of Test Result

| Report Clause | Ref Std. Clause | Test Items | Result (PASS/FAIL) | Remark |
|---------------|------------------------|--|--------------------|--|
| 3.1 | 15.403 (i) | 6dB & 26dB Bandwidth | Pass | - |
| 3.1 | 2.1049 | 99% Occupied Bandwidth | Reporting only | - |
| 3.2 | 15.407 (a) | Maximum Conducted Output Power | Pass | - |
| 3.3 | 15.407 (a) | Power Spectral Density | Pass | - |
| 3.4 | 15.407(b) | Unwanted Emissions | Pass | Under limit 9.32 dB at 30.000 MHz |
| 3.5 | 15.207 | AC Conducted Emission | Pass | Under limit 17.08 dB at 13.560 MHz |
| 3.6 | 15.407 (c) | Automatically Discontinue Transmission | Pass | - |
| 3.7 | 15.203 & 15.407 (a) | Antenna Requirement | Pass | - |

Declaration of Conformity:

The test results with all measurement uncertainty excluded are presented in accordance with the regulation limits or requirements declared by manufacturers.

Comments and Explanations:

The declared of product specification for EUT presented in the report are provided by the manufacturer, and the manufacturer takes all the responsibilities for the accuracy of product specification.

Reviewed by: Wii Chang

Report Producer: Yimin Ho



1 General Description

1.1 Product Feature of Equipment Under Test

| Product Feature | |
|---------------------------------|---|
| Equipment | Mobile computer |
| Brand Name | Zebra |
| Model Name | MC27AK |
| FCC ID | UZ7MC27AK |
| EUT supports Radios application | WCDMA/HSPA/LTE/NFC/GNSS WLAN 11a/b/g/n HT20/HT40 WLAN 11ac VHT20/VHT40/VHT80 Bluetooth BR/EDR/LE |
| HW Version | EV |
| SW Version | 10-11-31.00-QG-U00-PRD-HEL-04 |
| OS Version | Android 10 |
| MFD | 23JUN20 |
| EUT Stage | Engineering Sample |

Remark: The above EUT's information was declared by manufacturer.

| Specification of Accessories | | | | |
|---|------------|-------|-------------|------------------|
| AC Adapter | Brand Name | Zebra | Part Number | PWR-WUA5V12W0US |
| Battery | Brand Name | Zebra | Part Number | BT-000418-10 |
| USB Cable (TypeA plug to TypeC plug) | Brand Name | Zebra | Part Number | CBL-TC2X-USBC-01 |
| Trigger Handle | Brand Name | Zebra | Part Number | TRG-MC2X-SNP1-01 |
| Holster | Brand Name | Zebra | Part Number | SG-MC2X-HLSTR-01 |
| Holster | Brand Name | Zebra | Part Number | SG-MC3021212-01R |

1.2 Product Specification of Equipment Under Test

| Product Specification subjective to this standard | |
|---|--|
| Tx/Rx Channel Frequency Range | 5745 MHz ~ 5825 MHz |
| Maximum Output Power | 802.11a : 17.80 dBm / 0.0603 W 802.11n HT20 : 17.90 dBm / 0.0617 W 802.11n HT40 : 17.60 dBm / 0.0575 W 802.11ac VHT20: 18.00 dBm / 0.0631 W 802.11ac VHT40: 17.70 dBm / 0.0589 W 802.11ac VHT80: 17.70 dBm / 0.0589 W |
| 99% Occupied Bandwidth | 802.11a : 24.13 MHz 802.11ac VHT20 : 21.98 MHz 802.11ac VHT40 : 37.76 MHz 802.11ac VHT80 : 78.16 MHz |
| Type of Modulation | 802.11a/n : OFDM (BPSK / QPSK / 16QAM / 64QAM) 802.11ac : OFDM (BPSK / QPSK / 16QAM / 64QAM / 256QAM) |
| Antenna Type / Gain | PIFA Antenna with gain 3.11 dBi |



1.3 Modification of EUT

No modifications are made to the EUT during all test items.

1.4 Testing Location

| | | | |
|---------------------------|---|---------|-----------|
| Test Site | SPORTON INTERNATIONAL INC. EMC & Wireless Communications Laboratory | | |
| Test Site Location | No.52, Huaya 1st Rd., Guishan Dist., Taoyuan City, Taiwan (R.O.C.) TEL: +886-3-327-3456 FAX: +886-3-328-4978 | | |
| Test Site No. | Sporton Site No. | | |
| | TH05-HY | CO05-HY | 03CH07-HY |

Note: The test site complies with ANSI C63.4 2014 requirement.

FCC designation No.: TW1190

1.5 Applicable Standards

According to the specifications of the manufacturer, the EUT must comply with the requirements of the following standards:

- ♦ FCC Part 15 Subpart E
- ♦ FCC KDB 789033 D02 General UNII Test Procedures New Rules v02r01.
- ♦ FCC KDB 414788 D01 Radiated Test Site v01r01.
- ♦ ANSI C63.10-2013

Remark:

1. All test items were verified and recorded according to the standards and without any deviation during the test.
2. The TAF code is not including all the FCC KDB listed without accreditation.
3. This EUT has also been tested and complied with the requirements of FCC Part 15, Subpart B, recorded in a separate test report.



2 Test Configuration of Equipment Under Test

- a. The EUT has been associated with peripherals and configuration operated in a manner tended to maximize its emission characteristics in a typical application. Frequency range investigated: conduction emission (150 kHz to 30 MHz), radiation emission (9 kHz to the 10th harmonic of the highest fundamental frequency or to 40 GHz, whichever is lower). For radiated measurement, pre-scanned in three orthogonal panels, X, Y, Z. The worst cases (X plane) were recorded in this report.

- b. AC power line Conducted Emission was tested under maximum output power.

2.1 Carrier Frequency and Channel

| Frequency Band | Channel | Freq. (MHz) | Channel | Freq. (MHz) |
|--------------------------------------|---------|-------------|---------|-------------|
| 5725-5850 MHz Band 4 (U-NII-3) | 149 | 5745 | 157 | 5785 |
| | 151* | 5755 | 159* | 5795 |
| | 153 | 5765 | 161 | 5805 |
| | 155# | 5775 | 165 | 5825 |

Note:

- 1. The above Frequency and Channel in "*" were 802.11n HT40 and 802.11ac VHT40.
- 2. The above Frequency and Channel in "#n" were 802.11ac VHT80.



2.2 Test Mode

Final test modes are considering the modulation and worse data rates as below table.

| Modulation | Data Rate |
|---------------------------------|-----------|
| 802.11a | 6 Mbps |
| 802.11n HT20 (Covered by VHT20) | MCS0 |
| 802.11n HT40 (Covered by VHT40) | MCS0 |
| 802.11ac VHT20 | MCS0 |
| 802.11ac VHT40 | MCS0 |
| 802.11ac VHT80 | MCS0 |

| Test Cases | |
|-----------------------|---|
| AC Conducted Emission | Mode 1 : WLAN (5GHz) Link + Bluetooth Link + NFC On + Battery + USB Cable (Charging from AC Adapter) |

| Ch. # | | Band IV : 5725-5850 MHz | | | |
|-------|--------|-------------------------|----------------|----------------|----------------|
| | | 802.11a | 802.11ac VHT20 | 802.11ac VHT40 | 802.11ac VHT80 |
| L | Low | 149 | 149 | 151 | - |
| M | Middle | 157 | 157 | - | 155 |
| H | High | 165 | 165 | 159 | - |

Remark: For radiation spurious emission, the final modulation and the worst data rate was reference the max RF conducted power.



| 802.11a RF Output Power (dBm) | | | | | | | | | | |
|-------------------------------|-----------------|-----------------|--------------------|-----------------|-------|-------|-------|-------|-------|-------|
| Power vs. Channel | | | Power vs Data Rate | | | | | | | |
| Channel | Frequency (MHz) | Data Rate (bps) | Channel | Data Rate (bps) | | | | | | |
| | | 6M | | 9M | 12M | 18M | 24M | 36M | 48M | 54M |
| CH 149 | 5745 | 17.60 | CH 157 | 17.70 | 17.70 | 17.50 | 17.30 | 17.60 | 17.60 | 17.60 |
| CH 157 | 5785 | 17.80 | | | | | | | | |
| CH 165 | 5825 | 17.60 | | | | | | | | |

| 802.11n HT20 RF Output Power (dBm) | | | | | | | | | | |
|------------------------------------|-----------------|-----------|--------------------|-----------|-------|-------|-------|-------|-------|-------|
| Power vs. Channel | | | Power vs Data Rate | | | | | | | |
| Channel | Frequency (MHz) | MCS Index | Channel | MCS Index | | | | | | |
| | | MCS0 | | MCS1 | MCS2 | MCS3 | MCS4 | MCS5 | MCS6 | MCS7 |
| CH 149 | 5745 | 17.80 | CH 165 | 17.80 | 17.60 | 17.60 | 17.80 | 17.80 | 17.80 | 17.80 |
| CH 157 | 5785 | 17.60 | | | | | | | | |
| CH 165 | 5825 | 17.90 | | | | | | | | |

| 802.11n HT40 RF Output Power (dBm) | | | | | | | | | | |
|------------------------------------|-----------------|-----------|--------------------|-----------|-------|-------|-------|-------|-------|-------|
| Power vs. Channel | | | Power vs Data Rate | | | | | | | |
| Channel | Frequency (MHz) | MCS Index | Channel | MCS Index | | | | | | |
| | | MCS0 | | MCS1 | MCS2 | MCS3 | MCS4 | MCS5 | MCS6 | MCS7 |
| CH 151 | 5755 | 17.60 | CH 151 | 17.30 | 17.50 | 17.40 | 17.20 | 17.20 | 17.20 | 17.20 |
| CH 159 | 5795 | 17.50 | | | | | | | | |

| 802.11ac VHT20 RF Output Power (dBm) | | | | | | | | | | | |
|--------------------------------------|-----------------|-----------|--------------------|-----------|-------|-------|-------|-------|-------|-------|-------|
| Power vs. Channel | | | Power vs Data Rate | | | | | | | | |
| Channel | Frequency (MHz) | MCS Index | Channel | MCS Index | | | | | | | |
| | | MCS0 | | MCS1 | MCS2 | MCS3 | MCS4 | MCS5 | MCS6 | MCS7 | MCS8 |
| CH 149 | 5745 | 17.90 | CH 165 | 17.90 | 17.70 | 17.70 | 17.90 | 17.90 | 17.90 | 17.90 | 17.90 |
| CH 157 | 5785 | 17.70 | | | | | | | | | |
| CH 165 | 5825 | 18.00 | | | | | | | | | |

| 802.11ac VHT40 RF Output Power (dBm) | | | | | | | | | | | | |
|--------------------------------------|-----------------|-----------|--------------------|-----------|-------|-------|-------|-------|-------|-------|-------|-------|
| Power vs. Channel | | | Power vs Data Rate | | | | | | | | | |
| Channel | Frequency (MHz) | MCS Index | Channel | MCS Index | | | | | | | | |
| | | MCS0 | | MCS1 | MCS2 | MCS3 | MCS4 | MCS5 | MCS6 | MCS7 | MCS8 | MCS9 |
| CH 151 | 5755 | 17.70 | CH 151 | 17.40 | 17.60 | 17.50 | 17.30 | 17.30 | 17.30 | 17.30 | 17.30 | 17.30 |
| CH 159 | 5795 | 17.60 | | | | | | | | | | |

| 802.11ac VHT80 RF Output Power (dBm) | | | | | | | | | | | | | |
|--------------------------------------|-----------------|-----------|--------------------|-----------|-------|-------|-------|-------|-------|-------|-------|-------|-------|
| Power vs. Channel | | | Power vs Data Rate | | | | | | | | | | |
| Channel | Frequency (MHz) | MCS Index | Channel | MCS Index | | | | | | | | | |
| | | MCS0 | | MCS1 | MCS2 | MCS3 | MCS4 | MCS5 | MCS6 | MCS7 | MCS8 | MCS9 | |
| CH 155 | 5775 | 17.70 | CH 155 | 17.60 | 17.40 | 17.50 | 17.40 | 17.40 | 17.40 | 17.40 | 17.40 | 17.30 | 17.30 |

2.3 Connection Diagram of Test System

<AC Conducted Emission Mode>

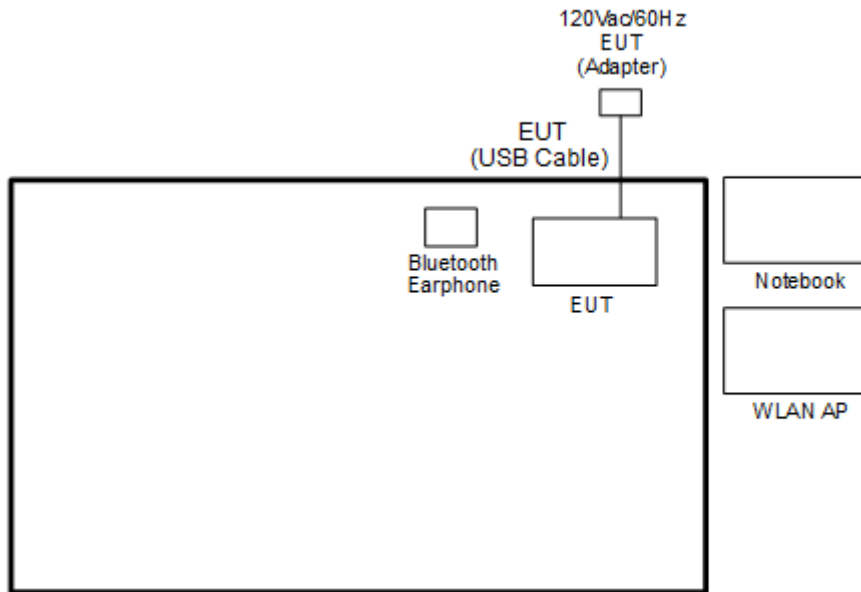

<WLAN Tx Mode>

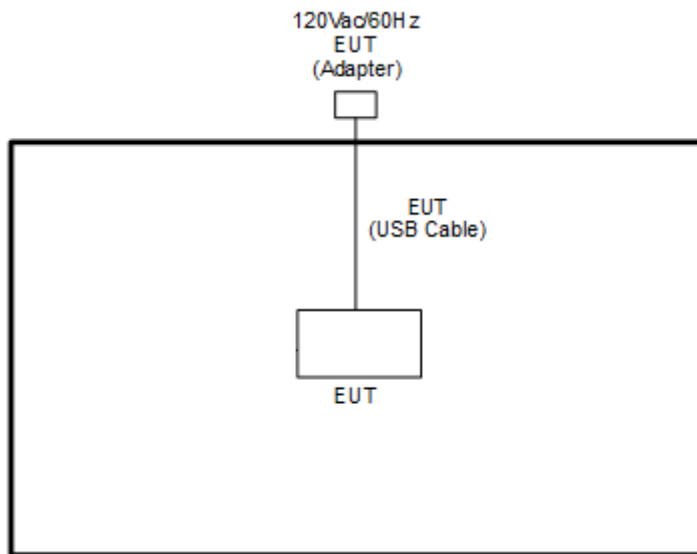



2.4 Support Unit used in test configuration and system

| Item | Equipment | Brand Name | Model Name | FCC ID | Data Cable | Power Cord |
|------|--------------------|---------------|---------------|-------------|------------|--|
| 1. | Bluetooth Earphone | Sony Ericsson | MW600 | PY7DDA-2029 | N/A | N/A |
| 2. | WLAN AP | ASUS | RT-AC66U | MSQ-RTAC66U | N/A | Unshielded, 1.8 m |
| 3. | Notebook | DELL | Latitude 3400 | FCC DoC | N/A | AC I/P: Unshielded, 1.2 m DC O/P: Shielded, 1.8 m |
| 4. | SD Card | SanDisk | MicroSD HC | FCC DoC | N/A | N/A |

2.5 EUT Operation Test Setup

The RF test items, utility “QRCT v4.0.00067.0” was installed in Notebook which was programmed in order to make the EUT get into the engineering modes to provide channel selection, power level, data rate and the application type and for continuous transmitting signals.

2.6 Measurement Results Explanation Example

For all conducted test items:

The offset level is set in the spectrum analyzer to compensate the RF cable loss and attenuator factor between EUT conducted output port and spectrum analyzer. With the offset compensation, the spectrum analyzer reading level is exactly the EUT RF output level.

Example :

The spectrum analyzer offset is derived from RF cable loss and attenuator factor.

Offset = RF cable loss + attenuator factor.

Following shows an offset computation example with cable loss 4.2 dB and 10dB attenuator.

$$\begin{aligned} \text{Offset(dB)} &= \text{RF cable loss(dB)} + \text{attenuator factor(dB)}. \\ &= 4.2 + 10 = 14.2 \text{ (dB)} \end{aligned}$$

3 Test Result

3.1 6dB and 26dB and 99% Occupied Bandwidth Measurement

3.1.1 Description of 6dB and 26dB and 99% Occupied Bandwidth

The minimum 6 dB bandwidth shall be at least 500 kHz.

26dB and 99% Occupied bandwidth are reporting only.

3.1.2 Measuring Instruments

See list of measuring equipment of this test report.

3.1.3 Test Procedures

1. The testing follows FCC KDB 789033 D02 General UNII Test Procedures New Rules v02r01. Section C) Emission bandwidth for the band 5.725-5.85GHz
2. Set RBW = 100kHz.
3. Set the VBW $\geq 3 \times$ RBW.
4. Detector = Peak.
5. Trace mode = max hold
6. Measure the maximum width of the emission that is 6 dB down from the peak of the emission.
7. Measure and record the results in the test report.

3.1.4 Test Setup

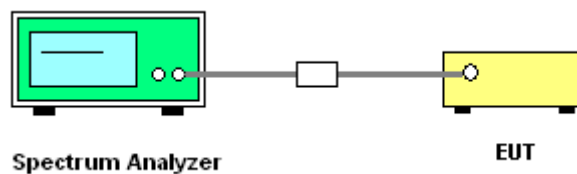



3.1.5 Test Result of 6dB and 26dB and 99% Occupied Bandwidth

| | | | |
|-----------------|------------------------------------|---------------------|-------------|
| Test Engineer : | Ryan Lin, Tommy Lee and Howard Lin | Temperature : | 21.2~24.1°C |
| | | Relative Humidity : | 47.2~57.8% |

| Band IV single antenna | | | | | | | | | | | | |
|------------------------|-----------|-----|-----|-------------|---------------------|-------|----------------------|-------|----------------------|-------|---------------------------------|-----------|
| Mod. | Data Rate | NTX | CH. | Freq. (MHz) | 99% Bandwidth (MHz) | | 26dB Bandwidth (MHz) | | 6 dB Bandwidth (MHz) | | 6 dB Bandwidth Min. Limit (MHz) | Pass/Fail |
| | | | | | Ant 1 | Ant 2 | Ant 1 | Ant 2 | Ant 1 | Ant 2 | | |
| 11a | 6Mbps | 1 | 149 | 5745 | 21.93 | - | 38.30 | - | 15.50 | - | 0.5 | Pass |
| 11a | 6Mbps | 1 | 157 | 5785 | 22.13 | - | 39.10 | - | 15.70 | - | 0.5 | Pass |
| 11a | 6Mbps | 1 | 165 | 5825 | 24.13 | - | 34.45 | - | 16.30 | - | 0.5 | Pass |
| VHT20 | MCS0 | 1 | 149 | 5745 | 21.98 | - | 38.40 | - | 17.30 | - | 0.5 | Pass |
| VHT20 | MCS0 | 1 | 157 | 5785 | 20.23 | - | 34.85 | - | 17.20 | - | 0.5 | Pass |
| VHT20 | MCS0 | 1 | 165 | 5825 | 18.93 | - | 30.70 | - | 17.55 | - | 0.5 | Pass |
| VHT40 | MCS0 | 1 | 151 | 5755 | 37.46 | - | 68.76 | - | 36.27 | - | 0.5 | Pass |
| VHT40 | MCS0 | 1 | 159 | 5795 | 37.76 | - | 76.05 | - | 36.27 | - | 0.5 | Pass |
| VHT80 | MCS0 | 1 | 155 | 5775 | 78.16 | - | 166.21 | - | 75.20 | - | 0.5 | Pass |

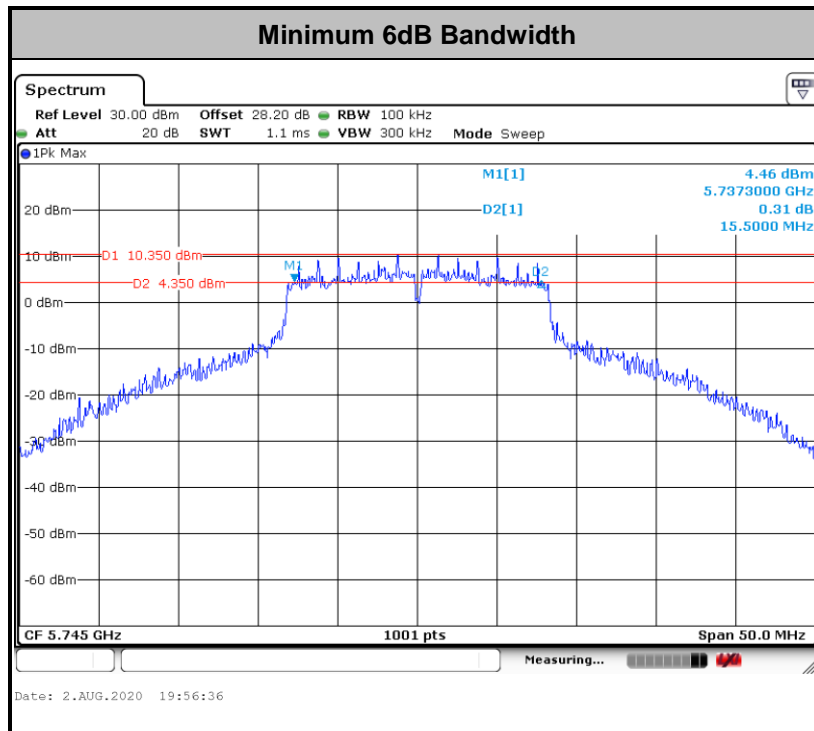

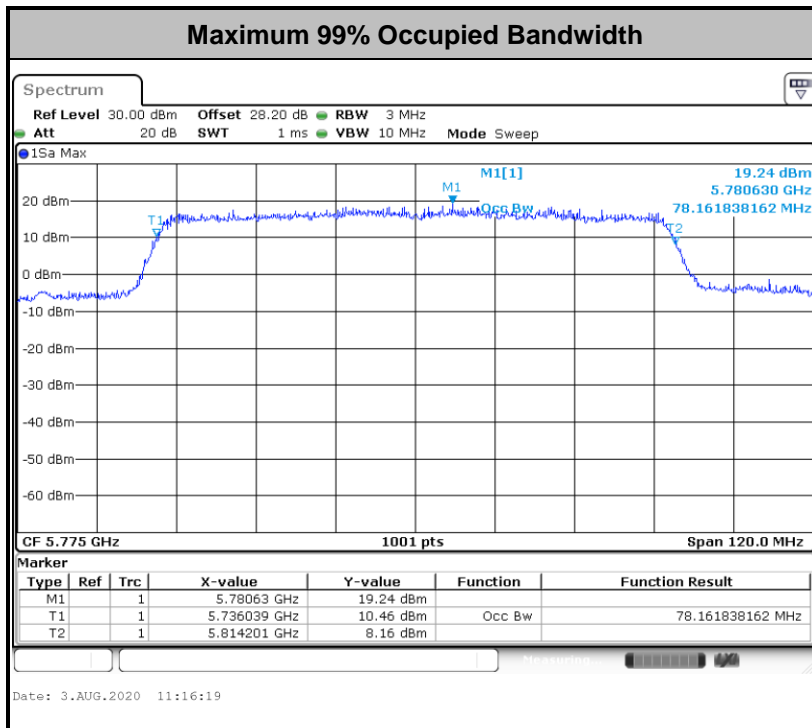
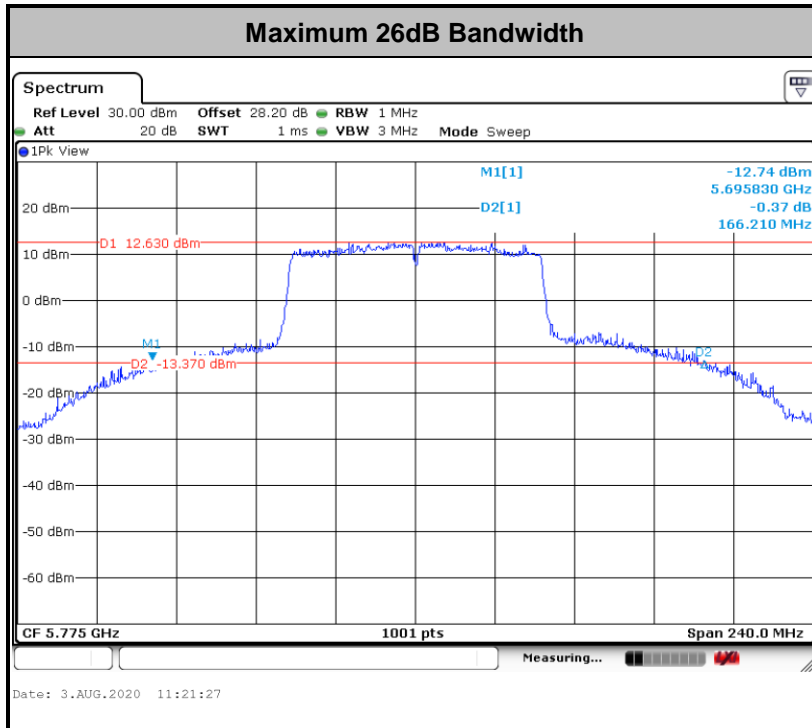

Note: The occupied channel bandwidth is maintained within the band of operation for all of the modulations.

3.2 Maximum Conducted Output Power Measurement

3.2.1 Limit of Maximum Conducted Output Power

For the band 5.725–5.85 GHz, the maximum conducted output power over the frequency band of operation shall not exceed 1 W.

If transmitting antennas of directional gain greater than 6 dBi are used, the peak output power shall be reduced by the amount in dB that the directional gain of the antenna exceeds 6 dBi.

3.2.2 Measuring Instruments

See list of measuring equipment of this test report.

3.2.3 Test Procedures

The testing follows Method PM-G of FCC KDB 789033 D02 General UNII Test Procedures New Rules v02r01.

Method PM-G (Measurement using a gated RF average power meter):

1. Measurement is performed using a wideband RF power meter.
2. The EUT is configured to transmit at its maximum power control level.
3. Measure the average power of the transmitter
4. Since the measurement is made only during the ON time of the transmitter, no duty cycle correction factor is required.

3.2.4 Test Setup

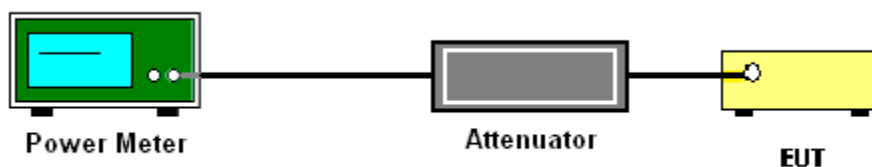



3.2.5 Test Result of Maximum Conducted Output Power

| | | | |
|-----------------|------------------------------------|---------------------|-------------|
| Test Engineer : | Ryan Lin, Tommy Lee and Howard Lin | Temperature : | 21.2~24.1°C |
| | | Relative Humidity : | 47.2~57.8% |

| Band IV single antenna | | | | | | | | | | | |
|------------------------|-----------|-----|-----|-------------|-------------------------------|-------|---------------------------------|-------|----------|-------|-----------|
| Mod. | Data Rate | NTX | CH. | Freq. (MHz) | Average Conducted Power (dBm) | | FCC Conducted Power Limit (dBm) | | DG (dBi) | | Pass/Fail |
| | | | | | Ant 1 | Ant 2 | Ant 1 | Ant 2 | Ant 1 | Ant 2 | |
| 11a | 6Mbps | 1 | 149 | 5745 | 17.60 | - | 30.00 | - | 3.11 | - | Pass |
| 11a | 6Mbps | 1 | 157 | 5785 | 17.80 | - | 30.00 | - | 3.11 | - | Pass |
| 11a | 6Mbps | 1 | 165 | 5825 | 17.60 | - | 30.00 | - | 3.11 | - | Pass |
| HT20 | MCS0 | 1 | 149 | 5745 | 17.80 | - | 30.00 | - | 3.11 | - | Pass |
| HT20 | MCS0 | 1 | 157 | 5785 | 17.60 | - | 30.00 | - | 3.11 | - | Pass |
| HT20 | MCS0 | 1 | 165 | 5825 | 17.90 | - | 30.00 | - | 3.11 | - | Pass |
| HT40 | MCS0 | 1 | 151 | 5755 | 17.60 | - | 30.00 | - | 3.11 | - | Pass |
| HT40 | MCS0 | 1 | 159 | 5795 | 17.50 | - | 30.00 | - | 3.11 | - | Pass |
| VHT20 | MCS0 | 1 | 149 | 5745 | 17.90 | - | 30.00 | - | 3.11 | - | Pass |
| VHT20 | MCS0 | 1 | 157 | 5785 | 17.70 | - | 30.00 | - | 3.11 | - | Pass |
| VHT20 | MCS0 | 1 | 165 | 5825 | 18.00 | - | 30.00 | - | 3.11 | - | Pass |
| VHT40 | MCS0 | 1 | 151 | 5755 | 17.70 | - | 30.00 | - | 3.11 | - | Pass |
| VHT40 | MCS0 | 1 | 159 | 5795 | 17.60 | - | 30.00 | - | 3.11 | - | Pass |
| VHT80 | MCS0 | 1 | 155 | 5775 | 17.70 | - | 30.00 | - | 3.11 | - | Pass |

3.3 Power Spectral Density Measurement

3.3.1 Limit of Power Spectral Density

For the band 5.725–5.85 GHz, the maximum power spectral density shall not exceed 30 dBm in any 500-kHz band.

If transmitting antennas of directional gain greater than 6 dBi are used, the peak output power shall be reduced by the amount in dB that the directional gain of the antenna exceeds 6 dBi.

3.3.2 Measuring Instruments

See list of measuring equipment of this test report.

3.3.3 Test Procedures

The testing follows FCC KDB 789033 D02 General UNII Test Procedures New Rules v02r01. Section F) Maximum power spectral density.

Method SA-3

(power averaging (rms) detection with max hold):

- Set span to encompass the entire emission bandwidth (EBW) of the signal.
 - Set RBW = 300 kHz.
 - Set VBW \geq 1 MHz.
 - Number of points in sweep \geq 2 Span / RBW.
 - Sweep time \leq (number of points in sweep) \times T, when duty cycle is less than 98 percent where T is the minimum transmission duration over which the transmitter is on and is transmitting at its maximum power control level for the tested mode of operation.
 - Detector = power averaging (rms).
 - Trace mode = max hold.
 - Allow max hold to run for at least 60 seconds, or longer as needed to allow the trace to stabilize.
1. The RF output of EUT was connected to the spectrum analyzer by a low loss cable.
 2. Each plot has already offset with cable loss, and attenuator loss. Measure the PPSD and record it.

3.3.4 Test Setup

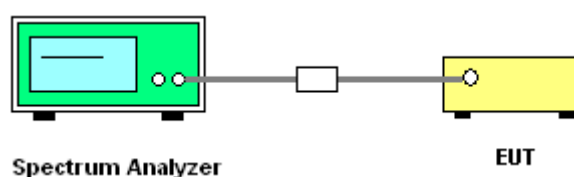



3.3.5 Test Result of Power Spectral Density

| | | | |
|-----------------|------------------------------------|---------------------|-------------|
| Test Engineer : | Ryan Lin, Tommy Lee and Howard Lin | Temperature : | 21.2~24.1°C |
| | | Relative Humidity : | 47.2~57.8% |

| Band IV single antenna | | | | | | | | | | | | | |
|------------------------|-----------|-----|-----|-------------|---------------------------------|-------|------------------------------------|-------|--------------------------------|-------|----------|-------|------------|
| Mod. | Data Rate | NTX | CH. | Freq. (MHz) | 10log (500kHz /RBW) Factor (dB) | | Average Power Density (dBm/500kHz) | | Average PSD Limit (dBm/500kHz) | | DG (dBi) | | Pass /Fail |
| | | | | | Ant 1 | Ant 2 | Ant 1 | Ant 2 | Ant 1 | Ant 2 | Ant 1 | Ant 2 | |
| 11a | 6Mbps | 1 | 149 | 5745 | 2.22 | - | 7.94 | - | 30.00 | - | 3.11 | - | Pass |
| 11a | 6Mbps | 1 | 157 | 5785 | 2.22 | - | 7.79 | - | 30.00 | - | 3.11 | - | Pass |
| 11a | 6Mbps | 1 | 165 | 5825 | 2.22 | - | 7.93 | - | 30.00 | - | 3.11 | - | Pass |
| VHT20 | MCS0 | 1 | 149 | 5745 | 2.22 | - | 8.10 | - | 30.00 | - | 3.11 | - | Pass |
| VHT20 | MCS0 | 1 | 157 | 5785 | 2.22 | - | 8.12 | - | 30.00 | - | 3.11 | - | Pass |
| VHT20 | MCS0 | 1 | 165 | 5825 | 2.22 | - | 8.34 | - | 30.00 | - | 3.11 | - | Pass |
| VHT40 | MCS0 | 1 | 151 | 5755 | 2.22 | - | 3.98 | - | 30.00 | - | 3.11 | - | Pass |
| VHT40 | MCS0 | 1 | 159 | 5795 | 2.22 | - | 3.70 | - | 30.00 | - | 3.11 | - | Pass |
| VHT80 | MCS0 | 1 | 155 | 5775 | 2.22 | - | 1.67 | - | 30.00 | - | 3.11 | - | Pass |

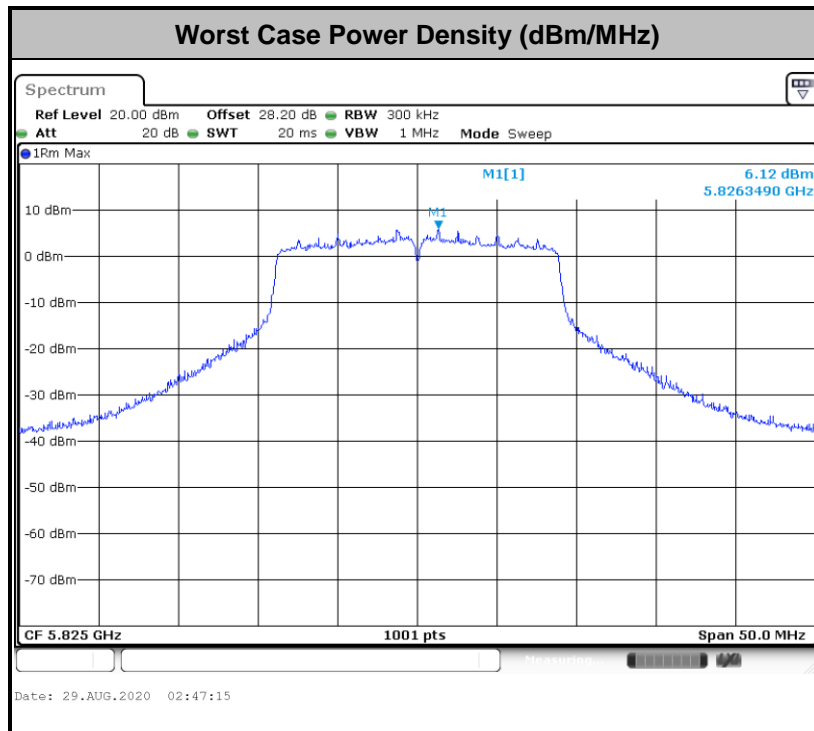



3.4 Unwanted Emissions Measurement

This section is to measure unwanted emissions through radiated measurement for band edge spurious emissions and out of band emissions measurement.

3.4.1 Limit of Unwanted Emissions

(1) For transmitters operating in the 5.725-5.85 GHz band:

15.407(b)(4)(i) All emissions shall be limited to a level of -27 dBm/MHz at 75 MHz or more above or below the band edge increasing linearly to 10 dBm/MHz at 25 MHz above or below the band edge, and from 25 MHz above or below the band edge increasing linearly to a level of 15.6 dBm/MHz at 5 MHz above or below the band edge, and from 5 MHz above or below the band edge increasing linearly to a level of 27 dBm/MHz at the band edge.

(2) Unwanted spurious emissions fallen in restricted bands shall comply with the general field strength limits as below table,

| Frequency (MHz) | Field Strength (microvolts/meter) | Measurement Distance (meters) |
|-----------------|-----------------------------------|-------------------------------|
| 0.009 – 0.490 | 2400/F(kHz) | 300 |
| 0.490 – 1.705 | 24000/F(kHz) | 30 |
| 1.705 – 30.0 | 30 | 30 |
| 30 – 88 | 100 | 3 |
| 88 – 216 | 150 | 3 |
| 216 - 960 | 200 | 3 |
| Above 960 | 500 | 3 |

Note: The following formula is used to convert the EIRP to field strength.

$$E = \frac{1000000\sqrt{30P}}{3} \text{ } \mu\text{V/m, where P is the eirp (Watts)}$$

| EIRP (dBm) | Field Strength at 3m (dBμV/m) |
|------------|-------------------------------|
| - 27 | 68.3 |

(3) KDB789033 D02 v02r01 G)2)c)

- (i) Sections 15.407(b)(1-3) specifies the unwanted emissions limit for the U-NII-1 and U-NII-2 bands. As specified, emissions above 1000 MHz that are outside of the restricted bands are subject to a peak emission limit of -27 dBm/MHz.
- (ii) Section 15.407(b)(4) specifies the unwanted emissions limit for the U-NII-3 band. A band emissions mask is specified in Section 15.407(b)(4)(i). The emission limits are based on the use of a peak detector.



3.4.2 Measuring Instruments

See list of measuring equipment of this test report.

3.4.3 Test Procedures

1. The testing follows FCC KDB 789033 D02 General UNII Test Procedures New Rules v02r01. Section G) Unwanted emissions measurement.
 - (1) Procedure for Unwanted Emissions Measurements Below 1000MHz
 - RBW = 120 kHz
 - VBW = 300 kHz
 - Detector = Peak
 - Trace mode = max hold
 - (2) Procedure for Peak Unwanted Emissions Measurements Above 1000 MHz
 - RBW = 1 MHz
 - VBW \geq 3 MHz
 - Detector = Peak
 - Sweep time = auto
 - Trace mode = max hold
 - (3) Procedures for Average Unwanted Emissions Measurements Above 1000MHz
 - RBW = 1 MHz
 - VBW = 10 Hz, when duty cycle is no less than 98 percent.
 - VBW \geq 1/T, when duty cycle is less than 98 percent where T is the minimum transmission duration over which the transmitter is on and is transmitting at its maximum power control level for the tested mode of operation.
2. The EUT was placed on a turntable with 0.8 meter for frequency below 1GHz and 1.5 meter for frequency above 1GHz respectively above ground.
3. The EUT was set 3 meters from the interference receiving antenna which was mounted on the top of a variable height antenna tower.
4. The antenna is a broadband antenna and its height is adjusted between one meter and four meters above ground to find the maximum value of the field strength for both horizontal polarization and vertical polarization of the antenna.
5. For each suspected emission, the EUT was arranged to its worst case and then adjust the antenna tower (from 1 m to 4 m) and turntable (from 0 degree to 360 degrees) to find the maximum reading.
6. For testing below 1GHz, if the emission level of the EUT in peak mode was 3 dB lower than the limit specified, then peak values of EUT will be reported, otherwise, the emissions will be repeated one by one using the CISPR quasi-peak method and reported.
7. For testing above 1GHz, the emission level of the EUT in peak mode was 20dB lower than average limit (that means the emission level in average mode also complies with the limit in average mode), then peak values of EUT will be reported, otherwise, the emissions will be measured in average mode again and reported.

3.4.4 Test Setup

For radiated emissions below 30MHz

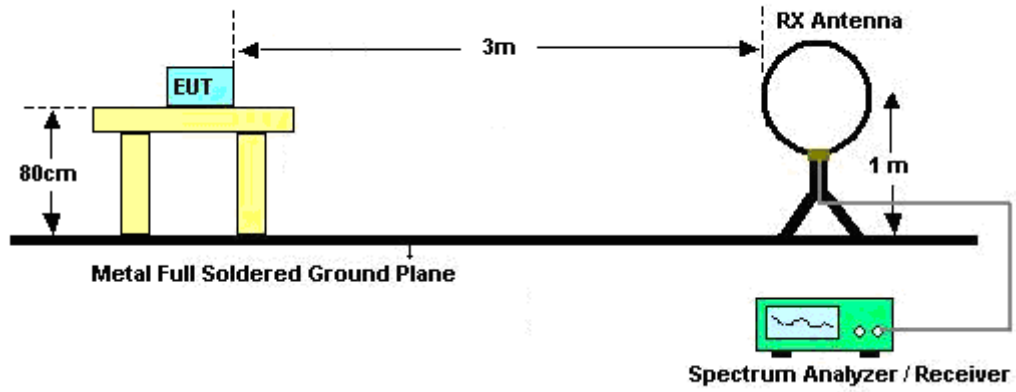

For radiated emissions from 30MHz to 1GHz

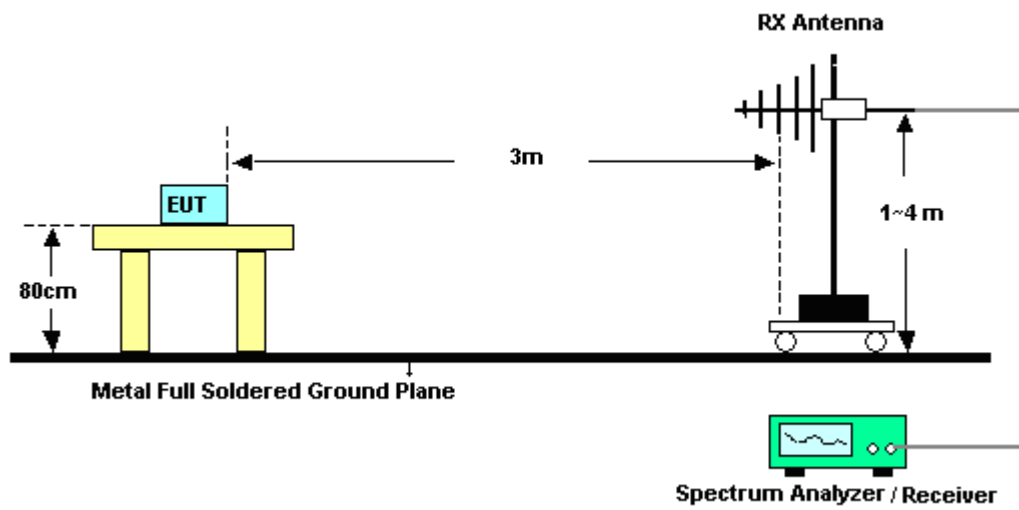

For radiated emissions above 1GHz

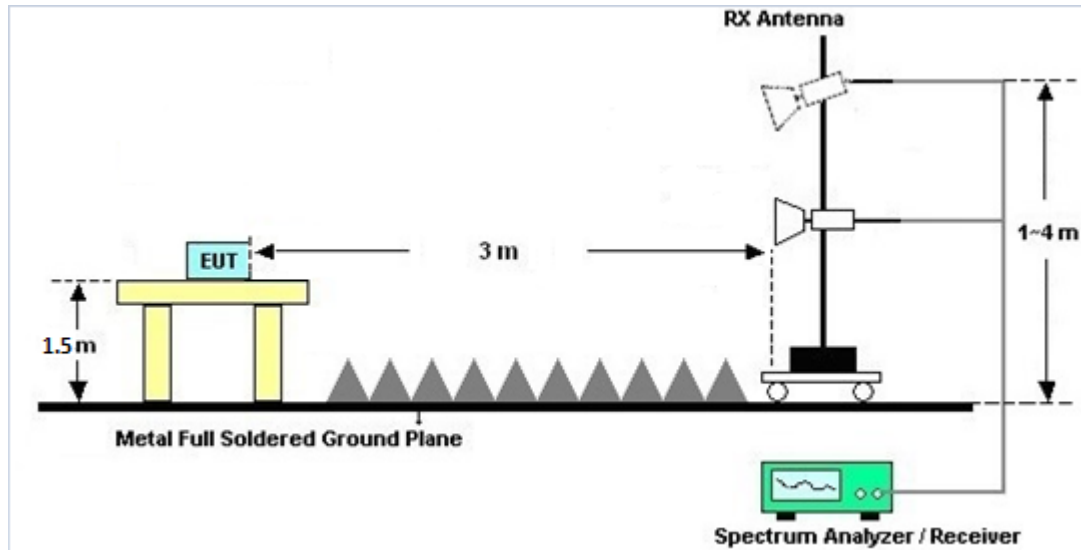

3.4.5 Test Results of Radiated Emissions (9 kHz ~ 30 MHz)

The low frequency, which started from 9 kHz to 30MHz, was pre-scanned and the result which was 20dB lower than the limit line was not reported.

There is a comparison data of both open-field test site and alternative test site - semi-Anechoic chamber according to 414788 D01 Radiated Test Site v01r01, and the result came out very similar.

3.4.6 Test Result of Radiated Band Edges

Please refer to Appendix B and C.

3.4.7 Duty Cycle

Please refer to Appendix D.

3.4.8 Test Result of Unwanted Radiated Emission (30MHz ~ 10th Harmonic)

Please refer to Appendix B and C.



3.5 AC Conducted Emission Measurement

3.5.1 Limit of AC Conducted Emission

For equipment that is designed to be connected to the public utility (AC) power line, the radio frequency voltage that is conducted back onto the AC power line on any frequency or frequencies within the band 150 kHz to 30 MHz shall not exceed the limits in the following table.

| Frequency of emission (MHz) | Conducted limit (dB μ V) | |
|-----------------------------|------------------------------|-----------|
| | Quasi-peak | Average |
| 0.15-0.5 | 66 to 56* | 56 to 46* |
| 0.5-5 | 56 | 46 |
| 5-30 | 60 | 50 |

*Decreases with the logarithm of the frequency.

3.5.2 Measuring Instruments

See list of measuring equipment of this test report.

3.5.3 Test Procedures

1. The EUT was placed 0.4 meter from the conducting wall of the shielding room was kept at least 80 centimeters from any other grounded conducting surface.
2. Connect EUT to the power mains through a line impedance stabilization network (LISN).
3. All the support units are connecting to the other LISN.
4. The LISN provides 50 ohm coupling impedance for the measuring instrument.
5. The FCC states that a 50 ohm, 50 microhenry LISN should be used.
6. Both sides of AC line were checked for maximum conducted interference.
7. The frequency range from 150 kHz to 30 MHz was searched.
8. Set the test-receiver system to Peak Detect Function and specified bandwidth with Maximum Hold Mode.

3.5.4 Test Setup



3.5.5 Test Result of AC Conducted Emission

Please refer to Appendix A.



3.6 Automatically Discontinue Transmission

3.6.1 Limit of Automatically Discontinue Transmission

The device shall automatically discontinue transmission in case of either absence of information to transmit or operational failure. These provisions are not intended to preclude the transmission of control or signaling information or the use of repetitive codes used by certain digital technologies to complete frame or burst intervals. Applicants shall include in their application for equipment authorization to describe how this requirement is met.

3.6.2 Measuring Instruments

See list of measuring equipment of this test report.

3.6.3 Test Result of Automatically Discontinue Transmission

While the EUT is not transmitting any information, the EUT can automatically discontinue transmission and become standby mode for power saving. The EUT can detect the controlling signal of ACK message transmitting from remote device and verify whether it shall resend or discontinue transmission.



3.7 Antenna Requirements

3.7.1 Standard Applicable

If transmitting antenna directional gain is greater than 6 dBi, both the peak transmit power and the peak power spectral density shall be reduced by the amount in dB that the directional gain of the antenna exceeds 6 dBi.

3.7.2 Antenna Anti-Replacement Construction

An embedded-in antenna design is used.

3.7.3 Antenna Gain

The antenna peak gain of EUT is less than 6 dBi. Therefore, it is not necessary to reduce maximum peak output power limit.



4 List of Measuring Equipment

| Instrument | Brand Name | Model No. | Serial No. | Characteristics | Calibration Date | Test Date | Due Date | Remark |
|---------------------------|-----------------|--------------------------------|---------------------------------|--------------------------|------------------|------------------------------|---------------|-----------------------|
| Bilog Antenna | TESEQ | CBL 6111D & 00800N1D01 N-06 | 35419 & 03 | 30MHz~1GHz | Apr. 29, 2020 | Aug. 08, 2020~ Aug. 19, 2020 | Apr. 28, 2021 | Radiation (03CH07-HY) |
| Double Ridge Horn Antenna | ESCO | 3117 | 00075962 | 1GHz ~ 18GHz | Dec. 06, 2019 | Aug. 08, 2020~ Aug. 19, 2020 | Dec. 05, 2020 | Radiation (03CH07-HY) |
| EMI Test Receiver | Agilent | N9038A (MXE) | MY5329005 3 | 20Hz~26.5GHz | May 21, 2020 | Aug. 08, 2020~ Aug. 19, 2020 | May 20, 2021 | Radiation (03CH07-HY) |
| Loop Antenna | Rohde & Schwarz | HFH2-Z2 | 100315 | 9 kHz~30 MHz | Dec. 26, 2019 | Aug. 08, 2020~ Aug. 19, 2020 | Dec. 25, 2020 | Radiation (03CH07-HY) |
| Preamplifier | MITEQ | AMF-7D-0010 1800-30-10P | 1590075 | 1GHz~18GHz | Apr. 23, 2020 | Aug. 08, 2020~ Aug. 19, 2020 | Apr. 22, 2021 | Radiation (03CH07-HY) |
| Preamplifier | COM-POWER | PA-103A | 161241 | 10MHz~1GHz | May 19, 2020 | Aug. 08, 2020~ Aug. 19, 2020 | May 18, 2021 | Radiation (03CH07-HY) |
| Preamplifier | Agilent | 8449B | 3008A02362 | 1GHz~26.5GHz | Nov. 01, 2019 | Aug. 08, 2020~ Aug. 19, 2020 | Oct. 31, 2020 | Radiation (03CH07-HY) |
| Filter | Microwave | H3G018G1 | SN477219 | 3GHz High Pass Filter | Nov. 01, 2019 | Aug. 08, 2020~ Aug. 19, 2020 | Oct. 31, 2020 | Radiation (03CH07-HY) |
| RF Cable | HUBER + SUHNER | SUCOFLEX 102 | MY2858/2,8 01606/2 | 18GHz~40GHz | Feb. 25, 2020 | Aug. 08, 2020~ Aug. 19, 2020 | Feb. 24, 2021 | Radiation (03CH07-HY) |
| RF Cable | HUBER + SUHNER | SUCOFLEX 126 | 532078/126 E | 30MHz~18GHz | N/A | Aug. 08, 2020~ Aug. 19, 2020 | N/A | Radiation (03CH07-HY) |
| RF Cable | HUBER + SUHNER | SUCOFLEX 104 | MY24971/4, MY28655/4 | 9kHz~30MHz | Feb. 25, 2020 | Aug. 08, 2020~ Aug. 19, 2020 | Feb. 24, 2021 | Radiation (03CH07-HY) |
| RF Cable | HUBER + SUHNER | SUCOFLEX 104 | MY28655/4, MY24971/4, MY15682/4 | 30MHz~1GHz | Feb. 25, 2020 | Aug. 08, 2020~ Aug. 19, 2020 | Feb. 24, 2021 | Radiation (03CH07-HY) |
| RF Cable | HUBER + SUHNER | SUCOFLEX 104 | MY28655/4, MY24971/4, MY15682/4 | 1GHz~18GHz | Feb. 25, 2020 | Aug. 08, 2020~ Aug. 19, 2020 | Feb. 24, 2021 | Radiation (03CH07-HY) |
| Controller | ChainTek | Chaintek 3000 | N/A | Control Turn table | N/A | Aug. 08, 2020~ Aug. 19, 2020 | N/A | Radiation (03CH07-HY) |
| Controller | Max-Full | MF7802 | MF7802083 68 | Control Ant Mast | N/A | Aug. 08, 2020~ Aug. 19, 2020 | N/A | Radiation (03CH07-HY) |
| Antenna Mast | Max-Full | MFA520BS | N/A | 1m~4m | N/A | Aug. 08, 2020~ Aug. 19, 2020 | N/A | Radiation (03CH07-HY) |
| Turn Table | ChainTek | Chaintek 3000 | N/A | 0~360 Degree | N/A | Aug. 08, 2020~ Aug. 19, 2020 | N/A | Radiation (03CH07-HY) |
| Attenuator | HONOVA | 5910 SMA-50-005-19-NE | ATT-36 | N/A | Nov. 01, 2019 | Aug. 08, 2020~ Aug. 19, 2020 | Oct. 31, 2020 | Radiation (03CH07-HY) |
| USB Data Logger | TECPEL | TR-32 | HE17XB249 5 | N/A | N/A | Aug. 08, 2020~ Aug. 19, 2020 | N/A | Radiation (03CH07-HY) |
| SHF-EHF Horn Antenna | SCHWARZBECK | BBHA 9170 | BBHA91702 51 | 18GHz~40GHz | Nov. 26, 2019 | Aug. 08, 2020~ Aug. 19, 2020 | Nov. 25, 2020 | Radiation (03CH07-HY) |
| Spectrum Analyzer | Agilent | N9030A | MY5235027 6 | 3Hz~44GHz | Jun. 09, 2020 | Aug. 08, 2020~ Aug. 19, 2020 | Jun. 08, 2021 | Radiation (03CH07-HY) |
| Filter | Wainwright | WHKX8-5872 .5-6750-1800 0-40ST | SN7 | 6.75GHz High Pass Filter | Aug. 22, 2019 | Aug. 08, 2020~ Aug. 19, 2020 | Aug. 21, 2020 | Radiation (03CH07-HY) |
| Preamplifier | EMEC | EM18G40G | 0600789 | 18-40GHz | N/A | Aug. 08, 2020~ Aug. 19, 2020 | N/A | Radiation (03CH07-HY) |
| Software | Audix | E3 6.2009-8-24 | 8050400465 6H | N/A | N/A | Aug. 08, 2020~ Aug. 19, 2020 | N/A | Radiation (03CH07-HY) |



| Instrument | Brand Name | Model No. | Serial No. | Characteristics | Calibration Date | Test Date | Due Date | Remark |
|--------------------------|--------------------|-----------------|-------------------|-----------------|------------------|---------------------------------|---------------|-------------------------|
| Hygrometer | Testo | 608-H1 | 34893241 | N/A | Mar. 02, 2020 | Aug. 03, 2020~ Aug. 29, 2020 | Mar. 01, 2021 | Conducted (TH05-HY) |
| Power Sensor | DARE | RPR3006W | 16I00054SN O10 | 10MHz~6GHz | Dec. 23, 2019 | Aug. 03, 2020~ Aug. 29, 2020 | Dec. 22, 2020 | Conducted (TH05-HY) |
| Signal Analyzer | Rohde & Schwarz | FSV40 | 101397 | 10Hz~40GHz | Nov. 15, 2019 | Aug. 03, 2020~ Aug. 29, 2020 | Nov. 14, 2020 | Conducted (TH05-HY) |
| Switch Box & RF Cable | EM Electronics | EMSW18SE | SW200302 | N/A | Mar. 17, 2020 | Aug. 03, 2020~ Aug. 29, 2020 | Mar. 16, 2021 | Conducted (TH05-HY) |
| AC Power Source | ChainTek | APC-1000W | N/A | N/A | N/A | Aug. 12, 2020 | N/A | Conduction (CO05-HY) |
| EMI Test Receiver | Rohde & Schwarz | ESR3 | 102388 | 9kHz~3.6GHz | Nov. 15, 2019 | Aug. 12, 2020 | Nov. 14, 2020 | Conduction (CO05-HY) |
| Hygrometer | Testo | 608-H1 | 34913912 | N/A | Nov. 07, 2019 | Aug. 12, 2020 | Nov. 06, 2020 | Conduction (CO05-HY) |
| LISN | Rohde & Schwarz | ENV216 | 100081 | 9kHz~30MHz | Nov. 15, 2019 | Aug. 12, 2020 | Nov. 14, 2020 | Conduction (CO05-HY) |
| Software | Rohde & Schwarz | EMC32 V10.30 | N/A | N/A | N/A | Aug. 12, 2020 | N/A | Conduction (CO05-HY) |
| LF Cable | HUBER + SUHNER | RG-214/U | LF01 | N/A | Jan. 02, 2020 | Aug. 12, 2020 | Jan. 01, 2021 | Conduction (CO05-HY) |
| Pulse Limiter | Rohde & Schwarz | ESH3-Z2 | 100851 | N/A | Jan. 02, 2020 | Aug. 12, 2020 | Jan. 01, 2021 | Conduction (CO05-HY) |



5 Uncertainty of Evaluation

Uncertainty of Conducted Emission Measurement (150kHz ~ 30MHz)

| | |
|---|-----|
| Measuring Uncertainty for a Level of Confidence of 95% ($U = 2Uc(y)$) | 2.3 |
|---|-----|

Uncertainty of Radiated Emission Measurement (30 MHz ~ 1000 MHz)

| | |
|---|-----|
| Measuring Uncertainty for a Level of Confidence of 95% ($U = 2Uc(y)$) | 4.7 |
|---|-----|

Uncertainty of Radiated Emission Measurement (1000 MHz ~ 18000 MHz)

| | |
|---|-----|
| Measuring Uncertainty for a Level of Confidence of 95% ($U = 2Uc(y)$) | 5.3 |
|---|-----|

Uncertainty of Radiated Emission Measurement (18000 MHz ~ 40000 MHz)

| | |
|---|-----|
| Measuring Uncertainty for a Level of Confidence of 95% ($U = 2Uc(y)$) | 5.0 |
|---|-----|



Appendix A. AC Conducted Emission Test Results

| | | | |
|-----------------|--------------|---------------------|---------|
| Test Engineer : | Howard Huang | Temperature : | 23~25°C |
| | | Relative Humidity : | 40~43% |

EUT Information

Report NO : 052917-01
 Test Mode : Mode 1
 Test Voltage : 120Vac/60Hz
 Phase : Line

Full Spectrum

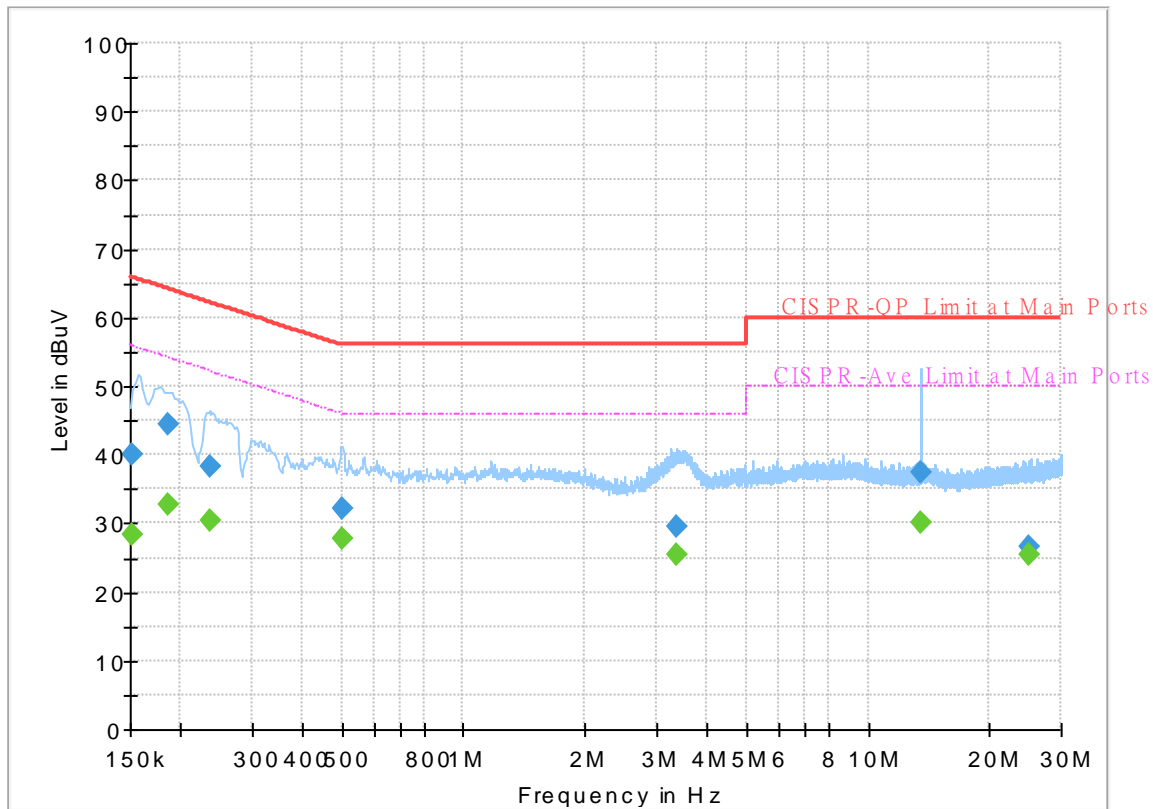

Final_Result

| Frequency (MHz) | QuasiPeak (dBuV) | CAverage (dBuV) | Limit (dBuV) | Margin (dB) | Line | Filter | Corr. (dB) |
|-----------------|------------------|-----------------|--------------|-------------|------|--------|------------|
| 0.152250 | --- | 28.47 | 55.88 | 27.41 | L1 | OFF | 19.6 |
| 0.152250 | 40.19 | --- | 65.88 | 25.69 | L1 | OFF | 19.6 |
| 0.186000 | --- | 32.62 | 54.21 | 21.59 | L1 | OFF | 19.6 |
| 0.186000 | 44.54 | --- | 64.21 | 19.67 | L1 | OFF | 19.6 |
| 0.235500 | --- | 30.41 | 52.25 | 21.84 | L1 | OFF | 19.6 |
| 0.235500 | 38.32 | --- | 62.25 | 23.93 | L1 | OFF | 19.6 |
| 0.501720 | --- | 27.72 | 46.00 | 18.28 | L1 | OFF | 19.6 |
| 0.501720 | 32.07 | --- | 56.00 | 23.93 | L1 | OFF | 19.6 |
| 3.358500 | --- | 25.52 | 46.00 | 20.48 | L1 | OFF | 19.7 |
| 3.358500 | 29.49 | --- | 56.00 | 26.51 | L1 | OFF | 19.7 |
| 13.560000 | --- | 30.02 | 50.00 | 19.98 | L1 | OFF | 20.2 |
| 13.560000 | 37.44 | --- | 60.00 | 22.56 | L1 | OFF | 20.2 |
| 24.949500 | --- | 25.52 | 50.00 | 24.48 | L1 | OFF | 20.5 |
| 24.949500 | 26.69 | --- | 60.00 | 33.31 | L1 | OFF | 20.5 |

EUT Information

Report NO : 052917-01
 Test Mode : Mode 1
 Test Voltage : 120Vac/60Hz
 Phase : Neutral

Full Spectrum

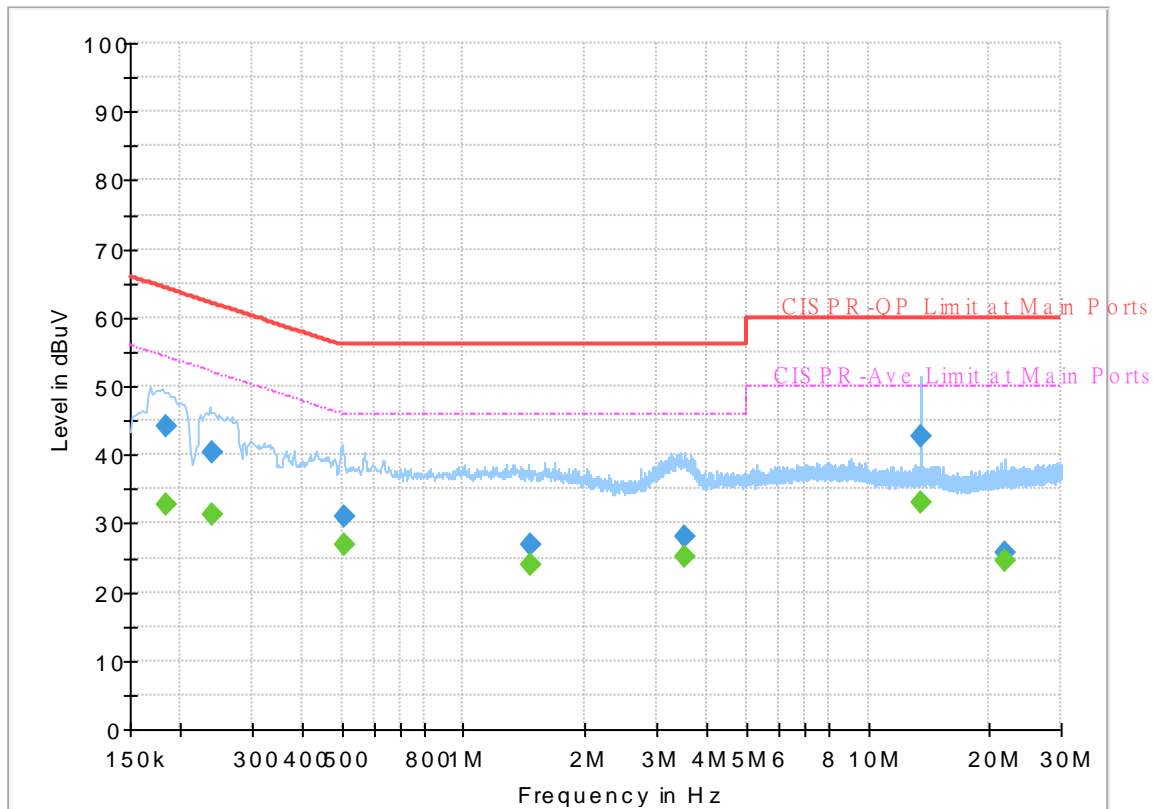

Final_Result

| Frequency (MHz) | QuasiPeak (dBuV) | CAverage (dBuV) | Limit (dBuV) | Margin (dB) | Line | Filter | Corr. (dB) |
|-----------------|------------------|-----------------|--------------|-------------|------|--------|------------|
| 0.183750 | --- | 32.67 | 54.31 | 21.64 | N | OFF | 19.5 |
| 0.183750 | 44.29 | --- | 64.31 | 20.02 | N | OFF | 19.5 |
| 0.240000 | --- | 31.17 | 52.10 | 20.93 | N | OFF | 19.5 |
| 0.240000 | 40.22 | --- | 62.10 | 21.88 | N | OFF | 19.5 |
| 0.505500 | --- | 26.88 | 46.00 | 19.12 | N | OFF | 19.5 |
| 0.505500 | 31.03 | --- | 56.00 | 24.97 | N | OFF | 19.5 |
| 1.469220 | --- | 24.10 | 46.00 | 21.90 | N | OFF | 19.6 |
| 1.469220 | 26.80 | --- | 56.00 | 29.20 | N | OFF | 19.6 |
| 3.503130 | --- | 25.18 | 46.00 | 20.82 | N | OFF | 19.6 |
| 3.503130 | 28.09 | --- | 56.00 | 27.91 | N | OFF | 19.6 |
| 13.560000 | --- | 32.92 | 50.00 | 17.08 | N | OFF | 19.9 |
| 13.560000 | 42.70 | --- | 60.00 | 17.30 | N | OFF | 19.9 |
| 21.711750 | --- | 24.70 | 50.00 | 25.30 | N | OFF | 19.9 |
| 21.711750 | 25.85 | --- | 60.00 | 34.15 | N | OFF | 19.9 |



Appendix B. Radiated Spurious Emission

| | | | |
|-----------------|-----------------------------------|---------------------|---------|
| Test Engineer : | Jesse Wang, Stan Hsieh and Ken Wu | Temperature : | 22~23°C |
| | | Relative Humidity : | 51~59% |

Band 4 - 5725~5850MHz

WIFI 802.11a (Band Edge @ 3m)

| WIFI Ant. | Note | Frequency (MHz) | Level (dBμV/m) | Over Limit (dB) | Limit Line (dBμV/m) | Read Level (dBμV) | Antenna Factor (dB/m) | Path Loss (dB) | Preamp Factor (dB) | Ant Pos (cm) | Table Pos (deg) | Peak Avg. (P/A) | Pol. (H/V) | |
|------------------------------|------|-------------------|------------------|-------------------|-----------------------|---------------------|-------------------------|------------------|----------------------|----------------|-------------------|-------------------|--------------|---|
| 802.11a CH 149 5745MHz | | 5620 | 47.95 | -20.25 | 68.2 | 36.29 | 34.9 | 12.07 | 35.31 | 103 | 38 | P | H | |
| | | 5700 | 52.51 | -52.69 | 105.2 | 40.63 | 35 | 12.2 | 35.32 | 103 | 38 | P | H | |
| | | 5718.8 | 64.45 | -46.01 | 110.46 | 52.53 | 35 | 12.24 | 35.32 | 103 | 38 | P | H | |
| | | 5725 | 74.84 | -47.36 | 122.2 | 62.91 | 35 | 12.25 | 35.32 | 103 | 38 | P | H | |
| | * | 5745 | 111.7 | - | - | 99.74 | 35 | 12.28 | 35.32 | 103 | 38 | P | H | |
| | * | 5745 | 103.85 | - | - | 91.89 | 35 | 12.28 | 35.32 | 103 | 38 | A | H | |
| | | | | | | | | | | | | | | H |
| | | | | | | | | | | | | | | H |
| | | | 5643.2 | 47.67 | -20.53 | 68.2 | 36.07 | 34.8 | 12.11 | 35.31 | 100 | 114 | P | V |
| | | | 5698.8 | 50.45 | -53.87 | 104.32 | 38.57 | 35 | 12.2 | 35.32 | 100 | 114 | P | V |
| | | | 5719.8 | 62.48 | -48.26 | 110.74 | 50.56 | 35 | 12.24 | 35.32 | 100 | 114 | P | V |
| | | | 5724.8 | 72.71 | -49.03 | 121.74 | 60.78 | 35 | 12.25 | 35.32 | 100 | 114 | P | V |
| | * | 5745 | 110.15 | - | - | 98.19 | 35 | 12.28 | 35.32 | 100 | 114 | P | V | |
| | * | 5745 | 102.4 | - | - | 90.44 | 35 | 12.28 | 35.32 | 100 | 114 | A | V | |
| | | | | | | | | | | | | | | V |
| | | | | | | | | | | | | | | V |



| WIFI Ant. 1 | Note | Frequency (MHz) | Level (dBμV/m) | Over Limit (dB) | Limit Line (dBμV/m) | Read Level (dBμV) | Antenna Factor (dB/m) | Path Loss (dB) | Preamp Factor (dB) | Ant Pos (cm) | Table Pos (deg) | Peak Avg. (P/A) | Pol. (H/V) |
|----------------|------|-------------------|------------------|-------------------|-----------------------|---------------------|-------------------------|------------------|----------------------|----------------|-------------------|-------------------|--------------|
| | | 5621.6 | 48.66 | -19.54 | 68.2 | 36.99 | 34.9 | 12.08 | 35.31 | 101 | 39 | P | H |
| | | 5668.8 | 49.24 | -32.91 | 82.15 | 37.56 | 34.85 | 12.15 | 35.32 | 101 | 39 | P | H |
| | | 5713 | 49.64 | -59.2 | 108.84 | 37.73 | 35 | 12.23 | 35.32 | 101 | 39 | P | H |
| | | 5720.2 | 49.04 | -62.22 | 111.26 | 37.12 | 35 | 12.24 | 35.32 | 101 | 39 | P | H |
| | * | 5785 | 112.33 | - | - | 100.31 | 35 | 12.35 | 35.33 | 101 | 39 | P | H |
| | * | 5785 | 104.42 | - | - | 92.4 | 35 | 12.35 | 35.33 | 101 | 39 | A | H |
| | | 5854.8 | 51.57 | -59.69 | 111.26 | 39.44 | 35.07 | 12.4 | 35.34 | 101 | 39 | P | H |
| | | 5856.8 | 51.13 | -59.17 | 110.3 | 39 | 35.07 | 12.4 | 35.34 | 101 | 39 | P | H |
| | | 5877.4 | 50.69 | -52.73 | 103.42 | 38.49 | 35.13 | 12.41 | 35.34 | 101 | 39 | P | H |
| | | 5939 | 49.26 | -18.94 | 68.2 | 36.96 | 35.2 | 12.44 | 35.34 | 101 | 39 | P | H |
| | | | | | | | | | | | | | H |
| | | | | | | | | | | | | | H |
| 802.11a | | | | | | | | | | | | | |
| CH 157 | | | | | | | | | | | | | |
| 5785MHz | | 5624.8 | 47.46 | -20.74 | 68.2 | 35.79 | 34.9 | 12.08 | 35.31 | 100 | 116 | P | V |
| | | 5685.2 | 48.36 | -45.92 | 94.28 | 36.5 | 35 | 12.18 | 35.32 | 100 | 116 | P | V |
| | | 5708.6 | 48.97 | -58.64 | 107.61 | 37.07 | 35 | 12.22 | 35.32 | 100 | 116 | P | V |
| | | 5723.4 | 48.88 | -69.67 | 118.55 | 36.96 | 35 | 12.24 | 35.32 | 100 | 116 | P | V |
| | * | 5785 | 109.72 | - | - | 97.7 | 35 | 12.35 | 35.33 | 100 | 116 | P | V |
| | * | 5785 | 102.52 | - | - | 90.5 | 35 | 12.35 | 35.33 | 100 | 116 | A | V |
| | | 5855 | 50.53 | -60.27 | 110.8 | 38.4 | 35.07 | 12.4 | 35.34 | 100 | 116 | P | V |
| | | 5855 | 50.53 | -60.27 | 110.8 | 38.4 | 35.07 | 12.4 | 35.34 | 100 | 116 | P | V |
| | | 5888.8 | 49.8 | -45.16 | 94.96 | 37.53 | 35.2 | 12.41 | 35.34 | 100 | 116 | P | V |
| | | 5936.8 | 49.16 | -19.04 | 68.2 | 36.86 | 35.2 | 12.44 | 35.34 | 100 | 116 | P | V |
| | | | | | | | | | | | | | V |
| | | | | | | | | | | | | | V |



| WiFi Ant. 1 | Note | Frequency (MHz) | Level (dBµV/m) | Over Limit (dB) | Limit Line (dBµV/m) | Read Level (dBµV) | Antenna Factor (dB/m) | Path Loss (dB) | Preamp Factor (dB) | Ant Pos (cm) | Table Pos (deg) | Peak Avg. (P/A) | Pol. (H/V) | |
|------------------------------|---|-------------------|------------------|-------------------|-----------------------|---------------------|-------------------------|------------------|----------------------|----------------|-------------------|-------------------|--------------|---|
| 802.11a CH 165 5825MHz | * | 5825 | 111.44 | - | - | 99.39 | 35 | 12.38 | 35.33 | 110 | 37 | P | H | |
| | * | 5825 | 103.65 | - | - | 91.6 | 35 | 12.38 | 35.33 | 110 | 37 | A | H | |
| | | 5850.4 | 64.9 | -56.39 | 121.29 | 52.84 | 35 | 12.4 | 35.34 | 110 | 37 | P | H | |
| | | 5855.6 | 62 | -48.63 | 110.63 | 49.87 | 35.07 | 12.4 | 35.34 | 110 | 37 | P | H | |
| | | 5878.2 | 50.81 | -52.01 | 102.82 | 38.61 | 35.13 | 12.41 | 35.34 | 110 | 37 | P | H | |
| | | 5943 | 49.41 | -18.79 | 68.2 | 37.11 | 35.2 | 12.44 | 35.34 | 110 | 37 | P | H | |
| | | | | | | | | | | | | | | H |
| | | | | | | | | | | | | | | H |
| | * | 5825 | 110.12 | - | - | 98.07 | 35 | 12.38 | 35.33 | 100 | 115 | P | V | |
| | * | 5825 | 102.87 | - | - | 90.82 | 35 | 12.38 | 35.33 | 100 | 115 | A | V | |
| | | 5852.6 | 60.75 | -55.52 | 116.27 | 48.69 | 35 | 12.4 | 35.34 | 100 | 115 | P | V | |
| | | 5857 | 58.79 | -51.45 | 110.24 | 46.66 | 35.07 | 12.4 | 35.34 | 100 | 115 | P | V | |
| | | 5885.4 | 51.84 | -45.64 | 97.48 | 39.64 | 35.13 | 12.41 | 35.34 | 100 | 115 | P | V | |
| | | 5928.4 | 48.88 | -19.32 | 68.2 | 36.59 | 35.2 | 12.43 | 35.34 | 100 | 115 | P | V | |
| | | | | | | | | | | | | | | V |
| | | | | | | | | | | | | | | V |
| | | | | | | | | | | | | | | V |
| Remark | 1. No other spurious found. 2. All results are PASS against Peak and Average limit line. | | | | | | | | | | | | | |



Band 4 5725~5850MHz

WIFI 802.11a (Harmonic @ 3m)

| WIFI Ant. 1 | Note | Frequency (MHz) | Level (dBμV/m) | Over Limit (dB) | Limit Line (dBμV/m) | Read Level (dBμV) | Antenna Factor (dB/m) | Path Loss (dB) | Preamp Factor (dB) | Ant Pos (cm) | Table Pos (deg) | Peak Avg. (P/A) | Pol. (H/V) |
|------------------------------|--|-------------------|------------------|-------------------|-----------------------|---------------------|-------------------------|------------------|----------------------|----------------|-------------------|-------------------|--------------|
| 802.11a CH 149 5745MHz | | 11490 | 45.33 | -28.67 | 74 | 46.19 | 38.18 | 18.48 | 57.52 | 100 | 0 | P | H |
| | | 17235 | 50.25 | -17.95 | 68.2 | 42.08 | 41.53 | 22.95 | 56.31 | 100 | 0 | P | H |
| | | | | | | | | | | | | | H |
| | | | | | | | | | | | | | H |
| | | 11490 | 44.43 | -29.57 | 74 | 45.29 | 38.18 | 18.48 | 57.52 | 100 | 0 | P | V |
| | | 17235 | 49.68 | -18.52 | 68.2 | 41.51 | 41.53 | 22.95 | 56.31 | 100 | 0 | P | V |
| | | | | | | | | | | | | | V |
| 802.11a CH 157 5785MHz | | 11570 | 44.58 | -29.42 | 74 | 45.04 | 38.33 | 18.55 | 57.34 | 100 | 0 | P | H |
| | | 17355 | 49.3 | -18.9 | 68.2 | 41.13 | 41.5 | 23.02 | 56.35 | 100 | 0 | P | H |
| | | | | | | | | | | | | | H |
| | | | | | | | | | | | | | H |
| | | 11570 | 45.23 | -28.77 | 74 | 45.69 | 38.33 | 18.55 | 57.34 | 100 | 0 | P | V |
| | | 17355 | 50.35 | -17.85 | 68.2 | 42.18 | 41.5 | 23.02 | 56.35 | 100 | 0 | P | V |
| | | | | | | | | | | | | | V |
| 802.11a CH 165 5825MHz | | 11650 | 44.63 | -29.37 | 74 | 44.71 | 38.44 | 18.63 | 57.15 | 100 | 0 | P | H |
| | | 17475 | 48.54 | -19.66 | 68.2 | 40.5 | 41.33 | 23.09 | 56.38 | 100 | 0 | P | H |
| | | | | | | | | | | | | | H |
| | | | | | | | | | | | | | H |
| | | 11650 | 44.82 | -29.18 | 74 | 44.9 | 38.44 | 18.63 | 57.15 | 100 | 0 | P | V |
| | | 17475 | 48.69 | -19.51 | 68.2 | 40.65 | 41.33 | 23.09 | 56.38 | 100 | 0 | P | V |
| | | | | | | | | | | | | | V |
| Remark | 1. No other spurious found. | | | | | | | | | | | | |
| | 2. All results are PASS against Peak and Average limit line. | | | | | | | | | | | | |



Band 4 5725~5850MHz

WIFI 802.11ac VHT20 (Band Edge @ 3m)

| WIFI Ant. 1 | Note | Frequency (MHz) | Level (dBμV/m) | Over Limit (dB) | Limit Line (dBμV/m) | Read Level (dBμV) | Antenna Factor (dB/m) | Path Loss (dB) | Preamp Factor (dB) | Ant Pos (cm) | Table Pos (deg) | Peak Avg. (P/A) | Pol. (H/V) | |
|-------------------------------|------|-------------------|------------------|-------------------|-----------------------|---------------------|-------------------------|------------------|----------------------|----------------|-------------------|-------------------|--------------|---|
| 802.11ac VHT20 CH 149 5745MHz | | 5622 | 47.93 | -20.27 | 68.2 | 36.26 | 34.9 | 12.08 | 35.31 | 101 | 41 | P | H | |
| | | 5694.2 | 50.35 | -50.57 | 100.92 | 38.47 | 35 | 12.2 | 35.32 | 101 | 41 | P | H | |
| | | 5719.8 | 69.92 | -40.82 | 110.74 | 58 | 35 | 12.24 | 35.32 | 101 | 41 | P | H | |
| | | 5725 | 76.98 | -45.22 | 122.2 | 65.05 | 35 | 12.25 | 35.32 | 101 | 41 | P | H | |
| | * | 5745 | 110.94 | - | - | 98.98 | 35 | 12.28 | 35.32 | 101 | 41 | P | H | |
| | * | 5745 | 103.39 | - | - | 91.43 | 35 | 12.28 | 35.32 | 101 | 41 | A | H | |
| | | | | | | | | | | | | | | H |
| | | | | | | | | | | | | | | H |
| | | | 5616.4 | 48.81 | -19.39 | 68.2 | 37.15 | 34.9 | 12.07 | 35.31 | 100 | 114 | P | V |
| | | | 5699.6 | 55.1 | -49.81 | 104.91 | 43.22 | 35 | 12.2 | 35.32 | 100 | 114 | P | V |
| | | | 5720 | 64.96 | -45.84 | 110.8 | 53.04 | 35 | 12.24 | 35.32 | 100 | 114 | P | V |
| | | | 5724.4 | 76.44 | -44.39 | 120.83 | 64.51 | 35 | 12.25 | 35.32 | 100 | 114 | P | V |
| | * | | 5745 | 109.32 | - | - | 97.36 | 35 | 12.28 | 35.32 | 100 | 114 | P | V |
| | * | | 5745 | 101.84 | - | - | 89.88 | 35 | 12.28 | 35.32 | 100 | 114 | A | V |
| | | | | | | | | | | | | | | V |
| | | | | | | | | | | | | | V | |



| WIFI Ant. 1 | Note | Frequency (MHz) | Level (dBμV/m) | Over Limit (dB) | Limit Line (dBμV/m) | Read Level (dBμV) | Antenna Factor (dB/m) | Path Loss (dB) | Preamp Factor (dB) | Ant Pos (cm) | Table Pos (deg) | Peak Avg. (P/A) | Pol. (H/V) |
|-------------|------|-------------------|------------------|-------------------|-----------------------|---------------------|-------------------------|------------------|----------------------|----------------|-------------------|-------------------|--------------|
| | | 5614.8 | 47.76 | -20.44 | 68.2 | 36.01 | 35 | 12.06 | 35.31 | 104 | 40 | P | H |
| | | 5664.8 | 49.22 | -29.97 | 79.19 | 37.69 | 34.7 | 12.15 | 35.32 | 104 | 40 | P | H |
| | | 5709 | 48.48 | -59.24 | 107.72 | 36.58 | 35 | 12.22 | 35.32 | 104 | 40 | P | H |
| | | 5723.6 | 48.28 | -70.73 | 119.01 | 36.36 | 35 | 12.24 | 35.32 | 104 | 40 | P | H |
| | * | 5785 | 109.7 | - | - | 97.68 | 35 | 12.35 | 35.33 | 104 | 40 | P | H |
| | * | 5785 | 102.42 | - | - | 90.4 | 35 | 12.35 | 35.33 | 104 | 40 | A | H |
| | | 5850.4 | 52.03 | -69.26 | 121.29 | 39.97 | 35 | 12.4 | 35.34 | 104 | 40 | P | H |
| | | 5859.4 | 50.84 | -58.73 | 109.57 | 38.71 | 35.07 | 12.4 | 35.34 | 104 | 40 | P | H |
| | | 5898.8 | 50.32 | -37.23 | 87.55 | 38.04 | 35.2 | 12.42 | 35.34 | 104 | 40 | P | H |
| | | 5939.2 | 50.83 | -17.37 | 68.2 | 38.53 | 35.2 | 12.44 | 35.34 | 104 | 40 | P | H |
| 802.11ac | | | | | | | | | | | | | H |
| VHT20 | | | | | | | | | | | | | H |
| CH 157 | | 5606 | 48.58 | -19.62 | 68.2 | 36.84 | 35 | 12.05 | 35.31 | 100 | 120 | P | V |
| 5785MHz | | 5694.8 | 49.91 | -51.46 | 101.37 | 38.03 | 35 | 12.2 | 35.32 | 100 | 120 | P | V |
| | | 5716.6 | 48.5 | -61.35 | 109.85 | 36.59 | 35 | 12.23 | 35.32 | 100 | 120 | P | V |
| | | 5724.4 | 49.45 | -71.38 | 120.83 | 37.52 | 35 | 12.25 | 35.32 | 100 | 120 | P | V |
| | * | 5785 | 109.12 | - | - | 97.1 | 35 | 12.35 | 35.33 | 100 | 120 | P | V |
| | * | 5785 | 101.8 | - | - | 89.78 | 35 | 12.35 | 35.33 | 100 | 120 | A | V |
| | | 5854.2 | 50.99 | -61.63 | 112.62 | 38.86 | 35.07 | 12.4 | 35.34 | 100 | 120 | P | V |
| | | 5860 | 51.5 | -57.9 | 109.4 | 39.37 | 35.07 | 12.4 | 35.34 | 100 | 120 | P | V |
| | | 5924.6 | 49.93 | -18.56 | 68.49 | 37.64 | 35.2 | 12.43 | 35.34 | 100 | 120 | P | V |
| | | 5948.4 | 50.66 | -17.54 | 68.2 | 38.36 | 35.2 | 12.44 | 35.34 | 100 | 120 | P | V |
| | | | | | | | | | | | | | V |
| | | | | | | | | | | | | | V |



| WIFI Ant. 1 | Note | Frequency (MHz) | Level (dBμV/m) | Over Limit (dB) | Limit Line (dBμV/m) | Read Level (dBμV) | Antenna Factor (dB/m) | Path Loss (dB) | Preamp Factor (dB) | Ant Pos (cm) | Table Pos (deg) | Peak Avg. (P/A) | Pol. (H/V) | |
|--|---|-------------------|------------------|-------------------|-----------------------|---------------------|-------------------------|------------------|----------------------|----------------|-------------------|-------------------|--------------|---|
| 802.11ac VHT20 CH 165 5825MHz | * | 5825 | 109.13 | - | - | 97.08 | 35 | 12.38 | 35.33 | 104 | 48 | P | H | |
| | * | 5825 | 101.97 | - | - | 89.92 | 35 | 12.38 | 35.33 | 104 | 48 | A | H | |
| | | 5850 | 60.81 | -61.39 | 122.2 | 48.74 | 35 | 12.4 | 35.33 | 104 | 48 | P | H | |
| | | 5855.6 | 52.06 | -58.57 | 110.63 | 39.93 | 35.07 | 12.4 | 35.34 | 104 | 48 | P | H | |
| | | 5886 | 51.55 | -45.48 | 97.03 | 39.35 | 35.13 | 12.41 | 35.34 | 104 | 48 | P | H | |
| | | 5939.6 | 52.01 | -16.19 | 68.2 | 39.71 | 35.2 | 12.44 | 35.34 | 104 | 48 | P | H | |
| | | | | | | | | | | | | | | H |
| | | | | | | | | | | | | | | H |
| | * | 5825 | 109.04 | - | - | 96.99 | 35 | 12.38 | 35.33 | 100 | 121 | 121 | P | V |
| | * | 5825 | 101.47 | - | - | 89.42 | 35 | 12.38 | 35.33 | 100 | 121 | 121 | A | V |
| | | 5850 | 62.57 | -59.63 | 122.2 | 50.5 | 35 | 12.4 | 35.33 | 100 | 121 | 121 | P | V |
| | | 5855.8 | 55.08 | -55.5 | 110.58 | 42.95 | 35.07 | 12.4 | 35.34 | 100 | 121 | 121 | P | V |
| | | 5879.8 | 51.39 | -50.24 | 101.63 | 39.19 | 35.13 | 12.41 | 35.34 | 100 | 121 | 121 | P | V |
| | | 5937 | 50.23 | -17.97 | 68.2 | 37.93 | 35.2 | 12.44 | 35.34 | 100 | 121 | 121 | P | V |
| | | | | | | | | | | | | | | V |
| | | | | | | | | | | | | | V | |
| Remark | 1. No other spurious found. 2. All results are PASS against Peak and Average limit line. | | | | | | | | | | | | | |



Band 4 5725~5850MHz

WIFI 802.11ac VHT20 (Harmonic @ 3m)

| WIFI Ant. 1 | Note | Frequency (MHz) | Level (dBμV/m) | Over Limit (dB) | Limit Line (dBμV/m) | Read Level (dBμV) | Antenna Factor (dB/m) | Path Loss (dB) | Preamp Factor (dB) | Ant Pos (cm) | Table Pos (deg) | Peak Avg. (P/A) | Pol. (H/V) | |
|-------------------------------|--|-------------------|------------------|-------------------|-----------------------|---------------------|-------------------------|------------------|----------------------|----------------|-------------------|-------------------|--------------|---|
| 802.11ac VHT20 CH 149 5745MHz | | 11490 | 44.28 | -29.72 | 74 | 45.14 | 38.18 | 18.48 | 57.52 | 100 | 0 | P | H | |
| | | 17235 | 49.47 | -18.73 | 68.2 | 41.3 | 41.53 | 22.95 | 56.31 | 100 | 0 | P | H | |
| | | | | | | | | | | | | | H | |
| | | | | | | | | | | | | | H | |
| | | | 11490 | 44.29 | -29.71 | 74 | 45.15 | 38.18 | 18.48 | 57.52 | 100 | 0 | P | V |
| | | | 17235 | 49.06 | -19.14 | 68.2 | 40.89 | 41.53 | 22.95 | 56.31 | 100 | 0 | P | V |
| | | | | | | | | | | | | | | V |
| 802.11ac VHT20 CH 157 5785MHz | | 11570 | 44.38 | -29.62 | 74 | 44.84 | 38.33 | 18.55 | 57.34 | 100 | 0 | P | H | |
| | | 17355 | 49.46 | -18.74 | 68.2 | 41.29 | 41.5 | 23.02 | 56.35 | 100 | 0 | P | H | |
| | | | | | | | | | | | | | H | |
| | | | | | | | | | | | | | H | |
| | | | 11570 | 45.25 | -28.75 | 74 | 45.71 | 38.33 | 18.55 | 57.34 | 100 | 0 | P | V |
| | | | 17355 | 50.31 | -17.89 | 68.2 | 42.14 | 41.5 | 23.02 | 56.35 | 100 | 0 | P | V |
| | | | | | | | | | | | | | | V |
| 802.11ac VHT20 CH 165 5825MHz | | 11650 | 44.97 | -29.03 | 74 | 45.05 | 38.44 | 18.63 | 57.15 | 100 | 0 | P | H | |
| | | 17475 | 48.73 | -19.47 | 68.2 | 40.69 | 41.33 | 23.09 | 56.38 | 100 | 0 | P | H | |
| | | | | | | | | | | | | | H | |
| | | | | | | | | | | | | | H | |
| | | | 11650 | 44.35 | -29.65 | 74 | 44.43 | 38.44 | 18.63 | 57.15 | 100 | 0 | P | V |
| | | | 17475 | 48.2 | -20 | 68.2 | 40.16 | 41.33 | 23.09 | 56.38 | 100 | 0 | P | V |
| | | | | | | | | | | | | | | V |
| Remark | 1. No other spurious found. | | | | | | | | | | | | | |
| | 2. All results are PASS against Peak and Average limit line. | | | | | | | | | | | | | |



Band 4 5725~5850MHz

WIFI 802.11ac VHT40 (Band Edge @ 3m)

| WIFI Ant. 1 | Note | Frequency (MHz) | Level (dBμV/m) | Over Limit (dB) | Limit Line (dBμV/m) | Read Level (dBμV) | Antenna Factor (dB/m) | Path Loss (dB) | Preamp Factor (dB) | Ant Pos (cm) | Table Pos (deg) | Peak Avg. (P/A) | Pol. (H/V) |
|-----------------|------|-------------------|------------------|-------------------|-----------------------|---------------------|-------------------------|------------------|----------------------|----------------|-------------------|-------------------|--------------|
| | | 5613.4 | 48.06 | -20.14 | 68.2 | 36.31 | 35 | 12.06 | 35.31 | 100 | 40 | P | H |
| | | 5700 | 53.65 | -51.55 | 105.2 | 41.77 | 35 | 12.2 | 35.32 | 100 | 40 | P | H |
| | | 5720 | 75.96 | -34.84 | 110.8 | 64.04 | 35 | 12.24 | 35.32 | 100 | 40 | P | H |
| | | 5722.8 | 77.31 | -39.87 | 117.18 | 65.39 | 35 | 12.24 | 35.32 | 100 | 40 | P | H |
| | * | 5755 | 107.7 | - | - | 95.73 | 35 | 12.3 | 35.33 | 100 | 40 | P | H |
| | * | 5755 | 100.09 | - | - | 88.12 | 35 | 12.3 | 35.33 | 100 | 40 | A | H |
| | | 5850.6 | 50.97 | -69.86 | 120.83 | 38.91 | 35 | 12.4 | 35.34 | 100 | 40 | P | H |
| | | 5874 | 50.41 | -55.07 | 105.48 | 38.21 | 35.13 | 12.41 | 35.34 | 100 | 40 | P | H |
| | | 5890.4 | 49.51 | -44.26 | 93.77 | 37.23 | 35.2 | 12.42 | 35.34 | 100 | 40 | P | H |
| | | 5934.4 | 49.95 | -18.25 | 68.2 | 37.65 | 35.2 | 12.44 | 35.34 | 100 | 40 | P | H |
| | | | | | | | | | | | | | H |
| | | | | | | | | | | | | | H |
| 802.11ac | | | | | | | | | | | | | |
| VHT40 | | | | | | | | | | | | | |
| CH 151 | | 5626.2 | 48.87 | -19.33 | 68.2 | 37.2 | 34.9 | 12.08 | 35.31 | 100 | 119 | P | V |
| 5755MHz | | 5690 | 53.79 | -44.04 | 97.83 | 41.92 | 35 | 12.19 | 35.32 | 100 | 119 | P | V |
| | | 5716.4 | 75.87 | -33.92 | 109.79 | 63.96 | 35 | 12.23 | 35.32 | 100 | 119 | P | V |
| | | 5724 | 78.17 | -41.75 | 119.92 | 66.25 | 35 | 12.24 | 35.32 | 100 | 119 | P | V |
| | * | 5755 | 106.39 | - | - | 94.42 | 35 | 12.3 | 35.33 | 100 | 119 | P | V |
| | * | 5755 | 98.9 | - | - | 86.93 | 35 | 12.3 | 35.33 | 100 | 119 | A | V |
| | | 5854.8 | 48.41 | -62.85 | 111.26 | 36.28 | 35.07 | 12.4 | 35.34 | 100 | 119 | P | V |
| | | 5864.2 | 49.54 | -58.68 | 108.22 | 37.41 | 35.07 | 12.4 | 35.34 | 100 | 119 | P | V |
| | | 5883.2 | 51.64 | -47.47 | 99.11 | 39.44 | 35.13 | 12.41 | 35.34 | 100 | 119 | P | V |
| | | 5931.6 | 50.31 | -17.89 | 68.2 | 38.01 | 35.2 | 12.44 | 35.34 | 100 | 119 | P | V |
| | | | | | | | | | | | | | V |
| | | | | | | | | | | | | | V |



| WIFI Ant. 1 | Note | Frequency (MHz) | Level (dBμV/m) | Over Limit (dB) | Limit Line (dBμV/m) | Read Level (dBμV) | Antenna Factor (dB/m) | Path Loss (dB) | Preamp Factor (dB) | Ant Pos (cm) | Table Pos (deg) | Peak Avg. (P/A) | Pol. (H/V) |
|-------------|---|-------------------|------------------|-------------------|-----------------------|---------------------|-------------------------|------------------|----------------------|----------------|-------------------|-------------------|--------------|
| | | 5645.6 | 49.29 | -18.91 | 68.2 | 37.68 | 34.8 | 12.12 | 35.31 | 100 | 40 | P | H |
| | | 5676.6 | 48.73 | -39.19 | 87.92 | 37.03 | 34.85 | 12.17 | 35.32 | 100 | 40 | P | H |
| | | 5714.4 | 51.02 | -58.21 | 109.23 | 39.11 | 35 | 12.23 | 35.32 | 100 | 40 | P | H |
| | | 5724.6 | 54.22 | -67.07 | 121.29 | 42.29 | 35 | 12.25 | 35.32 | 100 | 40 | P | H |
| | * | 5795 | 108.05 | - | - | 96.02 | 35 | 12.36 | 35.33 | 100 | 40 | P | H |
| | * | 5795 | 100.52 | - | - | 88.49 | 35 | 12.36 | 35.33 | 100 | 40 | A | H |
| | | 5853.6 | 55.85 | -58.14 | 113.99 | 43.72 | 35.07 | 12.4 | 35.34 | 100 | 40 | P | H |
| | | 5863.6 | 54.02 | -54.37 | 108.39 | 41.89 | 35.07 | 12.4 | 35.34 | 100 | 40 | P | H |
| | | 5878.2 | 52.79 | -50.03 | 102.82 | 40.59 | 35.13 | 12.41 | 35.34 | 100 | 40 | P | H |
| | | 5943 | 50.07 | -18.13 | 68.2 | 37.77 | 35.2 | 12.44 | 35.34 | 100 | 40 | P | H |
| 802.11ac | | | | | | | | | | | | | H |
| VHT40 | | | | | | | | | | | | | H |
| CH 159 | | 5636.4 | 48.21 | -19.99 | 68.2 | 36.62 | 34.8 | 12.1 | 35.31 | 100 | 120 | P | V |
| 5795MHz | | 5691.4 | 49.49 | -49.37 | 98.86 | 37.62 | 35 | 12.19 | 35.32 | 100 | 120 | P | V |
| | | 5719.2 | 51.86 | -58.72 | 110.58 | 39.94 | 35 | 12.24 | 35.32 | 100 | 120 | P | V |
| | | 5723.8 | 52.63 | -66.83 | 119.46 | 40.71 | 35 | 12.24 | 35.32 | 100 | 120 | P | V |
| | * | 5795 | 106.95 | - | - | 94.92 | 35 | 12.36 | 35.33 | 100 | 120 | P | V |
| | * | 5795 | 99.23 | - | - | 87.2 | 35 | 12.36 | 35.33 | 100 | 120 | A | V |
| | | 5851.2 | 55.43 | -64.03 | 119.46 | 43.37 | 35 | 12.4 | 35.34 | 100 | 120 | P | V |
| | | 5856.6 | 53.98 | -56.37 | 110.35 | 41.85 | 35.07 | 12.4 | 35.34 | 100 | 120 | P | V |
| | | 5883 | 50.53 | -48.73 | 99.26 | 38.33 | 35.13 | 12.41 | 35.34 | 100 | 120 | P | V |
| | | 5933.8 | 49.58 | -18.62 | 68.2 | 37.28 | 35.2 | 12.44 | 35.34 | 100 | 120 | P | V |
| | | | | | | | | | | | | | V |
| | | | | | | | | | | | | | V |
| Remark | 1. No other spurious found. 2. All results are PASS against Peak and Average limit line. | | | | | | | | | | | | |



Band 4 5725~5850MHz

WIFI 802.11ac VHT40 (Harmonic @ 3m)

| WIFI Ant. 1 | Note | Frequency (MHz) | Level (dBµV/m) | Over Limit (dB) | Limit Line (dBµV/m) | Read Level (dBµV) | Antenna Factor (dB/m) | Path Loss (dB) | Preamp Factor (dB) | Ant Pos (cm) | Table Pos (deg) | Peak Avg. (P/A) | Pol. (H/V) | |
|-------------------------------|--|-------------------|------------------|-------------------|-----------------------|---------------------|-------------------------|------------------|----------------------|----------------|-------------------|-------------------|--------------|---|
| 802.11ac VHT40 CH 151 5755MHz | | 11510 | 44.35 | -29.65 | 74 | 45.12 | 38.2 | 18.51 | 57.48 | 100 | 0 | P | H | |
| | | 17265 | 48.47 | -19.73 | 68.2 | 40.36 | 41.47 | 22.96 | 56.32 | 100 | 0 | P | H | |
| | | | | | | | | | | | | | H | |
| | | | | | | | | | | | | | H | |
| | | | 11510 | 44.7 | -29.3 | 74 | 45.47 | 38.2 | 18.51 | 57.48 | 100 | 0 | P | V |
| | | | 17265 | 48.71 | -19.49 | 68.2 | 40.6 | 41.47 | 22.96 | 56.32 | 100 | 0 | P | V |
| | | | | | | | | | | | | | | V |
| 802.11ac VHT40 CH 159 5795MHz | | 11590 | 46.31 | -27.69 | 74 | 46.66 | 38.37 | 18.57 | 57.29 | 100 | 0 | P | H | |
| | | 17385 | 50.12 | -18.08 | 68.2 | 41.87 | 41.57 | 23.04 | 56.36 | 100 | 0 | P | H | |
| | | | | | | | | | | | | | H | |
| | | | | | | | | | | | | | H | |
| | | | 11590 | 45.53 | -28.47 | 74 | 45.88 | 38.37 | 18.57 | 57.29 | 100 | 0 | P | V |
| | | | 17385 | 50.1 | -18.1 | 68.2 | 41.85 | 41.57 | 23.04 | 56.36 | 100 | 0 | P | V |
| | | | | | | | | | | | | | | V |
| Remark | 1. No other spurious found. | | | | | | | | | | | | | |
| | 2. All results are PASS against Peak and Average limit line. | | | | | | | | | | | | | |



Band 4 5725~5850MHz

WIFI 802.11ac VHT80 (Band Edge @ 3m)

| WIFI Ant. 1 | Note | Frequency (MHz) | Level (dBμV/m) | Over Limit (dB) | Limit Line (dBμV/m) | Read Level (dBμV) | Antenna Factor (dB/m) | Path Loss (dB) | Preamp Factor (dB) | Ant Pos (cm) | Table Pos (deg) | Peak Avg. (P/A) | Pol. (H/V) |
|-------------------------------|---|-------------------|------------------|-------------------|-----------------------|---------------------|-------------------------|------------------|----------------------|----------------|-------------------|-------------------|--------------|
| | | 5637.2 | 51.55 | -16.65 | 68.2 | 39.96 | 34.8 | 12.1 | 35.31 | 101 | 41 | P | H |
| | | 5695.6 | 72.98 | -28.98 | 101.96 | 61.1 | 35 | 12.2 | 35.32 | 101 | 41 | P | H |
| | | 5720 | 76.16 | -34.64 | 110.8 | 64.24 | 35 | 12.24 | 35.32 | 101 | 41 | P | H |
| | | 5722.8 | 76.73 | -40.45 | 117.18 | 64.81 | 35 | 12.24 | 35.32 | 101 | 41 | P | H |
| | * | 5775 | 104.63 | - | - | 92.63 | 35 | 12.33 | 35.33 | 101 | 41 | P | H |
| | * | 5775 | 97.37 | - | - | 85.37 | 35 | 12.33 | 35.33 | 101 | 41 | A | H |
| | | 5851.8 | 74.1 | -44 | 118.1 | 62.04 | 35 | 12.4 | 35.34 | 101 | 41 | P | H |
| | | 5861.2 | 72.43 | -36.63 | 109.06 | 60.3 | 35.07 | 12.4 | 35.34 | 101 | 41 | P | H |
| | | 5875.4 | 70.35 | -34.55 | 104.9 | 58.15 | 35.13 | 12.41 | 35.34 | 101 | 41 | P | H |
| | | 5932 | 52.27 | -15.93 | 68.2 | 39.97 | 35.2 | 12.44 | 35.34 | 101 | 41 | P | H |
| | | | | | | | | | | | | | H |
| | | | | | | | | | | | | | H |
| 802.11ac VHT80 CH 155 5775MHz | | 5632.8 | 50.73 | -17.47 | 68.2 | 39.15 | 34.8 | 12.09 | 35.31 | 100 | 119 | P | V |
| | | 5697.2 | 70.49 | -32.65 | 103.14 | 58.61 | 35 | 12.2 | 35.32 | 100 | 119 | P | V |
| | | 5718.8 | 77.65 | -32.81 | 110.46 | 65.73 | 35 | 12.24 | 35.32 | 100 | 119 | P | V |
| | | 5723.4 | 75.6 | -42.95 | 118.55 | 63.68 | 35 | 12.24 | 35.32 | 100 | 119 | P | V |
| | * | 5775 | 103.96 | - | - | 91.96 | 35 | 12.33 | 35.33 | 100 | 119 | P | V |
| | * | 5775 | 96.18 | - | - | 84.18 | 35 | 12.33 | 35.33 | 100 | 119 | A | V |
| | | 5850.2 | 74.08 | -47.66 | 121.74 | 62.02 | 35 | 12.4 | 35.34 | 100 | 119 | P | V |
| | | 5857.4 | 74.46 | -35.67 | 110.13 | 62.33 | 35.07 | 12.4 | 35.34 | 100 | 119 | P | V |
| | | 5875.8 | 66.52 | -38.09 | 104.61 | 54.32 | 35.13 | 12.41 | 35.34 | 100 | 119 | P | V |
| | | 5931.4 | 50.53 | -17.67 | 68.2 | 38.23 | 35.2 | 12.44 | 35.34 | 100 | 119 | P | V |
| | | | | | | | | | | | | | V |
| | | | | | | | | | | | | | V |
| Remark | 1. No other spurious found. 2. All results are PASS against Peak and Average limit line. | | | | | | | | | | | | |



Band 4 5725~5850MHz

WIFI 802.11ac VHT80 (Harmonic @ 3m)

| WIFI Ant. 1 | Note | Frequency (MHz) | Level (dBμV/m) | Over Limit (dB) | Limit Line (dBμV/m) | Read Level (dBμV) | Antenna Factor (dB/m) | Path Loss (dB) | Preamp Factor (dB) | Ant Pos (cm) | Table Pos (deg) | Peak Avg. (P/A) | Pol. (H/V) | |
|-------------------------------|---|-------------------|------------------|-------------------|-----------------------|---------------------|-------------------------|------------------|----------------------|----------------|-------------------|-------------------|--------------|---|
| 802.11ac VHT80 CH 155 5775MHz | | 11550 | 44.59 | -29.41 | 74 | 45.13 | 38.3 | 18.54 | 57.38 | 100 | 0 | P | H | |
| | | 17325 | 49.52 | -18.68 | 68.2 | 41.43 | 41.43 | 23 | 56.34 | 100 | 0 | P | H | |
| | | | | | | | | | | | | | H | |
| | | | | | | | | | | | | | H | |
| | | | 11550 | 44.38 | -29.62 | 74 | 44.92 | 38.3 | 18.54 | 57.38 | 100 | 0 | P | V |
| | | | 17325 | 48.85 | -19.35 | 68.2 | 40.76 | 41.43 | 23 | 56.34 | 100 | 0 | P | V |
| | | | | | | | | | | | | | | V |
| | | | | | | | | | | | | | | V |
| Remark | 1. No other spurious found. 2. All results are PASS against Peak and Average limit line. | | | | | | | | | | | | | |



Emission below 1GHz

5GHz WIFI 802.11ac VHT80 (LF)

| WIFI | Note | Frequency | Level | Over | Limit | Read | Antenna | Path | Preamp | Ant | Table | Peak | Pol. | |
|---------------------------------|--|-----------|------------|--------|------------|----------|----------|--------|--------|--------|---------|---------|---------|---|
| Ant. | | | | Limit | Line | Level | Factor | Loss | Factor | Pos | Pos | Avg. | | |
| 1 | | (MHz) | (dBµV/m) | (dB) | (dBµV/m) | (dBµV) | (dB/m) | (dB) | (dB) | (cm) | (deg) | (P/A) | (H/V) | |
| 5GHz 802.11ac VHT80 LF | | 30.27 | 22.27 | -17.73 | 40 | 27.03 | 24.32 | 0.93 | 30.01 | - | - | P | H | |
| | | 126.93 | 22.04 | -21.46 | 43.5 | 32.48 | 17.63 | 1.89 | 29.96 | - | - | P | H | |
| | | 147.18 | 24.47 | -19.03 | 43.5 | 35.12 | 17.27 | 2.03 | 29.95 | - | - | P | H | |
| | | 883.1 | 32.17 | -13.83 | 46 | 27.31 | 28.86 | 5.07 | 29.07 | - | - | P | H | |
| | | 944.7 | 32.54 | -13.46 | 46 | 26.2 | 29.82 | 5.25 | 28.73 | - | - | P | H | |
| | | 954.5 | 33.01 | -12.99 | 46 | 25.93 | 30.48 | 5.27 | 28.67 | 100 | 0 | P | H | |
| | | | | | | | | | | | | | | H |
| | | | | | | | | | | | | | | H |
| | | | | | | | | | | | | | | H |
| | | | | | | | | | | | | | | H |
| | | | | | | | | | | | | | | H |
| | | | | | | | | | | | | | | H |
| | | | | | | | | | | | | | | H |
| | | | 30 | 30.68 | -9.32 | 40 | 35.44 | 24.32 | 0.93 | 30.01 | 100 | 0 | P | V |
| | | | 48.63 | 27.38 | -12.62 | 40 | 41 | 15.19 | 1.18 | 29.99 | - | - | P | V |
| | | | 53.76 | 28.1 | -11.9 | 40 | 43.71 | 13.14 | 1.24 | 29.99 | - | - | P | V |
| | | | 913.9 | 32.39 | -13.61 | 46 | 27.27 | 28.87 | 5.16 | 28.91 | - | - | P | V |
| | | | 941.9 | 32.6 | -13.4 | 46 | 26.34 | 29.77 | 5.24 | 28.75 | - | - | P | V |
| | | | 957.3 | 33.24 | -12.76 | 46 | 26.15 | 30.47 | 5.28 | 28.66 | - | - | P | V |
| | | | | | | | | | | | | | V | |
| | | | | | | | | | | | | | V | |
| | | | | | | | | | | | | | V | |
| | | | | | | | | | | | | | V | |
| | | | | | | | | | | | | | V | |
| | | | | | | | | | | | | | V | |
| Remark | 1. No other spurious found. 2. All results are PASS against limit line. | | | | | | | | | | | | | |



Note symbol

| | |
|-----|--|
| * | Fundamental Frequency which can be ignored. However, the level of any unwanted emissions shall not exceed the level of the fundamental frequency. |
| ! | Test result is over limit line. |
| P/A | Peak or Average |
| H/V | Horizontal or Vertical |



A calculation example for radiated spurious emission is shown as below:

| WIFI | Note | Frequency | Level | Over | Limit | Read | Antenna | Path | Preamp | Ant | Table | Peak | Pol. |
|---------|------|-----------|------------|--------|------------|----------|----------|--------|--------|--------|---------|---------|---------|
| Ant. | | | | Limit | Line | Level | Factor | Loss | Factor | Pos | Pos | Avg. | |
| 1 | | (MHz) | (dBμV/m) | (dB) | (dBμV/m) | (dBμV) | (dB/m) | (dB) | (dB) | (cm) | (deg) | (P/A) | (H/V) |
| 802.11b | | 2390 | 55.45 | -18.55 | 74 | 54.51 | 32.22 | 4.58 | 35.86 | 103 | 308 | P | H |
| CH 01 | | | | | | | | | | | | | |
| 2412MHz | | 2390 | 43.54 | -10.46 | 54 | 42.6 | 32.22 | 4.58 | 35.86 | 103 | 308 | A | H |

1. Path Loss(dB) = Cable loss(dB) + Filter loss(dB) + Attenuator loss(dB)
2. Level(dBμV/m) = Antenna Factor(dB/m) + Path Loss(dB) + Read Level(dBμV) - Preamp Factor(dB)
3. Over Limit(dB) = Level(dBμV/m) – Limit Line(dBμV/m)

For Peak Limit @ 2390MHz:

1. Level(dBμV/m)
= Antenna Factor(dB/m) + Path Loss(dB) + Read Level(dBμV) - Preamp Factor(dB)
= 32.22(dB/m) + 4.58(dB) + 54.51(dBμV) – 35.86 (dB)
= 55.45 (dBμV/m)
2. Over Limit(dB)
= Level(dBμV/m) – Limit Line(dBμV/m)
= 55.45(dBμV/m) – 74(dBμV/m)
= -18.55(dB)

For Average Limit @ 2390MHz:

1. Level(dBμV/m)
= Antenna Factor(dB/m) + Path Loss(dB) + Read Level(dBμV) - Preamp Factor(dB)
= 32.22(dB/m) + 4.58(dB) + 42.6(dBμV) – 35.86 (dB)
= 43.54 (dBμV/m)
2. Over Limit(dB) = Level(dBμV/m) – Limit Line(dBμV/m)
= 43.54(dBμV/m) – 54(dBμV/m)
= -10.46(dB)

Both peak and average measured complies with the limit line, so test result is “PASS”.



Appendix C. Radiated Spurious Emission Plots

| | | | |
|-----------------|-----------------------------------|---------------------|---------|
| Test Engineer : | Jesse Wang, Stan Hsieh and Ken Wu | Temperature : | 22~23°C |
| | | Relative Humidity : | 51~59% |

Band 4 - 5725~5850MHz
WIFI 802.11a (Band Edge @ 3m)

| WIFI | Band 4 5725~5850MHz Band Edge @ 3m | |
|------|---|--|
| ANT | 802.11a CH149 5745MHz | |
| 1 | Horizontal | Fundamental |
| Peak | <p>Date: 2020-08-10 PEAK: 122.4</p> | <p>Date: 2020-08-10 PEAK: 122.4 AVG: 54</p> |
| | <p>Site : 03CH07-HY Condition : PEAK_BE(B4)_16-24 3m HF_ANT_00075962 HORIZONTAL Detector : Peak Project : 052917-01 Mode : 34</p> | <p>Site : 03CH07-HY Condition : PEAK(LIN)I 3m HF_ANT_00075962 HORIZONTAL Detector : Peak Project : 052917-01 Mode : 34</p> |



| | | |
|------|---|---|
| WIFI | Band 4 5725~5850MHz Band Edge @ 3m | |
| ANT | 802.11a CH149 5745MHz | |
| 1 | Vertical | Fundamental |
| Peak | <p>Site : ESCH07-RV Condition : PEAK_BE(B4)_16-24 3m HF_ANT_00075962 VERTICAL Detector : Peak Project : FR052917-01 Mode : 34</p> | <p>Site : ESCH07-RV Condition : PEAK(LNB)_3m HF_ANT_00075962 VERTICAL Detector : Peak Project : FR052917-01 Mode : 34</p> |

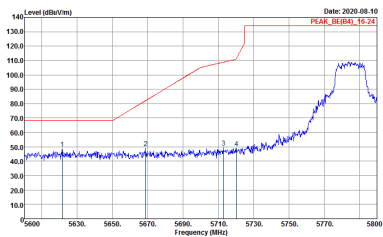
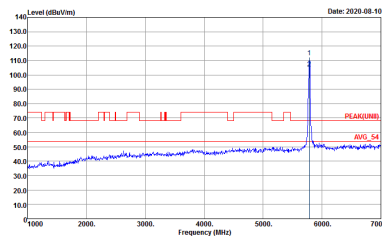
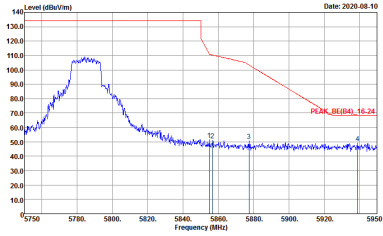

| WIFI | Band 4 5725~5850MHz Band Edge @ 3m | |
|--------------------|---|--|
| ANT | 802.11a CH157 5785MHz | |
| 1 | Horizontal | Fundamental |
| <p>Peak</p> |  <p>Site : 03CH07-HY Condition : PEAK_BE(B4)_16-24 3m HF_ANT_00075962 HORIZONTAL Detector : Peak Project : 052917-01 Mode : 35</p> |  <p>Site : 03CH07-HY Condition : PEAK(LNB) 3m HF_ANT_00075962 HORIZONTAL Detector : Peak Project : 052917-01 Mode : 35</p> |
| <p>Peak</p> |  <p>Site : 03CH07-HY Condition : PEAK_BE(B4)_16-24 3m HF_ANT_00075962 HORIZONTAL Detector : Peak Project : 052917-01 Mode : 35</p> | <p>Left blank</p> |

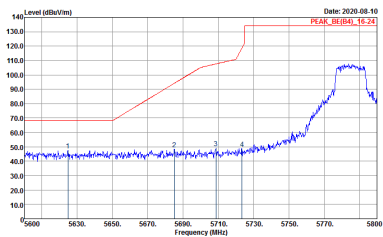
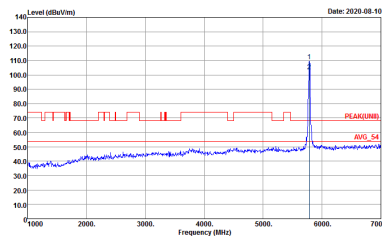
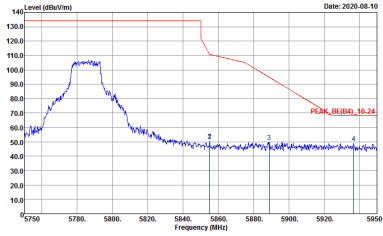

| WIFI | Band 4 5725~5850MHz Band Edge @ 3m | |
|--------------------|---|--|
| ANT | 802.11a CH157 5785MHz | |
| 1 | Vertical | Fundamental |
| <p>Peak</p> |  <p>Site : 03CH07-HY Condition : PEAK_BE(B4)_16-24 3m HF_ANT_00075962 VERTICAL Detector : Peak Project : 052917-01 Mode : 35</p> |  <p>Site : 03CH07-HY Condition : PEAK(LIN) 3m HF_ANT_00075962 VERTICAL Detector : Peak Project : 052917-01 Mode : 35</p> |
| <p>Peak</p> |  <p>Site : 03CH07-HY Condition : PEAK_BE(B4)_16-24 3m HF_ANT_00075962 VERTICAL Detector : Peak Project : 052917-01 Mode : 35</p> | <p>Left blank</p> |

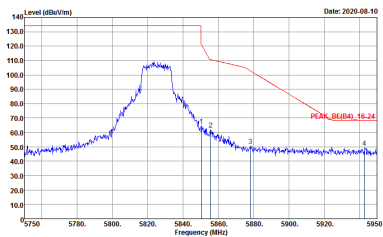
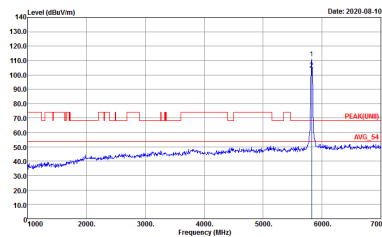

| | | |
|------|--|---|
| WIFI | Band 4 5725~5850MHz Band Edge @ 3m | |
| ANT | 802.11a CH165 5825MHz | |
| 1 | Horizontal | Fundamental |
| Peak |  <p>Site : E3CH07-RV Condition : PEAK_BE(B4) 16.24 3m HF_ANT_00075962 HORIZONTAL Detector : RBW:1000.000kHz VBW:3000.000kHz SWT:Auto Detector : Peak Project : FR052917-01 Mode : 36</p> |  <p>Site : E3CH07-RV Condition : PEAK(LIN) 3m HF_ANT_00075962 HORIZONTAL Detector : RBW:1000.000kHz VBW:3000.000kHz SWT:Auto Detector : Peak Project : FR052917-01 Mode : 36</p> |

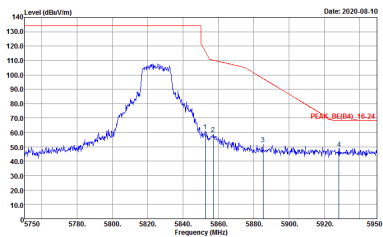
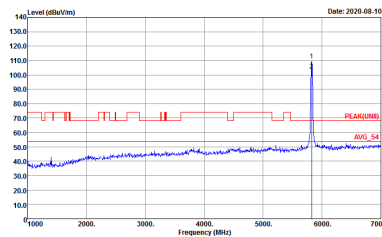

| | | |
|------|--|--|
| WIFI | Band 4 5725~5850MHz Band Edge @ 3m | |
| ANT | 802.11a CH165 5825MHz | |
| 1 | Vertical | Fundamental |
| Peak |  <p>Site : ESCH07-RV Condition : PEAK_BE(B4) 16-24 3m HF_ANT_00075962 VERTICAL Detector : RBW:1000.000kHz VBW:3000.000kHz SWT:Auto Detector : Peak Project : 052917-01 Mode : 36</p> |  <p>Site : ESCH07-RV Condition : PEAK(U/N1) 3m HF_ANT_00075962 VERTICAL Detector : RBW:1000.000kHz VBW:3000.000kHz SWT:Auto Detector : Peak Project : 052917-01 Mode : 36</p> |



**Band 4 5725~5850MHz
WIFI 802.11ac VHT20 (Band Edge @ 3m)**

| WIFI | Band 4 5725~5850MHz Band Edge @ 3m | |
|-------------|---|---|
| ANT | 802.11ac VHT20 CH149 5745MHz | |
| 1 | Horizontal | Fundamental |
| Peak | <p>Site : 03CH07-HY Condition : PEAK_BE(B4)_16-24 3m HF_ANT_00075962 HORIZONTAL Detector : Peak Project : 052917-01 Mode : 37</p> | <p>Site : 03CH07-HY Condition : PEAK(LIN) 3m HF_ANT_00075962 HORIZONTAL Detector : Peak Project : 052917-01 Mode : 37</p> |



| | | |
|-------------------------|---|---|
| WIFI | Band 4 5725~5850MHz Band Edge @ 3m | |
| ANT | 802.11ac VHT20 CH149 5745MHz | |
| 1 | Vertical | Fundamental |
| <p>Peak</p> <p>Avg.</p> | <p>Site : ESCH07-RV Condition : PEAK_BE(B4) 16-24 3m HF_ANT_00075962 VERTICAL Detector : RBW:1000.000kHz VBW:3000.000kHz SWT:Auto Project : FR052917-01 Mode : 37</p> | <p>Site : ESCH07-RV Condition : PEAKLNB 3m HF_ANT_00075962 VERTICAL Detector : RBW:1000.000kHz VBW:3000.000kHz SWT:Auto Project : FR052917-01 Mode : 37</p> |



| WIFI | Band 4 5725~5850MHz Band Edge @ 3m | |
|------|---|--|
| ANT | 802.11ac VHT20 CH157 5785MHz | |
| 1 | Horizontal | Fundamental |
| Peak | <p>Date: 2020.08.11 PEAK_BE(B4)_16-24</p> <p>Site : 03CH07-HY Condition : PEAK_BE(B4)_16-24 3m HF_ANT_00075962 HORIZONTAL Detector : RBW:1000.000kHz VBW:3000.000kHz SWT:Auto Project : 052917-01 Mode : 38</p> | <p>Date: 2020.08.11 PEAK(LNB) AVG_01</p> <p>Site : 03CH07-HY Condition : PEAK(LNB)_3m HF_ANT_00075962 HORIZONTAL Detector : RBW:1000.000kHz VBW:3000.000kHz SWT:Auto Project : 052917-01 Mode : 38</p> |
| Peak | <p>Date: 2020.08.11 PEAK_BE(B4)_16-24</p> <p>Site : 03CH07-HY Condition : PEAK_BE(B4)_16-24 3m HF_ANT_00075962 HORIZONTAL Detector : RBW:1000.000kHz VBW:3000.000kHz SWT:Auto Project : 052917-01 Mode : 38</p> | Left blank |

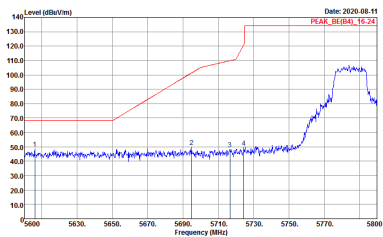
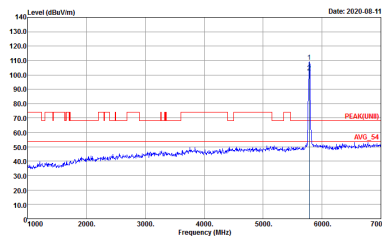
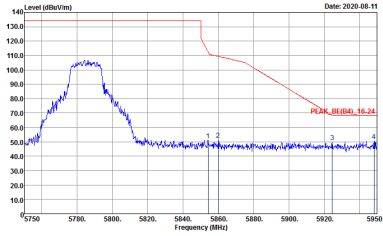

| WIFI | Band 4 5725~5850MHz Band Edge @ 3m | |
|--------------------|---|--|
| ANT | 802.11ac VHT20 CH157 5785MHz | |
| 1 | Vertical | Fundamental |
| <p>Peak</p> |  <p>Site : 03CH07-HY Condition : PEAK_BE(B4)_16-24 3m HF_ANT_00075962 VERTICAL Detector : Peak Project : 052917-01 Mode : 38</p> |  <p>Site : 03CH07-HY Condition : PEAK(LIN) 3m HF_ANT_00075962 VERTICAL Detector : Peak Project : 052917-01 Mode : 38</p> |
| <p>Peak</p> |  <p>Site : 03CH07-HY Condition : PEAK_BE(B4)_16-24 3m HF_ANT_00075962 VERTICAL Detector : Peak Project : 052917-01 Mode : 38</p> | <p>Left blank</p> |



| | | |
|------|---|---|
| WIFI | Band 4 5725~5850MHz Band Edge @ 3m | |
| ANT | 802.11ac VHT20 CH165 5825MHz | |
| 1 | Horizontal | Fundamental |
| Peak | <p>Site : E3CH07-11Y Condition : PEAK_BE(B4) 16-24 3m HF_ANT_00075962 HORIZONTAL Detector : RBW:1000.000KHz VBW:3000.000KHz SWT:Auto Detector : Peak Project : 052917-01 Mode : 39</p> | <p>Site : E3CH07-11Y Condition : PEAK(U11) 3m HF_ANT_00075962 HORIZONTAL Detector : RBW:1000.000KHz VBW:3000.000KHz SWT:Auto Detector : Peak Project : 052917-01 Mode : 39</p> |

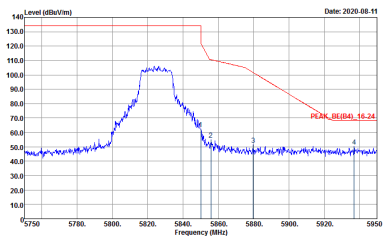
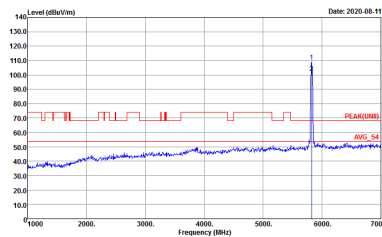

| WIFI | Band 4 5725~5850MHz Band Edge @ 3m | |
|---------------------------------------|---|--|
| ANT | 802.11ac VHT20 CH165 5825MHz | |
| 1 | Vertical | Fundamental |
| <p>Peak</p> <p>Avg.</p> |  <p>Date: 2020-08-11</p> <p>Site : ESCH07-RV Condition : PEAK_BE(B4) 16.24 3m HF_ANT_00075962 VERTICAL Detector : Peak Project : FR052917-01 Mode : 39</p> |  <p>Date: 2020-08-11</p> <p>Site : ESCH07-RV Condition : PEAK(UIN) 3m HF_ANT_00075962 VERTICAL Detector : Peak Project : FR052917-01 Mode : 39</p> |



Band 4 5725~5850MHz
WIFI 802.11ac VHT40 (Band Edge @ 3m)

| WIFI | Band 4 5725~5850MHz Band Edge @ 3m | |
|-------------|---|---|
| ANT | 802.11ac VHT40 CH151 5755MHz | |
| 1 | Horizontal | Fundamental |
| Peak | <p>Site : 03CH07-HY Condition : PEAK_BE(B4)_16.24 3m HF_ANT_00075962 HORIZONTAL Detector : Peak Project : 052917-01 Mode : 40</p> | <p>Site : 03CH07-HY Condition : PEAK(LIN) 3m HF_ANT_00075962 HORIZONTAL Detector : Peak Project : 052917-01 Mode : 40</p> |
| Peak | <p>Site : 03CH07-HY Condition : PEAK_BE(B4)_16.24 3m HF_ANT_00075962 HORIZONTAL Detector : Peak Project : 052917-01 Mode : 40</p> | Left blank |



| WIFI | Band 4 5725~5850MHz Band Edge @ 3m | |
|--------------------|---|--|
| ANT | 802.11ac VHT40 CH151 5755MHz | |
| 1 | Vertical | Fundamental |
| <p>Peak</p> | <p>Date: 2020.08.11 PEAK_BE(B4)_16-24</p> <p>Site : 03CH07-HY Condition : PEAK_BE(B4)_16-24 3m HF_ANT_00075962 VERTICAL Detector : RBW:1000.000kHz VBW:3000.000kHz SWT:Auto Project : 052917-01 Mode : 40</p> | <p>Date: 2020.08.11 PEAK(FUNB) AVG_01</p> <p>Site : 03CH07-HY Condition : PEAK(FUNB)_3m HF_ANT_00075962 VERTICAL Detector : RBW:1000.000kHz VBW:3000.000kHz SWT:Auto Project : 052917-01 Mode : 40</p> |
| <p>Peak</p> | <p>Date: 2020.08.11 PEAK_BE(B4)_16-24</p> <p>Site : 03CH07-HY Condition : PEAK_BE(B4)_16-24 3m HF_ANT_00075962 VERTICAL Detector : RBW:1000.000kHz VBW:3000.000kHz SWT:Auto Project : 052917-01 Mode : 40</p> | <p>Left blank</p> |

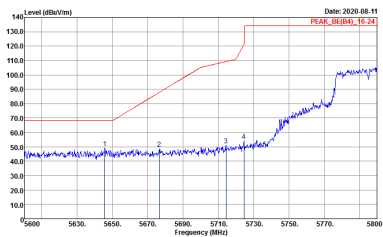
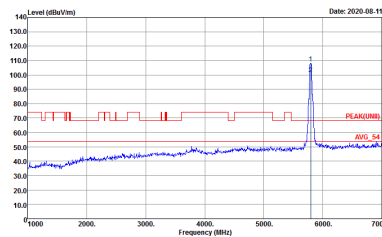
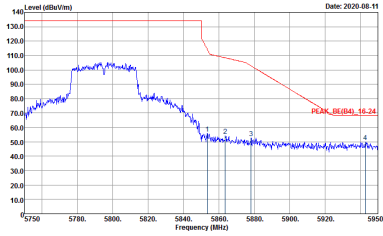

| WIFI | Band 4 5725~5850MHz Band Edge @ 3m | |
|--------------------|---|--|
| ANT | 802.11ac VHT40 CH159 5795MHz | |
| 1 | Horizontal | Fundamental |
| <p>Peak</p> |  <p>Site : 03CH07-HY Condition : PEAK_BE(B4)_16-24 3m HF_ANT_00075962 HORIZONTAL Detector : Peak Project : 052917-01 Mode : 41</p> |  <p>Site : 03CH07-HY Condition : PEAK(LIN) 3m HF_ANT_00075962 HORIZONTAL Detector : Peak Project : 052917-01 Mode : 41</p> |
| <p>Peak</p> |  <p>Site : 03CH07-HY Condition : PEAK_BE(B4)_16-24 3m HF_ANT_00075962 HORIZONTAL Detector : Peak Project : 052917-01 Mode : 41</p> | <p>Left blank</p> |

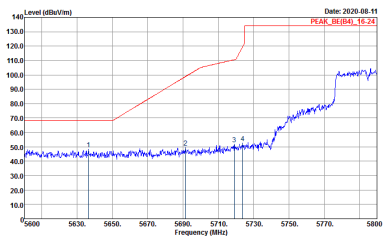
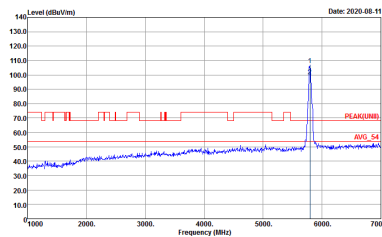
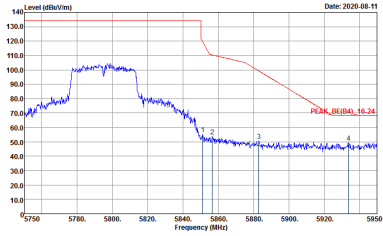

| WIFI | Band 4 5725~5850MHz Band Edge @ 3m | |
|--------------------|---|--|
| ANT | 802.11ac VHT40 CH159 5795MHz | |
| 1 | Vertical | Fundamental |
| <p>Peak</p> |  <p>Site : 03CH07-HY Condition : PEAK_BE(B4)_16-24 3m HF_ANT_00075962 VERTICAL Detector : Peak Project : 052917-01 Mode : 41</p> |  <p>Site : 03CH07-HY Condition : PEAK(LNB) 3m HF_ANT_00075962 VERTICAL Detector : Peak Project : 052917-01 Mode : 41</p> |
| <p>Peak</p> |  <p>Site : 03CH07-HY Condition : PEAK_BE(B4)_16-24 3m HF_ANT_00075962 VERTICAL Detector : Peak Project : 052917-01 Mode : 41</p> | <p>Left blank</p> |



Band 4 5725~5850MHz
WIFI 802.11ac VHT80 (Band Edge @ 3m)

| WIFI | Band 4 5725~5850MHz Band Edge @ 3m | |
|-------------|---|---|
| ANT | 802.11ac VHT80 CH155 5775MHz | |
| 1 | Horizontal | Fundamental |
| Peak | <p>Site : 03CH07-HY Condition : PEAK_BE(B4)_16-24 3m HF_ANT_00075962 HORIZONTAL Detector : Peak Project : 052917-01 Mode : 42</p> | <p>Site : 03CH07-HY Condition : PEAK(LIN) 3m HF_ANT_00075962 HORIZONTAL Detector : Peak Project : 052917-01 Mode : 42</p> |
| Peak | <p>Site : 03CH07-HY Condition : PEAK_BE(B4)_16-24 3m HF_ANT_00075962 HORIZONTAL Detector : Peak Project : 052917-01 Mode : 42</p> | Left blank |

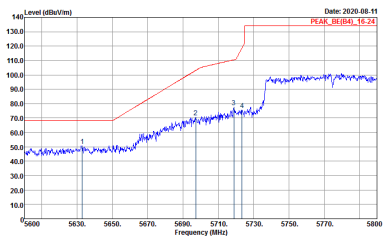
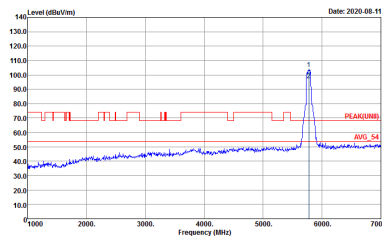
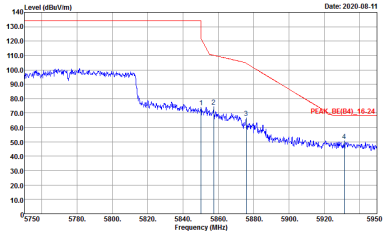

| WIFI | Band 4 5725~5850MHz Band Edge @ 3m | |
|--------------------|---|--|
| ANT | 802.11ac VHT80 CH155 5775MHz | |
| 1 | Vertical | Fundamental |
| <p>Peak</p> |  <p>Site : 03CH07-HY Condition : PEAK_BE(B4)_16-24 3m HF_ANT_00075962 VERTICAL Detector : Peak Project : 052917-01 Mode : 42</p> |  <p>Site : 03CH07-HY Condition : PEAK(LIN) 3m HF_ANT_00075962 VERTICAL Detector : Peak Project : 052917-01 Mode : 42</p> |
| <p>Peak</p> |  <p>Site : 03CH07-HY Condition : PEAK_BE(B4)_16-24 3m HF_ANT_00075962 VERTICAL Detector : Peak Project : 052917-01 Mode : 42</p> | <p>Left blank</p> |



Band 4 - 5725~5850MHz
WIFI 802.11a (Harmonic @ 3m)

| | | |
|----------------------------|---|---|
| WIFI | Band 4 5725~5850MHz Harmonic @ 3m | |
| ANT | 802.11a CH149 5745MHz | |
| 1 | Horizontal | Vertical |
| Peak Avg. | <p>Site : 03CH07-HY Condition : PEAK(UWB) 3m HF_ANT_00075962 HORIZONTAL Detector : Peak Project : 052917-01 Mode : 34</p> | <p>Site : 03CH07-HY Condition : PEAK(UWB) 3m HF_ANT_00075962 VERTICAL Detector : Peak Project : 052917-01 Mode : 34</p> |



| | | |
|--------------|---|---|
| WIFI | Band 4 5725~5850MHz Harmonic @ 3m | |
| ANT | 802.11a CH157 5785MHz | |
| 1 | Horizontal | Vertical |
| Peak Avg. | <p>Site : ESCH07-RV Condition : PEAK(LIN) 3m HE_ANT_00075962 HORIZONTAL Detector : Peak Project : 052917-01 Mode : 35</p> | <p>Site : ESCH07-RV Condition : PEAK(LIN) 3m HE_ANT_00075962 VERTICAL Detector : Peak Project : 052917-01 Mode : 35</p> |



| | | |
|----------------------------|--|--|
| WIFI | Band 4 5725~5850MHz Harmonic @ 3m | |
| ANT | 802.11a CH165 5825MHz | |
| 1 | Horizontal | Vertical |
| Peak Avg. | <p>Site : ESCH07-11Y Condition : PEAK(LIN) 3m HE_ANT_00075962 HORIZONTAL Detector : Peak Project : 052917-01 Mode : 36</p> | <p>Site : ESCH07-11Y Condition : PEAK(LIN) 3m HE_ANT_00075962 VERTICAL Detector : Peak Project : 052917-01 Mode : 36</p> |



**Band 4 5725~5850MHz
WIFI 802.11ac VHT20 (Harmonic @ 3m)**

| WIFI | Band 4 5725~5850MHz Harmonic @ 3m | |
|------------------------------------|---|---|
| ANT | 802.11ac VHT20 CH149 5745MHz | |
| 1 | Horizontal | Vertical |
| <p>Peak Avg.</p> | <p>Date: 2020.08.11</p> <p>Site : 03CH07-HY Condition : PEAK(LIN) 3m HF_ANT_00075962 HORIZONTAL Preamplifier : RBW:1000.000kHz VBW:2000.000kHz SWT:Auto Detector : Peak Project : 052917-01 Mode : 37</p> | <p>Date: 2020.08.11</p> <p>Site : 03CH07-HY Condition : PEAK(LIN) 3m HF_ANT_00075962 VERTICAL Preamplifier : RBW:1000.000kHz VBW:2000.000kHz SWT:Auto Detector : Peak Project : 052917-01 Mode : 37</p> |

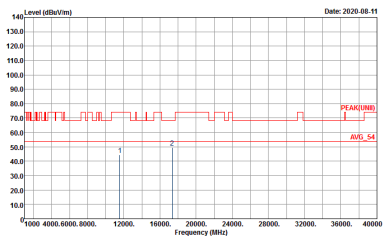
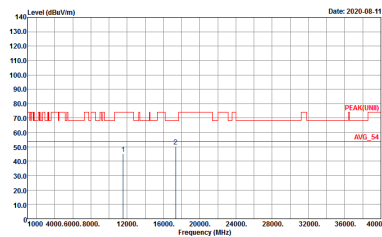

| | | |
|-------------------------|---|--|
| WIFI | Band 4 5725~5850MHz Harmonic @ 3m | |
| ANT | 802.11ac VHT20 CH157 5785MHz | |
| 1 | Horizontal | Vertical |
| <p>Peak</p> <p>Avg.</p> |  <p>Site : ESCH07-RV Condition : PEAK(LIN) 3m HE_ANT_00075962 HORIZONTAL Detector : Peak Project : 052917-01 Mode : 38</p> |  <p>Site : ESCH07-RV Condition : PEAK(LIN) 3m HE_ANT_00075962 VERTICAL Detector : Peak Project : 052917-01 Mode : 38</p> |

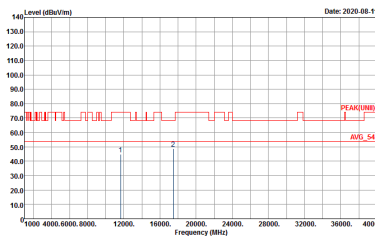
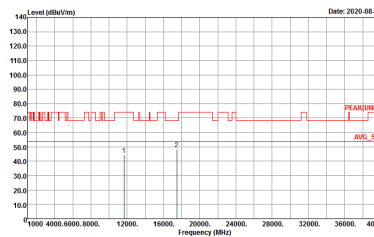

| | | |
|-------------------------|---|--|
| WIFI | Band 4 5725~5850MHz Harmonic @ 3m | |
| ANT | 802.11ac VHT20 CH165 5825MHz | |
| 1 | Horizontal | Vertical |
| <p>Peak</p> <p>Avg.</p> |  <p>Site : ESCH07-RV Condition : PEAK(LIN) 3m HE_ANT_00075962 HORIZONTAL Detector : Peak Project : 052917-01 Mode : 39</p> |  <p>Site : ESCH07-RV Condition : PEAK(LIN) 3m HE_ANT_00075962 VERTICAL Detector : Peak Project : 052917-01 Mode : 39</p> |

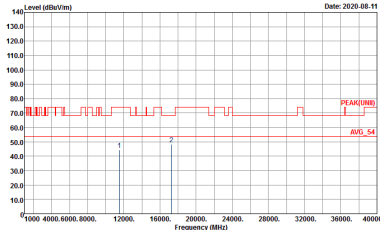
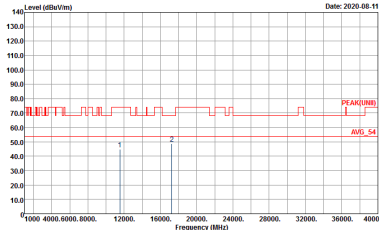

**Band 4 5725~5850MHz
WIFI 802.11ac VHT40 (Harmonic @ 3m)**

| WIFI | Band 4 5725~5850MHz Harmonic @ 3m | |
|------------------------------------|--|---|
| ANT | 802.11ac VHT40 CH151 5755MHz | |
| 1 | Horizontal | Vertical |
| <p>Peak Avg.</p> |  <p>Date: 2020.08.11</p> <p>Site : 03CH07-HY Condition : PEAK(UNII) 3m HF_ANT_00075962 HORIZONTAL Detector : Peak Project : 052917-01 Mode : 40</p> |  <p>Date: 2020.08.11</p> <p>Site : 03CH07-HY Condition : PEAK(UNII) 3m HF_ANT_00075962 VERTICAL Detector : Peak Project : 052917-01 Mode : 40</p> |

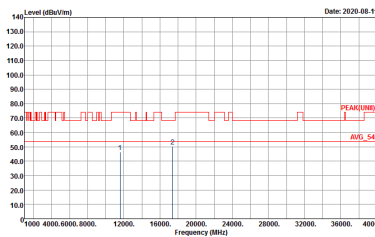
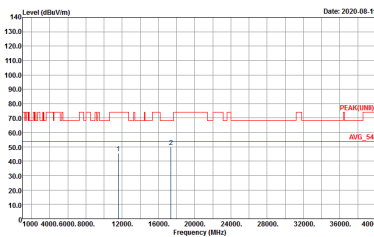

| | | |
|---------------------------------------|---|--|
| WIFI | Band 4 5725~5850MHz Harmonic @ 3m | |
| ANT | 802.11ac VHT40 CH159 5795MHz | |
| 1 | Horizontal | Vertical |
| <p>Peak</p> <p>Avg.</p> |  <p>Site : ESCH07-RV Condition : PEAK(LIN) 3m HE_ANT_00075962 HORIZONTAL Detector : Peak Project : 052917-01 Mode : 41</p> |  <p>Site : ESCH07-RV Condition : PEAK(LIN) 3m HE_ANT_00075962 VERTICAL Detector : Peak Project : 052917-01 Mode : 41</p> |



Band 4 5725~5850MHz
WIFI 802.11ac VHT80 (Harmonic @ 3m)

Table with 2 columns: Horizontal and Vertical. It contains two spectral plots showing Level (dBm/100MHz) vs Frequency (MHz) for Peak and Avg. measurements. Includes site and condition details for each plot.



Emission below 1GHz
5GHz WIFI 802.11ac VHT80 (LF)

| WIFI | 5GHz WIFI | |
|--------------|---|---|
| ANT | 802.11ac VHT80 LF | |
| 1 | Horizontal | Vertical |
| QP / Peak | <p>Site : 03CH07-HY Condition : QP 3m LF ANT: 35419(6) HORIZONTAL Detector : Peak Project : 052917-01 Mode : 44</p> | <p>Site : 03CH07-HY Condition : QP 3m LF ANT: 35419(6) VERTICAL Detector : Peak Project : 052917-01 Mode : 44</p> |



Appendix D. Duty Cycle Plots

| Band | Duty Cycle(%) | T(us) | 1/T(kHz) | VBW Setting | Duty Factor(dB) |
|---------------------|---------------|-------|----------|-------------|-----------------|
| 802.11a | 98.57 | - | - | 10Hz | 0.06 |
| 5GHz 802.11ac VHT20 | 97.98 | 1940 | 0.52 | 1kHz | 0.09 |
| 5GHz 802.11ac VHT40 | 96.96 | 950 | 1.05 | 3kHz | 0.13 |
| 5GHz 802.11ac VHT80 | 92.22 | 462 | 2.16 | 3kHz | 0.35 |

