



FCC RADIO TEST REPORT

FCC ID : UZ7MC27AK
Equipment : Mobile computer
Brand Name : Zebra
Model Name : MC27AK
Applicant : Zebra Technologies Corporation
1 Zebra Plaza, Holtsville, NY 11742
Manufacturer : Zebra Technologies Corporation
1 Zebra Plaza, Holtsville, NY 11742
Standard : FCC Part 15 Subpart E §15.407

The product was received on Jul. 07, 2020 and testing was started from Aug. 03, 2020 and completed on Aug. 29, 2020. We, SPORTON INTERNATIONAL INC., EMC & Wireless Communications Laboratory, would like to declare that the tested sample has been evaluated in accordance with the test procedures and has been in compliance with the applicable technical standards.

The test results in this report apply exclusively to the tested model / sample. Without written approval of SPORTON INTERNATIONAL INC. EMC & Wireless Communications Laboratory, the test report shall not be reproduced except in full.

Louis Wu

Approved by: Louis Wu

SPORTON INTERNATIONAL INC. EMC & Wireless Communications Laboratory
No. 52, Huaya 1st Rd., Guishan Dist., Taoyuan City, Taiwan (R.O.C.)



Table of Contents

History of this test report..... 3

Summary of Test Result..... 4

1 General Description 5

 1.1 Product Feature of Equipment Under Test..... 5

 1.2 Product Specification of Equipment Under Test..... 6

 1.3 Modification of EUT 6

 1.4 Testing Location 7

 1.5 Applicable Standards..... 7

2 Test Configuration of Equipment Under Test 8

 2.1 Carrier Frequency and Channel 8

 2.2 Test Mode..... 9

 2.3 Connection Diagram of Test System 14

 2.4 Support Unit used in test configuration and system 15

 2.5 EUT Operation Test Setup 15

 2.6 Measurement Results Explanation Example..... 15

3 Test Result 16

 3.1 26dB & 99% Occupied Bandwidth Measurement 16

 3.2 Maximum Conducted Output Power Measurement 20

 3.3 Power Spectral Density Measurement 25

 3.4 Unwanted Emissions Measurement 30

 3.5 AC Conducted Emission Measurement..... 35

 3.6 Automatically Discontinue Transmission 37

 3.7 Antenna Requirements 38

4 List of Measuring Equipment..... 39

5 Uncertainty of Evaluation 41

Appendix A. AC Conducted Emission Test Result

Appendix B. Radiated Spurious Emission

Appendix C. Radiated Spurious Emission Plots

Appendix D. Duty Cycle Plots

Appendix E. Setup Photographs



History of this test report

Report No.	Version	Description	Issued Date
FR052917-01E	01	Initial issue of report	Oct. 23, 2020



Summary of Test Result

Report Clause	Ref Std. Clause	Test Items	Result (PASS/FAIL)	Remark
3.1	15.403(i)	26dB Bandwidth	Pass	-
3.1	2.1049	99% Occupied Bandwidth	Reporting only	-
3.2	15.407(a)	Maximum Conducted Output Power	Pass	-
3.3	15.407(a)	Power Spectral Density	Pass	-
3.4	15.407(b)	Unwanted Emissions	Pass	Under limit 1.34 dB at 5350.080 MHz and 5725.320 MHz
3.5	15.207	AC Conducted Emission	Pass	Under limit 17.08 dB at 13.560 MHz
3.6	15.407(c)	Automatically Discontinue Transmission	Pass	-
3.7	15.203 15.407(a)	Antenna Requirement	Pass	-

Declaration of Conformity:

The test results with all measurement uncertainty excluded are presented in accordance with the regulation limits or requirements declared by manufacturers.

Comments and Explanations:

The declared of product specification for EUT presented in the report are provided by the manufacturer, and the manufacturer takes all the responsibilities for the accuracy of product specification.

Reviewed by: Wii Chang**Report Producer: Cindy Liu**



1 General Description

1.1 Product Feature of Equipment Under Test

Product Feature	
Equipment	Mobile computer
Brand Name	Zebra
Model Name	MC27AK
FCC ID	UZ7MC27AK
EUT supports Radios application	WCDMA/HSPA/LTE/NFC/GNSS WLAN 11a/b/g/n HT20/HT40 WLAN 11ac VHT20/VHT40/VHT80 Bluetooth BR/EDR/LE
HW Version	EV
SW Version	10-11-31.00-QG-U00-PRD-HEL-04
OS Version	Android 10
MFD	23JUN20
EUT Stage	Engineering Sample

Remark: The above EUT's information was declared by manufacturer.

Specification of Accessories				
AC Adapter	Brand Name	Zebra	Part Number	PWR-WUA5V12W0US
Battery	Brand Name	Zebra	Part Number	BT-000418-10
USB Cable (TypeA plug to TypeC plug)	Brand Name	Zebra	Part Number	CBL-TC2X-USBC-01
Trigger Handle	Brand Name	Zebra	Part Number	TRG-MC2X-SNP1-01
Holster	Brand Name	Zebra	Part Number	SG-MC2X-HLSTR-01
Holster	Brand Name	Zebra	Part Number	SG-MC3021212-01R

1.2 Product Specification of Equipment Under Test

Product Specification subjective to this standard	
Tx/Rx Frequency Range	5180 MHz ~ 5240 MHz 5260 MHz ~ 5320 MHz 5500 MHz ~ 5720 MHz
Maximum Output Power to Antenna	<5180 MHz ~ 5240 MHz> 802.11a: 19.00 dBm / 0.0794 W 802.11n HT20: 18.80 dBm / 0.0759 W 802.11n HT40: 18.90 dBm / 0.0776 W 802.11ac VHT20: 18.90 dBm / 0.0776 W 802.11ac VHT40: 19.00 dBm / 0.0794 W 802.11ac VHT80: 17.70 dBm / 0.0589 W <5260 MHz ~ 5320 MHz> 802.11a: 19.30 dBm / 0.0851 W 802.11n HT20: 19.20 dBm / 0.0832 W 802.11n HT40: 19.30 dBm / 0.0851 W 802.11ac VHT20: 19.30 dBm / 0.0851 W 802.11ac VHT40: 19.40 dBm / 0.0871 W 802.11ac VHT80: 15.80 dBm / 0.0380 W <5500 MHz ~ 5720 MHz> 802.11a: 20.00 dBm / 0.1000 W 802.11n HT20: 19.90 dBm / 0.0977 W 802.11n HT40: 19.90 dBm / 0.0977 W 802.11ac VHT20: 20.00 dBm / 0.1000 W 802.11ac VHT40: 20.00 dBm / 0.1000 W 802.11ac VHT80: 20.00 dBm / 0.1000 W
99% Occupied Bandwidth	802.11a: 22.68 MHz 802.11ac VHT20: 24.48 MHz 802.11ac VHT40: 51.85 MHz 802.11ac VHT80: 77.32 MHz
Antenna Type / Gain	<5180 MHz ~ 5240 MHz> PIFA Antenna with gain 2.63 dBi <5260 MHz ~ 5320 MHz> PIFA Antenna with gain 2.63 dBi <5500 MHz ~ 5720 MHz> PIFA Antenna with gain 3.65 dBi
Type of Modulation	802.11a/n : OFDM (BPSK/QPSK/16QAM/64QAM) 802.11ac : OFDM (BPSK/QPSK/16QAM/64QAM/256QAM)

1.3 Modification of EUT

No modifications are made to the EUT during all test items.



1.4 Testing Location

Test Site	SPORTON INTERNATIONAL INC. EMC & Wireless Communications Laboratory		
Test Site Location	No.52, Huaya 1st Rd., Guishan Dist., Taoyuan City, Taiwan (R.O.C.) TEL: +886-3-327-3456 FAX: +886-3-328-4978		
Test Site No.	Sporton Site No.		
	TH05-HY	CO05-HY	03CH07-HY

Note: The test site complies with ANSI C63.4 2014 requirement.

FCC designation No.: TW1190

1.5 Applicable Standards

According to the specifications of the manufacturer, the EUT must comply with the requirements of the following standards:

- ♦ FCC Part 15 Subpart E
- ♦ FCC KDB 789033 D02 General UNII Test Procedures New Rules v02r01.
- ♦ FCC KDB 414788 D01 Radiated Test Site v01r01.
- ♦ ANSI C63.10-2013

Remark:

1. All test items were verified and recorded according to the standards and without any deviation during the test.
2. The TAF code is not including all the FCC KDB listed without accreditation.
3. This EUT has also been tested and complied with the requirements of FCC Part 15, Subpart B, recorded in a separate test report.



2 Test Configuration of Equipment Under Test

- a. The EUT has been associated with peripherals and configuration operated in a manner tended to maximize its emission characteristics in a typical application. Frequency range investigated: conduction emission (150 kHz to 30 MHz), radiation emission (9 kHz to the 10th harmonic of the highest fundamental frequency or to 40 GHz, whichever is lower). For radiated measurement, pre-scanned in three orthogonal panels, X, Y, Z. The worst cases (X plane) were recorded in this report.
- b. AC power line Conducted Emission was tested under maximum output power.

2.1 Carrier Frequency and Channel

Frequency Band	Channel	Freq. (MHz)	Channel	Freq. (MHz)
5150-5250 MHz Band 1 (U-NII-1)	36	5180	44	5220
	38*	5190	46*	5230
	40	5200	48	5240
	42 [#]	5210		

Frequency Band	Channel	Freq. (MHz)	Channel	Freq. (MHz)
5250-5350 MHz Band 2 (U-NII-2A)	52	5260	60	5300
	54*	5270	62*	5310
	56	5280	64	5320
	58 [#]	5290		

Frequency Band	Channel	Freq. (MHz)	Channel	Freq. (MHz)
5470-5725 MHz Band 3 (U-NII-2C)	100	5500	112	5560
	102*	5510	116	5580
	104	5520	132	5660
	106 [#]	5530	134*	5670
	108	5540	136	5680
	110*	5550	140	5700



Frequency Band	Channel	Freq. (MHz)	Channel	Freq. (MHz)
TDWR Channel	118*	5590	124	5620
	120	5600	126*	5630
	122 [#]	5610	128	5640

Frequency Band	Channel	Freq. (MHz)	Channel	Freq. (MHz)
Straddle Channel	138 [#]	5690	144	5720
	142*	5710		

Note:

1. The above Frequency and Channel in "*" were 802.11n HT40 and 802.11ac VHT40.
2. The above Frequency and Channel in "[#]" were 802.11ac VHT80.

2.2 Test Mode

Final test modes are considering the modulation and worse data rates as below table.

Modulation	Data Rate
802.11a	6 Mbps
802.11n HT20 (Covered by VHT20)	MCS0
802.11n HT40 (Covered by VHT40)	MCS0
802.11ac VHT20	MCS0
802.11ac VHT40	MCS0
802.11ac VHT80	MCS0

Test Cases	
AC Conducted Emission	Mode 1 : WLAN (5GHz) Link + Bluetooth Link + NFC On + Battery + USB Cable (Charging from AC Adapter)



Ch. #		Band I : 5150-5250 MHz	Band II : 5250-5350 MHz	Band III : 5470-5725MHz
		802.11a	802.11a	802.11a
L	Low	36	52	100
M	Middle	44	60	116
H	High	48	64	140
Straddle		-	-	144

Ch. #		Band I : 5150-5250 MHz	Band II : 5250-5350 MHz	Band III : 5470-5725MHz
		802.11ac VHT20	802.11ac VHT20	802.11ac VHT20
L	Low	36	52	100
M	Middle	44	60	116
H	High	48	64	140
Straddle		-	-	144

Ch. #		Band I : 5150-5250 MHz	Band II : 5250-5350 MHz	Band III : 5470-5725MHz
		802.11ac VHT40	802.11ac VHT40	802.11ac VHT40
L	Low	38	54	102
M	Middle	-	-	110
H	High	46	62	134
Straddle		-	-	142

Ch. #		Band I : 5150-5250 MHz	Band II : 5250-5350 MHz	Band III : 5470-5725MHz
		802.11ac VHT80	802.11ac VHT80	802.11ac VHT80
L	Low	-	-	106
M	Middle	42	58	122
H	High	-	-	-
Straddle		-	-	138

Remark: For radiation spurious emission, the final modulation and the worst data rate was reference the max RF conducted power.



802.11a RF Output Power (dBm)										
Power vs. Channel			Power vs Data Rate							
Channel	Frequency (MHz)	Data Rate (bps)	Channel	Data Rate (bps)						
		6M		9M	12M	18M	24M	36M	48M	54M
CH 036	5180	18.80	CH 048	18.80	18.80	18.60	18.50	18.60	18.70	18.70
CH 044	5220	18.70								
CH 048	5240	19.00								
CH 052	5260	19.20	CH 060	19.20	19.20	18.90	18.70	19.20	19.20	19.20
CH 060	5300	19.30								
CH 064	5320	19.20								
CH 100	5500	19.90	CH 116	19.90	19.90	19.90	19.80	19.90	19.90	19.90
CH 116	5580	20.00								
CH 140	5700	19.60								
CH 144*	5720	20.00								

Note: The above Frequency and Channel in "*" were straddle Channel.

802.11n HT20 RF Output Power (dBm)										
Power vs. Channel			Power vs Data Rate							
Channel	Frequency (MHz)	MCS Index	Channel	MCS Index						
		MCS0		MCS1	MCS2	MCS3	MCS4	MCS5	MCS6	MCS7
CH 036	5180	18.60	CH 048	18.70	18.40	18.40	18.70	18.60	18.70	18.70
CH 044	5220	18.50								
CH 048	5240	18.80								
CH 052	5260	19.00	CH 064	19.10	19.10	19.10	19.10	19.10	19.10	19.10
CH 060	5300	19.10								
CH 064	5320	19.20								
CH 100	5500	19.70	CH 140	19.60	19.50	19.40	19.60	19.50	19.50	19.60
CH 116	5580	19.80								
CH 140	5700	19.90								
CH 144*	5720	19.80								

Note: The above Frequency and Channel in "*" were straddle Channel.



802.11n HT40 RF Output Power (dBm)										
Power vs. Channel			Power vs Data Rate							
Channel	Frequency (MHz)	MCS Index	Channel	MCS Index						
		MCS0		MCS1	MCS2	MCS3	MCS4	MCS5	MCS6	MCS7
CH 038	5190	17.80	CH 046	18.80	18.80	18.80	18.50	18.60	18.50	18.50
CH 046	5230	18.90								
CH 054	5270	19.30	CH 054	19.20	19.20	19.20	18.80	18.80	18.80	18.70
CH 062	5310	15.60								
CH 102	5510	19.30	CH 142*	19.6	19.5	19.5	19.4	19.4	19.4	19.4
CH 110	5550	19.60								
CH 134	5670	19.50								
CH 142*	5710	19.90								

Note: The above Frequency and Channel in "*" were straddle Channel.

802.11ac VHT20 RF Output Power (dBm)											
Power vs. Channel			Power vs Data Rate								
Channel	Frequency (MHz)	MCS Index	Channel	MCS Index							
		MCS0		MCS1	MCS2	MCS3	MCS4	MCS5	MCS6	MCS7	MCS8
CH 036	5180	18.70	CH 048	18.80	18.50	18.50	18.80	18.70	18.80	18.80	
CH 044	5220	18.60									
CH 048	5240	18.90									
CH 052	5260	19.10	CH 064	19.20	19.20	19.20	19.20	19.20	19.20	19.20	
CH 060	5300	19.20									
CH 064	5320	19.30									
CH 100	5500	19.80	CH 140	19.70	19.60	19.50	19.70	19.60	19.60	19.70	
CH 116	5580	19.90									
CH 140	5700	20.00									
CH 144*	5720	19.90									

Note: The above Frequency and Channel in "*" were straddle Channel.



802.11ac VHT40 RF Output Power (dBm)												
Power vs. Channel			Power vs Data Rate									
Channel	Frequency (MHz)	MCS Index	Channel	MCS Index								
		MCS0		MCS1	MCS2	MCS3	MCS4	MCS5	MCS6	MCS7	MCS8	MCS9
CH 038	5190	17.90	CH 046	18.9	18.9	18.9	18.6	18.7	18.6	18.6	18.6	18.6
CH 046	5230	19.00										
CH 054	5270	19.40	CH 054	19.3	19.3	19.3	18.9	18.9	18.9	18.8	18.8	18.9
CH 062	5310	15.70										
CH 102	5510	19.40	CH 142*	19.7	19.6	19.6	19.5	19.5	19.5	19.5	19.5	19.5
CH 110	5550	19.70										
CH 134	5670	19.60										
CH 142*	5710	20.00										

Note: The above Frequency and Channel in "*" were straddle Channel.

802.11ac VHT80 RF Output Power (dBm)												
Power vs. Channel			Power vs Data Rate									
Channel	Frequency (MHz)	MCS Index	Channel	MCS Index								
		MCS0		MCS1	MCS2	MCS3	MCS4	MCS5	MCS6	MCS7	MCS8	MCS9
CH 042	5210	17.70	CH 042	17.60	17.60	17.60	17.40	17.40	17.40	17.40	17.40	17.40
CH 058	5290	15.80	CH 058	15.70	15.70	15.50	15.30	15.30	15.20	15.20	15.20	15.20
CH 106	5530	17.60	CH 138*	19.90	19.90	19.90	19.50	19.50	19.50	19.50	19.50	19.50
CH 122	5610	19.70										
CH 138*	5690	20.00										

Note: The above Frequency and Channel in "*" were straddle Channel.

2.3 Connection Diagram of Test System

<AC Conducted Emission Mode>

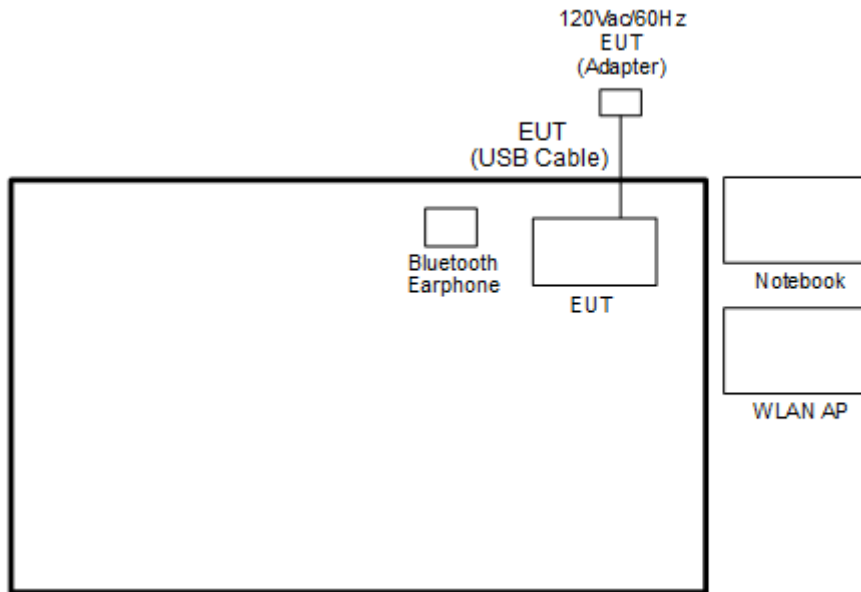

<WLAN Tx Mode>

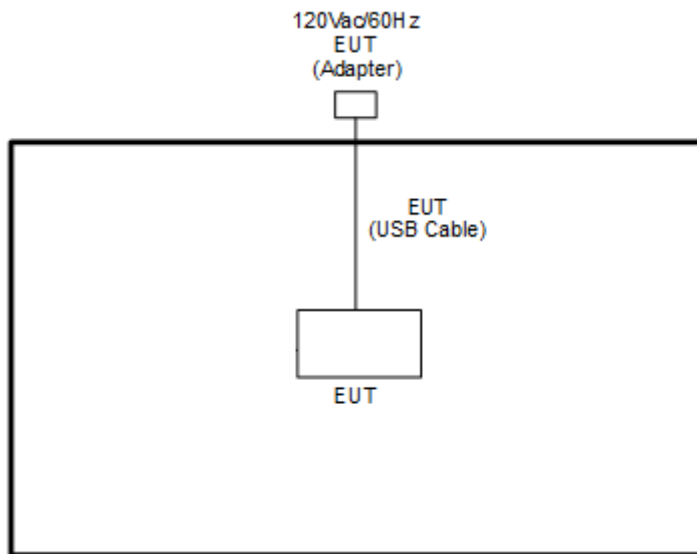



2.4 Support Unit used in test configuration and system

Item	Equipment	Brand Name	Model Name	FCC ID	Data Cable	Power Cord
1.	Bluetooth Earphone	Sony Ericsson	MW600	PY7DDA-2029	N/A	N/A
2.	WLAN AP	ASUS	RT-AC66U	MSQ-RTAC66U	N/A	Unshielded, 1.8 m
3.	Notebook	DELL	Latitude 3400	FCC DoC	N/A	AC I/P: Unshielded, 1.2 m DC O/P: Shielded, 1.8 m
4.	SD Card	SanDisk	MicroSD HC	FCC DoC	N/A	N/A

2.5 EUT Operation Test Setup

The RF test items, utility “QRCT v4.0.00067.0” was installed in Notebook which was programmed in order to make the EUT get into the engineering modes to provide channel selection, power level, data rate and the application type and for continuous transmitting signals.

2.6 Measurement Results Explanation Example

For all conducted test items:

The offset level is set in the spectrum analyzer to compensate the RF cable loss and attenuator factor between EUT conducted output port and spectrum analyzer. With the offset compensation, the spectrum analyzer reading level is exactly the EUT RF output level.

Example :

The spectrum analyzer offset is derived from RF cable loss and attenuator factor.

Offset = RF cable loss + attenuator factor.

Following shows an offset computation example with cable loss 4.2 dB and 10dB attenuator.

$$\begin{aligned} \text{Offset(dB)} &= \text{RF cable loss(dB)} + \text{attenuator factor(dB)}. \\ &= 4.2 + 10 = 14.2 \text{ (dB)} \end{aligned}$$

3 Test Result

3.1 26dB & 99% Occupied Bandwidth Measurement

3.1.1 Description of 26dB & 99% Occupied Bandwidth

This section is for reporting purpose only.

There is no restriction limits for bandwidth.

For Straddle Channel, according to KDB 789033 D02 General UNII Test Procedures New Rules v02r01, if the power and PSD of the devices are uniform and comply with the lower limits specified for the U-NII-2 bands, a single measurement over the entire emission bandwidth can be performed to show compliance.

3.1.2 Measuring Instruments

See list of measuring equipment of this test report.

3.1.3 Test Procedures

1. The testing follows FCC KDB 789033 D02 General UNII Test Procedures New Rules v02r01. Section C) Emission bandwidth
2. Set RBW = approximately 1% of the emission bandwidth.
3. Set the VBW > RBW.
4. Detector = Peak.
5. Trace mode = max hold
6. Measure the maximum width of the emission that is 26 dB down from the peak of the emission. Compare this with the RBW setting of the analyzer. Readjust RBW and repeat measurement as needed until the RBW/EBW ratio is approximately 1%.
7. For 99% Bandwidth Measurement, the spectrum analyzer's resolution bandwidth (RBW) is set 1-5% of the emission bandwidth and set the Video bandwidth (VBW) $\geq 3 * RBW$.
8. Measure and record the results in the test report.

3.1.4 Test Setup

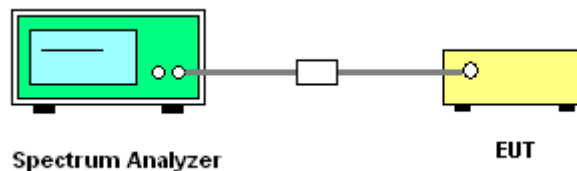



3.1.5 Test Result of 26dB & 99% Occupied Bandwidth

Test Engineer :	Tommy Lee and Howard Lin	Temperature :	21.2~24.1°C
		Relative Humidity :	47.2~57.8%

Band I													
Mod.	Data Rate	NTX	CH.	Freq. (MHz)	99% Bandwidth (MHz)		26 dB Bandwidth (MHz)		IC 99% Bandwidth Power Limit (dBm)		IC 99% Bandwidth EIRP Limit (dBm)		Note
					Ant 1	Ant 2	Ant 1	Ant 2	Ant 1	Ant 2	Ant 1	Ant 2	
11a	6Mbps	1	36	5180	22.03	-	38.45	-	-	-	23.01	-	-
11a	6Mbps	1	44	5220	20.33	-	35.80	-	-	-	23.01	-	
11a	6Mbps	1	48	5240	21.73	-	33.50	-	-	-	23.01	-	
HT20	MCS0	1	36	5180	22.93	-	40.60	-	-	-	23.01	-	
HT20	MCS0	1	44	5220	22.38	-	38.25	-	-	-	23.01	-	
HT20	MCS0	1	48	5240	22.73	-	39.30	-	-	-	23.01	-	
HT40	MCS0	1	38	5190	36.66	-	42.20	-	-	-	23.01	-	
HT40	MCS0	1	46	5230	37.66	-	58.50	-	-	-	23.01	-	
VHT80	MCS0	1	42	5210	76.84	-	85.83	-	-	-	23.01	-	

Band II															
Mod.	Data Rate	NTX	CH.	Freq. (MHz)	99% Bandwidth (MHz)		26 dB Bandwidth (MHz)		IC 99% Bandwidth Power Limit (dBm)		IC 99% Bandwidth EIRP Limit (dBm)		FCC 26dB Bandwidth Power Limit (dBm)	Note	
					Ant 1	Ant 2	Ant 1	Ant 2	Ant 1	Ant 2	Ant 1	Ant 2	Ant 1		Ant 2
11a	6Mbps	1	52	5260	21.83	-	38.05	-	23.98	-	30.00	-	23.98	-	-
11a	6Mbps	1	60	5300	19.08	-	32.65	-	23.81	-	29.81	-	23.98	-	
11a	6Mbps	1	64	5320	17.18	-	29.10	-	23.35	-	29.35	-	23.98	-	
HT20	MCS0	1	52	5260	24.48	-	42.35	-	23.98	-	30.00	-	23.98	-	
HT20	MCS0	1	60	5300	23.73	-	40.50	-	23.98	-	30.00	-	23.98	-	
HT20	MCS0	1	64	5320	18.28	-	29.60	-	23.62	-	29.62	-	23.98	-	
HT40	MCS0	1	54	5270	51.85	-	92.52	-	23.98	-	30.00	-	23.98	-	
HT40	MCS0	1	62	5310	36.66	-	42.32	-	23.98	-	30.00	-	23.98	-	
VHT80	MCS0	1	58	5290	77.08	-	85.19	-	23.98	-	30.00	-	23.98	-	



Band III																
Mod.	Data Rate	NTX	CH.	Freq. (MHz)	99% Bandwidth In U-NII 2C (MHz)		26 dB Bandwidth In U-NII 2C (MHz)		IC 99% Bandwidth Power Limit (dBm)		IC 99% Bandwidth EIRP Limit (dBm)		FCC 26dB Bandwidth Power Limit (dBm)		6 dB Bandwidth for Straddle Channel (MHz)	
					Ant 1	Ant 2	Ant 1	Ant 2	Ant 1	Ant 2	Ant 1	Ant 2	Ant 1	Ant 2	Ant 1	Ant 2
11a	6Mbps	1	100	5500	22.68	-	29.45	-	23.98	-	30.00	-	23.98	-	----	----
11a	6Mbps	1	116	5580	17.73	-	29.90	-	23.49	-	29.49	-	23.98	-	----	----
11a	6Mbps	1	140	5700	19.03	-	33.25	-	23.79	-	29.79	-	23.98	-	----	----
HT20	MCS0	1	100	5500	22.23	-	40.25	-	23.98	-	30.00	-	23.98	-	----	----
HT20	MCS0	1	116	5580	22.83	-	39.80	-	23.98	-	30.00	-	23.98	-	----	----
HT20	MCS0	1	140	5700	18.38	-	30.00	-	23.64	-	29.64	-	23.98	-	----	----
HT40	MCS0	1	102	5510	36.66	-	41.96	-	23.98	-	30.00	-	23.98	-	----	----
HT40	MCS0	1	110	5550	37.56	-	78.28	-	23.98	-	30.00	-	23.98	-	----	----
HT40	MCS0	1	134	5670	37.06	-	57.54	-	23.98	-	30.00	-	23.98	-	----	----
VHT80	MCS0	1	106	5530	76.96	-	85.11	-	23.98	-	30.00	-	23.98	-	----	----
VHT80	MCS0	1	122	5610	77.32	-	105.73	-	23.98	-	30.00	-	23.98	-	----	----

Band III straddle channel																
Mod.	Data Rate	NTX	CH.	Freq. (MHz)	99% Bandwidth In U-NII 2C (MHz)		26 dB Bandwidth In U-NII 2C (MHz)		IC 99% Bandwidth Power Limit (dBm)		IC 99% Bandwidth EIRP Limit (dBm)		FCC 26dB Bandwidth Power Limit (dBm)		6 dB Bandwidth for Straddle Channel (MHz)	
					Ant 1	Ant 2	Ant 1	Ant 2	Ant 1	Ant 2	Ant 1	Ant 2	Ant 1	Ant 2	Ant 1	Ant 2
11a	6Mbps	1	144	5720	14.29	-	20.65	-	22.55	-	28.55	-	23.98	-	2.95	-
HT20	MCS0	1	144	5720	16.14	-	24.70	-	23.08	-	29.08	-	23.98	-	3.8	-
HT40	MCS0	1	142	5710	33.78	-	50.36	-	23.98	-	30.00	-	23.98	-	2.18	-
VHT80	MCS0	1	138	5690	73.84	-	108.85	-	23.98	-	30.00	-	23.98	-	2.6	-

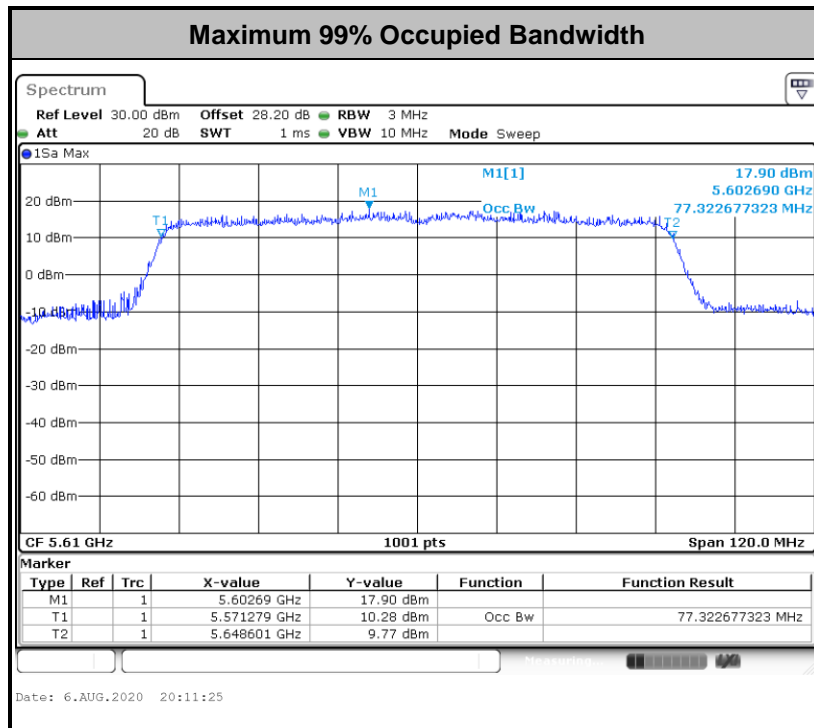
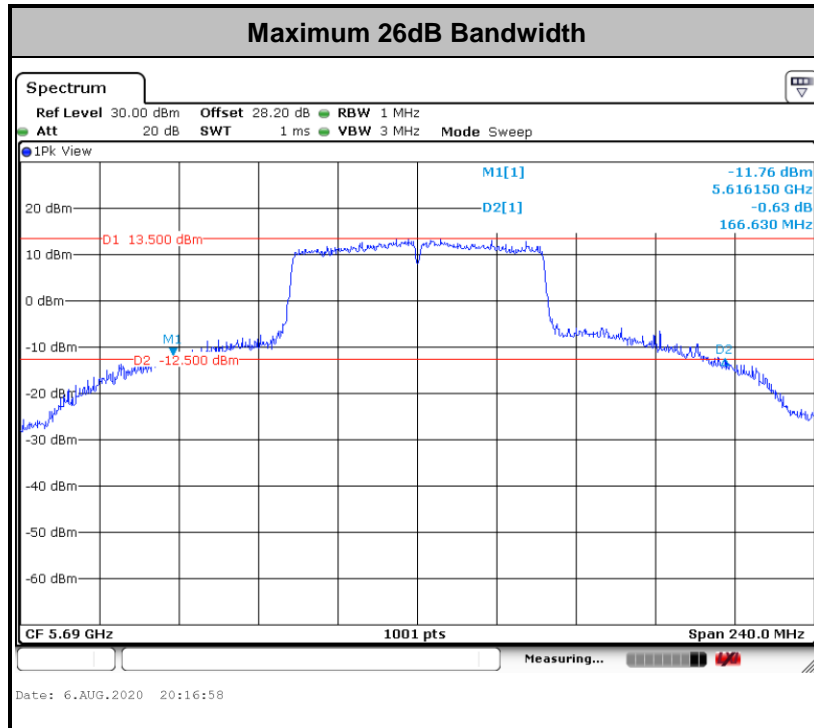

Note: The occupied channel bandwidth is maintained within the band of operation for all of the modulations.



3.2 Maximum Conducted Output Power Measurement

3.2.1 Limit of Maximum Conducted Output Power

<FCC 14-30 CFR 15.407>

For the 5.15–5.25 GHz bands:

- For mobile and portable client devices in the 5.15–5.25 GHz band, the maximum conducted output power over the frequency band of operation shall not exceed 250 mW. For an indoor access point operating in the band 5.15-5.25 GHz, the maximum conducted output power over the frequency band of operation shall not exceed 1 W.

For the 5.25–5.725 GHz bands:

- The maximum conducted output power over the frequency bands of operation shall not exceed the lesser of 250 mW or $11 \text{ dBm} + 10 \log B$, where B is the 26 dB emission bandwidth in megahertz.

For Straddle Channel, according to KDB 789033 D02 General UNII Test Procedures New Rules v02r01, if the power and PSD of the devices are uniform and comply with the lower limits specified for the U-NII-2 bands, a single measurement over the entire emission bandwidth can be performed to show compliance.

If transmitting antennas of directional gain greater than 6 dBi are used, the peak output power shall be reduced by the amount in dB that the directional gain of the antenna exceeds 6 dBi.

Note that U-NII-2 band, devices with a maximum e.i.r.p. greater than 500 mW shall implement TPC in order to have the capability to operate at least 6 dB below the maximum permitted e.i.r.p. of 1 W.

3.2.2 Measuring Instruments

See list of measuring equipment of this test report.

3.2.3 Test Procedures

The testing follows Method PM-G of FCC KDB 789033 D02 General UNII Test Procedures New Rules v02r01.

Method PM-G (Measurement using an RF average power meter):

1. Measurement is performed using a wideband RF power meter.
2. The EUT is configured to transmit at its maximum power control level.
3. Measure the average power of the transmitter
4. Since the measurement is made only during the ON time of the transmitter, no duty cycle correction factor is required.

For Straddle Channel, according to KDB 789033 D02 General UNII Test Procedures New Rules v02r01, if the power and PSD of the devices are uniform and comply with the lower limits specified for the U-NII-2 bands, a single measurement over the entire emission bandwidth can be performed to show compliance.

3.2.4 Test Setup

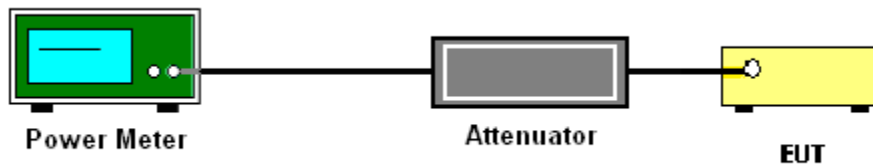



3.2.5 Test Result of Maximum Conducted Output Power

Test Engineer :	Tommy Lee and Howard Lin	Temperature :	21.2~24.1°C
		Relative Humidity :	47.2~57.8%

Band I												
Mod.	Data Rate	NTX	CH.	Freq. (MHz)	Average Conducted Power (dBm)			FCC Conducted Power Limit (dBm)		DG (dBi)		Pass/Fail
					Ant 1	Ant 2	SUM	Ant 1	Ant 2	Ant 1	Ant 2	
11a	6Mbps	1	36	5180	18.80	-		24.00	-	2.63	-	Pass
11a	6Mbps	1	44	5220	18.70	-		24.00	-	2.63	-	Pass
11a	6Mbps	1	48	5240	19.00	-		24.00	-	2.63	-	Pass
HT20	MCS0	1	36	5180	18.60	-		24.00	-	2.63	-	Pass
HT20	MCS0	1	44	5220	18.50	-		24.00	-	2.63	-	Pass
HT20	MCS0	1	48	5240	18.80	-		24.00	-	2.63	-	Pass
HT40	MCS0	1	38	5190	17.80	-		24.00	-	2.63	-	Pass
HT40	MCS0	1	46	5230	18.90	-		24.00	-	2.63	-	Pass
VHT20	MCS0	1	36	5180	18.70	-		24.00	-	2.63	-	Pass
VHT20	MCS0	1	44	5220	18.60	-		24.00	-	2.63	-	Pass
VHT20	MCS0	1	48	5240	18.90	-		24.00	-	2.63	-	Pass
VHT40	MCS0	1	38	5190	17.90	-		24.00	-	2.63	-	Pass
VHT40	MCS0	1	46	5230	19.00	-		24.00	-	2.63	-	Pass
VHT80	MCS0	1	42	5210	17.70	-		24.00	-	2.63	-	Pass



Band II													
Mod.	Data Rate	NTX	CH.	Freq. (MHz)	Average Conducted Power (dBm)			FCC Conducted Power Limit (dBm)		DG (dBi)		EIRP Power Limit (dBm)	Pass/Fail
					Ant 1	Ant 2	SUM	Ant 1	Ant 2	Ant 1	Ant 2		
11a	6Mbps	1	52	5260	19.20	-		23.98	-	2.63	-	30	Pass
11a	6Mbps	1	60	5300	19.30	-		23.98	-	2.63	-	30	Pass
11a	6Mbps	1	64	5320	19.20	-		23.98	-	2.63	-	30	Pass
HT20	MCS0	1	52	5260	19.00	-		23.98	-	2.63	-	30	Pass
HT20	MCS0	1	60	5300	19.10	-		23.98	-	2.63	-	30	Pass
HT20	MCS0	1	64	5320	19.20	-		23.98	-	2.63	-	30	Pass
HT40	MCS0	1	54	5270	19.30	-		23.98	-	2.63	-	30	Pass
HT40	MCS0	1	62	5310	15.60	-		23.98	-	2.63	-	30	Pass
VHT20	MCS0	1	52	5260	19.10	-		23.98	-	2.63	-	30	Pass
VHT20	MCS0	1	60	5300	19.20	-		23.98	-	2.63	-	30	Pass
VHT20	MCS0	1	64	5320	19.30	-		23.98	-	2.63	-	30	Pass
VHT40	MCS0	1	54	5270	19.40	-		23.98	-	2.63	-	30	Pass
VHT40	MCS0	1	62	5310	15.70	-		23.98	-	2.63	-	30	Pass
VHT80	MCS0	1	58	5290	15.80	-		23.98	-	2.63	-	30	Pass



Band III													
Mod.	Data Rate	NTX	CH.	Freq. (MHz)	Average Conducted Power (dBm)			FCC Conducted Power Limit (dBm)		DG (dBi)		EIRP Power Limit (dBm)	Pass/Fail
					Ant 1	Ant 2	SUM	Ant 1	Ant 2	Ant 1	Ant 2		
11a	6Mbps	1	100	5500	19.90	-		23.98	-	3.65	-	30	Pass
11a	6Mbps	1	116	5580	20.00	-		23.98	-	3.65	-	30	Pass
11a	6Mbps	1	140	5700	19.60	-		23.98	-	3.65	-	30	Pass
HT20	MCS0	1	100	5500	19.70	-		23.98	-	3.65	-	30	Pass
HT20	MCS0	1	116	5580	19.80	-		23.98	-	3.65	-	30	Pass
HT20	MCS0	1	140	5700	19.90	-		23.98	-	3.65	-	30	Pass
HT40	MCS0	1	102	5510	19.30	-		23.98	-	3.65	-	30	Pass
HT40	MCS0	1	110	5550	19.60	-		23.98	-	3.65	-	30	Pass
HT40	MCS0	1	134	5670	19.50	-		23.98	-	3.65	-	30	Pass
VHT20	MCS0	1	100	5500	19.80	-		23.98	-	3.65	-	30	Pass
VHT20	MCS0	1	116	5580	19.90	-		23.98	-	3.65	-	30	Pass
VHT20	MCS0	1	140	5700	20.00	-		23.98	-	3.65	-	30	Pass
VHT40	MCS0	1	102	5510	19.40	-		23.98	-	3.65	-	30	Pass
VHT40	MCS0	1	110	5550	19.70	-		23.98	-	3.65	-	30	Pass
VHT40	MCS0	1	134	5670	19.60	-		23.98	-	3.65	-	30	Pass
VHT80	MCS0	1	106	5530	17.60	-		23.98	-	3.65	-	30	Pass
VHT80	MCS0	1	122	5610	19.70	-		23.98	-	3.65	-	30	Pass

Band III straddle channel													
Mod.	Data Rate	NTX	CH.	Freq. (MHz)	Average Conducted Power (dBm)			FCC Conducted Power Limit (dBm)		DG (dBi)		EIRP Power Limit (dBm)	Pass/Fail
					Ant 1	Ant 2	SUM	Ant 1	Ant 2	Ant 1	Ant 2		
11a	6Mbps	1	144	5720	20.00	-		23.32	-	3.65	-	30	Pass
HT20	MCS0	1	144	5720	19.80	-		23.52	-	3.65	-	30	Pass
HT40	MCS0	1	142	5710	19.90	-		23.98	-	3.65	-	30	Pass
VHT20	MCS0	1	144	5720	19.90	-		23.98	-	3.65	-	30	Pass
VHT40	MCS0	1	142	5710	20.00	-		23.98	-	3.65	-	30	Pass
VHT80	MCS0	1	138	5690	20.00	-		23.98	-	3.65	-	30	Pass



3.3 Power Spectral Density Measurement

3.3.1 Limit of Power Spectral Density

<FCC 14-30 CFR 15.407>

For the 5.15–5.25 GHz bands:

For mobile and portable client devices in the 5.15–5.25 GHz band, the maximum power spectral density shall not exceed 11 dBm in any 1.0 MHz band. For an indoor access point operating in the band 5.15-5.25 GHz, the maximum power spectral density shall not exceed 17 dBm in any 1.0 MHz band.

For the 5.25–5.725 GHz bands:

The maximum power spectral density shall not exceed 11 dBm in any 1.0 MHz band.

For Straddle Channel, according to KDB 789033 D02 General UNII Test Procedures New Rules v02r01, if the power and PSD of the devices are uniform and comply with the lower limits specified for the U-NII-2 bands, a single measurement over the entire emission bandwidth can be performed to show compliance.

If transmitting antennas of directional gain greater than 6 dBi are used, the peak output power shall be reduced by the amount in dB that the directional gain of the antenna exceeds 6 dBi.

3.3.2 Measuring Instruments

See list of measuring equipment of this test report.

3.3.3 Test Procedures

The testing follows FCC KDB 789033 D02 General UNII Test Procedures New Rules v02r01.
Section F) Maximum power spectral density.

Method SA-3

(power averaging (rms) detection with max hold):

- Set span to encompass the entire emission bandwidth (EBW) of the signal.
 - Set RBW = 1 MHz.
 - Set VBW \geq 3 MHz
 - Number of points in sweep \geq 2 Span / RBW.
 - Sweep time \leq (number of points in sweep) \times T, when duty cycle is less than 98 percent where T is the minimum transmission duration over which the transmitter is on and is transmitting at its maximum power control level for the tested mode of operation.
 - Detector = power averaging (rms).
 - Trace mode = max hold.
 - Allow max hold to run for at least 60 seconds, or longer as needed to allow the trace to stabilize.
1. The RF output of EUT was connected to the spectrum analyzer by a low loss cable.
 2. Each plot has already offset with cable loss, and attenuator loss. Measure the PPSD and record it.

3.3.4 Test Setup

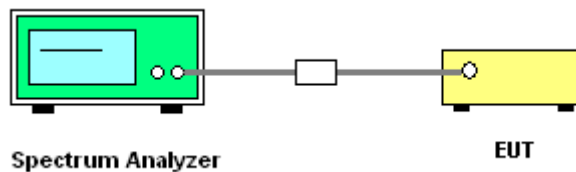



3.3.5 Test Result of Power Spectral Density

Test Engineer :	Tommy Lee and Howard Lin	Temperature :	21.2~24.1°C
		Relative Humidity :	47.2~57.8%

Band I												
Mod.	Data Rate	NTX	CH.	Freq. (MHz)	Average Power Density (dBm/MHz)			Average PSD Limit (dBm/MHz)		DG (dBi)		Pass /Fail
					Ant 1	Ant 2	SUM	Ant 1	Ant 2	Ant 1	Ant 2	
11a	6Mbps	1	36	5180	8.92	-		11.00	-	2.63	-	Pass
11a	6Mbps	1	44	5220	8.86	-		11.00	-	2.63	-	Pass
11a	6Mbps	1	48	5240	9.17	-		11.00	-	2.63	-	Pass
VHT20	MCS0	1	36	5180	8.91	-		11.00	-	2.63	-	Pass
VHT20	MCS0	1	44	5220	8.86	-		11.00	-	2.63	-	Pass
VHT20	MCS0	1	48	5240	9.14	-		11.00	-	2.63	-	Pass
VHT40	MCS0	1	38	5190	4.99	-		11.00	-	2.63	-	Pass
VHT40	MCS0	1	46	5230	6.12	-		11.00	-	2.63	-	Pass
VHT80	MCS0	1	42	5210	2.01	-		11.00	-	2.63	-	Pass

Band II												
Mod.	Data Rate	NTX	CH.	Freq. (MHz)	Average Power Density (dBm/MHz)			Average PSD Limit (dBm/MHz)		DG (dBi)		Pass /Fail
					Ant 1	Ant 2	SUM	Ant 1	Ant 2	Ant 1	Ant 2	
11a	6Mbps	1	52	5260	9.32	-		11.00	-	2.63	-	Pass
11a	6Mbps	1	60	5300	9.44	-		11.00	-	2.63	-	Pass
11a	6Mbps	1	64	5320	9.30	-		11.00	-	2.63	-	Pass
VHT20	MCS0	1	52	5260	9.51	-		11.00	-	2.63	-	Pass
VHT20	MCS0	1	60	5300	9.64	-		11.00	-	2.63	-	Pass
VHT20	MCS0	1	64	5320	9.55	-		11.00	-	2.63	-	Pass
VHT40	MCS0	1	54	5270	4.03	-		11.00	-	2.63	-	Pass
VHT40	MCS0	1	62	5310	2.55	-		11.00	-	2.63	-	Pass
VHT80	MCS0	1	58	5290	0.10	-		11.00	-	2.63	-	Pass



Band III												
Mod.	Data Rate	NTX	CH.	Freq. (MHz)	Average Power Density (dBm/MHz)			Average PSD Limit (dBm/MHz)		DG (dBi)		Pass /Fail
					Ant 1	Ant 2	SUM	Ant 1	Ant 2	Ant 1	Ant 2	
11a	6Mbps	1	100	5500	10.14	-		11.00	-	3.35	-	Pass
11a	6Mbps	1	116	5580	10.28	-		11.00	-	3.35	-	Pass
11a	6Mbps	1	140	5700	9.80	-		11.00	-	3.35	-	Pass
VHT20	MCS0	1	100	5500	10.06	-		11.00	-	3.35	-	Pass
VHT20	MCS0	1	116	5580	10.20	-		11.00	-	3.35	-	Pass
VHT20	MCS0	1	140	5700	10.32	-		11.00	-	3.35	-	Pass
VHT40	MCS0	1	102	5510	6.25	-		11.00	-	3.35	-	Pass
VHT40	MCS0	1	110	5550	6.75	-		11.00	-	3.35	-	Pass
VHT40	MCS0	1	134	5670	6.64	-		11.00	-	3.35	-	Pass
VHT80	MCS0	1	106	5530	2.22	-		11.00	-	3.35	-	Pass
VHT80	MCS0	1	122	5610	4.52	-		11.00	-	3.35	-	Pass

Band III straddle channel single antenna												
Mod.	Data Rate	NTX	CH.	Freq. (MHz)	Average Power Density (dBm/MHz)			Average PSD Limit (dBm/MHz)		DG (dBi)		Pass /Fail
					Ant 1	Ant 2	SUM	Ant 1	Ant 2	Ant 1	Ant 2	
11a	6Mbps	1	144	5720	10.73	-		11.00	-	3.65	-	Pass
VHT20	MCS0	1	144	5720	10.27	-		11.00	-	3.65	-	Pass
VHT40	MCS0	1	142	5710	7.20	-		11.00	-	3.65	-	Pass
VHT80	MCS0	1	138	5690	4.88	-		11.00	-	3.65	-	Pass

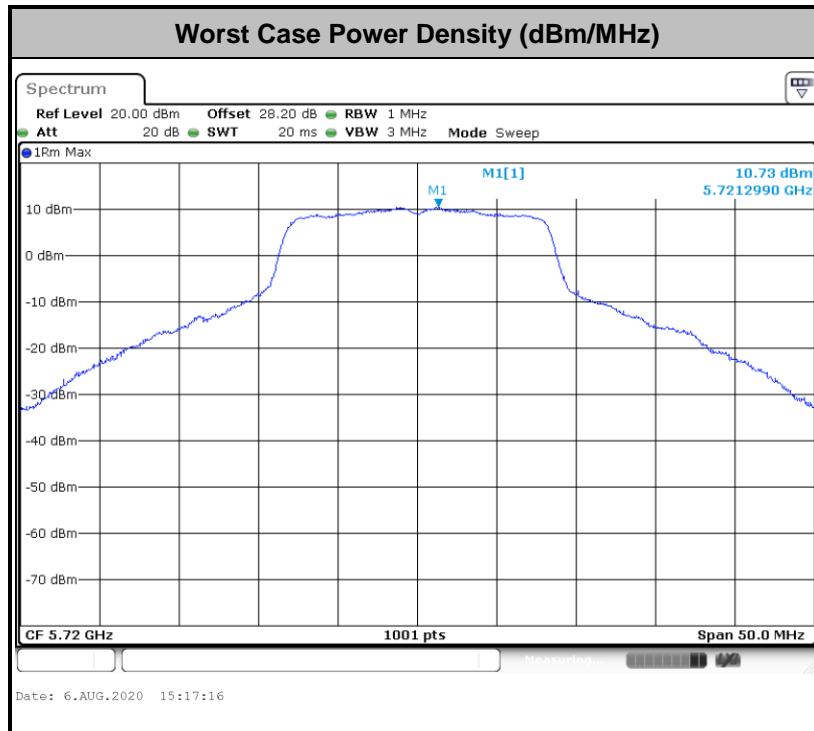



3.4 Unwanted Emissions Measurement

This section is to measure unwanted emissions through radiated measurement for band edge spurious emissions and out of band emissions measurement.

3.4.1 Limit of Unwanted Emissions

- (1) For transmitters operating in the 5150-5250 MHz band: all emissions outside of the 5150-5350 MHz band shall not exceed an EIRP of -27dBm/MHz.

For transmitters operating in the 5250-5350 MHz band: all emissions outside of the 5150-5350 MHz band shall not exceed an EIRP of -27 dBm/MHz. Devices operating in the 5250-5350 MHz band that generate emissions in the 5150-5250 MHz band must meet all applicable technical requirements for operation in the 5150-5250 MHz band (including indoor use) or alternatively meet an out-of-band emission EIRP limit of -27 dBm/MHz in the 5150-5250 MHz band.

For transmitters operating in the 5470-5600 MHz and 5650-5725MHz band: all emissions outside of the 5470-5600 MHz and 5650-5725MHz band shall not exceed an EIRP of -27 dBm/MHz.

- (2) Unwanted spurious emissions fallen in restricted bands shall comply with the general field strength limits as below table:

Frequency (MHz)	Field Strength (microvolts/meter)	Measurement Distance (meters)
0.009 – 0.490	2400/F(kHz)	300
0.490 – 1.705	24000/F(kHz)	30
1.705 – 30.0	30	30
30 – 88	100	3
88 – 216	150	3
216 - 960	200	3
Above 960	500	3

Note: The following formula is used to convert the EIRP to field strength.

$$E = \frac{1000000\sqrt{30P}}{3} \mu\text{V/m, where P is the eirp (Watts)}$$



EIRP (dBm)	Field Strength at 3m (dBμV/m)
- 27	68.3

(3) KDB789033 D02 v02r01 G)2)c)

- (i) Sections 15.407(b)(1-3) specifies the unwanted emissions limit for the U-NII-1 and U-NII-2 bands. As specified, emissions above 1000 MHz that are outside of the restricted bands are subject to a peak emission limit of -27 dBm/MHz.
- (ii) Section 15.407(b)(4) specifies the unwanted emissions limit for the U-NII-3 band. A band emissions mask is specified in Section 15.407(b)(4)(i). The emission limits are based on the use of a peak detector.

3.4.2 Measuring Instruments

See list of measuring equipment of this test report.

3.4.3 Test Procedures

1. The testing follows FCC KDB 789033 D02 General UNII Test Procedures New Rules v02r01. Section G) Unwanted emissions measurement.

(1) Procedure for Unwanted Emissions Measurements Below 1000MHz

- RBW = 120 kHz
- VBW = 300 kHz
- Detector = Peak
- Trace mode = max hold

(2) Procedure for Peak Unwanted Emissions Measurements Above 1000 MHz

- RBW = 1 MHz
- VBW ≥ 3 MHz
- Detector = Peak
- Sweep time = auto
- Trace mode = max hold



(3) Procedures for Average Unwanted Emissions Measurements Above 1000MHz

- RBW = 1 MHz
 - VBW = 10 Hz, when duty cycle is no less than 98 percent.
 - $VBW \geq 1/T$, when duty cycle is less than 98 percent where T is the minimum transmission duration over which the transmitter is on and is transmitting at its maximum power control level for the tested mode of operation.
2. The EUT was placed on a turntable with 0.8 meter for frequency below 1GHz and 1.5 meter for frequency above 1GHz respectively above ground.
 3. The EUT was set 3 meters from the interference receiving antenna which was mounted on the top of a variable height antenna tower.
 4. The antenna is a broadband antenna and its height is adjusted between one meter and four meters above ground to find the maximum value of the field strength for both horizontal polarization and vertical polarization of the antenna.
 5. For each suspected emission, the EUT was arranged to its worst case and then adjust the antenna tower (from 1 m to 4 m) and turntable (from 0 degree to 360 degrees) to find the maximum reading.
 6. For testing below 1GHz, if the emission level of the EUT in peak mode was 3 dB lower than the limit specified, then peak values of EUT will be reported, otherwise, the emissions will be repeated one by one using the CISPR quasi-peak method and reported.
 7. For testing above 1GHz, the emission level of the EUT in peak mode was 20dB lower than average limit (that means the emission level in average mode also complies with the limit in average mode), then peak values of EUT will be reported, otherwise, the emissions will be measured in average mode again and reported.

3.4.4 Test Setup

For radiated emissions below 30MHz

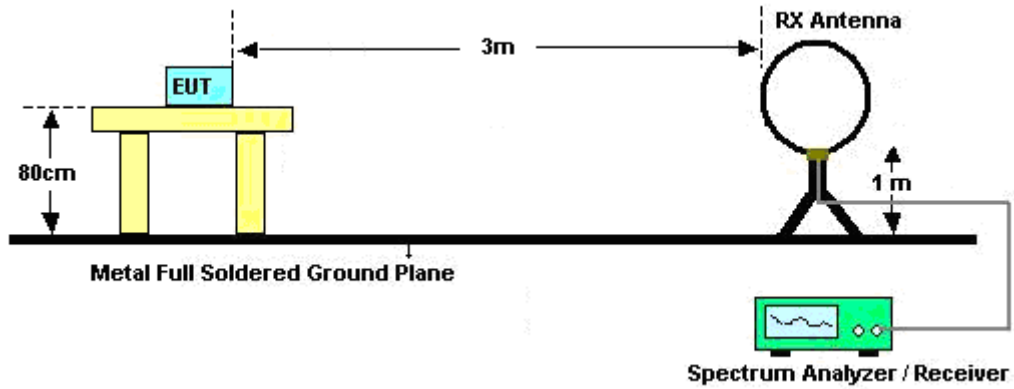

For radiated emissions from 30MHz to 1GHz

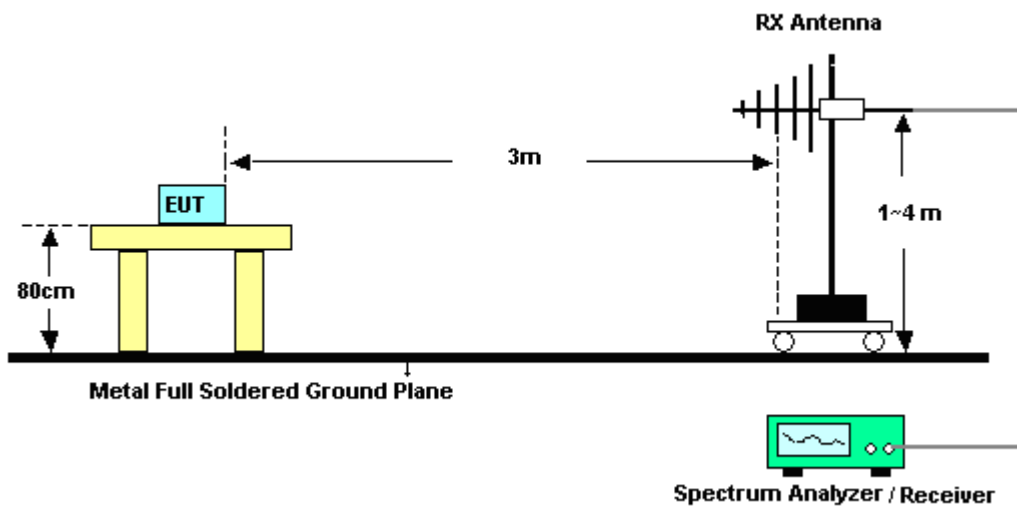

For radiated emissions above 1GHz

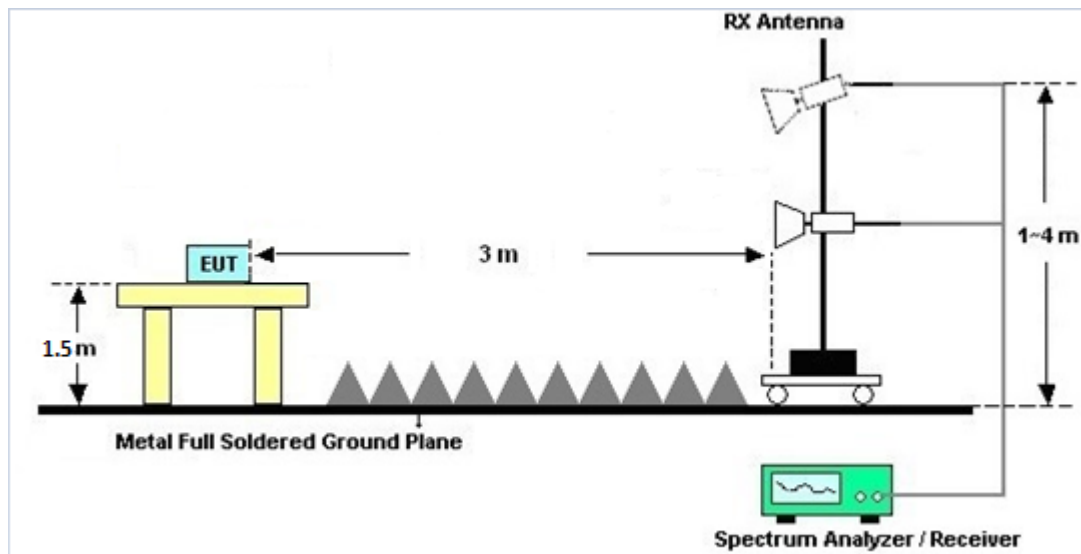

3.4.5 Test Results of Radiated Spurious Emissions (9 kHz ~ 30 MHz)

The low frequency, which started from 9 kHz to 30MHz, was pre-scanned and the result which was 20dB lower than the limit line was not reported.

There is a comparison data of both open-field test site and alternative test site - semi-Anechoic chamber according to 414788 D01 Radiated Test Site v01r01, and the result came out very similar.

3.4.6 Test Result of Radiated Spurious at Band Edges

Please refer to Appendix B and C.

3.4.7 Duty Cycle

Please refer to Appendix D.

3.4.8 Test Result of Radiated Spurious Emissions (30MHz ~ 10th Harmonic)

Please refer to Appendix B and C.



3.5 AC Conducted Emission Measurement

3.5.1 Limit of AC Conducted Emission

For equipment that is designed to be connected to the public utility (AC) power line, the radio frequency voltage that is conducted back onto the AC power line on any frequency or frequencies within the band 150 kHz to 30 MHz shall not exceed the limits in the following table.

Frequency of emission (MHz)	Conducted limit (dB μ V)	
	Quasi-peak	Average
0.15-0.5	66 to 56*	56 to 46*
0.5-5	56	46
5-30	60	50

*Decreases with the logarithm of the frequency.

3.5.2 Measuring Instruments

See list of measuring equipment of this test report.

3.5.3 Test Procedures

1. The EUT was placed 0.4 meter from the conducting wall of the shielding room was kept at least 80 centimeters from any other grounded conducting surface.
2. Connect EUT to the power mains through a line impedance stabilization network (LISN).
3. All the support units are connecting to the other LISN.
4. The LISN provides 50 ohm coupling impedance for the measuring instrument.
5. The FCC states that a 50 ohm, 50 microhenry LISN should be used.
6. Both sides of AC line were checked for maximum conducted interference.
7. The frequency range from 150 kHz to 30 MHz was searched.
8. Set the test-receiver system to Peak Detect Function and specified bandwidth with Maximum Hold Mode.

3.5.4 Test Setup

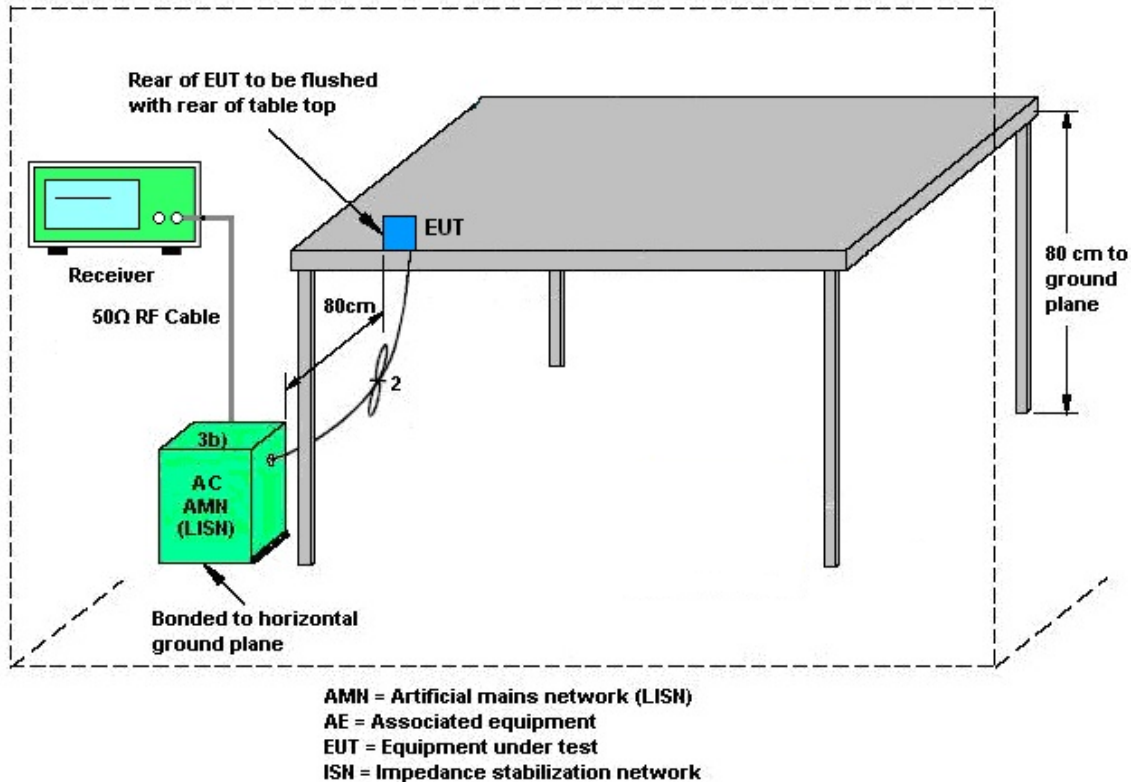

3.5.5 Test Result of AC Conducted Emission

Please refer to Appendix A.



3.6 Automatically Discontinue Transmission

3.6.1 Limit of Automatically Discontinue Transmission

The device shall automatically discontinue transmission in case of either absence of information to transmit or operational failure. These provisions are not intended to preclude the transmission of control or signaling information or the use of repetitive codes used by certain digital technologies to complete frame or burst intervals. Applicants shall include in their application for equipment authorization to describe how this requirement is met.

3.6.2 Measuring Instruments

See list of measuring equipment of this test report.

3.6.3 Test Result of Automatically Discontinue Transmission

While the EUT is not transmitting any information, the EUT can automatically discontinue transmission and become standby mode for power saving. The EUT can detect the controlling signal of ACK message transmitting from remote device and verify whether it shall resend or discontinue transmission.



3.7 Antenna Requirements

3.7.1 Standard Applicable

If transmitting antenna directional gain is greater than 6 dBi, both the peak transmit power and the peak power spectral density shall be reduced by the amount in dB that the directional gain of the antenna exceeds 6 dBi.

3.7.2 Antenna Anti-Replacement Construction

An embedded-in antenna design is used.

3.7.3 Antenna Gain

The antenna peak gain of EUT is less than 6 dBi. Therefore, it is not necessary to reduce maximum peak output power limit.



4 List of Measuring Equipment

Instrument	Brand Name	Model No.	Serial No.	Characteristics	Calibration Date	Test Date	Due Date	Remark
Bilog Antenna	TESEQ	CBL 6111D & 00800N1D01 N-06	35419 & 03	30MHz~1GHz	Apr. 29, 2020	Aug. 08, 2020~ Aug. 19, 2020	Apr. 28, 2021	Radiation (03CH07-HY)
Double Ridge Horn Antenna	ESCO	3117	00075962	1GHz ~ 18GHz	Dec. 06, 2019	Aug. 08, 2020~ Aug. 19, 2020	Dec. 05, 2020	Radiation (03CH07-HY)
EMI Test Receiver	Agilent	N9038A (MXE)	MY5329005 3	20Hz~26.5GHz	May 21, 2020	Aug. 08, 2020~ Aug. 19, 2020	May 20, 2021	Radiation (03CH07-HY)
Loop Antenna	Rohde & Schwarz	HFH2-Z2	100315	9 kHz~30 MHz	Dec. 26, 2019	Aug. 08, 2020~ Aug. 19, 2020	Dec. 25, 2020	Radiation (03CH07-HY)
Preamplifier	MITEQ	AMF-7D-0010 1800-30-10P	1590075	1GHz~18GHz	Apr. 23, 2020	Aug. 08, 2020~ Aug. 19, 2020	Apr. 22, 2021	Radiation (03CH07-HY)
Preamplifier	COM-POWER	PA-103A	161241	10MHz~1GHz	May 19, 2020	Aug. 08, 2020~ Aug. 19, 2020	May 18, 2021	Radiation (03CH07-HY)
Preamplifier	Agilent	8449B	3008A02362	1GHz~26.5GHz	Nov. 01, 2019	Aug. 08, 2020~ Aug. 19, 2020	Oct. 31, 2020	Radiation (03CH07-HY)
Filter	Microwave	H3G018G1	SN477219	3GHz High Pass Filter	Nov. 01, 2019	Aug. 08, 2020~ Aug. 19, 2020	Oct. 31, 2020	Radiation (03CH07-HY)
RF Cable	HUBER + SUHNER	SUCOFLEX 102	MY2858/2,8 01606/2	18GHz~40GHz	Feb. 25, 2020	Aug. 08, 2020~ Aug. 19, 2020	Feb. 24, 2021	Radiation (03CH07-HY)
RF Cable	HUBER + SUHNER	SUCOFLEX 126	532078/126 E	30MHz~18GHz	N/A	Aug. 08, 2020~ Aug. 19, 2020	N/A	Radiation (03CH07-HY)
RF Cable	HUBER + SUHNER	SUCOFLEX 104	MY24971/4, MY28655/4	9kHz~30MHz	Feb. 25, 2020	Aug. 08, 2020~ Aug. 19, 2020	Feb. 24, 2021	Radiation (03CH07-HY)
RF Cable	HUBER + SUHNER	SUCOFLEX 104	MY28655/4, MY24971/4, MY15682/4	30MHz~1GHz	Feb. 25, 2020	Aug. 08, 2020~ Aug. 19, 2020	Feb. 24, 2021	Radiation (03CH07-HY)
RF Cable	HUBER + SUHNER	SUCOFLEX 104	MY28655/4, MY24971/4, MY15682/4	1GHz~18GHz	Feb. 25, 2020	Aug. 08, 2020~ Aug. 19, 2020	Feb. 24, 2021	Radiation (03CH07-HY)
Controller	ChainTek	Chaintek 3000	N/A	Control Turn table	N/A	Aug. 08, 2020~ Aug. 19, 2020	N/A	Radiation (03CH07-HY)
Controller	Max-Full	MF7802	MF7802083 68	Control Ant Mast	N/A	Aug. 08, 2020~ Aug. 19, 2020	N/A	Radiation (03CH07-HY)
Antenna Mast	Max-Full	MFA520BS	N/A	1m~4m	N/A	Aug. 08, 2020~ Aug. 19, 2020	N/A	Radiation (03CH07-HY)
Turn Table	ChainTek	Chaintek 3000	N/A	0~360 Degree	N/A	Aug. 08, 2020~ Aug. 19, 2020	N/A	Radiation (03CH07-HY)
Attenuator	HONOVA	5910 SMA-50-005-19-NE	ATT-36	N/A	Nov. 01, 2019	Aug. 08, 2020~ Aug. 19, 2020	Oct. 31, 2020	Radiation (03CH07-HY)
USB Data Logger	TECPEL	TR-32	HE17XB249 5	N/A	N/A	Aug. 08, 2020~ Aug. 19, 2020	N/A	Radiation (03CH07-HY)
SHF-EHF Horn Antenna	SCHWARZBECK	BBHA 9170	BBHA91702 51	18GHz~40GHz	Nov. 26, 2019	Aug. 08, 2020~ Aug. 19, 2020	Nov. 25, 2020	Radiation (03CH07-HY)
Spectrum Analyzer	Agilent	N9030A	MY5235027 6	3Hz~44GHz	Jun. 09, 2020	Aug. 08, 2020~ Aug. 19, 2020	Jun. 08, 2021	Radiation (03CH07-HY)



Instrument	Brand Name	Model No.	Serial No.	Characteristics	Calibration Date	Test Date	Due Date	Remark
Filter	Wainwright	WHKX8-5872 .5-6750-1800 0-40ST	SN7	6.75GHz High Pass Filter	Aug. 22, 2019	Aug. 08, 2020~ Aug. 19, 2020	Aug. 21, 2020	Radiation (03CH07-HY)
Preamplifier	EMEC	EM18G40G	0600789	18-40GHz	N/A	Aug. 08, 2020~ Aug. 19, 2020	N/A	Radiation (03CH07-HY)
Software	Audix	E3 6.2009-8-24	8050400465 6H	N/A	N/A	Aug. 08, 2020~ Aug. 19, 2020	N/A	Radiation (03CH07-HY)
Hygrometer	Testo	608-H1	34893241	N/A	Mar. 02, 2020	Aug. 03, 2020~ Aug. 29, 2020	Mar. 01, 2021	Conducted (TH05-HY)
Power Sensor	DARE	RPR3006W	16I00054SN O10	10MHz~6GHz	Dec. 23, 2019	Aug. 03, 2020~ Aug. 29, 2020	Dec. 22, 2020	Conducted (TH05-HY)
Signal Analyzer	Rohde & Schwarz	FSV40	101397	10Hz~40GHz	Nov. 15, 2019	Aug. 03, 2020~ Aug. 29, 2020	Nov. 14, 2020	Conducted (TH05-HY)
Switch Box & RF Cable	EM Electronics	EMSW18SE	SW200302	N/A	Mar. 17, 2020	Aug. 03, 2020~ Aug. 29, 2020	Mar. 16, 2021	Conducted (TH05-HY)
AC Power Source	ChainTek	APC-1000W	N/A	N/A	N/A	Aug. 12, 2020	N/A	Conduction (CO05-HY)
EMI Test Receiver	Rohde & Schwarz	ESR3	102388	9kHz~3.6GHz	Nov. 15, 2019	Aug. 12, 2020	Nov. 14, 2020	Conduction (CO05-HY)
Hygrometer	Testo	608-H1	34913912	N/A	Nov. 07, 2019	Aug. 12, 2020	Nov. 06, 2020	Conduction (CO05-HY)
LISN	Rohde & Schwarz	ENV216	100081	9kHz~30MHz	Nov. 15, 2019	Aug. 12, 2020	Nov. 14, 2020	Conduction (CO05-HY)
Software	Rohde & Schwarz	EMC32 V10.30	N/A	N/A	N/A	Aug. 12, 2020	N/A	Conduction (CO05-HY)
LF Cable	HUBER + SUHNER	RG-214/U	LF01	N/A	Jan. 02, 2020	Aug. 12, 2020	Jan. 01, 2021	Conduction (CO05-HY)
Pulse Limiter	Rohde & Schwarz	ESH3-Z2	100851	N/A	Jan. 02, 2020	Aug. 12, 2020	Jan. 01, 2021	Conduction (CO05-HY)



5 Uncertainty of Evaluation

Uncertainty of Conducted Emission Measurement (150kHz ~ 30MHz)

Measuring Uncertainty for a Level of Confidence of 95% ($U = 2Uc(y)$)	2.3
---	-----

Uncertainty of Radiated Emission Measurement (30 MHz ~ 1000 MHz)

Measuring Uncertainty for a Level of Confidence of 95% ($U = 2Uc(y)$)	4.7
---	-----

Uncertainty of Radiated Emission Measurement (1000 MHz ~ 18000 MHz)

Measuring Uncertainty for a Level of Confidence of 95% ($U = 2Uc(y)$)	5.3
---	-----

Uncertainty of Radiated Emission Measurement (18000 MHz ~ 40000 MHz)

Measuring Uncertainty for a Level of Confidence of 95% ($U = 2Uc(y)$)	5.0
---	-----



Appendix A. AC Conducted Emission Test Results

Test Engineer :	Howard Huang	Temperature :	23~25°C
		Relative Humidity :	40~43%

EUT Information

Report NO : 052917-01
 Test Mode : Mode 1
 Test Voltage : 120Vac/60Hz
 Phase : Line

Full Spectrum

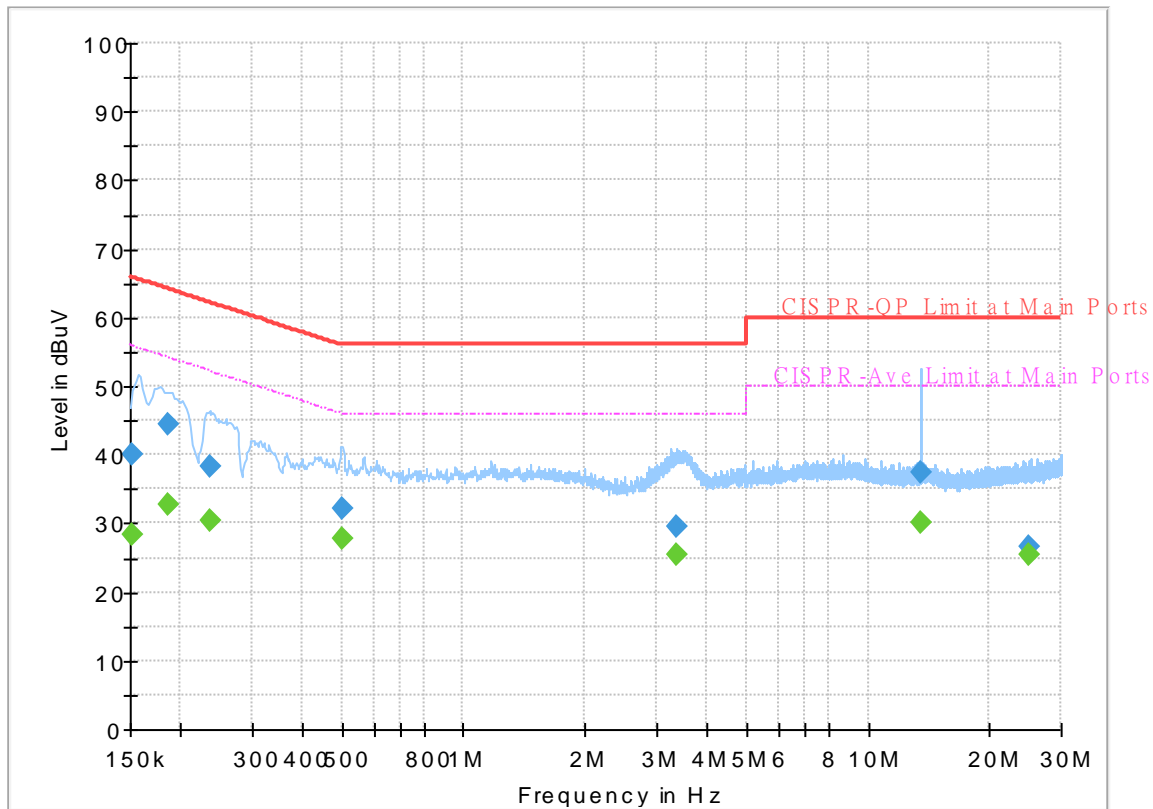

Final_Result

Frequency (MHz)	QuasiPeak (dBuV)	CAverage (dBuV)	Limit (dBuV)	Margin (dB)	Line	Filter	Corr. (dB)
0.152250	---	28.47	55.88	27.41	L1	OFF	19.6
0.152250	40.19	---	65.88	25.69	L1	OFF	19.6
0.186000	---	32.62	54.21	21.59	L1	OFF	19.6
0.186000	44.54	---	64.21	19.67	L1	OFF	19.6
0.235500	---	30.41	52.25	21.84	L1	OFF	19.6
0.235500	38.32	---	62.25	23.93	L1	OFF	19.6
0.501720	---	27.72	46.00	18.28	L1	OFF	19.6
0.501720	32.07	---	56.00	23.93	L1	OFF	19.6
3.358500	---	25.52	46.00	20.48	L1	OFF	19.7
3.358500	29.49	---	56.00	26.51	L1	OFF	19.7
13.560000	---	30.02	50.00	19.98	L1	OFF	20.2
13.560000	37.44	---	60.00	22.56	L1	OFF	20.2
24.949500	---	25.52	50.00	24.48	L1	OFF	20.5
24.949500	26.69	---	60.00	33.31	L1	OFF	20.5

EUT Information

Report NO : 052917-01
 Test Mode : Mode 1
 Test Voltage : 120Vac/60Hz
 Phase : Neutral

Full Spectrum

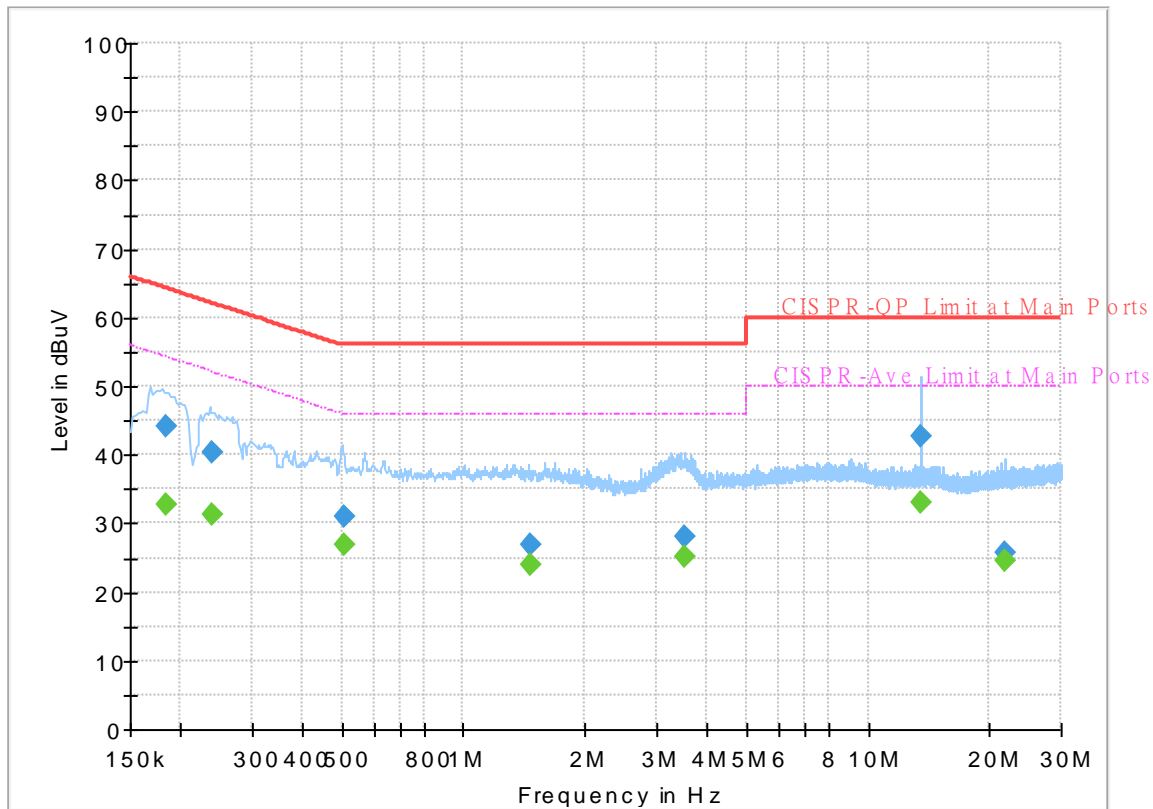

Final_Result

Frequency (MHz)	QuasiPeak (dBuV)	CAverage (dBuV)	Limit (dBuV)	Margin (dB)	Line	Filter	Corr. (dB)
0.183750	---	32.67	54.31	21.64	N	OFF	19.5
0.183750	44.29	---	64.31	20.02	N	OFF	19.5
0.240000	---	31.17	52.10	20.93	N	OFF	19.5
0.240000	40.22	---	62.10	21.88	N	OFF	19.5
0.505500	---	26.88	46.00	19.12	N	OFF	19.5
0.505500	31.03	---	56.00	24.97	N	OFF	19.5
1.469220	---	24.10	46.00	21.90	N	OFF	19.6
1.469220	26.80	---	56.00	29.20	N	OFF	19.6
3.503130	---	25.18	46.00	20.82	N	OFF	19.6
3.503130	28.09	---	56.00	27.91	N	OFF	19.6
13.560000	---	32.92	50.00	17.08	N	OFF	19.9
13.560000	42.70	---	60.00	17.30	N	OFF	19.9
21.711750	---	24.70	50.00	25.30	N	OFF	19.9
21.711750	25.85	---	60.00	34.15	N	OFF	19.9



Appendix B. Radiated Spurious Emission

Test Engineer :	Jesse Wang, Stan Hsieh and Ken Wu	Temperature :	22~23°C
		Relative Humidity :	51~59%

Band 1 - 5150~5250MHz

WIFI 802.11a (Band Edge @ 3m)

WIFI	Note	Frequency	Level	Over	Limit	Read	Antenna	Path	Preamp	Ant	Table	Peak	Pol.	
Ant. 1		(MHz)	(dBμV/m)	(dB)	Line (dBμV/m)	Level (dBμV)	Factor (dB/m)	Loss (dB)	Factor (dB)	Pos (cm)	Pos (deg)	Avg. (P/A)	(H/V)	
802.11a CH 36 5180MHz		5142.22	51.91	-22.09	74	41.38	34.4	11.55	35.42	100	38	P	H	
		5150	44.35	-9.65	54	33.81	34.4	11.56	35.42	100	38	A	H	
	*	5180	111.6	-	-	100.96	34.47	11.58	35.41	100	38	P	H	
	*	5180	104.03	-	-	93.39	34.47	11.58	35.41	100	38	A	H	
													H	
														H
			5148.2	51.58	-22.42	74	41.04	34.4	11.56	35.42	100	116	P	V
			5150	43.93	-10.07	54	33.39	34.4	11.56	35.42	100	116	A	V
	*		5180	110.61	-	-	99.97	34.47	11.58	35.41	100	116	P	V
	*		5180	102.98	-	-	92.34	34.47	11.58	35.41	100	116	A	V
														V
														V
802.11a CH 44 5220MHz		5140.14	49.34	-24.66	74	38.81	34.4	11.55	35.42	100	32	P	H	
		5150	40.39	-13.61	54	29.85	34.4	11.56	35.42	100	32	A	H	
	*	5220	112.09	-	-	101.37	34.5	11.62	35.4	100	32	P	H	
	*	5220	104.74	-	-	94.02	34.5	11.62	35.4	100	32	A	H	
			5355.56	48.73	-25.27	74	37.82	34.5	11.76	35.35	100	32	P	H
			5414.36	39.23	-14.77	54	28.03	34.7	11.83	35.33	100	32	A	H
			5103.48	49.17	-24.83	74	38.78	34.3	11.52	35.43	100	90	P	V
			5149.76	39.7	-14.3	54	29.16	34.4	11.56	35.42	100	90	A	V
	*		5220	109.65	-	-	98.93	34.5	11.62	35.4	100	90	P	V
	*		5220	101.88	-	-	91.16	34.5	11.62	35.4	100	90	A	V
			5358.36	48.2	-25.8	74	37.28	34.5	11.77	35.35	100	90	P	V
			5459.44	39.13	-14.87	54	27.86	34.7	11.88	35.31	100	90	A	V



802.11a CH 48 5240MHz		5111.8	48.89	-25.11	74	38.46	34.33	11.53	35.43	100	34	P	H
		5150	39.92	-14.08	54	29.38	34.4	11.56	35.42	100	34	A	H
	*	5240	111.56	-	-	100.81	34.5	11.64	35.39	100	34	P	H
	*	5240	104.06	-	-	93.31	34.5	11.64	35.39	100	34	A	H
		5409.6	49	-25	74	37.81	34.7	11.82	35.33	100	34	P	H
		5350	39.41	-14.59	54	28.5	34.5	11.76	35.35	100	34	A	H
		5079.56	49	-25	74	38.71	34.23	11.5	35.44	100	117	P	V
		5150	39.82	-14.18	54	29.28	34.4	11.56	35.42	100	117	A	V
	*	5240	109.01	-	-	98.26	34.5	11.64	35.39	100	117	P	V
	*	5240	101.25	-	-	90.5	34.5	11.64	35.39	100	117	A	V
		5434.8	48.07	-25.93	74	36.84	34.7	11.85	35.32	100	117	P	V
		5459.44	39.11	-14.89	54	27.84	34.7	11.88	35.31	100	117	A	V
Remark	1. No other spurious found. 2. All results are PASS against Peak and Average limit line.												



Band 1 5150~5250MHz
WIFI 802.11a (Harmonic @ 3m)

WIFI Ant. 1	Note	Frequency (MHz)	Level (dBµV/m)	Over Limit (dB)	Limit Line (dBµV/m)	Read Level (dBµV)	Antenna Factor (dB/m)	Path Loss (dB)	Preamp Factor (dB)	Ant Pos (cm)	Table Pos (deg)	Peak Avg. (P/A)	Pol. (H/V)
802.11a CH 36 5180MHz		10360	42.35	-25.85	68.2	46.33	37.47	17.58	59.03	100	0	P	H
		15540	45.88	-28.12	74	40.9	40.1	21.65	56.77	100	0	P	H
													H
													H
		10360	43.12	-25.08	68.2	47.1	37.47	17.58	59.03	100	0	P	V
		15540	44.88	-29.12	74	39.9	40.1	21.65	56.77	100	0	P	V
													V
													V
802.11a CH 44 5220MHz		10440	43.71	-24.49	68.2	47.5	37.53	17.65	58.97	100	0	P	H
		15660	45.63	-28.37	74	40.2	40.45	21.73	56.75	100	0	P	H
													H
													H
		10440	44.68	-23.52	68.2	48.47	37.53	17.65	58.97	100	0	P	V
		15660	45.9	-28.1	74	40.47	40.45	21.73	56.75	100	0	P	V
													V
													V
802.11a CH 48 5240MHz		10480	43.68	-24.52	68.2	47.36	37.58	17.68	58.94	100	0	P	H
		15720	46.49	-27.51	74	40.89	40.58	21.76	56.74	100	0	P	H
													H
													H
		10480	45.04	-23.16	68.2	48.72	37.58	17.68	58.94	100	0	P	V
		15720	47.16	-26.84	74	41.56	40.58	21.76	56.74	100	0	P	V
													V
													V
Remark	1. No other spurious found. 2. All results are PASS against Peak and Average limit line.												



Band 1 5150~5250MHz
WIFI 802.11ac VHT20 (Band Edge @ 3m)

WIFI Ant. 1	Note	Frequency (MHz)	Level (dBμV/m)	Over Limit (dB)	Limit Line (dBμV/m)	Read Level (dBμV)	Antenna Factor (dB/m)	Path Loss (dB)	Preamp Factor (dB)	Ant Pos (cm)	Table Pos (deg)	Peak Avg. (P/A)	Pol. (H/V)	
802.11ac VHT20 CH 36 5180MHz		5149.76	53.7	-20.3	74	43.16	34.4	11.56	35.42	100	36	P	H	
		5150	47.12	-6.88	54	36.58	34.4	11.56	35.42	100	36	A	H	
	*	5180	112.02	-	-	101.38	34.47	11.58	35.41	100	36	P	H	
	*	5180	104.39	-	-	93.75	34.47	11.58	35.41	100	36	A	H	
													H	
													H	
			5148.98	52.76	-21.24	74	42.22	34.4	11.56	35.42	100	116	P	V
			5149.76	46.16	-7.84	54	35.62	34.4	11.56	35.42	100	116	A	V
		*	5180	110.84	-	-	100.2	34.47	11.58	35.41	100	116	P	V
		*	5180	103.27	-	-	92.63	34.47	11.58	35.41	100	116	A	V
													V	
													V	
802.11ac VHT20 CH 44 5220MHz		5108.42	48.61	-25.39	74	38.19	34.33	11.52	35.43	100	33	P	H	
		5146.64	41.26	-12.74	54	30.73	34.4	11.55	35.42	100	33	A	H	
		*	5220	111.44	-	-	100.72	34.5	11.62	35.4	100	33	P	H
		*	5220	104.07	-	-	93.35	34.5	11.62	35.4	100	33	A	H
			5427.8	48.41	-25.59	74	37.19	34.7	11.84	35.32	100	33	P	H
			5435.64	40.46	-13.54	54	29.23	34.7	11.85	35.32	100	33	A	H
			5134.16	49.75	-24.25	74	39.26	34.37	11.54	35.42	100	119	P	V
			5149.5	40.95	-13.05	54	30.41	34.4	11.56	35.42	100	119	A	V
		*	5220	109.24	-	-	98.52	34.5	11.62	35.4	100	119	P	V
		*	5220	102.2	-	-	91.48	34.5	11.62	35.4	100	119	A	V
		5382.44	47.95	-26.05	74	36.87	34.63	11.79	35.34	100	119	P	V	
		5435.64	39.88	-14.12	54	28.65	34.7	11.85	35.32	100	119	A	V	



802.11ac VHT20 CH 48 5240MHz		5147.42	49.39	-24.61	74	38.85	34.4	11.56	35.42	100	34	P	H
		5135.72	40.63	-13.37	54	30.13	34.37	11.55	35.42	100	34	A	H
	*	5240	111.5	-	-	100.75	34.5	11.64	35.39	100	34	P	H
	*	5240	103.91	-	-	93.16	34.5	11.64	35.39	100	34	A	H
		5354.72	49.01	-24.99	74	38.1	34.5	11.76	35.35	100	34	P	H
		5356.12	40.41	-13.59	54	29.5	34.5	11.76	35.35	100	34	A	H
		5131.04	49.03	-24.97	74	38.55	34.37	11.54	35.43	100	118	P	V
		5143.52	40.47	-13.53	54	29.94	34.4	11.55	35.42	100	118	A	V
	*	5240	108.8	-	-	98.05	34.5	11.64	35.39	100	118	P	V
	*	5240	101.2	-	-	90.45	34.5	11.64	35.39	100	118	A	V
		5386.36	48.85	-25.15	74	37.76	34.63	11.8	35.34	100	118	P	V
		5440.68	39.75	-14.25	54	28.51	34.7	11.86	35.32	100	118	A	V
Remark	1. No other spurious found. 2. All results are PASS against Peak and Average limit line.												



Band 1 5150~5250MHz
WIFI 802.11ac VHT20 (Harmonic @ 3m)

WIFI Ant. 1	Note	Frequency (MHz)	Level (dBμV/m)	Over Limit (dB)	Limit Line (dBμV/m)	Read Level (dBμV)	Antenna Factor (dB/m)	Path Loss (dB)	Preamp Factor (dB)	Ant Pos (cm)	Table Pos (deg)	Peak Avg. (P/A)	Pol. (H/V)
802.11ac VHT20 CH 36 5180MHz		10360	42.81	-25.39	68.2	46.79	37.47	17.58	59.03	100	0	P	H
		15540	45.58	-28.42	74	40.6	40.1	21.65	56.77	100	0	P	H
													H
													H
		10360	42.56	-25.64	68.2	46.54	37.47	17.58	59.03	100	0	P	V
		15540	44.76	-29.24	74	39.78	40.1	21.65	56.77	100	0	P	V
													V
802.11ac VHT20 CH 44 5220MHz		10440	43.59	-24.61	68.2	47.38	37.53	17.65	58.97	100	0	P	H
		15660	45.47	-28.53	74	40.04	40.45	21.73	56.75	100	0	P	H
													H
													H
		10440	43.17	-25.03	68.2	46.96	37.53	17.65	58.97	100	0	P	V
		15660	45.81	-28.19	74	40.38	40.45	21.73	56.75	100	0	P	V
													V
802.11ac VHT20 CH 48 5240MHz		10480	43.32	-24.88	68.2	47	37.58	17.68	58.94	100	0	P	H
		15720	46.37	-27.63	74	40.77	40.58	21.76	56.74	100	0	P	H
													H
													H
		10480	44.57	-23.63	68.2	48.25	37.58	17.68	58.94	100	0	P	V
		15720	47.41	-26.59	74	41.81	40.58	21.76	56.74	100	0	P	V
													V
Remark	1. No other spurious found.												
	2. All results are PASS against Peak and Average limit line.												



Band 1 5150~5250MHz
WIFI 802.11ac VHT40 (Band Edge @ 3m)

WIFI Ant. 1	Note	Frequency (MHz)	Level (dBμV/m)	Over Limit (dB)	Limit Line (dBμV/m)	Read Level (dBμV)	Antenna Factor (dB/m)	Path Loss (dB)	Preamp Factor (dB)	Ant Pos (cm)	Table Pos (deg)	Peak Avg. (P/A)	Pol. (H/V)
802.11ac VHT40 CH 38 5190MHz		5149.24	58.34	-15.66	74	47.8	34.4	11.56	35.42	100	36	P	H
		5149.76	50.89	-3.11	54	40.35	34.4	11.56	35.42	100	36	A	H
	*	5190	106.13	-	-	95.48	34.47	11.59	35.41	100	36	P	H
	*	5190	98.2	-	-	87.55	34.47	11.59	35.41	100	36	A	H
		5426.68	47.96	-26.04	74	36.74	34.7	11.84	35.32	100	36	P	H
		5447.4	40.2	-13.8	54	28.96	34.7	11.86	35.32	100	36	A	H
		5150	57.54	-16.46	74	47	34.4	11.56	35.42	100	120	P	V
		5150	49.32	-4.68	54	38.78	34.4	11.56	35.42	100	120	A	V
	*	5190	104.55	-	-	93.9	34.47	11.59	35.41	100	120	P	V
	*	5190	96.83	-	-	86.18	34.47	11.59	35.41	100	120	A	V
		5427.24	46.81	-27.19	74	35.59	34.7	11.84	35.32	100	120	P	V
		5443.2	39.76	-14.24	54	28.52	34.7	11.86	35.32	100	120	A	V
802.11ac VHT40 CH 46 5230MHz		5147.68	52.97	-21.03	74	42.43	34.4	11.56	35.42	100	35	P	H
		5150	45.89	-8.11	54	35.35	34.4	11.56	35.42	100	35	A	H
	*	5230	109.04	-	-	98.3	34.5	11.63	35.39	100	35	P	H
	*	5230	100.84	-	-	90.1	34.5	11.63	35.39	100	35	A	H
		5385.8	48.58	-25.42	74	37.49	34.63	11.8	35.34	100	35	P	H
		5350.8	40.8	-13.2	54	29.89	34.5	11.76	35.35	100	35	A	H
		5148.98	51.32	-22.68	74	40.78	34.4	11.56	35.42	100	120	P	V
		5149.24	44.69	-9.31	54	34.15	34.4	11.56	35.42	100	120	A	V
	*	5230	105.34	-	-	94.6	34.5	11.63	35.39	100	120	P	V
	*	5230	98.84	-	-	88.1	34.5	11.63	35.39	100	120	A	V
	5415.48	47.41	-26.59	74	36.21	34.7	11.83	35.33	100	120	P	V	
	5432.28	39.82	-14.18	54	28.59	34.7	11.85	35.32	100	120	A	V	
Remark	1. No other spurious found. 2. All results are PASS against Peak and Average limit line.												



**Band 1 5150~5250MHz
WIFI 802.11ac VHT40 (Harmonic @ 3m)**

WIFI Ant. 1	Note	Frequency (MHz)	Level (dBμV/m)	Over Limit (dB)	Limit Line (dBμV/m)	Read Level (dBμV)	Antenna Factor (dB/m)	Path Loss (dB)	Preamp Factor (dB)	Ant Pos (cm)	Table Pos (deg)	Peak Avg. (P/A)	Pol. (H/V)	
802.11ac VHT40 CH 38 5190MHz		10380	43.14	-25.06	68.2	47.08	37.48	17.6	59.02	100	0	P	H	
		15570	45.89	-28.11	74	40.78	40.2	21.68	56.77	100	0	P	H	
													H	
													H	
			10380	43.13	-25.07	68.2	47.07	37.48	17.6	59.02	100	0	P	V
			15570	45.36	-28.64	74	40.25	40.2	21.68	56.77	100	0	P	V
														V
802.11ac VHT40 CH 46 5230MHz		10460	43.52	-24.68	68.2	47.27	37.55	17.66	58.96	100	0	P	H	
		15690	46.22	-27.78	74	40.67	40.55	21.75	56.75	100	0	P	H	
													H	
													H	
			10460	43.6	-24.6	68.2	47.35	37.55	17.66	58.96	100	0	P	V
			15690	46.24	-27.76	74	40.69	40.55	21.75	56.75	100	0	P	V
														V
Remark	1. No other spurious found.													
	2. All results are PASS against Peak and Average limit line.													



Band 1 5150~5250MHz
WIFI 802.11ac VHT80 (Band Edge @ 3m)

WIFI Ant. 1	Note	Frequency (MHz)	Level (dBμV/m)	Over Limit (dB)	Limit Line (dBμV/m)	Read Level (dBμV)	Antenna Factor (dB/m)	Path Loss (dB)	Preamp Factor (dB)	Ant Pos (cm)	Table Pos (deg)	Peak Avg. (P/A)	Pol. (H/V)
802.11ac VHT80 CH 42 5210MHz		5144.04	60.25	-13.75	74	49.72	34.4	11.55	35.42	105	37	P	H
		5150	50.38	-3.62	54	39.84	34.4	11.56	35.42	105	37	A	H
	*	5210	103.29	-	-	92.58	34.5	11.61	35.4	105	37	P	H
	*	5210	94.81	-	-	84.1	34.5	11.61	35.4	105	37	A	H
		5360.32	48.45	-25.55	74	37.53	34.5	11.77	35.35	105	37	P	H
		5359.76	40.93	-13.07	54	30.01	34.5	11.77	35.35	105	37	A	H
		5149.5	56.53	-17.47	74	45.99	34.4	11.56	35.42	103	119	P	V
		5149.76	49.15	-4.85	54	38.61	34.4	11.56	35.42	103	119	A	V
	*	5210	100.76	-	-	90.05	34.5	11.61	35.4	103	119	P	V
	*	5210	93.11	-	-	82.4	34.5	11.61	35.4	103	119	A	V
		5388.6	47.87	-26.13	74	36.78	34.63	11.8	35.34	103	119	P	V
	5446.84	40.04	-13.96	54	28.8	34.7	11.86	35.32	103	119	A	V	
Remark	1. No other spurious found. 2. All results are PASS against Peak and Average limit line.												



**Band 1 5150~5250MHz
WIFI 802.11ac VHT80 (Harmonic @ 3m)**

WIFI Ant. 1	Note	Frequency (MHz)	Level (dBμV/m)	Over Limit (dB)	Limit Line (dBμV/m)	Read Level (dBμV)	Antenna Factor (dB/m)	Path Loss (dB)	Preamp Factor (dB)	Ant Pos (cm)	Table Pos (deg)	Peak Avg. (P/A)	Pol. (H/V)	
802.11ac VHT80 CH 42 5210MHz		10420	43.76	-24.44	68.2	47.6	37.52	17.63	58.99	100	0	P	H	
		15630	45.93	-28.07	74	40.58	40.4	21.71	56.76	100	0	P	H	
													H	
													H	
			10420	43.92	-24.28	68.2	47.76	37.52	17.63	58.99	100	0	P	V
			15630	45.82	-28.18	74	40.47	40.4	21.71	56.76	100	0	P	V
														V
													V	
Remark	1. No other spurious found. 2. All results are PASS against Peak and Average limit line.													



Band 2 - 5250~5350MHz
WiFi 802.11a (Band Edge @ 3m)

WiFi Ant. 1	Note	Frequency (MHz)	Level (dBμV/m)	Over Limit (dB)	Limit Line (dBμV/m)	Read Level (dBμV)	Antenna Factor (dB/m)	Path Loss (dB)	Preamp Factor (dB)	Ant Pos (cm)	Table Pos (deg)	Peak Avg. (P/A)	Pol. (H/V)
802.11a CH 52 5260MHz		5072.8	48	-26	74	37.73	34.23	11.49	35.45	113	34	P	H
		5148.75	39.04	-14.96	54	28.5	34.4	11.56	35.42	113	34	A	H
	*	5260	111.4	-	-	100.55	34.57	11.66	35.38	113	34	P	H
	*	5260	103.75	-	-	92.9	34.57	11.66	35.38	113	34	A	H
		5350.32	47.55	-26.45	74	36.64	34.5	11.76	35.35	113	34	P	H
		5350.32	39.17	-14.83	54	28.26	34.5	11.76	35.35	113	34	A	H
		5081.55	49.55	-24.45	74	39.26	34.23	11.5	35.44	100	119	P	V
		5150	39.08	-14.92	54	28.54	34.4	11.56	35.42	100	119	A	V
	*	5260	108.95	-	-	98.1	34.57	11.66	35.38	100	119	P	V
	*	5260	100.96	-	-	90.11	34.57	11.66	35.38	100	119	A	V
		5358	47.68	-26.32	74	36.76	34.5	11.77	35.35	100	119	P	V
		5459.52	38.32	-15.68	54	27.05	34.7	11.88	35.31	100	119	A	V
802.11a CH 60 5300MHz		5116.9	47.69	-26.31	74	37.26	34.33	11.53	35.43	100	34	P	H
		5140.7	38.91	-15.09	54	28.38	34.4	11.55	35.42	100	34	A	H
	*	5300	109.7	-	-	98.67	34.7	11.7	35.37	100	34	P	H
	*	5300	103.62	-	-	92.59	34.7	11.7	35.37	100	34	A	H
		5353.2	49.82	-24.18	74	38.91	34.5	11.76	35.35	100	34	P	H
		5350.08	42.39	-11.61	54	31.48	34.5	11.76	35.35	100	34	A	H
		5137.55	48.12	-25.88	74	37.62	34.37	11.55	35.42	100	120	P	V
		5138.6	38.88	-15.12	54	28.38	34.37	11.55	35.42	100	120	A	V
	*	5300	108.34	-	-	97.31	34.7	11.7	35.37	100	120	P	V
	*	5300	100.46	-	-	89.43	34.7	11.7	35.37	100	120	A	V
		5363.76	48.05	-25.95	74	37.06	34.57	11.77	35.35	100	120	P	V
		5350.08	39.5	-14.5	54	28.59	34.5	11.76	35.35	100	120	A	V



802.11a CH 64 5320MHz	*	5320	110.4	-	-	99.4	34.63	11.73	35.36	100	34	P	H
	*	5320	102.2	-	-	91.2	34.63	11.73	35.36	100	34	A	H
		5354.08	55.19	-18.81	74	44.28	34.5	11.76	35.35	100	34	P	H
		5350.08	48.58	-5.42	54	37.67	34.5	11.76	35.35	100	34	A	H
													H
													H
	*	5320	106.9	-	-	95.9	34.63	11.73	35.36	100	239	P	V
	*	5320	99.27	-	-	88.27	34.63	11.73	35.36	100	239	A	V
		5350.08	52.44	-21.56	74	41.53	34.5	11.76	35.35	100	239	P	V
		5350.08	45.17	-8.83	54	34.26	34.5	11.76	35.35	100	239	A	V
													V
													V
Remark	<ol style="list-style-type: none"> 1. No other spurious found. 2. All results are PASS against Peak and Average limit line. 												



Band 2 5250~5350MHz
WIFI 802.11a (Harmonic @ 3m)

WIFI Ant. 1	Note	Frequency (MHz)	Level (dBμV/m)	Over Limit (dB)	Limit Line (dBμV/m)	Read Level (dBμV)	Antenna Factor (dB/m)	Path Loss (dB)	Preamp Factor (dB)	Ant Pos (cm)	Table Pos (deg)	Peak Avg. (P/A)	Pol. (H/V)
802.11a CH 52 5260MHz		10520	43.72	-24.48	68.2	47.34	37.6	17.7	58.92	100	0	P	H
		15780	46.76	-27.24	74	41.17	40.53	21.8	56.74	100	0	P	H
													H
													H
		10520	44.46	-23.74	68.2	48.08	37.6	17.7	58.92	100	0	P	V
		15780	46.28	-27.72	74	40.69	40.53	21.8	56.74	100	0	P	V
													V
													V
802.11a CH 60 5300MHz		10600	44.39	-29.61	74	47.91	37.6	17.76	58.88	100	0	P	H
		15900	46.47	-27.53	74	40.5	40.8	21.89	56.72	100	0	P	H
													H
													H
		10600	43.21	-30.79	74	46.73	37.6	17.76	58.88	100	0	P	V
		15900	46.81	-27.19	74	40.84	40.8	21.89	56.72	100	0	P	V
													V
													V
802.11a CH 64 5320MHz		10640	43.79	-30.21	74	47.23	37.63	17.79	58.86	100	0	P	H
		15960	45.46	-28.54	74	39.44	40.8	21.93	56.71	100	0	P	H
													H
													H
		10640	44.22	-29.78	74	47.66	37.63	17.79	58.86	100	0	P	V
		15960	45.22	-28.78	74	39.2	40.8	21.93	56.71	100	0	P	V
													V
													V
Remark	1. No other spurious found. 2. All results are PASS against Peak and Average limit line.												



Band 2 5250~5350MHz
WIFI 802.11ac VHT20 (Band Edge @ 3m)

WIFI Ant. 1	Note	Frequency (MHz)	Level (dBμV/m)	Over Limit (dB)	Limit Line (dBμV/m)	Read Level (dBμV)	Antenna Factor (dB/m)	Path Loss (dB)	Preamp Factor (dB)	Ant Pos (cm)	Table Pos (deg)	Peak Avg. (P/A)	Pol. (H/V)
802.11ac VHT20 CH 52 5260MHz		5109.9	48.79	-25.21	74	38.37	34.33	11.52	35.43	113	34	P	H
		5117.6	39.86	-14.14	54	29.43	34.33	11.53	35.43	113	34	A	H
	*	5260	110.75	-	-	99.9	34.57	11.66	35.38	113	34	P	H
	*	5260	103.36	-	-	92.51	34.57	11.66	35.38	113	34	A	H
		5382.24	47.92	-26.08	74	36.84	34.63	11.79	35.34	113	34	P	H
		5351.52	39.91	-14.09	54	29	34.5	11.76	35.35	113	34	A	H
		5096.6	47.8	-26.2	74	37.43	34.3	11.51	35.44	100	119	P	V
		5099.05	40.06	-13.94	54	29.69	34.3	11.51	35.44	100	119	A	V
	*	5260	107.55	-	-	96.7	34.57	11.66	35.38	100	119	P	V
	*	5260	100.82	-	-	89.97	34.57	11.66	35.38	100	119	A	V
		5351.52	48	-26	74	37.09	34.5	11.76	35.35	100	119	P	V
		5351.76	39.31	-14.69	54	28.4	34.5	11.76	35.35	100	119	A	V
802.11ac VHT20 CH 60 5300MHz		5100.1	48.29	-25.71	74	37.91	34.3	11.52	35.44	100	34	P	H
		5146.3	39.93	-14.07	54	29.4	34.4	11.55	35.42	100	34	A	H
	*	5300	112.64	-	-	101.61	34.7	11.7	35.37	100	34	P	H
	*	5300	103.84	-	-	92.81	34.7	11.7	35.37	100	34	A	H
		5354.64	50.91	-23.09	74	40	34.5	11.76	35.35	100	34	P	H
		5350.08	43.81	-10.19	54	32.9	34.5	11.76	35.35	100	34	A	H
		5118.3	48.13	-25.87	74	37.7	34.33	11.53	35.43	100	120	P	V
		5132.3	39.67	-14.33	54	29.19	34.37	11.54	35.43	100	120	A	V
	*	5300	107.94	-	-	96.91	34.7	11.7	35.37	100	120	P	V
	*	5300	100.74	-	-	89.71	34.7	11.7	35.37	100	120	A	V
	5351.04	47.93	-26.07	74	37.02	34.5	11.76	35.35	100	120	P	V	
	5350.32	40.52	-13.48	54	29.61	34.5	11.76	35.35	100	120	A	V	



802.11ac VHT20 CH 64 5320MHz	*	5320	110.3	-	-	99.3	34.63	11.73	35.36	100	34	P	H
	*	5320	102.6	-	-	91.6	34.63	11.73	35.36	100	34	A	H
		5351.52	57.55	-16.45	74	46.64	34.5	11.76	35.35	100	34	P	H
		5350.24	49.31	-4.69	54	38.4	34.5	11.76	35.35	100	34	A	H
													H
													H
	*	5320	106.47	-	-	95.47	34.63	11.73	35.36	100	239	P	V
	*	5320	99.24	-	-	88.24	34.63	11.73	35.36	100	239	A	V
		5350.88	53.61	-20.39	74	42.7	34.5	11.76	35.35	100	239	P	V
		5350.4	46.06	-7.94	54	35.15	34.5	11.76	35.35	100	239	A	V
													V
													V
Remark	1. No other spurious found. 2. All results are PASS against Peak and Average limit line.												



**Band 2 5250~5350MHz
WIFI 802.11ac VHT20 (Harmonic @ 3m)**

WIFI Ant. 1	Note	Frequency (MHz)	Level (dBμV/m)	Over Limit (dB)	Limit Line (dBμV/m)	Read Level (dBμV)	Antenna Factor (dB/m)	Path Loss (dB)	Preamp Factor (dB)	Ant Pos (cm)	Table Pos (deg)	Peak Avg. (P/A)	Pol. (H/V)	
802.11ac VHT20 CH 52 5260MHz		10520	43.75	-24.45	68.2	47.37	37.6	17.7	58.92	100	0	P	H	
		15780	46.8	-27.2	74	41.21	40.53	21.8	56.74	100	0	P	H	
													H	
													H	
			10520	44.03	-24.17	68.2	47.65	37.6	17.7	58.92	100	0	P	V
			15780	46.87	-27.13	74	41.28	40.53	21.8	56.74	100	0	P	V
														V
802.11ac VHT20 CH 60 5300MHz		10600	43.8	-30.2	74	47.32	37.6	17.76	58.88	100	0	P	H	
		15900	47.41	-26.59	74	41.44	40.8	21.89	56.72	100	0	P	H	
													H	
													H	
			10600	43.87	-30.13	74	47.39	37.6	17.76	58.88	100	0	P	V
			15900	46.86	-27.14	74	40.89	40.8	21.89	56.72	100	0	P	V
														V
802.11ac VHT20 CH 64 5320MHz		10640	43.62	-30.38	74	47.06	37.63	17.79	58.86	100	0	P	H	
		15960	45.64	-28.36	74	39.62	40.8	21.93	56.71	100	0	P	H	
													H	
													H	
			10640	44.33	-29.67	74	47.77	37.63	17.79	58.86	100	0	P	V
			15960	46.54	-27.46	74	40.52	40.8	21.93	56.71	100	0	P	V
														V
Remark	1. No other spurious found.													
	2. All results are PASS against Peak and Average limit line.													



Band 2 5250~5350MHz
WIFI 802.11ac VHT40 (Band Edge @ 3m)

WIFI Ant. 1	Note	Frequency (MHz)	Level (dBμV/m)	Over Limit (dB)	Limit Line (dBμV/m)	Read Level (dBμV)	Antenna Factor (dB/m)	Path Loss (dB)	Preamp Factor (dB)	Ant Pos (cm)	Table Pos (deg)	Peak Avg. (P/A)	Pol. (H/V)
802.11ac VHT40 CH 54 5270MHz		5132.65	49.65	-24.35	74	39.16	34.37	11.54	35.42	100	34	P	H
		5149.45	40.7	-13.3	54	30.16	34.4	11.56	35.42	100	34	A	H
	*	5270	106.41	-	-	95.55	34.57	11.67	35.38	100	34	P	H
	*	5270	99.16	-	-	88.3	34.57	11.67	35.38	100	34	A	H
		5351.28	51.29	-22.71	74	40.38	34.5	11.76	35.35	100	34	P	H
		5351.76	43.82	-10.18	54	32.91	34.5	11.76	35.35	100	34	A	H
		5106.05	47.91	-26.09	74	37.49	34.33	11.52	35.43	101	119	P	V
		5112	40.56	-13.44	54	30.13	34.33	11.53	35.43	101	119	A	V
	*	5270	104.58	-	-	93.72	34.57	11.67	35.38	101	119	P	V
	*	5270	96.96	-	-	86.1	34.57	11.67	35.38	101	119	A	V
		5351.52	47.54	-26.46	74	36.63	34.5	11.76	35.35	101	119	P	V
		5351.04	41.22	-12.78	54	30.31	34.5	11.76	35.35	101	119	A	V
802.11ac VHT40 CH 62 5310MHz		5144.2	48.57	-25.43	74	38.04	34.4	11.55	35.42	100	36	P	H
		5148.05	41.09	-12.91	54	30.55	34.4	11.56	35.42	100	36	A	H
	*	5310	104.34	-	-	93.35	34.63	11.72	35.36	100	36	P	H
	*	5310	97.12	-	-	86.13	34.63	11.72	35.36	100	36	A	H
		5350.8	57.03	-16.97	74	46.12	34.5	11.76	35.35	100	36	P	H
		5350.08	52.66	-1.34	54	41.75	34.5	11.76	35.35	100	36	A	H
		5074.2	48.81	-25.19	74	38.53	34.23	11.49	35.44	100	242	P	V
		5107.1	40.92	-13.08	54	30.5	34.33	11.52	35.43	100	242	A	V
	*	5310	102.18	-	-	91.19	34.63	11.72	35.36	100	242	P	V
	*	5310	94.09	-	-	83.1	34.63	11.72	35.36	100	242	A	V
	5357.04	55.48	-18.52	74	44.57	34.5	11.76	35.35	100	242	P	V	
	5350.08	48.27	-5.73	54	37.36	34.5	11.76	35.35	100	242	A	V	
Remark	1. No other spurious found. 2. All results are PASS against Peak and Average limit line.												



Band 2 5250~5350MHz
WIFI 802.11ac VHT40 (Harmonic @ 3m)

WIFI Ant. 1	Note	Frequency (MHz)	Level (dBμV/m)	Over Limit (dB)	Limit Line (dBμV/m)	Read Level (dBμV)	Antenna Factor (dB/m)	Path Loss (dB)	Preamp Factor (dB)	Ant Pos (cm)	Table Pos (deg)	Peak Avg. (P/A)	Pol. (H/V)	
802.11ac VHT40 CH 54 5270MHz		10540	43.2	-25	68.2	46.8	37.6	17.71	58.91	100	0	P	H	
		15810	46.38	-27.62	74	40.79	40.5	21.82	56.73	100	0	P	H	
													H	
													H	
			10540	43.27	-24.93	68.2	46.87	37.6	17.71	58.91	100	0	P	V
			15810	46.3	-27.7	74	40.71	40.5	21.82	56.73	100	0	P	V
														V
802.11ac VHT40 CH 62 5310MHz		10620	44.14	-29.86	74	47.61	37.62	17.78	58.87	100	0	P	H	
		15930	46.51	-27.49	74	40.51	40.8	21.91	56.71	100	0	P	H	
													H	
													H	
			10620	44.03	-29.97	74	47.5	37.62	17.78	58.87	100	0	P	V
			15930	46.48	-27.52	74	40.48	40.8	21.91	56.71	100	0	P	V
														V
Remark	1. No other spurious found.													
	2. All results are PASS against Peak and Average limit line.													



**Band 2 5250~5350MHz
WIFI 802.11ac VHT80 (Band Edge @ 3m)**

WIFI Ant. 1	Note	Frequency (MHz)	Level (dBμV/m)	Over Limit (dB)	Limit Line (dBμV/m)	Read Level (dBμV)	Antenna Factor (dB/m)	Path Loss (dB)	Preamp Factor (dB)	Ant Pos (cm)	Table Pos (deg)	Peak Avg. (P/A)	Pol. (H/V)
802.11ac VHT80 CH 58 5290MHz		5065.45	48.41	-25.59	74	38.2	34.17	11.49	35.45	104	33	P	H
		5147.35	40.46	-13.54	54	29.92	34.4	11.56	35.42	104	33	A	H
	*	5290	100.38	-	-	89.43	34.63	11.69	35.37	104	33	P	H
	*	5290	92.81	-	-	81.86	34.63	11.69	35.37	104	33	A	H
		5351.28	60.07	-13.93	74	49.16	34.5	11.76	35.35	104	33	P	H
		5350.32	52.39	-1.61	54	41.48	34.5	11.76	35.35	104	33	A	H
		5137.9	48.87	-25.13	74	38.37	34.37	11.55	35.42	100	121	P	V
		5105	40.67	-13.33	54	30.28	34.3	11.52	35.43	100	121	A	V
	*	5290	97.82	-	-	86.87	34.63	11.69	35.37	100	121	P	V
	*	5290	89.66	-	-	78.71	34.63	11.69	35.37	100	121	A	V
		5356.56	53.62	-20.38	74	42.71	34.5	11.76	35.35	100	121	P	V
	5350.08	47.23	-6.77	54	36.32	34.5	11.76	35.35	100	121	A	V	
Remark	1. No other spurious found. 2. All results are PASS against Peak and Average limit line.												



**Band 2 5250~5350MHz
WIFI 802.11ac VHT80 (Harmonic @ 3m)**

WIFI Ant. 1	Note	Frequency (MHz)	Level (dBμV/m)	Over Limit (dB)	Limit Line (dBμV/m)	Read Level (dBμV)	Antenna Factor (dB/m)	Path Loss (dB)	Preamp Factor (dB)	Ant Pos (cm)	Table Pos (deg)	Peak Avg. (P/A)	Pol. (H/V)	
802.11ac VHT80 CH 58 5290MHz		10580	42.82	-25.38	68.2	46.36	37.6	17.75	58.89	100	0	P	H	
		15870	47.06	-26.94	74	41.17	40.74	21.87	56.72	100	0	P	H	
													H	
													H	
			10580	44.08	-24.12	68.2	47.62	37.6	17.75	58.89	100	0	P	V
			15870	46.51	-27.49	74	40.62	40.74	21.87	56.72	100	0	P	V
														V
													V	
Remark	1. No other spurious found. 2. All results are PASS against Peak and Average limit line.													



Band 3 - 5470~5725MHz
WIFI 802.11a (Band Edge @ 3m)

WIFI Ant. 1	Note	Frequency (MHz)	Level (dBμV/m)	Over Limit (dB)	Limit Line (dBμV/m)	Read Level (dBμV)	Antenna Factor (dB/m)	Path Loss (dB)	Preamp Factor (dB)	Ant Pos (cm)	Table Pos (deg)	Peak Avg. (P/A)	Pol. (H/V)	
802.11a CH 100 5500MHz		5459.9	50.28	-23.72	74	39.01	34.7	11.88	35.31	121	35	P	H	
		5468.4	56.43	-11.77	68.2	45.05	34.8	11.89	35.31	121	35	P	H	
		5460	43.84	-10.16	54	32.57	34.7	11.88	35.31	121	35	A	H	
	*	5500	111.39	-	-	99.76	35	11.93	35.3	121	35	P	H	
	*	5500	103.72	-	-	92.09	35	11.93	35.3	121	35	A	H	
														H
			5454.64	49.01	-24.99	74	37.76	34.7	11.87	35.32	100	102	P	V
			5468.72	55.63	-12.57	68.2	44.25	34.8	11.89	35.31	100	102	P	V
			5460	42.29	-11.71	54	31.02	34.7	11.88	35.31	100	102	A	V
	*		5500	109.14	-	-	97.51	35	11.93	35.3	100	102	P	V
	*		5500	101.37	-	-	89.74	35	11.93	35.3	100	102	A	V
														V
802.11a CH 116 5580MHz		5449.12	47.72	-26.28	74	36.47	34.7	11.87	35.32	100	11	P	H	
		5461.6	49.04	-19.16	68.2	37.77	34.7	11.88	35.31	100	11	P	H	
		5457.76	39.52	-14.48	54	28.25	34.7	11.88	35.31	100	11	A	H	
	*	5580	111.28	-	-	99.7	34.87	12.02	35.31	100	11	P	H	
	*	5580	103.64	-	-	92.06	34.87	12.02	35.31	100	11	A	H	
			5735.705	50.06	-18.14	68.2	38.12	35	12.26	35.32	100	11	P	H
			5374.72	48.05	-25.95	74	37.04	34.57	11.78	35.34	115	103	P	V
			5469.76	47.7	-20.5	68.2	36.32	34.8	11.89	35.31	115	103	P	V
			5459.92	39.37	-14.63	54	28.1	34.7	11.88	35.31	115	103	A	V
	*		5580	109.75	-	-	98.17	34.87	12.02	35.31	115	103	P	V
	*		5580	102.1	-	-	90.52	34.87	12.02	35.31	115	103	A	V
			5755.865	49.94	-18.26	68.2	37.97	35	12.3	35.33	115	103	P	V



802.11a CH 140 5700MHz	*	5700	111.14	-	-	99.26	35	12.2	35.32	107	38	P	H
	*	5700	103.45	-	-	91.57	35	12.2	35.32	107	38	A	H
		5725.16	59.79	-8.41	68.2	47.86	35	12.25	35.32	107	38	P	H
													H
													H
													H
	*	5700	110.78	-	-	98.9	35	12.2	35.32	100	110	P	V
	*	5700	103.2	-	-	91.32	35	12.2	35.32	100	110	A	V
		5725	59.43	-8.77	68.2	47.5	35	12.25	35.32	100	110	P	V
													V
													V
													V
Remark	1. No other spurious found. 2. All results are PASS against Peak and Average limit line.												



Band 3 - 5470~5725MHz
WIFI 802.11a (Harmonic @ 3m)

WIFI Ant. 1	Note	Frequency (MHz)	Level (dBμV/m)	Over Limit (dB)	Limit Line (dBμV/m)	Read Level (dBμV)	Antenna Factor (dB/m)	Path Loss (dB)	Preamp Factor (dB)	Ant Pos (cm)	Table Pos (deg)	Peak Avg. (P/A)	Pol. (H/V)
802.11a CH 100 5500MHz		11000	44.35	-29.65	74	47.09	37.9	18.05	58.69	100	0	P	H
		16500	48.07	-20.13	68.2	40.51	41.6	22.38	56.42	100	0	P	H
													H
													H
		11000	44.34	-29.66	74	47.08	37.9	18.05	58.69	100	0	P	V
		16500	48.84	-19.36	68.2	41.28	41.6	22.38	56.42	100	0	P	V
													V
													V
802.11a CH 116 5580MHz		11160	43.98	-30.02	74	46.2	37.9	18.19	58.31	100	0	P	H
		16740	47.46	-20.74	68.2	38.85	42.36	22.58	56.33	100	0	P	H
													H
													H
		11160	44.81	-29.19	74	47.03	37.9	18.19	58.31	100	0	P	V
		16740	48.23	-19.97	68.2	39.62	42.36	22.58	56.33	100	0	P	V
													V
													V
802.11a CH 140 5700MHz		11400	45.23	-28.77	74	46.46	38.1	18.41	57.74	100	0	P	H
		17100	49.76	-18.44	68.2	41.16	42	22.87	56.27	100	0	P	H
													H
													H
		11400	44.34	-29.66	74	45.57	38.1	18.41	57.74	100	0	P	V
		17100	49.18	-19.02	68.2	40.58	42	22.87	56.27	100	0	P	V
													V
													V
Remark	1. No other spurious found. 2. All results are PASS against Peak and Average limit line.												



Band 3 - 5470~5725MHz
WIFI 802.11ac VHT20 (Band Edge @ 3m)

WIFI Ant. 1	Note	Frequency (MHz)	Level (dBμV/m)	Over Limit (dB)	Limit Line (dBμV/m)	Read Level (dBμV)	Antenna Factor (dB/m)	Path Loss (dB)	Preamp Factor (dB)	Ant Pos (cm)	Table Pos (deg)	Peak Avg. (P/A)	Pol. (H/V)	
802.11ac VHT20 CH 100 5500MHz		5458.8	53.42	-20.58	74	42.15	34.7	11.88	35.31	100	33	P	H	
		5469.04	59.39	-8.81	68.2	48.01	34.8	11.89	35.31	100	33	P	H	
		5460	46.75	-7.25	54	35.48	34.7	11.88	35.31	100	33	A	H	
	*	5500	112.2	-	-	100.57	35	11.93	35.3	100	33	P	H	
	*	5500	104.76	-	-	93.13	35	11.93	35.3	100	33	A	H	
														H
			5445.2	50.2	-23.8	74	38.96	34.7	11.86	35.32	100	103	P	V
			5467.6	56.27	-11.93	68.2	44.89	34.8	11.89	35.31	100	103	P	V
			5459.44	43.48	-10.52	54	32.21	34.7	11.88	35.31	100	103	A	V
	*		5500	109.32	-	-	97.69	35	11.93	35.3	100	103	P	V
	*		5500	101.53	-	-	89.9	35	11.93	35.3	100	103	A	V
													V	
802.11ac VHT20 CH 116 5580MHz		5453.68	49.79	-24.21	74	38.54	34.7	11.87	35.32	100	36	P	H	
		5468.56	49.17	-19.03	68.2	37.79	34.8	11.89	35.31	100	36	P	H	
		5453.68	40.41	-13.59	54	29.16	34.7	11.87	35.32	100	36	A	H	
	*	5580	111.69	-	-	100.11	34.87	12.02	35.31	100	36	P	H	
	*	5580	103.91	-	-	92.33	34.87	12.02	35.31	100	36	A	H	
			5739.17	49.86	-18.34	68.2	37.91	35	12.27	35.32	100	36	P	H
			5353.6	47.42	-26.58	74	36.51	34.5	11.76	35.35	100	17	P	V
			5469.52	47.09	-21.11	68.2	35.71	34.8	11.89	35.31	100	17	P	V
			5456.56	40.01	-13.99	54	28.74	34.7	11.88	35.31	100	17	A	V
	*		5580	109.88	-	-	98.3	34.87	12.02	35.31	100	17	P	V
	*		5580	102.19	-	-	90.61	34.87	12.02	35.31	100	17	A	V
		5728.775	49.61	-18.59	68.2	37.68	35	12.25	35.32	100	17	P	V	



802.11ac VHT20 CH 140 5700MHz	*	5700	110.18	-	-	98.3	35	12.2	35.32	120	38	P	H
	*	5700	102.44	-	-	90.56	35	12.2	35.32	120	38	A	H
		5725.32	65.92	-2.28	68.2	53.99	35	12.25	35.32	120	38	P	H
													H
													H
													H
	*	5700	111.5	-	-	99.62	35	12.2	35.32	106	14	P	V
	*	5700	103.38	-	-	91.5	35	12.2	35.32	106	14	A	V
		5725.32	66.86	-1.34	68.2	54.93	35	12.25	35.32	106	14	P	V
													V
													V
													V
Remark	1. No other spurious found. 2. All results are PASS against Peak and Average limit line.												



Band 3 - 5470~5725MHz
WIFI 802.11ac VHT20 (Harmonic @ 3m)

WIFI Ant. 1	Note	Frequency (MHz)	Level (dBμV/m)	Over Limit (dB)	Limit Line (dBμV/m)	Read Level (dBμV)	Antenna Factor (dB/m)	Path Loss (dB)	Preamp Factor (dB)	Ant Pos (cm)	Table Pos (deg)	Peak Avg. (P/A)	Pol. (H/V)
802.11ac VHT20 CH 100 5500MHz		11000	44.06	-29.94	74	46.8	37.9	18.05	58.69	100	0	P	H
		16500	47.52	-20.68	68.2	39.96	41.6	22.38	56.42	100	0	P	H
													H
													H
		11000	44.08	-29.92	74	46.82	37.9	18.05	58.69	100	0	P	V
		16500	47.83	-20.37	68.2	40.27	41.6	22.38	56.42	100	0	P	V
													V
802.11ac VHT20 CH 116 5580MHz		11160	43.71	-30.29	74	45.93	37.9	18.19	58.31	100	0	P	H
		16740	48.69	-19.51	68.2	40.08	42.36	22.58	56.33	100	0	P	H
													H
													H
		11160	44.28	-29.72	74	46.5	37.9	18.19	58.31	100	0	P	V
		16740	47.88	-20.32	68.2	39.27	42.36	22.58	56.33	100	0	P	V
													V
802.11ac VHT20 CH 140 5700MHz		11400	44.51	-29.49	74	45.74	38.1	18.41	57.74	100	0	P	H
		17100	48.73	-19.47	68.2	40.13	42	22.87	56.27	100	0	P	H
													H
													H
		11400	44.8	-29.2	74	46.03	38.1	18.41	57.74	100	0	P	V
		17100	49.08	-19.12	68.2	40.48	42	22.87	56.27	100	0	P	V
													V
Remark	1. No other spurious found.												
	2. All results are PASS against Peak and Average limit line.												



Band 3 - 5470~5725MHz
WIFI 802.11ac VHT40 (Band Edge @ 3m)

WIFI Ant. 1	Note	Frequency (MHz)	Level (dBμV/m)	Over Limit (dB)	Limit Line (dBμV/m)	Read Level (dBμV)	Antenna Factor (dB/m)	Path Loss (dB)	Preamp Factor (dB)	Ant Pos (cm)	Table Pos (deg)	Peak Avg. (P/A)	Pol. (H/V)
802.11ac VHT40 CH 102 5510MHz		5459.2	61.09	-12.91	74	49.82	34.7	11.88	35.31	100	27	P	H
		5468.32	66.69	-1.51	68.2	55.31	34.8	11.89	35.31	100	27	P	H
		5459.68	51.78	-2.22	54	40.51	34.7	11.88	35.31	100	27	A	H
	*	5510	105.34	-	-	93.7	35	11.94	35.3	100	27	P	H
	*	5510	98.54	-	-	86.9	35	11.94	35.3	100	27	A	H
		5732.87	48.67	-19.53	68.2	36.73	35	12.26	35.32	100	27	P	H
		5459.68	52.79	-21.21	74	41.52	34.7	11.88	35.31	100	11	P	V
		5466.16	60.74	-7.46	68.2	49.36	34.8	11.89	35.31	100	11	P	V
		5459.92	47.57	-6.43	54	36.3	34.7	11.88	35.31	100	11	A	V
	*	5510	103.24	-	-	91.6	35	11.94	35.3	100	11	P	V
	*	5510	95.94	-	-	84.3	35	11.94	35.3	100	11	A	V
		5730.98	48.73	-19.47	68.2	36.79	35	12.26	35.32	100	11	P	V
802.11ac VHT40 CH 110 5550MHz		5454.16	52.61	-21.39	74	41.36	34.7	11.87	35.32	100	30	P	H
		5469.28	56.38	-11.82	68.2	45	34.8	11.89	35.31	100	30	P	H
		5459.92	46.65	-7.35	54	35.38	34.7	11.88	35.31	100	30	A	H
	*	5550	107.93	-	-	96.46	34.8	11.98	35.31	100	30	P	H
	*	5550	101.65	-	-	90.18	34.8	11.98	35.31	100	30	A	H
		5757.755	49.92	-18.28	68.2	37.95	35	12.3	35.33	100	30	P	H
		5459.2	50.61	-23.39	74	39.34	34.7	11.88	35.31	100	14	P	V
		5468.8	51.99	-16.21	68.2	40.61	34.8	11.89	35.31	100	14	P	V
		5459.92	43.91	-10.09	54	32.64	34.7	11.88	35.31	100	14	A	V
	*	5550	106.06	-	-	94.59	34.8	11.98	35.31	100	14	P	V
	*	5550	99.44	-	-	87.97	34.8	11.98	35.31	100	14	A	V
	5764.685	49.14	-19.06	68.2	37.16	35	12.31	35.33	100	14	P	V	



802.11ac VHT40 CH 134 5670MHz		5410.2	48.63	-25.37	74	37.44	34.7	11.82	35.33	100	39	P	H
		5460.95	47.87	-20.33	68.2	36.6	34.7	11.88	35.31	100	39	P	H
		5451.5	40.87	-13.13	54	29.62	34.7	11.87	35.32	100	39	A	H
	*	5670	107.43	-	-	95.74	34.85	12.16	35.32	100	39	P	H
	*	5670	100.74	-	-	89.05	34.85	12.16	35.32	100	39	A	H
		5728.6	56.46	-11.74	68.2	44.53	35	12.25	35.32	100	39	P	H
		5448.7	48.13	-25.87	74	36.88	34.7	11.87	35.32	100	16	P	V
		5464.8	49.23	-18.97	68.2	37.86	34.8	11.88	35.31	100	16	P	V
		5459.55	40.45	-13.55	54	29.18	34.7	11.88	35.31	100	16	A	V
	*	5670	106.95	-	-	95.26	34.85	12.16	35.32	100	16	P	V
	*	5670	100.55	-	-	88.86	34.85	12.16	35.32	100	16	A	V
		5728.95	57.8	-10.4	68.2	45.87	35	12.25	35.32	100	16	P	V
Remark	1. No other spurious found. 2. All results are PASS against Peak and Average limit line.												



Band 3 - 5470~5725MHz
WIFI 802.11ac VHT40 (Harmonic @ 3m)

WIFI Ant. 1	Note	Frequency (MHz)	Level (dBμV/m)	Over Limit (dB)	Limit Line (dBμV/m)	Read Level (dBμV)	Antenna Factor (dB/m)	Path Loss (dB)	Preamp Factor (dB)	Ant Pos (cm)	Table Pos (deg)	Peak Avg. (P/A)	Pol. (H/V)	
802.11ac VHT40 CH 102 5510MHz		11020	44.73	-29.27	74	47.41	37.9	18.06	58.64	100	0	P	H	
		16530	49.68	-18.52	68.2	42.02	41.67	22.4	56.41	100	0	P	H	
													H	
													H	
			11020	44.19	-29.81	74	46.87	37.9	18.06	58.64	100	0	P	V
			16530	48.29	-19.91	68.2	40.63	41.67	22.4	56.41	100	0	P	V
														V
802.11ac VHT40 CH 110 5550MHz		11100	43.59	-30.41	74	46.01	37.9	18.13	58.45	100	0	P	H	
		16650	48.83	-19.37	68.2	40.6	42.1	22.5	56.37	100	0	P	H	
													H	
													H	
			11100	44.14	-29.86	74	46.56	37.9	18.13	58.45	100	0	P	V
			16650	49.01	-19.19	68.2	40.78	42.1	22.5	56.37	100	0	P	V
														V
802.11ac VHT40 CH 134 5670MHz		11340	44.57	-29.43	74	46.07	38.03	18.35	57.88	100	0	P	H	
		17010	49.52	-18.68	68.2	40.78	42.17	22.81	56.24	100	0	P	H	
													H	
													H	
			11340	44.76	-29.24	74	46.26	38.03	18.35	57.88	100	0	P	V
			17010	49.28	-18.92	68.2	40.54	42.17	22.81	56.24	100	0	P	V
														V
Remark	1. No other spurious found.													
	2. All results are PASS against Peak and Average limit line.													



Band 3 5470~5725MHz
WIFI 802.11ac VHT80 (Band Edge @ 3m)

WIFI Ant. 1	Note	Frequency (MHz)	Level (dBμV/m)	Over Limit (dB)	Limit Line (dBμV/m)	Read Level (dBμV)	Antenna Factor (dB/m)	Path Loss (dB)	Preamp Factor (dB)	Ant Pos (cm)	Table Pos (deg)	Peak Avg. (P/A)	Pol. (H/V)
802.11ac VHT80 CH 106 5530MHz		5455.84	55.91	-18.09	74	44.66	34.7	11.87	35.32	100	33	P	H
		5466.64	58.35	-9.85	68.2	46.97	34.8	11.89	35.31	100	33	P	H
		5458.72	51.11	-2.89	54	39.84	34.7	11.88	35.31	100	33	A	H
	*	5530	100.38	-	-	88.79	34.93	11.96	35.3	100	33	P	H
	*	5530	93.63	-	-	82.04	34.93	11.96	35.3	100	33	A	H
		5725	48.76	-19.44	68.2	36.83	35	12.25	35.32	100	33	P	H
		5454.16	57.1	-16.9	74	45.85	34.7	11.87	35.32	100	13	P	V
		5467.6	60.43	-7.77	68.2	49.05	34.8	11.89	35.31	100	13	P	V
		5458.96	46.9	-7.1	54	35.63	34.7	11.88	35.31	100	13	A	V
	*	5530	98.38	-	-	86.79	34.93	11.96	35.3	100	13	P	V
	*	5530	91.49	-	-	79.9	34.93	11.96	35.3	100	13	A	V
		5743.58	49.17	-19.03	68.2	37.21	35	12.28	35.32	100	13	P	V
802.11ac VHT80 CH 122 5610MHz		5452.55	51.53	-22.47	74	40.28	34.7	11.87	35.32	100	12	P	H
		5465.85	50.92	-17.28	68.2	39.54	34.8	11.89	35.31	100	12	P	H
		5455.7	45.65	-8.35	54	34.4	34.7	11.87	35.32	100	12	A	H
	*	5610	104.42	-	-	92.67	35	12.06	35.31	100	12	P	H
	*	5610	97.85	-	-	86.1	35	12.06	35.31	100	12	A	H
		5736.3	55.89	-12.31	68.2	43.95	35	12.26	35.32	100	12	P	H
		5456.05	49.76	-24.24	74	38.5	34.7	11.87	35.31	100	11	P	V
		5468.3	50.72	-17.48	68.2	39.34	34.8	11.89	35.31	100	11	P	V
		5458.15	43.81	-10.19	54	32.54	34.7	11.88	35.31	100	11	A	V
	*	5610	103.33	-	-	91.58	35	12.06	35.31	100	11	P	V
	*	5610	97.08	-	-	85.33	35	12.06	35.31	100	11	A	V
	5727.9	57.26	-10.94	68.2	45.33	35	12.25	35.32	100	11	P	V	
Remark	1. No other spurious found. 2. All results are PASS against Peak and Average limit line.												



Band 3 5470~5725MHz
WIFI 802.11ac VHT80 (Harmonic @ 3m)

WIFI Ant. 1	Note	Frequency (MHz)	Level (dBμV/m)	Over Limit (dB)	Limit Line (dBμV/m)	Read Level (dBμV)	Antenna Factor (dB/m)	Path Loss (dB)	Preamp Factor (dB)	Ant Pos (cm)	Table Pos (deg)	Peak Avg. (P/A)	Pol. (H/V)	
802.11ac VHT80 CH 106 5530MHz		11060	44.29	-29.71	74	46.84	37.9	18.1	58.55	100	0	P	H	
		16590	48.02	-20.18	68.2	40.19	41.77	22.45	56.39	100	0	P	H	
													H	
													H	
			11060	44.24	-29.76	74	46.79	37.9	18.1	58.55	100	0	P	V
			16590	48.46	-19.74	68.2	40.63	41.77	22.45	56.39	100	0	P	V
														V
802.11ac VHT80 CH 122 5610MHz		11220	44.8	-29.2	74	46.8	37.92	18.25	58.17	100	0	P	H	
		16830	48.87	-19.33	68.2	40.21	42.3	22.66	56.3	100	0	P	H	
													H	
													H	
			11220	44.41	-29.59	74	46.41	37.92	18.25	58.17	100	0	P	V
			16830	49.44	-18.76	68.2	40.78	42.3	22.66	56.3	100	0	P	V
														V
Remark	1. No other spurious found.													
	2. All results are PASS against Peak and Average limit line.													



Band 3 - Straddle Channel
WIFI 802.11a (Band Edge @ 3m)

WIFI	Note	Frequency	Level	Over	Limit	Read	Antenna	Path	Preamp	Ant	Table	Peak	Pol.
Ant.				Limit	Line	Level	Factor	Loss	Factor	Pos	Pos	Avg.	
1		(MHz)	(dBμV/m)	(dB)	(dBμV/m)	(dBμV)	(dB/m)	(dB)	(dB)	(cm)	(deg)	(P/A)	(H/V)
802.11a CH 144 5720MHz		5448.28	48.33	-25.67	74	37.08	34.7	11.87	35.32	116	39	P	H
		5466.22	48.44	-19.76	68.2	37.06	34.8	11.89	35.31	116	39	P	H
		5459.98	39.25	-14.75	54	27.98	34.7	11.88	35.31	116	39	A	H
	*	5720	112.11	-	-	100.19	35	12.24	35.32	116	39	P	H
	*	5720	104.31	-	-	92.39	35	12.24	35.32	116	39	A	H
		5921.75	50.76	-17.44	68.2	38.47	35.2	12.43	35.34	116	39	P	H
		5420.59	48.95	-25.05	74	37.75	34.7	11.83	35.33	108	109	P	V
		5467	47.76	-20.44	68.2	36.38	34.8	11.89	35.31	108	109	P	V
		5458.81	39.16	-14.84	54	27.89	34.7	11.88	35.31	108	109	A	V
	*	5720	111.46	-	-	99.54	35	12.24	35.32	108	109	P	V
	*	5720	103.63	-	-	91.71	35	12.24	35.32	108	109	A	V
		5920	52.85	-15.35	68.2	40.56	35.2	12.43	35.34	108	109	P	V
Remark	1. No other spurious found. 2. All results are PASS against Peak and Average limit line.												



**Band 3 - Straddle Channel
WIFI 802.11a (Harmonic @ 3m)**

WIFI Ant. 1	Note	Frequency (MHz)	Level (dBµV/m)	Over Limit (dB)	Limit Line (dBµV/m)	Read Level (dBµV)	Antenna Factor (dB/m)	Path Loss (dB)	Preamp Factor (dB)	Ant Pos (cm)	Table Pos (deg)	Peak Avg. (P/A)	Pol. (H/V)	
802.11a CH 144 5720MHz		11440	44.88	-29.12	74	45.95	38.13	18.44	57.64	100	0	P	H	
		17160	49.56	-18.64	68.2	41.21	41.73	22.91	56.29	100	0	P	H	
													H	
													H	
			11440	45.03	-28.97	74	46.1	38.13	18.44	57.64	100	0	P	V
			17160	50.01	-18.19	68.2	41.66	41.73	22.91	56.29	100	0	P	V
														V
														V
Remark	1. No other spurious found. 2. All results are PASS against Peak and Average limit line.													



Band 3 - Straddle Channel
WIFI 802.11ac VHT20 (Band Edge @ 3m)

Table with 14 columns: WIFI Ant. 1, Note, Frequency (MHz), Level (dBµV/m), Over Limit (dB), Limit Line (dBµV/m), Read Level (dBµV), Antenna Factor (dB/m), Path Loss (dB), Preamp Factor (dB), Ant Pos (cm), Table Pos (deg), Peak Avg. (P/A), Pol. (H/V). Rows include frequencies from 5356.24 to 5887.25 MHz and a Remark section.



**Band 3 - Straddle Channel
WIFI 802.11ac VHT20 (Harmonic @ 3m)**

WIFI Ant. 1	Note	Frequency (MHz)	Level (dBμV/m)	Over Limit (dB)	Limit Line (dBμV/m)	Read Level (dBμV)	Antenna Factor (dB/m)	Path Loss (dB)	Preamp Factor (dB)	Ant Pos (cm)	Table Pos (deg)	Peak Avg. (P/A)	Pol. (H/V)	
802.11ac VHT20 CH 144 5720MHz		11440	45.33	-28.67	74	46.4	38.13	18.44	57.64	100	0	P	H	
		17160	50.5	-17.7	68.2	42.15	41.73	22.91	56.29	100	0	P	H	
													H	
													H	
			11440	44.9	-29.1	74	45.97	38.13	18.44	57.64	100	0	P	V
			17160	50.08	-18.12	68.2	41.73	41.73	22.91	56.29	100	0	P	V
														V
													V	
Remark	1. No other spurious found. 2. All results are PASS against Peak and Average limit line.													



Band 3 - Straddle Channel
WIFI 802.11ac VHT40 (Band Edge @ 3m)

WIFI Ant. 1	Note	Frequency (MHz)	Level (dBμV/m)	Over Limit (dB)	Limit Line (dBμV/m)	Read Level (dBμV)	Antenna Factor (dB/m)	Path Loss (dB)	Preamp Factor (dB)	Ant Pos (cm)	Table Pos (deg)	Peak Avg. (P/A)	Pol. (H/V)
802.11ac VHT40 CH 142 5710MHz		5436.19	47.96	-26.04	74	36.73	34.7	11.85	35.32	100	40	P	H
		5470	48.23	-19.97	68.2	36.85	34.8	11.89	35.31	100	40	P	H
		5428	40.74	-13.26	54	29.52	34.7	11.84	35.32	100	40	A	H
	*	5710	109.21	-	-	97.31	35	12.22	35.32	100	40	P	H
	*	5710	102.38	-	-	90.48	35	12.22	35.32	100	40	A	H
		5906.25	51.17	-17.03	68.2	38.89	35.2	12.42	35.34	100	40	P	H
		5387.05	49.02	-24.98	74	37.93	34.63	11.8	35.34	100	12	P	V
		5469.73	47.17	-21.03	68.2	35.79	34.8	11.89	35.31	100	12	P	V
		5439.31	40.69	-13.31	54	29.45	34.7	11.86	35.32	100	12	A	V
	*	5710	109.46	-	-	97.56	35	12.22	35.32	100	12	P	V
	*	5710	102.21	-	-	90.31	35	12.22	35.32	100	12	A	V
	5871.25	51.11	-17.09	68.2	38.91	35.13	12.41	35.34	100	12	P	V	
Remark	1. No other spurious found. 2. All results are PASS against Peak and Average limit line.												



**Band 3 - Straddle Channel
WIFI 802.11ac VHT40 (Harmonic @ 3m)**

WIFI Ant. 1	Note	Frequency (MHz)	Level (dBµV/m)	Over Limit (dB)	Limit Line (dBµV/m)	Read Level (dBµV)	Antenna Factor (dB/m)	Path Loss (dB)	Preamp Factor (dB)	Ant Pos (cm)	Table Pos (deg)	Peak Avg. (P/A)	Pol. (H/V)	
802.11ac VHT40 CH 142 5710MHz		11420	44.86	-29.14	74	46.01	38.12	18.42	57.69	100	0	P	H	
		17130	50.19	-18.01	68.2	41.71	41.87	22.89	56.28	100	0	P	H	
													H	
													H	
			11420	45.59	-28.41	74	46.74	38.12	18.42	57.69	100	0	P	V
			17130	50.12	-18.08	68.2	41.64	41.87	22.89	56.28	100	0	P	V
														V
														V
Remark	1. No other spurious found. 2. All results are PASS against Peak and Average limit line.													



Band 3 - Straddle Channel
WIFI 802.11ac VHT80 (Band Edge @ 3m)

WIFI Ant. 1	Note	Frequency (MHz)	Level (dBμV/m)	Over Limit (dB)	Limit Line (dBμV/m)	Read Level (dBμV)	Antenna Factor (dB/m)	Path Loss (dB)	Preamp Factor (dB)	Ant Pos (cm)	Table Pos (deg)	Peak Avg. (P/A)	Pol. (H/V)
802.11ac VHT80 CH 138 5690MHz		5458.03	50.21	-23.79	74	38.94	34.7	11.88	35.31	100	40	P	H
		5469.34	49.6	-18.6	68.2	38.22	34.8	11.89	35.31	100	40	P	H
		5457.64	42.94	-11.06	54	31.67	34.7	11.88	35.31	100	40	A	H
	*	5690	106.21	-	-	94.34	35	12.19	35.32	100	40	P	H
	*	5690	99.55	-	-	87.68	35	12.19	35.32	100	40	A	H
		5851.3	58.49	-9.71	68.2	46.43	35	12.4	35.34	100	40	P	H
		5426.44	49	-25	74	37.79	34.7	11.84	35.33	100	13	P	V
		5468.56	47.99	-20.21	68.2	36.61	34.8	11.89	35.31	100	13	P	V
		5457.25	41.85	-12.15	54	30.58	34.7	11.88	35.31	100	13	A	V
	*	5690	106.12	-	-	94.25	35	12.19	35.32	100	13	P	V
	*	5690	99.69	-	-	87.82	35	12.19	35.32	100	13	A	V
		5858.8	56.15	-12.05	68.2	44.02	35.07	12.4	35.34	100	13	P	V
Remark	1. No other spurious found. 2. All results are PASS against Peak and Average limit line.												



Band 3 - Straddle Channel
WIFI 802.11ac VHT80 (Harmonic @ 3m)

WIFI Ant. 1	Note	Frequency (MHz)	Level (dBμV/m)	Over Limit (dB)	Limit Line (dBμV/m)	Read Level (dBμV)	Antenna Factor (dB/m)	Path Loss (dB)	Preamp Factor (dB)	Ant Pos (cm)	Table Pos (deg)	Peak Avg. (P/A)	Pol. (H/V)	
802.11ac VHT80 CH 138 5690MHz		11380	45.7	-28.3	74	47.03	38.08	18.38	57.79	100	0	P	H	
		17070	49.21	-18.99	68.2	40.56	42.07	22.84	56.26	100	0	P	H	
													H	
													H	
			11380	44.45	-29.55	74	45.78	38.08	18.38	57.79	100	0	P	V
			17070	49.11	-19.09	68.2	40.46	42.07	22.84	56.26	100	0	P	V
														V
														V
Remark	1. No other spurious found. 2. All results are PASS against Peak and Average limit line.													



Emission below 1GHz
5GHz WIFI 802.11ac VHT80 (LF)

WIFI	Note	Frequency	Level	Over	Limit	Read	Antenna	Path	Preamp	Ant	Table	Peak	Pol.	
Ant.				Limit	Line	Level	Factor	Loss	Factor	Pos	Pos	Avg.		
1		(MHz)	(dBμV/m)	(dB)	(dBμV/m)	(dBμV)	(dB/m)	(dB)	(dB)	(cm)	(deg)	(P/A)	(H/V)	
5GHz 802.11ac VHT80 LF		30.81	22.43	-17.57	40	27.38	24.12	0.94	30.01	-	-	P	H	
		127.47	21.14	-22.36	43.5	31.58	17.63	1.89	29.96	-	-	P	H	
		151.5	24.1	-19.4	43.5	34.81	17.17	2.07	29.95	-	-	P	H	
		909.7	31.97	-14.03	46	26.95	28.8	5.15	28.93	-	-	P	H	
		941.2	32.53	-13.47	46	26.29	29.75	5.24	28.75	-	-	P	H	
		959.4	34.38	-11.62	46	27.33	30.41	5.29	28.65	100	0	P	H	
													H	
													H	
													H	
													H	
													H	
													H	
			30	31.29	-8.71	40	36.05	24.32	0.93	30.01	100	0	P	V
			40.8	27.16	-12.84	40	37.08	19	1.08	30	-	-	P	V
			60.24	26.15	-13.85	40	42.93	11.91	1.3	29.99	-	-	P	V
			917.4	32.37	-13.63	46	27.09	29	5.17	28.89	-	-	P	V
			939.1	32.95	-13.05	46	26.83	29.66	5.23	28.77	-	-	P	V
			955.2	33.3	-12.7	46	26.17	30.53	5.27	28.67	-	-	P	V
												V		
												V		
												V		
												V		
												V		
												V		
Remark	1. No other spurious found. 2. All results are PASS against limit line.													



Note symbol

*	Fundamental Frequency which can be ignored. However, the level of any unwanted emissions shall not exceed the level of the fundamental frequency.
!	Test result is over limit line.
P/A	Peak or Average
H/V	Horizontal or Vertical



A calculation example for radiated spurious emission is shown as below:

WIFI	Note	Frequency	Level	Over	Limit	Read	Antenna	Path	Preamp	Ant	Table	Peak	Pol.
Ant.				Limit	Line	Level	Factor	Loss	Factor	Pos	Pos	Avg.	
1		(MHz)	(dBμV/m)	(dB)	(dBμV/m)	(dBμV)	(dB/m)	(dB)	(dB)	(cm)	(deg)	(P/A)	(H/V)
802.11b		2390	55.45	-18.55	74	54.51	32.22	4.58	35.86	103	308	P	H
CH 01													
2412MHz		2390	43.54	-10.46	54	42.6	32.22	4.58	35.86	103	308	A	H

1. Path Loss(dB) = Cable loss(dB) + Filter loss(dB) + Attenuator loss(dB)
2. Level(dBμV/m) = Antenna Factor(dB/m) + Path Loss(dB) + Read Level(dBμV) - Preamp Factor(dB)
3. Over Limit(dB) = Level(dBμV/m) – Limit Line(dBμV/m)

For Peak Limit @ 2390MHz:

1. Level(dBμV/m)
= Antenna Factor(dB/m) + Path Loss(dB) + Read Level(dBμV) - Preamp Factor(dB)
= 32.22(dB/m) + 4.58(dB) + 54.51(dBμV) – 35.86 (dB)
= 55.45 (dBμV/m)
2. Over Limit(dB)
= Level(dBμV/m) – Limit Line(dBμV/m)
= 55.45(dBμV/m) – 74(dBμV/m)
= -18.55(dB)

For Average Limit @ 2390MHz:

1. Level(dBμV/m)
= Antenna Factor(dB/m) + Path Loss(dB) + Read Level(dBμV) - Preamp Factor(dB)
= 32.22(dB/m) + 4.58(dB) + 42.6(dBμV) – 35.86 (dB)
= 43.54 (dBμV/m)
2. Over Limit(dB) = Level(dBμV/m) – Limit Line(dBμV/m)
= 43.54(dBμV/m) – 54(dBμV/m)
= -10.46(dB)

Both peak and average measured complies with the limit line, so test result is “PASS”.



Appendix C. Radiated Spurious Emission

Test Engineer :	Jesse Wang, Stan Hsieh and Ken Wu	Temperature :	22~23°C
		Relative Humidity :	51~59%

Note symbol

-L	Low channel location
-R	High channel location



Band 1 - 5150~5250MHz
WIFI 802.11a (Band Edge @ 3m)

WIFI	Band 1 5150~5250MHz Band Edge @ 3m	
ANT	802.11a CH36 5180MHz	
1	Horizontal	Fundamental
<p align="center">Peak</p>	<p>Site : 03CH07-HY Condition : PEAK_BE_74 3m HF_ANT_00075962 HORIZONTAL Detector : Peak Project : 052917-01 Mode : 1</p>	<p>Site : 03CH07-HY Condition : PEAK(FUN) 3m HF_ANT_00075962 HORIZONTAL Detector : Peak Project : 052917-01 Mode : 1</p>
<p align="center">Avg.</p>	<p>Site : 03CH07-HY Condition : AVG_BE_54 3m HF_ANT_00075962 HORIZONTAL Detector : Peak Project : 052917-01 Mode : 1</p>	<p align="center">Left blank</p>

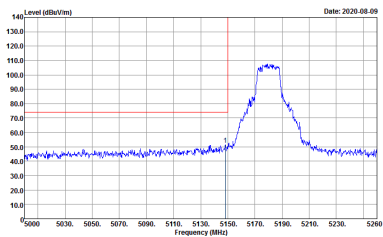
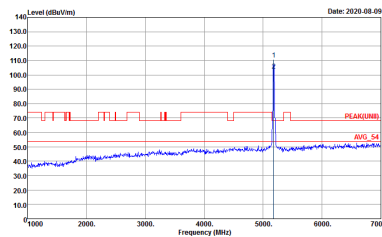
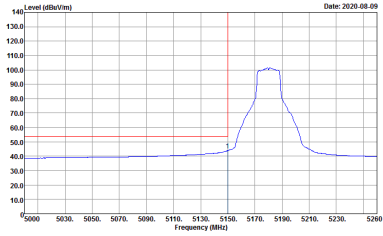

WIFI	Band 1 5150~5250MHz Band Edge @ 3m	
ANT	802.11a CH36 5180MHz	
1	Vertical	Fundamental
<p>Peak</p>	 <p>Site : 03CH07-HY Condition : PEAK_BE_74 3m HF_ANT_00075962 VERTICAL RBW:1000.000kHz VBW:3000.000kHz SWT:Auto Detector : Peak Project : 052917-01 Mode : 1</p>	 <p>Site : 03CH07-HY Condition : PEAK(LIMB) 3m HF_ANT_00075962 VERTICAL RBW:1000.000kHz VBW:3000.000kHz SWT:Auto Detector : Peak Project : 052917-01 Mode : 1</p>
<p>Avg.</p>	 <p>Site : 03CH07-HY Condition : AVG_BE_54 3m HF_ANT_00075962 VERTICAL RBW:1000.000kHz VBW:3000.000kHz SWT:Auto Detector : Peak Project : 052917-01 Mode : 1</p>	<p>Left blank</p>

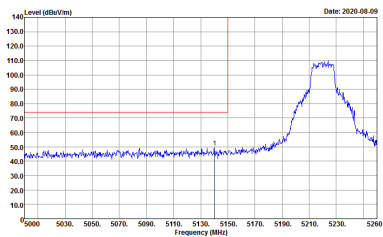
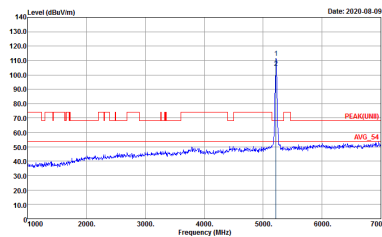
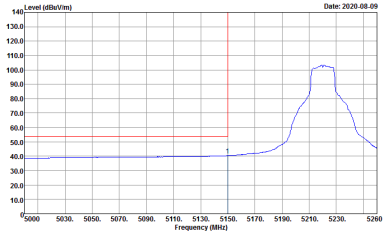

WIFI	Band 1 5150~5250MHz Band Edge @ 3m	
ANT	802.11a CH44 5220MHz - L	
1	Horizontal	Fundamental
<p>Peak</p>	 <p>Date: 2020-08-09</p> <p>Site : 03CH07-HY Condition : PEAK_BE_74 3m HF_ANT_00075962 HORIZONTAL Detector : RBW:1000.000kHz VBW:3000.000kHz SWT:Auto Project : 052917-01 Mode : 2</p>	 <p>Date: 2020-08-09</p> <p>Site : 03CH07-HY Condition : PEAK(LIN) 3m HF_ANT_00075962 HORIZONTAL Detector : RBW:1000.000kHz VBW:3000.000kHz SWT:Auto Project : 052917-01 Mode : 2</p>
<p>Avg.</p>	 <p>Date: 2020-08-09</p> <p>Site : 03CH07-HY Condition : AVG_BE_54 3m HF_ANT_00075962 HORIZONTAL Detector : RBW:1000.000kHz VBW:3000.000kHz SWT:Auto Project : 052917-01 Mode : 2</p>	<p>Left blank</p>

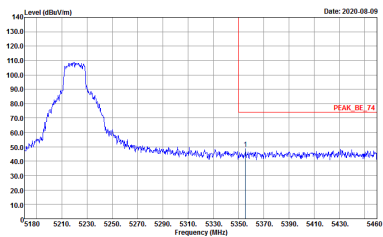
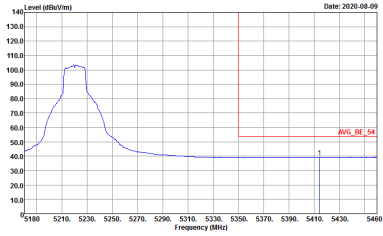

WIFI	Band 1 5150~5250MHz Band Edge @ 3m	
ANT	802.11a CH44 5220MHz - R	
1	Horizontal	Fundamental
<p>Peak</p>	 <p>Site : 03CH07-HY Condition : PEAK_BE_74 3m HF_ANT_00075962 HORIZONTAL Detector : Peak Project : 052917-01 Mode : 2</p>	<p>Left blank</p>
<p>Avg.</p>	 <p>Site : 03CH07-HY Condition : AVG_BE_54 3m HF_ANT_00075962 HORIZONTAL Detector : Peak Project : 052917-01 Mode : 2</p>	<p>Left blank</p>

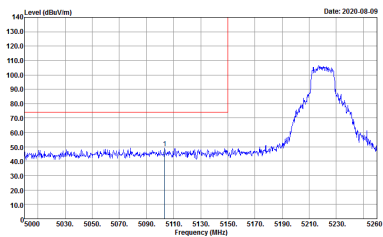
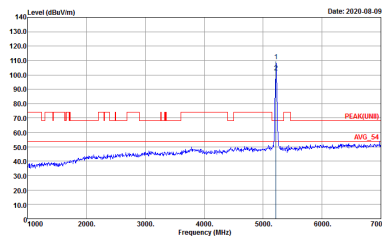
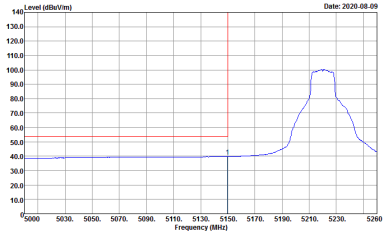

WIFI	Band 1 5150~5250MHz Band Edge @ 3m	
ANT	802.11a CH44 5220MHz - L	
1	Vertical	Fundamental
<p>Peak</p>	 <p>Site : 03CH07-HY Condition : PEAK_BE_74 3m HF_ANT_00075962 VERTICAL Detector : RBW:1000.000kHz VBW:3000.000kHz SWT:Auto Project : 052917-01 Mode : 2</p>	 <p>Site : 03CH07-HY Condition : PEAK(LIN) 3m HF_ANT_00075962 VERTICAL Detector : RBW:1000.000kHz VBW:3000.000kHz SWT:Auto Project : 052917-01 Mode : 2</p>
<p>Avg.</p>	 <p>Site : 03CH07-HY Condition : AVG_BE_54 3m HF_ANT_00075962 VERTICAL Detector : RBW:1000.000kHz VBW:3000.000kHz SWT:Auto Project : 052917-01 Mode : 2</p>	<p>Left blank</p>

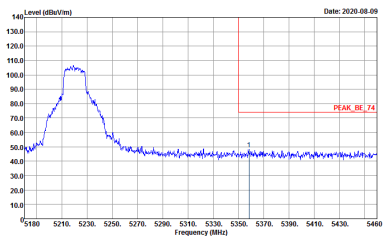
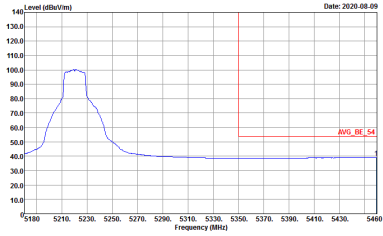

WIFI	Band 1 5150~5250MHz Band Edge @ 3m	
ANT	802.11a CH44 5220MHz - R	
1	Vertical	Fundamental
<p>Peak</p>	 <p>Site : 03CH07-HY Condition : PEAK_BE_74 3m HF_ANT_00075962 VERTICAL Detector : Peak Project : 052917-01 Mode : 2</p>	<p>Left blank</p>
<p>Avg.</p>	 <p>Site : 03CH07-HY Condition : AVG_BE_54 3m HF_ANT_00075962 VERTICAL Detector : Peak Project : 052917-01 Mode : 2</p>	<p>Left blank</p>

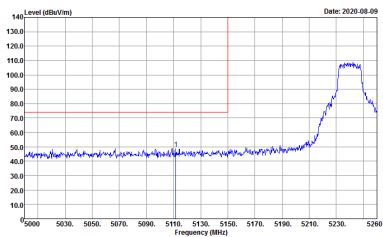
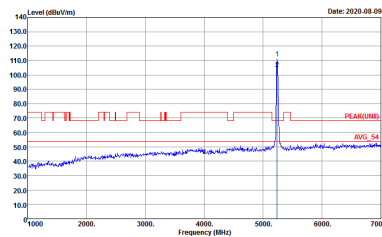
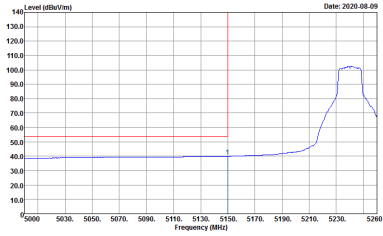

WIFI	Band 1 5150~5250MHz Band Edge @ 3m	
ANT	802.11a CH48 5240MHz - L	
1	Horizontal	Fundamental
<p>Peak</p>	 <p>Date: 2020-08-09</p> <p>Site : 03CH07-HY Condition : PEAK_BE_74 3m HF_ANT_00075962 HORIZONTAL RBW:1000.000kHz VBW:3000.000kHz SWT:Auto Detector : Peak Project : 052917-01 Mode : 3</p>	 <p>Date: 2020-08-09</p> <p>Site : 03CH07-HY Condition : PEAK(LIN) 3m HF_ANT_00075962 HORIZONTAL RBW:1000.000kHz VBW:3000.000kHz SWT:Auto Detector : Peak Project : 052917-01 Mode : 3</p>
<p>Avg.</p>	 <p>Date: 2020-08-09</p> <p>Site : 03CH07-HY Condition : AVG_BE_54 3m HF_ANT_00075962 HORIZONTAL RBW:1000.000kHz VBW:3000.000kHz SWT:Auto Detector : Peak Project : 052917-01 Mode : 3</p>	<p>Left blank</p>

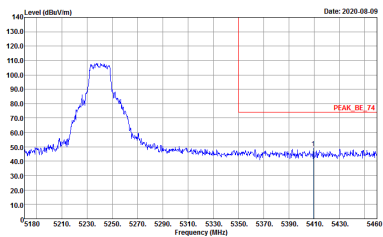
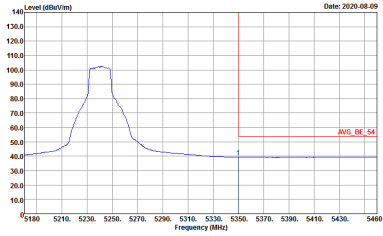

WIFI	Band 1 5150~5250MHz Band Edge @ 3m	
ANT	802.11a CH48 5240MHz - R	
1	Horizontal	Fundamental
<p>Peak</p>	 <p>Site : 03CH07-HY Condition : PEAK_BE_74 3m HF_ANT_00075962 HORIZONTAL Detector : RBW:1000.000kHz VBW:3000.000kHz SWT:Auto Project : 052917-01 Mode : 3</p>	<p>Left blank</p>
<p>Avg.</p>	 <p>Site : 03CH07-HY Condition : AVG_BE_54 3m HF_ANT_00075962 HORIZONTAL Detector : RBW:1000.000kHz VBW:0.010kHz SWT:Auto Project : 052917-01 Mode : 3</p>	<p>Left blank</p>

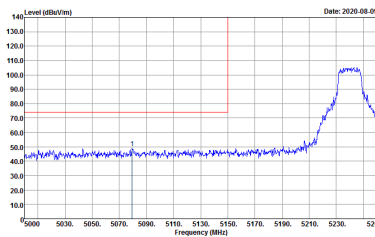
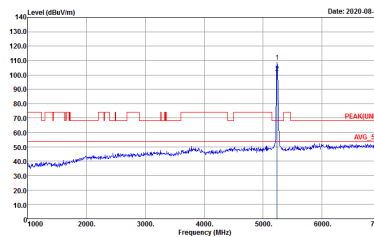
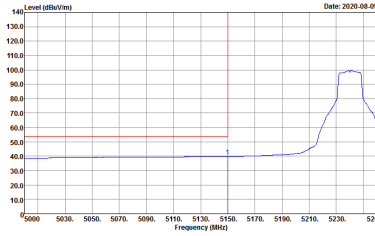

WIFI	Band 1 5150~5250MHz Band Edge @ 3m	
ANT	802.11a CH48 5240MHz - L	
1	Vertical	Fundamental
<p>Peak</p>	 <p>Site : 03CH07-HY Condition : PEAK_BE 74 3m HF_ANT_00075962 VERTICAL Detector : RBW:1000.000kHz VBW:3000.000kHz SWT:Auto Project : 052917-01 Mode : 3</p>	 <p>Site : 03CH07-HY Condition : PEAK(LIN) 3m HF_ANT_00075962 VERTICAL Detector : RBW:1000.000kHz VBW:3000.000kHz SWT:Auto Project : 052917-01 Mode : 3</p>
<p>Avg.</p>	 <p>Site : 03CH07-HY Condition : AVG_BE 54 3m HF_ANT_00075962 VERTICAL Detector : RBW:1000.000kHz VBW:3000.000kHz SWT:Auto Project : 052917-01 Mode : 3</p>	<p>Left blank</p>



WIFI	Band 1 5150~5250MHz Band Edge @ 3m	
ANT	802.11a CH48 5240MHz - R	
1	Vertical	Fundamental
Peak	<p>Site : 03CH07-HY Condition : PEAK_BE_74 3m HF_ANT_00075962 VERTICAL Detector : RBW:1000.000kHz VBW:3000.000kHz SWT:Auto Project : 052917-01 Mode : 3</p>	Left blank
Avg.	<p>Site : 03CH07-HY Condition : AVG_BE_54 3m HF_ANT_00075962 VERTICAL Detector : RBW:1000.000kHz VBW:3000.000kHz SWT:Auto Project : 052917-01 Mode : 3</p>	Left blank



Band 1 5150~5250MHz
WIFI 802.11ac VHT20 (Band Edge @ 3m)

WIFI	Band 1 5150~5250MHz Band Edge @ 3m	
ANT	802.11ac VHT20 CH36 5180MHz	
1	Horizontal	Fundamental
Peak	<p>Site : 03CH07-HY Condition : PEAK_BE_74 3m HF_ANT_00075962 HORIZONTAL Detector : Peak Project : 052917-01 Mode : 4</p>	<p>Site : 03CH07-HY Condition : PEAK(LIN) 3m HF_ANT_00075962 HORIZONTAL Detector : Peak Project : 052917-01 Mode : 4</p>
Avg.	<p>Site : 03CH07-HY Condition : AVG_BE_54 3m HF_ANT_00075962 HORIZONTAL Detector : Peak Project : 052917-01 Mode : 4</p>	Left blank

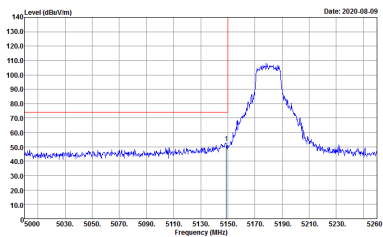
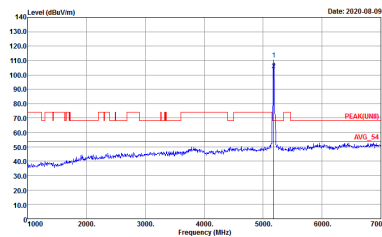
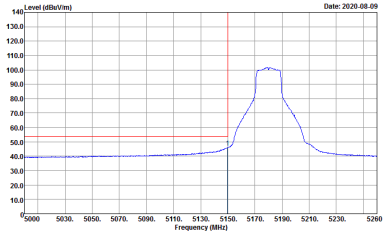

WIFI	Band 1 5150~5250MHz Band Edge @ 3m	
ANT	802.11ac VHT20 CH36 5180MHz	
1	Vertical	Fundamental
<p>Peak</p>	 <p>Date: 2020-08-09</p> <p>Site : 03CH07-HY Condition : PEAK_BE_74 3m HF_ANT_00075962 VERTICAL RBW:1000.000kHz VBW:3000.000kHz SWT:Auto Detector : Peak Project : 052917-01 Mode : 4</p>	 <p>Date: 2020-08-09</p> <p>Site : 03CH07-HY Condition : PEAK(LIN) 3m HF_ANT_00075962 VERTICAL RBW:1000.000kHz VBW:3000.000kHz SWT:Auto Detector : Peak Project : 052917-01 Mode : 4</p>
<p>Avg.</p>	 <p>Date: 2020-08-09</p> <p>Site : 03CH07-HY Condition : AVG_BE_54 3m HF_ANT_00075962 VERTICAL RBW:1000.000kHz VBW:1.000kHz SWT:Auto Detector : Peak Project : 052917-01 Mode : 4</p>	<p>Left blank</p>

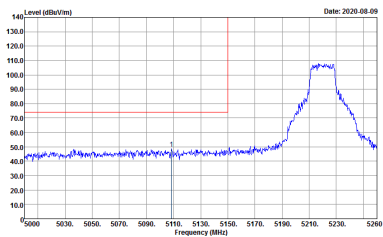
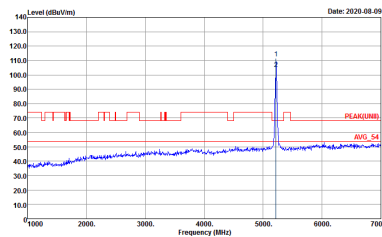
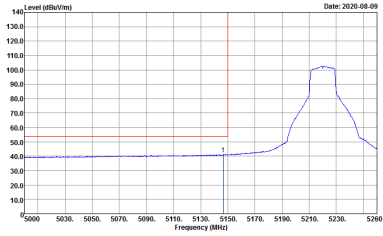

WIFI	Band 1 5150~5250MHz Band Edge @ 3m	
ANT	802.11ac VHT20 CH44 5220MHz - L	
1	Horizontal	Fundamental
<p>Peak</p>	 <p>Site : 03CH07-HY Condition : PEAK_BE_74 3m HF_ANT_00075962 HORIZONTAL Detector : Peak Project : 052917-01 Mode : 5</p>	 <p>Site : 03CH07-HY Condition : PEAK(LIN) 3m HF_ANT_00075962 HORIZONTAL Detector : Peak Project : 052917-01 Mode : 5</p>
<p>Avg.</p>	 <p>Site : 03CH07-HY Condition : AVG_BE_54 3m HF_ANT_00075962 HORIZONTAL Detector : Peak Project : 052917-01 Mode : 5</p>	<p>Left blank</p>

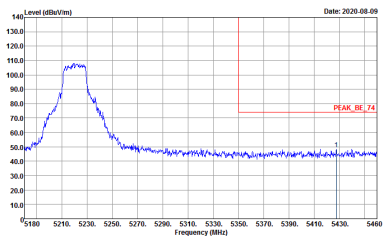
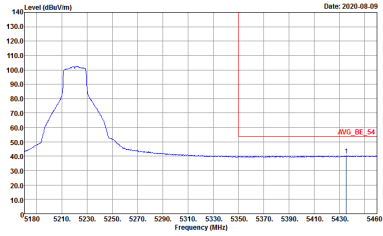

WIFI	Band 1 5150~5250MHz Band Edge @ 3m	
ANT	802.11ac VHT20 CH44 5220MHz - R	
1	Horizontal	Fundamental
<p>Peak</p>	 <p>Site : 03CH07-HY Condition : PEAK_BE_74 3m HF_ANT_00075962 HORIZONTAL Detector : Peak Project : 052917-01 Mode : S</p>	<p>Left blank</p>
<p>Avg.</p>	 <p>Site : 03CH07-HY Condition : AVG_BE_54 3m HF_ANT_00075962 HORIZONTAL Detector : Peak Project : 052917-01 Mode : S</p>	<p>Left blank</p>

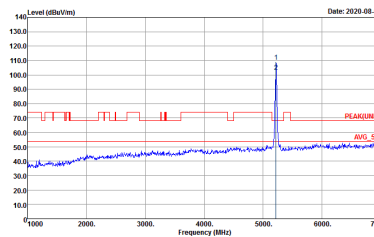
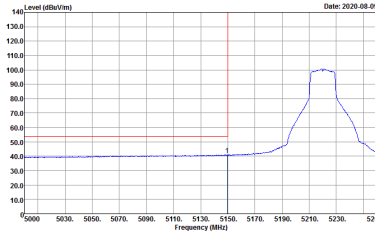

WIFI	Band 1 5150~5250MHz Band Edge @ 3m	
ANT	802.11ac VHT20 CH44 5220MHz - L	
1	Vertical	Fundamental
<p>Peak</p>	 <p>Site : 03CH07-HY Condition : PEAK_BE_74 3m HF_ANT_00075962 VERTICAL Detector : Peak Project : 052917-01 Mode : 5</p>	 <p>Site : 03CH07-HY Condition : PEAK(LIMB) 3m HF_ANT_00075962 VERTICAL Detector : Peak Project : 052917-01 Mode : 5</p>
<p>Avg.</p>	 <p>Site : 03CH07-HY Condition : AVG_BE_54 3m HF_ANT_00075962 VERTICAL Detector : Peak Project : 052917-01 Mode : 5</p>	<p>Left blank</p>

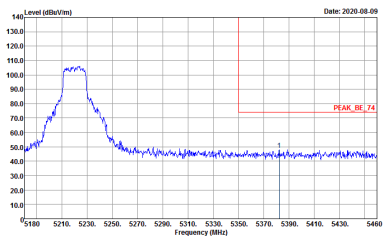
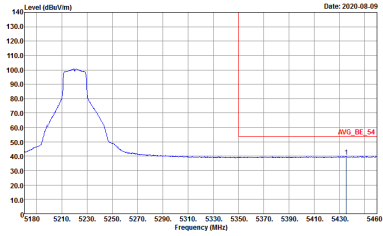

WIFI	Band 1 5150~5250MHz Band Edge @ 3m	
ANT	802.11ac VHT20 CH44 5220MHz - R	
1	Vertical	Fundamental
<p>Peak</p>	 <p>Site : 03CH07-HY Condition : PEAK_BE_74 3m HF_ANT_00075962 VERTICAL Detector : RBW:1000.000kHz VBW:3000.000kHz SWT:Auto Project : 052917-01 Mode : S</p>	<p>Left blank</p>
<p>Avg.</p>	 <p>Site : 03CH07-HY Condition : AVG_BE_54 3m HF_ANT_00075962 VERTICAL Detector : RBW:1000.000kHz VBW:1.000kHz SWT:Auto Project : 052917-01 Mode : S</p>	<p>Left blank</p>

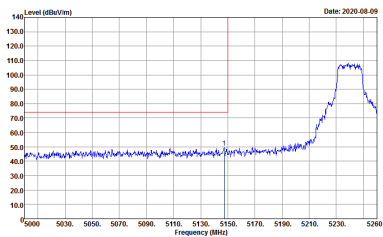
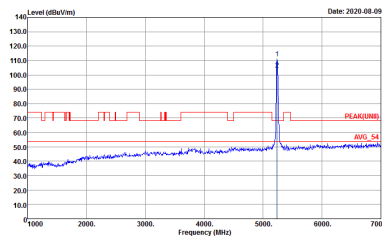
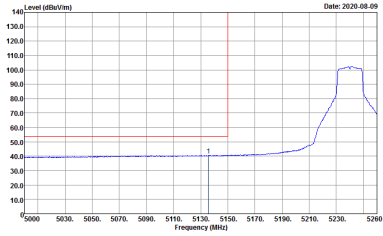

WIFI	Band 1 5150~5250MHz Band Edge @ 3m	
ANT	802.11ac VHT20 CH48 5240MHz - L	
1	Horizontal	Fundamental
<p>Peak</p>	 <p>Site : 03CH07-HY Condition : PEAK_BE_74 3m HF_ANT_00075962 HORIZONTAL Detector : Peak Project : 052917-01 Mode : 6</p>	 <p>Site : 03CH07-HY Condition : PEAK(LIN) 3m HF_ANT_00075962 HORIZONTAL Detector : Peak Project : 052917-01 Mode : 6</p>
<p>Avg.</p>	 <p>Site : 03CH07-HY Condition : AVG_BE_54 3m HF_ANT_00075962 HORIZONTAL Detector : Peak Project : 052917-01 Mode : 6</p>	<p>Left blank</p>

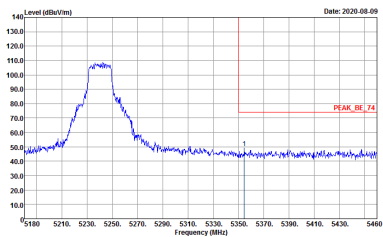
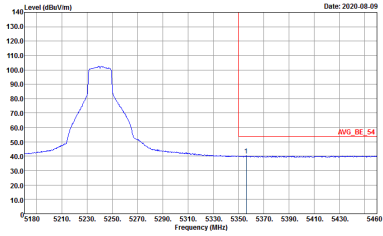

WIFI	Band 1 5150~5250MHz Band Edge @ 3m	
ANT	802.11ac VHT20 CH48 5240MHz - R	
1	Horizontal	Fundamental
<p>Peak</p>	 <p>Site : 03CH07-HY Condition : PEAK_BE_74 3m HF_ANT_00075962 HORIZONTAL Detector : Peak Project : 052917-01 Mode : 6</p>	<p>Left blank</p>
<p>Avg.</p>	 <p>Site : 03CH07-HY Condition : AVG_BE_54 3m HF_ANT_00075962 HORIZONTAL Detector : Peak Project : 052917-01 Mode : 6</p>	<p>Left blank</p>

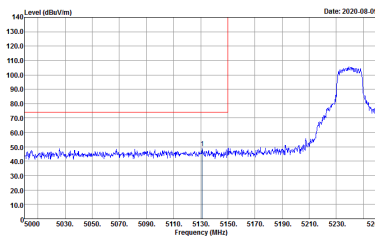
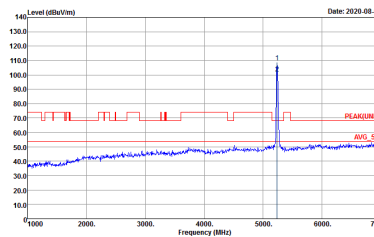
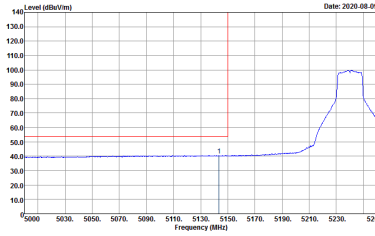

WIFI	Band 1 5150~5250MHz Band Edge @ 3m	
ANT	802.11ac VHT20 CH48 5240MHz - L	
1	Vertical	Fundamental
<p>Peak</p>	 <p>Date: 2020-08-09</p> <p>Site : 03CH07-HY Condition : PEAK_BE_74 3m HF_ANT_00075962 VERTICAL RBW:1000.000kHz VBW:3000.000kHz SWT:Auto Detector : Peak Project : 052917-01 Mode : 6</p>	 <p>Date: 2020-08-09</p> <p>Site : 03CH07-HY Condition : PEAK(LIN) 3m HF_ANT_00075962 VERTICAL RBW:1000.000kHz VBW:3000.000kHz SWT:Auto Detector : Peak Project : 052917-01 Mode : 6</p>
<p>Avg.</p>	 <p>Date: 2020-08-09</p> <p>Site : 03CH07-HY Condition : AVG_BE_54 3m HF_ANT_00075962 VERTICAL RBW:1000.000kHz VBW:1.000kHz SWT:Auto Detector : Peak Project : 052917-01 Mode : 6</p>	<p>Left blank</p>

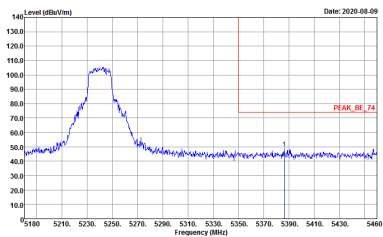
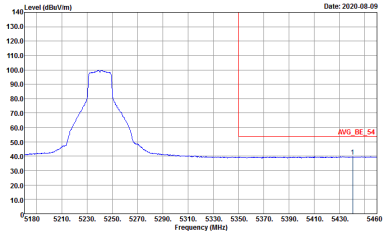

WIFI	Band 1 5150~5250MHz Band Edge @ 3m	
ANT	802.11ac VHT20 CH48 5240MHz - R	
1	Vertical	Fundamental
<p>Peak</p>	 <p>Site : 03CH07-HY Condition : PEAK_BE_74 3m HF_ANT_00075962 VERTICAL Detector : RBW:1000.000kHz VBW:3000.000kHz SWT:Auto Project : 052917-01 Mode : 6</p>	<p>Left blank</p>
<p>Avg.</p>	 <p>Site : 03CH07-HY Condition : AVG_BE_54 3m HF_ANT_00075962 VERTICAL Detector : RBW:1000.000kHz VBW:1.000kHz SWT:Auto Project : 052917-01 Mode : 6</p>	<p>Left blank</p>



Band 1 5150~5250MHz
WIFI 802.11ac VHT40 (Band Edge @ 3m)

WIFI	Band 1 5150~5250MHz Band Edge @ 3m	
ANT	802.11ac VHT40 CH38 5190MHz - L	
1	Horizontal	Fundamental
Peak	<p>Site : 03CH07-HY Condition : PEAK_BE_74 3m HF_ANT_00075962 HORIZONTAL Detector : Peak Project : 052917-01 Mode : 7</p>	<p>Site : 03CH07-HY Condition : PEAK(LIN) 3m HF_ANT_00075962 HORIZONTAL Detector : Peak Project : 052917-01 Mode : 7</p>
Avg.	<p>Site : 03CH07-HY Condition : AVG_BE_54 3m HF_ANT_00075962 HORIZONTAL Detector : Peak Project : 052917-01 Mode : 7</p>	Left blank

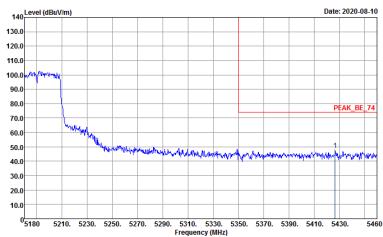
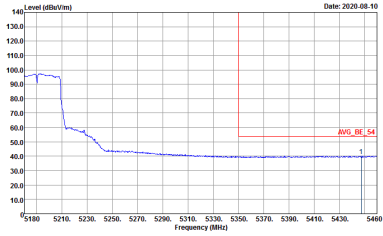

WIFI	Band 1 5150~5250MHz Band Edge @ 3m	
ANT	802.11ac VHT40 CH38 5190MHz - R	
1	Horizontal	Fundamental
<p>Peak</p>	 <p>Site : 03CH07-HY Condition : PEAK_BE_74 3m HF_ANT_00075962 HORIZONTAL Detector : Peak Project : 052917-01 Mode : 7</p>	<p>Left blank</p>
<p>Avg.</p>	 <p>Site : 03CH07-HY Condition : AVG_BE_54 3m HF_ANT_00075962 HORIZONTAL Detector : Peak Project : 052917-01 Mode : 7</p>	<p>Left blank</p>

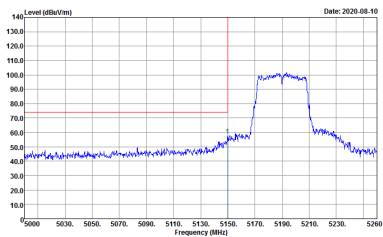
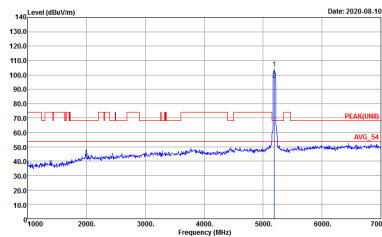
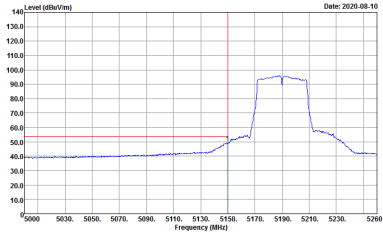

WIFI	Band 1 5150~5250MHz Band Edge @ 3m	
ANT	802.11ac VHT40 CH38 5190MHz - L	
1	Vertical	Fundamental
<p>Peak</p>	 <p>Site : 03CH07-HY Condition : PEAK_BE_74 3m HF_ANT_00075962 VERTICAL Detector : RBW:1000.000kHz VBW:3000.000kHz SWT:Auto Project : 052917-01 Mode : 7</p>	 <p>Site : 03CH07-HY Condition : PEAK(LIN) 3m HF_ANT_00075962 VERTICAL Detector : RBW:1000.000kHz VBW:3000.000kHz SWT:Auto Project : 052917-01 Mode : 7</p>
<p>Avg.</p>	 <p>Site : 03CH07-HY Condition : AVG_BE_54 3m HF_ANT_00075962 VERTICAL Detector : RBW:1000.000kHz VBW:3.000kHz SWT:Auto Project : 052917-01 Mode : 7</p>	<p>Left blank</p>

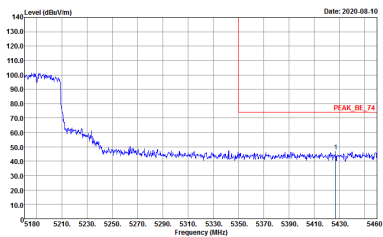
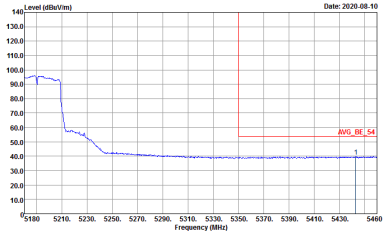

WIFI	Band 1 5150~5250MHz Band Edge @ 3m	
ANT	802.11ac VHT40 CH38 5190MHz - R	
1	Vertical	Fundamental
<p>Peak</p>	 <p>Site : 03CH07-HY Condition : PEAK_BE_74 3m HF_ANT_00075962 VERTICAL Detector : RBW:1000.000kHz VBW:3000.000kHz SWT:Auto Project : 052917-01 Mode : 7</p>	<p>Left blank</p>
<p>Avg.</p>	 <p>Site : 03CH07-HY Condition : AVG_BE_54 3m HF_ANT_00075962 VERTICAL Detector : RBW:1000.000kHz VBW:3.000kHz SWT:Auto Project : 052917-01 Mode : 7</p>	<p>Left blank</p>

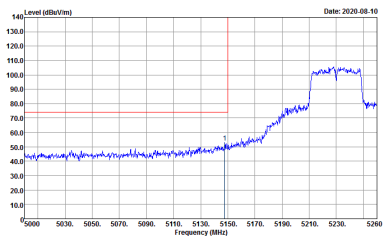
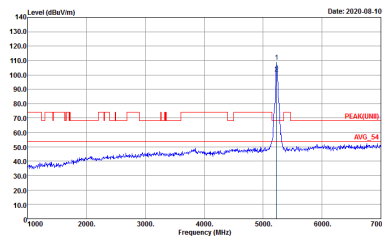
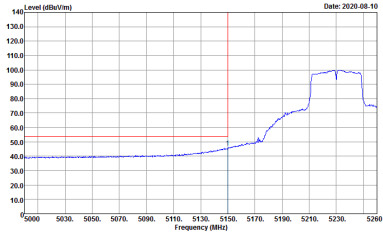

WIFI	Band 1 5150~5250MHz Band Edge @ 3m	
ANT	802.11ac VHT40 CH46 5230MHz - L	
1	Horizontal	Fundamental
<p>Peak</p>	 <p>Date: 2020-08-10</p> <p>Site : 03CH07-HY Condition : PEAK_BE_74 3m HF_ANT_00075962 HORIZONTAL Detector : RBW:1000.000kHz VBW:3000.000kHz SWT:Auto Project : 052917-01 Mode : 8</p>	 <p>Date: 2020-08-10</p> <p>Site : 03CH07-HY Condition : PEAK(LIN) 3m HF_ANT_00075962 HORIZONTAL Detector : RBW:1000.000kHz VBW:3000.000kHz SWT:Auto Project : 052917-01 Mode : 8</p>
<p>Avg.</p>	 <p>Date: 2020-08-10</p> <p>Site : 03CH07-HY Condition : AVG_BE_54 3m HF_ANT_00075962 HORIZONTAL Detector : RBW:1000.000kHz VBW:3.000kHz SWT:Auto Project : 052917-01 Mode : 8</p>	<p>Left blank</p>



WIFI	Band 1 5150~5250MHz Band Edge @ 3m	
ANT	802.11ac VHT40 CH46 5230MHz - R	
1	Horizontal	Fundamental
Peak	<p>Site : 03CH07-HY Condition : PEAK_BE_74 3m HF_ANT_00075962 HORIZONTAL Detector : Peak Project : 052917-01 Mode : 8</p>	Left blank
Avg.	<p>Site : 03CH07-HY Condition : AVG_BE_54 3m HF_ANT_00075962 HORIZONTAL Detector : Peak Project : 052917-01 Mode : 8</p>	Left blank

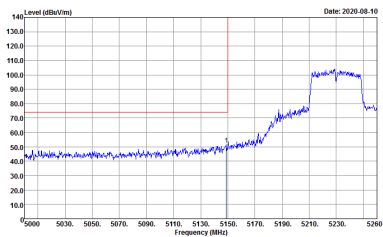
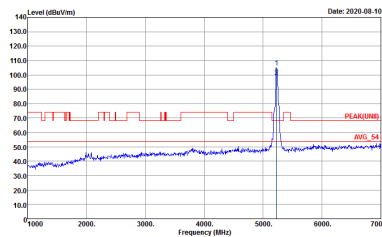
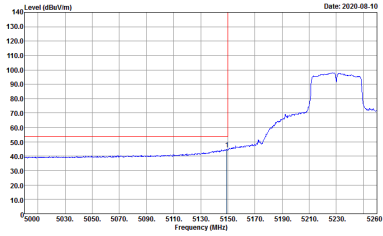

WIFI	Band 1 5150~5250MHz Band Edge @ 3m	
ANT	802.11ac VHT40 CH46 5230MHz - L	
1	Vertical	Fundamental
<p>Peak</p>	 <p>Site : 03CH07-HY Condition : PEAK_BE_74 3m HF_ANT_00075962 VERTICAL Detector : RBW:1000.000kHz VBW:3000.000kHz SWT:Auto Project : 052917-01 Mode : 8</p>	 <p>Site : 03CH07-HY Condition : PEAK(LIN) 3m HF_ANT_00075962 VERTICAL Detector : RBW:1000.000kHz VBW:3000.000kHz SWT:Auto Project : 052917-01 Mode : 8</p>
<p>Avg.</p>	 <p>Site : 03CH07-HY Condition : AVG_BE_54 3m HF_ANT_00075962 VERTICAL Detector : RBW:1000.000kHz VBW:3.000kHz SWT:Auto Project : 052917-01 Mode : 8</p>	<p>Left blank</p>



WIFI	Band 1 5150~5250MHz Band Edge @ 3m	
ANT	802.11ac VHT40 CH46 5230MHz - R	
1	Vertical	Fundamental
Peak	<p>Site : 03CH07-HY Condition : PEAK_BE_74 3m HF_ANT_00075962 VERTICAL Detector : RBW:1000.000kHz VBW:3000.000kHz SWT:Auto Project : 052917-01 Mode : B</p>	Left blank
Avg.	<p>Site : 03CH07-HY Condition : AVG_BE_54 3m HF_ANT_00075962 VERTICAL Detector : RBW:1000.000kHz VBW:3.000kHz SWT:Auto Project : 052917-01 Mode : B</p>	Left blank



**Band 1 5150~5250MHz
WIFI 802.11ac VHT80 (Band Edge @ 3m)**

WIFI	Band 1 5150~5250MHz Band Edge @ 3m	
ANT	802.11ac VHT80 CH42 5210MHz - L	
1	Horizontal	Fundamental
Peak	<p>Site : 03CH07-HY Condition : PEAK_BE_74 3m HF_ANT_00075962 HORIZONTAL Detector : Peak Project : 052917-01 Mode : 19 Setting : 16.5</p>	<p>Site : 03CH07-HY Condition : PEAK(LIN) 3m HF_ANT_00075962 HORIZONTAL Detector : Peak Project : 052917-01 Mode : 19 Setting : 16.5</p>
Avg.	<p>Site : 03CH07-HY Condition : AVG_BE_54 3m HF_ANT_00075962 HORIZONTAL Detector : Peak Project : 052917-01 Mode : 19 Setting : 16.5</p>	Left blank



WIFI	Band 1 5150~5250MHz Band Edge @ 3m	
ANT	802.11ac VHT80 CH42 5210MHz - R	
1	Horizontal	Fundamental
Peak	<p>Site : 03CH07-HY Condition : PEAK_BE_74 3m HF_ANT_00075962 HORIZONTAL RBW:1000.000kHz VBW:3000.000kHz SWT:Auto Detector : Peak</p>	Left blank
Avg.	<p>Site : 03CH07-HY Condition : AVG_BE_54 3m HF_ANT_00075962 HORIZONTAL RBW:1000.000kHz VBW:3.000kHz SWT:Auto Detector : Peak</p>	Left blank

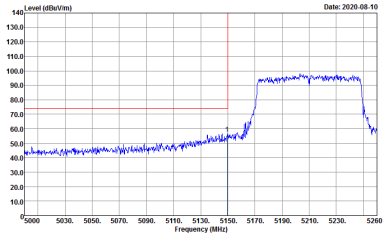
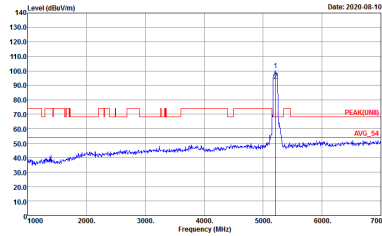
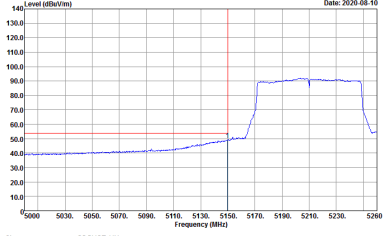

WIFI	Band 1 5150~5250MHz Band Edge @ 3m	
ANT	802.11ac VHT80 CH42 5210MHz - L	
1	Vertical	Fundamental
Peak	 <p>Site : 03CH07-HY Condition : PEAK_BE_74 3m HF_ANT_00075962 VERTICAL : RBW:1000.000kHz VBW:3000.000kHz SWT:Auto Detector : Peak</p>	 <p>Site : 03CH07-HY Condition : PEAK(FUN) 3m HF_ANT_00075962 VERTICAL : RBW:1000.000kHz VBW:3000.000kHz SWT:Auto Detector : Peak</p>
Avg.	 <p>Site : 03CH07-HY Condition : AVG_BE_54 3m HF_ANT_00075962 VERTICAL : RBW:1000.000kHz VBW:3.000kHz SWT:Auto Detector : Peak</p>	Left blank

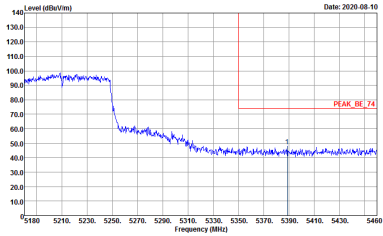
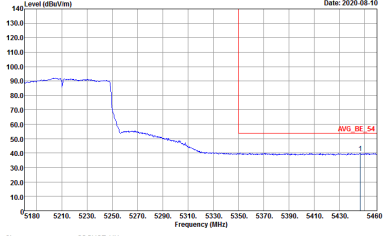

WIFI	Band 1 5150~5250MHz Band Edge @ 3m	
ANT	802.11ac VHT80 CH42 5210MHz - R	
1	Vertical	Fundamental
<p>Peak</p>	 <p>Site : 03CH07-HY Condition : PEAK_BE_74 3m HF_ANT_00075962 VERTICAL : RBW:1000.000kHz VBW:3000.000kHz SWT:Auto Detector : Peak</p>	<p>Left blank</p>
<p>Avg.</p>	 <p>Site : 03CH07-HY Condition : AVG_BE_54 3m HF_ANT_00075962 VERTICAL : RBW:1000.000kHz VBW:3.000kHz SWT:Auto Detector : Peak</p>	<p>Left blank</p>



Band 1 - 5150~5250MHz
WIFI 802.11a (Harmonic @ 3m)

Table with 2 columns: Horizontal and Vertical. Each column contains a spectral plot showing Level (dBuV/m) vs Frequency (MHz) with peak and average markers. Includes metadata like Site, Condition, Detector, Project, and Mode.

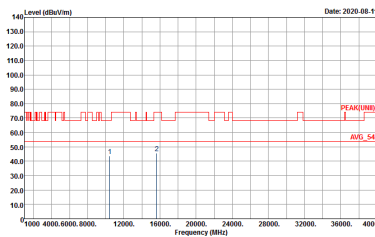
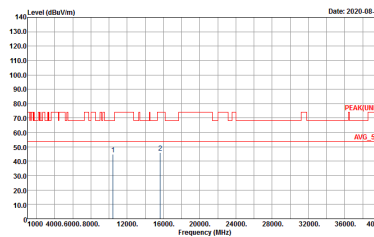

WIFI	Band 1 5150~5250MHz Harmonic @ 3m	
ANT	802.11a CH44 5220MHz	
1	Horizontal	Vertical
<p>Peak</p> <p>Avg.</p>	 <p>Site : ESCH07-RV Condition : PEAK(LIN) 3m HE_ANT_00075962 HORIZONTAL Detector : Peak Project : 052917-01 Mode : 2</p>	 <p>Site : ESCH07-RV Condition : PEAK(LIN) 3m HE_ANT_00075962 VERTICAL Detector : Peak Project : 052917-01 Mode : 2</p>

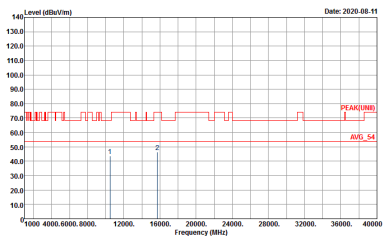
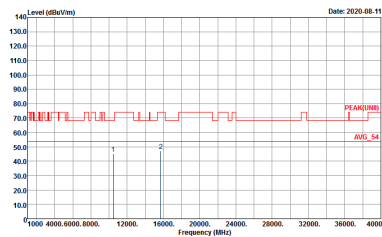

WIFI	Band 1 5150~5250MHz Harmonic @ 3m	
ANT	802.11a CH48 5240MHz	
1	Horizontal	Vertical
<p>Peak</p> <p>Avg.</p>	 <p>Date: 2020-08-11</p> <p>Site : ESCH07-RV Condition : PEAK(LIN) 3m HE_ANT_00075962 HORIZONTAL Detector : Peak Project : 052917-01 Mode : 3</p>	 <p>Date: 2020-08-11</p> <p>Site : ESCH07-RV Condition : PEAK(LIN) 3m HE_ANT_00075962 VERTICAL Detector : Peak Project : 052917-01 Mode : 3</p>



**Band 1 5150~5250MHz
WIFI 802.11ac VHT20 (Harmonic @ 3m)**

WIFI	Band 1 5150~5250MHz Harmonic @ 3m	
ANT	802.11ac VHT20 CH36 5180MHz	
1	Horizontal	Vertical
Peak Avg.	<p>Site : 03CH07-HY Condition : PEAK(UNII) 3m HF_ANT_00075962 HORIZONTAL Detector : Peak Project : 052917-01 Mode : 4</p>	<p>Site : 03CH07-HY Condition : PEAK(UNII) 3m HF_ANT_00075962 VERTICAL Detector : Peak Project : 052917-01 Mode : 4</p>

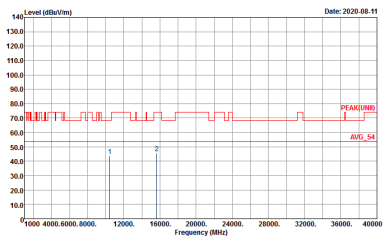
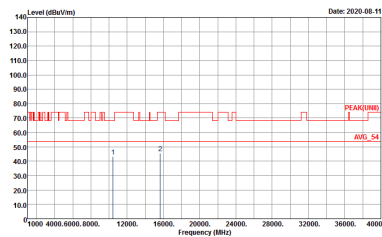

WIFI	Band 1 5150~5250MHz Harmonic @ 3m	
ANT	802.11ac VHT20 CH44 5220MHz	
1	Horizontal	Vertical
<p>Peak</p> <p>Avg.</p>	 <p>Site : ESCH07-RY Condition : PEAK(LIN) 3m HE_ANT_00075962 HORIZONTAL Detector : Peak Project : 052917-01 Mode : S</p>	 <p>Site : ESCH07-RY Condition : PEAK(LIN) 3m HE_ANT_00075962 VERTICAL Detector : Peak Project : 052917-01 Mode : S</p>

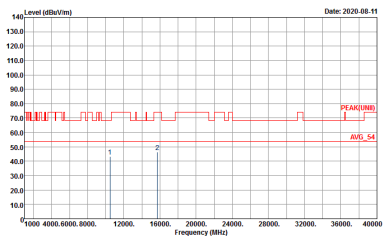
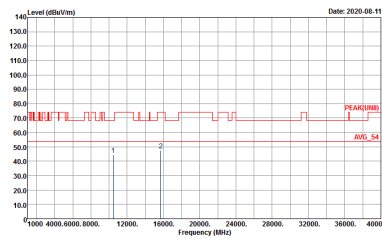

WIFI	Band 1 5150~5250MHz Harmonic @ 3m	
ANT	802.11ac VHT20 CH48 5240MHz	
1	Horizontal	Vertical
<p>Peak</p> <p>Avg.</p>	 <p>Site : ESCH07-RV Condition : PEAK(LIN) 3m HE_ANT_00075962 HORIZONTAL Detector : Peak Project : 052917-01 Mode : 7</p>	 <p>Site : ESCH07-RV Condition : PEAK(LIN) 3m HE_ANT_00075962 VERTICAL Detector : Peak Project : 052917-01 Mode : 7</p>



Band 1 5150~5250MHz
WIFI 802.11ac VHT40 (Harmonic @ 3m)

Table with 2 columns: Horizontal and Vertical. Each column contains a spectral plot showing Level (dBm/100MHz) vs Frequency (MHz) with peak and average markers. Includes metadata like Site, Condition, Detector, Project, Mode, and Setting.

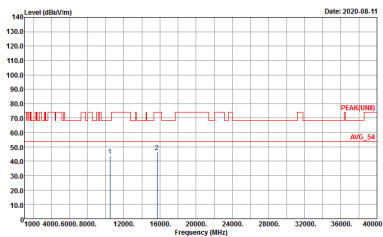
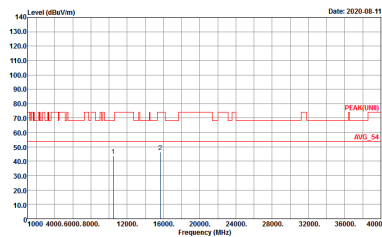

WIFI	Band 1 5150~5250MHz Harmonic @ 3m	
ANT	802.11ac VHT40 CH46 5230MHz	
1	Horizontal	Vertical
<p>Peak</p> <p>Avg.</p>	 <p>Site : ESCH07-HY Condition : PEAK(LIN) 3m HE_ANT_00075962 HORIZONTAL Detector : Peak Project : 052917-01 Mode : S</p>	 <p>Site : ESCH07-HY Condition : PEAK(LIN) 3m HE_ANT_00075962 VERTICAL Detector : Peak Project : 052917-01 Mode : S</p>



**Band 1 5150~5250MHz
WIFI 802.11ac VHT80 (Harmonic @ 3m)**

WIFI	Band 1 5150~5250MHz Harmonic @ 3m	
ANT	802.11ac VHT80 CH42 5210MHz	
1	Horizontal	Vertical
<p>Peak</p> <p>Avg.</p>	<p>Site : 03CH07-HY Condition : PEAK(UNII) 3m HF_ANT_00075962 HORIZONTAL Detector : Peak Project : 052917-01 Mode : 9</p>	<p>Site : 03CH07-HY Condition : PEAK(UNII) 3m HF_ANT_00075962 VERTICAL Detector : Peak Project : 052917-01 Mode : 9</p>



Band 2 - 5250~5350MHz
WIFI 802.11a (Band Edge @ 3m)

WIFI	Band 2 5250~5350MHz Band Edge @ 3m	
ANT	802.11a CH52 5260MHz - L	
1	Horizontal	Fundamental
Peak	<p>Site : 03CH07-HY Condition : PEAK_BE_74 3m HF_ANT_00075962 HORIZONTAL Detector : Peak Project : 052917-01 Mode : 10</p>	<p>Site : 03CH07-HY Condition : PEAKLNB1 3m HF_ANT_00075962 HORIZONTAL Detector : Peak Project : 052917-01 Mode : 10</p>
Avg.	<p>Site : 03CH07-HY Condition : AVG_BE_54 3m HF_ANT_00075962 HORIZONTAL Detector : Peak Project : 052917-01 Mode : 10</p>	Left blank



WIFI	Band 2 5250~5350MHz Band Edge @ 3m	
ANT	802.11a CH52 5260MHz - R	
1	Horizontal	Fundamental
<p>Peak</p>		<p>Left blank</p>
<p>Avg.</p>		<p>Left blank</p>

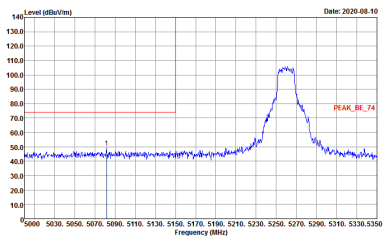
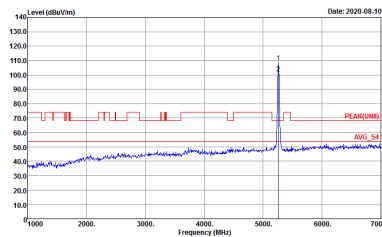
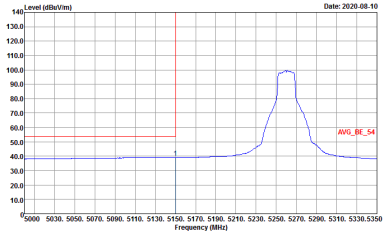

WIFI	Band 2 5250~5350MHz Band Edge @ 3m	
ANT	802.11a CH52 5260MHz - L	
1	Vertical	Fundamental
<p>Peak</p>	 <p>Site : 03CH07-HY Condition : PEAK_BE_74 3m HF_ANT_00075962 VERTICAL Detector : RBW:1000.000kHz VBW:3000.000kHz SWT:Auto Project : 052917-01 Mode : 10</p>	 <p>Site : 03CH07-HY Condition : PEAK(LINB) 3m HF_ANT_00075962 VERTICAL Detector : Peak Project : 052917-01 Mode : 10</p>
<p>Avg.</p>	 <p>Site : 03CH07-HY Condition : AVG_BE_54 3m HF_ANT_00075962 VERTICAL Detector : RBW:1000.000kHz VBW:3000.000kHz SWT:Auto Project : 052917-01 Mode : 10</p>	<p>Left blank</p>

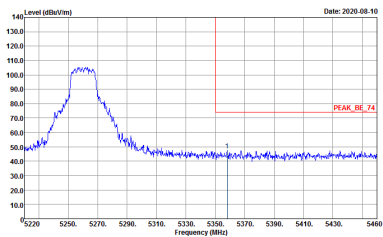
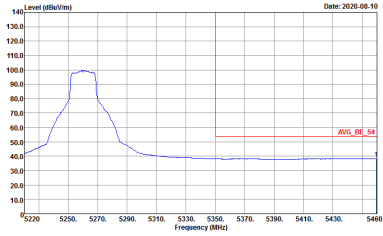

WIFI	Band 2 5250~5350MHz Band Edge @ 3m	
ANT	802.11a CH52 5260MHz - R	
1	Vertical	Fundamental
Peak	 <p>Site : 03CH07-HY Condition : PEAK_BE_74 3m HF_ANT_00075962 VERTICAL Detector : Peak Project : 052917-01 Mode : 10</p>	Left blank
Avg.	 <p>Site : 03CH07-HY Condition : AVG_BE_54 3m HF_ANT_00075962 VERTICAL Detector : Peak Project : 052917-01 Mode : 10</p>	Left blank

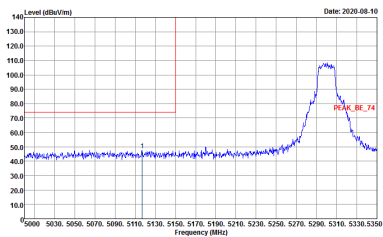
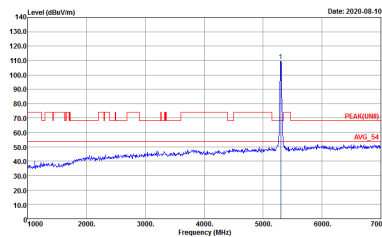
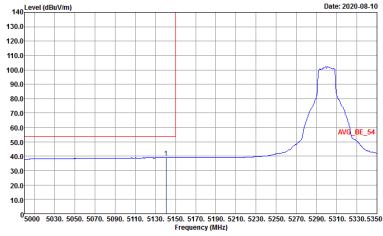

WIFI	Band 2 5250~5350MHz Band Edge @ 3m	
ANT	802.11a CH60 5300MHz - L	
1	Horizontal	Fundamental
<p>Peak</p>	 <p>Site : 03CH07-HY Condition : PEAK_BE_74 3m HF_ANT_00075962 HORIZONTAL Detector : RBW:1000.000kHz VBW:3000.000kHz SWT:Auto Project : 052917-01 Mode : 11</p>	 <p>Site : 03CH07-HY Condition : PEAK(LIN) 3m HF_ANT_00075962 HORIZONTAL Detector : RBW:1000.000kHz VBW:3000.000kHz SWT:Auto Project : 052917-01 Mode : 11</p>
<p>Avg.</p>	 <p>Site : 03CH07-HY Condition : AVG_BE_54 3m HF_ANT_00075962 HORIZONTAL Detector : RBW:1000.000kHz VBW:3000.000kHz SWT:Auto Project : 052917-01 Mode : 11</p>	<p>Left blank</p>



WIFI	Band 2 5250~5350MHz Band Edge @ 3m	
ANT	802.11a CH60 5300MHz - R	
1	Horizontal	Fundamental
<p>Peak</p>		<p>Left blank</p>
<p>Avg.</p>		<p>Left blank</p>

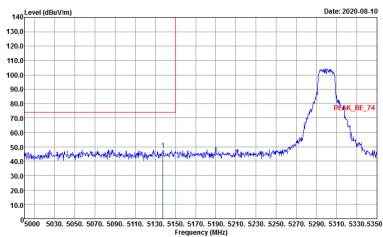
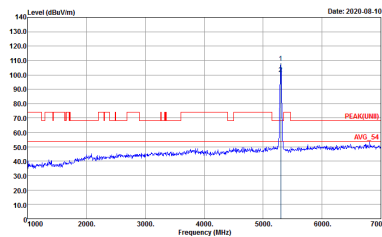
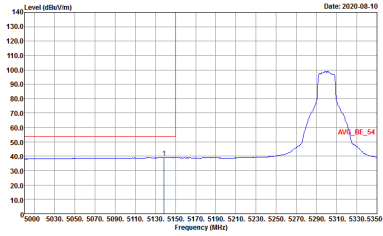

WIFI	Band 2 5250~5350MHz Band Edge @ 3m	
ANT	802.11a CH60 5300MHz - L	
1	Vertical	Fundamental
<p>Peak</p>	 <p>Site : 03CH07-HY Condition : PEAK_BE_74 3m HF_ANT_00075962 VERTICAL Detector : RBW:1000.000KHz VBW:3000.000KHz SWT:Auto Project : 052917-01 Mode : 11</p>	 <p>Site : 03CH07-HY Condition : PEAK(LIN) 3m HF_ANT_00075962 VERTICAL Detector : Peak Project : 052917-01 Mode : 11</p>
<p>Avg.</p>	 <p>Site : 03CH07-HY Condition : AVG_BE_54 3m HF_ANT_00075962 VERTICAL Detector : RBW:1000.000KHz VBW:3000.000KHz SWT:Auto Project : 052917-01 Mode : 11</p>	<p>Left blank</p>



WIFI	Band 2 5250~5350MHz Band Edge @ 3m	
ANT	802.11a CH60 5300MHz - R	
1	Vertical	Fundamental
<p>Peak</p>		<p>Left blank</p>
<p>Avg.</p>		<p>Left blank</p>

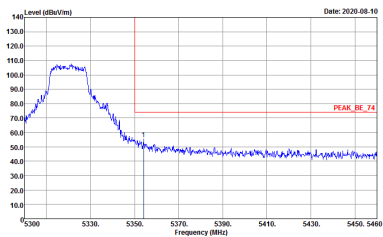
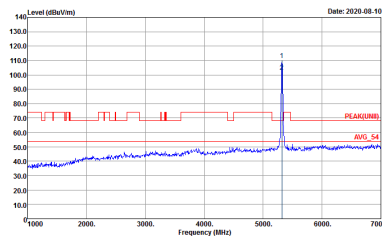
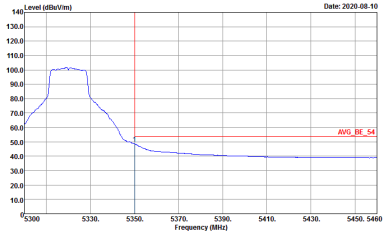

WIFI	Band 2 5250~5350MHz Band Edge @ 3m	
ANT	802.11a CH64 5320MHz	
1	Horizontal	Fundamental
<p>Peak</p>	 <p>Date: 2020-08-10</p> <p>Site : 03CH07-HY Condition : PEAK_BE_74 3m HF_ANT_00075962 HORIZONTAL Detector : Peak Project : 052917-01 Mode : 12</p>	 <p>Date: 2020-08-10</p> <p>Site : 03CH07-HY Condition : PEAK(LIN) 3m HF_ANT_00075962 HORIZONTAL Detector : Peak Project : 052917-01 Mode : 12</p>
<p>Avg.</p>	 <p>Date: 2020-08-10</p> <p>Site : 03CH07-HY Condition : AVG_BE_54 3m HF_ANT_00075962 HORIZONTAL Detector : Peak Project : 052917-01 Mode : 12</p>	<p>Left blank</p>

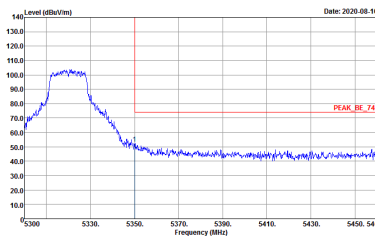
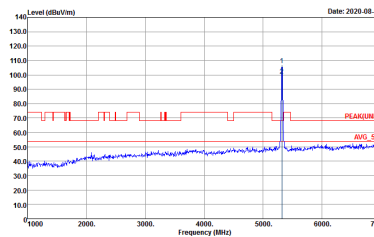
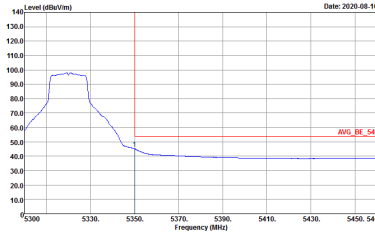

WIFI	Band 2 5250~5350MHz Band Edge @ 3m	
ANT	802.11a CH64 5320MHz	
1	Vertical	Fundamental
<p>Peak</p>	 <p>Site : 03CH07-HY Condition : PEAK_BE_74 3m HF_ANT_00075962 VERTICAL Detector : Peak Project : 052917-01 Mode : 12</p>	 <p>Site : 03CH07-HY Condition : PEAK(LIN) 3m HF_ANT_00075962 VERTICAL Detector : Peak Project : 052917-01 Mode : 12</p>
<p>Avg.</p>	 <p>Site : 03CH07-HY Condition : AVG_BE_54 3m HF_ANT_00075962 VERTICAL Detector : Peak Project : 052917-01 Mode : 12</p>	<p>Left blank</p>

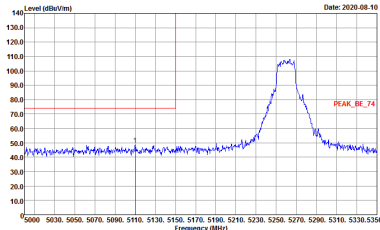
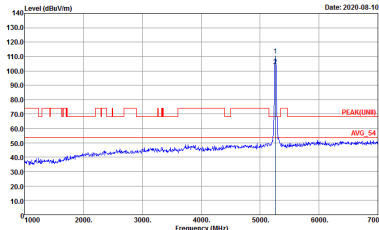
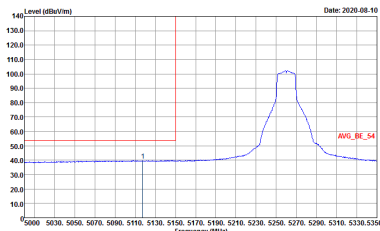

Band 2 5250~5350MHz
WIFI 802.11ac VHT20 (Band Edge @ 3m)

WIFI	Band 2 5250~5350MHz Band Edge @ 3m	
ANT	802.11ac VHT20 CH52 5260MHz - L	
1	Horizontal	Fundamental
<p>Peak</p>	 <p>Date: 2020-08-10</p> <p>Site : 03CH07-HY Condition : PEAK_BE_74 3m HF_ANT_00075962 HORIZONTAL : RBW:1000.000kHz VBW:3000.000kHz SWT:Auto Detector : Peak Project : 052917-01 Mode : 13</p>	 <p>Date: 2020-08-10</p> <p>Site : 03CH07-HY Condition : PEAK(LINB) 3m HF_ANT_00075962 HORIZONTAL : RBW:1000.000kHz VBW:3000.000kHz SWT:Auto Detector : Peak Project : 052917-01 Mode : 13</p>
<p>Avg.</p>	 <p>Date: 2020-08-10</p> <p>Site : 03CH07-HY Condition : AVG_BE_54 3m HF_ANT_00075962 HORIZONTAL : RBW:1000.000kHz VBW:1.000kHz SWT:Auto Detector : Peak Project : 052917-01 Mode : 13</p>	<p>Left blank</p>



WIFI	Band 2 5250~5350MHz Band Edge @ 3m	
ANT	802.11ac VHT20 CH52 5260MHz - R	
1	Horizontal	Fundamental
<p>Peak</p>		<p>Left blank</p>
<p>Avg.</p>		<p>Left blank</p>

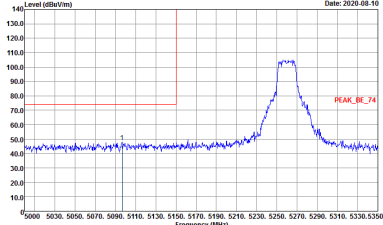
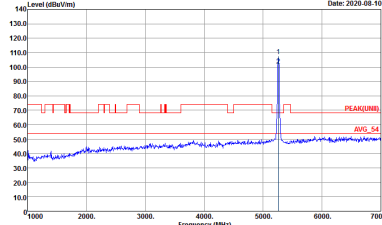
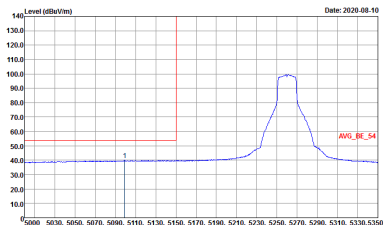

WIFI	Band 2 5250~5350MHz Band Edge @ 3m	
ANT	802.11ac VHT20 CH52 5260MHz - L	
1	Vertical	Fundamental
Peak	 <p>Site : 03CH07-HY Condition : PEAK_BE_74 3m HF_ANT_00075962 VERTICAL Detector : Peak Project : 052917-01 Mode : 13</p>	 <p>Site : 03CH07-HY Condition : PEAK(UNII) 3m HF_ANT_00075962 VERTICAL Detector : Peak Project : 052917-01 Mode : 13</p>
Avg.	 <p>Site : 03CH07-HY Condition : AVG_BE_54 3m HF_ANT_00075962 VERTICAL Detector : Peak Project : 052917-01 Mode : 13</p>	Left blank

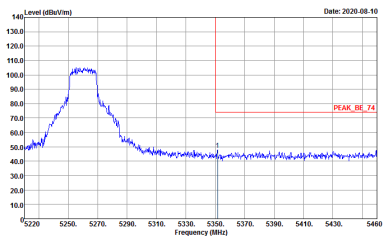
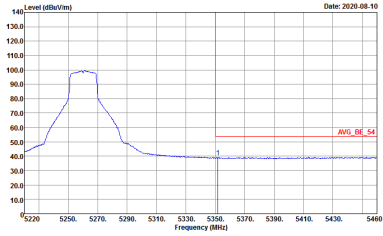

WIFI	Band 2 5250~5350MHz Band Edge @ 3m	
ANT	802.11ac VHT20 CH52 5260MHz - R	
1	Vertical	Fundamental
<p>Peak</p>	 <p>Site : 03CH07-HY Condition : PEAK_BE_74 3m HF_ANT_00075962 VERTICAL Detector : RBW:1000.000kHz VBW:3000.000kHz SWT:Auto Project : 052917-01 Mode : 13</p>	<p>Left blank</p>
<p>Avg.</p>	 <p>Site : 03CH07-HY Condition : AVG_BE_54 3m HF_ANT_00075962 VERTICAL Detector : RBW:1000.000kHz VBW:1.000kHz SWT:Auto Project : 052917-01 Mode : 13</p>	<p>Left blank</p>

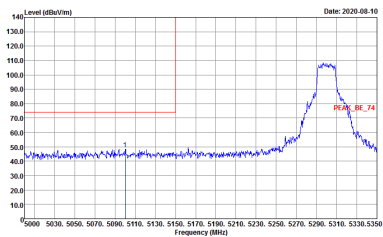
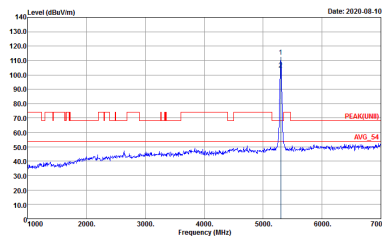
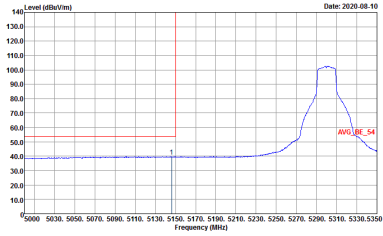

WIFI	Band 2 5250~5350MHz Band Edge @ 3m	
ANT	802.11ac VHT20 CH60 5300MHz - L	
1	Horizontal	Fundamental
Peak	 <p>Site : 03CH07-HY Condition : PEAK_BE_74 3m HF_ANT_00075962 HORIZONTAL Detector : Peak Project : 052917-01 Mode : 14</p>	 <p>Site : 03CH07-HY Condition : PEAK(LIN) 3m HF_ANT_00075962 HORIZONTAL Detector : Peak Project : 052917-01 Mode : 14</p>
Avg.	 <p>Site : 03CH07-HY Condition : AVG_BE_54 3m HF_ANT_00075962 HORIZONTAL Detector : Peak Project : 052917-01 Mode : 14</p>	Left blank



WIFI	Band 2 5250~5350MHz Band Edge @ 3m	
ANT	802.11ac VHT20 CH60 5300MHz - R	
1	Horizontal	Fundamental
<p>Peak</p>	<p>Site : 03CH07-HY Condition : PEAK_BE_74 3m HF_ANT_00075962 HORIZONTAL Detector : Peak Project : 052917-01 Mode : 14</p>	<p>Left blank</p>
<p>Avg.</p>	<p>Site : 03CH07-HY Condition : AVG_BE_54 3m HF_ANT_00075962 HORIZONTAL Detector : Peak Project : 052917-01 Mode : 14</p>	<p>Left blank</p>

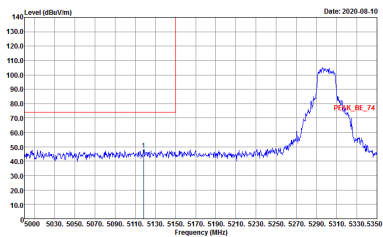
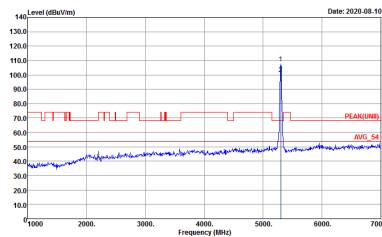
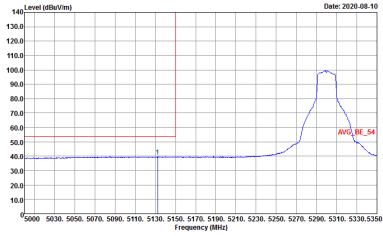

WIFI	Band 2 5250~5350MHz Band Edge @ 3m	
ANT	802.11ac VHT20 CH60 5300MHz - L	
1	Vertical	Fundamental
<p>Peak</p>	 <p>Site : 03CH07-HY Condition : PEAK_BE_74 3m HF_ANT_00075962 VERTICAL Detector : Peak Project : 052917-01 Mode : 14</p>	 <p>Site : 03CH07-HY Condition : PEAK(LIN) 3m HF_ANT_00075962 VERTICAL Detector : Peak Project : 052917-01 Mode : 14</p>
<p>Avg.</p>	 <p>Site : 03CH07-HY Condition : AVG_BE_54 3m HF_ANT_00075962 VERTICAL Detector : Peak Project : 052917-01 Mode : 14</p>	<p>Left blank</p>



WIFI	Band 2 5250~5350MHz Band Edge @ 3m	
ANT	802.11ac VHT20 CH60 5300MHz - R	
1	Vertical	Fundamental
<p>Peak</p>		<p>Left blank</p>
<p>Avg.</p>		<p>Left blank</p>

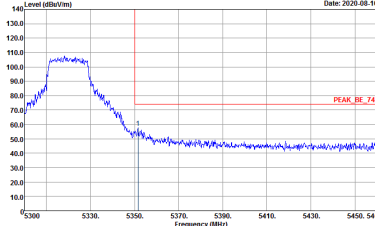
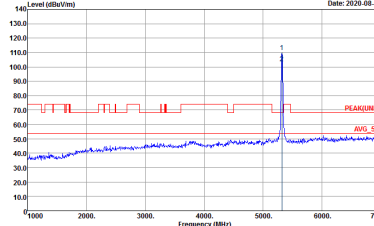
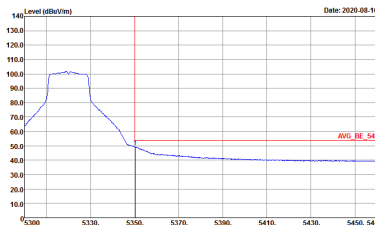

WIFI	Band 2 5250~5350MHz Band Edge @ 3m	
ANT	802.11ac VHT20 CH64 5320MHz	
1	Horizontal	Fundamental
Peak	 <p>Site : 03CH07-HY Condition : PEAK_BE_74 3m HF_ANT_00075962 HORIZONTAL Detector : Peak Project : 052917-01 Mode : 15</p>	 <p>Site : 03CH07-HY Condition : PEAK(LIN) 3m HF_ANT_00075962 HORIZONTAL Detector : Peak Project : 052917-01 Mode : 15</p>
Avg.	 <p>Site : 03CH07-HY Condition : AVG_BE_54 3m HF_ANT_00075962 HORIZONTAL Detector : Peak Project : 052917-01 Mode : 15</p>	Left blank

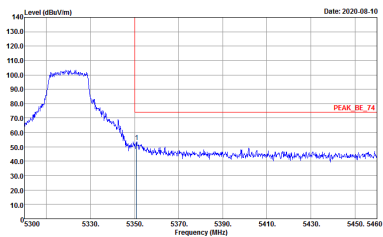
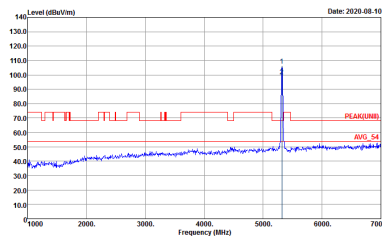
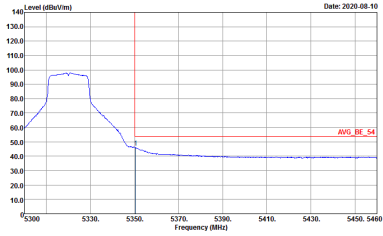

WIFI	Band 2 5250~5350MHz Band Edge @ 3m	
ANT	802.11ac VHT20 CH64 5320MHz	
1	Vertical	Fundamental
<p>Peak</p>	 <p>Site : 03CH07-HY Condition : PEAK_BE_74 3m HF_ANT_00075962 VERTICAL Detector : Peak Project : 052917-01 Mode : 15</p>	 <p>Site : 03CH07-HY Condition : PEAK(LIN) 3m HF_ANT_00075962 VERTICAL Detector : Peak Project : 052917-01 Mode : 15</p>
<p>Avg.</p>	 <p>Site : 03CH07-HY Condition : AVG_BE_54 3m HF_ANT_00075962 VERTICAL Detector : Peak Project : 052917-01 Mode : 15</p>	<p>Left blank</p>



Band 2 5250~5350MHz
WIFI 802.11ac VHT40 (Band Edge @ 3m)

WIFI	Band 2 5250~5350MHz Band Edge @ 3m	
ANT	802.11ac VHT40 CH54 5270 - L	
1	Horizontal	Fundamental
Peak	<p>Site : 03CH07-HY Condition : PEAK_BE_74 3m HF_ANT_00075962 HORIZONTAL RBW:1000.000kHz VBW:3000.000kHz SWT:Auto Detector : Peak Project : 052917-01 Mode : 16</p>	<p>Site : 03CH07-HY Condition : PEAK(LIN) 3m HF_ANT_00075962 HORIZONTAL RBW:1000.000kHz VBW:3000.000kHz SWT:Auto Detector : Peak Project : 052917-01 Mode : 16</p>
Avg.	<p>Site : 03CH07-HY Condition : AVG_BE_54 3m HF_ANT_00075962 HORIZONTAL RBW:1000.000kHz VBW:3.000kHz SWT:Auto Detector : Peak Project : 052917-01 Mode : 16</p>	Left blank



WIFI	Band 2 5250~5350MHz Band Edge @ 3m	
ANT	802.11ac VHT40 CH54 5270 - R	
1	Horizontal	Fundamental
<p>Peak</p>	<p>Site : 03CH07-HY Condition : PEAK_BE_74 3m HF_ANT_00075962 HORIZONTAL Detector : Peak Project : 052917-01 Mode : 16</p>	<p>Left blank</p>
<p>Avg.</p>	<p>Site : 03CH07-HY Condition : AVG_BE_54 3m HF_ANT_00075962 HORIZONTAL Detector : Peak Project : 052917-01 Mode : 16</p>	<p>Left blank</p>

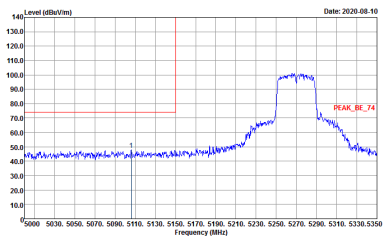
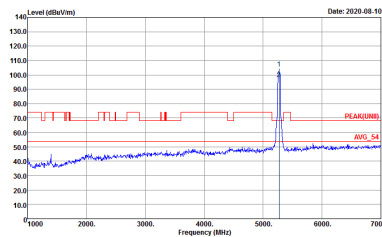
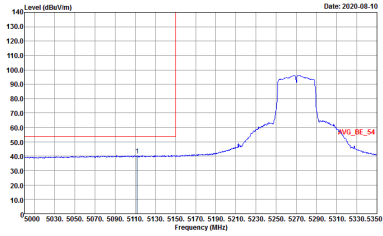

WIFI	Band 2 5250~5350MHz Band Edge @ 3m	
ANT	802.11ac VHT40 CH54 5270 - L	
1	Vertical	Fundamental
<p>Peak</p>	 <p>Date: 2020-08-10</p> <p>Site : 03CH07-HY Condition : PEAK_BE_74 3m HF_ANT_00075962 VERTICAL Detector : Peak Project : 052917-01 Mode : 16</p>	 <p>Date: 2020-08-10</p> <p>Site : 03CH07-HY Condition : PEAK(LIN) 3m HF_ANT_00075962 VERTICAL Detector : Peak Project : 052917-01 Mode : 16</p>
<p>Avg.</p>	 <p>Date: 2020-08-10</p> <p>Site : 03CH07-HY Condition : AVG_BE_54 3m HF_ANT_00075962 VERTICAL Detector : Peak Project : 052917-01 Mode : 16</p>	<p>Left blank</p>



WIFI	Band 2 5250~5350MHz Band Edge @ 3m	
ANT	802.11ac VHT40 CH54 5270 - R	
1	Vertical	Fundamental
<p>Peak</p>	<p>Site : 03CH07-HY Condition : PEAK_BE_74 3m HF_ANT_00075962 VERTICAL Detector : Peak Project : 052917-01 Mode : 16</p>	<p>Left blank</p>
<p>Avg.</p>	<p>Site : 03CH07-HY Condition : AVG_BE_54 3m HF_ANT_00075962 VERTICAL Detector : Peak Project : 052917-01 Mode : 16</p>	<p>Left blank</p>

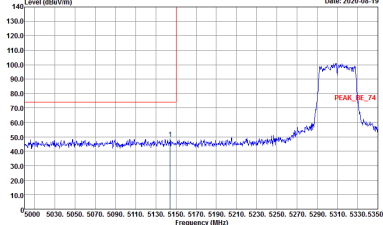
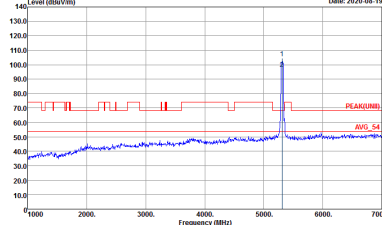

WIFI	Band 2 5250~5350MHz Band Edge @ 3m	
ANT	802.11ac VHT40 CH62 5310 - L	
1	Horizontal	Fundamental
Peak	 <p>Level (dBm/100MHz) vs Frequency (MHz) plot showing a peak at 5310 MHz. The y-axis ranges from 10.0 to 140.0 dBm/100MHz, and the x-axis ranges from 5000 to 5350 MHz. A red vertical line marks the peak at 5310 MHz, labeled 'PEAK_BE_74'. The plot shows a noise floor around 40 dBm/100MHz and a signal peak reaching approximately 100 dBm/100MHz.</p> <p>Site : 03CH07-HY Condition : PEAK_BE_74 3m HF_ANT_00075962 HORIZONTAL RBW:1000.000kHz VBW:3000.000kHz SWT:Auto Detector : Peak</p>	 <p>Level (dBm/100MHz) vs Frequency (MHz) plot showing a peak at 5310 MHz. The y-axis ranges from 10.0 to 140.0 dBm/100MHz, and the x-axis ranges from 1000 to 7000 MHz. A red vertical line marks the peak at 5310 MHz, labeled 'PEAK_LUMB'. The plot shows a noise floor around 40 dBm/100MHz and a signal peak reaching approximately 100 dBm/100MHz.</p> <p>Site : 03CH07-HY Condition : PEAK_LUMB 3m HF_ANT_00075962 HORIZONTAL RBW:1000.000kHz VBW:3000.000kHz SWT:Auto Detector : Peak</p>
Avg.	 <p>Level (dBm/100MHz) vs Frequency (MHz) plot showing an average at 5310 MHz. The y-axis ranges from 10.0 to 140.0 dBm/100MHz, and the x-axis ranges from 5000 to 5350 MHz. A red vertical line marks the average at 5310 MHz, labeled 'AVG_BE_54'. The plot shows a noise floor around 40 dBm/100MHz and an average signal level reaching approximately 60 dBm/100MHz.</p> <p>Site : 03CH07-HY Condition : AVG_BE_54 3m HF_ANT_00075962 HORIZONTAL RBW:1000.000kHz VBW:3.000kHz SWT:Auto Detector : Peak</p>	Left blank

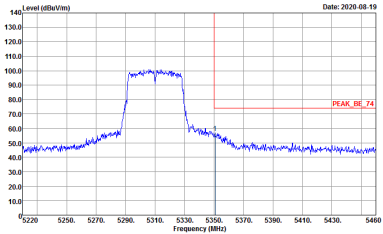
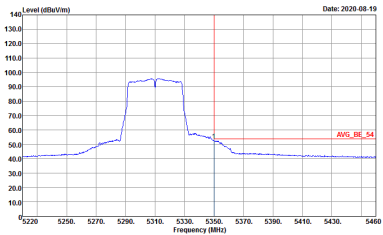

WIFI	Band 2 5250~5350MHz Band Edge @ 3m	
ANT	802.11ac VHT40 CH62 5310 - R	
1	Horizontal	Fundamental
Peak	 <p>Site : 03CH07-HY Condition : PEAK_BE_74 3m HF_ANT_00075962 HORIZONTAL : RBW:1000.000kHz VBW:3000.000kHz SWF:Auto Detector : Peak</p>	Left blank
Avg.	 <p>Site : 03CH07-HY Condition : AVG_BE_54 3m HF_ANT_00075962 HORIZONTAL : RBW:1000.000kHz VBW:3.000kHz SWF:Auto Detector : Peak</p>	Left blank

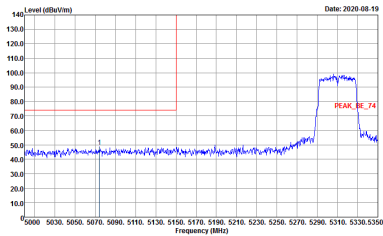
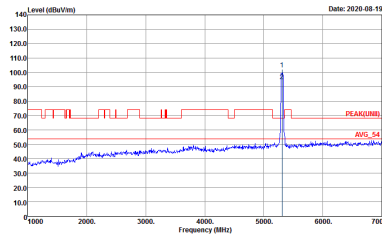
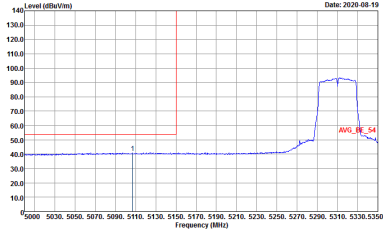

WIFI	Band 2 5250~5350MHz Band Edge @ 3m	
ANT	802.11ac VHT40 CH62 5310 - L	
1	Vertical	Fundamental
Peak	 <p>Site : 03CH07-HY Condition : PEAK_BE_74 3m HF_ANT_00075962 VERTICAL : RBW:1000.000kHz VBW:3000.000kHz SWT:Auto Detector : Peak</p>	 <p>Site : 03CH07-HY Condition : PEAK(LMB) 3m HF_ANT_00075962 VERTICAL : RBW:1000.000kHz VBW:3000.000kHz SWT:Auto Detector : Peak</p>
Avg.	 <p>Site : 03CH07-HY Condition : AVG_BE_54 3m HF_ANT_00075962 VERTICAL : RBW:1000.000kHz VBW:3.000kHz SWT:Auto Detector : Peak</p>	Left blank



WIFI	Band 2 5250~5350MHz Band Edge @ 3m	
ANT	802.11ac VHT40 CH62 5310 - R	
1	Vertical	Fundamental
Peak	<p>Site : 03CH07-HY Condition : PEAK_BE_74 3m HF_ANT_00075962 VERTICAL Detector : RBW:1000.000kHz VBW:3000.000kHz SWF:Auto : Peak</p>	Left blank
Avg.	<p>Site : 03CH07-HY Condition : AVG_BE_54 3m HF_ANT_00075962 VERTICAL Detector : RBW:1000.000kHz VBW:3.000kHz SWF:Auto : Peak</p>	Left blank



Band 2 5250~5350MHz
WIFI 802.11ac VHT80 (Band Edge @ 3m)

WIFI	Band 2 5250~5350MHz Band Edge @ 3m	
ANT	802.11ac VHT80 CH58 5290MHz - L	
1	Horizontal	Fundamental
Peak	<p>Site : 03CH07-HY Condition : PEAK_BE_74 3m HF_ANT_00075962 HORIZONTAL : RBW:1000.000kHz VBW:3000.000kHz SWT:Auto Detector : Peak Project : 052917-01 Mode : 18</p>	<p>Site : 03CH07-HY Condition : PEAK(LIN) 3m HF_ANT_00075962 HORIZONTAL : RBW:1000.000kHz VBW:3000.000kHz SWT:Auto Detector : Peak Project : 052917-01 Mode : 18</p>
Avg.	<p>Site : 03CH07-HY Condition : AVG_BE_54 3m HF_ANT_00075962 HORIZONTAL : RBW:1000.000kHz VBW:3.000kHz SWT:Auto Detector : Peak Project : 052917-01 Mode : 18</p>	Left blank

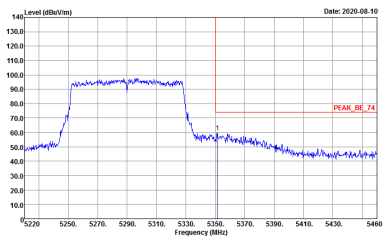
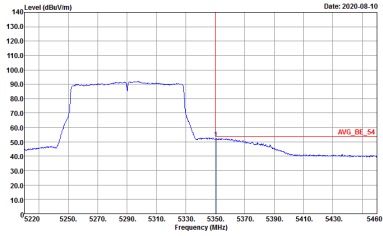

WIFI	Band 2 5250~5350MHz Band Edge @ 3m	
ANT	802.11ac VHT80 CH58 5290MHz - R	
1	Horizontal	Fundamental
<p>Peak</p>	 <p>Site : 03CH07-HY Condition : PEAK_BE_74 3m HF_ANT_00075962 HORIZONTAL Detector : Peak Project : 052917-01 Mode : 18</p>	<p>Left blank</p>
<p>Avg.</p>	 <p>Site : 03CH07-HY Condition : AVG_BE_54 3m HF_ANT_00075962 HORIZONTAL Detector : Peak Project : 052917-01 Mode : 18</p>	<p>Left blank</p>

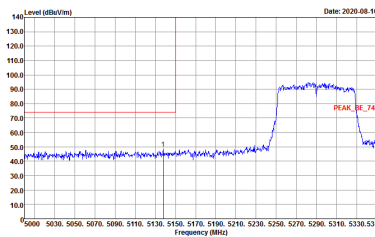
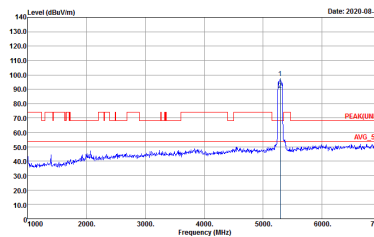
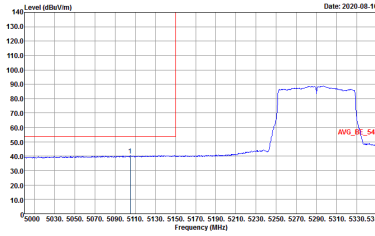

WIFI	Band 2 5250~5350MHz Band Edge @ 3m	
ANT	802.11ac VHT80 CH58 5290MHz - L	
1	Vertical	Fundamental
<p>Peak</p>	 <p>Date: 2020-08-10</p> <p>Site : 03CH07-HY Condition : PEAK_BE_74 3m HF_ANT_00075962 VERTICAL RBW:1000.000kHz VBW:3000.000kHz SWT:Auto Detector : Peak Project : 052917-01 Mode : 18</p>	 <p>Date: 2020-08-10</p> <p>Site : 03CH07-HY Condition : PEAK(LIN) 3m HF_ANT_00075962 VERTICAL RBW:1000.000kHz VBW:3000.000kHz SWT:Auto Detector : Peak Project : 052917-01 Mode : 18</p>
<p>Avg.</p>	 <p>Date: 2020-08-10</p> <p>Site : 03CH07-HY Condition : AVG_BE_54 3m HF_ANT_00075962 VERTICAL RBW:1000.000kHz VBW:3.000kHz SWT:Auto Detector : Peak Project : 052917-01 Mode : 18</p>	<p>Left blank</p>

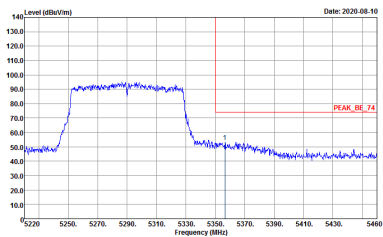
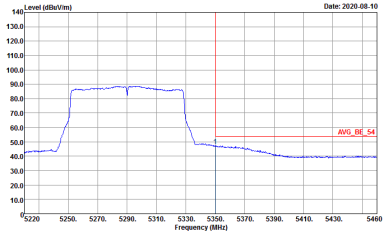

WIFI	Band 2 5250~5350MHz Band Edge @ 3m	
ANT	802.11ac VHT80 CH58 5290MHz - R	
1	Vertical	Fundamental
<p>Peak</p>	 <p>Site : 03CH07-HY Condition : PEAK_BE_74 3m HF_ANT_00075962 VERTICAL Detector : Peak Project : 052917-01 Mode : 18</p>	<p>Left blank</p>
<p>Avg.</p>	 <p>Site : 03CH07-HY Condition : AVG_BE_54 3m HF_ANT_00075962 VERTICAL Detector : Peak Project : 052917-01 Mode : 18</p>	<p>Left blank</p>



Band 2 - 5250~5350MHz
WIFI 802.11a (Harmonic @ 3m)

Table with 2 columns: Horizontal and Vertical. Each column contains a spectral plot showing Level (dBuV/m) vs Frequency (MHz) with Peak and Avg markers. Includes metadata like Site, Condition, Detector, Project, and Mode.

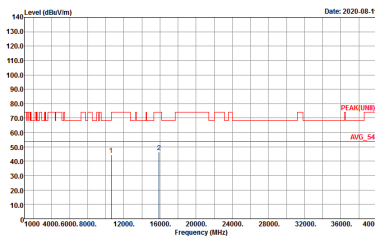
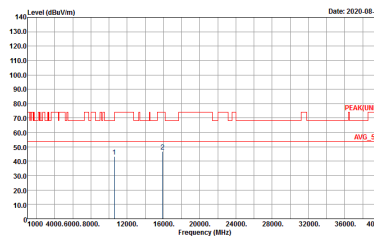

WIFI	Band 2 5250~5350MHz Harmonic @ 3m	
ANT	802.11a CH60 5300MHz	
1	Horizontal	Vertical
<p>Peak</p> <p>Avg.</p>	 <p>Site : ESCH07-RV Condition : PEAK(LIN) 3m HE_ANT_00075962 HORIZONTAL Detector : Peak Project : 052917-01 Mode : 11</p>	 <p>Site : ESCH07-RV Condition : PEAK(LIN) 3m HE_ANT_00075962 VERTICAL Detector : Peak Project : 052917-01 Mode : 11</p>

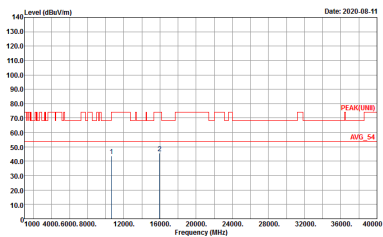
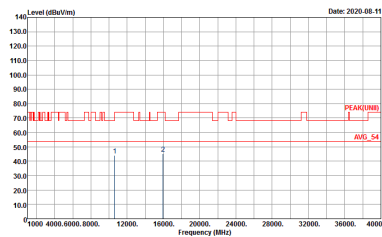

WIFI	Band 2 5250~5350MHz Harmonic @ 3m	
ANT	802.11a CH64 5320MHz	
1	Horizontal	Vertical
<p>Peak</p> <p>Avg.</p>	 <p>Site : ESCH07-RY Condition : PEAK(LIN) 3m HE_ANT_00075962 HORIZONTAL Detector : Peak Project : 052917-01 Mode : 12</p>	 <p>Site : ESCH07-RY Condition : PEAK(LIN) 3m HE_ANT_00075962 VERTICAL Detector : Peak Project : 052917-01 Mode : 12</p>



Band 2 5250~5350MHz
WIFI 802.11ac VHT20 (Harmonic @ 3m)

WIFI	Band 2 5250~5350MHz Harmonic @ 3m	
ANT	802.11ac VHT20 CH52 5260MHz	
1	Horizontal	Vertical
<p>Peak</p> <p>Avg.</p>	<p>Site : 03CH07-HY Condition : PEAK(UNII) 3m HF_ANT_00075962 HORIZONTAL Detector : Peak Project : 052917-01 Mode : 13</p>	<p>Site : 03CH07-HY Condition : PEAK(UNII) 3m HF_ANT_00075962 VERTICAL Detector : Peak Project : 052917-01 Mode : 13</p>

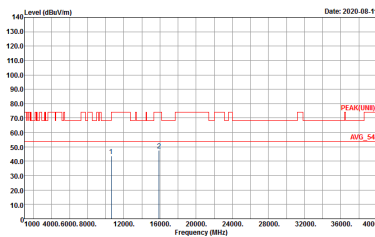
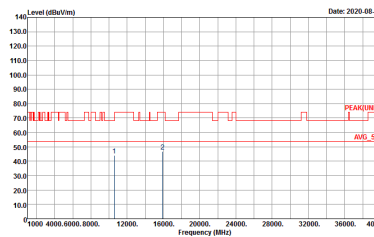

WIFI	Band 2 5250~5350MHz Harmonic @ 3m	
ANT	802.11ac VHT20 CH60 5300MHz	
1	Horizontal	Vertical
<p>Peak</p> <p>Avg.</p>	 <p>Site : ESCH07-RY Condition : PEAK(LIN) 3m HE_ANT_00075962 HORIZONTAL Detector : Peak Project : 052917-01 Mode : 14</p>	 <p>Site : ESCH07-RY Condition : PEAK(LIN) 3m HE_ANT_00075962 VERTICAL Detector : Peak Project : 052917-01 Mode : 14</p>

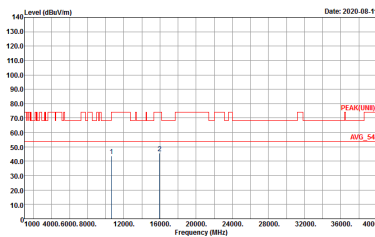
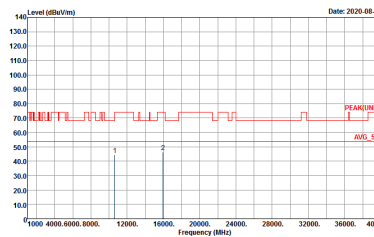

WIFI	Band 2 5250~5350MHz Harmonic @ 3m	
ANT	802.11ac VHT20 CH64 5320MHz	
1	Horizontal	Vertical
<p>Peak</p> <p>Avg.</p>	 <p>Site : ESCH07-RV Condition : PEAK(LIN) 3m HE_ANT_00075962 HORIZONTAL Detector : Peak Project : 052917-01 Mode : 15</p>	 <p>Site : ESCH07-RV Condition : PEAK(LIN) 3m HE_ANT_00075962 VERTICAL Detector : Peak Project : 052917-01 Mode : 15</p>



**Band 2 5250~5350MHz
WIFI 802.11ac VHT40 (Harmonic @ 3m)**

WIFI	Band 2 5250~5350MHz Harmonic @ 3m	
ANT	802.11ac VHT40 CH54 5270	
1	Horizontal	Vertical
<p>Peak</p> <p>Avg.</p>	<p>Site : 03CH07-HY Condition : PEAK(UNII) 3m HF_ANT_00075962 HORIZONTAL Detector : Peak Project : 052917-01 Mode : 16</p>	<p>Site : 03CH07-HY Condition : PEAK(UNII) 3m HF_ANT_00075962 VERTICAL Detector : Peak Project : 052917-01 Mode : 16</p>

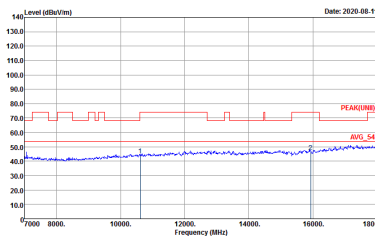
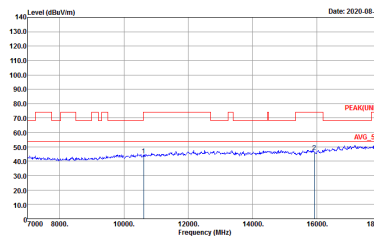

WIFI	Band 2 5250~5350MHz Harmonic @ 3m	
ANT	802.11ac VHT40 CH62 5310	
1	Horizontal	Vertical
<p>Peak</p> <p>Avg.</p>	 <p>Site : ESCH07-RV Condition : PEAK(LIN) 3m HE_ANT_00075962 HORIZONTAL Detector : Peak Project : 052917-01 Mode : 17</p>	 <p>Site : ESCH07-RV Condition : PEAK(LIN) 3m HE_ANT_00075962 VERTICAL Detector : Peak Project : 052917-01 Mode : 17</p>



**Band 2 5250~5350MHz
WIFI 802.11ac VHT80 (Harmonic @ 3m)**

WIFI	Band 2 5250~5350MHz Harmonic @ 3m	
ANT	802.11ac VHT80 CH58 5290MHz	
1	Horizontal	Vertical
<p>Peak</p> <p>Avg.</p>	<p>Site : 03CH07-HY Condition : PEAK(UNII) 3m HF_ANT_00075962 HORIZONTAL Detector : Peak Project : 052917-01 Mode : 18</p>	<p>Site : 03CH07-HY Condition : PEAK(UNII) 3m HF_ANT_00075962 VERTICAL Detector : Peak Project : 052917-01 Mode : 18</p>



Band 3 - 5470~5725MHz
WIFI 802.11a (Band Edge @ 3m)

WIFI	Band 3 5470~5725MHz Band Edge @ 3m	
ANT	802.11a CH100 5500MHz	
1	Horizontal	Fundamental
Peak	<p>Site : 03CH07-HY Condition : PEAK_BE(UIN0)_B3 3m HF_ANT_00075962 HORIZONTAL Detector : Peak Project : 052917-01 Mode : 19</p>	<p>Site : 03CH07-HY Condition : PEAK(UIN0) 3m HF_ANT_00075962 HORIZONTAL Detector : Peak Project : 052917-01 Mode : 19</p>
Avg.	<p>Site : 03CH07-HY Condition : AVG_BE(UIN0)_B3 3m HF_ANT_00075962 HORIZONTAL Detector : Peak Project : 052917-01 Mode : 19</p>	Left blank

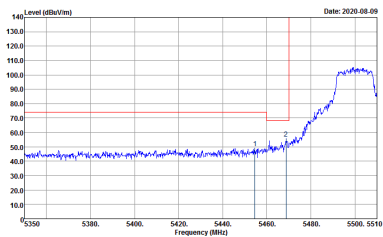
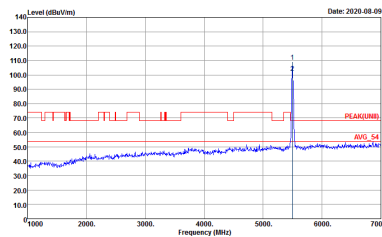
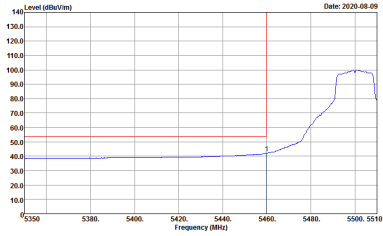

WIFI	Band 3 5470~5725MHz Band Edge @ 3m	
ANT	802.11a CH100 5500MHz	
1	Vertical	Fundamental
Peak	 <p>Date: 2020-08-09</p> <p>Site : 03CH07-HY Condition : PEAK_BE(LINII)_B3 3m HF_ANT_00075962 VERTICAL RBW:1000.000kHz VBW:3000.000kHz SWT:Auto Detector : Peak Project : 052917-01 Mode : 19</p>	 <p>Date: 2020-08-09</p> <p>Site : 03CH07-HY Condition : PEAK(LINII) 3m HF_ANT_00075962 VERTICAL RBW:1000.000kHz VBW:3000.000kHz SWT:Auto Detector : Peak Project : 052917-01 Mode : 19</p>
Avg.	 <p>Date: 2020-08-09</p> <p>Site : 03CH07-HY Condition : AVG_BE(LINII)_B3 3m HF_ANT_00075962 VERTICAL RBW:1000.000kHz VBW:3000.000kHz SWT:Auto Detector : Peak Project : 052917-01 Mode : 19</p>	Left blank

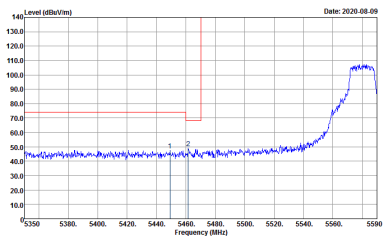
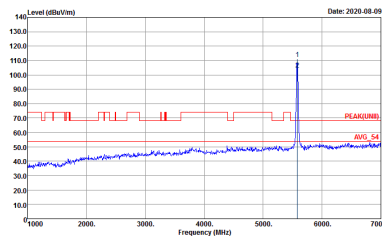
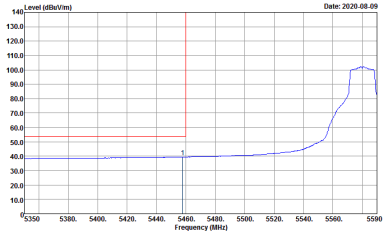

WIFI	Band 3 5470~5725MHz Band Edge @ 3m	
ANT	802.11a CH116 5580MHz - L	
1	Horizontal	Fundamental
<p>Peak</p>	 <p>Site : 03CH07-HY Condition : PEAK_BE(LNII)_B3 3m HF_ANT_00075962 HORIZONTAL Detector : Peak Project : 052917-01 Mode : 20</p>	 <p>Site : 03CH07-HY Condition : PEAK(LNII) 3m HF_ANT_00075962 HORIZONTAL Detector : Peak Project : 052917-01 Mode : 20</p>
<p>Avg.</p>	 <p>Site : 03CH07-HY Condition : AVG_BE(LNII)_B3 3m HF_ANT_00075962 HORIZONTAL Detector : Peak Project : 052917-01 Mode : 20</p>	<p>Left blank</p>



WIFI	Band 3 5470~5725MHz Band Edge @ 3m	
ANT	802.11a CH116 5580MHz - R	
1	Horizontal	Fundamental
Peak	<p>Site : ESCH07-HY Condition : PEAK_BE(UNH)_B3 3m HF ANT_00075962 HORIZONTAL Detector : Peak Project : FR052917-01 Mode : Z0</p>	Left blank

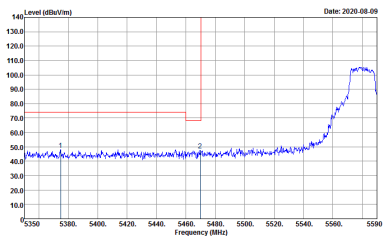
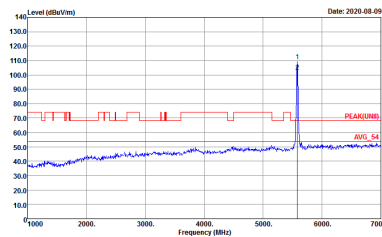
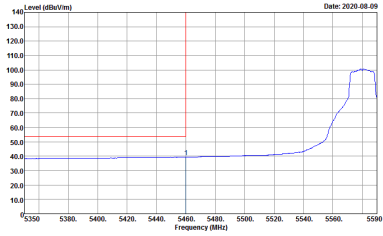

WIFI	Band 3 5470~5725MHz Band Edge @ 3m	
ANT	802.11a CH116 5580MHz - L	
1	Vertical	Fundamental
<p>Peak</p>	 <p>Site : 03CH07-HY Condition : PEAK_BE(LINII)_B3 3m HF_ANT_00075962 VERTICAL Detector : Peak Project : 052917-01 Mode : 20</p>	 <p>Site : 03CH07-HY Condition : PEAK(LINII) 3m HF_ANT_00075962 VERTICAL Detector : Peak Project : 052917-01 Mode : 20</p>
<p>Avg.</p>	 <p>Site : 03CH07-HY Condition : AVG_BE(LINII)_B3 3m HF_ANT_00075962 VERTICAL Detector : Peak Project : 052917-01 Mode : 20</p>	<p>Left blank</p>



WIFI	Band 3 5470~5725MHz Band Edge @ 3m	
ANT	802.11a CH116 5580MHz - R	
1	Vertical	Fundamental
Peak	<p>Site : E8CH07-HY Condition : PEAK_BE(UNII)_B3 3m HF ANT_00075962 VERTICAL Detector : Peak Project : FR052917-01 Mode : Z0</p>	Left blank



WIFI	Band 3 5470~5725MHz Band Edge @ 3m	
ANT	802.11a CH140 5700MHz	
1	Horizontal	Fundamental
Peak	<p>Site : E3CH07-RV Condition : PEAK_BE(UNII)_B3 3m HF ANT_00075962 HORIZONTAL Detector : Peak Project : FR052917-01 Mode : Z1</p>	<p>Site : E3CH07-RV Condition : PEAK(UNII) 3m HF ANT_00075962 HORIZONTAL Detector : Peak Project : FR052917-01 Mode : Z1</p>



WIFI	Band 3 5470~5725MHz Band Edge @ 3m	
ANT	802.11a CH140 5700MHz	
1	Vertical	Fundamental
Peak	<p>Site : ESCH07-RV Condition : PEAK_BE(UNI).B3 3m HF ANT_00075962 VERTICAL Detector : Peak Project : 052917-01 Mode : Z1</p>	<p>Site : ESCH07-RV Condition : PEAK(UNI) 3m HF ANT_00075962 VERTICAL Detector : Peak Project : 052917-01 Mode : Z1</p>



Band 3 5470~5725MHz
WIFI 802.11ac VHT20 (Band Edge @ 3m)

WIFI	Band 3 5470~5725MHz Band Edge @ 3m	
ANT	802.11ac VHT20 CH100 5500MHz	
1	Horizontal	Fundamental
Peak	<p>Site : 03CH07-HY Condition : PEAK_BE(LUNII)_B3 3m HF_ANT_00075962 HORIZONTAL Detector : Peak Project : 052917-01 Mode : Z3</p>	<p>Site : 03CH07-HY Condition : PEAK(LUNII) 3m HF_ANT_00075962 HORIZONTAL Detector : Peak Project : 052917-01 Mode : Z3</p>
Avg.	<p>Site : 03CH07-HY Condition : AVG_BE(LUNII)_B3 3m HF_ANT_00075962 HORIZONTAL Detector : Peak Project : 052917-01 Mode : Z3</p>	Left blank

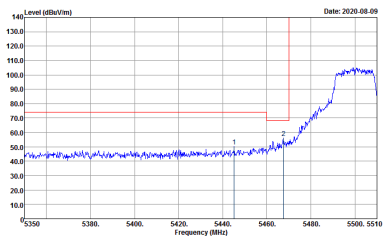
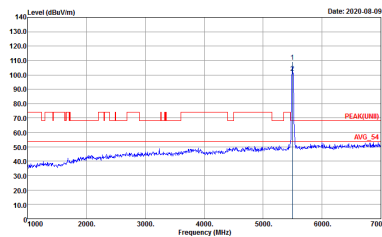
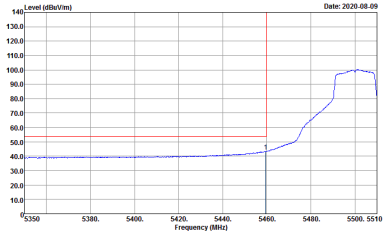

WIFI	Band 3 5470~5725MHz Band Edge @ 3m	
ANT	802.11ac VHT20 CH100 5500MHz	
1	Vertical	Fundamental
Peak	 <p>Date: 2020-08-09</p> <p>Site : 03CH07-HY Condition : PEAK_BE(LNII)_B3 3m HF_ANT_00075962 VERTICAL RBW:1000.000kHz VBW:3000.000kHz SWT:Auto Detector : Peak Project : 052917-01 Mode : 23</p>	 <p>Date: 2020-08-09</p> <p>Site : 03CH07-HY Condition : PEAK(LNII) 3m HF_ANT_00075962 VERTICAL RBW:1000.000kHz VBW:3000.000kHz SWT:Auto Detector : Peak Project : 052917-01 Mode : 23</p>
Avg.	 <p>Date: 2020-08-09</p> <p>Site : 03CH07-HY Condition : AVG_BE(LNII)_B3 3m HF_ANT_00075962 VERTICAL RBW:1000.000kHz VBW:1.000kHz SWT:Auto Detector : Peak Project : 052917-01 Mode : 23</p>	Left blank

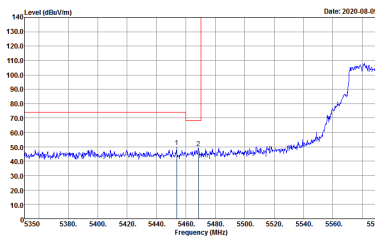
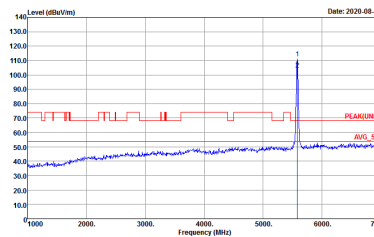
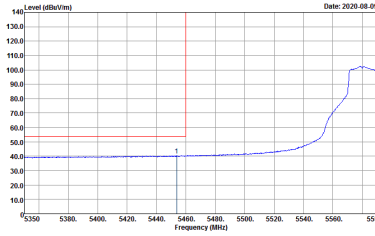

WIFI	Band 3 5470~5725MHz Band Edge @ 3m	
ANT	802.11ac VHT20 CH116 5580MHz - L	
1	Horizontal	Fundamental
<p>Peak</p>	 <p>Date: 2020-08-09</p> <p>Site : 03CH07-HY Condition : PEAK_BE(LNII)_B3 3m HF_ANT_00075962 HORIZONTAL Detector : Peak Project : 052917-01 Mode : 24</p>	 <p>Date: 2020-08-09</p> <p>Site : 03CH07-HY Condition : PEAK(LNII) 3m HF_ANT_00075962 HORIZONTAL Detector : Peak Project : 052917-01 Mode : 24</p>
<p>Avg.</p>	 <p>Date: 2020-08-09</p> <p>Site : 03CH07-HY Condition : AVG_BE(LNII)_B3 3m HF_ANT_00075962 HORIZONTAL Detector : Peak Project : 052917-01 Mode : 24</p>	<p>Left blank</p>



WIFI	Band 3 5470~5725MHz Band Edge @ 3m	
ANT	802.11ac VHT20 CH116 5580MHz - R	
1	Horizontal	Fundamental
Peak	<p>Site : ESKCH07-HY Condition : PEAK_BE(LINII)_B3 3m HF ANT_00075962 HORIZONTAL Detector : Peak Project : FR052917-01 Mode : Z4</p>	Left blank

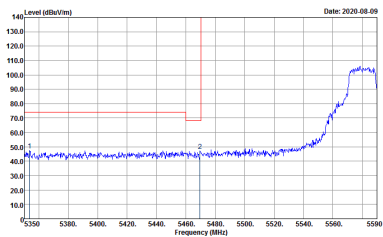
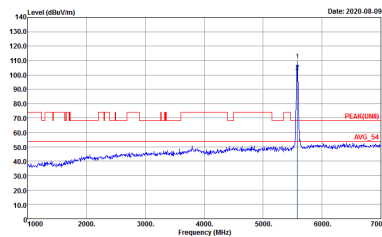
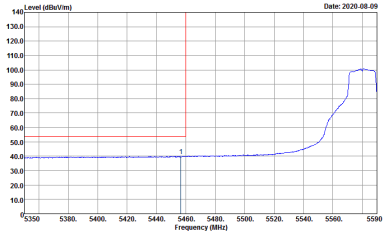

WIFI	Band 3 5470~5725MHz Band Edge @ 3m	
ANT	802.11ac VHT20 CH116 5580MHz - L	
1	Vertical	Fundamental
<p>Peak</p>	 <p>Site : 03CH07-HY Condition : PEAK_BE(LINII)_B3 3m HF_ANT_00075962 VERTICAL Detector : Peak Project : 052917-01 Mode : 24</p>	 <p>Site : 03CH07-HY Condition : PEAK(LINII) 3m HF_ANT_00075962 VERTICAL Detector : Peak Project : 052917-01 Mode : 24</p>
<p>Avg.</p>	 <p>Site : 03CH07-HY Condition : AVG_BE(LINII)_B3 3m HF_ANT_00075962 VERTICAL Detector : Peak Project : 052917-01 Mode : 24</p>	<p>Left blank</p>



WIFI	Band 3 5470~5725MHz Band Edge @ 3m	
ANT	802.11ac VHT20 CH116 5580MHz - R	
1	Vertical	Fundamental
Peak	<p>Site : ESKCH07-HY Condition : PEAK_BE(UNH)_B3 3m HF ANT_00075962 VERTICAL Detector : Peak Project : FR052917-01 Mode : Z4</p>	Left blank



WIFI	Band 3 5470~5725MHz Band Edge @ 3m	
ANT	802.11ac VHT20 CH140 5700MHz	
1	Horizontal	Fundamental
Peak	<p>Site : 03C4027-01 Condition : PEAK(LIN) 3m HF_ANT_00075962 HORIZONTAL Detector : Peak Project : 052917-01 Mode : 25</p>	<p>Site : 03C4027-01 Condition : PEAK_BE(LIN) B3 3m HF_ANT_00075962 HORIZONTAL Detector : Peak Project : 052917-01 Mode : 25</p>

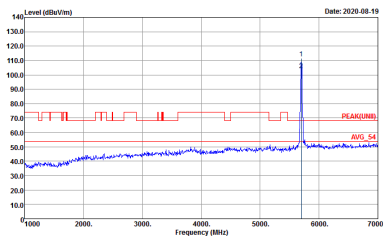
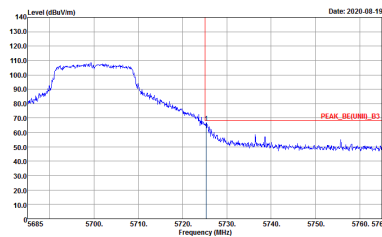

WIFI	Band 3 5470~5725MHz Band Edge @ 3m	
ANT	802.11ac VHT20 CH140 5700MHz	
1	Vertical	Fundamental
Peak	 <p>Site : 03C4027-01 Condition : PEAK(LIN) 3m HF_ANT_00075962 VERTICAL Detector : Peak Project : 052917-01 Mode : 25</p>	 <p>Site : 03C4027-01 Condition : PEAK_BE(LIN) B3 3m HF_ANT_00075962 VERTICAL Detector : Peak Project : 052917-01 Mode : 25</p>

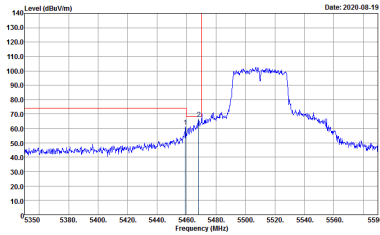
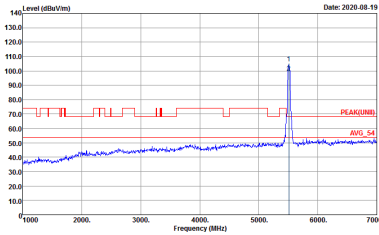
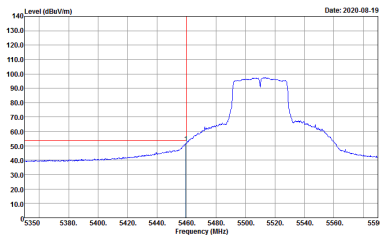

**Band 3 5470~5725MHz
WIFI 802.11ac VHT40 (Band Edge @ 3m)**

WIFI	Band 3 5470~5725MHz Band Edge @ 3m	
ANT	802.11ac VHT40 CH102 5510MHz - L	
1	Horizontal	Fundamental
Peak	 <p>Date: 2020-08-19</p> <p>Site : 03CH07-HY Condition : PEAK_BE(LNWI)_B3 3m HF_ANT_00075962 HORIZONTAL RBW:1000.000KHz VBW:3000.000KHz SWTA:Auto Detector : Peak Project : 052917-01 Mode : 27</p>	 <p>Date: 2020-08-19</p> <p>Site : 03CH07-HY Condition : PEAK(LNWI) 3m HF_ANT_00075962 HORIZONTAL RBW:1000.000KHz VBW:3000.000KHz SWTA:Auto Detector : Peak Project : 052917-01 Mode : 27</p>
Avg.	 <p>Date: 2020-08-19</p> <p>Site : 03CH07-HY Condition : AVG_BE(LNWI)_B3 3m HF_ANT_00075962 HORIZONTAL RBW:1000.000KHz VBW:3.000KHz SWTA:Auto Detector : Peak Project : 052917-01 Mode : 27</p>	Left blank



WIFI	Band 3 5470~5725MHz Band Edge @ 3m	
ANT	802.11ac VHT40 CH102 5510MHz - R	
1	Horizontal	Fundamental
Peak	<p>Site : :03C407-01 Condition : :PEAK_BE(LNII)_B3 3m HF_ANT_00075962 HORIZONTAL Detector : :Peak Project : :052917-01 Mode : :27</p>	Left blank