



FCC RADIO TEST REPORT

FCC ID : UZ7MC27BK
Equipment : Mobile computer
Brand Name : Zebra
Model Name : MC27BK
Applicant : Zebra Technologies Corporation
1 Zebra Plaza, Holtsville, NY 11742
Manufacturer : Zebra Technologies Corporation
1 Zebra Plaza, Holtsville, NY 11742
Standard : FCC Part 15 Subpart E §15.407

The product was received on Jul. 20, 2020 and testing was started from Aug. 04, 2020 and completed on Sep. 22, 2020. We, SPORTON INTERNATIONAL INC., EMC & Wireless Communications Laboratory, would like to declare that the tested sample has been evaluated in accordance with the test procedures and has been in compliance with the applicable technical standards.

The test results in this variant report apply exclusively to the tested model / sample. Without written approval of SPORTON INTERNATIONAL INC. EMC & Wireless Communications Laboratory, the test report shall not be reproduced except in full.

Louis Wu

Approved by: Louis Wu

SPORTON INTERNATIONAL INC. EMC & Wireless Communications Laboratory

No. 52, Huaya 1st Rd., Guishan Dist., Taoyuan City, Taiwan (R.O.C.)



Table of Contents

History of this test report.....	3
Summary of Test Result.....	4
1 General Description	5
1.1 Product Feature of Equipment Under Test.....	5
1.2 Product Specification of Equipment Under Test.....	5
1.3 Modification of EUT	5
1.4 Testing Location	6
1.5 Applicable Standards.....	6
2 Test Configuration of Equipment Under Test	7
2.1 Carrier Frequency and Channel	7
2.2 Test Mode.....	7
2.3 Connection Diagram of Test System.....	8
2.4 EUT Operation Test Setup	8
3 Test Result	9
3.1 Maximum Conducted Output Power Measurement	9
3.2 Unwanted Emissions Measurement.....	11
3.3 Antenna Requirements.....	15
4 List of Measuring Equipment.....	16
5 Uncertainty of Evaluation	17
Appendix A Radiated Spurious Emission	
Appendix B. Radiated Spurious Emission Plots	
Appendix C. Duty Cycle Plots	
Appendix D. Setup Photographs	
Appendix E. Original Report	



Summary of Test Result

Report Clause	Ref Std. Clause	Test Items	Result (PASS/FAIL)	Remark
-	15.403 (i)	6dB & 26dB Bandwidth	Not Required	-
-	2.1049	99% Occupied Bandwidth	Not Required	-
3.1	15.407 (a)	Maximum Conducted Output Power	Pass	-
-	15.407 (a)	Power Spectral Density	Not Required	-
3.2	15.407(b)	Unwanted Emissions	Pass	Under limit 7.52 dB at 51.870 MHz
-	15.207	AC Conducted Emission	Not Required	-
-	15.407 (c)	Automatically Discontinue Transmission	Not Required	-
3.3	15.203 & 15.407 (a)	Antenna Requirement	Pass	-

Note:

1. Not required means after assessing, test items are not necessary to carry out.
2. This is a variant report which can be referred Product Equality Declaration. All the test cases were performed on original report which can be referred to Sporton Report Number FR052917-01F as appendix E. Based on the original report, the test cases were verified.

Declaration of Conformity:
The test results with all measurement uncertainty excluded are presented in accordance with the regulation limits or requirements declared by manufacturers.
Comments and Explanations:
The declared of product specification for EUT presented in the report are provided by the manufacturer, and the manufacturer takes all the responsibilities for the accuracy of product specification.

Reviewed by: Wii Chang
Report Producer: Amy Chen

1 General Description

1.1 Product Feature of Equipment Under Test

Product Feature	
Equipment	Mobile computer
Brand Name	Zebra
Model Name	MC27BK
FCC ID	UZ7MC27BK
EUT supports Radios application	GSM/EGPRS/WCDMA/HSPA/LTE/NFC/GNSS WLAN 11a/b/g/n HT20/HT40 WLAN 11ac VHT20/VHT40/VHT80 Bluetooth BR/EDR/LE
HW Version	EV
SW Version	10-11-31.00-QG-U00-PRD-HEL-04
OS Version	Android 10
MFD	02JUN20
EUT Stage	Engineering sample

Remark: The above EUT's information was declared by manufacturer.

Specification of Accessories				
AC Adapter	Brand Name	Zebra	Part Number	PWR-WUA5V12W0US
Battery	Brand Name	Zebra	Part Number	BT-000418-10
USB Cable (TypeA plug to TypeC plug)	Brand Name	Zebra	Part Number	CBL-TC2X-USBC-01
Trigger Handle	Brand Name	Zebra	Part Number	TRG-MC2X-SNP1-01
Holster	Brand Name	Zebra	Part Number	SG-MC2X-HLSTR-01
Holster	Brand Name	Zebra	Part Number	SG-MC3021212-01R

1.2 Product Specification of Equipment Under Test

Standards-related Product Specification	
Tx/Rx Frequency Range	5725 MHz ~ 5850 MHz
Maximum Output Power	802.11a : 17.70 dBm / 0.0589 W 802.11n HT20 : 17.60 dBm / 0.0575 W 802.11n HT40 : 17.80 dBm / 0.0603 W 802.11ac VHT20: 17.50 dBm / 0.0562 W 802.11ac VHT40: 17.70 dBm / 0.0589 W 802.11ac VHT80: 17.60 dBm / 0.0575 W
Type of Modulation	802.11a/n : OFDM (BPSK / QPSK / 16QAM / 64QAM) 802.11ac : OFDM (BPSK / QPSK / 16QAM / 64QAM / 256QAM)
Antenna Gain / Gain	PIFA Antenna with gain 3.11 dBi

1.3 Modification of EUT

No modifications are made to the EUT during all test items.



1.4 Testing Location

Test Site	SPORTON INTERNATIONAL INC. EMC & Wireless Communications Laboratory	
Test Site Location	No.52, Huaya 1st Rd., Guishan Dist., Taoyuan City, Taiwan (R.O.C.) TEL: +886-3-327-3456 FAX: +886-3-328-4978	
Test Site No.	Sporton Site No.	
	TH05-HY	03CH07-HY

Note: The test site complies with ANSI C63.4 2014 requirement.

FCC designation No.: TW1190

1.5 Applicable Standards

According to the specifications of the manufacturer, the EUT must comply with the requirements of the following standards:

- ♦ FCC Part 15 Subpart E
- ♦ FCC KDB 789033 D02 General UNII Test Procedures New Rules v02r01.
- ♦ FCC KDB 414788 D01 Radiated Test Site v01r01.
- ♦ ANSI C63.10-2013

Remark:

1. All test items were verified and recorded according to the standards and without any deviation during the test.
2. The TAF code is not including all the FCC KDB listed without accreditation.
3. This EUT has also been tested and complied with the requirements of FCC Part 15, Subpart B, recorded in a separate test report.



2 Test Configuration of Equipment Under Test

The EUT has been associated with peripherals and configuration operated in a manner tended to maximize its emission characteristics in a typical application. Frequency range investigated: radiation emission (9 kHz to the 10th harmonic of the highest fundamental frequency or to 40 GHz, whichever is lower). For radiated measurement, pre-scanned in three orthogonal panels, X, Y, Z. The worst cases (X plane) were recorded in this report.

2.1 Carrier Frequency and Channel

Frequency Band	Channel	Freq. (MHz)	Channel	Freq. (MHz)
5725-5850 MHz Band 4 (U-NII-3)	149	5745	157	5785
	151*	5755	159*	5795
	153	5765	161	5805
	155 [#]	5775	165	5825

Note:

1. The above Frequency and Channel in "*" were 802.11n HT40 and 802.11ac VHT40.
2. The above Frequency and Channel in "[#]" were 802.11ac VHT80.

2.2 Test Mode

Final test modes are considering the modulation and worse data rates as below table.

Modulation		Data Rate
802.11a		6 Mbps
802.11n HT20 (Covered by VHT20)		MCS0
802.11n HT40 (Covered by VHT40)		MCS0
802.11ac VHT20		MCS0
802.11ac VHT40		MCS0
802.11ac VHT80		MCS0

Ch. #		Band IV : 5725-5850 MHz		
		802.11ac VHT20	802.11ac VHT40	802.11ac VHT80
L	Low	-	151	-
M	Middle	-	-	155
H	High	165	-	-

Remark: For radiation spurious emission, the final modulation and the worst data rate was reference the max RF conducted power.

2.3 Connection Diagram of Test System

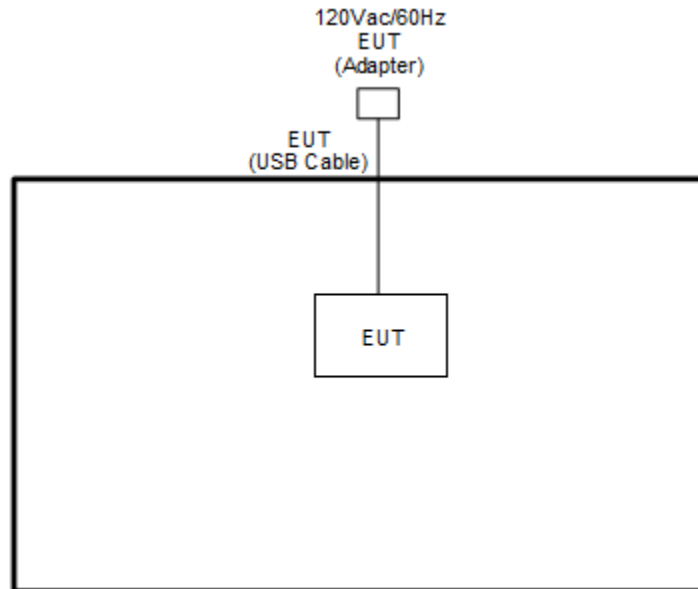

2.4 EUT Operation Test Setup

The RF test items, utility "QRCT Version 4.0.00156.0" was installed in Notebook which was programmed in order to make the EUT get into the engineering modes to provide channel selection, power level, data rate and the application type and for continuous transmitting signals.

3 Test Result

3.1 Maximum Conducted Output Power Measurement

3.1.1 Limit of Maximum Conducted Output Power

For the band 5.725–5.85 GHz, the maximum conducted output power over the frequency band of operation shall not exceed 1 W.

If transmitting antennas of directional gain greater than 6 dBi are used, the peak output power shall be reduced by the amount in dB that the directional gain of the antenna exceeds 6 dBi.

3.1.2 Measuring Instruments

See list of measuring equipment of this test report.

3.1.3 Test Procedures

The testing follows Method PM-G of FCC KDB 789033 D02 General UNII Test Procedures New Rules v02r01.

Method PM-G (Measurement using a gated RF average power meter):

1. Measurement is performed using a wideband RF power meter.
2. The EUT is configured to transmit at its maximum power control level.
3. Measure the average power of the transmitter
4. Since the measurement is made only during the ON time of the transmitter, no duty cycle correction factor is required.

3.1.4 Test Setup

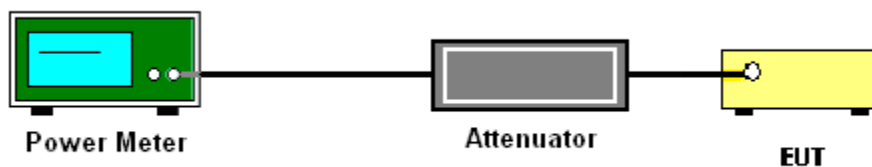



3.1.5 Test Result of Maximum Conducted Output Power

Test Engineer :	Ryan Lin, Howard Lin, and Tommy Lee	Temperature :	21.1~24.9°C
		Relative Humidity :	50.1~56.6%

Band IV single antenna												
Mod.	Data Rate	NTX	CH.	Freq. (MHz)	Average Conducted Power (dBm)			FCC Conducted Power Limit (dBm)		DG (dBi)		Pass/Fail
					Ant. 1	Ant. 2	SUM	Ant. 1	Ant. 2	Ant. 1	Ant. 2	
11a	6Mbps	1	149	5745	17.50	-	-	30.00	-	3.11	-	Pass
11a	6Mbps	1	157	5785	17.70	-	-	30.00	-	3.11	-	Pass
11a	6Mbps	1	165	5825	17.50	-	-	30.00	-	3.11	-	Pass
HT20	MCS0	1	149	5745	17.50	-	-	30.00	-	3.11	-	Pass
HT20	MCS0	1	157	5785	17.60	-	-	30.00	-	3.11	-	Pass
HT20	MCS0	1	165	5825	17.40	-	-	30.00	-	3.11	-	Pass
HT40	MCS0	1	151	5755	17.60	-	-	30.00	-	3.11	-	Pass
HT40	MCS0	1	159	5795	17.80	-	-	30.00	-	3.11	-	Pass
VHT20	MCS0	1	149	5745	17.40	-	-	30.00	-	3.11	-	Pass
VHT20	MCS0	1	157	5785	17.50	-	-	30.00	-	3.11	-	Pass
VHT20	MCS0	1	165	5825	17.30	-	-	30.00	-	3.11	-	Pass
VHT40	MCS0	1	151	5755	17.50	-	-	30.00	-	3.11	-	Pass
VHT40	MCS0	1	159	5795	17.70	-	-	30.00	-	3.11	-	Pass
VHT80	MCS0	1	155	5775	17.60	-	-	30.00	-	3.11	-	Pass



3.2 Unwanted Emissions Measurement

This section is to measure unwanted emissions through radiated measurement for band edge spurious emissions and out of band emissions measurement.

3.2.1 Limit of Unwanted Emissions

- (1) For transmitters operating in the 5.725-5.85 GHz band:
 15.407(b)(4)(i) All emissions shall be limited to a level of -27 dBm/MHz at 75 MHz or more above or below the band edge increasing linearly to 10 dBm/MHz at 25 MHz above or below the band edge, and from 25 MHz above or below the band edge increasing linearly to a level of 15.6 dBm/MHz at 5 MHz above or below the band edge, and from 5 MHz above or below the band edge increasing linearly to a level of 27 dBm/MHz at the band edge.
- (2) Unwanted spurious emissions fallen in restricted bands shall comply with the general field strength limits as below table,

Frequency (MHz)	Field Strength (microvolts/meter)	Measurement Distance (meters)
0.009 – 0.490	2400/F(kHz)	300
0.490 – 1.705	24000/F(kHz)	30
1.705 – 30.0	30	30
30 – 88	100	3
88 – 216	150	3
216 - 960	200	3
Above 960	500	3

Note: The following formula is used to convert the EIRP to field strength.

$$E = \frac{1000000\sqrt{30P}}{3} \mu\text{V/m, where P is the eirp (Watts)}$$

EIRP (dBm)	Field Strength at 3m (dBμV/m)
- 27	68.3

- (3) KDB789033 D02 v02r01 G)2)c)
 - (i) Sections 15.407(b)(1-3) specifies the unwanted emissions limit for the U-NII-1 and U-NII-2 bands. As specified, emissions above 1000 MHz that are outside of the restricted bands are subject to a peak emission limit of -27 dBm/MHz.
 - (ii) Section 15.407(b)(4) specifies the unwanted emissions limit for the U-NII-3 band. A band emissions mask is specified in Section 15.407(b)(4)(i). The emission limits are based on the use of a peak detector.

3.2.2 Measuring Instruments

See list of measuring equipment of this test report.



3.2.3 Test Procedures

1. The testing follows FCC KDB 789033 D02 General UNII Test Procedures New Rules v02r01. Section G) Unwanted emissions measurement.
 - (1) Procedure for Unwanted Emissions Measurements Below 1000MHz
 - RBW = 120 kHz
 - VBW = 300 kHz
 - Detector = Peak
 - Trace mode = max hold
 - (2) Procedure for Peak Unwanted Emissions Measurements Above 1000 MHz
 - RBW = 1 MHz
 - VBW \geq 3 MHz
 - Detector = Peak
 - Sweep time = auto
 - Trace mode = max hold
 - (3) Procedures for Average Unwanted Emissions Measurements Above 1000MHz
 - RBW = 1 MHz
 - VBW = 10 Hz, when duty cycle is no less than 98 percent.
 - VBW \geq 1/T, when duty cycle is less than 98 percent where T is the minimum transmission duration over which the transmitter is on and is transmitting at its maximum power control level for the tested mode of operation.
2. The EUT was placed on a turntable with 0.8 meter for frequency below 1GHz and 1.5 meter for frequency above 1GHz respectively above ground.
3. The EUT was set 3 meters from the interference receiving antenna which was mounted on the top of a variable height antenna tower.
4. The antenna is a broadband antenna and its height is adjusted between one meter and four meters above ground to find the maximum value of the field strength for both horizontal polarization and vertical polarization of the antenna.
5. For each suspected emission, the EUT was arranged to its worst case and then adjust the antenna tower (from 1 m to 4 m) and turntable (from 0 degree to 360 degrees) to find the maximum reading.
6. For testing below 1GHz, if the emission level of the EUT in peak mode was 3 dB lower than the limit specified, then peak values of EUT will be reported, otherwise, the emissions will be repeated one by one using the CISPR quasi-peak method and reported.
7. For testing above 1GHz, the emission level of the EUT in peak mode was 20dB lower than average limit (that means the emission level in average mode also complies with the limit in average mode), then peak values of EUT will be reported, otherwise, the emissions will be measured in average mode again and reported.

3.2.4 Test Setup

For radiated emissions below 30MHz

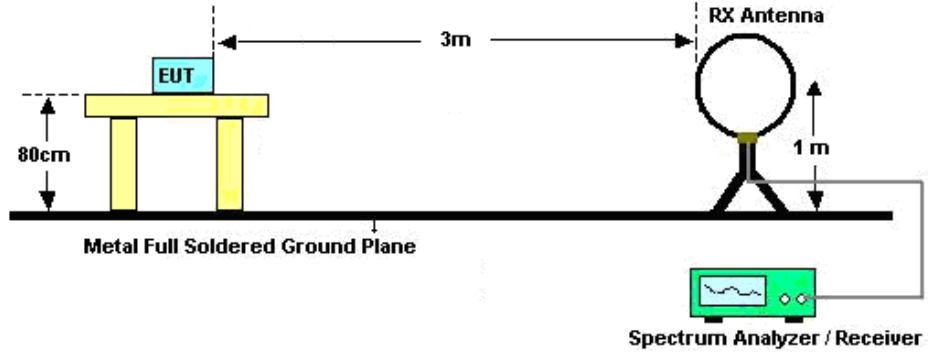

For radiated emissions from 30MHz to 1GHz

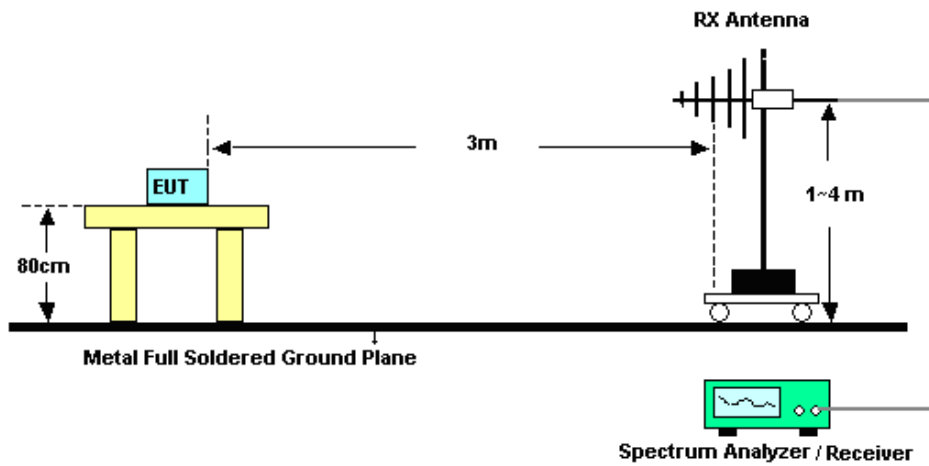

For radiated emissions above 1GHz

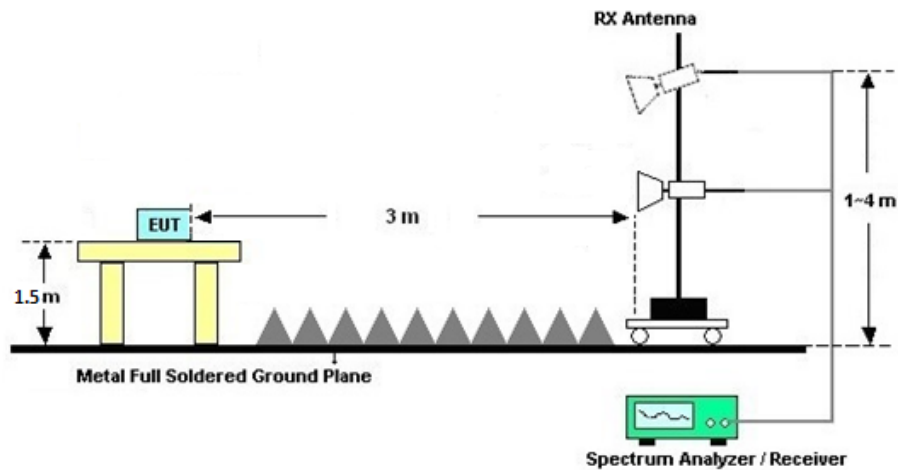



3.2.5 Test Results of Radiated Emissions (9 kHz ~ 30 MHz)

The low frequency, which started from 9 kHz to 30MHz, was pre-scanned and the result which was 20dB lower than the limit line was not reported.

There is a comparison data of both open-field test site and alternative test site - semi-Anechoic chamber according to 414788 D01 Radiated Test Site v01r01, and the result came out very similar.

3.2.6 Test Result of Radiated Band Edges

Please refer to Appendix A and B.

3.2.7 Duty Cycle

Please refer to Appendix C.

3.2.8 Test Result of Unwanted Radiated Emission (30MHz ~ 10th Harmonic)

Please refer to Appendix A and B..



3.3 Antenna Requirements

3.3.1 Standard Applicable

If transmitting antenna directional gain is greater than 6 dBi, both the peak transmit power and the peak power spectral density shall be reduced by the amount in dB that the directional gain of the antenna exceeds 6 dBi.

3.3.2 Antenna Anti-Replacement Construction

An embedded-in antenna design is used.

3.3.3 Antenna Gain

The antenna peak gain of EUT is less than 6 dBi. Therefore, it is not necessary to reduce maximum peak output power limit.



4 List of Measuring Equipment

Instrument	Brand Name	Model No.	Serial No.	Characteristics	Calibration Date	Test Date	Due Date	Remark
Hygrometer	Testo	608-H1	34893241	N/A	Mar. 02. 2020	Aug. 04. 2020~ Aug. 31. 2020	Mar. 01. 2021	Conducted (TH05-HY)
Power Sensor	DARE	RPR3006W	16I00054SNO 10	10MHz~6GHz	Dec. 23, 2019	Aug. 04. 2020~ Aug. 31. 2020	Dec. 22, 2020	Conducted (TH05-HY)
Signal Analyzer	Rohde & Schwarz	FSV40	101397	10Hz~40GHz	Nov. 15, 2019	Aug. 04. 2020~ Aug. 31. 2020	Nov. 14, 2020	Conducted (TH05-HY)
Switch Box & RF Cable	EM Electronics	EMSW18SE	SW200302	N/A	Mar. 17, 2020	Aug. 04. 2020~ Aug. 31. 2020	Mar. 16, 2021	Conducted (TH05-HY)
Loop Antenna	Rohde & Schwarz	HFH2-Z2	100315	9 kHz~30 MHz	Dec. 26, 2019	Sep. 22, 2020	Dec. 25, 2020	Radiation (03CH07-HY)
Bilog Antenna	TESEQ	CBL 6111D & 00800N1D01N -06	35419 & 03	30MHz~1GHz	Apr. 29, 2020	Sep. 22, 2020	Apr. 28, 2021	Radiation (03CH07-HY)
Double Ridge Horn Antenna	ESCO	3117	00075962	1GHz ~ 18GHz	Dec. 06, 2019	Sep. 22, 2020	Dec. 05, 2020	Radiation (03CH07-HY)
SHF-EHF Horn Antenna	SCHWARZBECK	BBHA 9170	BBHA917058 4	18GHz~40GHz	Dec. 10, 2019	Sep. 22, 2020	Dec. 09, 2020	Radiation (03CH07-HY)
EMI Test Receiver	Agilent	N9038A(MXE)	MY53290053	20Hz~26.5GHz	May 21, 2020	Sep. 22, 2020	May 20, 2021	Radiation (03CH07-HY)
Spectrum Analyzer	Agilent	N9030A	MY52350276	3Hz~44GHz	Jun. 09, 2020	Sep. 22, 2020	Jun. 08, 2021	Radiation (03CH07-HY)
Preamplifier	COM-POWER	PA-103A	161241	10MHz~1GHz	May 19, 2020	Sep. 22, 2020	May 18, 2021	Radiation (03CH07-HY)
Preamplifier	MITEQ	AMF-7D-0010 1800-30-10P	1590075	1GHz~18GHz	Apr. 23, 2020	Sep. 22, 2020	Apr. 22, 2021	Radiation (03CH07-HY)
Preamplifier	Agilent	8449B	3008A02362	1GHz~26.5GHz	Nov. 01, 2019	Sep. 22, 2020	Oct. 31, 2020	Radiation (03CH07-HY)
Preamplifier	EMEC	EM18G40G	060715	18GHz~40GHz	Dec. 13, 2019	Sep. 22, 2020	Dec. 12, 2020	Radiation (03CH07-HY)
RF Cable	HUBER + SUHNER	SUCOFLEX 102	MY2858/2,80 1606/2	18GHz~40GHz	Feb. 25, 2020	Sep. 22, 2020	Feb. 24, 2021	Radiation (03CH07-HY)
RF Cable	HUBER + SUHNER	SUCOFLEX 104	MY24971/4, MY28655/4	9kHz~30MHz	Feb. 25, 2020	Sep. 22, 2020	Feb. 24, 2021	Radiation (03CH07-HY)
RF Cable	HUBER + SUHNER	SUCOFLEX 104	MY28655/4, MY24971/4, MY15682/4	30MHz~1GHz	Feb. 25, 2020	Sep. 22, 2020	Feb. 24, 2021	Radiation (03CH07-HY)
RF Cable	HUBER + SUHNER	SUCOFLEX 104	MY28655/4, MY24971/4, MY15682/4	1GHz~18GHz	Feb. 25, 2020	Sep. 22, 2020	Feb. 24, 2021	Radiation (03CH07-HY)
RF Cable	HUBER + SUHNER	SUCOFLEX 102	801606/2	9KHz ~ 40GHz	N/A	Sep. 22, 2020	N/A	Radiation (03CH07-HY)
Antenna Mast	Max-Full	MFA520BS	N/A	1m~4m	N/A	Sep. 22, 2020	N/A	Radiation (03CH07-HY)
Turn Table	ChainTek	Chaintek 3000	N/A	0~360 Degree	N/A	Sep. 22, 2020	N/A	Radiation (03CH07-HY)
USB Data Logger	TECPEL	TR-32	HE17XB2495	N/A	N/A	Sep. 22, 2020	N/A	Radiation (03CH07-HY)
Software	Audix	E3 6.2009-8-24	N/A	N/A	N/A	Sep. 22, 2020	N/A	Radiation (03CH07-HY)



5 Uncertainty of Evaluation

Uncertainty of Radiated Emission Measurement (30 MHz ~ 1000 MHz)

Measuring Uncertainty for a Level of Confidence of 95% ($U = 2Uc(y)$)	4.7
---	-----

Uncertainty of Radiated Emission Measurement (1000 MHz ~ 18000 MHz)

Measuring Uncertainty for a Level of Confidence of 95% ($U = 2Uc(y)$)	5.3
---	-----

Uncertainty of Radiated Emission Measurement (18000 MHz ~ 40000 MHz)

Measuring Uncertainty for a Level of Confidence of 95% ($U = 2Uc(y)$)	5.0
---	-----



Appendix A. Radiated Spurious Emission

Test Engineer :	Jesse Wang	Temperature :	22~23°C
		Relative Humidity :	56~58%

Band 4 - 5725~5850MHz

WIFI 802.11ac VHT20 (Band Edge @ 3m)

WIFI Ant.	Note	Frequency (MHz)	Level (dBμV/m)	Over Limit (dB)	Limit Line (dBμV/m)	Read Level (dBμV)	Antenna Factor (dB/m)	Path Loss (dB)	Preamp Factor (dB)	Ant Pos (cm)	Table Pos (deg)	Peak Avg. (P/A)	Pol. (H/V)	
802.11ac VHT20 CH 165 5825MHz	*	5825	109.47	-	-	97.42	35	12.38	35.33	116	41	P	H	
	*	5825	101.82	-	-	89.77	35	12.38	35.33	116	41	A	H	
		5853.4	54.32	-60.13	114.45	42.26	35	12.4	35.34	116	41	P	H	
		5857.4	53.26	-56.87	110.13	41.13	35.07	12.4	35.34	116	41	P	H	
		5879.4	52.29	-49.64	101.93	40.09	35.13	12.41	35.34	116	41	P	H	
		5936	50.85	-17.35	68.2	38.55	35.2	12.44	35.34	116	41	P	H	
														H
														H
	*	5825	108.77	-	-	96.72	35	12.38	35.33	111	19	P	V	
	*	5825	101.3	-	-	89.25	35	12.38	35.33	111	19	A	V	
		5851.4	53.47	-65.54	119.01	41.41	35	12.4	35.34	111	19	P	V	
		5870.6	53.75	-52.68	106.43	41.55	35.13	12.41	35.34	111	19	P	V	
		5895.4	52.05	-38.02	90.07	39.77	35.2	12.42	35.34	111	19	P	V	
		5926.8	50.09	-18.11	68.2	37.8	35.2	12.43	35.34	111	19	P	V	
													V	
													V	
Remark	1. No other spurious found. 2. All results are PASS against Peak and Average limit line.													



Band 4 5725~5850MHz
WIFI 802.11ac VHT20 (Harmonic @ 3m)

Table with 14 columns: WIFI Ant. 1, Note, Frequency (MHz), Level (dBµV/m), Over Limit (dB), Limit Line (dBµV/m), Read Level (dBµV), Antenna Factor (dB/m), Path Loss (dB), Preamp Factor (dB), Ant Pos (cm), Table Pos (deg), Peak Avg. (P/A), Pol. (H/V). Rows include test data for 802.11ac VHT20 CH 165 5825MHz and a Remark section.



Band 4 5725~5850MHz
WIFI 802.11ac VHT40 (Band Edge @ 3m)

WIFI Ant. 1	Note	Frequency (MHz)	Level (dBμV/m)	Over Limit (dB)	Limit Line (dBμV/m)	Read Level (dBμV)	Antenna Factor (dB/m)	Path Loss (dB)	Preamp Factor (dB)	Ant Pos (cm)	Table Pos (deg)	Peak Avg. (P/A)	Pol. (H/V)
		5644.2	48.91	-19.29	68.2	37.31	34.8	12.11	35.31	118	39	P	H
		5698.4	53.33	-50.69	104.02	41.45	35	12.2	35.32	118	39	P	H
		5719.6	62.34	-48.35	110.69	50.42	35	12.24	35.32	118	39	P	H
		5723.6	65.08	-53.93	119.01	53.16	35	12.24	35.32	118	39	P	H
	*	5755	107.08	-	-	95.11	35	12.3	35.33	118	39	P	H
	*	5755	99.33	-	-	87.36	35	12.3	35.33	118	39	A	H
		5854	50.05	-63.03	113.08	37.92	35.07	12.4	35.34	118	39	P	H
		5861.6	50.61	-58.34	108.95	38.48	35.07	12.4	35.34	118	39	P	H
		5881.2	50.5	-50.09	100.59	38.3	35.13	12.41	35.34	118	39	P	H
		5927.6	49.49	-18.71	68.2	37.2	35.2	12.43	35.34	118	39	P	H
802.11ac													H
VHT40													H
CH 151		5631.6	48.91	-19.29	68.2	37.23	34.9	12.09	35.31	105	20	P	V
5755MHz		5695	52.47	-49.04	101.51	40.59	35	12.2	35.32	105	20	P	V
		5716.8	61.55	-48.36	109.91	49.64	35	12.23	35.32	105	20	P	V
		5723.8	61.74	-57.72	119.46	49.82	35	12.24	35.32	105	20	P	V
	*	5755	106.66	-	-	94.69	35	12.3	35.33	105	20	P	V
	*	5755	99.05	-	-	87.08	35	12.3	35.33	105	20	A	V
		5853.6	51.45	-62.54	113.99	39.32	35.07	12.4	35.34	105	20	P	V
		5873.6	50.99	-54.6	105.59	38.79	35.13	12.41	35.34	105	20	P	V
		5895.6	50.52	-39.4	89.92	38.24	35.2	12.42	35.34	105	20	P	V
		5933.4	51.09	-17.11	68.2	38.79	35.2	12.44	35.34	105	20	P	V
													V
													V

Remark

- No other spurious found.
- All results are PASS against Peak and Average limit line.



Band 4 5725~5850MHz

WIFI 802.11ac VHT40 (Harmonic @ 3m)

WIFI Ant. 1	Note	Frequency (MHz)	Level (dBμV/m)	Over Limit (dB)	Limit Line (dBμV/m)	Read Level (dBμV)	Antenna Factor (dB/m)	Path Loss (dB)	Preamp Factor (dB)	Ant Pos (cm)	Table Pos (deg)	Peak Avg. (P/A)	Pol. (H/V)	
802.11ac VHT40 CH 151 5755MHz		11510	45.27	-28.73	74	46.04	38.2	18.51	57.48	100	0	P	H	
		17265	48.64	-19.56	68.2	40.53	41.47	22.96	56.32	100	0	P	H	
													H	
													H	
			11510	46.23	-27.77	74	47	38.2	18.51	57.48	100	0	P	V
			17265	48.56	-19.64	68.2	40.45	41.47	22.96	56.32	100	0	P	V
														V
														V
Remark	1. No other spurious found. 2. All results are PASS against Peak and Average limit line.													



Band 4 5725~5850MHz
WIFI 802.11ac VHT80 (Band Edge @ 3m)

WIFI Ant. 1	Note	Frequency (MHz)	Level (dBμV/m)	Over Limit (dB)	Limit Line (dBμV/m)	Read Level (dBμV)	Antenna Factor (dB/m)	Path Loss (dB)	Preamp Factor (dB)	Ant Pos (cm)	Table Pos (deg)	Peak Avg. (P/A)	Pol. (H/V)
		5640.8	51.12	-17.08	68.2	39.52	34.8	12.11	35.31	126	40	P	H
		5698.2	61.93	-41.94	103.87	50.05	35	12.2	35.32	126	40	P	H
		5710.2	66.27	-41.79	108.06	54.37	35	12.22	35.32	126	40	P	H
		5721	68.18	-44.9	113.08	56.26	35	12.24	35.32	126	40	P	H
	*	5775	103.62	-	-	91.62	35	12.33	35.33	126	40	P	H
	*	5775	96.42	-	-	84.42	35	12.33	35.33	126	40	A	H
		5854.4	59.01	-53.16	112.17	46.88	35.07	12.4	35.34	126	40	P	H
		5859.4	60.61	-48.96	109.57	48.48	35.07	12.4	35.34	126	40	P	H
		5876.2	55.61	-48.7	104.31	43.41	35.13	12.41	35.34	126	40	P	H
		5927.8	50.36	-17.84	68.2	38.07	35.2	12.43	35.34	126	40	P	H
													H
													H
802.11ac VHT80 CH 155 5775MHz		5647.6	49.53	-18.67	68.2	37.92	34.8	12.12	35.31	102	17	P	V
		5700	60.19	-45.01	105.2	48.31	35	12.2	35.32	102	17	P	V
		5710	62.53	-45.47	108	50.63	35	12.22	35.32	102	17	P	V
		5723.6	59.22	-59.79	119.01	47.3	35	12.24	35.32	102	17	P	V
	*	5775	103.12	-	-	91.12	35	12.33	35.33	102	17	P	V
	*	5775	95.89	-	-	83.89	35	12.33	35.33	102	17	A	V
		5850.8	60.74	-59.64	120.38	48.68	35	12.4	35.34	102	17	P	V
		5858.2	59.92	-49.98	109.9	47.79	35.07	12.4	35.34	102	17	P	V
		5877.4	54.82	-48.6	103.42	42.62	35.13	12.41	35.34	102	17	P	V
		5940.4	50.09	-18.11	68.2	37.79	35.2	12.44	35.34	102	17	P	V
													V
													V

Remark 1. No other spurious found.
2. All results are PASS against Peak and Average limit line.



Band 4 5725~5850MHz
WIFI 802.11ac VHT80 (Harmonic @ 3m)

WIFI Ant. 1	Note	Frequency (MHz)	Level (dBμV/m)	Over Limit (dB)	Limit Line (dBμV/m)	Read Level (dBμV)	Antenna Factor (dB/m)	Path Loss (dB)	Preamp Factor (dB)	Ant Pos (cm)	Table Pos (deg)	Peak Avg. (P/A)	Pol. (H/V)	
802.11ac VHT80 CH 155 5775MHz		11550	45.63	-28.37	74	46.17	38.3	18.54	57.38	100	0	P	H	
		17325	50.23	-17.97	68.2	42.14	41.43	23	56.34	100	0	P	H	
													H	
													H	
			11550	45.1	-28.9	74	45.64	38.3	18.54	57.38	100	0	P	V
			17325	49.08	-19.12	68.2	40.99	41.43	23	56.34	100	0	P	V
														V
Remark	1. No other spurious found. 2. All results are PASS against Peak and Average limit line.													



Emission below 1GHz
5GHz WIFI 802.11ac VHT80 (LF)

WIFI	Note	Frequency	Level	Over	Limit	Read	Antenna	Path	Preamp	Ant	Table	Peak	Pol.	
Ant.				Limit	Line	Level	Factor	Loss	Factor	Pos	Pos	Avg.		
1		(MHz)	(dBμV/m)	(dB)	(dBμV/m)	(dBμV)	(dB/m)	(dB)	(dB)	(cm)	(deg)	(P/A)	(H/V)	
5GHz 802.11ac VHT80 LF		61.86	26.31	-13.69	40	43	11.73	1.57	29.99	-	-	P	H	
		206.85	31.57	-11.93	43.5	43.75	15.07	2.68	29.93	100	0	P	H	
		239.79	33.6	-12.4	46	43.65	17.09	2.78	29.92	-	-	P	H	
		837.6	31.72	-14.28	46	27.33	28.38	5.29	29.28	-	-	P	H	
		888.7	33.55	-12.45	46	28.32	28.72	5.55	29.04	-	-	P	H	
		953.8	33.79	-12.21	46	26.28	30.42	5.77	28.68	-	-	P	H	
														H
														H
														H
														H
														H
														H
														H
														H
														H
			51.87	32.48	-7.52	40	47.56	13.47	1.44	29.99	100	0	P	V
			65.91	31.04	-8.96	40	47.38	12	1.64	29.98	-	-	P	V
			219.27	28.61	-17.39	46	40.6	15.22	2.71	29.92	-	-	P	V
		745.2	33.42	-12.58	46	30.27	27.77	4.95	29.57	-	-	P	V	
		930.7	33.41	-12.59	46	27.16	29.35	5.71	28.81	-	-	P	V	
		952.4	34.01	-11.99	46	26.56	30.37	5.77	28.69	-	-	P	V	
													V	
													V	
													V	
													V	
													V	
													V	
Remark	1. No other spurious found. 2. All results are PASS against limit line.													



Note symbol

*	Fundamental Frequency which can be ignored. However, the level of any unwanted emissions shall not exceed the level of the fundamental frequency.
!	Test result is over limit line.
P/A	Peak or Average
H/V	Horizontal or Vertical



A calculation example for radiated spurious emission is shown as below:

WIFI	Note	Frequency	Level	Over	Limit	Read	Antenna	Path	Preamp	Ant	Table	Peak	Pol.
Ant.				Limit	Line	Level	Factor	Loss	Factor	Pos	Pos	Avg.	
1		(MHz)	(dBμV/m)	(dB)	(dBμV/m)	(dBμV)	(dB/m)	(dB)	(dB)	(cm)	(deg)	(P/A)	(H/V)
802.11b		2390	55.45	-18.55	74	54.51	32.22	4.58	35.86	103	308	P	H
CH 01													
2412MHz		2390	43.54	-10.46	54	42.6	32.22	4.58	35.86	103	308	A	H

1. Path Loss(dB) = Cable loss(dB) + Filter loss(dB) + Attenuator loss(dB)
2. Level(dBμV/m) = Antenna Factor(dB/m) + Path Loss(dB) + Read Level(dBμV) - Preamp Factor(dB)
3. Over Limit(dB) = Level(dBμV/m) – Limit Line(dBμV/m)

For Peak Limit @ 2390MHz:

1. Level(dBμV/m)
= Antenna Factor(dB/m) + Path Loss(dB) + Read Level(dBμV) - Preamp Factor(dB)
= 32.22(dB/m) + 4.58(dB) + 54.51(dBμV) – 35.86 (dB)
= 55.45 (dBμV/m)
2. Over Limit(dB)
= Level(dBμV/m) – Limit Line(dBμV/m)
= 55.45(dBμV/m) – 74(dBμV/m)
= -18.55(dB)

For Average Limit @ 2390MHz:

1. Level(dBμV/m)
= Antenna Factor(dB/m) + Path Loss(dB) + Read Level(dBμV) - Preamp Factor(dB)
= 32.22(dB/m) + 4.58(dB) + 42.6(dBμV) – 35.86 (dB)
= 43.54 (dBμV/m)
2. Over Limit(dB) = Level(dBμV/m) – Limit Line(dBμV/m)
= 43.54(dBμV/m) – 54(dBμV/m)
= -10.46(dB)

Both peak and average measured complies with the limit line, so test result is “PASS”.



Appendix B. Radiated Spurious Emission Plots

Test Engineer :	Jesse Wang	Temperature :	22~23°C
		Relative Humidity :	56~58%

Band 4 - 5725~5850MHz

WIFI 802.11ac VHT20 (Band Edge @ 3m)

WIFI	Band 4 5725~5850MHz Band Edge @ 3m	
ANT	802.11ac VHT20 CH165 5825MHz	
1	Horizontal	Fundamental
Peak	<p>Site : 03CH07-HY Condition : PEAK_BE(B4)_16-24 3m HF_ANT_0007962 HORIZONTAL Detector : Peak Project : 052913-02 Mode : 39</p>	<p>Site : 03CH07-HY Condition : PEAK(LIN) 3m HF_ANT_0007962 HORIZONTAL Detector : Peak Project : 052913-02 Mode : 39</p>



WIFI	Band 4 5725~5850MHz Band Edge @ 3m	
ANT	802.11ac VHT20 CH165 5825MHz	
1	Vertical	Fundamental
Peak Avg.	<p>Site : 03CH07-HY Condition : PEAK_BE(B4)_16-24 3m HF_ANT_00075962 VERTICAL Detector : RBW1000.000kHz VBW3000.000kHz SWT:Auto Project : Peak Mode : 39</p>	<p>Site : 03CH07-HY Condition : PEAK(UIN) 3m HF_ANT_00075962 VERTICAL Detector : RBW1000.000kHz VBW3000.000kHz SWT:Auto Project : Peak Mode : 39</p>



Band 4 5725~5850MHz
WIFI 802.11ac VHT40 (Band Edge @ 3m)

WIFI	Band 4 5725~5850MHz Band Edge @ 3m	
ANT	802.11ac VHT40 CH151 5755MHz	
1	Horizontal	Fundamental
<p align="center">Peak</p>	<p>Site : 03CH07-HY Condition : PEAK_BE(B4)_16-24 3m HF_ANT_0007962 HORIZONTAL Detector : Peak Project : 052913-02 Mode : 40</p>	<p>Site : 03CH07-HY Condition : PEAK(B4)_16-24 3m HF_ANT_0007962 HORIZONTAL Detector : Peak Project : 052913-02 Mode : 40</p>
<p align="center">Peak</p>	<p>Site : 03CH07-HY Condition : PEAK_BE(B4)_16-24 3m HF_ANT_0007962 HORIZONTAL Detector : Peak Project : 052913-02 Mode : 40</p>	<p align="center">Left blank</p>



WIFI	Band 4 5725~5850MHz Band Edge @ 3m	
ANT	802.11ac VHT40 CH151 5755MHz	
1	Vertical	Fundamental
Peak	<p>Site : 03CH07-HY Condition : PEAK_BE(B4)_16-24 3m HF_ANT_00075962 VERTICAL Detector : RBW:1000.000kHz VBW:3000.000kHz SWT:Auto Project : Peak Mode : 40</p>	<p>Site : 03CH07-HY Condition : PEAK(FUN1) 3m HF_ANT_00075962 VERTICAL Detector : RBW:1000.000kHz VBW:3000.000kHz SWT:Auto Project : Peak Mode : 40</p>
Peak	<p>Site : 03CH07-HY Condition : PEAK_BE(B4)_16-24 3m HF_ANT_00075962 VERTICAL Detector : RBW:1000.000kHz VBW:3000.000kHz SWT:Auto Project : Peak Mode : 40</p>	Left blank



**Band 4 5725~5850MHz
WIFI 802.11ac VHT80 (Band Edge @ 3m)**

WIFI	Band 4 5725~5850MHz Band Edge @ 3m	
ANT	802.11ac VHT80 CH155 5775MHz	
1	Horizontal	Fundamental
<p>Peak</p>	<p>Date: 2020-09-22 PEAK_BE(B4)_16.24</p> <p>Site : 03CH07-HY Condition : PEAK_BE(B4)_16-24 3m HF_ANT_0007962 HORIZONTAL RBW:1000.000kHz VBW:3000.000kHz SWT:Auto Detector : Peak Project : 052913-02 Mode : 42</p>	<p>Date: 2020-09-22 PEAK(BB) AVG_54</p> <p>Site : 03CH07-HY Condition : PEAK(BB) 3m HF_ANT_0007962 HORIZONTAL RBW:1000.000kHz VBW:3000.000kHz SWT:Auto Detector : Peak Project : 052913-02 Mode : 42</p>
<p>Peak</p>	<p>Date: 2020-09-22 PEAK_BE(B4)_16.24</p> <p>Site : 03CH07-HY Condition : PEAK_BE(B4)_16-24 3m HF_ANT_0007962 HORIZONTAL RBW:1000.000kHz VBW:3000.000kHz SWT:Auto Detector : Peak Project : 052913-02 Mode : 42</p>	<p>Left blank</p>

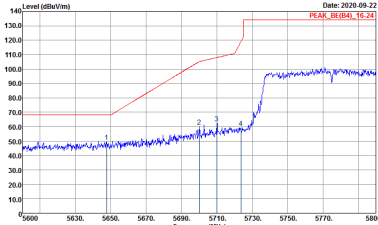
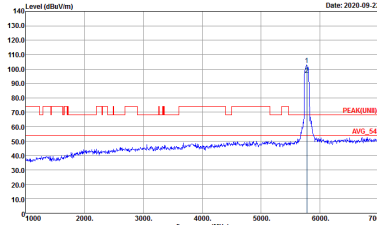
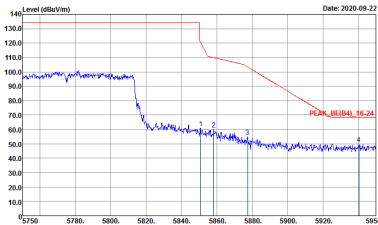

WIFI	Band 4 5725~5850MHz Band Edge @ 3m	
ANT	802.11ac VHT80 CH155 5775MHz	
1	Vertical	Fundamental
Peak	 <p>Site : 03CH07-HY Condition : PEAK_BE(04)_16-24 3m HF_ANT_00075962 VERTICAL Detector : RBW:1000.000kHz VBW:3000.000kHz SWT:Auto Project : 052913-02 Mode : 42</p>	 <p>Site : 03CH07-HY Condition : PEAK(UN1) 3m HF_ANT_00075962 VERTICAL Detector : RBW:1000.000kHz VBW:3000.000kHz SWT:Auto Project : 052913-02 Mode : 42</p>
Peak	 <p>Site : 03CH07-HY Condition : PEAK_BE(04)_16-24 3m HF_ANT_00075962 VERTICAL Detector : RBW:1000.000kHz VBW:3000.000kHz SWT:Auto Project : 052913-02 Mode : 42</p>	Left blank

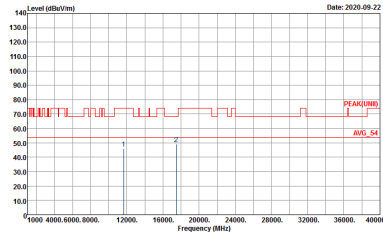
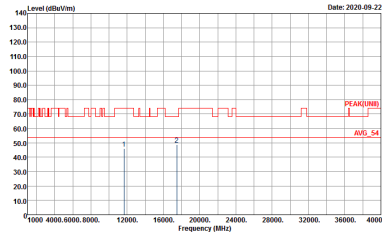

Band 4 - 5725~5850MHz
WIFI 802.11ac VHT20 (Harmonic @ 3m)

WIFI	Band 4 5725~5850MHz Harmonic @ 3m	
ANT	802.11ac VHT20 CH165 5825MHz	
1	Horizontal	Vertical
<p>Peak Avg.</p>	 <p>Site : 03C167-11Y Condition : PEAK(UNIT) 3m HF_ANT_00075962 HORIZONTAL Detector : Peak Project : 002913-02 Mode : 39</p>	 <p>Site : 03C167-11Y Condition : PEAK(UNIT) 3m HF_ANT_00075962 VERTICAL Detector : Peak Project : 002913-02 Mode : 39</p>



**Band 4 5725~5850MHz
WIFI 802.11ac VHT40 (Harmonic @ 3m)**

WIFI	Band 4 5725~5850MHz Harmonic @ 3m	
ANT	802.11ac VHT40 CH151 5755MHz	
1	Horizontal	Vertical
Peak Avg.	<p>Site : 03CH07-HY Condition : PEAK(UWII) 3m HF_ANT_00075562 HORIZONTAL Detector : Peak Project : 052913-02 Mode : 40</p>	<p>Site : 03CH07-HY Condition : PEAK(UWII) 3m HF_ANT_00075562 VERTICAL Detector : Peak Project : 052913-02 Mode : 40</p>

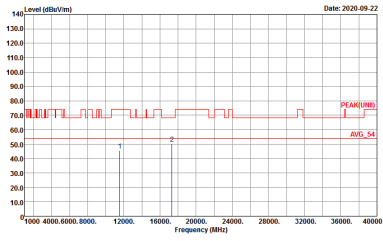
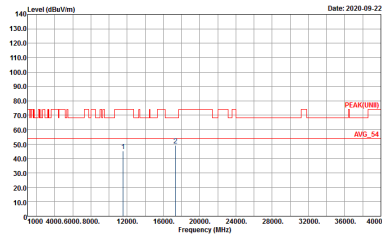

**Band 4 5725~5850MHz
WIFI 802.11ac VHT80 (Harmonic @ 3m)**

WIFI	Band 4 5725~5850MHz Harmonic @ 3m	
ANT	802.11ac VHT80 CH155 5775MHz	
1	Horizontal	Vertical
Peak Avg.	 <p>Site : 03CH07-HY Condition : PEAK(UWII) 3m HF_ANT_00075562 HORIZONTAL Detector : Peak Project : 052913-02 Mode : 142</p>	 <p>Site : 03CH07-HY Condition : PEAK(UWII) 3m HF_ANT_00075562 VERTICAL Detector : Peak Project : 052913-02 Mode : 142</p>



Emission below 1GHz
5GHz WIFI 802.11ac VHT80 (LF)

WIFI	5GHz WIFI	
ANT	802.11ac VHT80 LF	
1	Horizontal	Vertical
QP / Peak	<p>Site : 03C167-11Y Condition : QP 3m LF-ANT-35419(6) HORIZONTAL Detector : Peak Project : 022913-02 Mode : 42</p>	<p>Site : 03C167-11Y Condition : QP 3m LF-ANT-35419(6) VERTICAL Detector : Peak Project : 022913-02 Mode : 42</p>



Appendix C. Duty Cycle Plots

Band	Duty Cycle (%)	T(us)	1/T(kHz)	VBW Setting	Duty Factor (dB)
5GHz 802.11ac VHT20	97.97	1930.00	0.52	1kHz	0.09
5GHz 802.11ac VHT40	96.94	950.00	1.05	3kHz	0.13
5GHz 802.11ac VHT40	92.00	460.00	2.17	3kHz	0.36

