



# FCC RADIO TEST REPORT

**FCC ID** : UZ7MC27BK  
**Equipment** : Mobile computer  
**Brand Name** : Zebra  
**Model Name** : MC27BK  
**Applicant** : Zebra Technologies Corporation  
1 Zebra Plaza, Holtsville, NY 11742  
**Manufacturer** : Zebra Technologies Corporation  
1 Zebra Plaza, Holtsville, NY 11742  
**Standard** : FCC Part 15 Subpart E §15.407

The product was received on Jul. 20, 2020 and testing was started from Aug. 04, 2020 and completed on Sep. 28, 2020. We, SPORTON INTERNATIONAL INC., EMC & Wireless Communications Laboratory, would like to declare that the tested sample has been evaluated in accordance with the test procedures and has been in compliance with the applicable technical standards.

The test results in this variant report apply exclusively to the tested model / sample. Without written approval of SPORTON INTERNATIONAL INC. EMC & Wireless Communications Laboratory, the test report shall not be reproduced except in full.

*Louis Wu*

Approved by: Louis Wu

**SPORTON INTERNATIONAL INC. EMC & Wireless Communications Laboratory**

No. 52, Huaya 1st Rd., Guishan Dist., Taoyuan City, Taiwan (R.O.C.)



## Table of Contents

History of this test report.....	3
Summary of Test Result.....	4
<b>1 General Description .....</b>	<b>5</b>
1.1 Product Feature of Equipment Under Test.....	5
1.2 Product Specification of Equipment Under Test.....	6
1.3 Modification of EUT .....	6
1.4 Testing Location .....	7
1.5 Applicable Standards.....	7
<b>2 Test Configuration of Equipment Under Test .....</b>	<b>8</b>
2.1 Carrier Frequency and Channel .....	8
2.2 Test Mode.....	9
2.3 Connection Diagram of Test System.....	11
2.4 EUT Operation Test Setup .....	11
<b>3 Test Result .....</b>	<b>12</b>
3.1 Maximum Conducted Output Power Measurement .....	12
3.2 Unwanted Emissions Measurement.....	17
3.3 Automatically Discontinue Transmission .....	22
3.4 Antenna Requirements.....	23
<b>4 List of Measuring Equipment.....</b>	<b>24</b>
<b>5 Uncertainty of Evaluation .....</b>	<b>25</b>
<b>Appendix A Radiated Spurious Emission</b>	
<b>Appendix B. Radiated Spurious Emission Plots</b>	
<b>Appendix C. Duty Cycle Plots</b>	
<b>Appendix D. Setup Photographs</b>	
<b>Appendix E. Original Report</b>	



### History of this test report

Report No.	Version	Description	Issued Date
FR052913-02F	01	Initial issue of report	Oct. 28, 2020



### Summary of Test Result

Report Clause	Ref Std. Clause	Test Items	Result (PASS/FAIL)	Remark
-	15.403(i)	26dB Bandwidth	Not Required	-
-	2.1049	99% Occupied Bandwidth	Not Required	-
3.1	15.407(a)	Maximum Conducted Output Power	Pass	-
-	15.407(a)	Power Spectral Density	Not Required	-
3.2	15.407(b)	Unwanted Emissions	Pass	Under limit 2.01 dB at 5150.000 MHz
-	15.207	AC Conducted Emission	Not Required	-
3.3	15.407(c)	Automatically Discontinue Transmission	Not Required	-
3.4	15.203 15.407(a)	Antenna Requirement	Pass	-

**Note:**

1. Not required means after assessing, test items are not necessary to carry out.
2. This is a variant report which can be referred Product Equality Declaration. All the test cases were performed on original report which can be referred to Sporton Report Number FR052917-01E as appendix E. Based on the original report, the test cases were verified.

<b>Declaration of Conformity:</b>
The test results with all measurement uncertainty excluded are presented in accordance with the regulation limits or requirements declared by manufacturers.
<b>Comments and Explanations:</b>
The declared of product specification for EUT presented in the report are provided by the manufacturer, and the manufacturer takes all the responsibilities for the accuracy of product specification.

**Reviewed by: Wii Chang**  
**Report Producer: Vivian Hsu**



# 1 General Description

## 1.1 Product Feature of Equipment Under Test

Product Feature	
Equipment	Mobile computer
Brand Name	Zebra
Model Name	MC27BK
FCC ID	UZ7MC27BK
EUT supports Radios application	GSM/EGPRS/WCDMA/HSPA/LTE/NFC/GNSS WLAN 11a/b/g/n HT20/HT40 WLAN 11ac VHT20/VHT40/VHT80 Bluetooth BR/EDR/LE
HW Version	EV
SW Version	10-11-31.00-QG-U00-PRD-HEL-04
OS Version	Android 10
MFD	02JUN20
EUT Stage	Engineering sample

Remark: The above EUT's information was declared by manufacturer.

Specification of Accessories				
AC Adapter	Brand Name	Zebra	Part Number	PWR-WUA5V12W0US
Battery	Brand Name	Zebra	Part Number	BT-000418-10
USB Cable (TypeA plug to TypeC plug)	Brand Name	Zebra	Part Number	CBL-TC2X-USBC-01
Trigger Handle	Brand Name	Zebra	Part Number	TRG-MC2X-SNP1-01
Holster	Brand Name	Zebra	Part Number	SG-MC2X-HLSTR-01
Holster	Brand Name	Zebra	Part Number	SG-MC3021212-01R



### 1.2 Product Specification of Equipment Under Test

Product Specification subjective to this standard	
<b>Tx/Rx Frequency Range</b>	5180 MHz ~ 5240 MHz 5260 MHz ~ 5320 MHz 5500 MHz ~ 5720 MHz
<b>Maximum Output Power to Antenna</b>	<p><b>&lt;5180 MHz ~ 5240 MHz&gt;</b>  802.11a: 18.90 dBm / 0.0776 W  802.11n HT20: 18.70 dBm / 0.0741 W  802.11n HT40: 19.10 dBm / 0.0813 W  802.11ac VHT20: 18.60 dBm / 0.0724 W  802.11ac VHT40: 19.00 dBm / 0.0794 W  802.11ac VHT80: 17.70 dBm / 0.0589 W</p> <p><b>&lt;5260 MHz ~ 5320 MHz&gt;</b>  802.11a: 19.20 dBm / 0.0832 W  802.11n HT20: 19.10 dBm / 0.0813 W  802.11n HT40: 19.60 dBm / 0.0912 W  802.11ac VHT20: 19.00 dBm / 0.0794 W  802.11ac VHT40: 19.50 dBm / 0.0891 W  802.11ac VHT80: 15.70 dBm / 0.0372 W</p> <p><b>&lt;5500 MHz ~ 5720 MHz&gt;</b>  802.11a: 20.30 dBm / 0.1072 W  802.11n HT20: 19.90 dBm / 0.0977 W  802.11n HT40: 19.80 dBm / 0.0955 W  802.11ac VHT20: 19.80 dBm / 0.0955 W  802.11ac VHT40: 19.70 dBm / 0.0933 W  802.11ac VHT80: 20.00 dBm / 0.1000 W</p>
<b>Antenna Type / Gain</b>	<p><b>&lt;5180 MHz ~ 5240 MHz&gt;</b>  PIFA Antenna with gain 2.63 dBi</p> <p><b>&lt;5260 MHz ~ 5320 MHz&gt;</b>  PIFA Antenna with gain 2.63 dBi</p> <p><b>&lt;5500 MHz ~ 5720 MHz&gt;</b>  PIFA Antenna with gain 3.65 dBi</p>
<b>Type of Modulation</b>	802.11a/n : OFDM (BPSK/QPSK/16QAM/64QAM) 802.11ac : OFDM (BPSK/QPSK/16QAM/64QAM/256QAM)

### 1.3 Modification of EUT

No modifications are made to the EUT during all test items.



### 1.4 Testing Location

<b>Test Site</b>	SPORTON INTERNATIONAL INC. EMC & Wireless Communications Laboratory	
<b>Test Site Location</b>	No.52, Huaya 1st Rd., Guishan Dist., Taoyuan City, Taiwan (R.O.C.) TEL: +886-3-327-3456 FAX: +886-3-328-4978	
<b>Test Site No.</b>	<b>Sporton Site No.</b>	
	TH05-HY	03CH07-HY

**Note:** The test site complies with ANSI C63.4 2014 requirement.

FCC designation No.: TW1190

### 1.5 Applicable Standards

According to the specifications of the manufacturer, the EUT must comply with the requirements of the following standards:

- ♦ FCC Part 15 Subpart E
- ♦ FCC KDB 789033 D02 General UNII Test Procedures New Rules v02r01.
- ♦ FCC KDB 414788 D01 Radiated Test Site v01r01.
- ♦ ANSI C63.10-2013

**Remark:**

1. All test items were verified and recorded according to the standards and without any deviation during the test.
2. The TAF code is not including all the FCC KDB listed without accreditation.
3. This EUT has also been tested and complied with the requirements of FCC Part 15, Subpart B, recorded in a separate test report.



## 2 Test Configuration of Equipment Under Test

- a. The EUT has been associated with peripherals and configuration operated in a manner tended to maximize its emission characteristics in a typical application. Frequency range investigated: radiation emission (9 kHz to the 10th harmonic of the highest fundamental frequency or to 40 GHz, whichever is lower). For radiated measurement, pre-scanned in three orthogonal panels, X, Y, Z. The worst cases (X plane) were recorded in this report.

### 2.1 Carrier Frequency and Channel

Frequency Band	Channel	Freq. (MHz)	Channel	Freq. (MHz)
5150-5250 MHz Band 1 (U-NII-1)	36	5180	44	5220
	38*	5190	46*	5230
	40	5200	48	5240
	42#	5210		

Frequency Band	Channel	Freq. (MHz)	Channel	Freq. (MHz)
5250-5350 MHz Band 2 (U-NII-2A)	52	5260	60	5300
	54*	5270	62*	5310
	56	5280	64	5320
	58#	5290		

Frequency Band	Channel	Freq. (MHz)	Channel	Freq. (MHz)
5470-5725 MHz Band 3 (U-NII-2C)	100	5500	112	5560
	102*	5510	116	5580
	104	5520	132	5660
	106#	5530	134*	5670
	108	5540	136	5680
	110*	5550	140	5700





Frequency Band	Channel	Freq. (MHz)	Channel	Freq. (MHz)
TDWR Channel	118*	5590	124	5620
	120	5600	126*	5630
	122 <sup>#</sup>	5610	128	5640

Frequency Band	Channel	Freq. (MHz)	Channel	Freq. (MHz)
Straddle Channel	138 <sup>#</sup>	5690	144	5720
	142*	5710		

**Note:**

- 1. The above Frequency and Channel in "\*" were 802.11n HT40 and 802.11ac VHT40.
- 2. The above Frequency and Channel in "<sup>#</sup>" were 802.11ac VHT80.

## 2.2 Test Mode

Final test modes are considering the modulation and worse data rates as below table.

Modulation	Data Rate
802.11a	6 Mbps
802.11n HT20	MCS0
802.11n HT40	MCS0
802.11ac VHT20	MCS0
802.11ac VHT40	MCS0
802.11ac VHT80	MCS0



Ch. #		Band I : 5150-5250 MHz	Band II : 5250-5350 MHz	Band III : 5470-5725MHz
		802.11a	802.11a	802.11a
L	Low	36	52	100
M	Middle	44	60	116
H	High	48	64	140
Straddle		-	-	144

Ch. #		Band I : 5150-5250 MHz	Band II : 5250-5350 MHz	Band III : 5470-5725MHz
		802.11ac VHT20	802.11ac VHT20	802.11ac VHT20
L	Low	36	52	100
M	Middle	44	60	116
H	High	48	64	140
Straddle		-	-	144

Ch. #		Band I : 5150-5250 MHz	Band II : 5250-5350 MHz	Band III : 5470-5725MHz
		802.11ac VHT40	802.11ac VHT40	802.11ac VHT40
L	Low	38	54	102
M	Middle	-	-	110
H	High	46	62	134
Straddle		-	-	142

Ch. #		Band I : 5150-5250 MHz	Band II : 5250-5350 MHz	Band III : 5470-5725MHz
		802.11ac VHT80	802.11ac VHT80	802.11ac VHT80
L	Low	-	-	106
M	Middle	42	58	122
H	High	-	-	-
Straddle		-	-	138

**Remark:** For radiation spurious emission, the final modulation and the worst data rate was reference the max RF conducted power.

## 2.3 Connection Diagram of Test System

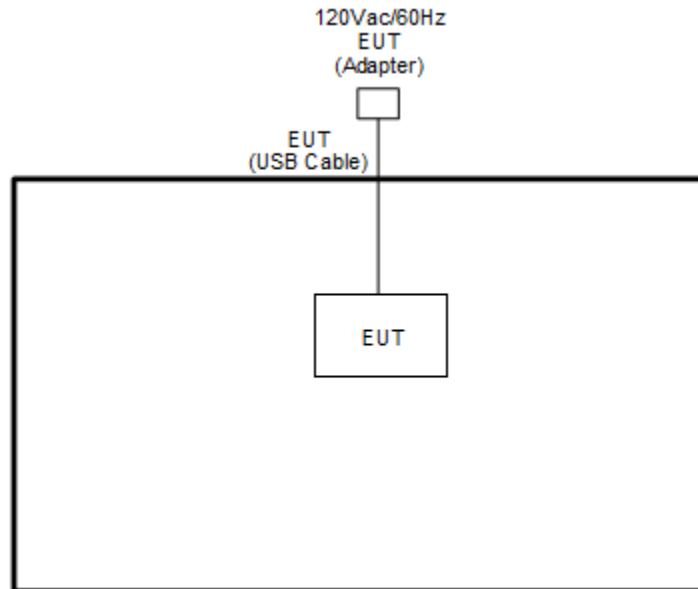

## 2.4 EUT Operation Test Setup

The RF test items, utility “QRCT Version 4.0.00156.0” was installed in Notebook which was programmed in order to make the EUT get into the engineering modes to provide channel selection, power level, data rate and the application type and for continuous transmitting signals.



### 3 Test Result

#### 3.1 Maximum Conducted Output Power Measurement

##### 3.1.1 Limit of Maximum Conducted Output Power

<FCC 14-30 CFR 15.407>

**For the 5.15–5.25 GHz bands:**

- For mobile and portable client devices in the 5.15–5.25 GHz band, the maximum conducted output power over the frequency band of operation shall not exceed 250 mW. For an indoor access point operating in the band 5.15-5.25 GHz, the maximum conducted output power over the frequency band of operation shall not exceed 1 W.

**For the 5.25–5.725 GHz bands:**

- The maximum conducted output power over the frequency bands of operation shall not exceed the lesser of 250 mW or  $11 \text{ dBm} + 10 \log B$ , where B is the 26 dB emission bandwidth in megahertz.

For Straddle Channel, according to KDB 789033 D02 General UNII Test Procedures New Rules v02r01, if the power and PSD of the devices are uniform and comply with the lower limits specified for the U-NII-2 bands, a single measurement over the entire emission bandwidth can be performed to show compliance.

If transmitting antennas of directional gain greater than 6 dBi are used, the peak output power shall be reduced by the amount in dB that the directional gain of the antenna exceeds 6 dBi.

Note that U-NII-2 band, devices with a maximum e.i.r.p. greater than 500 mW shall implement TPC in order to have the capability to operate at least 6 dB below the maximum permitted e.i.r.p. of 1 W.

##### 3.1.2 Measuring Instruments

See list of measuring equipment of this test report.

### 3.1.3 Test Procedures

The testing follows Method PM-G of FCC KDB 789033 D02 General UNII Test Procedures New Rules v02r01.

Method PM-G (Measurement using an RF average power meter):

1. Measurement is performed using a wideband RF power meter.
2. The EUT is configured to transmit at its maximum power control level.
3. Measure the average power of the transmitter
4. Since the measurement is made only during the ON time of the transmitter, no duty cycle correction factor is required.

For Straddle Channel, according to KDB 789033 D02 General UNII Test Procedures New Rules v02r01, if the power and PSD of the devices are uniform and comply with the lower limits specified for the U-NII-2 bands, a single measurement over the entire emission bandwidth can be performed to show compliance.

### 3.1.4 Test Setup

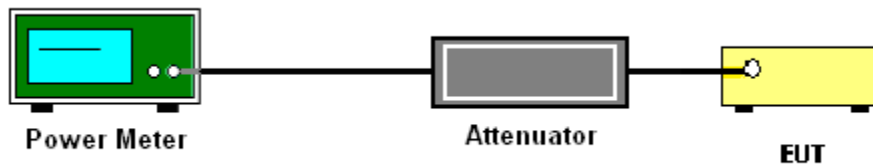



3.1.5 Test Result of Maximum Conducted Output Power

Test Engineer :	Ryan Lin, Howard Lin and Tommy Lee	Temperature :	21.1~24.9°C
		Relative Humidity :	50.1~56.6%

Band I												
Mod.	Data Rate	NTX	CH.	Freq. (MHz)	Average Conducted Power (dBm)			Conducted Power Limit (dBm)		DG (dBi)		Pass/Fail
					Ant 1	Ant 2	SUM	Ant 1	Ant 2	Ant 1	Ant 2	
11a	6Mbps	1	36	5180	18.70	-	-	24.00	-	2.63	-	Pass
11a	6Mbps	1	44	5220	18.30	-		24.00	-	2.63	-	Pass
11a	6Mbps	1	48	5240	18.90	-		24.00	-	2.63	-	Pass
HT20	MCS0	1	36	5180	18.70	-		24.00	-	2.63	-	Pass
HT20	MCS0	1	44	5220	18.60	-		24.00	-	2.63	-	Pass
HT20	MCS0	1	48	5240	18.50	-		24.00	-	2.63	-	Pass
HT40	MCS0	1	38	5190	17.90	-		24.00	-	2.63	-	Pass
HT40	MCS0	1	46	5230	19.10	-		24.00	-	2.63	-	Pass
VHT20	MCS0	1	36	5180	18.60	-		24.00	-	2.63	-	Pass
VHT20	MCS0	1	44	5220	18.50	-		24.00	-	2.63	-	Pass
VHT20	MCS0	1	48	5240	18.40	-		24.00	-	2.63	-	Pass
VHT40	MCS0	1	38	5190	17.80	-		24.00	-	2.63	-	Pass
VHT40	MCS0	1	46	5230	19.00	-		24.00	-	2.63	-	Pass
VHT80	MCS0	1	42	5210	17.70	-		24.00	-	2.63	-	Pass



Band II													
Mod.	Data Rate	NTX	CH.	Freq. (MHz)	Average Conducted Power (dBm)			Conducted Power Limit (dBm)		DG (dBi)		EIRP Power Limit (dBm)	Pass/Fail
					Ant 1	Ant 2	SUM	Ant 1	Ant 2	Ant 1	Ant 2		
11a	6Mbps	1	52	5260	19.20	-	-	23.98	-	2.63	-	26.99	Pass
11a	6Mbps	1	60	5300	19.10	-	-	23.98	-	2.63	-	26.99	Pass
11a	6Mbps	1	64	5320	19.00	-	-	23.98	-	2.63	-	26.99	Pass
HT20	MCS0	1	52	5260	18.80	-	-	23.98	-	2.63	-	26.99	Pass
HT20	MCS0	1	60	5300	18.80	-	-	23.98	-	2.63	-	26.99	Pass
HT20	MCS0	1	64	5320	19.10	-	-	23.98	-	2.63	-	26.99	Pass
HT40	MCS0	1	54	5270	19.60	-	-	23.98	-	2.63	-	26.99	Pass
HT40	MCS0	1	62	5310	17.40	-	-	23.98	-	2.63	-	26.99	Pass
VHT20	MCS0	1	52	5260	18.70	-	-	23.98	-	2.63	-	26.99	Pass
VHT20	MCS0	1	60	5300	18.70	-	-	23.98	-	2.63	-	26.99	Pass
VHT20	MCS0	1	64	5320	19.00	-	-	23.98	-	2.63	-	26.99	Pass
VHT40	MCS0	1	54	5270	19.50	-	-	23.98	-	2.63	-	26.99	Pass
VHT40	MCS0	1	62	5310	17.30	-	-	23.98	-	2.63	-	26.99	Pass
VHT80	MCS0	1	58	5290	15.70	-	-	23.98	-	2.63	-	26.99	Pass



Band III													
Mod.	Data Rate	NTX	CH.	Freq. (MHz)	Average Conducted Power (dBm)			Conducted Power Limit (dBm)		DG (dBi)		EIRP Power Limit (dBm)	Pass/Fail
					Ant 1	Ant 2	SUM	Ant 1	Ant 2	Ant 1	Ant 2		
11a	6Mbps	1	100	5500	19.70	-	-	23.98	-	3.65	-	26.99	Pass
11a	6Mbps	1	116	5580	19.60	-	-	23.98	-	3.65	-	26.99	Pass
11a	6Mbps	1	140	5700	19.40	-	-	23.98	-	3.65	-	26.99	Pass
HT20	MCS0	1	100	5500	19.50	-	-	23.98	-	3.65	-	26.99	Pass
HT20	MCS0	1	116	5580	19.90	-	-	23.98	-	3.65	-	26.99	Pass
HT20	MCS0	1	140	5700	19.60	-	-	23.98	-	3.65	-	26.99	Pass
HT40	MCS0	1	102	5510	19.00	-	-	23.98	-	3.65	-	26.99	Pass
HT40	MCS0	1	110	5550	19.80	-	-	23.98	-	3.65	-	26.99	Pass
HT40	MCS0	1	134	5670	19.70	-	-	23.98	-	3.65	-	26.99	Pass
VHT20	MCS0	1	100	5500	19.40	-	-	23.98	-	3.65	-	26.99	Pass
VHT20	MCS0	1	116	5580	19.80	-	-	23.98	-	3.65	-	26.99	Pass
VHT20	MCS0	1	140	5700	19.50	-	-	23.98	-	3.65	-	26.99	Pass
VHT40	MCS0	1	102	5510	18.90	-	-	23.98	-	3.65	-	26.99	Pass
VHT40	MCS0	1	110	5550	19.70	-	-	23.98	-	3.65	-	26.99	Pass
VHT40	MCS0	1	134	5670	19.60	-	-	23.98	-	3.65	-	26.99	Pass
VHT80	MCS0	1	106	5530	17.60	-	-	23.98	-	3.65	-	26.99	Pass
VHT80	MCS0	1	122	5610	19.70	-	-	23.98	-	3.65	-	26.99	Pass

Band III straddle channel													
Mod.	Data Rate	NTX	CH.	Freq. (MHz)	Average Conducted Power (dBm)			FCC Conducted Power Limit (dBm)		DG (dBi)		EIRP Power Limit (dBm)	Pass/Fail
					Ant 1	Ant 2	SUM	Ant 1	Ant 2	Ant 1	Ant 2		
11a	6Mbps	1	144	5720	20.30	-	-	23.98	-	3.65	-	26.99	Pass
HT20	MCS0	1	144	5720	19.50	-	-	23.98	-	3.65	-	26.99	Pass
HT40	MCS0	1	142	5710	19.60	-	-	23.98	-	3.65	-	26.99	Pass
VHT20	MCS0	1	144	5720	19.40	-	-	23.98	-	3.65	-	26.99	Pass
VHT40	MCS0	1	142	5710	19.50	-	-	23.98	-	3.65	-	26.99	Pass
VHT80	MCS0	1	138	5690	20.00	-	-	23.98	-	3.65	-	26.99	Pass





### 3.2 Unwanted Emissions Measurement

This section is to measure unwanted emissions through radiated measurement for band edge spurious emissions and out of band emissions measurement.

#### 3.2.1 Limit of Unwanted Emissions

- (1) For transmitters operating in the 5150-5250 MHz band: all emissions outside of the 5150-5350 MHz band shall not exceed an EIRP of -27dBm/MHz.

For transmitters operating in the 5250-5350 MHz band: all emissions outside of the 5150-5350 MHz band shall not exceed an EIRP of -27 dBm/MHz. Devices operating in the 5250-5350 MHz band that generate emissions in the 5150-5250 MHz band must meet all applicable technical requirements for operation in the 5150-5250 MHz band (including indoor use) or alternatively meet an out-of-band emission EIRP limit of -27 dBm/MHz in the 5150-5250 MHz band.

For transmitters operating in the 5470-5600 MHz and 5650-5725MHz band: all emissions outside of the 5470-5600 MHz and 5650-5725MHz band shall not exceed an EIRP of -27 dBm/MHz.

- (2) Unwanted spurious emissions fallen in restricted bands shall comply with the general field strength limits as below table:

Frequency (MHz)	Field Strength (microvolts/meter)	Measurement Distance (meters)
0.009 – 0.490	2400/F(kHz)	300
0.490 – 1.705	24000/F(kHz)	30
1.705 – 30.0	30	30
30 – 88	100	3
88 – 216	150	3
216 - 960	200	3
Above 960	500	3

**Note:** The following formula is used to convert the EIRP to field strength.

$$E = \frac{1000000\sqrt{30P}}{3} \text{ } \mu\text{V/m, where P is the eirp (Watts)}$$



EIRP (dBm)	Field Strength at 3m (dBμV/m)
- 27	68.3

(3) KDB789033 D02 v02r01 G)2)c)

- (i) Sections 15.407(b)(1-3) specifies the unwanted emissions limit for the U-NII-1 and U-NII-2 bands. As specified, emissions above 1000 MHz that are outside of the restricted bands are subject to a peak emission limit of -27 dBm/MHz.
- (ii) Section 15.407(b)(4) specifies the unwanted emissions limit for the U-NII-3 band. A band emissions mask is specified in Section 15.407(b)(4)(i). The emission limits are based on the use of a peak detector.

### 3.2.2 Measuring Instruments

See list of measuring equipment of this test report.

### 3.2.3 Test Procedures

1. The testing follows FCC KDB 789033 D02 General UNII Test Procedures New Rules v02r01. Section G) Unwanted emissions measurement.

(1) Procedure for Unwanted Emissions Measurements Below 1000MHz

- RBW = 120 kHz
- VBW = 300 kHz
- Detector = Peak
- Trace mode = max hold

(2) Procedure for Peak Unwanted Emissions Measurements Above 1000 MHz

- RBW = 1 MHz
- VBW ≥ 3 MHz
- Detector = Peak
- Sweep time = auto
- Trace mode = max hold



(3) Procedures for Average Unwanted Emissions Measurements Above 1000MHz

- RBW = 1 MHz
  - VBW = 10 Hz, when duty cycle is no less than 98 percent.
  - $VBW \geq 1/T$ , when duty cycle is less than 98 percent where T is the minimum transmission duration over which the transmitter is on and is transmitting at its maximum power control level for the tested mode of operation.
2. The EUT was placed on a turntable with 0.8 meter for frequency below 1GHz and 1.5 meter for frequency above 1GHz respectively above ground.
  3. The EUT was set 3 meters from the interference receiving antenna which was mounted on the top of a variable height antenna tower.
  4. The antenna is a broadband antenna and its height is adjusted between one meter and four meters above ground to find the maximum value of the field strength for both horizontal polarization and vertical polarization of the antenna.
  5. For each suspected emission, the EUT was arranged to its worst case and then adjust the antenna tower (from 1 m to 4 m) and turntable (from 0 degree to 360 degrees) to find the maximum reading.
  6. For testing below 1GHz, if the emission level of the EUT in peak mode was 3 dB lower than the limit specified, then peak values of EUT will be reported, otherwise, the emissions will be repeated one by one using the CISPR quasi-peak method and reported.
  7. For testing above 1GHz, the emission level of the EUT in peak mode was 20dB lower than average limit (that means the emission level in average mode also complies with the limit in average mode), then peak values of EUT will be reported, otherwise, the emissions will be measured in average mode again and reported.

### 3.2.4 Test Setup

For radiated emissions below 30MHz

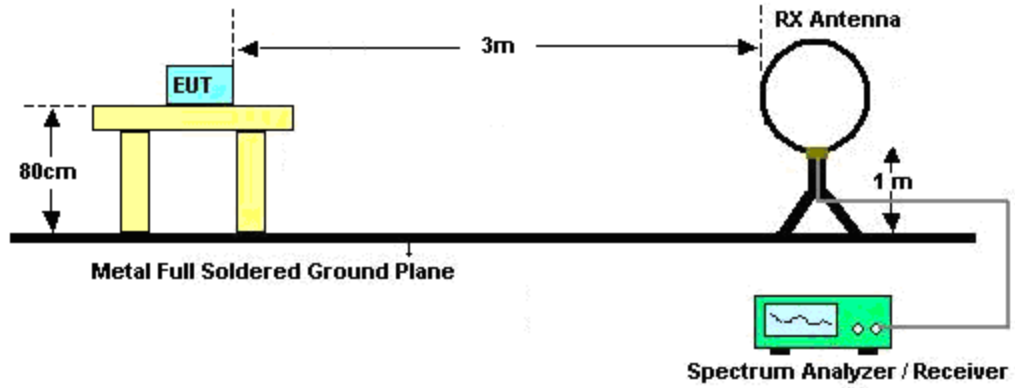

For radiated emissions from 30MHz to 1GHz

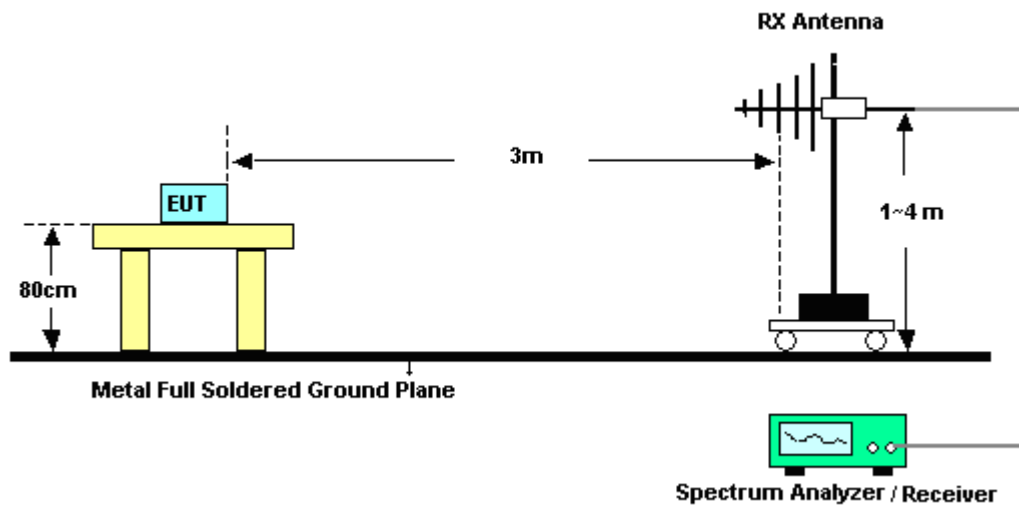

For radiated emissions above 1GHz

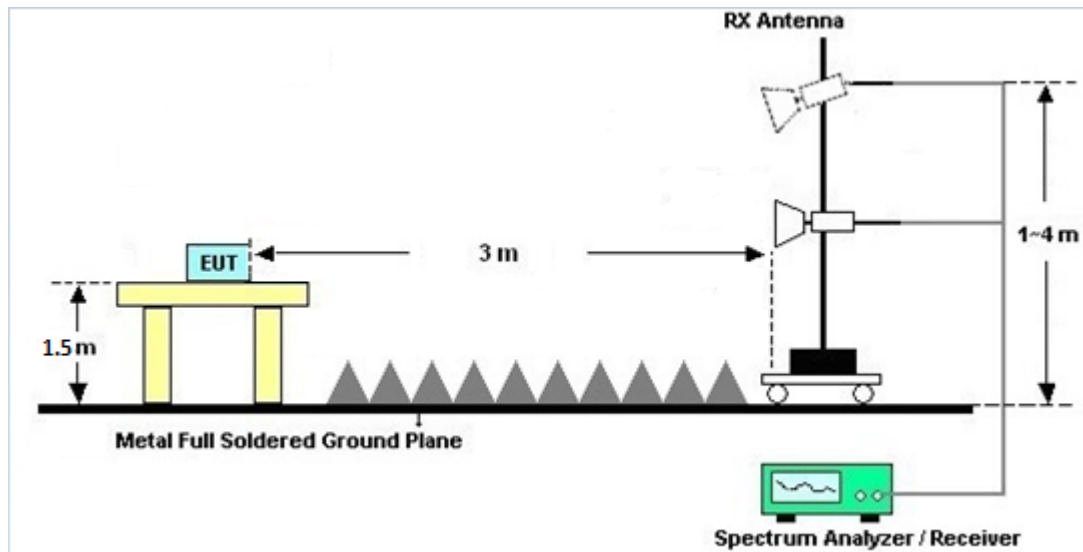

### 3.2.5 Test Results of Radiated Spurious Emissions (9 kHz ~ 30 MHz)

The low frequency, which started from 9 kHz to 30MHz, was pre-scanned and the result which was 20dB lower than the limit line was not reported.

There is a comparison data of both open-field test site and alternative test site - semi-Anechoic chamber according to 414788 D01 Radiated Test Site v01r01, and the result came out very similar.

### 3.2.6 Test Result of Radiated Band Edges

Please refer to Appendix A and B.

### 3.2.7 Duty Cycle

Please refer to Appendix C.

### 3.2.8 Test Result of Unwanted Radiated Emission (30MHz ~ 10th Harmonic)

Please refer to Appendix A and B..



### **3.3 Automatically Discontinue Transmission**

#### **3.3.1 Limit of Automatically Discontinue Transmission**

The device shall automatically discontinue transmission in case of either absence of information to transmit or operational failure. These provisions are not intended to preclude the transmission of control or signaling information or the use of repetitive codes used by certain digital technologies to complete frame or burst intervals. Applicants shall include in their application for equipment authorization to describe how this requirement is met.

#### **3.3.2 Measuring Instruments**

See list of measuring equipment of this test report.

#### **3.3.3 Test Result of Automatically Discontinue Transmission**

While the EUT is not transmitting any information, the EUT can automatically discontinue transmission and become standby mode for power saving. The EUT can detect the controlling signal of ACK message transmitting from remote device and verify whether it shall resend or discontinue transmission.



## **3.4 Antenna Requirements**

### **3.4.1 Standard Applicable**

If transmitting antenna directional gain is greater than 6 dBi, both the peak transmit power and the peak power spectral density shall be reduced by the amount in dB that the directional gain of the antenna exceeds 6 dBi.

### **3.4.2 Antenna Anti-Replacement Construction**

An embedded-in antenna design is used.

### **3.4.3 Antenna Gain**

The antenna peak gain of EUT is less than 6 dBi. Therefore, it is not necessary to reduce maximum peak output power limit.



## 4 List of Measuring Equipment

Instrument	Brand Name	Model No.	Serial No.	Characteristics	Calibration Date	Test Date	Due Date	Remark
Loop Antenna	Rohde & Schwarz	HFH2-Z2	100315	9 kHz~30 MHz	Dec. 26, 2019	Sep. 22, 2020~ Sep. 28, 2020	Dec. 25, 2020	Radiation (03CH07-HY)
Bilog Antenna	TESEQ	CBL 6111D & 00800N1D0 1N-06	35419 & 03	30MHz~1GHz	Apr. 29, 2020	Sep. 22, 2020~ Sep. 28, 2020	Apr. 28, 2021	Radiation (03CH07-HY)
Double Ridge Horn Antenna	ESCO	3117	00075962	1GHz ~ 18GHz	Dec. 06, 2019	Sep. 22, 2020~ Sep. 28, 2020	Dec. 05, 2020	Radiation (03CH07-HY)
SHF-EHF Horn Antenna	SCHWARZBE CK	BBHA 9170	BBHA917058 4	18GHz~40GHz	Dec. 10, 2019	Sep. 22, 2020~ Sep. 28, 2020	Dec. 09, 2020	Radiation (03CH07-HY)
EMI Test Receiver	Agilent	N9038A(MX E)	MY53290053	20Hz~26.5GHz	May 21, 2020	Sep. 22, 2020~ Sep. 28, 2020	May 20, 2021	Radiation (03CH07-HY)
Spectrum Analyzer	Agilent	N9030A	MY52350276	3Hz~44GHz	Jun. 09, 2020	Sep. 22, 2020~ Sep. 28, 2020	Jun. 08, 2021	Radiation (03CH07-HY)
Preamplifier	COM-POWE R	PA-103A	161241	10MHz~1GHz	May 19, 2020	Sep. 22, 2020~ Sep. 28, 2020	May 18, 2021	Radiation (03CH07-HY)
Preamplifier	MITEQ	AMF-7D-001 01800-30-10 P	1590075	1GHz~18GHz	Apr. 23, 2020	Sep. 22, 2020~ Sep. 28, 2020	Apr. 22, 2021	Radiation (03CH07-HY)
Preamplifier	Agilent	8449B	3008A02362	1GHz~26.5GHz	Nov. 01, 2019	Sep. 22, 2020~ Sep. 28, 2020	Oct. 31, 2020	Radiation (03CH07-HY)
Preamplifier	EMEC	EM18G40G	060715	18GHz~40GHz	Dec. 13, 2019	Sep. 22, 2020~ Sep. 28, 2020	Dec. 12, 2020	Radiation (03CH07-HY)
RF Cable	HUBER + SUHNER	SUCOFLEX 102	MY2858/2,80 1606/2	18GHz~40GHz	Feb. 25, 2020	Sep. 22, 2020~ Sep. 28, 2020	Feb. 24, 2021	Radiation (03CH07-HY)
RF Cable	HUBER + SUHNER	SUCOFLEX 104	MY24971/4, MY28655/4	9kHz~30MHz	Feb. 25, 2020	Sep. 22, 2020~ Sep. 28, 2020	Feb. 24, 2021	Radiation (03CH07-HY)
RF Cable	HUBER + SUHNER	SUCOFLEX 104	MY28655/4, MY24971/4, MY15682/4	30MHz~1GHz	Feb. 25, 2020	Sep. 22, 2020~ Sep. 28, 2020	Feb. 24, 2021	Radiation (03CH07-HY)
RF Cable	HUBER + SUHNER	SUCOFLEX 104	MY28655/4, MY24971/4, MY15682/4	1GHz~18GHz	Feb. 25, 2020	Sep. 22, 2020~ Sep. 28, 2020	Feb. 24, 2021	Radiation (03CH07-HY)
Antenna Mast	Max-Full	MFA520BS	N/A	1m~4m	N/A	Sep. 22, 2020~ Sep. 28, 2020	N/A	Radiation (03CH07-HY)
Turn Table	ChainTek	Chaintek 3000	N/A	0~360 Degree	N/A	Sep. 22, 2020~ Sep. 28, 2020	N/A	Radiation (03CH07-HY)
USB Data Logger	TECPEL	TR-32	HE17XB2495	N/A	N/A	Sep. 22, 2020~ Sep. 28, 2020	N/A	Radiation (03CH07-HY)
Software	Audix	E3 6.2009-8-24	N/A	N/A	N/A	Sep. 22, 2020~ Sep. 28, 2020	N/A	Radiation (03CH07-HY)
Hygrometer	Testo	608-H1	34893241	N/A	Mar. 02, 2020	Aug. 04. 2020~ Aug. 31. 2020	Mar. 01, 2021	Conducted (TH05-HY)
Power Sensor	DARE	RPR3006W	16100054SN O10	10MHz~6GHz	Dec. 23, 2019	Aug. 04. 2020~ Aug. 31. 2020	Dec. 22, 2020	Conducted (TH05-HY)
Signal Analyzer	Rohde & Schwarz	FSV40	101397	10Hz~40GHz	Nov. 15, 2019	Aug. 04. 2020~ Aug. 31. 2020	Nov. 14, 2020	Conducted (TH05-HY)
Switch Box & RF Cable	EM Electronics	EMSW18SE	SW200302	N/A	Mar. 17, 2020	Aug. 04. 2020~ Aug. 31. 2020	Mar. 16, 2021	Conducted (TH05-HY)





## 5 Uncertainty of Evaluation

### Uncertainty of Radiated Emission Measurement (30 MHz ~ 1000 MHz)

Measuring Uncertainty for a Level of Confidence of 95% ( $U = 2Uc(y)$ )	4.7
---	-----

### Uncertainty of Radiated Emission Measurement (1000 MHz ~ 18000 MHz)

Measuring Uncertainty for a Level of Confidence of 95% ( $U = 2Uc(y)$ )	5.3
---	-----

### Uncertainty of Radiated Emission Measurement (18000 MHz ~ 40000 MHz)

Measuring Uncertainty for a Level of Confidence of 95% ( $U = 2Uc(y)$ )	5.0
---	-----



## Appendix A. Radiated Spurious Emission

Test Engineer :	Jesse Wang, Stan Hsieh and Ken Wu	Temperature :	22~23°C
		Relative Humidity :	51~58%

### Band 1 - 5150~5250MHz

#### WIFI 802.11ac VHT20 (Band Edge @ 3m)

WIFI Ant.	Note	Frequency ( MHz )	Level ( dBμV/m )	Over Limit ( dB )	Limit Line ( dBμV/m )	Read Level ( dBμV )	Antenna Factor ( dB/m )	Path Loss ( dB )	Preamp Factor ( dB )	Ant Pos ( cm )	Table Pos ( deg )	Peak Avg. ( P/A )	Pol. ( H/V )	
802.11ac VHT20 CH 36 5180MHz		5147.68	51.34	-22.66	74	40.8	34.4	11.56	35.42	122	30	P	H	
		5150	43.6	-10.4	54	33.06	34.4	11.56	35.42	122	30	A	H	
	*	5180	110.09	-	-	99.45	34.47	11.58	35.41	122	30	P	H	
	*	5180	102.64	-	-	92	34.47	11.58	35.41	122	30	A	H	
													H	
														H
			5135.98	50.1	-23.9	74	39.6	34.37	11.55	35.42	109	105	P	V
			5144.56	41.75	-12.25	54	31.22	34.4	11.55	35.42	109	105	A	V
		*	5180	106.72	-	-	96.08	34.47	11.58	35.41	109	105	P	V
		*	5180	99.68	-	-	89.04	34.47	11.58	35.41	109	105	A	V
													V	
													V	
Remark	1. No other spurious found. 2. All results are PASS against Peak and Average limit line.													



**Band 1 5150~5250MHz  
WIFI 802.11ac VHT20 (Harmonic @ 3m)**

WIFI Ant. 1	Note	Frequency ( MHz )	Level ( dBμV/m )	Over Limit ( dB )	Limit Line ( dBμV/m )	Read Level (dBμV)	Antenna Factor ( dB/m )	Path Loss ( dB )	Preamp Factor ( dB )	Ant Pos ( cm )	Table Pos ( deg )	Peak Avg. (P/A)	Pol. (H/V)	
802.11ac VHT20 CH 36 5180MHz		10360	43.76	-24.44	68.2	47.74	37.47	17.58	59.03	100	0	P	H	
		15540	45.31	-28.69	74	40.33	40.1	21.65	56.77	100	0	P	H	
													H	
													H	
			10360	42.9	-25.3	68.2	46.88	37.47	17.58	59.03	100	0	P	V
			15540	44.93	-29.07	74	39.95	40.1	21.65	56.77	100	0	P	V
														V
													V	
<b>Remark</b>	1. No other spurious found. 2. All results are PASS against Peak and Average limit line.													



**Band 1 5150~5250MHz**  
**WIFI 802.11ac VHT40 (Band Edge @ 3m)**

WIFI Ant. 1	Note	Frequency ( MHz )	Level ( dBμV/m )	Over Limit ( dB )	Limit Line ( dBμV/m )	Read Level (dBμV)	Antenna Factor ( dB/m )	Path Loss ( dB )	Preamp Factor ( dB )	Ant Pos ( cm )	Table Pos ( deg )	Peak Avg. (P/A)	Pol. (H/V)
<b>802.11ac VHT40 CH 38 5190MHz</b>		5150	57.71	-16.29	74	47.17	34.4	11.56	35.42	119	31	P	H
		5150	51.99	-2.01	54	41.45	34.4	11.56	35.42	119	31	A	H
	*	5190	106.34	-	-	95.69	34.47	11.59	35.41	119	31	P	H
	*	5190	99.25	-	-	88.6	34.47	11.59	35.41	119	31	A	H
		5361.44	48.58	-25.42	74	37.59	34.57	11.77	35.35	119	31	P	H
		5412.4	40.79	-13.21	54	29.6	34.7	11.82	35.33	119	31	A	H
		5150	53.94	-20.06	74	43.4	34.4	11.56	35.42	100	92	P	V
		5149.76	47.68	-6.32	54	37.14	34.4	11.56	35.42	100	92	A	V
	*	5190	103.79	-	-	93.14	34.47	11.59	35.41	100	92	P	V
	*	5190	96.29	-	-	85.64	34.47	11.59	35.41	100	92	A	V
		5396.44	49.16	-24.84	74	37.99	34.7	11.81	35.34	100	92	P	V
	5388.32	40.58	-13.42	54	29.49	34.63	11.8	35.34	100	92	A	V	
<b>Remark</b>	1. No other spurious found. 2. All results are PASS against Peak and Average limit line.												



**Band 1 5150~5250MHz  
WIFI 802.11ac VHT40 (Harmonic @ 3m)**

WIFI Ant. 1	Note	Frequency ( MHz )	Level ( dBμV/m )	Over Limit ( dB )	Limit Line ( dBμV/m )	Read Level (dBμV)	Antenna Factor ( dB/m )	Path Loss ( dB )	Preamp Factor ( dB )	Ant Pos ( cm )	Table Pos ( deg )	Peak Avg. (P/A)	Pol. (H/V)	
802.11ac VHT40 CH 38 5190MHz		10380	42.37	-25.83	68.2	46.31	37.48	17.6	59.02	100	0	P	H	
		15570	45.72	-28.28	74	40.61	40.2	21.68	56.77	100	0	P	H	
													H	
													H	
			10380	44.31	-23.89	68.2	48.25	37.48	17.6	59.02	100	0	P	V
			15570	45.44	-28.56	74	40.33	40.2	21.68	56.77	100	0	P	V
														V
													V	
<b>Remark</b>	1. No other spurious found. 2. All results are PASS against Peak and Average limit line.													



**Band 1 5150~5250MHz  
WIFI 802.11ac VHT80 (Band Edge @ 3m)**

WIFI Ant. 1	Note	Frequency ( MHz )	Level ( dBμV/m )	Over Limit ( dB )	Limit Line ( dBμV/m )	Read Level (dBμV)	Antenna Factor ( dB/m )	Path Loss ( dB )	Preamp Factor ( dB )	Ant Pos ( cm )	Table Pos ( deg )	Peak Avg. (P/A)	Pol. (H/V)
<b>802.11ac VHT80 CH 42 5210MHz</b>		5148.72	66.36	-7.64	74	55.82	34.4	11.56	35.42	107	32	P	H
		5149.76	51.24	-2.76	54	40.7	34.4	11.56	35.42	107	32	A	H
	*	5210	102.96	-	-	92.25	34.5	11.61	35.4	107	32	P	H
	*	5210	95.61	-	-	84.9	34.5	11.61	35.4	107	32	A	H
		5403.72	48.44	-25.56	74	37.26	34.7	11.81	35.33	107	32	P	H
		5359.76	41.43	-12.57	54	30.51	34.5	11.77	35.35	107	32	A	H
		5140.92	55.83	-18.17	74	45.3	34.4	11.55	35.42	100	91	P	V
		5149.76	47.94	-6.06	54	37.4	34.4	11.56	35.42	100	91	A	V
	*	5210	100.77	-	-	90.06	34.5	11.61	35.4	100	91	P	V
	*	5210	93.56	-	-	82.85	34.5	11.61	35.4	100	91	A	V
		5357.24	49.23	-24.77	74	38.31	34.5	11.77	35.35	100	91	P	V
	5376	40.82	-13.18	54	29.81	34.57	11.78	35.34	100	91	A	V	
<b>Remark</b>	1. No other spurious found. 2. All results are PASS against Peak and Average limit line.												



**Band 1 5150~5250MHz  
WIFI 802.11ac VHT80 (Harmonic @ 3m)**

WIFI Ant. 1	Note	Frequency ( MHz )	Level ( dBμV/m )	Over Limit ( dB )	Limit Line ( dBμV/m )	Read Level (dBμV)	Antenna Factor ( dB/m )	Path Loss ( dB )	Preamp Factor ( dB )	Ant Pos ( cm )	Table Pos ( deg )	Peak Avg. (P/A)	Pol. (H/V)	
802.11ac VHT80 CH 42 5210MHz		10420	43.37	-24.83	68.2	47.21	37.52	17.63	58.99	100	0	P	H	
		15630	45.21	-28.79	74	39.86	40.4	21.71	56.76	100	0	P	H	
													H	
													H	
			10420	43.25	-24.95	68.2	47.09	37.52	17.63	58.99	100	0	P	V
			15630	45.34	-28.66	74	39.99	40.4	21.71	56.76	100	0	P	V
														V
														V
<b>Remark</b>	1. No other spurious found. 2. All results are PASS against Peak and Average limit line.													



Band 2 - 5250~5350MHz

WIFI 802.11ac VHT20 (Band Edge @ 3m)

WIFI Ant. 1	Note	Frequency ( MHz )	Level ( dBμV/m )	Over Limit ( dB )	Limit Line ( dBμV/m )	Read Level (dBμV)	Antenna Factor ( dB/m )	Path Loss ( dB )	Preamp Factor ( dB )	Ant Pos ( cm )	Table Pos ( deg )	Peak Avg. (P/A)	Pol. (H/V)
802.11ac VHT20 CH 64 5320MHz	*	5320	110.61	-	-	99.61	34.63	11.73	35.36	113	34	P	H
	*	5320	103	-	-	92	34.63	11.73	35.36	113	34	A	H
		5382.88	54.11	-19.89	74	43.03	34.63	11.79	35.34	113	34	P	H
		5351.84	44.78	-9.22	54	33.87	34.5	11.76	35.35	113	34	A	H
													H
													H
	*	5320	108.41	-	-	97.41	34.63	11.73	35.36	109	101	P	V
	*	5320	100.6	-	-	89.6	34.63	11.73	35.36	109	101	A	V
		5373.12	50.47	-23.53	74	39.46	34.57	11.78	35.34	109	101	P	V
		5351.2	42.78	-11.22	54	31.87	34.5	11.76	35.35	109	101	A	V
												V	
												V	
Remark	1. No other spurious found. 2. All results are PASS against Peak and Average limit line.												





**Band 2 5250~5350MHz  
WIFI 802.11ac VHT20 (Harmonic @ 3m)**

WIFI Ant. 1	Note	Frequency ( MHz )	Level ( dBμV/m )	Over Limit ( dB )	Limit Line ( dBμV/m )	Read Level (dBμV)	Antenna Factor ( dB/m )	Path Loss ( dB )	Preamp Factor ( dB )	Ant Pos ( cm )	Table Pos ( deg )	Peak Avg. (P/A)	Pol. (H/V)	
802.11ac VHT20 CH 64 5320MHz		10640	43.7	-30.3	74	47.14	37.63	17.79	58.86	100	0	P	H	
		15960	45.52	-28.48	74	39.5	40.8	21.93	56.71	100	0	P	H	
													H	
													H	
			10640	44.12	-29.88	74	47.56	37.63	17.79	58.86	100	0	P	V
			15960	44.89	-29.11	74	38.87	40.8	21.93	56.71	100	0	P	V
														V
													V	
<b>Remark</b>	1. No other spurious found. 2. All results are PASS against Peak and Average limit line.													



**Band 2 5250~5350MHz**  
**WIFI 802.11ac VHT40 (Band Edge @ 3m)**

WIFI Ant. 1	Note	Frequency ( MHz )	Level ( dBμV/m )	Over Limit ( dB )	Limit Line ( dBμV/m )	Read Level (dBμV)	Antenna Factor ( dB/m )	Path Loss ( dB )	Preamp Factor ( dB )	Ant Pos ( cm )	Table Pos ( deg )	Peak Avg. (P/A)	Pol. (H/V)
<b>802.11ac VHT40 CH 62 5310MHz</b>		5042.7	48.82	-25.18	74	38.71	34.1	11.47	35.46	123	33	P	H
		5084.35	40.83	-13.17	54	30.54	34.23	11.5	35.44	123	33	A	H
	*	5310	105.87	-	-	94.88	34.63	11.72	35.36	123	33	P	H
	*	5310	98.28	-	-	87.29	34.63	11.72	35.36	123	33	A	H
		5353.68	55.23	-18.77	74	44.32	34.5	11.76	35.35	123	33	P	H
		5350.32	51.79	-2.21	54	40.88	34.5	11.76	35.35	123	33	A	H
		5072.1	47.77	-26.23	74	37.5	34.23	11.49	35.45	100	116	P	V
		5052.15	40.85	-13.15	54	30.73	34.1	11.47	35.45	100	116	A	V
	*	5310	102.18	-	-	91.19	34.63	11.72	35.36	100	116	P	V
	*	5310	95.22	-	-	84.23	34.63	11.72	35.36	100	116	A	V
		5350.08	53.12	-20.88	74	42.21	34.5	11.76	35.35	100	116	P	V
	5350.08	47.74	-6.26	54	36.83	34.5	11.76	35.35	100	116	A	V	
<b>Remark</b>	1. No other spurious found. 2. All results are PASS against Peak and Average limit line.												



Band 2 5250~5350MHz
WIFI 802.11ac VHT40 (Harmonic @ 3m)

Table with 14 columns: WIFI Ant. 1, Note, Frequency (MHz), Level (dBµV/m), Over Limit (dB), Limit Line (dBµV/m), Read Level (dBµV), Antenna Factor (dB/m), Path Loss (dB), Preamp Factor (dB), Ant Pos (cm), Table Pos (deg), Peak Avg. (P/A), Pol. (H/V). Rows include data for 802.11ac VHT40 CH 62 at 10620 and 15930 MHz, and a Remark section.



**Band 2 5250~5350MHz  
WIFI 802.11ac VHT80 (Band Edge @ 3m)**

WIFI Ant. 1	Note	Frequency ( MHz )	Level ( dBμV/m )	Over Limit ( dB )	Limit Line ( dBμV/m )	Read Level (dBμV)	Antenna Factor ( dB/m )	Path Loss ( dB )	Preamp Factor ( dB )	Ant Pos ( cm )	Table Pos ( deg )	Peak Avg. (P/A)	Pol. (H/V)
<b>802.11ac VHT80 CH 58 5290MHz</b>		5128.8	49.31	-24.69	74	38.83	34.37	11.54	35.43	108	33	P	H
		5116.2	41.07	-12.93	54	30.64	34.33	11.53	35.43	108	33	A	H
	*	5290	101.01	-	-	90.06	34.63	11.69	35.37	108	33	P	H
	*	5290	93.86	-	-	82.91	34.63	11.69	35.37	108	33	A	H
		5359.68	55.86	-18.14	74	44.94	34.5	11.77	35.35	108	33	P	H
		5350.08	50.3	-3.7	54	39.39	34.5	11.76	35.35	108	33	A	H
		5079.45	49.3	-24.7	74	39.01	34.23	11.5	35.44	108	101	P	V
		5121.8	40.87	-13.13	54	30.44	34.33	11.53	35.43	108	101	A	V
	*	5290	97.24	-	-	86.29	34.63	11.69	35.37	108	101	P	V
	*	5290	89.57	-	-	78.62	34.63	11.69	35.37	108	101	A	V
		5352.96	55.02	-18.98	74	44.11	34.5	11.76	35.35	108	101	P	V
	5350.32	48.46	-5.54	54	37.55	34.5	11.76	35.35	108	101	A	V	
<b>Remark</b>	1. No other spurious found. 2. All results are PASS against Peak and Average limit line.												



**Band 2 5250~5350MHz**

**WIFI 802.11ac VHT80 (Harmonic @ 3m)**

WIFI Ant. 1	Note	Frequency ( MHz )	Level ( dBμV/m )	Over Limit ( dB )	Limit Line ( dBμV/m )	Read Level (dBμV)	Antenna Factor ( dB/m )	Path Loss ( dB )	Preamp Factor ( dB )	Ant Pos ( cm )	Table Pos ( deg )	Peak Avg. (P/A)	Pol. (H/V)	
802.11ac VHT80 CH 58 5290MHz		10580	44.09	-24.11	68.2	47.63	37.6	17.75	58.89	100	0	P	H	
		15870	46.36	-27.64	74	40.47	40.74	21.87	56.72	100	0	P	H	
													H	
													H	
			10580	42.98	-25.22	68.2	46.52	37.6	17.75	58.89	100	0	P	V
			15870	47	-27	74	41.11	40.74	21.87	56.72	100	0	P	V
														V
													V	
Remark	1. No other spurious found. 2. All results are PASS against Peak and Average limit line.													



Band 3 - 5470~5725MHz

WIFI 802.11ac VHT20 (Band Edge @ 3m)

WIFI Ant. 1	Note	Frequency ( MHz )	Level ( dBμV/m )	Over Limit ( dB )	Limit Line ( dBμV/m )	Read Level (dBμV)	Antenna Factor ( dB/m )	Path Loss ( dB )	Preamp Factor ( dB )	Ant Pos ( cm )	Table Pos ( deg )	Peak Avg. (P/A)	Pol. (H/V)
802.11ac VHT20 CH 140 5700MHz	*	5700	111.07	-	-	99.19	35	12.2	35.32	116	38	P	H
	*	5700	103.67	-	-	91.79	35	12.2	35.32	116	38	A	H
		5725.4	59.69	-8.51	68.2	47.76	35	12.25	35.32	116	38	P	H
													H
													H
													H
	*	5700	110.14	-	-	98.26	35	12.2	35.32	101	15	P	V
	*	5700	102.85	-	-	90.97	35	12.2	35.32	101	15	A	V
		5740.6	58.43	-9.77	68.2	46.48	35	12.27	35.32	101	15	P	V
													V
												V	
												V	
<b>Remark</b>	1. No other spurious found. 2. All results are PASS against Peak and Average limit line.												



**Band 3 - 5470~5725MHz  
WIFI 802.11ac VHT20 (Harmonic @ 3m)**

WIFI Ant. 1	Note	Frequency ( MHz )	Level ( dBμV/m )	Over Limit ( dB )	Limit Line ( dBμV/m )	Read Level (dBμV)	Antenna Factor ( dB/m )	Path Loss ( dB )	Preamp Factor ( dB )	Ant Pos ( cm )	Table Pos ( deg )	Peak Avg. (P/A)	Pol. (H/V)	
802.11ac VHT20 CH 140 5700MHz		11400	45.2	-28.8	74	46.43	38.1	18.41	57.74	100	0	P	H	
		17100	48.5	-19.7	68.2	39.9	42	22.87	56.27	100	0	P	H	
													H	
													H	
			11400	44.39	-29.61	74	45.62	38.1	18.41	57.74	100	0	P	V
			17100	48.2	-20	68.2	39.6	42	22.87	56.27	100	0	P	V
														V
														V
<b>Remark</b>	1. No other spurious found. 2. All results are PASS against Peak and Average limit line.													



**Band 3 - 5470~5725MHz  
WIFI 802.11ac VHT40 (Band Edge @ 3m)**

WIFI Ant. 1	Note	Frequency ( MHz )	Level ( dBμV/m )	Over Limit ( dB )	Limit Line ( dBμV/m )	Read Level ( dBμV )	Antenna Factor ( dB/m )	Path Loss ( dB )	Preamp Factor ( dB )	Ant Pos ( cm )	Table Pos ( deg )	Peak Avg. ( P/A )	Pol. ( H/V )
<b>802.11ac VHT40 CH 102 5510MHz</b>		5459.68	56.86	-17.14	74	45.59	34.7	11.88	35.31	115	35	P	H
		5469.76	65.56	-2.64	68.2	54.18	34.8	11.89	35.31	115	35	P	H
		5459.44	50.82	-3.18	54	39.55	34.7	11.88	35.31	115	35	A	H
	*	5510	107.07	-	-	95.43	35	11.94	35.3	115	35	P	H
	*	5510	100.3	-	-	88.66	35	11.94	35.3	115	35	A	H
		5738.855	48.27	-19.93	68.2	36.32	35	12.27	35.32	115	35	P	H
		5458.48	53.02	-20.98	74	41.75	34.7	11.88	35.31	100	115	P	V
		5468.8	60.89	-7.31	68.2	49.51	34.8	11.89	35.31	100	115	P	V
		5459.92	47.83	-6.17	54	36.56	34.7	11.88	35.31	100	115	A	V
	*	5510	104.03	-	-	92.39	35	11.94	35.3	100	115	P	V
	*	5510	97.46	-	-	85.82	35	11.94	35.3	100	115	A	V
		5741.69	48.6	-19.6	68.2	36.65	35	12.27	35.32	100	115	P	V
<b>Remark</b>	1. No other spurious found. 2. All results are PASS against Peak and Average limit line.												





**Band 3 - 5470~5725MHz  
WIFI 802.11ac VHT40 (Harmonic @ 3m)**

WIFI Ant. 1	Note	Frequency ( MHz )	Level ( dBμV/m )	Over Limit ( dB )	Limit Line ( dBμV/m )	Read Level ( dBμV )	Antenna Factor ( dB/m )	Path Loss ( dB )	Preamp Factor ( dB )	Ant Pos ( cm )	Table Pos ( deg )	Peak Avg. ( P/A )	Pol. ( H/V )	
802.11ac VHT40 CH 102 5510MHz		11020	44.38	-29.62	74	47.06	37.9	18.06	58.64	100	0	P	H	
		16530	48.07	-20.13	68.2	40.41	41.67	22.4	56.41	100	0	P	H	
													H	
													H	
			11020	44.42	-29.58	74	47.1	37.9	18.06	58.64	100	0	P	V
			16530	47.95	-20.25	68.2	40.29	41.67	22.4	56.41	100	0	P	V
														V
													V	
<b>Remark</b>	1. No other spurious found. 2. All results are PASS against Peak and Average limit line.													



**Band 3 5470~5725MHz**  
**WIFI 802.11ac VHT80 (Band Edge @ 3m)**

WIFI Ant. 1	Note	Frequency ( MHz )	Level ( dBμV/m )	Over Limit ( dB )	Limit Line ( dBμV/m )	Read Level ( dBμV )	Antenna Factor ( dB/m )	Path Loss ( dB )	Preamp Factor ( dB )	Ant Pos ( cm )	Table Pos ( deg )	Peak Avg. ( P/A )	Pol. ( H/V )
<b>802.11ac VHT80 CH 106 5530MHz</b>		5456.08	57	-17	74	45.74	34.7	11.87	35.31	125	36	P	H
		5470	58.24	-9.96	68.2	46.86	34.8	11.89	35.31	125	36	P	H
		5459.68	50.54	-3.46	54	39.27	34.7	11.88	35.31	125	36	A	H
	*	5530	102.07	-	-	90.48	34.93	11.96	35.3	125	36	P	H
	*	5530	95.99	-	-	84.4	34.93	11.96	35.3	125	36	A	H
		5758.7	48.75	-19.45	68.2	36.78	35	12.3	35.33	125	36	P	H
		5459.2	53.94	-20.06	74	42.67	34.7	11.88	35.31	110	115	P	V
		5460.88	56.27	-11.93	68.2	45	34.7	11.88	35.31	110	115	P	V
		5459.68	48.14	-5.86	54	36.87	34.7	11.88	35.31	110	115	A	V
	*	5530	98.99	-	-	87.4	34.93	11.96	35.3	110	115	P	V
	*	5530	92.63	-	-	81.04	34.93	11.96	35.3	110	115	A	V
		5760.275	49.23	-18.97	68.2	37.26	35	12.3	35.33	110	115	P	V
<b>Remark</b>	1. No other spurious found. 2. All results are PASS against Peak and Average limit line.												



**Band 3 5470~5725MHz  
WIFI 802.11ac VHT80 (Harmonic @ 3m)**

WIFI Ant. 1	Note	Frequency ( MHz )	Level ( dBμV/m )	Over Limit ( dB )	Limit Line ( dBμV/m )	Read Level (dBμV)	Antenna Factor ( dB/m )	Path Loss ( dB )	Preamp Factor ( dB )	Ant Pos ( cm )	Table Pos ( deg )	Peak Avg. (P/A)	Pol. (H/V)	
802.11ac VHT80 CH 106 5530MHz		11060	43.9	-30.1	74	46.45	37.9	18.1	58.55	100	0	P	H	
		16590	46.14	-22.06	68.2	38.31	41.77	22.45	56.39	100	0	P	H	
													H	
													H	
			11060	44.05	-29.95	74	46.6	37.9	18.1	58.55	100	0	P	V
			16590	47.35	-20.85	68.2	39.52	41.77	22.45	56.39	100	0	P	V
														V
														V
<b>Remark</b>	1. No other spurious found. 2. All results are PASS against Peak and Average limit line.													





**Note symbol**

*	<b>Fundamental Frequency</b> which can be ignored. However, the level of any unwanted emissions shall not exceed the level of the fundamental frequency.
!	Test result is <b>over limit</b> line.
P/A	<b>Peak</b> or <b>Average</b>
H/V	<b>Horizontal</b> or <b>Vertical</b>



A calculation example for radiated spurious emission is shown as below:

WIFI	Note	Frequency	Level	Over	Limit	Read	Antenna	Path	Preamp	Ant	Table	Peak	Pol.
Ant.				Limit	Line	Level	Factor	Loss	Factor	Pos	Pos	Avg.	
1		( MHz )	( dBμV/m )	( dB )	( dBμV/m )	( dBμV )	( dB/m )	( dB )	( dB )	( cm )	( deg )	( P/A )	( H/V )
802.11b		2390	55.45	-18.55	74	54.51	32.22	4.58	35.86	103	308	P	H
CH 01													
2412MHz		2390	43.54	-10.46	54	42.6	32.22	4.58	35.86	103	308	A	H

1. Path Loss(dB) = Cable loss(dB) + Filter loss(dB) + Attenuator loss(dB)
2. Level(dBμV/m) = Antenna Factor(dB/m) + Path Loss(dB) + Read Level(dBμV) - Preamp Factor(dB)
3. Over Limit(dB) = Level(dBμV/m) – Limit Line(dBμV/m)

**For Peak Limit @ 2390MHz:**

1. Level(dBμV/m)  
= Antenna Factor(dB/m) + Path Loss(dB) + Read Level(dBμV) - Preamp Factor(dB)  
= 32.22(dB/m) + 4.58(dB) + 54.51(dBμV) – 35.86 (dB)  
= 55.45 (dBμV/m)
2. Over Limit(dB)  
= Level(dBμV/m) – Limit Line(dBμV/m)  
= 55.45(dBμV/m) – 74(dBμV/m)  
= -18.55(dB)

**For Average Limit @ 2390MHz:**

1. Level(dBμV/m)  
= Antenna Factor(dB/m) + Path Loss(dB) + Read Level(dBμV) - Preamp Factor(dB)  
= 32.22(dB/m) + 4.58(dB) + 42.6(dBμV) – 35.86 (dB)  
= 43.54 (dBμV/m)
2. Over Limit(dB) = Level(dBμV/m) – Limit Line(dBμV/m)  
= 43.54(dBμV/m) – 54(dBμV/m)  
= -10.46(dB)

**Both peak and average measured complies with the limit line, so test result is “PASS”.**



## Appendix B. Radiated Spurious Emission

Test Engineer :	Jesse Wang, Stan Hsieh and Ken Wu	Temperature :	22~23°C
		Relative Humidity :	51~58%

### Note symbol

-L	Low channel location
-R	High channel location

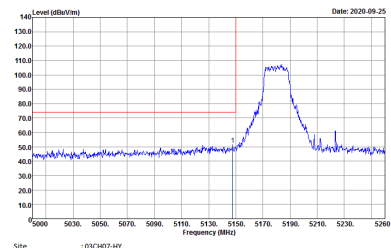
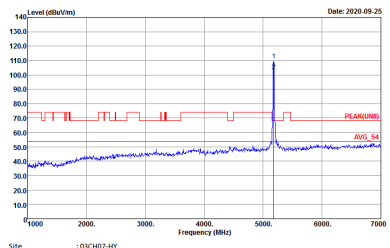
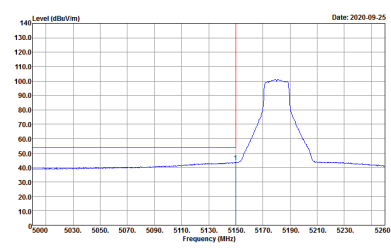

**Band 1 - 5150~5250MHz**  
**WIFI 802.11ac VHT20 (Band Edge @ 3m)**

WIFI	Band 1 5150~5250MHz Band Edge @ 3m	
ANT	802.11ac VHT20 CH36 5180MHz	
1	Horizontal	Fundamental
<b>Peak</b>	 <p>Site : 03CH07-HY            Condition : PEAK_BE_74 3m HF_ANT_00075962 HORIZONTAL            : RBW:1000.000kHz VBW:3000.000kHz SWT:Auto            Detector : Peak            Project : 052913-02            Mode : 4</p>	 <p>Site : 03CH07-HY            Condition : PEAK(FUN) 3m HF_ANT_00075962 HORIZONTAL            : RBW:1000.000kHz VBW:3000.000kHz SWT:Auto            Detector : Peak            Project : 052913-02            Mode : 4</p>
<b>Avg.</b>	 <p>Site : 03CH07-HY            Condition : AVG_BE_54 3m HF_ANT_00075962 HORIZONTAL            : RBW:1000.000kHz VBW:3.000kHz SWT:Auto            Detector : Peak            Project : 052913-02            Mode : 4</p>	<b>Left blank</b>





WIFI	Band 1 5150~5250MHz Band Edge @ 3m	
ANT	802.11ac VHT20 CH36 5180MHz	
1	Vertical	Fundamental
Peak	<p>Date: 2020-09-25</p> <p>Site : 03CH07-01            Condition : PEAK_BE_74 3m HF_ANT_00070962 VERTICAL            RBW:1000.000kHz VBW:3000.000kHz SWT:Auto            Detector : Peak            Project : 052913-02            Mode : 4</p>	<p>Date: 2020-09-25</p> <p>Site : 03CH07-01            Condition : PEAK(LIMB) 3m HF_ANT_00070962 VERTICAL            RBW:1000.000kHz VBW:3000.000kHz SWT:Auto            Detector : Peak            Project : 052913-02            Mode : 4</p>
Avg.	<p>Date: 2020-09-25</p> <p>Site : 03CH07-01            Condition : AVG_BE_34 3m HF_ANT_00070962 VERTICAL            RBW:1000.000kHz VBW:3000.000kHz SWT:Auto            Detector : Peak            Project : 052913-02            Mode : 4</p>	Left blank



**Band 1 5150~5250MHz  
WIFI 802.11ac VHT40 (Band Edge @ 3m)**

WIFI	Band 1 5150~5250MHz Band Edge @ 3m	
ANT	802.11ac VHT40 CH38 5190MHz - L	
1	Horizontal	Fundamental
<b>Peak</b>	<p>Site : 03CH07-HY Condition : PEAK_BE_74 3m HF_ANT_00075962 HORIZONTAL Detector : Peak Project : 052913-02 Mode : 7</p>	<p>Site : 03CH07-HY Condition : PEAK(LIN) 3m HF_ANT_00075962 HORIZONTAL Detector : Peak Project : 052913-02 Mode : 7</p>
<b>Avg.</b>	<p>Site : 03CH07-HY Condition : AVG_BE_54 3m HF_ANT_00075962 HORIZONTAL Detector : Peak Project : 052913-02 Mode : 7</p>	<b>Left blank</b>

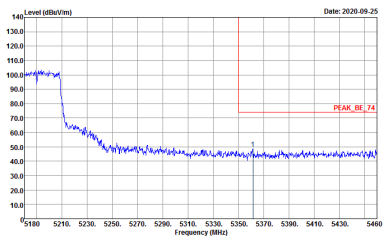
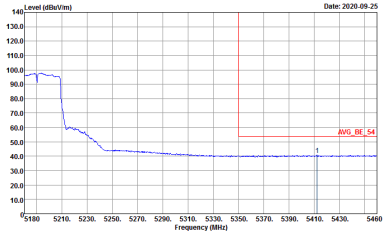

WIFI	Band 1 5150~5250MHz Band Edge @ 3m	
ANT	802.11ac VHT40 CH38 5190MHz - R	
1	Horizontal	Fundamental
<p><b>Peak</b></p>	 <p>Site : 03CH07-HY            Condition : PEAK_BE_74 3m HF_ANT_00070962 HORIZONTAL            Detector : Peak            Project : 052913-02            Mode : 7</p>	<p>Left blank</p>
<p><b>Avg.</b></p>	 <p>Site : 03CH07-HY            Condition : AVG_BE_54 3m HF_ANT_00070962 HORIZONTAL            Detector : Peak            Project : 052913-02            Mode : 7</p>	<p>Left blank</p>

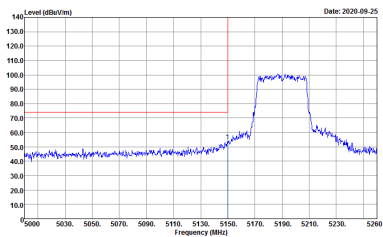
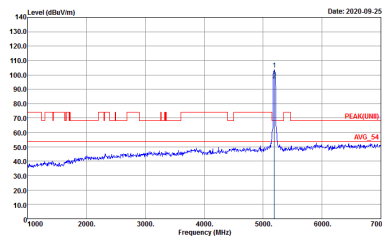
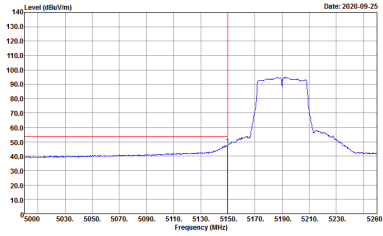

WIFI	Band 1 5150~5250MHz Band Edge @ 3m	
ANT	802.11ac VHT40 CH38 5190MHz - L	
1	Vertical	Fundamental
<p><b>Peak</b></p>	 <p>Site : 03CH07-01            Condition : PEAK_BE_74 3m HF_ANT_00070962 VERTICAL            Detector : Peak            Project : 052913-02            Mode : 7</p>	 <p>Site : 03CH07-01            Condition : PEAK(LIN) 3m HF_ANT_00070962 VERTICAL            Detector : Peak            Project : 052913-02            Mode : 7</p>
<p><b>Avg.</b></p>	 <p>Site : 03CH07-01            Condition : AVG_BE_34 3m HF_ANT_00070962 VERTICAL            Detector : Peak            Project : 052913-02            Mode : 7</p>	<p><b>Left blank</b></p>



WIFI	Band 1 5150~5250MHz Band Edge @ 3m	
ANT	802.11ac VHT40 CH38 5190MHz - R	
1	Vertical	Fundamental
Peak	<p>Site : 03CH07-01 Condition : PEAK_BE_74 3m HF_ANT_00070962 VERTICAL Detector : Peak Project : 052913-02 Mode : 7</p>	Left blank
Avg.	<p>Site : 03CH07-01 Condition : AVG_BE_54 3m HF_ANT_00070962 VERTICAL Detector : Peak Project : 052913-02 Mode : 7</p>	Left blank

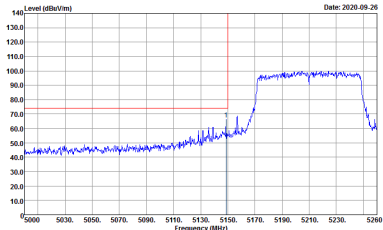
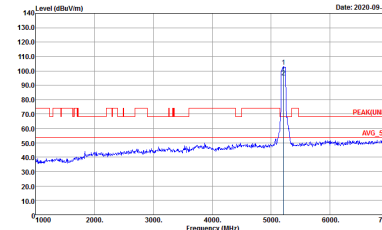
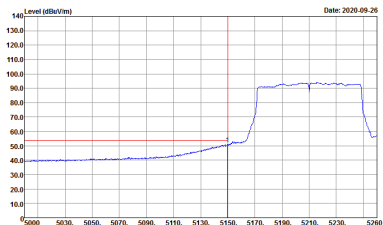

**Band 1 5150~5250MHz**  
**WIFI 802.11ac VHT80 (Band Edge @ 3m)**

WIFI	Band 1 5150~5250MHz Band Edge @ 3m	
ANT	802.11ac VHT80 CH42 5210MHz - L	
1	Horizontal	Fundamental
<b>Peak</b>	 <p>Site : 03CH07-HY            Condition : PEAK_BE_74 3m HF_ANT_00075962 HORIZONTAL            RBW:1000.000kHz VBW:3000.000kHz SWT:Auto            Detector : Peak            Project : 052913-02            Mode : 19</p>	 <p>Site : 03CH07-HY            Condition : PEAK(LIN) 3m HF_ANT_00075962 HORIZONTAL            RBW:1000.000kHz VBW:3000.000kHz SWT:Auto            Detector : Peak            Project : 052913-02            Mode : 19</p>
<b>Avg.</b>	 <p>Site : 03CH07-HY            Condition : AVG_BE_54 3m HF_ANT_00075962 HORIZONTAL            RBW:1000.000kHz VBW:3.000kHz SWT:Auto            Detector : Peak            Project : 052913-02            Mode : 19</p>	<b>Left blank</b>



WIFI	Band 1 5150~5250MHz Band Edge @ 3m	
ANT	802.11ac VHT80 CH42 5210MHz - R	
1	Horizontal	Fundamental
<p><b>Peak</b></p>	<p>Site : 03CH07-HY            Condition : PEAK_BE_74 3m HF_ANT_00070962 HORIZONTAL            Detector : Peak            Project : 052913-02            Mode : 9</p>	<p>Left blank</p>
<p><b>Avg.</b></p>	<p>Site : 03CH07-HY            Condition : AVG_BE_34 3m HF_ANT_00070962 HORIZONTAL            Detector : Peak            Project : 052913-02            Mode : 9</p>	<p>Left blank</p>

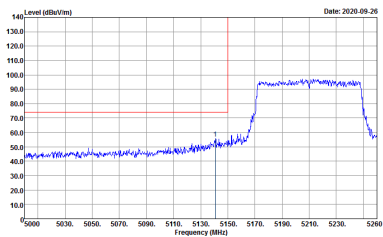
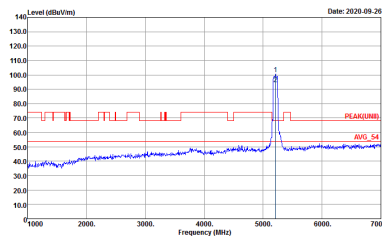
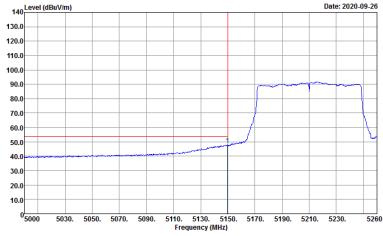

WIFI	Band 1 5150~5250MHz Band Edge @ 3m	
ANT	802.11ac VHT80 CH42 5210MHz - L	
1	Vertical	Fundamental
Peak	 <p>Date: 2020-09-26</p> <p>Site : 03CH07-HY            Condition : PEAK_BE_74 3m HF_ANT_00070962 VERTICAL            Detector : Peak            Project : 052913-02            Mode : 9</p>	 <p>Date: 2020-09-26</p> <p>Site : 03CH07-HY            Condition : PEAK(LIN) 3m HF_ANT_00070962 VERTICAL            Detector : Peak            Project : 052913-02            Mode : 9</p>
Avg.	 <p>Date: 2020-09-26</p> <p>Site : 03CH07-HY            Condition : AVG_BE_34 3m HF_ANT_00070962 VERTICAL            Detector : Peak            Project : 052913-02            Mode : 9</p>	Left blank



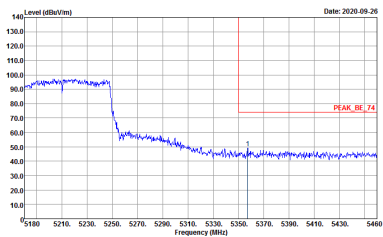
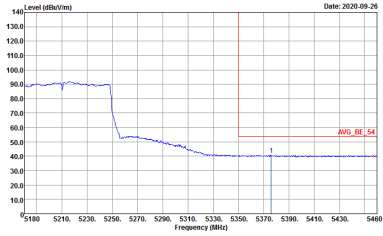

WIFI	Band 1 5150~5250MHz Band Edge @ 3m	
ANT	802.11ac VHT80 CH42 5210MHz - R	
1	Vertical	Fundamental
<p><b>Peak</b></p>	 <p>Date: 2020-09-26</p> <p>Site : 03CH07-01          Condition : PEAK_BE_74 3m HF_ANT_00070962 VERTICAL          Detector : Peak          Project : 052913-02          Mode : 9</p>	<p>Left blank</p>
<p><b>Avg.</b></p>	 <p>Date: 2020-09-26</p> <p>Site : 03CH07-01          Condition : AVG_BE_54 3m HF_ANT_00070962 VERTICAL          Detector : Peak          Project : 052913-02          Mode : 9</p>	<p>Left blank</p>



**Band 1 - 5150~5250MHz**  
**WIFI 802.11ac VHT20 (Harmonic @ 3m)**

<b>WIFI</b>	<b>Band 1 5150~5250MHz Harmonic @ 3m</b>	
<b>ANT</b>	<b>802.11ac VHT20 CH36 5180MHz</b>	
<b>1</b>	<b>Horizontal</b>	<b>Vertical</b>
<b>Peak</b> <b>Avg.</b>	<p>Site : 09C407-HY          Condition : PEAK(VN1) 3m HF_ANT_00075962 HORIZONTAL          Detector : Peak          Project : 052913-02          Mode : 4</p>	<p>Site : 09C407-HY          Condition : PEAK(VN1) 3m HF_ANT_00075962 VERTICAL          Detector : Peak          Project : 052913-02          Mode : 4</p>



**Band 1 5150~5250MHz  
WIFI 802.11ac VHT40 (Harmonic @ 3m)**

WIFI	Band 1 5150~5250MHz Harmonic @ 3m	
ANT	802.11ac VHT40 CH38 5190MHz	
1	Horizontal	Vertical
Peak Avg.	<p>Date: 2020-09-26</p>	<p>Date: 2020-09-26</p>
	<p>Site : 03CH07-HY Condition : PEAK(LINII) 3m HF_ANT_00075962 HORIZONTAL Detector : Peak Project : 052913-02 Mode : 7</p>	<p>Site : 03CH07-HY Condition : PEAK(LINII) 3m HF_ANT_00075962 VERTICAL Detector : Peak Project : 052913-02 Mode : 7</p>



**Band 1 5150~5250MHz  
WIFI 802.11ac VHT80 (Harmonic @ 3m)**

WIFI	Band 1 5150~5250MHz Harmonic @ 3m	
ANT	802.11ac VHT80 CH42 5210MHz	
1	Horizontal	Vertical
Peak Avg.		



**Band 2 - 5250~5350MHz**  
**WIFI 802.11ac VHT20 (Band Edge @ 3m)**

WIFI	Band 2 5250~5350MHz Band Edge @ 3m	
ANT	802.11ac VHT20 CH64 5320MHz	
1	Horizontal	Fundamental
<b>Peak</b>	<p>Site : 03CH07-HY            Condition : PEAK_BE_74 3m HF_ANT_00075962 HORIZONTAL            : RBW:1000.000kHz VBW:3000.000kHz SWT:Auto            Detector : Peak            Project : 052913-02            Mode : 15</p>	<p>Site : 03CH07-HY            Condition : PEAK(LNB1) 3m HF_ANT_00075962 HORIZONTAL            : RBW:1000.000kHz VBW:3000.000kHz SWT:Auto            Detector : Peak            Project : 052913-02            Mode : 15</p>
<b>Avg.</b>	<p>Site : 03CH07-HY            Condition : AVG_BE_54 3m HF_ANT_00075962 HORIZONTAL            : RBW:1000.000kHz VBW:3.000kHz SWT:Auto            Detector : Peak            Project : 052913-02            Mode : 15</p>	Left blank



WIFI	Band 2 5250~5350MHz Band Edge @ 3m	
ANT	802.11ac VHT20 CH64 5320MHz	
1	Vertical	Fundamental
<p><b>Peak</b></p>	<p>Date: 2020-09-25</p> <p>Site : 03CH07-HY            Condition : PEAK_BE_74 3m HF_ANT_00070962 VERTICAL            Detector : Peak            Project : 052913-02            Mode : 15</p>	<p>Date: 2020-09-25</p> <p>Site : 03CH07-HY            Condition : PEAK(LIN) 3m HF_ANT_00070962 VERTICAL            Detector : Peak            Project : 052913-02            Mode : 15</p>
<p><b>Avg.</b></p>	<p>Date: 2020-09-25</p> <p>Site : 03CH07-HY            Condition : AVG_BE_54 3m HF_ANT_00070962 VERTICAL            Detector : Peak            Project : 052913-02            Mode : 15</p>	<p><b>Left blank</b></p>



**Band 2 5250~5350MHz**  
**WIFI 802.11ac VHT40 (Band Edge @ 3m)**

WIFI	Band 2 5250~5350MHz Band Edge @ 3m	
ANT	802.11ac VHT40 CH62 5310 - L	
1	Horizontal	Fundamental
<b>Peak</b>	<p>Site : 03CH07-HY            Condition : PEAK_BE_74 3m HF_ANT_00075962 HORIZONTAL            RBW:1000.000kHz VBW:3000.000kHz SWT:Auto            Detector : Peak            Project : 052913-02            Mode : 17</p>	<p>Site : 03CH07-HY            Condition : PEAK(LIN) 3m HF_ANT_00075962 HORIZONTAL            RBW:1000.000kHz VBW:3000.000kHz SWT:Auto            Detector : Peak            Project : 052913-02            Mode : 17</p>
<b>Avg.</b>	<p>Site : 03CH07-HY            Condition : AVG_BE_54 3m HF_ANT_00075962 HORIZONTAL            RBW:1000.000kHz VBW:3.000kHz SWT:Auto            Detector : Peak            Project : 052913-02            Mode : 17</p>	<b>Left blank</b>



WIFI	Band 2 5250~5350MHz Band Edge @ 3m	
ANT	802.11ac VHT40 CH62 5310 - R	
1	Horizontal	Fundamental
<p><b>Peak</b></p>	<p>Site : 03CH07-01          Condition : PEAK_BE_74 3m HF_ANT_00070962 HORIZONTAL          Detector : Peak          Project : 052913-02          Mode : 17</p>	<p>Left blank</p>
<p><b>Avg.</b></p>	<p>Site : 03CH07-01          Condition : AVG_BE_54 3m HF_ANT_00070962 HORIZONTAL          Detector : Peak          Project : 052913-02          Mode : 17</p>	<p>Left blank</p>





WIFI	Band 2 5250~5350MHz Band Edge @ 3m	
ANT	802.11ac VHT40 CH62 5310 - L	
1	Vertical	Fundamental
<p><b>Peak</b></p>	<p>Date: 2020-09-25</p> <p>Site : 03CH07-01            Condition : PEAK_BE_74 3m HF_ANT_00075962 VERTICAL            Detector : Peak            Project : 052913-02            Mode : 17</p>	<p>Date: 2020-09-25</p> <p>Site : 03CH07-01            Condition : PEAK(LIN) 3m HF_ANT_00075962 VERTICAL            Detector : Peak            Project : 052913-02            Mode : 17</p>
<p><b>Avg.</b></p>	<p>Date: 2020-09-25</p> <p>Site : 03CH07-01            Condition : AVG_BE_54 3m HF_ANT_00075962 VERTICAL            Detector : Peak            Project : 052913-02            Mode : 17</p>	<p><b>Left blank</b></p>

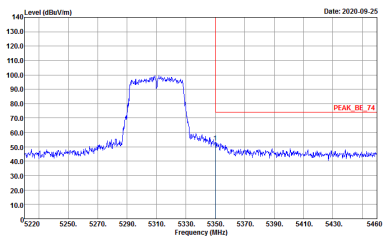
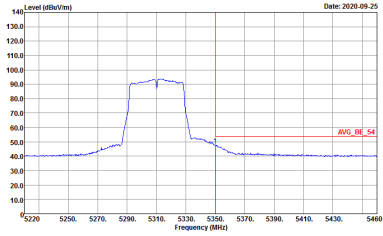

WIFI	Band 2 5250~5350MHz Band Edge @ 3m	
ANT	802.11ac VHT40 CH62 5310 - R	
1	Vertical	Fundamental
<p><b>Peak</b></p>	 <p>Site : 03CH07-01          Condition : PEAK_BE_74 3m HF_ANT_00070962 VERTICAL          Detector : Peak          Project : 052913-02          Mode : 17</p>	<p>Left blank</p>
<p><b>Avg.</b></p>	 <p>Site : 03CH07-01          Condition : AVG_BE_34 3m HF_ANT_00070962 VERTICAL          Detector : Peak          Project : 052913-02          Mode : 17</p>	<p>Left blank</p>

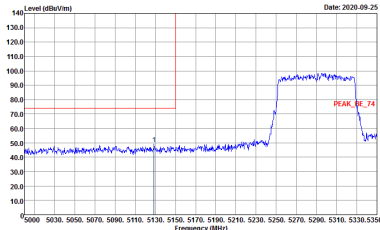
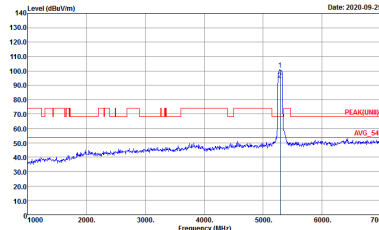
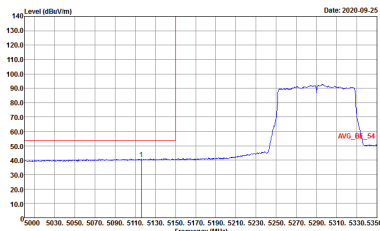

**Band 2 5250~5350MHz**  
**WIFI 802.11ac VHT80 (Band Edge @ 3m)**

WIFI	Band 2 5250~5350MHz Band Edge @ 3m	
ANT	802.11ac VHT80 CH58 5290MHz - L	
1	Horizontal	Fundamental
Peak	 <p>Date: 2020-09-25</p> <p>Site : 03CH07-HY            Condition : PEAK_BE_74 3m HF_ANT_00075962 HORIZONTAL            RBW:1000.000kHz VBW:3000.000kHz SWT:Auto            Detector : Peak            Project : 052913-02            Mode : 18</p>	 <p>Date: 2020-09-25</p> <p>Site : 03CH07-HY            Condition : PEAK(UM) 3m HF_ANT_00075962 HORIZONTAL            RBW:1000.000kHz VBW:3000.000kHz SWT:Auto            Detector : Peak            Project : 052913-02            Mode : 18</p>
Avg.	 <p>Date: 2020-09-25</p> <p>Site : 03CH07-HY            Condition : AVG_BE_54 3m HF_ANT_00075962 HORIZONTAL            RBW:1000.000kHz VBW:3.000kHz SWT:Auto            Detector : Peak            Project : 052913-02            Mode : 18</p>	Left blank

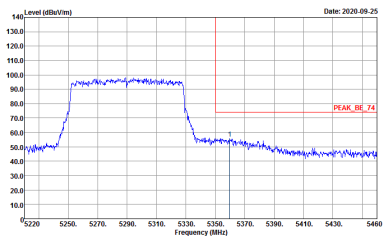
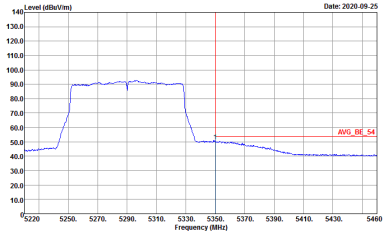

WIFI	Band 2 5250~5350MHz Band Edge @ 3m	
ANT	802.11ac VHT80 CH58 5290MHz - R	
1	Horizontal	Fundamental
Peak	 <p>Site : 03CH07-HY  Condition : PEAK_BE_74 3m HF_ANT_00070962 HORIZONTAL  Detector : Peak  Project : 052913-02  Mode : 1B</p>	Left blank
Avg.	 <p>Site : 03CH07-HY  Condition : AVG_BE_54 3m HF_ANT_00070962 HORIZONTAL  Detector : Peak  Project : 052913-02  Mode : 1B</p>	Left blank



WIFI	Band 2 5250~5350MHz Band Edge @ 3m	
ANT	802.11ac VHT80 CH58 5290MHz - L	
1	Vertical	Fundamental
<p><b>Peak</b></p>	<p>Site : 03CH07-HY            Condition : PEAK_BE_74 3m HF_ANT_00075962 VERTICAL            RBW:1000.000kHz VBW:3000.000kHz SWT:Auto            Detector : Peak            Project : 052913-02            Mode : 18</p>	<p>Site : 03CH07-HY            Condition : PEAK(LIN)_51 3m HF_ANT_00075962 VERTICAL            RBW:1000.000kHz VBW:3000.000kHz SWT:Auto            Detector : Peak            Project : 052913-02            Mode : 18</p>
<p><b>Avg.</b></p>	<p>Site : 03CH07-HY            Condition : AVG_BE_54 3m HF_ANT_00075962 VERTICAL            RBW:1000.000kHz VBW:3000.000kHz SWT:Auto            Detector : Peak            Project : 052913-02            Mode : 18</p>	<p><b>Left blank</b></p>



WIFI	Band 2 5250~5350MHz Band Edge @ 3m	
ANT	802.11ac VHT80 CH58 5290MHz - R	
1	Vertical	Fundamental
<p><b>Peak</b></p>		<p>Left blank</p>
<p><b>Avg.</b></p>		<p>Left blank</p>



**Band 2 - 5250~5350MHz**  
**WIFI 802.11ac VHT20 (Harmonic @ 3m)**

<b>WIFI</b>	<b>Band 2 5250~5350MHz Harmonic @ 3m</b>	
<b>ANT</b>	<b>802.11ac VHT20 CH64 5320MHz</b>	
<b>1</b>	<b>Horizontal</b>	<b>Vertical</b>
<b>Peak</b> <b>Avg.</b>	<p>Site : 03C407-HY          Condition : PEAK(Volts) 3m HF_ANT_00075962 HORIZONTAL          Detector : Peak          Project : 052913-02          Mode : 15</p>	<p>Site : 03C407-HY          Condition : PEAK(Volts) 3m HF_ANT_00075962 VERTICAL          Detector : Peak          Project : 052913-02          Mode : 15</p>



**Band 2 5250~5350MHz  
WIFI 802.11ac VHT40 (Harmonic @ 3m)**

WIFI	Band 2 5250~5350MHz Harmonic @ 3m	
ANT	802.11ac VHT40 CH62 5310	
1	Horizontal	Vertical
<b>Peak Avg.</b>	<p>Site : 03CH07-HY Condition : PEAK(LIN11) 3m HF_ANT_00075962 HORIZONTAL Detector : Peak Project : 052913-02 Mode : 17</p>	<p>Site : 03CH07-HY Condition : PEAK(LIN11) 3m HF_ANT_00075962 VERTICAL Detector : Peak Project : 052913-02 Mode : 17</p>





**Band 2 5250~5350MHz**  
**WIFI 802.11ac VHT80 (Harmonic @ 3m)**

WIFI	Band 2 5250~5350MHz Harmonic @ 3m	
ANT	802.11ac VHT80 CH58 5290MHz	
1	Horizontal	Vertical
Peak Avg.	<p>Date: 2020-09-26</p> <p>Site : 03CH07-HY            Condition : PEAK(LIN11) 3m HF_ANT_00075962 HORIZONTAL            Detector : Peak            Project : 052913-02            Mode : 18</p>	<p>Date: 2020-09-26</p> <p>Site : 03CH07-HY            Condition : PEAK(LIN11) 3m HF_ANT_00075962 VERTICAL            Detector : Peak            Project : 052913-02            Mode : 18</p>



**Band 3 - 5470~5725MHz**  
**WIFI 802.11ac VHT20 (Band Edge @ 3m)**

WIFI	Band 3 5470~5725MHz Band Edge @ 3m	
ANT	802.11ac VHT20 CH140 5700MHz	
1	Horizontal	Fundamental
<b>Peak</b>	<p>Site : 03C407-HY            Condition : PEAK_BE(LN1)_B3 3m HF_ANT_00075962 HORIZONTAL            : RBW:1000.000kHz VBW:3000.000kHz SWT:Auto            Detector : Peak            Project : 052913-02            Mode : 25</p>	<p>Site : 03C407-HY            Condition : PEAK(LN1) 3m HF_ANT_00075962 HORIZONTAL            : RBW:1000.000kHz VBW:3000.000kHz SWT:Auto            Detector : Peak            Project : 052913-02            Mode : 25</p>

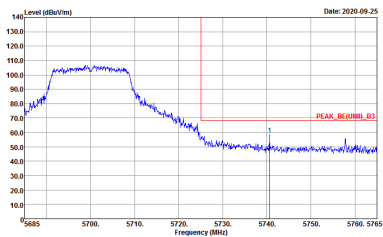
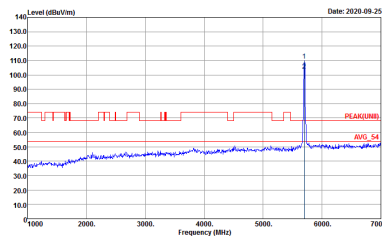

WIFI	Band 3 5470~5725MHz Band Edge @ 3m	
ANT	802.11ac VHT20 CH140 5700MHz	
1	Vertical	Fundamental
Peak	 <p>Date: 2020-09-25</p> <p>Site : 03C407-01          Condition : PEAK_BE(LIN) B3 3m HF_ANT_00075962 VERTICAL          RBW:1000.000kHz VBW:3000.000kHz SWT:Auto          Detector : Peak          Project : 052913-02          Mode : 25</p>	 <p>Date: 2020-09-25</p> <p>Site : 03C407-01          Condition : PEAK(LIN) 3m HF_ANT_00075962 VERTICAL          RBW:1000.000kHz VBW:3000.000kHz SWT:Auto          Detector : Peak          Project : 052913-02          Mode : 25</p>

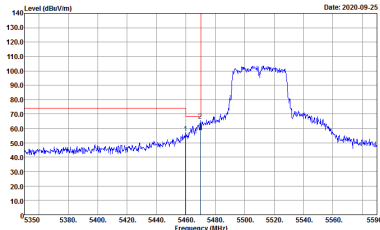
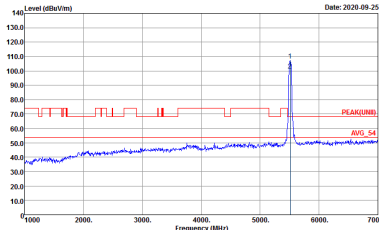
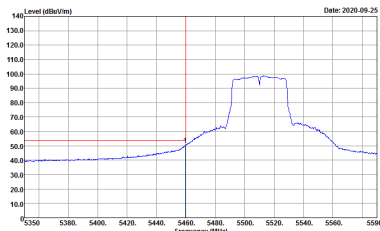

**Band 3 5470~5725MHz**  
**WIFI 802.11ac VHT40 (Band Edge @ 3m)**

WIFI	Band 3 5470~5725MHz Band Edge @ 3m	
ANT	802.11ac VHT40 CH102 5510MHz - L	
1	Horizontal	Fundamental
<p><b>Peak</b></p>	 <p>Site : 03CH07-HY            Condition : PEAK_BE(LNWI)_B3 3m HF_ANT_00075962 HORIZONTAL            RBW:1000.000kHz VBW:3000.000kHz SWT:Auto            Detector : Peak            Project : 052913-02            Mode : 27</p>	 <p>Site : 03CH07-HY            Condition : PEAK(LNWI) 3m HF_ANT_00075962 HORIZONTAL            RBW:1000.000kHz VBW:3000.000kHz SWT:Auto            Detector : Peak            Project : 052913-02            Mode : 27</p>
<p><b>Avg.</b></p>	 <p>Site : 03CH07-HY            Condition : AVG_BE(LNWI)_B3 3m HF_ANT_00075962 HORIZONTAL            RBW:1000.000kHz VBW:3.000kHz SWT:Auto            Detector : Peak            Project : 052913-02            Mode : 27</p>	<p><b>Left blank</b></p>



WIFI	Band 3 5470~5725MHz Band Edge @ 3m	
ANT	802.11ac VHT40 CH102 5510MHz - R	
1	Horizontal	Fundamental
Peak	<p>Site : 03CH07-011 Condition : PEAK_BE(LNII)_B3 3m HF_ANT_00075962 HORIZONTAL Detector : Peak Project : 052913-02 Mode : 27</p>	Left blank

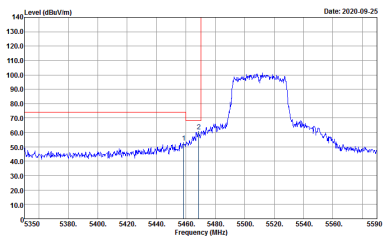
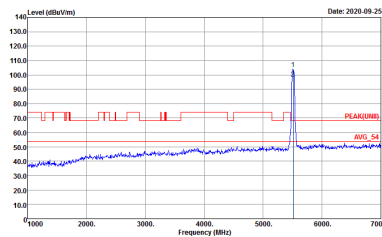
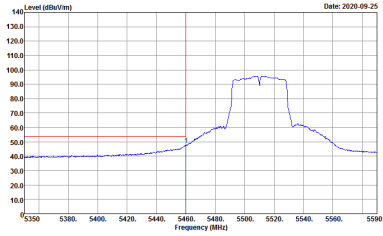

WIFI	Band 3 5470~5725MHz Band Edge @ 3m	
ANT	802.11ac VHT40 CH102 5510MHz - L	
1	Vertical	Fundamental
<p><b>Peak</b></p>	 <p>Date: 2020-09-25</p> <p>Site : 03CH07-HY            Condition : PEAK_BE(LIN1)_B3 3m HF_ANT_00075962 VERTICAL            RBW:1000.000kHz VBW:3000.000kHz SWT:Auto            Detector : Peak            Project : 052913-02            Mode : 27</p>	 <p>Date: 2020-09-25</p> <p>Site : 03CH07-HY            Condition : PEAK(LIN1) 3m HF_ANT_00075962 VERTICAL            RBW:1000.000kHz VBW:3000.000kHz SWT:Auto            Detector : Peak            Project : 052913-02            Mode : 27</p>
<p><b>Avg.</b></p>	 <p>Date: 2020-09-25</p> <p>Site : 03CH07-HY            Condition : AVG_BE(LIN1)_B3 3m HF_ANT_00075962 VERTICAL            RBW:1000.000kHz VBW:3.000kHz SWT:Auto            Detector : Peak            Project : 052913-02            Mode : 27</p>	<p><b>Left blank</b></p>



WIFI	Band 3 5470~5725MHz Band Edge @ 3m	
ANT	802.11ac VHT40 CH102 5510MHz - R	
1	Vertical	Fundamental
Peak	<p>Site : 03CH07-011 Condition : PEAK_BE(UNII)_B3 3m HF_ANT_00075962 VERTICAL Detector : Peak Project : 052913-02 Mode : 27</p>	Left blank

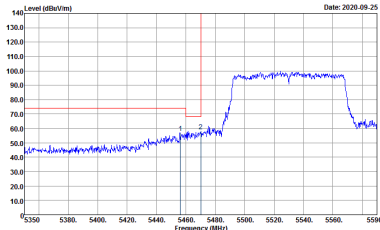
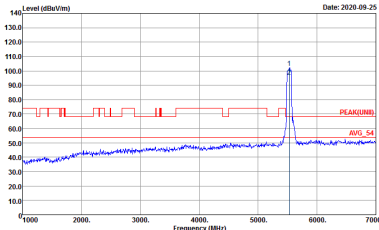
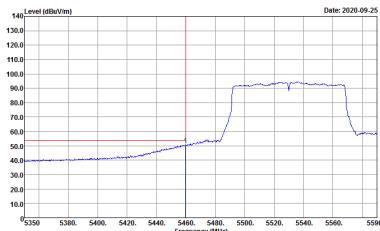

**Band 3 5470~5725MHz  
WIFI 802.11ac VHT80 (Band Edge @ 3m)**

WIFI	Band 3 5470~5725MHz Band Edge @ 3m	
ANT	802.11ac VHT80 CH106 5530MHz - L	
1	Horizontal	Fundamental
<p><b>Peak</b></p>	 <p>Date: 2020-09-25</p> <p>Site : 03CH07-HY Condition : PEAK_BE(LNWI)_B3 3m HF_ANT_00075962 HORIZONTAL RBW:1000.000kHz VBW:3000.000kHz SWT:Auto Detector : Peak Project : 052913-02 Mode : 31</p>	 <p>Date: 2020-09-25</p> <p>Site : 03CH07-HY Condition : PEAK(LNWI) 3m HF_ANT_00075962 HORIZONTAL RBW:1000.000kHz VBW:3000.000kHz SWT:Auto Detector : Peak Project : 052913-02 Mode : 31</p>
<p><b>Avg.</b></p>	 <p>Date: 2020-09-25</p> <p>Site : 03CH07-HY Condition : AVG_BE(LNWI)_B3 3m HF_ANT_00075962 HORIZONTAL RBW:1000.000kHz VBW:3.000kHz SWT:Auto Detector : Peak Project : 052913-02 Mode : 31</p>	<p><b>Left blank</b></p>





WIFI	Band 3 5470~5725MHz Band Edge @ 3m	
ANT	802.11ac VHT80 CH106 5530MHz - R	
1	Horizontal	Fundamental
Peak	<p>Site : 03CH07-011 Condition : PEAK_BE(UNII)_B3 3m HF_ANT_00075962 HORIZONTAL Detector : Peak Project : 052913-02 Mode : 31</p>	Left blank

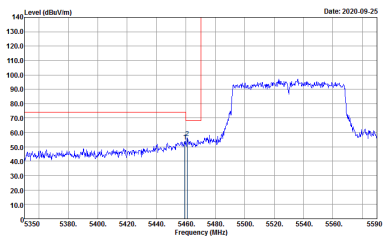
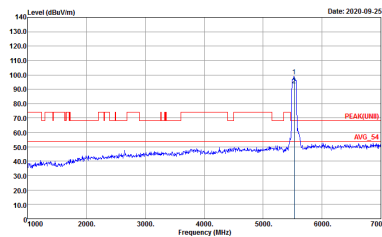

WIFI	Band 3 5470~5725MHz Band Edge @ 3m	
ANT	802.11ac VHT80 CH106 5530MHz - L	
1	Vertical	Fundamental
Peak	 <p>Site : 03CH07-HY            Condition : PEAK_BE(LIN1)_B3 3m HF_ANT_00075962 VERTICAL            RBW:1000.000kHz VBW:3000.000kHz SWT:Auto            Detector : Peak            Project : 052913-02            Mode : 31</p>	 <p>Site : 03CH07-HY            Condition : PEAK(LIN1) 3m HF_ANT_00075962 VERTICAL            RBW:1000.000kHz VBW:3000.000kHz SWT:Auto            Detector : Peak            Project : 052913-02            Mode : 31</p>
Avg.	 <p>Site : 03CH07-HY            Condition : AVG_BE(LIN1)_B3 3m HF_ANT_00075962 VERTICAL            RBW:1000.000kHz VBW:3.000kHz SWT:Auto            Detector : Peak            Project : 052913-02            Mode : 31</p>	Left blank



WIFI	Band 3 5470~5725MHz Band Edge @ 3m	
ANT	802.11ac VHT80 CH106 5530MHz - R	
1	Vertical	Fundamental
Peak	<p>Site : 03CH07-011 Condition : PEAK_BE(UNII)_B3 3m HF_ANT_00075962 VERTICAL Detector : Peak Project : 052913-02 Mode : 31</p>	Left blank



**Band 3 - 5470~5725MHz**  
**WIFI 802.11ac VHT20 (Harmonic @ 3m)**

<b>WIFI</b>	<b>Band 3 5470~5725MHz Harmonic @ 3m</b>	
<b>ANT</b>	<b>802.11ac VHT20 CH140 5700MHz</b>	
<b>1</b>	<b>Horizontal</b>	<b>Vertical</b>
<b>Peak</b> <b>Avg.</b>	<p>Site : 09C407-HY          Condition : PEAK(VOL) 3m HF_ANT_00075962 HORIZONTAL          Detector : Peak          Project : 052913-02          Mode : 25</p>	<p>Site : 09C407-HY          Condition : PEAK(VOL) 3m HF_ANT_00075962 VERTICAL          Detector : Peak          Project : 052913-02          Mode : 25</p>



**Band 3 5470~5725MHz  
WIFI 802.11ac VHT40 (Harmonic @ 3m)**

WIFI	Band 3 5470~5725MHz Harmonic @ 3m	
ANT	802.11ac VHT40 CH102 5510MHz	
1	Horizontal	Vertical
<b>Peak Avg.</b>	<p>Site : 03CH07-HY Condition : PEAK(LIN11) 3m HF_ANT_00075962 HORIZONTAL Detector : Peak Project : 052913-02 Mode : 27</p>	<p>Site : 03CH07-HY Condition : PEAK(LIN11) 3m HF_ANT_00075962 VERTICAL Detector : Peak Project : 052913-02 Mode : 27</p>



**Band 3 5470~5725MHz  
WIFI 802.11ac VHT80 (Harmonic @ 3m)**

WIFI	Band 3 5470~5725MHz Harmonic @ 3m	
ANT	802.11ac VHT80 CH106 5530MHz	
1	Horizontal	Vertical
<b>Peak Avg.</b>	<p>Date: 2020-09-26</p> <p>Site : 03CH07-HY Condition : PEAK(LINII) 3m HF_ANT_00075962 HORIZONTAL Detector : Peak Project : 052913-02 Mode : 31</p>	<p>Date: 2020-09-26</p> <p>Site : 03CH07-HY Condition : PEAK(LINII) 3m HF_ANT_00075962 VERTICAL Detector : Peak Project : 052913-02 Mode : 31</p>



Emission below 1GHz
5GHz WIFI 802.11ac VHT40 (LF)

Table with 2 columns: Horizontal and Vertical. Each column contains a spectral plot of Level (dBuV/m) vs Frequency (MHz) from 50 to 1000 MHz. The plots show a blue signal line and a red limit line. Metadata includes Site: 03CH07-HY, Condition: QP 3m LF-ANT:15419(6) HORIZONTAL, Detector: Peak, Project: 052913-02, Mode: -43.

QP / Peak



### Appendix C. Duty Cycle Plots

Band	Duty Cycle(%)	T(us)	1/T(kHz)	VBW Setting	Duty Factor(dB)
802.11a	98.10	-	-	10Hz	0.08
5GHz 802.11ac VHT20	97.97	1930	0.52	1kHz	0.09
5GHz 802.11ac VHT40	94.95	940	1.06	3kHz	0.23
5GHz 802.11ac VHT80	86.00	430	2.33	3kHz	0.66

