



FCC RADIO TEST REPORT

FCC ID : UZ7MC27BK
Equipment : Mobile computer
Brand Name : Zebra
Model Name : MC27BK
Applicant : Zebra Technologies Corporation
1 Zebra Plaza, Holtsville, NY 11742
Manufacturer : Zebra Technologies Corporation
1 Zebra Plaza, Holtsville, NY 11742
Standard : FCC 47 CFR Part 2, 22(H), 24(E), 27

The product was received on Jul. 20, 2020 and testing was started from Sep. 19, 2020 and completed on Sep. 30, 2020. We, SPORTON INTERNATIONAL INC. EMC & Wireless Communications Laboratory, would like to declare that the tested sample has been evaluated in accordance with the test procedures given in ANSI / TIA-603-E and has been in compliance with the applicable technical standards.

The test results in this report apply exclusively to the tested model / sample. Without written approval of SPORTON INTERNATIONAL INC. EMC & Wireless Communications Laboratory, the test report shall not be reproduced except in full.

Louis Wu

Approved by: Louis Wu

SPORTON INTERNATIONAL INC. EMC & Wireless Communications Laboratory
No. 52, Huaya 1st Rd., Guishan Dist., Taoyuan City, Taiwan (R.O.C.)



Table of Contents

History of this test report.....	3
Summary of Test Result.....	4
1 General Description	6
1.1 Product Feature of Equipment Under Test.....	6
1.2 Product Specification of Equipment Under Test.....	7
1.3 Modification of EUT	7
1.4 Emission Designator.....	8
1.5 Testing Location	9
1.6 Applicable Standards.....	10
2 Test Configuration of Equipment Under Test	11
2.1 Test Mode.....	11
2.2 Connection Diagram of Test System.....	13
2.3 Support Unit used in test configuration and system	13
2.4 Measurement Results Explanation Example.....	13
2.5 Frequency List of Low/Middle/High Channels	14
3 Conducted Test Items.....	17
3.1 Measuring Instruments	17
3.2 Conducted Output Power and ERP/EIRP	18
3.3 Peak-to-Average Ratio	19
3.4 Occupied Bandwidth.....	20
3.5 Conducted Band Edge	21
3.6 Conducted Spurious Emission	23
3.7 Frequency Stability	24
4 Radiated Test Items	25
4.1 Measuring Instruments	25
4.2 Radiated Spurious Emission Measurement	27
5 List of Measuring Equipment.....	28
6 Uncertainty of Evaluation.....	29
Appendix A. Test Results of Conducted Test	
Appendix B. Test Results of ERP/EIRP and Radiated Test	
Appendix C. Test Setup Photographs	



Summary of Test Result

Report Clause	Ref Std. Clause	Test Items	Result (PASS/FAIL)	Remark
3.2	§2.1046	Conducted Output Power	Reporting only	-
	§22.913 (a)(2)	Effective Radiated Power (Band 5)	Pass	
	§24.232 (c) §27.50 (h)(2)	Equivalent Isotropic Radiated Power (Band 2) (Band 7) (Band 38) (Band 41)		
	§27.50 (d)(4)	Equivalent Isotropic Radiated Power (Band 4)		
3.3	§24.232 (d) §27.50 (d)(5)	Peak-to-Average Ratio	Pass	-
3.4	§2.1049	Occupied Bandwidth	Reporting only	-
3.5	§2.1051 §22.917 (a) §24.238 (a) §27.53 (h)	Conducted Band Edge Measurement (Band 2) (Band 4) (Band 5)	Pass	-
	§2.1051 §27.53 (m)(4)	Conducted Band Edge Measurement (Band 7) (Band 38) (Band 41)		
3.6	§2.1051 §22.917 (a) §24.238 (a) §27.53 (h)	Conducted Spurious Emission (Band 2) (Band 4) (Band 5)	Pass	-
	§2.1051 §27.53 (m)(4)	Conducted Spurious Emission (Band 7) (Band 38) (Band 41)		
3.7	§2.1055 §22.355 §24.235 §27.54	Frequency Stability Temperature & Voltage	Pass	-



Report Clause	Ref Std. Clause	Test Items	Result (PASS/FAIL)	Remark
4.2	§2.1053 §22.917 (a) §24.238 (a) §27.53 (h)	Radiated Spurious Emission (Band 2) (Band 4) (Band 5)	Pass	Under limit 8.06 dB at 8016.000 MHz
	§2.1051 §27.53 (m)(4)	Radiated Spurious Emission (Band 7) (Band 38) (Band 41)		

Declaration of Conformity:

The test results with all measurement uncertainty excluded are presented in accordance with the regulation limits or requirements declared by manufacturers.

Comments and Explanations:

The declared of product specification for EUT presented in the report are provided by the manufacturer, and the manufacturer takes all the responsibilities for the accuracy of product specification.

Reviewed by: Wii Chang

Report Producer: Tina Chuang



1 General Description

1.1 Product Feature of Equipment Under Test

Product Feature	
Equipment	Mobile computer
Brand Name	Zebra
Model Name	MC27BK
FCC ID	UZ7MC27BK
EUT supports Radios application	GSM/EGPRS/WCDMA/HSPA/LTE/NFC/GNSS WLAN 11a/b/g/n HT20/HT40 WLAN 11ac VHT20/VHT40/VHT80 Bluetooth BR/EDR/LE
HW Version	EV
SW Version	10-11-31.00-QG-U00-PRD-HEL-04
OS Version	Android 10
MFD	02JUN20
EUT Stage	Engineering sample

Remark: The above EUT's information was declared by manufacturer.

Specification of Accessories				
AC Adapter	Brand Name	Zebra	Part Number	PWR-WUA5V12W0US
Battery	Brand Name	Zebra	Part Number	BT-000418-10
USB Cable (TypeA plug to TypeC plug)	Brand Name	Zebra	Part Number	CBL-TC2X-USBC-01
Trigger Handle	Brand Name	Zebra	Part Number	TRG-MC2X-SNP1-01
Holster	Brand Name	Zebra	Part Number	SG-MC2X-HLSTR-01
Holster	Brand Name	Zebra	Part Number	SG-MC3021212-01R



1.2 Product Specification of Equipment Under Test

Product Specification subjective to this standard	
Tx Frequency	LTE Band 2: 1850.7 MHz ~ 1909.3 MHz LTE Band 4: 1710.7 MHz ~ 1754.3 MHz LTE Band 5: 824.7 MHz ~ 848.3 MHz LTE Band 7: 2502.5 MHz ~ 2567.5 MHz LTE Band 38: 2572.5 MHz ~ 2617.5 MHz LTE Band 41: 2498.5 MHz ~ 2687.5 MHz
Rx Frequency	LTE Band 2: 1930.7 MHz ~ 1989.3 MHz LTE Band 4: 2110.7 MHz ~ 2154.3 MHz LTE Band 5: 869.7 MHz ~ 893.3 MHz LTE Band 7: 2622.5 MHz ~ 2687.5 MHz LTE Band 38: 2572.5 MHz ~ 2617.5 MHz LTE Band 41: 2498.5 MHz ~ 2687.5 MHz
Bandwidth	LTE Band 2: 1.4MHz / 3MHz / 5MHz / 10MHz / 15MHz / 20MHz LTE Band 4: 1.4MHz / 3MHz / 5MHz / 10MHz / 15MHz / 20MHz LTE Band 5: 1.4MHz / 3MHz / 5MHz / 10MHz LTE Band 7: 5MHz / 10MHz / 15MHz / 20MHz LTE Band 38: 5MHz / 10MHz / 15MHz / 20MHz LTE Band 41: 5MHz / 10MHz / 15MHz / 20MHz
Maximum Output Power to Antenna	LTE Band 2: 24.13 dBm LTE Band 4: 23.87 dBm LTE Band 5: 24.13 dBm LTE Band 7: 23.58 dBm LTE Band 38: 23.77 dBm LTE Band 41: 24.01 dBm
Antenna Type	PIFA Antenna
Antenna Gain	LTE Band 2: 3.35 dBi LTE Band 4: 3.04 dBi LTE Band 5: -1.94 dBi LTE Band 7: 2.80 dBi LTE Band 38: 2.80 dBi LTE Band 41: 2.80 dBi
Type of Modulation	QPSK / 16QAM / 64QAM

1.3 Modification of EUT

No modifications are made to the EUT during all test items.



1.4 Emission Designator

LTE Band 2		QPSK			16QAM			64QAM		
BW (MHz)	Frequency Range (MHz)	Emission Designator (99%OBW)	Frequency Tolerance (ppm)	Maximum EIRP(W)	Emission Designator (99%OBW)	Frequency Tolerance (ppm)	Maximum EIRP(W)	Emission Designator (99%OBW)	Frequency Tolerance (ppm)	Maximum EIRP(W)
1.4	1850.7 ~ 1909.3	1M09G7D	-	0.3556	1M10W7D	-	0.3013	-	-	0.2388
3	1851.5 ~ 1908.5	2M71G7D	-	0.3532	2M72W7D	-	0.2967	-	-	0.2393
5	1852.5 ~ 1907.5	4M51G7D	-	0.3597	4M50W7D	-	0.3048	-	-	0.2421
10	1855.0 ~ 1905.0	9M13G7D	0.0097	0.3656	9M03W7D	-	0.3126	-	-	0.2438
15	1857.5 ~ 1902.5	13M4G7D	-	0.3767	13M5W7D	-	0.3199	-	-	0.2472
20	1860.0 ~ 1900.0	18M0G7D	-	0.3828	17M9W7D	-	0.3228	-	-	0.2523
LTE Band 4		QPSK			16QAM			64QAM		
BW (MHz)	Frequency Range (MHz)	Emission Designator (99%OBW)	Frequency Tolerance (ppm)	Maximum EIRP(W)	Emission Designator (99%OBW)	Frequency Tolerance (ppm)	Maximum EIRP(W)	Emission Designator (99%OBW)	Frequency Tolerance (ppm)	Maximum EIRP(W)
1.4	1710.7 ~ 1754.3	1M10G7D	-	0.4887	1M10W7D	-	0.3945	-	-	0.3112
3	1711.5 ~ 1753.5	2M72G7D	-	0.4875	2M73W7D	-	0.3936	-	-	0.3141
5	1712.5 ~ 1752.5	4M50G7D	-	0.4887	4M49W7D	-	0.3999	-	-	0.3126
10	1715.0 ~ 1750.0	9M09G7D	0.0151	0.4853	9M07W7D	-	0.3981	-	-	0.3105
15	1717.5 ~ 1747.5	13M6G7D	-	0.4842	13M5W7D	-	0.3936	-	-	0.3097
20	1720.0 ~ 1745.0	17M9G7D	-	0.4909	17M9W7D	-	0.3981	-	-	0.3112
LTE Band 5		QPSK			16QAM			64QAM		
BW (MHz)	Frequency Range (MHz)	Emission Designator (99%OBW)	Frequency Tolerance (ppm)	Maximum ERP(W)	Emission Designator (99%OBW)	Frequency Tolerance (ppm)	Maximum ERP(W)	Emission Designator (99%OBW)	Frequency Tolerance (ppm)	Maximum ERP(W)
1.4	824.7 ~ 848.3	1M09G7D	-	0.2612	1M09W7D	-	0.2084	-	-	0.1648
3	825.5 ~ 847.5	2M72G7D	-	0.2512	2M75W7D	-	0.2118	-	-	0.1671
5	826.5 ~ 846.5	4M51G7D	-	0.2500	4M50W7D	-	0.2128	-	-	0.1679
10	829.0 ~ 844.0	9M09G7D	0.0175	0.2618	9M05W7D	-	0.2128	-	-	0.1660
LTE Band 7		QPSK			16QAM			64QAM		
BW (MHz)	Frequency Range (MHz)	Emission Designator (99%OBW)	Frequency Tolerance (ppm)	Maximum EIRP(W)	Emission Designator (99%OBW)	Frequency Tolerance (ppm)	Maximum EIRP(W)	Emission Designator (99%OBW)	Frequency Tolerance (ppm)	Maximum EIRP(W)
5	2502.5 ~ 2567.5	4M51G7D	-	0.4246	4M50W7D	-	0.3690	-	-	0.2924
10	2505.0 ~ 2565.0	9M05G7D	0.0044	0.4246	9M03W7D	-	0.3715	-	-	0.2911
15	2507.5 ~ 2562.5	13M4G7D	-	0.4266	13M5W7D	-	0.3556	-	-	0.2904
20	2510.0 ~ 2560.0	17M9G7D	-	0.4345	17M9W7D	-	0.3707	-	-	0.2871



LTE Band 38		QPSK			16QAM			64QAM		
BW (MHz)	Frequency Range (MHz)	Emission Designator (99%OBW)	Frequency Tolerance (ppm)	Maximum EIRP(W)	Emission Designator (99%OBW)	Frequency Tolerance (ppm)	Maximum EIRP(W)	Emission Designator (99%OBW)	Frequency Tolerance (ppm)	Maximum EIRP(W)
5	2572.5 ~ 2617.5	4M51G7D	-	0.4498	4M50W7D	-	0.3681	-	-	0.2679
10	2575.0 ~ 2615.0	9M05G7D	0.0047	0.4426	9M09W7D	-	0.3622	-	-	0.2673
15	2577.5 ~ 2612.5	13M5G7D	-	0.4457	13M5W7D	-	0.3648	-	-	0.2667
20	2580.0 ~ 2610.0	17M9G7D	-	0.4539	17M9W7D	-	0.3622	-	-	0.2649
LTE Band 41		QPSK			16QAM			64QAM		
BW (MHz)	Frequency Range (MHz)	Emission Designator (99%OBW)	Frequency Tolerance (ppm)	Maximum EIRP(W)	Emission Designator (99%OBW)	Frequency Tolerance (ppm)	Maximum EIRP(W)	Emission Designator (99%OBW)	Frequency Tolerance (ppm)	Maximum EIRP(W)
5	2498.5 ~ 2687.5	4M51G7D	-	0.4624	4M49W7D	-	0.3673	-	-	0.2704
10	2501.0 ~ 2685.0	9M03G7D	0.0051	0.4645	9M07W7D	-	0.3724	-	-	0.2685
15	2503.5 ~ 2682.5	13M4G7D	-	0.4645	13M5W7D	-	0.3724	-	-	0.2679
20	2506.0 ~ 2680.0	17M9G7D	-	0.4797	17M9W7D	-	0.3715	-	-	0.2673

1.5 Testing Location

Test Site	SPORTON INTERNATIONAL INC. EMC & Wireless Communications Laboratory	
Test Site Location	No.52, Huaya 1st Rd., Guishan Dist., Taoyuan City, Taiwan (R.O.C.) TEL: +886-3-327-3456 FAX: +886-3-328-4978	
Test Site No.	Sporton Site No.	
	TH05-HY	03CH07-HY
Test Engineer	Bryant Liu	Jesse Wang, Stan Hsieh, Ken Wu
Temperature	22~24°C	23~25°C
Relative Humidity	51~55%	50~56%

Note: The test site complies with ANSI C63.4 2014 requirement.

FCC Designation No.: TW1190



1.6 Applicable Standards

According to the specifications of the manufacturer, the EUT must comply with the requirements of the following standards:

- ♦ ANSI C63.26-2015
- ♦ ANSI / TIA-603-E
- ♦ FCC 47 CFR Part 2, 22(H), 24(E), 27
- ♦ FCC KDB 971168 D01 Power Meas. License Digital Systems v03r01
- ♦ FCC KDB 412172 D01 Determining ERP and EIRP v01r01
- ♦ FCC KDB 414788 D01 Radiated Test Site v01r01.

Remark:

1. All test items were verified and recorded according to the standards and without any deviation during the test.
2. This EUT has also been tested and complied with the requirements of FCC Part 15, Subpart B, recorded in a separate test report.
3. The TAF code is not including all the FCC KDB listed without accreditation.



2 Test Configuration of Equipment Under Test

2.1 Test Mode

Antenna port conducted and radiated test items listed below are performed according to KDB 971168 D01 Power Meas. License Digital Systems v03r01 with maximum output power.

For radiated measurement, pre-scanned in three orthogonal panels, X, Y, Z. The worst cases (Y Plane for LTE Band 2, 4, 5, 7; and Z Plane for LTE Band 38, 41) were recorded in this report.

Test Items	Band	Bandwidth (MHz)						Modulation			RB #			Test Channel		
		1.4	3	5	10	15	20	QPSK	16QAM	64QAM	1	Half	Full	L	M	H
Max. Output Power	2	v	v	v	v	v	v	v	v	v	v	v	v	v	v	v
	4	v	v	v	v	v	v	v	v	v	v	v	v	v	v	v
	5	v	v	v	v	-	-	v	v	v	v	v	v	v	v	v
	7	-	-	v	v	v	v	v	v	v	v	v	v	v	v	v
	38	-	-	v	v	v	v	v	v	v	v	v	v	v	v	v
	41	-	-	v	v	v	v	v	v	v	v	v	v	v	v	v
Peak-to-Average Ratio	2						v	v	v		v		v	v	v	v
	4						v	v	v		v		v	v	v	v
	5				v	-	-	v	v		v		v	v	v	v
	7	-	-				v	v	v		v		v	v	v	v
	38	-	-				v	v	v		v		v	v	v	v
	41	-	-				v	v	v		v		v	v	v	v
26dB and 99% Bandwidth	2	v	v	v	v	v	v	v	v				v	v	v	v
	4	v	v	v	v	v	v	v	v				v	v	v	v
	5	v	v	v	v	-	-	v	v				v	v	v	v
	7	-	-	v	v	v	v	v	v				v	v	v	v
	38	-	-	v	v	v	v	v	v				v	v	v	v
	41	-	-	v	v	v	v	v	v				v	v	v	v
Conducted Band Edge	2	v	v	v	v	v	v	v	v		v		v			v
	4	v	v	v	v	v	v	v	v		v		v			v
	5	v	v	v	v	-	-	v	v		v		v			v
	7	-	-	v	v	v	v	v	v		v		v			v
	38	-	-	v	v	v	v	v	v		v		v			v
	41	-	-	v	v	v	v	v	v		v		v			v



Test Items	Band	Bandwidth (MHz)						Modulation			RB #			Test Channel		
		1.4	3	5	10	15	20	QPSK	16QAM	64QAM	1	Half	Full	L	M	H
Conducted Spurious Emission	2	v	v	v	v	v	v	v	v		v			v	v	v
	4	v	v	v	v	v	v	v	v		v			v	v	v
	5	v	v	v	v	-	-	v	v		v			v	v	v
	7	-	-	v	v	v	v	v	v		v			v	v	v
	38	-	-	v	v	v	v	v	v		v			v	v	v
	41	-	-	v	v	v	v	v	v		v			v	v	v
Frequency Stability	2				v			v					v		v	
	4				v			v					v		v	
	5				v	-	-	v					v		v	
	7	-	-		v			v					v		v	
	38	-	-		v			v					v		v	
	41	-	-		v			v					v		v	
E.R.P / E.I.R.P	2	v	v	v	v	v	v	v	v	v	v			v	v	v
	4	v	v	v	v	v	v	v	v	v	v			v	v	v
	5	v	v	v	v	-	-	v	v	v	v			v	v	v
	7	-	-	v	v	v	v	v	v	v	v			v	v	v
	38	-	-	v	v	v	v	v	v	v	v			v	v	v
	41	-	-	v	v	v	v	v	v	v	v			v	v	v
Radiated Spurious Emission	2	Worst Case												v	v	v
	4	Worst Case												v	v	v
	5	Worst Case												v	v	v
	7	Worst Case												v	v	v
	38	Worst Case												v	v	v
	41	Worst Case												v	v	v
Remark	1. The mark "v " means that this configuration is chosen for testing 2. The mark "- " means that this bandwidth is not supported. 3. The device is investigated from 30MHz to 10 times of fundamental signal for radiated spurious emission test under different RB size/offset and modulations in exploratory test. Subsequently, only the worst case emissions are reported.															

2.2 Connection Diagram of Test System

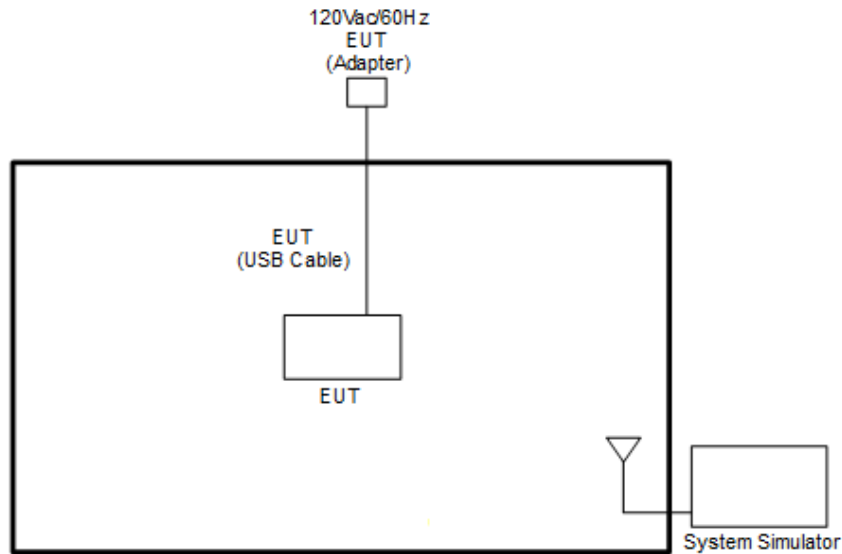

2.3 Support Unit used in test configuration and system

Item	Equipment	Brand Name	Model No.	FCC ID	Data Cable	Power Cord
1.	System Simulator	Anritsu	MT8820C	N/A	N/A	Unshielded, 1.8 m

2.4 Measurement Results Explanation Example

For all conducted test items:

The offset level is set in the spectrum analyzer to compensate the RF cable loss and attenuator factor between EUT conducted output port and spectrum analyzer. With the offset compensation, the spectrum analyzer reading level is exactly the EUT RF output level.

The spectrum analyzer offset is derived from RF cable loss and attenuator factor.

Offset = RF cable loss + attenuator factor.

Following shows an offset computation example with cable loss 4.2 dB and 10dB attenuator.

Example :

$$\begin{aligned} \text{Offset(dB)} &= \text{RF cable loss(dB)} + \text{attenuator factor(dB)}. \\ &= 4.2 + 10 = 14.2 \text{ (dB)} \end{aligned}$$



2.5 Frequency List of Low/Middle/High Channels

LTE Band 2 Channel and Frequency List				
BW [MHz]	Channel/Frequency(MHz)	Lowest	Middle	Highest
20	Channel	18700	18900	19100
	Frequency	1860	1880	1900
15	Channel	18675	18900	19125
	Frequency	1857.5	1880	1902.5
10	Channel	18650	18900	19150
	Frequency	1855	1880	1905
5	Channel	18625	18900	19175
	Frequency	1852.5	1880	1907.5
3	Channel	18615	18900	19185
	Frequency	1851.5	1880	1908.5
1.4	Channel	18607	18900	19193
	Frequency	1850.7	1880	1909.3

LTE Band 4 Channel and Frequency List				
BW [MHz]	Channel/Frequency(MHz)	Lowest	Middle	Highest
20	Channel	20050	20175	20300
	Frequency	1720	1732.5	1745
15	Channel	20025	20175	20325
	Frequency	1717.5	1732.5	1747.5
10	Channel	20000	20175	20350
	Frequency	1715	1732.5	1750
5	Channel	19975	20175	20375
	Frequency	1712.5	1732.5	1752.5
3	Channel	19965	20175	20385
	Frequency	1711.5	1732.5	1753.5
1.4	Channel	19957	20175	20393
	Frequency	1710.7	1732.5	1754.3



LTE Band 5 Channel and Frequency List				
BW [MHz]	Channel/Frequency(MHz)	Lowest	Middle	Highest
10	Channel	20450	20525	20600
	Frequency	829	836.5	844
5	Channel	20425	20525	20625
	Frequency	826.5	836.5	846.5
3	Channel	20415	20525	20635
	Frequency	825.5	836.5	847.5
1.4	Channel	20407	20525	20643
	Frequency	824.7	836.5	848.3

LTE Band 7 Channel and Frequency List				
BW [MHz]	Channel/Frequency(MHz)	Lowest	Middle	Highest
20	Channel	20850	21100	21350
	Frequency	2510	2535	2560
15	Channel	20825	21100	21375
	Frequency	2507.5	2535	2562.5
10	Channel	20800	21100	21400
	Frequency	2505	2535	2565
5	Channel	20775	21100	21425
	Frequency	2502.5	2535	2567.5



LTE Band 38 Channel and Frequency List				
BW [MHz]	Channel/Frequency(MHz)	Lowest	Middle	Highest
20	Channel	37850	38000	38150
	Frequency	2580.0	2595.0	2610.0
15	Channel	37825	38000	38175
	Frequency	2577.5	2595.0	2612.5
10	Channel	37800	38000	38200
	Frequency	2575.0	2595.0	2615.0
5	Channel	37775	38000	38225
	Frequency	2572.5	2595.0	2617.5

LTE Band 41 Channel and Frequency List				
BW [MHz]	Channel/Frequency(MHz)	Lowest	Middle	Highest
20	Channel	39750	40620	41490
	Frequency	2506.0	2593.0	2680.0
15	Channel	39725	40620	41515
	Frequency	2503.5	2593.0	2682.5
10	Channel	39700	40620	41540
	Frequency	2501.0	2593.0	2685.0
5	Channel	39675	40620	41565
	Frequency	2498.5	2593.0	2687.5

3 Conducted Test Items

3.1 Measuring Instruments

See list of measuring instruments of this test report.

3.1.1 Test Setup

3.1.2 Conducted Output Power

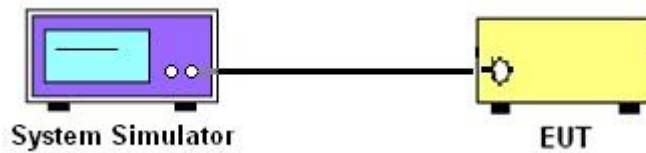

3.1.3 Peak-to-Average Ratio, Occupied Bandwidth ,Conducted Band-Edge and Conducted Spurious Emission

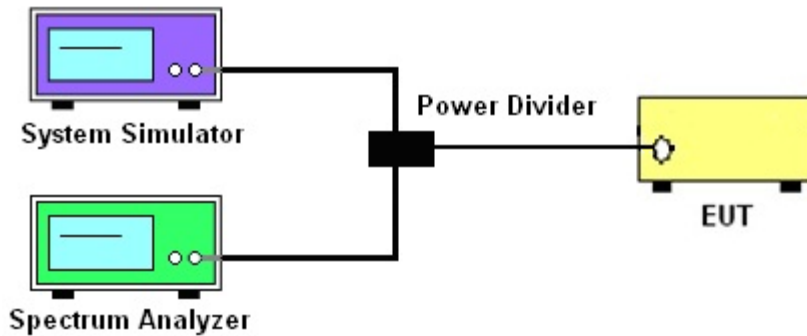

3.1.4 Frequency Stability

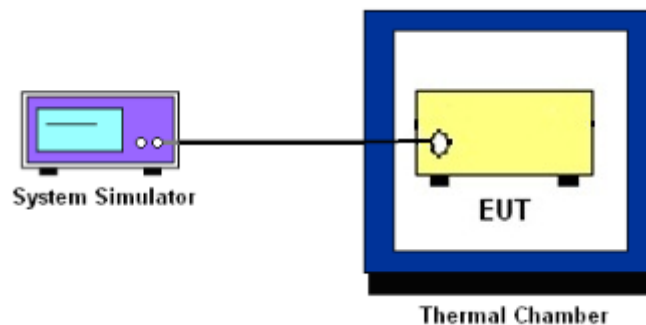

3.1.5 Test Result of Conducted Test

Please refer to Appendix A.



3.2 Conducted Output Power and ERP/EIRP

3.2.1 Description of the Conducted Output Power Measurement and ERP/EIRP Measurement

A system simulator was used to establish communication with the EUT. Its parameters were set to force the EUT transmitting at maximum output power. The measured power in the radio frequency on the transmitter output terminals shall be reported.

The ERP of mobile transmitters must not exceed 7 Watts for LTE Band 5

The EIRP of mobile transmitters must not exceed 2 Watts for LTE Band 2 and Band 7 and Band 38 and Band 41

The EIRP of mobile transmitters must not exceed 1 Watts for LTE Band 4

According to KDB 412172 D01 Power Approach,

$EIRP = P_T + G_T - L_C$, $ERP = EIRP - 2.15$, where

P_T = transmitter output power in dBm

G_T = gain of the transmitting antenna in dBi

L_C = signal attenuation in the connecting cable between the transmitter and antenna in dB

3.2.2 Test Procedures

1. The transmitter output port was connected to the system simulator.
2. Set EUT at maximum power through the system simulator.
3. Select lowest, middle, and highest channels for each band and different modulation.
4. Measure and record the power level from the system simulator.



3.3 Peak-to-Average Ratio

3.3.1 Description of the PAR Measurement

Power Complementary Cumulative Distribution Function (CCDF) curves provide a means for characterizing the power peaks of a digitally modulated signal on a statistical basis. A CCDF curve depicts the probability of the peak signal amplitude exceeding the average power level. Most contemporary measurement instrumentation include the capability to produce CCDF curves for an input signal provided that the instrument's resolution bandwidth can be set wide enough to accommodate the entire input signal bandwidth. In measuring transmissions in this band using an average power technique, the peak-to-average ratio (PAR) of the transmission may not exceed 13 dB.

3.3.2 Test Procedures

The testing follows ANSI C63.26-2015 Section 5.2.6

1. The EUT was connected to spectrum and system simulator via a power divider.
2. Set the CCDF (Complementary Cumulative Distribution Function) option in spectrum analyzer.
3. The highest RF powers were measured and recorded the maximum PAPR level associated with a probability of 0.1 %.
4. Record the deviation as Peak to Average Ratio.



3.4 Occupied Bandwidth

3.4.1 Description of Occupied Bandwidth Measurement

The occupied bandwidth is the width of a frequency band such that, below the lower and above the upper frequency limits, the mean powers emitted are each equal to a specified percentage 0.5% of the total mean transmitted power.

The 26 dB emission bandwidth is defined as the frequency range between two points, one above and one below the carrier frequency, at which the spectral density of the emission is attenuated 26 dB below the maximum in-band spectral density of the modulated signal. Spectral density (power per unit bandwidth) is to be measured with a detector of resolution bandwidth equal to approximately 1.0% of the emission bandwidth.

3.4.2 Test Procedures

The testing follows ANSI C63.26-2015 Section 5.4.3 (26dB) and Section 5.4.4 (99OB)

1. The EUT was connected to spectrum analyzer and system simulator via a power divider.
2. The spectrum analyzer center frequency is set to the nominal EUT channel center frequency. The span range for the spectrum analyzer shall be between two and five times the anticipated OBW.
3. The nominal resolution bandwidth (RBW) shall be in the range of 1 to 5 % of the anticipated OBW, and the VBW shall be at least 3 times the RBW.
4. Set the detection mode to peak, and the trace mode to max hold.
5. Determine the reference value: Set the EUT to transmit a modulated signal. Allow the trace to stabilize. Set the spectrum analyzer marker to the highest level of the displayed trace.
(this is the reference value)
6. Determine the “-26 dB down amplitude” as equal to (Reference Value – X).
7. Place two markers, one at the lowest and the other at the highest frequency of the envelope of the spectral display such that each marker is at or slightly below the “-X dB down amplitude” determined in step 6. If a marker is below this “-X dB down amplitude” value it shall be placed as close as possible to this value. The OBW is the positive frequency difference between the two markers.
8. Use the 99 % power bandwidth function of the spectrum analyzer and report the measured bandwidth.



3.5 Conducted Band Edge

3.5.1 Description of Conducted Band Edge Measurement

22.917(a)

For operations in the 824 – 849 MHz band, the FCC limit is $43 + 10\log_{10}(P[\text{Watts}])$ dB below the transmitter power $P(\text{Watts})$ in a 100kHz bandwidth. However, in the 1MHz bands immediately outside and adjacent to the licensee's frequency block, a resolution bandwidth of at least one percent of the emission bandwidth of the fundamental emission of the transmitter may be employed.

24.238 (a)

For operations in the 1850-1910 and 1930-1990 MHz band, the FCC limit is $43 + 10\log_{10}(P[\text{Watts}])$ dB below the transmitter power $P(\text{Watts})$ in a 1MHz bandwidth. However, in the 1 MHz bands immediately outside and adjacent to the frequency block a resolution bandwidth of at least one percent of the emission bandwidth of the fundamental emission of the transmitter may be employed.

27.53 (h)

For operations in the 1710 – 1755 MHz band, 1755-1780 MHz, the FCC limit is $43 + 10\log_{10}(P[\text{Watts}])$ dB below the transmitter power $P(\text{Watts})$ in a 1 MHz bandwidth. However, in the 1MHz bands immediately outside and adjacent to the licensee's frequency block, a resolution bandwidth of at least one percent of the emission bandwidth of the fundamental emission of the transmitter may be employed.

**27.53(m)(4)**

For mobile digital stations, the attenuation factor shall be not less than $40 + 10 \log (P)$ dB on all frequencies between the channel edge and 5 megahertz from the channel edge, $43 + 10 \log (P)$ dB on all frequencies between 5 megahertz and X megahertz from the channel edge, and $55 + 10 \log (P)$ dB on all frequencies more than X megahertz from the channel edge, where X is the greater of 6 megahertz or the actual emission bandwidth as defined in paragraph (m)(6) of this section. In addition, the attenuation factor shall not be less that $43 + 10 \log (P)$ dB on all frequencies between 2490.5 MHz and 2496 MHz and $55 + 10 \log (P)$ dB at or below 2490.5 MHz. Mobile Satellite Service licensees operating on frequencies below 2495 MHz may also submit a documented interference complaint against BRS licensees operating on channel BRS Channel 1 on the same terms and conditions as adjacent channel BRS or EBS licensees.

3.5.2 Test Procedures

The testing follows FCC KDB 971168 D01 v03r01 Section 6.1.

1. The EUT was connected to spectrum analyzer and system simulator via a power divider.
2. The band edges of low and high channels for the highest RF powers were measured.
3. Set RBW \geq 1% EBW in the 1MHz band immediately outside and adjacent to the band edge.
4. Beyond the 1 MHz band from the band edge, RBW=1MHz was used.
5. Set spectrum analyzer with RMS detector.
6. The RF fundamental frequency should be excluded against the limit line in the operating frequency band.
7. Checked that all the results comply with the emission limit line.

The limit line is derived from $43 + 10\log(P)$ dB below the transmitter power P(Watts)

For LTE Band 7, 38, 41

The other 40 dB, and 55 dB have additionally applied same calculation above.



3.6 Conducted Spurious Emission

3.6.1 Description of Conducted Spurious Emission Measurement

The power of any emission outside of the authorized operating frequency ranges must be lower than the transmitter power (P) by a factor of at least $43 + 10 \log (P)$ dB.

For LTE Band 7, 38, 41

The power of any emission outside of the authorized operating frequency ranges must be lower than the transmitter power (P) by a factor of at least $55 + 10 \log (P)$ dB.

It is measured by means of a calibrated spectrum analyzer and scanned from 30 MHz up to a frequency including its 10th harmonic.

3.6.2 Test Procedures

The testing follows FCC KDB 971168 D01 v03r01 Section 6.1.

1. The EUT was connected to spectrum analyzer and system simulator via a power divider.
2. The RF output of EUT was connected to the spectrum analyzer by RF cable and attenuator.
The path loss was compensated to the results for each measurement.
3. The middle channel for the highest RF power within the transmitting frequency was measured.
4. The conducted spurious emission for the whole frequency range was taken.
5. Make the measurement with the spectrum analyzer's RBW = 1MHz, VBW = 3MHz.
6. Set spectrum analyzer with RMS detector.
7. Taking the record of maximum spurious emission.
8. The RF fundamental frequency should be excluded against the limit line in the operating frequency band.
9. The limit line is derived from $43 + 10\log(P)$ dB below the transmitter power P(Watts)
For LTE Band 7, 38, 41
The limit line is derived from $55 + 10\log(P)$ dB below the transmitter power P(Watts)



3.7 Frequency Stability

3.7.1 Description of Frequency Stability Measurement

22.355

The frequency stability shall be measured by variation of ambient temperature and variation of primary supply voltage to ensure that the fundamental emission stays within the authorized frequency block. The frequency stability of the transmitter shall be maintained within $\pm 0.00025\%$ ($\pm 2.5\text{ppm}$) of the center frequency.

24.235 & 27.54

The frequency stability shall be sufficient to ensure that the fundamental emission stays within the authorized frequency block.

3.7.2 Test Procedures for Temperature Variation

The testing follows FCC KDB 971168 D01 v03r01 Section 9.0.

1. The EUT was set up in the thermal chamber and connected with the system simulator.
2. With power OFF, the temperature was decreased to -30°C and the EUT was stabilized before testing. Power was applied and the maximum change in frequency was recorded within one minute.
3. With power OFF, the temperature was raised in 10°C step up to 50°C . The EUT was stabilized at each step for at least half an hour. Power was applied and the maximum frequency change was recorded within one minute.

3.7.3 Test Procedures for Voltage Variation

The testing follows FCC KDB 971168 D01 v03r01 Section 9.0.

1. The EUT was placed in a temperature chamber at $20\pm 5^{\circ}\text{C}$ and connected with the system simulator.
2. The power supply voltage to the EUT was varied from 85% to 115% of the nominal value measured at the input to the EUT.
3. The variation in frequency was measured for the worst case.

4 Radiated Test Items

4.1 Measuring Instruments

See list of measuring instruments of this test report.

4.1.1 Test Setup

For radiated test below 30MHz

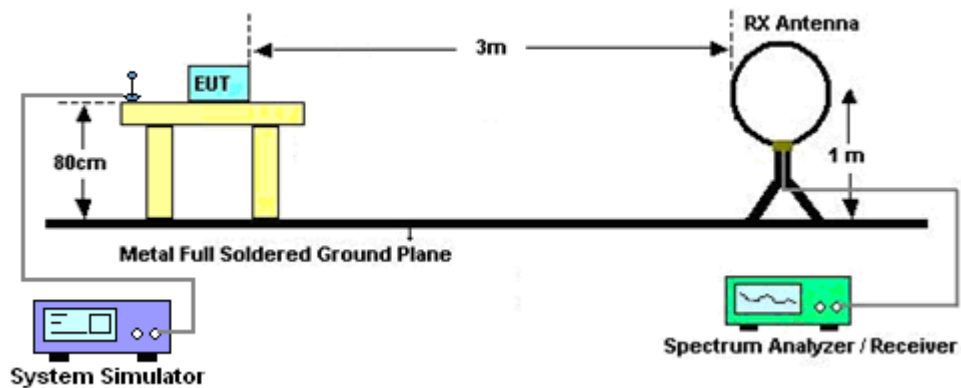

For radiated test from 30MHz to 1GHz

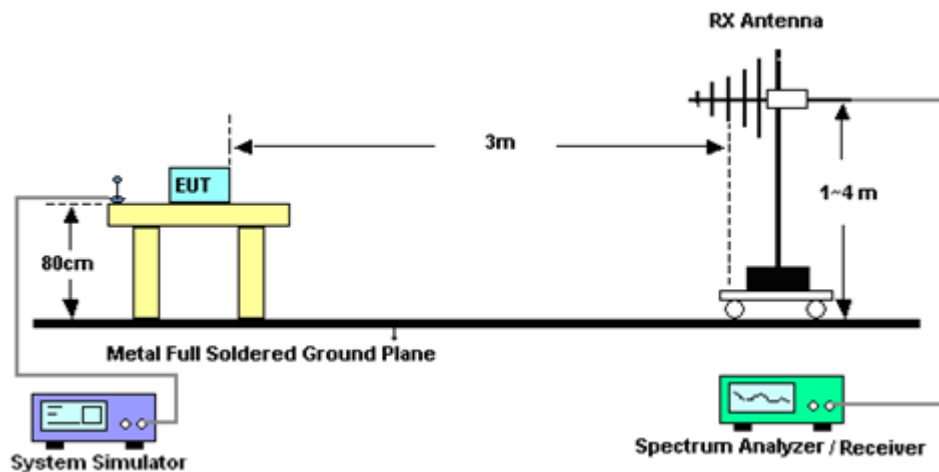

For radiated test above 1GHz

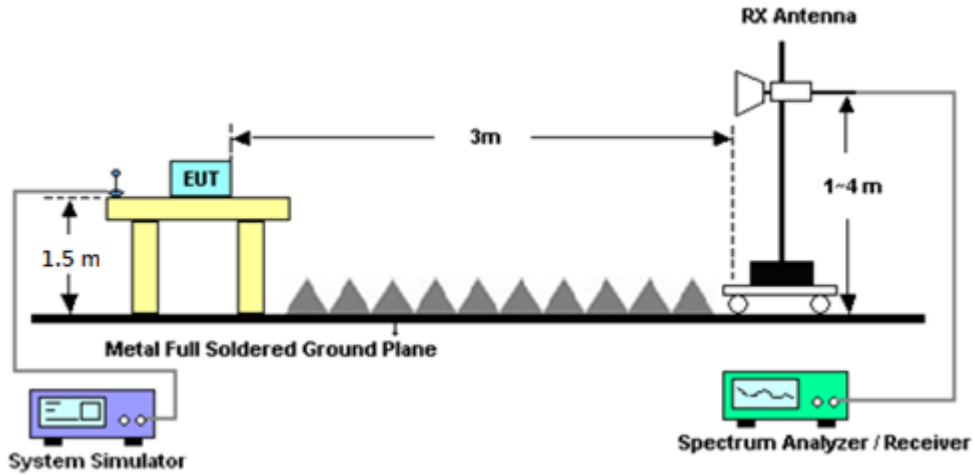

4.1.2 Test Result of Radiated Test

Please refer to Appendix B.

Note:

The low frequency, which started from 9 kHz to 30MHz, was pre-scanned and the result which was 20dB lower than the limit line was not reported.

There is a comparison data of both open-field test site and alternative test site - semi-Anechoic chamber according to 414788 D01 Radiated Test Site v01r01, and the result came out very similar.



4.2 Radiated Spurious Emission Measurement

4.2.1 Description of Radiated Spurious Emission Measurement

The radiated spurious emission was measured by substitution method according to ANSI / TIA-603-E. The power of any emission outside of the authorized operating frequency ranges must be attenuated below the transmitter power (P) by a factor of at least $43 + 10 \log (P)$ dB.

For LTE Band 7, 38, 41

The power of any emission outside of the authorized operating frequency ranges must be attenuated below the transmitter power (P) by a factor of at least $55 + 10 \log (P)$ dB.

The spectrum is scanned from 30 MHz up to a frequency including its 10th harmonic.

4.2.2 Test Procedures

The testing follows FCC KDB 971168 D01 v03r01 Section 7 and ANSI / TIA-603-E Section 2.2.12.

1. The EUT was placed on a turntable with 0.8 meter for frequency below 1GHz and 1.5 meter for frequency above 1GHz respectively above ground.
2. The EUT was set 3 meters from the receiving antenna, which was mounted on the antenna tower.
3. The table was rotated 360 degrees to determine the position of the highest spurious emission.
4. The height of the receiving antenna is varied between one meter and four meters to search the maximum spurious emission for both horizontal and vertical polarizations.
5. Make the measurement with the spectrum analyzer's RBW = 1MHz, VBW = 3MHz, taking the record of maximum spurious emission.
6. A horn antenna was substituted in place of the EUT and was driven by a signal generator.
7. Tune the output power of signal generator to the same emission level with EUT maximum spurious emission.
8. Taking the record of output power at antenna port.
9. Repeat step 7 to step 8 for another polarization.
10. The RF fundamental frequency should be excluded against the limit line in the operating frequency band.

The limit line is derived from $43 + 10\log(P)$ dB below the transmitter power P(Watts)

For LTE Band 7, 38, 41

The limit line is derived from $55 + 10\log(P)$ dB below the transmitter power P(Watts)

EIRP (dBm) = S.G. Power – Tx Cable Loss + Tx Antenna Gain

ERP (dBm) = EIRP - 2.15



5 List of Measuring Equipment

Instrument	Brand Name	Model No.	Serial No.	Characteristics	Calibration Date	Test Date	Due Date	Remark
Base Station (Measure)	Anritsu	MT8821C	6262002534 1	N/A	Oct. 24, 2019	Sep. 19, 2020~ Sep. 23, 2020	Oct. 23, 2020	Conducted (TH05-HY)
Spectrum Analyzer	Rohde & Schwarz	FSV40	101397	10Hz~40GHz	Nov. 15, 2019	Sep. 19, 2020~ Sep. 23, 2020	Nov. 14, 2020	Conducted (TH05-HY)
Temperature Chamber	ESPEC	SU-241	92003713	-30°C~95°C	May 15, 2020	Sep. 19, 2020~ Sep. 23, 2020	May 14, 2021	Conducted (TH05-HY)
Programmable Power Supply	GW Instek	PSS-2005	EL890094	1V~20V 0.5A~5A	Oct. 09, 2019	Sep. 19, 2020~ Sep. 23, 2020	Oct. 08, 2020	Conducted (TH05-HY)
Coupler	Warison	20dB 25W SMA Directional Coupler	#A	1-18GHz	Jan. 13, 2020	Sep. 19, 2020~ Sep. 23, 2020	Jan. 12, 2021	Conducted (TH05-HY)
Bilog Antenna	TESEQ	CBL 6111D & 00800N1D01N -06	35419 & 03	30MHz~1GHz	Apr. 29, 2020	Sep. 26, 2020~ Oct. 02, 2020	Apr. 28, 2021	Radiation (03CH07-HY)
Double Ridge Horn Antenna	ESCO	3117	00075962	1GHz ~ 18GHz	Dec. 06, 2019	Sep. 26, 2020~ Sep. 30, 2020	Dec. 05, 2020	Radiation (03CH07-HY)
EMI Test Receiver	Agilent	N9038A(MXE)	MY53290053	20Hz~26.5GHz	May 21, 2020	Sep. 26, 2020~ Sep. 30, 2020	May 20, 2021	Radiation (03CH07-HY)
Spectrum Analyzer	Agilent	N9030A	MY52350276	3Hz~44GHz	Jun. 09, 2020	Sep. 26, 2020~ Sep. 30, 2020	Jun. 08, 2021	Radiation (03CH07-HY)
Preamplifier	COM-POWER	PA-103A	161241	10MHz~1GHz	May 19, 2020	Sep. 26, 2020~ Sep. 30, 2020	May 18, 2021	Radiation (03CH07-HY)
Preamplifier	Agilent	8449B	3008A02362	1GHz~26.5GHz	Nov. 01, 2019	Sep. 26, 2020~ Sep. 30, 2020	Oct. 31, 2020	Radiation (03CH07-HY)
RF Cable	HUBER + SUHNER	SUCOFLEX 102	MY2858/2,80 1606/2	18GHz~40GHz	Feb. 25, 2020	Sep. 26, 2020~ Sep. 30, 2020	Feb. 24, 2021	Radiation (03CH07-HY)
RF Cable	HUBER + SUHNER	SUCOFLEX 104	MY28655/4, MY24971/4, MY15682/4	30MHz~1GHz	Feb. 25, 2020	Sep. 26, 2020~ Sep. 30, 2020	Feb. 24, 2021	Radiation (03CH07-HY)
RF Cable	HUBER + SUHNER	SUCOFLEX 104	MY28655/4, MY24971/4, MY15682/4	1GHz~18GHz	Feb. 25, 2020	Sep. 26, 2020~ Sep. 30, 2020	Feb. 24, 2021	Radiation (03CH07-HY)
Controller	ChainTek	Chaintek 3000	N/A	Control Turn table	N/A	Sep. 26, 2020~ Sep. 30, 2020	N/A	Radiation (03CH07-HY)
Controller	Max-Full	MF7802	MF78020836 8	Control Ant Mast	N/A	Sep. 26, 2020~ Sep. 30, 2020	N/A	Radiation (03CH07-HY)
Antenna Mast	Max-Full	MFA520BS	N/A	1m~4m	N/A	Sep. 26, 2020~ Sep. 30, 2020	N/A	Radiation (03CH07-HY)
Turn Table	ChainTek	Chaintek 3000	N/A	0~360 Degree	N/A	Sep. 26, 2020~ Sep. 30, 2020	N/A	Radiation (03CH07-HY)
USB Data Logger	TECPEL	TR-32	HE17XB2495	N/A	N/A	Sep. 26, 2020~ Sep. 30, 2020	N/A	Radiation (03CH07-HY)
Horn Antenna	EMCO	3117	00143261	1GHz~18GHz	Jan. 10, 2020	Sep. 26, 2020~ Sep. 30, 2020	Jan. 09, 2021	Radiation (03CH07-HY)
SHF-EHF Horn Antenna	SCHWARZBE CK	BBHA 9170	BBHA917025 1	18GHz~40GHz	Nov. 26, 2019	Sep. 26, 2020~ Sep. 30, 2020	Nov. 25, 2020	Radiation (03CH07-HY)
Preamplifier	EMEC	EM18G40G	060715	18GHz~40GHz	Dec. 13, 2019	Sep. 26, 2020~ Sep. 30, 2020	Dec. 12, 2020	Radiation (03CH07-HY)
Software	Audix	E3 6.2009-8-24	N/A	N/A	N/A	Sep. 26, 2020~ Sep. 30, 2020	N/A	Radiation (03CH07-HY)
Signal Generator	Anritsu	MG3710A	6261943042	2G / 3G / LTE / 5G FR1	May 10, 2020	Sep. 26, 2020~ Sep. 30, 2020	May 09, 2021	Radiation (03CH07-HY)



6 Uncertainty of Evaluation

Uncertainty of Radiated Emission Measurement (30 MHz ~ 1000 MHz)

Measuring Uncertainty for a Level of Confidence of 95% ($U = 2Uc(y)$)	3.35
---	------

Uncertainty of Radiated Emission Measurement (1 GHz ~ 18 GHz)

Measuring Uncertainty for a Level of Confidence of 95% ($U = 2Uc(y)$)	3.81
---	------

Uncertainty of Radiated Emission Measurement (18 GHz ~ 40 GHz)

Measuring Uncertainty for a Level of Confidence of 95% ($U = 2Uc(y)$)	4.85
---	------



Appendix A. Test Results of Conducted Test

Conducted Output Power(Average power)

LTE Band 2 Maximum Average Power [dBm]						
BW [MHz]	RB Size	RB Offset	Mod	Lowest	Middle	Highest
20	1	0	QPSK	23.99	24.13	24.12
20	1	49		23.92	24.00	23.92
20	1	99		23.81	23.87	23.83
20	50	0		23.08	23.09	22.99
20	50	24		22.99	23.02	22.98
20	50	50		22.93	23.04	22.96
20	100	0		23.04	23.05	22.90
20	1	0	16-QAM	23.39	23.37	23.17
20	1	49		23.20	23.23	23.14
20	1	99		23.06	23.18	23.02
20	50	0		22.16	22.15	21.96
20	50	24		22.20	22.14	22.14
20	50	50		22.08	22.08	22.07
20	100	0		22.10	22.14	21.96
20	1	0	64-QAM	22.31	22.32	22.08
20	1	49		22.22	22.25	22.22
20	1	99		22.08	22.21	22.00
20	50	0		21.14	21.17	21.03
20	50	24		21.20	21.17	21.08
20	50	50		21.10	21.08	21.06
20	100	0		21.12	21.14	21.04
15	1	0	QPSK	23.94	24.01	24.06
15	1	37		23.79	23.96	23.80
15	1	74		23.69	23.75	23.80
15	36	0		22.95	22.99	22.82
15	36	20		22.94	22.99	22.85
15	36	39		22.84	22.91	22.90
15	75	0		22.97	22.91	22.79
15	1	0	16-QAM	23.35	23.27	23.07
15	1	37		23.14	23.17	23.09
15	1	74		23.00	23.06	22.90
15	36	0		22.11	22.08	21.87
15	36	20		22.10	22.02	22.05
15	36	39		21.99	22.05	21.95
15	75	0		22.03	22.05	21.84
15	1	0	64-QAM	22.20	22.23	22.04
15	1	37		22.14	22.13	22.18
15	1	74		21.98	22.10	21.87
15	36	0		21.05	21.06	20.99
15	36	20		21.08	21.07	20.99
15	36	39		21.00	20.98	20.96
15	75	0		21.02	21.11	20.92



LTE Band 2 Maximum Average Power [dBm]						
BW [MHz]	RB Size	RB Offset	Mod	Lowest	Middle	Highest
10	1	0	QPSK	23.89	23.90	23.93
10	1	25		23.76	23.92	23.77
10	1	49		23.64	23.64	23.68
10	25	0		22.91	22.95	22.75
10	25	12		22.88	22.89	22.72
10	25	25		22.71	22.83	22.80
10	50	0		22.92	22.87	22.69
10	1	0	16-QAM	23.25	23.15	22.94
10	1	25		23.05	23.05	22.98
10	1	49		22.91	23.02	22.82
10	25	0		22.05	21.96	21.74
10	25	12		22.03	21.90	21.93
10	25	25		21.96	21.93	21.90
10	50	0		21.98	22.01	21.81
10	1	0	64-QAM	22.17	22.12	21.94
10	1	25		22.04	22.09	22.06
10	1	49		21.95	22.04	21.84
10	25	0		21.01	21.01	20.95
10	25	12		21.02	20.99	20.91
10	25	25		20.91	20.94	20.84
10	50	0		20.96	20.99	20.83
5	1	0	QPSK	23.81	23.85	23.86
5	1	12		23.63	23.85	23.71
5	1	24		23.56	23.61	23.58
5	12	0		22.88	22.83	22.67
5	12	7		22.77	22.86	22.65
5	12	13		22.62	22.71	22.74
5	25	0		22.86	22.84	22.63
5	1	0	16-QAM	23.14	23.06	22.82
5	1	12		22.95	22.95	22.86
5	1	24		22.84	22.96	22.76
5	12	0		22.01	21.91	21.67
5	12	7		21.90	21.86	21.80
5	12	13		21.93	21.89	21.84
5	25	0		21.89	21.91	21.75
5	1	0	64-QAM	22.14	22.07	21.82
5	1	12		21.91	22.02	21.98
5	1	24		21.88	21.97	21.81
5	12	0		20.96	20.96	20.91
5	12	7		20.98	20.92	20.87
5	12	13		20.87	20.84	20.71
5	25	0		20.85	20.92	20.76



LTE Band 2 Maximum Average Power [dBm]						
BW [MHz]	RB Size	RB Offset	Mod	Lowest	Middle	Highest
3	1	0	QPSK	23.76	23.78	23.77
3	1	8		23.54	23.74	23.59
3	1	14		23.51	23.58	23.51
3	8	0		22.82	22.76	22.58
3	8	4		22.64	22.82	22.53
3	8	7		22.53	22.58	22.64
3	15	0		22.76	22.81	22.55
3	1	0	16-QAM	23.02	22.95	22.72
3	1	8		22.90	22.83	22.83
3	1	14		22.75	22.89	22.69
3	8	0		21.96	21.86	21.59
3	8	4		21.77	21.82	21.72
3	8	7		21.90	21.85	21.72
3	15	0		21.76	21.86	21.72
3	1	0	64-QAM	22.09	22.04	21.73
3	1	8		21.83	21.90	21.91
3	1	14		21.80	21.91	21.74
3	8	0		20.89	20.92	20.79
3	8	4		20.85	20.88	20.83
3	8	7		20.79	20.71	20.60
3	15	0		20.81	20.80	20.72
1.4	1	0	QPSK	23.70	23.71	23.64
1.4	1	3		23.72	23.79	23.69
1.4	1	5		23.64	23.67	23.62
1.4	3	0		23.77	23.76	23.73
1.4	3	1		23.75	23.79	23.73
1.4	3	3		23.76	23.81	23.67
1.4	6	0		22.72	22.79	22.69
1.4	1	0	16-QAM	22.96	22.99	22.80
1.4	1	3		23.08	23.09	22.87
1.4	1	5		22.95	23.02	22.77
1.4	3	0		22.78	22.85	22.65
1.4	3	1		22.81	22.94	22.69
1.4	3	3		22.83	22.80	22.61
1.4	6	0		21.96	22.00	21.82
1.4	1	0	64-QAM	21.97	22.03	21.81
1.4	1	3		22.04	22.04	21.85
1.4	1	5		21.99	21.93	21.79
1.4	3	0		21.92	22.06	21.89
1.4	3	1		21.95	22.02	21.80
1.4	3	3		21.91	22.08	21.83
1.4	6	0		20.84	20.89	20.69



LTE Band 4 Maximum Average Power [dBm]						
BW [MHz]	RB Size	RB Offset	Mod	Lowest	Middle	Highest
20	1	0	QPSK	23.72	23.87	23.86
20	1	49		23.61	23.62	23.59
20	1	99		23.59	23.58	23.57
20	50	0		22.65	22.66	22.57
20	50	24		22.53	22.53	22.52
20	50	50		22.51	22.55	22.56
20	100	0		22.62	22.63	22.62
20	1	0	16-QAM	22.94	22.96	22.70
20	1	49		22.78	22.83	22.74
20	1	99		22.60	22.72	22.53
20	50	0		21.70	21.73	21.51
20	50	24		21.74	21.67	21.64
20	50	50		21.60	21.64	21.66
20	100	0		21.63	21.67	21.60
20	1	0	64-QAM	21.84	21.89	21.66
20	1	49		21.75	21.84	21.75
20	1	99		21.68	21.78	21.60
20	50	0		20.69	20.69	20.56
20	50	24		20.78	20.77	20.62
20	50	50		20.60	20.64	20.61
20	100	0		20.69	20.73	20.58
15	1	0	QPSK	23.71	23.73	23.81
15	1	37		23.57	23.64	23.60
15	1	74		23.60	23.56	23.60
15	36	0		22.65	22.55	22.50
15	36	20		22.53	22.50	22.50
15	36	39		22.50	22.54	22.57
15	75	0		22.63	22.55	22.66
15	1	0	16-QAM	22.89	22.91	22.69
15	1	37		22.80	22.80	22.74
15	1	74		22.65	22.77	22.53
15	36	0		21.72	21.73	21.54
15	36	20		21.77	21.64	21.66
15	36	39		21.62	21.62	21.64
15	75	0		21.68	21.71	21.56
15	1	0	64-QAM	21.80	21.87	21.66
15	1	37		21.79	21.80	21.80
15	1	74		21.65	21.75	21.64
15	36	0		20.67	20.66	20.61
15	36	20		20.81	20.80	20.64
15	36	39		20.63	20.64	20.61
15	75	0		20.70	20.70	20.57



LTE Band 4 Maximum Average Power [dBm]						
BW [MHz]	RB Size	RB Offset	Mod	Lowest	Middle	Highest
10	1	0	QPSK	23.70	23.73	23.82
10	1	25		23.58	23.66	23.54
10	1	49		23.63	23.63	23.53
10	25	0		22.69	22.53	22.50
10	25	12		22.50	22.57	22.50
10	25	25		22.50	22.60	22.58
10	50	0		22.57	22.50	22.61
10	1	0	16-QAM	22.96	22.96	22.71
10	1	25		22.81	22.82	22.76
10	1	49		22.64	22.74	22.50
10	25	0		21.73	21.72	21.55
10	25	12		21.73	21.68	21.64
10	25	25		21.65	21.63	21.67
10	50	0		21.68	21.72	21.56
10	1	0	64-QAM	21.83	21.88	21.65
10	1	25		21.75	21.79	21.75
10	1	49		21.66	21.79	21.61
10	25	0		20.66	20.65	20.55
10	25	12		20.81	20.77	20.61
10	25	25		20.59	20.66	20.59
10	50	0		20.69	20.77	20.57
5	1	0	QPSK	23.74	23.71	23.85
5	1	12		23.61	23.64	23.58
5	1	24		23.63	23.61	23.54
5	12	0		22.69	22.54	22.55
5	12	7		22.56	22.55	22.50
5	12	13		22.53	22.58	22.53
5	25	0		22.60	22.51	22.62
5	1	0	16-QAM	22.94	22.98	22.72
5	1	12		22.74	22.83	22.72
5	1	24		22.58	22.69	22.50
5	12	0		21.67	21.77	21.50
5	12	7		21.78	21.65	21.59
5	12	13		21.55	21.61	21.69
5	25	0		21.63	21.71	21.60
5	1	0	64-QAM	21.86	21.91	21.61
5	1	12		21.73	21.84	21.74
5	1	24		21.70	21.75	21.61
5	12	0		20.74	20.72	20.52
5	12	7		20.78	20.81	20.57
5	12	13		20.62	20.62	20.63
5	25	0		20.64	20.74	20.59



LTE Band 4 Maximum Average Power [dBm]						
BW [MHz]	RB Size	RB Offset	Mod	Lowest	Middle	Highest
3	1	0	QPSK	23.72	23.78	23.84
3	1	8		23.58	23.66	23.59
3	1	14		23.54	23.53	23.57
3	8	0		22.70	22.63	22.54
3	8	4		22.52	22.52	22.50
3	8	7		22.51	22.57	22.58
3	15	0		22.60	22.50	22.67
3	1	0	16-QAM	22.90	22.91	22.73
3	1	8		22.79	22.81	22.71
3	1	14		22.62	22.70	22.56
3	8	0		21.68	21.72	21.54
3	8	4		21.75	21.66	21.61
3	8	7		21.55	21.62	21.61
3	15	0		21.60	21.69	21.60
3	1	0	64-QAM	21.89	21.93	21.64
3	1	8		21.79	21.89	21.75
3	1	14		21.69	21.77	21.58
3	8	0		20.66	20.66	20.54
3	8	4		20.79	20.72	20.58
3	8	7		20.61	20.63	20.62
3	15	0		20.66	20.71	20.54
1.4	1	0	QPSK	23.63	23.79	23.85
1.4	1	3		23.58	23.55	23.50
1.4	1	5		23.54	23.56	23.57
1.4	3	0		23.62	23.81	23.85
1.4	3	1		23.61	23.59	23.57
1.4	3	3		23.53	23.53	23.57
1.4	6	0		22.59	22.55	22.56
1.4	1	0	16-QAM	22.89	22.92	22.65
1.4	1	3		22.74	22.83	22.71
1.4	1	5		22.59	22.72	22.50
1.4	3	0		22.85	22.90	22.63
1.4	3	1		22.72	22.83	22.71
1.4	3	3		22.53	22.69	22.50
1.4	6	0		21.58	21.64	21.54
1.4	1	0	64-QAM	21.79	21.89	21.63
1.4	1	3		21.73	21.75	21.75
1.4	1	5		21.60	21.73	21.58
1.4	3	0		21.77	21.80	21.61
1.4	3	1		21.74	21.83	21.74
1.4	3	3		21.67	21.76	21.57
1.4	6	0		20.63	20.66	20.50



LTE Band 5 Maximum Average Power [dBm]						
BW [MHz]	RB Size	RB Offset	Mod	Lowest	Middle	Highest
10	1	0	QPSK	23.97	24.13	23.95
10	1	25		23.87	23.91	23.93
10	1	49		23.79	23.84	23.75
10	25	0		22.93	22.97	22.93
10	25	12		22.91	22.96	22.92
10	25	25		22.88	22.92	22.82
10	50	0		22.91	22.92	22.77
10	1	0	16-QAM	23.16	23.23	23.10
10	1	25		23.06	23.16	23.14
10	1	49		23.02	23.03	23.14
10	25	0		21.97	21.99	21.90
10	25	12		21.98	22.06	22.10
10	25	25		21.94	22.00	21.93
10	50	0		22.00	22.04	21.94
10	1	0	64-QAM	22.13	22.15	21.98
10	1	25		22.03	22.14	22.11
10	1	49		21.90	22.08	22.07
10	25	0		20.99	21.01	20.99
10	25	12		20.96	21.09	21.06
10	25	25		20.98	21.00	20.98
10	50	0		21.05	21.12	20.98
5	1	0	QPSK	23.85	23.88	23.77
5	1	12		23.89	23.85	23.93
5	1	24		23.73	23.83	23.75
5	12	0		22.84	23.03	22.81
5	12	7		22.93	23.03	22.91
5	12	13		22.84	22.93	22.87
5	25	0		22.89	22.94	22.78
5	1	0	16-QAM	23.13	23.15	23.06
5	1	12		23.09	23.23	23.19
5	1	24		23.05	23.10	23.08
5	12	0		22.02	22.02	21.95
5	12	7		21.91	22.12	22.09
5	12	13		21.90	22.03	21.93
5	25	0		21.98	21.99	21.90
5	1	0	64-QAM	22.08	22.11	22.04
5	1	12		22.07	22.20	22.10
5	1	24		21.90	22.05	22.00
5	12	0		20.95	21.09	20.98
5	12	7		21.03	21.03	21.10
5	12	13		20.91	20.99	21.05
5	25	0		21.05	21.06	20.96



LTE Band 5 Maximum Average Power [dBm]						
BW [MHz]	RB Size	RB Offset	Mod	Lowest	Middle	Highest
3	1	0	QPSK	23.82	23.92	23.81
3	1	8		23.82	23.95	23.93
3	1	14		23.82	23.85	23.76
3	8	0		22.84	23.02	22.85
3	8	4		22.90	22.98	22.93
3	8	7		22.84	22.93	22.88
3	15	0		22.87	22.93	22.75
3	1	0	16-QAM	23.15	23.20	23.04
3	1	8		23.15	23.21	23.18
3	1	14		22.98	23.04	23.10
3	8	0		21.97	22.00	21.99
3	8	4		21.94	22.03	22.05
3	8	7		21.91	21.97	21.94
3	15	0		22.01	22.03	21.87
3	1	0	64-QAM	22.06	22.12	22.01
3	1	8		22.04	22.18	22.16
3	1	14		22.00	22.13	22.09
3	8	0		20.94	21.02	20.99
3	8	4		21.01	21.02	21.07
3	8	7		21.00	21.02	21.00
3	15	0		20.95	21.03	20.97
1.4	1	0	QPSK	23.96	24.09	23.88
1.4	1	3		23.86	23.84	23.86
1.4	1	5		23.75	23.75	23.67
1.4	3	0		23.96	24.12	23.87
1.4	3	1		23.86	23.90	23.93
1.4	3	3		23.70	23.80	23.74
1.4	6	0		22.91	22.92	22.73
1.4	1	0	16-QAM	23.07	23.14	23.09
1.4	1	3		22.96	23.08	23.07
1.4	1	5		22.92	22.94	23.04
1.4	3	0		23.10	23.14	23.10
1.4	3	1		22.96	23.14	23.12
1.4	3	3		23.00	22.96	23.14
1.4	6	0		22.00	21.97	21.92
1.4	1	0	64-QAM	22.08	22.11	21.88
1.4	1	3		21.93	22.10	22.08
1.4	1	5		21.84	22.02	22.00
1.4	3	0		22.12	22.08	21.92
1.4	3	1		21.99	22.11	22.10
1.4	3	3		21.86	22.04	22.02
1.4	6	0		21.01	21.12	20.89



LTE Band 7 Maximum Average Power [dBm]						
BW [MHz]	RB Size	RB Offset	Mod	Lowest	Middle	Highest
20	1	0	QPSK	23.46	23.58	23.27
20	1	49		23.40	23.49	23.11
20	1	99		23.35	23.38	23.17
20	50	0		22.42	22.62	22.29
20	50	24		22.61	22.54	22.33
20	50	50		22.53	22.49	22.20
20	100	0		22.57	22.58	22.28
20	1	0	16-QAM	22.70	22.82	22.61
20	1	49		22.81	22.77	22.43
20	1	99		22.89	22.81	22.54
20	50	0		21.60	21.58	21.38
20	50	24		21.55	21.63	21.37
20	50	50		21.73	21.64	21.30
20	100	0		21.69	21.63	21.39
20	1	0	64-QAM	21.66	21.70	21.54
20	1	49		21.74	21.76	21.45
20	1	99		21.78	21.72	21.40
20	50	0		20.57	20.61	20.39
20	50	24		20.62	20.63	20.39
20	50	50		20.69	20.59	20.34
20	100	0		20.65	20.59	20.43
15	1	0	QPSK	23.42	23.43	23.20
15	1	37		23.40	23.50	23.11
15	1	74		23.38	23.39	23.09
15	36	0		22.46	22.52	22.23
15	36	20		22.52	22.48	22.25
15	36	39		22.62	22.51	22.22
15	75	0		22.56	22.45	22.31
15	1	0	16-QAM	22.72	22.88	22.60
15	1	37		22.76	22.78	22.51
15	1	74		22.90	22.71	22.50
15	36	0		21.56	21.56	21.39
15	36	20		21.58	21.67	21.37
15	36	39		21.64	21.66	21.30
15	75	0		21.64	21.56	21.33
15	1	0	64-QAM	21.65	21.78	21.53
15	1	37		21.74	21.71	21.47
15	1	74		21.83	21.72	21.39
15	36	0		20.54	20.59	20.44
15	36	20		20.57	20.60	20.37
15	36	39		20.74	20.58	20.34
15	75	0		20.72	20.66	20.45



LTE Band 7 Maximum Average Power [dBm]						
BW [MHz]	RB Size	RB Offset	Mod	Lowest	Middle	Highest
10	1	0	QPSK	23.45	23.48	23.18
10	1	25		23.35	23.48	23.08
10	1	49		23.31	23.38	23.12
10	25	0		22.46	22.51	22.26
10	25	12		22.45	22.53	22.26
10	25	25		22.62	22.49	22.22
10	50	0		22.64	22.45	22.24
10	1	0	16-QAM	22.73	22.81	22.64
10	1	25		22.77	22.83	22.41
10	1	49		22.90	22.73	22.47
10	25	0		21.58	21.64	21.39
10	25	12		21.55	21.65	21.37
10	25	25		21.67	21.61	21.25
10	50	0		21.68	21.62	21.39
10	1	0	64-QAM	21.74	21.80	21.53
10	1	25		21.73	21.72	21.38
10	1	49		21.84	21.62	21.40
10	25	0		20.54	20.59	20.35
10	25	12		20.57	20.62	20.41
10	25	25		20.74	20.57	20.35
10	50	0		20.68	20.68	20.42
5	1	0	QPSK	23.37	23.48	23.25
5	1	12		23.35	23.47	23.11
5	1	24		23.32	23.40	23.17
5	12	0		22.46	22.45	22.26
5	12	7		22.44	22.52	22.33
5	12	13		22.56	22.49	22.24
5	25	0		22.59	22.51	22.32
5	1	0	16-QAM	22.77	22.87	22.64
5	1	12		22.79	22.85	22.44
5	1	24		22.87	22.81	22.46
5	12	0		21.51	21.56	21.34
5	12	7		21.56	21.62	21.39
5	12	13		21.64	21.57	21.28
5	25	0		21.62	21.58	21.40
5	1	0	64-QAM	21.71	21.78	21.50
5	1	12		21.73	21.71	21.41
5	1	24		21.86	21.62	21.37
5	12	0		20.56	20.61	20.36
5	12	7		20.58	20.68	20.43
5	12	13		20.66	20.67	20.34
5	25	0		20.65	20.61	20.43



LTE Band 38 Maximum Average Power [dBm]						
BW [MHz]	RB Size	RB Offset	Mod	Lowest	Middle	Highest
20	1	0	QPSK	23.76	23.77	23.62
20	1	49		23.60	23.41	23.47
20	1	99		23.49	23.44	23.51
20	50	0		22.69	22.75	22.62
20	50	24		22.68	22.62	22.61
20	50	50		22.65	22.52	22.47
20	100	0		22.69	22.70	22.58
20	1	0	16-QAM	22.79	22.67	22.72
20	1	49		22.79	22.63	22.61
20	1	99		22.60	22.59	22.55
20	50	0		21.89	21.76	21.69
20	50	24		21.77	21.70	21.72
20	50	50		21.68	21.65	21.68
20	100	0		21.81	21.59	21.67
20	1	0	64-QAM	21.42	21.36	21.30
20	1	49		21.43	21.23	21.18
20	1	99		21.30	21.25	21.17
20	50	0		20.88	20.69	20.71
20	50	24		20.76	20.69	20.62
20	50	50		20.69	20.58	20.63
20	100	0		20.72	20.62	20.60
15	1	0	QPSK	23.69	23.53	23.58
15	1	37		23.67	23.49	23.48
15	1	74		23.47	23.43	23.47
15	36	0		22.73	22.60	22.56
15	36	20		22.65	22.64	22.58
15	36	39		22.63	22.51	22.53
15	75	0		22.65	22.53	22.55
15	1	0	16-QAM	22.82	22.74	22.73
15	1	37		22.80	22.53	22.62
15	1	74		22.66	22.64	22.62
15	36	0		21.89	21.77	21.63
15	36	20		21.82	21.63	21.69
15	36	39		21.73	21.63	21.65
15	75	0		21.76	21.67	21.66
15	1	0	64-QAM	21.46	21.34	21.33
15	1	37		21.43	21.22	21.19
15	1	74		21.25	21.21	21.25
15	36	0		20.83	20.74	20.72
15	36	20		20.80	20.61	20.64
15	36	39		20.70	20.67	20.64
15	75	0		20.75	20.61	20.64



LTE Band 38 Maximum Average Power [dBm]						
BW [MHz]	RB Size	RB Offset	Mod	Lowest	Middle	Highest
10	1	0	QPSK	23.66	23.61	23.58
10	1	25		23.59	23.41	23.48
10	1	49		23.50	23.47	23.48
10	25	0		22.68	22.59	22.53
10	25	12		22.73	22.56	22.55
10	25	25		22.63	22.51	22.49
10	50	0		22.61	22.51	22.55
10	1	0	16-QAM	22.79	22.74	22.70
10	1	25		22.75	22.60	22.61
10	1	49		22.65	22.59	22.54
10	25	0		21.82	21.74	21.69
10	25	12		21.85	21.62	21.66
10	25	25		21.74	21.65	21.64
10	50	0		21.80	21.61	21.61
10	1	0	64-QAM	21.47	21.36	21.26
10	1	25		21.39	21.21	21.24
10	1	49		21.27	21.21	21.22
10	25	0		20.86	20.73	20.67
10	25	12		20.86	20.61	20.68
10	25	25		20.73	20.60	20.64
10	50	0		20.75	20.64	20.59
5	1	0	QPSK	23.73	23.54	23.52
5	1	12		23.60	23.50	23.48
5	1	24		23.52	23.45	23.46
5	12	0		22.78	22.58	22.57
5	12	7		22.68	22.63	22.59
5	12	13		22.61	22.55	22.51
5	25	0		22.66	22.59	22.54
5	1	0	16-QAM	22.86	22.70	22.74
5	1	12		22.76	22.60	22.61
5	1	24		22.67	22.58	22.61
5	12	0		21.87	21.78	21.69
5	12	7		21.81	21.68	21.63
5	12	13		21.68	21.65	21.66
5	25	0		21.74	21.61	21.69
5	1	0	64-QAM	21.48	21.31	21.25
5	1	12		21.42	21.20	21.22
5	1	24		21.28	21.19	21.18
5	12	0		20.87	20.73	20.66
5	12	7		20.86	20.63	20.64
5	12	13		20.70	20.60	20.62
5	25	0		20.72	20.62	20.64



LTE Band 41 Maximum Average Power [dBm]						
BW [MHz]	RB Size	RB Offset	Mod	Lowest	Middle	Highest
20	1	0	QPSK	23.77	23.75	24.01
20	1	49		23.61	23.75	23.73
20	1	99		23.70	23.72	23.57
20	50	0		22.75	22.70	22.83
20	50	24		22.80	22.81	22.82
20	50	50		22.79	22.79	22.71
20	100	0		22.80	22.80	22.81
20	1	0	16-QAM	22.75	22.83	22.70
20	1	49		22.77	22.90	22.85
20	1	99		22.82	22.88	22.78
20	50	0		21.81	21.78	21.79
20	50	24		21.84	21.91	21.84
20	50	50		21.84	21.89	21.83
20	100	0		21.77	21.84	21.82
20	1	0	64-QAM	21.41	21.40	21.18
20	1	49		21.38	21.47	21.45
20	1	99		21.41	21.44	21.08
20	50	0		20.81	20.83	20.77
20	50	24		20.88	20.88	20.88
20	50	50		20.84	20.92	20.75
20	100	0		20.77	20.76	20.67
15	1	0	QPSK	23.64	23.87	23.63
15	1	37		23.63	23.78	23.70
15	1	74		23.69	23.68	23.60
15	36	0		22.66	22.70	22.69
15	36	20		22.72	22.76	22.67
15	36	39		22.77	22.74	22.68
15	75	0		22.74	22.83	22.61
15	1	0	16-QAM	22.73	22.79	22.77
15	1	37		22.72	22.91	22.81
15	1	74		22.85	22.80	22.85
15	36	0		21.85	21.87	21.78
15	36	20		21.88	21.98	21.89
15	36	39		21.89	21.92	21.87
15	75	0		21.77	21.87	21.82
15	1	0	64-QAM	21.42	21.44	21.11
15	1	37		21.39	21.48	21.42
15	1	74		21.45	21.44	21.13
15	36	0		20.81	20.79	20.78
15	36	20		20.85	20.88	20.82
15	36	39		20.90	20.92	20.70
15	75	0		20.79	20.78	20.69



LTE Band 41 Maximum Average Power [dBm]						
BW [MHz]	RB Size	RB Offset	Mod	Lowest	Middle	Highest
10	1	0	QPSK	23.65	23.87	23.73
10	1	25		23.57	23.74	23.76
10	1	49		23.64	23.75	23.64
10	25	0		22.67	22.67	22.69
10	25	12		22.74	22.82	22.69
10	25	25		22.77	22.80	22.66
10	50	0		22.74	22.79	22.63
10	1	0	16-QAM	22.75	22.79	22.80
10	1	25		22.72	22.91	22.90
10	1	49		22.82	22.83	22.81
10	25	0		21.83	21.80	21.79
10	25	12		21.82	21.91	21.88
10	25	25		21.89	21.89	21.92
10	50	0		21.86	21.82	21.84
10	1	0	64-QAM	21.32	21.39	21.15
10	1	25		21.33	21.49	21.45
10	1	49		21.41	21.46	21.10
10	25	0		20.77	20.75	20.71
10	25	12		20.85	20.90	20.82
10	25	25		20.90	20.93	20.68
10	50	0		20.77	20.74	20.60
5	1	0	QPSK	23.61	23.85	23.65
5	1	12		23.67	23.80	23.71
5	1	24		23.63	23.66	23.62
5	12	0		22.72	22.75	22.69
5	12	7		22.79	22.84	22.69
5	12	13		22.73	22.78	22.69
5	25	0		22.77	22.74	22.69
5	1	0	16-QAM	22.78	22.78	22.75
5	1	12		22.78	22.85	22.85
5	1	24		22.79	22.84	22.81
5	12	0		21.86	21.82	21.82
5	12	7		21.84	21.88	21.88
5	12	13		21.90	21.86	21.91
5	25	0		21.79	21.87	21.84
5	1	0	64-QAM	21.36	21.37	21.17
5	1	12		21.36	21.50	21.52
5	1	24		21.47	21.45	21.08
5	12	0		20.76	20.82	20.70
5	12	7		20.87	20.95	20.79
5	12	13		20.87	20.90	20.65
5	25	0		20.78	20.76	20.63



LTE Band 2

Peak-to-Average Ratio

Mode	LTE Band 2 / 20MHz				
Mod.	QPSK		16QAM		Limit: 13dB
RB Size	1RB	Full RB	1RB	Full RB	Result
Lowest CH	3.30	4.32	4.64	5.65	PASS
Middle CH	3.19	4.14	4.35	5.42	
Highest CH	3.30	4.14	4.81	5.39	



LTE Band 2 / 20MHz / QPSK

Lowest Channel / 1RB

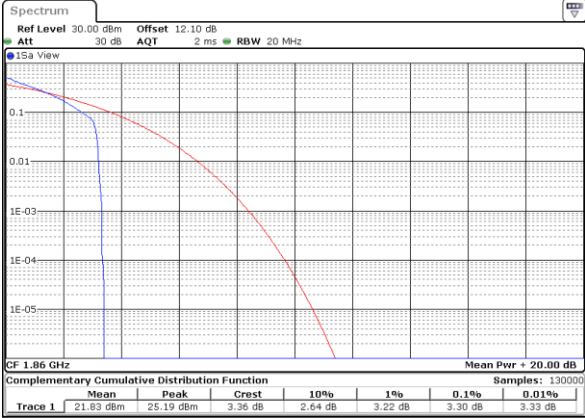

Date: 22_SEP.2020 21:58:01

Lowest Channel / Full RB

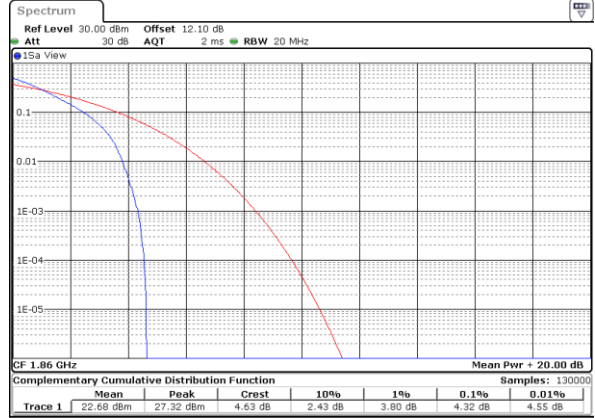

Date: 22_SEP.2020 21:58:12

Middle Channel / 1RB



Date: 22_SEP.2020 21:58:23

Middle Channel / Full RB

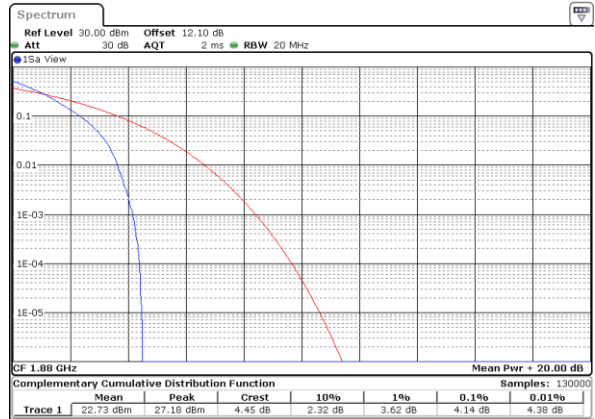

Date: 22_SEP.2020 21:58:34

Highest Channel / 1RB

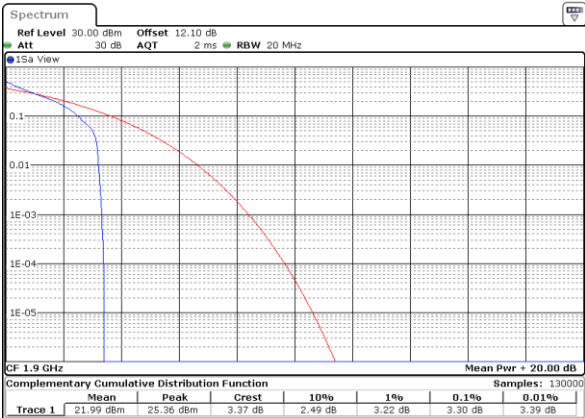

Date: 22_SEP.2020 21:58:45

Highest Channel / Full RB

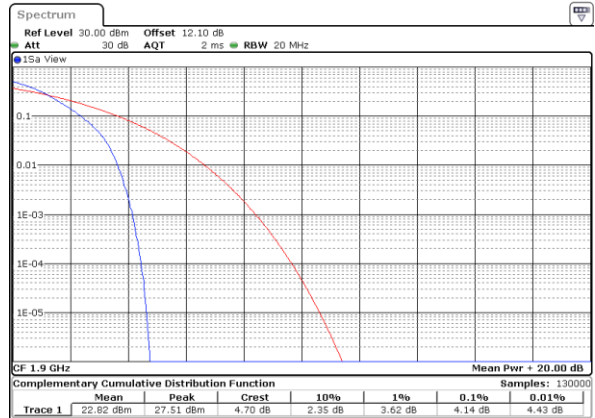

Date: 22_SEP.2020 21:58:55



LTE Band 2 / 20MHz / 16QAM

Lowest Channel / 1RB

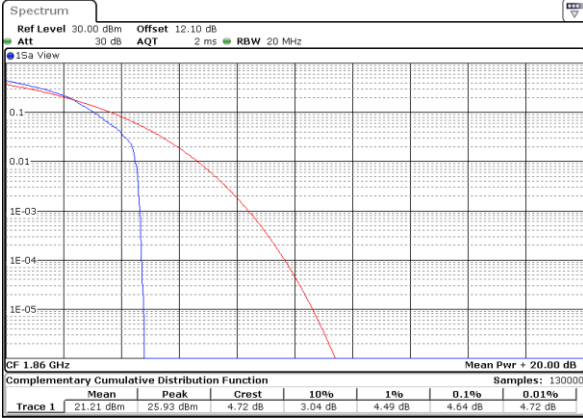

Date: 22_SEP.2020 21:56:36

Lowest Channel / Full RB

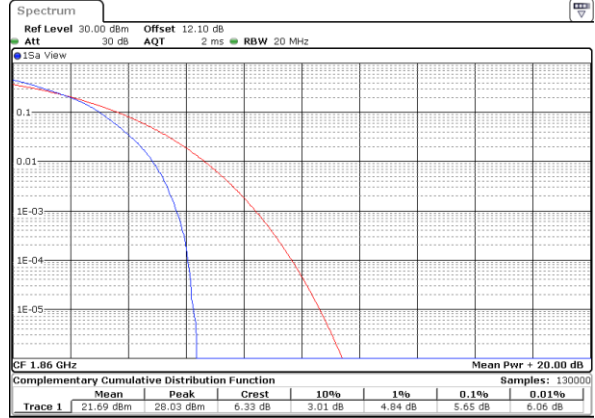

Date: 22_SEP.2020 21:56:59

Middle Channel / 1RB

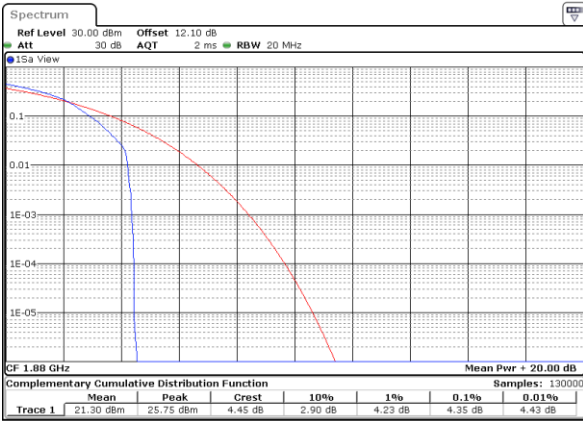

Date: 22_SEP.2020 21:57:12

Middle Channel / Full RB

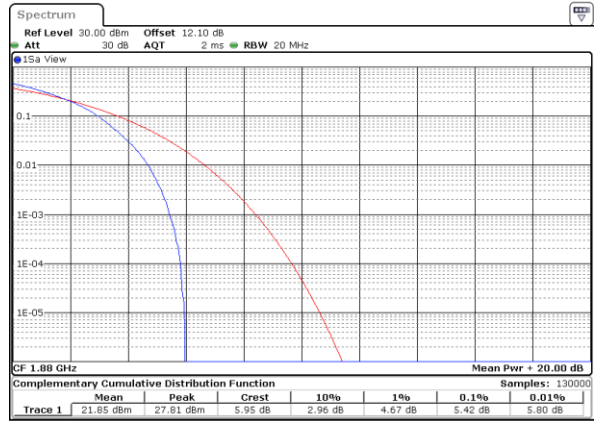

Date: 22_SEP.2020 21:57:22

Highest Channel / 1RB

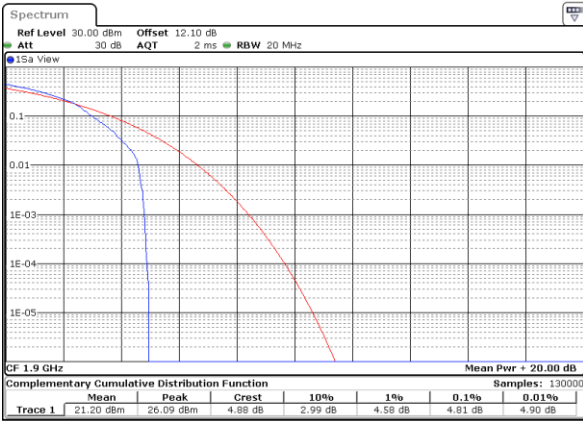

Date: 22_SEP.2020 21:57:32

Highest Channel / Full RB

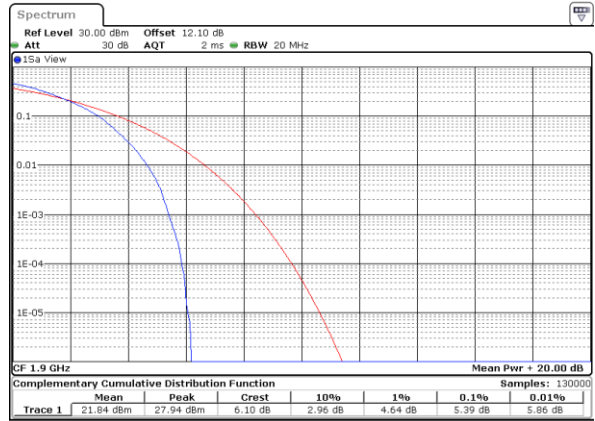

Date: 22_SEP.2020 21:57:51



26dB Bandwidth

Mode	LTE Band 2 : 26dB BW(MHz)											
	1.4MHz		3MHz		5MHz		10MHz		15MHz		20MHz	
BW												
Mod.	QPSK	16QAM	QPSK	16QAM	QPSK	16QAM	QPSK	16QAM	QPSK	16QAM	QPSK	16QAM
Lowest CH	1.24	1.22	3.03	3.06	4.96	4.95	9.87	9.87	14.51	14.45	18.98	19.18
Middle CH	1.23	1.22	3.00	2.95	4.99	4.96	9.63	9.79	14.48	14.42	18.86	19.02
Highest CH	1.24	1.21	3.02	3.03	4.99	4.97	9.81	9.89	14.33	14.27	19.22	18.86



LTE Band 2

Lowest Channel / 1.4MHz / QPSK

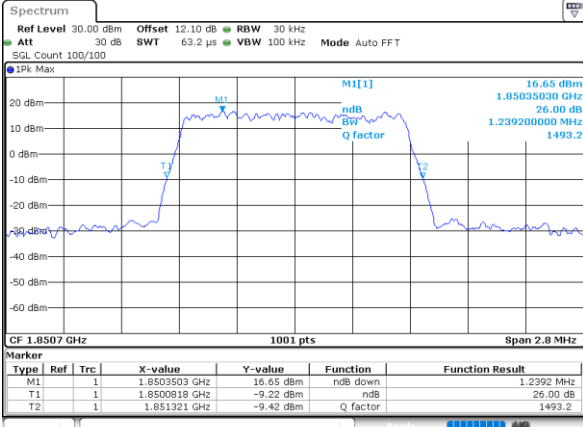

Date: 22_SEP.2020 21:40:52

Lowest Channel / 1.4MHz / 16QAM

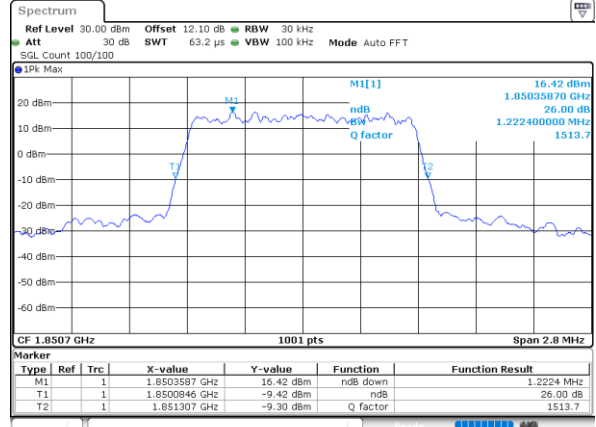

Date: 22_SEP.2020 21:41:04

Middle Channel / 1.4MHz / QPSK

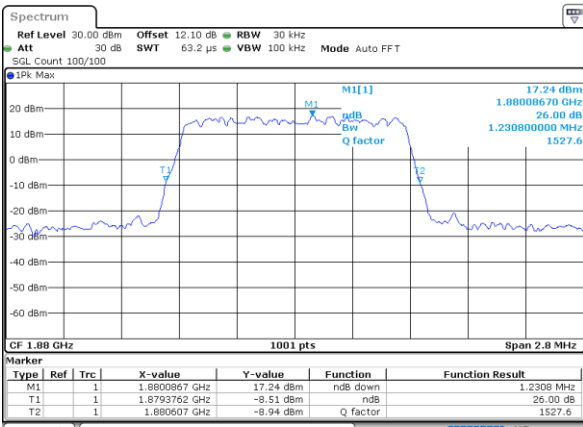

Date: 22_SEP.2020 21:47:13

Middle Channel / 1.4MHz / 16QAM

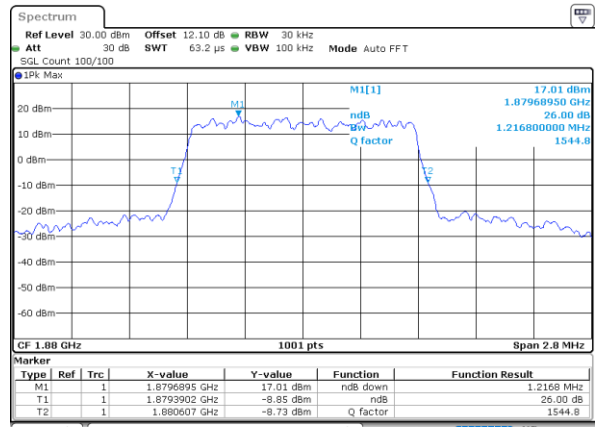

Date: 22_SEP.2020 21:47:24

Highest Channel / 1.4MHz / QPSK

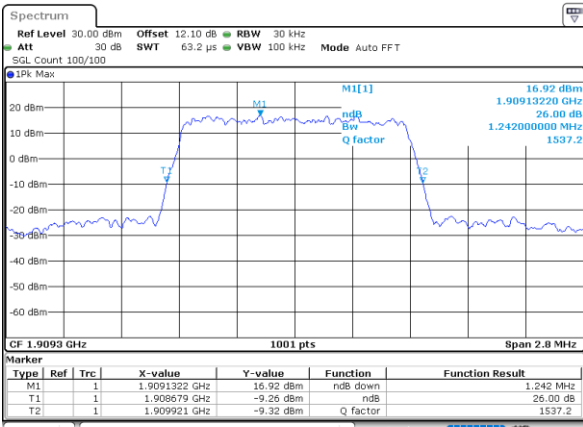

Date: 22_SEP.2020 21:49:20

Highest Channel / 1.4MHz / 16QAM

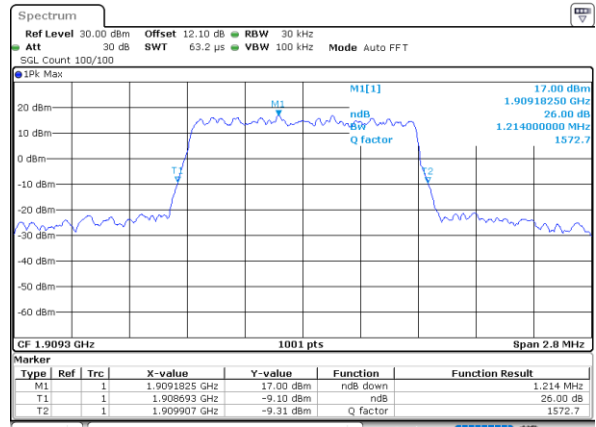

Date: 22_SEP.2020 21:49:32



LTE Band 2

Lowest Channel / 3MHz / QPSK

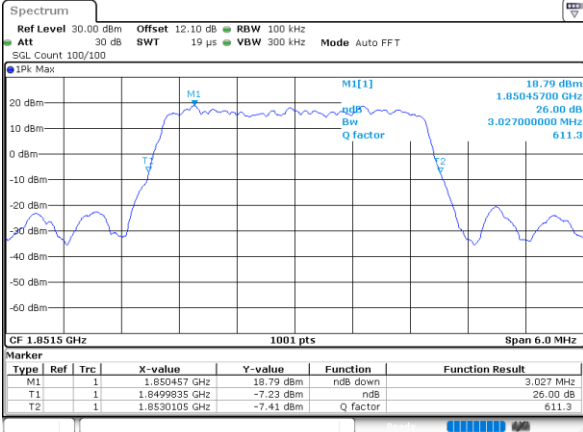

Date: 22_SEP.2020 20:11:25

Lowest Channel / 3MHz / 16QAM

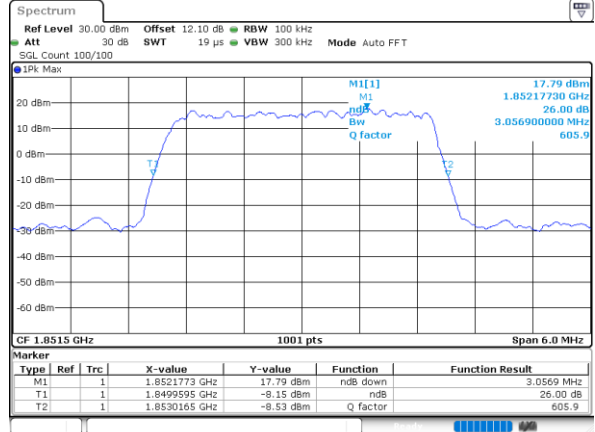

Date: 22_SEP.2020 20:11:37

Middle Channel / 3MHz / QPSK

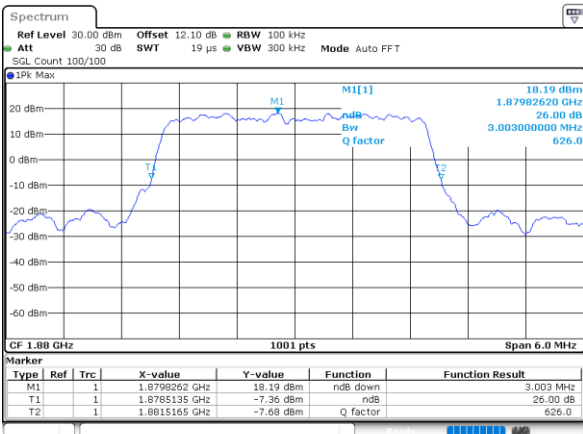

Date: 22_SEP.2020 20:17:33

Middle Channel / 3MHz / 16QAM

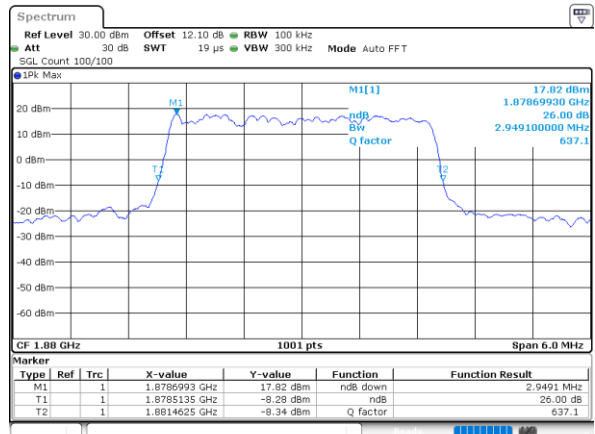

Date: 22_SEP.2020 20:17:44

Highest Channel / 3MHz / QPSK

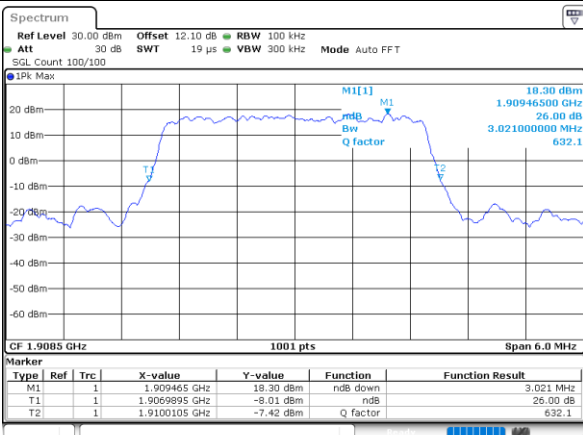

Date: 22_SEP.2020 20:19:41

Highest Channel / 3MHz / 16QAM

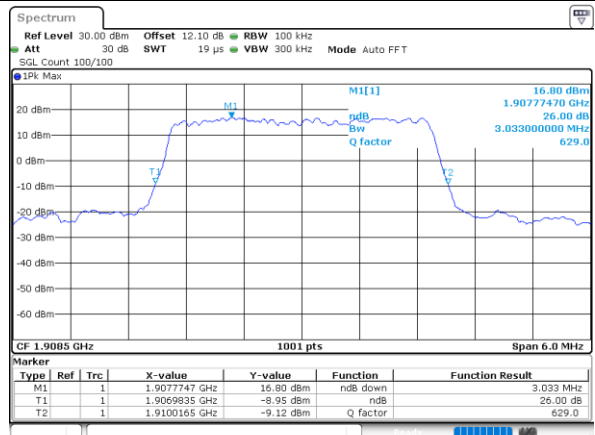

Date: 22_SEP.2020 20:19:52



LTE Band 2

Lowest Channel / 5MHz / QPSK

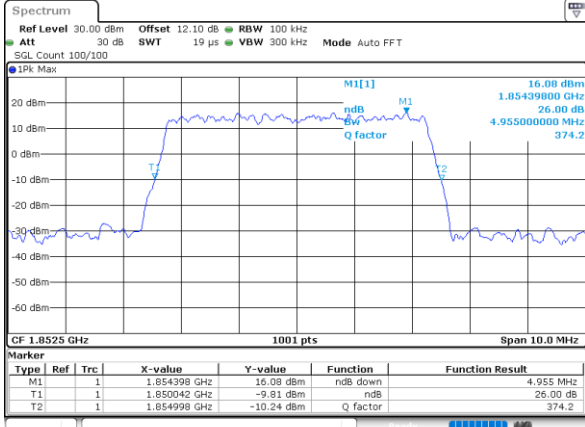

Date: 22_SEP.2020 20:25:51

Lowest Channel / 5MHz / 16QAM

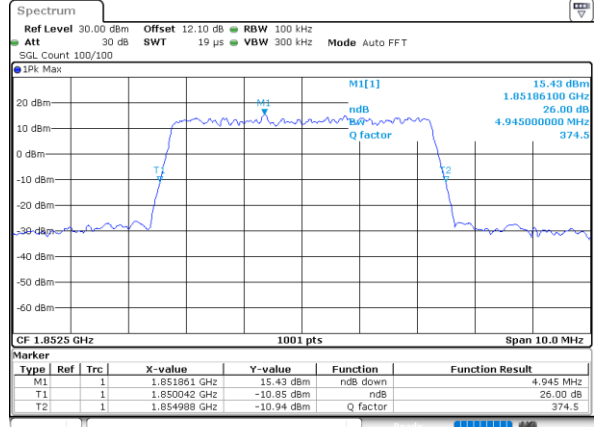

Date: 22_SEP.2020 20:26:02

Middle Channel / 5MHz / QPSK

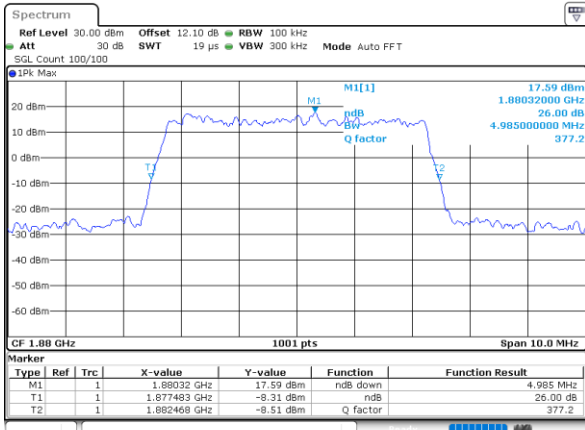

Date: 22_SEP.2020 20:31:58

Middle Channel / 5MHz / 16QAM

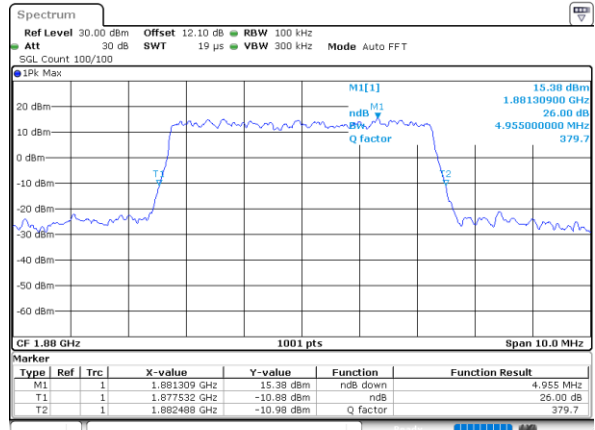

Date: 22_SEP.2020 20:32:09

Highest Channel / 5MHz / QPSK

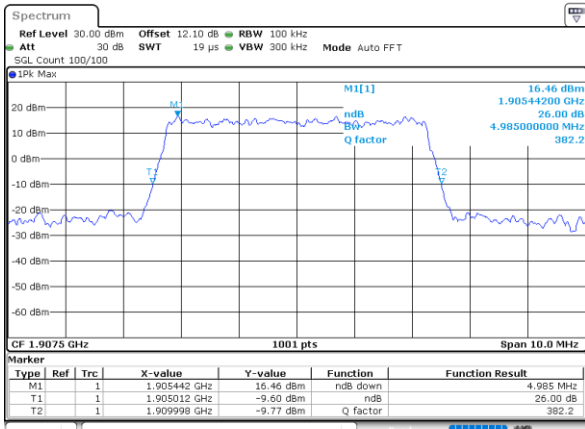

Date: 22_SEP.2020 20:34:05

Highest Channel / 5MHz / 16QAM

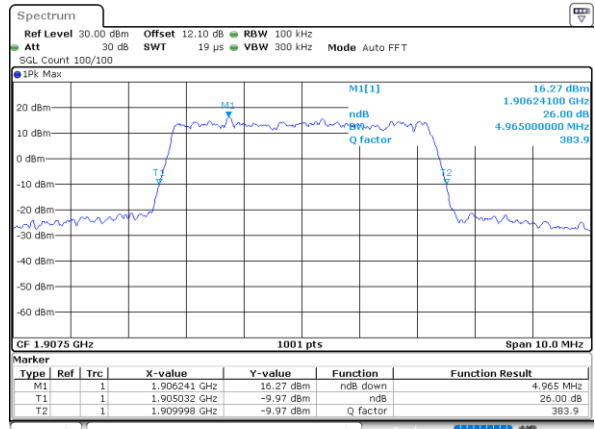

Date: 22_SEP.2020 20:34:17



LTE Band 2

Lowest Channel / 10MHz / QPSK

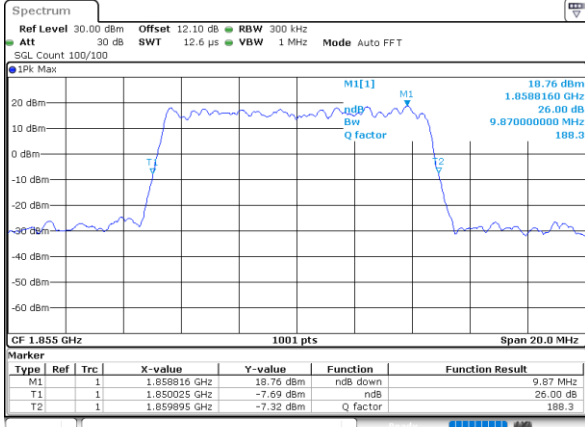

Date: 22_SEP.2020 20:40:15

Lowest Channel / 10MHz / 16QAM

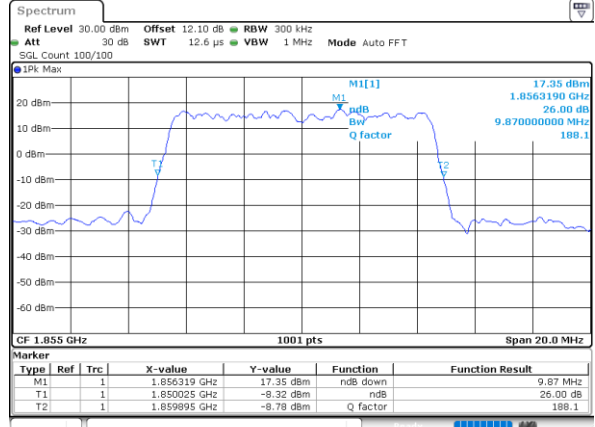

Date: 22_SEP.2020 20:40:27

Middle Channel / 10MHz / QPSK

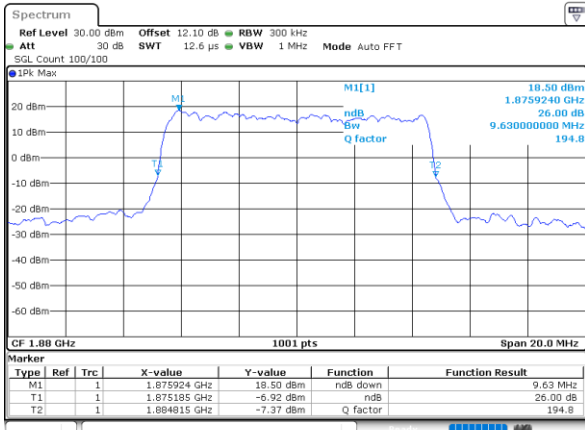

Date: 22_SEP.2020 20:46:23

Middle Channel / 10MHz / 16QAM

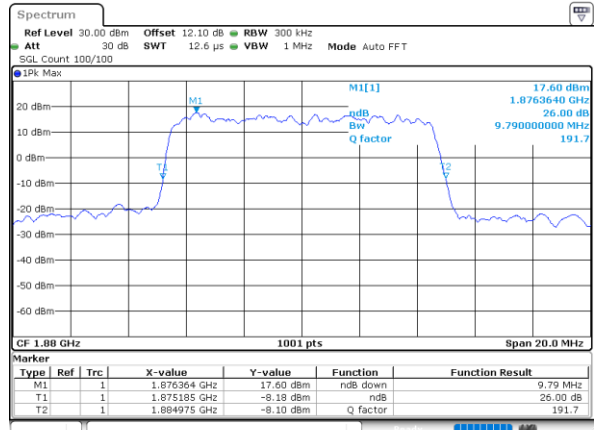

Date: 22_SEP.2020 20:46:34

Highest Channel / 10MHz / QPSK

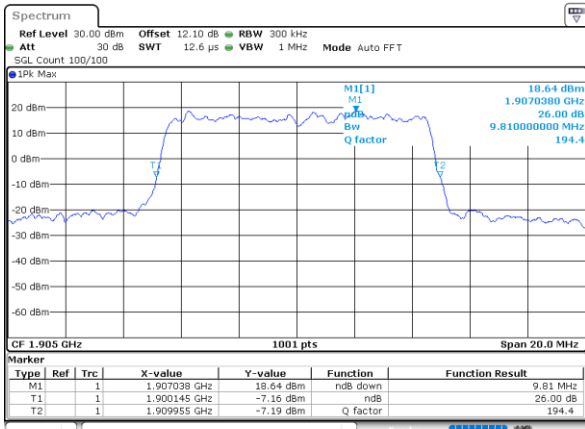

Date: 22_SEP.2020 20:48:30

Highest Channel / 10MHz / 16QAM

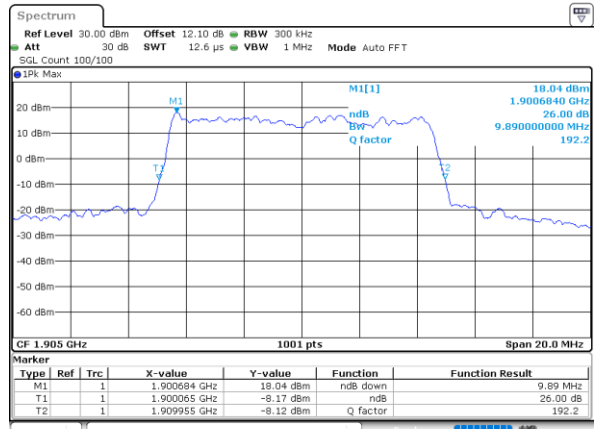

Date: 22_SEP.2020 20:48:42



LTE Band 2

Lowest Channel / 15MHz / QPSK

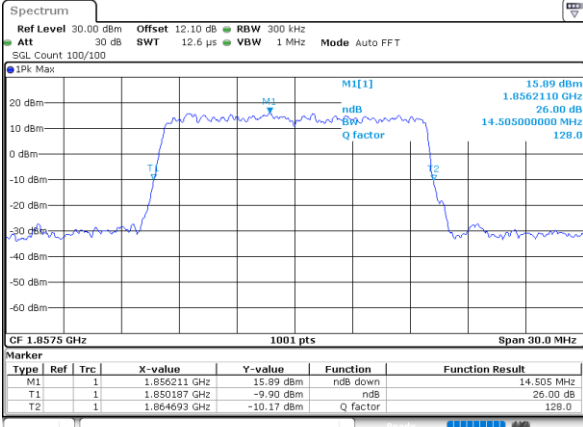

Date: 22_SEP.2020 21:05:55

Lowest Channel / 15MHz / 16QAM

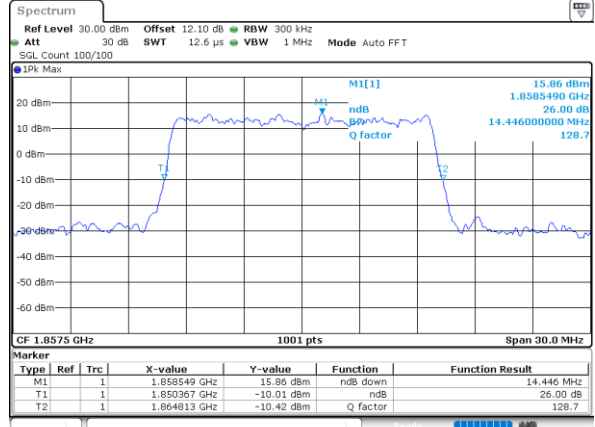

Date: 22_SEP.2020 21:06:07

Middle Channel / 15MHz / QPSK

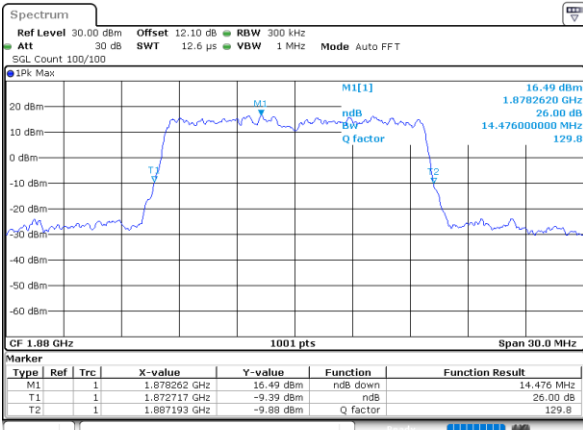

Date: 22_SEP.2020 21:12:03

Middle Channel / 15MHz / 16QAM

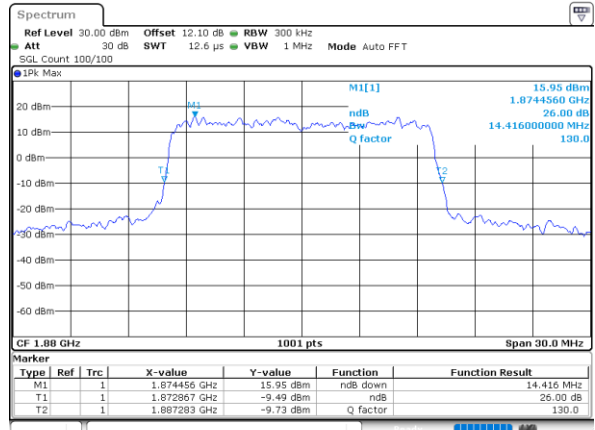

Date: 22_SEP.2020 21:12:15

Highest Channel / 15MHz / QPSK

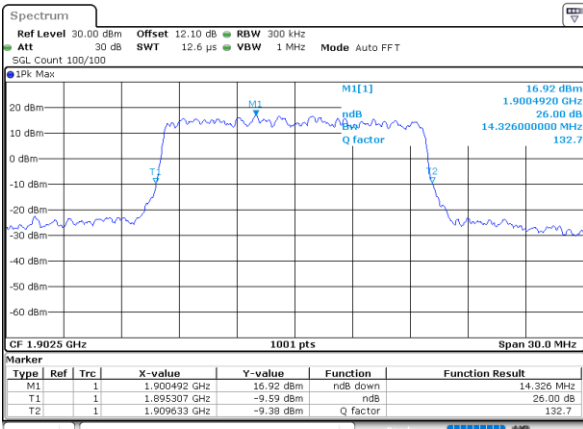

Date: 22_SEP.2020 21:14:11

Highest Channel / 15MHz / 16QAM

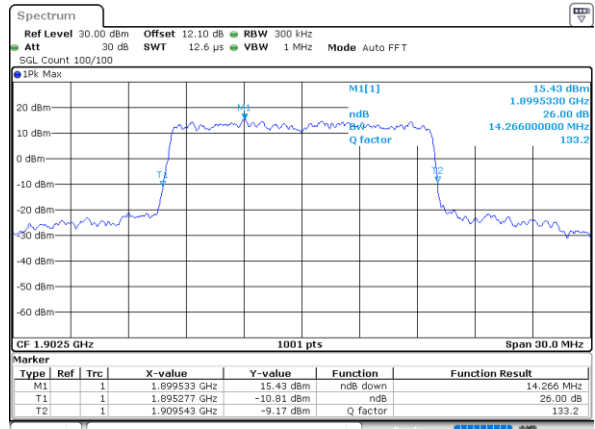

Date: 22_SEP.2020 21:14:23



LTE Band 2

Lowest Channel / 20MHz / QPSK

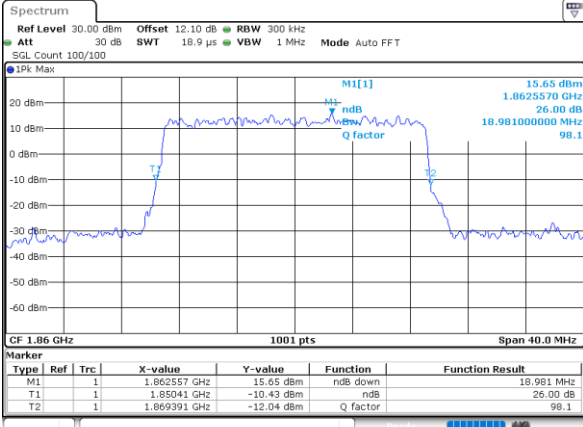

Date: 22_SEP.2020 21:20:20

Lowest Channel / 20MHz / 16QAM

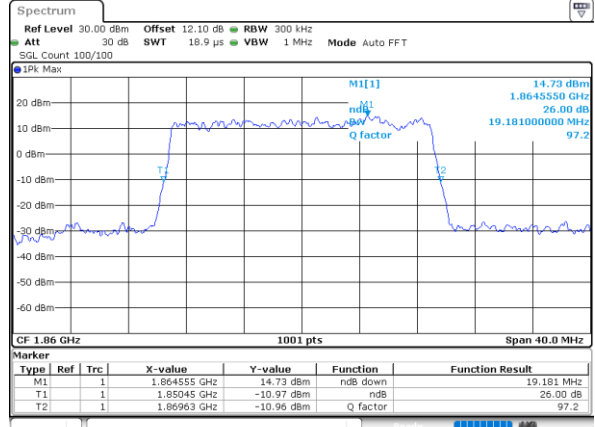

Date: 22_SEP.2020 21:20:32

Middle Channel / 20MHz / QPSK

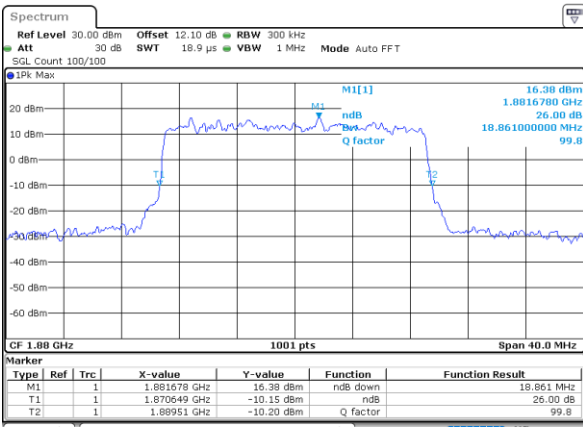

Date: 22_SEP.2020 21:26:28

Middle Channel / 20MHz / 16QAM

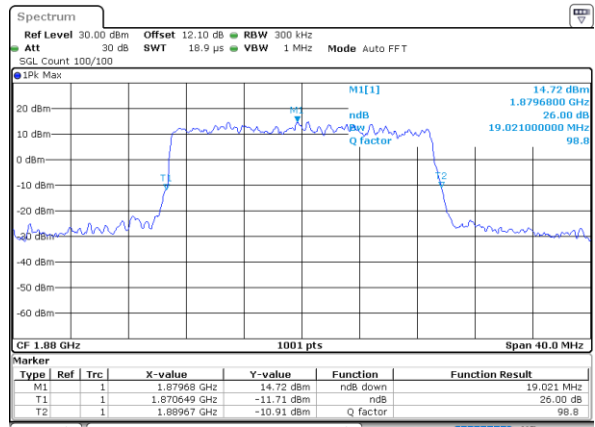

Date: 22_SEP.2020 21:26:39

Highest Channel / 20MHz / QPSK

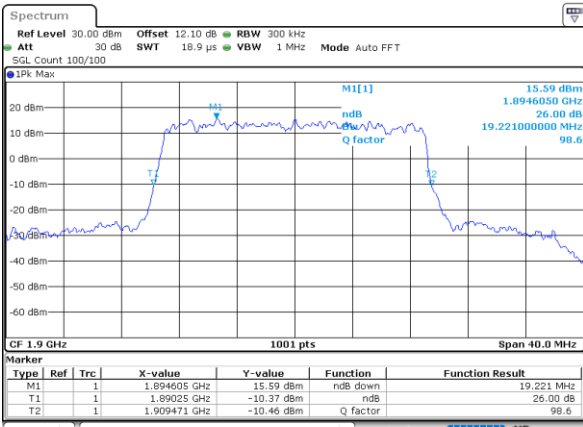

Date: 22_SEP.2020 21:28:36

Highest Channel / 20MHz / 16QAM

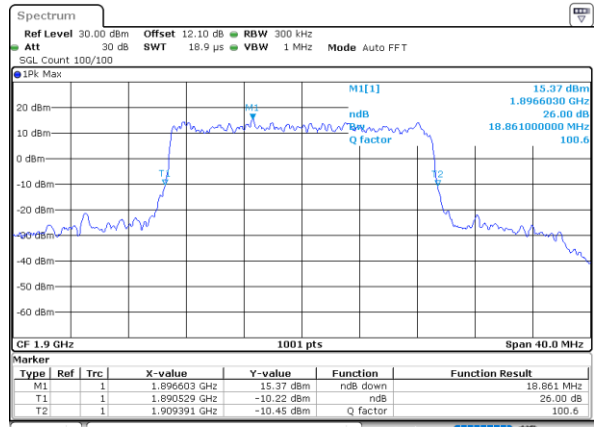

Date: 22_SEP.2020 21:28:47



Occupied Bandwidth

Mode	LTE Band 2 : 99%OBW(MHz)											
	1.4MHz		3MHz		5MHz		10MHz		15MHz		20MHz	
BW	QPSK	16QAM	QPSK	16QAM	QPSK	16QAM	QPSK	16QAM	QPSK	16QAM	QPSK	16QAM
Lowest CH	1.09	1.10	2.71	2.72	4.50	4.48	9.13	8.99	13.37	13.49	17.98	17.90
Middle CH	1.09	1.09	2.71	2.72	4.51	4.50	9.03	9.03	13.37	13.43	17.94	17.90
Highest CH	1.09	1.09	2.71	2.72	4.51	4.50	8.99	9.03	13.43	13.43	17.86	17.90



LTE Band 2

Lowest Channel / 1.4MHz / QPSK

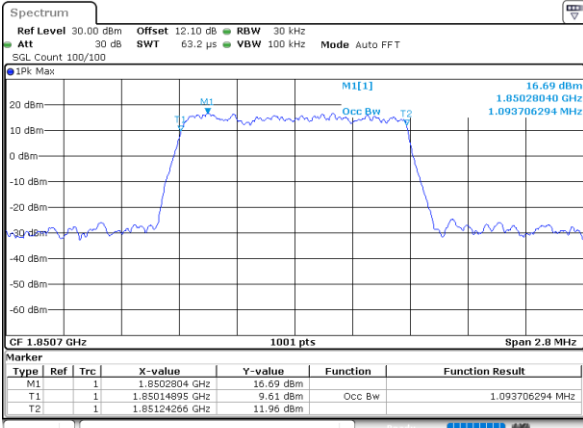

Date: 22_SEP.2020 21:40:29

Lowest Channel / 1.4MHz / 16QAM

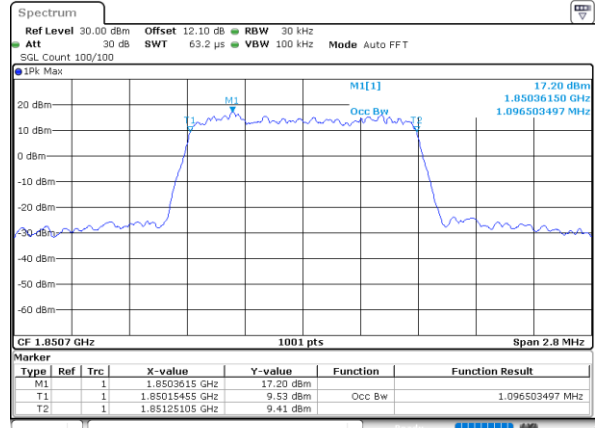

Date: 22_SEP.2020 21:40:41

Middle Channel / 1.4MHz / QPSK

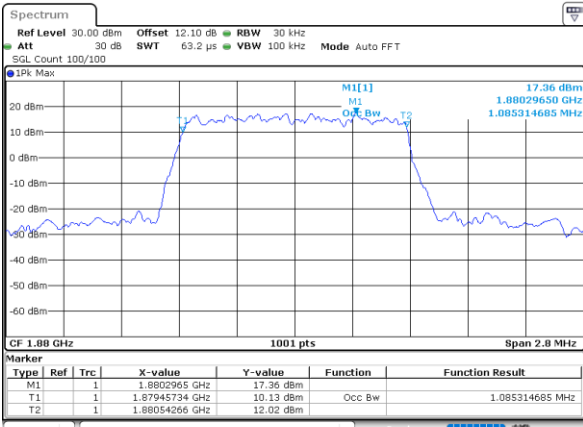

Date: 22_SEP.2020 21:46:50

Middle Channel / 1.4MHz / 16QAM

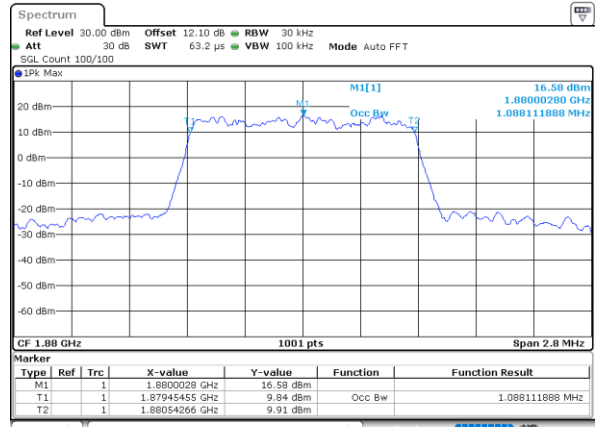

Date: 22_SEP.2020 21:47:01

Highest Channel / 1.4MHz / QPSK

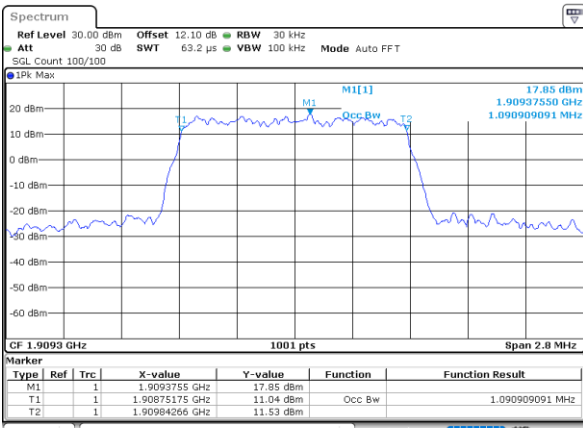

Date: 22_SEP.2020 21:48:56

Highest Channel / 1.4MHz / 16QAM

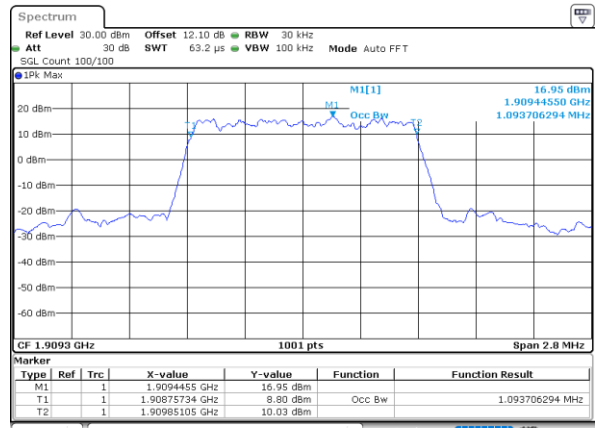

Date: 22_SEP.2020 21:49:08



LTE Band 2

Lowest Channel / 3MHz / QPSK

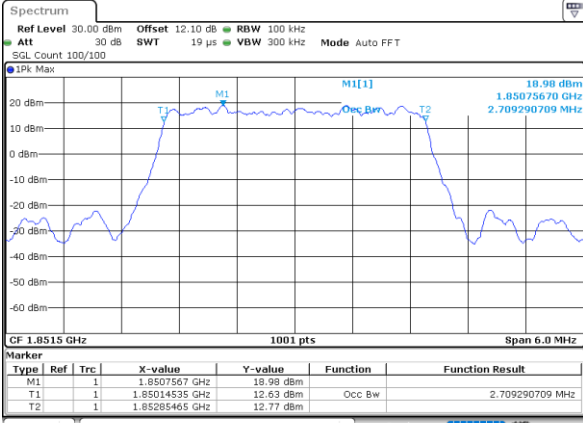

Date: 22_SEP.2020 20:11:02

Lowest Channel / 3MHz / 16QAM

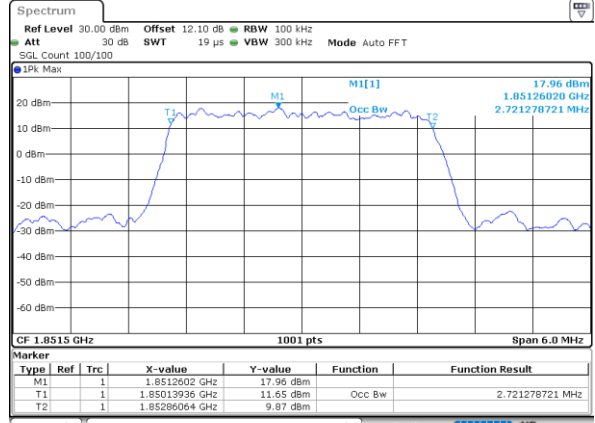

Date: 22_SEP.2020 20:11:14

Middle Channel / 3MHz / QPSK

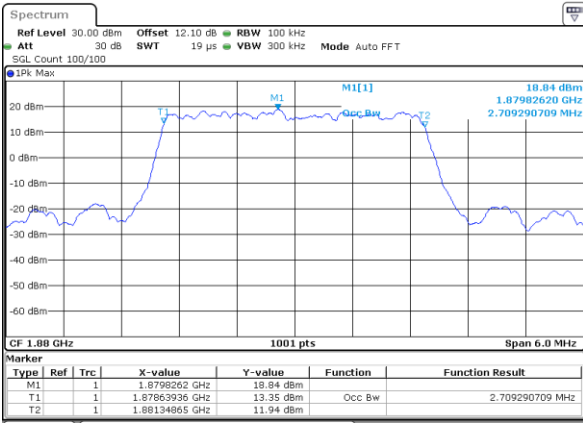

Date: 22_SEP.2020 20:17:10

Middle Channel / 3MHz / 16QAM

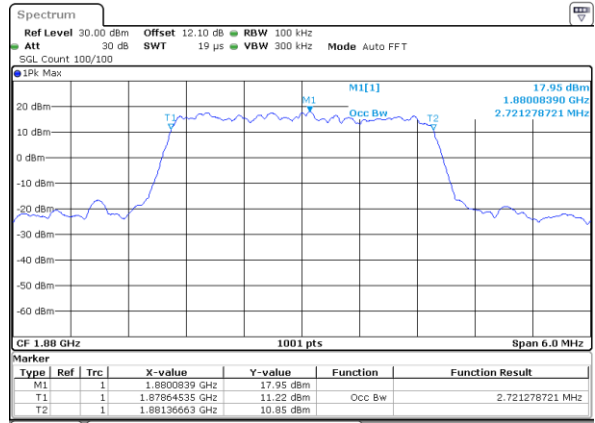

Date: 22_SEP.2020 20:17:22

Highest Channel / 3MHz / QPSK

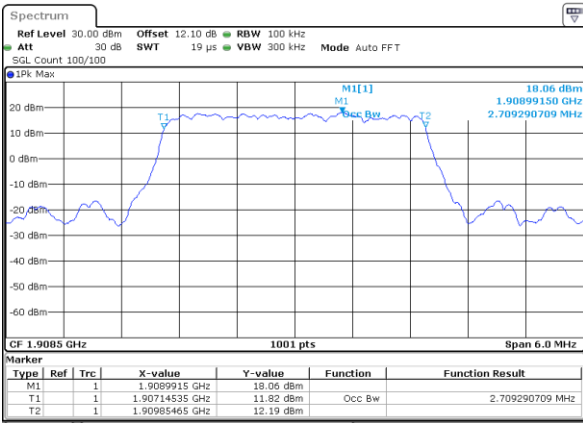

Date: 22_SEP.2020 20:19:17

Highest Channel / 3MHz / 16QAM

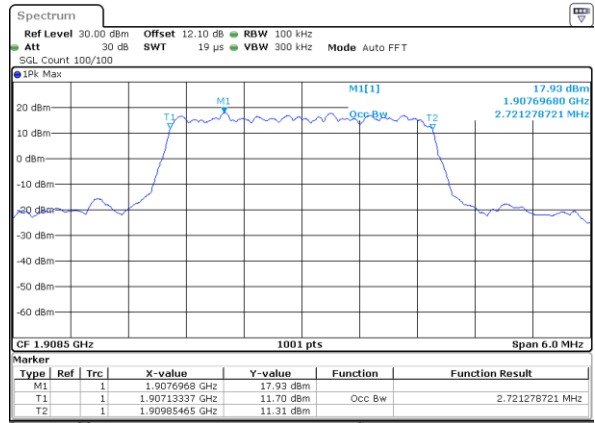

Date: 22_SEP.2020 20:19:29



LTE Band 2

Lowest Channel / 5MHz / QPSK

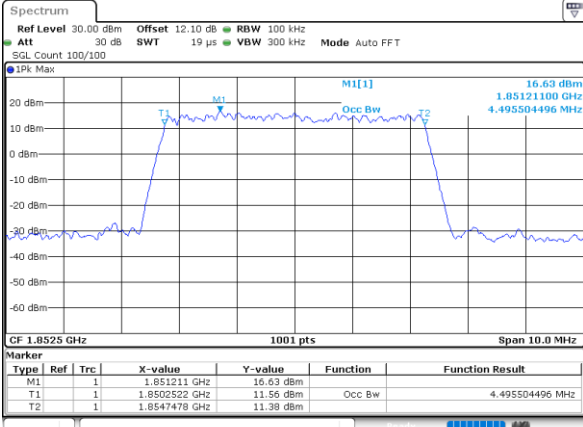

Date: 22_SEP.2020 20:25:27

Lowest Channel / 5MHz / 16QAM

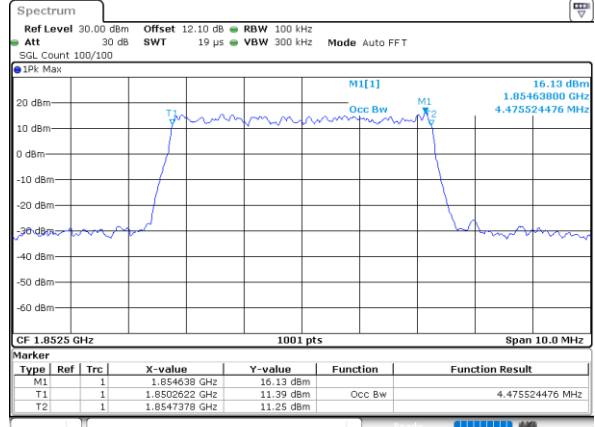

Date: 22_SEP.2020 20:25:139

Middle Channel / 5MHz / QPSK

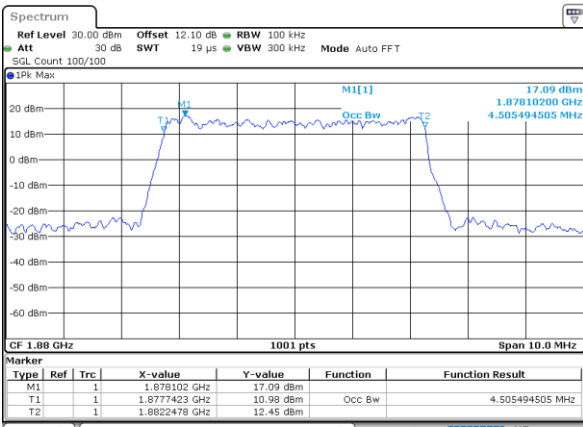

Date: 22_SEP.2020 20:31:05

Middle Channel / 5MHz / 16QAM

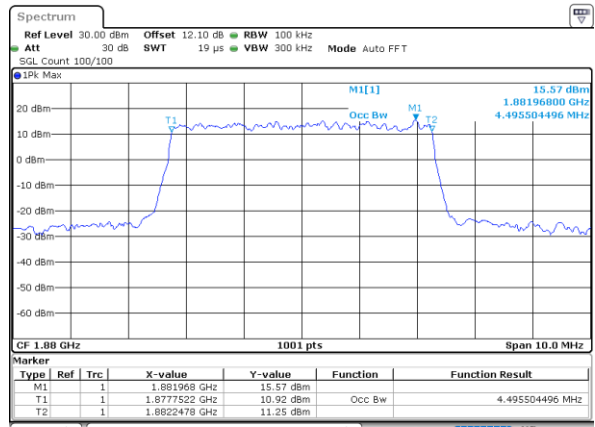

Date: 22_SEP.2020 20:31:147

Highest Channel / 5MHz / QPSK

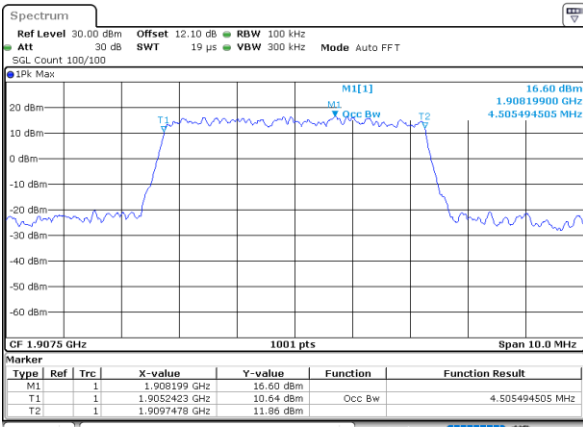

Date: 22_SEP.2020 20:33:42

Highest Channel / 5MHz / 16QAM

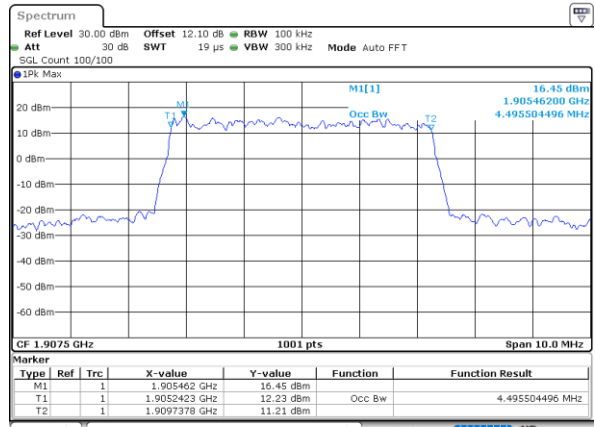

Date: 22_SEP.2020 20:33:154



LTE Band 2

Lowest Channel / 10MHz / QPSK

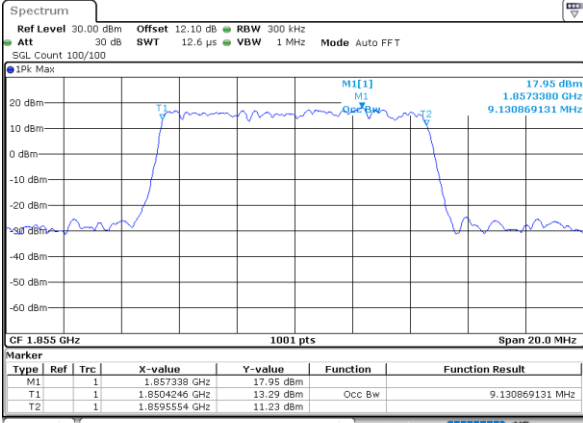

Date: 22_SEP.2020 20:39:51

Lowest Channel / 10MHz / 16QAM

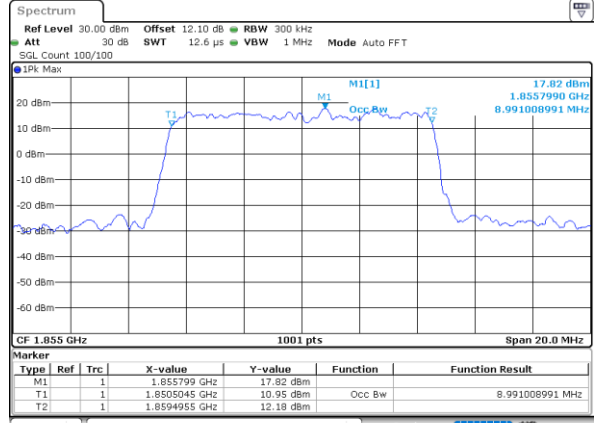

Date: 22_SEP.2020 20:40:03

Middle Channel / 10MHz / QPSK

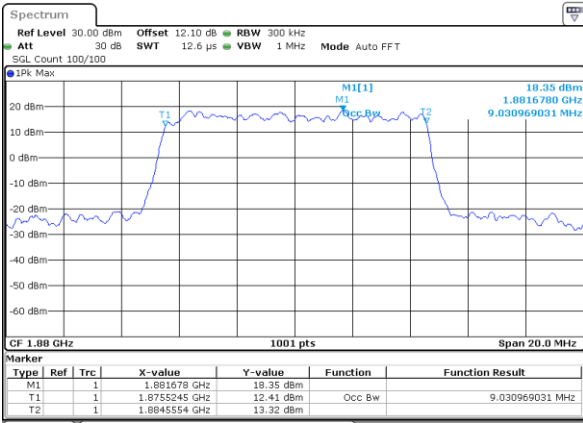

Date: 22_SEP.2020 20:46:00

Middle Channel / 10MHz / 16QAM

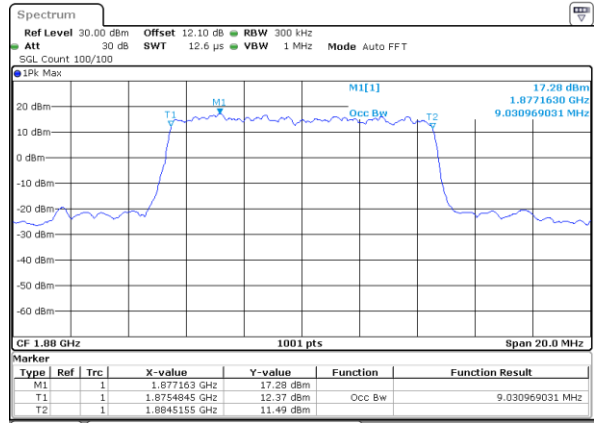

Date: 22_SEP.2020 20:46:11

Highest Channel / 10MHz / QPSK

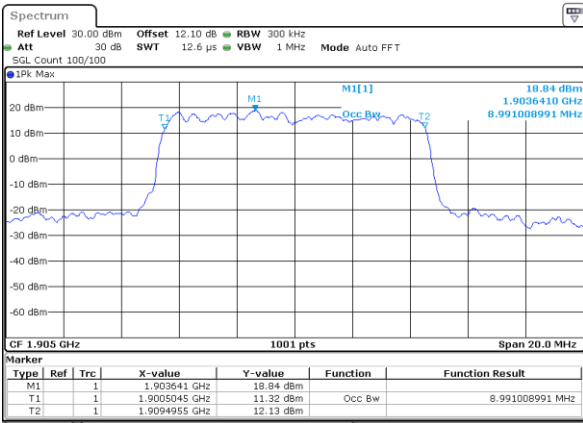

Date: 22_SEP.2020 20:48:07

Highest Channel / 10MHz / 16QAM

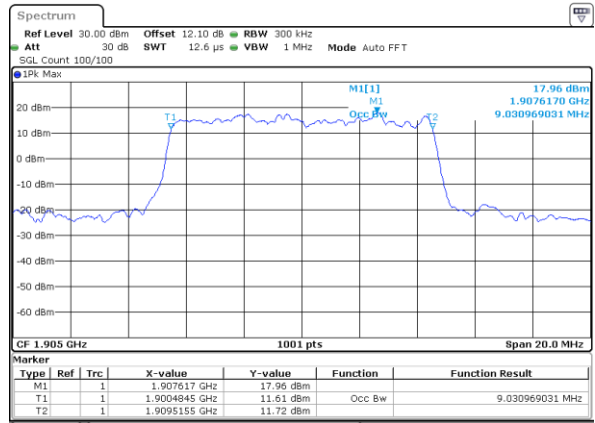

Date: 22_SEP.2020 20:48:18



LTE Band 2

Lowest Channel / 15MHz / QPSK

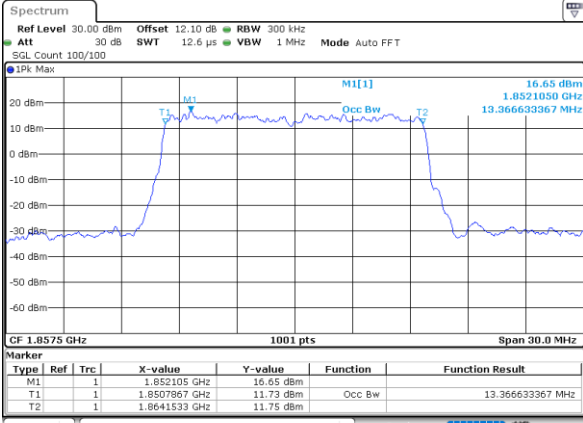

Date: 22_SEP.2020 21:05:32

Lowest Channel / 15MHz / 16QAM

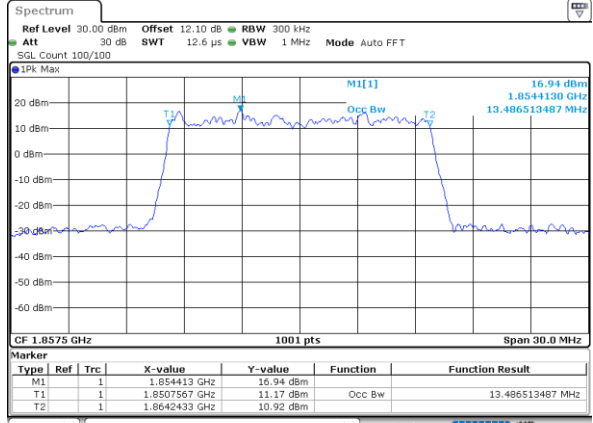

Date: 22_SEP.2020 21:05:44

Middle Channel / 15MHz / QPSK

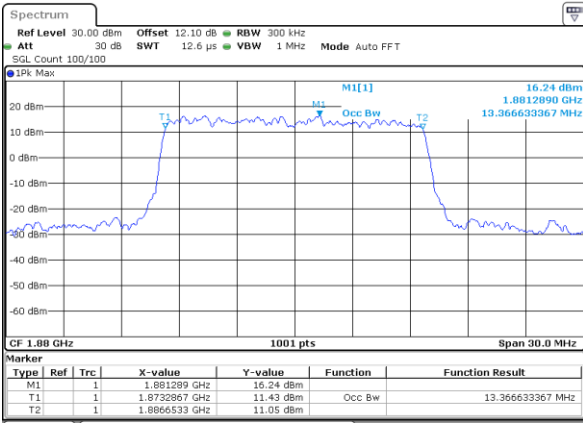

Date: 22_SEP.2020 21:11:41

Middle Channel / 15MHz / 16QAM

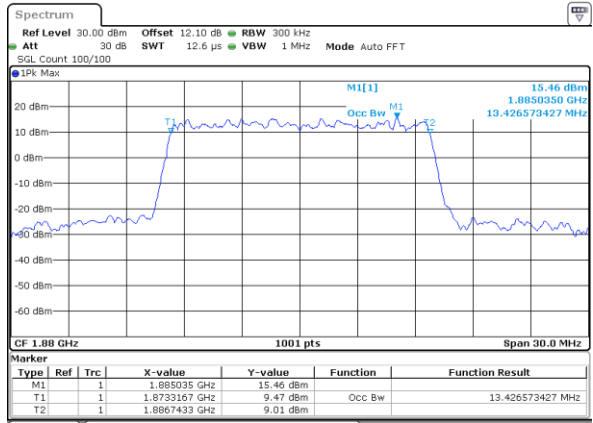

Date: 22_SEP.2020 21:11:52

Highest Channel / 15MHz / QPSK

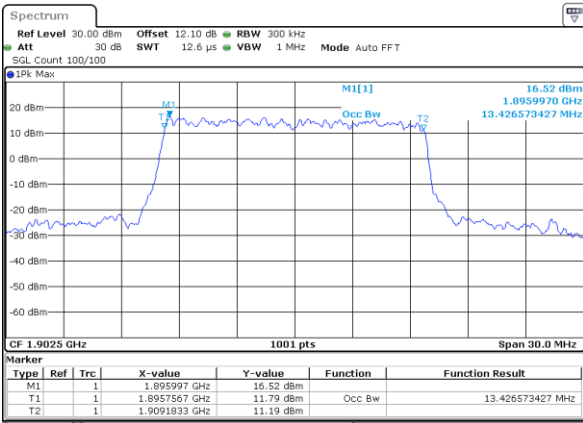

Date: 22_SEP.2020 21:13:47

Highest Channel / 15MHz / 16QAM

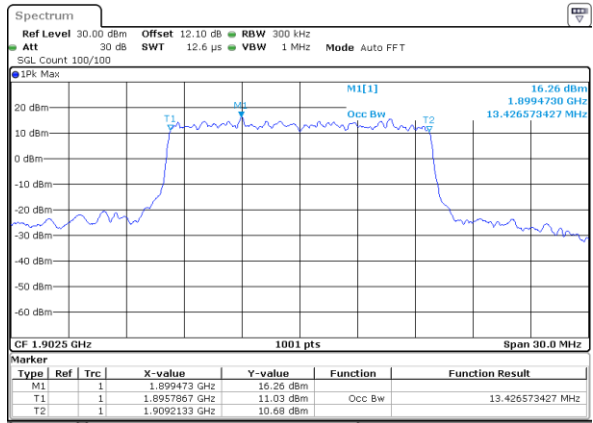

Date: 22_SEP.2020 21:13:59



LTE Band 2

Lowest Channel / 20MHz / QPSK

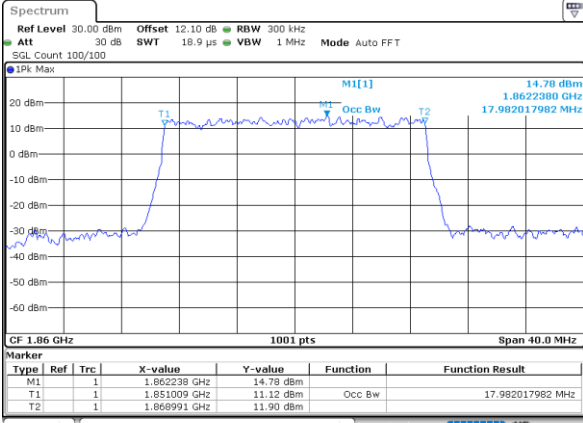

Date: 22_SEP.2020 21:19:57

Lowest Channel / 20MHz / 16QAM

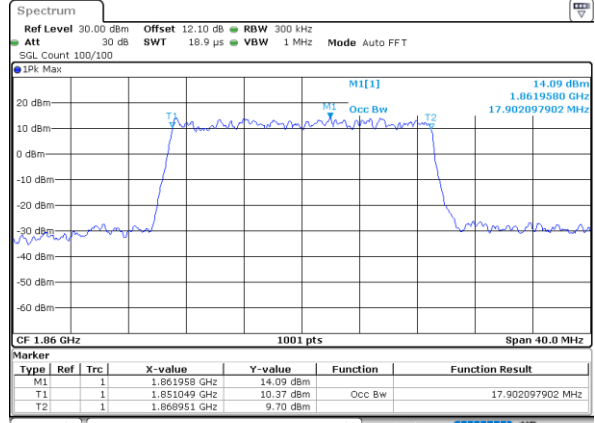

Date: 22_SEP.2020 21:20:09

Middle Channel / 20MHz / QPSK

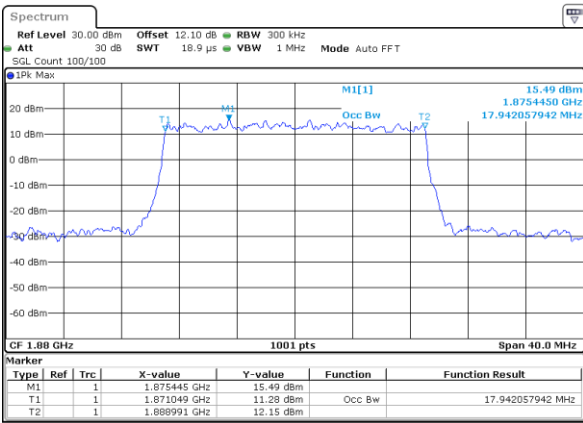

Date: 22_SEP.2020 21:26:06

Middle Channel / 20MHz / 16QAM

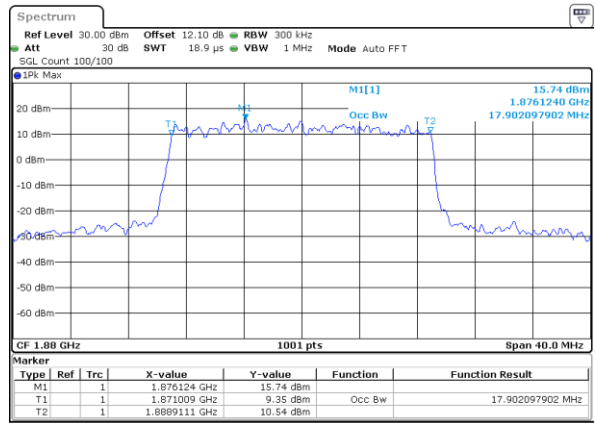

Date: 22_SEP.2020 21:26:17

Highest Channel / 20MHz / QPSK

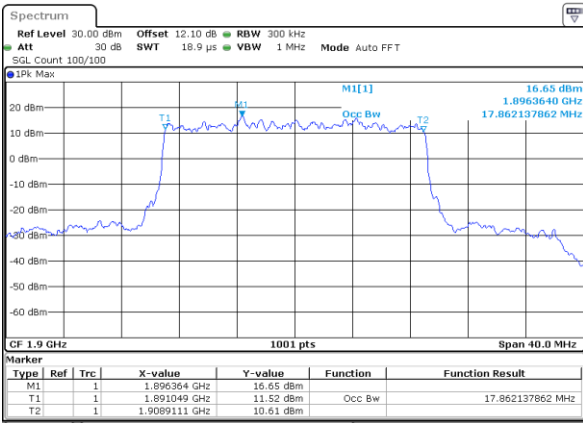

Date: 22_SEP.2020 21:28:12

Highest Channel / 20MHz / 16QAM

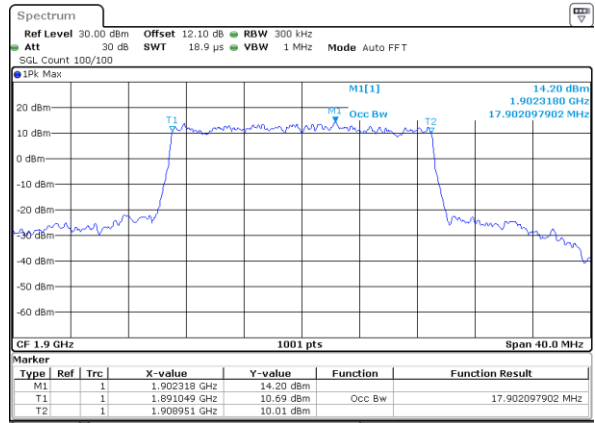

Date: 22_SEP.2020 21:28:24



Conducted Band Edge

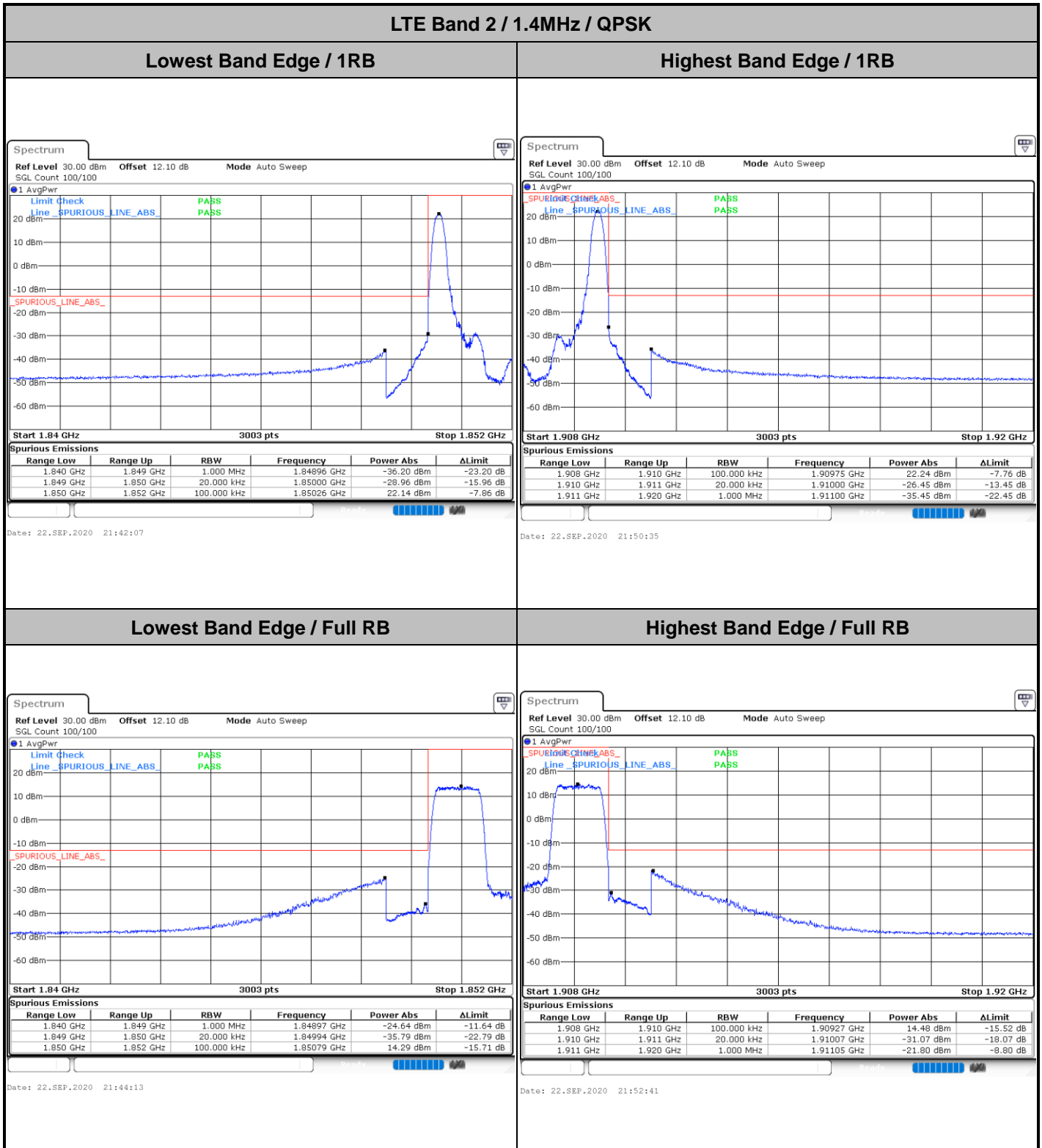



LTE Band 2 / 1.4MHz / 16QAM

Lowest Band Edge / 1 RB

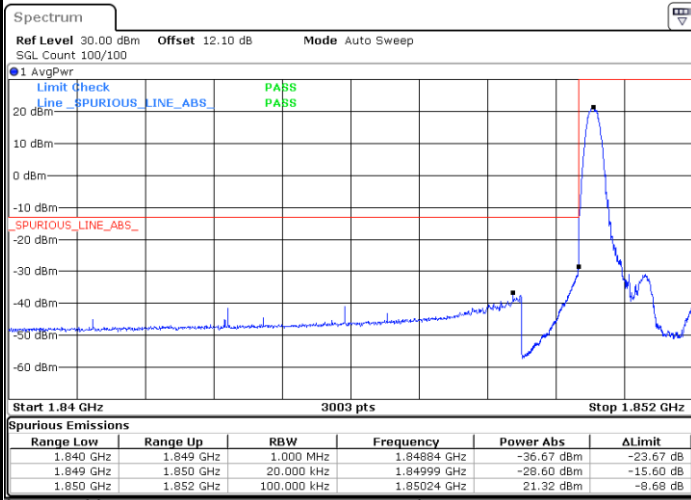

Date: 22.SEP.2020 21:43:10

Highest Band Edge / 1 RB

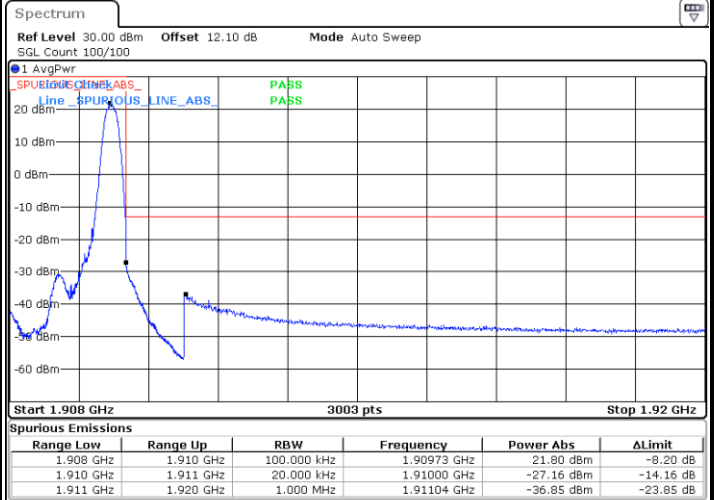

Date: 22.SEP.2020 21:51:38

Lowest Band Edge / Full RB

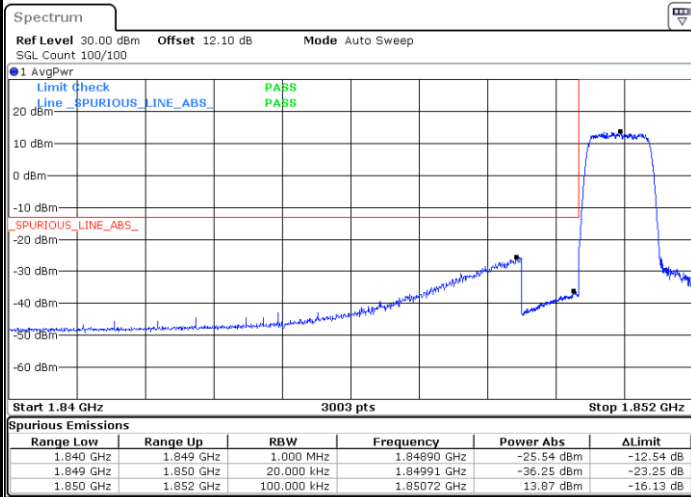

Date: 22.SEP.2020 21:45:16

Highest Band Edge / Full RB

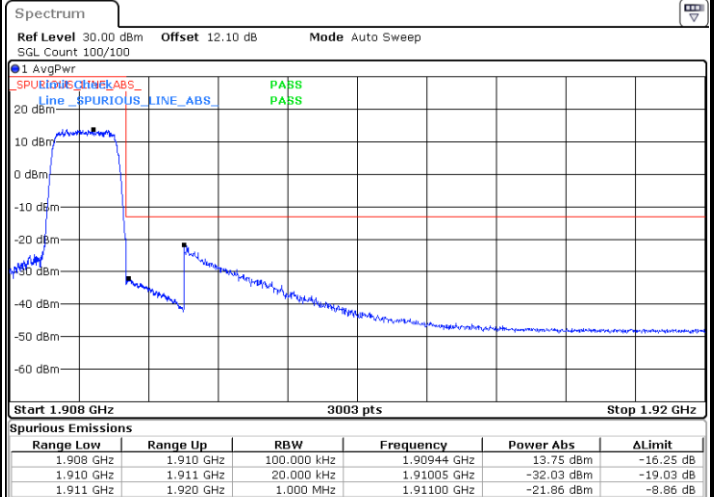

Date: 22.SEP.2020 21:53:44



LTE Band 2 / 3MHz / QPSK

Lowest Band Edge / 1RB

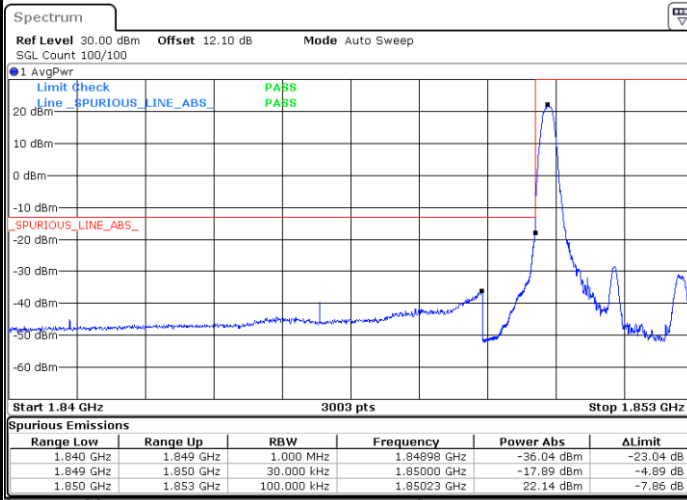

Highest Band Edge / 1 RB

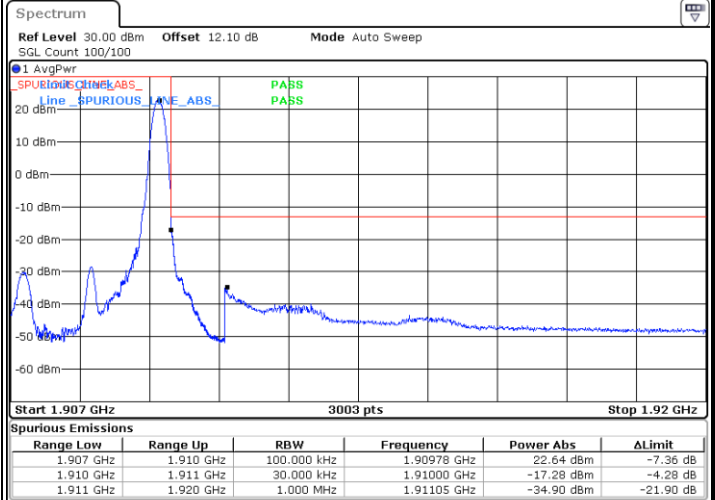

Lowest Band Edge / Full RB

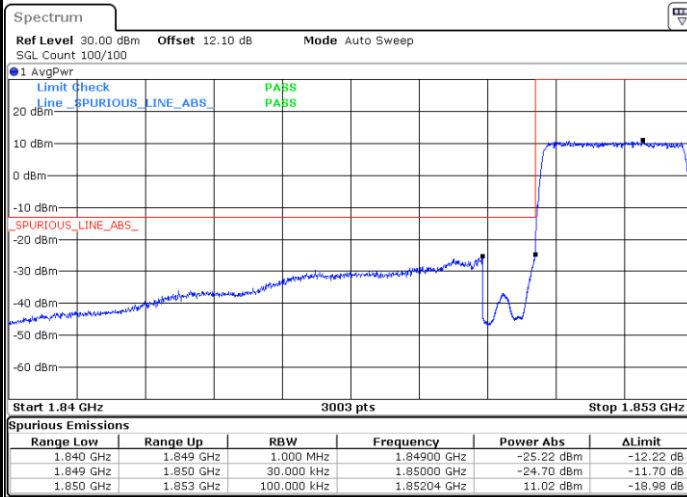

Highest Band Edge / Full RB

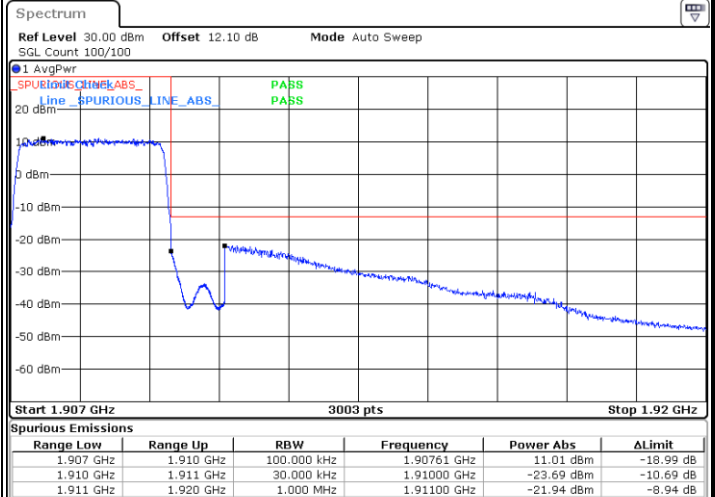



LTE Band 2 / 3MHz / 16QAM

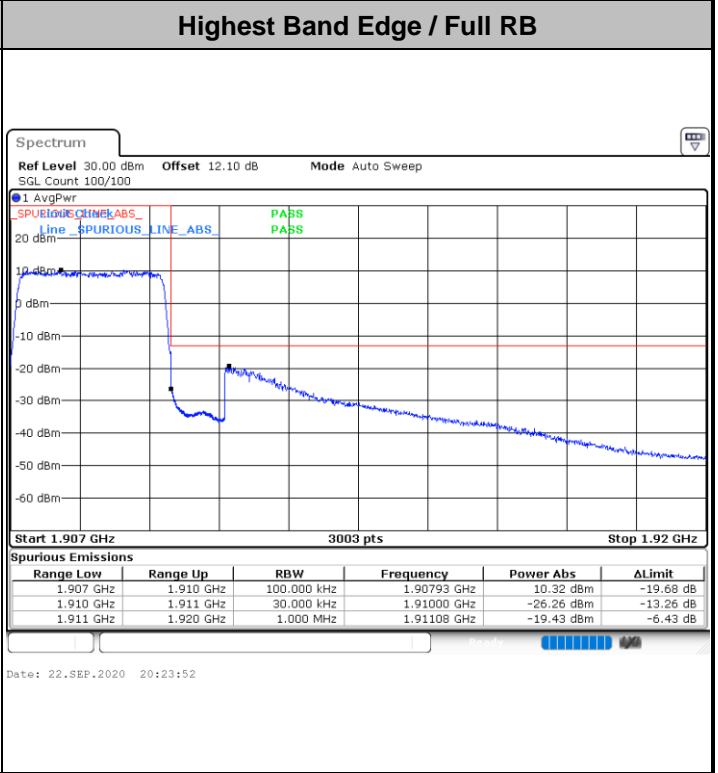
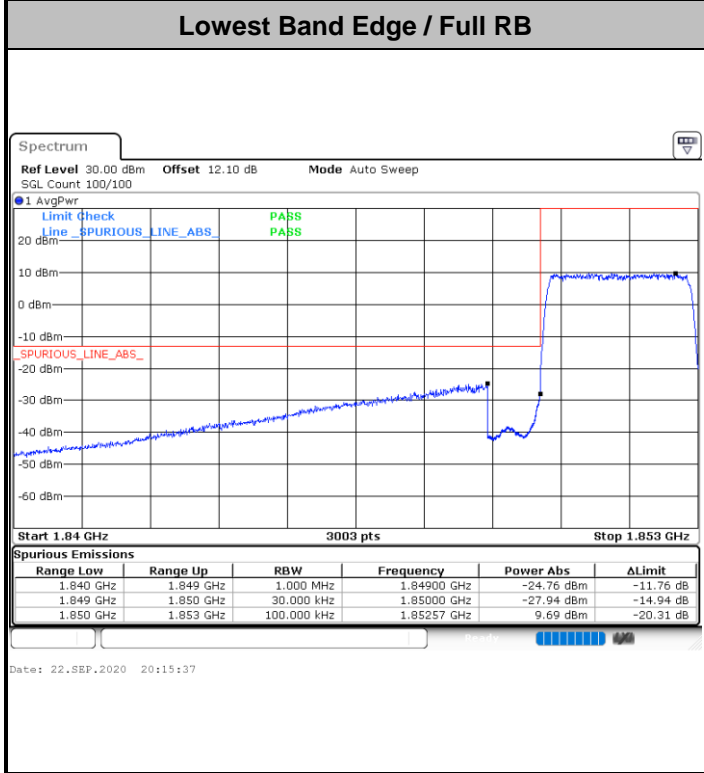
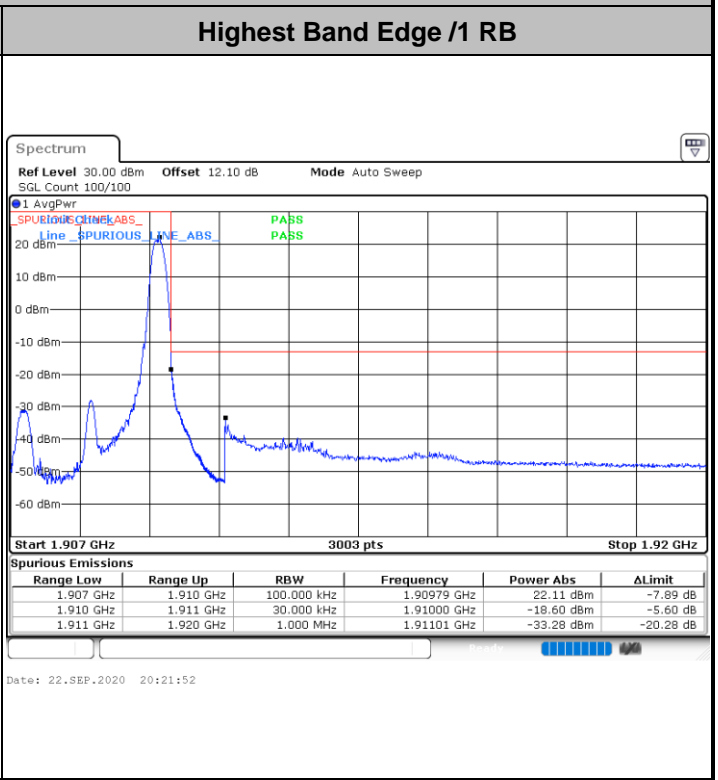
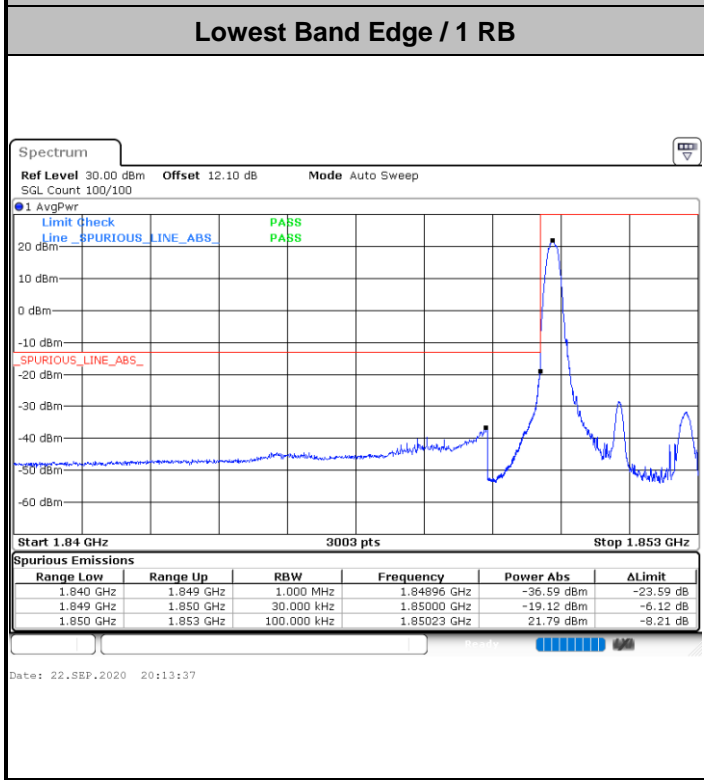



LTE Band 2 / 5MHz / QPSK

Lowest Band Edge / 1 RB

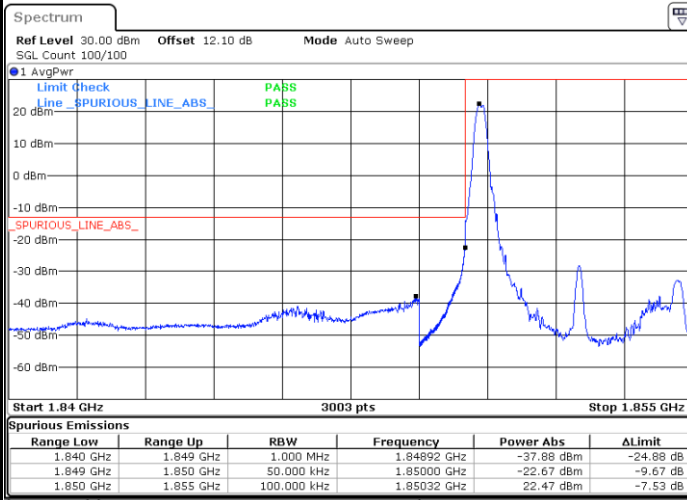

Date: 22.SEP.2020 20:27:02

Highest Band Edge / 1 RB

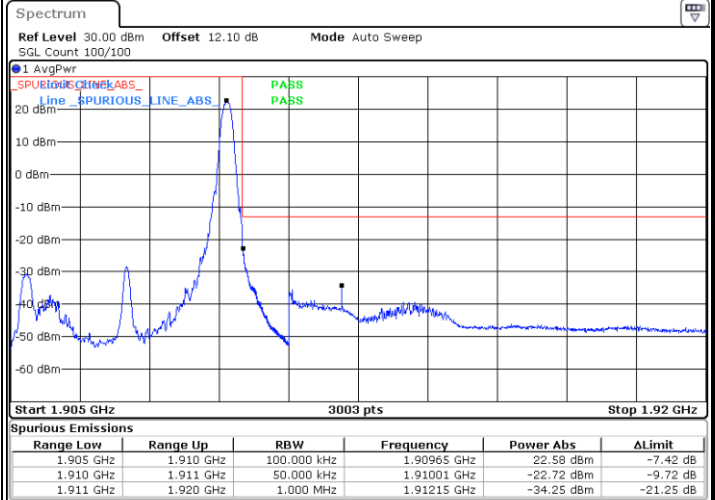

Date: 22.SEP.2020 20:35:17

Lowest Band Edge / Full RB

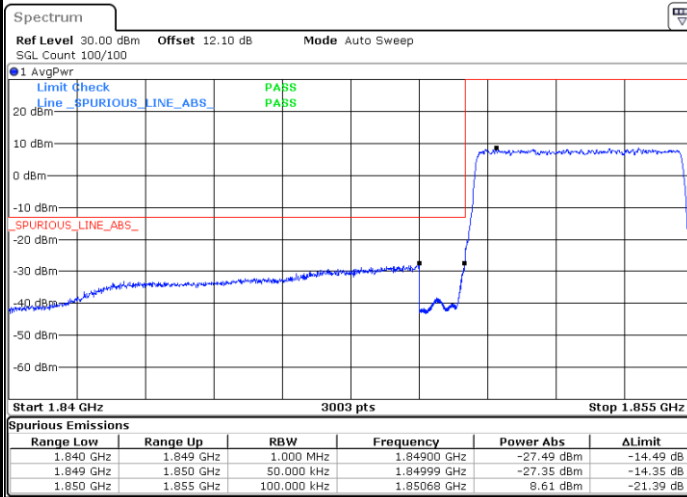

Date: 22.SEP.2020 20:29:02

Highest Band Edge / Full RB

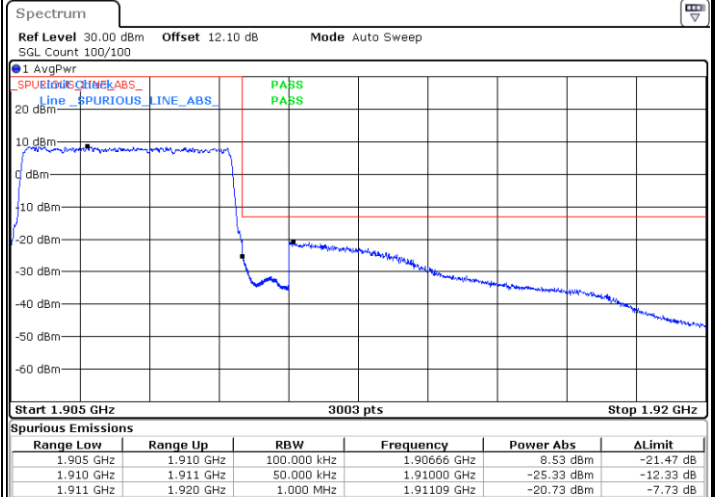

Date: 22.SEP.2020 20:37:17



LTE Band 2 / 5MHz / 16QAM

Lowest Band Edge / 1RB

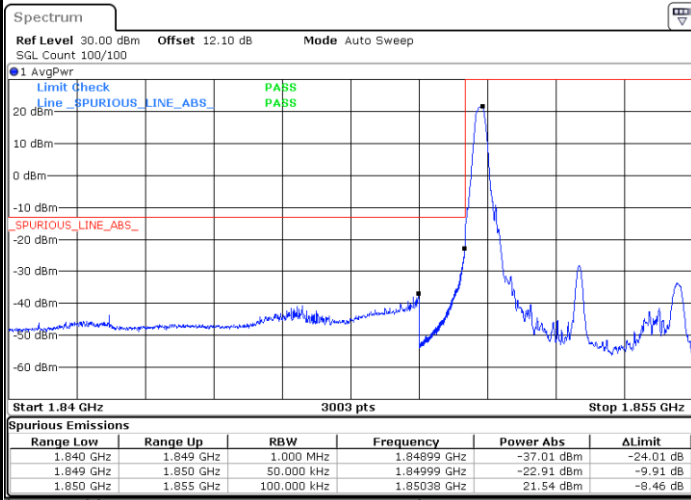

Date: 22.SEP.2020 20:28:02

Highest Band Edge / 1 RB

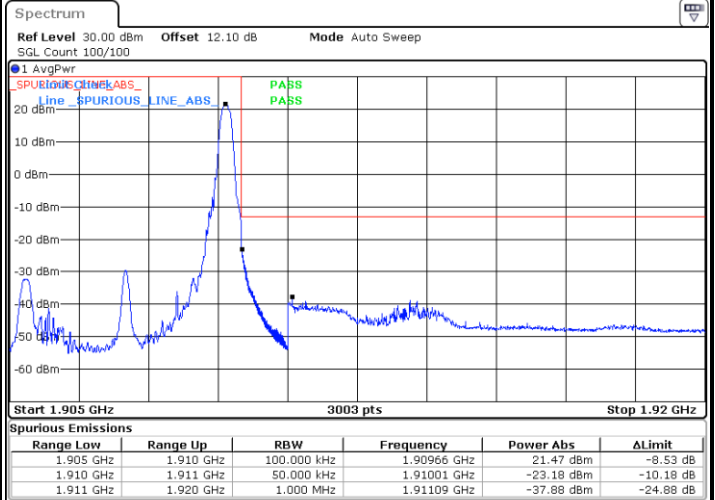

Date: 22.SEP.2020 20:36:17

Lowest Band Edge / Full RB

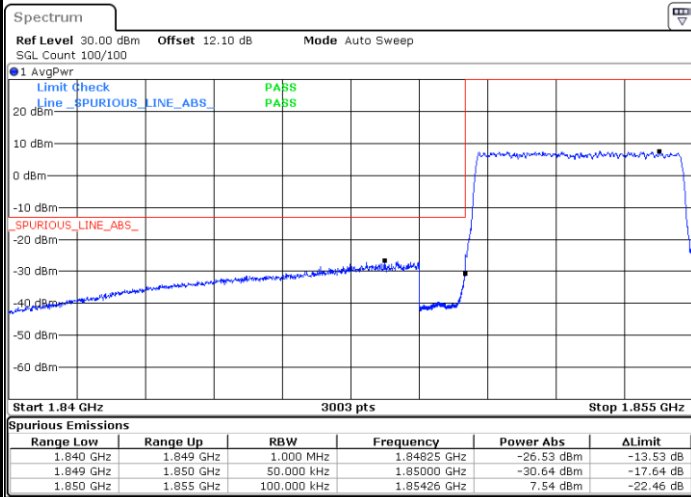

Date: 22.SEP.2020 20:30:02

Highest Band Edge / Full RB

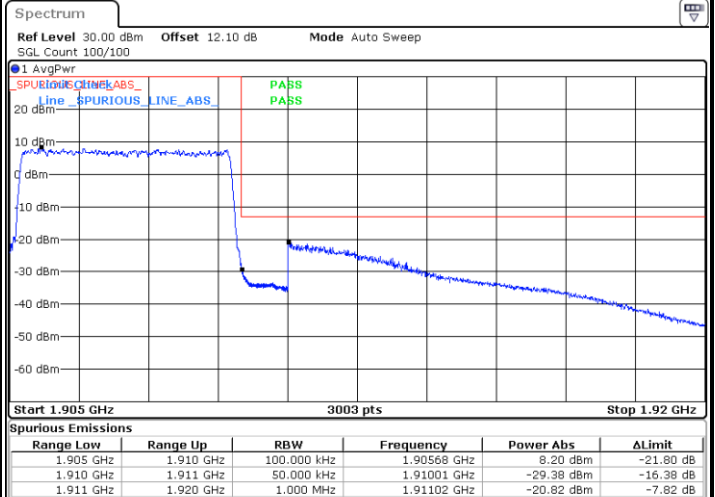

Date: 22.SEP.2020 20:38:17



LTE Band 2 / 10MHz / QPSK

Lowest Band Edge / 1 RB

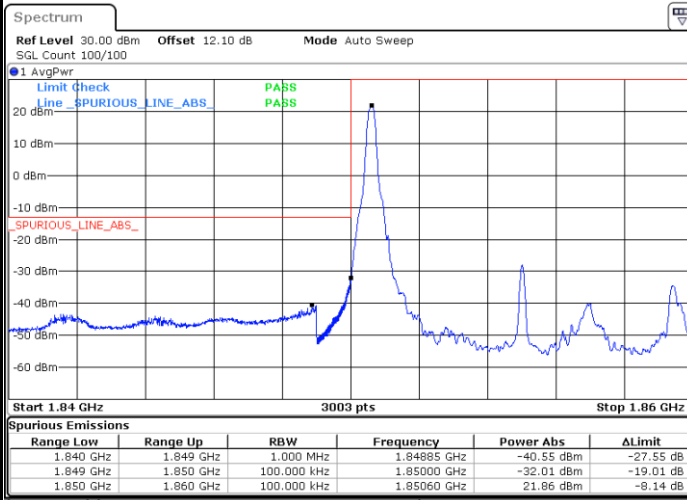

Date: 22.SEP.2020 20:41:26

Highest Band Edge / 1 RB

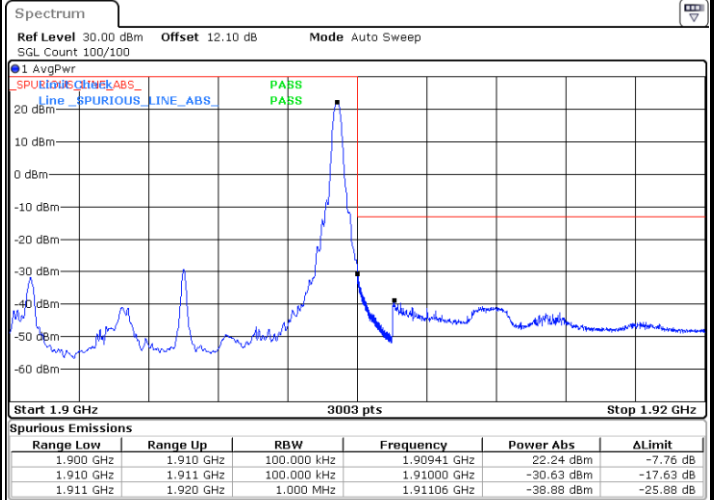

Date: 22.SEP.2020 20:49:42

Lowest Band Edge / Full RB

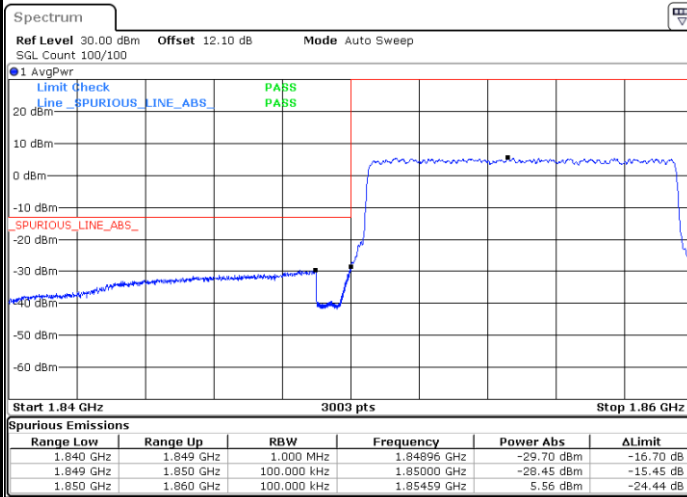

Date: 22.SEP.2020 20:43:26

Highest Band Edge / Full RB

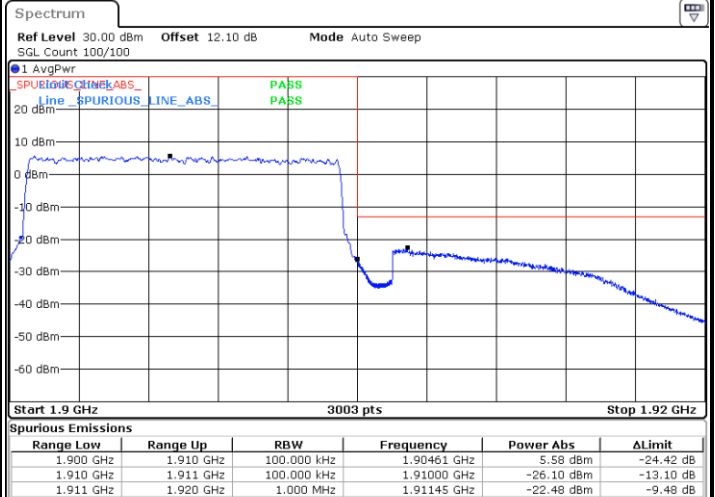

Date: 22.SEP.2020 20:51:42