



Add: No.51 Xueyuan Road, Haidian District, Beijing, 100191, China  
Tel: +86-10-62304633-2079 Fax: +86-10-62304633-2504  
E-mail: cttl@chinattl.com http://www.chinattl.cn

Client **Sporton**

Certificate No: **Z19-60054**

## CALIBRATION CERTIFICATE

Object **D750V3 - SN: 1107**

Calibration Procedure(s) **FF-Z11-003-01**  
**Calibration Procedures for dipole validation kits**

Calibration date: **March 8, 2019**

This calibration Certificate documents the traceability to national standards, which realize the physical units of measurements(SI). The measurements and the uncertainties with confidence probability are given on the following pages and are part of the certificate.

All calibrations have been conducted in the closed laboratory facility: environment temperature(22±3)°C and humidity<70%.

Calibration Equipment used (M&TE critical for calibration)

Primary Standards	ID #	Cal Date(Calibrated by, Certificate No.)	Scheduled Calibration
Power Meter NRP2	106277	20-Aug-18 (CTTL, No.J18X06862)	Aug-19
Power sensor NRP8S	104291	20-Aug-18 (CTTL, No.J18X06862)	Aug-19
Reference Probe EX3DV4	SN 3617	31-Jan-19(SPEAG,No.EX3-3617_Jan19)	Jan-20
DAE4	SN 1331	06-Feb-19(SPEAG,No.DAE4-1331_Feb19)	Feb-20
Secondary Standards	ID #	Cal Date(Calibrated by, Certificate No.)	Scheduled Calibration
Signal Generator E4438C	MY49071430	23-Jan-19 (CTTL, No.J19X00336)	Jan-20
NetworkAnalyzer E5071C	MY46110673	24-Jan-19 (CTTL, No.J19X00547)	Jan-20

	Name	Function	Signature
Calibrated by:	Zhao Jing	SAR Test Engineer	
Reviewed by:	Yu Zongying	SAR Test Engineer	
Approved by:	Qi Dianyuan	SAR Project Leader	

Issued: March 10, 2019

This calibration certificate shall not be reproduced except in full without written approval of the laboratory.



In Collaboration with

**s p e a g**  
CALIBRATION LABORATORY

Add: No.51 Xueyuan Road, Haidian District, Beijing, 100191, China  
Tel: +86-10-62304633-2079 Fax: +86-10-62304633-2504  
E-mail: cttl@chinattl.com http://www.chinattl.cn

### Glossary:

TSL	tissue simulating liquid
ConvF	sensitivity in TSL / NORM <sub>x,y,z</sub>
N/A	not applicable or not measured

### Calibration is Performed According to the Following Standards:

- IEEE Std 1528-2013, "IEEE Recommended Practice for Determining the Peak Spatial-Averaged Specific Absorption Rate (SAR) in the Human Head from Wireless Communications Devices: Measurement Techniques", June 2013
- IEC 62209-1, "Measurement procedure for assessment of specific absorption rate of human exposure to radio frequency fields from hand-held and body-mounted wireless communication devices- Part 1: Device used next to the ear (Frequency range of 300MHz to 6GHz)", July 2016
- IEC 62209-2, "Procedure to measure the Specific Absorption Rate (SAR) For wireless communication devices used in close proximity to the human body (frequency range of 30MHz to 6GHz)", March 2010
- KDB865664, SAR Measurement Requirements for 100 MHz to 6 GHz

### Additional Documentation:

- DASY4/5 System Handbook

### Methods Applied and Interpretation of Parameters:

- Measurement Conditions:** Further details are available from the Validation Report at the end of the certificate. All figures stated in the certificate are valid at the frequency indicated.
- Antenna Parameters with TSL:** The dipole is mounted with the spacer to position its feed point exactly below the center marking of the flat phantom section, with the arms oriented parallel to the body axis.
- Feed Point Impedance and Return Loss:** These parameters are measured with the dipole positioned under the liquid filled phantom. The impedance stated is transformed from the measurement at the SMA connector to the feed point. The Return Loss ensures low reflected power. No uncertainty required.
- Electrical Delay:** One-way delay between the SMA connector and the antenna feed point. No uncertainty required.
- SAR measured:** SAR measured at the stated antenna input power.
- SAR normalized:** SAR as measured, normalized to an input power of 1 W at the antenna connector.
- SAR for nominal TSL parameters:** The measured TSL parameters are used to calculate the nominal SAR result.

The reported uncertainty of measurement is stated as the standard uncertainty of Measurement multiplied by the coverage factor  $k=2$ , which for a normal distribution Corresponds to a coverage probability of approximately 95%.



Add: No.51 Xueyuan Road, Haidian District, Beijing, 100191, China  
Tel: +86-10-62304633-2079 Fax: +86-10-62304633-2504  
E-mail: cttl@chinattl.com http://www.chinattl.cn

### Measurement Conditions

DASY system configuration, as far as not given on page 1.

<b>DASY Version</b>	DASY52	52.10.2.1495
<b>Extrapolation</b>	Advanced Extrapolation	
<b>Phantom</b>	Triple Flat Phantom 5.1C	
<b>Distance Dipole Center - TSL</b>	15 mm	with Spacer
<b>Zoom Scan Resolution</b>	dx, dy, dz = 5 mm	
<b>Frequency</b>	750 MHz ± 1 MHz	

### Head TSL parameters

The following parameters and calculations were applied.

	Temperature	Permittivity	Conductivity
<b>Nominal Head TSL parameters</b>	22.0 °C	41.9	0.89 mho/m
<b>Measured Head TSL parameters</b>	(22.0 ± 0.2) °C	43.1 ± 6 %	0.86 mho/m ± 6 %
<b>Head TSL temperature change during test</b>	<1.0 °C	----	----

### SAR result with Head TSL

<b>SAR averaged over 1 cm<sup>3</sup> (1 g) of Head TSL</b>	Condition	
SAR measured	250 mW input power	2.02 W/kg
SAR for nominal Head TSL parameters	normalized to 1W	<b>8.32 W/kg ± 18.8 % (k=2)</b>
<b>SAR averaged over 10 cm<sup>3</sup> (10 g) of Head TSL</b>	Condition	
SAR measured	250 mW input power	1.37 W/kg
SAR for nominal Head TSL parameters	normalized to 1W	<b>5.61 W/kg ± 18.7 % (k=2)</b>

### Body TSL parameters

The following parameters and calculations were applied.

	Temperature	Permittivity	Conductivity
<b>Nominal Body TSL parameters</b>	22.0 °C	55.5	0.96 mho/m
<b>Measured Body TSL parameters</b>	(22.0 ± 0.2) °C	54.8 ± 6 %	0.94 mho/m ± 6 %
<b>Body TSL temperature change during test</b>	<1.0 °C	----	----

### SAR result with Body TSL

<b>SAR averaged over 1 cm<sup>3</sup> (1 g) of Body TSL</b>	Condition	
SAR measured	250 mW input power	2.09 W/kg
SAR for nominal Body TSL parameters	normalized to 1W	<b>8.45 W/kg ± 18.8 % (k=2)</b>
<b>SAR averaged over 10 cm<sup>3</sup> (10 g) of Body TSL</b>	Condition	
SAR measured	250 mW input power	1.40 W/kg
SAR for nominal Body TSL parameters	normalized to 1W	<b>5.65 W/kg ± 18.7 % (k=2)</b>



Add: No.51 Xueyuan Road, Haidian District, Beijing, 100191, China  
Tel: +86-10-62304633-2079 Fax: +86-10-62304633-2504  
E-mail: cttl@chinattl.com http://www.chinattl.cn

## Appendix (Additional assessments outside the scope of CNAS L0570)

### Antenna Parameters with Head TSL

Impedance, transformed to feed point	55.2Ω- 1.55jΩ
Return Loss	- 25.7dB

### Antenna Parameters with Body TSL

Impedance, transformed to feed point	48.4Ω- 3.30jΩ
Return Loss	- 28.6dB

### General Antenna Parameters and Design

Electrical Delay (one direction)	0.980 ns
----------------------------------	----------

After long term use with 100W radiated power, only a slight warming of the dipole near the feedpoint can be measured.

The dipole is made of standard semirigid coaxial cable. The center conductor of the feeding line is directly connected to the second arm of the dipole. The antenna is therefore short-circuited for DC-signals. On some of the dipoles, small end caps are added to the dipole arms in order to improve matching when loaded according to the position as explained in the "Measurement Conditions" paragraph. The SAR data are not affected by this change. The overall dipole length is still according to the Standard.

No excessive force must be applied to the dipole arms, because they might bend or the soldered connections near the feedpoint may be damaged.

### Additional EUT Data

Manufactured by	SPEAG
-----------------	-------



Add: No.51 Xueyuan Road, Haidian District, Beijing, 100191, China  
Tel: +86-10-62304633-2079 Fax: +86-10-62304633-2504  
E-mail: cttl@chinattl.com http://www.chinattl.cn

### DASY5 Validation Report for Head TSL

Date: 03.07.2019

Test Laboratory: CTTL, Beijing, China

**DUT: Dipole 750 MHz; Type: D750V3; Serial: D750V3 - SN: 1107**

Communication System: UID 0, CW; Frequency: 750 MHz; Duty Cycle: 1:1

Medium parameters used:  $f = 750$  MHz;  $\sigma = 0.864$  S/m;  $\epsilon_r = 43.14$ ;  $\rho = 1000$  kg/m<sup>3</sup>

Phantom section: Right Section

DASY5 Configuration:

- Probe: EX3DV4 - SN3617; ConvF(10.03, 10.03, 10.03) @ 750 MHz; Calibrated: 1/31/2019
- Sensor-Surface: 1.4mm (Mechanical Surface Detection)
- Electronics: DAE4 Sn1331; Calibrated: 2/6/2019
- Phantom: MFP\_V5.1C ; Type: QD 000 P51CA; Serial: 1062
- Measurement SW: DASY52, Version 52.10 (2); SEMCAD X Version 14.6.12 (7450)

**Dipole Calibration/Zoom Scan (7x7x7) (7x7x7)/Cube 0:** Measurement grid: dx=5mm, dy=5mm, dz=5mm

Reference Value = 54.80 V/m; Power Drift = -0.04 dB

Peak SAR (extrapolated) = 2.90 W/kg

**SAR(1 g) = 2.02 W/kg; SAR(10 g) = 1.37 W/kg**

Maximum value of SAR (measured) = 2.62 W/kg

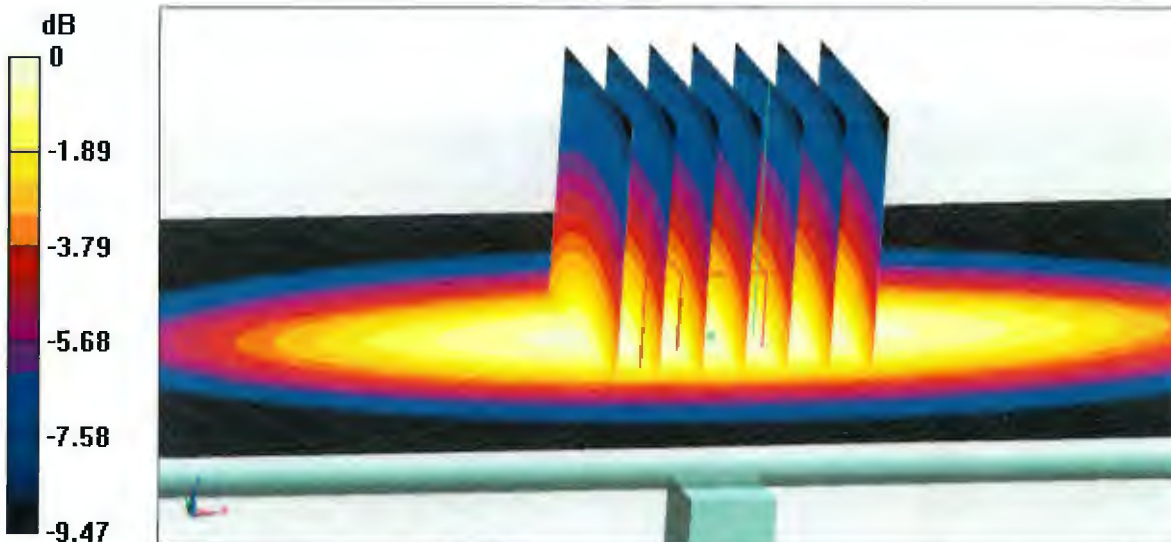

**0 dB = 2.62 W/kg = 4.18 dBW/kg**



In Collaboration with

**s p e a g**

BRATION LABORATORY

Add: No.51 Xueyuan Road, Haidian District, Beijing, 100191, China

Tel: +86-10-62304633-2079

Fax: +86-10-62304633-2504

E-mail: [ctl@chinattl.com](mailto:ctl@chinattl.com)

<http://www.chinattl.cn>

### Impedance Measurement Plot for Head TSL

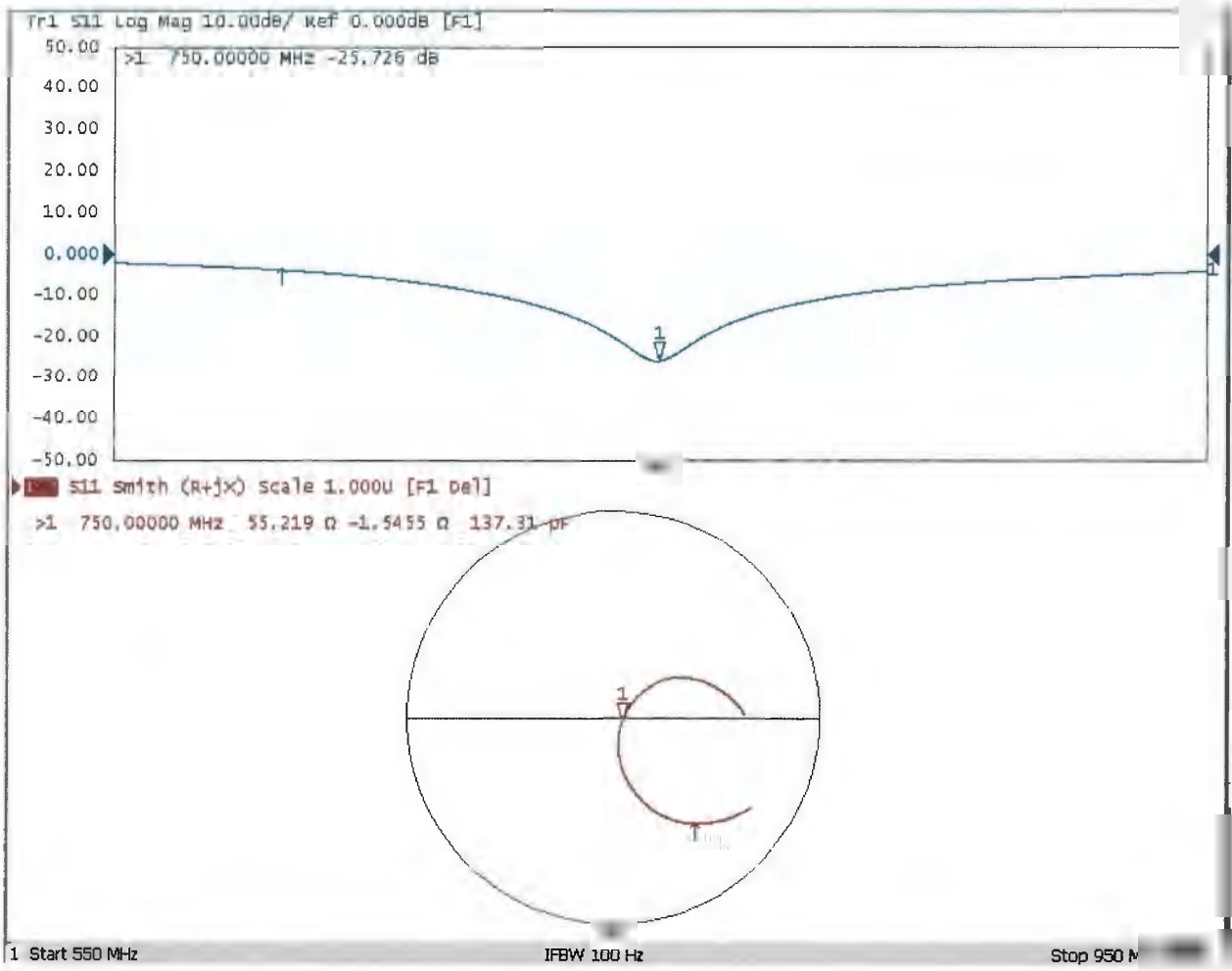



Add: No.51 Xueyuan Road, Haidian District, Beijing, 100191, China  
Tel: +86-10-62304633-2079 Fax: +86-10-62304633-2504  
E-mail: cttl@chinattl.com http://www.chinattl.cn

**DASY5 Validation Report for Body TSL**

Date: 03.07.2019

Test Laboratory: CTTL, Beijing, China

**DUT: Dipole 750 MHz; Type: D750V3; Serial: D750V3 - SN: 1107**

Communication System: UID 0, CW; Frequency: 750 MHz; Duty Cycle: 1:1

Medium parameters used:  $f = 750$  MHz;  $\sigma = 0.943$  S/m;  $\epsilon_r = 54.78$ ;  $\rho = 1000$  kg/m<sup>3</sup>

Phantom section: Center Section

DASY5 Configuration:

- Probe: EX3DV4 - SN3617; ConvF(9.85, 9.85, 9.85) @ 750 MHz; Calibrated: 1/31/2019
- Sensor-Surface: 1.4mm (Mechanical Surface Detection)
- Electronics: DAE4 Sn1331; Calibrated: 2/6/2019
- Phantom: MFP\_V5.1C ; Type: QD 000 P51CA; Serial: 1062
- Measurement SW: DASY52, Version 52.10 (2); SEMCAD X Version 14.6.12 (7450)

**Dipole Calibration/Zoom Scan (7x7x7) (7x7x7)/Cube 0:** Measurement grid: dx=5mm, dy=5mm, dz=5mm

Reference Value = 52.31 V/m; Power Drift = 0.00 dB

Peak SAR (extrapolated) = 3.09 W/kg

**SAR(1 g) = 2.09 W/kg; SAR(10 g) = 1.4 W/kg**

Maximum value of SAR (measured) = 2.75 W/kg

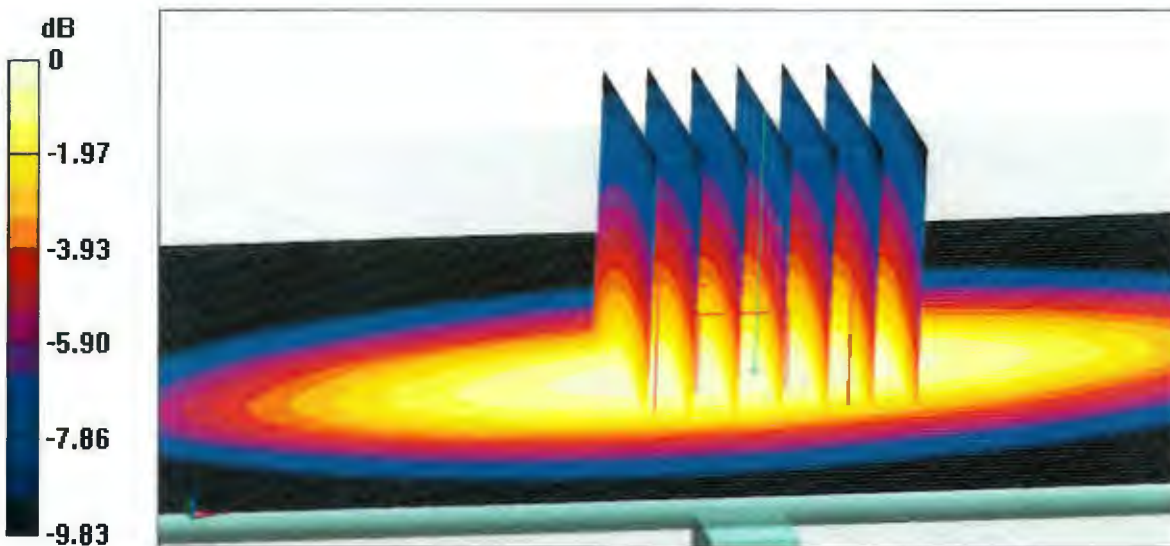

**0 dB = 2.75 W/kg = 4.39 dBW/kg**



Add: No.51 Xueyuan Road, Haidian District, Beijing, 100191, China  
Tel: +86-10-62304633-2079 Fax: +86-10-62304633-2504  
E-mail: cttl@chinattl.com http://www.chinattl.cn

### Impedance Measurement Plot for Body TSL

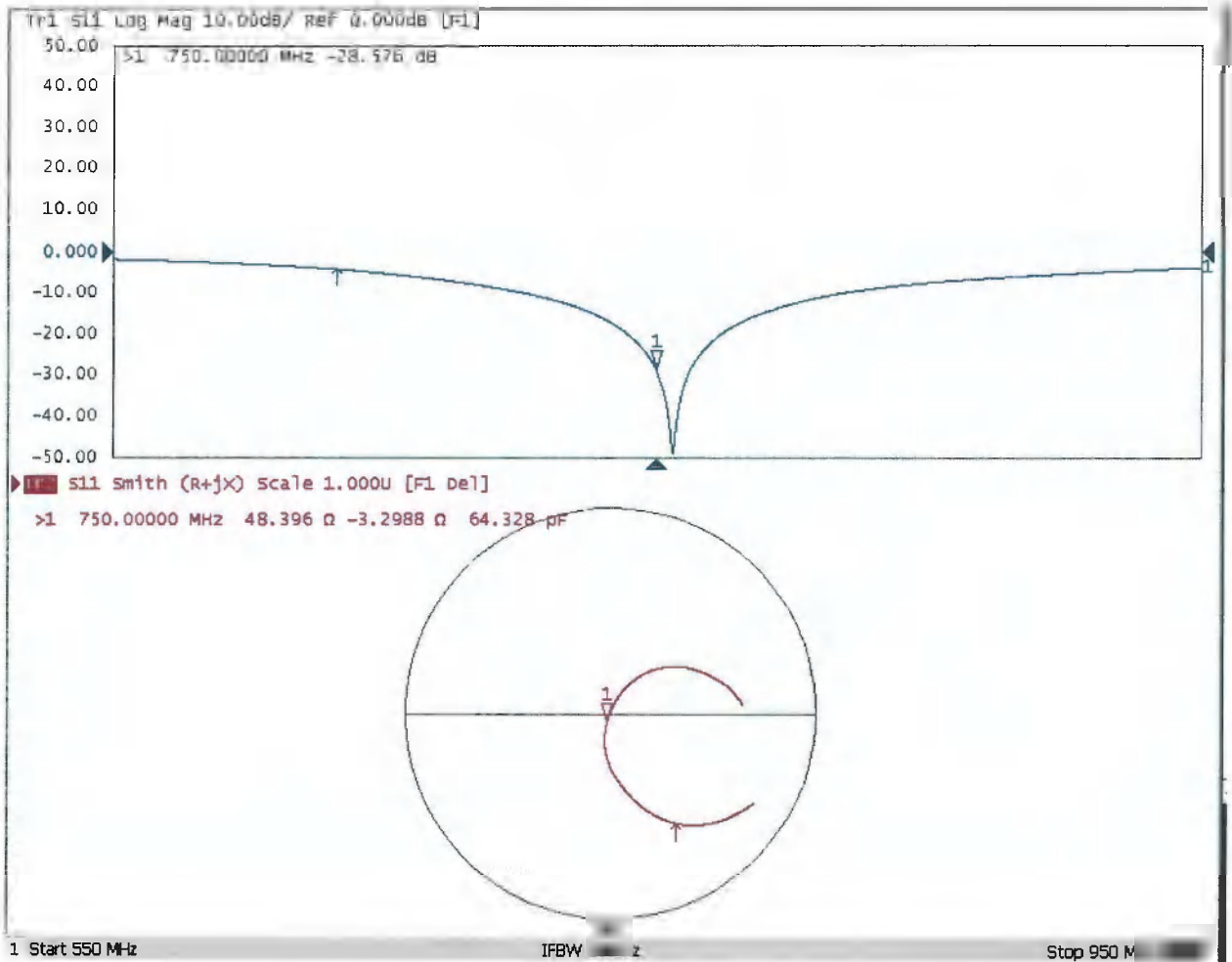





### D750V3, serial no. 1107 Extended Dipole Calibrations

Referring to KDB 450824, if dipoles are verified in return loss ( $<-20\text{dB}$ , within 20% of prior calibration), and in impedance (within 5 ohm of prior calibration), the annual calibration is not necessary and the calibration interval can be extended.

#### <Justification of the extended calibration>

D750V3 – serial no. 1107						
750MHZ						
Date of Measurement	Return-Loss (dB)	Delta (%)	Real Impedance (ohm)	Delta (ohm)	Imaginary Impedance (ohm)	Delta (ohm)
03.08.2019 (Cal. Report)	-25.726		55.219		-1.5455	
03.07.2020 (extended)	-25.760	0.13	59.446	-4.227	-3.2169	1.6714

The return loss is  $<-20\text{dB}$ , within 20% of prior calibration; the impedance is within 5 ohm of prior calibration. Therefore the verification result should support extended calibration.



<Dipole Verification Data> - D750 V3, serial no. 1107 (Data of Measurement : 03.07.2020)

750 MHz - Head

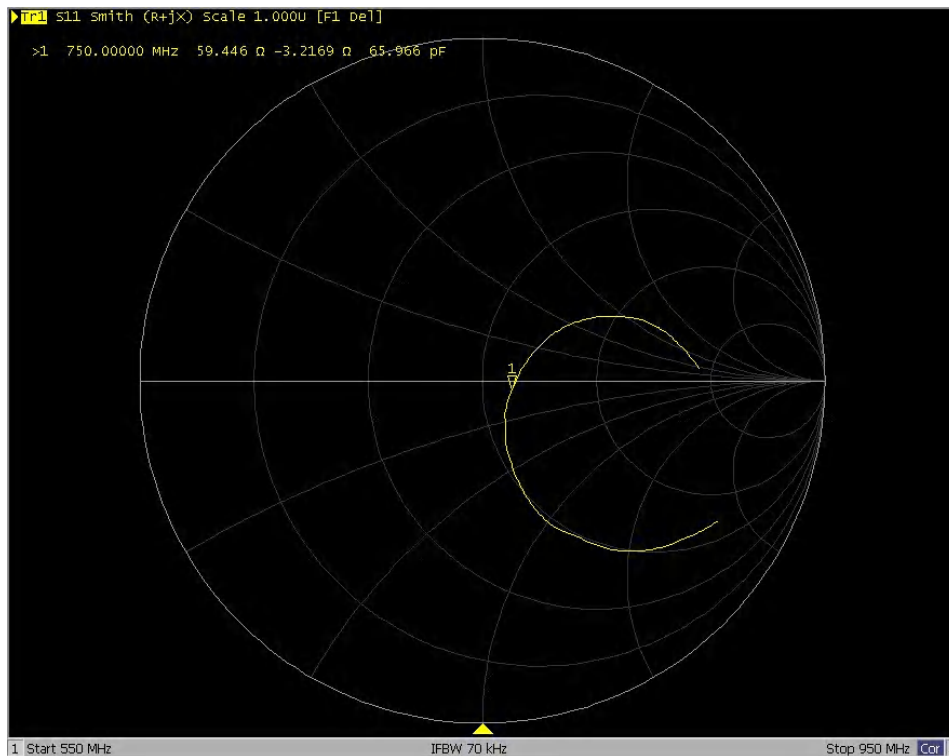
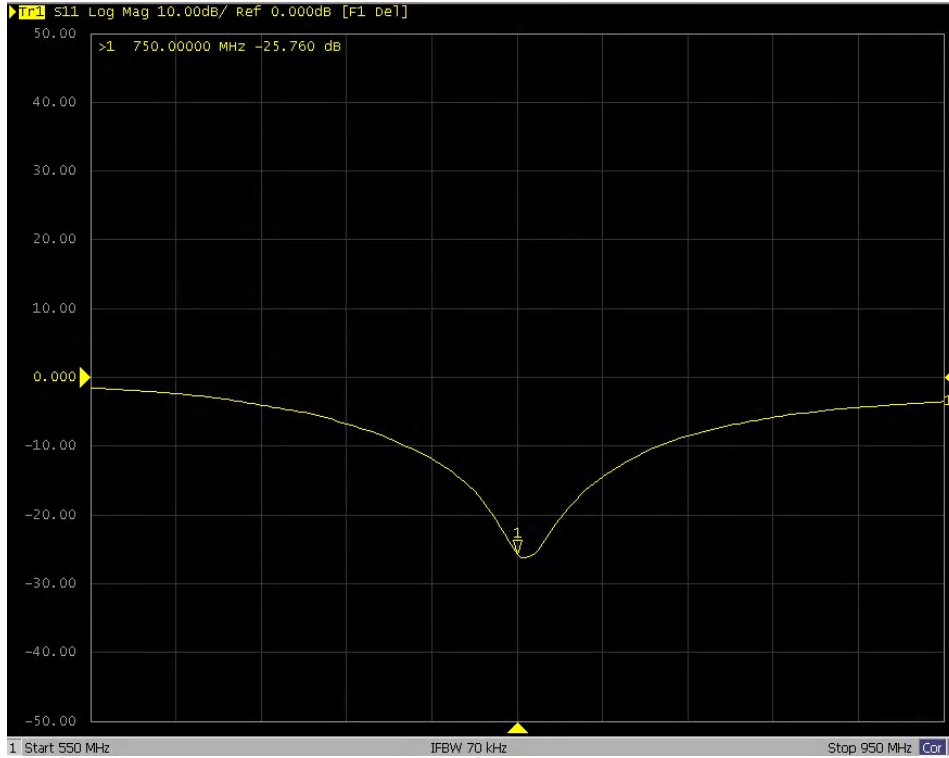



Accredited by the Swiss Accreditation Service (SAS)  
The Swiss Accreditation Service is one of the signatories to the EA  
Multilateral Agreement for the recognition of calibration certificates

Accreditation No.: **SCS 0108**

Client **Sporton**

Certificate No: **D835V2-4d167\_Nov19**

## CALIBRATION CERTIFICATE

Object **D835V2 - SN:4d167**

Calibration procedure(s) **QA CAL-05.v11  
Calibration Procedure for SAR Validation Sources between 0.7-3 GHz**

Calibration date: **November 25, 2019**

This calibration certificate documents the traceability to national standards, which realize the physical units of measurements (SI).  
The measurements and the uncertainties with confidence probability are given on the following pages and are part of the certificate.

All calibrations have been conducted in the closed laboratory facility: environment temperature ( $22 \pm 3$ )°C and humidity < 70%.

Calibration Equipment used (M&TE critical for calibration)

Primary Standards	ID #	Cal Date (Certificate No.)	Scheduled Calibration
Power meter NRP	SN: 104778	03-Apr-19 (No. 217-02892/02893)	Apr-20
Power sensor NRP-Z91	SN: 103244	03-Apr-19 (No. 217-02892)	Apr-20
Power sensor NRP-Z91	SN: 103245	03-Apr-19 (No. 217-02893)	Apr-20
Reference 20 dB Attenuator	SN: 5058 (20k)	04-Apr-19 (No. 217-02894)	Apr-20
Type-N mismatch combination	SN: 5047.2 / 06327	04-Apr-19 (No. 217-02895)	Apr-20
Reference Probe EX3DV4	SN: 7349	29-May-19 (No. EX3-7349_May19)	May-20
DAE4	SN: 601	30-Apr-19 (No. DAE4-601_Apr19)	Apr-20

Secondary Standards	ID #	Check Date (in house)	Scheduled Check
Power meter E4419B	SN: GB39512475	30-Oct-14 (in house check Feb-19)	In house check: Oct-20
Power sensor HP 8481A	SN: US37292783	07-Oct-15 (in house check Oct-18)	In house check: Oct-20
Power sensor HP 8481A	SN: MY41092317	07-Oct-15 (in house check Oct-18)	In house check: Oct-20
RF generator R&S SMT-06	SN: 100972	15-Jun-15 (in house check Oct-18)	In house check: Oct-20
Network Analyzer Agilent E8358A	SN: US41080477	31-Mar-14 (in house check Oct-19)	In house check: Oct-20

Calibrated by: **Jeton Kastrati**      Name: **Jeton Kastrati**      Function: **Laboratory Technician**

Approved by: **Katja Pokovic**      Name: **Katja Pokovic**      Function: **Technical Manager**

Signature

Issued: November 25, 2019

This calibration certificate shall not be reproduced except in full without written approval of the laboratory.



Accredited by the Swiss Accreditation Service (SAS)

The Swiss Accreditation Service is one of the signatories to the EA  
Multilateral Agreement for the recognition of calibration certificates

### Glossary:

TSL	tissue simulating liquid
ConvF	sensitivity in TSL / NORM x,y,z
N/A	not applicable or not measured

### Calibration is Performed According to the Following Standards:

- IEEE Std 1528-2013, "IEEE Recommended Practice for Determining the Peak Spatial-Averaged Specific Absorption Rate (SAR) in the Human Head from Wireless Communications Devices: Measurement Techniques", June 2013
- IEC 62209-1, "Measurement procedure for the assessment of Specific Absorption Rate (SAR) from hand-held and body-mounted devices used next to the ear (frequency range of 300 MHz to 6 GHz)", July 2016
- IEC 62209-2, "Procedure to determine the Specific Absorption Rate (SAR) for wireless communication devices used in close proximity to the human body (frequency range of 30 MHz to 6 GHz)", March 2010
- KDB 865664, "SAR Measurement Requirements for 100 MHz to 6 GHz"

### Additional Documentation:

- DASY4/5 System Handbook

### Methods Applied and Interpretation of Parameters:

- Measurement Conditions:** Further details are available from the Validation Report at the end of the certificate. All figures stated in the certificate are valid at the frequency indicated.
- Antenna Parameters with TSL:** The dipole is mounted with the spacer to position its feed point exactly below the center marking of the flat phantom section, with the arms oriented parallel to the body axis.
- Feed Point Impedance and Return Loss:** These parameters are measured with the dipole positioned under the liquid filled phantom. The impedance stated is transformed from the measurement at the SMA connector to the feed point. The Return Loss ensures low reflected power. No uncertainty required.
- Electrical Delay:** One-way delay between the SMA connector and the antenna feed point. No uncertainty required.
- SAR measured:** SAR measured at the stated antenna input power.
- SAR normalized:** SAR as measured, normalized to an input power of 1 W at the antenna connector.
- SAR for nominal TSL parameters:** The measured TSL parameters are used to calculate the nominal SAR result.

The reported uncertainty of measurement is stated as the standard uncertainty of measurement multiplied by the coverage factor  $k=2$ , which for a normal distribution corresponds to a coverage probability of approximately 95%.

## Measurement Conditions

DASY system configuration, as far as not given on page 1.

<b>DASY Version</b>	DASY5	V52.10.3
<b>Extrapolation</b>	Advanced Extrapolation	
<b>Phantom</b>	Modular Flat Phantom	
<b>Distance Dipole Center - TSL</b>	15 mm	with Spacer
<b>Zoom Scan Resolution</b>	dx, dy, dz = 5 mm	
<b>Frequency</b>	835 MHz ± 1 MHz	

## Head TSL parameters

The following parameters and calculations were applied.

	Temperature	Permittivity	Conductivity
<b>Nominal Head TSL parameters</b>	22.0 °C	41.5	0.90 mho/m
<b>Measured Head TSL parameters</b>	(22.0 ± 0.2) °C	42.0 ± 6 %	0.91 mho/m ± 6 %
<b>Head TSL temperature change during test</b>	< 0.5 °C	----	----

## SAR result with Head TSL

<b>SAR averaged over 1 cm<sup>3</sup> (1 g) of Head TSL</b>	Condition	
SAR measured	250 mW input power	2.40 W/kg
SAR for nominal Head TSL parameters	normalized to 1W	<b>9.55 W/kg ± 17.0 % (k=2)</b>

<b>SAR averaged over 10 cm<sup>3</sup> (10 g) of Head TSL</b>	condition	
SAR measured	250 mW input power	1.56 W/kg
SAR for nominal Head TSL parameters	normalized to 1W	<b>6.21 W/kg ± 16.5 % (k=2)</b>

## Appendix (Additional assessments outside the scope of SCS 0108)

### Antenna Parameters with Head TSL

Impedance, transformed to feed point	50.8 $\Omega$ - 3.8 j $\Omega$
Return Loss	- 28.2 dB

### General Antenna Parameters and Design

Electrical Delay (one direction)	1.390 ns
----------------------------------	----------

After long term use with 100W radiated power, only a slight warming of the dipole near the feedpoint can be measured.

The dipole is made of standard semirigid coaxial cable. The center conductor of the feeding line is directly connected to the second arm of the dipole. The antenna is therefore short-circuited for DC-signals. On some of the dipoles, small end caps are added to the dipole arms in order to improve matching when loaded according to the position as explained in the "Measurement Conditions" paragraph. The SAR data are not affected by this change. The overall dipole length is still according to the Standard.

No excessive force must be applied to the dipole arms, because they might bend or the soldered connections near the feedpoint may be damaged.

### Additional EUT Data

Manufactured by	SPEAG
-----------------	-------

## DASY5 Validation Report for Head TSL

Date: 25.11.2019

Test Laboratory: SPEAG, Zurich, Switzerland

**DUT: Dipole 835 MHz; Type: D835V2; Serial: D835V2 - SN:4d167**

Communication System: UID 0 - CW; Frequency: 835 MHz

Medium parameters used:  $f = 835$  MHz;  $\sigma = 0.91$  S/m;  $\epsilon_r = 42$ ;  $\rho = 1000$  kg/m<sup>3</sup>

Phantom section: Flat Section

Measurement Standard: DASY5 (IEEE/IEC/ANSI C63.19-2011)

DASY52 Configuration:

- Probe: EX3DV4 - SN7349; ConvF(9.89, 9.89, 9.89) @ 835 MHz; Calibrated: 29.05.2019
- Sensor-Surface: 1.4mm (Mechanical Surface Detection)
- Electronics: DAE4 Sn601; Calibrated: 30.04.2019
- Phantom: Flat Phantom 4.9 (front); Type: QD 00L P49 AA; Serial: 1001
- DASY52 52.10.3(1513); SEMCAD X 14.6.13(7474)

### Dipole Calibration for Head Tissue/Pin=250 mW, d=15mm/Zoom Scan (7x7x7)/Cube 0:

Measurement grid: dx=5mm, dy=5mm, dz=5mm

Reference Value = 63.15 V/m; Power Drift = -0.00 dB

Peak SAR (extrapolated) = 3.59 W/kg

**SAR(1 g) = 2.4 W/kg; SAR(10 g) = 1.56 W/kg**

Smallest distance from peaks to all points 3 dB below = 16 mm

Ratio of SAR at M2 to SAR at M1 = 66.8%

Maximum value of SAR (measured) = 3.20 W/kg

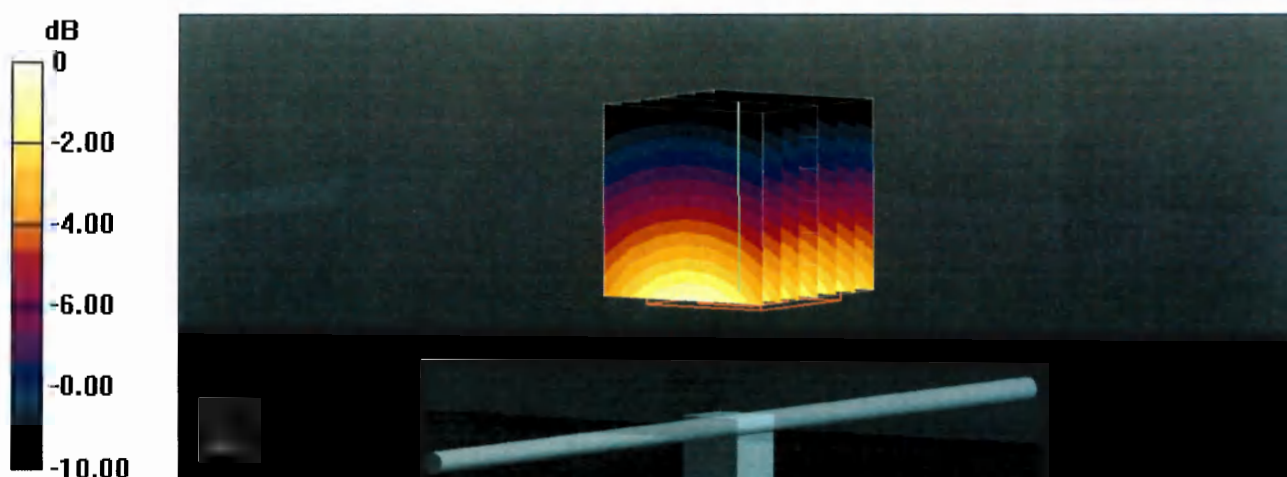

0 dB = 3.20 W/kg = 5.05 dBW/kg

# Impedance Measurement Plot for Head TSL





## Appendix: Transfer Calibration at Four Validation Locations on SAM Head<sup>1</sup>

### Evaluation Condition

Phantom	SAM Head Phantom	For usage with cSAR3DV2-R/L
---------	------------------	-----------------------------

### SAR result with SAM Head (Top $\cong$ C0)

<b>SAR averaged over 1 cm<sup>3</sup> (1 g) of Head TSL</b>	Condition	
SAR for nominal Head TSL parameters	normalized to 1W	<b>9.24 W/kg <math>\pm</math> 17.5 % (k=2)</b>

<b>SAR averaged over 10 cm<sup>3</sup> (10 g) of Head TSL</b>	condition	
SAR for nominal Head TSL parameters	normalized to 1W	<b>6.10 W/kg <math>\pm</math> 16.9 % (k=2)</b>

### SAR result with SAM Head (Mouth $\cong$ F90)

<b>SAR averaged over 1 cm<sup>3</sup> (1 g) of Head TSL</b>	Condition	
SAR for nominal Head TSL parameters	normalized to 1W	<b>9.70 W/kg <math>\pm</math> 17.5 % (k=2)</b>

<b>SAR averaged over 10 cm<sup>3</sup> (10 g) of Head TSL</b>	condition	
SAR for nominal Head TSL parameters	normalized to 1W	<b>6.50 W/kg <math>\pm</math> 16.9 % (k=2)</b>

### SAR result with SAM Head (Neck $\cong$ H0)

<b>SAR averaged over 1 cm<sup>3</sup> (1 g) of Head TSL</b>	Condition	
SAR for nominal Head TSL parameters	normalized to 1W	<b>9.22 W/kg <math>\pm</math> 17.5 % (k=2)</b>

<b>SAR averaged over 10 cm<sup>3</sup> (10 g) of Head TSL</b>	condition	
SAR for nominal Head TSL parameters	normalized to 1W	<b>6.21 W/kg <math>\pm</math> 16.9 % (k=2)</b>

### SAR result with SAM Head (Ear $\cong$ D90)

<b>SAR averaged over 1 cm<sup>3</sup> (1 g) of Head TSL</b>	Condition	
SAR for nominal Head TSL parameters	normalized to 1W	<b>7.93 W/kg <math>\pm</math> 17.5 % (k=2)</b>

<b>SAR averaged over 10 cm<sup>3</sup> (10 g) of Head TSL</b>	condition	
SAR for nominal Head TSL parameters	normalized to 1W	<b>5.33 W/kg <math>\pm</math> 16.9 % (k=2)</b>

<sup>1</sup> Additional assessments outside the current scope of SCS 0108



In Collaboration with  
**s p e a g**  
 CALIBRATION LABORATORY



中国认可  
 国际互认  
 校准  
 CALIBRATION  
 CNAS L0570

Add: No.51 Xueyuan Road, Haidian District, Beijing, 100191, China  
 Tel: +86-10-62304633-2079 Fax: +86-10-62304633-2504  
 E-mail: cttl@chinattl.com http://www.chinattl.cn

Client **Sporton**

Certificate No: **Z19-60057**

## CALIBRATION CERTIFICATE

Object **D1750V2 - SN: 1112**

Calibration Procedure(s) **FF-Z11-003-01**  
**Calibration Procedures for dipole validation kits**

Calibration date: **March 7, 2019**

This calibration Certificate documents the traceability to national standards, which realize the physical units of measurements(SI). The measurements and the uncertainties with confidence probability are given on the following pages and are part of the certificate.

All calibrations have been conducted in the closed laboratory facility: environment temperature(22±3)°C and humidity<70%.

Calibration Equipment used (M&TE critical for calibration)

Primary Standards	ID #	Cal Date(Calibrated by, Certificate No.)	Scheduled Calibration
Power Meter NRP2	106277	20-Aug-18 (CTTL, No.J18X06862)	Aug-19
Power sensor NRP8S	104291	20-Aug-18 (CTTL, No.J18X06862)	Aug-19
Reference Probe EX3DV4	SN 3617	31-Jan-19(SPEAG,No.EX3-3617_Jan19)	Jan-20
DAE4	SN 1331	06-Feb-19(SPEAG,No.DAE4-1331_Feb19)	Feb-20
Secondary Standards	ID #	Cal Date(Calibrated by, Certificate No.)	Scheduled Calibration
Signal Generator E4438C	MY49071430	23-Jan-19 (CTTL, No.J19X00336)	Jan-20
NetworkAnalyzer E5071C	MY46110673	24-Jan-19 (CTTL, No.J19X00547)	Jan-20

	Name	Function	Signature
Calibrated by:	Zhao Jing	SAR Test Engineer	
Reviewed by:	Lin Hao	SAR Test Engineer	
Approved by:	Qi Dianyuan	SAR Project Leader	

Issued: March 9, 2019

This calibration certificate shall not be reproduced except in full without written approval of the laboratory.



Add: No.51 Xueyuan Road, Haidian District, Beijing, 100191, China  
Tel: +86-10-62304633-2079 Fax: +86-10-62304633-2504  
E-mail: cttl@chinattl.com http://www.chinattl.cn

**Glossary:**

TSL tissue simulating liquid  
ConvF sensitivity in TSL / NORM<sub>x,y,z</sub>  
N/A not applicable or not measured

**Calibration is Performed According to the Following Standards:**

- a) IEEE Std 1528-2013, "IEEE Recommended Practice for Determining the Peak Spatial-Averaged Specific Absorption Rate (SAR) in the Human Head from Wireless Communications Devices: Measurement Techniques", June 2013
- b) IEC 62209-1, "Measurement procedure for assessment of specific absorption rate of human exposure to radio frequency fields from hand-held and body-mounted wireless communication devices- Part 1: Device used next to the ear (Frequency range of 300MHz to 6GHz)", July 2016
- c) IEC 62209-2, "Procedure to measure the Specific Absorption Rate (SAR) For wireless communication devices used in close proximity to the human body (frequency range of 30MHz to 6GHz)", March 2010
- d) KDB865664, SAR Measurement Requirements for 100 MHz to 6 GHz

**Additional Documentation:**

- e) DASY4/5 System Handbook

**Methods Applied and Interpretation of Parameters:**

- *Measurement Conditions:* Further details are available from the Validation Report at the end of the certificate. All figures stated in the certificate are valid at the frequency indicated.
- *Antenna Parameters with TSL:* The dipole is mounted with the spacer to position its feed point exactly below the center marking of the flat phantom section, with the arms oriented parallel to the body axis.
- *Feed Point Impedance and Return Loss:* These parameters are measured with the dipole positioned under the liquid filled phantom. The impedance stated is transformed from the measurement at the SMA connector to the feed point. The Return Loss ensures low reflected power. No uncertainty required.
- *Electrical Delay:* One-way delay between the SMA connector and the antenna feed point. No uncertainty required.
- *SAR measured:* SAR measured at the stated antenna input power.
- *SAR normalized:* SAR as measured, normalized to an input power of 1 W at the antenna connector.
- *SAR for nominal TSL parameters:* The measured TSL parameters are used to calculate the nominal SAR result.

The reported uncertainty of measurement is stated as the standard uncertainty of Measurement multiplied by the coverage factor  $k=2$ , which for a normal distribution Corresponds to a coverage probability of approximately 95%.



Add: No.51 Xueyuan Road, Haidian District, Beijing, 100191, China  
Tel: +86-10-62304633-2079 Fax: +86-10-62304633-2504  
E-mail: cttl@chinattl.com http://www.chinattl.cn

### Measurement Conditions

DASY system configuration, as far as not given on page 1.

DASY Version	DASY52	52.10.2.1495
Extrapolation	Advanced Extrapolation	
Phantom	Triple Flat Phantom 5.1C	
Distance Dipole Center - TSL	10 mm	with Spacer
Zoom Scan Resolution	dx, dy, dz = 5 mm	
Frequency	1750 MHz ± 1 MHz	

### Head TSL parameters

The following parameters and calculations were applied.

	Temperature	Permittivity	Conductivity
Nominal Head TSL parameters	22.0 °C	40.1	1.37 mho/m
Measured Head TSL parameters	(22.0 ± 0.2) °C	41.1 ± 6 %	1.39 mho/m ± 6 %
Head TSL temperature change during test	<1.0 °C	----	----

### SAR result with Head TSL

SAR averaged over 1 cm <sup>3</sup> (1 g) of Head TSL	Condition	
SAR measured	250 mW input power	9.20 W/kg
SAR for nominal Head TSL parameters	normalized to 1W	<b>36.7 W/kg ± 18.8 % (k=2)</b>
SAR averaged over 10 cm <sup>3</sup> (10 g) of Head TSL	Condition	
SAR measured	250 mW input power	4.87 W/kg
SAR for nominal Head TSL parameters	normalized to 1W	<b>19.4 W/kg ± 18.7 % (k=2)</b>

### Body TSL parameters

The following parameters and calculations were applied.

	Temperature	Permittivity	Conductivity
Nominal Body TSL parameters	22.0 °C	53.4	1.49 mho/m
Measured Body TSL parameters	(22.0 ± 0.2) °C	53.5 ± 6 %	1.47 mho/m ± 6 %
Body TSL temperature change during test	<1.0 °C	----	----

### SAR result with Body TSL

SAR averaged over 1 cm <sup>3</sup> (1 g) of Body TSL	Condition	
SAR measured	250 mW input power	9.25 W/kg
SAR for nominal Body TSL parameters	normalized to 1W	<b>37.4 W/kg ± 18.8 % (k=2)</b>
SAR averaged over 10 cm <sup>3</sup> (10 g) of Body TSL	Condition	
SAR measured	250 mW input power	4.92 W/kg
SAR for nominal Body TSL parameters	normalized to 1W	<b>19.8 W/kg ± 18.7 % (k=2)</b>



Add: No.51 Xueyuan Road, Haidian District, Beijing, 100191, China  
 Tel: +86-10-62304633-2079 Fax: +86-10-62304633-2504  
 E-mail: cttl@chinattl.com http://www.chinattl.cn

**Appendix (Additional assessments outside the scope of CNAS L0570)**

**Antenna Parameters with Head TSL**

Impedance, transformed to feed point	48.8Ω- 1.87 jΩ
Return Loss	- 33.0 dB

**Antenna Parameters with Body TSL**

Impedance, transformed to feed point	46.4Ω- 1.07 jΩ
Return Loss	- 28.3 dB

**General Antenna Parameters and Design**

Electrical Delay (one direction)	1.080 ns
----------------------------------	----------

After long term use with 100W radiated power, only a slight warming of the dipole near the feedpoint can be measured.

The dipole is made of standard semirigid coaxial cable. The center conductor of the feeding line is directly connected to the second arm of the dipole. The antenna is therefore short-circuited for DC-signals. On some of the dipoles, small end caps are added to the dipole arms in order to improve matching when loaded according to the position as explained in the "Measurement Conditions" paragraph. The SAR data are not affected by this change. The overall dipole length is still according to the Standard.

No excessive force must be applied to the dipole arms, because they might bend or the soldered connections near the feedpoint may be damaged.

**Additional EUT Data**

Manufactured by	SPEAG
-----------------	-------



Add: No.51 Xueyuan Road, Haidian District, Beijing, 100191, China  
Tel: +86-10-62304633-2079 Fax: +86-10-62304633-2504  
E-mail: cttl@chinattl.com http://www.chinattl.cn

### DASY5 Validation Report for Head TSL

Date: 03.06.2019

Test Laboratory: CTTL, Beijing, China

**DUT: Dipole 1750 MHz; Type: D1750V2; Serial: D1750V2 - SN: 1112**

Communication System: UID 0, CW; Frequency: 1750 MHz; Duty Cycle: 1:1

Medium parameters used:  $f = 1750$  MHz;  $\sigma = 1.389$  S/m;  $\epsilon_r = 41.13$ ;  $\rho = 1000$  kg/m<sup>3</sup>

Phantom section: Right Section

DASY5 Configuration:

- Probe: EX3DV4 - SN3617; ConvF(8.38, 8.38, 8.38) @ 1750 MHz; Calibrated: 1/31/2019
- Sensor-Surface: 1.4mm (Mechanical Surface Detection)
- Electronics: DAE4 Sn1331; Calibrated: 2/6/2019
- Phantom: MFP\_V5.1C ; Type: QD 000 P51CA; Serial: 1062
- Measurement SW: DASY52, Version 52.10 (2); SEMCAD X Version 14.6.12 (7450)

**System Performance Check/Zoom Scan (7x7x7) (7x7x7)/Cube 0:** Measurement grid:

$dx=5$ mm,  $dy=5$ mm,  $dz=5$ mm

Reference Value = 93.87 V/m; Power Drift = 0.00 dB

Peak SAR (extrapolated) = 17.3 W/kg

SAR(1 g) = 9.2 W/kg; SAR(10 g) = 4.87 W/kg

Maximum value of SAR (measured) = 14.4 W/kg

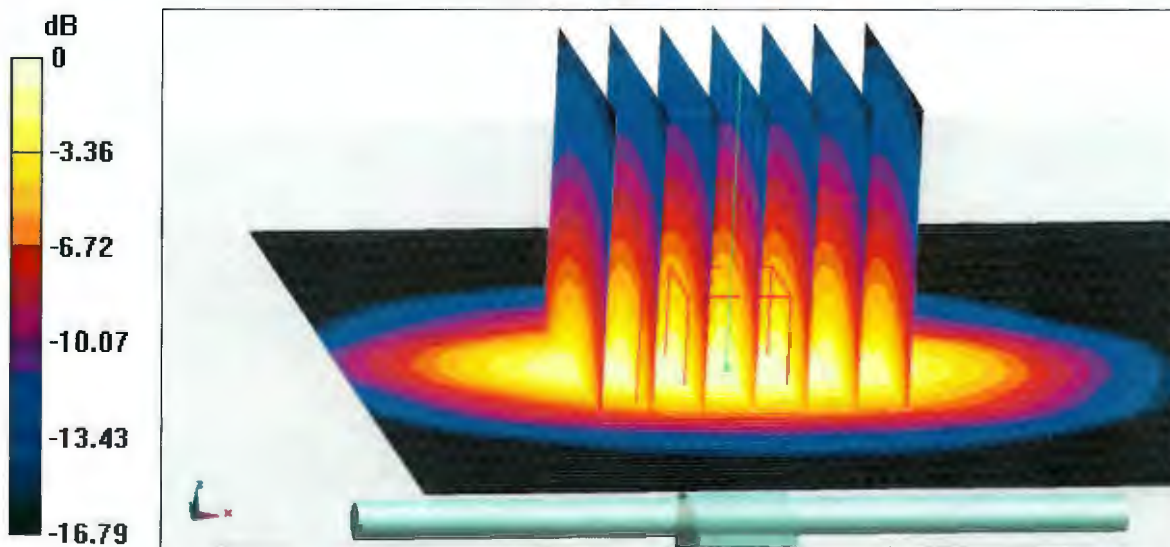

0 dB = 14.4 W/kg = 11.58 dBW/kg



Add: No.51 Xueyuan Road, Haidian District, Beijing, 100191, China  
Tel: +86-10-62304633-2079 Fax: +86-10-62304633-2504  
E-mail: cttl@chinattl.com http://www.chinattl.cn

### Impedance Measurement Plot for Head TSL

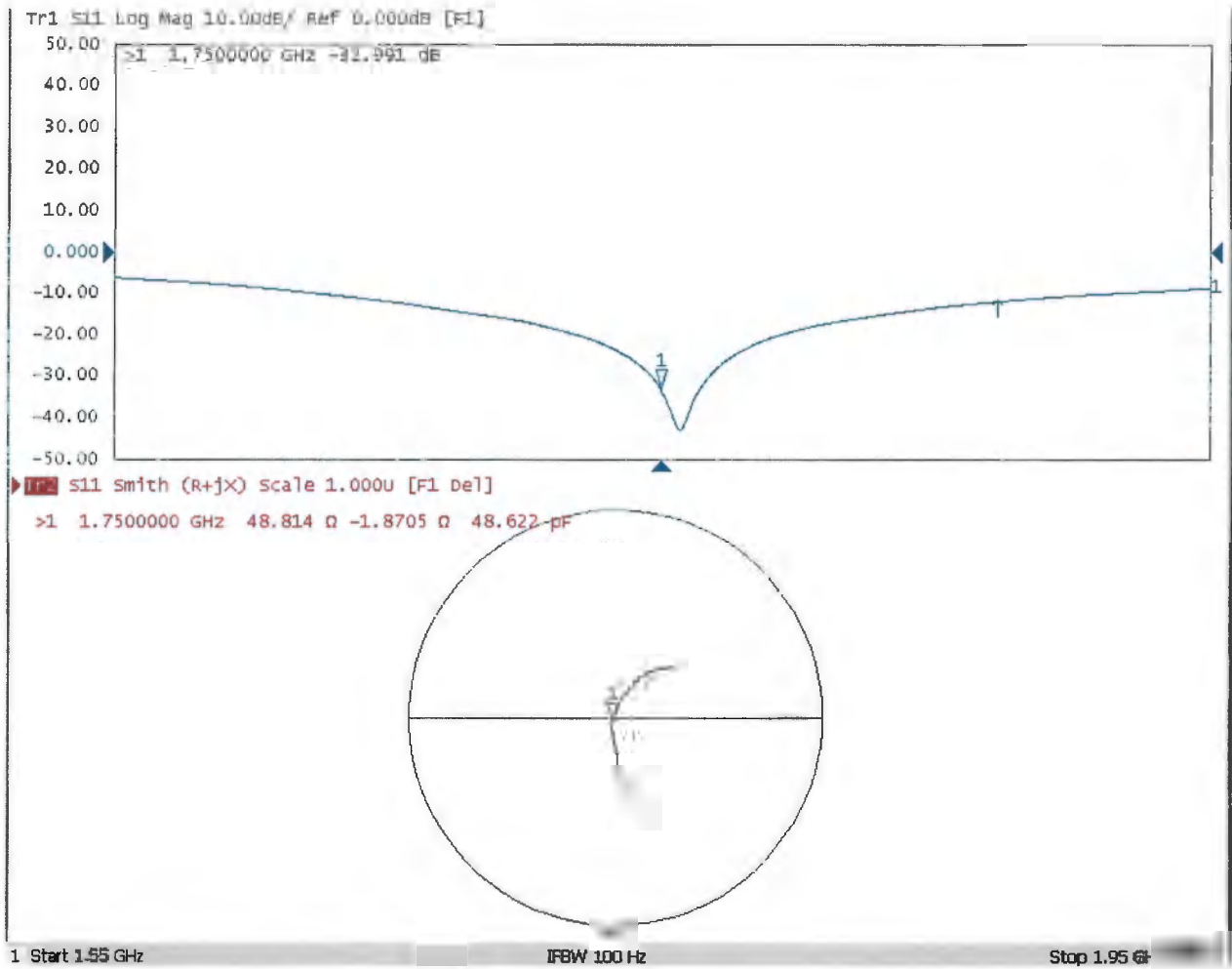



Add: No.51 Xueyuan Road, Haidian District, Beijing, 100191, China  
Tel: +86-10-62304633-2079 Fax: +86-10-62304633-2504  
E-mail: cttl@chinattl.com http://www.chinattl.cn

### DASY5 Validation Report for Body TSL

Date: 03.06.2019

Test Laboratory: CTTL, Beijing, China

**DUT: Dipole 1750 MHz; Type: D1750V2; Serial: D1750V2 - SN: 1112**

Communication System: UID 0, CW; Frequency: 1750 MHz; Duty Cycle: 1:1

Medium parameters used:  $f = 1750$  MHz;  $\sigma = 1.465$  S/m;  $\epsilon_r = 53.49$ ;  $\rho = 1000$  kg/m<sup>3</sup>

Phantom section: Center Section

DASY5 Configuration:

- Probe: EX3DV4 - SN3617; ConvF(8.03, 8.03, 8.03) @ 1750 MHz; Calibrated: 1/31/2019
- Sensor-Surface: 1.4mm (Mechanical Surface Detection)
- Electronics: DAE4 Sn1331; Calibrated: 2/6/2019
- Phantom: MFP\_V5.1C ; Type: QD 000 P51CA; Serial: 1062
- Measurement SW: DASY52, Version 52.10 (2); SEMCAD X Version 14.6.12 (7450)

**System Performance Check/Zoom Scan (7x7x7) (7x7x7)/Cube 0:** Measurement grid:

$dx=5$ mm,  $dy=5$ mm,  $dz=5$ mm

Reference Value = 91.64 V/m; Power Drift = 0.03 dB

Peak SAR (extrapolated) = 17.0 W/kg

**SAR(1 g) = 9.25 W/kg; SAR(10 g) = 4.92 W/kg**

Maximum value of SAR (measured) = 14.3 W/kg

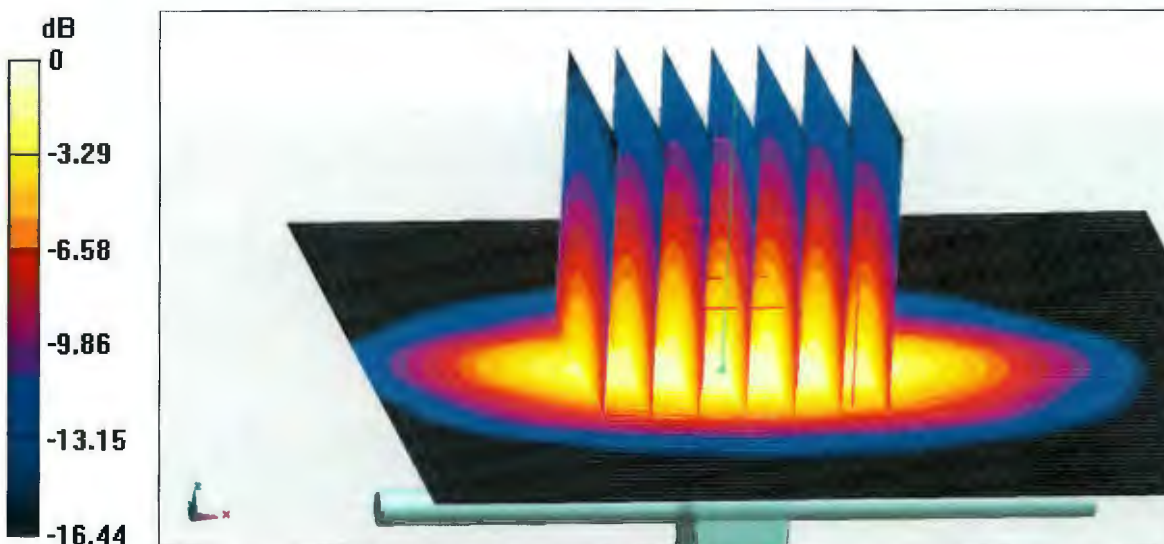

**0 dB = 14.3 W/kg = 11.55 dBW/kg**





Add: No.51 Xueyuan Road, Haidian District, Beijing, 100191, China  
Tel: +86-10-62304633-2079 Fax: +86-10-62304633-2504  
E-mail: cttl@chinattl.com http://www.chinattl.cn

### Impedance Measurement Plot for Body TSL

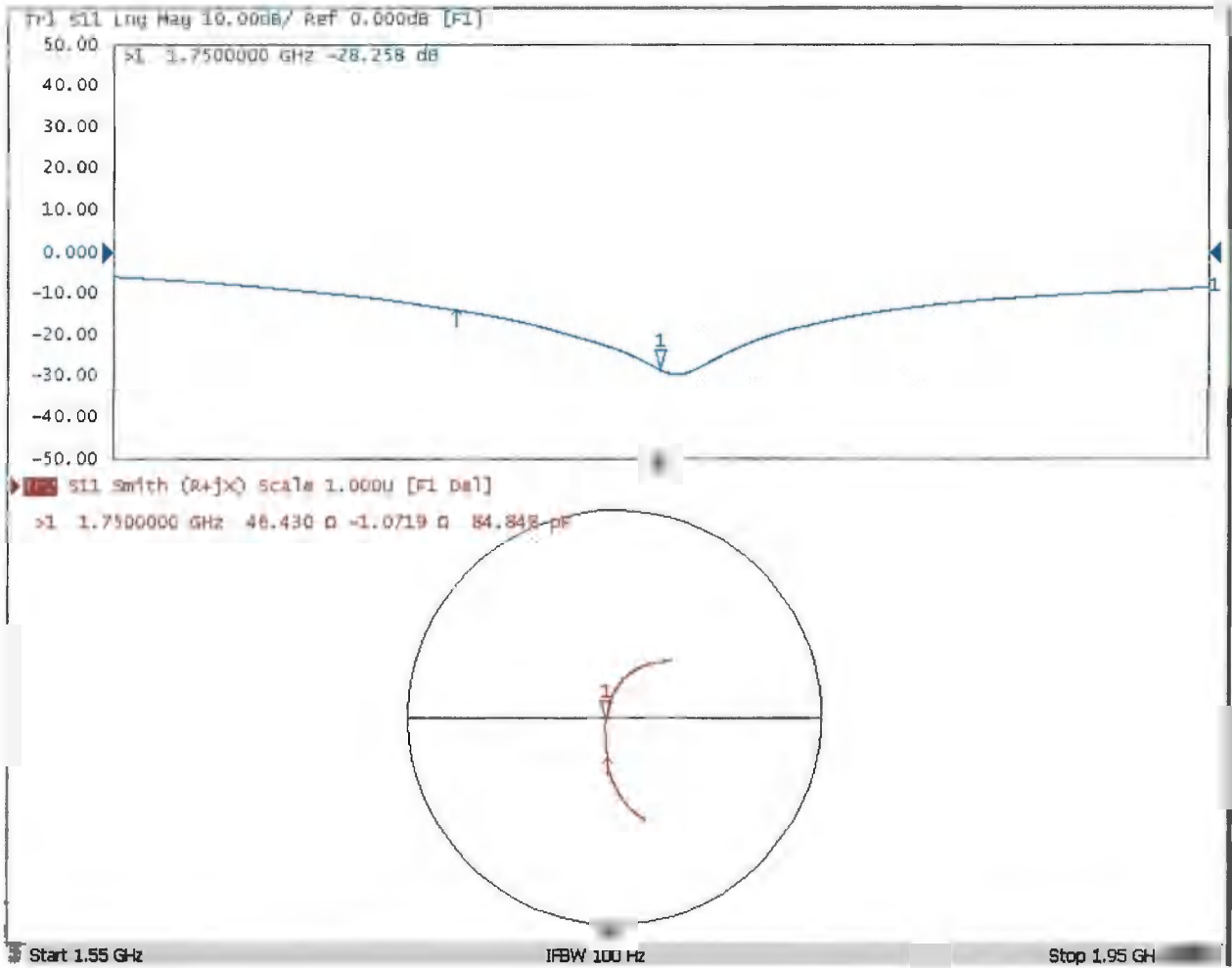



## D1750V2, serial no. 1112 Extended Dipole Calibrations

Referring to KDB 450824, if dipoles are verified in return loss ( $< -20\text{dB}$ , within 20% of prior calibration), and in impedance (within 5 ohm of prior calibration), the annual calibration is not necessary and the calibration interval can be extended.

### <Justification of the extended calibration>

D1750V2 – serial no. 1112						
1750MHZ						
Date of Measurement	Return-Loss (dB)	Delta (%)	Real Impedance (ohm)	Delta (ohm)	Imaginary Impedance (ohm)	Delta (ohm)
03.07.2019 (Cal. Report)	-32.991		48.814		-1.8705	
03.06.2020 (extended)	-33.589	1.81	48.573	0.241	-4.0211	2.1506

The return loss is  $< -20\text{dB}$ , within 20% of prior calibration; the impedance is within 5 ohm of prior calibration. Therefore the verification result should support extended calibration.



<Dipole Verification Data> - D1750 V2, serial no. 1112 (Data of Measurement : 03.06.2020)

1750 MHz - Head

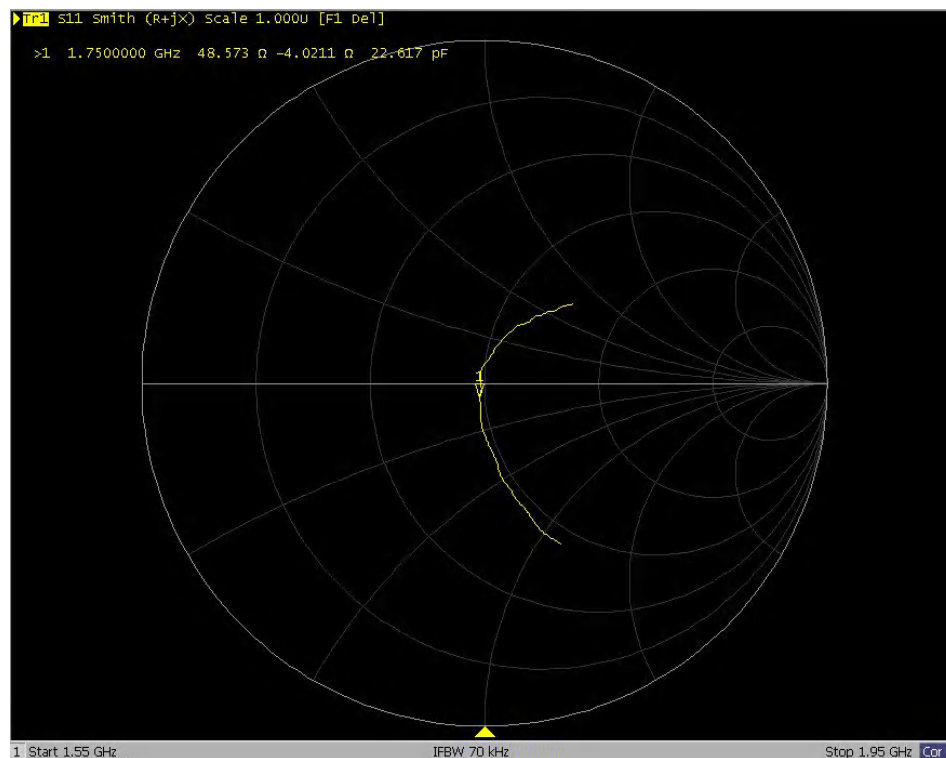
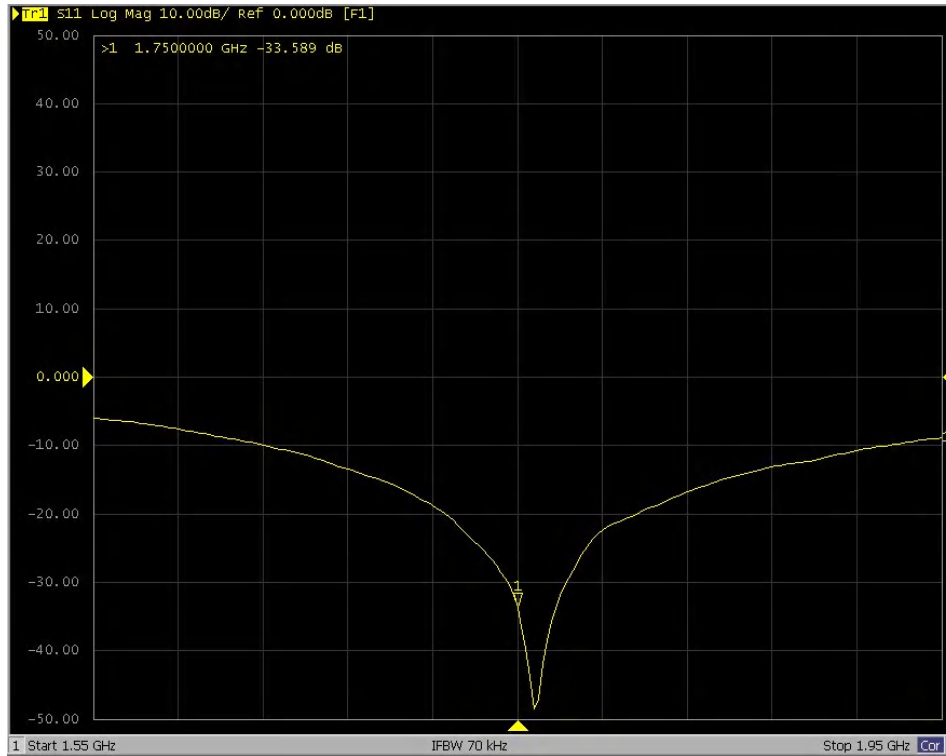

SPORTON INTERNATIONAL INC.

TEL : 886-3-327-3456

FAX : 886-3-328-4978



In Collaboration with  
**s p e a g**  
CALIBRATION LABORATORY



中国认可  
国际互认  
校准  
CALIBRATION  
CNAS L0570

Add: No.51 Xueyuan Road, Haidian District, Beijing, 100191, China  
Tel: +86-10-62304633-2079 Fax: +86-10-62304633-2504  
E-mail: cttl@chinattl.com http://www.chinattl.cn

Client **Sporton**

Certificate No: **Z18-60324**

## CALIBRATION CERTIFICATE

Object **D1900V2 - SN: 5d041**

Calibration Procedure(s) **FF-Z11-003-01**  
**Calibration Procedures for dipole validation kits**

Calibration date: **September 11, 2018**

This calibration Certificate documents the traceability to national standards, which realize the physical units of measurements(SI). The measurements and the uncertainties with confidence probability are given on the following pages and are part of the certificate.

All calibrations have been conducted in the closed laboratory facility: environment temperature(22±3)°C and humidity<70%.

Calibration Equipment used (M&TE critical for calibration)

Primary Standards	ID #	Cal Date(Calibrated by, Certificate No.)	Scheduled Calibration
Power Meter NRVD	102083	01-Nov-17 (CTTL, No.J17X08756)	Oct-18
Power sensor NRV-Z5	100542	01-Nov-17 (CTTL, No.J17X08756)	Oct-18
Reference Probe EX3DV4	SN 7464	12-Sep-17(SPEAG,No.EX3-7464_Sep17)	Sep-18
DAE4	SN 1524	13-Sep-17(SPEAG,No.DAE4-1524_Sep17)	Sep-18
Secondary Standards	ID #	Cal Date(Calibrated by, Certificate No.)	Scheduled Calibration
Signal Generator E4438C	MY49071430	23-Jan-18 (CTTL, No.J18X00560)	Jan-19
NetworkAnalyzer E5071C	MY46110673	24-Jan-18 (CTTL, No.J18X00561)	Jan-19

	Name	Function	Signature
Calibrated by:	Zhao Jing	SAR Test Engineer	
Reviewed by:	Lin Jun	SAR Test Engineer	
Approved by:	Qi Dianyuan	SAR Project Leader	

Issued: September 15, 2018

This calibration certificate shall not be reproduced except in full without written approval of the laboratory.



In Collaboration with

**s p e a g**  
CALIBRATION LABORATORY

Add: No.51 Xueyuan Road, Haidian District, Beijing, 100191, China  
Tel: +86-10-62304633-2079 Fax: +86-10-62304633-2504  
E-mail: [ctl@chinattl.com](mailto:ctl@chinattl.com) <http://www.chinattl.cn>

#### lossary:

TSL	tissue simulating liquid
ConvF	sensitivity in TSL / NORM <sub>x,y,z</sub>
N/A	not applicable or not measured

#### Calibration is Performed According to the Following Standards:

- IEEE Std 1528-2013, "IEEE Recommended Practice for Determining the Peak Spatial-Averaged Specific Absorption Rate (SAR) in the Human Head from Wireless Communications Devices: Measurement Techniques", June 2013
- IEC 62209-1, "Measurement procedure for assessment of specific absorption rate of human exposure to radio frequency fields from hand-held and body-mounted wireless communication devices- Part 1: Device used next to the ear (Frequency range of 300MHz to 6GHz)", July 2016
- IEC 62209-2, "Procedure to measure the Specific Absorption Rate (SAR) For wireless communication devices used in close proximity to the human body (frequency range of 30MHz to 6GHz)", March 2010
- KDB865664, SAR Measurement Requirements for 100 MHz to 6 GHz

#### Additional Documentation:

- DASY4/5 System Handbook

#### Methods Applied and Interpretation of Parameters:

- Measurement Conditions:** Further details are available from the Validation Report at the end of the certificate. All figures stated in the certificate are valid at the frequency indicated.
- Antenna Parameters with TSL:** The dipole is mounted with the spacer to position its feed point exactly below the center marking of the flat phantom section, with the arms oriented parallel to the body axis.
- Feed Point Impedance and Return Loss:** These parameters are measured with the dipole positioned under the liquid filled phantom. The impedance stated is transformed from the measurement at the SMA connector to the feed point. The Return Loss ensures low reflected power. No uncertainty required.
- Electrical Delay:** One-way delay between the SMA connector and the antenna feed point. No uncertainty required.
- SAR measured:** SAR measured at the stated antenna input power.
- SAR normalized:** SAR as measured, normalized to an input power of 1 W at the antenna connector.
- SAR for nominal TSL parameters:** The measured TSL parameters are used to calculate the nominal SAR result.

The reported uncertainty of measurement is stated as the standard uncertainty of Measurement multiplied by the coverage factor  $k=2$ , which for a normal distribution Corresponds to a coverage probability of approximately 95%.



Add: No.51 Xueyuan Road, Haidian District, Beijing, 100191, China  
Tel: +86-10-62304633-2079 Fax: +86-10-62304633-2504  
E-mail: cttl@chinattl.com http://www.chinattl.cn

### Measurement Conditions

DASY system configuration, as far as not given on page 1.

DASY Version	DASY52	52.10.1.1476
Extrapolation	Advanced Extrapolation	
Phantom	Triple Flat Phantom 5.1C	
Distance Dipole Center - TSL	10 mm	with Spacer
Zoom Scan Resolution	dx, dy, dz = 5 mm	
Frequency	1900 MHz $\pm$ 1 MHz	

### Head TSL parameters

The following parameters and calculations were applied.

	Temperature	Permittivity	Conductivity
Nominal Head TSL parameters	22.0 °C	40.0	1.40 mho/m
Measured Head TSL parameters	(22.0 $\pm$ 0.2) °C	40.4 $\pm$ 6 %	1.44 mho/m $\pm$ 6 %
Head TSL temperature change during test	<1.0 °C	----	----

### SAR result with Head TSL

SAR averaged over 1 cm <sup>3</sup> (1 g) of Head TSL	Condition	
SAR measured	250 mW input power	10.2 mW / g
SAR for nominal Head TSL parameters	normalized to 1W	40.2 mW / g $\pm$ 18.8 % (k=2)
SAR averaged over 10 cm <sup>3</sup> (10 g) of Head TSL	Condition	
SAR measured	250 mW input power	5.35 mW / g
SAR for nominal Head TSL parameters	normalized to 1W	21.2 mW / g $\pm$ 18.7 % (k=2)

### Body TSL parameters

The following parameters and calculations were applied.

	Temperature	Permittivity	Conductivity
Nominal Body TSL parameters	22.0 °C	53.3	1.52 mho/m
Measured Body TSL parameters	(22.0 $\pm$ 0.2) °C	53.3 $\pm$ 6 %	1.49 mho/m $\pm$ 6 %
Body TSL temperature change during test	<1.0 °C	----	----

### SAR result with Body TSL

SAR averaged over 1 cm <sup>3</sup> (1 g) of Body TSL	Condition	
SAR measured	250 mW input power	9.94 mW / g
SAR for nominal Body TSL parameters	normalized to 1W	40.2 mW / g $\pm$ 18.8 % (k=2)
SAR averaged over 10 cm <sup>3</sup> (10 g) of Body TSL	Condition	
SAR measured	250 mW input power	5.35 mW / g
SAR for nominal Body TSL parameters	normalized to 1W	21.5 mW / g $\pm$ 18.7 % (k=2)



Add: No.51 Xueyuan Road, Haidian District, Beijing, 100191, China  
Tel: +86-10-62304633-2079 Fax: +86-10-62304633-2504  
E-mail: cttl@chinattl.com http://www.chinattl.cn

### Appendix (Additional assessments outside the scope of CNAS L0570)

#### Antenna Parameters with Head TSL

Impedance, transformed to feed point	$52.9\Omega + 7.43j\Omega$
Return Loss	- 22.3dB

#### Antenna Parameters with Body TSL

Impedance, transformed to feed point	$47.6\Omega + 6.80j\Omega$
Return Loss	- 22.7dB

#### General Antenna Parameters and Design

Electrical Delay (one direction)	1.066 ns
----------------------------------	----------

After long term use with 100W radiated power, only a slight warming of the dipole near the feedpoint can be measured.

The dipole is made of standard semirigid coaxial cable. The center conductor of the feeding line is directly connected to the second arm of the dipole. The antenna is therefore short-circuited for DC-signals. On some of the dipoles, small end caps are added to the dipole arms in order to improve matching when loaded according to the position as explained in the "Measurement Conditions" paragraph. The SAR data are not affected by this change. The overall dipole length is still according to the Standard.

No excessive force must be applied to the dipole arms, because they might bend or the soldered connections near the feedpoint may be damaged.

#### Additional EUT Data

Manufactured by	SPEAG
-----------------	-------



Add: No.51 Xueyuan Road, Haidian District, Beijing, 100191, China  
Tel: +86-10-62304633-2079 Fax: +86-10-62304633-2504  
E-mail: cttl@chinattl.com http://www.chinattl.cn

**DASY5 Validation Report for Head TSL**

Date: 09.10.2018

Test Laboratory: CTTL, Beijing, China

**DUT: Dipole 1900 MHz; Type: D1900V2; Serial: D1900V2 - SN: 5d041**

Communication System: UID 0, CW; Frequency: 1900 MHz; Duty Cycle: 1:1

Medium parameters used:  $f = 1900$  MHz;  $\sigma = 1.438$  S/m;  $\epsilon_r = 40.37$ ;  $\rho = 1000$  kg/m<sup>3</sup>

Phantom section: Center Section

DASY5 Configuration:

- Probe: EX3DV4 - SN7464; ConvF(8.39, 8.39, 8.39) @ 1900 MHz; Calibrated: 9/12/2017
- Sensor-Surface: 1.4mm (Mechanical Surface Detection)
- Electronics: DAE4 Sn1524; Calibrated: 9/13/2017
- Phantom: MFP\_V5.1C ; Type: QD 000 P51CA; Serial: 1062
- Measurement SW: DASY52, Version 52.10 (1); SEMCAD X Version 14.6.11 (7439)

**System Performance Check/Zoom Scan (7x7x7) (7x7x7)/Cube 0: Measurement grid:**

$dx=5$ mm,  $dy=5$ mm,  $dz=5$ mm

Reference Value = 98.66 V/m; Power Drift = -0.02 dB

Peak SAR (extrapolated) = 19.1 W/kg

**SAR(1 g) = 10.2 W/kg; SAR(10 g) = 5.35 W/kg**

Maximum value of SAR (measured) = 15.7 W/kg

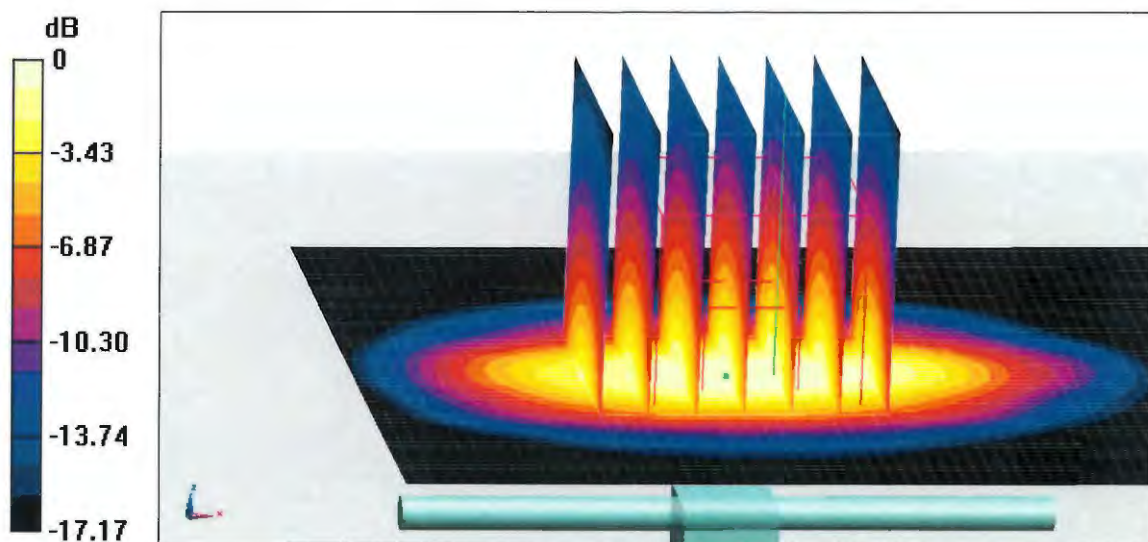

**0 dB = 15.7 W/kg = 11.96 dBW/kg**





Add: No.51 Xueyuan Road, Haidian District, Beijing, 100191, China  
Tel: +86-10-62304633-2079 Fax: +86-10-62304633-2504  
E-mail: cttl@chinattl.com http://www.chinattl.cn

### Impedance Measurement Plot for Head TSL

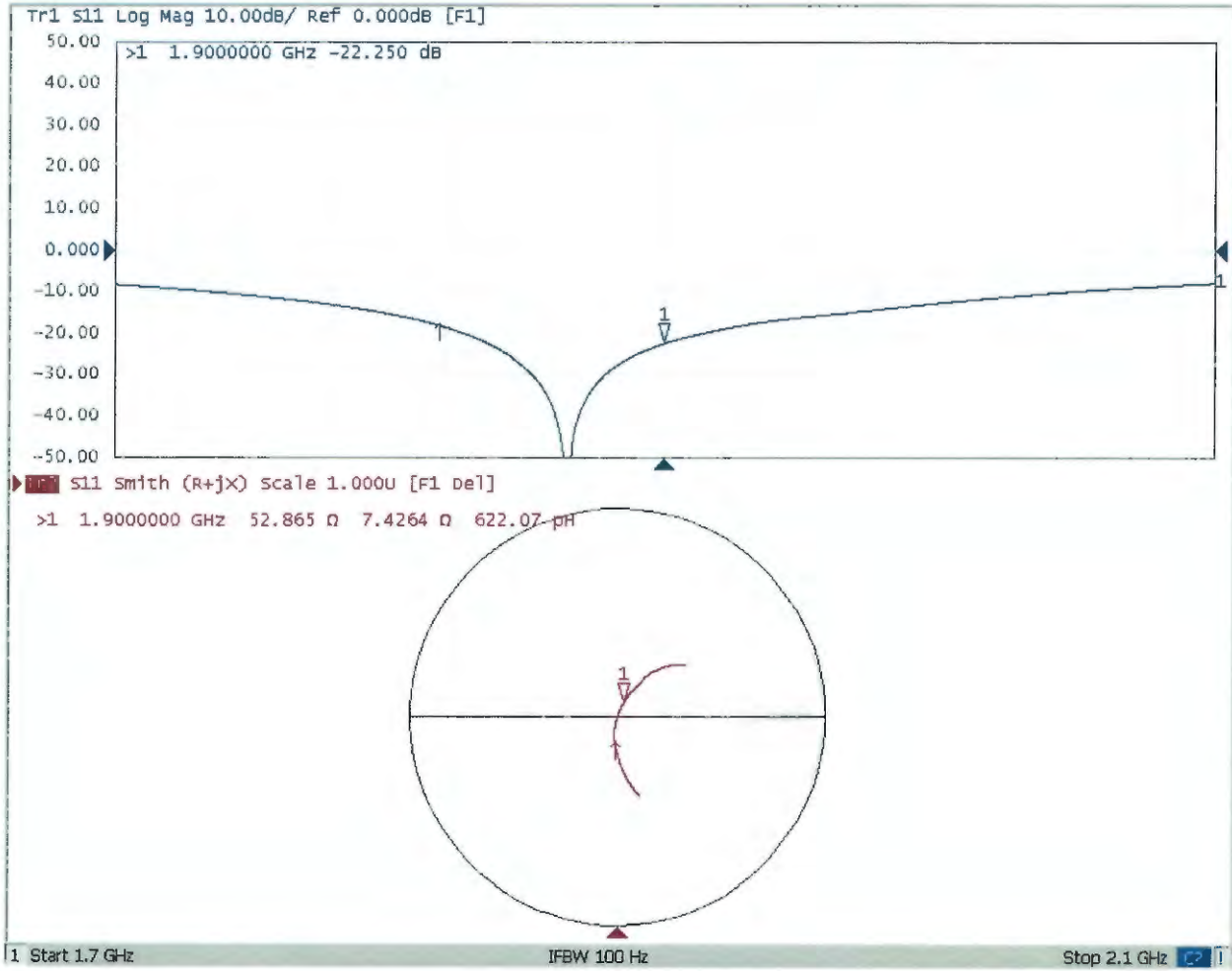



Add: No.51 Xueyuan Road, Haidian District, Beijing, 100191, China  
Tel: +86-10-62304633-2079 Fax: +86-10-62304633-2504  
E-mail: ctfl@chinattl.com http://www.chinattl.cn

**DASY5 Validation Report for Body TSL**

Date: 09.10.2018

Test Laboratory: CTTL, Beijing, China

**DUT: Dipole 1900 MHz; Type: D1900V2; Serial: D1900V2 - SN: 5d041**

Communication System: UID 0, CW; Frequency: 1900 MHz; Duty Cycle: 1:1

Medium parameters used:  $f = 1900$  MHz;  $\sigma = 1.493$  S/m;  $\epsilon_r = 53.34$ ;  $\rho = 1000$  kg/m<sup>3</sup>

Phantom section: Right Section

DASY5 Configuration:

- Probe: EX3DV4 - SN7464; ConvF(8.32, 8.32, 8.32) @ 1900 MHz; Calibrated: 9/12/2017
- Sensor-Surface: 1.4mm (Mechanical Surface Detection)
- Electronics: DAE4 Sn1524; Calibrated: 9/13/2017
- Phantom: MFP\_V5.1C ; Type: QD 000 P51CA; Serial: 1062
- Measurement SW: DASY52, Version 52.10 (1); SEMCAD X Version 14.6.11 (7439)

**System Performance Check/Zoom Scan (7x7x7) (7x7x7)/Cube 0:** Measurement grid:

$dx=5$ mm,  $dy=5$ mm,  $dz=5$ mm

Reference Value = 94.03 V/m; Power Drift = -0.08 dB

Peak SAR (extrapolated) = 17.5 W/kg

**SAR(1 g) = 9.94 W/kg; SAR(10 g) = 5.35 W/kg**

Maximum value of SAR (measured) = 15.0 W/kg

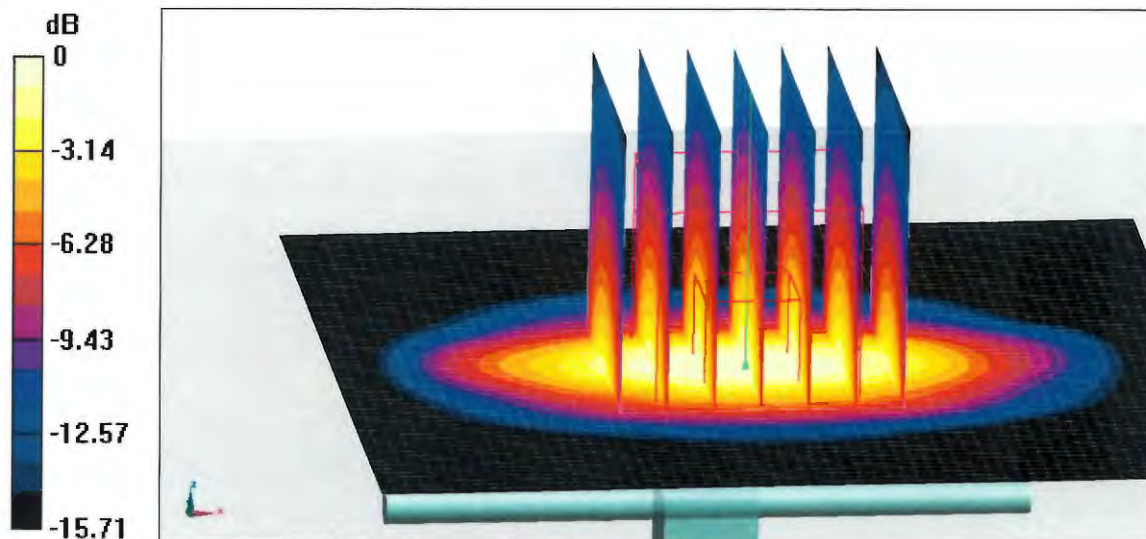

**0 dB = 15.0 W/kg = 11.76 dBW/kg**



Add: No.51 Xueyuan Road, Haidian District, Beijing, 100191, China  
Tel: +86-10-62304633-2079 Fax: +86-10-62304633-2504  
E-mail: cttl@chinattl.com http://www.chinattl.cn

### Impedance Measurement Plot for Body TSL

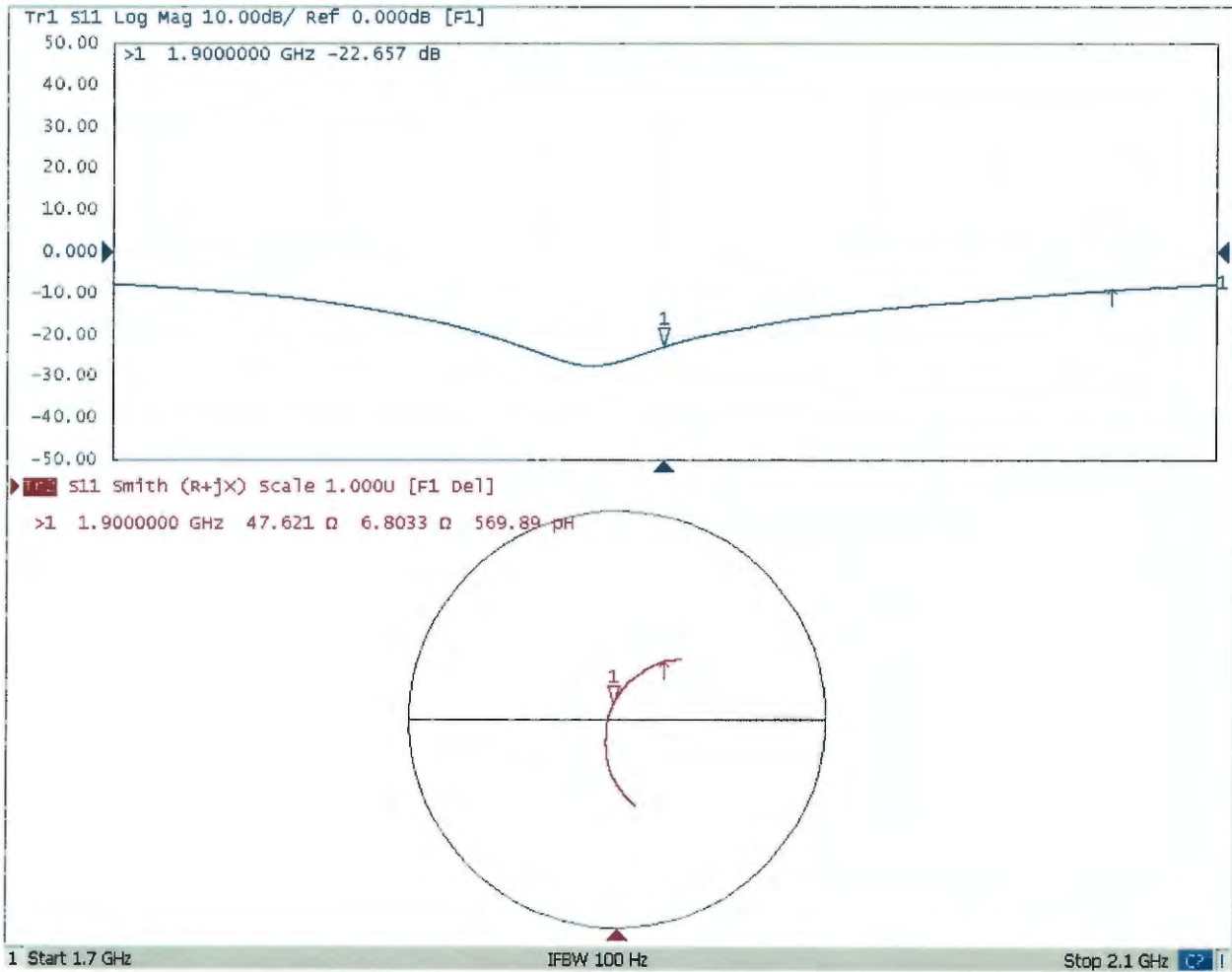



---

## D1900V2, serial no. 5D041 Extended Dipole Calibrations

Referring to KDB 450824, if dipoles are verified in return loss (<-20dB, within 20% of prior calibration), and in impedance (within 5 ohm of prior calibration), the annual calibration is not necessary and the calibration interval can be extended.

### <Justification of the extended calibration>

D1900V2 – serial no. 5D041						
1900MHZ						
Date of Measurement	Return-Loss (dB)	Delta (%)	Real Impedance (ohm)	Delta (ohm)	Imaginary Impedance (ohm)	Delta (ohm)
09.11.2018	-22.25		52.865		7.4264	
09.10.2019	-22.745	2.225	52.269	0.596	7.2587	0.1677
09.09.2020	-24.365	9.506	51.557	1.308	4.6953	2.7311

The return loss is < -20dB, within 20% of prior calibration; the impedance is within 5 ohm of prior calibration. Therefore the verification result should support extended calibration.



<Dipole Verification Data> - D1900 V2, serial no. 5D041 (Data of Measurement : 9.10.2019)

1900 MHz - Head

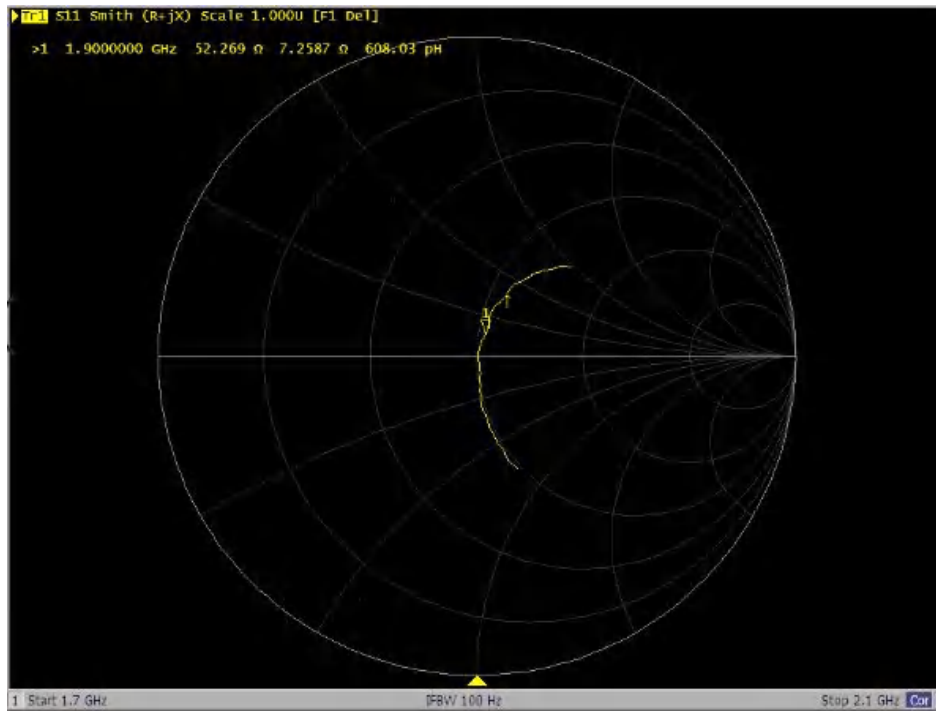
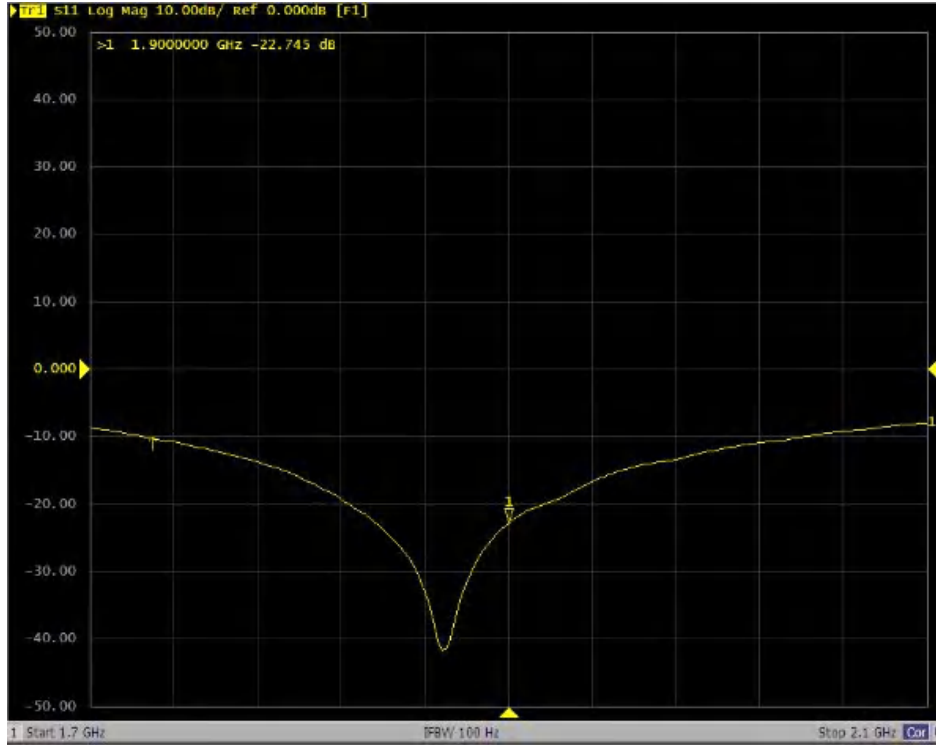



<Dipole Verification Data> - D1900 V2, serial no. 5D041 (Data of Measurement : 09.09.2020)

1900 MHz - Head

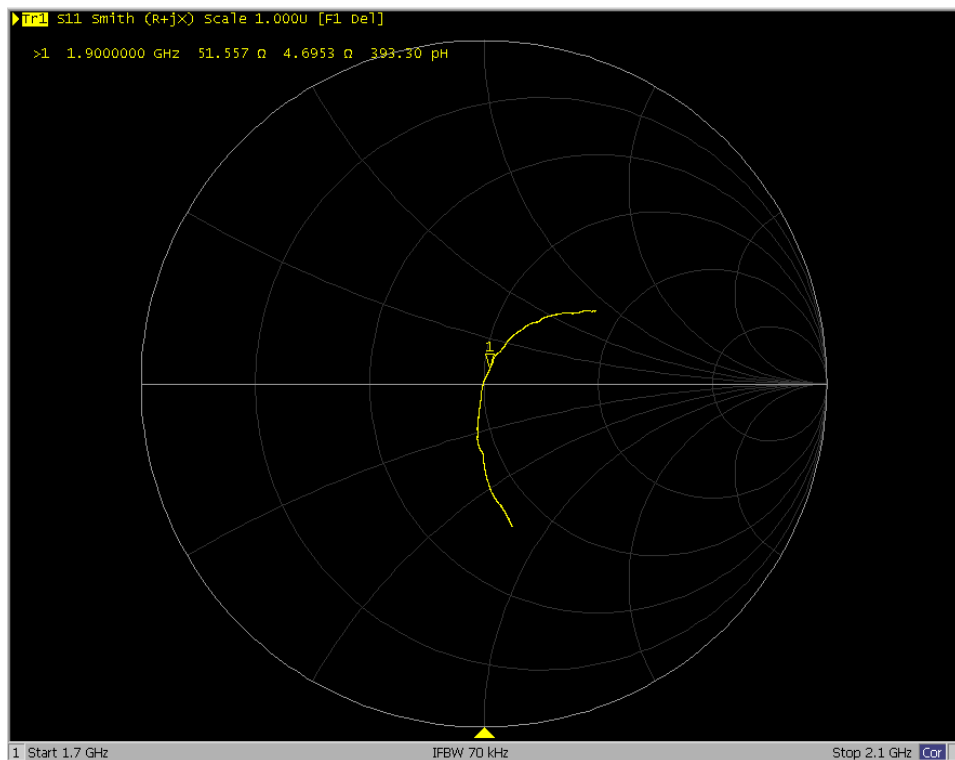
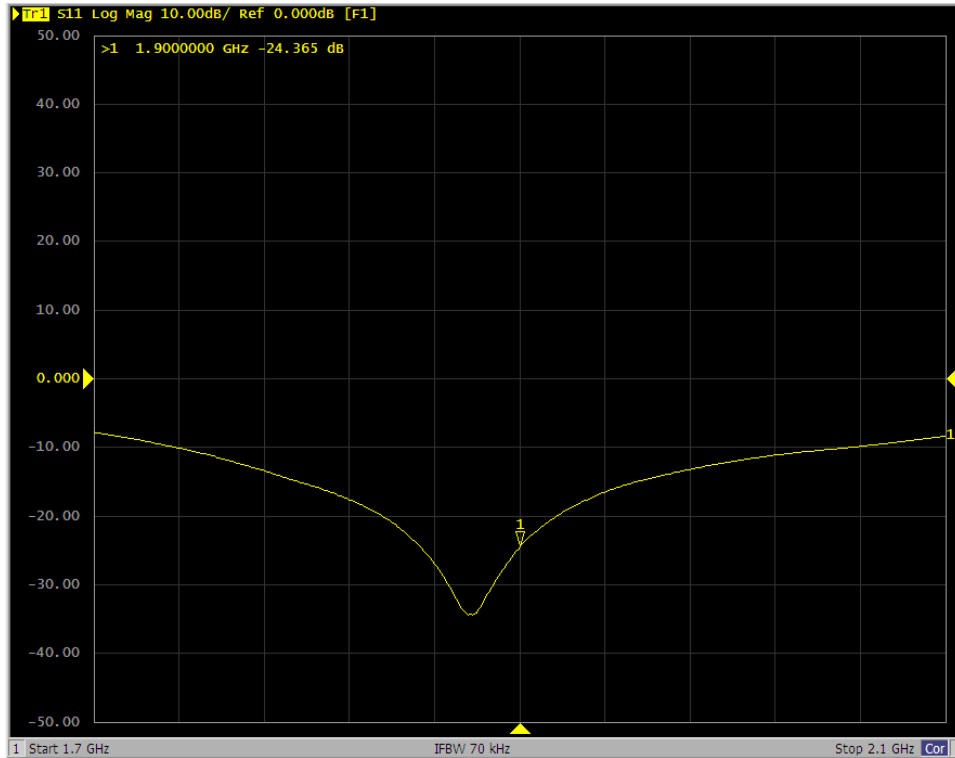



Accredited by the Swiss Accreditation Service (SAS)  
The Swiss Accreditation Service is one of the signatories to the EA  
Multilateral Agreement for the recognition of calibration certificates

Accreditation No.: **SCS 0108**

Client **Sporton**

Certificate No: **D2450V2-929\_Nov19**

## CALIBRATION CERTIFICATE

Object **D2450V2 - SN:929**

Calibration procedure(s) **QA CAL-05.v11  
Calibration Procedure for SAR Validation Sources between 0.7-3 GHz**

Calibration date: **November 21, 2019**

This calibration certificate documents the traceability to national standards, which realize the physical units of measurements (SI).  
The measurements and the uncertainties with confidence probability are given on the following pages and are part of the certificate.

All calibrations have been conducted in the closed laboratory facility: environment temperature ( $22 \pm 3$ )°C and humidity < 70%.

Calibration Equipment used (M&TE critical for calibration)

Primary Standards	ID #	Cal Date (Certificate No.)	Scheduled Calibration
Power meter NRP	SN: 104778	03-Apr-19 (No. 217-02892/02893)	Apr-20
Power sensor NRP-Z91	SN: 103244	03-Apr-19 (No. 217-02892)	Apr-20
Power sensor NRP-Z91	SN: 103245	03-Apr-19 (No. 217-02893)	Apr-20
Reference 20 dB Attenuator	SN: 5058 (20k)	04-Apr-19 (No. 217-02894)	Apr-20
Type-N mismatch combination	SN: 5047.2 / 06327	04-Apr-19 (No. 217-02895)	Apr-20
Reference Probe EX3DV4	SN: 7349	29-May-19 (No. EX3-7349_May19)	May-20
DAE4	SN: 601	30-Apr-19 (No. DAE4-601_Apr19)	Apr-20

Secondary Standards	ID #	Check Date (in house)	Scheduled Check
Power meter E4419B	SN: GB39512475	30-Oct-14 (in house check Feb-19)	In house check: Oct-20
Power sensor HP 8481A	SN: US37292783	07-Oct-15 (in house check Oct-18)	In house check: Oct-20
Power sensor HP 8481A	SN: MY41092317	07-Oct-15 (in house check Oct-18)	In house check: Oct-20
RF generator R&S SMT-06	SN: 100972	15-Jun-15 (in house check Oct-18)	In house check: Oct-20
Network Analyzer Agilent E8358A	SN: US41080477	31-Mar-14 (in house check Oct-19)	In house check: Oct-20

Calibrated by: **Claudio Leubler**      Name: Claudio Leubler      Function: Laboratory Technician

Approved by: **Katja Pokovic**      Name: Katja Pokovic      Function: Technical Manager

Signature

Issued: November 25, 2019

This calibration certificate shall not be reproduced except in full without written approval of the laboratory.



Accredited by the Swiss Accreditation Service (SAS)

The Swiss Accreditation Service is one of the signatories to the EA  
Multilateral Agreement for the recognition of calibration certificates

Accreditation No.: **SCS 0108**

### Glossary:

TSL	tissue simulating liquid
ConvF	sensitivity in TSL / NORM x,y,z
N/A	not applicable or not measured

### Calibration is Performed According to the Following Standards:

- IEEE Std 1528-2013, "IEEE Recommended Practice for Determining the Peak Spatial-Averaged Specific Absorption Rate (SAR) in the Human Head from Wireless Communications Devices: Measurement Techniques", June 2013
- IEC 62209-1, "Measurement procedure for the assessment of Specific Absorption Rate (SAR) from hand-held and body-mounted devices used next to the ear (frequency range of 300 MHz to 6 GHz)", July 2016
- IEC 62209-2, "Procedure to determine the Specific Absorption Rate (SAR) for wireless communication devices used in close proximity to the human body (frequency range of 30 MHz to 6 GHz)", March 2010
- KDB 865664, "SAR Measurement Requirements for 100 MHz to 6 GHz"

### Additional Documentation:

- DASY4/5 System Handbook

### Methods Applied and Interpretation of Parameters:

- Measurement Conditions:** Further details are available from the Validation Report at the end of the certificate. All figures stated in the certificate are valid at the frequency indicated.
- Antenna Parameters with TSL:** The dipole is mounted with the spacer to position its feed point exactly below the center marking of the flat phantom section, with the arms oriented parallel to the body axis.
- Feed Point Impedance and Return Loss:** These parameters are measured with the dipole positioned under the liquid filled phantom. The impedance stated is transformed from the measurement at the SMA connector to the feed point. The Return Loss ensures low reflected power. No uncertainty required.
- Electrical Delay:** One-way delay between the SMA connector and the antenna feed point. No uncertainty required.
- SAR measured:** SAR measured at the stated antenna input power.
- SAR normalized:** SAR as measured, normalized to an input power of 1 W at the antenna connector.
- SAR for nominal TSL parameters:** The measured TSL parameters are used to calculate the nominal SAR result.

The reported uncertainty of measurement is stated as the standard uncertainty of measurement multiplied by the coverage factor  $k=2$ , which for a normal distribution corresponds to a coverage probability of approximately 95%.



## Measurement Conditions

DASY system configuration, as far as not given on page 1.

<b>DASY Version</b>	DASY5	V52.10.3
<b>Extrapolation</b>	Advanced Extrapolation	
<b>Phantom</b>	Modular Flat Phantom	
<b>Distance Dipole Center - TSL</b>	10 mm	with Spacer
<b>Zoom Scan Resolution</b>	dx, dy, dz = 5 mm	
<b>Frequency</b>	2450 MHz $\pm$ 1 MHz	

## Head TSL parameters

The following parameters and calculations were applied.

	Temperature	Permittivity	Conductivity
<b>Nominal Head TSL parameters</b>	22.0 °C	39.2	1.80 mho/m
<b>Measured Head TSL parameters</b>	(22.0 $\pm$ 0.2) °C	38.2 $\pm$ 6 %	1.84 mho/m $\pm$ 6 %
<b>Head TSL temperature change during test</b>	< 0.5 °C	----	----

## SAR result with Head TSL

<b>SAR averaged over 1 cm<sup>3</sup> (1 g) of Head TSL</b>	Condition	
SAR measured	250 mW input power	13.5 W/kg
SAR for nominal Head TSL parameters	normalized to 1W	<b>53.1 W/kg <math>\pm</math> 17.0 % (k=2)</b>

<b>SAR averaged over 10 cm<sup>3</sup> (10 g) of Head TSL</b>	condition	
SAR measured	250 mW input power	6.24 W/kg
SAR for nominal Head TSL parameters	normalized to 1W	<b>24.7 W/kg <math>\pm</math> 16.5 % (k=2)</b>

## Appendix (Additional assessments outside the scope of SCS 0108)

### Antenna Parameters with Head TSL

Impedance, transformed to feed point	52.6 $\Omega$ + 5.2 j $\Omega$
Return Loss	- 24.9 dB

### General Antenna Parameters and Design

Electrical Delay (one direction)	1.161 ns
----------------------------------	----------

After long term use with 100W radiated power, only a slight warming of the dipole near the feedpoint can be measured.

The dipole is made of standard semirigid coaxial cable. The center conductor of the feeding line is directly connected to the second arm of the dipole. The antenna is therefore short-circuited for DC-signals. On some of the dipoles, small end caps are added to the dipole arms in order to improve matching when loaded according to the position as explained in the "Measurement Conditions" paragraph. The SAR data are not affected by this change. The overall dipole length is still according to the Standard.

No excessive force must be applied to the dipole arms, because they might bend or the soldered connections near the feedpoint may be damaged.

### Additional EUT Data

Manufactured by	SPEAG
-----------------	-------

## DASY5 Validation Report for Head TSL

Date: 21.11.2019

Test Laboratory: SPEAG, Zurich, Switzerland

**DUT: Dipole 2450 MHz; Type: D2450V2; Serial: D2450V2 - SN:929**

Communication System: UID 0 - CW; Frequency: 2450 MHz

Medium parameters used:  $f = 2450$  MHz;  $\sigma = 1.84$  S/m;  $\epsilon_r = 38.2$ ;  $\rho = 1000$  kg/m<sup>3</sup>

Phantom section: Flat Section

Measurement Standard: DASY5 (IEEE/IEC/ANSI C63.19-2011)

DASY52 Configuration:

- Probe: EX3DV4 - SN7349; ConvF(7.9, 7.9, 7.9) @ 2450 MHz; Calibrated: 29.05.2019
- Sensor-Surface: 1.4mm (Mechanical Surface Detection)
- Electronics: DAE4 Sn601; Calibrated: 30.04.2019
- Phantom: Flat Phantom 5.0 (front); Type: QD 000 P50 AA; Serial: 1001
- DASY52 52.10.3(1513); SEMCAD X 14.6.13(7474)

### Dipole Calibration for Head Tissue/Pin=250 mW, d=10mm/Zoom Scan (7x7x7)/Cube 0:

Measurement grid: dx=5mm, dy=5mm, dz=5mm

Reference Value = 117.5 V/m; Power Drift = 0.07 dB

Peak SAR (extrapolated) = 26.8 W/kg

**SAR(1 g) = 13.5 W/kg; SAR(10 g) = 6.24 W/kg**

Smallest distance from peaks to all points 3 dB below = 9 mm

Ratio of SAR at M2 to SAR at M1 = 50.9%

Maximum value of SAR (measured) = 22.1 W/kg

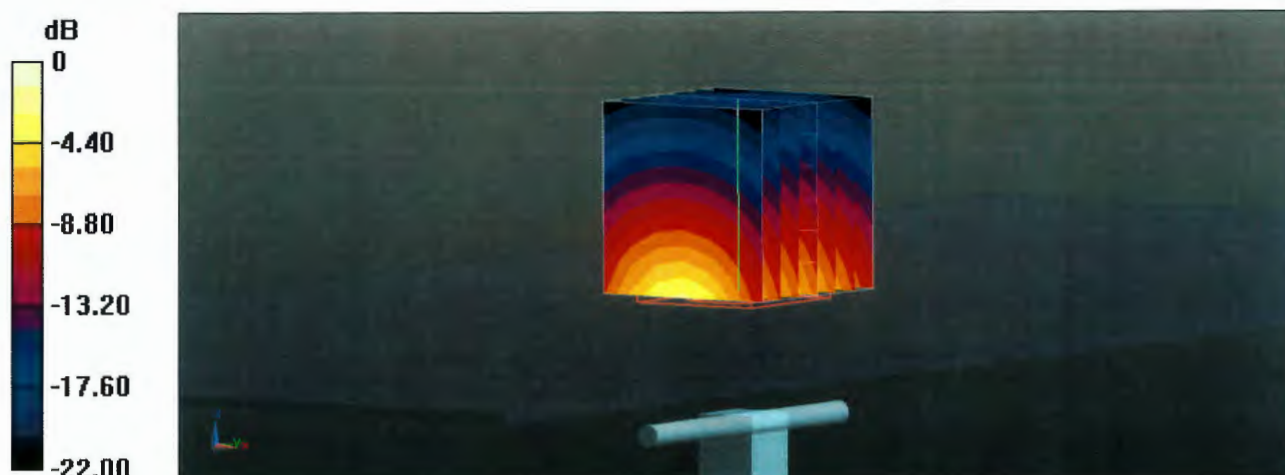

0 dB = 22.1 W/kg = 13.44 dBW/kg

# Impedance Measurement Plot for Head TSL

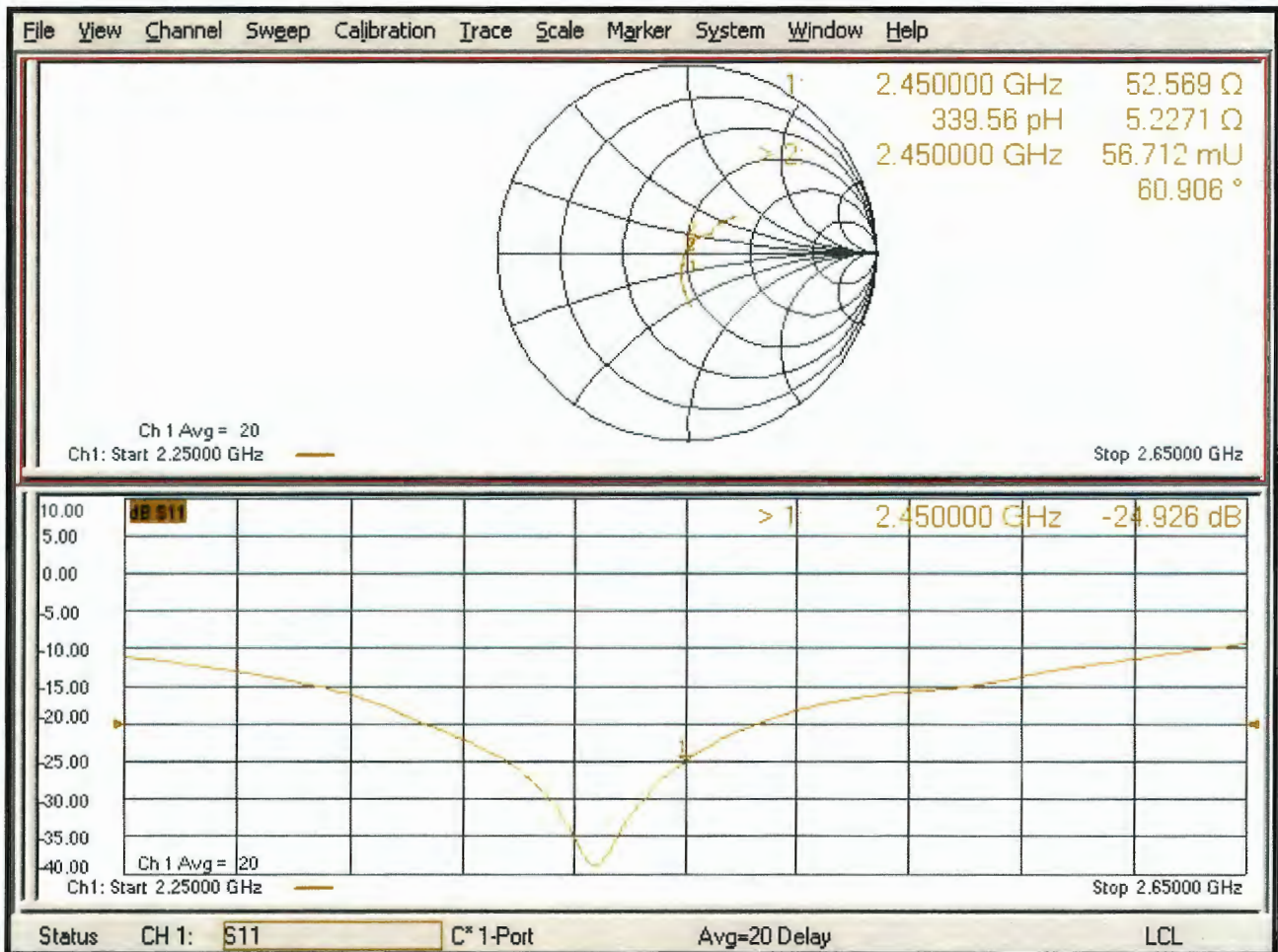

## Appendix: Transfer Calibration at Four Validation Locations on SAM Head<sup>1</sup>

### Evaluation Condition

Phantom	SAM Head Phantom	For usage with cSAR3DV2-R/L
---------	------------------	-----------------------------

### SAR result with SAM Head (Top $\cong$ C0)

<b>SAR averaged over 1 cm<sup>3</sup> (1 g) of Head TSL</b>	Condition	
SAR for nominal Head TSL parameters	normalized to 1W	<b>56.6 W/kg <math>\pm</math> 17.5 % (k=2)</b>

<b>SAR averaged over 10 cm<sup>3</sup> (10 g) of Head TSL</b>	condition	
SAR for nominal Head TSL parameters	normalized to 1W	<b>26.3 W/kg <math>\pm</math> 16.9 % (k=2)</b>

### SAR result with SAM Head (Mouth $\cong$ F90)

<b>SAR averaged over 1 cm<sup>3</sup> (1 g) of Head TSL</b>	Condition	
SAR for nominal Head TSL parameters	normalized to 1W	<b>57.7 W/kg <math>\pm</math> 17.5 % (k=2)</b>

<b>SAR averaged over 10 cm<sup>3</sup> (10 g) of Head TSL</b>	condition	
SAR for nominal Head TSL parameters	normalized to 1W	<b>27.6 W/kg <math>\pm</math> 16.9 % (k=2)</b>

### SAR result with SAM Head (Neck $\cong$ H0)

<b>SAR averaged over 1 cm<sup>3</sup> (1 g) of Head TSL</b>	Condition	
SAR for nominal Head TSL parameters	normalized to 1W	<b>54.4 W/kg <math>\pm</math> 17.5 % (k=2)</b>

<b>SAR averaged over 10 cm<sup>3</sup> (10 g) of Head TSL</b>	condition	
SAR for nominal Head TSL parameters	normalized to 1W	<b>25.2 W/kg <math>\pm</math> 16.9 % (k=2)</b>

### SAR result with SAM Head (Ear $\cong$ D90)

<b>SAR averaged over 1 cm<sup>3</sup> (1 g) of Head TSL</b>	Condition	
SAR for nominal Head TSL parameters	normalized to 1W	<b>34.8 W/kg <math>\pm</math> 17.5 % (k=2)</b>

<b>SAR averaged over 10 cm<sup>3</sup> (10 g) of Head TSL</b>	condition	
SAR for nominal Head TSL parameters	normalized to 1W	<b>17.5 W/kg <math>\pm</math> 16.9 % (k=2)</b>

<sup>1</sup> Additional assessments outside the current scope of SCS 0108



In Collaboration with  
**s p e a g**  
CALIBRATION LABORATORY



中国认可  
国际互认  
校准  
CALIBRATION  
CNAS L0570

Add: No.51 Xueyuan Road, Haidian District, Beijing, 100191, China  
Tel: +86-10-62304633-2079 Fax: +86-10-62304633-2504  
E-mail: cttl@chinattl.com http://www.chinattl.cn

Client **Sporton**

Certificate No: **Z19-60060**

## CALIBRATION CERTIFICATE

Object **D2600V2 - SN: 1078**

Calibration Procedure(s) **FF-Z11-003-01**  
**Calibration Procedures for dipole validation kits**

Calibration date: **March 6, 2019**

This calibration Certificate documents the traceability to national standards, which realize the physical units of measurements(SI). The measurements and the uncertainties with confidence probability are given on the following pages and are part of the certificate.

All calibrations have been conducted in the closed laboratory facility: environment temperature(22±3)°C and humidity<70%.

Calibration Equipment used (M&TE critical for calibration)

Primary Standards	ID #	Cal Date(Calibrated by, Certificate No.)	Scheduled Calibration
Power Meter NRP2	106277	20-Aug-18 (CTTL, No.J18X06862)	Aug-19
Power sensor NRP8S	104291	20-Aug-18 (CTTL, No.J18X06862)	Aug-19
Reference Probe EX3DV4	SN 3617	31-Jan-19(SPEAG,No.EX3-3617_Jan19)	Jan-20
DAE4	SN 1331	06-Feb-19(SPEAG,No.DAE4-1331_Feb19)	Feb-20
Secondary Standards	ID #	Cal Date(Calibrated by, Certificate No.)	Scheduled Calibration
Signal Generator E4438C	MY49071430	23-Jan-19 (CTTL, No.J19X00336)	Jan-20
Network Analyzer E5071C	MY46110673	24-Jan-19 (CTTL, No.J19X00547)	Jan-20

	Name	Function
Calibrated by:	Zhao Jing	SAR Test Engineer
Reviewed by:	Lin Hao	SAR Test Engineer
Approved by:	Qi Dianyuan	SAR Project Leader

Signature

Issued: March 8, 2019

This calibration certificate shall not be reproduced except in full without written approval of the laboratory.



In Collaboration with

**s p e a g**

**CALIBRATION LABORATORY**

Add: No.51 Xueyuan Road, Haidian District, Beijing, 100191, China  
Tel: +86-10-62304633-2079 Fax: +86-10-62304633-2504  
E-mail: cttl@chinattl.com http://www.chinattl.cn

### Glossary:

TSL	tissue simulating liquid
ConvF	sensitivity in TSL / NORM <sub>x,y,z</sub>
N/A	not applicable or not measured

### Calibration is Performed According to the Following Standards:

- IEEE Std 1528-2013, "IEEE Recommended Practice for Determining the Peak Spatial-Averaged Specific Absorption Rate (SAR) in the Human Head from Wireless Communications Devices: Measurement Techniques", June 2013
- IEC 62209-1, "Measurement procedure for assessment of specific absorption rate of human exposure to radio frequency fields from hand-held and body-mounted wireless communication devices- Part 1: Device used next to the ear (Frequency range of 300MHz to 6GHz)", July 2016
- IEC 62209-2, "Procedure to measure the Specific Absorption Rate (SAR) For wireless communication devices used in close proximity to the human body (frequency range of 30MHz to 6GHz)", March 2010
- KDB865664, SAR Measurement Requirements for 100 MHz to 6 GHz

### Additional Documentation:

- DASY4/5 System Handbook

### Methods Applied and Interpretation of Parameters:

- Measurement Conditions:** Further details are available from the Validation Report at the end of the certificate. All figures stated in the certificate are valid at the frequency indicated.
- Antenna Parameters with TSL:** The dipole is mounted with the spacer to position its feed point exactly below the center marking of the flat phantom section, with the arms oriented parallel to the body axis.
- Feed Point Impedance and Return Loss:** These parameters are measured with the dipole positioned under the liquid filled phantom. The impedance stated is transformed from the measurement at the SMA connector to the feed point. The Return Loss ensures low reflected power. No uncertainty required.
- Electrical Delay:** One-way delay between the SMA connector and the antenna feed point. No uncertainty required.
- SAR measured:** SAR measured at the stated antenna input power.
- SAR normalized:** SAR as measured, normalized to an input power of 1 W at the antenna connector.
- SAR for nominal TSL parameters:** The measured TSL parameters are used to calculate the nominal SAR result.

The reported uncertainty of measurement is stated as the standard uncertainty of Measurement multiplied by the coverage factor  $k=2$ , which for a normal distribution Corresponds to a coverage probability of approximately 95%.



In Collaboration with

**s p e a g**  
CALIBRATION LABORATORY

Add: No.51 Xueyuan Road, Haidian District, Beijing, 100191, China

Tel: +86-10-62304633-2079

Fax: +86-10-62304633-2504

E-mail: cttl@chinattl.com

http://www.chinattl.cn

## Measurement Conditions

DASY system configuration, as far as not given on page 1.

DASY Version	DASY52	52.10.2.1495
Extrapolation	Advanced Extrapolation	
Phantom	Triple Flat Phantom 5.1C	
Distance Dipole Center - TSL	10 mm	with Spacer
Zoom Scan Resolution	dx, dy, dz = 5 mm	
Frequency	2600 MHz $\pm$ 1 MHz	

## Head TSL parameters

The following parameters and calculations were applied.

	Temperature	Permittivity	Conductivity
Nominal Head TSL parameters	22.0 °C	39.0	1.96 mho/m
Measured Head TSL parameters	(22.0 $\pm$ 0.2) °C	38.9 $\pm$ 6 %	1.99 mho/m $\pm$ 6 %
Head TSL temperature change during test	<1.0 °C	----	----

## SAR result with Head TSL

SAR averaged over 1 cm <sup>3</sup> (1 g) of Head TSL	Condition	
SAR measured	250 mW input power	14.5 W/kg
SAR for nominal Head TSL parameters	normalized to 1W	<b>57.6 W/kg <math>\pm</math> 18.8 % (k=2)</b>
SAR averaged over 10 cm <sup>3</sup> (10 g) of Head TSL	Condition	
SAR measured	250 mW input power	6.41 W/kg
SAR for nominal Head TSL parameters	normalized to 1W	<b>25.5 W/kg <math>\pm</math> 18.7 % (k=2)</b>

## Body TSL parameters

The following parameters and calculations were applied.

	Temperature	Permittivity	Conductivity
Nominal Body TSL parameters	22.0 °C	52.5	2.16 mho/m
Measured Body TSL parameters	(22.0 $\pm$ 0.2) °C	52.0 $\pm$ 6 %	2.14 mho/m $\pm$ 6 %
Body TSL temperature change during test	<1.0 °C	----	----

## SAR result with Body TSL

SAR averaged over 1 cm <sup>3</sup> (1 g) of Body TSL	Condition	
SAR measured	250 mW input power	13.4 W/kg
SAR for nominal Body TSL parameters	normalized to 1W	<b>53.7 W/kg <math>\pm</math> 18.8 % (k=2)</b>
SAR averaged over 10 cm <sup>3</sup> (10 g) of Body TSL	Condition	
SAR measured	250 mW input power	5.93 W/kg
SAR for nominal Body TSL parameters	normalized to 1W	<b>23.7 W/kg <math>\pm</math> 18.7 % (k=2)</b>





Add: No.51 Xueyuan Road, Haidian District, Beijing, 100191, China  
Tel: +86-10-62304633-2079 Fax: +86-10-62304633-2504  
E-mail: cttl@chinattl.com http://www.chinattl.cn

## Appendix(Additional assessments outside the scope of CNAS L0570)

### Antenna Parameters with Head TSL

Impedance, transformed to feed point	49.6Ω- 6.35jΩ
Return Loss	- 23.9dB

### Antenna Parameters with Body TSL

Impedance, transformed to feed point	46.0Ω- 5.66jΩ
Return Loss	- 22.8dB

### General Antenna Parameters and Design

Electrical Delay (one direction)	1.016 ns
----------------------------------	----------

After long term use with 100W radiated power, only a slight warming of the dipole near the feedpoint can be measured.

The dipole is made of standard semirigid coaxial cable. The center conductor of the feeding line is directly connected to the second arm of the dipole. The antenna is therefore short-circuited for DC-signals. On some of the dipoles, small end caps are added to the dipole arms in order to improve matching when loaded according to the position as explained in the "Measurement Conditions" paragraph. The SAR data are not affected by this change. The overall dipole length is still according to the Standard.

No excessive force must be applied to the dipole arms, because they might bend or the soldered connections near the feedpoint may be damaged.

### Additional EUT Data

Manufactured by	SPEAG
-----------------	-------



Add: No.51 Xueyuan Road, Haidian District, Beijing, 100191, China  
Tel: +86-10-62304633-2079 Fax: +86-10-62304633-2504  
E-mail: cttl@chinattl.com http://www.chinattl.cn

**DASY5 Validation Report for Head TSL**

Date: 03.05.2019

Test Laboratory: CTTL, Beijing, China

**DUT: Dipole 2600 MHz; Type: D2600V2; Serial: D2600V2 - SN: 1078**

Communication System: UID 0, CW; Frequency: 2600 MHz; Duty Cycle: 1:1

Medium parameters used:  $f = 2600$  MHz;  $\sigma = 1.992$  S/m;  $\epsilon_r = 38.91$ ;  $\rho = 1000$  kg/m<sup>3</sup>

Phantom section: Center Section

DASY5 Configuration:

- Probe: EX3DV4 - SN3617; ConvF(7.19, 7.19, 7.19) @ 2600 MHz; Calibrated: 1/31/2019
- Sensor-Surface: 1.4mm (Mechanical Surface Detection)
- Electronics: DAE4 Sn1331; Calibrated: 2/6/2019
- Phantom: MFP\_V5.1C ; Type: QD 000 P51CA; Serial: 1062
- Measurement SW: DASY52, Version 52.10 (2); SEMCAD X Version 14.6.12 (7450)

**Dipole Calibration/Zoom Scan (7x7x7) (7x7x7)/Cube 0:** Measurement grid: dx=5mm, dy=5mm, dz=5mm

Reference Value = 91.73 V/m; Power Drift = -0.07 dB

Peak SAR (extrapolated) = 31.6 W/kg

**SAR(1 g) = 14.5 W/kg; SAR(10 g) = 6.41 W/kg**

Maximum value of SAR (measured) = 25.0 W/kg

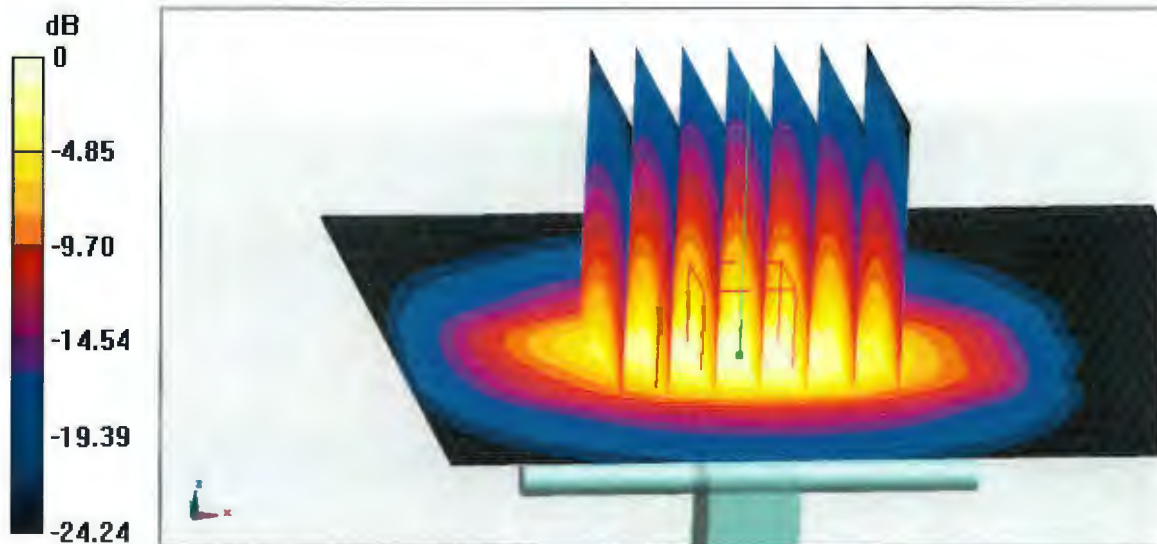

0 dB = 25.0 W/kg = 13.98 dBW/kg



Add: No.51 Xueyuan Road, Haidian District, Beijing, 100191, China  
Tel: +86-10-62304633-2079 Fax: +86-10-62304633-2504  
E-mail: cttl@chinattl.com http://www.chinattl.cn

### Impedance Measurement Plot for Head TSL

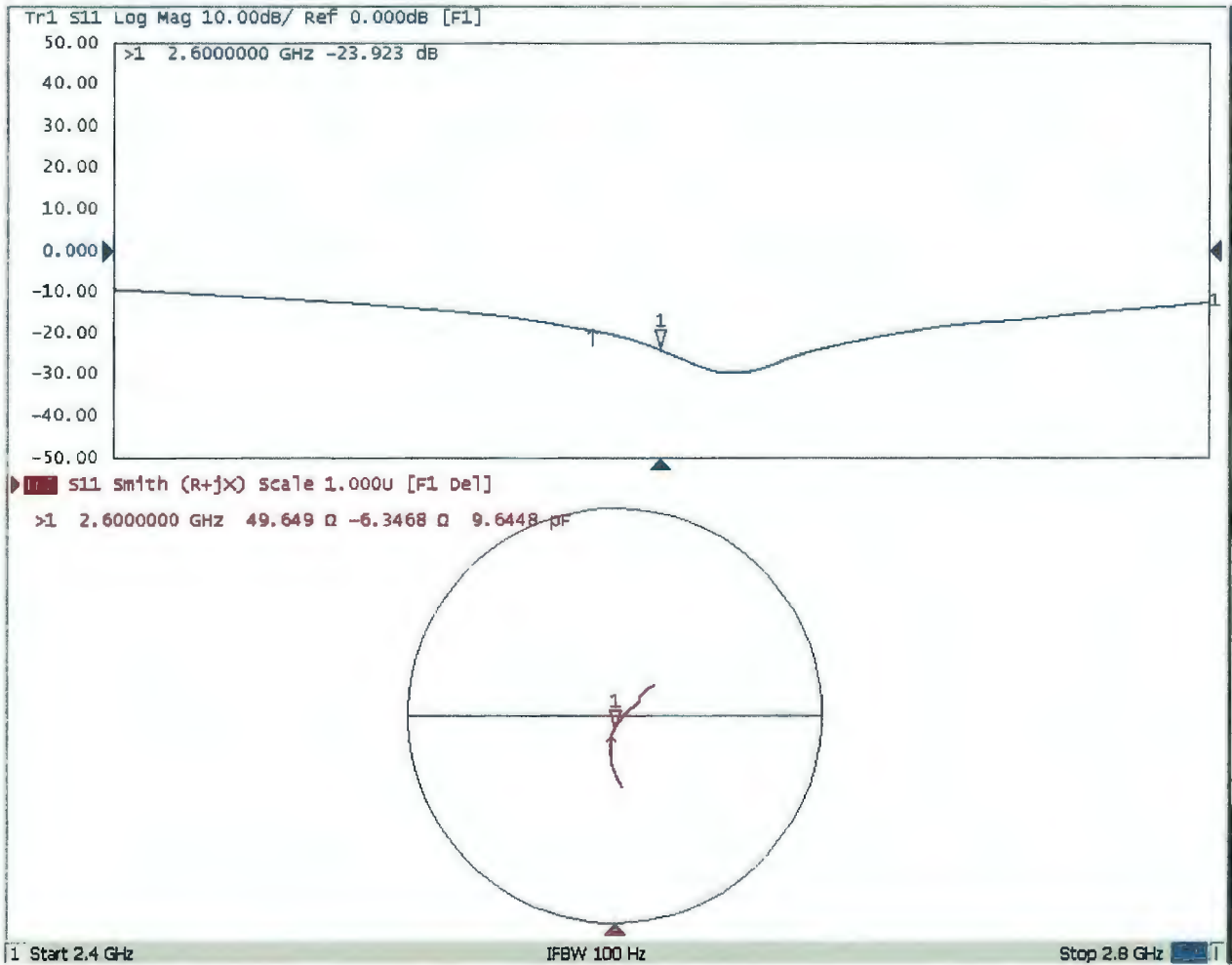



Add: No.51 Xueyuan Road, Haidian District, Beijing, 100191, China  
Tel: +86-10-62304633-2079 Fax: +86-10-62304633-2504  
E-mail: cttl@chinattl.com http://www.chinattl.cn

**DASY5 Validation Report for Body TSL**

Date: 03.05.2019

Test Laboratory: CTTL, Beijing, China

**DUT: Dipole 2600 MHz; Type: D2600V2; Serial: D2600V2 - SN: 1078**

Communication System: UID 0, CW; Frequency: 2600 MHz; Duty Cycle: 1:1

Medium parameters used:  $f = 2600$  MHz;  $\sigma = 2.139$  S/m;  $\epsilon_r = 51.97$ ;  $\rho = 1000$  kg/m<sup>3</sup>

Phantom section: Right Section

DASY5 Configuration:

- Probe: EX3DV4 - SN3617; ConvF(7.49, 7.49, 7.49) @ 2600 MHz; Calibrated: 1/31/2019
- Sensor-Surface: 1.4mm (Mechanical Surface Detection)
- Electronics: DAE4 Sn1331; Calibrated: 2/6/2019
- Phantom: MFP\_V5.1C ; Type: QD 000 P51CA; Serial: 1062
- Measurement SW: DASY52, Version 52.10 (2); SEMCAD X Version 14.6.12 (7450)

**Dipole Calibration/Zoom Scan (7x7x7) (7x7x7)/Cube 0:** Measurement grid: dx=5mm, dy=5mm, dz=5mm

Reference Value = 95.97 V/m; Power Drift = 0.08 dB

Peak SAR (extrapolated) = 29.3 W/kg

**SAR(1 g) = 13.4 W/kg; SAR(10 g) = 5.93 W/kg**

Maximum value of SAR (measured) = 22.9 W/kg

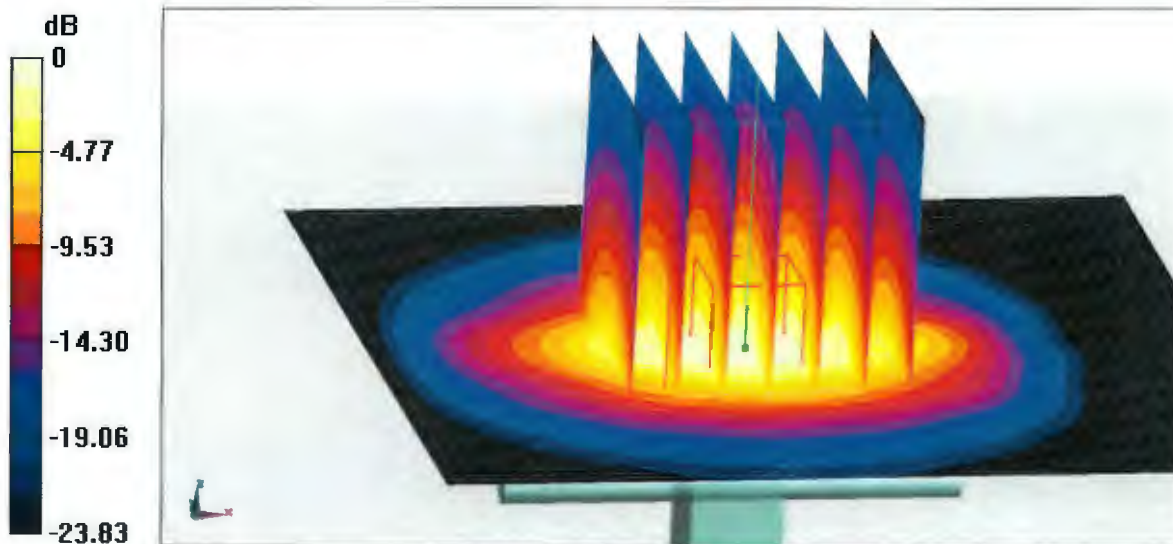

0 dB = 22.9 W/kg = 13.60 dBW/kg



Add: No.51 Xueyuan Road, Haidian District, Beijing, 100191, China  
Tel: +86-10-62304633-2079 Fax: +86-10-62304633-2504  
E-mail: cttl@chinattl.com http://www.chinattl.cn

### Impedance Measurement Plot for Body TSL

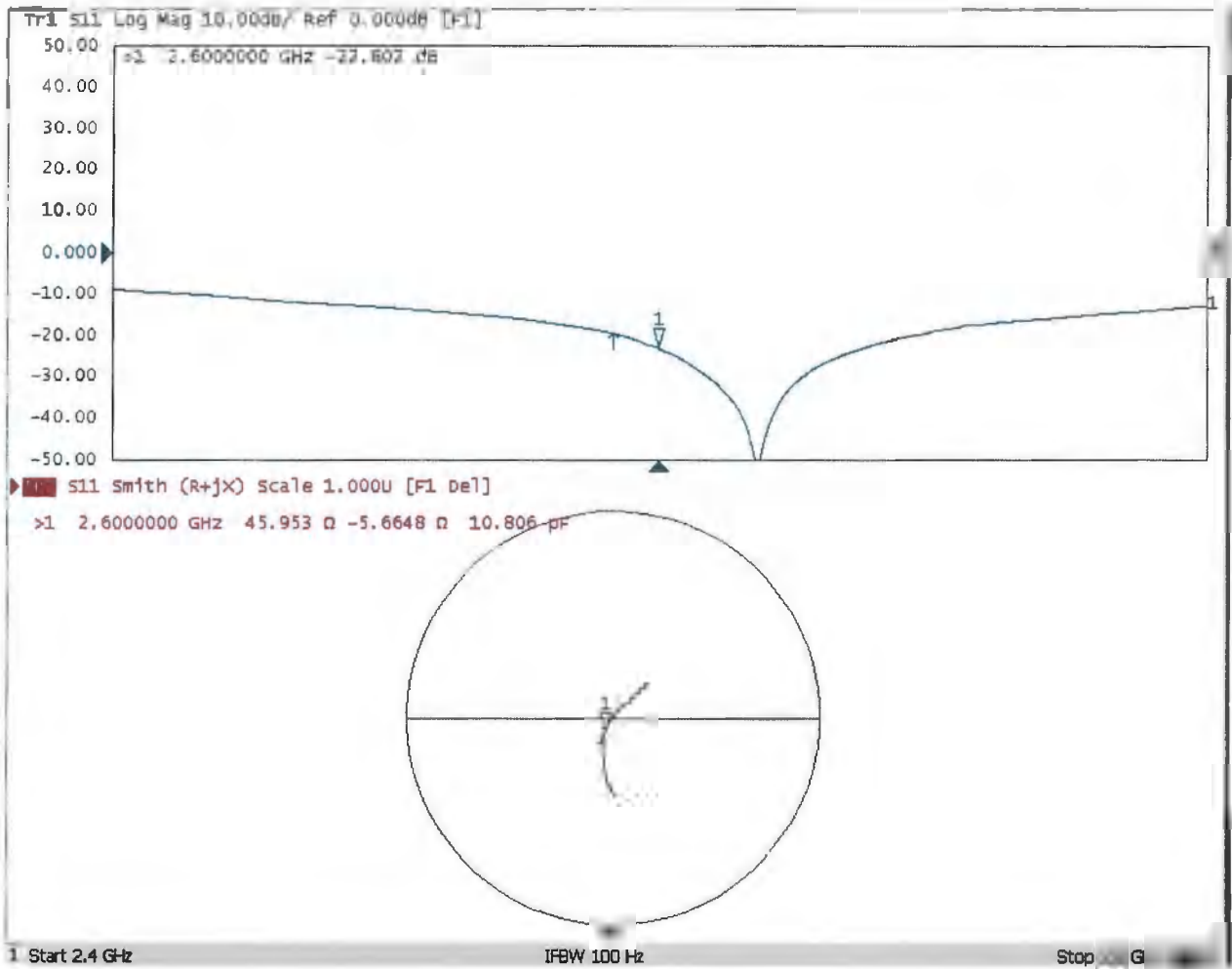



## D2600V2, serial no. 1078 Extended Dipole Calibrations

Referring to KDB 450824, if dipoles are verified in return loss ( $< -20\text{dB}$ , within 20% of prior calibration), and in impedance (within 5 ohm of prior calibration), the annual calibration is not necessary and the calibration interval can be extended.

### <Justification of the extended calibration>

D2600V2 – serial no. 1078						
2600MHZ						
Date of Measurement	Return-Loss (dB)	Delta (%)	Real Impedance (ohm)	Delta (ohm)	Imaginary Impedance (ohm)	Delta (ohm)
03.06.2019 (Cal. Report)	-23.923		49.649		-6.3468	
03.05.2020 (extended)	-23.769	-0.64	50.320	-0.671	-7.2897	0.9429

The return loss is  $< -20\text{dB}$ , within 20% of prior calibration; the impedance is within 5 ohm of prior calibration. Therefore the verification result should support extended calibration.



<Dipole Verification Data> - D2600 V2, serial no. 1078 (Data of Measurement : 03.05.2020)

2600 MHz - Head

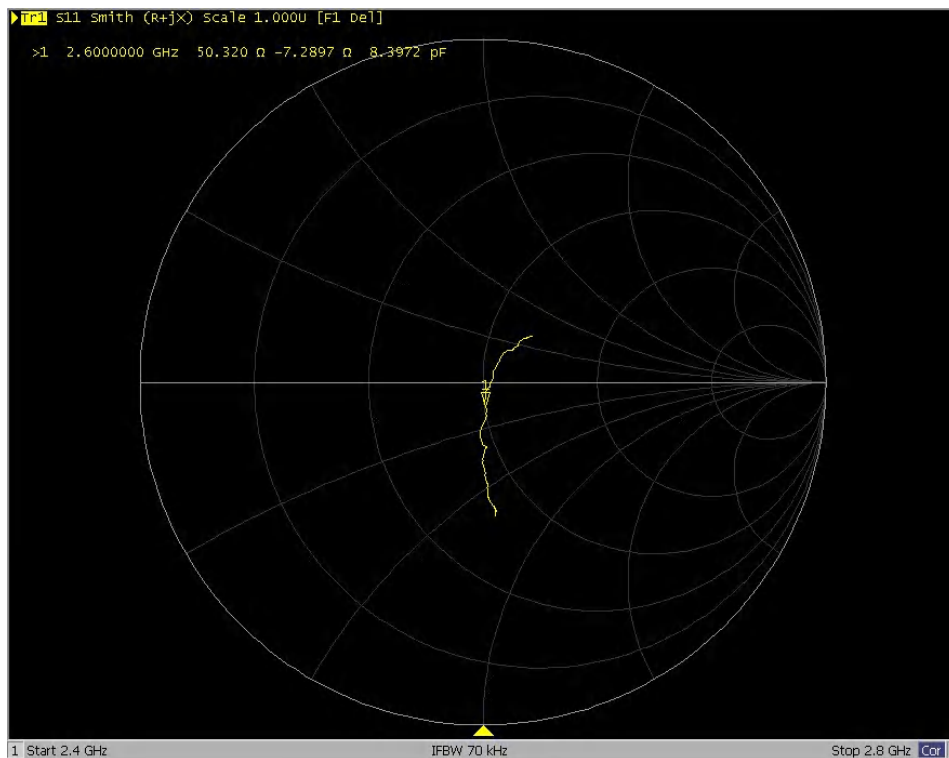
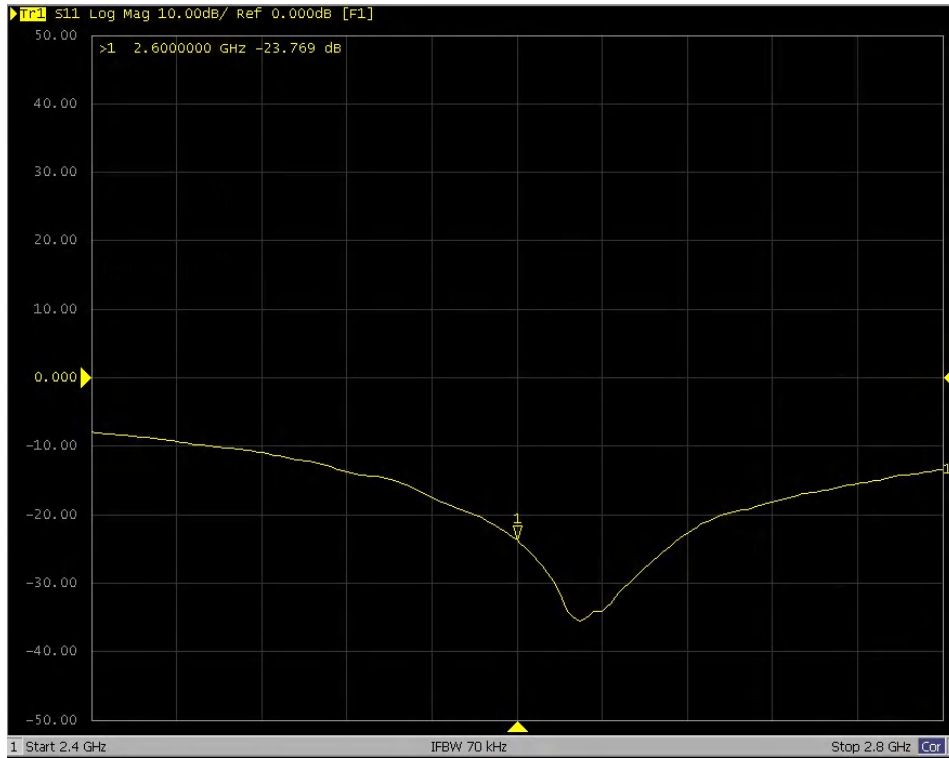



Accredited by the Swiss Accreditation Service (SAS)  
The Swiss Accreditation Service is one of the signatories to the EA  
Multilateral Agreement for the recognition of calibration certificates

Accreditation No.: **SCS 0108**

Client **Sporton**

Certificate No: **D5GHzV2-1006\_Sep18**

## CALIBRATION CERTIFICATE

Object **D5GHzV2 - SN:1006**

Calibration procedure(s) **QA CAL-22.v3  
Calibration procedure for dipole validation kits between 3-6 GHz**

Calibration date: **September 27, 2018**

This calibration certificate documents the traceability to national standards, which realize the physical units of measurements (SI).  
The measurements and the uncertainties with confidence probability are given on the following pages and are part of the certificate.

All calibrations have been conducted in the closed laboratory facility: environment temperature (22 ± 3)°C and humidity < 70%.

Calibration Equipment used (M&TE critical for calibration)

Primary Standards	ID #	Cal Date (Certificate No.)	Scheduled Calibration
Power meter NRP	SN: 104778	04-Apr-18 (No. 217-02672/02673)	Apr-19
Power sensor NRP-Z91	SN: 103244	04-Apr-18 (No. 217-02672)	Apr-19
Power sensor NRP-Z91	SN: 103245	04-Apr-18 (No. 217-02673)	Apr-19
Reference 20 dB Attenuator	SN: 5058 (20k)	04-Apr-18 (No. 217-02682)	Apr-19
Type-N mismatch combination	SN: 5047.2 / 06327	04-Apr-18 (No. 217-02683)	Apr-19
Reference Probe EX3DV4	SN: 3503	30-Dec-17 (No. EX3-3503_Dec17)	Dec-18
DAE4	SN: 601	26-Oct-17 (No. DAE4-601_Oct17)	Oct-18

Secondary Standards	ID #	Check Date (in house)	Scheduled Check
Power meter EPM-442A	SN: GB37480704	07-Oct-15 (in house check Oct-16)	In house check: Oct-18
Power sensor HP 8481A	SN: US37292783	07-Oct-15 (in house check Oct-16)	In house check: Oct-18
Power sensor HP 8481A	SN: MY41092317	07-Oct-15 (in house check Oct-16)	In house check: Oct-18
RF generator R&S SMT-06	SN: 100972	15-Jun-15 (in house check Oct-16)	In house check: Oct-18
Network Analyzer Agilent E8358A	SN: US41080477	31-Mar-14 (in house check Oct-17)	In house check: Oct-18

Calibrated by:	Name <b>Jeton Kastrati</b>	Function <b>Laboratory Technician</b>	Signature 
Approved by:	Name <b>Katja Pokovic</b>	Function <b>Technical Manager</b>	Signature 

Issued: September 28, 2018

This calibration certificate shall not be reproduced except in full without written approval of the laboratory.





Accredited by the Swiss Accreditation Service (SAS)

Accreditation No.: **SCS 0108**

The Swiss Accreditation Service is one of the signatories to the EA  
Multilateral Agreement for the recognition of calibration certificates

### Glossary:

TSL	tissue simulating liquid
ConvF	sensitivity in TSL / NORM x,y,z
N/A	not applicable or not measured

### Calibration is Performed According to the Following Standards:

- IEEE Std 1528-2013, "IEEE Recommended Practice for Determining the Peak Spatial-Averaged Specific Absorption Rate (SAR) in the Human Head from Wireless Communications Devices: Measurement Techniques", June 2013
- IEC 62209-1, "Measurement procedure for the assessment of Specific Absorption Rate (SAR) from hand-held and body-mounted devices used next to the ear (frequency range of 300 MHz to 6 GHz)", July 2016
- IEC 62209-2, "Procedure to determine the Specific Absorption Rate (SAR) for wireless communication devices used in close proximity to the human body (frequency range of 30 MHz to 6 GHz)", March 2010
- KDB 865664, "SAR Measurement Requirements for 100 MHz to 6 GHz"

### Additional Documentation:

- DASY4/5 System Handbook

### Methods Applied and Interpretation of Parameters:

- Measurement Conditions:** Further details are available from the Validation Report at the end of the certificate. All figures stated in the certificate are valid at the frequency indicated.
- Antenna Parameters with TSL:** The dipole is mounted with the spacer to position its feed point exactly below the center marking of the flat phantom section, with the arms oriented parallel to the body axis.
- Feed Point Impedance and Return Loss:** These parameters are measured with the dipole positioned under the liquid filled phantom. The impedance stated is transformed from the measurement at the SMA connector to the feed point. The Return Loss ensures low reflected power. No uncertainty required.
- Electrical Delay:** One-way delay between the SMA connector and the antenna feed point. No uncertainty required.
- SAR measured:** SAR measured at the stated antenna input power.
- SAR normalized:** SAR as measured, normalized to an input power of 1 W at the antenna connector.
- SAR for nominal TSL parameters:** The measured TSL parameters are used to calculate the nominal SAR result.

The reported uncertainty of measurement is stated as the standard uncertainty of measurement multiplied by the coverage factor  $k=2$ , which for a normal distribution corresponds to a coverage probability of approximately 95%.

## Measurement Conditions

DASY system configuration, as far as not given on page 1.

<b>DASY Version</b>	DASY5	V52.10.1
<b>Extrapolation</b>	Advanced Extrapolation	
<b>Phantom</b>	Modular Flat Phantom V5.0	
<b>Distance Dipole Center - TSL</b>	10 mm	with Spacer
<b>Zoom Scan Resolution</b>	dx, dy = 4.0 mm, dz = 1.4 mm	Graded Ratio = 1.4 (Z direction)
<b>Frequency</b>	5250 MHz ± 1 MHz 5600 MHz ± 1 MHz 5750 MHz ± 1 MHz	

## Head TSL parameters at 5250 MHz

The following parameters and calculations were applied.

	Temperature	Permittivity	Conductivity
<b>Nominal Head TSL parameters</b>	22.0 °C	35.9	4.71 mho/m
<b>Measured Head TSL parameters</b>	(22.0 ± 0,2) °C	36.0 ± 6 %	4.61 mho/m ± 6 %
<b>Head TSL temperature change during test</b>	< 0.5 °C	----	----

## SAR result with Head TSL at 5250 MHz

SAR averaged over 1 cm <sup>3</sup> (1 g) of Head TSL	Condition	
SAR measured	100 mW input power	8.07 W/kg
SAR for nominal Head TSL parameters	normalized to 1W	<b>80.7 W/kg ± 19.9 % (k=2)</b>

SAR averaged over 10 cm <sup>3</sup> (10 g) of Head TSL	condition	
SAR measured	100 mW input power	2.32 W/kg
SAR for nominal Head TSL parameters	normalized to 1W	<b>23.2 W/kg ± 19.5 % (k=2)</b>

### Head TSL parameters at 5600 MHz

The following parameters and calculations were applied.

	Temperature	Permittivity	Conductivity
Nominal Head TSL parameters	22.0 °C	35.5	5.07 mho/m
Measured Head TSL parameters	(22.0 ± 0.2) °C	35.4 ± 6 %	4.98 mho/m ± 6 %
Head TSL temperature change during test	< 0.5 °C	---	---

### SAR result with Head TSL at 5600 MHz

SAR averaged over 1 cm <sup>3</sup> (1 g) of Head TSL	Condition	
SAR measured	100 mW input power	8.34 W/kg
SAR for nominal Head TSL parameters	normalized to 1W	83.3 W / kg ± 19.9 % (k=2)

SAR averaged over 10 cm <sup>3</sup> (10 g) of Head TSL	condition	
SAR measured	100 mW input power	2.38 W/kg
SAR for nominal Head TSL parameters	normalized to 1W	23.8 W/kg ± 19.5 % (k=2)

### Head TSL parameters at 5750 MHz

The following parameters and calculations were applied.

	Temperature	Permittivity	Conductivity
Nominal Head TSL parameters	22.0 °C	35.4	5.22 mho/m
Measured Head TSL parameters	(22.0 ± 0.2) °C	35.2 ± 6 %	5.14 mho/m ± 6 %
Head TSL temperature change during test	< 0.5 °C	---	---

### SAR result with Head TSL at 5750 MHz

SAR averaged over 1 cm <sup>3</sup> (1 g) of Head TSL	Condition	
SAR measured	100 mW input power	8.05 W/kg
SAR for nominal Head TSL parameters	normalized to 1W	80.4 W/kg ± 19.9 % (k=2)

SAR averaged over 10 cm <sup>3</sup> (10 g) of Head TSL	condition	
SAR measured	100 mW input power	2.29 W/kg
SAR for nominal Head TSL parameters	normalized to 1W	22.9 W/kg ± 19.5 % (k=2)

### Body TSL parameters at 5250 MHz

The following parameters and calculations were applied.

	Temperature	Permittivity	Conductivity
Nominal Body TSL parameters	22.0 °C	48.9	5.36 mho/m
Measured Body TSL parameters	(22.0 ± 0.2) °C	46.9 ± 6 %	5.46 mho/m ± 6 %
Body TSL temperature change during test	< 0.5 °C	---	---

### SAR result with Body TSL at 5250 MHz

SAR averaged over 1 cm <sup>3</sup> (1 g) of Body TSL	Condition	
SAR measured	100 mW input power	7.89 W/kg
SAR for nominal Body TSL parameters	normalized to 1W	<b>78.3 W/kg ± 19.9 % (k=2)</b>

SAR averaged over 10 cm <sup>3</sup> (10 g) of Body TSL	condition	
SAR measured	100 mW input power	2.19 W/kg
SAR for nominal Body TSL parameters	normalized to 1W	<b>21.7 W/kg ± 19.5 % (k=2)</b>

### Body TSL parameters at 5600 MHz

The following parameters and calculations were applied.

	Temperature	Permittivity	Conductivity
Nominal Body TSL parameters	22.0 °C	48.5	5.77 mho/m
Measured Body TSL parameters	(22.0 ± 0.2) °C	46.3 ± 6 %	5.93 mho/m ± 6 %
Body TSL temperature change during test	< 0.5 °C	---	---

### SAR result with Body TSL at 5600 MHz

SAR averaged over 1 cm <sup>3</sup> (1 g) of Body TSL	Condition	
SAR measured	100 mW input power	8.17 W/kg
SAR for nominal Body TSL parameters	normalized to 1W	<b>81.0 W/kg ± 19.9 % (k=2)</b>

SAR averaged over 10 cm <sup>3</sup> (10 g) of Body TSL	condition	
SAR measured	100 mW input power	2.28 W/kg
SAR for nominal Body TSL parameters	normalized to 1W	<b>22.5 W/kg ± 19.5 % (k=2)</b>

### Body TSL parameters at 5750 MHz

The following parameters and calculations were applied.

	Temperature	Permittivity	Conduotivity
Nominal Body TSL parameters	22.0 °C	48.3	5.94 mho/m
Measured Body TSL parameters	(22.0 ± 0.2) °C	46.0 ± 6 %	6.14 mho/m ± 6 %
Body TSL temperature ohange during test	< 0.5 °C	----	----

### SAR result with Body TSL at 5750 MHz

SAR averaged over 1 cm <sup>3</sup> (1 g) of Body TSL	Condition	
SAR measured	100 mW input power	7.81 W/kg
SAR for nominal Body TSL parameters	normalized to 1W	<b>77.4 W/kg ± 19.9 % (k=2)</b>

SAR averaged over 10 cm <sup>3</sup> (10 g) of Body TSL	condition	
SAR measured	100 mW input power	2.15 W/kg
SAR for nominal Body TSL parameters	normalized to 1W	<b>21.3 W/kg ± 19.5 % (k=2)</b>

## Appendix (Additional assessments outside the scope of SCS 0108)

### Antenna Parameters with Head TSL at 5250 MHz

Impedance, transformed to feed point	54.6 $\Omega$ - 7.6 j $\Omega$
Return Loss	- 21.5 dB

### Antenna Parameters with Head TSL at 5600 MHz

Impedance, transformed to feed point	57.2 $\Omega$ - 6.3 j $\Omega$
Return Loss	- 21.0 dB

### Antenna Parameters with Head TSL at 5750 MHz

Impedance, transformed to feed point	60.0 $\Omega$ + 4.5 j $\Omega$
Return Loss	- 20.1 dB

### Antenna Parameters with Body TSL at 5250 MHz

Impedance, transformed to feed point	54.2 $\Omega$ - 5.6 j $\Omega$
Return Loss	- 23.5 dB

### Antenna Parameters with Body TSL at 5600 MHz

Impedance, transformed to feed point	58.2 $\Omega$ - 5.3 j $\Omega$
Return Loss	- 20.9 dB

### Antenna Parameters with Body TSL at 5750 MHz

Impedance, transformed to feed point	59.6 $\Omega$ + 5.6 j $\Omega$
Return Loss	- 19.9 dB

### General Antenna Parameters and Design

Electrical Delay (one direction)	1.201 ns
----------------------------------	----------

After long term use with 100W radiated power, only a slight warming of the dipole near the feedpoint can be measured.

The dipole is made of standard semirigid coaxial cable. The center conductor of the feeding line is directly connected to the second arm of the dipole. The antenna is therefore short-circuited for DC-signals. On some of the dipoles, small end caps are added to the dipole arms in order to improve matching when loaded according to the position as explained in the "Measurement Conditions" paragraph. The SAR data are not affected by this change. The overall dipole length is still according to the Standard.

No excessive force must be applied to the dipole arms, because they might bend or the soldered connections near the feedpoint may be damaged.

### Additional EUT Data

Manufactured by	SPEAG
Manufactured on	August 28, 2003

## DASY5 Validation Report for Head TSL

Date: 27.09.2018

Test Laboratory: SPEAG, Zurich, Switzerland

**DUT: Dipole D5GHzV2; Type: D5GHzV2; Serial: D5GHzV2 - SN:1006**

Communication System: UID 0 - CW; Frequency: 5250 MHz, Frequency: 5600 MHz, Frequency: 5750 MHz  
Medium parameters used:  $f = 5250$  MHz;  $\sigma = 4.61$  S/m;  $\epsilon_r = 36$ ;  $\rho = 1000$  kg/m<sup>3</sup>,  
Medium parameters used:  $f = 5600$  MHz;  $\sigma = 4.98$  S/m;  $\epsilon_r = 35.4$ ;  $\rho = 1000$  kg/m<sup>3</sup>,  
Medium parameters used:  $f = 5750$  MHz;  $\sigma = 5.14$  S/m;  $\epsilon_r = 35.2$ ;  $\rho = 1000$  kg/m<sup>3</sup>  
Phantom section: Flat Section  
Measurement Standard: DASY5 (IEEE/IEC/ANSI C63.19-2011)

DASY52 Configuration:

- Probe: EX3DV4 - SN3503; ConvF(5.51, 5.51, 5.51) @ 5250 MHz, ConvF(5.05, 5.05, 5.05) @ 5600 MHz, ConvF(4.98, 4.98, 4.98) @ 5750 MHz; Calibrated: 30.12.2017
- Sensor-Surface: 1.4mm (Mechanical Surface Detection)
- Electronics: DAE4 Sn601; Calibrated: 26.10.2017
- Phantom: Flat Phantom 5.0 (front); Type: QD 000 P50 AA; Serial: 1001
- DASY52 52.10.1(1476); SEMCAD X 14.6.11(7439)

**Dipole Calibration for Head Tissue/Pin=100mW, dist=10mm, f=5250 MHz/Zoom Scan, dist=1.4mm (8x8x7)/Cube 0:** Measurement grid: dx=4mm, dy=4mm, dz=1.4mm  
Reference Value = 79.28 V/m; Power Drift = -0.04 dB  
Peak SAR (extrapolated) = 26.7 W/kg  
**SAR(1 g) = 8.07 W/kg; SAR(10 g) = 2.32 W/kg**  
Maximum value of SAR (measured) = 18.1 W/kg

**Dipole Calibration for Head Tissue/Pin=100mW, dist=10mm, f=5600 MHz/Zoom Scan, dist=1.4mm (8x8x7)/Cube 0:** Measurement grid: dx=4mm, dy=4mm, dz=1.4mm  
Reference Value = 76.15 V/m; Power Drift = -0.05 dB  
Peak SAR (extrapolated) = 30.2 W/kg  
**SAR(1 g) = 8.34 W/kg; SAR(10 g) = 2.38 W/kg**  
Maximum value of SAR (measured) = 19.3 W/kg

**Dipole Calibration for Head Tissue/Pin=100mW, dist=10mm, f=5750 MHz/Zoom Scan, dist=1.4mm (8x8x7)/Cube 0:** Measurement grid: dx=4mm, dy=4mm, dz=1.4mm  
Reference Value = 74.61 V/m; Power Drift = -0.03 dB  
Peak SAR (extrapolated) = 29.8 W/kg  
**SAR(1 g) = 8.05 W/kg; SAR(10 g) = 2.29 W/kg**  
Maximum value of SAR (measured) = 18.9 W/kg

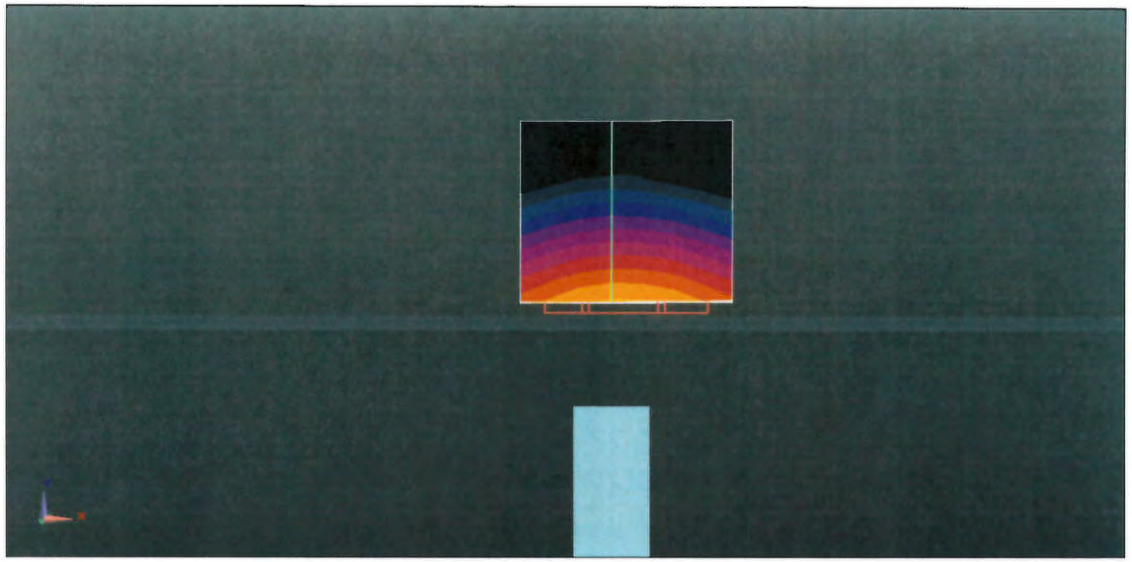
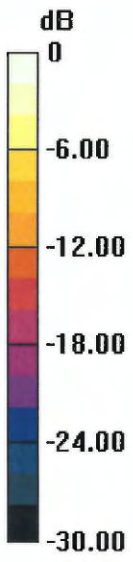

0 dB = 18.1 W/kg = 12.58 dBW/kg



# Impedance Measurement Plot for Head TSL

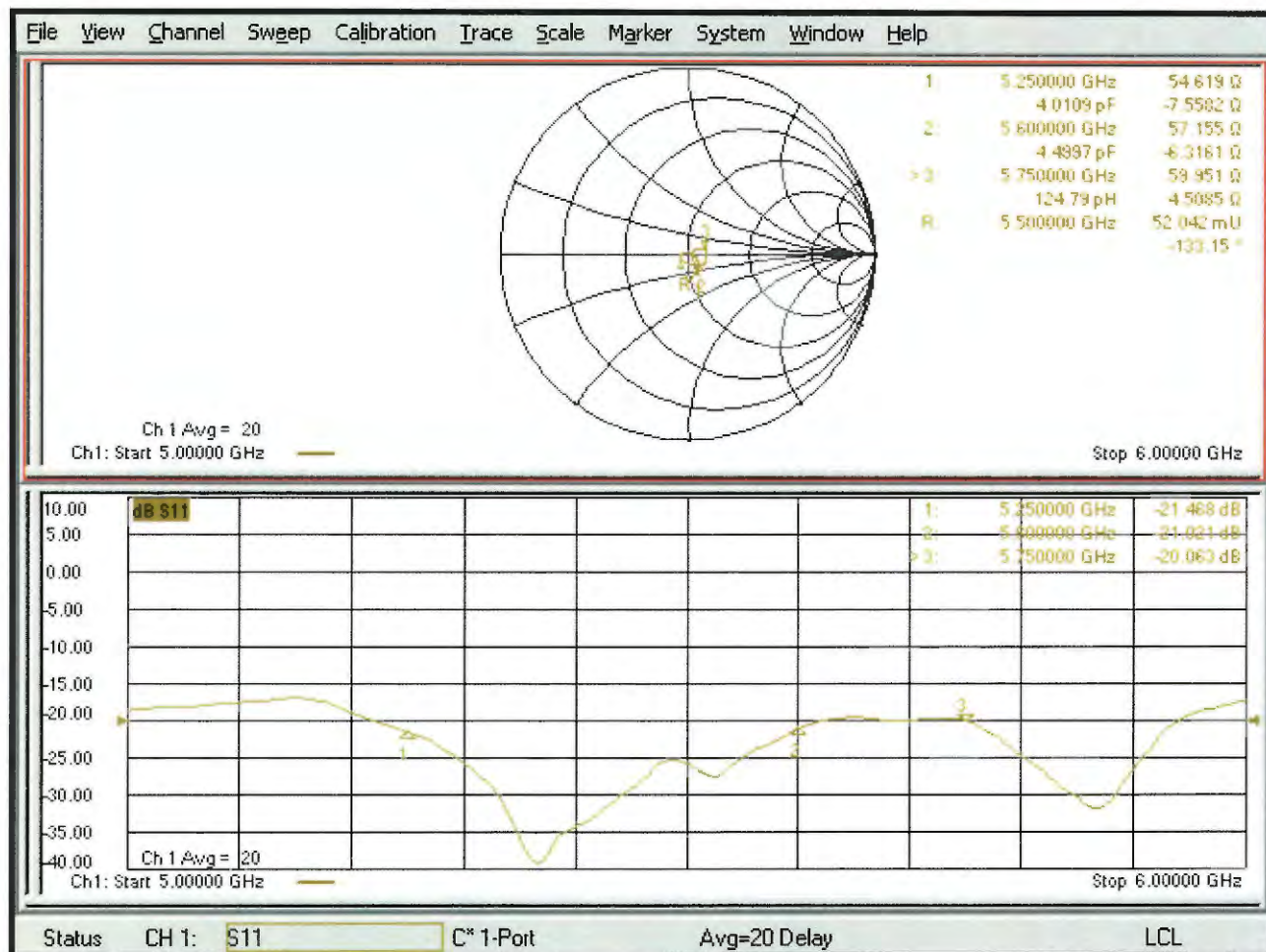

## DASY5 Validation Report for Body TSL

Date: 25.09.2018

Test Laboratory: SPEAG, Zurich, Switzerland

### DUT: Dipole D5GHzV2; Type: D5GHzV2; Serial: D5GHzV2 - SN:1006

Communication System: UID 0 - CW; Frequency: 5250 MHz, Frequency: 5600 MHz, Frequency: 5750 MHz

Medium parameters used:  $f = 5250$  MHz;  $\sigma = 5.46$  S/m;  $\epsilon_r = 46.9$ ;  $\rho = 1000$  kg/m<sup>3</sup>,

Medium parameters used:  $f = 5600$  MHz;  $\sigma = 5.93$  S/m;  $\epsilon_r = 46.3$ ;  $\rho = 1000$  kg/m<sup>3</sup>,

Medium parameters used:  $f = 5750$  MHz;  $\sigma = 6.14$  S/m;  $\epsilon_r = 46$ ;  $\rho = 1000$  kg/m<sup>3</sup>

Phantom section: Flat Section

Measurement Standard: DASY5 (IEEE/IEC/ANSI C63.19-2011)

### DASY52 Configuration:

- Probe: EX3DV4 - SN3503; ConvF(5.26, 5.26, 5.26) @ 5250 MHz, ConvF(4.65, 4.65, 4.65) @ 5600 MHz, ConvF(4.57, 4.57, 4.57) @ 5750 MHz; Calibrated: 30.12.2017
- Sensor-Surface: 1.4mm (Mechanical Surface Detection)
- Electronics: DAE4 Sn601; Calibrated: 26.10.2017
- Phantom: Flat Phantom 5.0 (back); Type: QD 000 P50 AA; Serial: 1002
- DASY52 52.10.1(1476); SEMCAD X 14.6.11(7439)

### Dipole Calibration for Body Tissue/Pin=100mW, dist=10mm, f=5250 MHz/Zoom Scan, dist=1.4mm (8x8x7)/Cnbc 0:

Measurement grid: dx=4mm, dy=4mm, dz=1.4mm

Reference Value = 69.77 V/m; Power Drift = -0.08 dB

Peak SAR (extrapolated) = 30.6 W/kg

**SAR(1 g) = 7.89 W/kg; SAR(10 g) = 2.19 W/kg**

Maximum value of SAR (measured) = 18.6 W/kg

### Dipole Calibration for Body Tissue/Pin=100mW, dist=10mm, f=5600 MHz/Zoom Scan, dist=1.4mm (8x8x7)/Cnbc 0:

Measurement grid: dx=4mm, dy=4mm, dz=1.4mm

Reference Value = 69.30 V/m; Power Drift = -0.06 dB

Peak SAR (extrapolated) = 34.2 W/kg

**SAR(1 g) = 8.17 W/kg; SAR(10 g) = 2.28 W/kg**

Maximum value of SAR (measured) = 19.8 W/kg

### Dipole Calibration for Body Tissue/Pin=100mW, dist=10mm, f=5750 MHz/Zoom Scan, dist=1.4mm (8x8x7)/Cnbc 0:

Measurement grid: dx=4mm, dy=4mm, dz=1.4mm

Reference Value = 67.65 V/m; Power Drift = -0.07 dB

Peak SAR (extrapolated) = 34.0 W/kg

**SAR(1 g) = 7.81 W/kg; SAR(10 g) = 2.15 W/kg**

Maximum value of SAR (measured) = 19.3 W/kg

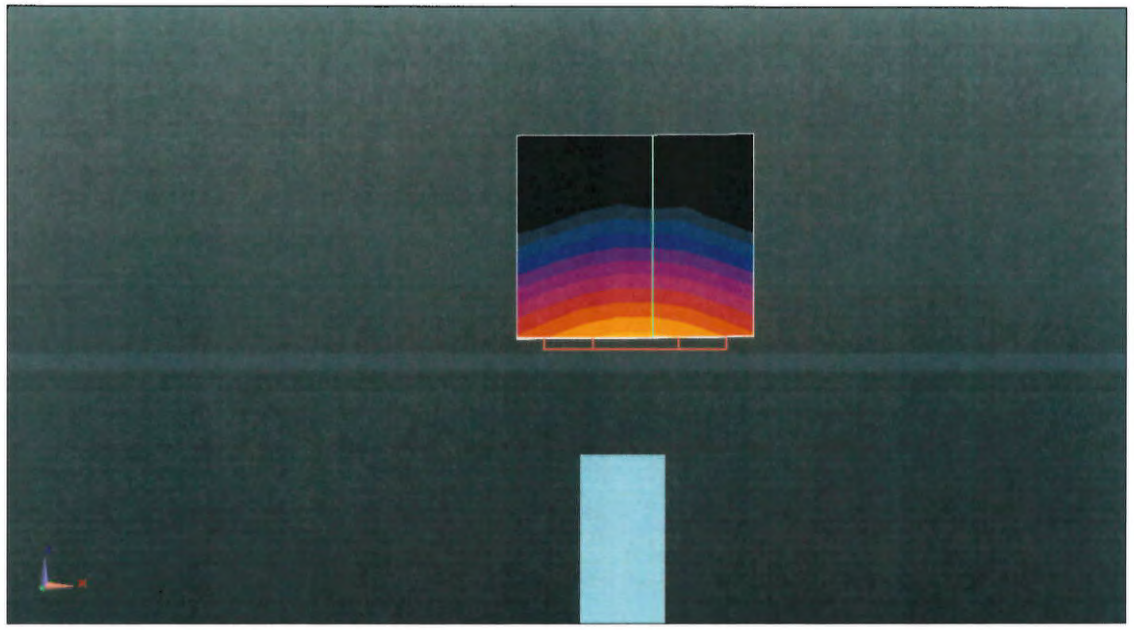
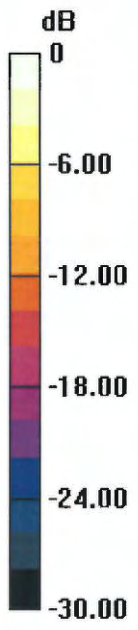

0 dB = 18.6 W/kg = 12.70 dBW/kg

# Impedance Measurement Plot for Body TSL

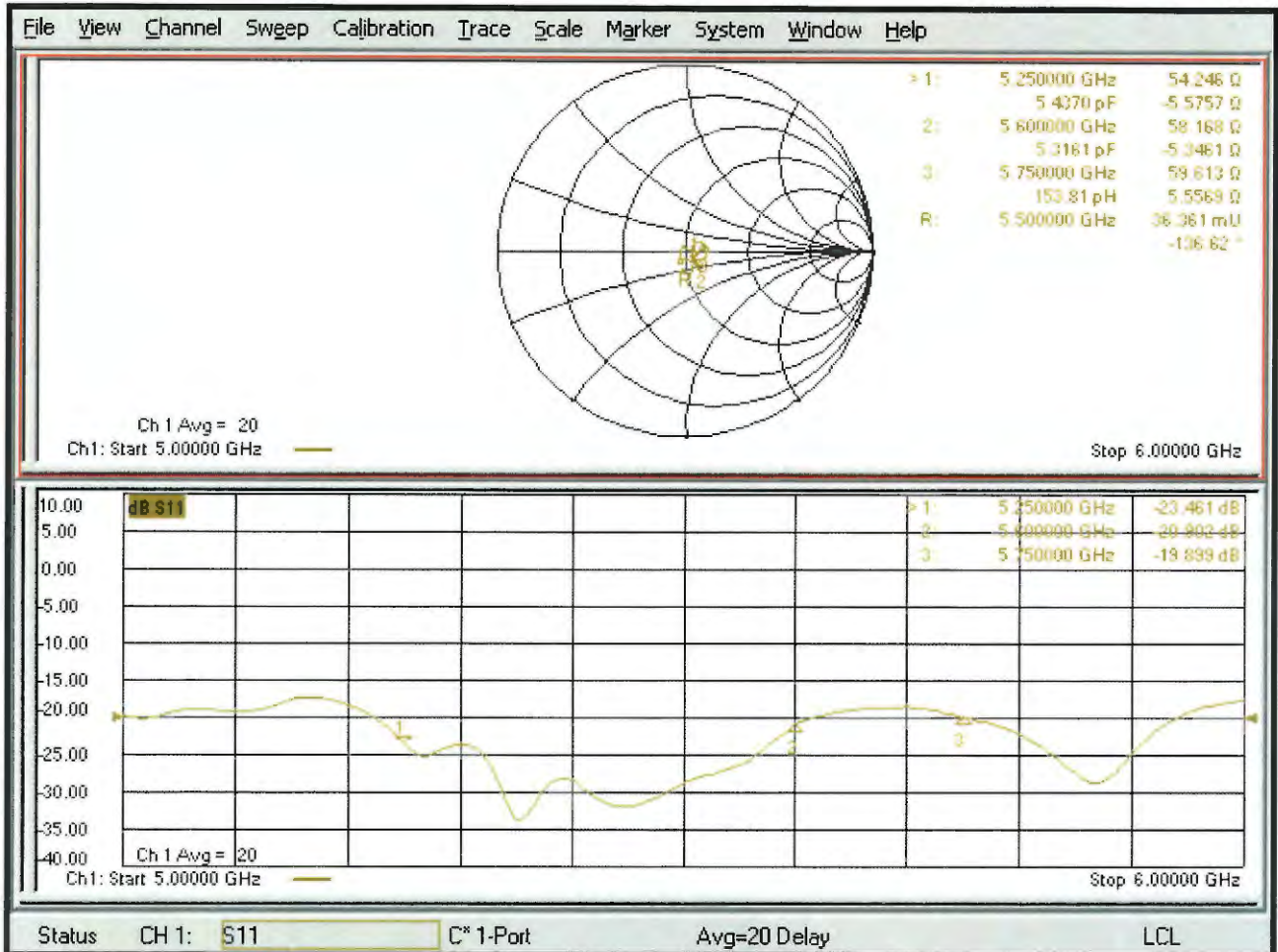



## D5GHZV2, serial no. 1006 Extended Dipole Calibrations

Referring to KDB 450824, if dipoles are verified in return loss (<-20dB, within 20% of prior calibration), and in impedance (within 5 ohm of prior calibration), the annual calibration is not necessary and the calibration interval can be extended.

### <Justification of the extended calibration>

D5GHZV2 – serial no. 1006						
5250MHZ						
Date of Measurement	Return-Loss (dB)	Delta (%)	Real Impedance (ohm)	Delta (ohm)	Imaginary Impedance (ohm)	Delta (ohm)
09.27.2018	-21.5		54.6		-7.6	
09.26.2019	-21.012	-2.27	55.323	0.723	-8.641	-1.041
09.25.2020	22.882	6.43	57.047	-2.447	-6.7446	-0.8554
5600MHZ						
Date of Measurement	Return-Loss (dB)	Delta (%)	Real Impedance (ohm)	Delta (ohm)	Imaginary Impedance (ohm)	Delta (ohm)
09.27.2018	-21.0		57.2		-6.3	
09.26.2019	-22.897	9.03	56.831	-0.369	-5.573	0.727
09.25.2020	21.297	1.41	58.698	-1.498	-6.3444	0.0444
5750MHZ						
Date of Measurement	Return-Loss (dB)	Delta (%)	Real Impedance (ohm)	Delta (ohm)	Imaginary Impedance (ohm)	Delta (ohm)
09.27.2018	-20.1		60		4.5	
09.26.2019	-23.437	16.6	56.589	-3.411	2.755	-1.745
09.25.2020	22.264	10.77	58.203	1.797	3.1992	1.3008

The return loss is <-20dB, within 20% of prior calibration; the impedance is within 5 ohm of prior calibration. Therefore the verification result should support extended calibration.



<Dipole Verification Data> - D5GHz V2, serial no. 1006 (Data of Measurement : 09.26.2019)

5GHZ MHz - Head

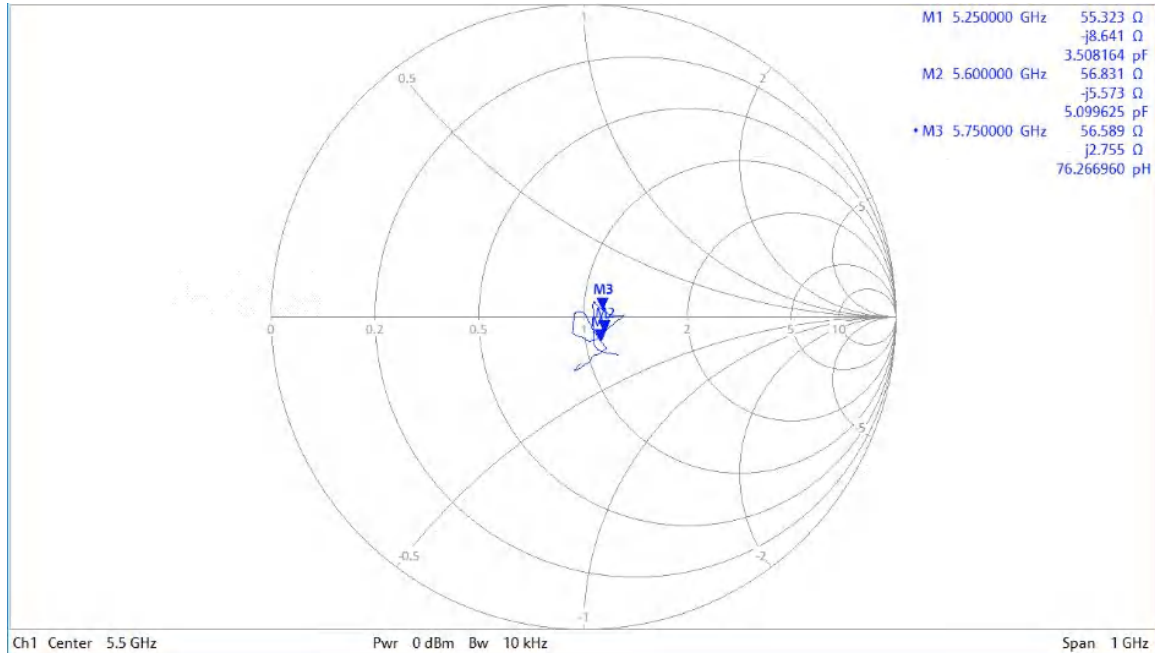
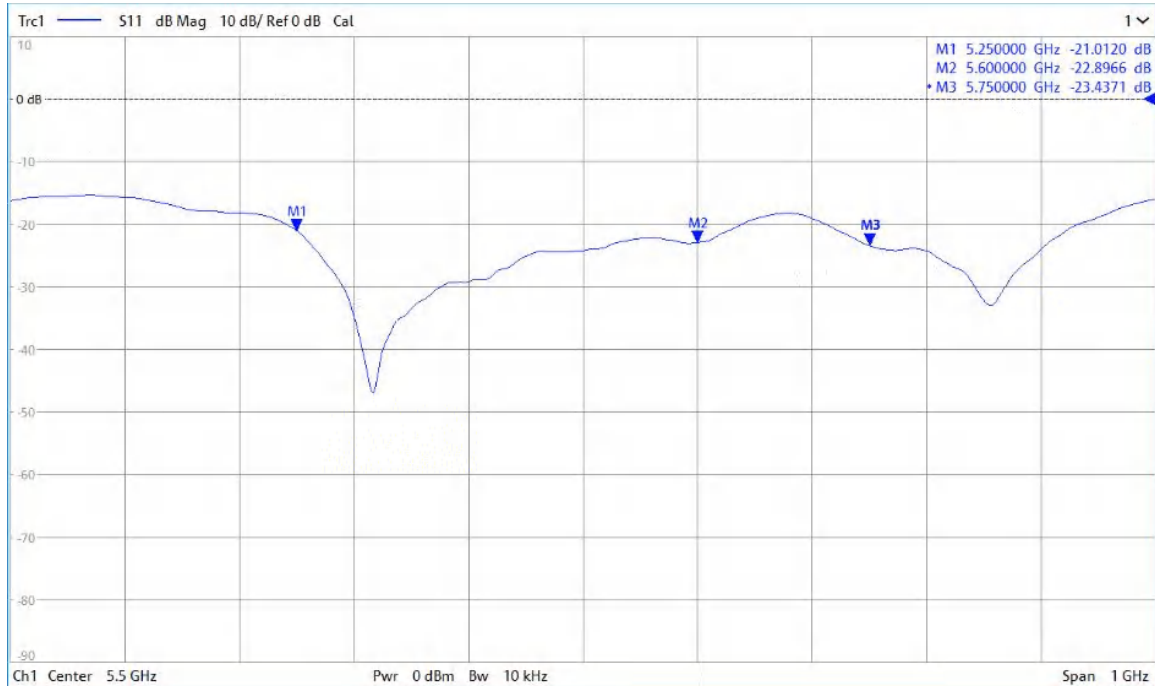



<Dipole Verification Data> - D5GHz V2, serial no. 1006 (Data of Measurement : 9.25.2020)

5GHZHz - Head

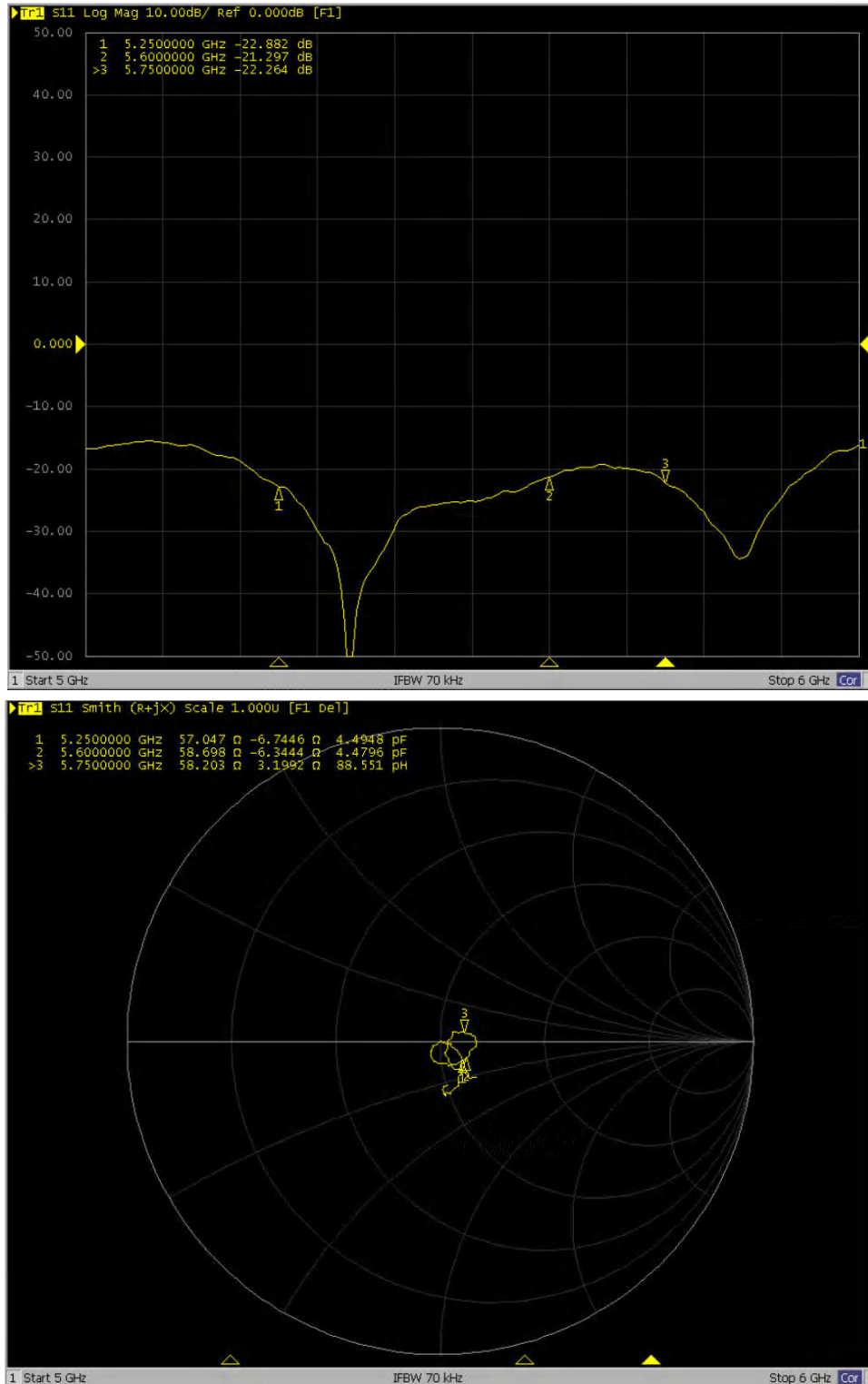



Accredited by the Swiss Accreditation Service (SAS)  
The Swiss Accreditation Service is one of the signatories to the EA  
Multilateral Agreement for the recognition of calibration certificates

Accreditation No.: **SCS 0108**

Client **Sporton**

Certificate No: **DAE4-316\_Dec19**

## CALIBRATION CERTIFICATE

Object **DAE4 - SD 000 D04 BJ - SN: 316**

Calibration procedure(s) **QA CAL-06.v29  
Calibration procedure for the data acquisition electronics (DAE)**

Calibration date: **December 20, 2019**

This calibration certificate documents the traceability to national standards, which realize the physical units of measurements (SI).  
The measurements and the uncertainties with confidence probability are given on the following pages and are part of the certificate.

All calibrations have been conducted in the closed laboratory facility: environment temperature  $(22 \pm 3)^\circ\text{C}$  and humidity  $< 70\%$ .

Calibration Equipment used (M&TE critical for calibration)

Primary Standards	ID #	Cal Date (Certificate No.)	Scheduled Calibration
Keithley Multimeter Type 2001	SN: 0810278	03-Sep-19 (No:25949)	Sep-20
Secondary Standards	ID #	Check Date (in house)	Scheduled Check
Auto DAE Calibration Unit	SE UWS 053 AA 1001	07-Jan-19 (in house check)	In house check: Jan-20
Calibrator Box V2.1	SE UMS 006 AA 1002	07-Jan-19 (in house check)	In house check: Jan-20

Calibrated by: **Name** Dominique Steffen **Function** Laboratory Technician

**Signature**

Approved by: **Name** Sven Kühn **Function** Deputy Manager

Issued: December 20, 2019

This calibration certificate shall not be reproduced except in full without written approval of the laboratory.





Accredited by the Swiss Accreditation Service (SAS)

The Swiss Accreditation Service is one of the signatories to the EA  
Multilateral Agreement for the recognition of calibration certificates

Accreditation No.: **SCS 0108**

## Glossary

DAE	data acquisition electronics
Connector angle	information used in DASY system to align probe sensor X to the robot coordinate system.

## Methods Applied and Interpretation of Parameters

- *DC Voltage Measurement:* Calibration Factor assessed for use in DASY system by comparison with a calibrated instrument traceable to national standards. The figure given corresponds to the full scale range of the voltmeter in the respective range.
- *Connector angle:* The angle of the connector is assessed measuring the angle mechanically by a tool inserted. Uncertainty is not required.
- The following parameters as documented in the Appendix contain technical information as a result from the performance test and require no uncertainty.
  - *DC Voltage Measurement Linearity:* Verification of the Linearity at +10% and -10% of the nominal calibration voltage. Influence of offset voltage is included in this measurement.
  - *Common mode sensitivity:* Influence of a positive or negative common mode voltage on the differential measurement.
  - *Channel separation:* Influence of a voltage on the neighbor channels not subject to an input voltage.
  - *AD Converter Values with inputs shorted:* Values on the internal AD converter corresponding to zero input voltage
  - *Input Offset Measurement:* Output voltage and statistical results over a large number of zero voltage measurements.
  - *Input Offset Current:* Typical value for information; Maximum channel input offset current, not considering the input resistance.
  - *Input resistance:* Typical value for information: DAE input resistance at the connector, during internal auto-zeroing and during measurement.
  - *Low Battery Alarm Voltage:* Typical value for information. Below this voltage, a battery alarm signal is generated.
  - *Power consumption:* Typical value for information. Supply currents in various operating modes.

## DC Voltage Measurement

A/D - Converter Resolution nominal

High Range: 1LSB = 6.1 $\mu$ V, full range = -100...+300 mV

Low Range: 1LSB = 61nV, full range = -1.....+3mV

DASY measurement parameters: Auto Zero Time: 3 sec; Measuring time: 3 sec

Calibration Factors	X	Y	Z
High Range	404.222 $\pm$ 0.02% (k=2)	404.340 $\pm$ 0.02% (k=2)	404.214 $\pm$ 0.02% (k=2)
Low Range	3.94432 $\pm$ 1.50% (k=2)	3.93891 $\pm$ 1.50% (k=2)	3.93491 $\pm$ 1.50% (k=2)

## Connector Angle

Connector Angle to be used in DASY system	351.0 $^{\circ}$ $\pm$ 1 $^{\circ}$
---	-------------------------------------

## Appendix (Additional assessments outside the scope of SCS0108)

### 1. DC Voltage Linearity

High Range	Reading ( $\mu\text{V}$ )	Difference ( $\mu\text{V}$ )	Error (%)
Channel X + Input	200033.79	-1.09	-0.00
Channel X + Input	20012.40	6.92	0.03
Channel X - Input	-20006.83	-0.86	0.00
Channel Y + Input	200033.53	-2.69	-0.00
Channel Y + Input	20008.43	3.05	0.02
Channel Y - Input	-20010.15	-4.07	0.02
Channel Z + Input	200034.86	-1.22	-0.00
Channel Z + Input	20008.64	3.29	0.02
Channel Z - Input	-20008.63	-2.56	0.01

Low Range	Reading ( $\mu\text{V}$ )	Difference ( $\mu\text{V}$ )	Error (%)
Channel X + Input	2001.29	0.04	0.00
Channel X + Input	200.99	-0.13	-0.07
Channel X - Input	-199.14	-0.42	0.21
Channel Y + Input	2000.84	-0.15	-0.01
Channel Y + Input	200.05	-0.92	-0.46
Channel Y - Input	-200.40	-1.57	0.79
Channel Z + Input	2002.11	1.03	0.05
Channel Z + Input	200.05	-0.93	-0.46
Channel Z - Input	-200.01	-1.10	0.55

### 2. Common mode sensitivity

DASY measurement parameters: Auto Zero Time: 3 sec; Measuring time: 3 sec

	Common mode Input Voltage (mV)	High Range Average Reading ( $\mu\text{V}$ )	Low Range Average Reading ( $\mu\text{V}$ )
Channel X	200	5.00	3.82
	- 200	-3.92	-5.26
Channel Y	200	-2.06	-2.20
	- 200	-1.01	-0.39
Channel Z	200	-16.18	-15.29
	- 200	12.55	13.75

### 3. Channel separation

DASY measurement parameters: Auto Zero Time: 3 sec; Measuring time: 3 sec

	Input Voltage (mV)	Channel X ( $\mu\text{V}$ )	Channel Y ( $\mu\text{V}$ )	Channel Z ( $\mu\text{V}$ )
Channel X	200	-	-2.18	-1.31
Channel Y	200	5.06	-	-0.73
Channel Z	200	7.48	2.18	-

#### 4. AD-Converter Values with inputs shorted

DASY measurement parameters: Auto Zero Time: 3 sec; Measuring time: 3 sec

	High Range (LSB)	Low Range (LSB)
Channel X	16028	15863
Channel Y	16055	15706
Channel Z	16125	15108

#### 5. Input Offset Measurement

DASY measurement parameters: Auto Zero Time: 3 sec; Measuring time: 3 sec

Input 10M $\Omega$

	Average ( $\mu$ V)	min. Offset ( $\mu$ V)	max. Offset ( $\mu$ V)	Std. Deviation ( $\mu$ V)
Channel X	0.72	-0.41	1.93	0.38
Channel Y	-1.38	-2.30	-0.32	0.38
Channel Z	0.21	-0.55	0.92	0.33

#### 6. Input Offset Current

Nominal Input circuitry offset current on all channels: <25fA

#### 7. Input Resistance (Typical values for information)

	Zeroing (kOhm)	Measuring (MOhm)
Channel X	200	200
Channel Y	200	200
Channel Z	200	200

#### 8. Low Battery Alarm Voltage (Typical values for information)

Typical values	Alarm Level (VDC)
Supply (+ Vcc)	+7.9
Supply (- Vcc)	-7.6

#### 9. Power Consumption (Typical values for information)

Typical values	Switched off (mA)	Stand by (mA)	Transmitting (mA)
Supply (+ Vcc)	+0.01	+6	+14
Supply (- Vcc)	-0.01	-8	-9



Accredited by the Swiss Accreditation Service (SAS)  
The Swiss Accreditation Service is one of the signatories to the EA  
Multilateral Agreement for the recognition of calibration certificates

Accreditation No.: **SCS 0108**

Client **Sporton**

Certificate No: **DAE3-495\_Jul20**

## CALIBRATION CERTIFICATE

Object **DAE3 - SD 000 D03 AD - SN: 495**

Calibration procedure(s) **QA CAL-06.v30  
Calibration procedure for the data acquisition electronics (DAE)**

Calibration date: **July 21, 2020**

This calibration certificate documents the traceability to national standards, which realize the physical units of measurements (SI).  
The measurements and the uncertainties with confidence probability are given on the following pages and are part of the certificate.

All calibrations have been conducted in the closed laboratory facility: environment temperature (22 ± 3)°C and humidity < 70%.

Calibration Equipment used (M&TE critical for calibration)

Primary Standards	ID #	Cal Date (Certificate No.)	Scheduled Calibration
Keithley Multimeter Type 2001	SN: 0810278	03-Sep-19 (No:25949)	Sep-20
Secondary Standards	ID #	Check Date (in house)	Scheduled Check
Auto DAE Calibration Unit	SE UWS 053 AA 1001	09-Jan-20 (in house check)	In house check: Jan-21
Calibrator Box V2.1	SE UMS 006 AA 1002	09-Jan-20 (in house check)	In house check: Jan-21

	Name	Function	Signature
Calibrated by:	Adrian Gehring	Laboratory Technician	
Approved by:	Sven Kühn	Deputy Manager	

Issued: July 21, 2020

This calibration certificate shall not be reproduced except in full without written approval of the laboratory.



Accredited by the Swiss Accreditation Service (SAS)

The Swiss Accreditation Service is one of the signatories to the EA  
Multilateral Agreement for the recognition of calibration certificates

Accreditation No.: **SCS 0108**

## Glossary

DAE	data acquisition electronics
Connector angle	information used in DASY system to align probe sensor X to the robot coordinate system.

## Methods Applied and Interpretation of Parameters

- *DC Voltage Measurement:* Calibration Factor assessed for use in DASY system by comparison with a calibrated instrument traceable to national standards. The figure given corresponds to the full scale range of the voltmeter in the respective range.
- *Connector angle:* The angle of the connector is assessed measuring the angle mechanically by a tool inserted. Uncertainty is not required.
- The following parameters as documented in the Appendix contain technical information as a result from the performance test and require no uncertainty.
  - *DC Voltage Measurement Linearity:* Verification of the Linearity at +10% and -10% of the nominal calibration voltage. Influence of offset voltage is included in this measurement.
  - *Common mode sensitivity:* Influence of a positive or negative common mode voltage on the differential measurement.
  - *Channel separation:* Influence of a voltage on the neighbor channels not subject to an input voltage.
  - *AD Converter Values with inputs shorted:* Values on the internal AD converter corresponding to zero input voltage
  - *Input Offset Measurement:* Output voltage and statistical results over a large number of zero voltage measurements.
  - *Input Offset Current:* Typical value for information; Maximum channel input offset current, not considering the input resistance.
  - *Input resistance:* Typical value for information: DAE input resistance at the connector, during internal auto-zeroing and during measurement.
  - *Low Battery Alarm Voltage:* Typical value for information. Below this voltage, a battery alarm signal is generated.
  - *Power consumption:* Typical value for information. Supply currents in various operating modes.

## DC Voltage Measurement

A/D - Converter Resolution nominal

High Range: 1LSB = 6.1 $\mu$ V, full range = -100...+300 mV

Low Range: 1LSB = 61nV, full range = -1.....+3mV

DASY measurement parameters: Auto Zero Time: 3 sec; Measuring time: 3 sec

Calibration Factors	X	Y	Z
High Range	404.364 $\pm$ 0.02% (k=2)	405.348 $\pm$ 0.02% (k=2)	405.733 $\pm$ 0.02% (k=2)
Low Range	3.95262 $\pm$ 1.50% (k=2)	3.99078 $\pm$ 1.50% (k=2)	3.96555 $\pm$ 1.50% (k=2)

## Connector Angle

Connector Angle to be used in DASY system	307.0 $^{\circ}$ $\pm$ 1 $^{\circ}$
---	-------------------------------------

## Appendix (Additional assessments outside the scope of SCS0108)

### 1. DC Voltage Linearity

High Range	Reading ( $\mu\text{V}$ )	Difference ( $\mu\text{V}$ )	Error (%)
Channel X + Input	199992.29	-0.65	-0.00
Channel X + Input	20004.65	3.15	0.02
Channel X - Input	-20000.24	1.47	-0.01
Channel Y + Input	199989.77	-3.38	-0.00
Channel Y + Input	20000.99	-0.44	-0.00
Channel Y - Input	-20000.37	1.37	-0.01
Channel Z + Input	199994.32	0.95	0.00
Channel Z + Input	20004.19	2.81	0.01
Channel Z - Input	-19997.26	4.58	-0.02

Low Range	Reading ( $\mu\text{V}$ )	Difference ( $\mu\text{V}$ )	Error (%)
Channel X + Input	2000.20	-0.53	-0.03
Channel X + Input	201.04	-0.09	-0.04
Channel X - Input	-198.67	0.06	-0.03
Channel Y + Input	2000.94	0.25	0.01
Channel Y + Input	201.89	0.92	0.46
Channel Y - Input	-199.68	-0.80	0.40
Channel Z + Input	1999.89	-0.83	-0.04
Channel Z + Input	198.93	-2.12	-1.06
Channel Z - Input	-199.77	-0.91	0.46

### 2. Common mode sensitivity

DASY measurement parameters: Auto Zero Time: 3 sec; Measuring time: 3 sec

	Common mode Input Voltage (mV)	High Range Average Reading ( $\mu\text{V}$ )	Low Range Average Reading ( $\mu\text{V}$ )
Channel X	200	4.13	2.65
	- 200	-1.85	-3.74
Channel Y	200	0.78	0.57
	- 200	-1.77	-2.19
Channel Z	200	2.53	2.66
	- 200	-4.31	-4.76

### 3. Channel separation

DASY measurement parameters: Auto Zero Time: 3 sec; Measuring time: 3 sec

	Input Voltage (mV)	Channel X ( $\mu\text{V}$ )	Channel Y ( $\mu\text{V}$ )	Channel Z ( $\mu\text{V}$ )
Channel X	200	-	-0.28	-1.53
Channel Y	200	7.68	-	0.09
Channel Z	200	5.22	6.28	-



#### 4. AD-Converter Values with inputs shorted

DASY measurement parameters: Auto Zero Time: 3 sec; Measuring time: 3 sec

	High Range (LSB)	Low Range (LSB)
Channel X	15810	16735
Channel Y	15762	17107
Channel Z	15908	17506

#### 5. Input Offset Measurement

DASY measurement parameters: Auto Zero Time: 3 sec; Measuring time: 3 sec

Input 10M $\Omega$

	Average ( $\mu$ V)	min. Offset ( $\mu$ V)	max. Offset ( $\mu$ V)	Std. Deviation ( $\mu$ V)
Channel X	0.59	-0.31	2.01	0.48
Channel Y	-0.17	-1.80	1.25	0.55
Channel Z	-0.38	-2.26	1.47	0.65

#### 6. Input Offset Current

Nominal Input circuitry offset current on all channels: <25fA

#### 7. Input Resistance (Typical values for information)

	Zeroing (kOhm)	Measuring (MOhm)
Channel X	200	200
Channel Y	200	200
Channel Z	200	200

#### 8. Low Battery Alarm Voltage (Typical values for information)

Typical values	Alarm Level (VDC)
Supply (+ Vcc)	+7.9
Supply (- Vcc)	-7.6

#### 9. Power Consumption (Typical values for information)

Typical values	Switched off (mA)	Stand by (mA)	Transmitting (mA)
Supply (+ Vcc)	+0.01	+6	+14
Supply (- Vcc)	-0.01	-8	-9



Accredited by the Swiss Accreditation Service (SAS)  
The Swiss Accreditation Service is one of the signatories to the EA  
Multilateral Agreement for the recognition of calibration certificates

Accreditation No.: **SCS 0108**

Client **Sporton**

Certificate No: **DAE4-1424\_Jan20**

## CALIBRATION CERTIFICATE

Object **DAE4 - SD 000 D04 BM - SN: 1424**

Calibration procedure(s) **QA CAL-06.v29  
Calibration procedure for the data acquisition electronics (DAE)**

Calibration date: **January 24, 2020**

This calibration certificate documents the traceability to national standards, which realize the physical units of measurements (SI).  
The measurements and the uncertainties with confidence probability are given on the following pages and are part of the certificate.

All calibrations have been conducted in the closed laboratory facility: environment temperature ( $22 \pm 3$ )°C and humidity < 70%.

Calibration Equipment used (M&TE critical for calibration)

Primary Standards	ID #	Cal Date (Certificate No.)	Scheduled Calibration
Keithley Multimeter Type 2001	SN: 0810278	03-Sep-19 (No:25949)	Sep-20
Secondary Standards	ID #	Check Date (in house)	Scheduled Check
Auto DAE Calibration Unit	SE UWS 053 AA 1001	09-Jan-20 (in house check)	In house check: Jan-21
Calibrator Box V2.1	SE UMS 006 AA 1002	09-Jan-20 (in house check)	In house check: Jan-21

	<b>Name</b>	<b>Function</b>	<b>Signature</b>
Calibrated by:	Adrian Gehring	Laboratory Technician	

	<b>Name</b>	<b>Function</b>	<b>Signature</b>
Approved by:	Sven Kühn	Deputy Manager	

Issued: January 24, 2020

This calibration certificate shall not be reproduced except in full without written approval of the laboratory.



Accredited by the Swiss Accreditation Service (SAS)

The Swiss Accreditation Service is one of the signatories to the EA  
Multilateral Agreement for the recognition of calibration certificates

Accreditation No.: **SCS 0108**

## Glossary

DAE	data acquisition electronics
Connector angle	information used in DASY system to align probe sensor X to the robot coordinate system.

## Methods Applied and Interpretation of Parameters

- *DC Voltage Measurement:* Calibration Factor assessed for use in DASY system by comparison with a calibrated instrument traceable to national standards. The figure given corresponds to the full scale range of the voltmeter in the respective range.
- *Connector angle:* The angle of the connector is assessed measuring the angle mechanically by a tool inserted. Uncertainty is not required.
- The following parameters as documented in the Appendix contain technical information as a result from the performance test and require no uncertainty.
  - *DC Voltage Measurement Linearity:* Verification of the Linearity at +10% and -10% of the nominal calibration voltage. Influence of offset voltage is included in this measurement.
  - *Common mode sensitivity:* Influence of a positive or negative common mode voltage on the differential measurement.
  - *Channel separation:* Influence of a voltage on the neighbor channels not subject to an input voltage.
  - *AD Converter Values with inputs shorted:* Values on the internal AD converter corresponding to zero input voltage
  - *Input Offset Measurement:* Output voltage and statistical results over a large number of zero voltage measurements.
  - *Input Offset Current:* Typical value for information; Maximum channel input offset current, not considering the input resistance.
  - *Input resistance:* Typical value for information: DAE input resistance at the connector, during internal auto-zeroing and during measurement.
  - *Low Battery Alarm Voltage:* Typical value for information. Below this voltage, a battery alarm signal is generated.
  - *Power consumption:* Typical value for information. Supply currents in various operating modes.

## DC Voltage Measurement

A/D - Converter Resolution nominal

High Range: 1LSB = 6.1 $\mu$ V, full range = -100...+300 mV

Low Range: 1LSB = 61nV, full range = -1.....+3mV

DASY measurement parameters: Auto Zero Time: 3 sec; Measuring time: 3 sec

Calibration Factors	X	Y	Z
High Range	403.154 $\pm$ 0.02% (k=2)	403.632 $\pm$ 0.02% (k=2)	403.207 $\pm$ 0.02% (k=2)
Low Range	3.96939 $\pm$ 1.50% (k=2)	3.99672 $\pm$ 1.50% (k=2)	3.98379 $\pm$ 1.50% (k=2)

## Connector Angle

Connector Angle to be used in DASY system	358.0 $^{\circ}$ $\pm$ 1 $^{\circ}$
---	-------------------------------------

## Appendix (Additional assessments outside the scope of SCS0108)

### 1. DC Voltage Linearity

High Range	Reading ( $\mu\text{V}$ )	Difference ( $\mu\text{V}$ )	Error (%)
Channel X + Input	199991.78	-2.60	-0.00
Channel X + Input	20002.26	0.43	0.00
Channel X - Input	-19999.39	2.05	-0.01
Channel Y + Input	199992.50	-2.06	-0.00
Channel Y + Input	20001.82	0.00	0.00
Channel Y - Input	-20002.88	-1.46	0.01
Channel Z + Input	199994.03	-0.25	-0.00
Channel Z + Input	20000.92	-0.79	-0.00
Channel Z - Input	-20003.25	-1.72	0.01

Low Range	Reading ( $\mu\text{V}$ )	Difference ( $\mu\text{V}$ )	Error (%)
Channel X + Input	2001.27	0.14	0.01
Channel X + Input	201.50	-0.01	-0.00
Channel X - Input	-197.98	0.37	-0.18
Channel Y + Input	2001.11	-0.09	-0.00
Channel Y + Input	200.95	-0.69	-0.34
Channel Y - Input	-198.79	-0.52	0.26
Channel Z + Input	2001.32	0.19	0.01
Channel Z + Input	200.32	-1.11	-0.55
Channel Z - Input	-199.90	-1.46	0.74

### 2. Common mode sensitivity

DASY measurement parameters: Auto Zero Time: 3 sec; Measuring time: 3 sec

	Common mode Input Voltage (mV)	High Range Average Reading ( $\mu\text{V}$ )	Low Range Average Reading ( $\mu\text{V}$ )
Channel X	200	-1.25	-2.37
	- 200	2.47	1.18
Channel Y	200	-13.29	-13.42
	- 200	12.27	12.19
Channel Z	200	-9.08	-9.03
	- 200	7.21	6.68

### 3. Channel separation

DASY measurement parameters: Auto Zero Time: 3 sec; Measuring time: 3 sec

	Input Voltage (mV)	Channel X ( $\mu\text{V}$ )	Channel Y ( $\mu\text{V}$ )	Channel Z ( $\mu\text{V}$ )
Channel X	200	-	3.50	-3.56
Channel Y	200	8.47	-	3.59
Channel Z	200	9.31	6.86	-

#### 4. AD-Converter Values with inputs shorted

DASY measurement parameters: Auto Zero Time: 3 sec; Measuring time: 3 sec

	High Range (LSB)	Low Range (LSB)
Channel X	15957	15898
Channel Y	15884	16568
Channel Z	15879	14410

#### 5. Input Offset Measurement

DASY measurement parameters: Auto Zero Time: 3 sec; Measuring time: 3 sec

Input 10M $\Omega$

	Average ( $\mu$ V)	min. Offset ( $\mu$ V)	max. Offset ( $\mu$ V)	Std. Deviation ( $\mu$ V)
Channel X	0.91	-0.44	1.60	0.34
Channel Y	0.05	-0.80	0.98	0.40
Channel Z	-0.65	-1.82	0.20	0.32

#### 6. Input Offset Current

Nominal Input circuitry offset current on all channels: <25fA

#### 7. Input Resistance (Typical values for information)

	Zeroing (kOhm)	Measuring (MOhm)
Channel X	200	200
Channel Y	200	200
Channel Z	200	200

#### 8. Low Battery Alarm Voltage (Typical values for information)

Typical values	Alarm Level (VDC)
Supply (+ Vcc)	+7.9
Supply (- Vcc)	-7.6

#### 9. Power Consumption (Typical values for information)

Typical values	Switched off (mA)	Stand by (mA)	Transmitting (mA)
Supply (+ Vcc)	+0.01	+6	+14
Supply (- Vcc)	-0.01	-8	-9