



# FCC RADIO TEST REPORT

FCC ID : UZ7MC27AK  
Equipment : Mobile computer  
Brand Name : Zebra  
Model Name : MC27AK  
Applicant : Zebra Technologies Corporation  
1 Zebra Plaza, Holtsville, NY 11742  
Manufacturer : Zebra Technologies Corporation  
1 Zebra Plaza, Holtsville, NY 11742  
Standard : FCC Part 15 Subpart E §15.407

The product was received on Jul. 07, 2020 and testing was started from Aug. 03, 2020 and completed on Aug. 29, 2020. We, SPORTON INTERNATIONAL INC., EMC & Wireless Communications Laboratory, would like to declare that the tested sample has been evaluated in accordance with the test procedures and has been in compliance with the applicable technical standards.

The test results in this report apply exclusively to the tested model / sample. Without written approval of SPORTON INTERNATIONAL INC. EMC & Wireless Communications Laboratory, the test report shall not be reproduced except in full.

*Louis Wu*

Approved by: Louis Wu

**SPORTON INTERNATIONAL INC. EMC & Wireless Communications Laboratory**

No. 52, Huaya 1st Rd., Guishan Dist., Taoyuan City, Taiwan (R.O.C.)



## Table of Contents

History of this test report.....	3
Summary of Test Result.....	4
<b>1 General Description .....</b>	<b>5</b>
1.1 Product Feature of Equipment Under Test.....	5
1.2 Product Specification of Equipment Under Test.....	5
1.3 Modification of EUT .....	6
1.4 Testing Location .....	6
1.5 Applicable Standards.....	6
<b>2 Test Configuration of Equipment Under Test .....</b>	<b>7</b>
2.1 Carrier Frequency and Channel .....	7
2.2 Test Mode.....	8
2.3 Connection Diagram of Test System.....	10
2.4 Support Unit used in test configuration and system .....	11
2.5 EUT Operation Test Setup .....	11
2.6 Measurement Results Explanation Example.....	11
<b>3 Test Result .....</b>	<b>12</b>
3.1 6dB and 26dB and 99% Occupied Bandwidth Measurement .....	12
3.2 Maximum Conducted Output Power Measurement .....	15
3.3 Power Spectral Density Measurement .....	17
3.4 Unwanted Emissions Measurement.....	19
3.5 AC Conducted Emission Measurement.....	23
3.6 Automatically Discontinue Transmission .....	25
3.7 Antenna Requirements.....	26
<b>4 List of Measuring Equipment.....</b>	<b>27</b>
<b>5 Uncertainty of Evaluation.....</b>	<b>29</b>
<b>Appendix A. AC Conducted Emission Test Result</b>	
<b>Appendix B. Radiated Spurious Emission</b>	
<b>Appendix C. Radiated Spurious Emission Plots</b>	
<b>Appendix D. Duty Cycle Plots</b>	
<b>Appendix E. Setup Photographs</b>	



### History of this test report

Report No.	Version	Description	Issued Date
FR052917-01F	01	Initial issue of report	Oct. 20, 2020



### Summary of Test Result

Report Clause	Ref Std. Clause	Test Items	Result (PASS/FAIL)	Remark
3.1	15.403 (i)	6dB & 26dB Bandwidth	Pass	-
3.1	2.1049	99% Occupied Bandwidth	Reporting only	-
3.2	15.407 (a)	Maximum Conducted Output Power	Pass	-
3.3	15.407 (a)	Power Spectral Density	Pass	-
3.4	15.407(b)	Unwanted Emissions	Pass	Under limit 9.32 dB at 30.000 MHz
3.5	15.207	AC Conducted Emission	Pass	Under limit 17.08 dB at 13.560 MHz
3.6	15.407 (c)	Automatically Discontinue Transmission	Pass	-
3.7	15.203 & 15.407 (a)	Antenna Requirement	Pass	-

**Declaration of Conformity:**

The test results with all measurement uncertainty excluded are presented in accordance with the regulation limits or requirements declared by manufacturers.

**Comments and Explanations:**

The declared of product specification for EUT presented in the report are provided by the manufacturer, and the manufacturer takes all the responsibilities for the accuracy of product specification.

**Reviewed by: Wii Chang**

**Report Producer: Yimin Ho**



# 1 General Description

## 1.1 Product Feature of Equipment Under Test

Product Feature	
Equipment	Mobile computer
Brand Name	Zebra
Model Name	MC27AK
FCC ID	UZ7MC27AK
EUT supports Radios application	WCDMA/HSPA/LTE/NFC/GNSS WLAN 11a/b/g/n HT20/HT40 WLAN 11ac VHT20/VHT40/VHT80 Bluetooth BR/EDR/LE
HW Version	EV
SW Version	10-11-31.00-QG-U00-PRD-HEL-04
OS Version	Android 10
MFD	23JUN20
EUT Stage	Engineering Sample

Remark: The above EUT's information was declared by manufacturer.

Specification of Accessories				
AC Adapter	Brand Name	Zebra	Part Number	PWR-WUA5V12W0US
Battery	Brand Name	Zebra	Part Number	BT-000418-10
USB Cable (TypeA plug to TypeC plug)	Brand Name	Zebra	Part Number	CBL-TC2X-USBC-01
Trigger Handle	Brand Name	Zebra	Part Number	TRG-MC2X-SNP1-01
Holster	Brand Name	Zebra	Part Number	SG-MC2X-HLSTR-01
Holster	Brand Name	Zebra	Part Number	SG-MC3021212-01R

## 1.2 Product Specification of Equipment Under Test

Product Specification subjective to this standard	
Tx/Rx Channel Frequency Range	5745 MHz ~ 5825 MHz
Maximum Output Power	802.11a : 17.80 dBm / 0.0603 W 802.11n HT20 : 17.90 dBm / 0.0617 W 802.11n HT40 : 17.60 dBm / 0.0575 W 802.11ac VHT20: 18.00 dBm / 0.0631 W 802.11ac VHT40: 17.70 dBm / 0.0589 W 802.11ac VHT80: 17.70 dBm / 0.0589 W
99% Occupied Bandwidth	802.11a : 24.13 MHz 802.11ac VHT20 : 21.98 MHz 802.11ac VHT40 : 37.76 MHz 802.11ac VHT80 : 78.16 MHz
Type of Modulation	802.11a/n : OFDM (BPSK / QPSK / 16QAM / 64QAM) 802.11ac : OFDM (BPSK / QPSK / 16QAM / 64QAM / 256QAM)
Antenna Type / Gain	PIFA Antenna with gain 3.11 dBi



### 1.3 Modification of EUT

No modifications are made to the EUT during all test items.

### 1.4 Testing Location

<b>Test Site</b>	SPORTON INTERNATIONAL INC. EMC & Wireless Communications Laboratory		
<b>Test Site Location</b>	No.52, Huaya 1st Rd., Guishan Dist., Taoyuan City, Taiwan (R.O.C.) TEL: +886-3-327-3456 FAX: +886-3-328-4978		
<b>Test Site No.</b>	<b>Sporton Site No.</b>		
	TH05-HY	CO05-HY	03CH07-HY

**Note:** The test site complies with ANSI C63.4 2014 requirement.

FCC designation No.: TW1190

### 1.5 Applicable Standards

According to the specifications of the manufacturer, the EUT must comply with the requirements of the following standards:

- ♦ FCC Part 15 Subpart E
- ♦ FCC KDB 789033 D02 General UNII Test Procedures New Rules v02r01.
- ♦ FCC KDB 414788 D01 Radiated Test Site v01r01.
- ♦ ANSI C63.10-2013

**Remark:**

1. All test items were verified and recorded according to the standards and without any deviation during the test.
2. The TAF code is not including all the FCC KDB listed without accreditation.
3. This EUT has also been tested and complied with the requirements of FCC Part 15, Subpart B, recorded in a separate test report.



## 2 Test Configuration of Equipment Under Test

- a. The EUT has been associated with peripherals and configuration operated in a manner tended to maximize its emission characteristics in a typical application. Frequency range investigated: conduction emission (150 kHz to 30 MHz), radiation emission (9 kHz to the 10th harmonic of the highest fundamental frequency or to 40 GHz, whichever is lower). For radiated measurement, pre-scanned in three orthogonal panels, X, Y, Z. The worst cases (X plane) were recorded in this report.
  
- b. AC power line Conducted Emission was tested under maximum output power.

### 2.1 Carrier Frequency and Channel

Frequency Band	Channel	Freq. (MHz)	Channel	Freq. (MHz)
5725-5850 MHz Band 4 (U-NII-3)	149	5745	157	5785
	151*	5755	159*	5795
	153	5765	161	5805
	155#	5775	165	5825

**Note:**

- 1. The above Frequency and Channel in "\*" were 802.11n HT40 and 802.11ac VHT40.
- 2. The above Frequency and Channel in "#n" were 802.11ac VHT80.



## 2.2 Test Mode

Final test modes are considering the modulation and worse data rates as below table.

Modulation	Data Rate
802.11a	6 Mbps
802.11n HT20 (Covered by VHT20)	MCS0
802.11n HT40 (Covered by VHT40)	MCS0
802.11ac VHT20	MCS0
802.11ac VHT40	MCS0
802.11ac VHT80	MCS0

Test Cases	
AC Conducted Emission	Mode 1 : WLAN (5GHz) Link + Bluetooth Link + NFC On + Battery + USB Cable (Charging from AC Adapter)

Ch. #		Band IV : 5725-5850 MHz			
		802.11a	802.11ac VHT20	802.11ac VHT40	802.11ac VHT80
L	Low	149	149	151	-
M	Middle	157	157	-	155
H	High	165	165	159	-

**Remark:** For radiation spurious emission, the final modulation and the worst data rate was reference the max RF conducted power.





802.11a RF Output Power (dBm)										
Power vs. Channel			Power vs Data Rate							
Channel	Frequency (MHz)	Data Rate (bps)	Channel	Data Rate (bps)						
		6M		9M	12M	18M	24M	36M	48M	54M
CH 149	5745	17.60	CH 157	17.70	17.70	17.50	17.30	17.60	17.60	17.60
CH 157	5785	17.80								
CH 165	5825	17.60								

802.11n HT20 RF Output Power (dBm)										
Power vs. Channel			Power vs Data Rate							
Channel	Frequency (MHz)	MCS Index	Channel	MCS Index						
		MCS0		MCS1	MCS2	MCS3	MCS4	MCS5	MCS6	MCS7
CH 149	5745	17.80	CH 165	17.80	17.60	17.60	17.80	17.80	17.80	17.80
CH 157	5785	17.60								
CH 165	5825	17.90								

802.11n HT40 RF Output Power (dBm)										
Power vs. Channel			Power vs Data Rate							
Channel	Frequency (MHz)	MCS Index	Channel	MCS Index						
		MCS0		MCS1	MCS2	MCS3	MCS4	MCS5	MCS6	MCS7
CH 151	5755	17.60	CH 151	17.30	17.50	17.40	17.20	17.20	17.20	17.20
CH 159	5795	17.50								

802.11ac VHT20 RF Output Power (dBm)											
Power vs. Channel			Power vs Data Rate								
Channel	Frequency (MHz)	MCS Index	Channel	MCS Index							
		MCS0		MCS1	MCS2	MCS3	MCS4	MCS5	MCS6	MCS7	MCS8
CH 149	5745	17.90	CH 165	17.90	17.70	17.70	17.90	17.90	17.90	17.90	17.90
CH 157	5785	17.70									
CH 165	5825	18.00									

802.11ac VHT40 RF Output Power (dBm)												
Power vs. Channel			Power vs Data Rate									
Channel	Frequency (MHz)	MCS Index	Channel	MCS Index								
		MCS0		MCS1	MCS2	MCS3	MCS4	MCS5	MCS6	MCS7	MCS8	MCS9
CH 151	5755	17.70	CH 151	17.40	17.60	17.50	17.30	17.30	17.30	17.30	17.30	17.30
CH 159	5795	17.60										

802.11ac VHT80 RF Output Power (dBm)													
Power vs. Channel			Power vs Data Rate										
Channel	Frequency (MHz)	MCS Index	Channel	MCS Index									
		MCS0		MCS1	MCS2	MCS3	MCS4	MCS5	MCS6	MCS7	MCS8	MCS9	
CH 155	5775	17.70	CH 155	17.60	17.40	17.50	17.40	17.40	17.40	17.40	17.40	17.30	17.30

## 2.3 Connection Diagram of Test System

<AC Conducted Emission Mode>

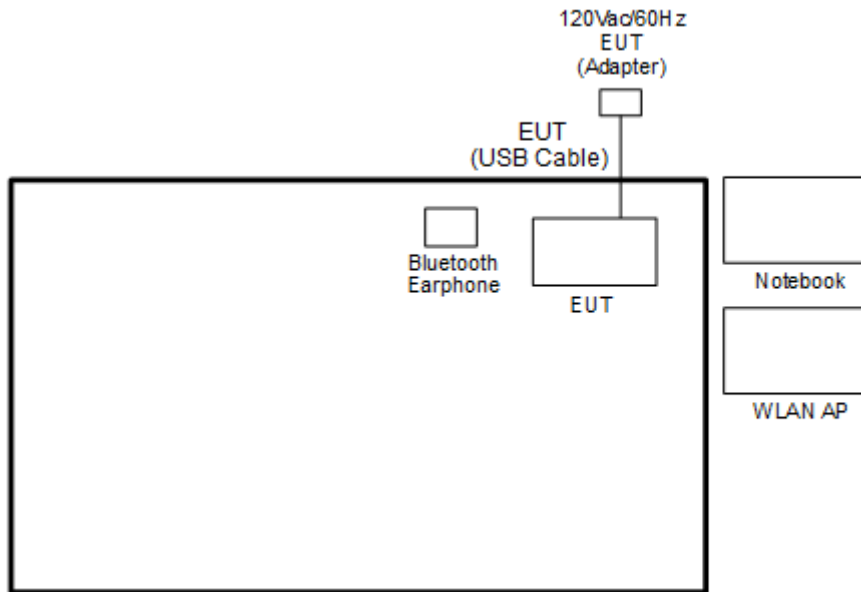

<WLAN Tx Mode>

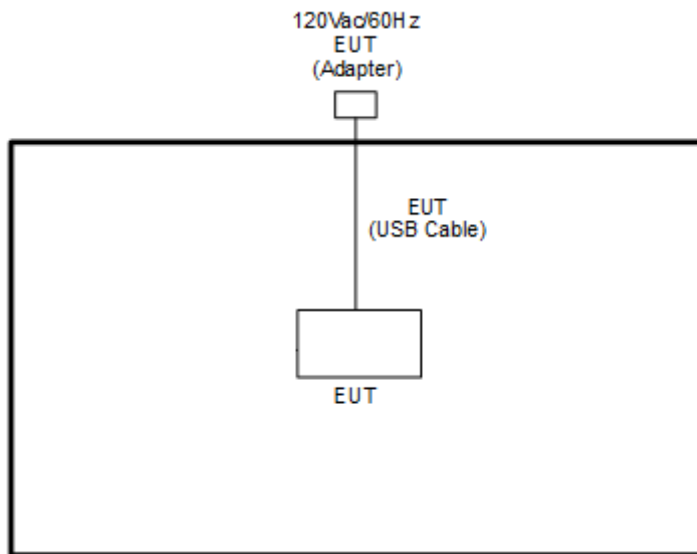



## 2.4 Support Unit used in test configuration and system

Item	Equipment	Brand Name	Model Name	FCC ID	Data Cable	Power Cord
1.	Bluetooth Earphone	Sony Ericsson	MW600	PY7DDA-2029	N/A	N/A
2.	WLAN AP	ASUS	RT-AC66U	MSQ-RTAC66U	N/A	Unshielded, 1.8 m
3.	Notebook	DELL	Latitude 3400	FCC DoC	N/A	AC I/P: Unshielded, 1.2 m DC O/P: Shielded, 1.8 m
4.	SD Card	SanDisk	MicroSD HC	FCC DoC	N/A	N/A

## 2.5 EUT Operation Test Setup

The RF test items, utility "QRCT v4.0.00067.0" was installed in Notebook which was programmed in order to make the EUT get into the engineering modes to provide channel selection, power level, data rate and the application type and for continuous transmitting signals.

## 2.6 Measurement Results Explanation Example

**For all conducted test items:**

The offset level is set in the spectrum analyzer to compensate the RF cable loss and attenuator factor between EUT conducted output port and spectrum analyzer. With the offset compensation, the spectrum analyzer reading level is exactly the EUT RF output level.

Example :

The spectrum analyzer offset is derived from RF cable loss and attenuator factor.

*Offset = RF cable loss + attenuator factor.*

Following shows an offset computation example with cable loss 4.2 dB and 10dB attenuator.

$$\begin{aligned} \text{Offset(dB)} &= \text{RF cable loss(dB)} + \text{attenuator factor(dB)}. \\ &= 4.2 + 10 = 14.2 \text{ (dB)} \end{aligned}$$

### 3 Test Result

#### 3.1 6dB and 26dB and 99% Occupied Bandwidth Measurement

##### 3.1.1 Description of 6dB and 26dB and 99% Occupied Bandwidth

The minimum 6 dB bandwidth shall be at least 500 kHz.

26dB and 99% Occupied bandwidth are reporting only.

##### 3.1.2 Measuring Instruments

See list of measuring equipment of this test report.

##### 3.1.3 Test Procedures

1. The testing follows FCC KDB 789033 D02 General UNII Test Procedures New Rules v02r01. Section C) Emission bandwidth for the band 5.725-5.85GHz
2. Set RBW = 100kHz.
3. Set the VBW  $\geq 3 \times$  RBW.
4. Detector = Peak.
5. Trace mode = max hold
6. Measure the maximum width of the emission that is 6 dB down from the peak of the emission.
7. Measure and record the results in the test report.

##### 3.1.4 Test Setup

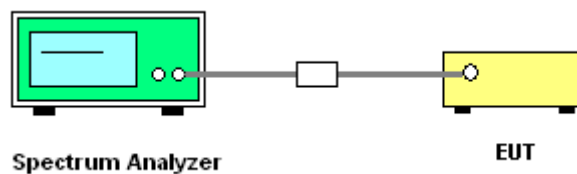



3.1.5 Test Result of 6dB and 26dB and 99% Occupied Bandwidth

Test Engineer :	Ryan Lin, Tommy Lee and Howard Lin	Temperature :	21.2~24.1°C
		Relative Humidity :	47.2~57.8%

Band IV single antenna												
Mod.	Data Rate	NTX	CH.	Freq. (MHz)	99% Bandwidth (MHz)		26dB Bandwidth (MHz)		6 dB Bandwidth (MHz)		6 dB Bandwidth Min. Limit (MHz)	Pass/Fail
					Ant 1	Ant 2	Ant 1	Ant 2	Ant 1	Ant 2		
11a	6Mbps	1	149	5745	21.93	-	38.30	-	15.50	-	0.5	Pass
11a	6Mbps	1	157	5785	22.13	-	39.10	-	15.70	-	0.5	Pass
11a	6Mbps	1	165	5825	24.13	-	34.45	-	16.30	-	0.5	Pass
VHT20	MCS0	1	149	5745	21.98	-	38.40	-	17.30	-	0.5	Pass
VHT20	MCS0	1	157	5785	20.23	-	34.85	-	17.20	-	0.5	Pass
VHT20	MCS0	1	165	5825	18.93	-	30.70	-	17.55	-	0.5	Pass
VHT40	MCS0	1	151	5755	37.46	-	68.76	-	36.27	-	0.5	Pass
VHT40	MCS0	1	159	5795	37.76	-	76.05	-	36.27	-	0.5	Pass
VHT80	MCS0	1	155	5775	78.16	-	166.21	-	75.20	-	0.5	Pass

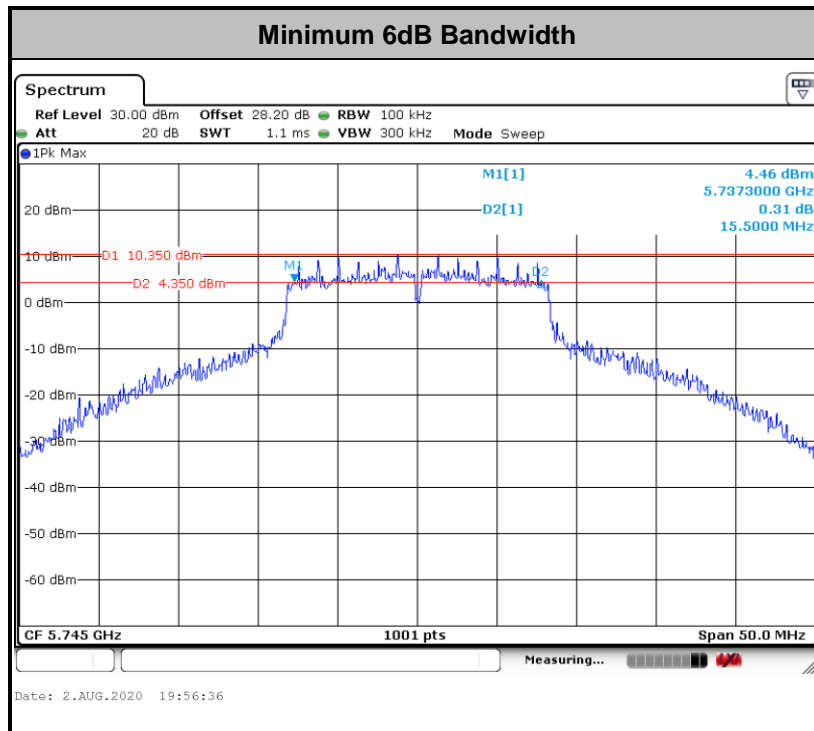

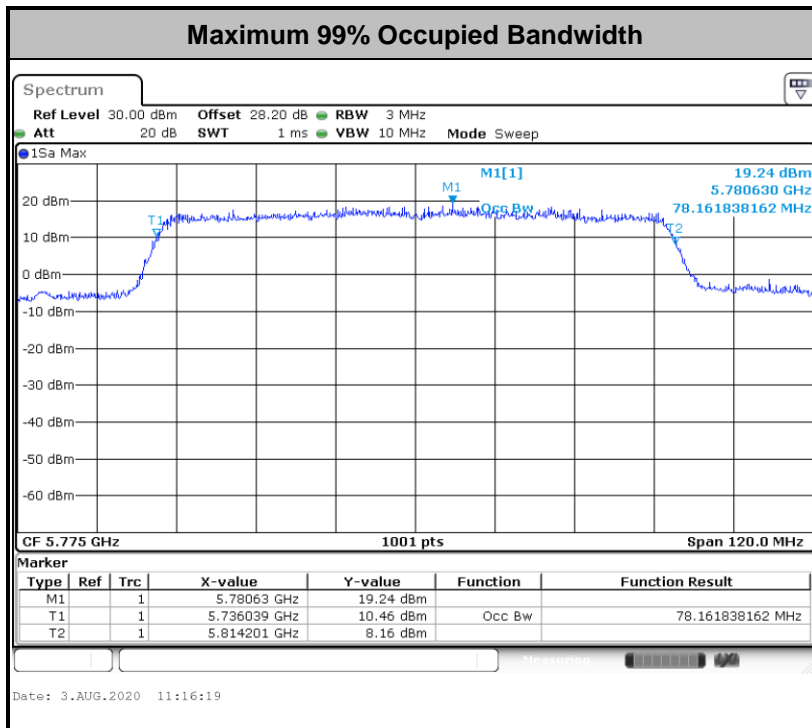
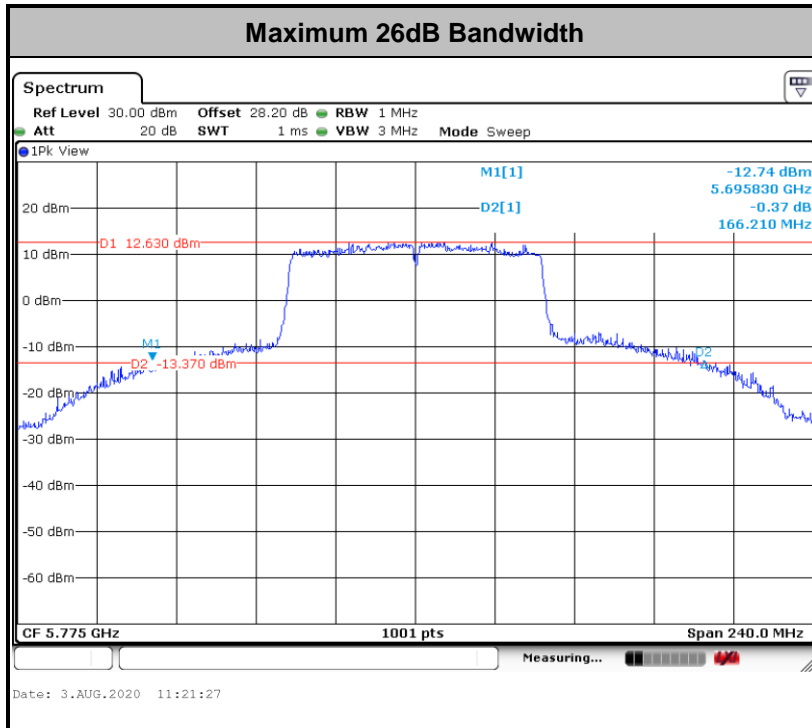

**Note:** The occupied channel bandwidth is maintained within the band of operation for all of the modulations.

## 3.2 Maximum Conducted Output Power Measurement

### 3.2.1 Limit of Maximum Conducted Output Power

For the band 5.725–5.85 GHz, the maximum conducted output power over the frequency band of operation shall not exceed 1 W.

If transmitting antennas of directional gain greater than 6 dBi are used, the peak output power shall be reduced by the amount in dB that the directional gain of the antenna exceeds 6 dBi.

### 3.2.2 Measuring Instruments

See list of measuring equipment of this test report.

### 3.2.3 Test Procedures

The testing follows Method PM-G of FCC KDB 789033 D02 General UNII Test Procedures New Rules v02r01.

Method PM-G (Measurement using a gated RF average power meter):

1. Measurement is performed using a wideband RF power meter.
2. The EUT is configured to transmit at its maximum power control level.
3. Measure the average power of the transmitter
4. Since the measurement is made only during the ON time of the transmitter, no duty cycle correction factor is required.

### 3.2.4 Test Setup

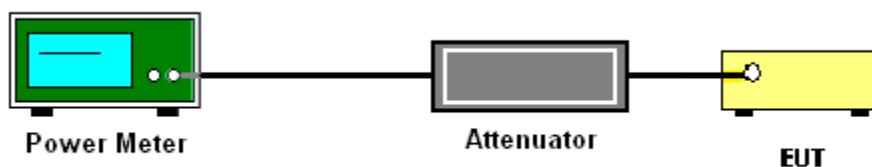



3.2.5 Test Result of Maximum Conducted Output Power

Test Engineer :	Ryan Lin, Tommy Lee and Howard Lin	Temperature :	21.2~24.1°C
		Relative Humidity :	47.2~57.8%

Band IV single antenna											
Mod.	Data Rate	NTX	CH.	Freq. (MHz)	Average Conducted Power (dBm)		FCC Conducted Power Limit (dBm)		DG (dBi)		Pass/Fail
					Ant 1	Ant 2	Ant 1	Ant 2	Ant 1	Ant 2	
11a	6Mbps	1	149	5745	17.60	-	30.00	-	3.11	-	Pass
11a	6Mbps	1	157	5785	17.80	-	30.00	-	3.11	-	Pass
11a	6Mbps	1	165	5825	17.60	-	30.00	-	3.11	-	Pass
HT20	MCS0	1	149	5745	17.80	-	30.00	-	3.11	-	Pass
HT20	MCS0	1	157	5785	17.60	-	30.00	-	3.11	-	Pass
HT20	MCS0	1	165	5825	17.90	-	30.00	-	3.11	-	Pass
HT40	MCS0	1	151	5755	17.60	-	30.00	-	3.11	-	Pass
HT40	MCS0	1	159	5795	17.50	-	30.00	-	3.11	-	Pass
VHT20	MCS0	1	149	5745	17.90	-	30.00	-	3.11	-	Pass
VHT20	MCS0	1	157	5785	17.70	-	30.00	-	3.11	-	Pass
VHT20	MCS0	1	165	5825	18.00	-	30.00	-	3.11	-	Pass
VHT40	MCS0	1	151	5755	17.70	-	30.00	-	3.11	-	Pass
VHT40	MCS0	1	159	5795	17.60	-	30.00	-	3.11	-	Pass
VHT80	MCS0	1	155	5775	17.70	-	30.00	-	3.11	-	Pass



### 3.3 Power Spectral Density Measurement

#### 3.3.1 Limit of Power Spectral Density

For the band 5.725–5.85 GHz, the maximum power spectral density shall not exceed 30 dBm in any 500-kHz band.

If transmitting antennas of directional gain greater than 6 dBi are used, the peak output power shall be reduced by the amount in dB that the directional gain of the antenna exceeds 6 dBi.

#### 3.3.2 Measuring Instruments

See list of measuring equipment of this test report.

#### 3.3.3 Test Procedures

The testing follows FCC KDB 789033 D02 General UNII Test Procedures New Rules v02r01. Section F) Maximum power spectral density.

##### # Method SA-3 #

(power averaging (rms) detection with max hold):

- Set span to encompass the entire emission bandwidth (EBW) of the signal.
  - Set RBW = 300 kHz.
  - Set VBW  $\geq$  1 MHz.
  - Number of points in sweep  $\geq$  2 Span / RBW.
  - Sweep time  $\leq$  (number of points in sweep)  $\times$  T, when duty cycle is less than 98 percent where T is the minimum transmission duration over which the transmitter is on and is transmitting at its maximum power control level for the tested mode of operation.
  - Detector = power averaging (rms).
  - Trace mode = max hold.
  - Allow max hold to run for at least 60 seconds, or longer as needed to allow the trace to stabilize.
1. The RF output of EUT was connected to the spectrum analyzer by a low loss cable.
  2. Each plot has already offset with cable loss, and attenuator loss. Measure the PPSD and record it.

#### 3.3.4 Test Setup

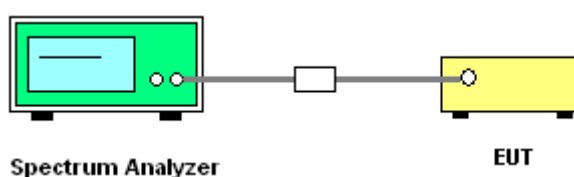



3.3.5 Test Result of Power Spectral Density

Test Engineer :	Ryan Lin, Tommy Lee and Howard Lin	Temperature :	21.2~24.1°C
		Relative Humidity :	47.2~57.8%

Band IV single antenna													
Mod.	Data Rate	NTX	CH.	Freq. (MHz)	10log (500kHz /RBW) Factor (dB)		Average Power Density (dBm/500kHz)		Average PSD Limit (dBm/500kHz)		DG (dBi)		Pass /Fail
					Ant 1	Ant 2	Ant 1	Ant 2	Ant 1	Ant 2	Ant 1	Ant 2	
11a	6Mbps	1	149	5745	2.22	-	7.94	-	30.00	-	3.11	-	Pass
11a	6Mbps	1	157	5785	2.22	-	7.79	-	30.00	-	3.11	-	Pass
11a	6Mbps	1	165	5825	2.22	-	7.93	-	30.00	-	3.11	-	Pass
VHT20	MCS0	1	149	5745	2.22	-	8.10	-	30.00	-	3.11	-	Pass
VHT20	MCS0	1	157	5785	2.22	-	8.12	-	30.00	-	3.11	-	Pass
VHT20	MCS0	1	165	5825	2.22	-	8.34	-	30.00	-	3.11	-	Pass
VHT40	MCS0	1	151	5755	2.22	-	3.98	-	30.00	-	3.11	-	Pass
VHT40	MCS0	1	159	5795	2.22	-	3.70	-	30.00	-	3.11	-	Pass
VHT80	MCS0	1	155	5775	2.22	-	1.67	-	30.00	-	3.11	-	Pass

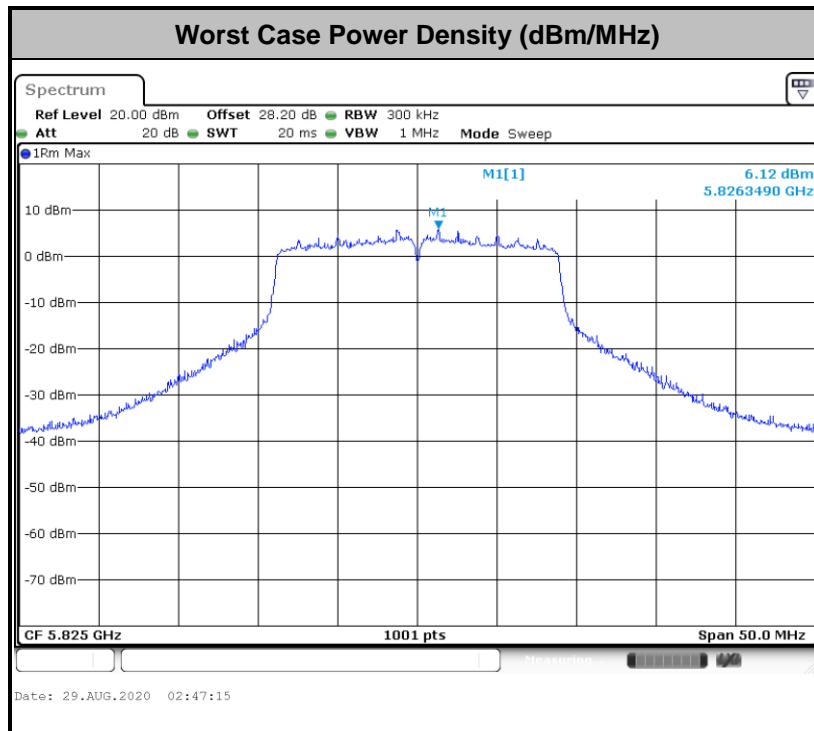



### 3.4 Unwanted Emissions Measurement

This section is to measure unwanted emissions through radiated measurement for band edge spurious emissions and out of band emissions measurement.

#### 3.4.1 Limit of Unwanted Emissions

(1) For transmitters operating in the 5.725-5.85 GHz band:

15.407(b)(4)(i) All emissions shall be limited to a level of -27 dBm/MHz at 75 MHz or more above or below the band edge increasing linearly to 10 dBm/MHz at 25 MHz above or below the band edge, and from 25 MHz above or below the band edge increasing linearly to a level of 15.6 dBm/MHz at 5 MHz above or below the band edge, and from 5 MHz above or below the band edge increasing linearly to a level of 27 dBm/MHz at the band edge.

(2) Unwanted spurious emissions fallen in restricted bands shall comply with the general field strength limits as below table,

Frequency (MHz)	Field Strength (microvolts/meter)	Measurement Distance (meters)
0.009 – 0.490	2400/F(kHz)	300
0.490 – 1.705	24000/F(kHz)	30
1.705 – 30.0	30	30
30 – 88	100	3
88 – 216	150	3
216 - 960	200	3
Above 960	500	3

**Note:** The following formula is used to convert the EIRP to field strength.

$$E = \frac{1000000\sqrt{30P}}{3} \text{ } \mu\text{V/m, where P is the eirp (Watts)}$$

EIRP (dBm)	Field Strength at 3m (dBμV/m)
- 27	68.3

(3) KDB789033 D02 v02r01 G)2)c)

(i) Sections 15.407(b)(1-3) specifies the unwanted emissions limit for the U-NII-1 and U-NII-2 bands. As specified, emissions above 1000 MHz that are outside of the restricted bands are subject to a peak emission limit of -27 dBm/MHz.

(ii) Section 15.407(b)(4) specifies the unwanted emissions limit for the U-NII-3 band. A band emissions mask is specified in Section 15.407(b)(4)(i). The emission limits are based on the use of a peak detector.



### 3.4.2 Measuring Instruments

See list of measuring equipment of this test report.

### 3.4.3 Test Procedures

1. The testing follows FCC KDB 789033 D02 General UNII Test Procedures New Rules v02r01. Section G) Unwanted emissions measurement.
  - (1) Procedure for Unwanted Emissions Measurements Below 1000MHz
    - RBW = 120 kHz
    - VBW = 300 kHz
    - Detector = Peak
    - Trace mode = max hold
  - (2) Procedure for Peak Unwanted Emissions Measurements Above 1000 MHz
    - RBW = 1 MHz
    - VBW  $\geq$  3 MHz
    - Detector = Peak
    - Sweep time = auto
    - Trace mode = max hold
  - (3) Procedures for Average Unwanted Emissions Measurements Above 1000MHz
    - RBW = 1 MHz
    - VBW = 10 Hz, when duty cycle is no less than 98 percent.
    - VBW  $\geq$  1/T, when duty cycle is less than 98 percent where T is the minimum transmission duration over which the transmitter is on and is transmitting at its maximum power control level for the tested mode of operation.
2. The EUT was placed on a turntable with 0.8 meter for frequency below 1GHz and 1.5 meter for frequency above 1GHz respectively above ground.
3. The EUT was set 3 meters from the interference receiving antenna which was mounted on the top of a variable height antenna tower.
4. The antenna is a broadband antenna and its height is adjusted between one meter and four meters above ground to find the maximum value of the field strength for both horizontal polarization and vertical polarization of the antenna.
5. For each suspected emission, the EUT was arranged to its worst case and then adjust the antenna tower (from 1 m to 4 m) and turntable (from 0 degree to 360 degrees) to find the maximum reading.
6. For testing below 1GHz, if the emission level of the EUT in peak mode was 3 dB lower than the limit specified, then peak values of EUT will be reported, otherwise, the emissions will be repeated one by one using the CISPR quasi-peak method and reported.
7. For testing above 1GHz, the emission level of the EUT in peak mode was 20dB lower than average limit (that means the emission level in average mode also complies with the limit in average mode), then peak values of EUT will be reported, otherwise, the emissions will be measured in average mode again and reported.

### 3.4.4 Test Setup

For radiated emissions below 30MHz

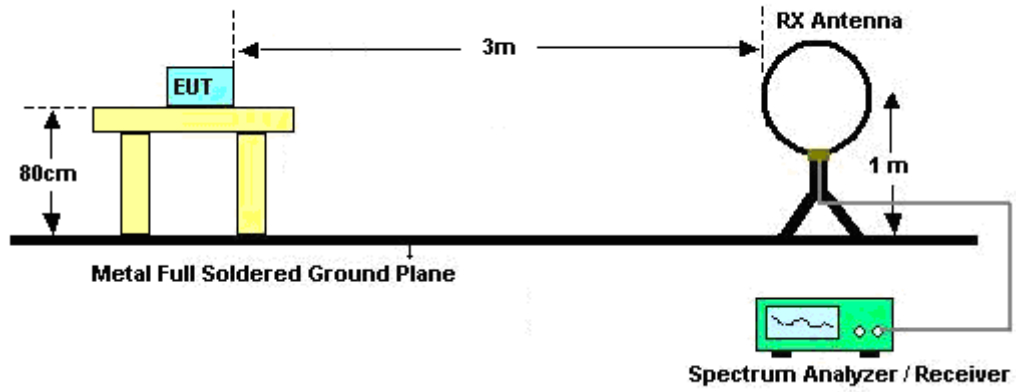

For radiated emissions from 30MHz to 1GHz

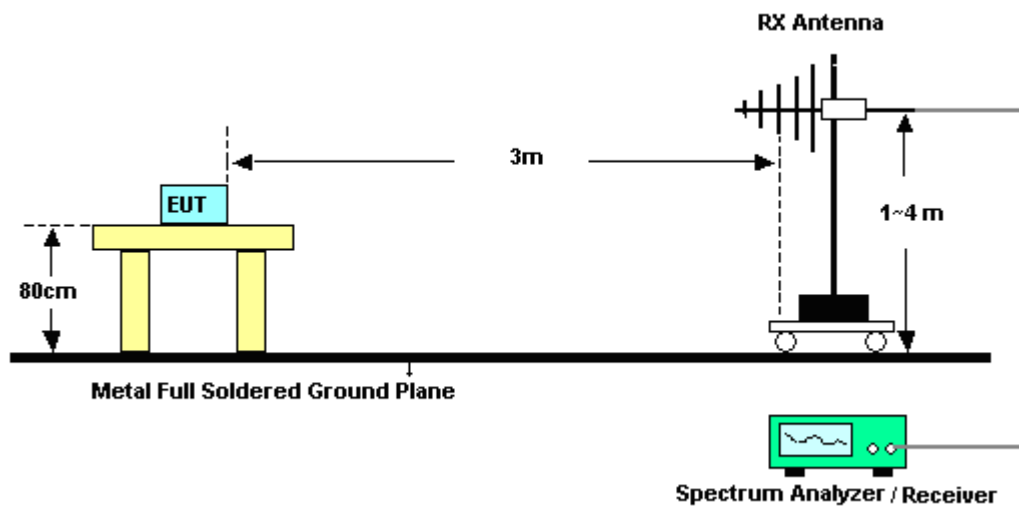

For radiated emissions above 1GHz

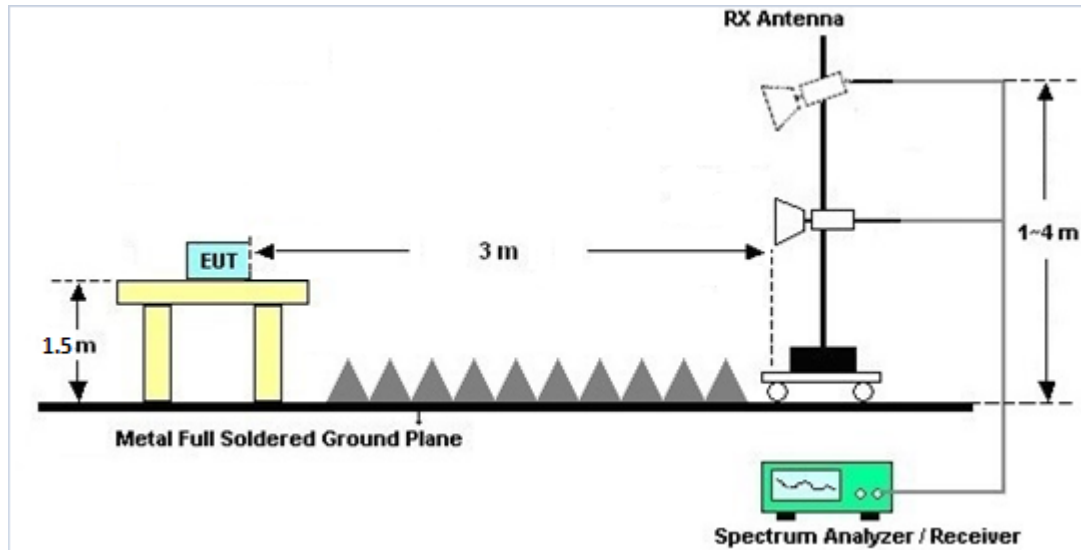

### 3.4.5 Test Results of Radiated Emissions (9 kHz ~ 30 MHz)

The low frequency, which started from 9 kHz to 30MHz, was pre-scanned and the result which was 20dB lower than the limit line was not reported.

There is a comparison data of both open-field test site and alternative test site - semi-Anechoic chamber according to 414788 D01 Radiated Test Site v01r01, and the result came out very similar.

### 3.4.6 Test Result of Radiated Band Edges

Please refer to Appendix B and C.

### 3.4.7 Duty Cycle

Please refer to Appendix D.

### 3.4.8 Test Result of Unwanted Radiated Emission (30MHz ~ 10th Harmonic)

Please refer to Appendix B and C.



### 3.5 AC Conducted Emission Measurement

#### 3.5.1 Limit of AC Conducted Emission

For equipment that is designed to be connected to the public utility (AC) power line, the radio frequency voltage that is conducted back onto the AC power line on any frequency or frequencies within the band 150 kHz to 30 MHz shall not exceed the limits in the following table.

Frequency of emission (MHz)	Conducted limit (dBµV)	
	Quasi-peak	Average
0.15-0.5	66 to 56*	56 to 46*
0.5-5	56	46
5-30	60	50

\*Decreases with the logarithm of the frequency.

#### 3.5.2 Measuring Instruments

See list of measuring equipment of this test report.

#### 3.5.3 Test Procedures

1. The EUT was placed 0.4 meter from the conducting wall of the shielding room was kept at least 80 centimeters from any other grounded conducting surface.
2. Connect EUT to the power mains through a line impedance stabilization network (LISN).
3. All the support units are connecting to the other LISN.
4. The LISN provides 50 ohm coupling impedance for the measuring instrument.
5. The FCC states that a 50 ohm, 50 microhenry LISN should be used.
6. Both sides of AC line were checked for maximum conducted interference.
7. The frequency range from 150 kHz to 30 MHz was searched.
8. Set the test-receiver system to Peak Detect Function and specified bandwidth with Maximum Hold Mode.

### 3.5.4 Test Setup

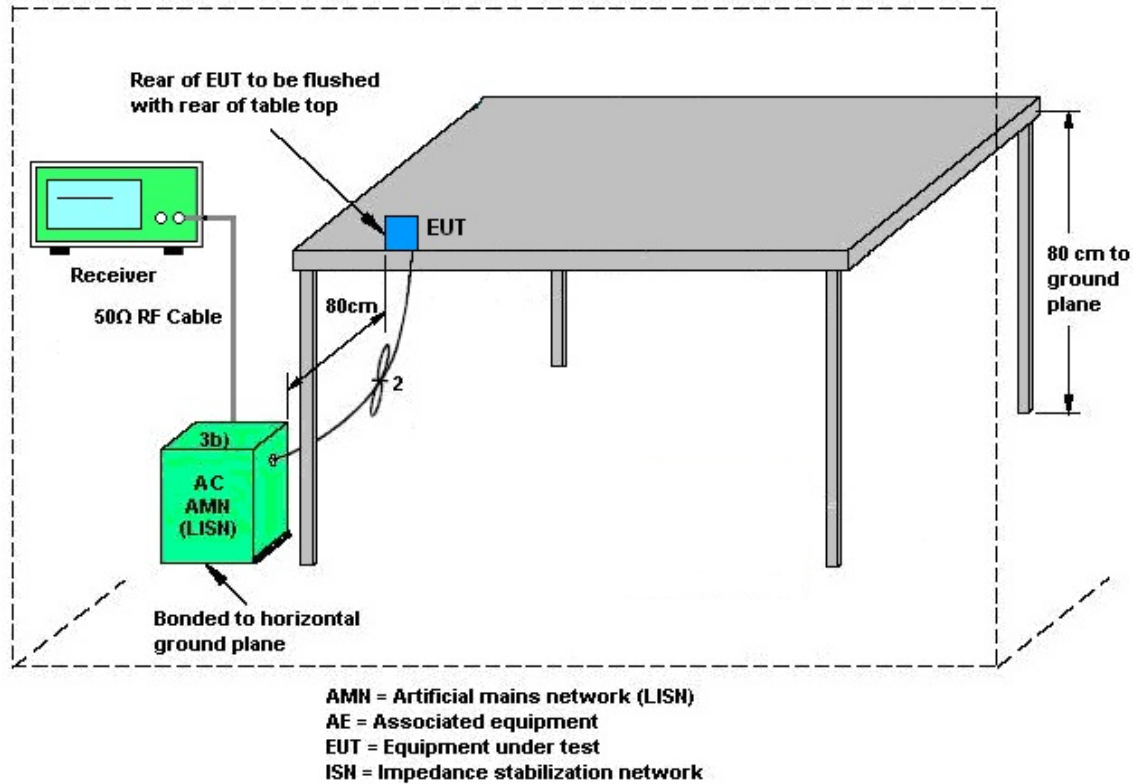

### 3.5.5 Test Result of AC Conducted Emission

Please refer to Appendix A.





## **3.6 Automatically Discontinue Transmission**

### **3.6.1 Limit of Automatically Discontinue Transmission**

The device shall automatically discontinue transmission in case of either absence of information to transmit or operational failure. These provisions are not intended to preclude the transmission of control or signaling information or the use of repetitive codes used by certain digital technologies to complete frame or burst intervals. Applicants shall include in their application for equipment authorization to describe how this requirement is met.

### **3.6.2 Measuring Instruments**

See list of measuring equipment of this test report.

### **3.6.3 Test Result of Automatically Discontinue Transmission**

While the EUT is not transmitting any information, the EUT can automatically discontinue transmission and become standby mode for power saving. The EUT can detect the controlling signal of ACK message transmitting from remote device and verify whether it shall resend or discontinue transmission.



## **3.7 Antenna Requirements**

### **3.7.1 Standard Applicable**

If transmitting antenna directional gain is greater than 6 dBi, both the peak transmit power and the peak power spectral density shall be reduced by the amount in dB that the directional gain of the antenna exceeds 6 dBi.

### **3.7.2 Antenna Anti-Replacement Construction**

An embedded-in antenna design is used.

### **3.7.3 Antenna Gain**

The antenna peak gain of EUT is less than 6 dBi. Therefore, it is not necessary to reduce maximum peak output power limit.



## 4 List of Measuring Equipment

Instrument	Brand Name	Model No.	Serial No.	Characteristics	Calibration Date	Test Date	Due Date	Remark
Bilog Antenna	TESEQ	CBL 6111D & 00800N1D01 N-06	35419 & 03	30MHz~1GHz	Apr. 29, 2020	Aug. 08, 2020~ Aug. 19, 2020	Apr. 28, 2021	Radiation (03CH07-HY)
Double Ridge Horn Antenna	ESCO	3117	00075962	1GHz ~ 18GHz	Dec. 06, 2019	Aug. 08, 2020~ Aug. 19, 2020	Dec. 05, 2020	Radiation (03CH07-HY)
EMI Test Receiver	Agilent	N9038A (MXE)	MY5329005 3	20Hz~26.5GHz	May 21, 2020	Aug. 08, 2020~ Aug. 19, 2020	May 20, 2021	Radiation (03CH07-HY)
Loop Antenna	Rohde & Schwarz	HFH2-Z2	100315	9 kHz~30 MHz	Dec. 26, 2019	Aug. 08, 2020~ Aug. 19, 2020	Dec. 25, 2020	Radiation (03CH07-HY)
Preamplifier	MITEQ	AMF-7D-0010 1800-30-10P	1590075	1GHz~18GHz	Apr. 23, 2020	Aug. 08, 2020~ Aug. 19, 2020	Apr. 22, 2021	Radiation (03CH07-HY)
Preamplifier	COM-POWER	PA-103A	161241	10MHz~1GHz	May 19, 2020	Aug. 08, 2020~ Aug. 19, 2020	May 18, 2021	Radiation (03CH07-HY)
Preamplifier	Agilent	8449B	3008A02362	1GHz~26.5GHz	Nov. 01, 2019	Aug. 08, 2020~ Aug. 19, 2020	Oct. 31, 2020	Radiation (03CH07-HY)
Filter	Microwave	H3G018G1	SN477219	3GHz High Pass Filter	Nov. 01, 2019	Aug. 08, 2020~ Aug. 19, 2020	Oct. 31, 2020	Radiation (03CH07-HY)
RF Cable	HUBER + SUHNER	SUCOFLEX 102	MY2858/2,8 01606/2	18GHz~40GHz	Feb. 25, 2020	Aug. 08, 2020~ Aug. 19, 2020	Feb. 24, 2021	Radiation (03CH07-HY)
RF Cable	HUBER + SUHNER	SUCOFLEX 126	532078/126 E	30MHz~18GHz	N/A	Aug. 08, 2020~ Aug. 19, 2020	N/A	Radiation (03CH07-HY)
RF Cable	HUBER + SUHNER	SUCOFLEX 104	MY24971/4, MY28655/4	9kHz~30MHz	Feb. 25, 2020	Aug. 08, 2020~ Aug. 19, 2020	Feb. 24, 2021	Radiation (03CH07-HY)
RF Cable	HUBER + SUHNER	SUCOFLEX 104	MY28655/4, MY24971/4, MY15682/4	30MHz~1GHz	Feb. 25, 2020	Aug. 08, 2020~ Aug. 19, 2020	Feb. 24, 2021	Radiation (03CH07-HY)
RF Cable	HUBER + SUHNER	SUCOFLEX 104	MY28655/4, MY24971/4, MY15682/4	1GHz~18GHz	Feb. 25, 2020	Aug. 08, 2020~ Aug. 19, 2020	Feb. 24, 2021	Radiation (03CH07-HY)
Controller	ChainTek	Chaintek 3000	N/A	Control Turn table	N/A	Aug. 08, 2020~ Aug. 19, 2020	N/A	Radiation (03CH07-HY)
Controller	Max-Full	MF7802	MF7802083 68	Control Ant Mast	N/A	Aug. 08, 2020~ Aug. 19, 2020	N/A	Radiation (03CH07-HY)
Antenna Mast	Max-Full	MFA520BS	N/A	1m~4m	N/A	Aug. 08, 2020~ Aug. 19, 2020	N/A	Radiation (03CH07-HY)
Turn Table	ChainTek	Chaintek 3000	N/A	0~360 Degree	N/A	Aug. 08, 2020~ Aug. 19, 2020	N/A	Radiation (03CH07-HY)
Attenuator	HONOVA	5910 SMA-50-005-19-NE	ATT-36	N/A	Nov. 01, 2019	Aug. 08, 2020~ Aug. 19, 2020	Oct. 31, 2020	Radiation (03CH07-HY)
USB Data Logger	TECPEL	TR-32	HE17XB249 5	N/A	N/A	Aug. 08, 2020~ Aug. 19, 2020	N/A	Radiation (03CH07-HY)
SHF-EHF Horn Antenna	SCHWARZBECK	BBHA 9170	BBHA91702 51	18GHz~40GHz	Nov. 26, 2019	Aug. 08, 2020~ Aug. 19, 2020	Nov. 25, 2020	Radiation (03CH07-HY)
Spectrum Analyzer	Agilent	N9030A	MY5235027 6	3Hz~44GHz	Jun. 09, 2020	Aug. 08, 2020~ Aug. 19, 2020	Jun. 08, 2021	Radiation (03CH07-HY)
Filter	Wainwright	WHKX8-5872 .5-6750-1800 0-40ST	SN7	6.75GHz High Pass Filter	Aug. 22, 2019	Aug. 08, 2020~ Aug. 19, 2020	Aug. 21, 2020	Radiation (03CH07-HY)
Preamplifier	EMEC	EM18G40G	0600789	18-40GHz	N/A	Aug. 08, 2020~ Aug. 19, 2020	N/A	Radiation (03CH07-HY)
Software	Audix	E3 6.2009-8-24	8050400465 6H	N/A	N/A	Aug. 08, 2020~ Aug. 19, 2020	N/A	Radiation (03CH07-HY)



Instrument	Brand Name	Model No.	Serial No.	Characteristics	Calibration Date	Test Date	Due Date	Remark
Hygrometer	Testo	608-H1	34893241	N/A	Mar. 02, 2020	Aug. 03, 2020~ Aug. 29, 2020	Mar. 01, 2021	Conducted (TH05-HY)
Power Sensor	DARE	RPR3006W	16I00054SN O10	10MHz~6GHz	Dec. 23, 2019	Aug. 03, 2020~ Aug. 29, 2020	Dec. 22, 2020	Conducted (TH05-HY)
Signal Analyzer	Rohde & Schwarz	FSV40	101397	10Hz~40GHz	Nov. 15, 2019	Aug. 03, 2020~ Aug. 29, 2020	Nov. 14, 2020	Conducted (TH05-HY)
Switch Box & RF Cable	EM Electronics	EMSW18SE	SW200302	N/A	Mar. 17, 2020	Aug. 03, 2020~ Aug. 29, 2020	Mar. 16, 2021	Conducted (TH05-HY)
AC Power Source	ChainTek	APC-1000W	N/A	N/A	N/A	Aug. 12, 2020	N/A	Conduction (CO05-HY)
EMI Test Receiver	Rohde & Schwarz	ESR3	102388	9kHz~3.6GHz	Nov. 15, 2019	Aug. 12, 2020	Nov. 14, 2020	Conduction (CO05-HY)
Hygrometer	Testo	608-H1	34913912	N/A	Nov. 07, 2019	Aug. 12, 2020	Nov. 06, 2020	Conduction (CO05-HY)
LISN	Rohde & Schwarz	ENV216	100081	9kHz~30MHz	Nov. 15, 2019	Aug. 12, 2020	Nov. 14, 2020	Conduction (CO05-HY)
Software	Rohde & Schwarz	EMC32 V10.30	N/A	N/A	N/A	Aug. 12, 2020	N/A	Conduction (CO05-HY)
LF Cable	HUBER + SUHNER	RG-214/U	LF01	N/A	Jan. 02, 2020	Aug. 12, 2020	Jan. 01, 2021	Conduction (CO05-HY)
Pulse Limiter	Rohde & Schwarz	ESH3-Z2	100851	N/A	Jan. 02, 2020	Aug. 12, 2020	Jan. 01, 2021	Conduction (CO05-HY)



## 5 Uncertainty of Evaluation

### Uncertainty of Conducted Emission Measurement (150kHz ~ 30MHz)

Measuring Uncertainty for a Level of Confidence of 95% ( $U = 2Uc(y)$ )	2.3
---	-----

### Uncertainty of Radiated Emission Measurement (30 MHz ~ 1000 MHz)

Measuring Uncertainty for a Level of Confidence of 95% ( $U = 2Uc(y)$ )	4.7
---	-----

### Uncertainty of Radiated Emission Measurement (1000 MHz ~ 18000 MHz)

Measuring Uncertainty for a Level of Confidence of 95% ( $U = 2Uc(y)$ )	5.3
---	-----

### Uncertainty of Radiated Emission Measurement (18000 MHz ~ 40000 MHz)

Measuring Uncertainty for a Level of Confidence of 95% ( $U = 2Uc(y)$ )	5.0
---	-----



## Appendix A. AC Conducted Emission Test Results

Test Engineer :	Howard Huang	Temperature :	23~25°C
		Relative Humidity :	40~43%

# EUT Information

Report NO : 052917-01  
 Test Mode : Mode 1  
 Test Voltage : 120Vac/60Hz  
 Phase : Line

Full Spectrum

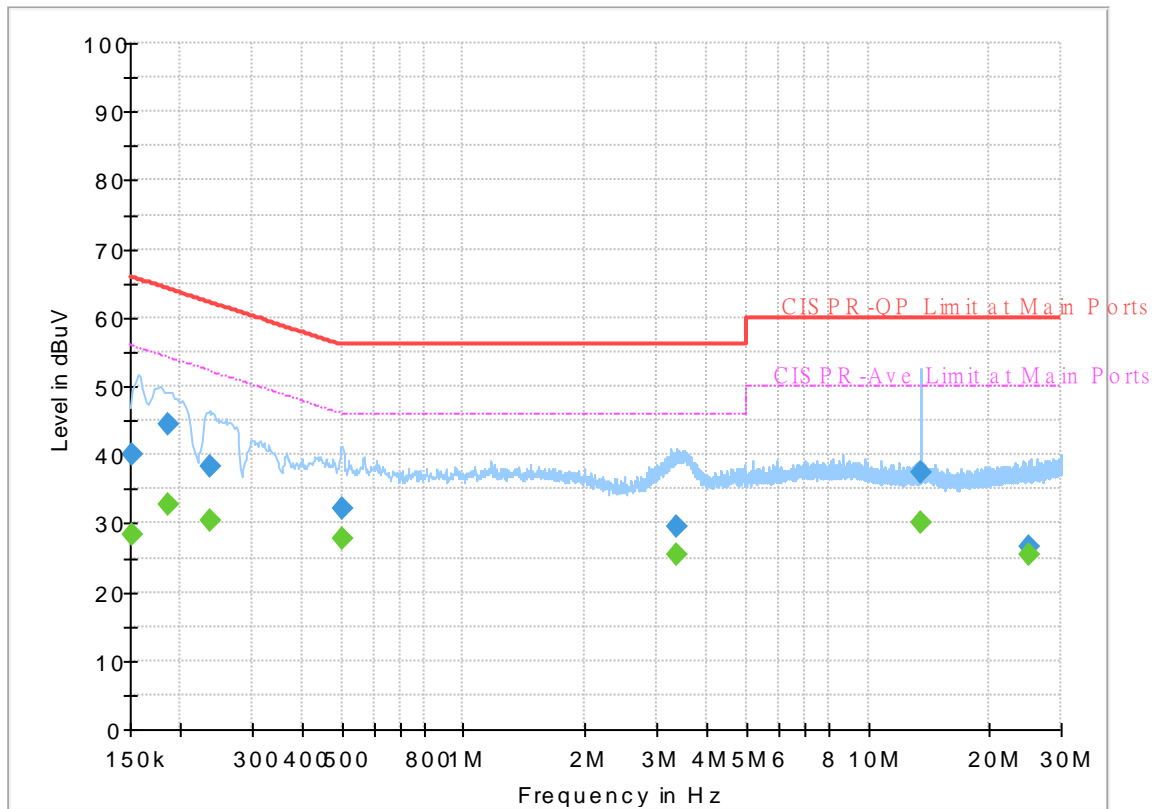

## Final\_Result

Frequency (MHz)	QuasiPeak (dBuV)	CAverage (dBuV)	Limit (dBuV)	Margin (dB)	Line	Filter	Corr. (dB)
0.152250	---	28.47	55.88	27.41	L1	OFF	19.6
0.152250	40.19	---	65.88	25.69	L1	OFF	19.6
0.186000	---	32.62	54.21	21.59	L1	OFF	19.6
0.186000	44.54	---	64.21	19.67	L1	OFF	19.6
0.235500	---	30.41	52.25	21.84	L1	OFF	19.6
0.235500	38.32	---	62.25	23.93	L1	OFF	19.6
0.501720	---	27.72	46.00	18.28	L1	OFF	19.6
0.501720	32.07	---	56.00	23.93	L1	OFF	19.6
3.358500	---	25.52	46.00	20.48	L1	OFF	19.7
3.358500	29.49	---	56.00	26.51	L1	OFF	19.7
13.560000	---	30.02	50.00	19.98	L1	OFF	20.2
13.560000	37.44	---	60.00	22.56	L1	OFF	20.2
24.949500	---	25.52	50.00	24.48	L1	OFF	20.5
24.949500	26.69	---	60.00	33.31	L1	OFF	20.5

# EUT Information

Report NO : 052917-01  
 Test Mode : Mode 1  
 Test Voltage : 120Vac/60Hz  
 Phase : Neutral

Full Spectrum

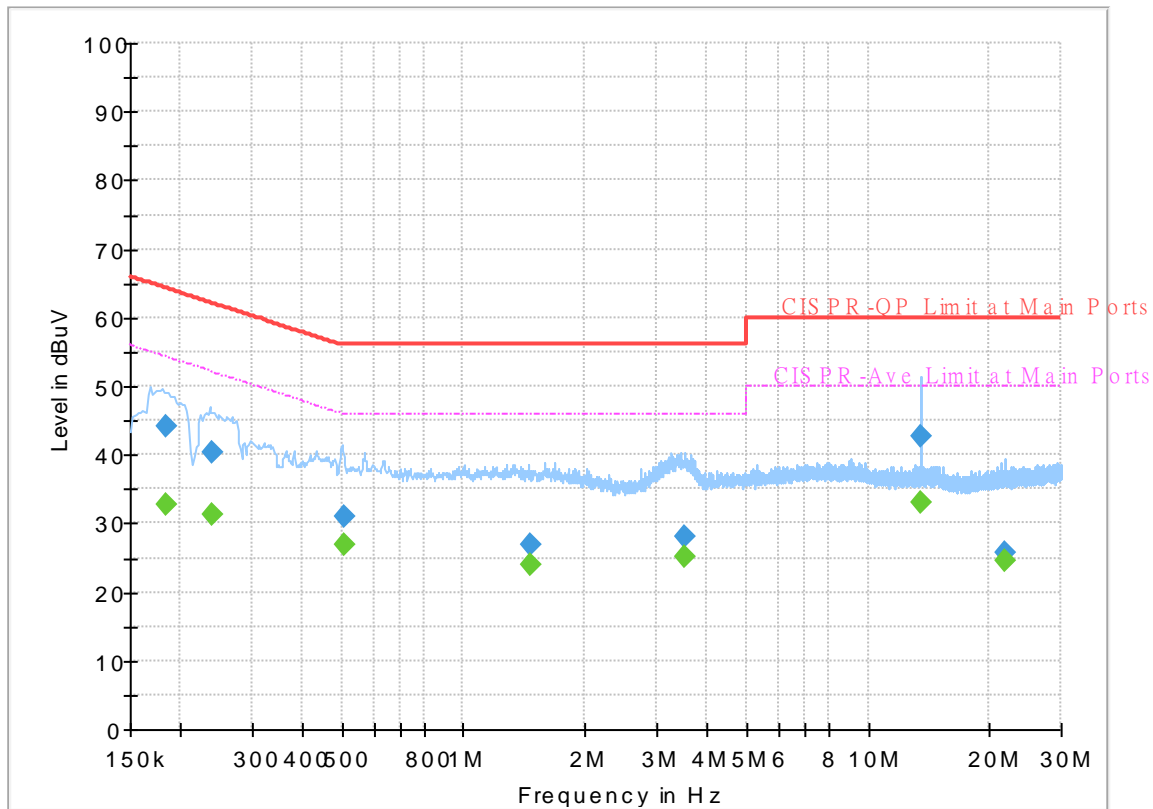

## Final\_Result

Frequency (MHz)	QuasiPeak (dBuV)	CAverage (dBuV)	Limit (dBuV)	Margin (dB)	Line	Filter	Corr. (dB)
0.183750	---	32.67	54.31	21.64	N	OFF	19.5
0.183750	44.29	---	64.31	20.02	N	OFF	19.5
0.240000	---	31.17	52.10	20.93	N	OFF	19.5
0.240000	40.22	---	62.10	21.88	N	OFF	19.5
0.505500	---	26.88	46.00	19.12	N	OFF	19.5
0.505500	31.03	---	56.00	24.97	N	OFF	19.5
1.469220	---	24.10	46.00	21.90	N	OFF	19.6
1.469220	26.80	---	56.00	29.20	N	OFF	19.6
3.503130	---	25.18	46.00	20.82	N	OFF	19.6
3.503130	28.09	---	56.00	27.91	N	OFF	19.6
13.560000	---	32.92	50.00	17.08	N	OFF	19.9
13.560000	42.70	---	60.00	17.30	N	OFF	19.9
21.711750	---	24.70	50.00	25.30	N	OFF	19.9
21.711750	25.85	---	60.00	34.15	N	OFF	19.9





## Appendix B. Radiated Spurious Emission

Test Engineer :	Jesse Wang, Stan Hsieh and Ken Wu	Temperature :	22~23°C
		Relative Humidity :	51~59%

Band 4 - 5725~5850MHz

WIFI 802.11a (Band Edge @ 3m)

WIFI Ant.	Note	Frequency ( MHz )	Level ( dBμV/m )	Over Limit ( dB )	Limit Line ( dBμV/m )	Read Level ( dBμV )	Antenna Factor ( dB/m )	Path Loss ( dB )	Preamp Factor ( dB )	Ant Pos ( cm )	Table Pos ( deg )	Peak Avg. ( P/A )	Pol. ( H/V )	
802.11a CH 149 5745MHz		5620	47.95	-20.25	68.2	36.29	34.9	12.07	35.31	103	38	P	H	
		5700	52.51	-52.69	105.2	40.63	35	12.2	35.32	103	38	P	H	
		5718.8	64.45	-46.01	110.46	52.53	35	12.24	35.32	103	38	P	H	
		5725	74.84	-47.36	122.2	62.91	35	12.25	35.32	103	38	P	H	
	*	5745	111.7	-	-	99.74	35	12.28	35.32	103	38	P	H	
	*	5745	103.85	-	-	91.89	35	12.28	35.32	103	38	A	H	
														H
														H
			5643.2	47.67	-20.53	68.2	36.07	34.8	12.11	35.31	100	114	P	V
			5698.8	50.45	-53.87	104.32	38.57	35	12.2	35.32	100	114	P	V
			5719.8	62.48	-48.26	110.74	50.56	35	12.24	35.32	100	114	P	V
			5724.8	72.71	-49.03	121.74	60.78	35	12.25	35.32	100	114	P	V
	*	5745	110.15	-	-	98.19	35	12.28	35.32	100	114	P	V	
	*	5745	102.4	-	-	90.44	35	12.28	35.32	100	114	A	V	
														V
														V



WIFI Ant. 1	Note	Frequency ( MHz )	Level ( dBµV/m )	Over Limit ( dB )	Limit Line ( dBµV/m )	Read Level ( dBµV )	Antenna Factor ( dB/m )	Path Loss ( dB )	Preamp Factor ( dB )	Ant Pos ( cm )	Table Pos ( deg )	Peak Avg. ( P/A )	Pol. ( H/V )
		5621.6	48.66	-19.54	68.2	36.99	34.9	12.08	35.31	101	39	P	H
		5668.8	49.24	-32.91	82.15	37.56	34.85	12.15	35.32	101	39	P	H
		5713	49.64	-59.2	108.84	37.73	35	12.23	35.32	101	39	P	H
		5720.2	49.04	-62.22	111.26	37.12	35	12.24	35.32	101	39	P	H
	*	5785	112.33	-	-	100.31	35	12.35	35.33	101	39	P	H
	*	5785	104.42	-	-	92.4	35	12.35	35.33	101	39	A	H
		5854.8	51.57	-59.69	111.26	39.44	35.07	12.4	35.34	101	39	P	H
		5856.8	51.13	-59.17	110.3	39	35.07	12.4	35.34	101	39	P	H
		5877.4	50.69	-52.73	103.42	38.49	35.13	12.41	35.34	101	39	P	H
		5939	49.26	-18.94	68.2	36.96	35.2	12.44	35.34	101	39	P	H
													H
													H
<b>802.11a</b>													
<b>CH 157</b>													
<b>5785MHz</b>		5624.8	47.46	-20.74	68.2	35.79	34.9	12.08	35.31	100	116	P	V
		5685.2	48.36	-45.92	94.28	36.5	35	12.18	35.32	100	116	P	V
		5708.6	48.97	-58.64	107.61	37.07	35	12.22	35.32	100	116	P	V
		5723.4	48.88	-69.67	118.55	36.96	35	12.24	35.32	100	116	P	V
	*	5785	109.72	-	-	97.7	35	12.35	35.33	100	116	P	V
	*	5785	102.52	-	-	90.5	35	12.35	35.33	100	116	A	V
		5855	50.53	-60.27	110.8	38.4	35.07	12.4	35.34	100	116	P	V
		5855	50.53	-60.27	110.8	38.4	35.07	12.4	35.34	100	116	P	V
		5888.8	49.8	-45.16	94.96	37.53	35.2	12.41	35.34	100	116	P	V
		5936.8	49.16	-19.04	68.2	36.86	35.2	12.44	35.34	100	116	P	V
													V
													V



WiFi Ant. 1	Note	Frequency ( MHz )	Level ( dBμV/m )	Over Limit ( dB )	Limit Line ( dBμV/m )	Read Level ( dBμV )	Antenna Factor ( dB/m )	Path Loss ( dB )	Preamp Factor ( dB )	Ant Pos ( cm )	Table Pos ( deg )	Peak Avg. ( P/A )	Pol. ( H/V )	
802.11a CH 165 5825MHz	*	5825	111.44	-	-	99.39	35	12.38	35.33	110	37	P	H	
	*	5825	103.65	-	-	91.6	35	12.38	35.33	110	37	A	H	
		5850.4	64.9	-56.39	121.29	52.84	35	12.4	35.34	110	37	P	H	
		5855.6	62	-48.63	110.63	49.87	35.07	12.4	35.34	110	37	P	H	
		5878.2	50.81	-52.01	102.82	38.61	35.13	12.41	35.34	110	37	P	H	
		5943	49.41	-18.79	68.2	37.11	35.2	12.44	35.34	110	37	P	H	
														H
														H
	*	5825	110.12	-	-	98.07	35	12.38	35.33	100	115	P	V	
	*	5825	102.87	-	-	90.82	35	12.38	35.33	100	115	A	V	
		5852.6	60.75	-55.52	116.27	48.69	35	12.4	35.34	100	115	P	V	
		5857	58.79	-51.45	110.24	46.66	35.07	12.4	35.34	100	115	P	V	
		5885.4	51.84	-45.64	97.48	39.64	35.13	12.41	35.34	100	115	P	V	
		5928.4	48.88	-19.32	68.2	36.59	35.2	12.43	35.34	100	115	P	V	
														V
														V
														V
<b>Remark</b>	1. No other spurious found. 2. All results are PASS against Peak and Average limit line.													



**Band 4 5725~5850MHz**

**WIFI 802.11a (Harmonic @ 3m)**

WIFI Ant. 1	Note	Frequency ( MHz )	Level ( dBμV/m )	Over Limit ( dB )	Limit Line ( dBμV/m )	Read Level ( dBμV )	Antenna Factor ( dB/m )	Path Loss ( dB )	Preamp Factor ( dB )	Ant Pos ( cm )	Table Pos ( deg )	Peak Avg. ( P/A )	Pol. ( H/V )
802.11a CH 149 5745MHz		11490	45.33	-28.67	74	46.19	38.18	18.48	57.52	100	0	P	H
		17235	50.25	-17.95	68.2	42.08	41.53	22.95	56.31	100	0	P	H
													H
													H
		11490	44.43	-29.57	74	45.29	38.18	18.48	57.52	100	0	P	V
		17235	49.68	-18.52	68.2	41.51	41.53	22.95	56.31	100	0	P	V
													V
802.11a CH 157 5785MHz		11570	44.58	-29.42	74	45.04	38.33	18.55	57.34	100	0	P	H
		17355	49.3	-18.9	68.2	41.13	41.5	23.02	56.35	100	0	P	H
													H
													H
		11570	45.23	-28.77	74	45.69	38.33	18.55	57.34	100	0	P	V
		17355	50.35	-17.85	68.2	42.18	41.5	23.02	56.35	100	0	P	V
													V
802.11a CH 165 5825MHz		11650	44.63	-29.37	74	44.71	38.44	18.63	57.15	100	0	P	H
		17475	48.54	-19.66	68.2	40.5	41.33	23.09	56.38	100	0	P	H
													H
													H
		11650	44.82	-29.18	74	44.9	38.44	18.63	57.15	100	0	P	V
		17475	48.69	-19.51	68.2	40.65	41.33	23.09	56.38	100	0	P	V
													V
Remark	1. No other spurious found.												
	2. All results are PASS against Peak and Average limit line.												



**Band 4 5725~5850MHz**

**WIFI 802.11ac VHT20 (Band Edge @ 3m)**

WIFI Ant. 1	Note	Frequency ( MHz )	Level ( dBμV/m )	Over Limit ( dB )	Limit Line ( dBμV/m )	Read Level ( dBμV )	Antenna Factor ( dB/m )	Path Loss ( dB )	Preamp Factor ( dB )	Ant Pos ( cm )	Table Pos ( deg )	Peak Avg. ( P/A )	Pol. ( H/V )	
802.11ac VHT20 CH 149 5745MHz		5622	47.93	-20.27	68.2	36.26	34.9	12.08	35.31	101	41	P	H	
		5694.2	50.35	-50.57	100.92	38.47	35	12.2	35.32	101	41	P	H	
		5719.8	69.92	-40.82	110.74	58	35	12.24	35.32	101	41	P	H	
		5725	76.98	-45.22	122.2	65.05	35	12.25	35.32	101	41	P	H	
	*	5745	110.94	-	-	98.98	35	12.28	35.32	101	41	P	H	
	*	5745	103.39	-	-	91.43	35	12.28	35.32	101	41	A	H	
														H
														H
			5616.4	48.81	-19.39	68.2	37.15	34.9	12.07	35.31	100	114	P	V
			5699.6	55.1	-49.81	104.91	43.22	35	12.2	35.32	100	114	P	V
			5720	64.96	-45.84	110.8	53.04	35	12.24	35.32	100	114	P	V
			5724.4	76.44	-44.39	120.83	64.51	35	12.25	35.32	100	114	P	V
	*		5745	109.32	-	-	97.36	35	12.28	35.32	100	114	P	V
	*		5745	101.84	-	-	89.88	35	12.28	35.32	100	114	A	V
														V
													V	



WIFI Ant. 1	Note	Frequency ( MHz )	Level ( dBμV/m )	Over Limit ( dB )	Limit Line ( dBμV/m )	Read Level ( dBμV )	Antenna Factor ( dB/m )	Path Loss ( dB )	Preamp Factor ( dB )	Ant Pos ( cm )	Table Pos ( deg )	Peak Avg. ( P/A )	Pol. ( H/V )
		5614.8	47.76	-20.44	68.2	36.01	35	12.06	35.31	104	40	P	H
		5664.8	49.22	-29.97	79.19	37.69	34.7	12.15	35.32	104	40	P	H
		5709	48.48	-59.24	107.72	36.58	35	12.22	35.32	104	40	P	H
		5723.6	48.28	-70.73	119.01	36.36	35	12.24	35.32	104	40	P	H
	*	5785	109.7	-	-	97.68	35	12.35	35.33	104	40	P	H
	*	5785	102.42	-	-	90.4	35	12.35	35.33	104	40	A	H
		5850.4	52.03	-69.26	121.29	39.97	35	12.4	35.34	104	40	P	H
		5859.4	50.84	-58.73	109.57	38.71	35.07	12.4	35.34	104	40	P	H
		5898.8	50.32	-37.23	87.55	38.04	35.2	12.42	35.34	104	40	P	H
		5939.2	50.83	-17.37	68.2	38.53	35.2	12.44	35.34	104	40	P	H
802.11ac													H
VHT20													H
CH 157		5606	48.58	-19.62	68.2	36.84	35	12.05	35.31	100	120	P	V
5785MHz		5694.8	49.91	-51.46	101.37	38.03	35	12.2	35.32	100	120	P	V
		5716.6	48.5	-61.35	109.85	36.59	35	12.23	35.32	100	120	P	V
		5724.4	49.45	-71.38	120.83	37.52	35	12.25	35.32	100	120	P	V
	*	5785	109.12	-	-	97.1	35	12.35	35.33	100	120	P	V
	*	5785	101.8	-	-	89.78	35	12.35	35.33	100	120	A	V
		5854.2	50.99	-61.63	112.62	38.86	35.07	12.4	35.34	100	120	P	V
		5860	51.5	-57.9	109.4	39.37	35.07	12.4	35.34	100	120	P	V
		5924.6	49.93	-18.56	68.49	37.64	35.2	12.43	35.34	100	120	P	V
		5948.4	50.66	-17.54	68.2	38.36	35.2	12.44	35.34	100	120	P	V
													V
													V



WIFI Ant. 1	Note	Frequency ( MHz )	Level ( dBμV/m )	Over Limit ( dB )	Limit Line ( dBμV/m )	Read Level ( dBμV )	Antenna Factor ( dB/m )	Path Loss ( dB )	Preamp Factor ( dB )	Ant Pos ( cm )	Table Pos ( deg )	Peak Avg. ( P/A )	Pol. ( H/V )	
802.11ac VHT20 CH 165 5825MHz	*	5825	109.13	-	-	97.08	35	12.38	35.33	104	48	P	H	
	*	5825	101.97	-	-	89.92	35	12.38	35.33	104	48	A	H	
		5850	60.81	-61.39	122.2	48.74	35	12.4	35.33	104	48	P	H	
		5855.6	52.06	-58.57	110.63	39.93	35.07	12.4	35.34	104	48	P	H	
		5886	51.55	-45.48	97.03	39.35	35.13	12.41	35.34	104	48	P	H	
		5939.6	52.01	-16.19	68.2	39.71	35.2	12.44	35.34	104	48	P	H	
														H
														H
	*	5825	109.04	-	-	96.99	35	12.38	35.33	100	121	121	P	V
	*	5825	101.47	-	-	89.42	35	12.38	35.33	100	121	121	A	V
		5850	62.57	-59.63	122.2	50.5	35	12.4	35.33	100	121	121	P	V
		5855.8	55.08	-55.5	110.58	42.95	35.07	12.4	35.34	100	121	121	P	V
		5879.8	51.39	-50.24	101.63	39.19	35.13	12.41	35.34	100	121	121	P	V
		5937	50.23	-17.97	68.2	37.93	35.2	12.44	35.34	100	121	121	P	V
														V
													V	
Remark	1. No other spurious found. 2. All results are PASS against Peak and Average limit line.													



**Band 4 5725~5850MHz**

**WIFI 802.11ac VHT20 (Harmonic @ 3m)**

WIFI Ant. 1	Note	Frequency ( MHz )	Level ( dBμV/m )	Over Limit ( dB )	Limit Line ( dBμV/m )	Read Level ( dBμV )	Antenna Factor ( dB/m )	Path Loss ( dB )	Preamp Factor ( dB )	Ant Pos ( cm )	Table Pos ( deg )	Peak Avg. ( P/A )	Pol. ( H/V )
802.11ac VHT20 CH 149 5745MHz		11490	44.28	-29.72	74	45.14	38.18	18.48	57.52	100	0	P	H
		17235	49.47	-18.73	68.2	41.3	41.53	22.95	56.31	100	0	P	H
													H
													H
		11490	44.29	-29.71	74	45.15	38.18	18.48	57.52	100	0	P	V
		17235	49.06	-19.14	68.2	40.89	41.53	22.95	56.31	100	0	P	V
													V
802.11ac VHT20 CH 157 5785MHz		11570	44.38	-29.62	74	44.84	38.33	18.55	57.34	100	0	P	H
		17355	49.46	-18.74	68.2	41.29	41.5	23.02	56.35	100	0	P	H
													H
													H
		11570	45.25	-28.75	74	45.71	38.33	18.55	57.34	100	0	P	V
		17355	50.31	-17.89	68.2	42.14	41.5	23.02	56.35	100	0	P	V
													V
802.11ac VHT20 CH 165 5825MHz		11650	44.97	-29.03	74	45.05	38.44	18.63	57.15	100	0	P	H
		17475	48.73	-19.47	68.2	40.69	41.33	23.09	56.38	100	0	P	H
													H
													H
		11650	44.35	-29.65	74	44.43	38.44	18.63	57.15	100	0	P	V
		17475	48.2	-20	68.2	40.16	41.33	23.09	56.38	100	0	P	V
													V
Remark	1. No other spurious found.												
	2. All results are PASS against Peak and Average limit line.												





Band 4 5725~5850MHz

WIFI 802.11ac VHT40 (Band Edge @ 3m)

WIFI Ant. 1	Note	Frequency ( MHz )	Level ( dBμV/m )	Over Limit ( dB )	Limit Line ( dBμV/m )	Read Level ( dBμV )	Antenna Factor ( dB/m )	Path Loss ( dB )	Preamp Factor ( dB )	Ant Pos ( cm )	Table Pos ( deg )	Peak Avg. ( P/A )	Pol. ( H/V )
		5613.4	48.06	-20.14	68.2	36.31	35	12.06	35.31	100	40	P	H
		5700	53.65	-51.55	105.2	41.77	35	12.2	35.32	100	40	P	H
		5720	75.96	-34.84	110.8	64.04	35	12.24	35.32	100	40	P	H
		5722.8	77.31	-39.87	117.18	65.39	35	12.24	35.32	100	40	P	H
	*	5755	107.7	-	-	95.73	35	12.3	35.33	100	40	P	H
	*	5755	100.09	-	-	88.12	35	12.3	35.33	100	40	A	H
		5850.6	50.97	-69.86	120.83	38.91	35	12.4	35.34	100	40	P	H
		5874	50.41	-55.07	105.48	38.21	35.13	12.41	35.34	100	40	P	H
		5890.4	49.51	-44.26	93.77	37.23	35.2	12.42	35.34	100	40	P	H
		5934.4	49.95	-18.25	68.2	37.65	35.2	12.44	35.34	100	40	P	H
													H
													H
<b>802.11ac</b>													
<b>VHT40</b>													
<b>CH 151</b>		5626.2	48.87	-19.33	68.2	37.2	34.9	12.08	35.31	100	119	P	V
<b>5755MHz</b>		5690	53.79	-44.04	97.83	41.92	35	12.19	35.32	100	119	P	V
		5716.4	75.87	-33.92	109.79	63.96	35	12.23	35.32	100	119	P	V
		5724	78.17	-41.75	119.92	66.25	35	12.24	35.32	100	119	P	V
	*	5755	106.39	-	-	94.42	35	12.3	35.33	100	119	P	V
	*	5755	98.9	-	-	86.93	35	12.3	35.33	100	119	A	V
		5854.8	48.41	-62.85	111.26	36.28	35.07	12.4	35.34	100	119	P	V
		5864.2	49.54	-58.68	108.22	37.41	35.07	12.4	35.34	100	119	P	V
		5883.2	51.64	-47.47	99.11	39.44	35.13	12.41	35.34	100	119	P	V
		5931.6	50.31	-17.89	68.2	38.01	35.2	12.44	35.34	100	119	P	V
													V
													V



WIFI Ant. 1	Note	Frequency ( MHz )	Level ( dBμV/m )	Over Limit ( dB )	Limit Line ( dBμV/m )	Read Level ( dBμV )	Antenna Factor ( dB/m )	Path Loss ( dB )	Preamp Factor ( dB )	Ant Pos ( cm )	Table Pos ( deg )	Peak Avg. ( P/A )	Pol. ( H/V )
		5645.6	49.29	-18.91	68.2	37.68	34.8	12.12	35.31	100	40	P	H
		5676.6	48.73	-39.19	87.92	37.03	34.85	12.17	35.32	100	40	P	H
		5714.4	51.02	-58.21	109.23	39.11	35	12.23	35.32	100	40	P	H
		5724.6	54.22	-67.07	121.29	42.29	35	12.25	35.32	100	40	P	H
	*	5795	108.05	-	-	96.02	35	12.36	35.33	100	40	P	H
	*	5795	100.52	-	-	88.49	35	12.36	35.33	100	40	A	H
		5853.6	55.85	-58.14	113.99	43.72	35.07	12.4	35.34	100	40	P	H
		5863.6	54.02	-54.37	108.39	41.89	35.07	12.4	35.34	100	40	P	H
		5878.2	52.79	-50.03	102.82	40.59	35.13	12.41	35.34	100	40	P	H
		5943	50.07	-18.13	68.2	37.77	35.2	12.44	35.34	100	40	P	H
802.11ac													H
VHT40													H
CH 159		5636.4	48.21	-19.99	68.2	36.62	34.8	12.1	35.31	100	120	P	V
5795MHz		5691.4	49.49	-49.37	98.86	37.62	35	12.19	35.32	100	120	P	V
		5719.2	51.86	-58.72	110.58	39.94	35	12.24	35.32	100	120	P	V
		5723.8	52.63	-66.83	119.46	40.71	35	12.24	35.32	100	120	P	V
	*	5795	106.95	-	-	94.92	35	12.36	35.33	100	120	P	V
	*	5795	99.23	-	-	87.2	35	12.36	35.33	100	120	A	V
		5851.2	55.43	-64.03	119.46	43.37	35	12.4	35.34	100	120	P	V
		5856.6	53.98	-56.37	110.35	41.85	35.07	12.4	35.34	100	120	P	V
		5883	50.53	-48.73	99.26	38.33	35.13	12.41	35.34	100	120	P	V
		5933.8	49.58	-18.62	68.2	37.28	35.2	12.44	35.34	100	120	P	V
													V
													V
Remark	1. No other spurious found. 2. All results are PASS against Peak and Average limit line.												



**Band 4 5725~5850MHz**

**WIFI 802.11ac VHT40 (Harmonic @ 3m)**

WIFI Ant. 1	Note	Frequency ( MHz )	Level ( dBµV/m )	Over Limit ( dB )	Limit Line ( dBµV/m )	Read Level ( dBµV )	Antenna Factor ( dB/m )	Path Loss ( dB )	Preamp Factor ( dB )	Ant Pos ( cm )	Table Pos ( deg )	Peak Avg. ( P/A )	Pol. ( H/V )	
802.11ac VHT40 CH 151 5755MHz		11510	44.35	-29.65	74	45.12	38.2	18.51	57.48	100	0	P	H	
		17265	48.47	-19.73	68.2	40.36	41.47	22.96	56.32	100	0	P	H	
													H	
													H	
			11510	44.7	-29.3	74	45.47	38.2	18.51	57.48	100	0	P	V
			17265	48.71	-19.49	68.2	40.6	41.47	22.96	56.32	100	0	P	V
														V
802.11ac VHT40 CH 159 5795MHz		11590	46.31	-27.69	74	46.66	38.37	18.57	57.29	100	0	P	H	
		17385	50.12	-18.08	68.2	41.87	41.57	23.04	56.36	100	0	P	H	
													H	
													H	
			11590	45.53	-28.47	74	45.88	38.37	18.57	57.29	100	0	P	V
			17385	50.1	-18.1	68.2	41.85	41.57	23.04	56.36	100	0	P	V
														V
Remark	1. No other spurious found.													
	2. All results are PASS against Peak and Average limit line.													



Band 4 5725~5850MHz

WIFI 802.11ac VHT80 (Band Edge @ 3m)

WIFI Ant. 1	Note	Frequency ( MHz )	Level ( dBμV/m )	Over Limit ( dB )	Limit Line ( dBμV/m )	Read Level ( dBμV )	Antenna Factor ( dB/m )	Path Loss ( dB )	Preamp Factor ( dB )	Ant Pos ( cm )	Table Pos ( deg )	Peak Avg. ( P/A )	Pol. ( H/V )
		5637.2	51.55	-16.65	68.2	39.96	34.8	12.1	35.31	101	41	P	H
		5695.6	72.98	-28.98	101.96	61.1	35	12.2	35.32	101	41	P	H
		5720	76.16	-34.64	110.8	64.24	35	12.24	35.32	101	41	P	H
		5722.8	76.73	-40.45	117.18	64.81	35	12.24	35.32	101	41	P	H
	*	5775	104.63	-	-	92.63	35	12.33	35.33	101	41	P	H
	*	5775	97.37	-	-	85.37	35	12.33	35.33	101	41	A	H
		5851.8	74.1	-44	118.1	62.04	35	12.4	35.34	101	41	P	H
		5861.2	72.43	-36.63	109.06	60.3	35.07	12.4	35.34	101	41	P	H
		5875.4	70.35	-34.55	104.9	58.15	35.13	12.41	35.34	101	41	P	H
		5932	52.27	-15.93	68.2	39.97	35.2	12.44	35.34	101	41	P	H
													H
													H
802.11ac VHT80 CH 155 5775MHz		5632.8	50.73	-17.47	68.2	39.15	34.8	12.09	35.31	100	119	P	V
		5697.2	70.49	-32.65	103.14	58.61	35	12.2	35.32	100	119	P	V
		5718.8	77.65	-32.81	110.46	65.73	35	12.24	35.32	100	119	P	V
		5723.4	75.6	-42.95	118.55	63.68	35	12.24	35.32	100	119	P	V
	*	5775	103.96	-	-	91.96	35	12.33	35.33	100	119	P	V
	*	5775	96.18	-	-	84.18	35	12.33	35.33	100	119	A	V
		5850.2	74.08	-47.66	121.74	62.02	35	12.4	35.34	100	119	P	V
		5857.4	74.46	-35.67	110.13	62.33	35.07	12.4	35.34	100	119	P	V
		5875.8	66.52	-38.09	104.61	54.32	35.13	12.41	35.34	100	119	P	V
		5931.4	50.53	-17.67	68.2	38.23	35.2	12.44	35.34	100	119	P	V
													V
													V
Remark	1. No other spurious found. 2. All results are PASS against Peak and Average limit line.												



**Band 4 5725~5850MHz**

**WIFI 802.11ac VHT80 (Harmonic @ 3m)**

WIFI Ant. 1	Note	Frequency ( MHz )	Level ( dBμV/m )	Over Limit ( dB )	Limit Line ( dBμV/m )	Read Level ( dBμV )	Antenna Factor ( dB/m )	Path Loss ( dB )	Preamp Factor ( dB )	Ant Pos ( cm )	Table Pos ( deg )	Peak Avg. ( P/A )	Pol. ( H/V )	
802.11ac VHT80 CH 155 5775MHz		11550	44.59	-29.41	74	45.13	38.3	18.54	57.38	100	0	P	H	
		17325	49.52	-18.68	68.2	41.43	41.43	23	56.34	100	0	P	H	
													H	
													H	
			11550	44.38	-29.62	74	44.92	38.3	18.54	57.38	100	0	P	V
			17325	48.85	-19.35	68.2	40.76	41.43	23	56.34	100	0	P	V
														V
													V	
Remark	1. No other spurious found. 2. All results are PASS against Peak and Average limit line.													



Emission below 1GHz

5GHz WIFI 802.11ac VHT80 (LF)

WIFI	Note	Frequency	Level	Over	Limit	Read	Antenna	Path	Preamp	Ant	Table	Peak	Pol.	
Ant.				Limit	Line	Level	Factor	Loss	Factor	Pos	Pos	Avg.		
1		( MHz )	( dBµV/m )	( dB )	( dBµV/m )	( dBµV )	( dB/m )	( dB )	( dB )	( cm )	( deg )	( P/A )	( H/V )	
5GHz 802.11ac VHT80 LF		30.27	22.27	-17.73	40	27.03	24.32	0.93	30.01	-	-	P	H	
		126.93	22.04	-21.46	43.5	32.48	17.63	1.89	29.96	-	-	P	H	
		147.18	24.47	-19.03	43.5	35.12	17.27	2.03	29.95	-	-	P	H	
		883.1	32.17	-13.83	46	27.31	28.86	5.07	29.07	-	-	P	H	
		944.7	32.54	-13.46	46	26.2	29.82	5.25	28.73	-	-	P	H	
		954.5	33.01	-12.99	46	25.93	30.48	5.27	28.67	100	0	P	H	
														H
														H
														H
														H
														H
														H
														H
														H
														H
			30	30.68	-9.32	40	35.44	24.32	0.93	30.01	100	0	P	V
			48.63	27.38	-12.62	40	41	15.19	1.18	29.99	-	-	P	V
			53.76	28.1	-11.9	40	43.71	13.14	1.24	29.99	-	-	P	V
			913.9	32.39	-13.61	46	27.27	28.87	5.16	28.91	-	-	P	V
			941.9	32.6	-13.4	46	26.34	29.77	5.24	28.75	-	-	P	V
		957.3	33.24	-12.76	46	26.15	30.47	5.28	28.66	-	-	P	V	
													V	
													V	
													V	
													V	
													V	
													V	
<b>Remark</b>	1. No other spurious found. 2. All results are PASS against limit line.													



**Note symbol**

*	<b>Fundamental Frequency</b> which can be ignored. However, the level of any unwanted emissions shall not exceed the level of the fundamental frequency.
!	Test result is <b>over limit</b> line.
P/A	<b>Peak</b> or <b>Average</b>
H/V	<b>Horizontal</b> or <b>Vertical</b>



A calculation example for radiated spurious emission is shown as below:

WIFI	Note	Frequency	Level	Over	Limit	Read	Antenna	Path	Preamp	Ant	Table	Peak	Pol.
Ant.				Limit	Line	Level	Factor	Loss	Factor	Pos	Pos	Avg.	
1		( MHz )	( dBμV/m )	( dB )	( dBμV/m )	( dBμV )	( dB/m )	( dB )	( dB )	( cm )	( deg )	( P/A )	( H/V )
802.11b		2390	55.45	-18.55	74	54.51	32.22	4.58	35.86	103	308	P	H
CH 01		2390	43.54	-10.46	54	42.6	32.22	4.58	35.86	103	308	A	H
2412MHz													

1. Path Loss(dB) = Cable loss(dB) + Filter loss(dB) + Attenuator loss(dB)
2. Level(dBμV/m) = Antenna Factor(dB/m) + Path Loss(dB) + Read Level(dBμV) - Preamp Factor(dB)
3. Over Limit(dB) = Level(dBμV/m) – Limit Line(dBμV/m)

**For Peak Limit @ 2390MHz:**

1. Level(dBμV/m)  
= Antenna Factor(dB/m) + Path Loss(dB) + Read Level(dBμV) - Preamp Factor(dB)  
= 32.22(dB/m) + 4.58(dB) + 54.51(dBμV) – 35.86 (dB)  
= 55.45 (dBμV/m)
2. Over Limit(dB)  
= Level(dBμV/m) – Limit Line(dBμV/m)  
= 55.45(dBμV/m) – 74(dBμV/m)  
= -18.55(dB)

**For Average Limit @ 2390MHz:**

1. Level(dBμV/m)  
= Antenna Factor(dB/m) + Path Loss(dB) + Read Level(dBμV) - Preamp Factor(dB)  
= 32.22(dB/m) + 4.58(dB) + 42.6(dBμV) – 35.86 (dB)  
= 43.54 (dBμV/m)
2. Over Limit(dB) = Level(dBμV/m) – Limit Line(dBμV/m)  
= 43.54(dBμV/m) – 54(dBμV/m)  
= -10.46(dB)

**Both peak and average measured complies with the limit line, so test result is “PASS”.**





## Appendix C. Radiated Spurious Emission Plots

Test Engineer :	Jesse Wang, Stan Hsieh and Ken Wu	Temperature :	22~23°C
		Relative Humidity :	51~59%

**Band 4 - 5725~5850MHz**  
**WIFI 802.11a (Band Edge @ 3m)**

WIFI	Band 4 5725~5850MHz Band Edge @ 3m	
ANT	802.11a CH149 5745MHz	
1	Horizontal	Fundamental
Peak	<p>Date: 2020-08-10 PEAK_BE(RED)_E24</p>	<p>Date: 2020-08-10 PEAK(LINB) AVG_S4</p>
	<p>Site : 03CH07-HY            Condition : PEAK_BE(B4)_16-24 3m HF_ANT_00075962 HORIZONTAL            Detector : Peak            Project : 052917-01            Mode : 34</p>	<p>Site : 03CH07-HY            Condition : PEAK(LINB) 3m HF_ANT_00075962 HORIZONTAL            Detector : Peak            Project : 052917-01            Mode : 34</p>



WIFI	Band 4 5725~5850MHz Band Edge @ 3m	
ANT	802.11a CH149 5745MHz	
1	Vertical	Fundamental
Peak	<p>Site : ESCH07-RV Condition : PEAK_BE(B4)_16-24 3m HF_ANT_00075962 VERTICAL Detector : RBW:1000.000kHz VBW:3000.000kHz SWT:Auto Project : FR052917-01 Mode : 34</p>	<p>Site : ESCH07-RV Condition : PEAK(LNB)_3m HF_ANT_00075962 VERTICAL Detector : RBW:1000.000kHz VBW:3000.000kHz SWT:Auto Project : FR052917-01 Mode : 34</p>

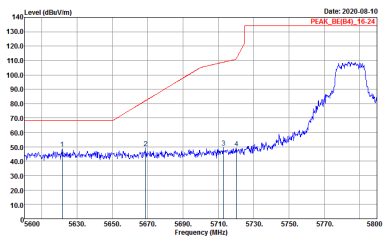
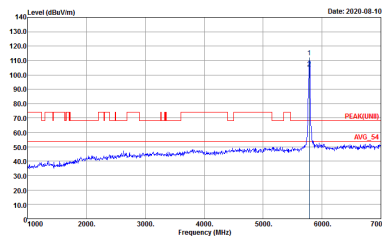
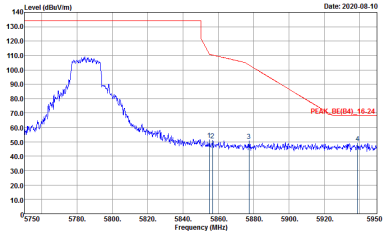

WIFI	Band 4 5725~5850MHz Band Edge @ 3m	
ANT	802.11a CH157 5785MHz	
1	Horizontal	Fundamental
<p><b>Peak</b></p>	 <p>Date: 2020-08-10 PEAK_BE(B4)_16-24</p> <p>Site : 03CH07-HY Condition : PEAK_BE(B4)_16-24 3m HF_ANT_00075962 HORIZONTAL Detector : Peak Project : 052917-01 Mode : 35</p>	 <p>Date: 2020-08-10 PEAK(LNB) AVG-24</p> <p>Site : 03CH07-HY Condition : PEAK(LNB)_3m HF_ANT_00075962 HORIZONTAL Detector : Peak Project : 052917-01 Mode : 35</p>
<p><b>Peak</b></p>	 <p>Date: 2020-08-10 PEAK_BE(B4)_16-24</p> <p>Site : 03CH07-HY Condition : PEAK_BE(B4)_16-24 3m HF_ANT_00075962 HORIZONTAL Detector : Peak Project : 052917-01 Mode : 35</p>	<p><b>Left blank</b></p>

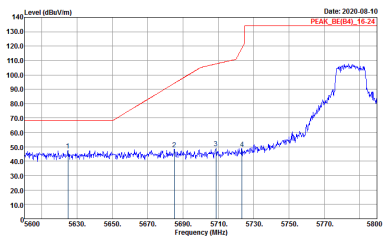
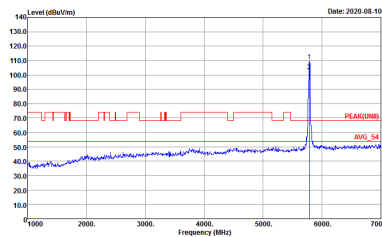
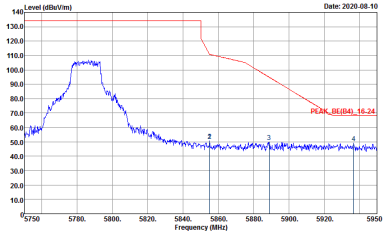

WIFI	Band 4 5725~5850MHz Band Edge @ 3m	
ANT	802.11a CH157 5785MHz	
1	Vertical	Fundamental
<p><b>Peak</b></p>	 <p>Site : 03CH07-HY            Condition : PEAK_BE(B4)_16-24 3m HF_ANT_00075962 VERTICAL            Detector : Peak            Project : 052917-01            Mode : 35</p>	 <p>Site : 03CH07-HY            Condition : PEAK(LIN) 3m HF_ANT_00075962 VERTICAL            Detector : Peak            Project : 052917-01            Mode : 35</p>
<p><b>Peak</b></p>	 <p>Site : 03CH07-HY            Condition : PEAK_BE(B4)_16-24 3m HF_ANT_00075962 VERTICAL            Detector : Peak            Project : 052917-01            Mode : 35</p>	<p><b>Left blank</b></p>

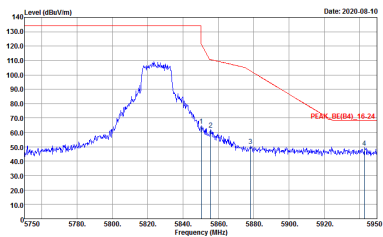
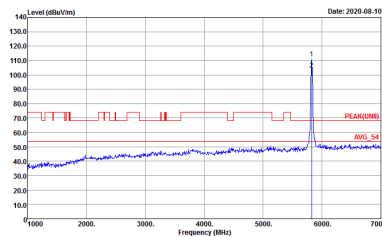

WIFI	Band 4 5725~5850MHz Band Edge @ 3m	
ANT	802.11a CH165 5825MHz	
1	Horizontal	Fundamental
Peak	 <p>Site : E3CH07-RV          Condition : PEAK_BE(B4)_16.24 3m HF_ANT_00075962 HORIZONTAL          Detector : RBW:1000.000kHz VBW:3000.000kHz SWT:Auto          Detector : Peak          Project : FR052917-01          Mode : 36</p>	 <p>Site : E3CH07-RV          Condition : PEAK(LIN) 3m HF_ANT_00075962 HORIZONTAL          Detector : RBW:1000.000kHz VBW:3000.000kHz SWT:Auto          Detector : Peak          Project : FR052917-01          Mode : 36</p>

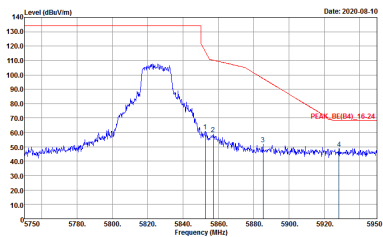
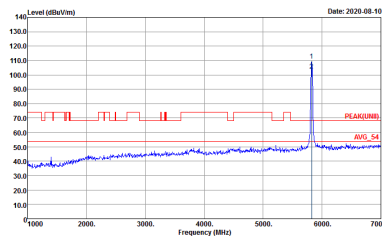

WIFI	Band 4 5725~5850MHz Band Edge @ 3m	
ANT	802.11a CH165 5825MHz	
1	Vertical	Fundamental
Peak	 <p>Site : E3CH07-RV          Condition : PEAK_BE(B4) 16-24 3m HF_ANT_00075962 VERTICAL          RBW:1000.000kHz VBW:3000.000kHz SWT:Auto          Detector : Peak          Project : 052917-01          Mode : 36</p>	 <p>Site : E3CH07-RV          Condition : PEAK(U/N1) 3m HF_ANT_00075962 VERTICAL          RBW:1000.000kHz VBW:3000.000kHz SWT:Auto          Detector : Peak          Project : 052917-01          Mode : 36</p>



**Band 4 5725~5850MHz**  
**WIFI 802.11ac VHT20 (Band Edge @ 3m)**

WIFI	Band 4 5725~5850MHz Band Edge @ 3m	
ANT	802.11ac VHT20 CH149 5745MHz	
1	Horizontal	Fundamental
<b>Peak</b>	<p>Site : 03CH07-HY            Condition : PEAK_BE(B4)_16-24 3m HF_ANT_00075962 HORIZONTAL            Detector : Peak            Project : 052917-01            Mode : 37</p>	<p>Site : 03CH07-HY            Condition : PEAK(LIN) 3m HF_ANT_00075962 HORIZONTAL            Detector : Peak            Project : 052917-01            Mode : 37</p>

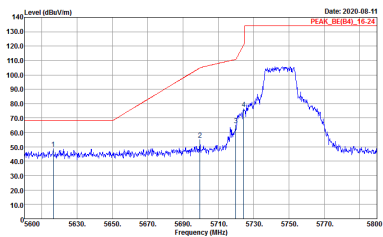
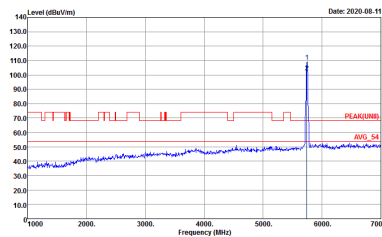

WIFI	Band 4 5725~5850MHz Band Edge @ 3m	
ANT	802.11ac VHT20 CH149 5745MHz	
1	Vertical	Fundamental
<p>Peak Avg.</p>	 <p>Date: 2020-08-11 PEAK_BE(B4)_16-24</p> <p>Site : ESCH07-11Y Condition : PEAK_BE(B4)_16-24 3m HF_ANT_00075962 VERTICAL Detector : RBW:1000.000kHz VBW:3000.000kHz SWT:Auto Project : FR052917-01 Mode : 37</p>	 <p>Date: 2020-08-11 PEAK(FUNB) AVG_54</p> <p>Site : ESCH07-11Y Condition : PEAK(FUNB)_3m HF_ANT_00075962 VERTICAL Detector : RBW:1000.000kHz VBW:3000.000kHz SWT:Auto Project : FR052917-01 Mode : 37</p>





WIFI	Band 4 5725~5850MHz Band Edge @ 3m	
ANT	802.11ac VHT20 CH157 5785MHz	
1	Horizontal	Fundamental
Peak	<p>Date: 2020.08.11 PEAK_BE(B4)_16-24</p> <p>Site : 03CH07-HY Condition : PEAK_BE(B4)_16-24 3m HF_ANT_00075962 HORIZONTAL Detector : RBW:1000.000kHz VBW:3000.000kHz SWT:Auto Project : 052917-01 Mode : 38</p>	<p>Date: 2020.08.11 PEAK(B4)</p> <p>Site : 03CH07-HY Condition : PEAK(LIN) 3m HF_ANT_00075962 HORIZONTAL Detector : RBW:1000.000kHz VBW:3000.000kHz SWT:Auto Project : 052917-01 Mode : 38</p>
Peak	<p>Date: 2020.08.11 PEAK_BE(B4)_16-24</p> <p>Site : 03CH07-HY Condition : PEAK_BE(B4)_16-24 3m HF_ANT_00075962 HORIZONTAL Detector : RBW:1000.000kHz VBW:3000.000kHz SWT:Auto Project : 052917-01 Mode : 38</p>	Left blank

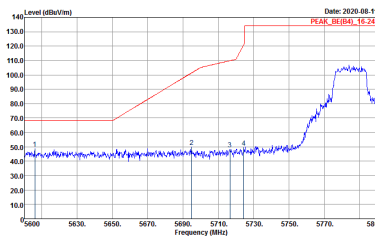
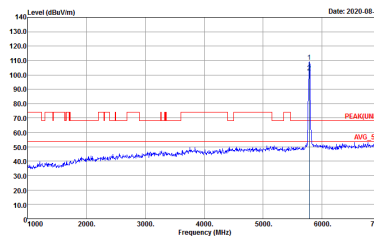
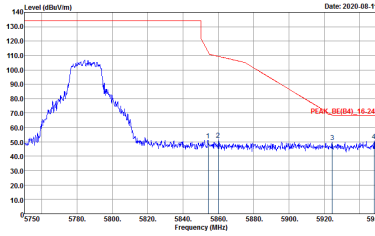

WIFI	Band 4 5725~5850MHz Band Edge @ 3m	
ANT	802.11ac VHT20 CH157 5785MHz	
1	Vertical	Fundamental
<p><b>Peak</b></p>	 <p>Site : 03CH07-HY            Condition : PEAK_BE(B4)_16-24 3m HF_ANT_00075962 VERTICAL            Detector : Peak            Project : 052917-01            Mode : 38</p>	 <p>Site : 03CH07-HY            Condition : PEAK(LIN) 3m HF_ANT_00075962 VERTICAL            Detector : Peak            Project : 052917-01            Mode : 38</p>
<p><b>Peak</b></p>	 <p>Site : 03CH07-HY            Condition : PEAK_BE(B4)_16-24 3m HF_ANT_00075962 VERTICAL            Detector : Peak            Project : 052917-01            Mode : 38</p>	<p><b>Left blank</b></p>



WIFI	Band 4 5725~5850MHz Band Edge @ 3m	
ANT	802.11ac VHT20 CH165 5825MHz	
1	Horizontal	Fundamental
<p><b>Peak</b></p>	<p>Site : ESCH07-RV            Condition : PEAK_BE(B4) 16-24 3m HF_ANT_00075962 HORIZONTAL            Detector : RBW:1000.000kHz VBW:3000.000kHz SWT:Auto            Detector : Peak            Project : FR052917-01            Mode : 39</p>	<p>Site : ESCH07-RV            Condition : PEAK(U/N) 3m HF_ANT_00075962 HORIZONTAL            Detector : RBW:1000.000kHz VBW:3000.000kHz SWT:Auto            Detector : Peak            Project : FR052917-01            Mode : 39</p>

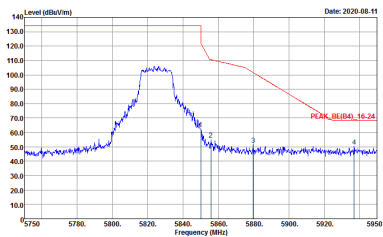
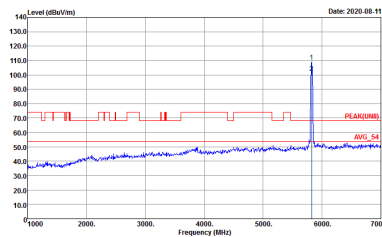

WIFI	Band 4 5725~5850MHz Band Edge @ 3m	
ANT	802.11ac VHT20 CH165 5825MHz	
1	Vertical	Fundamental
<p>Peak</p> <p>Avg.</p>	 <p>Site : ESCH07-RV          Condition : PEAK_BE(B4) 16.24 3m HF_ANT_00075962 VERTICAL          Detector : RBW:1000.000kHz VBW:3000.000kHz SWT:Auto          Detector : Peak          Project : 052917-01          Mode : 39</p>	 <p>Site : ESCH07-RV          Condition : PEAK(U/N) 3m HF_ANT_00075962 VERTICAL          Detector : RBW:1000.000kHz VBW:3000.000kHz SWT:Auto          Detector : Peak          Project : 052917-01          Mode : 39</p>



**Band 4 5725~5850MHz**  
**WIFI 802.11ac VHT40 (Band Edge @ 3m)**

WIFI	Band 4 5725~5850MHz Band Edge @ 3m	
ANT	802.11ac VHT40 CH151 5755MHz	
1	Horizontal	Fundamental
<b>Peak</b>	<p>Site : 03CH07-HY            Condition : PEAK_BE(B4)_16-24 3m HF_ANT_00075962 HORIZONTAL            Detector : Peak            Project : 052917-01            Mode : 40</p>	<p>Site : 03CH07-HY            Condition : PEAK(LIN) 3m HF_ANT_00075962 HORIZONTAL            Detector : Peak            Project : 052917-01            Mode : 40</p>
<b>Peak</b>	<p>Site : 03CH07-HY            Condition : PEAK_BE(B4)_16-24 3m HF_ANT_00075962 HORIZONTAL            Detector : Peak            Project : 052917-01            Mode : 40</p>	<b>Left blank</b>



WIFI	Band 4 5725~5850MHz Band Edge @ 3m	
ANT	802.11ac VHT40 CH151 5755MHz	
1	Vertical	Fundamental
<p><b>Peak</b></p>	<p>Date: 2020.08.11 PEAK_BE(B4)_16-24</p> <p>Site : 03CH07-HY Condition : PEAK_BE(B4)_16-24 3m HF_ANT_00075962 VERTICAL Detector : RBW:1000.000kHz VBW:3000.000kHz SWT:Auto Project : 052917-01 Mode : 40</p>	<p>Date: 2020.08.11 PEAK(FUNB) AVG_01</p> <p>Site : 03CH07-HY Condition : PEAK(FUNB)_3m HF_ANT_00075962 VERTICAL Detector : RBW:1000.000kHz VBW:3000.000kHz SWT:Auto Project : 052917-01 Mode : 40</p>
<p><b>Peak</b></p>	<p>Date: 2020.08.11 PEAK_BE(B4)_16-24</p> <p>Site : 03CH07-HY Condition : PEAK_BE(B4)_16-24 3m HF_ANT_00075962 VERTICAL Detector : RBW:1000.000kHz VBW:3000.000kHz SWT:Auto Project : 052917-01 Mode : 40</p>	<p><b>Left blank</b></p>

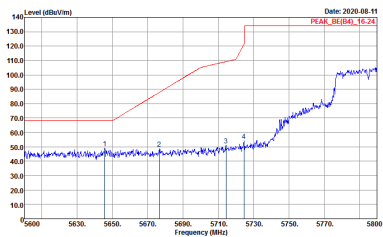
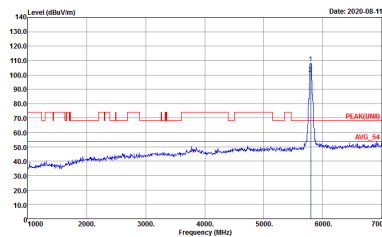
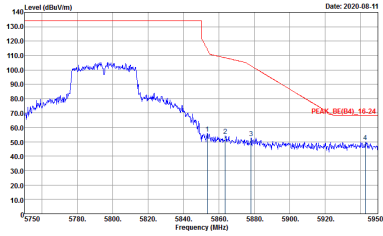

WIFI	Band 4 5725~5850MHz Band Edge @ 3m	
ANT	802.11ac VHT40 CH159 5795MHz	
1	Horizontal	Fundamental
<p><b>Peak</b></p>	 <p>Site : 03CH07-HY            Condition : PEAK_BE(B4)_16-24 3m HF_ANT_00075962 HORIZONTAL            Detector : Peak            Project : 052917-01            Mode : 41</p>	 <p>Site : 03CH07-HY            Condition : PEAK(UIN) 3m HF_ANT_00075962 HORIZONTAL            Detector : Peak            Project : 052917-01            Mode : 41</p>
<p><b>Peak</b></p>	 <p>Site : 03CH07-HY            Condition : PEAK_BE(B4)_16-24 3m HF_ANT_00075962 HORIZONTAL            Detector : Peak            Project : 052917-01            Mode : 41</p>	<p><b>Left blank</b></p>

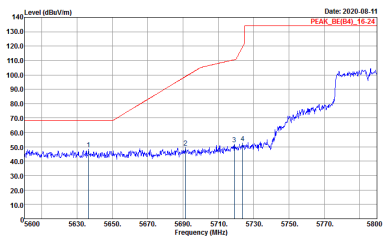
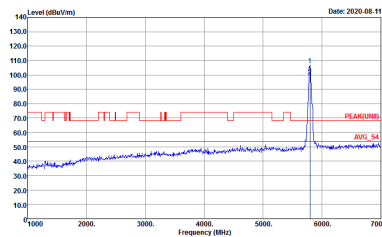
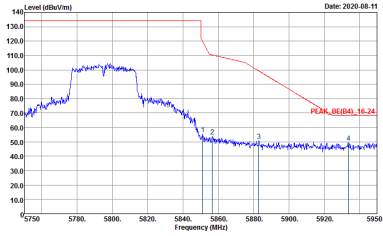

WIFI	Band 4 5725~5850MHz Band Edge @ 3m	
ANT	802.11ac VHT40 CH159 5795MHz	
1	Vertical	Fundamental
<p><b>Peak</b></p>	 <p>Site : 03CH07-HY            Condition : PEAK_BE(B4)_16-24 3m HF_ANT_00075962 VERTICAL            Detector : Peak            Project : 052917-01            Mode : 41</p>	 <p>Site : 03CH07-HY            Condition : PEAK(LNB) 3m HF_ANT_00075962 VERTICAL            Detector : Peak            Project : 052917-01            Mode : 41</p>
<p><b>Peak</b></p>	 <p>Site : 03CH07-HY            Condition : PEAK_BE(B4)_16-24 3m HF_ANT_00075962 VERTICAL            Detector : Peak            Project : 052917-01            Mode : 41</p>	<p><b>Left blank</b></p>





**Band 4 5725~5850MHz**  
**WIFI 802.11ac VHT80 (Band Edge @ 3m)**

WIFI	Band 4 5725~5850MHz Band Edge @ 3m	
ANT	802.11ac VHT80 CH155 5775MHz	
1	Horizontal	Fundamental
<b>Peak</b>	<p>Site : 03CH07-HY            Condition : PEAK_BE(B4)_16-24 3m HF_ANT_00075962 HORIZONTAL            RBW:1000.000kHz VBW:3000.000kHz SWT:Auto            Detector : Peak            Project : 052917-01            Mode : 42</p>	<p>Site : 03CH07-HY            Condition : PEAK(LIN) 3m HF_ANT_00075962 HORIZONTAL            RBW:1000.000kHz VBW:3000.000kHz SWT:Auto            Detector : Peak            Project : 052917-01            Mode : 42</p>
<b>Peak</b>	<p>Site : 03CH07-HY            Condition : PEAK_BE(B4)_16-24 3m HF_ANT_00075962 HORIZONTAL            RBW:1000.000kHz VBW:3000.000kHz SWT:Auto            Detector : Peak            Project : 052917-01            Mode : 42</p>	<b>Left blank</b>

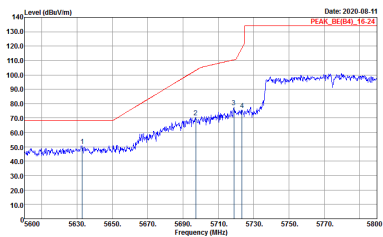
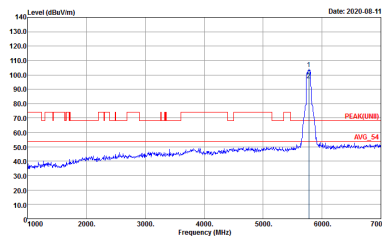
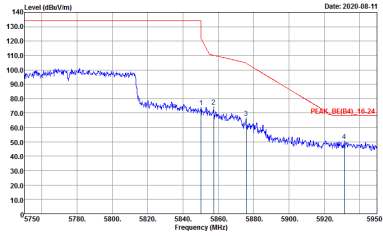

WIFI	Band 4 5725~5850MHz Band Edge @ 3m	
ANT	802.11ac VHT80 CH155 5775MHz	
1	Vertical	Fundamental
<p><b>Peak</b></p>	 <p>Site : 03CH07-HY            Condition : PEAK_BE(B4)_16-24 3m HF_ANT_00075962 VERTICAL            Detector : RBW:1000.000kHz VBW:3000.000kHz SWT:Auto            Detector : Peak            Project : 052917-01            Mode : 42</p>	 <p>Site : 03CH07-HY            Condition : PEAK(FUN) 3m HF_ANT_00075962 VERTICAL            Detector : RBW:1000.000kHz VBW:3000.000kHz SWT:Auto            Detector : Peak            Project : 052917-01            Mode : 42</p>
<p><b>Peak</b></p>	 <p>Site : 03CH07-HY            Condition : PEAK_BE(B4)_16-24 3m HF_ANT_00075962 VERTICAL            Detector : RBW:1000.000kHz VBW:3000.000kHz SWT:Auto            Detector : Peak            Project : 052917-01            Mode : 42</p>	<p><b>Left blank</b></p>



**Band 4 - 5725~5850MHz**  
**WIFI 802.11a (Harmonic @ 3m)**

<b>WIFI</b>	<b>Band 4 5725~5850MHz Harmonic @ 3m</b>	
<b>ANT</b>	<b>802.11a CH149 5745MHz</b>	
<b>1</b>	<b>Horizontal</b>	<b>Vertical</b>
<b>Peak</b> <b>Avg.</b>	<p>Site : 03CH07-HY          Condition : PEAK(UWB) 3m HF_ANT_00075962 HORIZONTAL          Detector : Peak          Project : 052917-01          Mode : 34</p>	<p>Site : 03CH07-HY          Condition : PEAK(UWB) 3m HF_ANT_00075962 VERTICAL          Detector : Peak          Project : 052917-01          Mode : 34</p>

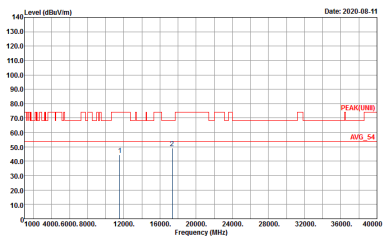
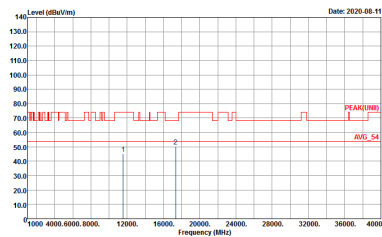

WIFI	Band 4 5725~5850MHz Harmonic @ 3m	
ANT	802.11a CH157 5785MHz	
1	Horizontal	Vertical
<p>Peak</p> <p>Avg.</p>	 <p>Site : ESCH07-HY          Condition : PEAK(LIN) 3m HE_ANT_00075962 HORIZONTAL          Detector : Peak          Project : 052917-01          Mode : 35</p>	 <p>Site : ESCH07-HY          Condition : PEAK(LIN) 3m HE_ANT_00075962 VERTICAL          Detector : Peak          Project : 052917-01          Mode : 35</p>

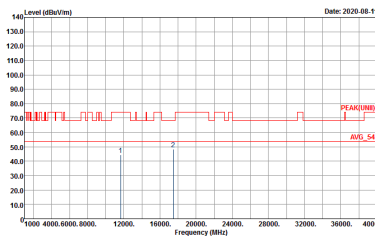
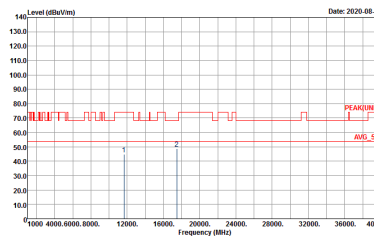

WIFI	Band 4 5725~5850MHz Harmonic @ 3m	
ANT	802.11a CH165 5825MHz	
1	Horizontal	Vertical
<p>Peak</p> <p>Avg.</p>	 <p>Site : ESCH07-RY          Condition : PEAK(LIN) 3m HE_ANT_00075962 HORIZONTAL          Detector : Peak          Project : 052917-01          Mode : 36</p>	 <p>Site : ESCH07-RY          Condition : PEAK(LIN) 3m HE_ANT_00075962 VERTICAL          Detector : Peak          Project : 052917-01          Mode : 36</p>



**Band 4 5725~5850MHz  
WIFI 802.11ac VHT20 (Harmonic @ 3m)**

WIFI	Band 4 5725~5850MHz Harmonic @ 3m	
ANT	802.11ac VHT20 CH149 5745MHz	
1	Horizontal	Vertical
<p><b>Peak</b> <b>Avg.</b></p>	<p>Site : 03CH07-HY          Condition : PEAK(LIN) 3m HF_ANT_00075962 HORIZONTAL          Detector : Peak          Project : 052917-01          Mode : 37</p>	<p>Site : 03CH07-HY          Condition : PEAK(LIN) 3m HF_ANT_00075962 VERTICAL          Detector : Peak          Project : 052917-01          Mode : 37</p>

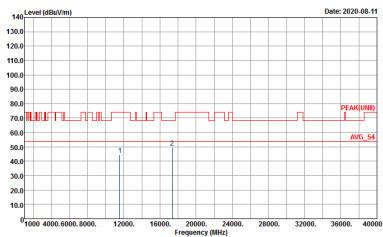
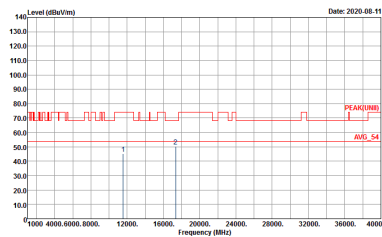

WIFI	Band 4 5725~5850MHz Harmonic @ 3m	
ANT	802.11ac VHT20 CH157 5785MHz	
1	Horizontal	Vertical
<p>Peak</p> <p>Avg.</p>	 <p>Site : ESCH07-RV          Condition : PEAK(LIN) 3m HE_ANT_00075962 HORIZONTAL          Detector : Peak          Project : 052917-01          Mode : 38</p>	 <p>Site : ESCH07-RV          Condition : PEAK(LIN) 3m HE_ANT_00075962 VERTICAL          Detector : Peak          Project : 052917-01          Mode : 38</p>



WIFI	Band 4 5725~5850MHz Harmonic @ 3m	
ANT	802.11ac VHT20 CH165 5825MHz	
1	Horizontal	Vertical
<b>Peak</b> <b>Avg.</b>	<p>Site : ESCH07-RV Condition : PEAK(LIN) 3m HE_ANT_00075962 HORIZONTAL Detector : Peak Project : 052917-01 Mode : 39</p>	<p>Site : ESCH07-RV Condition : PEAK(LIN) 3m HE_ANT_00075962 VERTICAL Detector : Peak Project : 052917-01 Mode : 39</p>



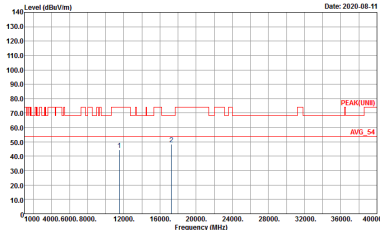
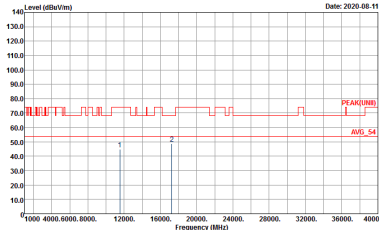

**Band 4 5725~5850MHz  
WIFI 802.11ac VHT40 (Harmonic @ 3m)**

WIFI	Band 4 5725~5850MHz Harmonic @ 3m	
ANT	802.11ac VHT40 CH151 5755MHz	
1	Horizontal	Vertical
<p><b>Peak</b> <b>Avg.</b></p>	 <p>Date: 2020.08.11</p> <p>Site : 03CH07-HY Condition : PEAK(UNII) 3m HF_ANT_00075962 HORIZONTAL Detector : Peak Project : 052917-01 Mode : 40</p>	 <p>Date: 2020.08.11</p> <p>Site : 03CH07-HY Condition : PEAK(UNII) 3m HF_ANT_00075962 VERTICAL Detector : Peak Project : 052917-01 Mode : 40</p>



WIFI	Band 4 5725~5850MHz Harmonic @ 3m	
ANT	802.11ac VHT40 CH159 5795MHz	
1	Horizontal	Vertical
<b>Peak</b> <b>Avg.</b>	<p>Site : ESCH07-RV Condition : PEAK(LIN) 3m HE_ANT_00075962 HORIZONTAL Detector : Peak Project : 052917-01 Mode : 41</p>	<p>Site : ESCH07-RV Condition : PEAK(LIN) 3m HE_ANT_00075962 VERTICAL Detector : Peak Project : 052917-01 Mode : 41</p>

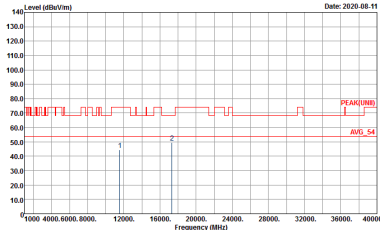
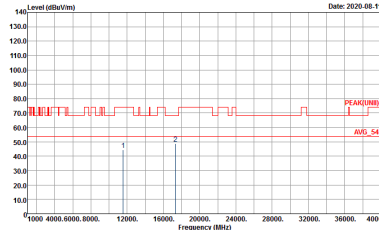

**Band 4 5725~5850MHz  
WIFI 802.11ac VHT80 (Harmonic @ 3m)**

WIFI	Band 4 5725~5850MHz Harmonic @ 3m	
ANT	802.11ac VHT80 CH155 5775MHz	
1	Horizontal	Vertical
<p><b>Peak</b> <b>Avg.</b></p>	 <p>Site : 03CH07-HY Condition : PEAK(UNII) 3m HF_ANT_00075962 HORIZONTAL Detector : Peak Project : 052917-01 Mode : 42</p>	 <p>Site : 03CH07-HY Condition : PEAK(UNII) 3m HF_ANT_00075962 VERTICAL Detector : Peak Project : 052917-01 Mode : 42</p>



Emission below 1GHz  
5GHz WIFI 802.11ac VHT80 (LF)

WIFI	5GHz WIFI	
ANT	802.11ac VHT80 LF	
1	Horizontal	Vertical
QP / Peak	<p>Site : 03CH07-HY Condition : QP 3m LF ANT: 15419(6) HORIZONTAL Detector : Peak Project : 052917-01 Mode : 44</p>	<p>Site : 03CH07-HY Condition : QP 3m LF ANT: 15419(6) VERTICAL Detector : Peak Project : 052917-01 Mode : 44</p>



### Appendix D. Duty Cycle Plots

Band	Duty Cycle(%)	T(us)	1/T(kHz)	VBW Setting	Duty Factor(dB)
802.11a	98.57	-	-	10Hz	0.06
5GHz 802.11ac VHT20	97.98	1940	0.52	1kHz	0.09
5GHz 802.11ac VHT40	96.96	950	1.05	3kHz	0.13
5GHz 802.11ac VHT80	92.22	462	2.16	3kHz	0.35

