



FCC RADIO TEST REPORT

FCC ID : UZ7MC27AJ
Equipment : Mobile computer
Brand Name : Zebra
Model Name : MC27AJ
Applicant : Zebra Technologies Corporation
1 Zebra Plaza, Holtsville, NY 11742
Manufacturer : Zebra Technologies Corporation
1 Zebra Plaza, Holtsville, NY 11742
Standard : FCC Part 15 Subpart C §15.247

The product was received on Jul. 30, 2020 and testing was started from Jul. 30, 2020 and completed on Sep. 02, 2020. We, SPORTON INTERNATIONAL INC., EMC & Wireless Communications Laboratory, would like to declare that the tested sample has been evaluated in accordance with the test procedures and has been in compliance with the applicable technical standards.

The test results in this variant report apply exclusively to the tested model / sample. Without written approval of SPORTON INTERNATIONAL INC. EMC & Wireless Communications Laboratory, the test report shall not be reproduced except in full.

Louis Wu

Reviewed by: Louis Wu

SPORTON INTERNATIONAL INC. EMC & Wireless Communications Laboratory

No. 52, Huaya 1st Rd., Guishan Dist., Taoyuan City, Taiwan (R.O.C.)



Table of Contents

History of this test report.....	3
Summary of Test Result.....	4
1 General Description.....	5
1.1 Product Feature of Equipment Under Test.....	5
1.2 Product Specification of Equipment Under Test.....	5
1.3 Modification of EUT	5
1.4 Testing Location	6
1.5 Applicable Standards.....	6
2 Test Configuration of Equipment Under Test.....	7
2.1 Carrier Frequency Channel	7
2.2 Test Mode.....	8
2.3 Connection Diagram of Test System.....	11
2.4 Support Unit used in test configuration and system	11
2.5 EUT Operation Test Setup	11
3 Test Result.....	12
3.1 Output Power Measurement.....	12
3.2 Radiated Band Edges and Spurious Emission Measurement	14
3.3 Antenna Requirements.....	18
4 List of Measuring Equipment	19
5 Uncertainty of Evaluation.....	20
Appendix A. Radiated Spurious Emission	
Appendix B. Radiated Spurious Emission Plots	
Appendix C. Duty Cycle Plots	
Appendix D. Setup Photographs	



History of this test report

Report No.	Version	Description	Issued Date									
FR052917-02A	01	<p>This is a variant report for MC27AJ, and the differences between this model name and MC27AK are as listed below:</p> <table border="1"> <thead> <tr> <th>Item/Model</th> <th>MC27AK</th> <th>MC27AJ</th> </tr> </thead> <tbody> <tr> <td>Camera</td> <td>O</td> <td>X</td> </tr> <tr> <td>NFC</td> <td>O</td> <td>X</td> </tr> </tbody> </table> <p>All the test cases were performed on original report which can be referred to Sporton Report Number FR052917-01A.</p>	Item/Model	MC27AK	MC27AJ	Camera	O	X	NFC	O	X	Oct. 29, 2020
Item/Model	MC27AK	MC27AJ										
Camera	O	X										
NFC	O	X										



Summary of Test Result

Report Clause	Ref Std. Clause	Test Items	Result (PASS/FAIL)	Remark
-	15.247(a)(1)	Number of Channels	Not Required	-
-	15.247(a)(1)	Hopping Channel Separation	Not Required	-
-	15.247(a)(1)	Dwell Time of Each Channel	Not Required	-
-	15.247(a)(1)	20dB Bandwidth	Not Required	-
-	2.1049	99% Occupied Bandwidth	Not Required	-
3.1	15.247(b)(1)	Peak Output Power	Pass	-
-	15.247(d)	Conducted Band Edges	Not Required	-
-	15.247(d)	Conducted Spurious Emission	Not Required	-
3.2	15.247(d)	Radiated Band Edges and Radiated Spurious Emission	Pass	Under limit 8.37 dB at 30.000 MHz
-	15.207	AC Conducted Emission	Not Required	-
3.3	15.203 & 15.247(b)	Antenna Requirement	Pass	-

Note: Not required means after assessing, test items are not necessary to carry out.

Declaration of Conformity:

The test results with all measurement uncertainty excluded are presented in accordance with the regulation limits or requirements declared by manufacturers.

Comments and Explanations:

The declared of product specification for EUT presented in the report are provided by the manufacturer, and the manufacturer takes all the responsibilities for the accuracy of product specification.

Reviewed by: Wii Chang

Report Producer: Lucy Wu



1 General Description

1.1 Product Feature of Equipment Under Test

Product Feature	
Equipment	Mobile computer
Brand Name	Zebra
Model Name	MC27AJ
FCC ID	UZ7MC27AJ
EUT supports Radios application	WCDMA/HSPA/LTE/GNSS WLAN 11a/b/g/n HT20/HT40 WLAN 11ac VHT20/VHT40/VHT80 Bluetooth BR/EDR/LE
HW Version	EV
SW Version	10-11-31.00-QG-U00-PRD-HEL-04
OS Version	Android 10
MFD	23JUN20
EUT Stage	Engineering Sample

Remark: The above EUT's information was declared by manufacturer.

Specification of Accessories				
AC Adapter	Brand Name	Zebra	Part Number	PWR-WUA5V12W0US
Battery	Brand Name	Zebra	Part Number	BT-000418-10
USB Cable (TypeA plug to TypeC plug)	Brand Name	Zebra	Part Number	CBL-TC2X-USBC-01
Trigger Handle	Brand Name	Zebra	Part Number	TRG-MC2X-SNP1-01
Holster	Brand Name	Zebra	Part Number	SG-MC2X-HLSTR-01
Holster	Brand Name	Zebra	Part Number	SG-MC3021212-01R

1.2 Product Specification of Equipment Under Test

Product Specification subjective to this standard	
Tx/Rx Frequency Range	2402 MHz ~ 2480 MHz
Number of Channels	79
Carrier Frequency of Each Channel	2402+n*1 MHz; n=0~78
Maximum Output Power to Antenna	Bluetooth BR(1Mbps) : 4.83 dBm (0.0030 W) Bluetooth EDR (2Mbps) : 6.77 dBm (0.0048 W) Bluetooth EDR (3Mbps) : 7.22 dBm (0.0053 W)
Antenna Type / Gain	PIFA Antenna type with gain 2.31 dBi
Type of Modulation	Bluetooth BR (1Mbps) : GFSK Bluetooth EDR (2Mbps) : $\pi/4$ -DQPSK Bluetooth EDR (3Mbps) : 8-DPSK

1.3 Modification of EUT

No modifications are made to the EUT during all test items.



1.4 Testing Location

Test Site	SPORTON INTERNATIONAL INC. EMC & Wireless Communications Laboratory	
Test Site Location	No.52, Huaya 1st Rd., Guishan Dist., Taoyuan City, Taiwan (R.O.C.) TEL: +886-3-327-3456 FAX: +886-3-328-4978	
Test Site No.	Sporton Site No.	
	TH05-HY	03CH07-HY

Note: The test site complies with ANSI C63.4 2014 requirement.

FCC designation No.: TW1190

1.5 Applicable Standards

According to the specifications of the manufacturer, the EUT must comply with the requirements of the following standards:

- ♦ FCC Part 15 Subpart C §15.247
- ♦ FCC KDB Publication No. 558074 D01 DTS Meas. Guidance v05r02
- ♦ FCC KDB 414788 D01 Radiated Test Site v01r01
- ♦ ANSI C63.10-2013

Remark:

1. All test items were verified and recorded according to the standards and without any deviation during the test.
2. The TAF code is not including all the FCC KDB listed without accreditation.
3. This EUT has also been tested and complied with the requirements of FCC Part 15, Subpart B, recorded in a separate test report.



2 Test Configuration of Equipment Under Test

2.1 Carrier Frequency Channel

Frequency Band	Channel	Freq. (MHz)	Channel	Freq. (MHz)	Channel	Freq. (MHz)
2400-2483.5 MHz	0	2402	27	2429	54	2456
	1	2403	28	2430	55	2457
	2	2404	29	2431	56	2458
	3	2405	30	2432	57	2459
	4	2406	31	2433	58	2460
	5	2407	32	2434	59	2461
	6	2408	33	2435	60	2462
	7	2409	34	2436	61	2463
	8	2410	35	2437	62	2464
	9	2411	36	2438	63	2465
	10	2412	37	2439	64	2466
	11	2413	38	2440	65	2467
	12	2414	39	2441	66	2468
	13	2415	40	2442	67	2469
	14	2416	41	2443	68	2470
	15	2417	42	2444	69	2471
	16	2418	43	2445	70	2472
	17	2419	44	2446	71	2473
	18	2420	45	2447	72	2474
	19	2421	46	2448	73	2475
	20	2422	47	2449	74	2476
	21	2423	48	2450	75	2477
	22	2424	49	2451	76	2478
	23	2425	50	2452	77	2479
	24	2426	51	2453	78	2480
	25	2427	52	2454	-	-
	26	2428	53	2455	-	-



2.2 Test Mode

Channel	Frequency	Bluetooth Average Output Power		
		GFSK / 1Mbps		
		DH1	DH3	DH5
Ch00	2402MHz	3.80 dBm	3.80 dBm	3.78 dBm
Ch39	2441MHz	4.20 dBm	4.17 dBm	4.14 dBm
Ch78	2480MHz	4.60 dBm	4.58 dBm	4.56 dBm

Channel	Frequency	Bluetooth Average Output Power		
		$\pi/4$ -DQPSK / 2Mbps		
		2DH1	2DH3	2DH5
Ch00	2402MHz	3.41 dBm	3.29 dBm	3.25 dBm
Ch39	2441MHz	3.83 dBm	3.73 dBm	3.71 dBm
Ch78	2480MHz	4.27 dBm	4.13 dBm	4.08 dBm

Channel	Frequency	Bluetooth Average Output Power		
		8-DPSK / 3Mbps		
		3DH1	3DH3	3DH5
Ch00	2402MHz	3.41 dBm	3.31 dBm	3.24 dBm
Ch39	2441MHz	3.85 dBm	3.74 dBm	3.70 dBm
Ch78	2480MHz	4.28 dBm	4.18 dBm	4.11 dBm



Channel	Frequency	Bluetooth Peak Output Power		
		GFSK / 1Mbps		
		DH1	DH3	DH5
Ch00	2402MHz	4.01 dBm	3.97 dBm	3.95 dBm
Ch39	2441MHz	4.37 dBm	4.32 dBm	4.30 dBm
Ch78	2480MHz	4.83 dBm	4.77 dBm	4.76 dBm

Channel	Frequency	Bluetooth Peak Output Power		
		$\pi/4$ -DQPSK / 2Mbps		
		2DH1	2DH3	2DH5
Ch00	2402MHz	5.89 dBm	5.88 dBm	5.86 dBm
Ch39	2441MHz	6.38 dBm	6.37 dBm	6.35 dBm
Ch78	2480MHz	6.77 dBm	6.76 dBm	6.73 dBm

Channel	Frequency	Bluetooth Peak Output Power		
		8-DPSK / 3Mbps		
		3DH1	3DH3	3DH5
Ch00	2402MHz	6.40 dBm	6.36 dBm	6.34 dBm
Ch39	2441MHz	6.81 dBm	6.78 dBm	6.77 dBm
Ch78	2480MHz	7.22 dBm	7.16 dBm	7.12 dBm

Remark:The data rate was set in 3Mbps for all the test items due to the highest RF output power.



- a. The EUT has been associated with peripherals and configuration operated in a manner tended to maximize its emission characteristics in a typical application. Frequency range investigated: radiation emission (9 kHz to the 10th harmonic of the highest fundamental frequency or to 40 GHz, whichever is lower). For radiated measurement, pre-scanned in three orthogonal panels, X, Y, Z. The worst cases (X plane) were recorded in this report, and the worst mode of radiated spurious emissions is Bluetooth 3Mbps mode, and recorded in this report.

The following summary table is showing all test modes to demonstrate in compliance with the standard.

Summary table of Test Cases	
Test Item	Data Rate / Modulation
Radiated Test Cases	Bluetooth EDR 3Mbps 8-DPSK
	Mode 1: CH00_2402 MHz
	Mode 2: CH39_2441 MHz
	Mode 3: CH78_2480 MHz
Remark: For radiated test cases, the worst mode data rate 3Mbps was reported only since the highest RF output power in the preliminary tests. The conducted spurious emissions and conducted band edge measurement for other data rates were not worse than 3Mbps, and no other significantly frequencies found in conducted spurious emission.	

2.3 Connection Diagram of Test System

<Bluetooth Tx Mode>

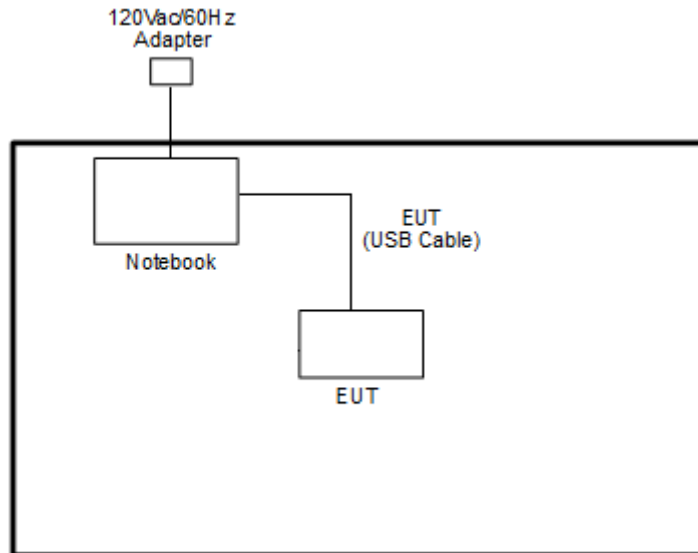

2.4 Support Unit used in test configuration and system

Item	Equipment	Brand Name	Model Name	FCC ID	Data Cable	Power Cord
1.	Notebook	DELL	Latitude E3340	FCC DoC/ Contains FCC ID: PD97260NGU	N/A	AC I/P: Unshielded, 1.2 m DC O/P: Shielded, 1.8 m

2.5 EUT Operation Test Setup

The RF test items, utility "QRCT4.0.00156.0" was installed in Notebook which was programmed in order to make the EUT get into the engineering modes to provide channel selection, power level, data rate and the application type and for continuous transmitting signals.

3 Test Result

3.1 Output Power Measurement

3.1.1 Limit of Output Power

The maximum peak conducted output power of the intentional radiator shall not exceed the following:
For frequency hopping systems operating in the 2400-2483.5 MHz band employing at least 75 non-overlapping hopping channels, and all frequency hopping systems in the 5725-5850 MHz band: 1 watt. For all other frequency hopping systems in the 2400-2483.5 MHz band 0.125 watts.

3.1.2 Measuring Instruments

See list of measuring equipment of this test report.

3.1.3 Test Procedures

1. The testing follows ANSI C63.10-2013 clause 7.8.5.
2. The RF output of EUT was connected to the power meter by RF cable and attenuator. The path loss was compensated to the results for each measurement.
3. Set to the maximum power setting and enable the EUT transmit continuously.
4. Measure the conducted output power with cable loss and record the results in the test report.
5. Measure and record the results in the test report.

3.1.4 Test Setup

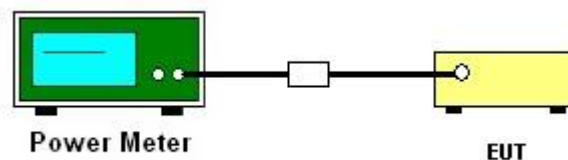



3.1.5 Test Result of Peak Output Power

Test Engineer :	Tommy Lee	Temperature :	23.5~24.3°C
		Relative Humidity :	49~55%

DH	CH.	NTX	Peak Power (dBm)	Power Limit (dBm)	Test Result
DH1	0	1	4.01	20.97	Pass
	39	1	4.37	20.97	Pass
	78	1	4.83	20.97	Pass

2DH	CH.	NTX	Peak Power (dBm)	Power Limit (dBm)	Test Result
2DH1	0	1	5.89	20.97	Pass
	39	1	6.38	20.97	Pass
	78	1	6.77	20.97	Pass

3DH	CH.	NTX	Peak Power (dBm)	Power Limit (dBm)	Test Result
3DH1	0	1	6.40	20.97	Pass
	39	1	6.81	20.97	Pass
	78	1	7.22	20.97	Pass

3.1.6 Test Result of Average Output Power (Reporting Only)

Test Engineer :	Tommy Lee	Temperature :	23.5~24.3°C
		Relative Humidity :	49~55%

DH	CH.	NTX	Average Power (dBm)	Duty Factor (dB)
DH1	0	1	3.80	5.15
	39	1	4.20	5.15
	78	1	4.60	5.15

2DH	CH.	NTX	Average Power (dBm)	Duty Factor (dB)
2DH1	0	1	3.41	5.08
	39	1	3.83	5.08
	78	1	4.27	5.08

3DH	CH.	NTX	Average Power (dBm)	Duty Factor (dB)
3DH1	0	1	3.41	5.08
	39	1	3.85	5.08
	78	1	4.28	5.08



3.2 Radiated Band Edges and Spurious Emission Measurement

3.2.1 Limit of Radiated Band Edges and Spurious Emission

In any 100 kHz bandwidth outside the intentional radiator frequency band, all harmonics/spurious must be at least 20 dB below the highest emission level within the authorized band. In addition, radiated emissions which fall in the restricted bands must also comply with the limits as below.

Frequency (MHz)	Field Strength (microvolts/meter)	Measurement Distance (meters)
0.009 – 0.490	2400/F(kHz)	300
0.490 – 1.705	24000/F(kHz)	30
1.705 – 30.0	30	30
30 – 88	100	3
88 – 216	150	3
216 - 960	200	3
Above 960	500	3

3.2.2 Measuring Instruments

See list of measuring equipment of this test report.



3.2.3 Test Procedures

1. The EUT was placed on a turntable with 0.8 meter for frequency below 1GHz and 1.5 meter for frequency above 1GHz respectively above ground.
2. The EUT was set 3 meters from the interference receiving antenna, which was mounted on the top of a variable height antenna tower.
3. For each suspected emission, the EUT was arranged to its worst case and then tune the Antenna tower (from 1 m to 4 m) and turntable (from 0 degree to 360 degrees) to find the maximum reading. A pre-amp and a high pass filter are used for the test in order to get better signal level to comply with the guidelines.
4. Set to the maximum power setting and enable the EUT transmit continuously.
5. Use the following spectrum analyzer settings:
 - (1) Span shall wide enough to fully capture the emission being measured;
 - (2) Set RBW=100 kHz for $f < 1$ GHz, RBW=1MHz for $f > 1$ GHz ; VBW \geq RBW; Sweep = auto; Detector function = peak; Trace = max hold for peak
 - (3) For average measurement: use duty cycle correction factor method per 15.35(c).
Duty cycle = On time/100 milliseconds
On time = $N_1 * L_1 + N_2 * L_2 + \dots + N_{n-1} * L_{n-1} + N_n * L_n$
Where N_1 is number of type 1 pulses, L_1 is length of type 1 pulses, etc.
Average Emission Level = Peak Emission Level + $20 * \log(\text{Duty cycle})$
6. Corrected Reading: Antenna Factor + Cable Loss + Read Level - Preamp Factor = Level
7. For testing below 1GHz, if the emission level of the EUT in peak mode was 3 dB lower than the limit specified, then peak values of EUT will be reported, otherwise, the emissions will be repeated one by one using the CISPR quasi-peak method and reported.
8. For testing above 1GHz, the emission level of the EUT in peak mode was 20dB lower than average limit (that means the emission level in average mode also complies with the limit in average mode), then peak values of EUT will be reported, otherwise, the emissions will be measured in average mode again and reported.

Note: The average levels were calculated from the peak level corrected with duty cycle correction factor (-24.76dB) derived from $20 \log(\text{dwell time}/100\text{ms})$. This correction is only for signals that hop with the fundamental signal, such as band-edge and harmonic. Other spurious signals that are independent of the hopping signal would not use this correction.

3.2.4 Test Setup

For radiated emissions below 30MHz

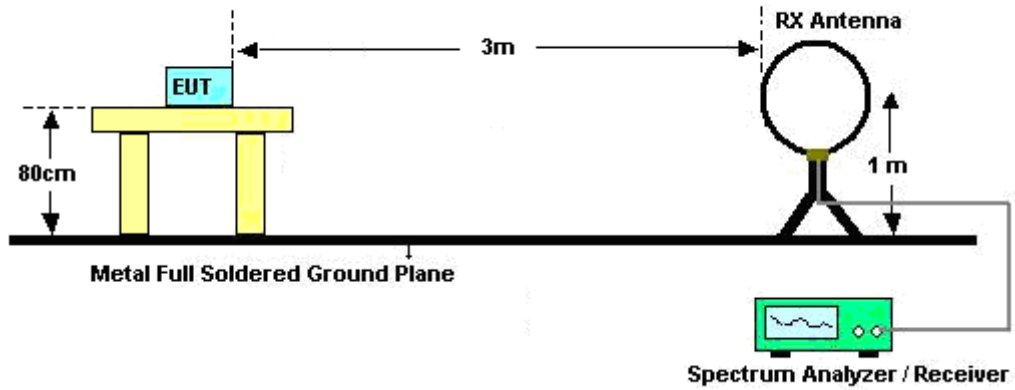

For radiated emissions from 30MHz to 1GHz

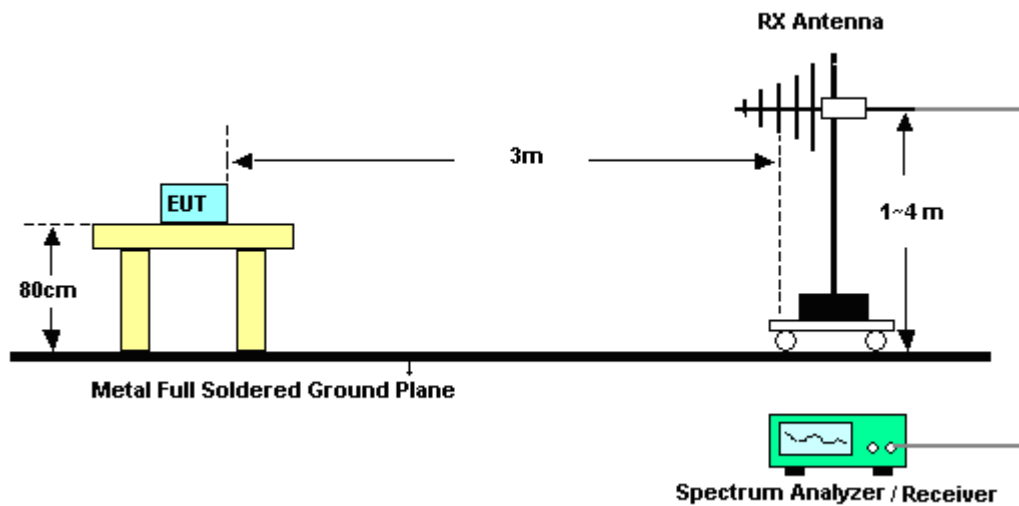

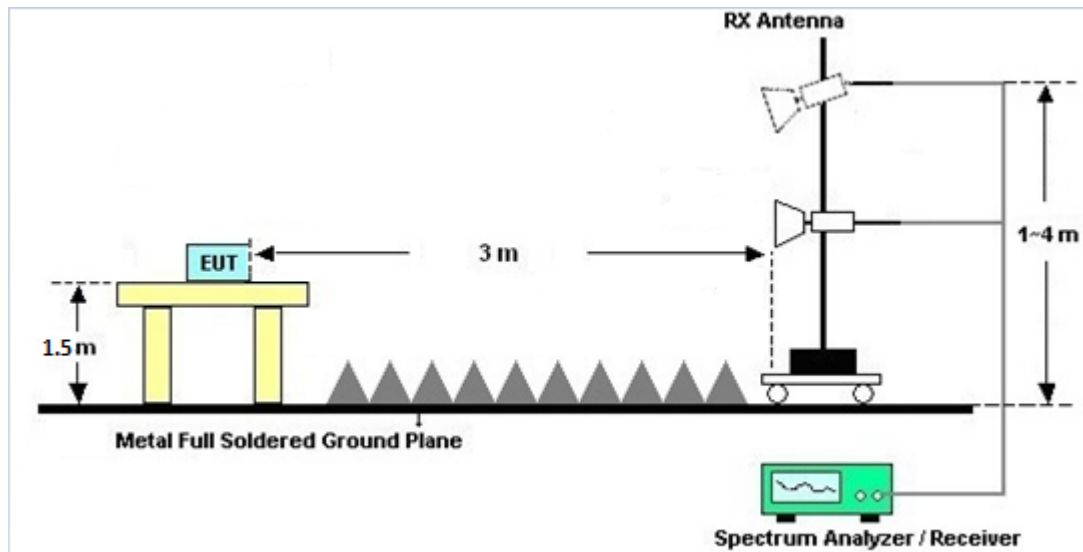
For radiated emissions above 1GHz**3.2.5 Test Results of Radiated Spurious Emissions (9 kHz ~ 30 MHz)**

The low frequency, which started from 9 kHz to 30MHz, was pre-scanned and the result which was 20dB lower than the limit line was not reported.

There is a comparison data of both open-field test site and alternative test site - semi-Anechoic chamber according to 414788 D01 Radiated Test Site v01r01, and the result came out very similar.

3.2.6 Test Result of Radiated Spurious at Band Edges

Please refer to Appendix A and B.

3.2.7 Duty Cycle

Please refer to Appendix C.

3.2.8 Test Result of Radiated Spurious Emission (30MHz ~ 10th Harmonic)

Please refer to Appendix A and B.



3.3 Antenna Requirements

3.3.1 Standard Applicable

If directional gain of transmitting antennas is greater than 6dBi, the power shall be reduced by the same level in dB comparing to gain minus 6dBi. The use of a permanently attached antenna or of an antenna that uses a unique coupling to the intentional radiator shall be considered sufficient to comply with the rule.

3.3.2 Antenna Anti-Replacement Construction

An embedded-in antenna design is used.

3.3.3 Antenna Gain

The antenna peak gain of EUT is less than 6 dBi. Therefore, it is not necessary to reduce maximum peak output power limit.



4 List of Measuring Equipment

Instrument	Brand Name	Model No.	Serial No.	Characteristics	Calibration Date	Test Date	Due Date	Remark
Hygrometer	Testo	608-H1	34893241	N/A	Mar. 02, 2020	Jul. 30, 2020~ Sep. 02, 2020	Mar. 01, 2021	Conducted (TH05-HY)
Power Meter	Agilent	E4416A	GB4129234 4	N/A	Dec. 27, 2019	Jul. 30, 2020~ Sep. 02, 2020	Dec. 26, 2020	Conducted (TH05-HY)
Power Sensor	Agilent	E9327A	US4044154 8	50MHz~18GHz	Dec. 27, 2019	Jul. 30, 2020~ Sep. 02, 2020	Dec. 26, 2020	Conducted (TH05-HY)
Signal Analyzer	Rohde & Schwarz	FSV40	101397	10Hz~40GHz	Nov. 15, 2019	Jul. 30, 2020~ Sep. 02, 2020	Nov. 14, 2020	Conducted (TH05-HY)
BT Base Station	Rohde & Schwarz	CBT	101136	BT 3.0	Oct. 27, 2019	Jul. 30, 2020~ Sep. 02, 2020	Oct. 26, 2020	Conducted (TH05-HY)
Switch Box & RF Cable	EM Electronics	EMSW18SE	SW200302	N/A	Mar. 17, 2020	Jul. 30, 2020~ Sep. 02, 2020	Mar. 16, 2021	Conducted (TH05-HY)
Loop Antenna	Rohde & Schwarz	HFH2-Z2	100315	9 kHz~30 MHz	Dec. 26, 2019	Aug. 27, 2020~ Aug. 29, 2020	Dec. 25, 2020	Radiation (03CH07-HY)
Bilog Antenna	TESEQ	CBL 6111D & 00800N1D01 N-06	35419 & 03	30MHz~1GHz	Apr. 29, 2020	Aug. 27, 2020~ Aug. 29, 2020	Apr. 28, 2021	Radiation (03CH07-HY)
Double Ridge Horn Antenna	ESCO	3117	00075962	1GHz ~ 18GHz	Dec. 06, 2019	Aug. 27, 2020~ Aug. 29, 2020	Dec. 05, 2020	Radiation (03CH07-HY)
SHF-EHF Horn Antenna	SCHWARZBECK	BBHA 9170	BBHA9170 584	18GHz~40GHz	Dec. 10, 2019	Aug. 27, 2020~ Aug. 29, 2020	Dec. 09, 2020	Radiation (03CH07-HY)
EMI Test Receiver	Agilent	N9038A(MXE)	MY5329005 3	20Hz~26.5GHz	May 21, 2020	Aug. 27, 2020~ Aug. 29, 2020	May 20, 2021	Radiation (03CH07-HY)
Spectrum Analyzer	Agilent	N9030A	MY5235027 6	3Hz~44GHz	Jun. 09, 2020	Aug. 27, 2020~ Aug. 29, 2020	Jun. 08, 2021	Radiation (03CH07-HY)
Preamplifier	COM-POWER	PA-103A	161241	10MHz~1GHz	May 19, 2020	Aug. 27, 2020~ Aug. 29, 2020	May 18, 2021	Radiation (03CH07-HY)
Preamplifier	MITEQ	AMF-7D-001 01800-30-10 P	1590075	1GHz~18GHz	Apr. 23, 2020	Aug. 27, 2020~ Aug. 29, 2020	Apr. 22, 2021	Radiation (03CH07-HY)
Preamplifier	Agilent	8449B	3008A0236 2	1GHz~26.5GHz	Nov. 01, 2019	Aug. 27, 2020~ Aug. 29, 2020	Oct. 31, 2020	Radiation (03CH07-HY)
Preamplifier	EMEC	EM18G40G	060715	18GHz~40GHz	Dec. 13, 2019	Aug. 27, 2020~ Aug. 29, 2020	Dec. 12, 2020	Radiation (03CH07-HY)
RF Cable	HUBER + SUHNER	SUCOFLEX 102	MY2858/2,8 01606/2	18GHz~40GHz	Feb. 25, 2020	Aug. 27, 2020~ Aug. 29, 2020	Feb. 24, 2021	Radiation (03CH07-HY)
RF Cable	HUBER + SUHNER	SUCOFLEX 104	MY24971/4, MY28655/4	9kHz~30MHz	Feb. 25, 2020	Aug. 27, 2020~ Aug. 29, 2020	Feb. 24, 2021	Radiation (03CH07-HY)
RF Cable	HUBER + SUHNER	SUCOFLEX 104	MY28655/4, MY24971/4, MY15682/4	30MHz~1GHz	Feb. 25, 2020	Aug. 27, 2020~ Aug. 29, 2020	Feb. 24, 2021	Radiation (03CH07-HY)
RF Cable	HUBER + SUHNER	SUCOFLEX 104	MY28655/4, MY24971/4, MY15682/4	1GHz~18GHz	Feb. 25, 2020	Aug. 27, 2020~ Aug. 29, 2020	Feb. 24, 2021	Radiation (03CH07-HY)
Antenna Mast	Max-Full	MFA520BS	N/A	1m~4m	N/A	Aug. 27, 2020~ Aug. 29, 2020	N/A	Radiation (03CH07-HY)
Turn Table	ChainTek	Chaintek 3000	N/A	0~360 Degree	N/A	Aug. 27, 2020~ Aug. 29, 2020	N/A	Radiation (03CH07-HY)
USB Data Logger	TECPEL	TR-32	HE17XB24 95	N/A	N/A	Aug. 27, 2020~ Aug. 29, 2020	N/A	Radiation (03CH07-HY)
Software	Audix	E3 6.2009-8-24	N/A	N/A	N/A	Aug. 27, 2020~ Aug. 29, 2020	N/A	Radiation (03CH07-HY)



5 Uncertainty of Evaluation

Uncertainty of Radiated Emission Measurement (30 MHz ~ 1000 MHz)

Measuring Uncertainty for a Level of Confidence of 95% ($U = 2Uc(y)$)	4.7
---	-----

Uncertainty of Radiated Emission Measurement (1000 MHz ~ 18000 MHz)

Measuring Uncertainty for a Level of Confidence of 95% ($U = 2Uc(y)$)	5.3
---	-----

Uncertainty of Radiated Emission Measurement (18000 MHz ~ 40000 MHz)

Measuring Uncertainty for a Level of Confidence of 95% ($U = 2Uc(y)$)	5.0
---	-----



Appendix A. Radiated Spurious Emission

Test Engineer :	Jesse Wang, Stan Hsieh and Ken Wu	Temperature :	22~23°C
		Relative Humidity :	51~58%

2.4GHz 2400~2483.5MHz

BT (Band Edge @ 3m)

BT	Note	Frequency	Level	Over	Limit	Read	Antenna	Path	Preamp	Ant	Table	Peak	Pol.	
		(MHz)	(dBμV/m)	(dB)	Limit	Level	Factor	Loss	Factor	Pos	Pos	Avg.		
		(MHz)	(dBμV/m)	(dB)	Line	(dBμV)	(dB/m)	(dB)	(dB)	(cm)	(deg)	(P/A)	(H/V)	
BT CH00 2402MHz		2355.36	44.6	-29.4	74	40.02	31.87	7.92	35.21	304	286	P	H	
		2355.36	19.84	-34.16	54	-	-	-	-	-	-	A	H	
	*	2402	96.93	-	-	92.37	31.8	8	35.24	304	286	P	H	
	*	2402	72.17	-	-	-	-	-	-	-	-	A	H	
													H	
														H
			2371.53	44.71	-29.29	74	40.15	31.83	7.95	35.22	100	131	P	V
			2371.53	19.95	-34.05	54	-	-	-	-	-	-	A	V
	*		2402	95.41	-	-	90.85	31.8	8	35.24	100	131	P	V
	*		2402	70.65	-	-	-	-	-	-	-	-	A	V
														V
														V
Remark	1. No other spurious found. 2. All results are PASS against Peak and Average limit line.													



2.4GHz 2400~2483.5MHz
BT (Harmonic @ 3m)

BT	Note	Frequency	Level	Over	Limit	Read	Antenna	Path	Preamp	Ant	Table	Peak	Pol.	
				Limit	Line	Level	Factor	Loss	Factor	Pos	Pos	Avg.		
		(MHz)	(dBμV/m)	(dB)	(dBμV/m)	(dBμV)	(dB/m)	(dB)	(dB)	(cm)	(deg)	(P/A)	(H/V)	
BT CH 00 2402MHz		4804	40.45	-33.55	74	53.42	34	11.97	58.94	100	0	P	H	
		4804	15.69	-38.31	54	-	-	-	-	-	-	A	H	
													H	
													H	
		4804	41.32	-32.68	74	54.29	34	11.97	58.94	100	0	P	V	
		4804	16.56	-37.44	54	-	-	-	-	-	-	-	A	V
														V
														V
Remark	1. No other spurious found. 2. All results are PASS against Peak and Average limit line.													



Emission below 1GHz

2.4GHz BT (LF)

BT	Note	Frequency	Level	Over	Limit	Read	Antenna	Path	Preamp	Ant	Table	Peak	Pol.	
				Limit	Line	Level	Factor	Loss	Factor	Pos	Pos	Avg.		
		(MHz)	(dBμV/m)	(dB)	(dBμV/m)	(dBμV)	(dB/m)	(dB)	(dB)	(cm)	(deg)	(P/A)	(H/V)	
2.4GHz BT LF		200.64	30.99	-12.51	43.5	43.55	14.99	2.38	29.93	-	-	P	H	
		220.89	31.3	-14.7	46	43.36	15.36	2.5	29.92	-	-	P	H	
		256.53	32.41	-13.59	46	40.49	19.13	2.7	29.91	-	-	P	H	
		857.9	35.68	-10.32	46	31	28.88	4.99	29.19	100	0	P	H	
		882.4	35.17	-10.83	46	30.32	28.86	5.06	29.07	-	-	P	H	
		955.2	33.82	-12.18	46	26.69	30.53	5.27	28.67	-	-	P	H	
														H
														H
														H
														H
														H
														H
			30	31.63	-8.37	40	36.39	24.32	0.93	30.01	100	0	P	V
			34.59	21.63	-18.37	40	28.52	22.13	0.99	30.01	-	-	P	V
			229.8	35.74	-10.26	46	46.91	16.2	2.55	29.92	-	-	P	V
			598.9	33.17	-12.83	46	33.32	25.52	4.16	29.83	-	-	P	V
			883.8	32.8	-13.2	46	27.95	28.84	5.07	29.06	-	-	P	V
			958	34.39	-11.61	46	27.32	30.44	5.28	28.65	-	-	P	V
														V
														V
													V	
													V	
													V	
													V	
Remark	1. No other spurious found. 2. All results are PASS against limitline.													



Note symbol

*	Fundamental Frequency which can be ignored. However, the level of any unwanted emissions shall not exceed the level of the fundamental frequency.
!	Test result is over limit line.
P/A	Peak or Average
H/V	Horizontal or Vertical



A calculation example for radiated spurious emission is shown as below:

BT	Note	Frequency	Level	Over	Limit	Read	Antenna	Path	Preamp	Ant	Table	Peak	Pol.
		(MHz)	(dBμV/m)	(dB)	(dBμV/m)	(dBμV)	(dB/m)	(dB)	(dB)	(cm)	(deg)	(P/A)	(H/V)
BT CH 00 2402MHz		2390	55.45	-18.55	74	54.51	32.22	4.58	35.86	103	308	P	H
		2390	43.54	-10.46	54	42.6	32.22	4.58	35.86	103	308	A	H

1. Path Loss(dB) = Cable loss(dB) + Filter loss(dB) + Attenuator loss(dB)

2. Level(dBμV/m) =

Antenna Factor(dB/m) + Path Loss(dB) + Read Level(dBμV) - Preamp Factor(dB)

3. Over Limit(dB) = Level(dBμV/m) – Limit Line(dBμV/m)

For Peak Limit @ 2390MHz:

1. Level(dBμV/m)

= Antenna Factor(dB/m) + Path Loss(dB) + Read Level(dBμV) - Preamp Factor(dB)

= 32.22(dB/m) + 4.58(dB) + 54.51(dBμV) – 35.86 (dB)

= 55.45 (dBμV/m)

2. Over Limit(dB)

= Level(dBμV/m) – Limit Line(dBμV/m)

= 55.45(dBμV/m) – 74(dBμV/m)

= -18.55(dB)

For Average Limit @ 2390MHz:

1. Level(dBμV/m)

= Antenna Factor(dB/m) + Path Loss(dB) + Read Level(dBμV) - Preamp Factor(dB)

= 32.22(dB/m) + 4.58(dB) + 42.6(dBμV) – 35.86 (dB)

= 43.54 (dBμV/m)

2. Over Limit(dB)

= Level(dBμV/m) – Limit Line(dBμV/m)

= 43.54(dBμV/m) – 54(dBμV/m)

= -10.46(dB)

Both peak and average measured complies with the limit line, so test result is “PASS”.



Appendix B. Radiated Spurious Emission Plots

Test Engineer :	Jesse Wang, Stan Hsieh and Ken Wu	Temperature :	22~23°C
		Relative Humidity :	51~58%

2.4GHz 2400~2483.5MHz

BT (Band Edge @ 3m)

BT	2.4GHz 2400~2483.5MHz Band Edge @ 3m	
	BT CH00 2402MHz	
	Horizontal	Fundamental
Peak	<p>Site : 03CH07-HY Condition : PEAK_BE_24 3m HF_ANT_00075962 HORIZONTAL Detector : Peak Project : 052917-02 Mode : 1</p>	<p>Site : 03CH07-HY Condition : PEAK_24 3m HF_ANT_00075962 HORIZONTAL Detector : Peak Project : 052917-02 Mode : 1</p>

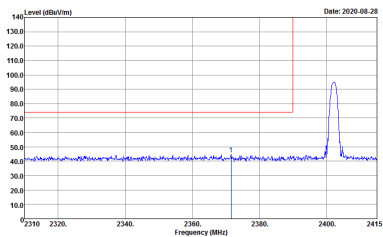
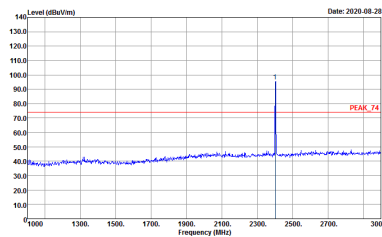

BT	2.4GHz 2400~2483.5MHz Band Edge @ 3m	
	BT CH00 2402MHz	
	Vertical	Fundamental
Peak	 <p>Date: 2020-08-28</p> <p>Site : 03C407-01 Condition : PEAK_BE_74 3m HF_ANT_00075962 VERTICAL RBW:1000.000kHz VBW:3000.000kHz SWT:Auto Detector : Peak Project : 052917-02 Mode : 1</p>	 <p>Date: 2020-08-28</p> <p>Site : 03C407-01 Condition : PEAK_74 3m HF_ANT_00075962 VERTICAL RBW:1000.000kHz VBW:3000.000kHz SWT:Auto Detector : Peak Project : 052917-02 Mode : 1</p>



2.4GHz 2400~2483.5MHz

BT (Harmonic @ 3m)

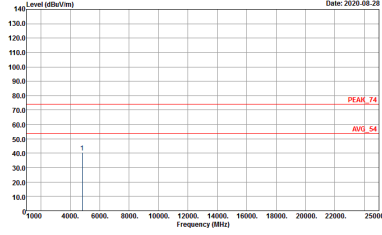
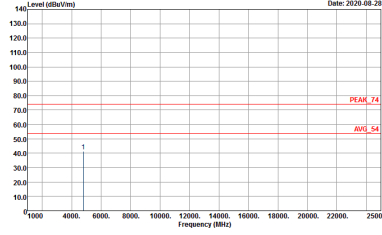
BT	2.4GHz 2400~2483.5MHz Harmonic @ 3m	
	BT CH00 2402MHz	
	Horizontal	Vertical
Peak Avg.	 <p>Site : 03C2407-09 Condition : PEAK_74 3m HF_ANT_00075962 HORIZONTAL Detector : Peak Project : 052917-02 Mode : 1</p>	 <p>Site : 03C2407-09 Condition : PEAK_74 3m HF_ANT_00075962 VERTICAL Detector : Peak Project : 052917-02 Mode : 1</p>



Emission below 1GHz

2.4GHz BT (LF)

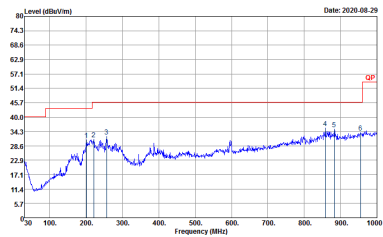
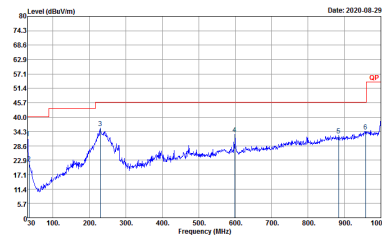
BT	2.4GHz 2400~2483.5MHz	
	BT LF	
	Horizontal	Vertical
QP / Peak	 <p data-bbox="430 873 813 929">Site : 03C1027-01Y Condition : QP 3m LF-ANT:35413(6) HORIZONTAL Detector : Peak Project : 052917-02 Mode : 22</p>	 <p data-bbox="901 873 1284 929">Site : 03C1027-01Y Condition : QP 3m LF-ANT:35419(6) VERTICAL Detector : Peak Project : 052917-02 Mode : 22</p>



Appendix C. Duty Cycle Plots

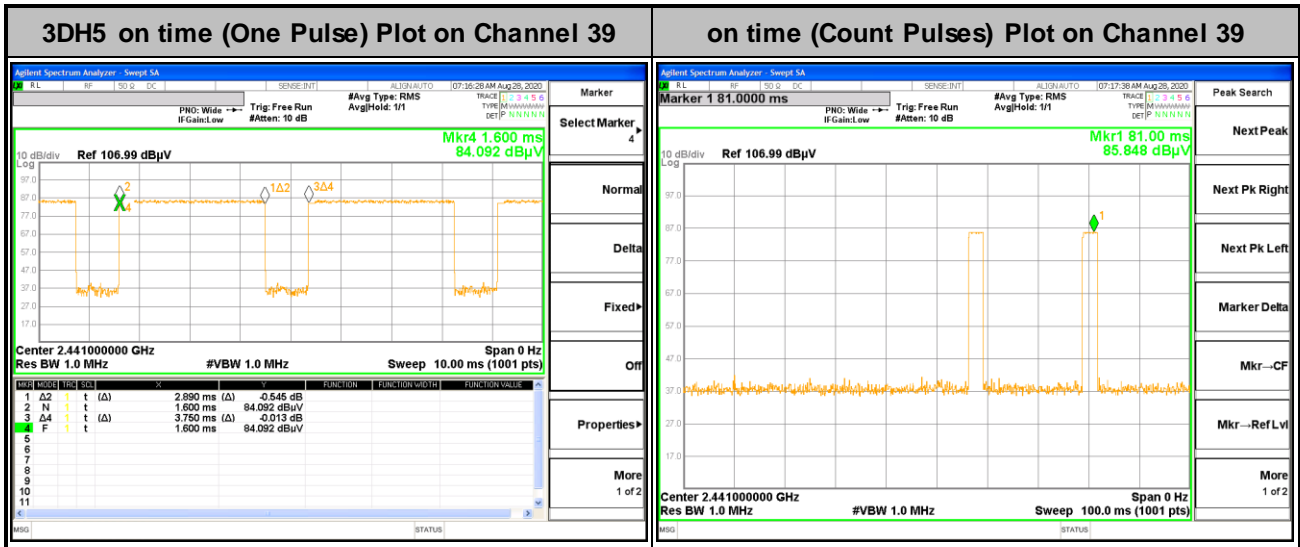

Note:

1. Worst case Duty cycle = on time/100 milliseconds = $2 * 2.89 / 100 = 5.78 \%$
2. Worst case Duty cycle correction factor = $20 * \log(\text{Duty cycle}) = -24.76 \text{ dB}$
3. 3DH5 has the highest duty cycle worst case and is reported.

Duty Cycle Correction Factor Consideration for AFH mode:

Bluetooth normal hopping rate is 1600Hz and reduced to 800Hz in AFH mode; due to the reduced number of hopping frequencies, with the same packet configuration the dwell time in each channel frequency within 100msec period is longer in AFH mode than normal mode.

In AFH mode, the minimum hopping frequencies are 20, to get the longest dwell time DH5 packet is observed; the period to have DH5 packet completing one hopping sequence is

$$2.89 \text{ ms} \times 20 \text{ channels} = 57.8 \text{ ms}$$

There cannot be 2 complete hopping sequences within 100ms period, considering the random hopping behavior, maximum 2 hops can be possibly observed within the period. $[100 \text{ ms} / 57.8 \text{ ms}] = 2 \text{ hops}$

Thus, the maximum possible ON time:

$$2.89 \text{ ms} \times 2 = 5.78 \text{ ms}$$

Worst case Duty Cycle Correction factor, which is derived from the maximum possible ON time,

$$20 \times \log(5.78 \text{ ms}/100 \text{ ms}) = -24.76 \text{ dB}$$