

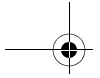

AP-650 Series Thin Access Point

Installation Guide





MOTOROLA and the Stylized M Logo are registered in the US Patent & Trademark Office. Symbol is a registered trademark of Symbol Technologies, Inc. All other product or service names are the property of their respective owners. © Motorola, Inc. 2009. All rights reserved.

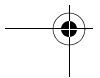
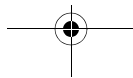
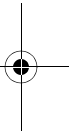
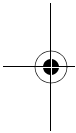

Table of Contents

1	Introduction	1
1.1	Document Conventions	1
1.2	Warnings	1
1.3	Site Preparation.....	2
1.4	AP-650 Package Contents	2
1.4.1	External Antenna Model Package Contents	2
1.4.2	Integrated Antenna Model Package Contents.....	2
1.5	Features	3
2	Hardware Installation	4
2.1	Installation Instructions.....	4
2.2	Precautions	5
2.3	Access Point Placement	5
2.4	Integrated Antenna Model Wall Mount Instructions	5
2.4.1	Wall Mount Hardware	5
2.4.2	Wall Mount Procedure	6
2.5	Integrated Antenna Model Suspended Ceiling T-Bar Mount Instructions	8
2.5.1	Suspended Ceiling Mount Procedure.....	8
2.6	External Antenna Model Wall Mount Instructions	9
2.6.1	Wall Mount Hardware	9
2.6.2	Wall Mount Procedure	10
2.7	External Antenna Model Suspended Ceiling Tile (Plenum) Mount Instructions .	11
2.7.1	Suspended Ceiling Mount Hardware.....	11
2.7.2	Ceiling Mount Procedure.....	12
2.8	AP-650 External Antenna Model Antenna Options	13
2.9	LED Indicators.....	14
3	Specifications.....	15



- 3.1 AP-650 External Antenna Model Electrical Characteristics 15
- 3.2 AP-650 External Antenna Model Physical Characteristics 15
- 3.3 AP-650 Integrated Antenna Model Electrical Characteristics 16
- 3.4 AP-650 Integrated Antenna Model Physical Characteristics 16
- 3.5 Radio Characteristics 17

4 Regulatory Information..... 18

- 4.1 Regulatory Overview 18
- 4.2 Wireless Device Country Approvals..... 18
 - 4.2.1 Country Selection – Note for AP & Wireless Switch 18
 - 4.2.2 Frequency of Operation – FCC and IC 19
- 4.3 Health and Safety Recommendations..... 19
 - 4.3.1 Warnings for the use of Wireless Devices 19
 - 4.3.2 Potentially Hazardous Atmospheres – Fixed Installations 19
 - 4.3.3 Safety in Hospitals 19
- 4.4 RF Exposure Guidelines 20
 - 4.4.1 Safety Information..... 20
- 4.5 International 20
- 4.6 EU 20
- 4.7 US and Canada 20
- 4.8 Power Supply..... 21
- 4.9 Radio Frequency Interference Requirements—FCC 21
- 4.10 Radio Frequency Interference Requirements – Canada 21
 - 4.10.1 Radio Transmitters 21
- 4.11 CE Marking and European Economic Area (EEA) 22
- 4.12 Statement of Compliance..... 22
- 4.13 Waste Electrical and Electronic Equipment (WEEE) 23
- 4.14 TURKISH WEEE Statement of Compliance 24
- 4.15 Japan (VCCI) - Voluntary Control Council for Interference Class B ITE 24
- 4.16 Korea Warning Statement for Class B ITE 25
- 4.17 Other Countries 25
 - 4.17.1 Australia 25
 - 4.17.2 Brazil 25

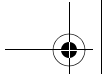

4.17.3 Chile 25
 4.17.4 Mexico 26
 4.17.5 Taiwan 26
 4.17.6 Korea 27

5 Motorola’s Enterprise Mobility Support Center 28

5.1 Customer Support Web Sites 28
 5.2 Manuals 28
 5.3 General Information 28

6 AP-650 Series ROHS Compliance 29

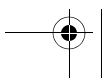
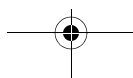
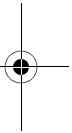
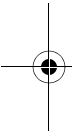

1 Introduction

The AP-650 Thin Access Point, a component of the Motorola Wireless Switch System, links wireless 802.11a/b/g/n devices to the switch, enabling growth of your wireless network with a cost-effective alternative to standard access points. The AP-650 Thin Access Point provides two placement options: wall and ceiling. Wall mount slots fit onto two screws provided. Arrows on the case guide placement of the screws. For placement above a suspended ceiling, a safety wire tie point on the case provides for a loop of safety wire. The light pipe fits through a hole in the ceiling tile to provide a view of the unit's status lights.

The AP-650 Thin Access Point receives all power and transfers data through the same CAT-5 or better Ethernet cable. There is no additional power supply required. An 802.3af Ethernet switch or power injector is required.

1.1 Document Conventions

The following graphical alerts are used in this document to indicate notable situations:



NOTE Tips, hints, or special requirements that you should take note of.



CAUTION Care is required. Disregarding a caution can result in data loss or equipment malfunction.



WARNING! Indicates a condition or procedure that could result in personal injury or equipment damage.

1.2 Warnings

- Read all installation instructions and site survey reports, and verify correct equipment installation before connecting the AP-650 Thin Access Point.
- Remove jewelry and watches before installing this equipment.
- Verify that the unit is grounded before connecting it to the power source.
- Verify that any device connected to this unit is properly wired and grounded.
- Verify there is adequate ventilation around the device, and that ambient temperatures meet equipment operation specifications.

2 AP-650 Series Thin Access Point: **Installation Guide**

1.3 Site Preparation

- Consult your site survey and network analysis reports to determine specific equipment placement, power drops, and so on.
- Assign installation responsibility to the appropriate personnel.
- Identify and document where all installed components are located.
- Ensure adequate, dust-free ventilation to all installed equipment.
- Identify and prepare Ethernet and console port connections.
- Verify that cable lengths are within the maximum allowable distances for optimal signal transmission.

1.4 AP-650 Package Contents

The AP-650 model Thin Access Point comes in four configurations, two Integrated Antenna models and two External Antenna models. The contents of the package differ between the Integrated Antenna model and the External Antenna model.

1.4.1 External Antenna Model Package Contents

- AP-650 Thin Access Point with external antenna connectors (Plenum Rated)
- Two wall mount screws
- Two wall anchors
- Light pipe
- Badge for light pipe
- *AP-650 Installation Guide (This Guide)*

1.4.2 Integrated Antenna Model Package Contents

- AP-650 Thin Access Point with integrated antennas
- Two wall mount screws
- Two wall anchors
- *AP-650 Installation Guide (This Guide)*

1.5 Features

- One RJ-45 connector
- LED indicators
- Safety wire tie point
- Slots for wall mounting
- Clips for mounting on a suspended ceiling T-bar
- Lock port for Kensington® style Security Lock

The AP-650 Thin Access Point has one RJ-45 connector supporting an 10/100/1000 Ethernet port and requires 802.3af-compliant power from an external source.



NOTE When operating in a Gigabit Ethernet environment CAT-5e or CAT-6 cable is required for Gigabit operation.

The AP-650 Thin Access Point comes in both single and dual radio versions both supporting 802.11a/b/g/n.

The Thin Access Point contains runtime firmware which enables the unit to boot after either a power up or a watchdog reset. The runtime firmware on the Thin Access Point and the firmware downloaded from the switch can be updated via the Ethernet interface from the Wireless Switch.

2 Hardware Installation

2.1 Installation Instructions

The AP-650 Thin Access Point mounts either on a wall with wide-shoulder screws or on a suspended ceiling T-bar. This unit is not designed for mounting on a desk.

To prepare for installation, perform the following steps:

1. Match the model number on the purchase order with the model numbers in the packing list and on the case of the device shipped.
2. Verify that the contents of the box include the intended AP-650 Thin Access Point and that the included hardware matches the package contents on page 2.

Part Number	Description
AP-0650-60010-XX	802.11a/b/g/n single radio integrated antenna configuration
AP-0650-66020-XX	802.11a/b/g/n dual radio integrated antenna configuration
AP-0650-60030-XX	802.11a/b/g/n single radio external antenna configuration
AP-0650-66040-XX	802.11a/b/g/n dual radio external antenna configuration



NOTE In the above part numbers *XX* represents the 2-digit country code which specifies which country the model is designed for. A country code of "WW" represents a world wide model.

3. Review site survey and network analysis reports to determine the location and mounting position for the AP-650 Thin Access Point.
4. Connect a CAT-5 or better Ethernet cable to a compatible 802.3af power source and run the cable to the installation site. Ensure that there is sufficient slack on the cable to perform the installation steps.



NOTE When operating in a Gigabit Ethernet environment CAT-5e or CAT-6 cable is required for Gigabit operation.

2.2 Precautions

Before installing an AP-650 model Thin Access Point, verify the following:

- Motorola recommends not to install the AP-650 in wet or dusty areas.
- Verify the environment has a continuous temperature range between 0° C to 50° C.

2.3 Access Point Placement

For optimal performance, install the access point away from transformers, heavy-duty motors, fluorescent lights, microwave ovens, refrigerators and other industrial equipment. Signal loss can occur when metal, concrete, walls or floors block transmission. Install the access point in an open area or add access points as needed to improve coverage.

Antenna coverage is analogous to lighting. Users might find an area lit from far away to be not bright enough. An area lit sharply might minimize coverage and create *dark areas*. Uniform antenna placement in an area (like even placement of a light bulb) provides even, efficient coverage.

Place the access point using the following guidelines:

- Install the access point at an ideal height of 10 feet from the ground.
- Orient the access point antennas vertically for best reception.

To maximize the access point's radio coverage area, Motorola recommends conducting a site survey to define and document radio interference obstacles before installing the access point.

2.4 Integrated Antenna Model Wall Mount Instructions

This mounting requires hanging the AP-650 Thin Access Point along its width or length using the two slots on the bottom of the unit. The AP-650 can be mounted onto any plaster, wood, or cement wall surface using the provided wall anchors when necessary. The illustration shows a lengthwise mount.

2.4.1 Wall Mount Hardware

- Two wide-shoulder Phillips pan head self-tapping screws
- Two wall anchors
- Security cable (optional)



NOTE In the event that the original mounting screws are lost, the following screws can be used instead: (ANSI Standard) #6-18 X 0.875in. Type A or AB Self-Tapping Screw, or (ANSI Standard Metric) M3.5 X 0.6 X 20mm Type D Self-Tapping Screw.

6 AP-650 Series Thin Access Point: Installation Guide

2.4.2 Wall Mount Procedure

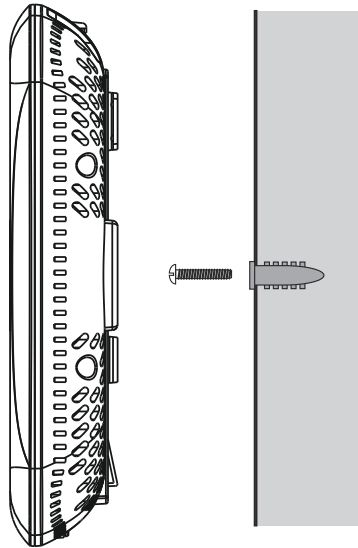

Integrated Antenna Wall Mount

1. Orient the case on the wall by its width or length.

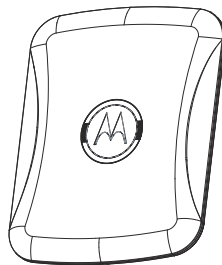

Correct Orientation

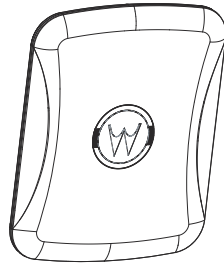

Incorrect Orientation



CAUTION To ensure proper operation of the AP-650 Thin Access Point ensure that the thin access point is mounted in the correct orientation as shown above.

2. Using the arrows on one edge of the case as guides, move the edge to the midline of the mounting area and mark points on the midline for the screws

3. At each point, drill a hole in the wall, insert an anchor, screw into the anchor the wall mounting screw and stop when there is 1mm between the screw head and the wall.



NOTE When pre-drilling a hole the recommended hole size is 2.8mm (0.11in.) if the screws are going directly into the wall and 6mm (0.23in.) if the provided wall anchors are being used.

4. If required, install and attach a security cable to the unit's lock port.
5. Attach the Ethernet cable to the unit and to a switch with an 802.3af-compatible power source.
6. Place the middle of each of the case's mount slots over the screw heads.
7. Slide the case down along the mounting surface to hang the mount slots on the screw heads.
8. Verify the unit has power by observing that the LEDs are lit or flashing.

8 AP-650 Series Thin Access Point: Installation Guide

2.5 Integrated Antenna Model Suspended Ceiling T-Bar Mount Instructions

Ceiling mount requires holding the AP-650 Thin Access Point up against a T-bar of a suspended ceiling grid and twisting the case onto the T-bar.

2.5.1 Suspended Ceiling Mount Procedure

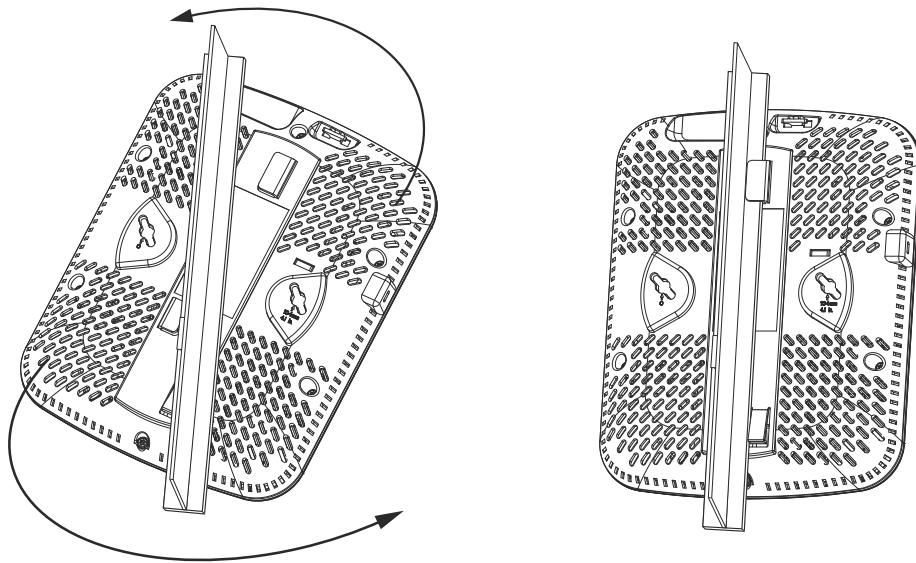

1. If required, install and attach a security cable to the unit's lock port.
2. Plug the Ethernet cable into the unit and to a switch with an 802.3af-compatible power source.
3. Face the bottom of the T-bar with the back of the case.
4. Orient the case by its length and the length of the T-bar.
5. Rotate the case in place 45 degrees clockwise, or about 10 o'clock.
6. Push the back of the case onto the bottom of the T-bar.
7. Rotate the case 45 degrees counter-clockwise. The clips click as they fasten to the T-bar.
8. Verify the unit has power by observing the LEDs.

2.6 External Antenna Model Wall Mount Instructions

Wall mounting requires hanging the AP-650 Thin Access Point along its width or length using the pair of slots on the bottom of the unit. The AP-650 can be mounted onto any plaster, wood, or cement wall surface using the provided wall anchors when necessary. The illustration shows a lengthwise mount

2.6.1 Wall Mount Hardware

- Two wide-shoulder Phillips pan head self-tapping screws
- Two wall anchors
- Safety wire (recommended) and security cable (optional)



NOTE In the event that the original mounting screws are lost, the following screws can be used instead: (ANSI Standard) #6-18 X 0.875in. Type A or AB Self-Tapping Screw, or (ANSI Standard Metric) M3.5 X 0.6 X 20mm Type D Self-Tapping Screw.

2.6.2 Wall Mount Procedure

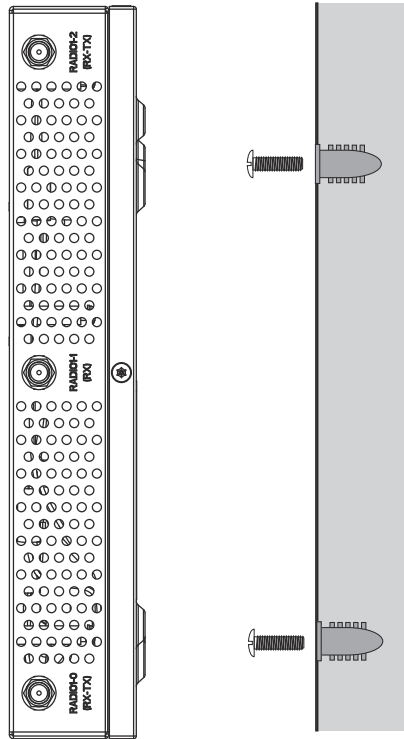

1. Orient the case on the wall by its width or length.
2. Using the arrows on one edge of the case as guides, move the edge to the midline of the mounting area and mark points on the midline for the screws.
3. At each point, drill a hole in the wall, insert an anchor, screw into the anchor the wall mounting screw and stop when there is 1mm between the screw head and the wall.



NOTE When pre-drilling a hole the recommended hole size is 2.8mm (0.11in.) if the screws are going directly into the wall and 6mm (0.23in.) if the provided wall anchors are being used.

4. If required, loop a safety wire, between 1.5mm (.06in.) and 2.5mm (.10in.) in diameter, around the tie post and secure the loop.
5. If required, install and attach a security cable to the unit's lock port.

6. Place the large corner of each of the case's mount slots over the screw heads.
7. Slide the case down along the mounting surface to hang the mount slots on the screw heads.
8. Attach appropriate antennas to the connectors.
9. Attach the Ethernet cable to the unit and to a switch with an 802.3af compatible power source.
10. Verify the unit has power by observing that the LEDs are lit or flashing.

2.7 External Antenna Model Suspended Ceiling Tile (Plenum) Mount Instructions

Ceiling mount requires placing the AP-650 Thin Access Point above a suspended ceiling and installing the provided light pipe for viewing the status lights of the unit.



NOTE Notes or warnings about suspended ceiling mounts apply to all installations where the unit is placed on suspended ceiling tile. The case has a safety wire tie point for a standard safety wire.



CAUTION Motorola does not recommend mounting the AP-650 Thin Access Point directly to any suspended ceiling tile with a thickness less than 12.7mm (0.5in.) or a suspended ceiling tile with an unsupported span greater than 660mm (26in.). Motorola strongly recommends fitting the AP-650 Thin Access Point with a safety wire suitable for the specific installation. The safety wire should be a standard ceiling suspension cable or equivalent steel wire between 1.59mm (.062in.) and 2.5mm (.10in.) in diameter.

This placement requires installation of the provided light pipe for viewing the status lights of the unit.

2.7.1 Suspended Ceiling Mount Hardware

- Light pipe
- Badge for light pipe
- Safety wire (recommended) and security cable (optional)

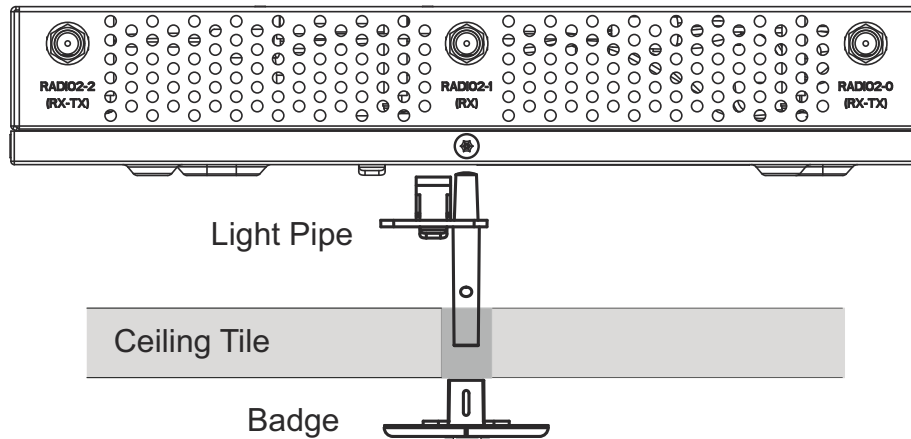
12 AP-650 Series Thin Access Point: **Installation Guide****2.7.2 Ceiling Mount Procedure**

1. If possible, remove the ceiling tile from its frame and place it, finished side down, on a work surface.
2. If required, install a safety wire, between 1.5mm (.06in.) and 2.5mm (.10in.) in diameter, in the ceiling space.
3. If required, install and attach a security cable to the unit's lock port.
4. Mark a point on the upper or unfinished side of the tile.
5. Push the light pipe through the tile at the mark and remove the light pipe. If necessary, use a drill to make a hole in the tile.
6. Attach appropriate antennas to the connectors.
7. Snap the clips of the light pipe into the bottom of the case.
8. Fit the light pipe into hole in the tile from its unfinished side.
9. Attach any safety wire to the safety wire tie point or security cable to the unit's lock port.
10. Bring the tile into the ceiling space.
11. Plug the Ethernet cable into the unit and to a switch with an 802.3af-compatible power source.
12. Verify the unit has power by observing the LEDs.
13. Place the ceiling tile back in its frame.
14. Snap the badge onto the light pipe from the finished side of the tile.

2.8 AP-650 External Antenna Model Antenna Options

Motorola supports two antenna suites for AP-650 External Antenna models. One antenna suite supporting the 2.4 GHz band and another antenna suite supporting the 5 GHz band. Select an antenna model best suited to the intended operational environment of your access point.

On single radio versions, the R-SMA connectors can support both bands and should be connected to a R-SMA dual-band antenna or an appropriate single band antenna.

The 2.4 GHz antenna suite includes the following models:

Part Number	Antenna Type
ML-2499-HPA3-01R	Omni-Directional Antenna
ML-2499-SD3-01R	Patch Antenna
ML-2452-APA2-01	Dual-Band
ML-2452-PNA5-01R	Panel Antenna
ML-2452-PTA3M3-036	Omni-Directional Antenna

The 5 GHz antenna suite includes the following models:

Part Number	Antenna Type
ML-5299-HPA1-01R	Omni-Directional Antenna
ML-5299-PTA1-01R	Patch Antenna
ML-2452-APA2-01	Dual-Band
ML-2452-PNA5-01R	Panel Antenna
ML-2452-PTA3M3-036	Omni-Directional Antenna

For up-to-date information on supported antennas and antenna specifications please see the Motorola Antenna Specification Guide available on the Motorola website.

2.9 LED Indicators

Both the Integrated Antenna model and the External Antenna model have LED activity indicators on the front of the case for use with wall mount. With the External Antenna model unit mounted above a ceiling, LEDs are at the center of an oval badge on the ceiling; a light pipe enables viewing the back LEDs through the ceiling tile.

The LEDs provide a status display indicating error conditions, transmission, and network activity for the 5 GHz 802.11a/n (amber) radio or the 2.4 GHz 802.11b/g/n (green) radio.

Task	5 GHz Activity LED Amber	2.4 GHz Activity LED Greenantenna Type
Booting	The amber LED flashes three times per second until firmware is loaded. During boot, 802.11a/n mobiles cannot associate.	The green LED flashes three times per second until firmware is loaded. During boot, 802.11b/g/n mobiles cannot associate.
Normal	After adoption, the amber LED is steady or flashes with 802.11a/n radio traffic.	After adoption, the green LED is steady or flashes with 802.11b/g/n radio traffic.
End	The amber LED flashes once per second if an error prevents the 802.11a/n radio from operating normally.	The green LED flashes once per second if an error prevents the 802.11b/g/n radio from operating normally.

3 Specifications

3.1 AP-650 External Antenna Model Electrical Characteristics

An AP-650 External Antenna model Thin Access Point has the following electrical characteristics:

Operating Current & Voltage 180ma- 270ma @ 48VDC

3.2 AP-650 External Antenna Model Physical Characteristics

An AP-650 External Antenna model Thin Access Point has the following physical characteristics:

Dimensions 8.50 in. Depth x 5.5 in. Width x 1.5 in. Height
21.59 cm Depth x 13.97 cm Width x 3.81 cm Height

Housing Metal

Weight 2.5 lbs / 1.13 kg

Operating Temperature 32°F to 122°F/0°C to 50°C

Storage Temperature -40°F to 185°F/-40°C to 85°C

Operating Humidity 5 to 95% Relative Humidity non-condensing

Storage Humidity 85% Relative Humidity non-condensing

Operating Altitude (max) 8,000 ft @ 28C

Storage Altitude (max) 30,000 ft @ 12C

Electrostatic Discharge +/-15kV Air and +/-8kV Contact @ 50% Relative Humidity

3.3 AP-650 Integrated Antenna Model Electrical Characteristics

An AP-650 Integrated model Thin Access Point has the following electrical characteristics:

Operating Current & Voltage 180ma- 270ma @ 48VDC

3.4 AP-650 Integrated Antenna Model Physical Characteristics

An AP-650 Integrated Antenna model Thin Access Point has the following physical characteristics:

<i>Dimensions</i>	9.50 in. Depth x 7.5 in. Width x 1.9 in. Height 24.13 cm Depth x 19.05 cm Width x 4.83 cm Height
<i>Housing</i>	Plastic
<i>Weight</i>	2.0 lbs / 0.91 kg
<i>Operating Temperature</i>	32°F to 122°F/0°C to 50°C
<i>Storage Temperature</i>	-40°F to 185°F/-40°C to 85°C
<i>Operating Humidity</i>	5 to 95% Relative Humidity non-condensing
<i>Storage Humidity</i>	85% Relative Humidity non-condensing
<i>Operating Altitude (max)</i>	8,000 ft @ 28C
<i>Storage Altitude (max)</i>	30,000 ft @ 12C
<i>Electrostatic Discharge</i>	+/-15kV Air and +/-8kV Contact @ 50% Relative Humidity

3.5 Radio Characteristics

The AP-650 model Thin Access Points have the following radio characteristics:

<i>Operating Channels</i>	All channels from 4920 MHz to 5825 MHz except channel 52 -64 Channels 1-13 (2412-2472 MHz) Channel 14 (2484 MHz) Japan only Actual operating frequencies depend on regulatory approval for the country of use.
<i>Data Rates Supported</i>	802.11g: 1,2,5.5,11,6,9,12,18,24,36,48, and 54Mbps 802.11a: 6,9,12,18,24,36,48, and 54Mbps 802.11n: MCS 0-15 up to 300Mbps
<i>Wireless Medium</i>	<i>Direct Sequence Spread Spectrum (DSSS), Orthogonal Frequency Division Multiplexing (OFDM) Spatial multiplexing (MIMO)</i>
<i>Network Standards</i>	802.11a, 802.11b, 802.11g, 802.3, 802.11n (Draft 2.0)
<i>Maximum Available Transmit Power</i>	Maximum available conducted transmit power per chain: 2.4 GHz: 21dBm Maximum available conducted transmit power all chains: 2.4 GHz: 24dBm Maximum available conducted transmit power per chain: 5 GHz: 19dBm Maximum available conducted transmit power all chains: 5 GHz: 22dBm
<i>Transmit Power Adjustment</i>	1dB increments
<i>Antenna Configuration</i>	2x3 MIMO (transmit on two and receive on all three antennas)

4 Regulatory Information

4.1 Regulatory Overview

This device is approved under the Symbol Technologies brand: Symbol Technologies, Inc., is the Enterprise Mobility business of Motorola, Inc. ("Motorola").

This guide applies to Model Number AP-650

All Motorola/Symbol devices are designed to be compliant with rules and regulations in locations they are sold and will be labeled as required.

Local language translations are available at the following website: <http://support.symbol.com>

Any changes or modifications to Motorola/Symbol Technologies equipment, not expressly approved by Motorola/Symbol Technologies, could void the user's authority to operate the equipment.

Motorola/Symbol Access Points must be professionally installed and configured so that the Radio Frequency Output Power will not exceed the maximum allowable limit for the country of operation.



Antennas: Use only the supplied or an approved replacement antenna. Unauthorized antennas, modifications, or attachments could cause damage and may violate regulations.

Use of an unapproved antenna is illegal under FCC regulations subjecting the end user to fines and equipment seizure.

Radio Modules

This Access Point contains approved radio module(s) MB82. These module(s) are identified below.

MB82 – a DFS Master WLAN 802.11 abgn MIMO 3x3 radio module.

4.2 Wireless Device Country Approvals

Regulatory markings, subject to certification, are applied to the device signifying the radio(s) is/are approved for use in the following countries: United States, Canada, Japan, China, S. Korea, Australia, and Europe.

Please refer to the Symbol Declaration of Conformity (DoC) for details of other country markings. This is available at

<http://www2.symbol.com/doc/>.

Note: For 2.4GHz or 5GHz Products: Europe includes, Austria, Belgium, Bulgaria, Czech Republic, Cyprus, Denmark, Estonia, Finland, France, Germany, Greece, Hungary, Iceland, Ireland, Italy, Latvia, Liechtenstein, Lithuania, Luxembourg, Malta, Netherlands, Norway, Poland, Portugal, Romania, Slovak Republic, Slovenia, Spain, Sweden, Switzerland and the United Kingdom.



Operation of the device without regulatory approval is illegal.

4.2.1 Country Selection – Note for AP & Wireless Switch

Select only the country in which you are using the device. Any other selection will make the operation of this device illegal. The US version of the Access Point only lists US in the Country Selection List.

4.2.2 Frequency of Operation – FCC and IC

5 GHz Only

The use in the UNII (Unlicensed National Information Infrastructure) band 1 5150-5250 MHz band and band 3 5470-5725 MHz is restricted to Indoor Use Only; any other use will make the operation of this device illegal. Any device labeled INDOOR USE ONLY may not be legally used outdoors.

2.4 GHz Only

The available channels for 802.11 b/g operation in the US are Channels 1 to 11. The range of channels is limited by firmware.

4.3 Health and Safety Recommendations



4.3.1 Warnings for the use of Wireless Devices

Please observe all warning notices with regard to the usage of wireless devices

4.3.2 Potentially Hazardous Atmospheres – Fixed Installations

You are reminded of the need to observe restrictions on the use of radio devices in fuel depots, chemical plants etc. and areas where the air contains chemicals or particles (such as grain, dust, or metal powders).

4.3.3 Safety in Hospitals



Wireless devices transmit radio frequency energy and may affect medical electrical equipment. When installed adjacent to other equipment, it is advised to verify that the adjacent equipment is not adversely affected.

Pacemakers

Pacemaker manufacturers recommended that a minimum of 15cm (6 inches) be maintained between a handheld wireless device and a pacemaker to avoid potential interference with the pacemaker. These recommendations are consistent with independent research and recommendations by Wireless Technology Research.

Persons with Pacemakers:

- Should ALWAYS keep the device more than 15cm (6 inches) from their pacemaker when turned ON.
- Should not carry the device in a breast pocket.
- Should use the ear furthest from the pacemaker to minimize the potential for interference.
- If you have any reason to suspect that interference is taking place, turn OFF your device.

Other Medical Devices

Please consult your physician or the manufacturer of the medical device, to determine if the operation of your wireless product may interfere with the medical device.



4.4 RF Exposure Guidelines

4.4.1 Safety Information

Reducing RF Exposure—Use Properly

Only operate the device in accordance with the instructions supplied.

4.5 International

The device complies with internationally recognized standards covering human exposure to electromagnetic fields from radio devices. For information on “International” human exposure to electromagnetic fields refer to the Motorola/Symbol Declaration of Conformity (DoC) at <http://www2.symbol.com/doc/>.

4.6 EU

Remote and Standalone Antenna Configurations

To comply with EU RF exposure requirements, antennas that are mounted externally at remote locations or operating near users at stand-alone desktop of similar configurations must operate with a minimum separation distance of 20 cm from all persons.

4.7 US and Canada

Co-located statement

To comply with FCC RF exposure compliance requirement, the antennas used for this transmitter must not be co-located or operating in conjunction with any other transmitter/antenna except those already approved in this filling.

Remote and Standalone Antenna Configurations

To comply with FCC RF exposure requirements, antennas that are mounted externally at remote locations or operating near users at stand-alone desktop of similar configurations must operate with a minimum separation distance of 20 cm from all persons.

4.8 Power Supply

This device is powered from a 802.3af compliant power source which is UL approved and certified by the appropriate agencies.

4.9 Radio Frequency Interference Requirements—FCC



This equipment has been tested and found to comply with the limits for a Class B digital device, pursuant to Part 15 of the FCC rules. These limits are designed to provide reasonable protection against harmful interference in a residential installation. This equipment generates, uses and can radiate radio frequency energy and, if not installed and used in accordance with the instructions, may cause harmful interference to radio communications. However there is no guarantee that interference will not occur in a particular installation. If this equipment does cause harmful interference to radio or television reception, which can be determined by turning the equipment off and on, the user is encouraged to try to correct the interference by one or more of the following measures:

- Reorient or relocate the receiving antenna
- Increase the separation between the equipment and receiver
- Connect the equipment into an outlet on a circuit different from that to which the receiver is connected
- Consult the dealer or an experienced radio/TV technician for help

Radio Transmitters (Part 15)

This device complies with Part 15 of the FCC Rules. Operation is subject to the following two conditions: (1) this device may not cause harmful interference, and (2) this device must accept any interference received, including interference that may cause undesired operation.

Restricted Band 5.60 – 5.65 GHz

4.10 Radio Frequency Interference Requirements – Canada

This Class B digital apparatus complies with Canadian ICES-003.

Cet appareil numérique de la classe B est conforme à la norme NMB-003 du Canada.

22 AP-650 Series Thin Access Point: Installation Guide

4.10.1 Radio Transmitters

For RLAN Devices:

The use of 5 GHz RLAN's, for use in Canada, have the following restrictions:

- Restricted Band 5.60 – 5.65 GHz

This device complies with RSS 210 of Industry & Science Canada. Operation is subject to the following two conditions: (1) this device may not cause harmful interference and (2) this device must accept any interference received, including interference that may cause undesired operation.

Label Marking: The Term "IC:" before the radio certification only signifies that Industry Canada technical specifications were met.

4.11 CE Marking and European Economic Area (EEA)



The use of 2.4 GHz RLAN's, for use through the EEA, have the following restrictions:

- Maximum radiated transmit power of 100 mW EIRP in the frequency range 2.400 -2.4835 GHz.
- France, outside usage is restricted to 2.4 – 2.454 GHz.
- Italy requires a user license for outside usage.

4.12 Statement of Compliance

Motorola/Symbol hereby, declares that this device is in compliance with the essential requirements and other relevant provisions of Directive 1999/5/EC. A Declaration of Conformity may be obtained from

<http://www2.symbol.com/doc/>.

4.13 Waste Electrical and Electronic Equipment (WEEE)



English: For EU Customers: All products at the end of their life must be returned to Symbol for recycling. For information on how to return product, please go to: http://www.symbol.com/environmental_compliance.

Čeština: Pro zákazníky z EU: Všechny produkty je nutné po skončení jejich životnosti vrátit společnosti Symbol k recyklaci. Informace o způsobu vrácení produktu najdete na webové stránce: http://www.symbol.com/environmental_compliance.

Dansk: Til kunder i EU: Alle produkter skal returneres til Symbol til recirkulering, når de er udtjent. Læs oplysningerne om returnering af produkter på: http://www.symbol.com/environmental_compliance.

Deutsch: Für Kunden innerhalb der EU: Alle Produkte müssen am Ende ihrer Lebensdauer zum Recycling an Symbol zurückgesandt werden. Informationen zur Rücksendung von Produkten finden Sie unter http://www.symbol.com/environmental_compliance.

Eesti: EL klientidele: kõik tooted tuleb nende eluea lõppedes tagastada taaskasutamise eesmärgil Symbol'ile. Lisainformatsiooni saamiseks toote tagastamise kohta külastage palun aadressi: http://www.symbol.com/environmental_compliance.

Español: Para clientes en la Unión Europea: todos los productos deberán entregarse a Symbol al final de su ciclo de vida para que sean reciclados. Si desea más información sobre cómo devolver un producto, visite: http://www.symbol.com/environmental_compliance.

Ελληνικά: Για πελάτες στην Ε.Ε.: Όλα τα προϊόντα, στο τέλος της διάρκειας ζωής τους, πρέπει να επιστρέφονται στην Symbol για ανακύκλωση. Για περισσότερες πληροφορίες σχετικά με την επιστροφή ενός προϊόντος, επισκεφθείτε τη διεύθυνση http://www.symbol.com/environmental_compliance στο Διαδίκτυο.

Français : Clients de l'Union Européenne : Tous les produits en fin de cycle de vie doivent être retournés à Symbol pour recyclage. Pour de plus amples informations sur le retour de produits, consultez : http://www.symbol.com/environmental_compliance.

Italiano: per i clienti dell'UE: tutti i prodotti che sono giunti al termine del rispettivo ciclo di vita devono essere restituiti a Symbol al fine di consentirne il riciclaggio. Per informazioni sulle modalità di restituzione, visitare il seguente sito Web: http://www.symbol.com/environmental_compliance.

Latviešu: ES klientiem: visi produkti pēc to kalpošanas mūža beigām ir jānogādā atpakaļ Symbol otrreizējai pārstrādei. Lai iegūtu informāciju par produktu nogādāšanu Symbol, lūdzu, skatiet: http://www.symbol.com/environmental_compliance.

Lietuvių: ES vartotojams: visi gaminiai, pasibaigus jų eksploatacijos laikui, turi būti gražinti utilizuoti į kompaniją „Symbol“. Daugiau informacijos, kaip gražinti gaminį, rasite: http://www.symbol.com/environmental_compliance.

Magyar: Az EU-ban vásárlóknak: Minden tönkrement termékét a Symbol vállalathoz kell eljuttatni újrahasznosítás céljából. A termék visszajuttatásának módjával kapcsolatos tudnivalókról látogasson el a http://www.symbol.com/environmental_compliance weboldalra

24 AP-650 Series Thin Access Point: Installation Guide

Malti: Għal klijenti fl-UE: il-prodotti kollha li jkunu waslu fl-aħħar tal-hajja ta' l-użu tagħhom, iridu jiġu rritornati għand Symbol għar-riċiklaġġ. Għal aktar tagħrif dwar kif għandek tirritorna l-prodott, jekk jogħġbok żur: http://www.symbol.com/environmental_compliance.

Nederlands: Voor klanten in de EU: alle producten dienen aan het einde van hun levensduur naar Symbol te worden teruggezonden voor recycling. Raadpleeg http://www.symbol.com/environmental_compliance voor meer informatie over het terugzenden van producten.

Polski: Klienci z obszaru Unii Europejskiej: Produkty wycofane z eksploatacji należy zwrócić do firmy Symbol w celu ich utylizacji. Informacje na temat zwrotu produktów znajdują się na stronie internetowej http://www.symbol.com/environmental_compliance.

Português: Para clientes da UE: todos os produtos no fim de vida devem ser devolvidos à Symbol para reciclagem. Para obter informações sobre como devolver o produto, visite: http://www.symbol.com/environmental_compliance.

Slovenski: Za kupce v EU: vsi izdelki se morajo po poteku življenjske dobe vrniti podjetju Symbol za reciklažo. Za informacije o vračilu izdelka obiščite: http://www.symbol.com/environmental_compliance.

Slovenščina: Pre zákazníkov z krajín EU: Všetky výrobky musia byť po uplynutí doby ich životnosti vrátené spoločnosti Symbol na recykláciu. Bližšie informácie o vrátení výrobkov nájdete na: http://www.symbol.com/environmental_compliance.

Suomi: Asiakaat Euroopan unionin alueella: Kaikki tuotteet on palautettava kierrätettäväksi Symbol-yhtiöön, kun tuotetta ei enää käytetä. Lisätietoja tuotteen palauttamisesta on osoitteessa http://www.symbol.com/environmental_compliance.

4.14 TURKISH WEEE Statement of Compliance

EEE Yönetmeliğine Uygundur

4.15 Japan (VCCI) - Voluntary Control Council for Interference Class B ITE

この装置は、情報処理装置等電波障害自主規制協議会（VCCI）の基準に基づくクラスB情報技術装置です。この装置は、家庭環境で使用することを目的としていますが、この装置がラジオやテレビジョン受信機に近接して使用されると、受信障害を引き起こすことがあります。取扱説明書に従って正しい取り扱いをして下さい。

This is a Class B product based on the standard of the Voluntary Control Council for Interference from Information Technology Equipment (VCCI). If this is used near a radio or television receiver in a domestic environment, it may cause radio interference. Install and use the equipment according to the instruction manual.

4.16 Korea Warning Statement for Class B ITE

기종별	사용자안내문
B급 기기 (가정용 방송통신기기)	이 기기는 가정용 (B급) 으로 전자파적합등록을 한 기기로서 주로 가정에서 사용하는 것을 목적으로 하며, 모든 지역에서 사용할 수 있습니다.
Class B (Broadcasting Communication Device for Home Use)	This device obtained EMC registration mainly for home use (Class B) and may be used in all areas.

4.17 Other Countries

4.17.1 Australia

Use of 5 GHz WLAN's in Australia is restricted in the following band 5.50 – 5.65 GHz.

4.17.2 Brazil

Regulatory declarations for AP-650 - BRAZIL

Note: The certification mark applied to the AP-650 is for Restrict Radiation Equipment. This equipment operates on a secondary basis and does not have the right for protection against harmful interference from other users including same equipment types. Also this equipment must not cause interference to systems operating on primary basis.

For more information consult the website <http://www.anatel.gov.br>

Declarações Regulamentares para AP-650 - Brasil

Nota: "A marca de certificação se aplica ao Transceptor, modelo AP-650. Este equipamento opera em caráter secundário, isto é, não tem direito a proteção contra interferência prejudicial, mesmo de estações do mesmo tipo, e não pode causar interferência a sistemas operando em caráter primário."

Para maiores informações sobre ANATEL consulte o site: <http://www.anatel.gov.br>

4.17.3 Chile

"Este equipo cumple con la Resolución No 403 de 2008, de la Subsecretaria de telecomunicaciones, relativa a radiaciones electromagnéticas."

"This device complies with the Resolution Not 403 of 2008, of the Undersecretary of telecommunications, relating to electromagnetic radiation."

4.17.4 Mexico

Restrict Frequency Range to: 2.450 – 2.4835 GHz.

4.17.5 Taiwan

NOTICE!

According to: Administrative Regulations on Low Power Radio Waves Radiated Devices

Article 12

Without permission granted by the DGT, any company, enterprise, or user is not allowed to change frequency, enhance transmitting power or alter original characteristic as well as performance to an approved low power radio-frequency devices.

Article 14

The low power radio-frequency devices shall not influence aircraft security and interfere legal communications; If found, the user shall cease operating immediately until no interference is achieved.

The said legal communications means radio communications is operated in compliance with the Telecommunications Act.

The low power radio-frequency devices must be susceptible with the interference from legal communications or ISM radio wave radiated devices.

臺灣

低功率電波輻射性電機管理辦法

第十二條

經型式認證合格之低功率射頻電機，非經許可，公司、商號或使用者均不得擅自變更頻率、加大功率或變更原設計之特性及功能。

第十四條

低功率射頻電機之使用不得影響飛航安全及干擾合法通信；經發現有干擾現象時，應立即停用，並改善至無干擾時方得繼續使用。

前項合法通信，指依電信規定作業之無線電通信。

低功率射頻電機須忍受合法通信或工業、科學及醫療用電波輻射性電機設備之干擾。

Wireless device operate in the frequency band of 5.25-5.35 GHz, limited for Indoor use only.

在 5.25–5.35 赫頻帶內操作之無線資訊傳輸設備， 限於室內使用。

4.17.6 Korea

For a radio equipment using 2400~2483.5MHz or 5725~5825MHz, the following two expression should be displayed:

1. "This radio equipment can be interfered during operation."

당해 무선설비는 운용 중 전파혼신 가능성이 있음

2. "This radio equipment cannot provide a service relevant to the human life safety, as it can be crossed" through the user manual etc.

당해 무선설비는 전파혼신 가능성이 있으므로 인명안전과 관련된 서비스는 할 수 없습니다

5 Motorola's Enterprise Mobility Support Center

If you have a problem with your equipment, contact Enterprise Mobility support for your region. Contact information is available at: <http://support.symbol.com/support/>.

When contacting Enterprise Mobility support, please provide the following information:

- *Serial number of the unit*
- *Model number or product name*
- *Software type and version number*

Motorola responds to calls by email, telephone or fax within the time limits set forth in support agreements. If you purchased your Enterprise Mobility business product from a Motorola business partner, contact that business partner for support.

5.1 Customer Support Web Sites

Motorola's Support Central Web site, located at <http://support.symbol.com/support/> provides information and online assistance including developer tools, software downloads, product manuals and online repair requests.

5.2 Manuals

<http://support.symbol.com/support/product/manuals.do>

5.3 General Information

Obtain additional information by contacting Motorola at:

Telephone (North America): 1-800-722-6234

Telephone (International): +1-631-738-5200

Website: <http://www.motorola.com>

6 AP-650 Series ROHS Compliance



部件名称 (Parts)	有毒有害物质或元素 					
	铅 (Pb)	汞 (Hg)	镉 (Cd)	六价铬 (Cr ⁶⁺)	多溴联苯 (PBB)	多溴二苯醚 (PBDE)
金属部件 (Metal Parts)	X	O	O	O	O	O
电路模块 (Circuit Modules)	X	O	O	O	O	O
电缆及电缆组件 (Cables and Cable Assemblies)	X	O	O	O	O	O
塑料和聚合物部件 (Plastic and Polymeric Parts)	O	O	O	O	O	O
光学和光学组件 (Optics and Optical Components)	O	O	O	O	O	O
电池 (Batteries)	O	O	O	O	O	O

O : 表示该有毒有害物质在该部件所有均质材料中的含量均在 SJ/T11363-2006 标准规定的限量要求以下。

X : 表示该有毒有害物质至少在该部件的某一均质材料中的含量超出 SJ/T11363-2006 标准规定的限量要求。

对销售之日的所售产品，本表表示，公司供应链的电子信息产品可能包含这些物质。注意：在所售产品中可能会也可能不会含有所有列出的部件。

This table was created to comply with China RoHS requirements for Motorola's AP-650 and AP-650 model access points.

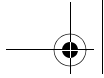

30 *AP-650 Series Thin Access Point: Installation Guide*

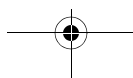
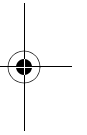
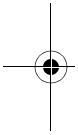



MOTOROLA INC.
1303 E. ALGONQUIN ROAD
SCHAUMBURG, IL 60196
<http://www.motorola.com>

72-131207-01 Pilot Run Version
October 2009

