



SPORTON International Inc.

No. 52, Hwa Ya 1st Rd., Kwei-Shan Hsiang, TaoYuan Hsien, Taiwan, R.O.C.
Ph: 886-3-327-3456 / FAX: 886-3-327-0973 / www.sporton.com.tw

FCC RADIO TEST REPORT

Applicant's company	Motorola, Inc.
Applicant Address	One Motorola Plaza Holtsville NY 111742 USA
FCC ID	UZ7MB82
Manufacturer's company	Wistron NeWeb Corporation
Manufacturer Address	No.10-1,Li-hsin Road I,Hsinchu Science Park,Hsinchu 300,Taiwan, R.O.C.

Product Name	MB82 Access Point Radio Module
Brand Name	Motorola
Model Name	MB82
Test Rule Part(s)	47 CFR FCC Part 15 Subpart C § 15.247
Test Freq. Range	2400 ~ 2483.5MHz / 5725 ~ 5850MHz
Received Date	Aug. 07, 2009
Final Test Date	Sep. 30, 2009
Submission Type	Original Equipment

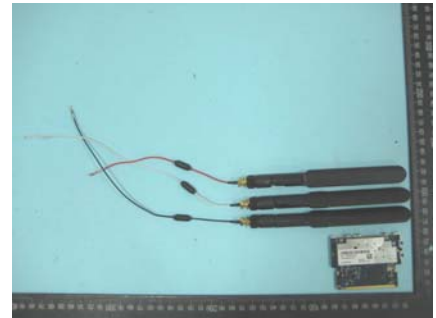

Statement

Test result included is only for the Draft n, 802.11b/g part and 802.11a (5725 ~ 5850MHz) of the product.

The test result in this report refers exclusively to the presented test model / sample.

Without written approval of SPORTON International Inc., the test report shall not be reproduced except in full.

The measurements and test results shown in this test report were made in accordance with the procedures and found in compliance with the limit given in ANSI C63.4-2003 and 47 CFR FCC Part 15 Subpart C.

The test equipment used to perform the test is calibrated and traceable to NML/ROC.



Table of Contents

1. CERTIFICATE OF COMPLIANCE	1
2. SUMMARY OF THE TEST RESULT	2
3. GENERAL INFORMATION	3
3.1. Product Details.....	3
3.2. Accessories.....	5
3.3. Table for Filed Antenna.....	6
3.4. Table for Carrier Frequencies	8
3.5. Table for Test Modes.....	9
3.6. Table for Testing Locations.....	10
3.7. Table for Supporting Units	10
3.8. Table for Parameters of Test Software Setting	11
3.9. Test Configurations	17
4. TEST RESULT	29
4.1. AC Power Line Conducted Emissions Measurement.....	29
4.2. Maximum Conducted Output Power Measurement.....	43
4.3. Power Spectral Density Measurement	206
4.4. 6dB Spectrum Bandwidth Measurement	285
4.5. Radiated Emissions Measurement	364
4.6. Band Edge Emissions Measurement	620
4.7. Antenna Requirements	687
5. LIST OF MEASURING EQUIPMENTS	688
6. TEST LOCATION.....	690
7. TAF CERTIFICATE OF ACCREDITATION	691
APPENDIX A. PHOTOGRAPHS OF EUT.....	A1 ~ A14
APPENDIX B. TEST PHOTOS.....	B1 ~ B34
APPENDIX C. MAXIMUM PERMISSIBLE EXPOSURE.....	C1 ~ C12
APPENDIX D. CO-LOCATION REPORT.....	D1 ~ D16



History of This Test Report

Original Issue Date: Oct. 12, 2009

Report No.: FR972826AB

- No additional attachment.
- Additional attachment were issued as following record:

Attachment No.	Issue Date	Description



1. CERTIFICATE OF COMPLIANCE

Product Name : MB82 Access Point Radio Module
Brand Name : Motorola
Model Name : MB82
Applicant : Motorola, Inc.
Test Rule Part(s) : 47 CFR FCC Part 15 Subpart C § 15.247

Sporton International as requested by the applicant to evaluate the EMC performance of the product sample received on Aug. 07, 2009 would like to declare that the tested sample has been evaluated and found to be in compliance with the tested rule parts. The data recorded as well as the test configuration specified is true and accurate for showing the sample's EMC nature.

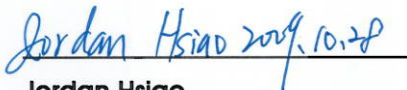
A handwritten signature in blue ink that reads 'Jordan Hsiao 2009.10.28' is written over a horizontal line.

Jordan Hsiao

SPORTON INTERNATIONAL INC.

2. SUMMARY OF THE TEST RESULT

Applied Standard: 47 CFR FCC Part 15 Subpart C				
Part	Rule Section	Description of Test	Result	Under Limit
4.1	15.207	AC Power Line Conducted Emissions	Complies	7.74 dB
4.2	15.247(b)(3)	Maximum Conducted Output Power	Complies	1.50 dB
4.3	15.247(e)	Power Spectral Density	Complies	3.77 dB
4.4	15.247(a)(2)	6dB Spectrum Bandwidth	Complies	-
4.5	15.247(d)	Radiated Emissions	Complies	0.06 dB
4.6	15.247(d)	Band Edge Emissions	Complies	0.01 dB
4.7	15.203	Antenna Requirements	Complies	-

Test Items	Uncertainty	Remark
AC Power Line Conducted Emissions	±2.3dB	Confidence levels of 95%
Maximum Conducted Output Power	±0.8dB	Confidence levels of 95%
Power Spectral Density	±0.5dB	Confidence levels of 95%
6dB Spectrum Bandwidth	±8.5×10 ⁻⁸	Confidence levels of 95%
Radiated Emissions (9kHz~30MHz)	±0.8dB	Confidence levels of 95%
Radiated Emissions (30MHz~1000MHz)	±1.9dB	Confidence levels of 95%
Radiated / Band Edge Emissions (1GHz~18GHz)	±1.9dB	Confidence levels of 95%
Radiated Emissions (18GHz~40GHz)	±1.9dB	Confidence levels of 95%
Temperature	±0.7°C	Confidence levels of 95%
Humidity	±3.2%	Confidence levels of 95%
DC / AC Power Source	±1.4%	Confidence levels of 95%

3. GENERAL INFORMATION

3.1. Product Details

Draft n

Items	Description
Product Type	WLAN (2TX, 3RX)
Radio Type	Intentional Transceiver
Power Type	From Host System
Modulation	see the below table for draft n
Data Modulation	OFDM (BPSK / QPSK / 16QAM / 64QAM)
Data Rate (Mbps)	see the below table for Draft n
Frequency Range	2400 ~ 2483.5MHz / 5725 ~ 5850MHz
Channel Number	For 2.4GHz Band: 11 for 20MHz bandwidth ; 7 for 40MHz bandwidth For 5GHz Band: 5 for 20MHz bandwidth ; 2 for 40MHz bandwidth
Channel Band Width (99%)	For 2.4GHz Band: MCS8 (20MHz): 17.64 MHz ; MCS8 (40MHz): 36.32 MHz For 5GHz Band: MCS8 (20MHz): 17.64 MHz ; MCS8 (40MHz): 36.32 MHz
Conducted Output Power	For 2.4GHz Band: MCS8 (20MHz): 27.17 dBm ; MCS8 (40MHz): 22.86 dBm For 5GHz Band: MCS8 (20MHz): 23.77 dBm ; MCS8 (40MHz): 24.20 dBm
Carrier Frequencies	Please refer to section 3.4
Antenna	Please refer to section 3.3

802.11a/b/g

Items	Description
Product Type	WLAN (2TX, 3RX)
Radio Type	Intentional Transceiver
Power Type	From Host System
Modulation	DSSS for IEEE 802.11b ; OFDM for IEEE 802.11a/g
Data Modulation	DSSS (BPSK / QPSK / CCK) ; OFDM (BPSK / QPSK / 16QAM / 64QAM)
Data Rate (Mbps)	DSSS (1/ 2/ 5.5/11) ; OFDM (6/9/12/18/24/36/48/54)
Frequency Range	2400 ~ 2483.5MHz / 5725 ~ 5850MHz
Channel Number	11b/g: 11 ; 11a: 5
Channel Band Width (99%)	11b: 14.72 MHz ; 11g: 16.60 MHz ; 11a: 16.48 MHz
Conducted Output Power	11b: 26.31 dBm ; 11g: 27.50 dBm ; 11a: 24.79 dBm
Carrier Frequencies	Please refer to section 3.4
Antenna	Please refer to section 3.3

Antenna & Band width

Antenna	Two (TX)	
	20 MHz	40 MHz
20802.11a	V	X
802.11b	V	X
802.11g	V	X
Draff n	V	V

Draft n spec

MCS Index	Nss	Modulation	R	NBPS	NCBPS		NDBPS		Datarate(Mbps)			
					20MHz	40MHz	20MHz	40MHz	800nsGI		400nsGI	
									20MHz	40MHz	20MHz	40MHz
0	1	BPSK	1/2	1	52	108	26	54	6.5	13.5	7.200	15
1	1	QPSK	1/2	2	104	216	52	108	13.0	27.0	14.400	30
2	1	QPSK	3/4	2	104	216	78	162	19.5	40.5	21.700	45
3	1	16-QAM	1/2	4	208	432	104	216	26.0	54.0	28.900	60
4	1	16-QAM	3/4	4	208	432	156	324	39.0	81.0	43.300	90
5	1	64-QAM	2/3	6	312	648	208	432	52.0	108.0	57.800	120
6	1	64-QAM	3/4	6	312	648	234	486	58.5	121.5	65.000	135
7	1	64-QAM	5/6	6	312	648	260	540	65.0	135.0	72.200	150
8	2	BPSK	1/2	1	104	216	52	108	13.0	27.0	14.444	30
9	2	QPSK	1/2	2	208	432	104	216	26.0	54.0	28.889	60
10	2	QPSK	3/4	2	208	432	156	324	39.0	81.0	43.333	90
11	2	16-QAM	1/2	4	416	864	208	432	52.0	108.0	57.778	120
12	2	16-QAM	3/4	4	416	864	312	648	78.0	162.0	86.667	180
13	2	64-QAM	2/3	6	624	1296	416	864	104.0	216.0	115.556	240
14	2	64-QAM	3/4	6	624	1296	468	972	117.0	243.0	130.000	270
15	2	64-QAM	5/6	6	624	1296	520	1080	130.0	270.0	144.444	300

Symbol	Explanation
NSS	Number of spatial streams
R	Code rate
NBPS	Number of coded bits per single carrier
NCBPS	Number of coded bits per symbol
NDBPS	Number of data bits per symbol
GI	guard interval

3.2. Accessories

N/A

3.3. Table for Filed Antenna

Ant.	Brand	Model Name	Antenna Type	Connector	Frequency Band	Antenna Gain (dBi)
1	Symbol	ML-2452-APA2-01	Dipole Antenna	Reversed-SMA	2.4GHz	7
	Symbol	ML-2452-APA2-01	Dipole Antenna	Reversed-SMA	5GHz	7
2	MOTOROLA	RPAA-M1	Embedded Antenna	I-PEX	2.4GHz	2
	MOTOROLA	RPAA-M1	Embedded Antenna	I-PEX	5GHz	3.42
3	Symbol	ML-2499-SD3-01R	Patch Antenna	RP-BNC Male	2.4GHz	3.5
	Symbol	ML-5299-PTA1-01R	Patch Antenna	RP-SMA Male	5GHz	3
4	Symbol	ML-2499-HPA3-01R	Omni Antenna	RP-BNC Male	2.4GHz	3.3
	Symbol	ML-5299-HPA1-01R	Omni Antenna	RP-SMA Male	5GHz	4.2
5	Symbol	ML-2452-PNA5-01R	Panel Antenna	N Type Male	2.4GHz	4.5
	Symbol	ML-2452-PNA5-01R	Panel Antenna	N Type Male	5GHz	5
6	Symbol	ML-2452-PTA3M3-036	Omni Antenna	RP-SMA Male	2.4GHz	4
	Symbol	ML-2452-PTA3M3-036	Omni Antenna	RP-SMA Male	5GHz	7

Test external cable is used to connect the EUT and antenna.

Loss of External Cable list

Ant.	Frequency Band	Loss of External Cable (dB)
1	2.4GHz	0.65
	5GHz	1.42
2	2.4GHz	-
	5GHz	-
3	2.4GHz	0.65
	5GHz	1.42
4	2.4GHz	0.65
	5GHz	1.42
5	2.4GHz	1.54
	5GHz	2.23
6	2.4GHz	0.65
	5GHz	1.42

Note:

The EUT has three antenna connectors which can be used for transmitting and receiving simultaneously as 2Tx and 3Rx. There are six sets of antenna provided to this EUT and all of them can be used as transmitting and receiving antenna.

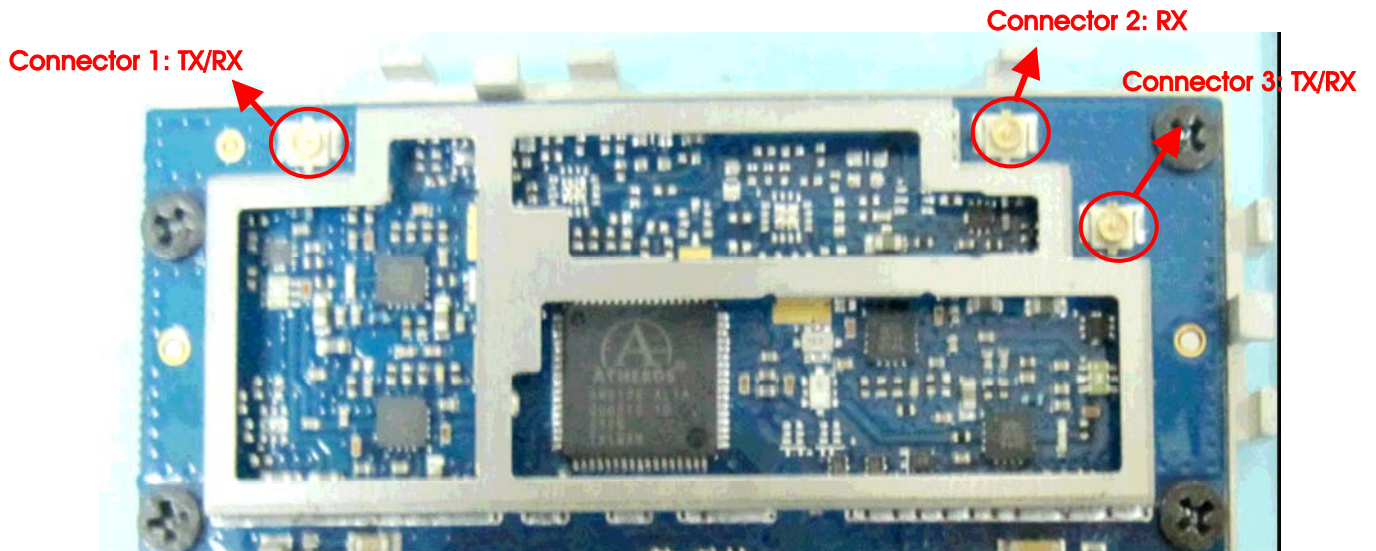

3.4. Table for Carrier Frequencies

For 2.4GHz Band

Frequency Allocation for 802.11b/g

There are two bandwidth systems for draft n.

For both 20MHz bandwidth systems, use Channel 1~Channel 11.

For both 40MHz bandwidth systems, use Channel 3~Channel 9.

Frequency Band	Channel No.	Frequency	Channel No.	Frequency
2400~2483.5MHz	1	2412 MHz	7	2442 MHz
	2	2417 MHz	8	2447 MHz
	3	2422 MHz	9	2452 MHz
	4	2427 MHz	10	2457 MHz
	5	2432 MHz	11	2462 MHz
	6	2437 MHz		

For 5GHz Band

Frequency Allocation for 802.11a

There are two bandwidth systems for draft n.

For 20MHz bandwidth systems, use Channel 149, 153, 157, 161, 165.

For 40MHz bandwidth systems, use Channel 151, 159.

Frequency Band	Channel No.	Frequency	Channel No.	Frequency
5725~5850 MHz (USA/Canada/Taiwan)	149	5745 MHz	159	5795 MHz
	151	5755 MHz	161	5805 MHz
	153	5765 MHz	165	5825 MHz
	157	5785 MHz		

3.5. Table for Test Modes

Preliminary tests were performed in different data rate to find the worst radiated emission. The data rate shown in the table below is the worst-case rate with respect to the specific test item. Investigation has been done on all the possible configurations for searching the worst cases. The following table is a list of the test modes shown in this test report.

For 2.4GHz Band

Test Items	Mode	Data Rate	Channel	Antenna
AC Power Line Conducted Emissions	Normal Link	Auto	-	-
Max. Peak Conducted Output Power	MCS8/20MHz	13 Mbps	1/6/11	1/2/3/4/5/6
	MCS8/40MHz	27 Mbps	3/6/9	1/2/3/4/5/6
	11b/CCK	1 Mbps	1/6/11	1/2/3/4/5/6
	11g/BPSK	6 Mbps	1/6/11	1/2/3/4/5/6
Power Spectral Density 6dB Spectrum Bandwidth	MCS8/20MHz	13 Mbps	1/6/11	1/2/3/4/5/6
	MCS8/40MHz	27 Mbps	3/6/9	1/2/3/4/5/6
	11b/CCK	1 Mbps	1/6/11	1/2/3/4/5/6
	11g/BPSK	6 Mbps	1/6/11	1/2/3/4/5/6
Radiated Emissions Below 1GHz	Normal Link	Auto	-	-
Radiated Emissions Above 1GHz	MCS8/20MHz	13 Mbps	1/6/11	1/2/3/4/5/6
	MCS8/40MHz	27 Mbps	3/6/9	1/2/3/4/5/6
	11b/CCK	1 Mbps	1/6/11	1/2/3/4/5/6
	11g/BPSK	6 Mbps	1/6/11	1/2/3/4/5/6
Band Edge Emissions	MCS8/20MHz	13 Mbps	1/11	1/2/3/4/5/6
	MCS8/40MHz	27 Mbps	3/9	1/2/3/4/5/6
	11b/CCK	1 Mbps	1/11	1/2/3/4/5/6
	11g/BPSK	6 Mbps	1/11	1/2/3/4/5/6

For 5GHz Band

Test Items	Mode	Data Rate	Channel	Antenna
AC Power Line Conducted Emissions	Normal Link	Auto	-	-
Max. Peak Conducted Output Power	MCS8/20MHz	13 Mbps	149/157/165	1/2/3/4/5/6
	MCS8/40MHz	27 Mbps	151/159	1/2/3/4/5/6
	11a/BPSK	6 Mbps	149/157/165	1/2/3/4/5/6
Power Spectral Density 6dB Spectrum Bandwidth	MCS8/20MHz	13 Mbps	149/157/165	1/2/3/4/5/6
	MCS8/40MHz	27 Mbps	151/159	1/2/3/4/5/6
	11a/BPSK	6 Mbps	149/157/165	1/2/3/4/5/6
Radiated Emissions Below 1GHz	Normal Link	Auto	-	-
Radiated Emissions Above 1GHz	MCS8/20MHz	13 Mbps	149/157/165	1/2/3/4/5/6
	MCS8/40MHz	27 Mbps	151/159	1/2/3/4/5/6
	11a/BPSK	6 Mbps	149/157/165	1/2/3/4/5/6
Band Edge Emissions	MCS8/20MHz	13 Mbps	149/157/165	1/2/3/4/5/6
	MCS8/40MHz	27 Mbps	151/159	1/2/3/4/5/6
	11a/BPSK	6 Mbps	149/157/165	1/2/3/4/5/6

3.6. Table for Testing Locations

Test Site No.	Site Category	Location	FCC Reg. No.	IC File No.	VCCI Reg. No
03CH03-HY	SAC	Hwa Ya	480872	IC 4086	-
CO04-HY	Conduction	Hwa Ya	480872	IC 4086	-
TH01-HY	OVEN Room	Hwa Ya	480872	IC 4086	-

Open Area Test Site (OATS); Semi Anechoic Chamber (SAC); Fully Anechoic Chamber (FAC).

Please refer section 6 for Test Site Address.

3.7. Table for Supporting Units

Support Unit	Brand	Model	FCC ID
Notebook	DELL	D400	E2K24GBRL
Mouse	iCooky	AMS0706W	DoC
Modem	ACEEX	DM1414	IFAXDM1414
Printer	EPSON	LQ-300+	DoC
Notebook	DELL	D505	E2K24GBRL

3.8. Table for Parameters of Test Software Setting

During testing, Channel & Power Controlling Software provided by the customer was used to control the operating channel as well as the output power level. The RF output power selection is for the setting of RF output power expected by the customer and is going to be fixed on the firmware of the final end product.

<For Antenna 1 >:

For 2.4GHz Band

Power Parameters of Draft n

Test Software Version	ART		
Frequency	2412 MHz	2437 MHz	2462 MHz
MCS8 20MHz	16	20	16.5
Frequency	2422 MHz	2437 MHz	2452 MHz
MCS8 40MHz	14.5	16.5	13

Power Parameters of IEEE 802.11b/g

Test Software Version	ART		
Frequency	2412 MHz	2437 MHz	2462 MHz
IEEE 802.11b	19.5	21	20
IEEE 802.11g	17	21	16.5

For 5GHz Band

Power Parameters of Draft n

Test Software Version	ART		
Frequency	5745 MHz	5785 MHz	5825 MHz
MCS8 20MHz	18	18	18
Frequency	5755 MHz	5795 MHz	-
MCS8 40MHz	18	18	-

Power Parameters of IEEE 802.11a

Test Software Version	ART		
Frequency	5745 MHz	5785 MHz	5825 MHz
IEEE 802.11a	19	19	19

<For Antenna 2>:

For 2.4GHz Band

Power Parameters of Draft n

Test Software Version	ART		
Frequency	2412 MHz	2437 MHz	2462 MHz
MCS8 20MHz	15	20	15
Frequency	2422 MHz	2437 MHz	2452 MHz
MCS8 40MHz	12.5	15.5	11.5

Power Parameters of IEEE 802.11b/g

Test Software Version	ART		
Frequency	2412 MHz	2437 MHz	2462 MHz
IEEE 802.11b	19	21	18.5
IEEE 802.11g	16	21	16

For 5GHz Band

Power Parameters of Draft n

Test Software Version	ART		
Frequency	5745 MHz	5785 MHz	5825 MHz
MCS8 20MHz	18	18	18
Frequency	5755 MHz	5795 MHz	-
MCS8 40MHz	18	18	-

Power Parameters of IEEE 802.11a

Test Software Version	ART		
Frequency	5745 MHz	5785 MHz	5825 MHz
IEEE 802.11a	19	19	19

<For Antenna 3>:

For 2.4GHz Band

Power Parameters of Draft n

Test Software Version	ART		
Frequency	2412 MHz	2437 MHz	2462 MHz
MCS8 20MHz	14.5	19.5	14.5
Frequency	2422 MHz	2437 MHz	2452 MHz
MCS8 40MHz	12	14.5	11

Power Parameters of IEEE 802.11b/g

Test Software Version	ART		
Frequency	2412 MHz	2437 MHz	2462 MHz
IEEE 802.11b	19	19.5	18.5
IEEE 802.11g	15.5	19	15

For 5GHz Band

Power Parameters of Draft n

Test Software Version	ART		
Frequency	5745 MHz	5785 MHz	5825 MHz
MCS8 20MHz	18	18	18
Frequency	5755 MHz	5795 MHz	-
MCS8 40MHz	18	18	-

Power Parameters of IEEE 802.11a

Test Software Version	ART		
Frequency	5745 MHz	5785 MHz	5825 MHz
IEEE 802.11a	19	19	19

<For Antenna 4>:

For 2.4GHz Band

Power Parameters of Draft n

Test Software Version	ART		
Frequency	2412 MHz	2437 MHz	2462 MHz
MCS8 20MHz	14	19	13
Frequency	2422 MHz	2437 MHz	2452 MHz
MCS8 40MHz	10.5	14	9.5

Power Parameters of IEEE 802.11b/g

Test Software Version	ART		
Frequency	2412 MHz	2437 MHz	2462 MHz
IEEE 802.11b	19	21	19.5
IEEE 802.11g	13.5	19	14

For 5GHz Band

Power Parameters of Draft n

Test Software Version	ART		
Frequency	5745 MHz	5785 MHz	5825 MHz
MCS8 20MHz	18	18	18
Frequency	5755 MHz	5795 MHz	-
MCS8 40MHz	18	18	-

Power Parameters of IEEE 802.11a

Test Software Version	ART		
Frequency	5745 MHz	5785 MHz	5825 MHz
IEEE 802.11a	19	19	19

<For Antenna 5>:

For 2.4GHz Band

Power Parameters of Draft n

Test Software Version	ART		
Frequency	2412 MHz	2437 MHz	2462 MHz
MCS8 20MHz	12.5	18	12
Frequency	2422 MHz	2437 MHz	2452 MHz
MCS8 40MHz	10	13	9

Power Parameters of IEEE 802.11b/g

Test Software Version	ART		
Frequency	2412 MHz	2437 MHz	2462 MHz
IEEE 802.11b	16.5	20	17
IEEE 802.11g	13	17	13

For 5GHz Band

Power Parameters of Draft n

Test Software Version	ART		
Frequency	5745 MHz	5785 MHz	5825 MHz
MCS8 20MHz	18	18	18
Frequency	5755 MHz	5795 MHz	-
MCS8 40MHz	18	18	-

Power Parameters of IEEE 802.11a

Test Software Version	ART		
Frequency	5745 MHz	5785 MHz	5825 MHz
IEEE 802.11a	19	19	19

<For Antenna 6>:

For 2.4GHz Band

Power Parameters of Draft n

Test Software Version	ART		
Frequency	2412 MHz	2437 MHz	2462 MHz
MCS8 20MHz	13	19	13.5
Frequency	2422 MHz	2437 MHz	2452 MHz
MCS8 40MHz	10	13.5	10

Power Parameters of IEEE 802.11b/g

Test Software Version	ART		
Frequency	2412 MHz	2437 MHz	2462 MHz
IEEE 802.11b	17.5	20.5	19
IEEE 802.11g	15	19	13.5

For 5GHz Band

Power Parameters of Draft n

Test Software Version	ART		
Frequency	5745 MHz	5785 MHz	5825 MHz
MCS8 20MHz	18	18	18
Frequency	5755 MHz	5795 MHz	-
MCS8 40MHz	18	18	-

Power Parameters of IEEE 802.11a

Test Software Version	ART		
Frequency	5745 MHz	5785 MHz	5825 MHz
IEEE 802.11a	19	19	19

During the test, the following programs under WIN XP were executed:

Executed "ART" to control the EUT continuously transmit RF signal.

3.9. Test Configurations

3.9.1. Radiation Emissions Test Configuration

Test Configuration: 9kHz~1GHz

<For Antenna 1>: For 2.4GHz/5GHz Band

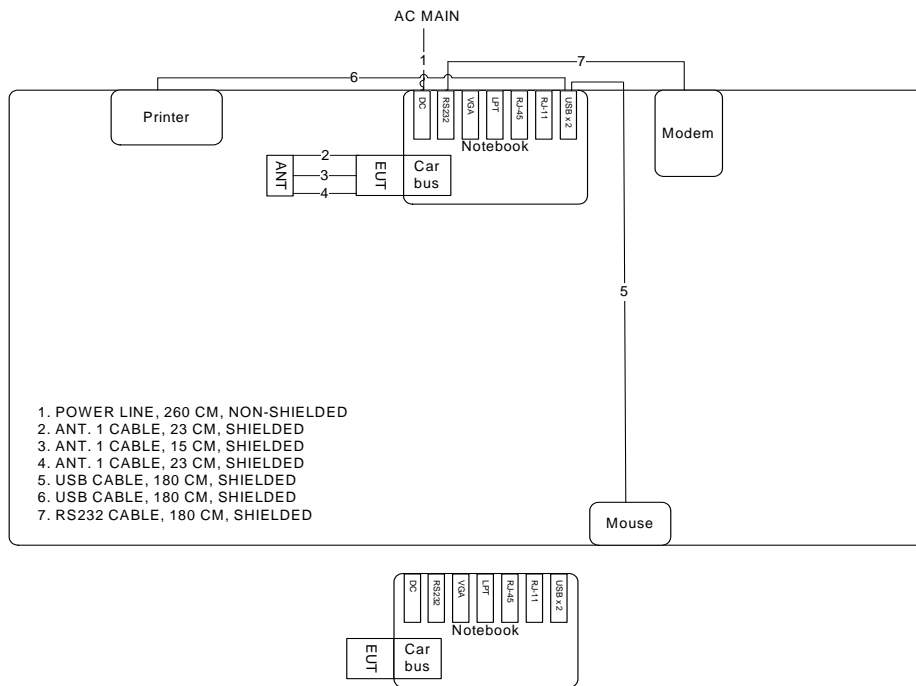

<For Antenna 2>: For 2.4GHz/5GHz Band

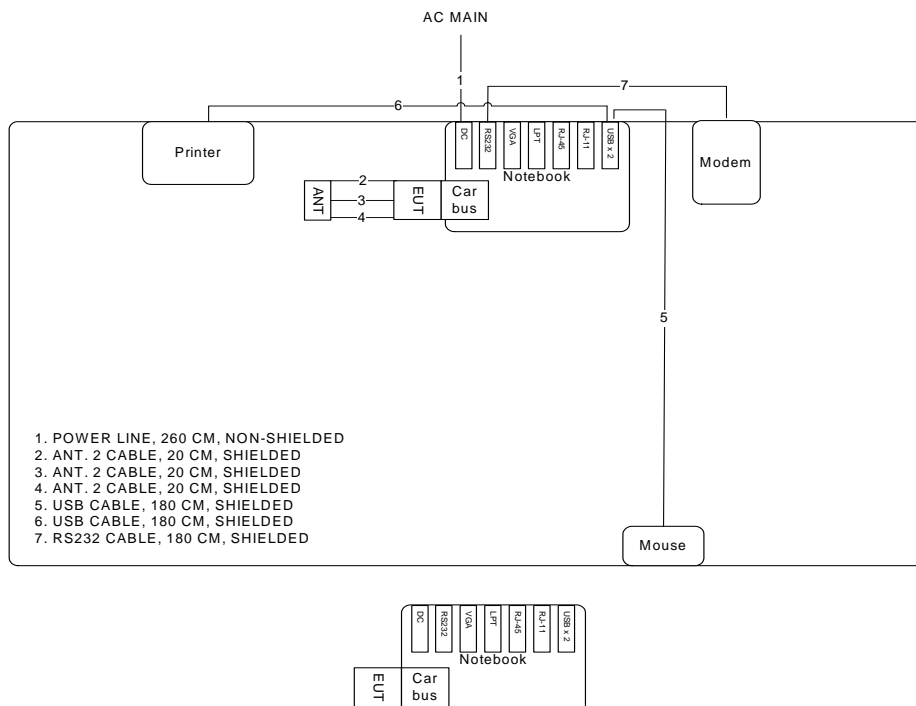

<For Antenna 3>: For 5GHz Band

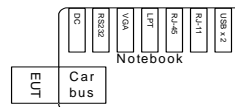
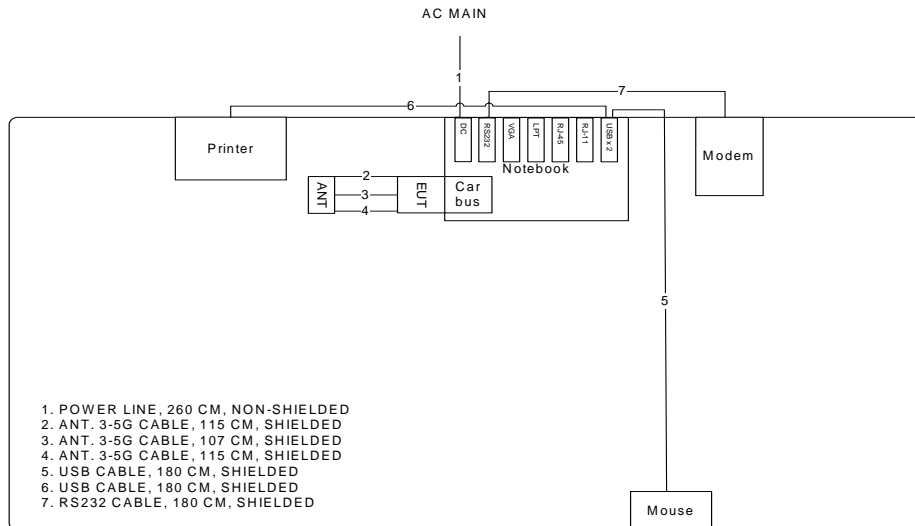

<For Antenna 3>: For 2.4GHz Band

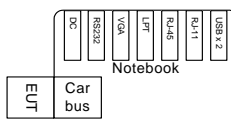
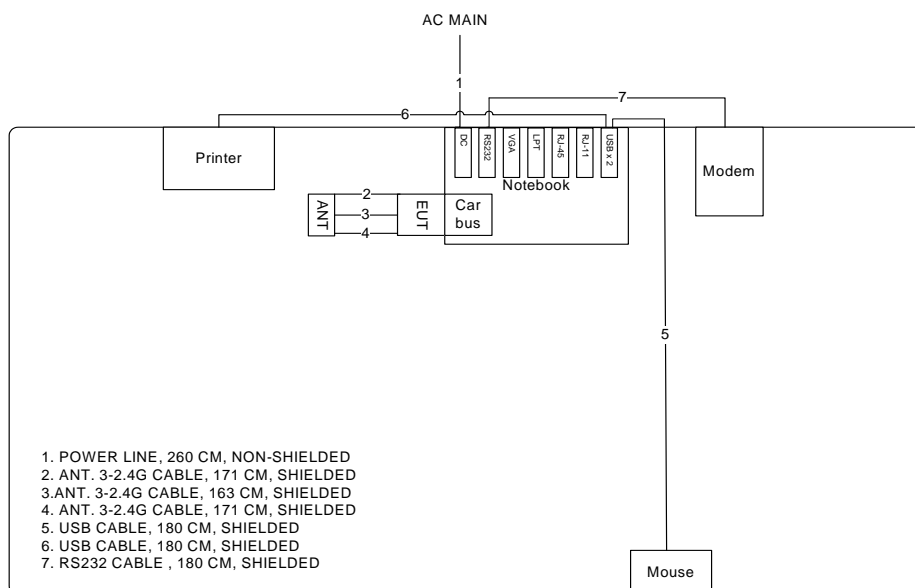

<For Antenna 4>: For 5GHz Band

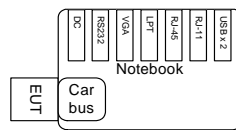
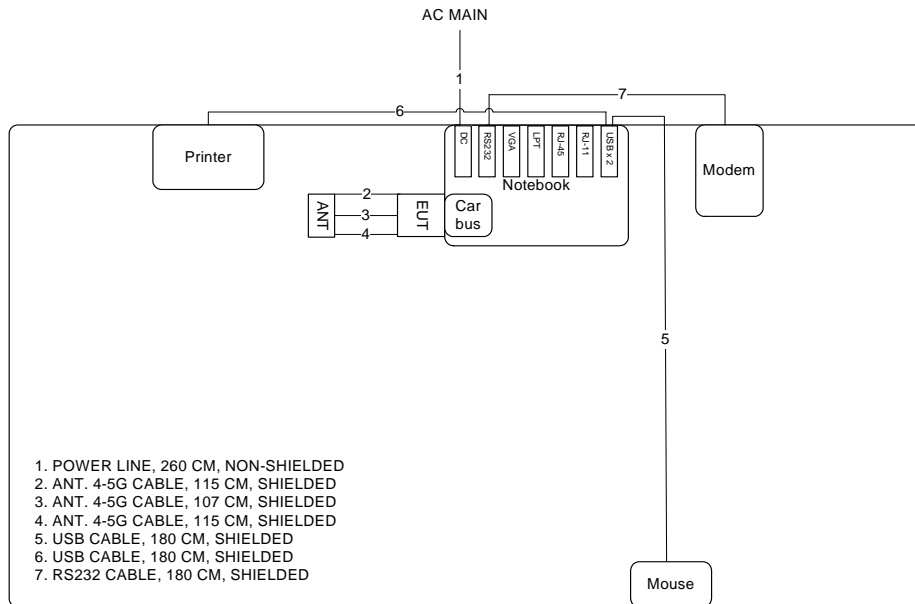

<For Antenna 4>: For 2.4GHz Band

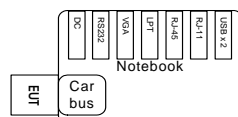
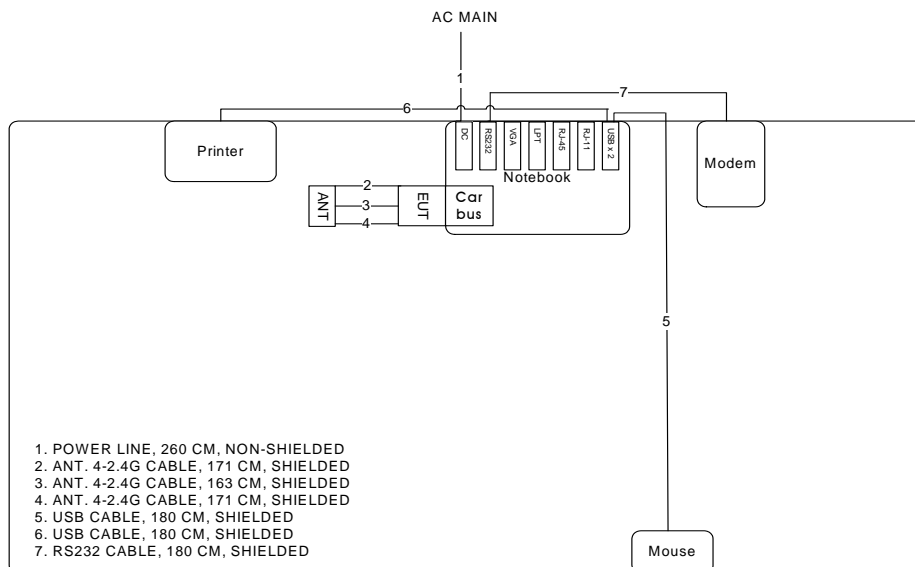

<For Antenna 5>: For 2.4GHz/5GHz Band

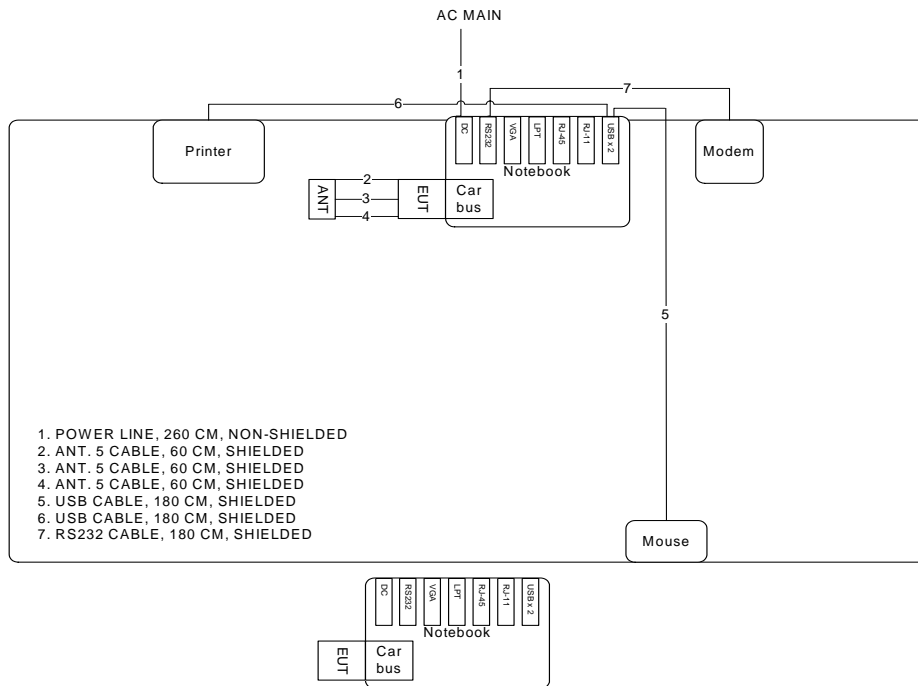

<For Antenna 6>: For 2.4GHz/5GHz Band

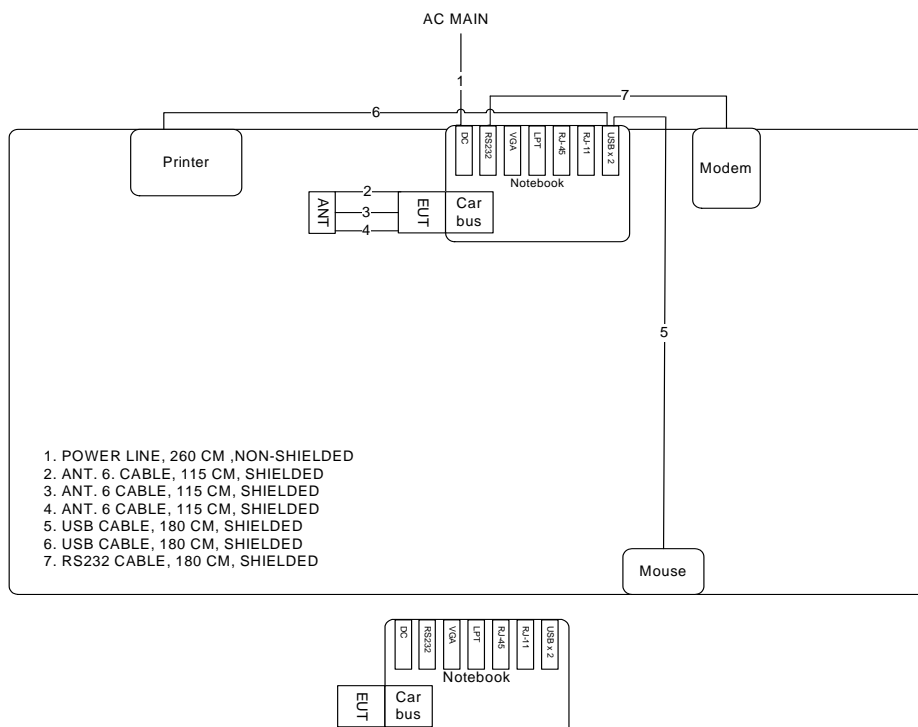

Test Configuration: above 1GHz

<For Antenna 1>: For 2.4GHz/5GHz Band

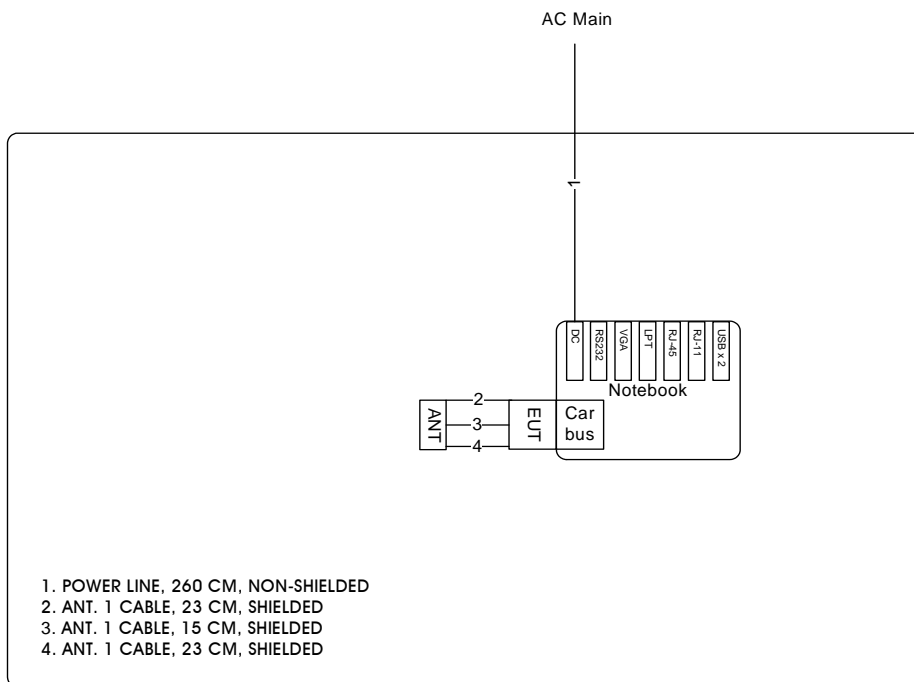

<For Antenna 2>: For 2.4GHz/5GHz Band

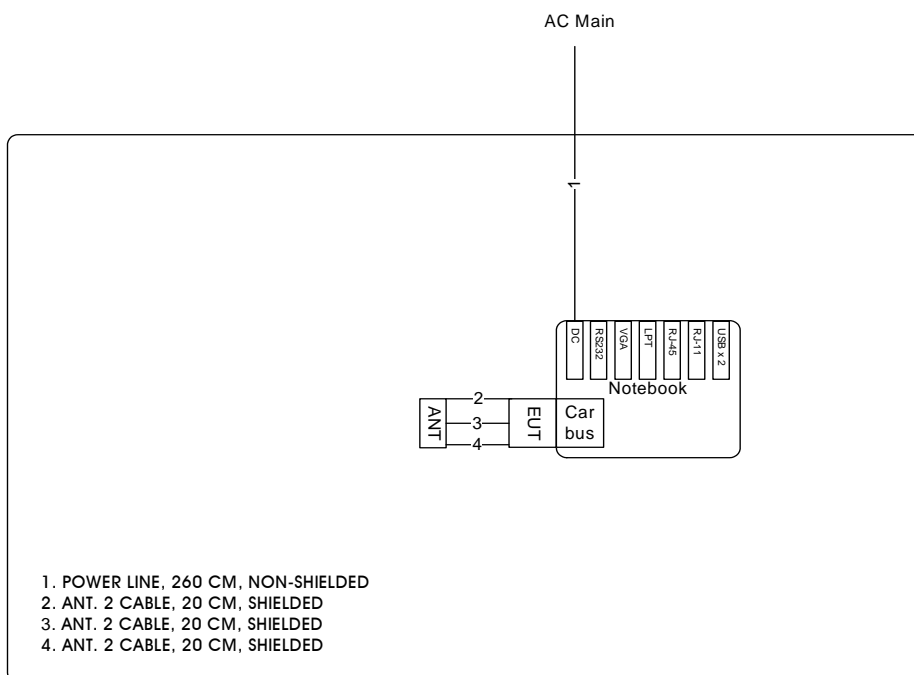

<For Antenna 3>: For 5GHz Band

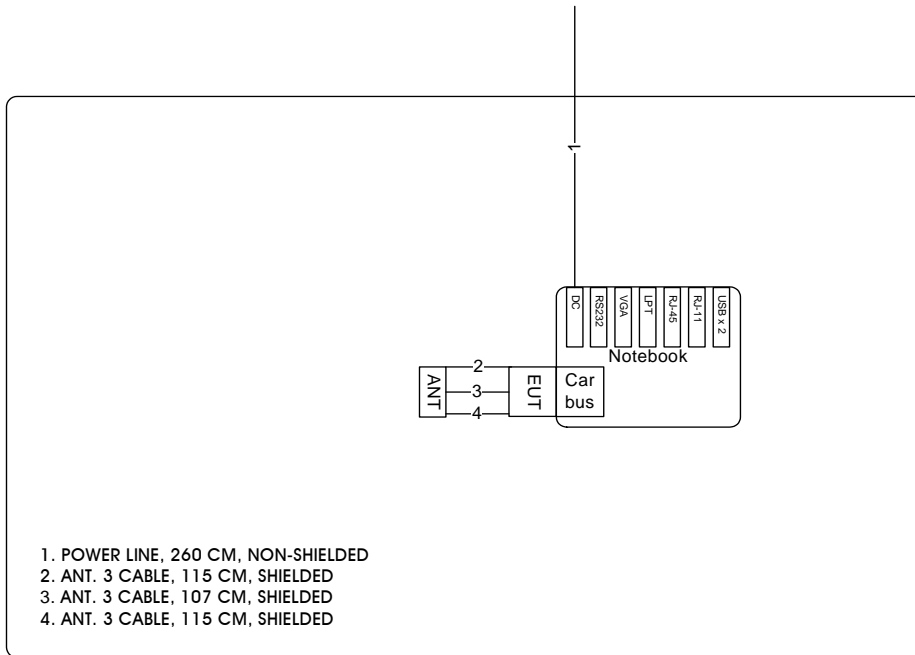

<For Antenna 3>: For 2.4GHz Band

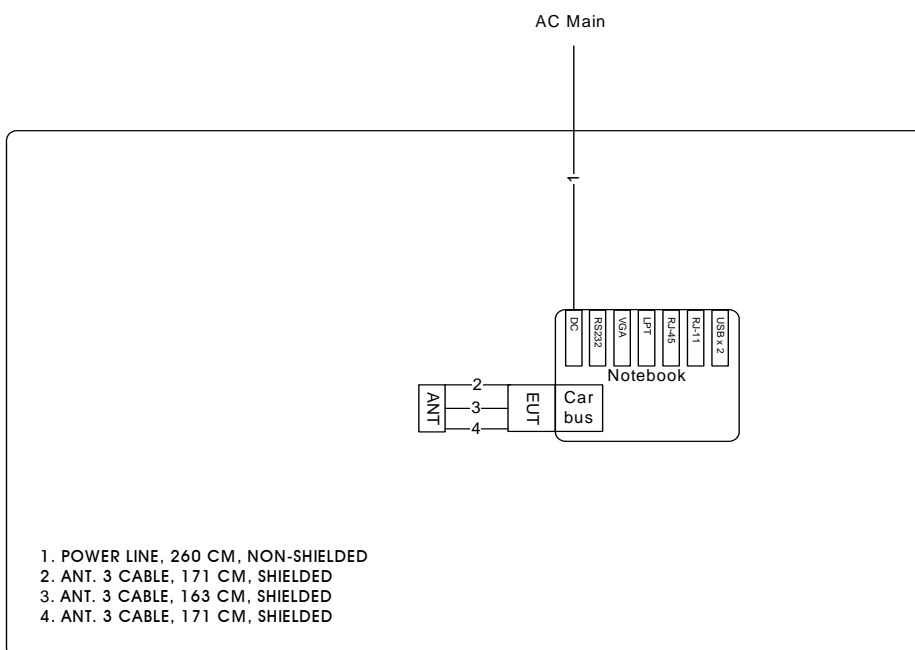

<For Antenna 4>: For 5GHz Band

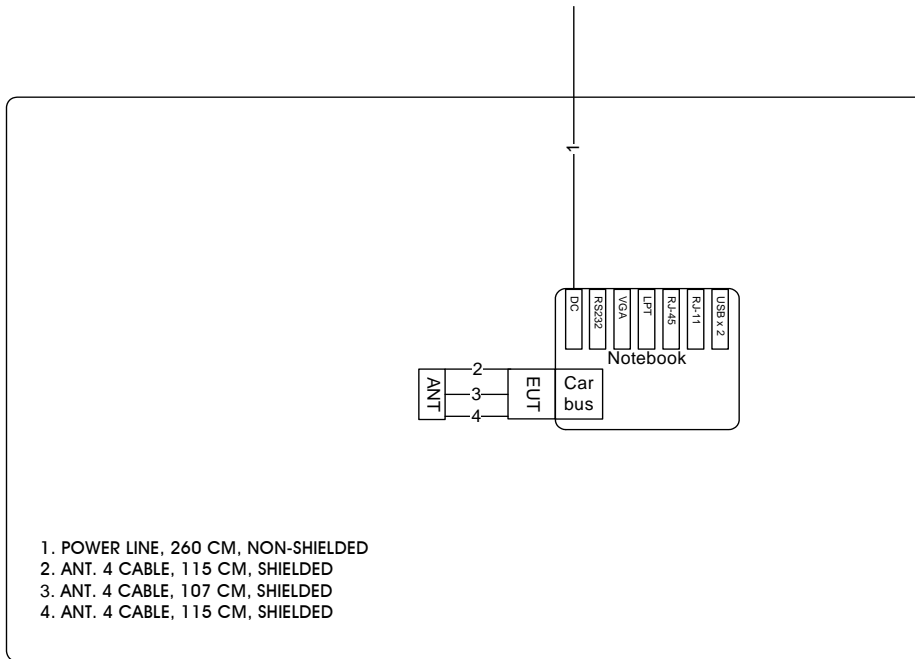

<For Antenna 4>: For 2.4GHz Band

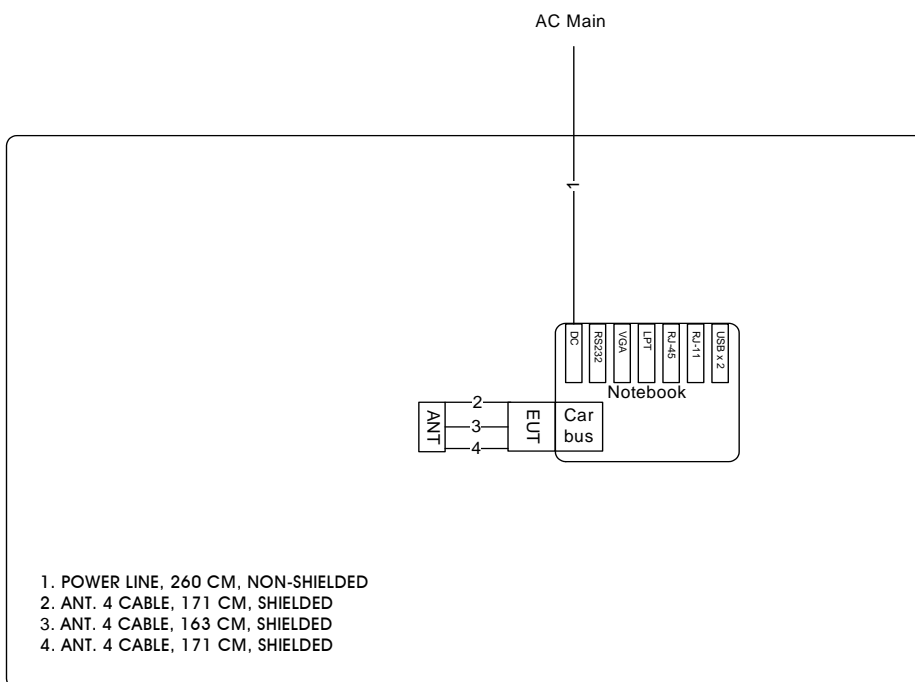

<For Antenna 5>: For 2.4GHz/5GHz Band

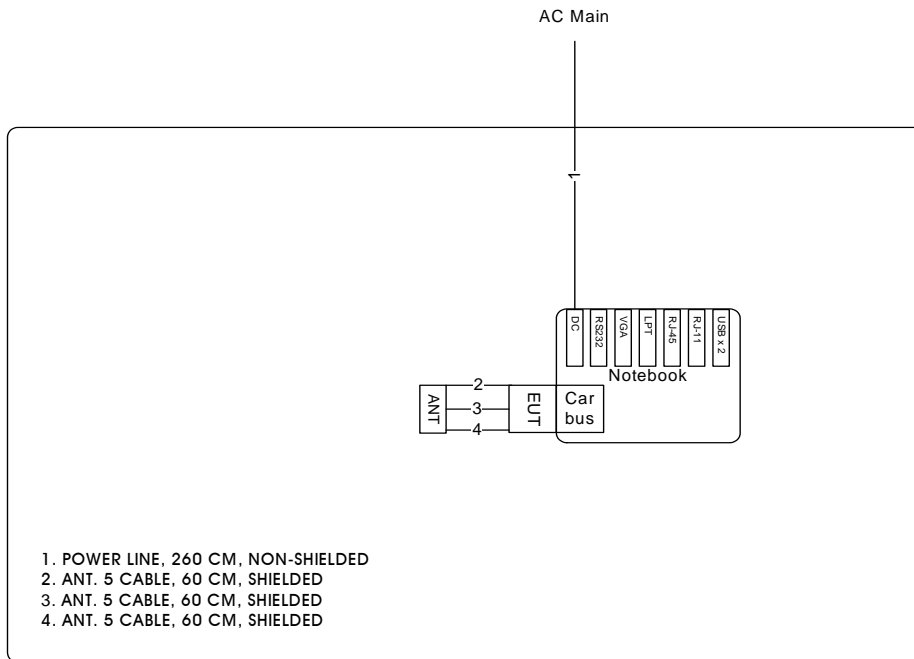

<For Antenna 6>: For 2.4GHz/5GHz Band

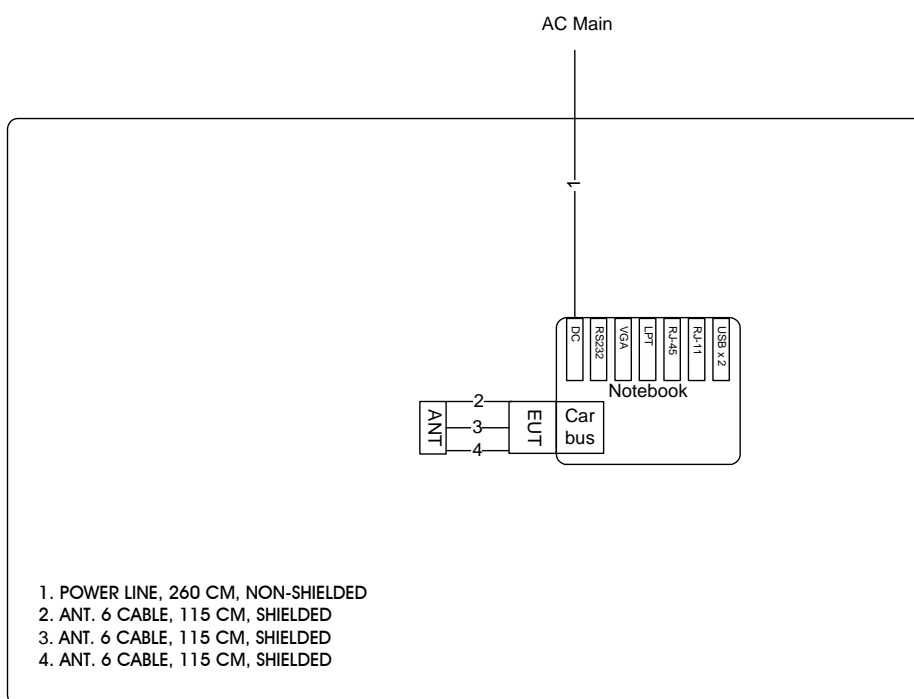

3.9.2. AC Power Line Conduction Emissions Test Configuration

<For Antenna 1>: For 2.4GHz/5GHz Band

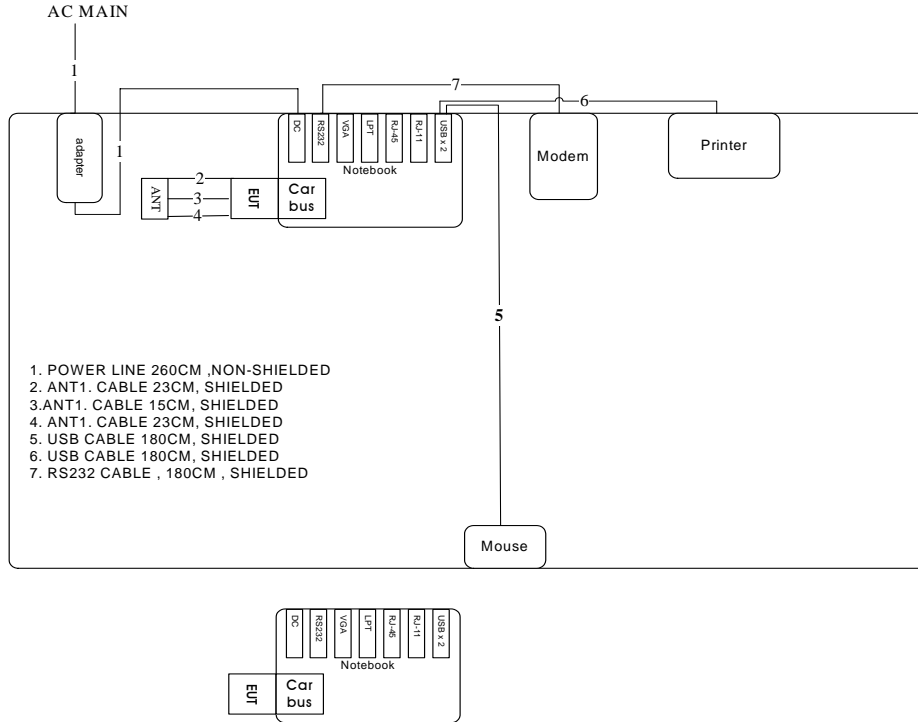

<For Antenna 2>: For 2.4GHz/5GHz Band

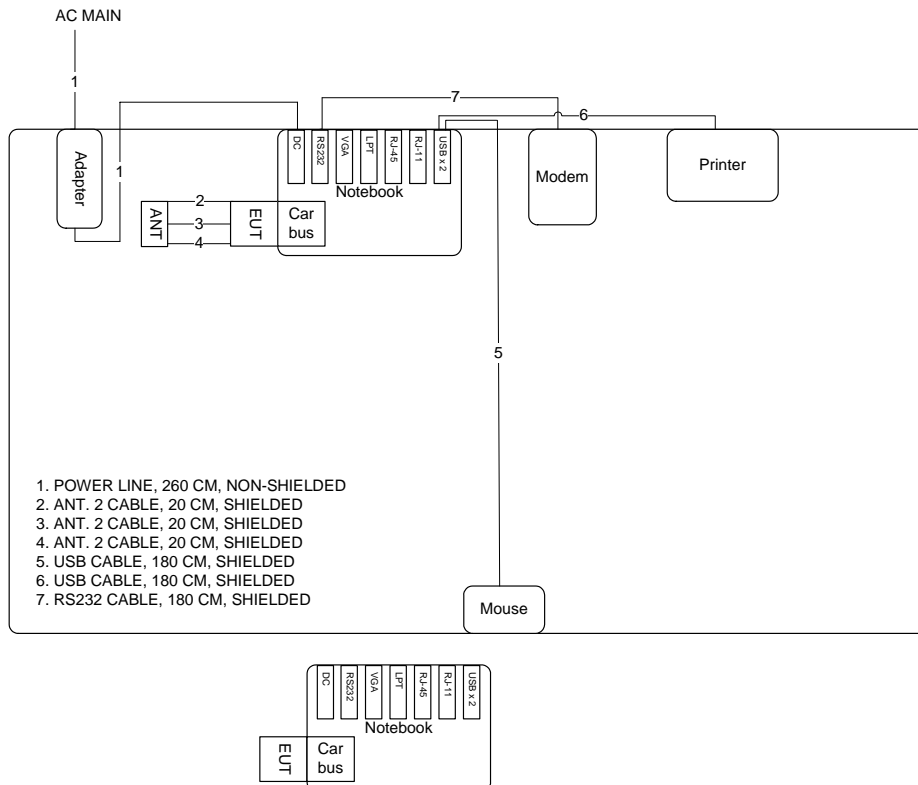

<For Antenna 3>: For 5GHz Band

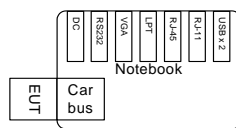
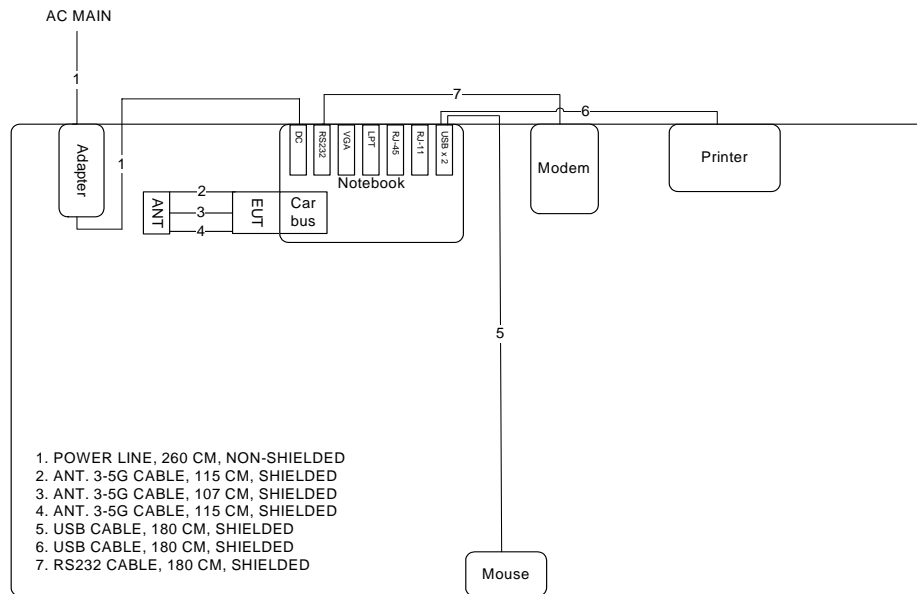

<For Antenna 3>: For 2.4GHz Band

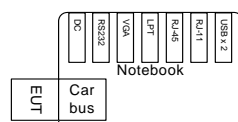
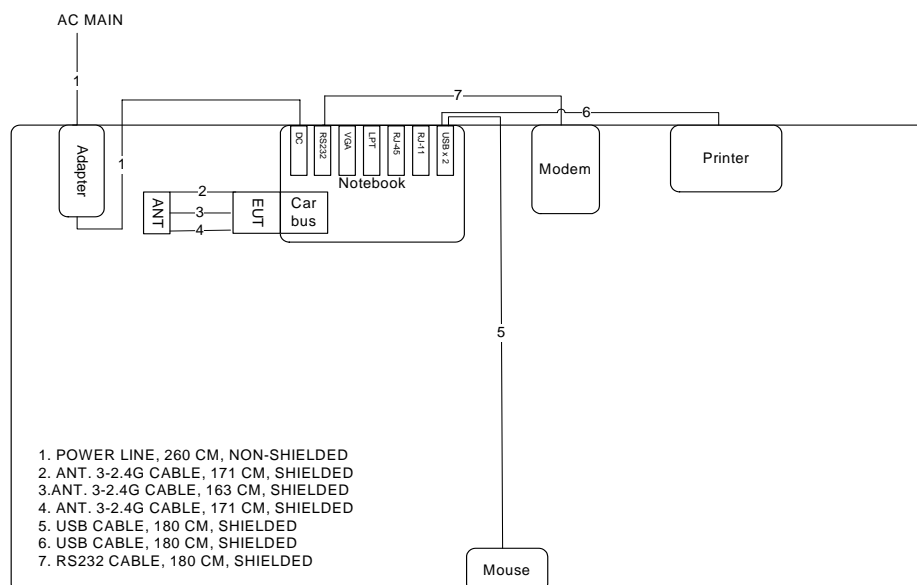

<For Antenna 4>: For 5GHz Band

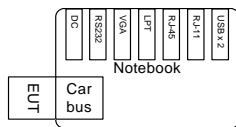
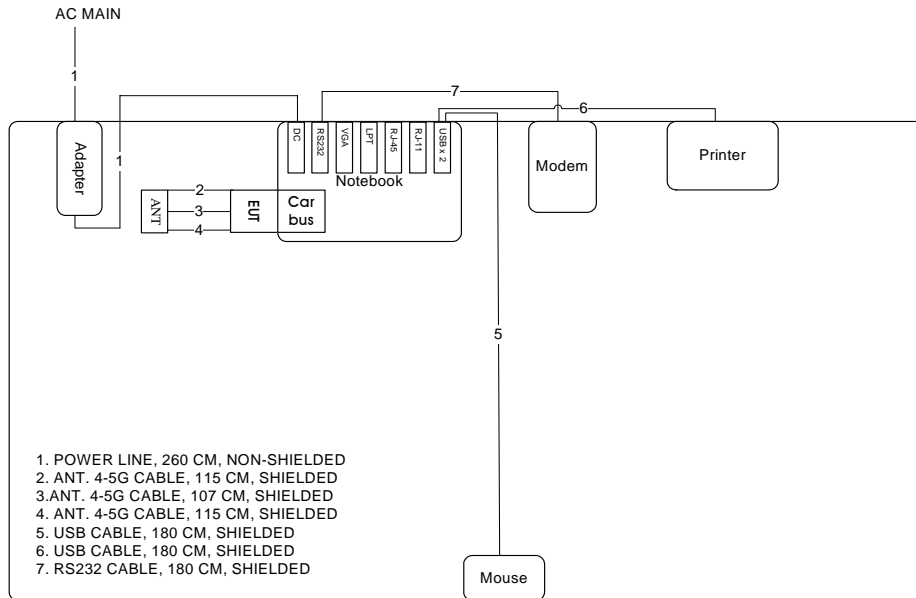

<For Antenna 4>: For 2.4GHz Band

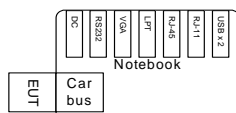
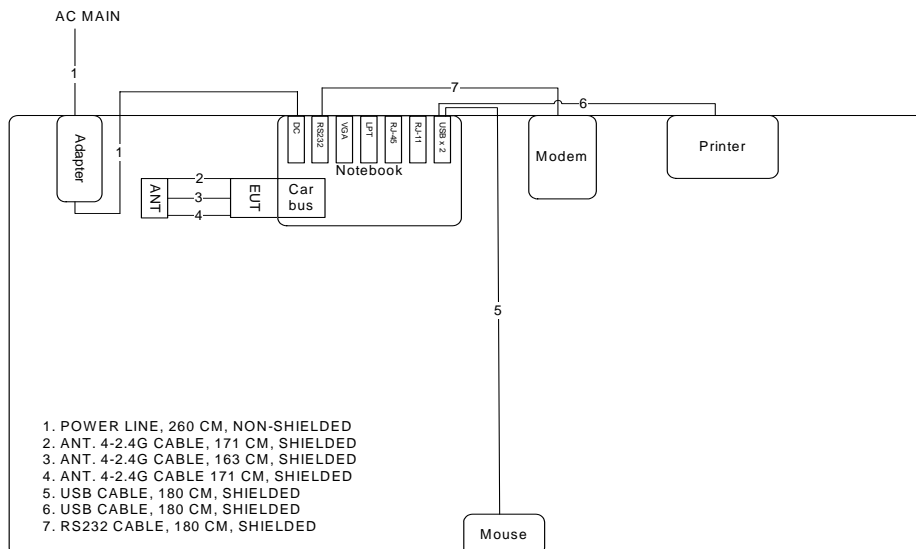

<For Antenna 5>:

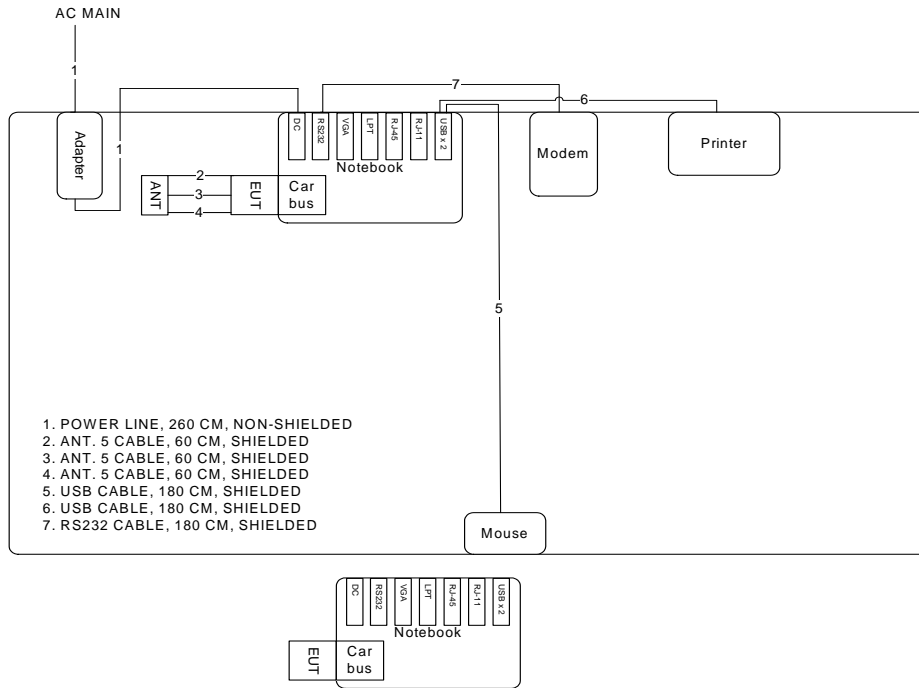

<For Antenna 6>:

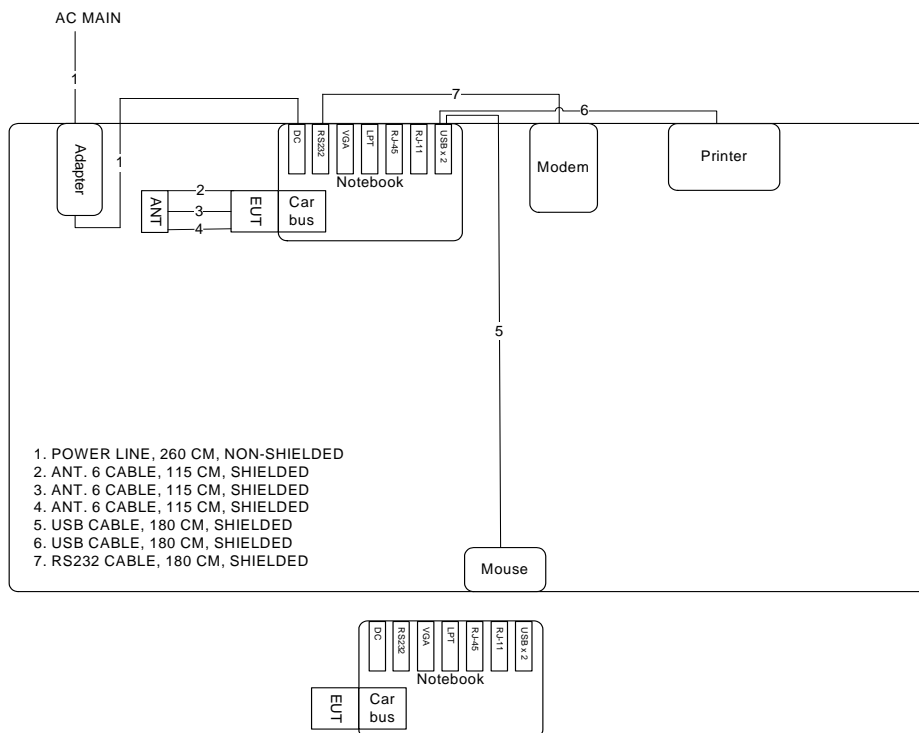

4. TEST RESULT

4.1. AC Power Line Conducted Emissions Measurement

4.1.1. Limit

For this product which is designed to be connected to the AC power line, the radio frequency voltage that is conducted back onto the AC power line on any frequency or frequencies within the band 150 kHz to 30 MHz shall not exceed below limits table.

Frequency (MHz)	QP Limit (dBuV)	AV Limit (dBuV)
0.15~0.5	66~56	56~46
0.5~5	56	46
5~30	60	50

4.1.2. Measuring Instruments and Setting

Please refer to section 5 of equipments list in this report. The following table is the setting of the receiver.

Receiver Parameters	Setting
Attenuation	10 dB
Start Frequency	0.15 MHz
Stop Frequency	30 MHz
IF Bandwidth	9 KHz

4.1.3. Test Procedures

1. Configure the EUT according to ANSI C63.4. The EUT or host of EUT has to be placed 0.4 meter far from the conducting wall of the shielding room and at least 80 centimeters from any other grounded conducting surface.
2. Connect EUT or host of EUT to the power mains through a line impedance stabilization network (LISN).
3. All the support units are connected to the other LISNs. The LISN should provide 50uH/50ohms coupling impedance.
4. The frequency range from 150 KHz to 30 MHz was searched.
5. Set the test-receiver system to Peak Detect Function and Specified Bandwidth with Maximum Hold Mode.
6. The measurement has to be done between each power line and ground at the power terminal.

4.1.4. Test Setup Layout

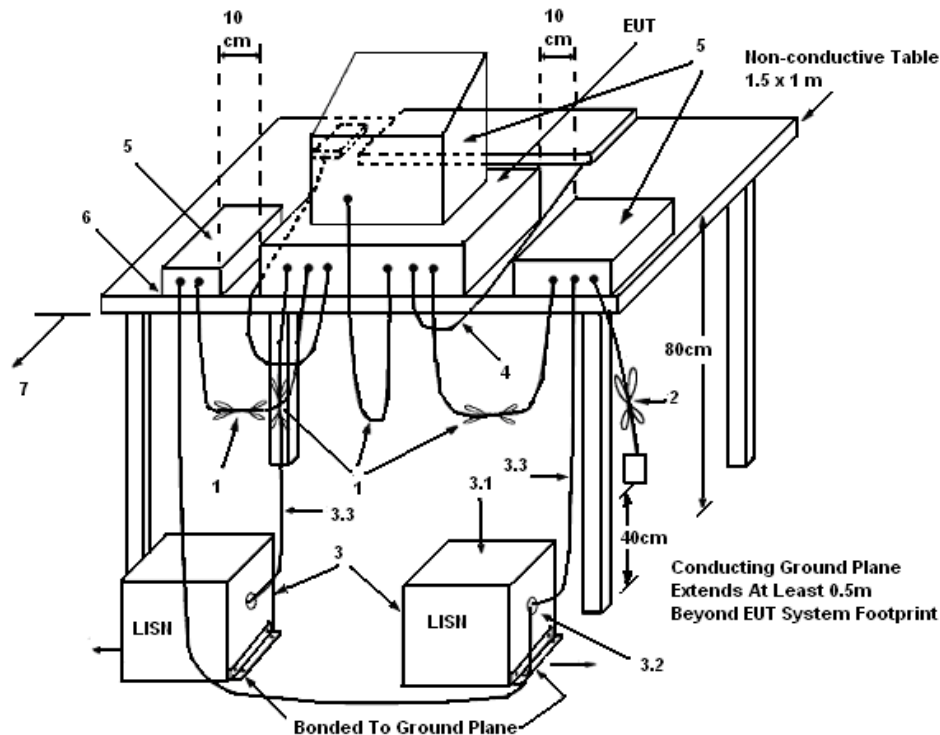

LEGEND:

- (1) Interconnecting cables that hang closer than 40 cm to the ground plane shall be folded back and forth in the center forming a bundle 30 to 40 cm long.
- (2) I/O cables that are not connected to a peripheral shall be bundled in the center. The end of the cable may be terminated, if required, using the correct terminating impedance. The overall length shall not exceed 1 m.
- (3) EUT connected to one LISN. Unused LISN measuring port connectors shall be terminated in 50 Ω . LISN can be placed on top of, or immediately beneath, reference ground plane.
 - (3.1) All other equipment powered from additional LISN(s).
 - (3.2) Multiple outlet strip can be used for multiple power cords of non-EUT equipment.
 - (3.3) LISN at least 80 cm from nearest part of EUT chassis.
- (4) Cables of hand-operated devices, such as keyboards, mice, etc., shall be placed as for normal use.
- (5) Non-EUT components of EUT system being tested.
- (6) Rear of EUT, including peripherals, shall all be aligned and flush with rear of tabletop.
- (7) Rear of tabletop shall be 40 cm removed from a vertical conducting plane that is bonded to the ground plane.

4.1.5. Test Deviation

There is no deviation with the original standard.

4.1.6. EUT Operation during Test

The EUT was placed on the test table and programmed in normal function.

4.1.7. Results of AC Power Line Conducted Emissions Measurement

<For Antenna 1>:

Temperature	24°C	Humidity	56%
Test Engineer	Peter Wu	Phase	Line
Configuration	Normal Link / Antenna 1		

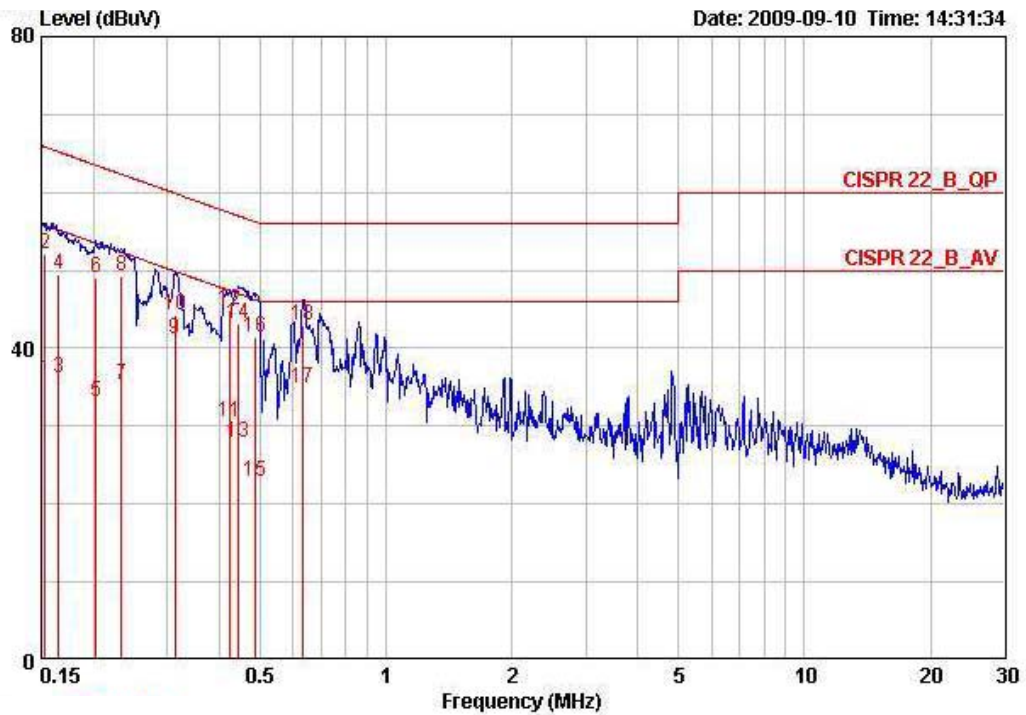

	Freq	Level	Over Limit	Limit Line	Read Level	LISN Factor	Cable Loss	Remark
	MHz	dBuV	dB	dBuV	dBuV	dB	dB	
1	0.15321	36.01	-19.81	55.82	35.74	0.07	0.20	AVERAGE
2	0.15321	52.02	-13.80	65.82	51.75	0.07	0.20	QP
3	0.16501	36.17	-19.04	55.21	35.90	0.07	0.20	AVERAGE
4	0.16501	49.47	-15.74	65.21	49.20	0.07	0.20	QP
5	0.20289	33.15	-20.34	53.49	32.90	0.05	0.20	AVERAGE
6	0.20289	48.97	-14.52	63.49	48.72	0.05	0.20	QP
7	0.23285	35.40	-16.95	52.35	35.15	0.05	0.20	AVERAGE
8	0.23285	49.36	-12.99	62.35	49.11	0.05	0.20	QP
9	0.31328	41.12	-8.77	49.88	40.88	0.04	0.20	AVERAGE
10	0.31328	44.25	-15.64	59.88	44.01	0.04	0.20	QP
11	0.42150	30.49	-16.93	47.42	30.26	0.03	0.20	AVERAGE
12	0.42150	45.01	-12.41	57.42	44.78	0.03	0.20	QP
13	0.44443	27.86	-19.12	46.98	27.63	0.03	0.20	AVERAGE
14	0.44443	43.22	-13.76	56.98	42.99	0.03	0.20	QP
15	0.48632	22.87	-23.36	46.23	22.73	0.03	0.11	AVERAGE
16	0.48632	41.45	-14.78	56.23	41.31	0.03	0.11	QP
17	0.63018	34.85	-11.15	46.00	34.62	0.03	0.20	AVERAGE
18	0.63018	42.93	-13.07	56.00	42.70	0.03	0.20	QP

Temperature	24°C	Humidity	56%
Test Engineer	Peter Wu	Phase	Neutral
Configuration	Normal Link / Antenna 1		

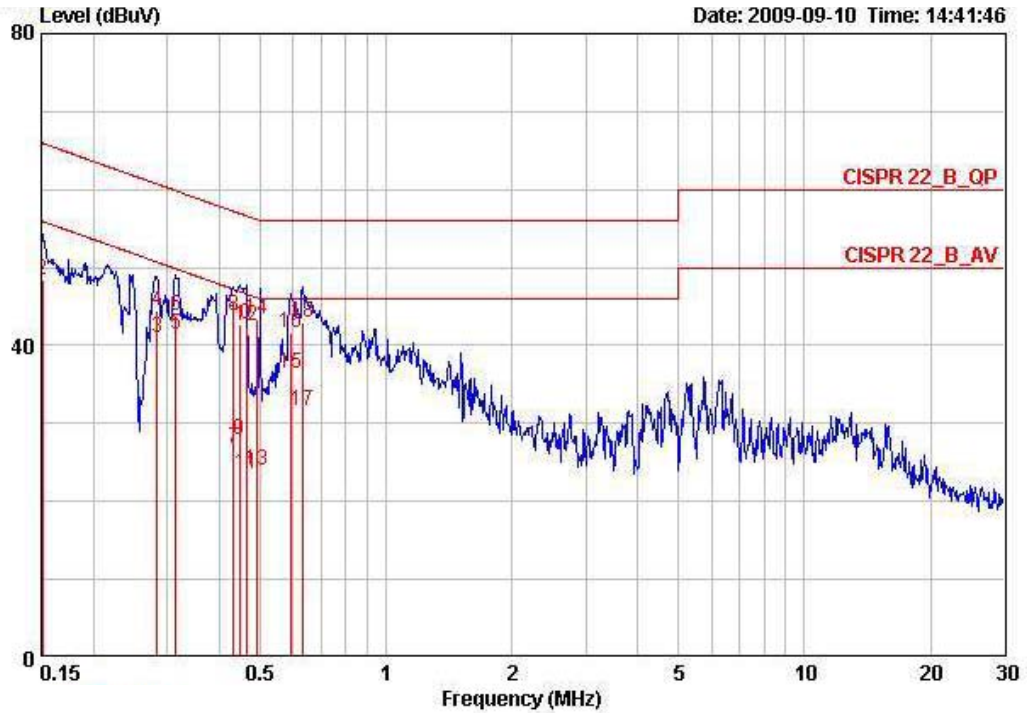

	Freq	Level	Over Limit	Limit Line	Read Level	LISN Factor	Cable Loss	Remark
	MHz	dBuV	dB	dBuV	dBuV	dB	dB	
1	0.15080	36.15	-19.80	55.96	35.85	0.10	0.20	AVERAGE
2	0.15080	48.31	-17.64	65.96	48.01	0.10	0.20	QP
3	0.28328	40.92	-9.79	50.72	40.65	0.07	0.20	AVERAGE
4	0.28328	44.49	-16.22	60.72	44.22	0.07	0.20	QP
5	0.31495	41.52	-8.32	49.84	41.25	0.07	0.20	AVERAGE
6	0.31495	43.84	-16.00	59.84	43.57	0.07	0.20	QP
7	0.43281	26.79	-20.41	47.20	26.52	0.07	0.20	AVERAGE
8	0.43281	43.90	-13.30	57.20	43.63	0.07	0.20	QP
9	0.44679	27.94	-18.99	46.93	27.67	0.07	0.20	AVERAGE
10	0.44679	42.78	-14.15	56.93	42.51	0.07	0.20	QP
11	0.46614	23.56	-23.02	46.58	23.29	0.07	0.20	AVERAGE
12	0.46614	42.61	-13.97	56.58	42.34	0.07	0.20	QP
13	0.49237	23.93	-22.20	46.13	23.73	0.07	0.13	AVERAGE
14	0.49237	43.37	-12.76	56.13	43.17	0.07	0.13	QP
15	0.59324	36.44	-9.56	46.00	36.17	0.07	0.20	AVERAGE
16	0.59324	41.67	-14.33	56.00	41.40	0.07	0.20	QP
17	0.63383	31.68	-14.32	46.00	31.41	0.07	0.20	AVERAGE
18	0.63383	42.91	-13.09	56.00	42.64	0.07	0.20	QP

Note: Level = Read Level + LISN Factor + Cable Loss

<For Antenna 2>:

Temperature	24°C	Humidity	56%
Test Engineer	Peter Wu	Phase	Line
Configuration	Normal Link / Antenna 2		

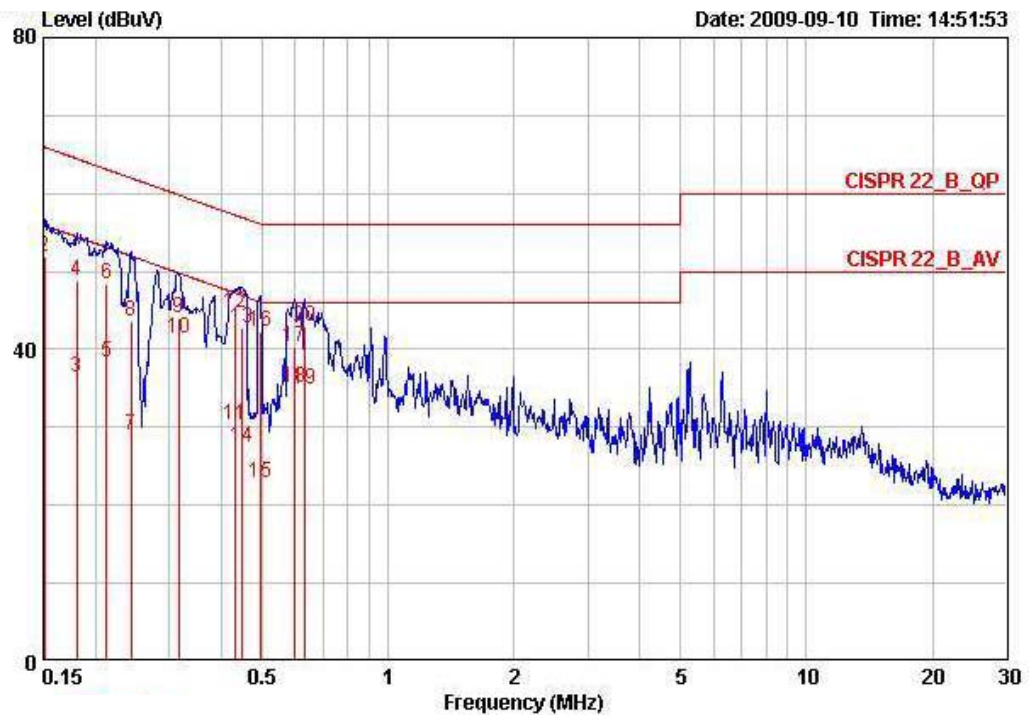

	Freq	Level	Over Limit	Limit Line	Read Level	LISN Factor	Cable Loss	Remark
	MHz	dBuV	dB	dBuV	dBuV	dB	dB	
1	0.15080	36.90	-19.05	55.96	36.63	0.07	0.20	AVERAGE
2	0.15080	51.83	-14.12	65.96	51.56	0.07	0.20	QP
3	0.18056	36.34	-18.12	54.46	36.08	0.06	0.20	AVERAGE
4	0.18056	48.86	-15.60	64.46	48.60	0.06	0.20	QP
5	0.21279	38.37	-14.73	53.10	38.12	0.05	0.20	AVERAGE
6	0.21279	48.47	-14.63	63.10	48.22	0.05	0.20	QP
7	0.24293	29.07	-22.92	52.00	28.83	0.04	0.20	AVERAGE
8	0.24293	43.62	-18.37	62.00	43.38	0.04	0.20	QP
9	0.31608	44.01	-15.80	59.81	43.77	0.04	0.20	QP
10	0.31608	41.37	-8.44	49.81	41.13	0.04	0.20	AVERAGE
11	0.43052	30.37	-16.87	47.24	30.14	0.03	0.20	AVERAGE
12	0.43052	44.70	-12.54	57.24	44.47	0.03	0.20	QP
13	0.44916	42.77	-14.12	56.89	42.54	0.03	0.20	QP
14	0.44916	27.52	-19.37	46.89	27.29	0.03	0.20	AVERAGE
15	0.49411	22.85	-23.25	46.10	22.64	0.03	0.18	AVERAGE
16	0.49411	42.40	-13.70	56.10	42.19	0.03	0.18	QP
17	0.59794	40.35	-15.65	56.00	40.12	0.03	0.20	QP
18	0.59794	35.02	-10.98	46.00	34.79	0.03	0.20	AVERAGE
19	0.63048	34.77	-11.23	46.00	34.54	0.03	0.20	AVERAGE
20	0.63048	42.99	-13.01	56.00	42.76	0.03	0.20	QP

Temperature	24°C	Humidity	56%
Test Engineer	Peter Wu	Phase	Neutral
Configuration	Normal Link / Antenna 2		

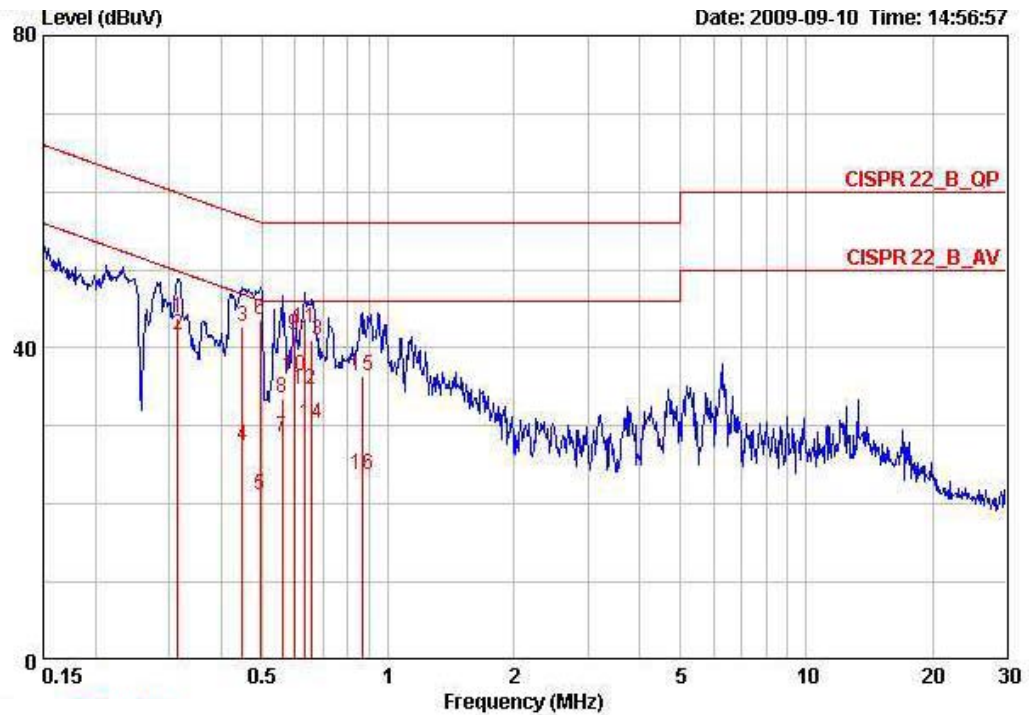

	Freq	Level	Over Limit	Limit Line	Read Level	LISN Factor	Cable Loss	Remark
	MHz	dBuV	dB	dBuV	dBuV	dB	dB	
1	0.31495	43.86	-15.98	59.84	43.59	0.07	0.20	QP
2	0.31495	41.71	-8.13	49.84	41.44	0.07	0.20	AVERAGE
3	0.44916	42.79	-14.10	56.89	42.52	0.07	0.20	QP
4	0.44916	27.51	-19.38	46.89	27.24	0.07	0.20	AVERAGE
5	0.49411	21.10	-25.00	46.10	20.85	0.07	0.18	AVERAGE
6	0.49411	43.68	-12.42	56.10	43.43	0.07	0.18	QP
7	0.55815	28.60	-17.40	46.00	28.33	0.07	0.20	AVERAGE
8	0.55815	33.48	-22.52	56.00	33.21	0.07	0.20	QP
9	0.59695	41.53	-14.47	56.00	41.26	0.07	0.20	QP
10	0.59695	36.39	-9.61	46.00	36.12	0.07	0.20	AVERAGE
11	0.63048	42.53	-13.47	56.00	42.26	0.07	0.20	QP
12	0.63048	34.61	-11.39	46.00	34.34	0.07	0.20	AVERAGE
13	0.65778	40.90	-15.10	56.00	40.63	0.07	0.20	QP
14	0.65778	30.32	-15.68	46.00	30.05	0.07	0.20	AVERAGE
15	0.86643	36.51	-19.49	56.00	36.24	0.07	0.20	QP
16	0.86643	23.77	-22.23	46.00	23.50	0.07	0.20	AVERAGE

Note: Level = Read Level + LISN Factor + Cable Loss

<For Antenna 3>:

Temperature	24°C	Humidity	56%
Test Engineer	Peter Wu	Phase	Line
Configuration	Normal Link / Antenna 3		

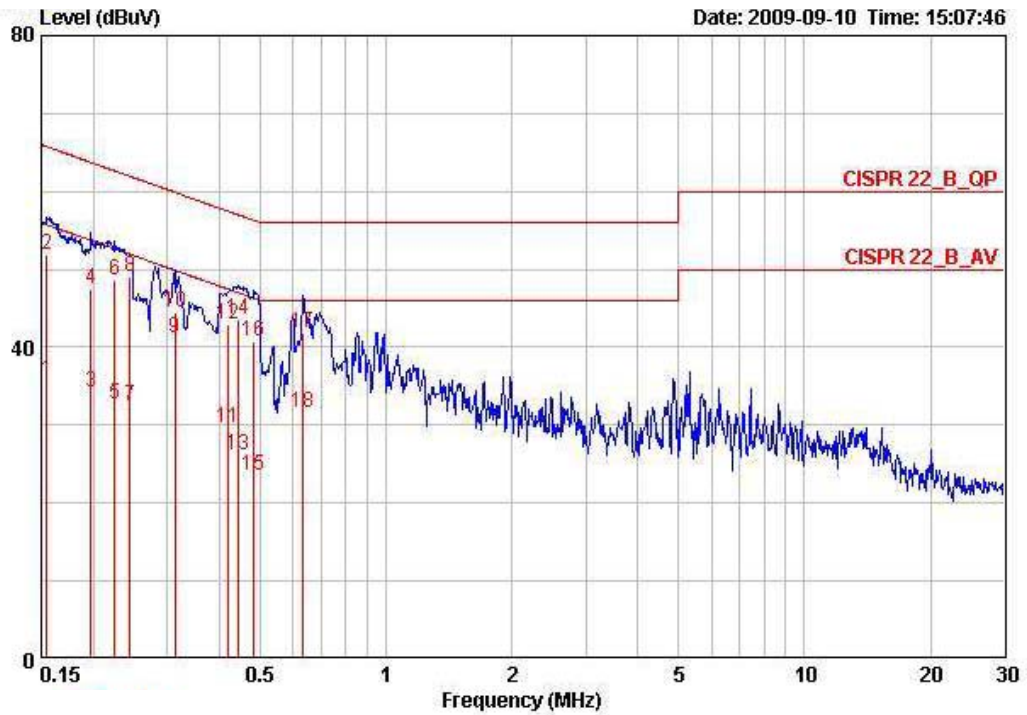

	Freq	Level	Over Limit	Limit Line	Read Level	LISN Factor	Cable Loss	Remark
	MHz	dBuV	dB	dBuV	dBuV	dB	dB	
1	0.15485	35.72	-20.01	55.74	35.45	0.07	0.20	AVERAGE
2	0.15485	51.81	-13.92	65.74	51.54	0.07	0.20	QP
3	0.19758	34.14	-19.57	53.71	33.89	0.05	0.20	AVERAGE
4	0.19758	47.43	-16.28	63.71	47.18	0.05	0.20	QP
5	0.22437	32.64	-20.02	52.66	32.39	0.05	0.20	AVERAGE
6	0.22437	48.64	-14.02	62.66	48.39	0.05	0.20	QP
7	0.24422	32.45	-19.50	51.95	32.21	0.04	0.20	AVERAGE
8	0.24422	48.98	-12.97	61.95	48.74	0.04	0.20	QP
9	0.31328	41.31	-8.58	49.88	41.07	0.04	0.20	AVERAGE
10	0.31328	44.45	-15.44	59.88	44.21	0.04	0.20	QP
11	0.41927	29.69	-17.77	47.46	29.46	0.03	0.20	AVERAGE
12	0.41927	42.95	-14.51	57.46	42.72	0.03	0.20	QP
13	0.44208	26.14	-20.88	47.02	25.91	0.03	0.20	AVERAGE
14	0.44208	43.62	-13.40	57.02	43.39	0.03	0.20	QP
15	0.48375	23.49	-22.78	46.27	23.36	0.03	0.10	AVERAGE
16	0.48375	40.68	-15.59	56.27	40.55	0.03	0.10	QP
17	0.63383	41.89	-14.11	56.00	41.66	0.03	0.20	QP
18	0.63383	31.58	-14.42	46.00	31.35	0.03	0.20	AVERAGE

Temperature	24°C	Humidity	56%
Test Engineer	Peter Wu	Phase	Neutral
Configuration	Normal Link / Antenna 3		

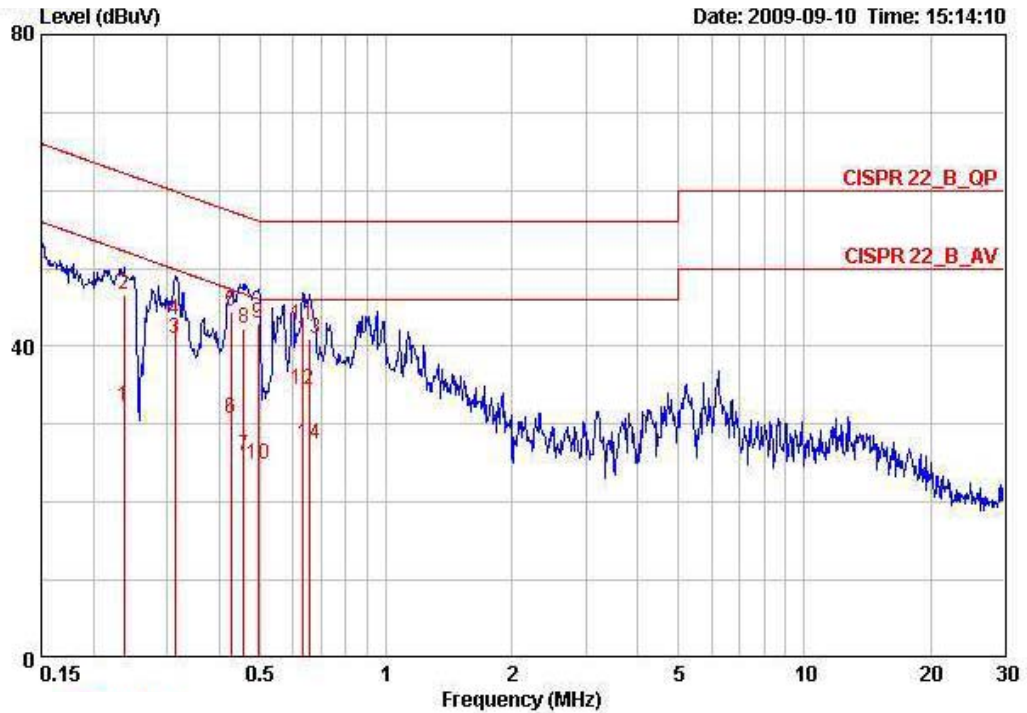

	Freq	Level	Over Limit	Limit Line	Read Level	LISN Factor	Cable Loss	Remark
	MHz	dBuV	dB	dBuV	dBuV	dB	dB	
1	0.23658	32.26	-19.96	52.22	31.98	0.08	0.20	AVERAGE
2	0.23658	46.62	-15.60	62.22	46.34	0.08	0.20	QP
3	0.31328	41.08	-8.80	49.88	40.81	0.07	0.20	AVERAGE
4	0.31328	43.30	-16.58	59.88	43.03	0.07	0.20	QP
5	0.42599	44.55	-12.78	57.33	44.28	0.07	0.20	QP
6	0.42599	30.74	-16.59	47.33	30.47	0.07	0.20	AVERAGE
7	0.45636	25.88	-20.88	46.76	25.61	0.07	0.20	AVERAGE
8	0.45636	42.23	-14.53	56.76	41.96	0.07	0.20	QP
9	0.49411	43.00	-13.10	56.10	42.75	0.07	0.18	QP
10	0.49411	24.82	-21.28	46.10	24.57	0.07	0.18	AVERAGE
11	0.63383	42.79	-13.21	56.00	42.52	0.07	0.20	QP
12	0.63383	34.48	-11.52	46.00	34.21	0.07	0.20	AVERAGE
13	0.65430	41.00	-15.00	56.00	40.73	0.07	0.20	QP
14	0.65430	27.57	-18.43	46.00	27.30	0.07	0.20	AVERAGE

Note: Level = Read Level + LISN Factor + Cable Loss

<For Antenna 4>:

Temperature	24°C	Humidity	56%
Test Engineer	Peter Wu	Phase	Line
Configuration	Normal Link / Antenna 4		

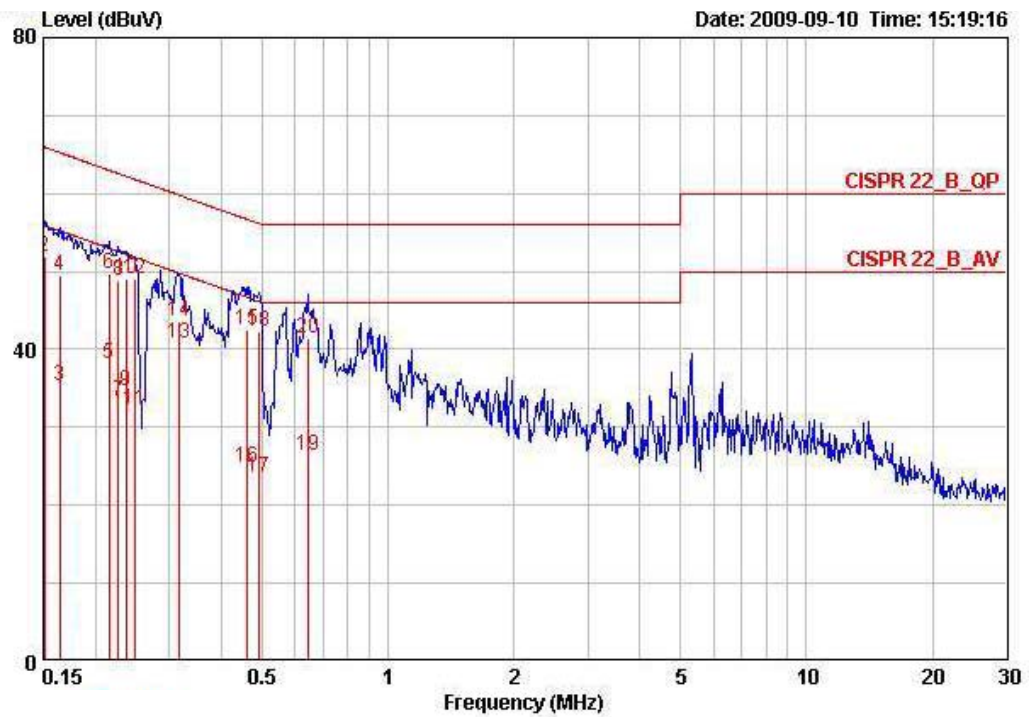

	Freq	Level	Over Limit	Limit Line	Read Level	LISN Factor	Cable Loss	Remark
	MHz	dBuV	dB	dBuV	dBuV	dB	dB	
1	0.15080	36.90	-19.05	55.96	36.63	0.07	0.20	AVERAGE
2	0.15080	51.87	-14.08	65.96	51.60	0.07	0.20	QP
3	0.16414	35.34	-19.91	55.25	35.07	0.07	0.20	AVERAGE
4	0.16414	49.54	-15.71	65.25	49.27	0.07	0.20	QP
5	0.21506	38.05	-14.96	53.01	37.80	0.05	0.20	AVERAGE
6	0.21506	49.71	-13.30	63.01	49.46	0.05	0.20	QP
7	0.22676	33.30	-19.27	52.57	33.05	0.05	0.20	AVERAGE
8	0.22676	48.80	-13.77	62.57	48.55	0.05	0.20	QP
9	0.23658	34.68	-17.54	52.22	34.43	0.05	0.20	AVERAGE
10	0.23658	48.97	-13.25	62.22	48.72	0.05	0.20	QP
11	0.24814	32.18	-19.64	51.82	31.94	0.04	0.20	AVERAGE
12	0.24814	49.00	-12.82	61.82	48.76	0.04	0.20	QP
13	0.31662	40.72	-9.08	49.80	40.48	0.04	0.20	AVERAGE
14	0.31662	43.53	-16.27	59.80	43.29	0.04	0.20	QP
15	0.45878	42.53	-14.18	56.71	42.30	0.03	0.20	QP
16	0.45878	24.77	-21.94	46.71	24.54	0.03	0.20	AVERAGE
17	0.49150	23.60	-22.55	46.14	23.44	0.03	0.13	AVERAGE
18	0.49150	42.37	-13.78	56.14	42.21	0.03	0.13	QP
19	0.64398	26.37	-19.63	46.00	26.14	0.03	0.20	AVERAGE
20	0.64398	41.52	-14.48	56.00	41.29	0.03	0.20	QP

Temperature	24°C	Humidity	56%
Test Engineer	Peter Wu	Phase	Neutral
Configuration	Normal Link / Antenna 4		

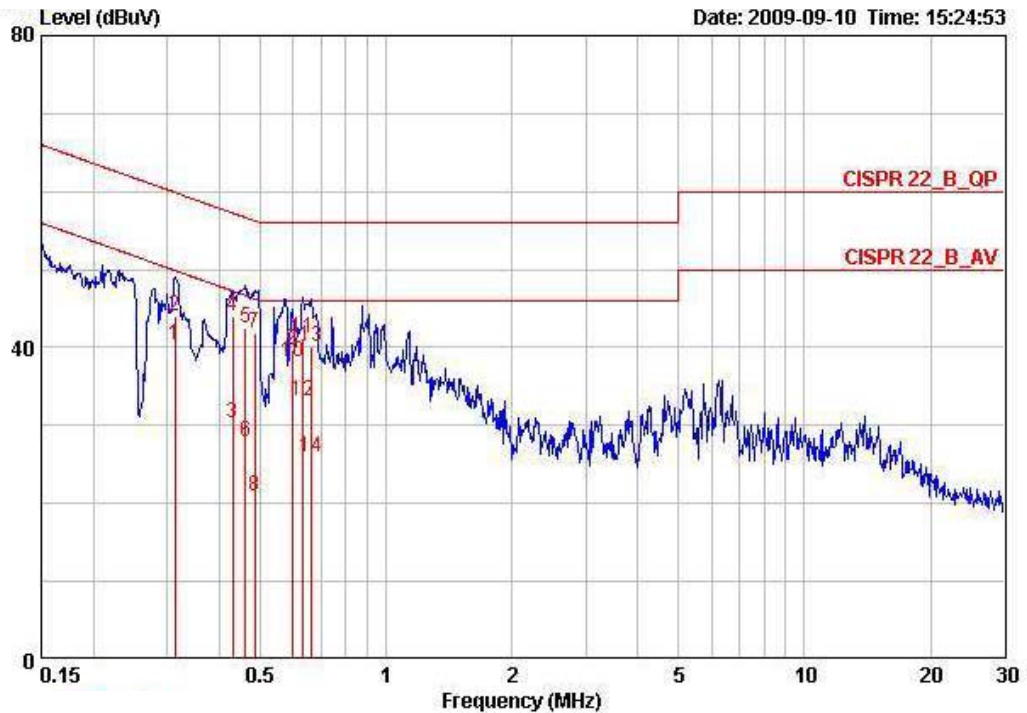

	Freq	Level	Over Limit	Limit Line	Read Level	LISN Factor	Cable Loss	Remark
	MHz	dBuV	dB	dBuV	dBuV	dB	dB	
1	0.31328	40.41	-9.47	49.88	40.14	0.07	0.20	AVERAGE
2	0.31328	44.06	-15.82	59.88	43.79	0.07	0.20	QP
3	0.43052	30.25	-16.99	47.24	29.98	0.07	0.20	AVERAGE
4	0.43052	44.02	-13.22	57.24	43.75	0.07	0.20	QP
5	0.46122	42.41	-14.26	56.67	42.14	0.07	0.20	QP
6	0.46122	27.89	-18.78	46.67	27.62	0.07	0.20	AVERAGE
7	0.48632	41.77	-14.46	56.23	41.59	0.07	0.11	QP
8	0.48632	20.93	-25.30	46.23	20.75	0.07	0.11	AVERAGE
9	0.59553	39.75	-16.25	56.00	39.48	0.07	0.20	QP
10	0.59553	38.16	-7.84	46.00	37.89	0.07	0.20	AVERAGE
11	0.63383	41.11	-14.89	56.00	40.84	0.07	0.20	QP
12	0.63383	33.13	-12.87	46.00	32.86	0.07	0.20	AVERAGE
13	0.66478	40.20	-15.80	56.00	39.93	0.07	0.20	QP
14	0.66478	25.84	-20.16	46.00	25.57	0.07	0.20	AVERAGE

Note: Level = Read Level + LISN Factor + Cable Loss

<For Antenna 5>:

Temperature	24°C	Humidity	56%
Test Engineer	Peter Wu	Phase	Line
Configuration	Normal Link / Antenna 5		

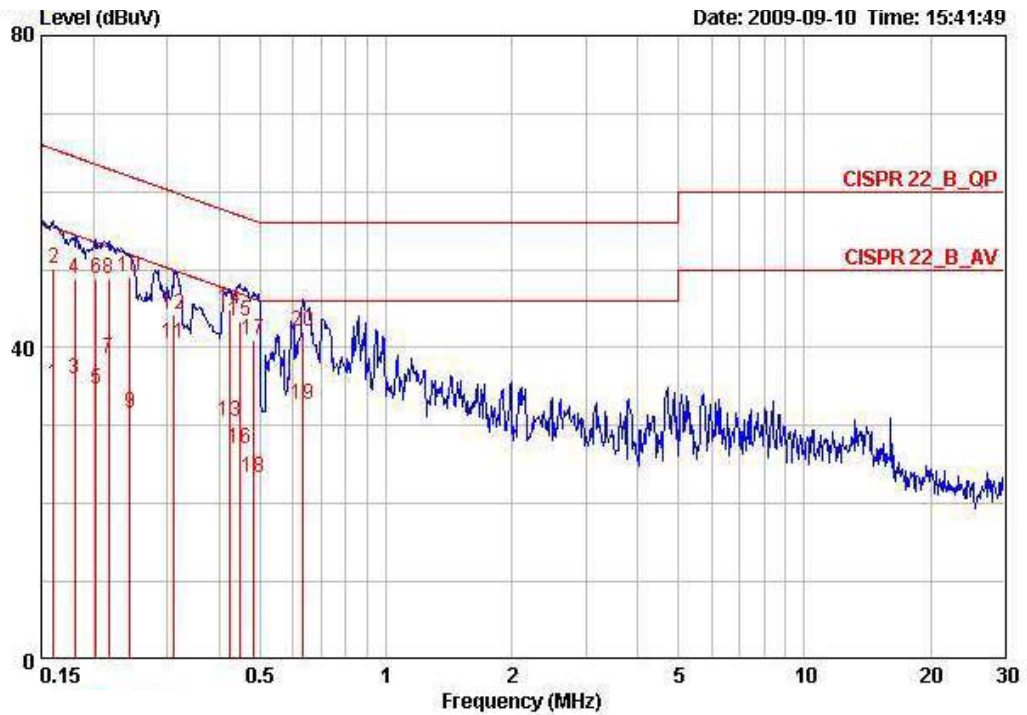

	Freq	Level	Over Limit	Limit Line	Read Level	LISN Factor	Cable Loss	Remark
	MHz	dBuV	dB	dBuV	dBuV	dB	dB	
1	0.16070	35.22	-20.21	55.43	34.95	0.07	0.20	AVERAGE
2	0.16070	50.04	-15.39	65.43	49.77	0.07	0.20	QP
3	0.18056	36.05	-18.41	54.46	35.79	0.06	0.20	AVERAGE
4	0.18056	48.90	-15.56	64.46	48.64	0.06	0.20	QP
5	0.20289	34.63	-18.86	53.49	34.38	0.05	0.20	AVERAGE
6	0.20289	48.91	-14.58	63.49	48.66	0.05	0.20	QP
7	0.21735	38.67	-14.25	52.92	38.42	0.05	0.20	AVERAGE
8	0.21735	48.81	-14.11	62.92	48.56	0.05	0.20	QP
9	0.24422	31.57	-20.38	51.95	31.33	0.04	0.20	AVERAGE
10	0.24422	49.06	-12.89	61.95	48.82	0.04	0.20	QP
11	0.31163	40.45	-9.48	49.93	40.21	0.04	0.20	AVERAGE
12	0.31163	44.31	-15.62	59.93	44.07	0.04	0.20	QP
13	0.42150	30.49	-16.93	47.42	30.26	0.03	0.20	AVERAGE
14	0.42150	44.95	-12.47	57.42	44.72	0.03	0.20	QP
15	0.44679	43.36	-13.57	56.93	43.13	0.03	0.20	QP
16	0.44679	27.12	-19.81	46.93	26.89	0.03	0.20	AVERAGE
17	0.48119	41.05	-15.27	56.32	40.92	0.03	0.10	QP
18	0.48119	23.42	-22.90	46.32	23.29	0.03	0.10	AVERAGE
19	0.63048	32.67	-13.33	46.00	32.44	0.03	0.20	AVERAGE
20	0.63048	42.17	-13.83	56.00	41.94	0.03	0.20	QP

Temperature	24°C	Humidity	56%
Test Engineer	Peter Wu	Phase	Neutral
Configuration	Normal Link / Antenna 5		

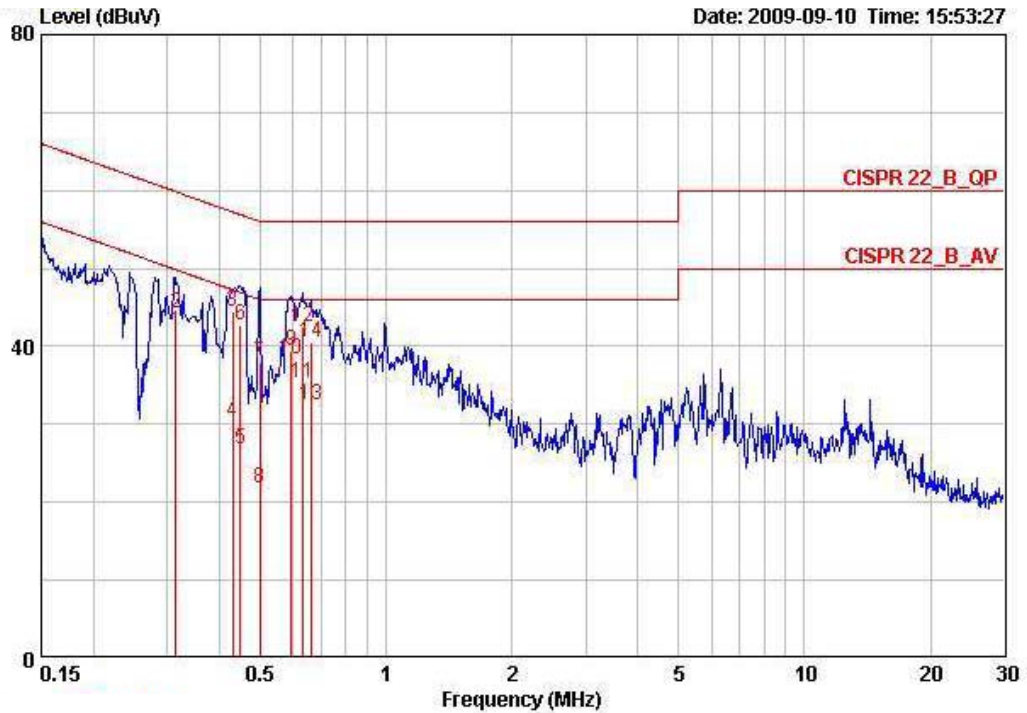

	Freq	Level	Over Limit	Limit Line	Read Level	LISN Factor	Cable Loss	Remark
	MHz	dBuV	dB	dBuV	dBuV	dB	dB	
1	0.31523	41.95	-7.88	49.83	41.68	0.07	0.20	AVERAGE
2	0.31523	44.16	-15.67	59.83	43.89	0.07	0.20	QP
3	0.43052	44.38	-12.86	57.24	44.11	0.07	0.20	QP
4	0.43052	30.30	-16.94	47.24	30.03	0.07	0.20	AVERAGE
5	0.44916	26.73	-20.16	46.89	26.46	0.07	0.20	AVERAGE
6	0.44916	42.77	-14.12	56.89	42.50	0.07	0.20	QP
7	0.49937	37.87	-18.14	56.01	37.62	0.07	0.18	QP
8	0.49937	21.79	-24.22	46.01	21.54	0.07	0.18	AVERAGE
9	0.59478	39.54	-16.46	56.00	39.27	0.07	0.20	QP
10	0.59478	38.26	-7.74	46.00	37.99	0.07	0.20	AVERAGE
11	0.63048	35.39	-10.61	46.00	35.12	0.07	0.20	AVERAGE
12	0.63048	42.61	-13.39	56.00	42.34	0.07	0.20	QP
13	0.66127	32.44	-13.56	46.00	32.17	0.07	0.20	AVERAGE
14	0.66127	40.44	-15.56	56.00	40.17	0.07	0.20	QP

Note: Level = Read Level + LISN Factor + Cable Loss

<For Antenna 6>:

Temperature	24°C	Humidity	56%
Test Engineer	Peter Wu	Phase	Line
Configuration	Normal Link / Antenna 6		

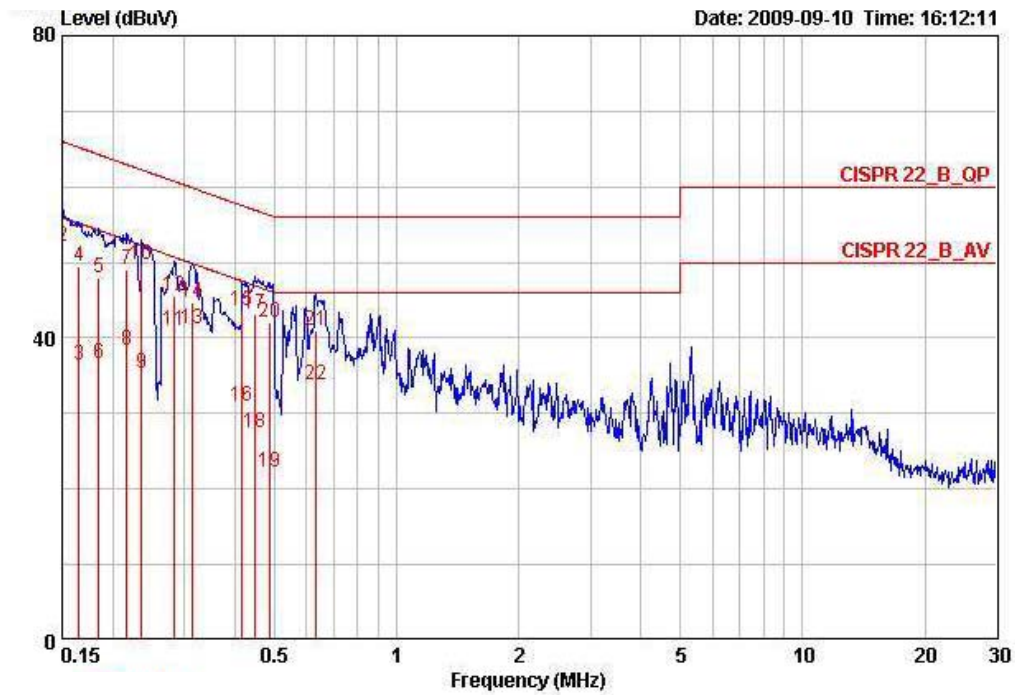

	Freq	Level	Over Limit	Limit Line	Read Level	LISN Factor	Cable Loss	Remark
	MHz	dBuV	dB	dBuV	dBuV	dB	dB	
1	0.15000	37.32	-18.68	56.00	37.04	0.08	0.20	AVERAGE
2	0.15000	52.11	-13.89	66.00	51.83	0.08	0.20	QP
3	0.16501	36.40	-18.81	55.21	36.13	0.07	0.20	AVERAGE
4	0.16501	49.43	-15.78	65.21	49.16	0.07	0.20	QP
5	0.18443	47.86	-16.43	64.28	47.60	0.06	0.20	QP
6	0.18443	36.65	-17.64	54.28	36.39	0.06	0.20	AVERAGE
7	0.21620	49.13	-13.84	62.96	48.88	0.05	0.20	QP
8	0.21620	38.37	-14.60	52.96	38.12	0.05	0.20	AVERAGE
9	0.23533	35.21	-17.05	52.26	34.96	0.05	0.20	AVERAGE
10	0.23533	49.61	-12.65	62.26	49.36	0.05	0.20	QP
11	0.28328	40.89	-9.83	50.72	40.65	0.04	0.20	AVERAGE
12	0.28328	45.46	-15.26	60.72	45.22	0.04	0.20	QP
13	0.31495	41.18	-8.66	49.84	40.94	0.04	0.20	AVERAGE
14	0.31495	44.77	-15.07	59.84	44.53	0.04	0.20	QP
15	0.41705	43.49	-14.02	57.51	43.26	0.03	0.20	QP
16	0.41705	30.90	-16.61	47.51	30.67	0.03	0.20	AVERAGE
17	0.44916	43.09	-13.80	56.89	42.86	0.03	0.20	QP
18	0.44916	27.41	-19.48	46.89	27.18	0.03	0.20	AVERAGE
19	0.48632	22.13	-24.10	46.23	21.99	0.03	0.11	AVERAGE
20	0.48632	42.07	-14.16	56.23	41.93	0.03	0.11	QP
21	0.63383	40.99	-15.01	56.00	40.76	0.03	0.20	QP
22	0.63383	33.79	-12.21	46.00	33.56	0.03	0.20	AVERAGE

Temperature	24°C	Humidity	56%
Test Engineer	Peter Wu	Phase	Neutral
Configuration	Normal Link / Antenna 6		

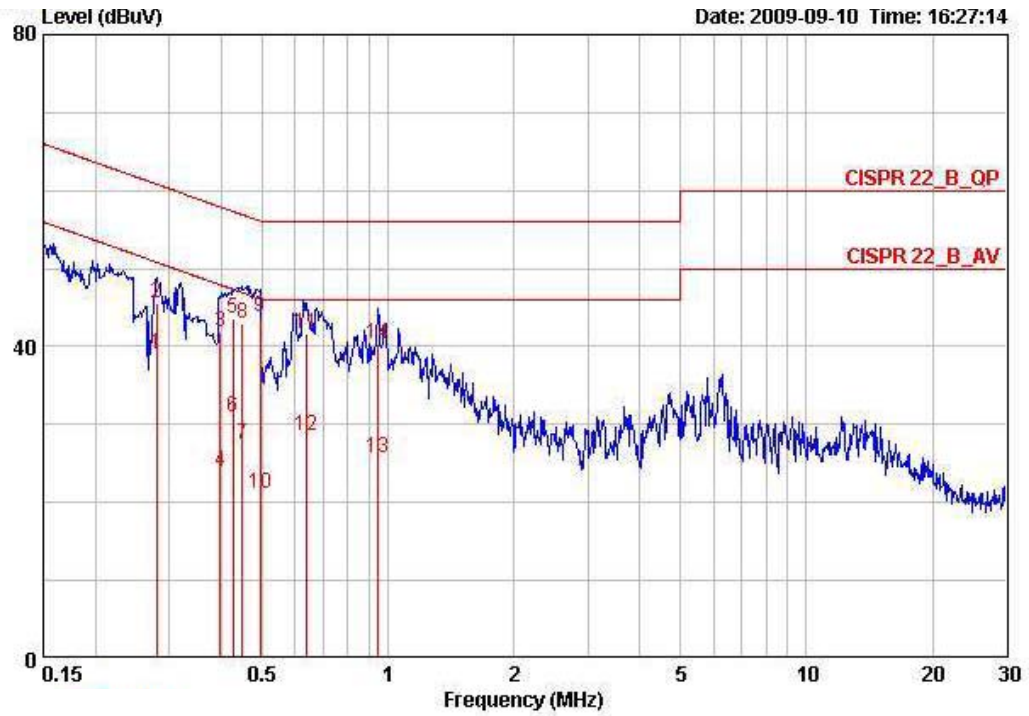

	Freq	Level	Over Limit	Limit Line	Read Level	LISN Factor	Cable Loss	Remark
	MHz	dBuV	dB	dBuV	dBuV	dB	dB	
1	0.28029	39.01	-11.80	50.81	38.73	0.08	0.20	AVERAGE
2	0.28029	45.46	-15.35	60.81	45.18	0.08	0.20	QP
3	0.39763	41.80	-16.10	57.90	41.53	0.07	0.20	QP
4	0.39763	24.08	-23.82	47.90	23.81	0.07	0.20	AVERAGE
5	0.42599	43.57	-13.76	57.33	43.30	0.07	0.20	QP
6	0.42599	30.88	-16.45	47.33	30.61	0.07	0.20	AVERAGE
7	0.44916	27.56	-19.33	46.89	27.29	0.07	0.20	AVERAGE
8	0.44916	42.95	-13.94	56.89	42.68	0.07	0.20	QP
9	0.49411	43.76	-12.34	56.10	43.51	0.07	0.18	QP
10	0.49411	21.20	-24.90	46.10	20.95	0.07	0.18	AVERAGE
11	0.63733	41.67	-14.33	56.00	41.40	0.07	0.20	QP
12	0.63733	28.65	-17.35	46.00	28.38	0.07	0.20	AVERAGE
13	0.94809	25.69	-20.31	46.00	25.42	0.07	0.20	AVERAGE
14	0.94809	40.25	-15.75	56.00	39.98	0.07	0.20	QP

Note: Level = Read Level + LISN Factor + Cable Loss

4.2. Maximum Conducted Output Power Measurement

4.2.1. Limit

For systems using digital modulation in the 2400-2483.5MHz, the limit for peak output power is 30dBm. The limited has to be reduced by the amount in dB that the gain of the antenna exceed 6dBi. In case of point-to-point operation, the limit has to be reduced by 1dB for every 3dB that the directional gain of the antenna exceeds 6dBi. Systems operating in the 5725-5850 MHz band that are used exclusively for fixed, point-to-point operations may employ transmitting antennas with directional gain greater than 6 dBi without any corresponding reduction in transmitter conducted output power.

4.2.2. Measuring Instruments and Setting

Please refer to section 5 of equipments list in this report. The following table is the setting of the spectrum analyzer.

Spectrum Parameter	Setting
Attenuation	Auto
Span Frequency	Encompass the entire emissions bandwidth (EBW) of the signal
RB	1MHz
VB	3MHz
Detector	RMS
Trace	Max Hold
Sweep Time	Auto

4.2.3. Test Procedures

1. The transmitter output (antenna port) was connected to the spectrum analyzer.
2. Test was performed in accordance with Measurement of Digital Transmission Systems Operating under Section 15.247 March 23, 2005.
3. When measuring maximum conducted output power with multiple antenna systems, add every result of the values by mathematic formula.

4.2.4. Test Setup Layout

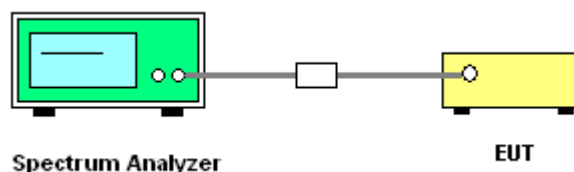

4.2.5. Test Deviation

There is no deviation with the original standard.

4.2.6. EUT Operation during Test

The EUT was programmed to be in continuously transmitting mode.

4.2.7. Test Result of Maximum Conducted Output Power

<For Antenna 1>:

Temperature	21°C	Humidity	56%
Test Engineer	Johnson Chang	Configurations	Draft n / Antenna 1

For 2.4GHz Band

Configuration Draft n MCS8 20MHz Ant. 1-1

Channel	Frequency	Conducted Power (dBm)	Max. Limit (dBm)	Result
1	2412 MHz	19.12	29.00	Complies
6	2437 MHz	23.96	29.00	Complies
11	2462 MHz	20.49	29.00	Complies

Configuration Draft n MCS8 20MHz Ant. 1-3

Channel	Frequency	Conducted Power (dBm)	Max. Limit (dBm)	Result
1	2412 MHz	20.38	29.00	Complies
6	2437 MHz	24.35	29.00	Complies
11	2462 MHz	21.72	29.00	Complies

Configuration Draft n MCS8 20MHz Ant. 1-1 + Ant. 1-3

Channel	Frequency	Conducted Power (dBm)	Max. Limit (dBm)	Result
1	2412 MHz	22.81	29.00	Complies
6	2437 MHz	27.17	29.00	Complies
11	2462 MHz	24.16	29.00	Complies

Configuration Drafft n MCS8 40MHz Ant. 1-1

Channel	Frequency	Conducted Power (dBm)	Max. Limit (dBm)	Result
3	2422 MHz	17.32	29.00	Complies
6	2437 MHz	19.68	29.00	Complies
9	2452 MHz	16.97	29.00	Complies

Configuration Drafft n MCS8 40MHz Ant. 1-3

Channel	Frequency	Conducted Power (dBm)	Max. Limit (dBm)	Result
3	2422 MHz	17.96	29.00	Complies
6	2437 MHz	20.01	29.00	Complies
9	2452 MHz	17.24	29.00	Complies

Configuration Drafft n MCS8 40MHz Ant. 1-1 + Ant. 1-3

Channel	Frequency	Conducted Power (dBm)	Max. Limit (dBm)	Result
3	2422 MHz	20.66	29.00	Complies
6	2437 MHz	22.86	29.00	Complies
9	2452 MHz	20.12	29.00	Complies

For 5GHz Band
Configuration Draft n MCS8 20MHz Ant. 1-1

Channel	Frequency	Conducted Power (dBm)	Max. Limit (dBm)	Result
149	5745 MHz	20.74	29.00	Complies
157	5785 MHz	20.59	29.00	Complies
165	5825 MHz	19.42	29.00	Complies

Configuration Draft n MCS8 20MHz Ant. 1-3

Channel	Frequency	Conducted Power (dBm)	Max. Limit (dBm)	Result
149	5745 MHz	20.77	29.00	Complies
157	5785 MHz	20.62	29.00	Complies
165	5825 MHz	19.69	29.00	Complies

Configuration Draft n MCS8 20MHz Ant. 1-1 + Ant. 1-3

Channel	Frequency	Conducted Power (dBm)	Max. Limit (dBm)	Result
149	5745 MHz	23.77	29.00	Complies
157	5785 MHz	23.62	29.00	Complies
165	5825 MHz	22.57	29.00	Complies

Configuration Drafft n MCS8 40MHz Ant. 1-1

Channel	Frequency	Conducted Power (dBm)	Max. Limit (dBm)	Result
151	5755 MHz	21.18	29.00	Complies
159	5795 MHz	20.65	29.00	Complies

Configuration Drafft n MCS8 40MHz Ant. 1-3

Channel	Frequency	Conducted Power (dBm)	Max. Limit (dBm)	Result
151	5755 MHz	21.20	29.00	Complies
159	5795 MHz	20.91	29.00	Complies

Configuration Drafft n MCS8 40MHz Ant. 1-1 + Ant. 1-3

Channel	Frequency	Conducted Power (dBm)	Max. Limit (dBm)	Result
151	5755 MHz	24.20	29.00	Complies
159	5795 MHz	23.79	29.00	Complies

Temperature	21°C	Humidity	56%
Test Engineer	Johnson Chang	Configurations	802.11a/b/g / Antenna 1

Configuration IEEE 802.11b Ant. 1-1

Channel	Frequency	Conducted Power (dBm)	Max. Limit (dBm)	Result
1	2412 MHz	21.67	29.00	Complies
6	2437 MHz	22.85	29.00	Complies
11	2462 MHz	21.66	29.00	Complies

Configuration IEEE 802.11b Ant. 1-3

Channel	Frequency	Conducted Power (dBm)	Max. Limit (dBm)	Result
1	2412 MHz	21.75	29.00	Complies
6	2437 MHz	23.71	29.00	Complies
11	2462 MHz	23.51	29.00	Complies

Configuration IEEE 802.11b Ant. 1-1 + Ant. 1-3

Channel	Frequency	Conducted Power (dBm)	Max. Limit (dBm)	Result
1	2412 MHz	24.72	29.00	Complies
6	2437 MHz	26.31	29.00	Complies
11	2462 MHz	25.69	29.00	Complies

Configuration IEEE 802.11g Ant. 1-1

Channel	Frequency	Conducted Power (dBm)	Max. Limit (dBm)	Result
1	2412 MHz	19.29	29.00	Complies
6	2437 MHz	24.46	29.00	Complies
11	2462 MHz	19.95	29.00	Complies

Configuration IEEE 802.11g Ant. 1-3

Channel	Frequency	Conducted Power (dBm)	Max. Limit (dBm)	Result
1	2412 MHz	21.06	29.00	Complies
6	2437 MHz	24.51	29.00	Complies
11	2462 MHz	20.87	29.00	Complies

Configuration IEEE 802.11g Ant. 1-1 + Ant. 1-3

Channel	Frequency	Conducted Power (dBm)	Max. Limit (dBm)	Result
1	2412 MHz	23.27	29.00	Complies
6	2437 MHz	27.50	29.00	Complies
11	2462 MHz	23.44	29.00	Complies

Configuration IEEE 802.11a Ant. 1-1

Channel	Frequency	Conducted Power (dBm)	Max. Limit (dBm)	Result
149	5745 MHz	21.72	29.00	Complies
157	5785 MHz	21.53	29.00	Complies
165	5825 MHz	20.76	29.00	Complies

Configuration IEEE 802.11a Ant. 1-3

Channel	Frequency	Conducted Power (dBm)	Max. Limit (dBm)	Result
149	5745 MHz	21.83	29.00	Complies
157	5785 MHz	21.54	29.00	Complies
165	5825 MHz	20.86	29.00	Complies

Configuration IEEE 802.11a Ant. 1-1 + Ant. 1-3

Channel	Frequency	Conducted Power (dBm)	Max. Limit (dBm)	Result
149	5745 MHz	24.79	29.00	Complies
157	5785 MHz	24.55	29.00	Complies
165	5825 MHz	23.82	29.00	Complies

<For Antenna 2>:

Temperature	21°C	Humidity	56%
Test Engineer	Johnson Chang	Configurations	Draft n / Antenna 2

For 2.4GHz Band

Configuration Draft n MCS8 20MHz Ant. 2-1

Channel	Frequency	Conducted Power (dBm)	Max. Limit (dBm)	Result
1	2412 MHz	18.07	30.00	Complies
6	2437 MHz	23.96	30.00	Complies
11	2462 MHz	19.15	30.00	Complies

Configuration Draft n MCS8 20MHz Ant. 2-3

Channel	Frequency	Conducted Power (dBm)	Max. Limit (dBm)	Result
1	2412 MHz	19.39	30.00	Complies
6	2437 MHz	24.35	30.00	Complies
11	2462 MHz	20.08	30.00	Complies

Configuration Draft n MCS8 20MHz Ant. 2-1 + Ant. 2-3

Channel	Frequency	Conducted Power (dBm)	Max. Limit (dBm)	Result
1	2412 MHz	21.79	30.00	Complies
6	2437 MHz	27.17	30.00	Complies
11	2462 MHz	22.65	30.00	Complies

Configuration Draft n MCS8 40MHz Ant. 2-1

Channel	Frequency	Conducted Power (dBm)	Max. Limit (dBm)	Result
3	2422 MHz	15.61	30.00	Complies
6	2437 MHz	18.94	30.00	Complies
9	2452 MHz	15.35	30.00	Complies

Configuration Draft n MCS8 40MHz Ant. 2-3

Channel	Frequency	Conducted Power (dBm)	Max. Limit (dBm)	Result
3	2422 MHz	16.36	30.00	Complies
6	2437 MHz	19.34	30.00	Complies
9	2452 MHz	15.69	30.00	Complies

Configuration Draft n MCS8 40MHz Ant. 2-1 + Ant. 2-3

Channel	Frequency	Conducted Power (dBm)	Max. Limit (dBm)	Result
3	2422 MHz	19.01	30.00	Complies
6	2437 MHz	22.15	30.00	Complies
9	2452 MHz	18.53	30.00	Complies

For 5GHz Band
Configuration Draft n MCS8 20MHz Ant. 2-1

Channel	Frequency	Conducted Power (dBm)	Max. Limit (dBm)	Result
149	5745 MHz	20.74	30.00	Complies
157	5785 MHz	20.59	30.00	Complies
165	5825 MHz	19.42	30.00	Complies

Configuration Draft n MCS8 20MHz Ant. 2-3

Channel	Frequency	Conducted Power (dBm)	Max. Limit (dBm)	Result
149	5745 MHz	20.77	30.00	Complies
157	5785 MHz	20.62	30.00	Complies
165	5825 MHz	19.69	30.00	Complies

Configuration Draft n MCS8 20MHz Ant. 2-1 + Ant. 2-3

Channel	Frequency	Conducted Power (dBm)	Max. Limit (dBm)	Result
149	5745 MHz	23.77	30.00	Complies
157	5785 MHz	23.62	30.00	Complies
165	5825 MHz	22.57	30.00	Complies

Configuration Drafft n MCS8 40MHz Ant. 2-1

Channel	Frequency	Conducted Power (dBm)	Max. Limit (dBm)	Result
151	5755 MHz	21.20	30.00	Complies
159	5795 MHz	20.91	30.00	Complies

Configuration Drafft n MCS8 40MHz Ant. 2-3

Channel	Frequency	Conducted Power (dBm)	Max. Limit (dBm)	Result
151	5755 MHz	21.18	30.00	Complies
159	5795 MHz	20.65	30.00	Complies

Configuration Drafft n MCS8 40MHz Ant. 2-1 + Ant. 2-3

Channel	Frequency	Conducted Power (dBm)	Max. Limit (dBm)	Result
151	5755 MHz	24.20	30.00	Complies
159	5795 MHz	23.79	30.00	Complies

Temperature	21°C	Humidity	56%
Test Engineer	Johnson Chang	Configurations	802.11a/b/g / Antenna 2

Configuration IEEE 802.11b Ant. 2-1

Channel	Frequency	Conducted Power (dBm)	Max. Limit (dBm)	Result
1	2412 MHz	20.82	30.00	Complies
6	2437 MHz	22.85	30.00	Complies
11	2462 MHz	20.10	30.00	Complies

Configuration IEEE 802.11b Ant. 2-3

Channel	Frequency	Conducted Power (dBm)	Max. Limit (dBm)	Result
1	2412 MHz	21.01	30.00	Complies
6	2437 MHz	23.71	30.00	Complies
11	2462 MHz	21.87	30.00	Complies

Configuration IEEE 802.11b Ant. 2-1 + Ant. 2-3

Channel	Frequency	Conducted Power (dBm)	Max. Limit (dBm)	Result
1	2412 MHz	23.93	30.00	Complies
6	2437 MHz	26.31	30.00	Complies
11	2462 MHz	24.08	30.00	Complies

Configuration IEEE 802.11g Ant. 2-1

Channel	Frequency	Conducted Power (dBm)	Max. Limit (dBm)	Result
1	2412 MHz	18.09	30.00	Complies
6	2437 MHz	24.46	30.00	Complies
11	2462 MHz	19.49	30.00	Complies

Configuration IEEE 802.11g Ant. 2-3

Channel	Frequency	Conducted Power (dBm)	Max. Limit (dBm)	Result
1	2412 MHz	19.91	30.00	Complies
6	2437 MHz	24.51	30.00	Complies
11	2462 MHz	20.34	30.00	Complies

Configuration IEEE 802.11g Ant. 2-1 + Ant. 2-3

Channel	Frequency	Conducted Power (dBm)	Max. Limit (dBm)	Result
1	2412 MHz	22.10	30.00	Complies
6	2437 MHz	27.50	30.00	Complies
11	2462 MHz	22.95	30.00	Complies

Configuration IEEE 802.11a Ant. 2-1

Channel	Frequency	Conducted Power (dBm)	Max. Limit (dBm)	Result
149	5745 MHz	21.72	30.00	Complies
157	5785 MHz	21.53	30.00	Complies
165	5825 MHz	20.76	30.00	Complies

Configuration IEEE 802.11a Ant. 2-3

Channel	Frequency	Conducted Power (dBm)	Max. Limit (dBm)	Result
149	5745 MHz	21.83	30.00	Complies
157	5785 MHz	21.54	30.00	Complies
165	5825 MHz	20.86	30.00	Complies

Configuration IEEE 802.11a Ant. 2-1 + Ant. 2-3

Channel	Frequency	Conducted Power (dBm)	Max. Limit (dBm)	Result
149	5745 MHz	24.79	30.00	Complies
157	5785 MHz	24.55	30.00	Complies
165	5825 MHz	23.82	30.00	Complies

<For Antenna 3>:

Temperature	21°C	Humidity	56%
Test Engineer	Johnson Chang	Configurations	Draft n / Antenna 3

For 2.4GHz Band

Configuration Draft n MCS8 20MHz Ant. 3-1

Channel	Frequency	Conducted Power (dBm)	Max. Limit (dBm)	Result
1	2412 MHz	17.60	30.00	Complies
6	2437 MHz	23.35	30.00	Complies
11	2462 MHz	18.75	30.00	Complies

Configuration Draft n MCS8 20MHz Ant. 3-3

Channel	Frequency	Conducted Power (dBm)	Max. Limit (dBm)	Result
1	2412 MHz	18.97	30.00	Complies
6	2437 MHz	23.66	30.00	Complies
11	2462 MHz	19.86	30.00	Complies

Configuration Draft n MCS8 20MHz Ant. 3-1 + Ant. 3-3

Channel	Frequency	Conducted Power (dBm)	Max. Limit (dBm)	Result
1	2412 MHz	21.35	30.00	Complies
6	2437 MHz	26.52	30.00	Complies
11	2462 MHz	22.35	30.00	Complies

Configuration Drafft n MCS8 40MHz Ant. 3-1

Channel	Frequency	Conducted Power (dBm)	Max. Limit (dBm)	Result
3	2422 MHz	15.15	30.00	Complies
6	2437 MHz	17.78	30.00	Complies
9	2452 MHz	14.83	30.00	Complies

Configuration Drafft n MCS8 40MHz Ant. 3-3

Channel	Frequency	Conducted Power (dBm)	Max. Limit (dBm)	Result
3	2422 MHz	15.76	30.00	Complies
6	2437 MHz	17.86	30.00	Complies
9	2452 MHz	15.09	30.00	Complies

Configuration Drafft n MCS8 40MHz Ant. 3-1 + Ant. 3-3

Channel	Frequency	Conducted Power (dBm)	Max. Limit (dBm)	Result
3	2422 MHz	18.48	30.00	Complies
6	2437 MHz	20.83	30.00	Complies
9	2452 MHz	17.97	30.00	Complies

For 5GHz Band
Configuration Draft n MCS8 20MHz Ant. 3-1

Channel	Frequency	Conducted Power (dBm)	Max. Limit (dBm)	Result
149	5745 MHz	20.74	30.00	Complies
157	5785 MHz	20.59	30.00	Complies
165	5825 MHz	19.69	30.00	Complies

Configuration Draft n MCS8 20MHz Ant. 3-3

Channel	Frequency	Conducted Power (dBm)	Max. Limit (dBm)	Result
149	5745 MHz	20.77	30.00	Complies
157	5785 MHz	20.62	30.00	Complies
165	5825 MHz	19.42	30.00	Complies

Configuration Draft n MCS8 20MHz Ant. 3-1 + Ant. 3-3

Channel	Frequency	Conducted Power (dBm)	Max. Limit (dBm)	Result
149	5745 MHz	23.77	30.00	Complies
157	5785 MHz	23.62	30.00	Complies
165	5825 MHz	22.57	30.00	Complies

Configuration Drafft n MCS8 40MHz Ant. 3-1

Channel	Frequency	Conducted Power (dBm)	Max. Limit (dBm)	Result
151	5755 MHz	21.18	30.00	Complies
159	5795 MHz	20.65	30.00	Complies

Configuration Drafft n MCS8 40MHz Ant. 3-3

Channel	Frequency	Conducted Power (dBm)	Max. Limit (dBm)	Result
151	5755 MHz	21.20	30.00	Complies
159	5795 MHz	20.91	30.00	Complies

Configuration Drafft n MCS8 40MHz Ant. 3-1 + Ant. 3-3

Channel	Frequency	Conducted Power (dBm)	Max. Limit (dBm)	Result
151	5755 MHz	24.20	30.00	Complies
159	5795 MHz	23.79	30.00	Complies

Temperature	21°C	Humidity	56%
Test Engineer	Johnson Chang	Configurations	802.11a/b/g / Antenna 3

Configuration IEEE 802.11b Ant. 3-1

Channel	Frequency	Conducted Power (dBm)	Max. Limit (dBm)	Result
1	2412 MHz	20.82	30.00	Complies
6	2437 MHz	22.26	30.00	Complies
11	2462 MHz	20.10	30.00	Complies

Configuration IEEE 802.11b Ant. 3-3

Channel	Frequency	Conducted Power (dBm)	Max. Limit (dBm)	Result
1	2412 MHz	21.01	30.00	Complies
6	2437 MHz	21.43	30.00	Complies
11	2462 MHz	21.87	30.00	Complies

Configuration IEEE 802.11b Ant. 3-1 + Ant. 3-3

Channel	Frequency	Conducted Power (dBm)	Max. Limit (dBm)	Result
1	2412 MHz	23.93	30.00	Complies
6	2437 MHz	24.88	30.00	Complies
11	2462 MHz	24.08	30.00	Complies

Configuration IEEE 802.11g Ant. 3-1

Channel	Frequency	Conducted Power (dBm)	Max. Limit (dBm)	Result
1	2412 MHz	17.78	30.00	Complies
6	2437 MHz	22.72	30.00	Complies
11	2462 MHz	18.40	30.00	Complies

Configuration IEEE 802.11g Ant. 3-3

Channel	Frequency	Conducted Power (dBm)	Max. Limit (dBm)	Result
1	2412 MHz	19.38	30.00	Complies
6	2437 MHz	22.85	30.00	Complies
11	2462 MHz	19.95	30.00	Complies

Configuration IEEE 802.11g Ant. 3-1 + Ant. 3-3

Channel	Frequency	Conducted Power (dBm)	Max. Limit (dBm)	Result
1	2412 MHz	21.66	30.00	Complies
6	2437 MHz	25.80	30.00	Complies
11	2462 MHz	22.25	30.00	Complies

Configuration IEEE 802.11a Ant. 3-1

Channel	Frequency	Conducted Power (dBm)	Max. Limit (dBm)	Result
149	5745 MHz	21.72	30.00	Complies
157	5785 MHz	21.53	30.00	Complies
165	5825 MHz	20.76	30.00	Complies

Configuration IEEE 802.11a Ant. 3-3

Channel	Frequency	Conducted Power (dBm)	Max. Limit (dBm)	Result
149	5745 MHz	21.83	30.00	Complies
157	5785 MHz	21.54	30.00	Complies
165	5825 MHz	20.86	30.00	Complies

Configuration IEEE 802.11a Ant. 3-1 + Ant. 3-3

Channel	Frequency	Conducted Power (dBm)	Max. Limit (dBm)	Result
149	5745 MHz	24.79	30.00	Complies
157	5785 MHz	24.55	30.00	Complies
165	5825 MHz	23.82	30.00	Complies

<For Antenna 4>:

Temperature	21°C	Humidity	56%
Test Engineer	Johnson Chang	Configurations	Draft n / Antenna 4

For 2.4GHz Band

Configuration Draft n MCS8 20MHz Ant. 4-1

Channel	Frequency	Conducted Power (dBm)	Max. Limit (dBm)	Result
1	2412 MHz	17.17	30.00	Complies
6	2437 MHz	22.83	30.00	Complies
11	2462 MHz	17.31	30.00	Complies

Configuration Draft n MCS8 20MHz Ant. 4-3

Channel	Frequency	Conducted Power (dBm)	Max. Limit (dBm)	Result
1	2412 MHz	18.43	30.00	Complies
6	2437 MHz	23.35	30.00	Complies
11	2462 MHz	18.34	30.00	Complies

Configuration Draft n MCS8 20MHz Ant. 4-1 + Ant. 4-3

Channel	Frequency	Conducted Power (dBm)	Max. Limit (dBm)	Result
1	2412 MHz	20.86	30.00	Complies
6	2437 MHz	26.11	30.00	Complies
11	2462 MHz	20.87	30.00	Complies

Configuration Drafft n MCS8 40MHz Ant. 4-1

Channel	Frequency	Conducted Power (dBm)	Max. Limit (dBm)	Result
3	2422 MHz	13.55	30.00	Complies
6	2437 MHz	17.29	30.00	Complies
9	2452 MHz	13.53	30.00	Complies

Configuration Drafft n MCS8 40MHz Ant. 4-3

Channel	Frequency	Conducted Power (dBm)	Max. Limit (dBm)	Result
3	2422 MHz	14.10	30.00	Complies
6	2437 MHz	17.39	30.00	Complies
9	2452 MHz	13.64	30.00	Complies

Configuration Drafft n MCS8 40MHz Ant. 4-1 + Ant. 4-3

Channel	Frequency	Conducted Power (dBm)	Max. Limit (dBm)	Result
3	2422 MHz	16.84	30.00	Complies
6	2437 MHz	20.35	30.00	Complies
9	2452 MHz	16.60	30.00	Complies

For 5GHz Band
Configuration Draft n MCS8 20MHz Ant. 4-1

Channel	Frequency	Conducted Power (dBm)	Max. Limit (dBm)	Result
149	5745 MHz	20.74	30.00	Complies
157	5785 MHz	20.59	30.00	Complies
165	5825 MHz	19.42	30.00	Complies

Configuration Draft n MCS8 20MHz Ant. 4-3

Channel	Frequency	Conducted Power (dBm)	Max. Limit (dBm)	Result
149	5745 MHz	20.77	30.00	Complies
157	5785 MHz	20.62	30.00	Complies
165	5825 MHz	19.69	30.00	Complies

Configuration Draft n MCS8 20MHz Ant. 4-1 + Ant. 4-3

Channel	Frequency	Conducted Power (dBm)	Max. Limit (dBm)	Result
149	5745 MHz	23.77	30.00	Complies
157	5785 MHz	23.62	30.00	Complies
165	5825 MHz	22.57	30.00	Complies

Configuration Drafft n MCS8 40MHz Ant. 4-1

Channel	Frequency	Conducted Power (dBm)	Max. Limit (dBm)	Result
151	5755 MHz	21.18	30.00	Complies
159	5795 MHz	20.65	30.00	Complies

Configuration Drafft n MCS8 40MHz Ant. 4-3

Channel	Frequency	Conducted Power (dBm)	Max. Limit (dBm)	Result
151	5755 MHz	21.20	30.00	Complies
159	5795 MHz	20.91	30.00	Complies

Configuration Drafft n MCS8 40MHz Ant. 4-1 + Ant. 4-3

Channel	Frequency	Conducted Power (dBm)	Max. Limit (dBm)	Result
151	5755 MHz	24.20	30.00	Complies
159	5795 MHz	23.79	30.00	Complies

Temperature	21°C	Humidity	56%
Test Engineer	Johnson Chang	Configurations	802.11a/b/g / Antenna 4

Configuration IEEE 802.11b Ant. 4-1

Channel	Frequency	Conducted Power (dBm)	Max. Limit (dBm)	Result
1	2412 MHz	20.82	30.00	Complies
6	2437 MHz	22.85	30.00	Complies
11	2462 MHz	21.23	30.00	Complies

Configuration IEEE 802.11b Ant. 4-3

Channel	Frequency	Conducted Power (dBm)	Max. Limit (dBm)	Result
1	2412 MHz	21.01	30.00	Complies
6	2437 MHz	23.71	30.00	Complies
11	2462 MHz	23.12	30.00	Complies

Configuration IEEE 802.11b Ant. 4-1 + Ant. 4-3

Channel	Frequency	Conducted Power (dBm)	Max. Limit (dBm)	Result
1	2412 MHz	23.93	30.00	Complies
6	2437 MHz	26.31	30.00	Complies
11	2462 MHz	25.29	30.00	Complies

Configuration IEEE 802.11g Ant. 4-1

Channel	Frequency	Conducted Power (dBm)	Max. Limit (dBm)	Result
1	2412 MHz	15.65	30.00	Complies
6	2437 MHz	22.16	30.00	Complies
11	2462 MHz	17.84	30.00	Complies

Configuration IEEE 802.11g Ant. 4-3

Channel	Frequency	Conducted Power (dBm)	Max. Limit (dBm)	Result
1	2412 MHz	17.24	30.00	Complies
6	2437 MHz	22.20	30.00	Complies
11	2462 MHz	18.31	30.00	Complies

Configuration IEEE 802.11g Ant. 4-1 + Ant. 4-3

Channel	Frequency	Conducted Power (dBm)	Max. Limit (dBm)	Result
1	2412 MHz	19.53	30.00	Complies
6	2437 MHz	25.19	30.00	Complies
11	2462 MHz	21.09	30.00	Complies

Configuration IEEE 802.11a Ant. 4-1

Channel	Frequency	Conducted Power (dBm)	Max. Limit (dBm)	Result
149	5745 MHz	21.72	30.00	Complies
157	5785 MHz	21.53	30.00	Complies
165	5825 MHz	20.76	30.00	Complies

Configuration IEEE 802.11a Ant. 4-3

Channel	Frequency	Conducted Power (dBm)	Max. Limit (dBm)	Result
149	5745 MHz	21.83	30.00	Complies
157	5785 MHz	21.54	30.00	Complies
165	5825 MHz	20.86	30.00	Complies

Configuration IEEE 802.11a Ant. 4-1 + Ant. 4-3

Channel	Frequency	Conducted Power (dBm)	Max. Limit (dBm)	Result
149	5745 MHz	24.79	30.00	Complies
157	5785 MHz	24.55	30.00	Complies
165	5825 MHz	23.82	30.00	Complies

<For Antenna 5>:

Temperature	21°C	Humidity	56%
Test Engineer	Johnson Chang	Configurations	Draft n / Antenna 5

For 2.4GHz Band

Configuration Draft n MCS8 20MHz Ant. 5-1

Channel	Frequency	Conducted Power (dBm)	Max. Limit (dBm)	Result
1	2412 MHz	15.72	30.00	Complies
6	2437 MHz	21.94	30.00	Complies
11	2462 MHz	16.27	30.00	Complies

Configuration Draft n MCS8 20MHz Ant. 5-3

Channel	Frequency	Conducted Power (dBm)	Max. Limit (dBm)	Result
1	2412 MHz	16.78	30.00	Complies
6	2437 MHz	21.98	30.00	Complies
11	2462 MHz	17.15	30.00	Complies

Configuration Draft n MCS8 20MHz Ant. 5-1 + Ant. 5-3

Channel	Frequency	Conducted Power (dBm)	Max. Limit (dBm)	Result
1	2412 MHz	19.29	30.00	Complies
6	2437 MHz	24.97	30.00	Complies
11	2462 MHz	19.74	30.00	Complies

Configuration Drafft n MCS8 40MHz Ant. 5-1

Channel	Frequency	Conducted Power (dBm)	Max. Limit (dBm)	Result
3	2422 MHz	13.33	30.00	Complies
6	2437 MHz	16.64	30.00	Complies
9	2452 MHz	13.25	30.00	Complies

Configuration Drafft n MCS8 40MHz Ant. 5-3

Channel	Frequency	Conducted Power (dBm)	Max. Limit (dBm)	Result
3	2422 MHz	13.86	30.00	Complies
6	2437 MHz	16.65	30.00	Complies
9	2452 MHz	13.31	30.00	Complies

Configuration Drafft n MCS8 40MHz Ant. 5-1 + Ant. 5-3

Channel	Frequency	Conducted Power (dBm)	Max. Limit (dBm)	Result
3	2422 MHz	16.61	30.00	Complies
6	2437 MHz	19.66	30.00	Complies
9	2452 MHz	16.29	30.00	Complies

For 5GHz Band
Configuration Draft n MCS8 20MHz Ant. 5-1

Channel	Frequency	Conducted Power (dBm)	Max. Limit (dBm)	Result
149	5745 MHz	20.74	30.00	Complies
157	5785 MHz	20.59	30.00	Complies
165	5825 MHz	19.42	30.00	Complies

Configuration Draft n MCS8 20MHz Ant. 5-3

Channel	Frequency	Conducted Power (dBm)	Max. Limit (dBm)	Result
149	5745 MHz	20.77	30.00	Complies
157	5785 MHz	20.62	30.00	Complies
165	5825 MHz	19.69	30.00	Complies

Configuration Draft n MCS8 20MHz Ant. 5-1 + Ant. 5-3

Channel	Frequency	Conducted Power (dBm)	Max. Limit (dBm)	Result
149	5745 MHz	23.77	30.00	Complies
157	5785 MHz	23.62	30.00	Complies
165	5825 MHz	22.57	30.00	Complies

Configuration Drafft n MCS8 40MHz Ant. 5-1

Channel	Frequency	Conducted Power (dBm)	Max. Limit (dBm)	Result
151	5755 MHz	21.18	30.00	Complies
159	5795 MHz	20.65	30.00	Complies

Configuration Drafft n MCS8 40MHz Ant. 5-3

Channel	Frequency	Conducted Power (dBm)	Max. Limit (dBm)	Result
151	5755 MHz	21.20	30.00	Complies
159	5795 MHz	20.91	30.00	Complies

Configuration Drafft n MCS8 40MHz Ant. 5-1 + Ant. 5-3

Channel	Frequency	Conducted Power (dBm)	Max. Limit (dBm)	Result
151	5755 MHz	24.20	30.00	Complies
159	5795 MHz	23.79	30.00	Complies

Temperature	21°C	Humidity	56%
Test Engineer	Johnson Chang	Configurations	802.11a/b/g / Antenna 5

Configuration IEEE 802.11b Ant. 5-1

Channel	Frequency	Conducted Power (dBm)	Max. Limit (dBm)	Result
1	2412 MHz	17.96	30.00	Complies
6	2437 MHz	22.08	30.00	Complies
11	2462 MHz	18.82	30.00	Complies

Configuration IEEE 802.11b Ant. 5-3

Channel	Frequency	Conducted Power (dBm)	Max. Limit (dBm)	Result
1	2412 MHz	18.73	30.00	Complies
6	2437 MHz	23.01	30.00	Complies
11	2462 MHz	20.58	30.00	Complies

Configuration IEEE 802.11b Ant. 5-1 + Ant. 5-3

Channel	Frequency	Conducted Power (dBm)	Max. Limit (dBm)	Result
1	2412 MHz	21.37	30.00	Complies
6	2437 MHz	25.58	30.00	Complies
11	2462 MHz	22.80	30.00	Complies

Configuration IEEE 802.11g Ant. 5-1

Channel	Frequency	Conducted Power (dBm)	Max. Limit (dBm)	Result
1	2412 MHz	15.18	30.00	Complies
6	2437 MHz	19.97	30.00	Complies
11	2462 MHz	16.37	30.00	Complies

Configuration IEEE 802.11g Ant. 5-3

Channel	Frequency	Conducted Power (dBm)	Max. Limit (dBm)	Result
1	2412 MHz	16.81	30.00	Complies
6	2437 MHz	20.47	30.00	Complies
11	2462 MHz	19.79	30.00	Complies

Configuration IEEE 802.11g Ant. 5-1 + Ant. 5-3

Channel	Frequency	Conducted Power (dBm)	Max. Limit (dBm)	Result
1	2412 MHz	19.08	30.00	Complies
6	2437 MHz	23.24	30.00	Complies
11	2462 MHz	21.42	30.00	Complies

Configuration IEEE 802.11a Ant. 5-1

Channel	Frequency	Conducted Power (dBm)	Max. Limit (dBm)	Result
149	5745 MHz	21.72	30.00	Complies
157	5785 MHz	21.53	30.00	Complies
165	5825 MHz	20.76	30.00	Complies

Configuration IEEE 802.11a Ant. 5-3

Channel	Frequency	Conducted Power (dBm)	Max. Limit (dBm)	Result
149	5745 MHz	21.83	30.00	Complies
157	5785 MHz	21.54	30.00	Complies
165	5825 MHz	20.86	30.00	Complies

Configuration IEEE 802.11a Ant. 5-1 + Ant. 5-3

Channel	Frequency	Conducted Power (dBm)	Max. Limit (dBm)	Result
149	5745 MHz	24.79	30.00	Complies
157	5785 MHz	24.55	30.00	Complies
165	5825 MHz	23.82	30.00	Complies

<For Antenna 6>:

Temperature	21°C	Humidity	56%
Test Engineer	Johnson Chang	Configurations	Draft n / Antenna 6

For 2.4GHz Band

Configuration Draft n MCS8 20MHz Ant. 6-1

Channel	Frequency	Conducted Power (dBm)	Max. Limit (dBm)	Result
1	2412 MHz	16.37	30.00	Complies
6	2437 MHz	23.35	30.00	Complies
11	2462 MHz	18.83	30.00	Complies

Configuration Draft n MCS8 20MHz Ant. 6-3

Channel	Frequency	Conducted Power (dBm)	Max. Limit (dBm)	Result
1	2412 MHz	17.45	30.00	Complies
6	2437 MHz	22.83	30.00	Complies
11	2462 MHz	17.94	30.00	Complies

Configuration Draft n MCS8 20MHz Ant. 6-1 + Ant. 6-3

Channel	Frequency	Conducted Power (dBm)	Max. Limit (dBm)	Result
1	2412 MHz	19.95	30.00	Complies
6	2437 MHz	26.11	30.00	Complies
11	2462 MHz	21.42	30.00	Complies

Configuration Drafft n MCS8 40MHz Ant. 6-1

Channel	Frequency	Conducted Power (dBm)	Max. Limit (dBm)	Result
3	2422 MHz	13.33	30.00	Complies
6	2437 MHz	16.97	30.00	Complies
9	2452 MHz	14.13	30.00	Complies

Configuration Drafft n MCS8 40MHz Ant. 6-3

Channel	Frequency	Conducted Power (dBm)	Max. Limit (dBm)	Result
3	2422 MHz	13.86	30.00	Complies
6	2437 MHz	17.11	30.00	Complies
9	2452 MHz	14.10	30.00	Complies

Configuration Drafft n MCS8 40MHz Ant. 6-1 + Ant. 6-3

Channel	Frequency	Conducted Power (dBm)	Max. Limit (dBm)	Result
3	2422 MHz	16.61	30.00	Complies
6	2437 MHz	20.05	30.00	Complies
9	2452 MHz	17.13	30.00	Complies

For 5GHz Band
Configuration Draft n MCS8 20MHz Ant. 6-1

Channel	Frequency	Conducted Power (dBm)	Max. Limit (dBm)	Result
149	5745 MHz	20.77	30.00	Complies
157	5785 MHz	20.62	30.00	Complies
165	5825 MHz	19.42	30.00	Complies

Configuration Draft n MCS8 20MHz Ant. 6-3

Channel	Frequency	Conducted Power (dBm)	Max. Limit (dBm)	Result
149	5745 MHz	20.74	30.00	Complies
157	5785 MHz	20.59	30.00	Complies
165	5825 MHz	19.69	30.00	Complies

Configuration Draft n MCS8 20MHz Ant. 6-1 + Ant. 6-3

Channel	Frequency	Conducted Power (dBm)	Max. Limit (dBm)	Result
149	5745 MHz	23.77	30.00	Complies
157	5785 MHz	23.62	30.00	Complies
165	5825 MHz	22.57	30.00	Complies

Configuration Drafft n MCS8 40MHz Ant. 6-1

Channel	Frequency	Conducted Power (dBm)	Max. Limit (dBm)	Result
151	5755 MHz	21.20	30.00	Complies
159	5795 MHz	20.91	30.00	Complies

Configuration Drafft n MCS8 40MHz Ant. 6-3

Channel	Frequency	Conducted Power (dBm)	Max. Limit (dBm)	Result
151	5755 MHz	21.18	30.00	Complies
159	5795 MHz	20.65	30.00	Complies

Configuration Drafft n MCS8 40MHz Ant. 6-1 + Ant. 6-3

Channel	Frequency	Conducted Power (dBm)	Max. Limit (dBm)	Result
151	5755 MHz	24.20	30.00	Complies
159	5795 MHz	23.79	30.00	Complies

Temperature	21°C	Humidity	56%
Test Engineer	Johnson Chang	Configurations	802.11a/b/g / Antenna 6

Configuration IEEE 802.11b Ant. 6-1

Channel	Frequency	Conducted Power (dBm)	Max. Limit (dBm)	Result
1	2412 MHz	19.03	30.00	Complies
6	2437 MHz	23.28	30.00	Complies
11	2462 MHz	22.51	30.00	Complies

Configuration IEEE 802.11b Ant. 6-3

Channel	Frequency	Conducted Power (dBm)	Max. Limit (dBm)	Result
1	2412 MHz	19.67	30.00	Complies
6	2437 MHz	22.57	30.00	Complies
11	2462 MHz	20.52	30.00	Complies

Configuration IEEE 802.11b Ant. 6-1 + Ant. 6-3

Channel	Frequency	Conducted Power (dBm)	Max. Limit (dBm)	Result
1	2412 MHz	22.37	30.00	Complies
6	2437 MHz	25.95	30.00	Complies
11	2462 MHz	24.64	30.00	Complies

Configuration IEEE 802.11g Ant. 6-1

Channel	Frequency	Conducted Power (dBm)	Max. Limit (dBm)	Result
1	2412 MHz	17.10	30.00	Complies
6	2437 MHz	22.16	30.00	Complies
11	2462 MHz	17.80	30.00	Complies

Configuration IEEE 802.11g Ant. 6-3

Channel	Frequency	Conducted Power (dBm)	Max. Limit (dBm)	Result
1	2412 MHz	19.14	30.00	Complies
6	2437 MHz	22.20	30.00	Complies
11	2462 MHz	17.18	30.00	Complies

Configuration IEEE 802.11g Ant. 6-1 + Ant. 6-3

Channel	Frequency	Conducted Power (dBm)	Max. Limit (dBm)	Result
1	2412 MHz	21.25	30.00	Complies
6	2437 MHz	25.19	30.00	Complies
11	2462 MHz	20.51	30.00	Complies

Configuration IEEE 802.11a Ant. 6-1

Channel	Frequency	Conducted Power (dBm)	Max. Limit (dBm)	Result
149	5745 MHz	21.72	30.00	Complies
157	5785 MHz	21.53	30.00	Complies
165	5825 MHz	20.76	30.00	Complies

Configuration IEEE 802.11a Ant. 6-3

Channel	Frequency	Conducted Power (dBm)	Max. Limit (dBm)	Result
149	5745 MHz	21.83	30.00	Complies
157	5785 MHz	21.54	30.00	Complies
165	5825 MHz	20.86	30.00	Complies

Configuration IEEE 802.11a Ant. 6-1 + Ant. 6-3

Channel	Frequency	Conducted Power (dBm)	Max. Limit (dBm)	Result
149	5745 MHz	24.79	30.00	Complies
157	5785 MHz	24.55	30.00	Complies
165	5825 MHz	23.82	30.00	Complies

<For Antenna 1>:

Channel Output Power Plot on Configuration Draft n MCS8 20MHz Ant. 1-1 / 2412 MHz

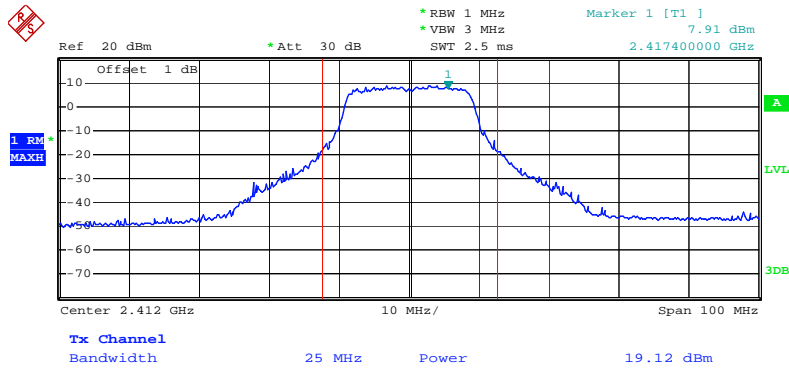

Date: 14.SEP.2009 13:44:28

Channel Output Power Plot on Configuration Draft n MCS8 20MHz Ant. 1-1 / 2437 MHz

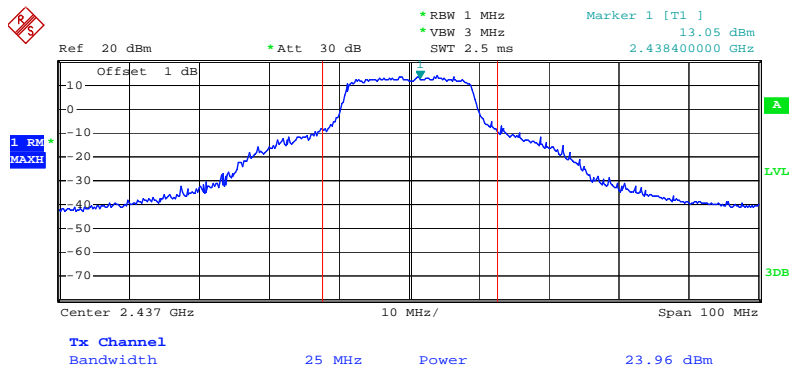

Date: 14.SEP.2009 19:09:34

Channel Output Power Plot on Configuration Draft n MCS8 20MHz Ant. 1-1 / 2462 MHz

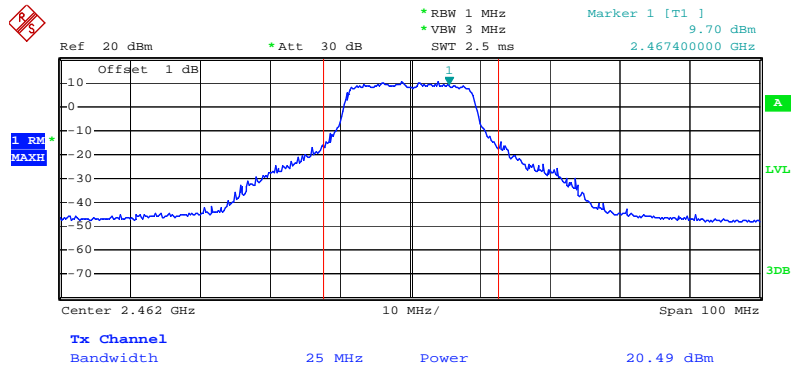

Date: 14.SEP.2009 19:08:24

Channel Output Power Plot on Configuration Draft n MCS8 20MHz Ant. 1-3 / 2412 MHz

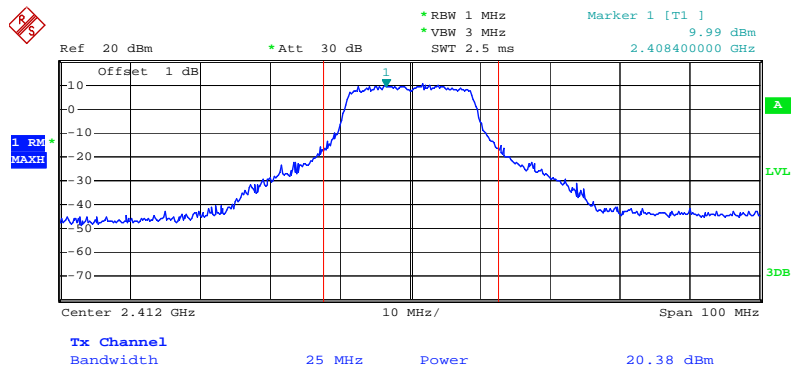

Date: 14.SEP.2009 19:17:36

Channel Output Power Plot on Configuration Draft n MCS8 20MHz Ant. 1-3 / 2437 MHz

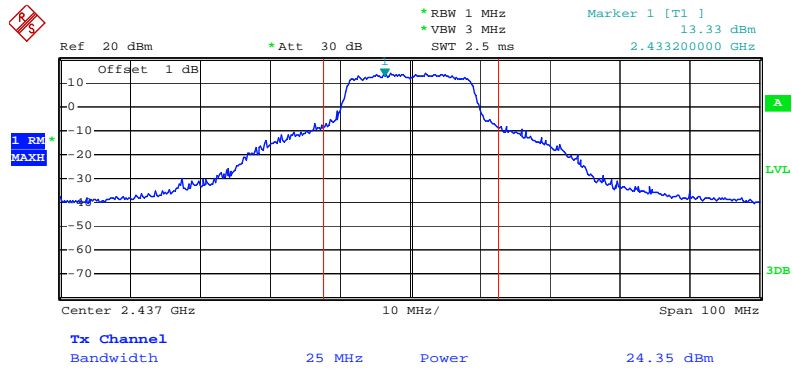

Date: 14.SEP.2009 13:52:02

Channel Output Power Plot on Configuration Draft n MCS8 20MHz Ant. 1-3 / 2462 MHz

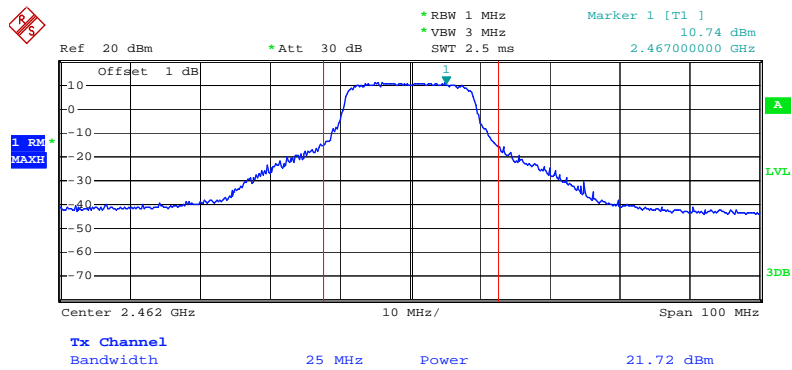

Date: 14.SEP.2009 13:53:57

Channel Output Power Plot on Configuration Draft n MCS8 40MHz Ant. 1-1 / 2422 MHz

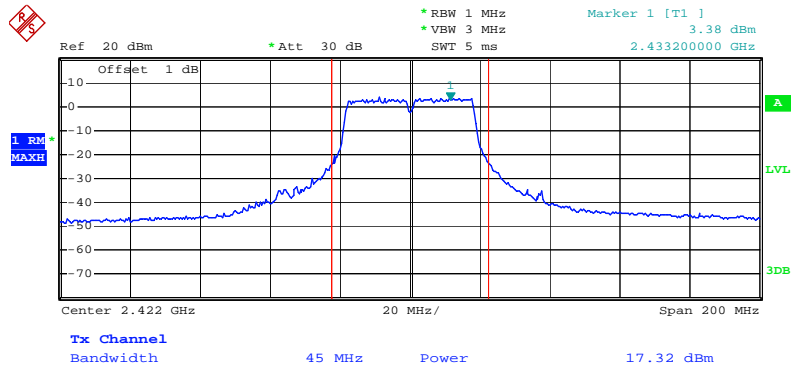

Date: 14.SEP.2009 14:17:00

Channel Output Power Plot on Configuration Draft n MCS8 40MHz Ant. 1-1 / 2437 MHz

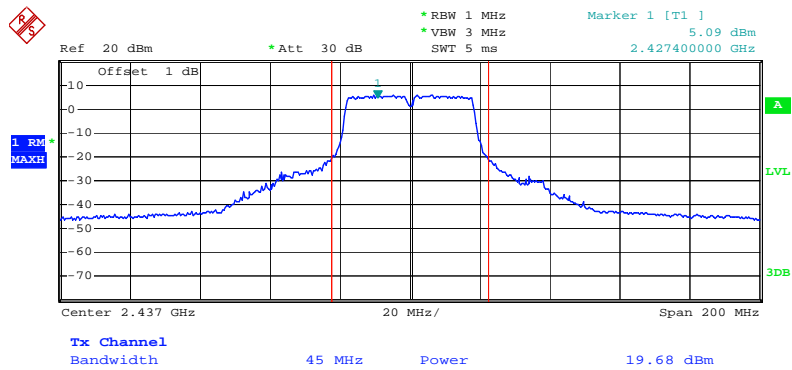

Date: 14.SEP.2009 14:07:11

Channel Output Power Plot on Configuration Draft n MCS8 40MHz Ant. 1-1 / 2452 MHz

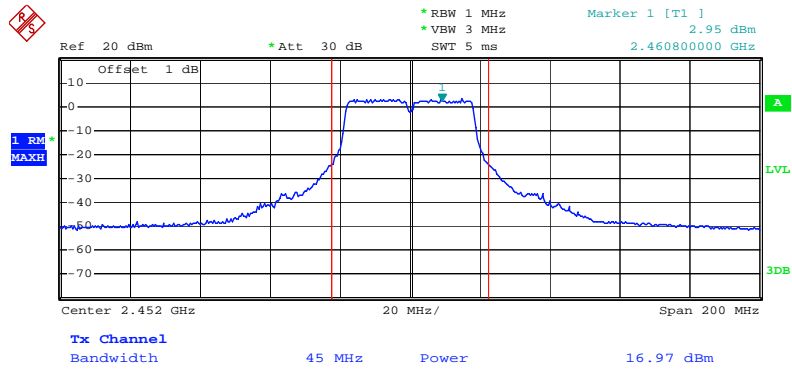

Date: 14.SEP.2009 19:36:02

Channel Output Power Plot on Configuration Draft n MCS8 40MHz Ant. 1-3 / 2422 MHz

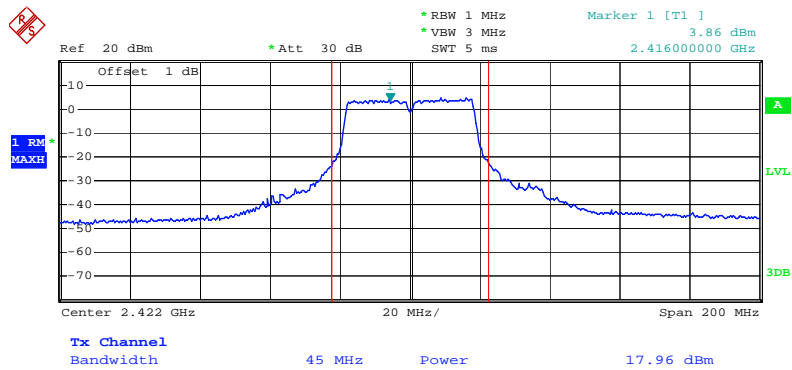

Date: 14.SEP.2009 19:19:20

Channel Output Power Plot on Configuration Draft n MCS8 40MHz Ant. 1-3 / 2437 MHz

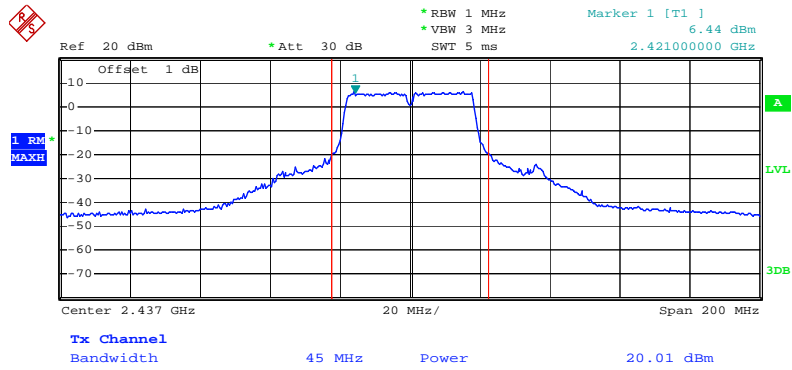

Date: 14.SEP.2009 19:35:09

Channel Output Power Plot on Configuration Draft n MCS8 40MHz Ant. 1-3 / 2452 MHz

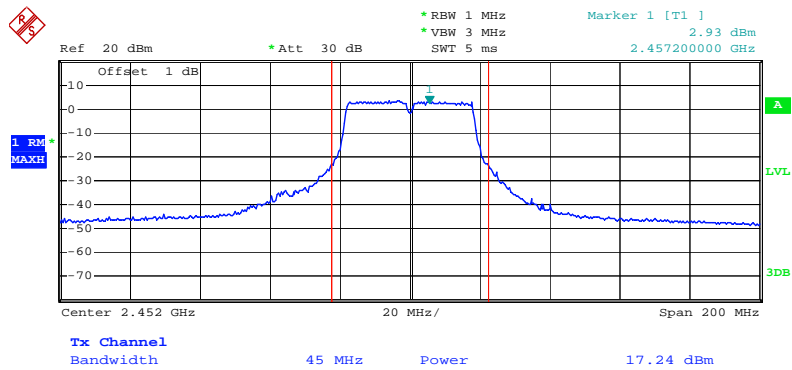

Date: 14.SEP.2009 14:02:33

Channel Output Power Plot on Configuration 11a Draft n MCS8 20MHz Ant. 1-1 / 5745 MHz

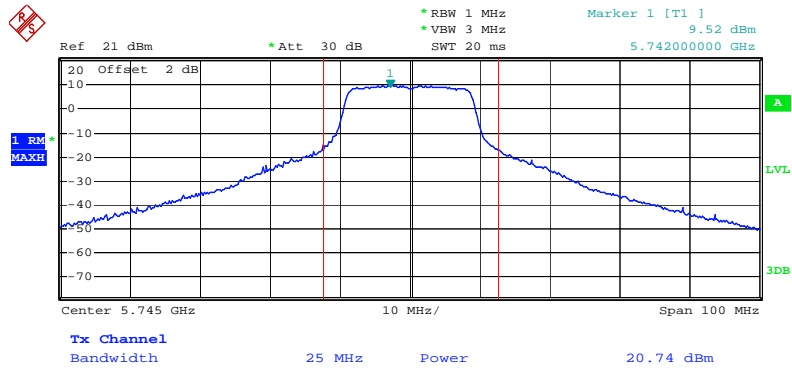

Date: 14.SEP.2009 19:55:51

Channel Output Power Plot on Configuration 11a Draft n MCS8 20MHz Ant. 1-1 / 5785MHz

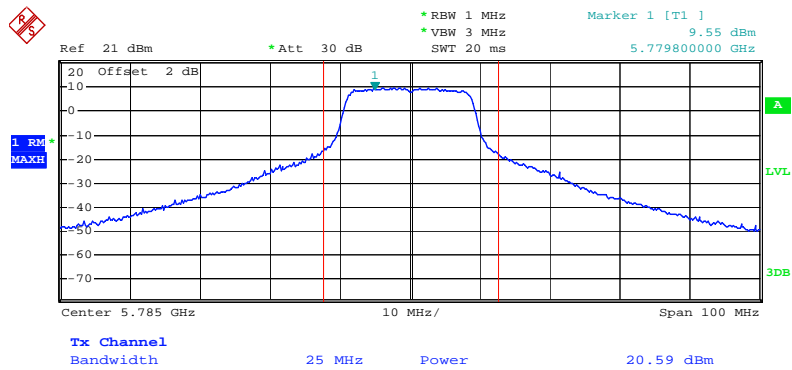

Date: 14.SEP.2009 19:54:59

Channel Output Power Plot on Configuration 11a Draft n MCS8 20MHz Ant. 1-1 / 5825 MHz

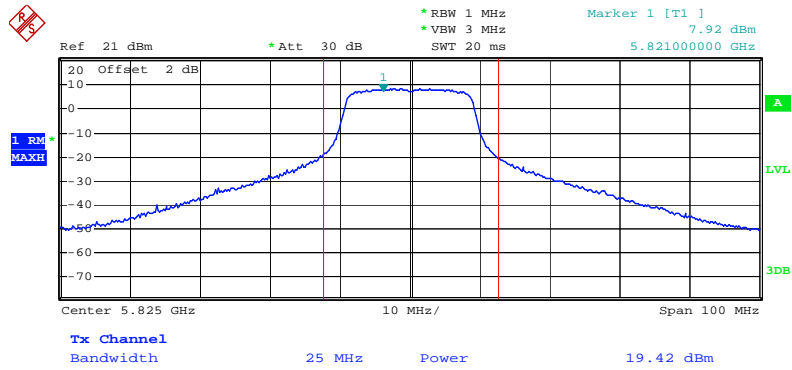

Date: 14.SEP.2009 20:05:55

Channel Output Power Plot on Configuration 11a Draft n MCS8 20MHz Ant. 1-3 / 5745 MHz

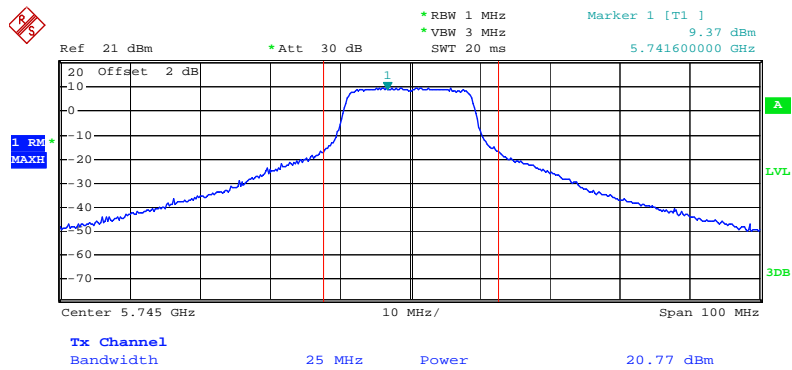

Date: 14.SEP.2009 20:10:17

Channel Output Power Plot on Configuration 11a Draft n MCS8 20MHz Ant. 1-3 / 5785MHz

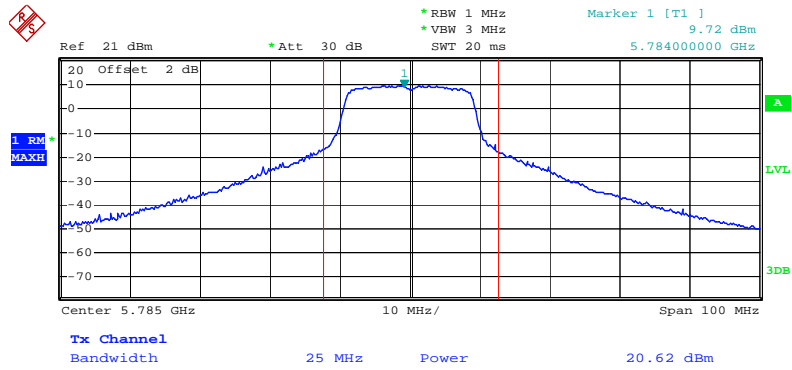

Date: 14.SEP.2009 20:08:55

Channel Output Power Plot on Configuration 11a Draft n MCS8 20MHz Ant. 1-3 / 5825 MHz

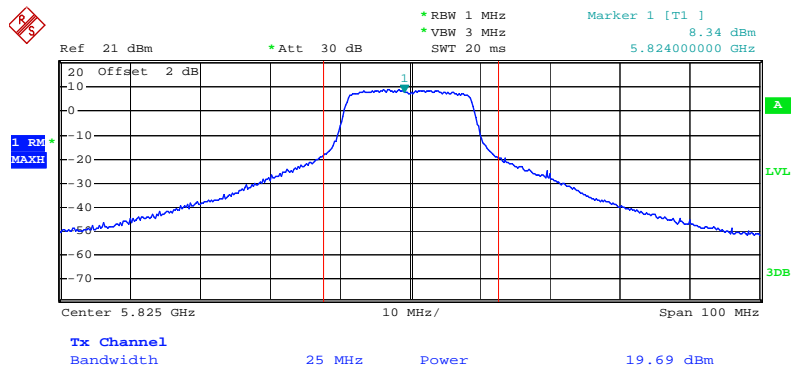

Date: 14.SEP.2009 19:52:58

Channel Output Power Plot on Configuration 11a Draft n MCS8 40MHz Ant. 1-1 / 5755 MHz

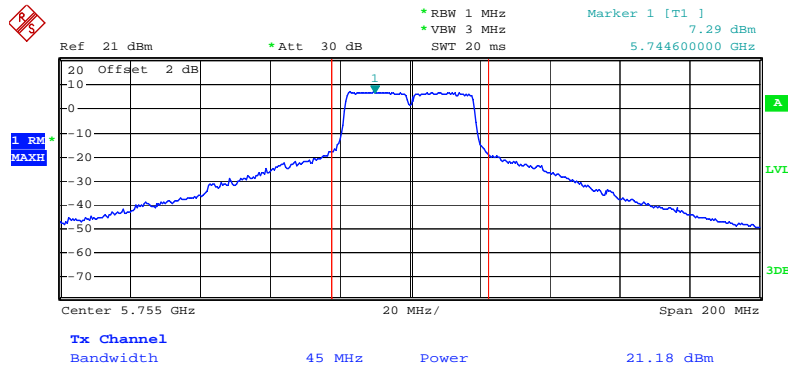

Date: 14.SEP.2009 19:58:04

Channel Output Power Plot on Configuration 11a Draft n MCS8 40MHz Ant. 1-1 / 5795 MHz

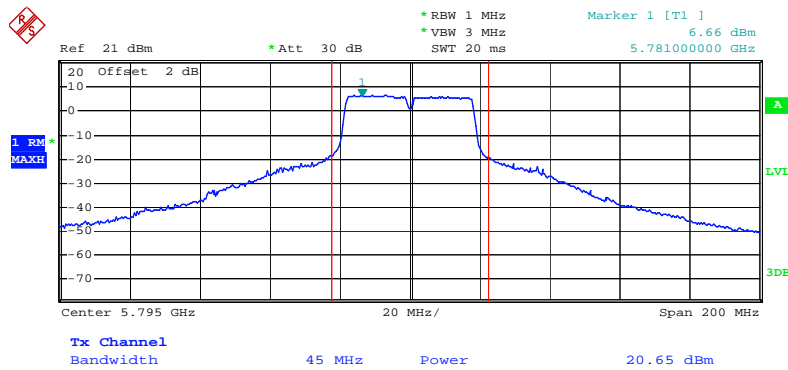

Date: 14.SEP.2009 19:58:56

Channel Output Power Plot on Configuration 11a Draft n MCS8 40MHz Ant. 1-3 / 5755 MHz

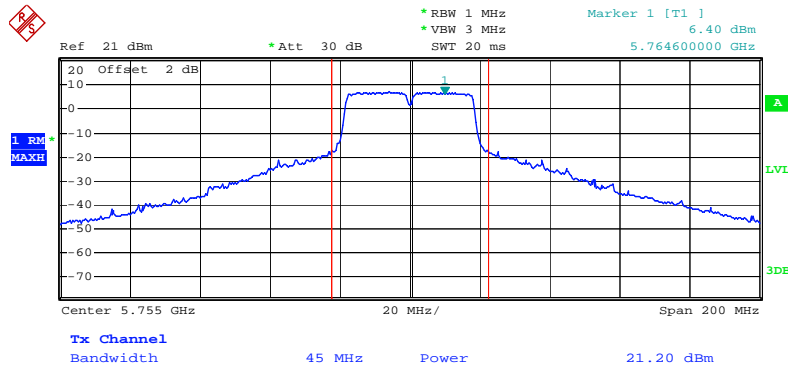

Date: 14.SEP.2009 20:02:42

Channel Output Power Plot on Configuration 11a Draft n MCS8 40MHz Ant. 1-3 / 5795 MHz

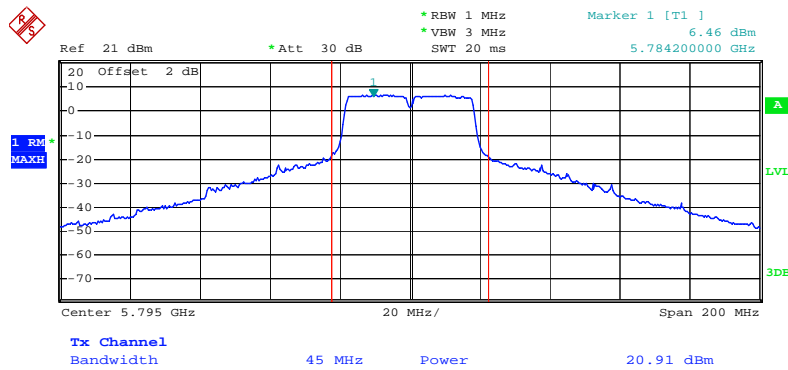

Date: 14.SEP.2009 20:00:20

Conducted Output Power Plot on Configuration IEEE 802.11b Ant. 1-1/ 2412 MHz

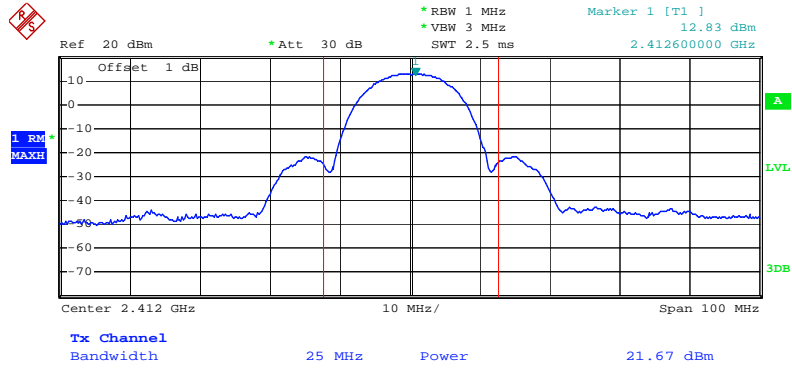

Date: 14.SEP.2009 11:08:43

Conducted Output Power Plot on Configuration IEEE 802.11b Ant. 1-1 / 2437 MHz

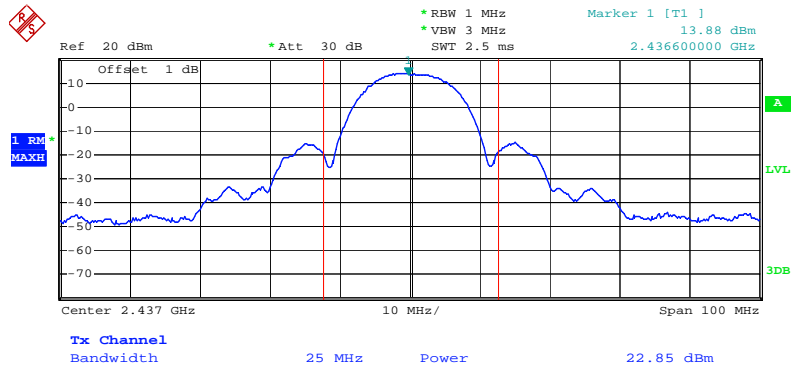

Date: 14.SEP.2009 17:05:04

Conducted Output Power Plot on Configuration IEEE 802.11b Ant. 1-1 / 2462 MHz

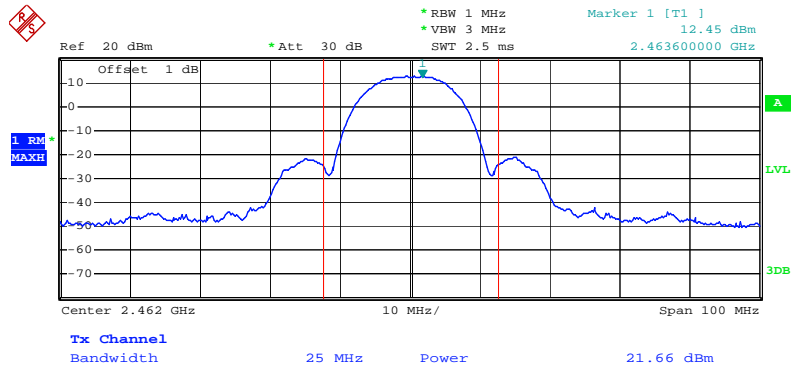

Date: 14.SEP.2009 17:13:35

Conducted Output Power Plot on Configuration IEEE 802.11b Ant. 1-3 / 2412 MHz

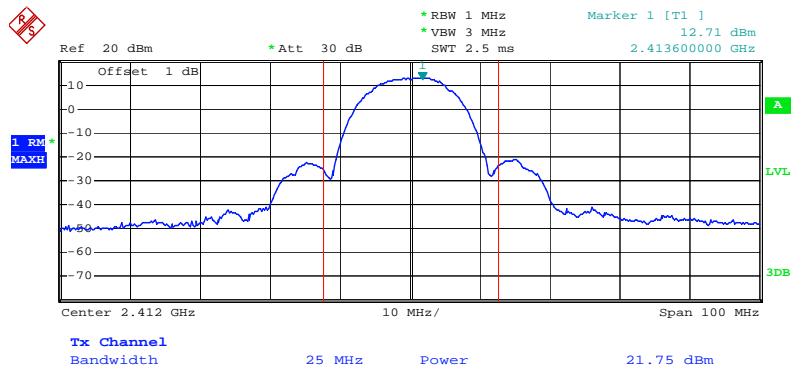

Date: 14.SEP.2009 17:06:22

Conducted Output Power Plot on Configuration IEEE 802.11b Ant. 1-3 / 2437 MHz

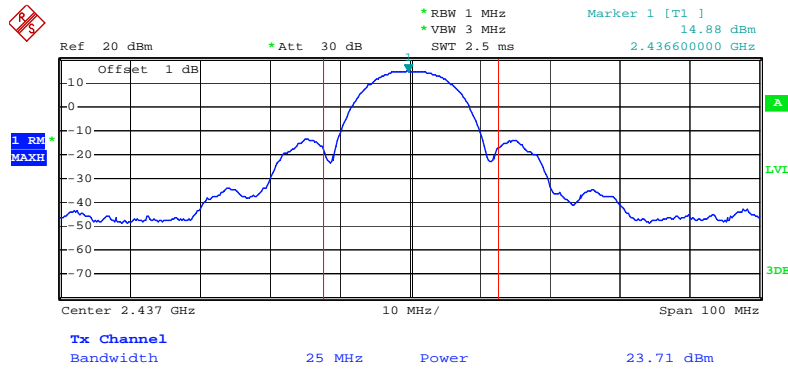

Date: 14.SEP.2009 11:14:20

Conducted Output Power Plot on Configuration IEEE 802.11b Ant. 1-3 / 2462 MHz

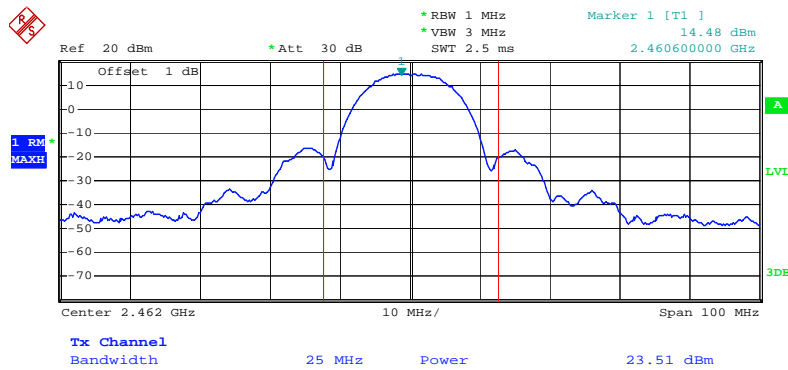

Date: 14.SEP.2009 11:26:51

Conducted Output Power Plot on Configuration IEEE 802.11g Ant. 1-1 / 2412 MHz

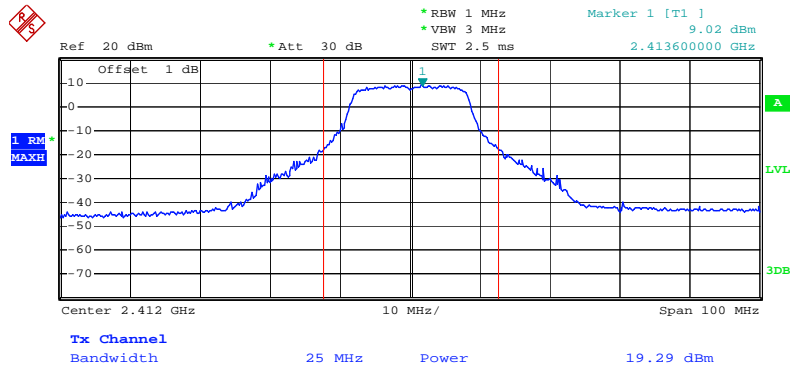

Date: 14.SEP.2009 13:40:13

Conducted Output Power Plot on Configuration IEEE 802.11g Ant. 1-1 / 2437 MHz

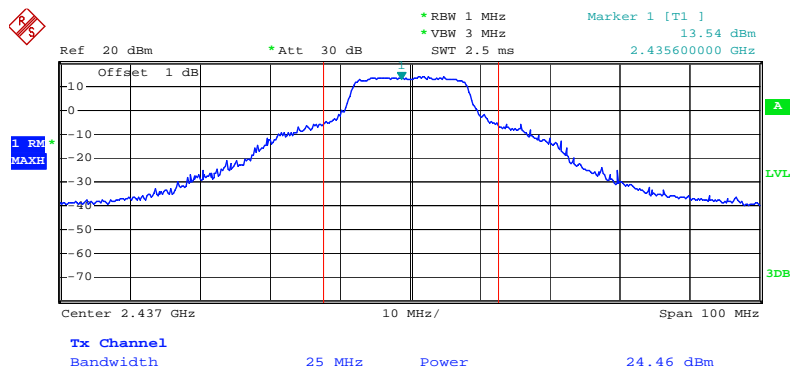

Date: 14.SEP.2009 13:36:05

Conducted Output Power Plot on Configuration IEEE 802.11g Ant. 1-1 / 2462 MHz

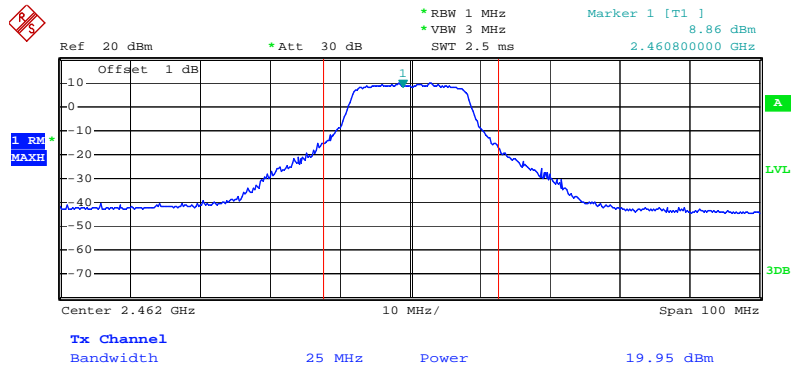

Date: 14.SEP.2009 11:36:25

Conducted Output Power Plot on Configuration IEEE 802.11g Ant. 1-3 / 2412 MHz

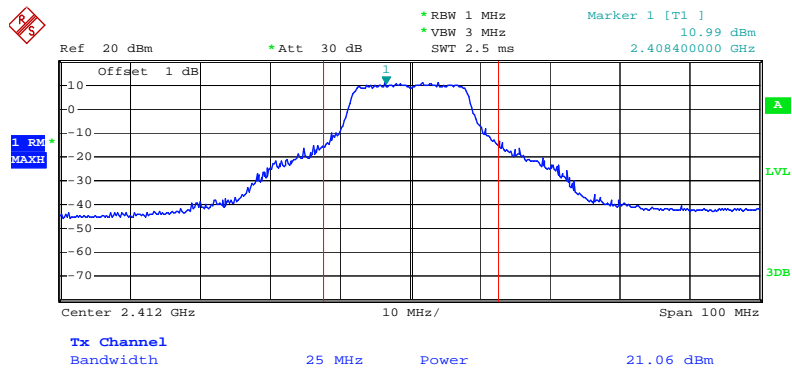

Date: 14.SEP.2009 18:25:20

Conducted Output Power Plot on Configuration IEEE 802.11g Ant. 1-3 / 2437 MHz

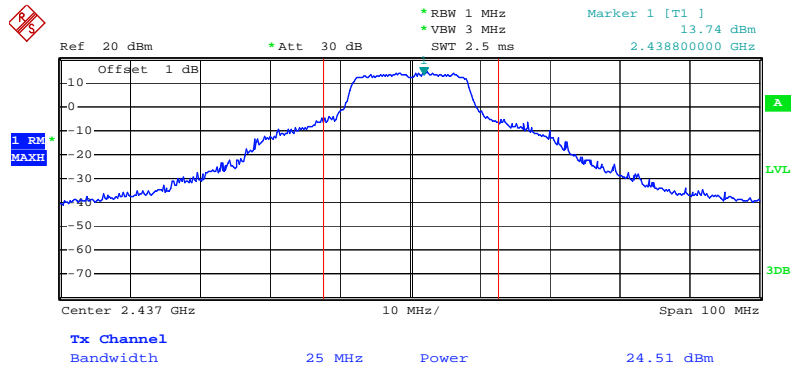

Date: 14.SEP.2009 18:33:45

Conducted Output Power Plot on Configuration IEEE 802.11g Ant. 1-3 / 2462 MHz

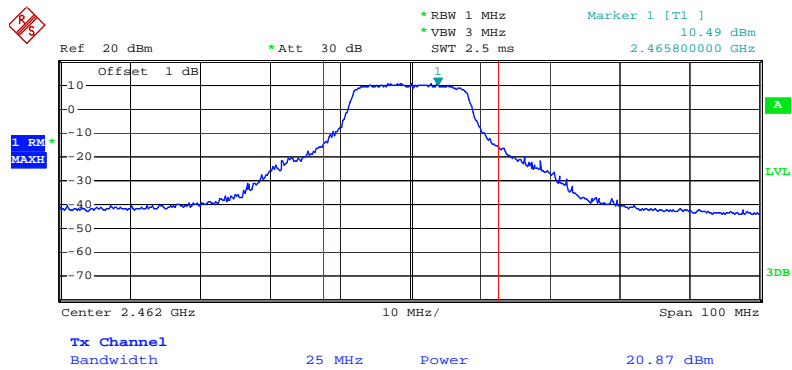

Date: 14.SEP.2009 11:32:19

Conducted Output Power Plot on Configuration IEEE 802.11a Ant. 1-1 / 5745 MHz

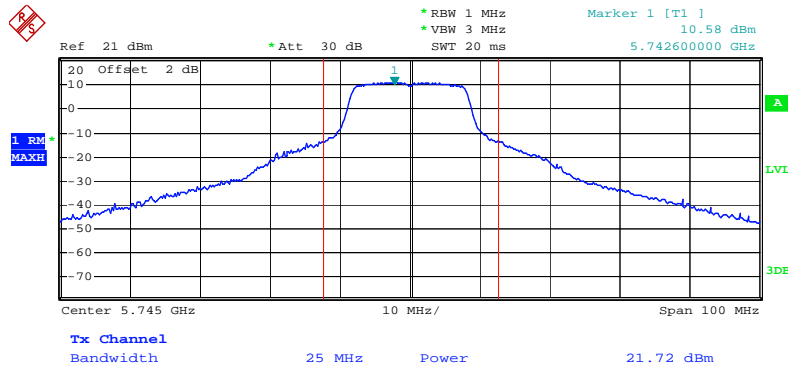

Date: 14.SEP.2009 20:17:14

Conducted Output Power Plot on Configuration IEEE 802.11a Ant. 1-1 / 5785 MHz

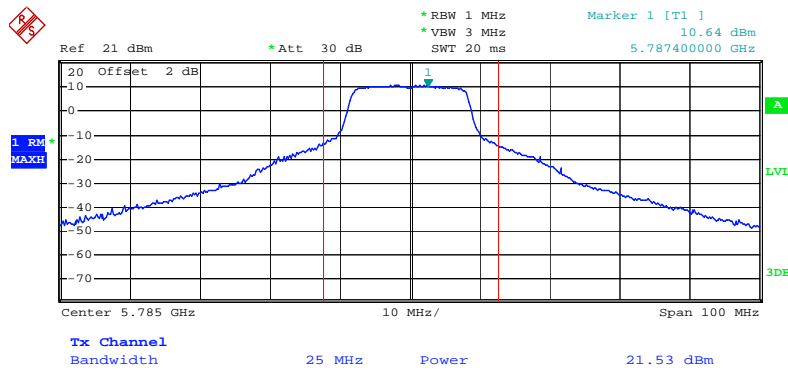

Date: 14.SEP.2009 20:17:40

Conducted Output Power Plot on Configuration IEEE 802.11a Ant. 1-1 / 5825 MHz

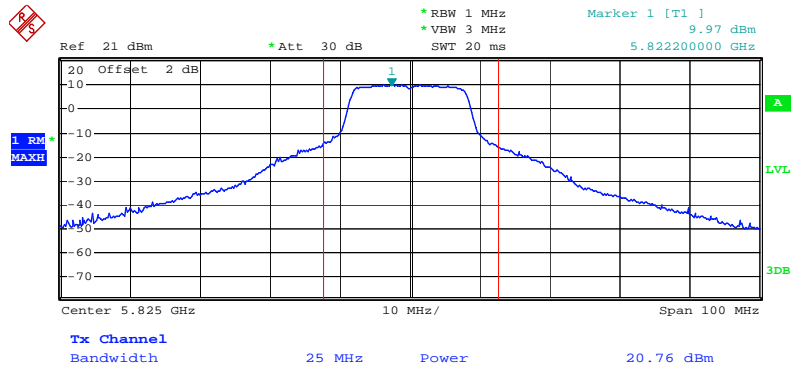

Date: 14.SEP.2009 20:18:00

Conducted Output Power Plot on Configuration IEEE 802.11a Ant. 1-3 / 5745 MHz

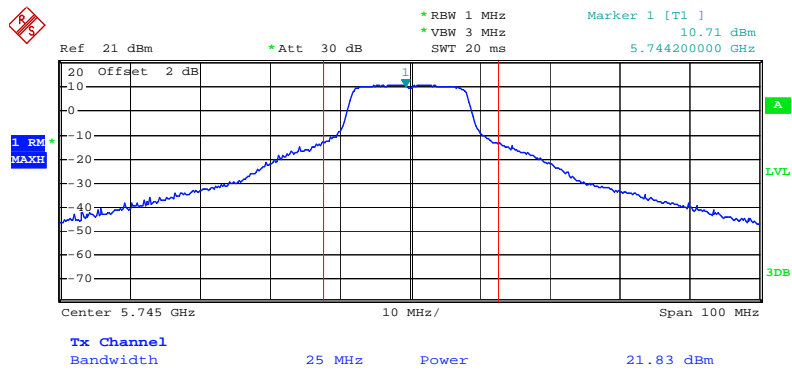

Date: 14.SEP.2009 19:50:19

Conducted Output Power Plot on Configuration IEEE 802.11a Ant. 1-3 / 5785 MHz

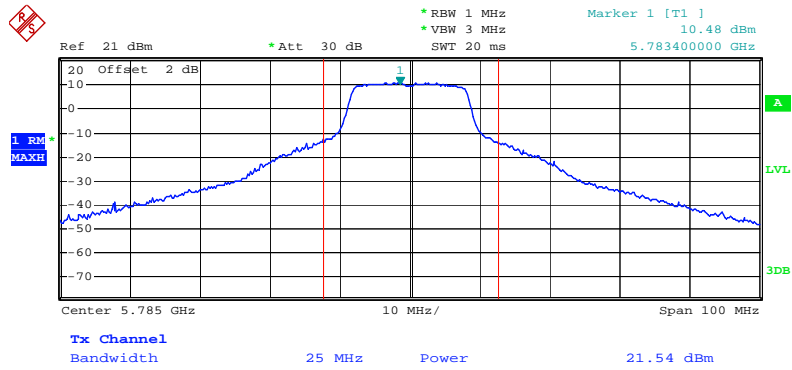

Date: 14.SEP.2009 19:47:29

Conducted Output Power Plot on Configuration IEEE 802.11a Ant. 1-3 / 5825 MHz

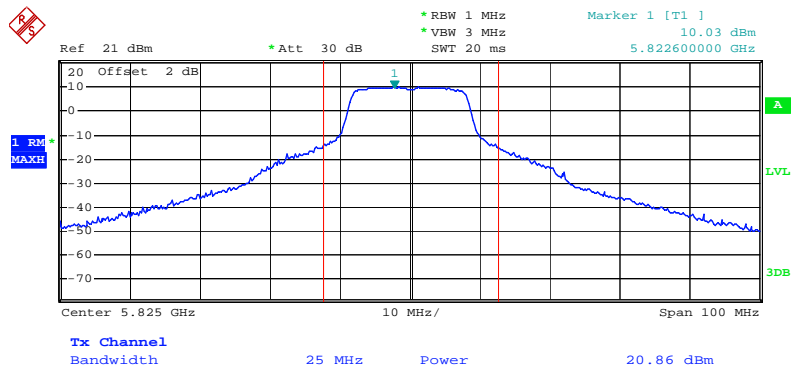

Date: 14.SEP.2009 19:51:10

<For Antenna 2>:

Channel Output Power Plot on Configuration Draft n MCS8 20MHz Ant. 2-1 / 2412 MHz

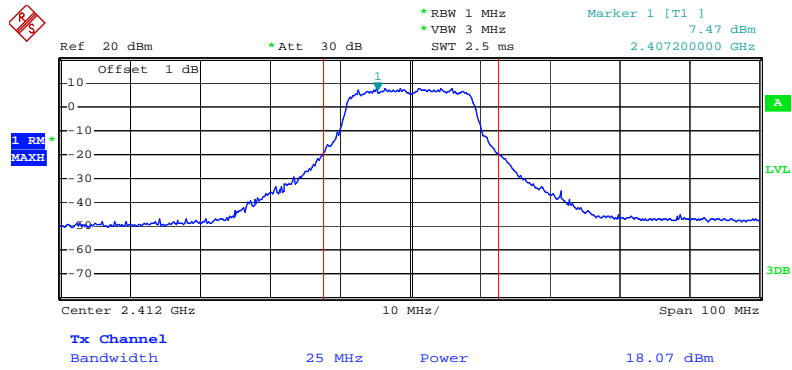

Date: 14.SEP.2009 13:45:09

Channel Output Power Plot on Configuration Draft n MCS8 20MHz Ant. 2-1 / 2437 MHz

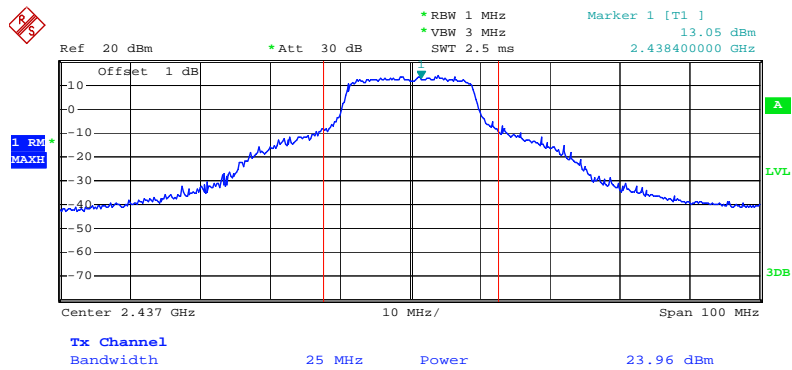

Date: 14.SEP.2009 19:09:34

Channel Output Power Plot on Configuration Draft n MCS8 20MHz Ant. 2-1 / 2462 MHz

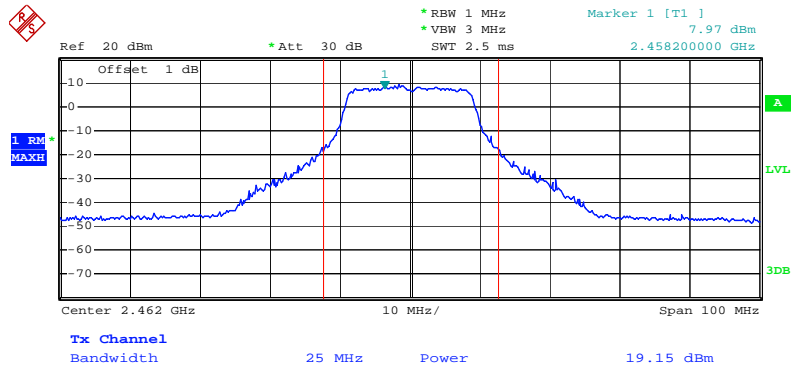

Date: 14.SEP.2009 19:07:51

Channel Output Power Plot on Configuration Draft n MCS8 20MHz Ant. 2-3 / 2412 MHz

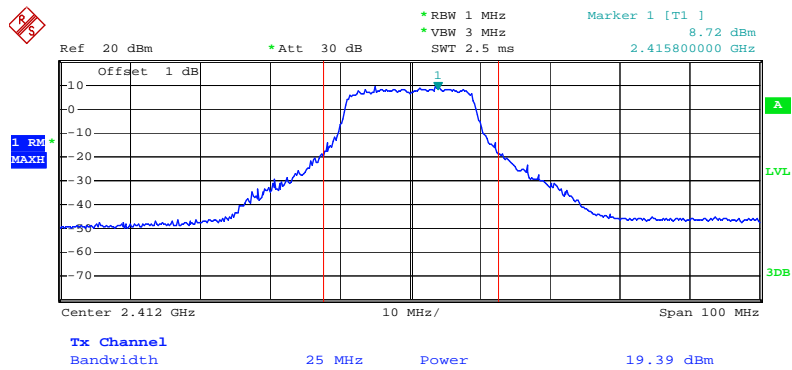

Date: 14.SEP.2009 19:16:57

Channel Output Power Plot on Configuration Draft n MCS8 20MHz Ant. 2-3 / 2437 MHz

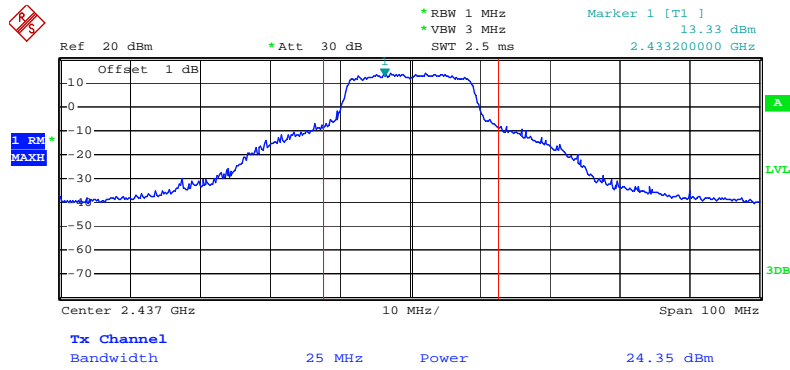

Date: 14.SEP.2009 13:52:02

Channel Output Power Plot on Configuration Draft n MCS8 20MHz Ant. 2-3 / 2462 MHz

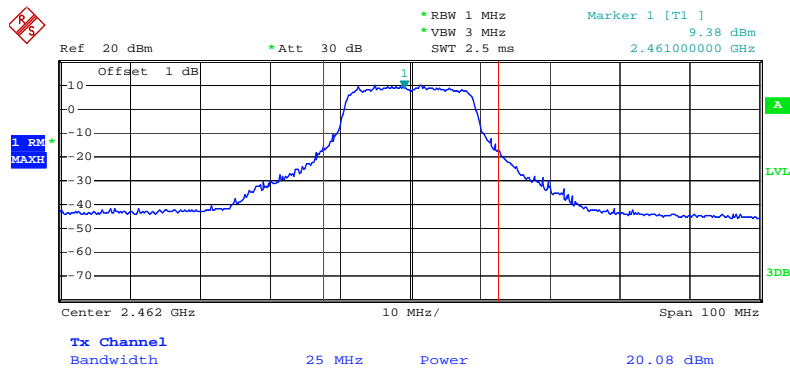

Date: 14.SEP.2009 13:54:43

Channel Output Power Plot on Configuration Draft n MCS8 40MHz Ant. 2-1 / 2422 MHz

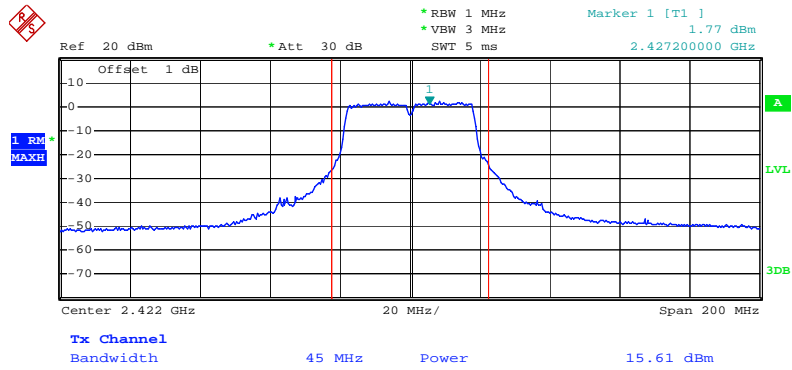

Date: 14.SEP.2009 14:16:30

Channel Output Power Plot on Configuration Draft n MCS8 40MHz Ant. 2-1 / 2437 MHz

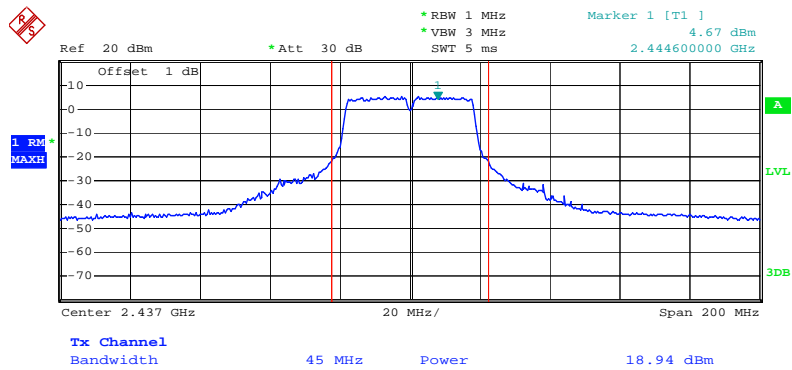

Date: 14.SEP.2009 14:08:10

Channel Output Power Plot on Configuration Draft n MCS8 40MHz Ant. 2-1 / 2452 MHz

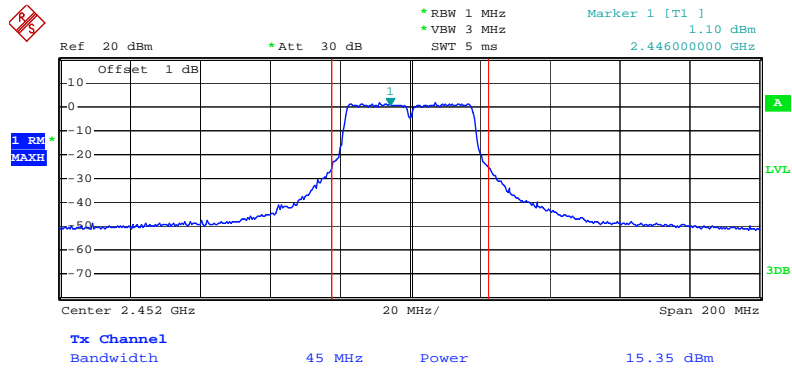

Date: 14.SEP.2009 19:36:49

Channel Output Power Plot on Configuration Draft n MCS8 40MHz Ant. 2-3 / 2422 MHz

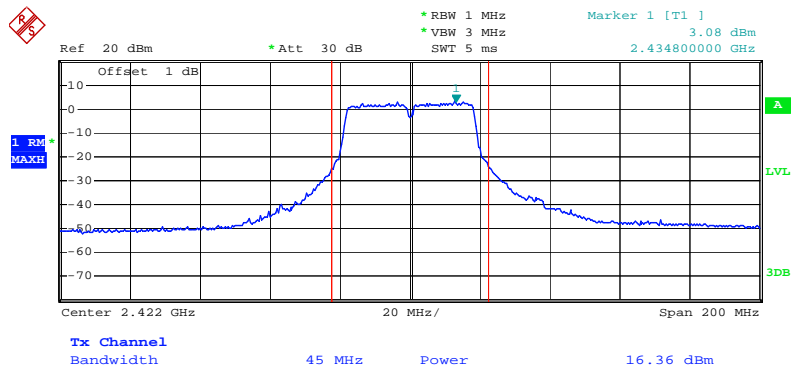

Date: 14.SEP.2009 19:20:01

Channel Output Power Plot on Configuration Draft n MCS8 40MHz Ant. 2-3 / 2437 MHz

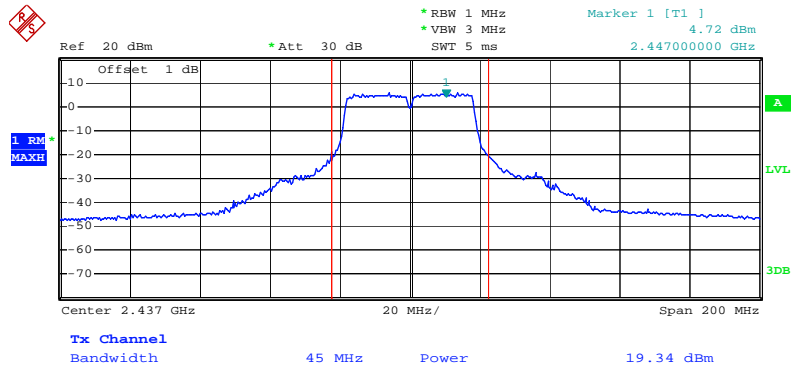

Date: 14.SEP.2009 19:32:30

Channel Output Power Plot on Configuration Draft n MCS8 40MHz Ant. 2-3 / 2452 MHz

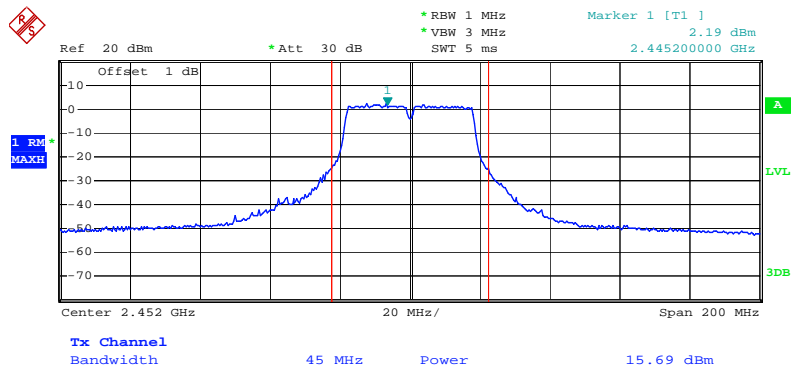

Date: 14.SEP.2009 14:03:33

Channel Output Power Plot on Configuration 11a Draft n MCS8 20MHz Ant. 2-1 / 5745 MHz

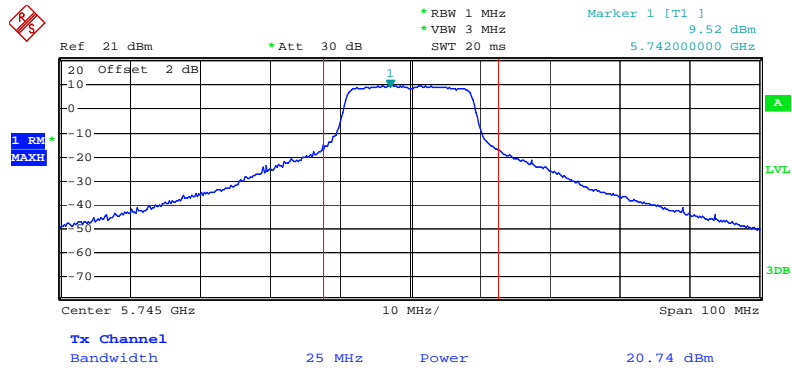

Date: 14.SEP.2009 19:55:51

Channel Output Power Plot on Configuration 11a Draft n MCS8 20MHz Ant. 2-1 / 5785MHz

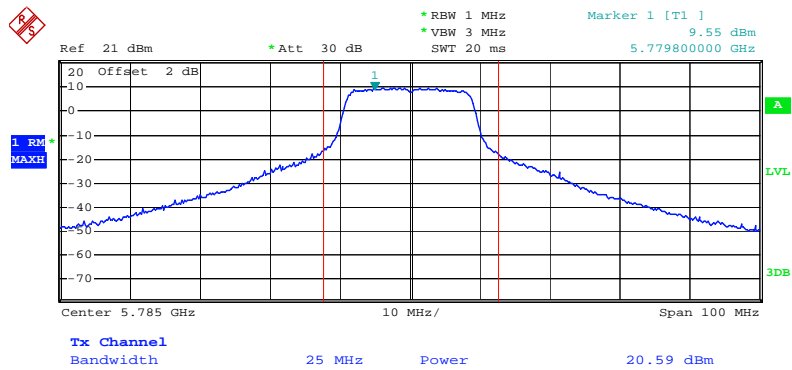

Date: 14.SEP.2009 19:54:59

Channel Output Power Plot on Configuration 11a Draft n MCS8 20MHz Ant. 2-1 / 5825 MHz

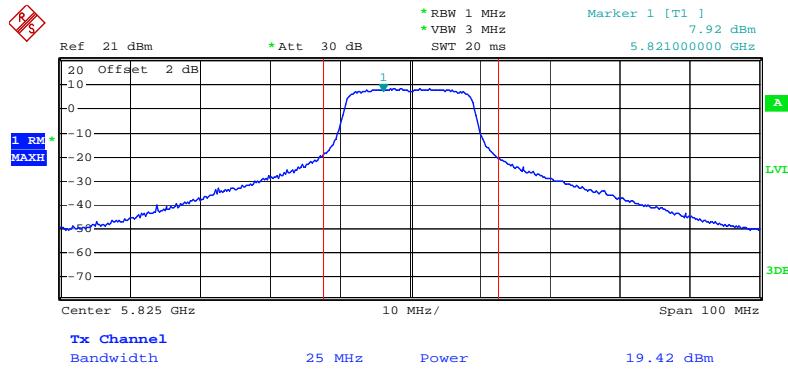

Date: 14.SEP.2009 20:05:55

Channel Output Power Plot on Configuration 11a Draft n MCS8 20MHz Ant. 2-3 / 5745 MHz

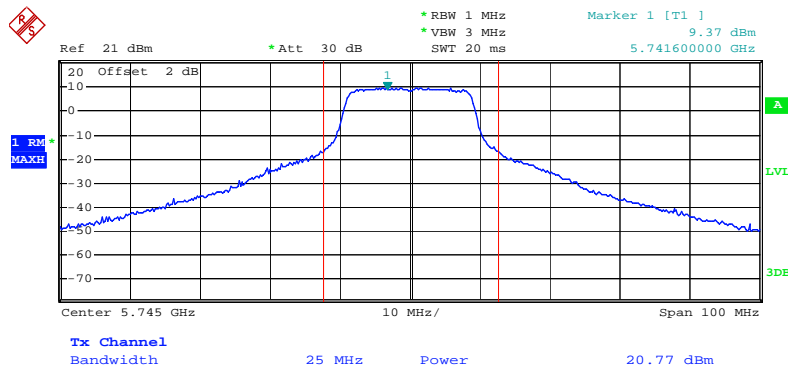

Date: 14.SEP.2009 20:10:17

Channel Output Power Plot on Configuration 11a Draft n MCS8 20MHz Ant. 2-3 / 5785MHz

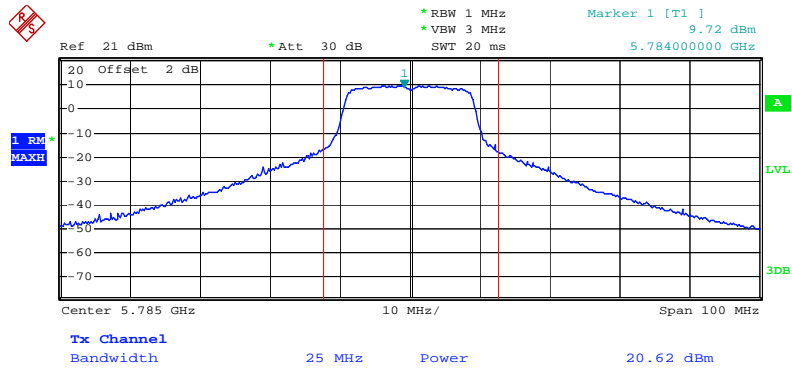

Date: 14.SEP.2009 20:08:55

Channel Output Power Plot on Configuration 11a Draft n MCS8 20MHz Ant. 2-3 / 5825 MHz

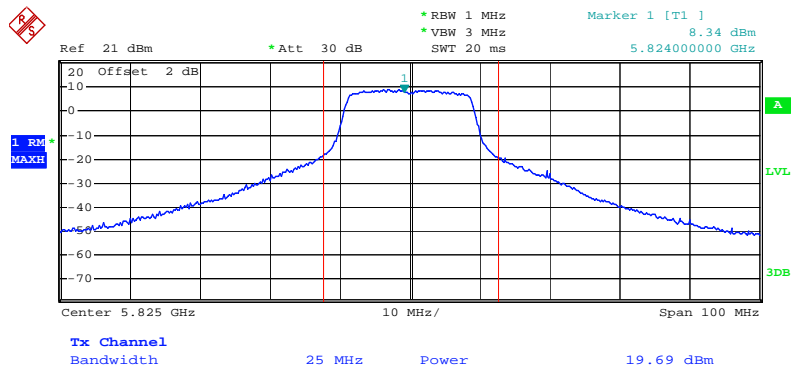

Date: 14.SEP.2009 19:52:58

Channel Output Power Plot on Configuration 11a Draft n MCS8 40MHz Ant. 2-1 / 5755 MHz

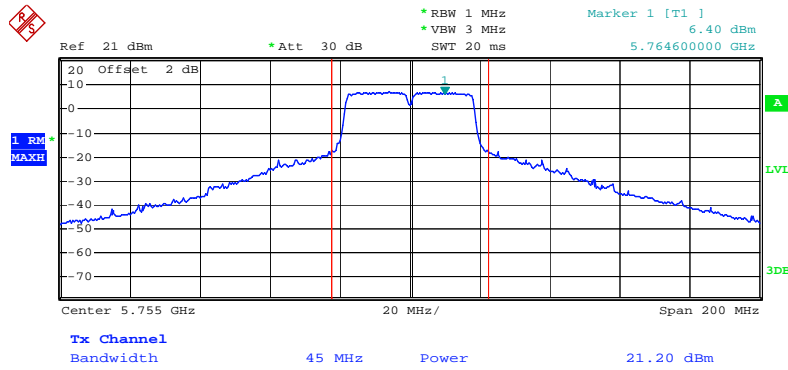

Date: 14.SEP.2009 20:02:42

Channel Output Power Plot on Configuration 11a Draft n MCS8 40MHz Ant. 2-1 / 5795 MHz

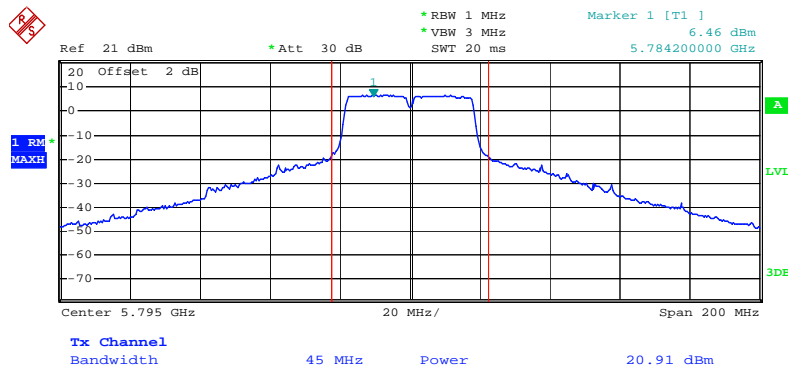

Date: 14.SEP.2009 20:00:20

Channel Output Power Plot on Configuration 11a Draft n MCS8 40MHz Ant. 2-3 / 5755 MHz

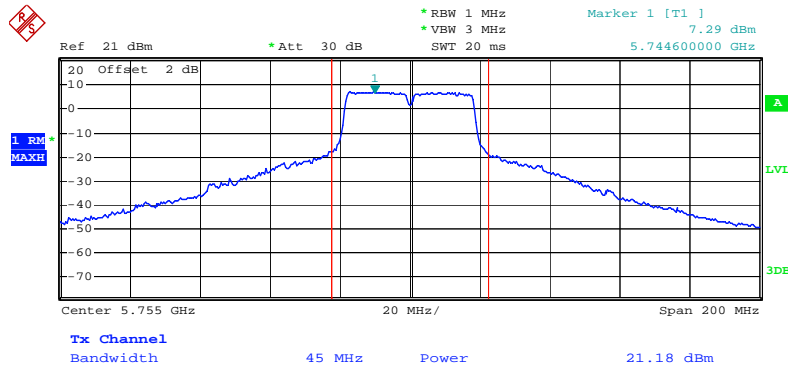

Date: 14.SEP.2009 19:58:04

Channel Output Power Plot on Configuration 11a Draft n MCS8 40MHz Ant. 2-3 / 5795 MHz

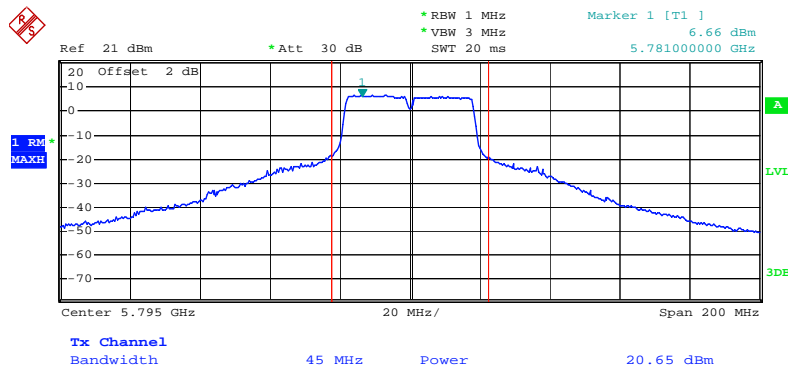

Date: 14.SEP.2009 19:58:56

Conducted Output Power Plot on Configuration IEEE 802.11b Ant. 2-1/ 2412 MHz

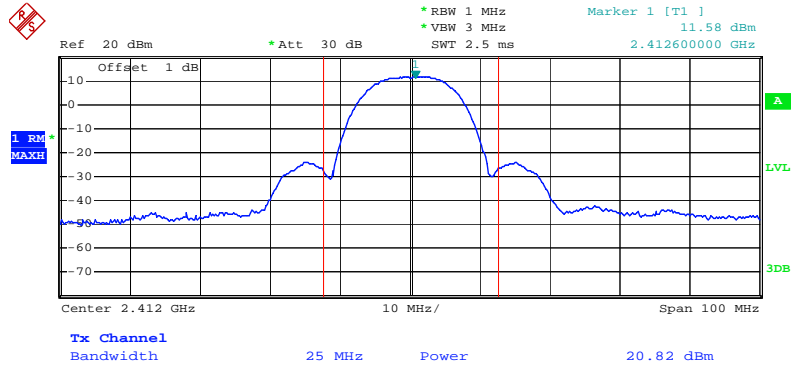

Date: 14.SEP.2009 11:09:33

Conducted Output Power Plot on Configuration IEEE 802.11b Ant. 2-1 / 2437 MHz

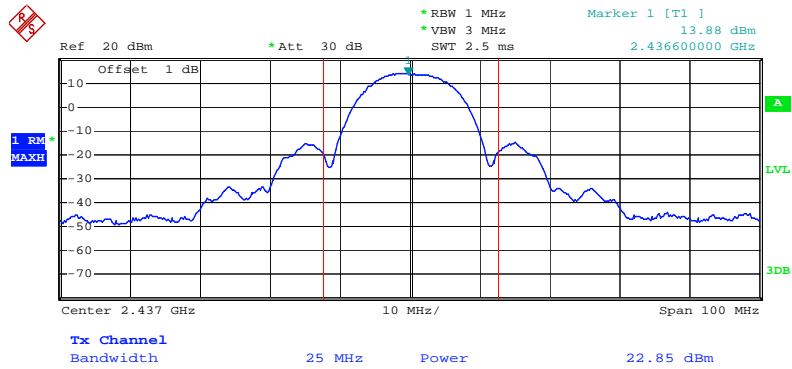

Date: 14.SEP.2009 17:05:04

Conducted Output Power Plot on Configuration IEEE 802.11b Ant. 2-1 / 2462 MHz

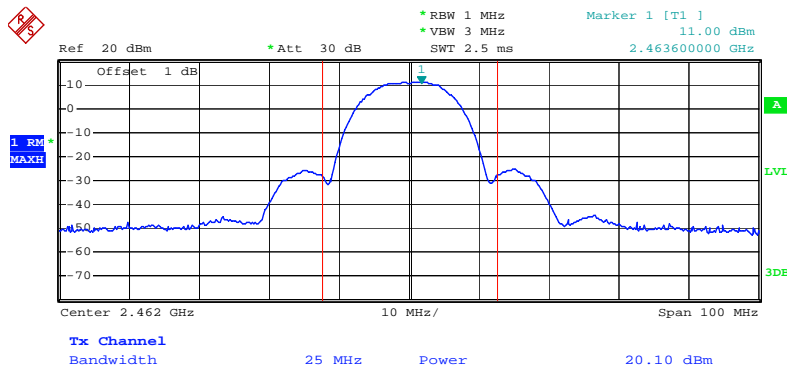

Date: 14.SEP.2009 17:12:58

Conducted Output Power Plot on Configuration IEEE 802.11b Ant. 2-3 / 2412 MHz

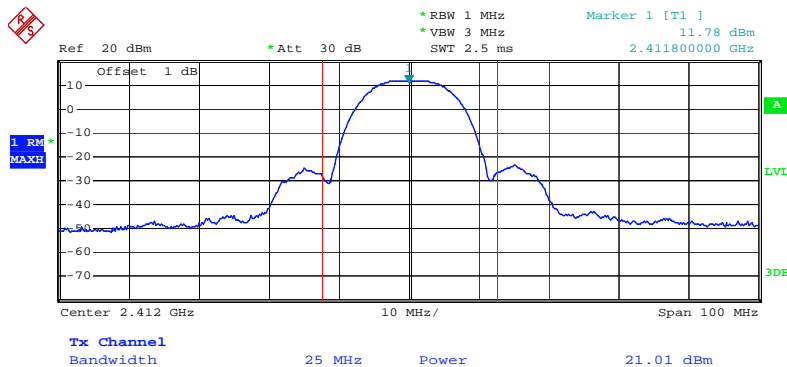

Date: 14.SEP.2009 17:07:01

Conducted Output Power Plot on Configuration IEEE 802.11b Ant. 2-3 / 2437 MHz

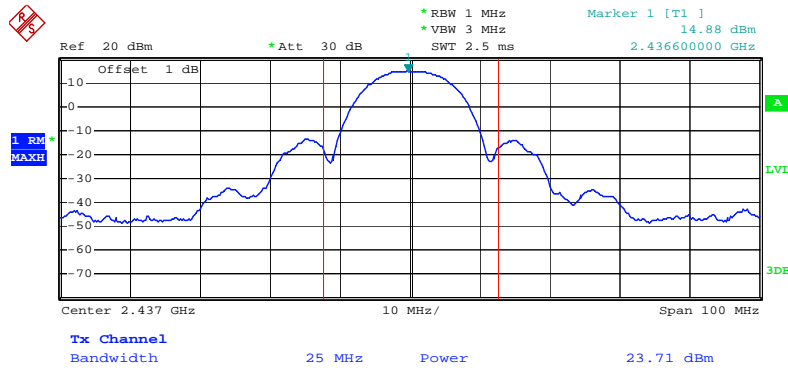

Date: 14.SEP.2009 11:14:20

Conducted Output Power Plot on Configuration IEEE 802.11b Ant. 2-3 / 2462 MHz

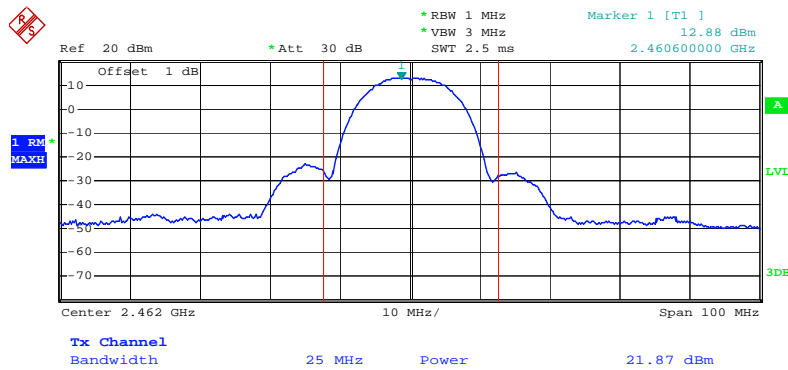

Date: 14.SEP.2009 11:29:17

Conducted Output Power Plot on Configuration IEEE 802.11g Ant. 2-1 / 2412 MHz

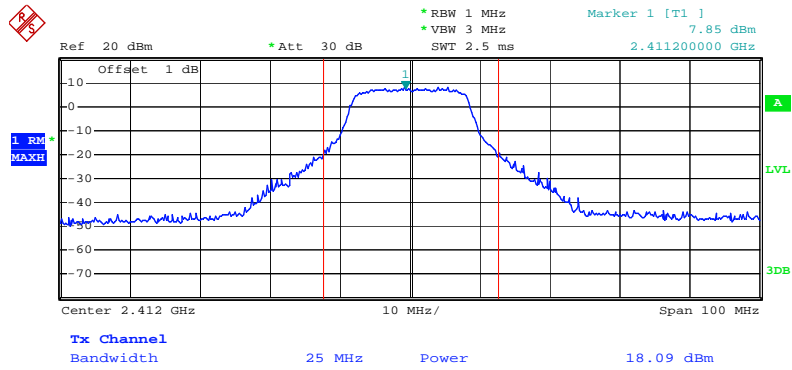

Date: 14.SEP.2009 13:40:51

Conducted Output Power Plot on Configuration IEEE 802.11g Ant. 2-1 / 2437 MHz

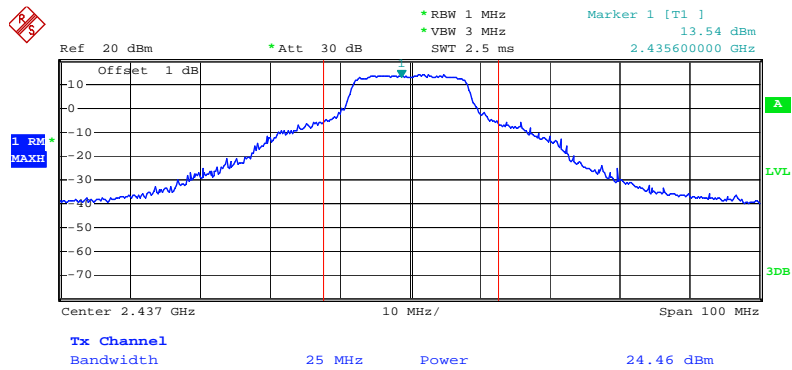

Date: 14.SEP.2009 13:36:05

Conducted Output Power Plot on Configuration IEEE 802.11g Ant. 2-1 / 2462 MHz

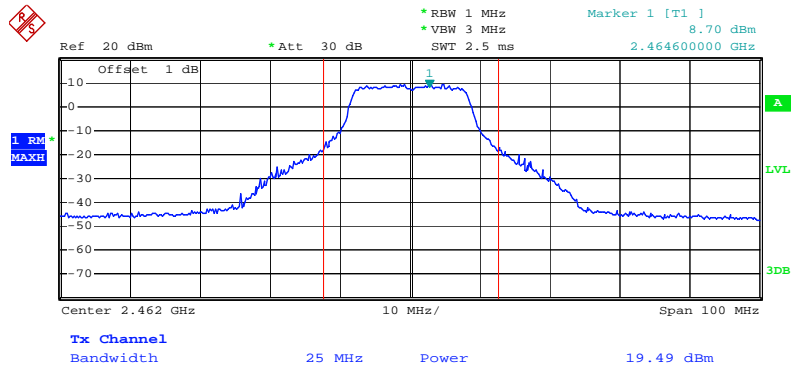

Date: 14.SEP.2009 18:59:28

Conducted Output Power Plot on Configuration IEEE 802.11g Ant. 2-3 / 2412 MHz

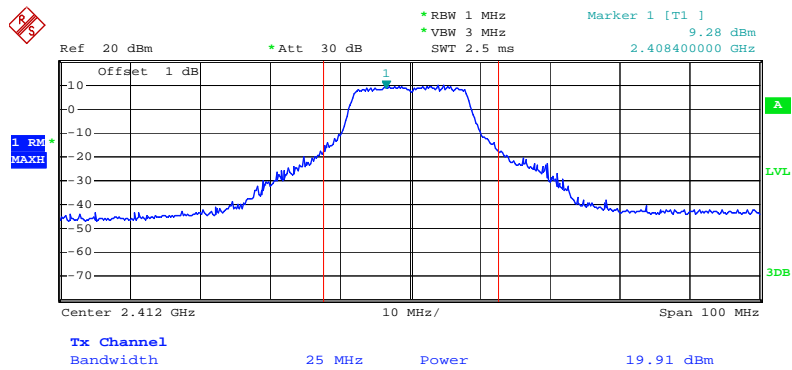

Date: 14.SEP.2009 18:27:25

Conducted Output Power Plot on Configuration IEEE 802.11g Ant. 2-3 / 2437 MHz

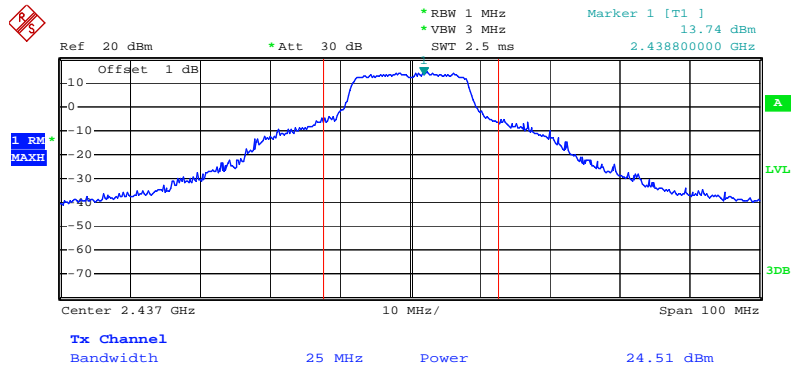

Date: 14.SEP.2009 18:33:45

Conducted Output Power Plot on Configuration IEEE 802.11g Ant. 2-3 / 2462 MHz

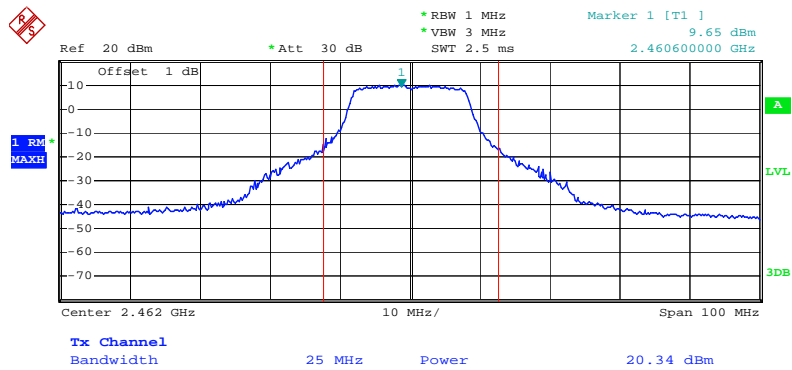

Date: 14.SEP.2009 11:33:54

Conducted Output Power Plot on Configuration IEEE 802.11a Ant. 2-1 / 5745 MHz

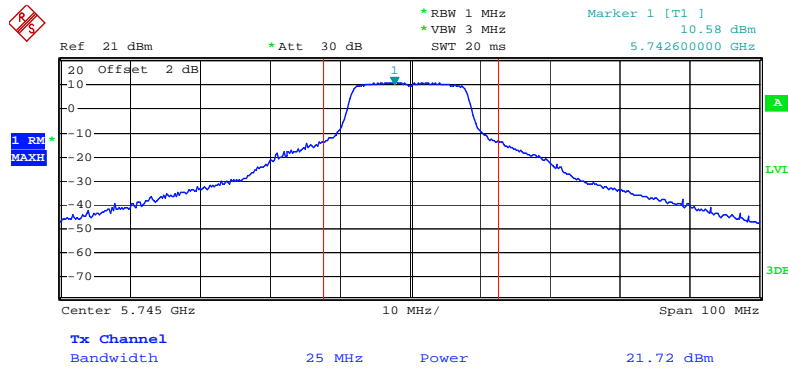

Date: 14.SEP.2009 20:17:14

Conducted Output Power Plot on Configuration IEEE 802.11a Ant. 2-1 / 5785 MHz

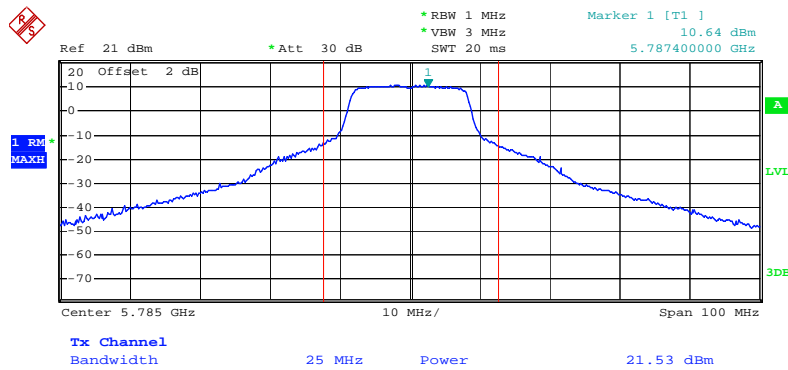

Date: 14.SEP.2009 20:17:40

Conducted Output Power Plot on Configuration IEEE 802.11a Ant. 2-1 / 5825 MHz

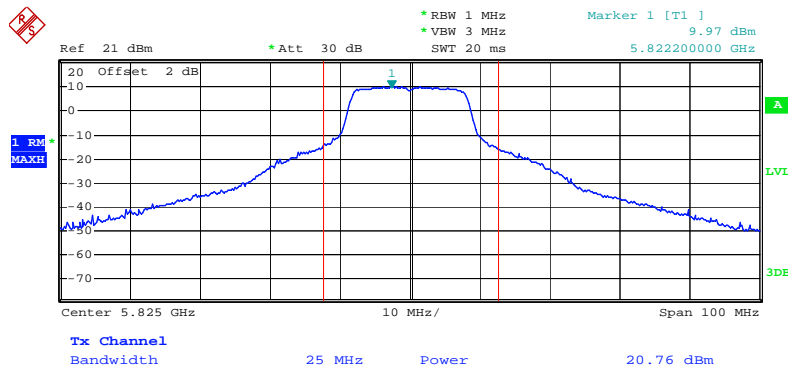

Date: 14.SEP.2009 20:18:00

Conducted Output Power Plot on Configuration IEEE 802.11a Ant. 2-3 / 5745 MHz

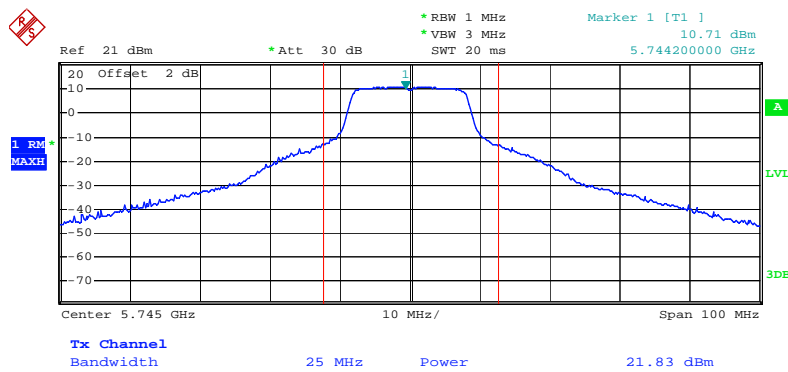

Date: 14.SEP.2009 19:50:19

Conducted Output Power Plot on Configuration IEEE 802.11a Ant. 2-3 / 5785 MHz

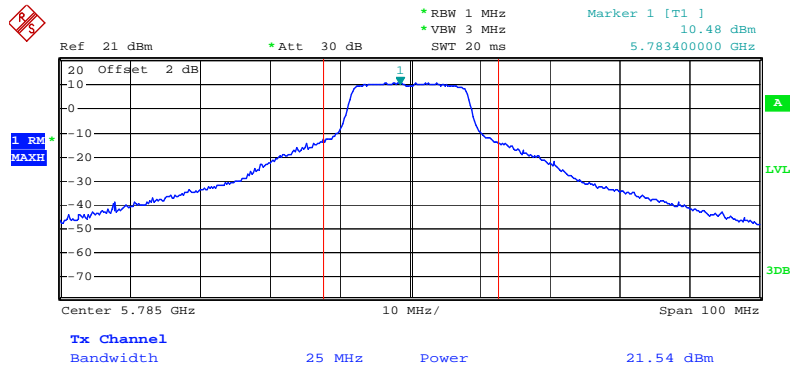

Date: 14.SEP.2009 19:47:29

Conducted Output Power Plot on Configuration IEEE 802.11a Ant. 2-3 / 5825 MHz

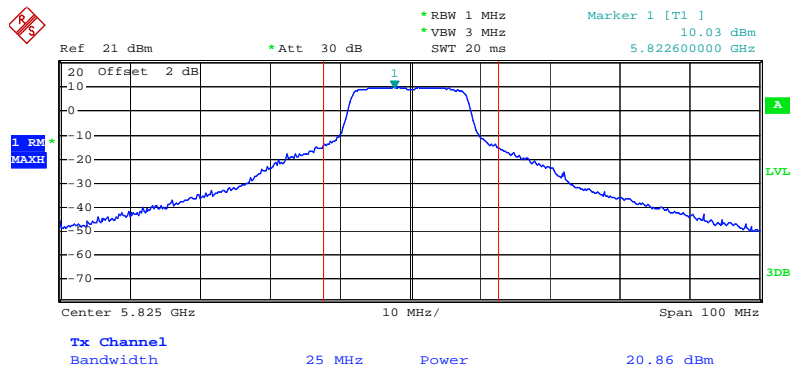

Date: 14.SEP.2009 19:51:10

<For Antenna 3>:

Channel Output Power Plot on Configuration Draft n MCS8 20MHz Ant. 3-1 / 2412 MHz

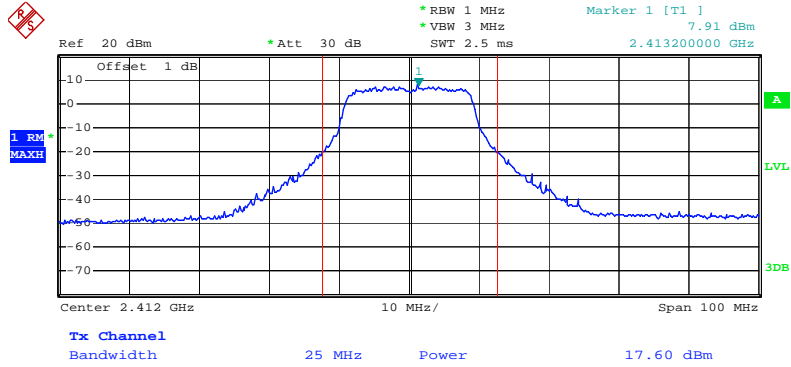

Date: 14.SEP.2009 13:45:50

Channel Output Power Plot on Configuration Draft n MCS8 20MHz Ant. 3-1 / 2437 MHz

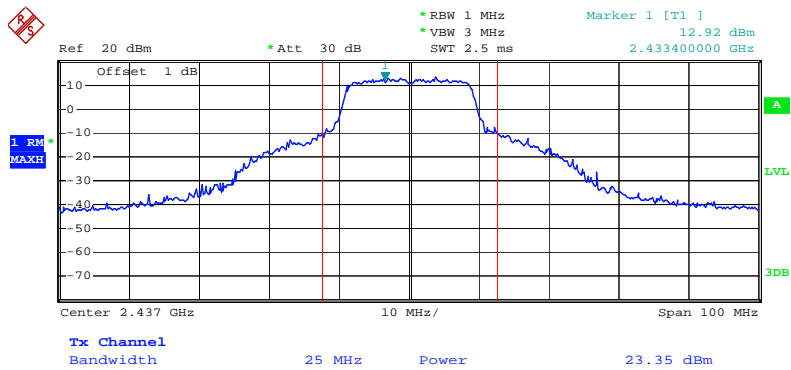

Date: 14.SEP.2009 19:10:19

Channel Output Power Plot on Configuration Draft n MCS8 20MHz Ant. 3-1 / 2462 MHz

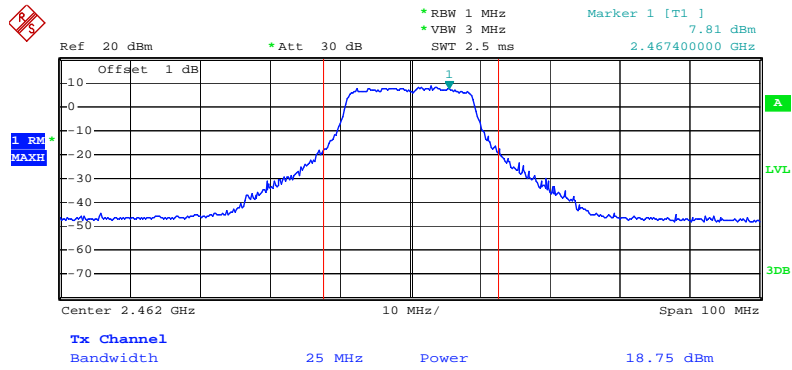

Date: 14.SEP.2009 19:06:53

Channel Output Power Plot on Configuration Draft n MCS8 20MHz Ant. 3-3 / 2412 MHz

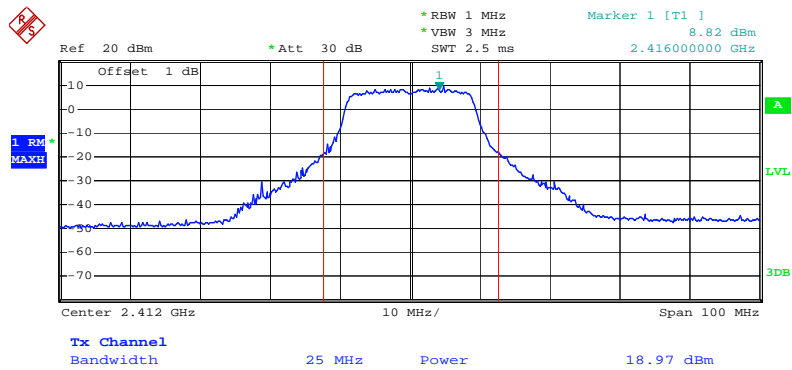

Date: 14.SEP.2009 19:16:27

Channel Output Power Plot on Configuration Draft n MCS8 20MHz Ant. 3-3 / 2437 MHz

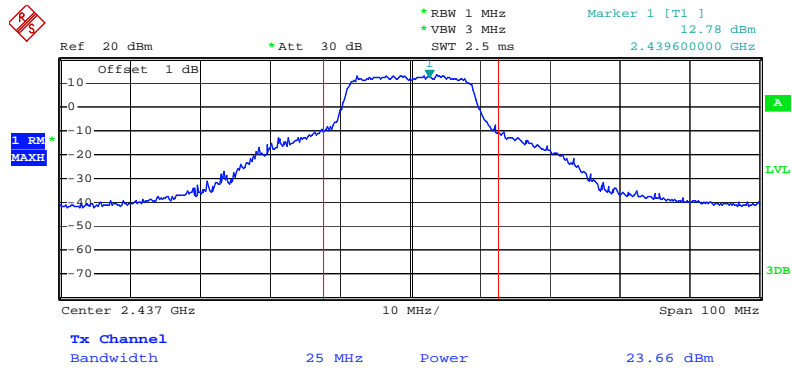

Date: 14.SEP.2009 13:51:27

Channel Output Power Plot on Configuration Draft n MCS8 20MHz Ant. 3-3 / 2462 MHz

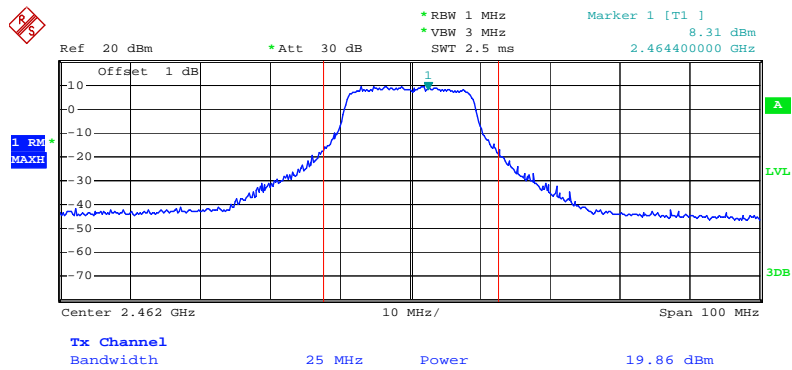

Date: 14.SEP.2009 13:57:55

Channel Output Power Plot on Configuration Draft n MCS8 40MHz Ant. 3-1 / 2422 MHz

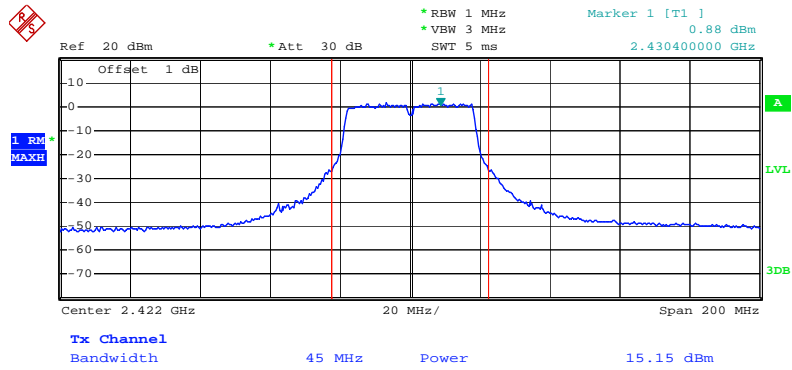

Date: 14.SEP.2009 14:15:59

Channel Output Power Plot on Configuration Draft n MCS8 40MHz Ant. 3-1 / 2437 MHz

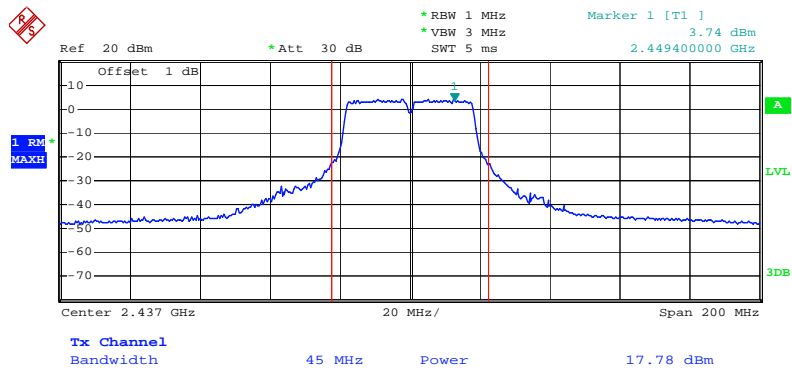

Date: 14.SEP.2009 14:08:55

Channel Output Power Plot on Configuration Draft n MCS8 40MHz Ant. 3-1 / 2452 MHz

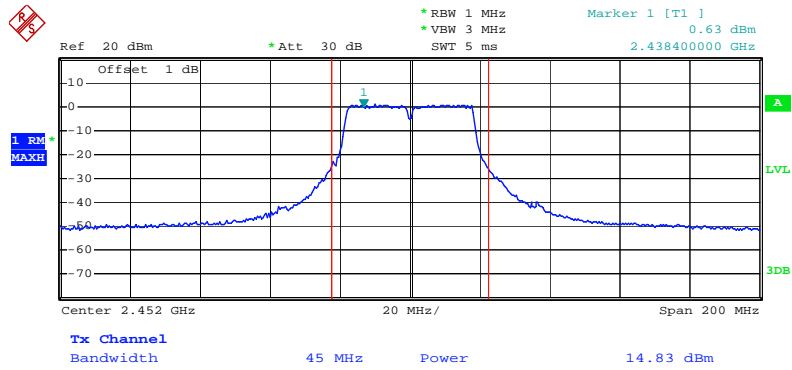

Date: 14.SEP.2009 19:37:24

Channel Output Power Plot on Configuration Draft n MCS8 40MHz Ant. 3-3 / 2422 MHz

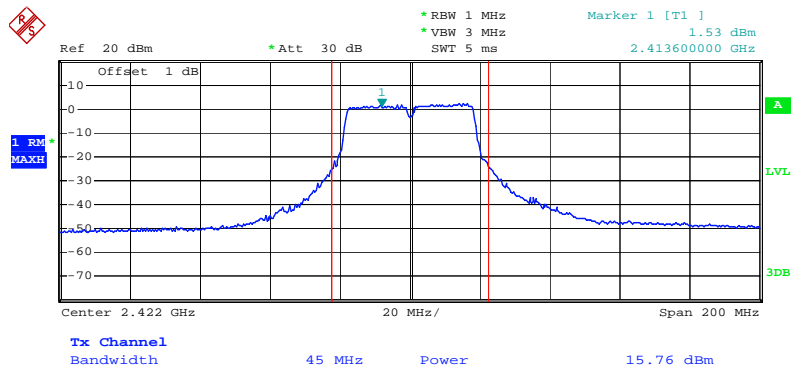

Date: 14.SEP.2009 19:21:47

Channel Output Power Plot on Configuration Draft n MCS8 40MHz Ant. 3-3 / 2437 MHz

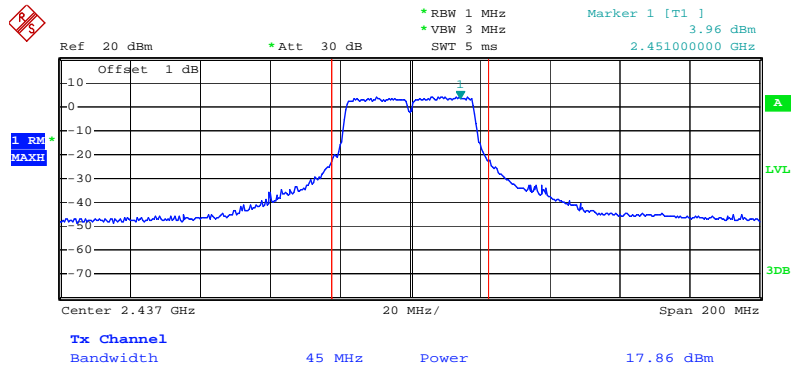

Date: 14.SEP.2009 19:26:25

Channel Output Power Plot on Configuration Draft n MCS8 40MHz Ant. 3-3 / 2452 MHz

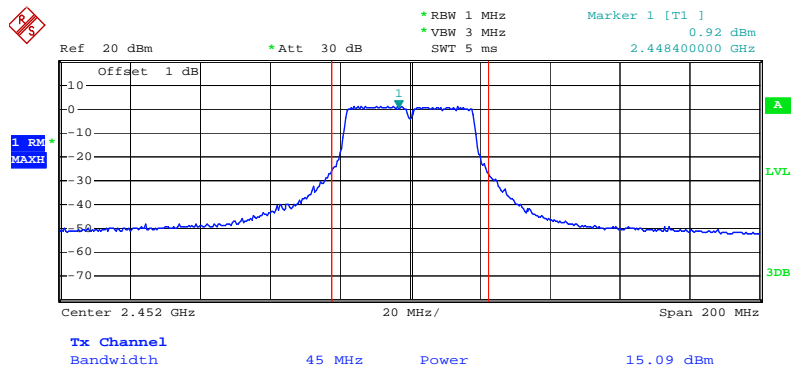

Date: 14.SEP.2009 14:04:09

Channel Output Power Plot on Configuration 11a Draft n MCS8 20MHz Ant. 3-1 / 5745 MHz

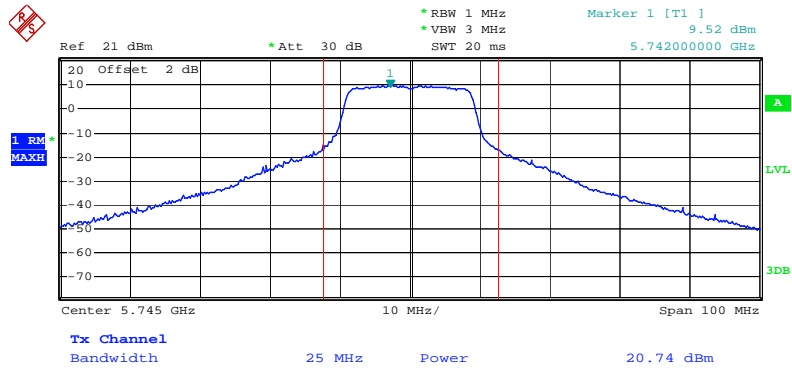

Date: 14.SEP.2009 19:55:51

Channel Output Power Plot on Configuration 11a Draft n MCS8 20MHz Ant. 3-1 / 5785MHz

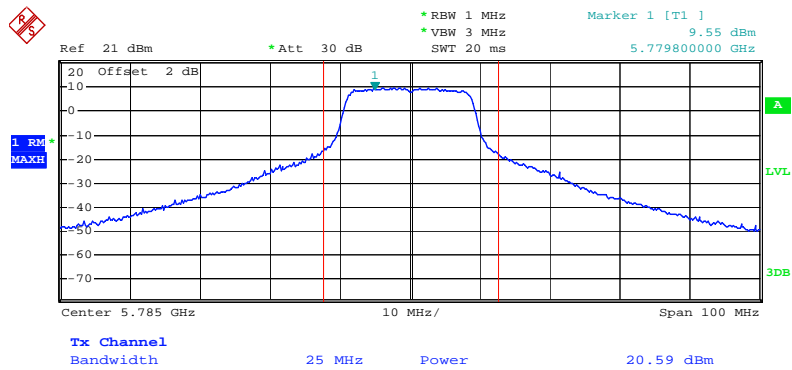

Date: 14.SEP.2009 19:54:59

Channel Output Power Plot on Configuration 11a Draft n MCS8 20MHz Ant. 3-1 / 5825 MHz

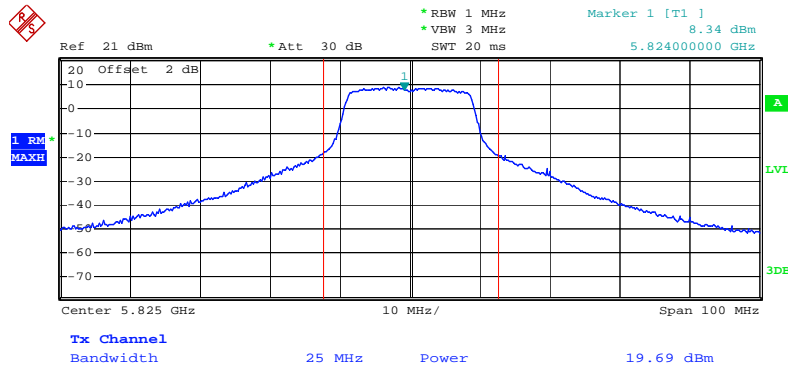

Date: 14.SEP.2009 19:52:58

Channel Output Power Plot on Configuration 11a Draft n MCS8 20MHz Ant. 3-3 / 5745 MHz

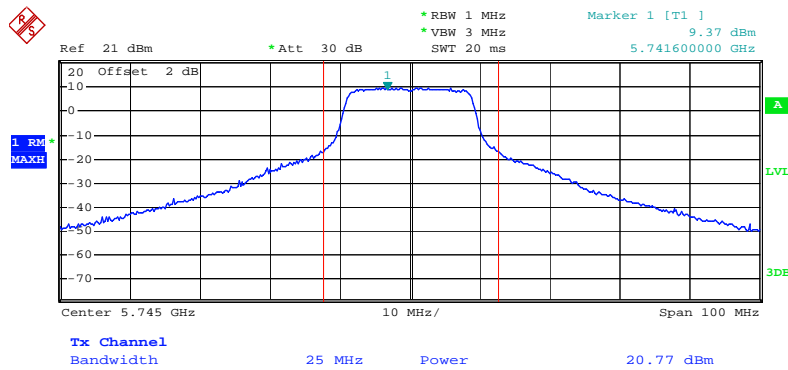

Date: 14.SEP.2009 20:10:17

Channel Output Power Plot on Configuration 11a Draft n MCS8 20MHz Ant. 3-3 / 5785MHz

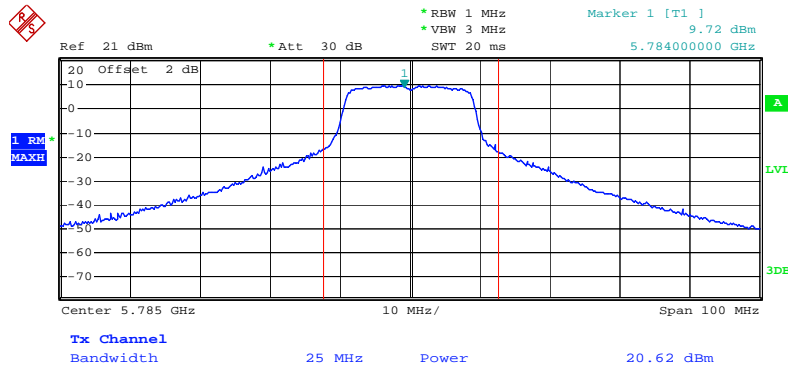

Date: 14.SEP.2009 20:08:55

Channel Output Power Plot on Configuration 11a Draft n MCS8 20MHz Ant. 3-3 / 5825 MHz

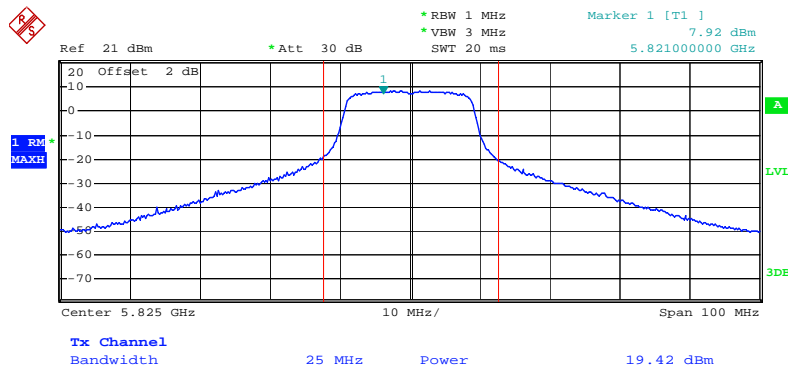

Date: 14.SEP.2009 20:05:55

Channel Output Power Plot on Configuration 11a Draft n MCS8 40MHz Ant. 3-1 / 5755 MHz

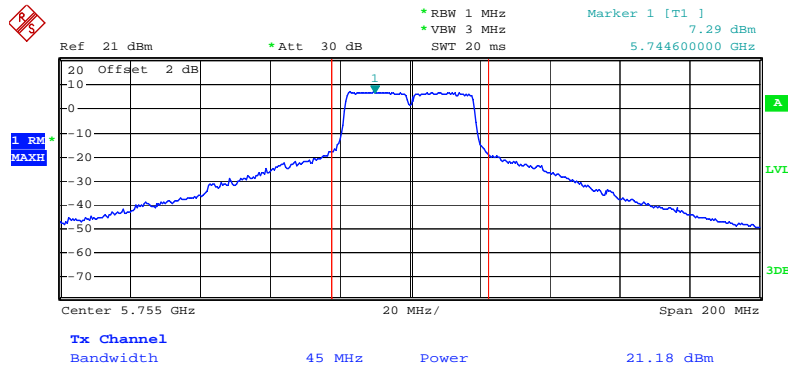

Date: 14.SEP.2009 19:58:04

Channel Output Power Plot on Configuration 11a Draft n MCS8 40MHz Ant. 3-1 / 5795 MHz

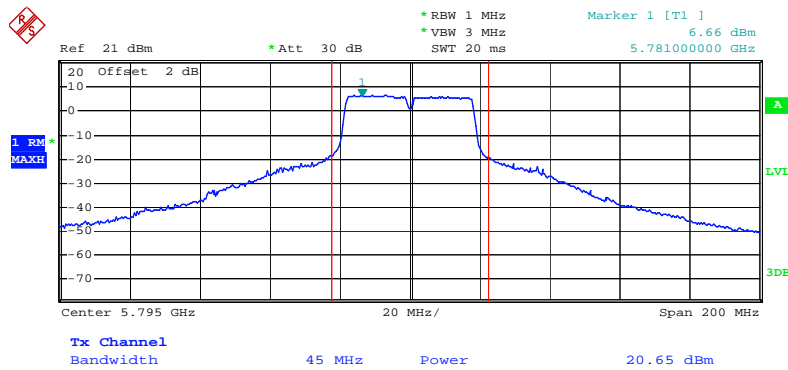

Date: 14.SEP.2009 19:58:56

Channel Output Power Plot on Configuration 11a Draft n MCS8 40MHz Ant. 3-3 / 5755 MHz

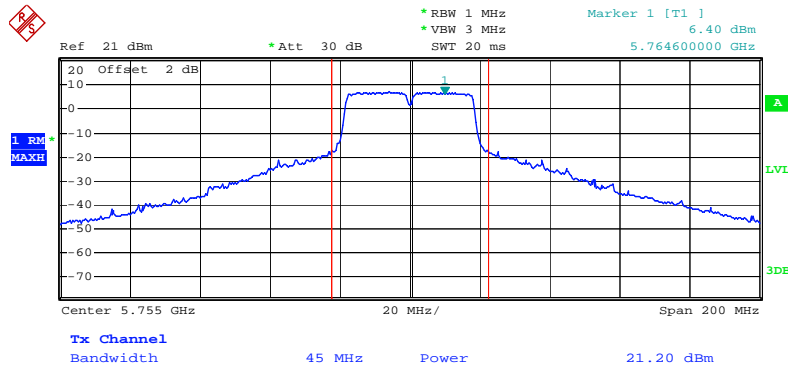

Date: 14.SEP.2009 20:02:42

Channel Output Power Plot on Configuration 11a Draft n MCS8 40MHz Ant. 3-3 / 5795 MHz

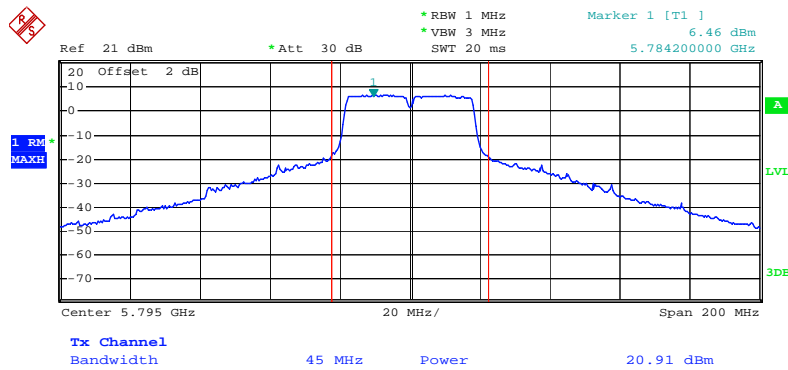

Date: 14.SEP.2009 20:00:20

Conducted Output Power Plot on Configuration IEEE 802.11b Ant. 3-1/ 2412 MHz

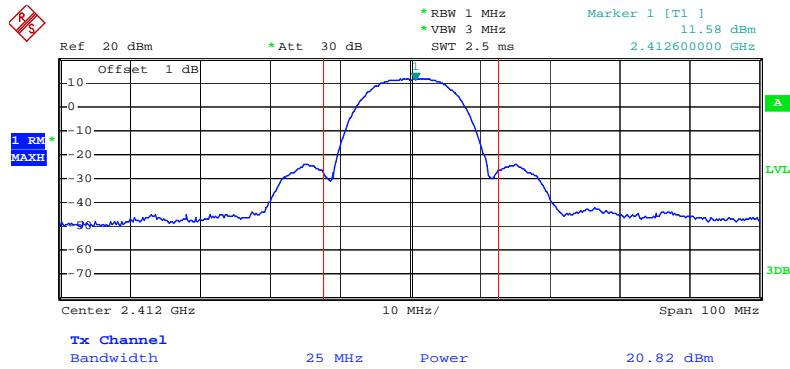

Date: 14.SEP.2009 11:09:33

Conducted Output Power Plot on Configuration IEEE 802.11b Ant. 3-1 / 2437 MHz

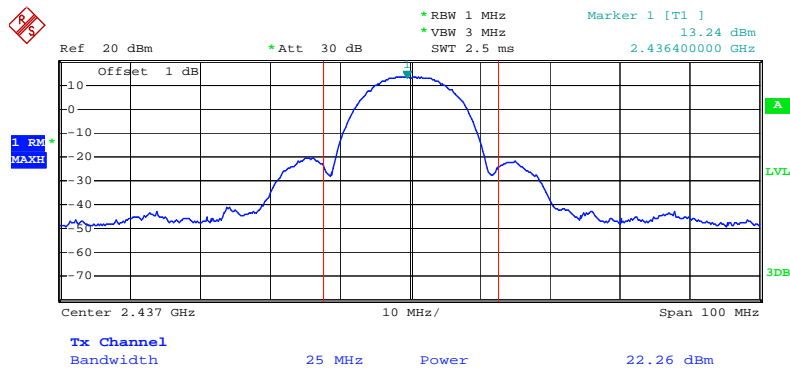

Date: 14.SEP.2009 11:13:40

Conducted Output Power Plot on Configuration IEEE 802.11b Ant. 3-1 / 2462 MHz

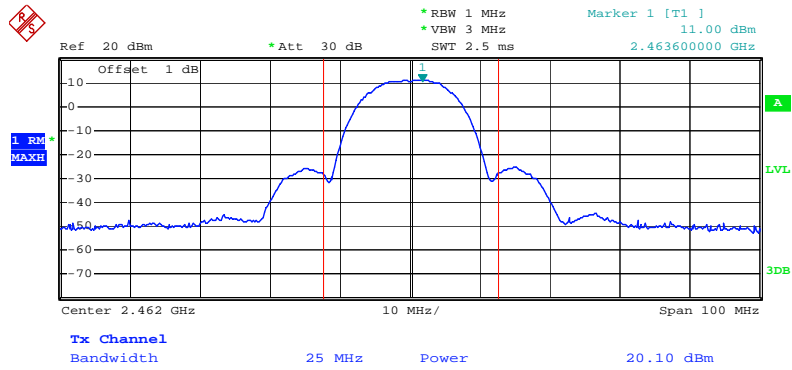

Date: 14.SEP.2009 17:12:58

Conducted Output Power Plot on Configuration IEEE 802.11b Ant. 3-3 / 2412 MHz

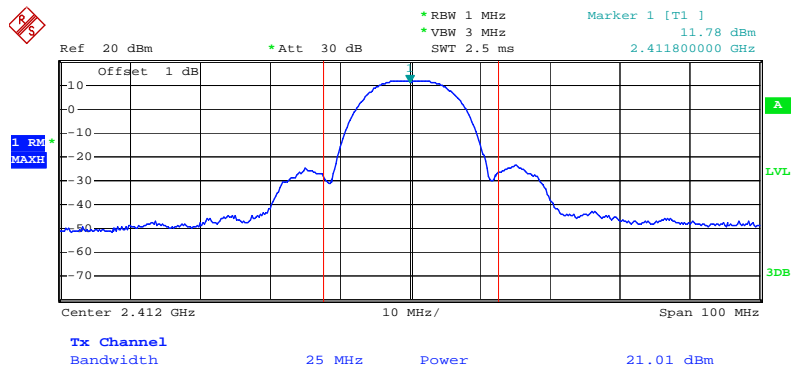

Date: 14.SEP.2009 17:07:01

Conducted Output Power Plot on Configuration IEEE 802.11b Ant. 3-3 / 2437 MHz

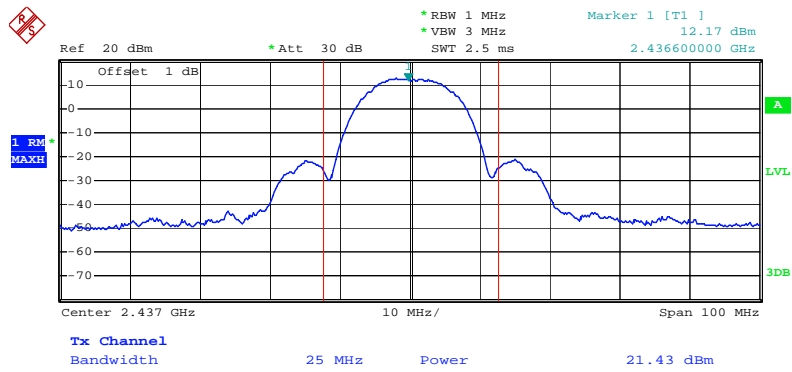

Date: 14.SEP.2009 17:04:16

Conducted Output Power Plot on Configuration IEEE 802.11b Ant. 3-3 / 2462 MHz

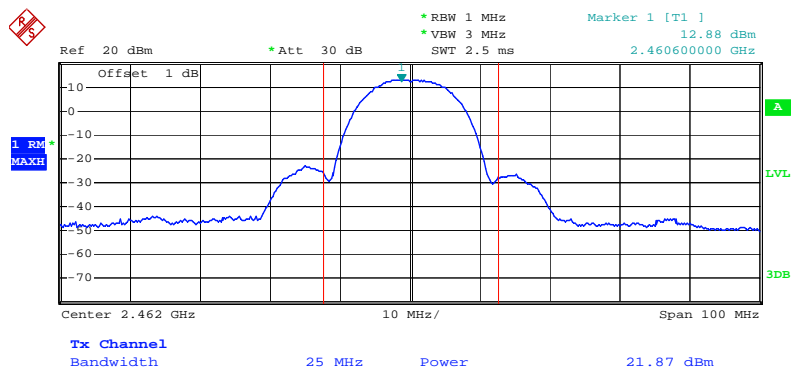

Date: 14.SEP.2009 11:29:17

Conducted Output Power Plot on Configuration IEEE 802.11g Ant. 3-1 / 2412 MHz

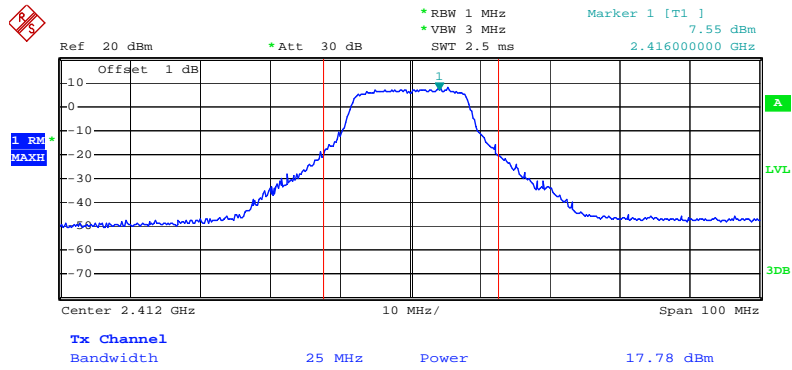

Date: 14.SEP.2009 13:41:21

Conducted Output Power Plot on Configuration IEEE 802.11g Ant. 3-1 / 2437 MHz

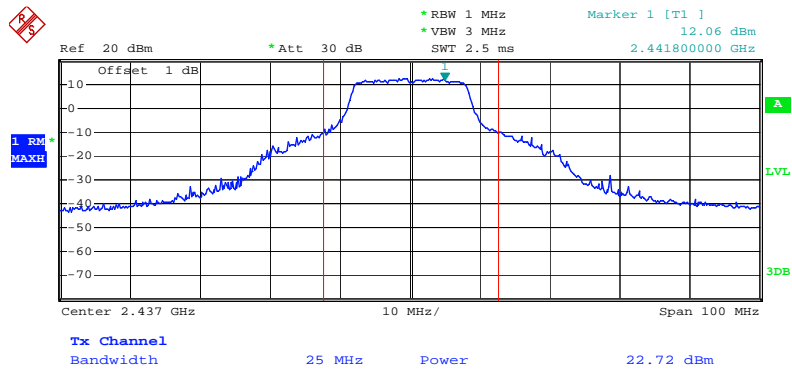

Date: 14.SEP.2009 18:33:02

Conducted Output Power Plot on Configuration IEEE 802.11g Ant. 3-1 / 2462 MHz

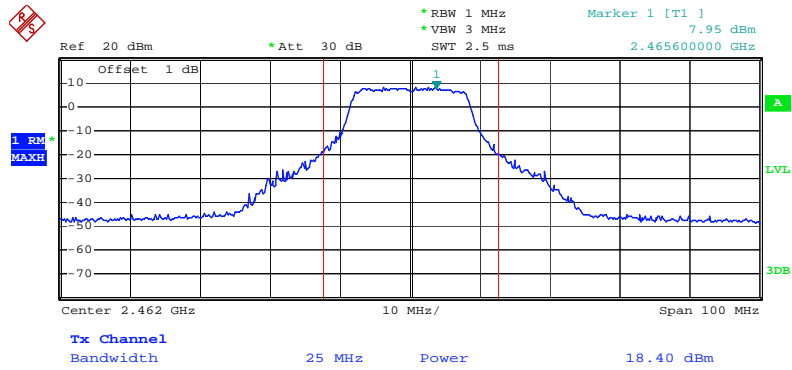

Date: 14.SEP.2009 19:00:03

Conducted Output Power Plot on Configuration IEEE 802.11g Ant. 3-3 / 2412 MHz

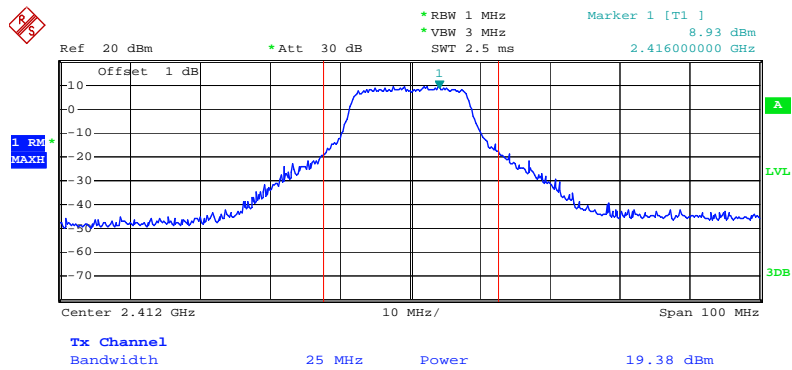

Date: 14.SEP.2009 18:27:49

Conducted Output Power Plot on Configuration IEEE 802.11g Ant. 3-3 / 2437 MHz

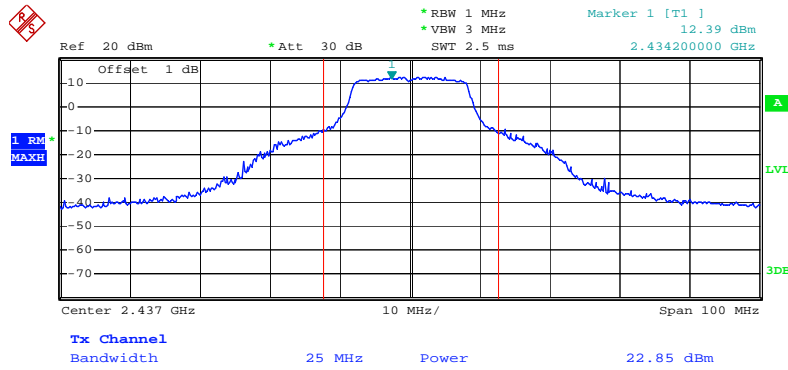

Date: 14.SEP.2009 13:37:27

Conducted Output Power Plot on Configuration IEEE 802.11g Ant. 3-3 / 2462 MHz

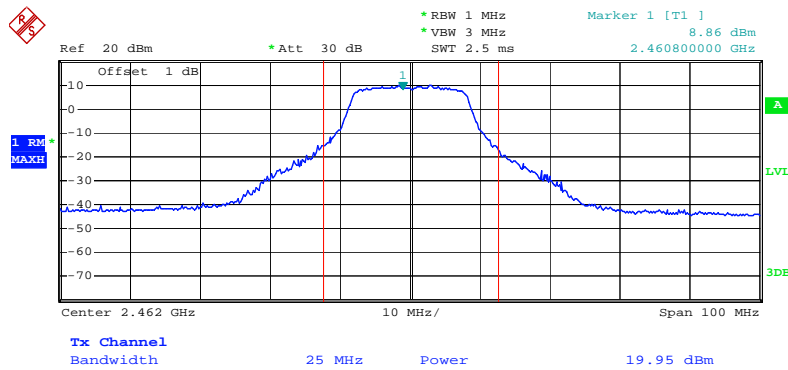

Date: 14.SEP.2009 11:36:25

Conducted Output Power Plot on Configuration IEEE 802.11a Ant. 3-1 / 5745 MHz

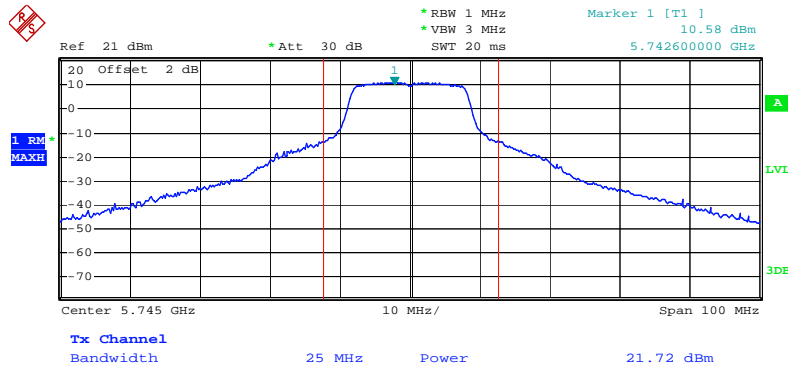

Date: 14.SEP.2009 20:17:14

Conducted Output Power Plot on Configuration IEEE 802.11a Ant. 3-1 / 5785 MHz

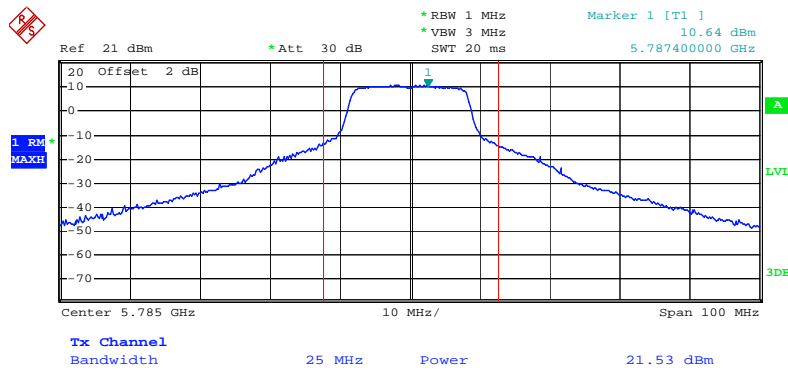

Date: 14.SEP.2009 20:17:40

Conducted Output Power Plot on Configuration IEEE 802.11a Ant. 3-1 / 5825 MHz

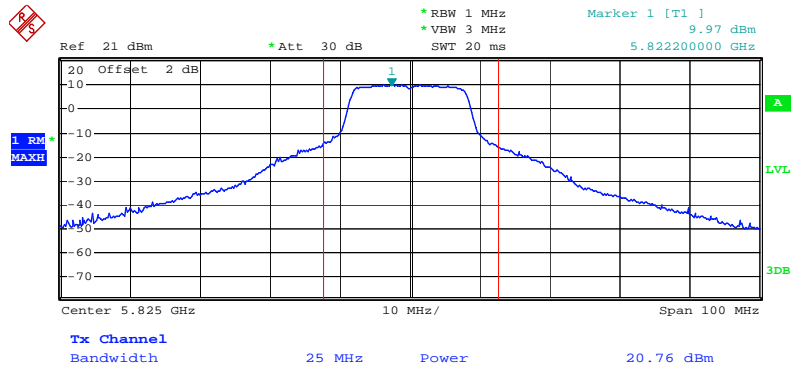

Date: 14.SEP.2009 20:18:00

Conducted Output Power Plot on Configuration IEEE 802.11a Ant. 3-3 / 5745 MHz

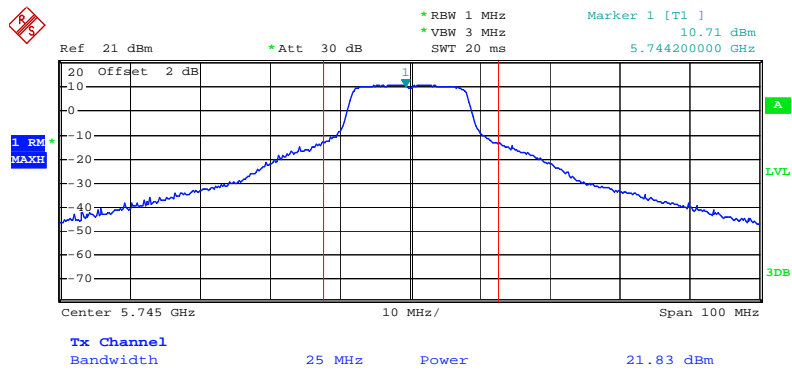

Date: 14.SEP.2009 19:50:19

Conducted Output Power Plot on Configuration IEEE 802.11a Ant. 3-3 / 5785 MHz

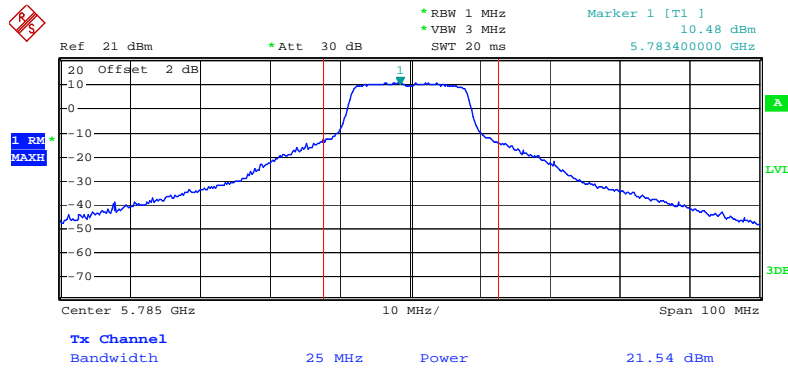

Date: 14.SEP.2009 19:47:29

Conducted Output Power Plot on Configuration IEEE 802.11a Ant. 3-3 / 5825 MHz



Date: 14.SEP.2009 19:51:10

<For Antenna 4>:

Channel Output Power Plot on Configuration Draft n MCS8 20MHz Ant. 4-1 / 2412 MHz

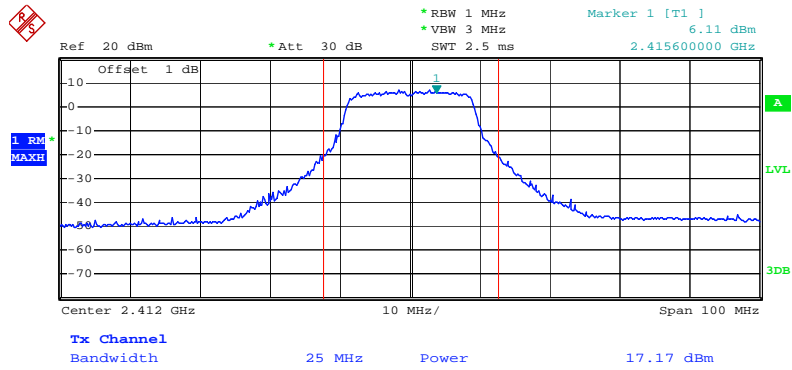

Date: 14.SEP.2009 13:46:37

Channel Output Power Plot on Configuration Draft n MCS8 20MHz Ant. 4-1 / 2437 MHz

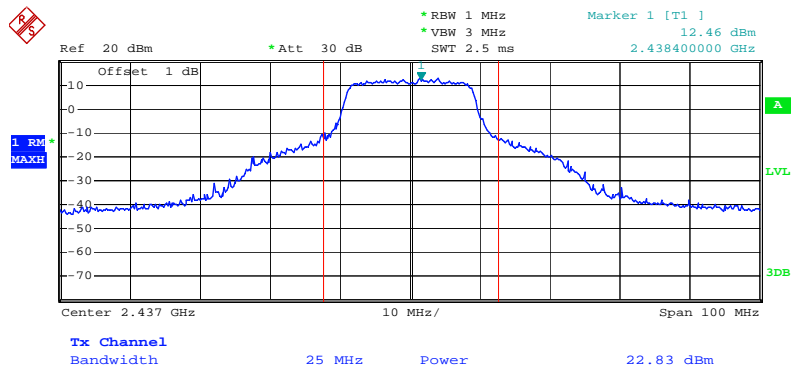

Date: 14.SEP.2009 19:11:06

Channel Output Power Plot on Configuration Draft n MCS8 20MHz Ant. 4-1 / 2462 MHz

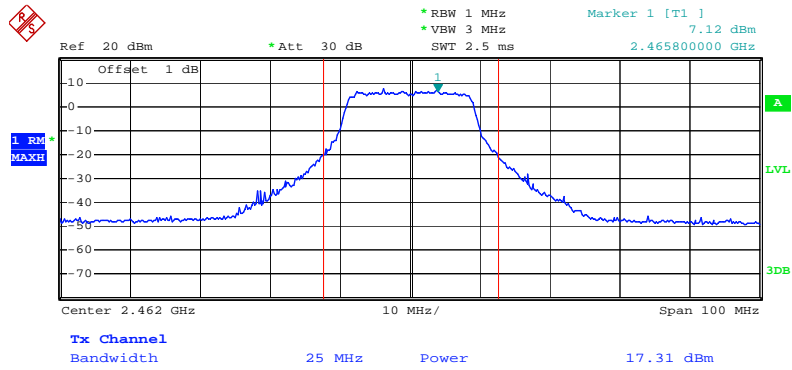

Date: 14.SEP.2009 19:06:10

Channel Output Power Plot on Configuration Draft n MCS8 20MHz Ant. 4-3 / 2412 MHz

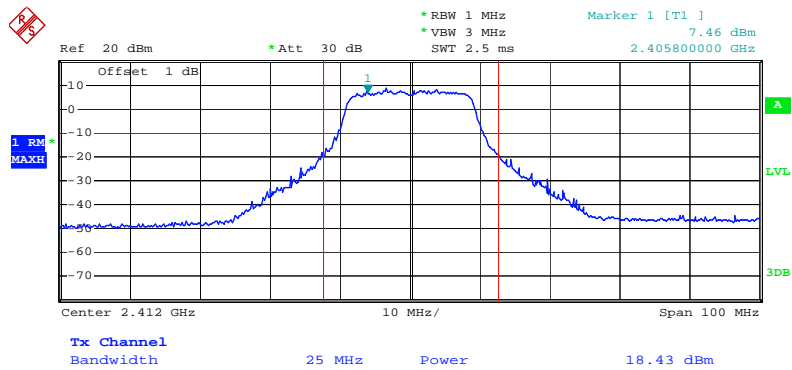

Date: 14.SEP.2009 19:15:46

Channel Output Power Plot on Configuration Draft n MCS8 20MHz Ant. 4-3 / 2437 MHz

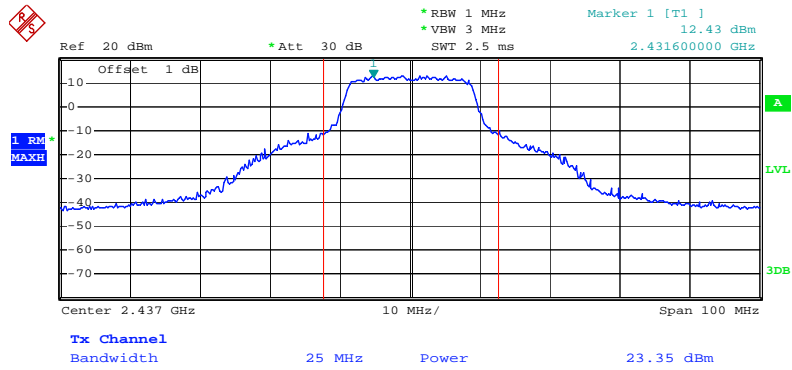

Date: 14.SEP.2009 13:49:07

Channel Output Power Plot on Configuration Draft n MCS8 20MHz Ant. 4-3 / 2462 MHz

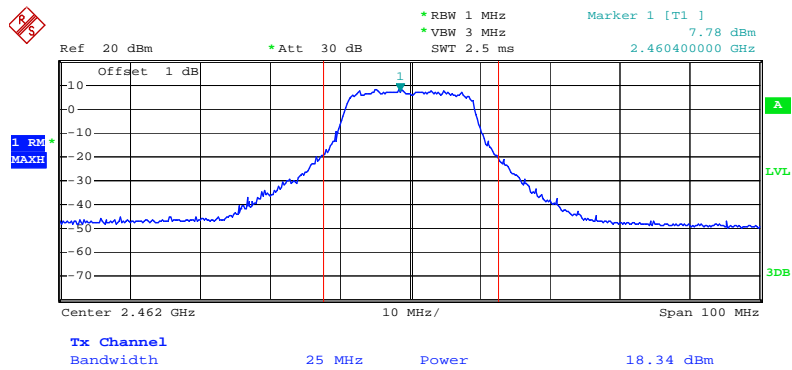

Date: 14.SEP.2009 13:58:57

Channel Output Power Plot on Configuration Draft n MCS8 40MHz Ant. 4-1 / 2422 MHz

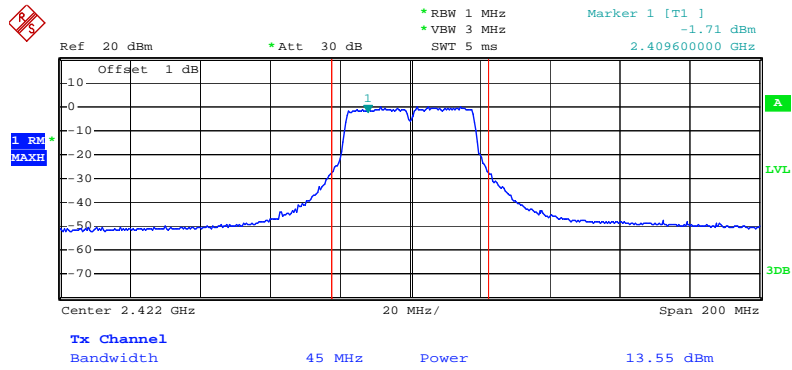

Date: 14.SEP.2009 14:15:26

Channel Output Power Plot on Configuration Draft n MCS8 40MHz Ant. 4-1 / 2437 MHz

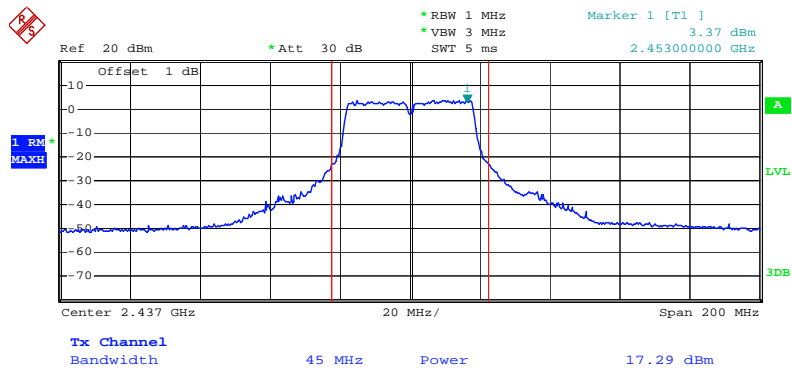

Date: 14.SEP.2009 19:25:55

Channel Output Power Plot on Configuration Draft n MCS8 40MHz Ant. 4-1 / 2452 MHz

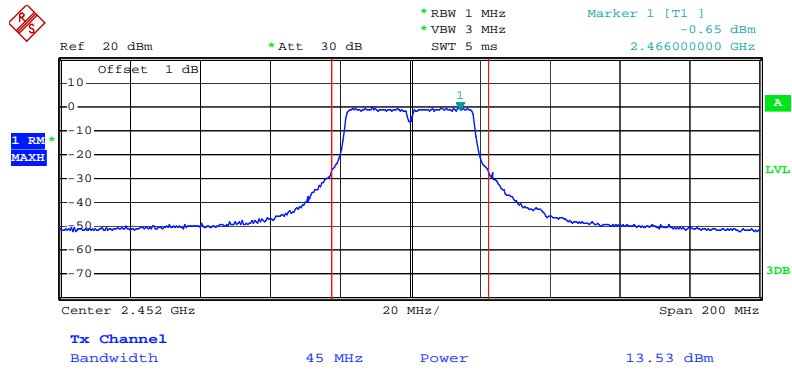

Date: 14.SEP.2009 19:38:02

Channel Output Power Plot on Configuration Draft n MCS8 40MHz Ant. 4-3 / 2422 MHz

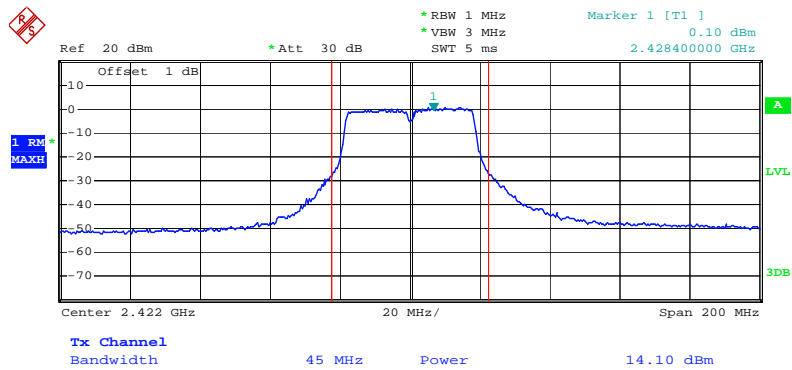

Date: 14.SEP.2009 19:22:44

Channel Output Power Plot on Configuration Draft n MCS8 40MHz Ant. 4-3 / 2437 MHz

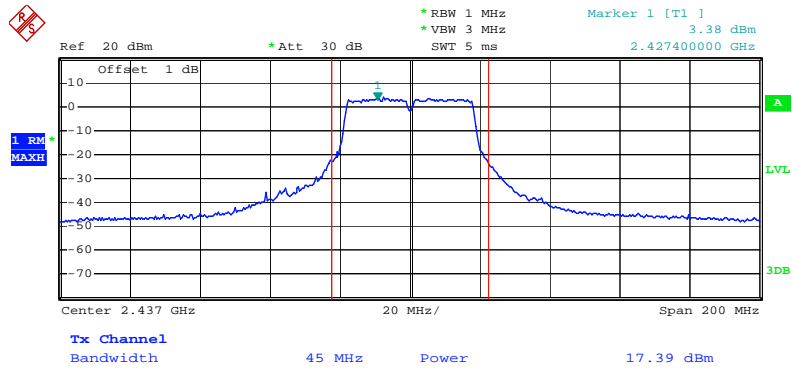

Date: 14.SEP.2009 14:11:43

Channel Output Power Plot on Configuration Draft n MCS8 40MHz Ant. 4-3 / 2452 MHz

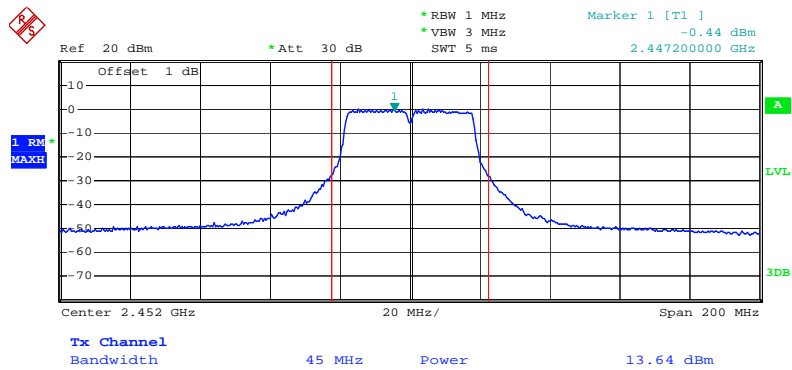

Date: 14.SEP.2009 14:04:39

Channel Output Power Plot on Configuration 11a Draft n MCS8 20MHz Ant. 4-1 / 5745 MHz

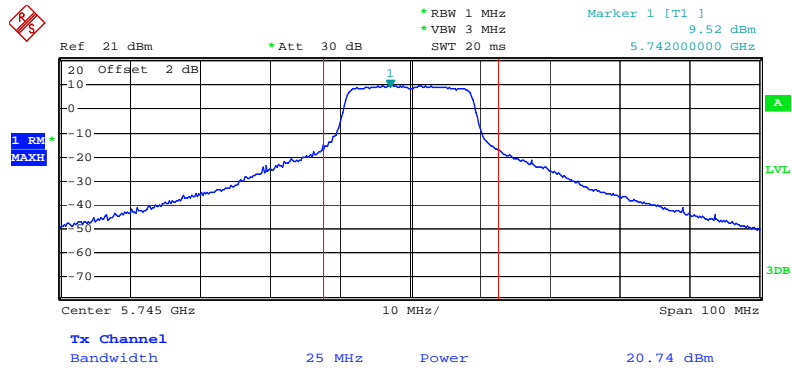

Date: 14.SEP.2009 19:55:51

Channel Output Power Plot on Configuration 11a Draft n MCS8 20MHz Ant. 4-1 / 5785MHz

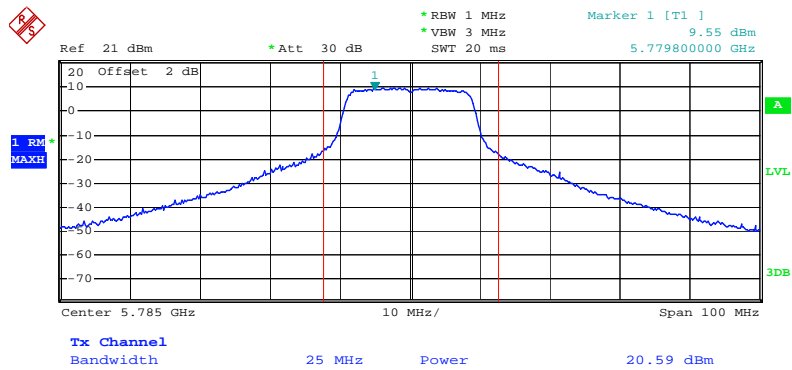

Date: 14.SEP.2009 19:54:59

Channel Output Power Plot on Configuration 11a Draft n MCS8 20MHz Ant. 4-1 / 5825 MHz

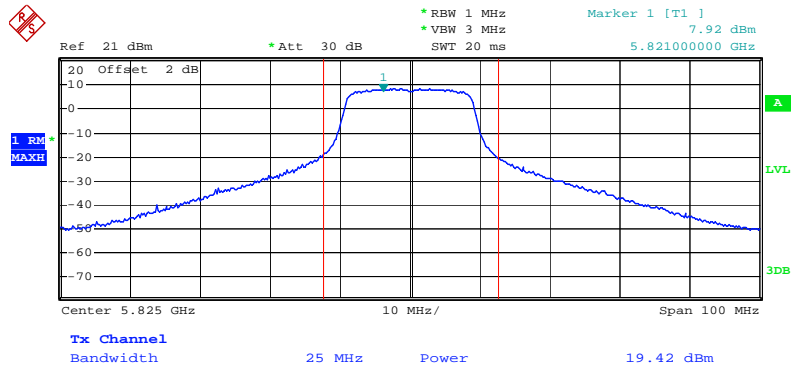

Date: 14.SEP.2009 20:05:55

Channel Output Power Plot on Configuration 11a Draft n MCS8 20MHz Ant. 4-3 / 5745 MHz

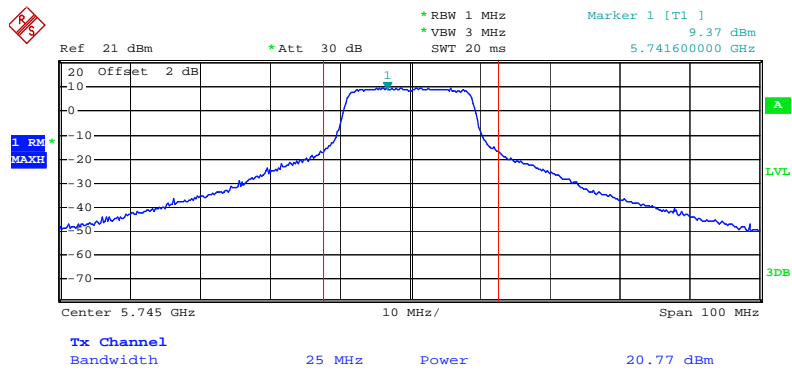

Date: 14.SEP.2009 20:10:17

Channel Output Power Plot on Configuration 11a Draft n MCS8 20MHz Ant. 4-3 / 5785MHz

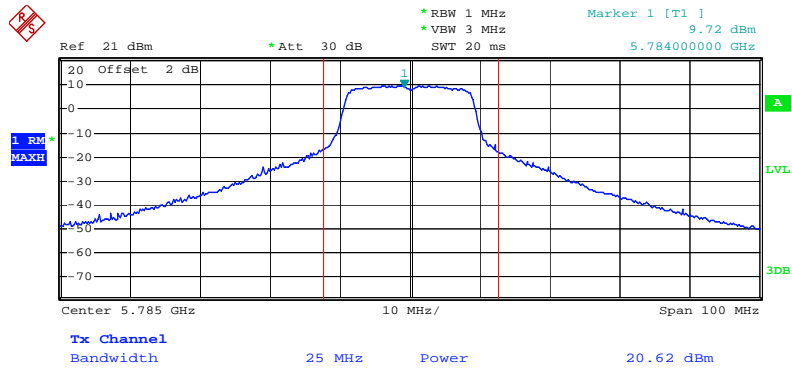

Date: 14.SEP.2009 20:08:55

Channel Output Power Plot on Configuration 11a Draft n MCS8 20MHz Ant. 4-3 / 5825 MHz

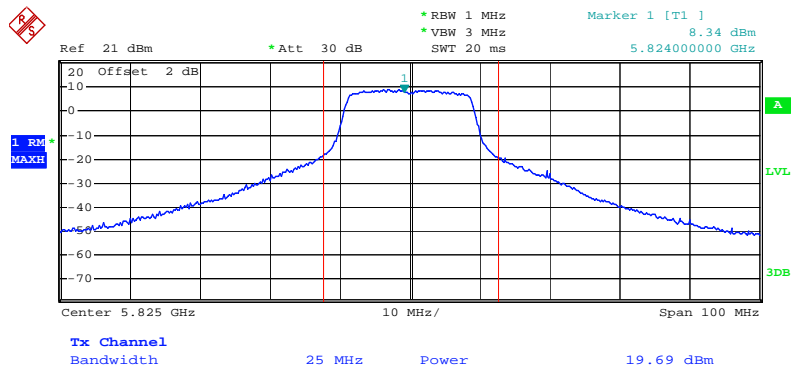

Date: 14.SEP.2009 19:52:58

Channel Output Power Plot on Configuration 11a Draft n MCS8 40MHz Ant. 4-1 / 5755 MHz

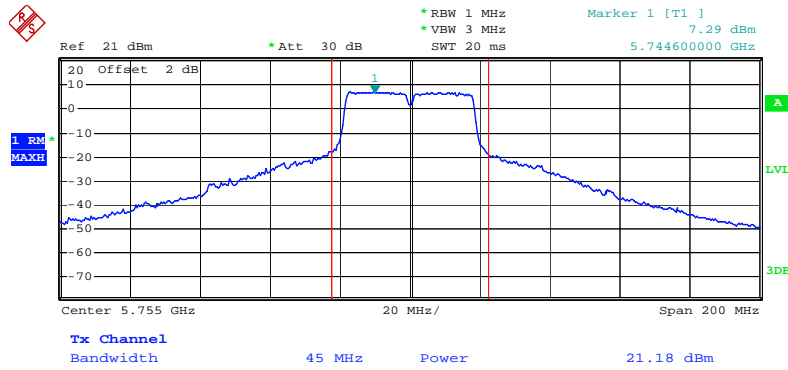

Date: 14.SEP.2009 19:58:04

Channel Output Power Plot on Configuration 11a Draft n MCS8 40MHz Ant. 4-1 / 5795 MHz

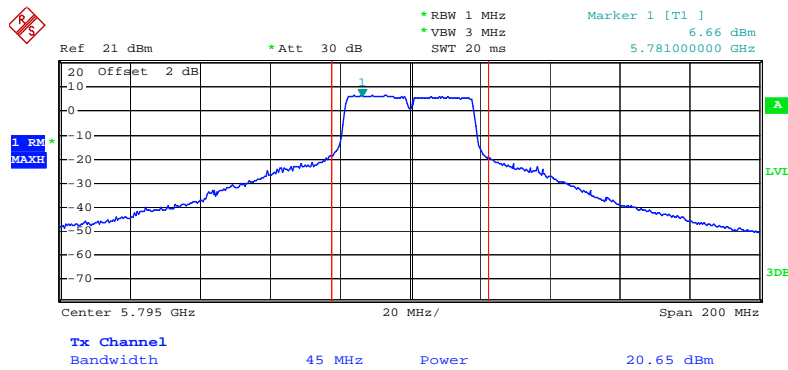

Date: 14.SEP.2009 19:58:56

Channel Output Power Plot on Configuration 11a Draft n MCS8 40MHz Ant. 4-3 / 5755 MHz

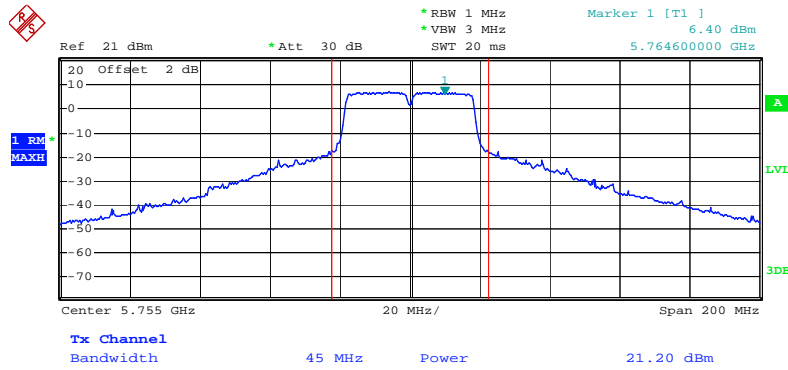

Date: 14.SEP.2009 20:02:42

Channel Output Power Plot on Configuration 11a Draft n MCS8 40MHz Ant. 4-3 / 5795 MHz

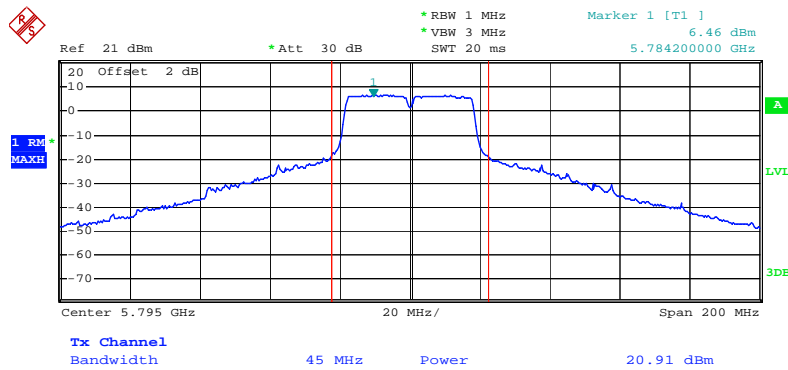

Date: 14.SEP.2009 20:00:20

Conducted Output Power Plot on Configuration IEEE 802.11b Ant. 4-1/ 2412 MHz

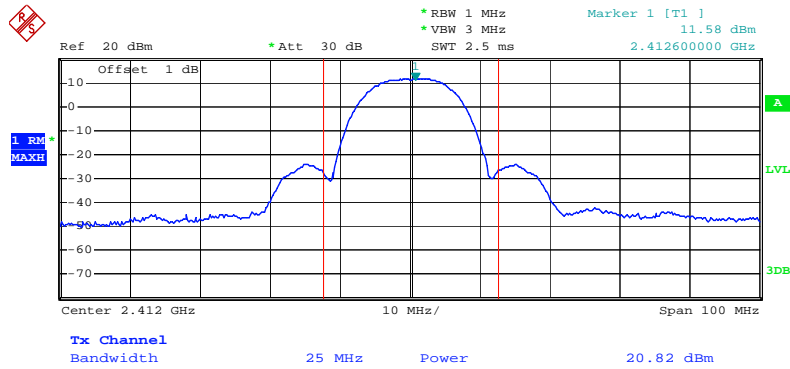

Date: 14.SEP.2009 11:09:33

Conducted Output Power Plot on Configuration IEEE 802.11b Ant. 4-1 / 2437 MHz

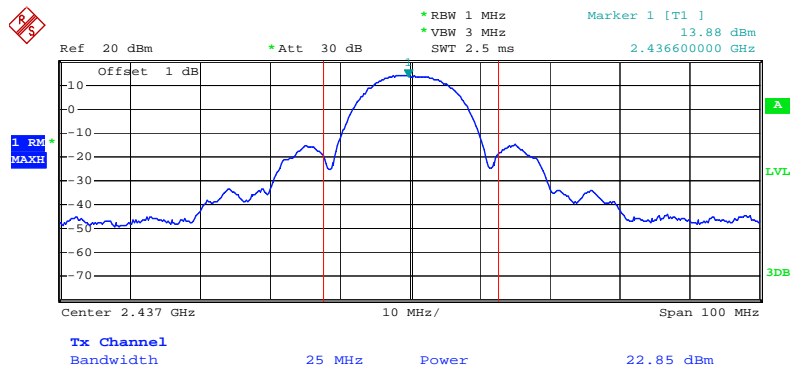

Date: 14.SEP.2009 17:05:04

Conducted Output Power Plot on Configuration IEEE 802.11b Ant. 4-1 / 2462 MHz

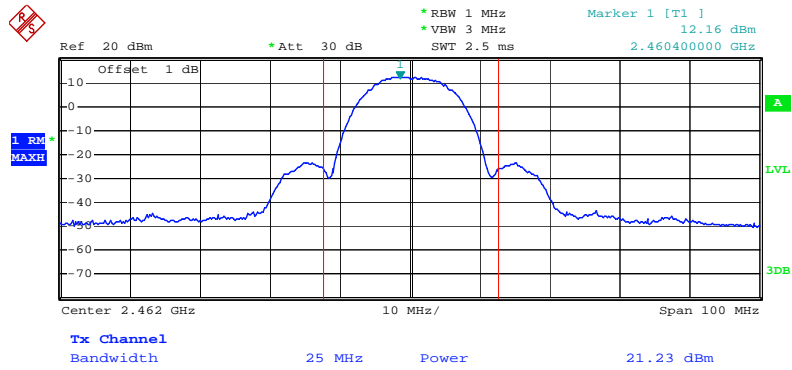

Date: 14.SEP.2009 17:12:18

Conducted Output Power Plot on Configuration IEEE 802.11b Ant. 4-3 / 2412 MHz

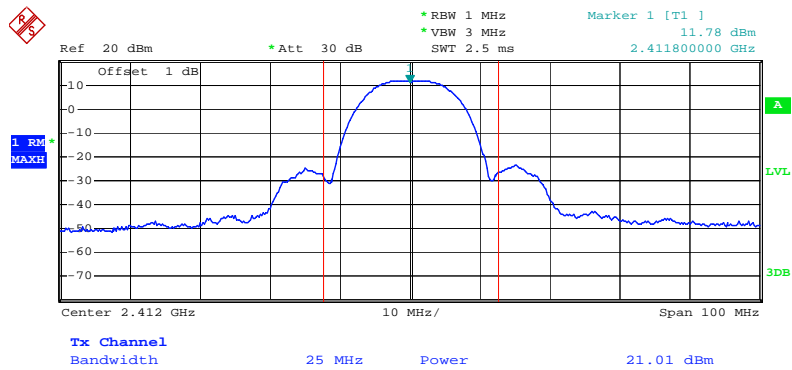

Date: 14.SEP.2009 17:07:01

Conducted Output Power Plot on Configuration IEEE 802.11b Ant. 4-3 / 2437 MHz

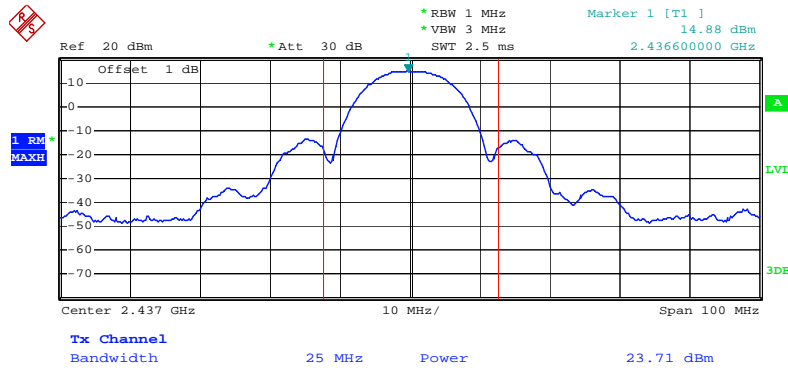

Date: 14.SEP.2009 11:14:20

Conducted Output Power Plot on Configuration IEEE 802.11b Ant. 4-3 / 2462 MHz

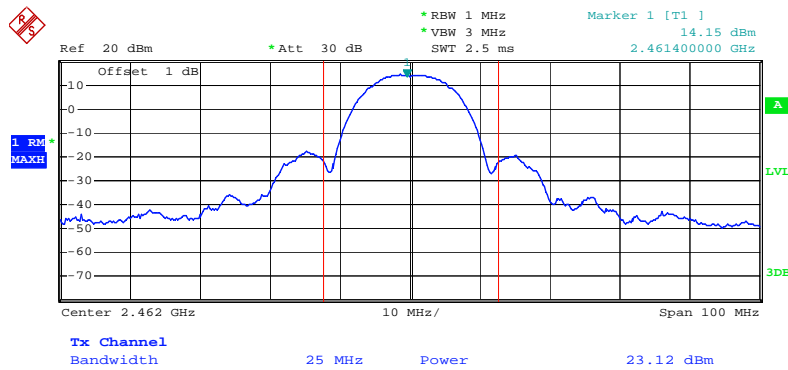

Date: 14.SEP.2009 11:30:04

Conducted Output Power Plot on Configuration IEEE 802.11g Ant. 4-1 / 2412 MHz

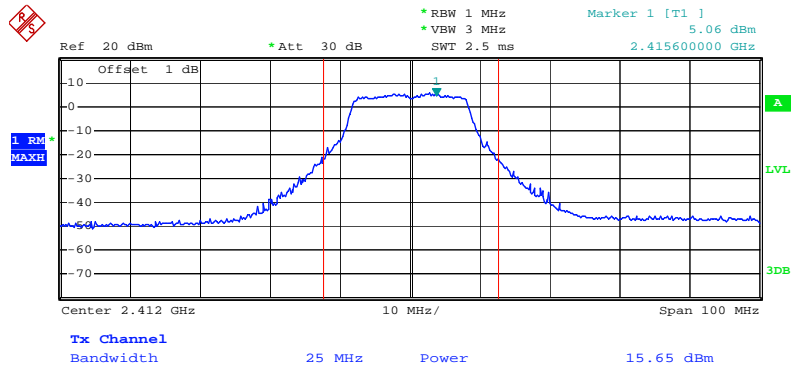

Date: 14.SEP.2009 13:42:35

Conducted Output Power Plot on Configuration IEEE 802.11g Ant. 4-1 / 2437 MHz

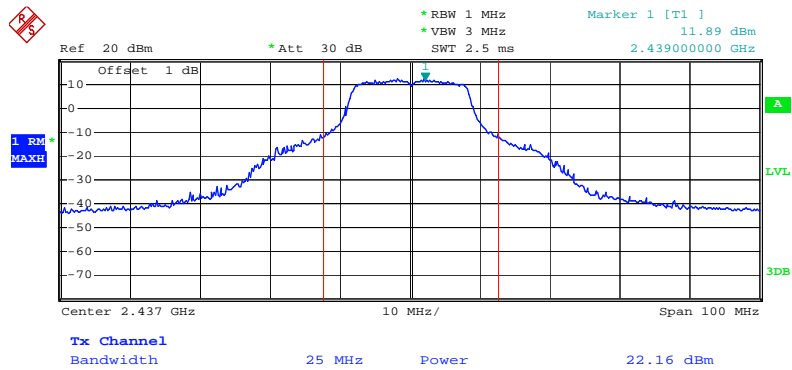

Date: 14.SEP.2009 13:38:40

Conducted Output Power Plot on Configuration IEEE 802.11g Ant. 4-1 / 2462 MHz

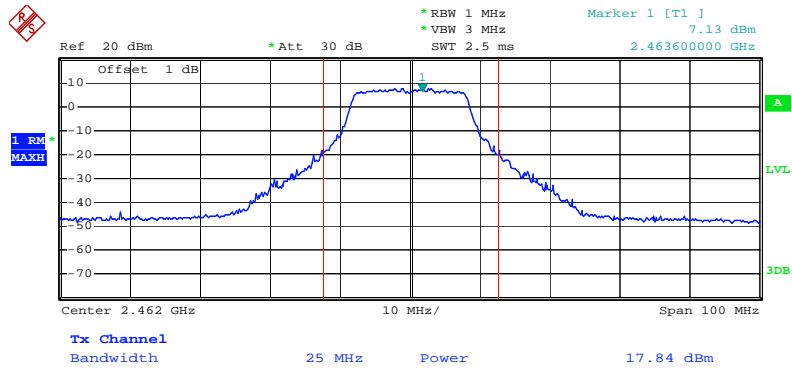

Date: 14.SEP.2009 19:00:37

Conducted Output Power Plot on Configuration IEEE 802.11g Ant. 4-3 / 2412 MHz

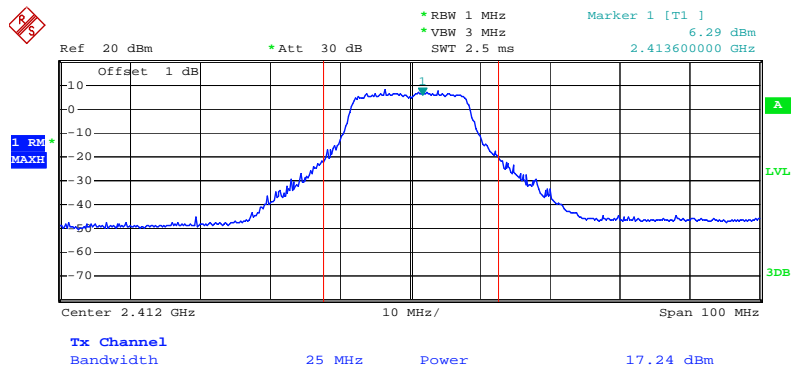

Date: 14.SEP.2009 18:28:56

Conducted Output Power Plot on Configuration IEEE 802.11g Ant. 4-3 / 2437 MHz

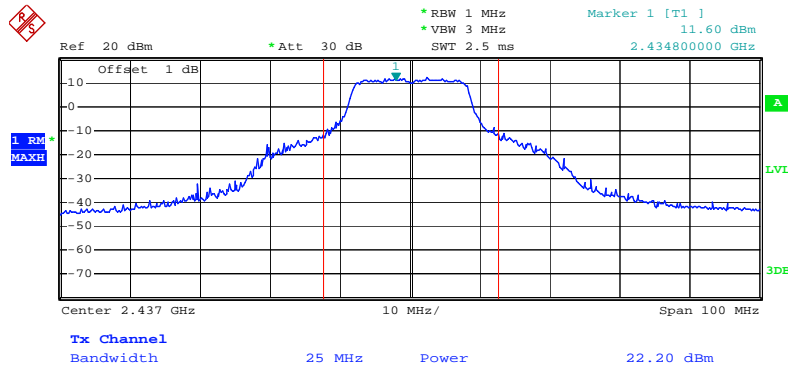

Date: 14.SEP.2009 18:31:26

Conducted Output Power Plot on Configuration IEEE 802.11g Ant. 4-3 / 2462 MHz

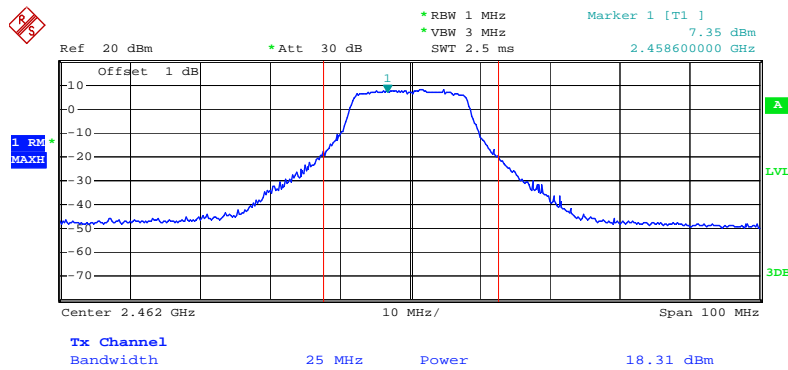

Date: 14.SEP.2009 11:37:20

Conducted Output Power Plot on Configuration IEEE 802.11a Ant. 4-1 / 5745 MHz

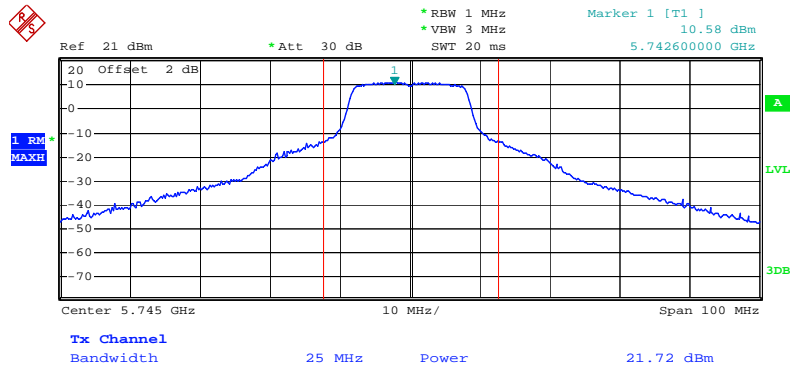

Date: 14.SEP.2009 20:17:14

Conducted Output Power Plot on Configuration IEEE 802.11a Ant. 4-1 / 5785 MHz

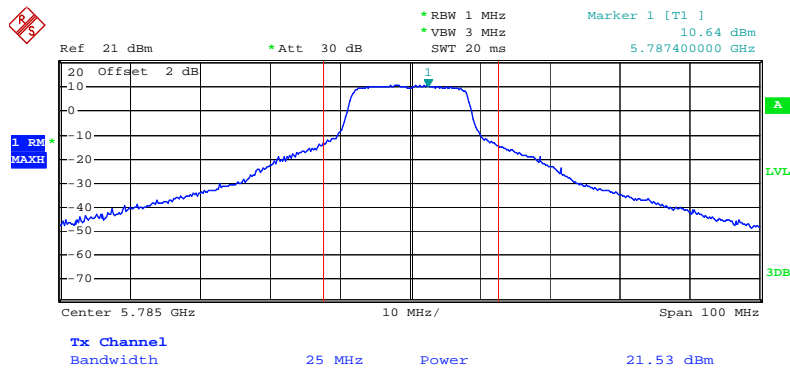

Date: 14.SEP.2009 20:17:40

Conducted Output Power Plot on Configuration IEEE 802.11a Ant. 4-1 / 5825 MHz

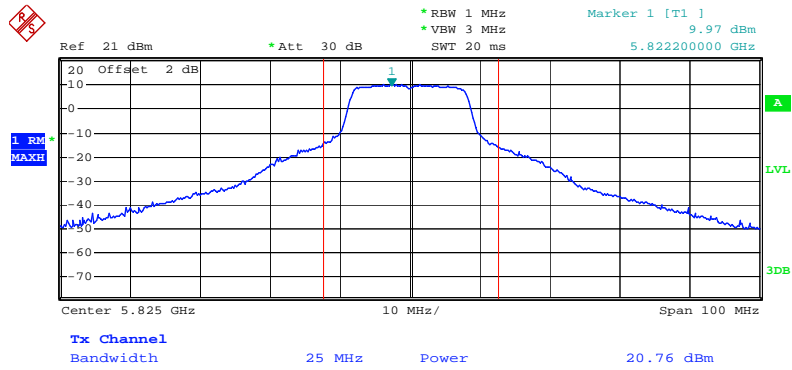

Date: 14.SEP.2009 20:18:00

Conducted Output Power Plot on Configuration IEEE 802.11a Ant. 4-3 / 5745 MHz

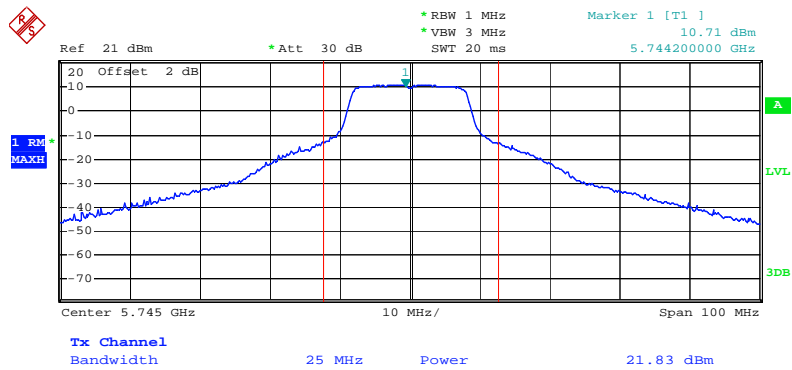

Date: 14.SEP.2009 19:50:19

Conducted Output Power Plot on Configuration IEEE 802.11a Ant. 4-3 / 5785 MHz

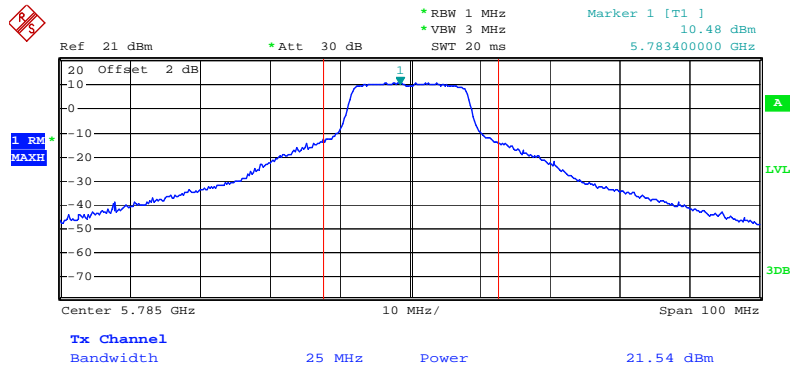

Date: 14.SEP.2009 19:47:29

Conducted Output Power Plot on Configuration IEEE 802.11a Ant. 4-3 / 5825 MHz

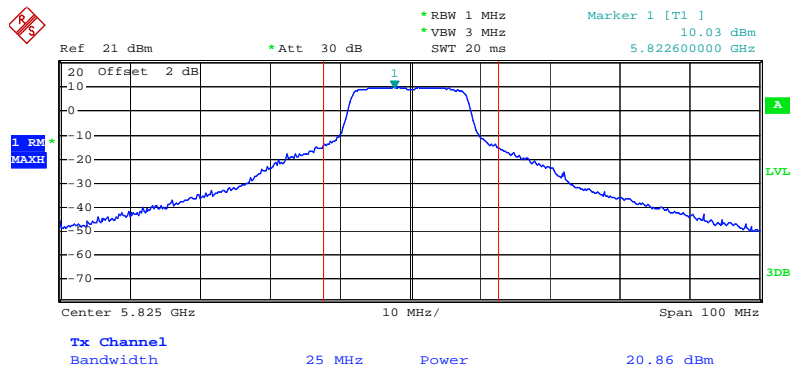

Date: 14.SEP.2009 19:51:10

<For Antenna 5>:

Channel Output Power Plot on Configuration Draft n MCS8 20MHz Ant. 5-1 / 2412 MHz

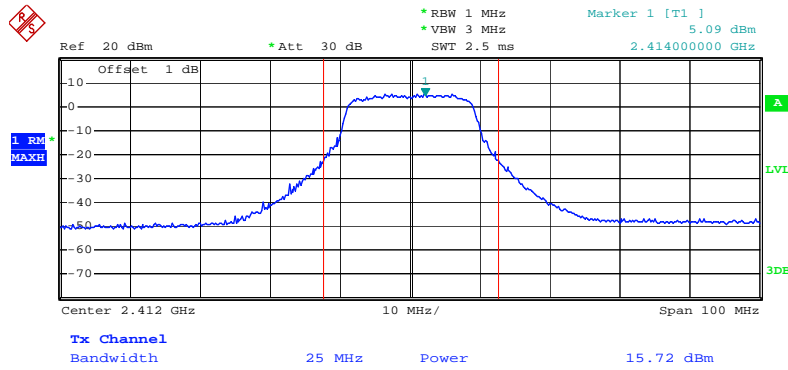

Date: 14.SEP.2009 13:47:16

Channel Output Power Plot on Configuration Draft n MCS8 20MHz Ant. 5-1 / 2437 MHz

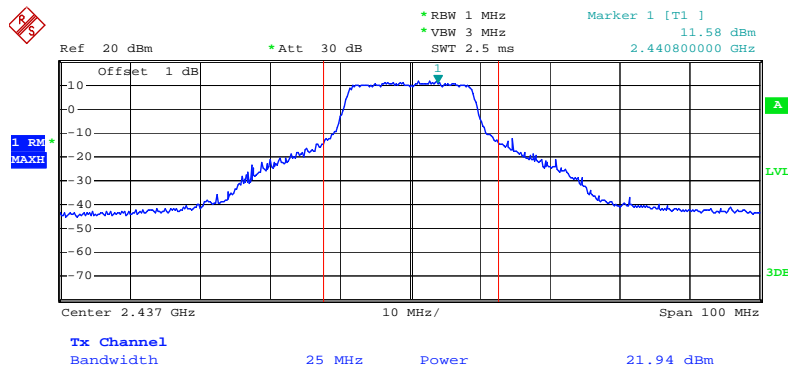

Date: 14.SEP.2009 19:12:02

Channel Output Power Plot on Configuration Draft n MCS8 20MHz Ant. 5-1 / 2462 MHz

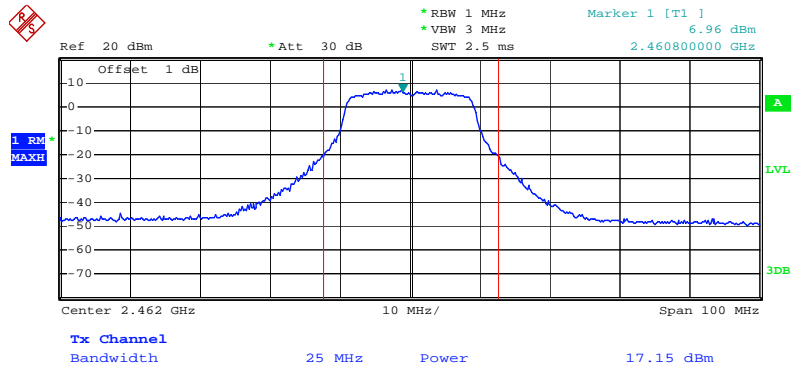

Date: 14.SEP.2009 14:00:03

Channel Output Power Plot on Configuration Draft n MCS8 20MHz Ant. 5-3 / 2412 MHz

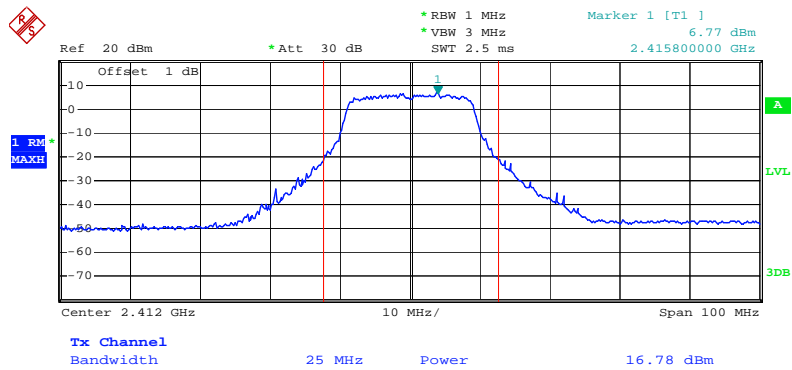

Date: 14.SEP.2009 19:15:12

Channel Output Power Plot on Configuration Draft n MCS8 20MHz Ant. 5-3 / 2437 MHz

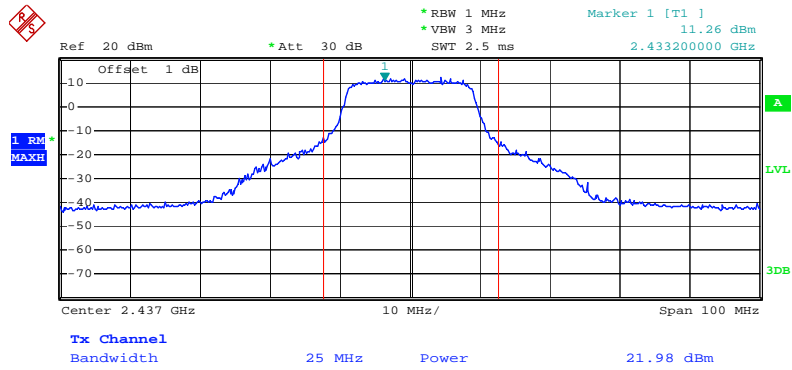

Date: 14.SEP.2009 13:50:37

Channel Output Power Plot on Configuration Draft n MCS8 20MHz Ant. 5-3 / 2462 MHz

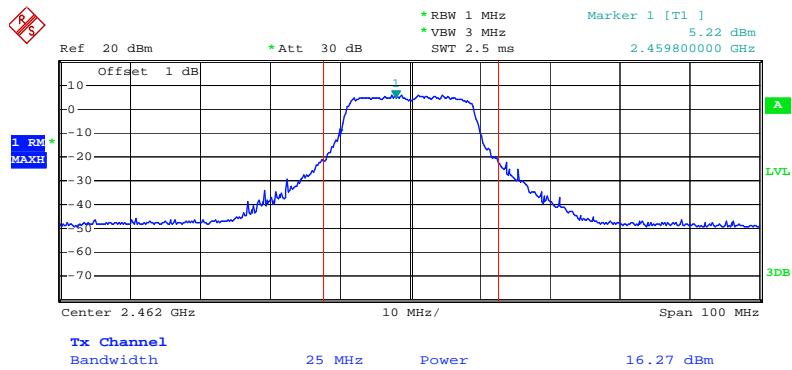

Date: 14.SEP.2009 19:05:00

Channel Output Power Plot on Configuration Draft n MCS8 40MHz Ant. 5-1 / 2422 MHz

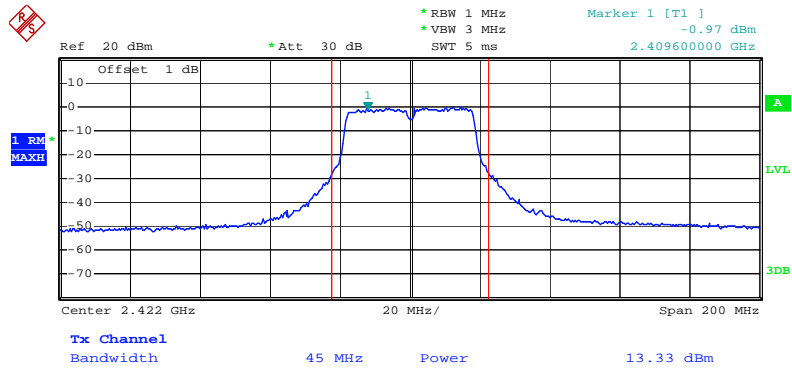

Date: 14.SEP.2009 14:13:46

Channel Output Power Plot on Configuration Draft n MCS8 40MHz Ant. 5-1 / 2437 MHz

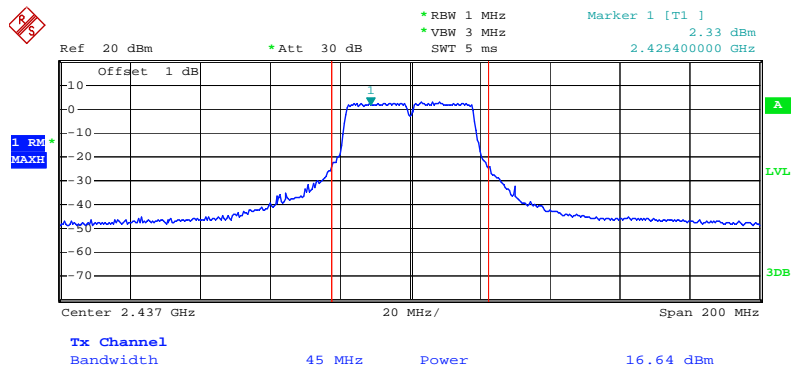

Date: 14.SEP.2009 14:12:24

Channel Output Power Plot on Configuration Draft n MCS8 40MHz Ant. 5-1 / 2452 MHz

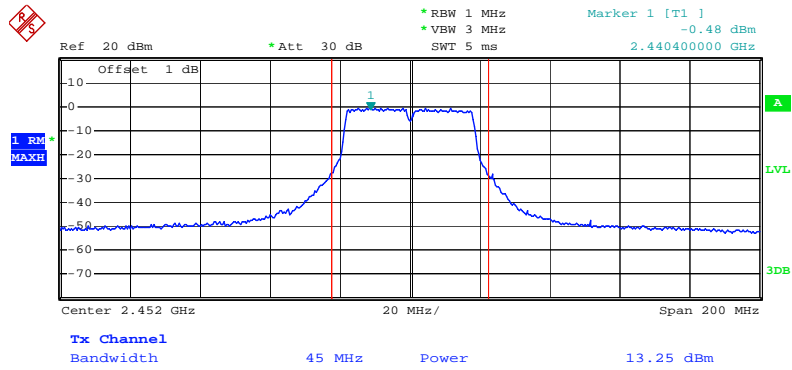

Date: 14.SEP.2009 14:05:24

Channel Output Power Plot on Configuration Draft n MCS8 40MHz Ant. 5-3 / 2422 MHz

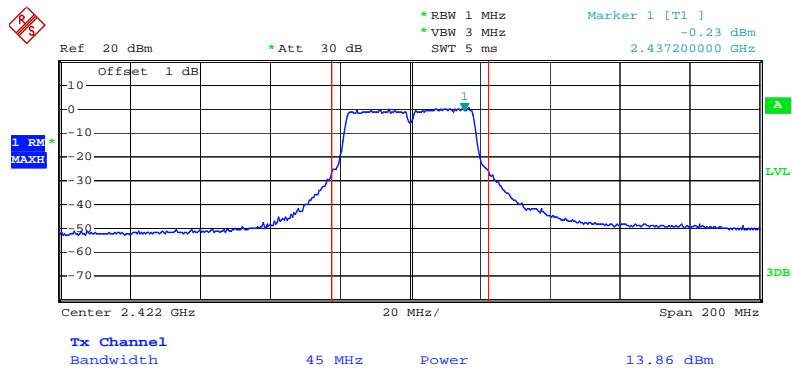

Date: 14.SEP.2009 19:23:22

Channel Output Power Plot on Configuration Draft n MCS8 40MHz Ant. 5-3 / 2437 MHz

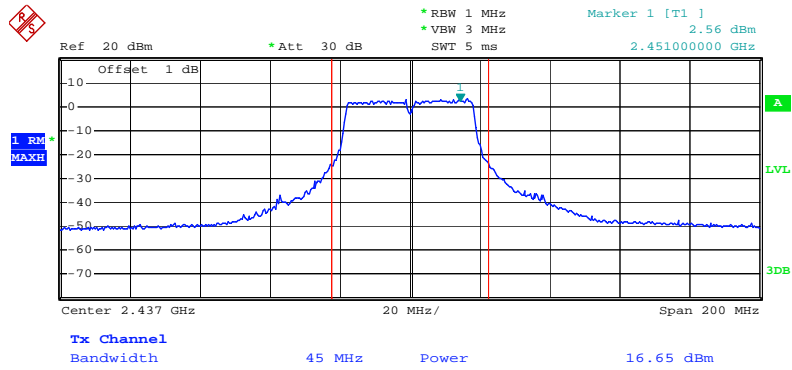

Date: 14.SEP.2009 19:25:34

Channel Output Power Plot on Configuration Draft n MCS8 40MHz Ant. 5-3 / 2452 MHz

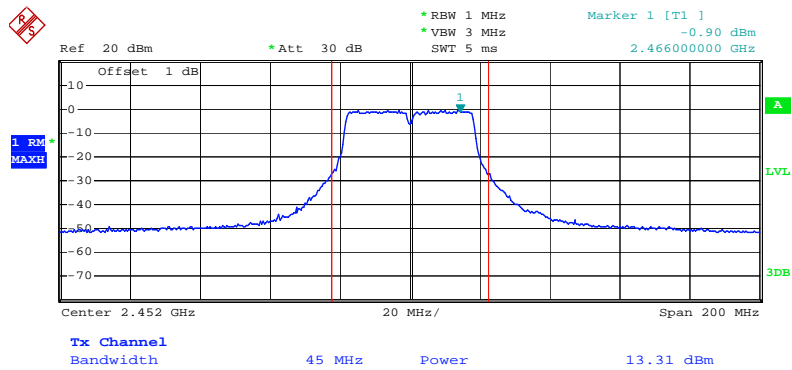

Date: 14.SEP.2009 19:38:48

Channel Output Power Plot on Configuration 11a Draft n MCS8 20MHz Ant. 5-1 / 5745 MHz

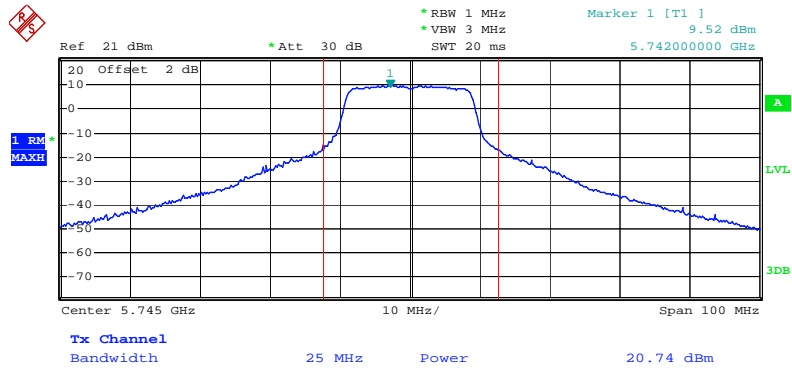

Date: 14.SEP.2009 19:55:51

Channel Output Power Plot on Configuration 11a Draft n MCS8 20MHz Ant. 5-1 / 5785MHz

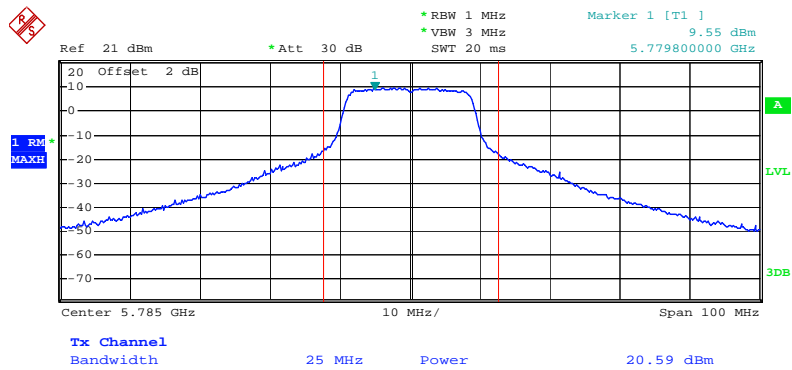

Date: 14.SEP.2009 19:54:59

Channel Output Power Plot on Configuration 11a Draft n MCS8 20MHz Ant. 5-1 / 5825 MHz

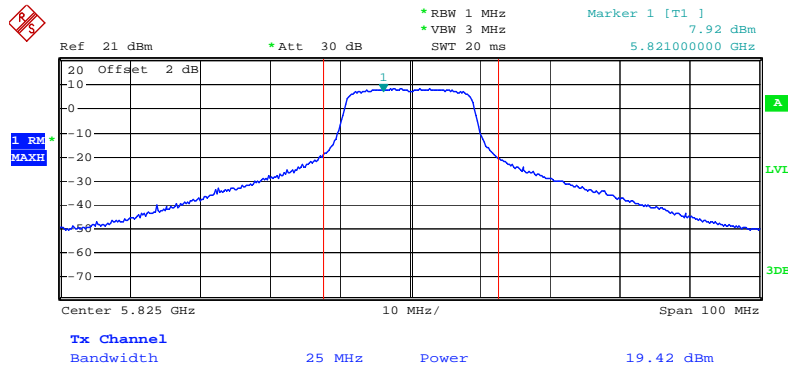

Date: 14.SEP.2009 20:05:55

Channel Output Power Plot on Configuration 11a Draft n MCS8 20MHz Ant. 5-3 / 5745 MHz

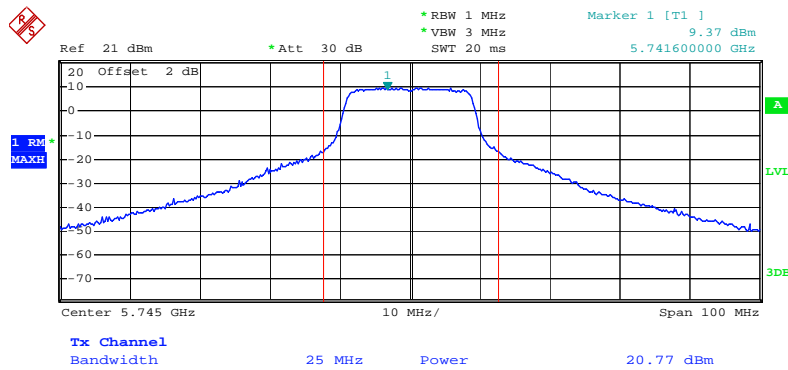

Date: 14.SEP.2009 20:10:17

Channel Output Power Plot on Configuration 11a Draft n MCS8 20MHz Ant. 5-3 / 5785MHz

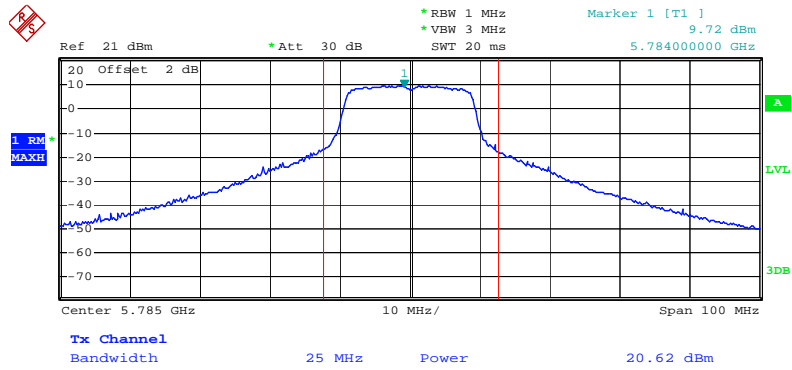

Date: 14.SEP.2009 20:08:55

Channel Output Power Plot on Configuration 11a Draft n MCS8 20MHz Ant. 5-3 / 5825 MHz

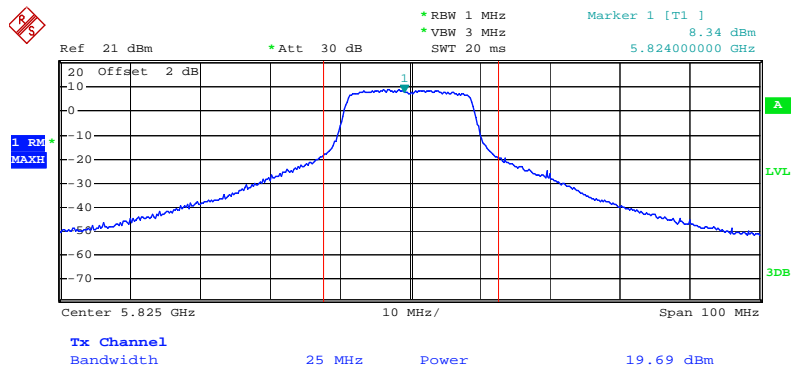

Date: 14.SEP.2009 19:52:58

Channel Output Power Plot on Configuration 11a Draft n MCS8 40MHz Ant. 5-1 / 5755 MHz

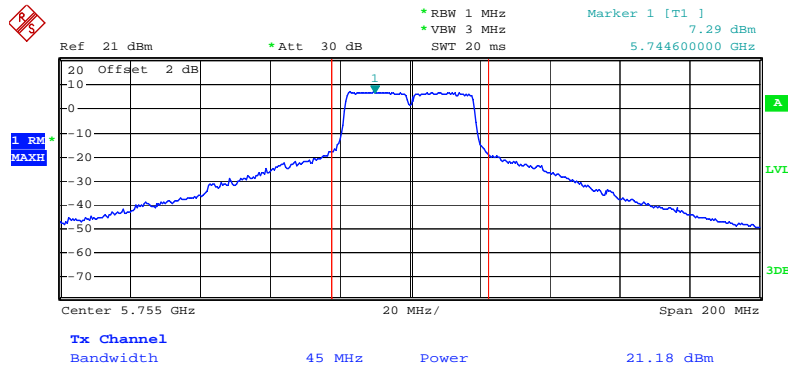

Date: 14.SEP.2009 19:58:04

Channel Output Power Plot on Configuration 11a Draft n MCS8 40MHz Ant. 5-1 / 5795 MHz

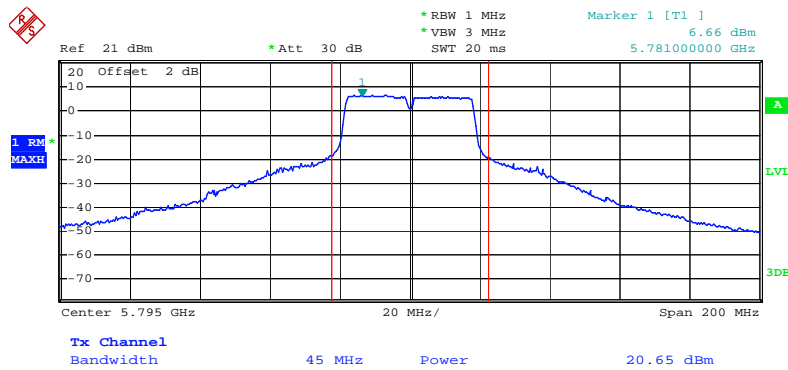

Date: 14.SEP.2009 19:58:56

Channel Output Power Plot on Configuration 11a Draft n MCS8 40MHz Ant. 5-3 / 5755 MHz

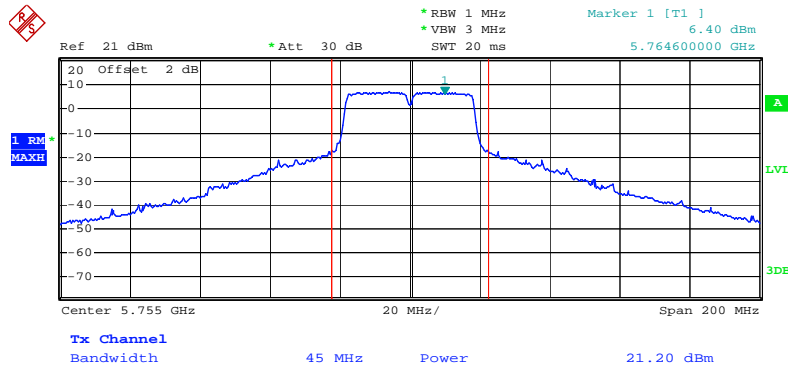

Date: 14.SEP.2009 20:02:42

Channel Output Power Plot on Configuration 11a Draft n MCS8 40MHz Ant. 5-3 / 5795 MHz

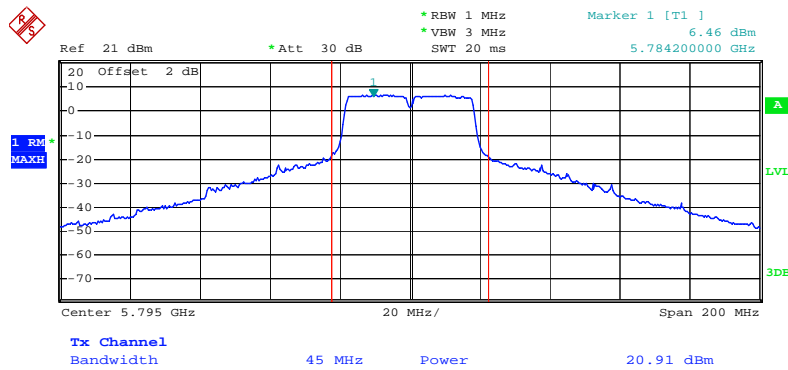

Date: 14.SEP.2009 20:00:20

Conducted Output Power Plot on Configuration IEEE 802.11b Ant. 5-1/ 2412 MHz

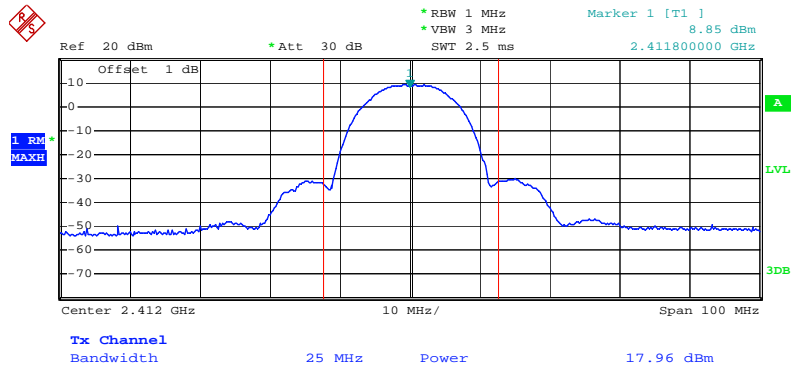

Date: 14.SEP.2009 11:10:32

Conducted Output Power Plot on Configuration IEEE 802.11b Ant. 5-1 / 2437 MHz

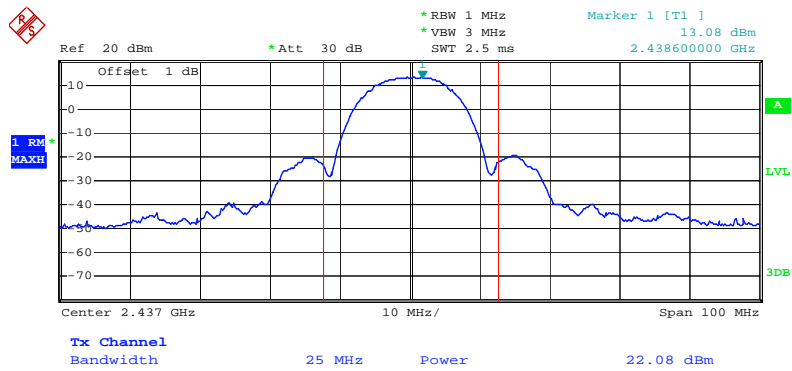

Date: 14.SEP.2009 17:03:25

Conducted Output Power Plot on Configuration IEEE 802.11b Ant. 5-1 / 2462 MHz

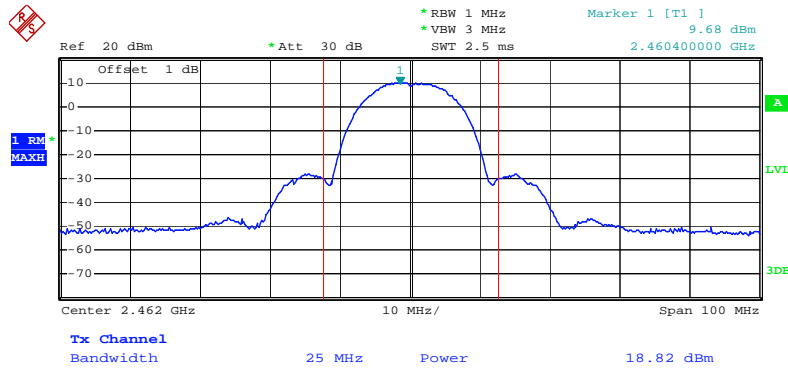

Date: 14.SEP.2009 17:11:39

Conducted Output Power Plot on Configuration IEEE 802.11b Ant. 5-3 / 2412 MHz

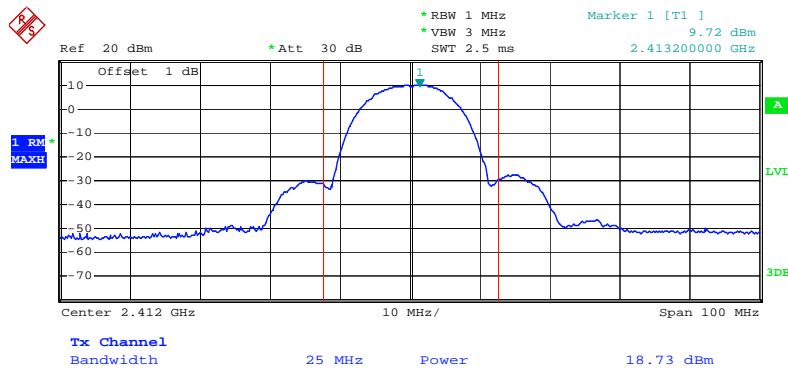

Date: 14.SEP.2009 17:07:42

Conducted Output Power Plot on Configuration IEEE 802.11g Ant. 5-1 / 2412 MHz

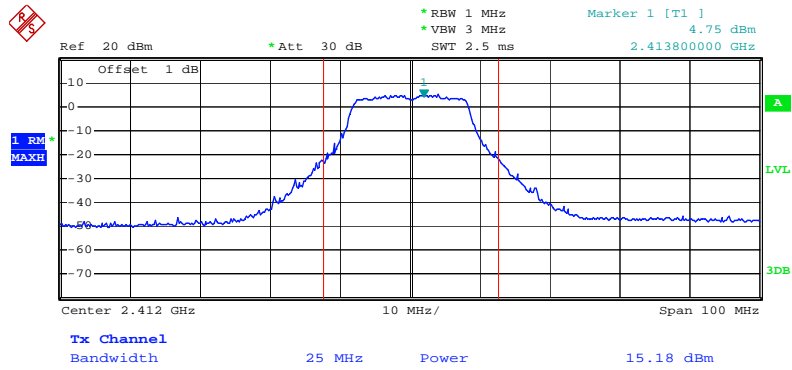

Date: 14.SEP.2009 13:43:32

Conducted Output Power Plot on Configuration IEEE 802.11g Ant. 5-1 / 2437 MHz

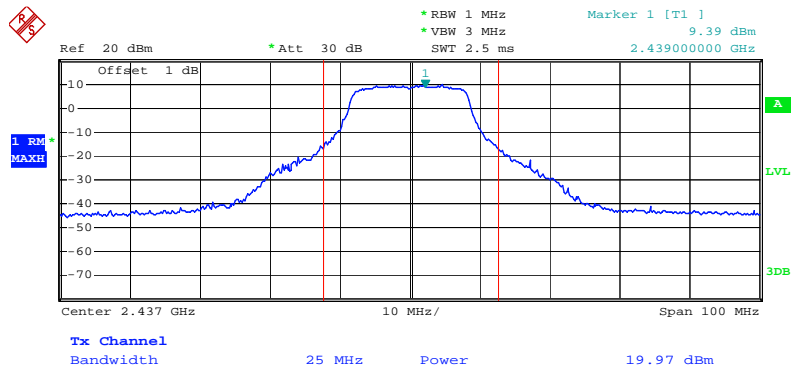

Date: 14.SEP.2009 13:39:23

Conducted Output Power Plot on Configuration IEEE 802.11g Ant. 5-1 / 2462 MHz

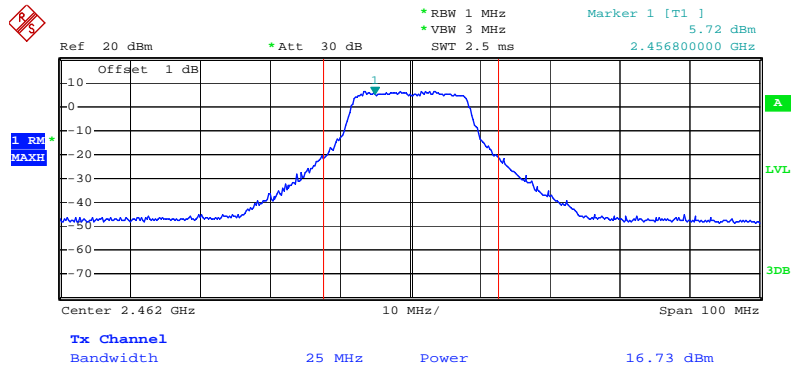

Date: 14.SEP.2009 19:01:12

Conducted Output Power Plot on Configuration IEEE 802.11g Ant. 5-3 / 2412 MHz

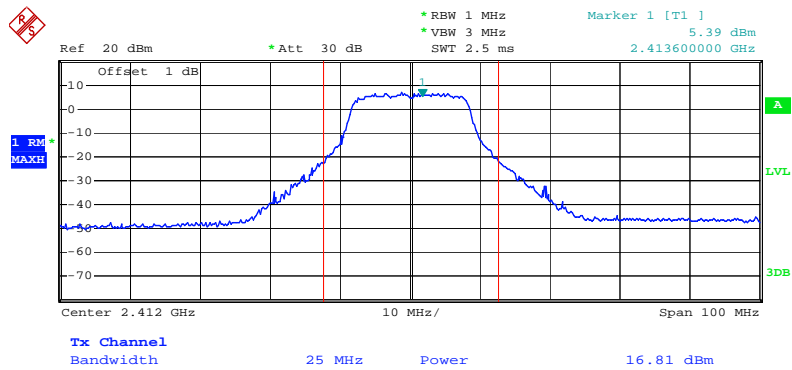

Date: 14.SEP.2009 18:29:47

Conducted Output Power Plot on Configuration IEEE 802.11g Ant. 5-3 / 2437 MHz

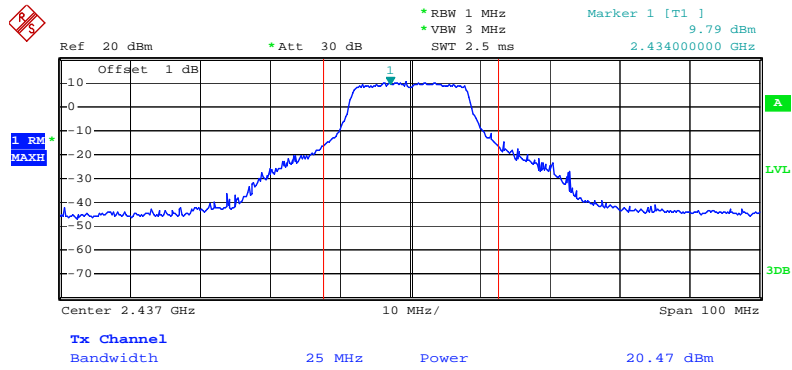

Date: 14.SEP.2009 18:32:28

Conducted Output Power Plot on Configuration IEEE 802.11g Ant. 5-3 / 2462 MHz

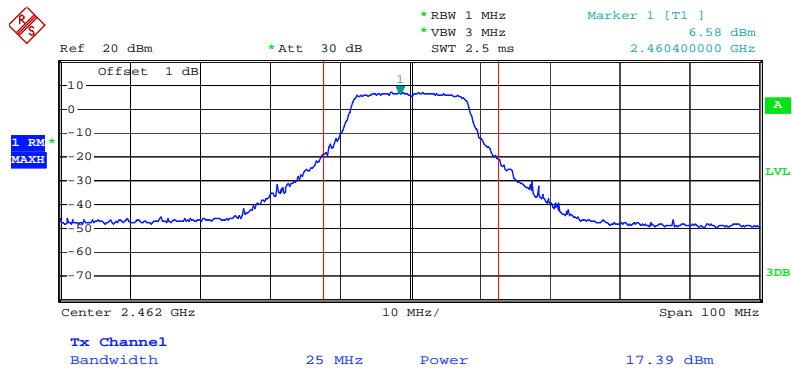

Date: 14.SEP.2009 11:38:01

Conducted Output Power Plot on Configuration IEEE 802.11a Ant. 5-1 / 5745 MHz

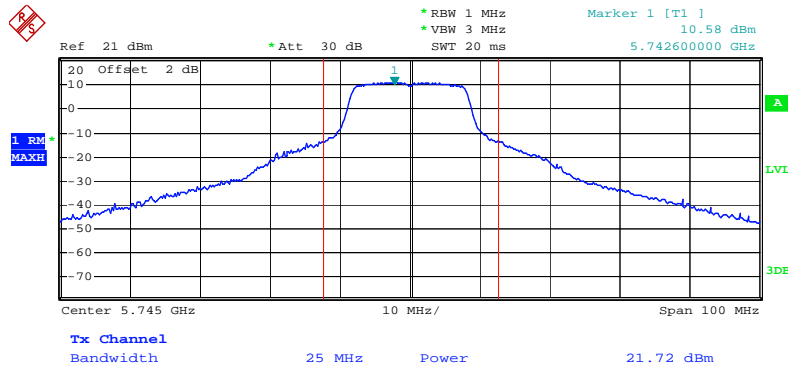

Date: 14.SEP.2009 20:17:14

Conducted Output Power Plot on Configuration IEEE 802.11a Ant. 5-1 / 5785 MHz

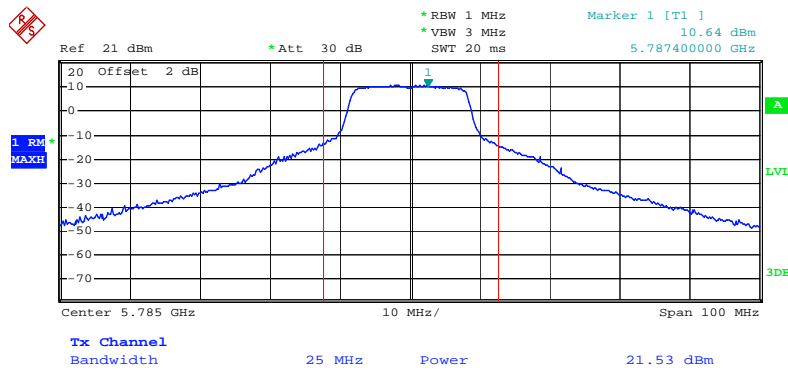

Date: 14.SEP.2009 20:17:40

Conducted Output Power Plot on Configuration IEEE 802.11a Ant. 5-1 / 5825 MHz

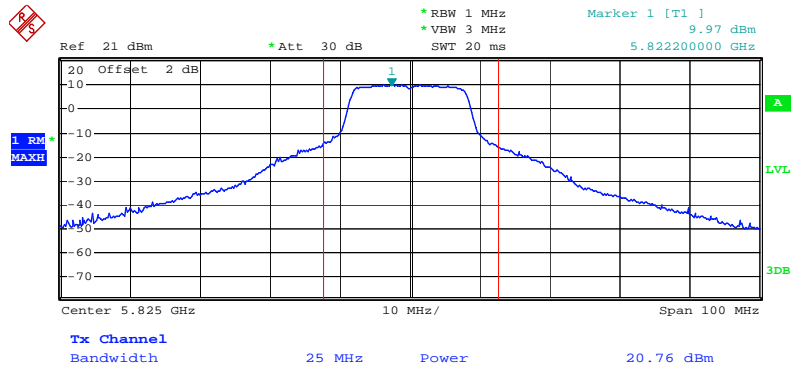

Date: 14.SEP.2009 20:18:00

Conducted Output Power Plot on Configuration IEEE 802.11a Ant. 5-3 / 5745 MHz

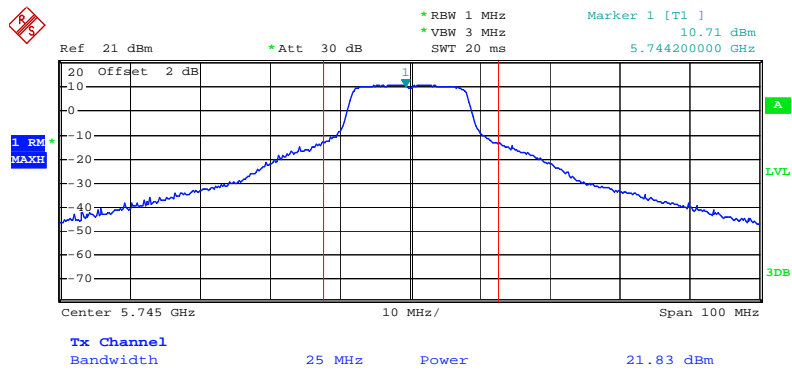

Date: 14.SEP.2009 19:50:19

Conducted Output Power Plot on Configuration IEEE 802.11a Ant. 5-3 / 5785 MHz

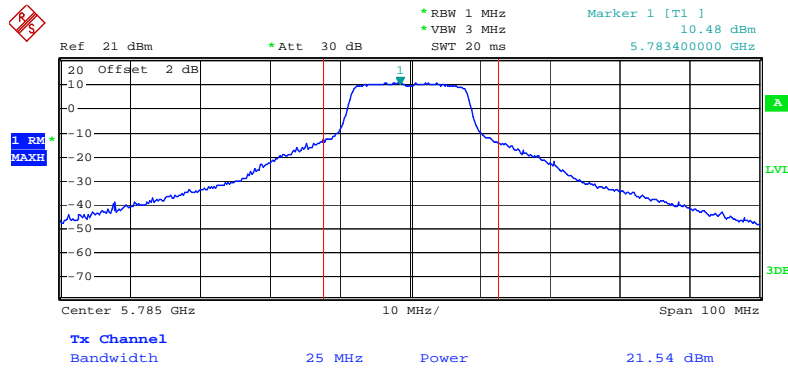

Date: 14.SEP.2009 19:47:29

Conducted Output Power Plot on Configuration IEEE 802.11a Ant. 5-3 / 5825 MHz



Date: 14.SEP.2009 19:51:10

<For Antenna 6>:

Channel Output Power Plot on Configuration Draft n MCS8 20MHz Ant. 6-1 / 2412 MHz

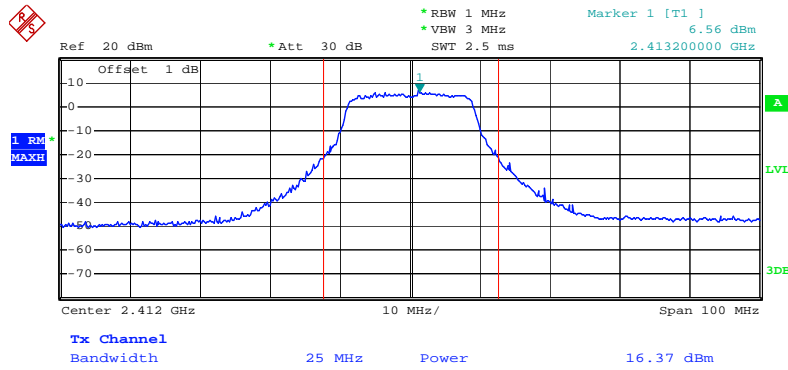

Date: 14.SEP.2009 13:48:08

Channel Output Power Plot on Configuration Draft n MCS8 20MHz Ant. 6-1 / 2437 MHz

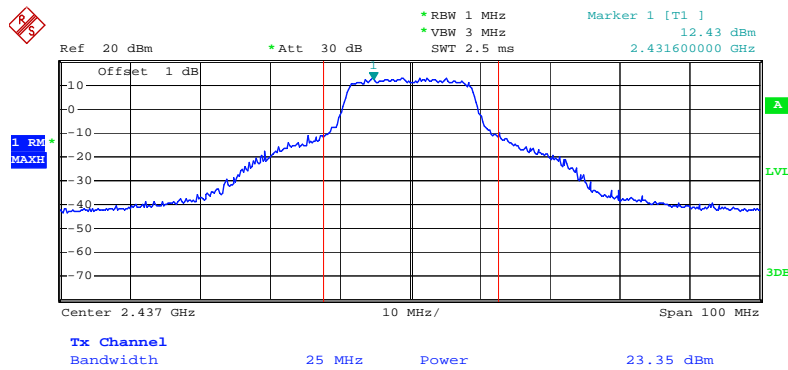

Date: 14.SEP.2009 13:49:07

Channel Output Power Plot on Configuration Draft n MCS8 20MHz Ant. 6-1 / 2462 MHz

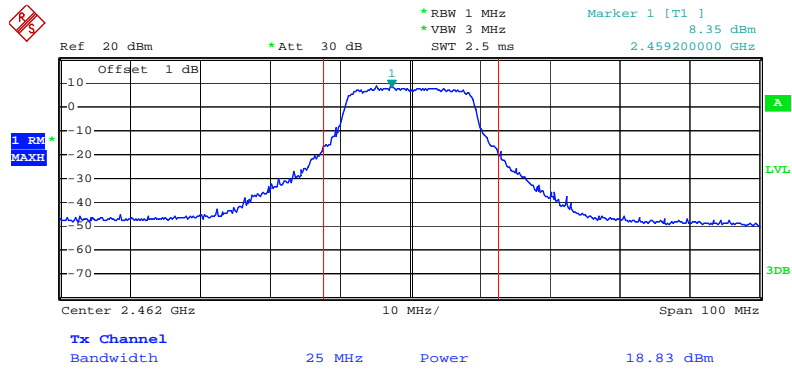

Date: 14.SEP.2009 14:00:43

Channel Output Power Plot on Configuration Draft n MCS8 20MHz Ant. 6-3 / 2412 MHz

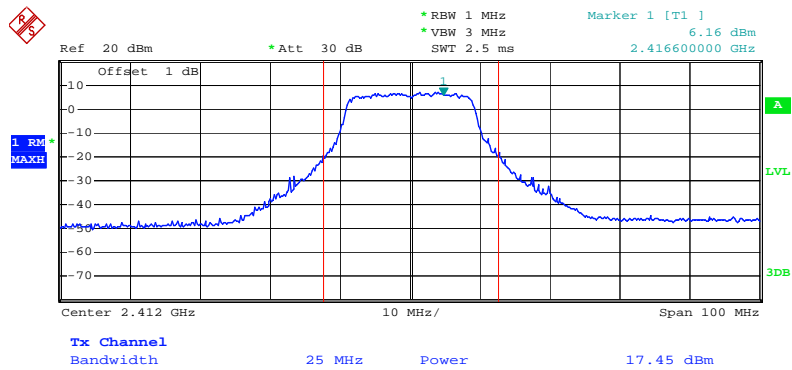

Date: 14.SEP.2009 19:14:23

Channel Output Power Plot on Configuration Draft n MCS8 20MHz Ant. 6-3 / 2437 MHz

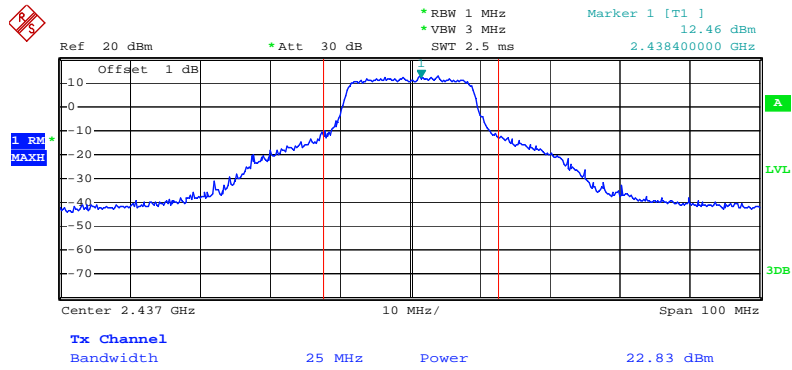

Date: 14.SEP.2009 19:11:06

Channel Output Power Plot on Configuration Draft n MCS8 20MHz Ant. 6-3 / 2462 MHz

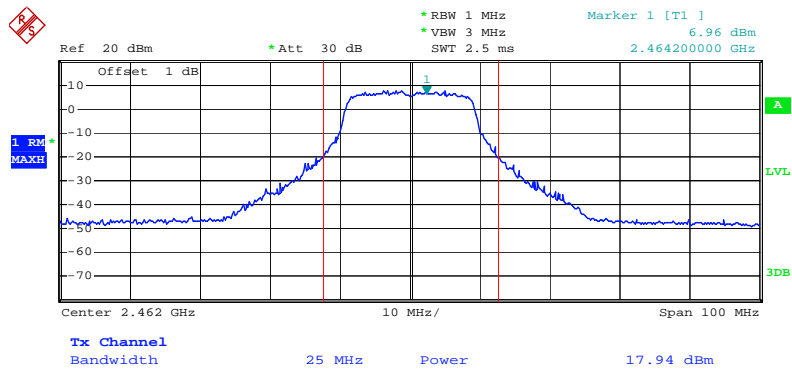

Date: 14.SEP.2009 19:02:30

Channel Output Power Plot on Configuration Draft n MCS8 40MHz Ant. 6-1 / 2422 MHz

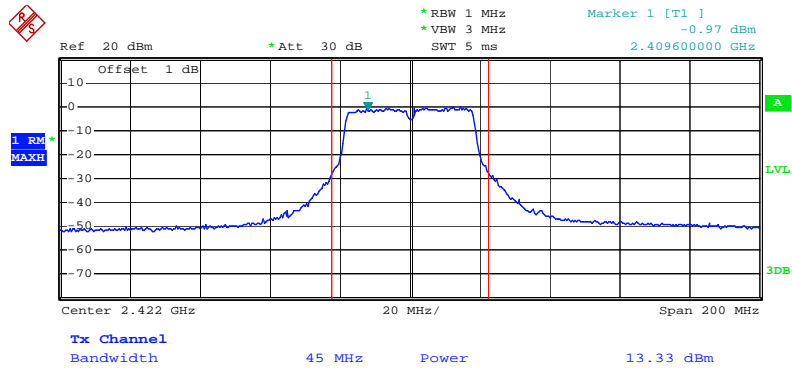

Date: 14.SEP.2009 14:13:46

Channel Output Power Plot on Configuration Draft n MCS8 40MHz Ant. 6-1 / 2437 MHz

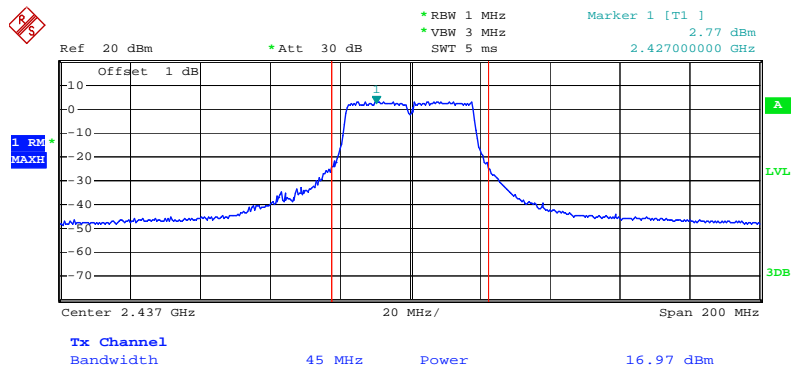

Date: 14.SEP.2009 14:12:55

Channel Output Power Plot on Configuration Draft n MCS8 40MHz Ant. 6-1 / 2452 MHz

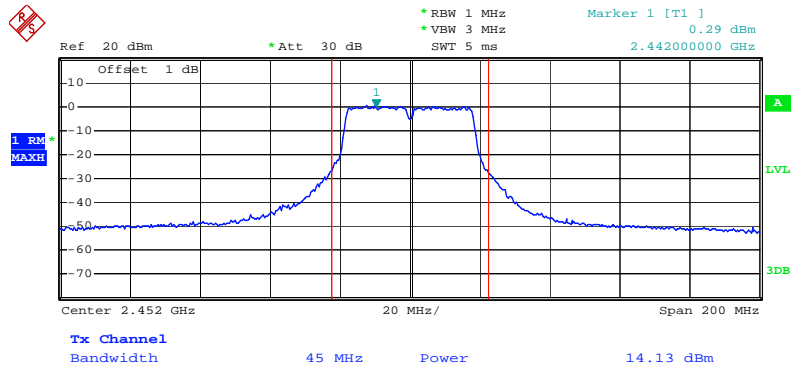

Date: 14.SEP.2009 14:06:03

Channel Output Power Plot on Configuration Draft n MCS8 40MHz Ant. 6-3 / 2422 MHz

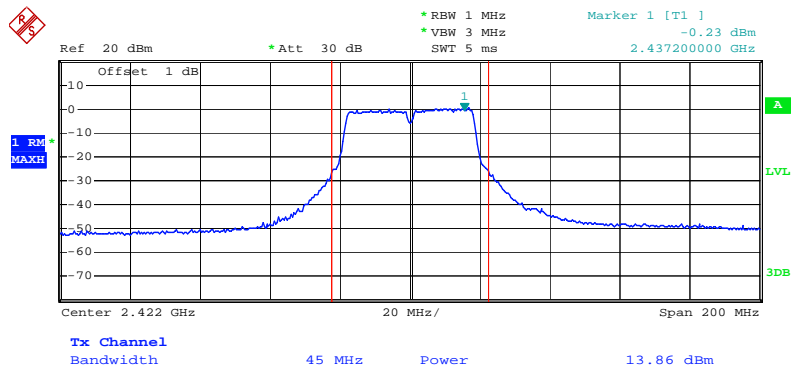

Date: 14.SEP.2009 19:23:22

Channel Output Power Plot on Configuration Draft n MCS8 40MHz Ant. 6-3 / 2437 MHz

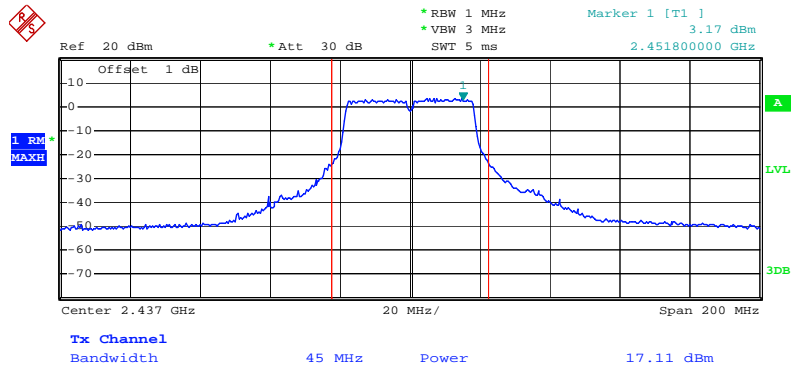

Date: 14.SEP.2009 19:24:04

Channel Output Power Plot on Configuration Draft n MCS8 40MHz Ant. 6-3 / 2452 MHz

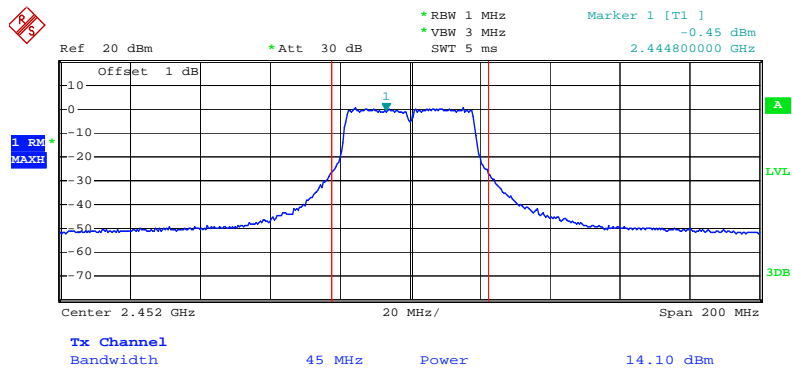

Date: 14.SEP.2009 19:39:28

Channel Output Power Plot on Configuration 11a Draft n MCS8 20MHz Ant. 6-1 / 5745 MHz

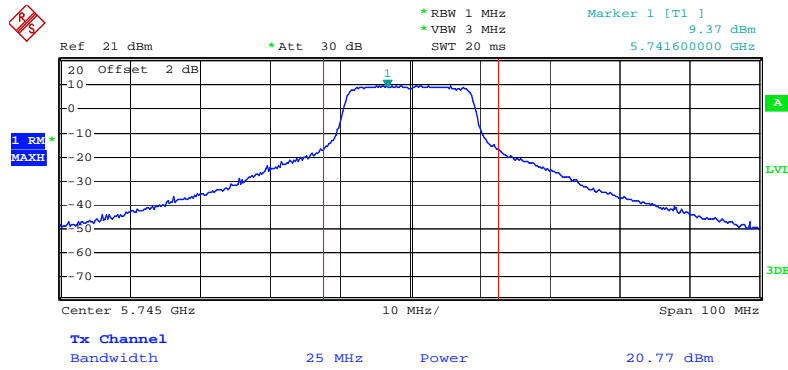

Date: 14.SEP.2009 20:10:17

Channel Output Power Plot on Configuration 11a Draft n MCS8 20MHz Ant. 6-1 / 5785MHz

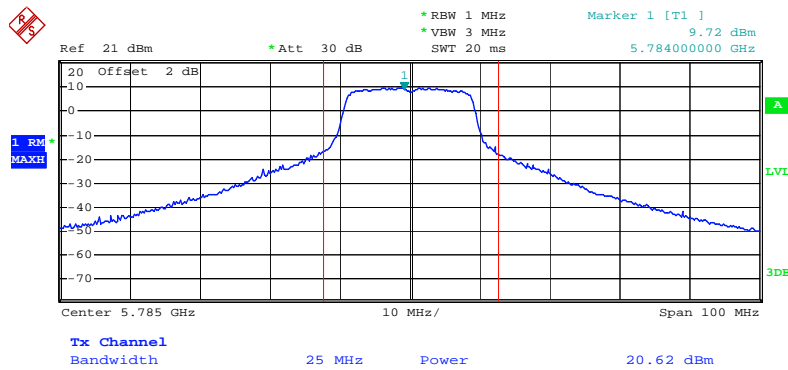

Date: 14.SEP.2009 20:08:55

Channel Output Power Plot on Configuration 11a Draft n MCS8 20MHz Ant. 6-1 / 5825 MHz

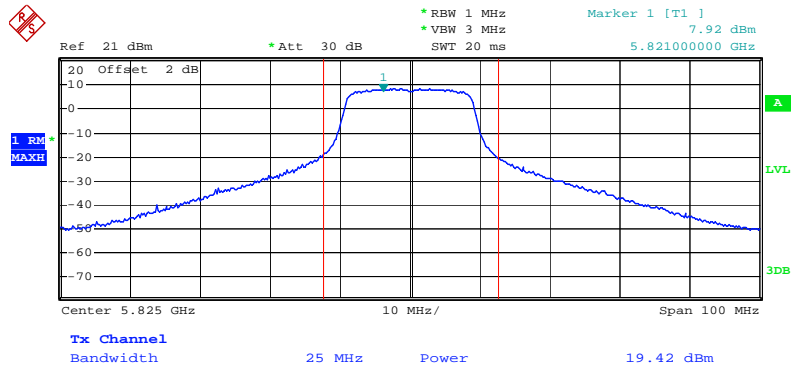

Date: 14.SEP.2009 20:05:55

Channel Output Power Plot on Configuration 11a Draft n MCS8 20MHz Ant. 6-3 / 5745 MHz

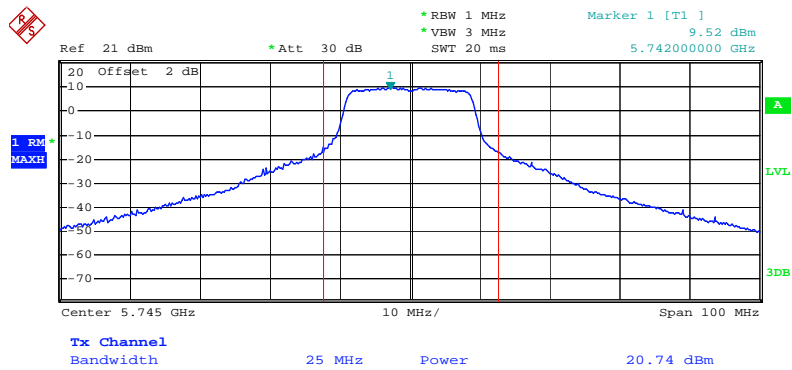

Date: 14.SEP.2009 19:55:51

Channel Output Power Plot on Configuration 11a Draft n MCS8 20MHz Ant. 6-3 / 5785MHz

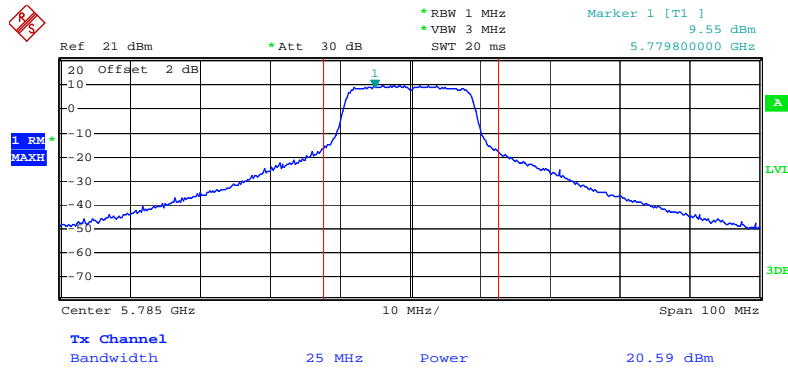

Date: 14.SEP.2009 19:54:59

Channel Output Power Plot on Configuration 11a Draft n MCS8 20MHz Ant. 6-3 / 5825 MHz

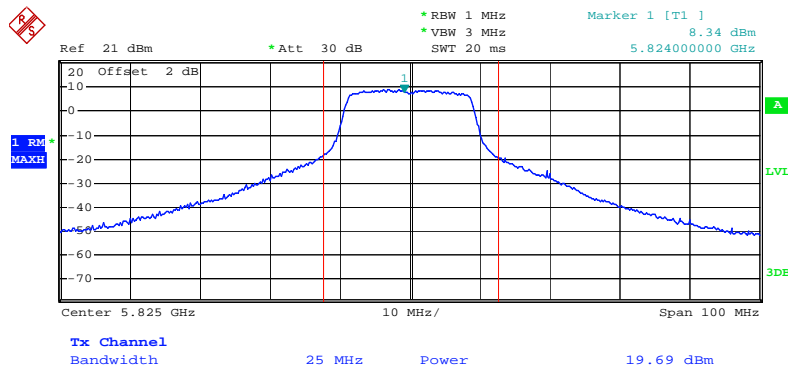

Date: 14.SEP.2009 19:52:58

Channel Output Power Plot on Configuration 11a Draft n MCS8 40MHz Ant. 6-1 / 5755 MHz

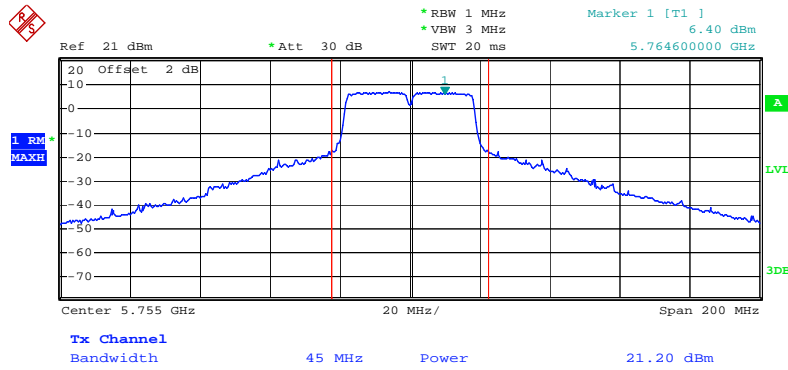

Date: 14.SEP.2009 20:02:42

Channel Output Power Plot on Configuration 11a Draft n MCS8 40MHz Ant. 6-1 / 5795 MHz

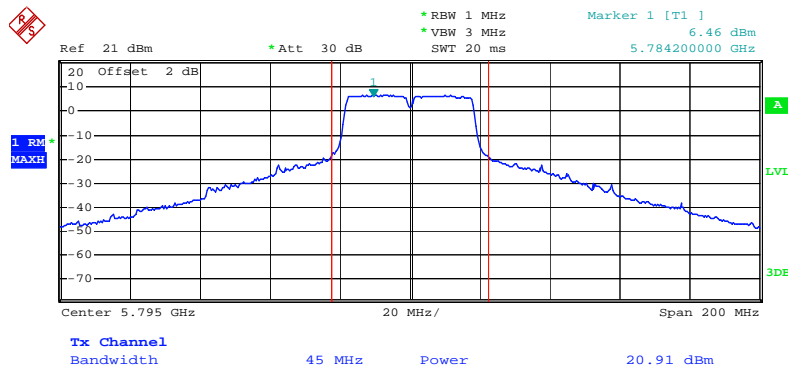

Date: 14.SEP.2009 20:00:20

Channel Output Power Plot on Configuration 11a Draft n MCS8 40MHz Ant. 6-3 / 5755 MHz

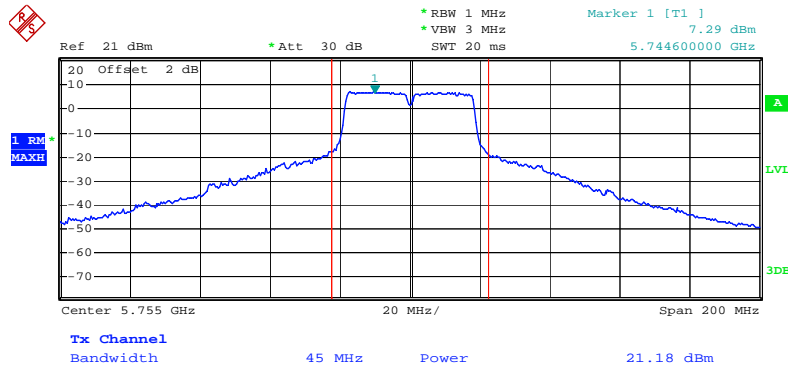

Date: 14.SEP.2009 19:58:04

Channel Output Power Plot on Configuration 11a Draft n MCS8 40MHz Ant. 6-3 / 5795 MHz

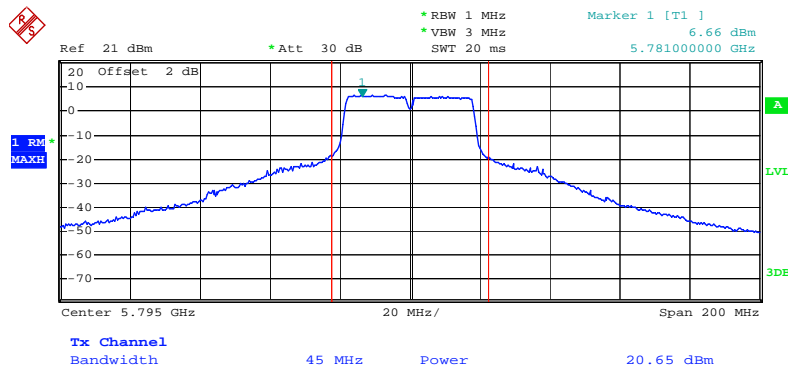

Date: 14.SEP.2009 19:58:56

Conducted Output Power Plot on Configuration IEEE 802.11b Ant. 6-1/ 2412 MHz

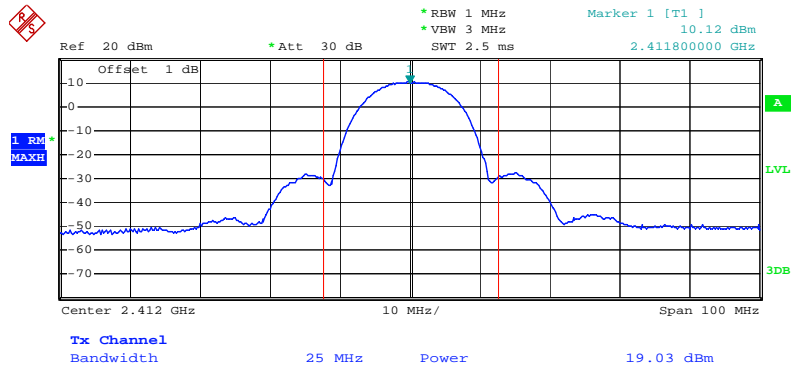

Date: 14.SEP.2009 11:11:18

Conducted Output Power Plot on Configuration IEEE 802.11b Ant. 6-1 / 2437 MHz

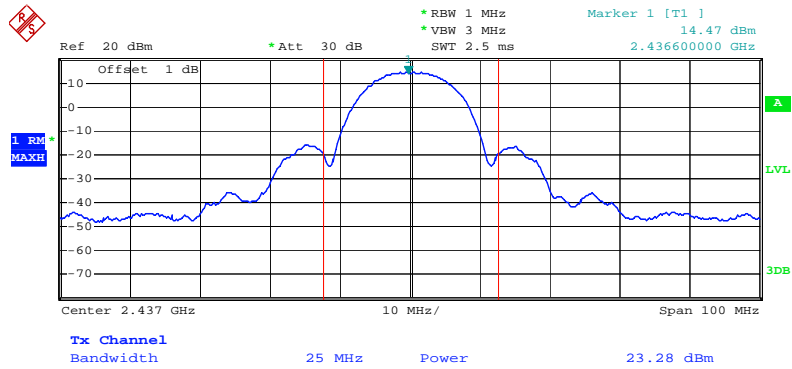

Date: 14.SEP.2009 11:12:25

Conducted Output Power Plot on Configuration IEEE 802.11b Ant. 6-1 / 2462 MHz

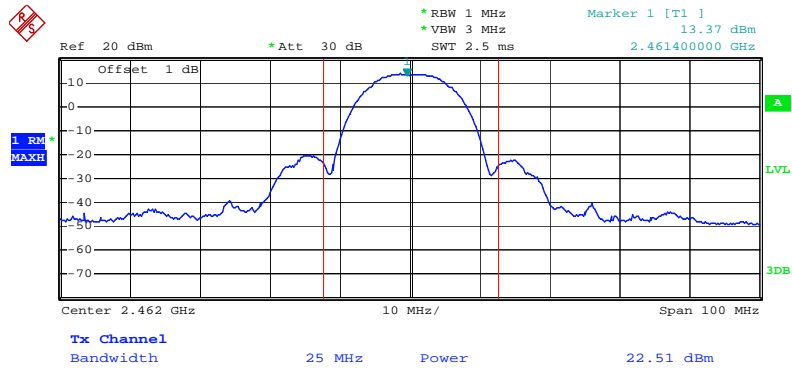

Date: 14.SEP.2009 11:30:45

Conducted Output Power Plot on Configuration IEEE 802.11b Ant. 6-3 / 2412 MHz

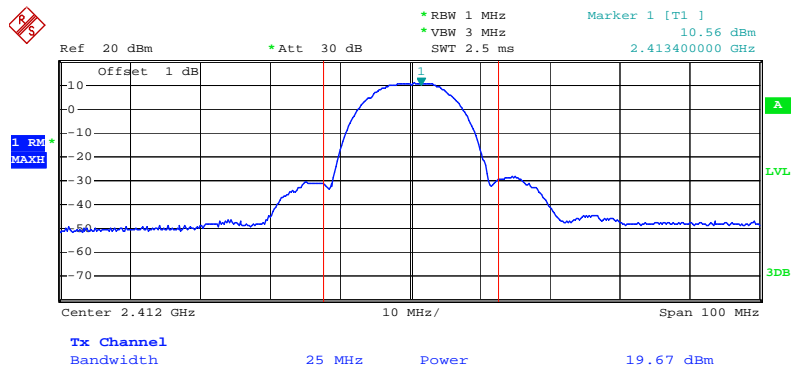

Date: 14.SEP.2009 17:08:52

Conducted Output Power Plot on Configuration IEEE 802.11b Ant. 6-3 / 2437 MHz

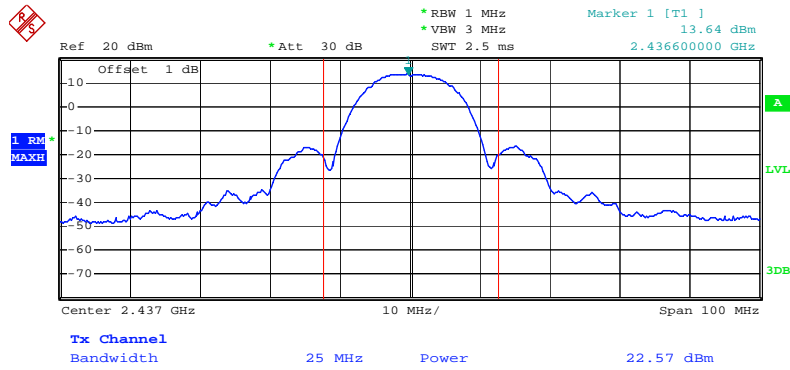

Date: 14.SEP.2009 17:02:46

Conducted Output Power Plot on Configuration IEEE 802.11b Ant. 6-3 / 2462 MHz

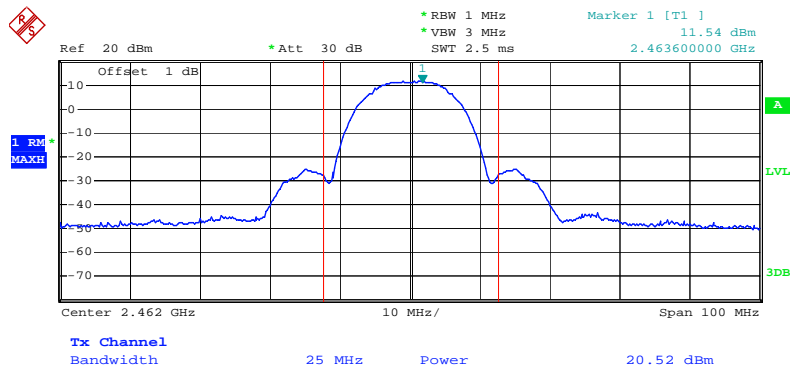

Date: 14.SEP.2009 17:10:49

Conducted Output Power Plot on Configuration IEEE 802.11g Ant. 6-1 / 2412 MHz

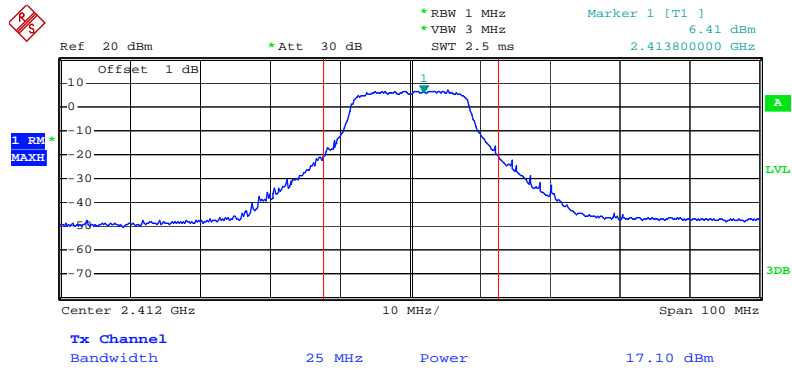

Date: 14.SEP.2009 13:42:03

Conducted Output Power Plot on Configuration IEEE 802.11g Ant. 6-1 / 2437 MHz

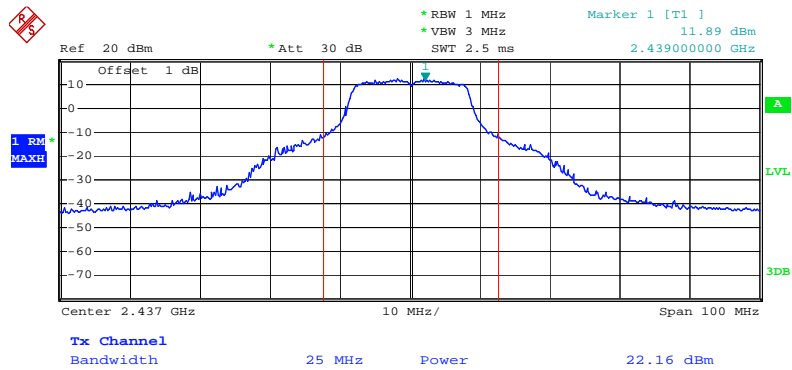

Date: 14.SEP.2009 13:38:40

Conducted Output Power Plot on Configuration IEEE 802.11g Ant. 6-1 / 2462 MHz

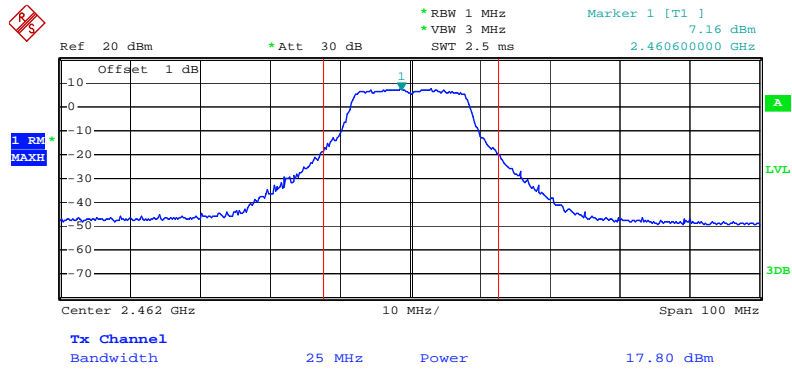

Date: 14.SEP.2009 11:38:42

Conducted Output Power Plot on Configuration IEEE 802.11g Ant. 6-3 / 2412 MHz

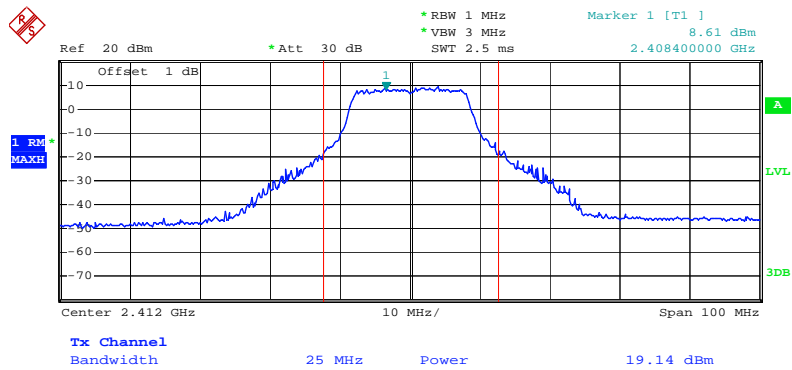

Date: 14.SEP.2009 18:30:27

Conducted Output Power Plot on Configuration IEEE 802.11g Ant. 6-3 / 2437 MHz

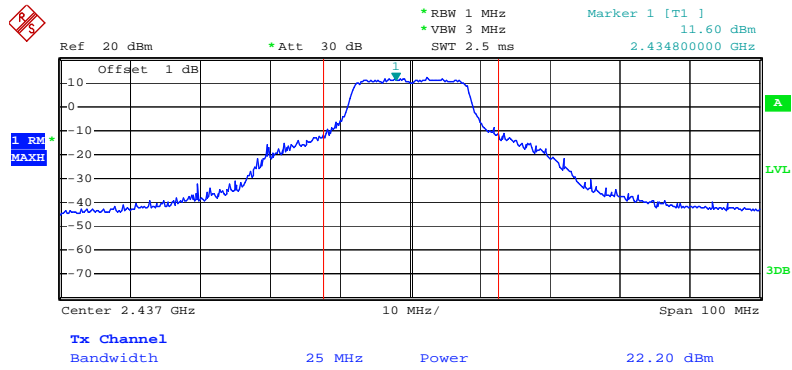

Date: 14.SEP.2009 18:31:26

Conducted Output Power Plot on Configuration IEEE 802.11g Ant. 6-3 / 2462 MHz

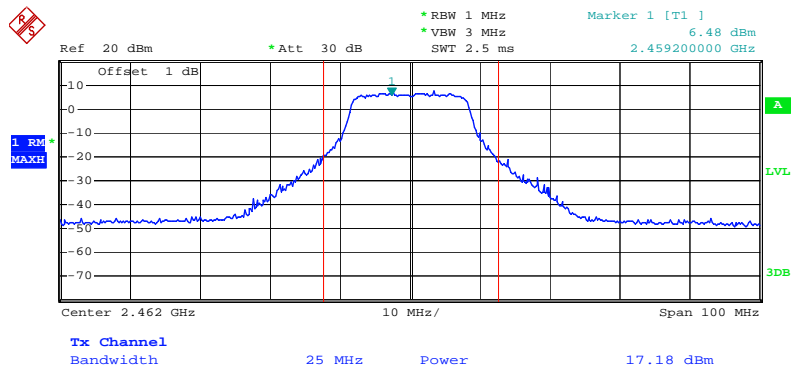

Date: 14.SEP.2009 19:01:37

Conducted Output Power Plot on Configuration IEEE 802.11a Ant. 6-1 / 5745 MHz

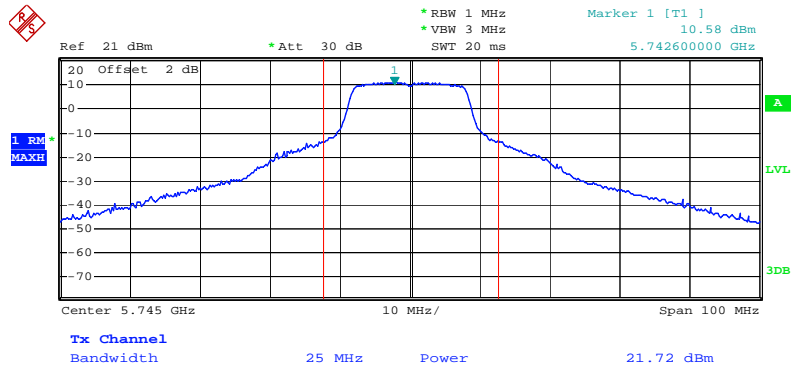

Date: 14.SEP.2009 20:17:14

Conducted Output Power Plot on Configuration IEEE 802.11a Ant. 6-1 / 5785 MHz

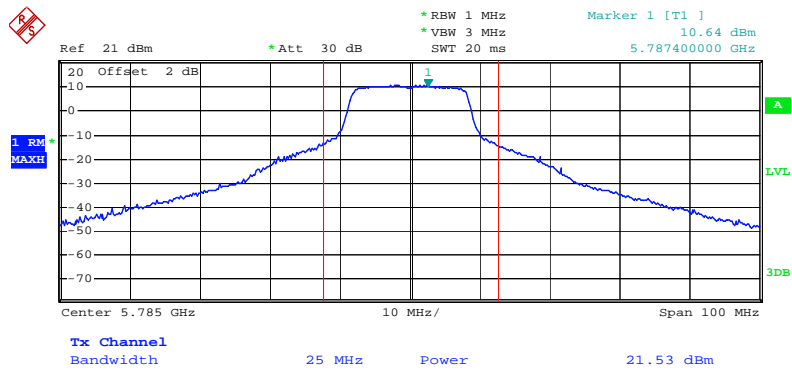

Date: 14.SEP.2009 20:17:40

Conducted Output Power Plot on Configuration IEEE 802.11a Ant. 6-1 / 5825 MHz

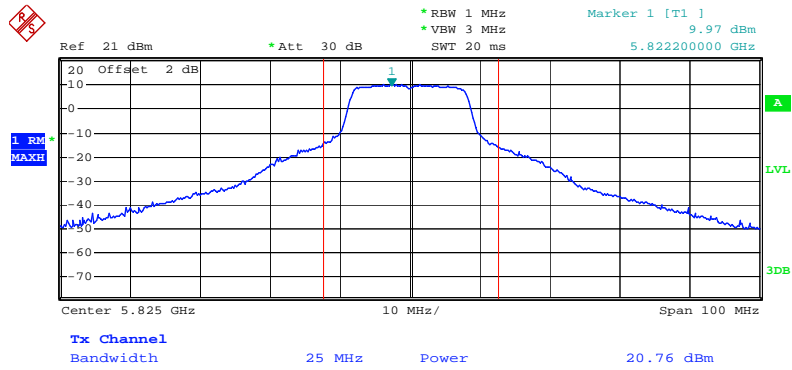

Date: 14.SEP.2009 20:18:00

Conducted Output Power Plot on Configuration IEEE 802.11a Ant. 6-3 / 5745 MHz

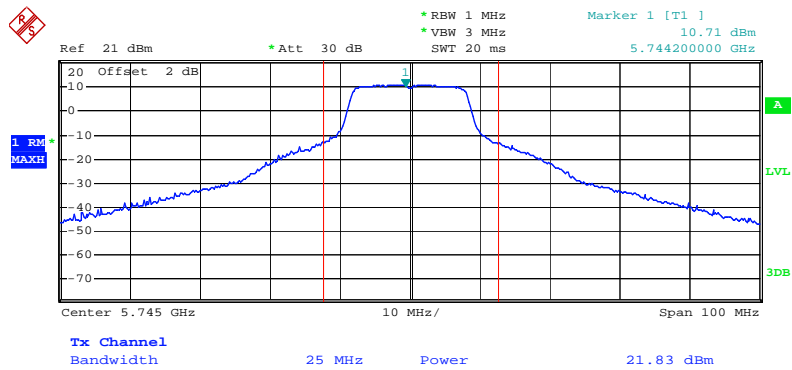

Date: 14.SEP.2009 19:50:19

Conducted Output Power Plot on Configuration IEEE 802.11a Ant. 6-3 / 5785 MHz

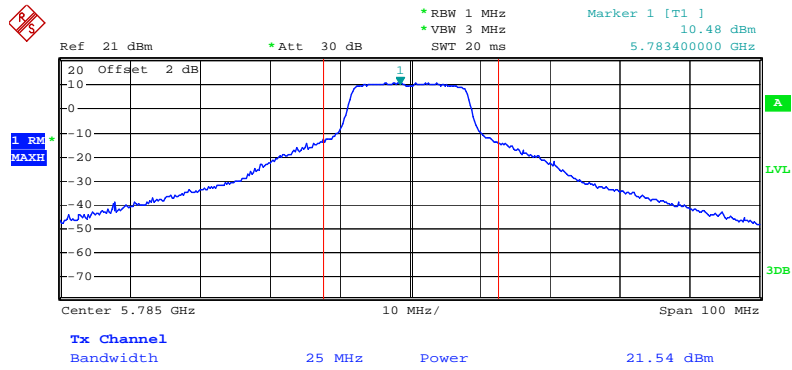

Date: 14.SEP.2009 19:47:29

Conducted Output Power Plot on Configuration IEEE 802.11a Ant. 6-3 / 5825 MHz

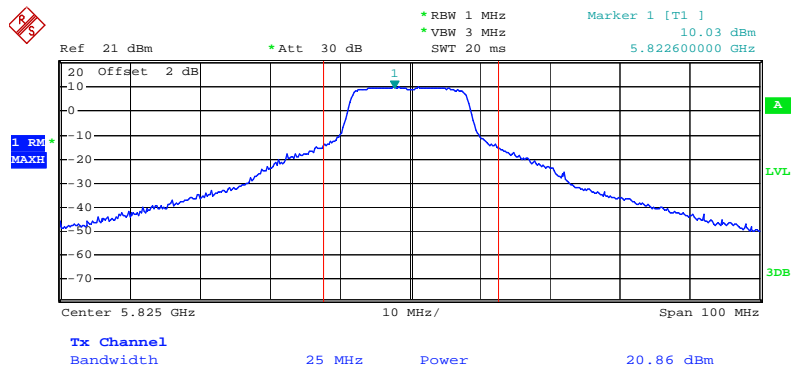

Date: 14.SEP.2009 19:51:10

4.3. Power Spectral Density Measurement

4.3.1. Limit

For digitally modulated systems, the power spectral density conducted from the intentional radiator to the antenna shall not be greater than 8dBm in any 3 kHz band during any time interval of continuous transmission.

4.3.2. Measuring Instruments and Setting

Please refer to section 5 of equipments list in this report. The following table is the setting of the spectrum analyzer.

Spectrum Parameter	Setting
Attenuation	Auto
Span Frequency	30 kHz
RB	3 kHz
VB	30 kHz
Detector	Peak
Trace	Max Hold
Sweep Time	10s

4.3.3. Test Procedures

1. The transmitter output (antenna port) was connected to the spectrum analyzer.
2. Set RBW of spectrum analyzer to 3kHz and VBW to 30kHz. Set Detector to Peak, Trace to Max Hold.
3. Mark the frequency with maximum peak power as the center of the display of the spectrum.
4. Set the span to 30kHz and the sweep time to 10s and record the maximum peak value.
5. Measuring multiple antennas, the connector is required to link with spectrum analyzer through a combiner.

4.3.4. Test Setup Layout

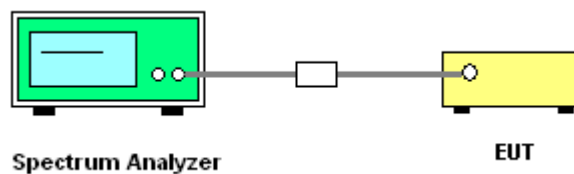

4.3.5. Test Deviation

There is no deviation with the original standard.

4.3.6. EUT Operation during Test

The EUT was programmed to be in continuously transmitting mode.

4.3.7. Test Result of Power Spectral Density

<For Antenna 1>:

Temperature	21°C	Humidity	56%
Test Engineer	Johnson Chang	Configurations	Draft n / Antenna 1

For 2.4GHz Band

Configuration Draft n MCS8 20MHz Ant. 1-1 + Ant. 1-3

Channel	Frequency	Power Density (dBm/3kHz)	Max. Limit (dBm/3kHz)	Result
1	2412 MHz	-4.32	8.00	Complies
6	2437 MHz	0.16	8.00	Complies
11	2462 MHz	-3.95	8.00	Complies

Configuration Draft n MCS8 40MHz Ant. 1-1 + Ant. 1-3

Channel	Frequency	Power Density (dBm/3kHz)	Max. Limit (dBm/3kHz)	Result
3	2422 MHz	-8.84	8.00	Complies
6	2437 MHz	-7.25	8.00	Complies
9	2452 MHz	-10.67	8.00	Complies

For 5GHz Band

Configuration 11a Draft n MCS8 20MHz Ant. 1-1 + Ant. 1-3

Channel	Frequency	Power Density (dBm/3kHz)	Max. Limit (dBm/3kHz)	Result
149	5745 MHz	-2.65	8.00	Complies
157	5785 MHz	-2.66	8.00	Complies
165	5825 MHz	-2.31	8.00	Complies

Configuration 11a Draft n MCS8 40MHz Ant. 1-1 + Ant. 1-3

Channel	Frequency	Power Density (dBm/3kHz)	Max. Limit (dBm/3kHz)	Result
151	5755 MHz	-4.70	8.00	Complies
159	5795 MHz	-3.96	8.00	Complies

Temperature	21°C	Humidity	56%
Test Engineer	Johnson Chang	Configurations	802.11a/b/g / Antenna 1

Configuration IEEE 802.11b Ant. 1-1 + Ant. 1-3

Channel	Frequency	Power Density (dBm/3kHz)	Max. Limit (dBm/3kHz)	Result
1	2412 MHz	3.83	8.00	Complies
6	2437 MHz	4.23	8.00	Complies
11	2462 MHz	4.04	8.00	Complies

Configuration IEEE 802.11g Ant. 1-1 + Ant. 1-3

Channel	Frequency	Power Density (dBm/3kHz)	Max. Limit (dBm/3kHz)	Result
1	2412 MHz	-0.44	8.00	Complies
6	2437 MHz	2.92	8.00	Complies
11	2462 MHz	0.06	8.00	Complies

Configuration IEEE 802.11a Ant. 1-1 + Ant. 1-3

Channel	Frequency	Power Density (dBm/3kHz)	Max. Limit (dBm/3kHz)	Result
149	5745 MHz	2.03	8.00	Complies
157	5785 MHz	0.91	8.00	Complies
165	5825 MHz	0.28	8.00	Complies

<For Antenna 2>:

Temperature	21°C	Humidity	56%
Test Engineer	Johnson Chang	Configurations	Draft n / Antenna 2

For 2.4GHz Band

Configuration Draft n MCS8 20MHz Ant. 2-1 + Ant. 2-3

Channel	Frequency	Power Density (dBm/3kHz)	Max. Limit (dBm/3kHz)	Result
1	2412 MHz	-5.14	8.00	Complies
6	2437 MHz	0.16	8.00	Complies
11	2462 MHz	-4.68	8.00	Complies

Configuration Draft n MCS8 40MHz Ant. 2-1 + Ant. 2-3

Channel	Frequency	Power Density (dBm/3kHz)	Max. Limit (dBm/3kHz)	Result
3	2422 MHz	-10.29	8.00	Complies
6	2437 MHz	-7.80	8.00	Complies
9	2452 MHz	-11.74	8.00	Complies

For 5GHz Band

Configuration 11a Draft n MCS8 20MHz Ant. 2-1 + Ant. 2-3

Channel	Frequency	Power Density (dBm/3kHz)	Max. Limit (dBm/3kHz)	Result
149	5745 MHz	-2.65	8.00	Complies
157	5785 MHz	-2.66	8.00	Complies
165	5825 MHz	-2.31	8.00	Complies

Configuration 11a Draft n MCS8 40MHz Ant. 2-1 + Ant. 2-3

Channel	Frequency	Power Density (dBm/3kHz)	Max. Limit (dBm/3kHz)	Result
151	5755 MHz	-4.70	8.00	Complies
159	5795 MHz	-3.96	8.00	Complies

Temperature	21°C	Humidity	56%
Test Engineer	Johnson Chang	Configurations	802.11a/b/g / Antenna 2

Configuration IEEE 802.11b Ant. 2-1 + Ant. 2-3

Channel	Frequency	Power Density (dBm/3kHz)	Max. Limit (dBm/3kHz)	Result
1	2412 MHz	3.75	8.00	Complies
6	2437 MHz	4.23	8.00	Complies
11	2462 MHz	3.16	8.00	Complies

Configuration IEEE 802.11g Ant. 2-1 + Ant. 2-3

Channel	Frequency	Power Density (dBm/3kHz)	Max. Limit (dBm/3kHz)	Result
1	2412 MHz	-1.15	8.00	Complies
6	2437 MHz	2.92	8.00	Complies
11	2462 MHz	-0.65	8.00	Complies

Configuration IEEE 802.11a Ant. 2-1 + Ant. 2-3

Channel	Frequency	Power Density (dBm/3kHz)	Max. Limit (dBm/3kHz)	Result
149	5745 MHz	2.03	8.00	Complies
157	5785 MHz	0.91	8.00	Complies
165	5825 MHz	0.28	8.00	Complies

<For Antenna 3>:

Temperature	21°C	Humidity	56%
Test Engineer	Johnson Chang	Configurations	Draft n / Antenna 3

For 2.4GHz Band

Configuration Draft n MCS8 20MHz Ant. 3-1 + Ant. 3-3

Channel	Frequency	Power Density (dBm/3kHz)	Max. Limit (dBm/3kHz)	Result
1	2412 MHz	-5.65	8.00	Complies
6	2437 MHz	-0.33	8.00	Complies
11	2462 MHz	-5.33	8.00	Complies

Configuration Draft n MCS8 40MHz Ant. 3-1 + Ant. 3-3

Channel	Frequency	Power Density (dBm/3kHz)	Max. Limit (dBm/3kHz)	Result
3	2422 MHz	-11.34	8.00	Complies
6	2437 MHz	-8.10	8.00	Complies
9	2452 MHz	-12.02	8.00	Complies

For 5GHz Band

Configuration 11a Draft n MCS8 20MHz Ant. 3-1 + Ant. 3-3

Channel	Frequency	Power Density (dBm/3kHz)	Max. Limit (dBm/3kHz)	Result
149	5745 MHz	-2.65	8.00	Complies
157	5785 MHz	-2.66	8.00	Complies
165	5825 MHz	-2.31	8.00	Complies

Configuration 11a Draft n MCS8 40MHz Ant. 3-1 + Ant. 3-3

Channel	Frequency	Power Density (dBm/3kHz)	Max. Limit (dBm/3kHz)	Result
151	5755 MHz	-4.70	8.00	Complies
159	5795 MHz	-3.96	8.00	Complies

Temperature	21°C	Humidity	56%
Test Engineer	Johnson Chang	Configurations	802.11a/b/g / Antenna 3

Configuration IEEE 802.11b Ant. 3-1 + Ant. 3-3

Channel	Frequency	Power Density (dBm/3kHz)	Max. Limit (dBm/3kHz)	Result
1	2412 MHz	3.75	8.00	Complies
6	2437 MHz	2.66	8.00	Complies
11	2462 MHz	3.16	8.00	Complies

Configuration IEEE 802.11g Ant. 3-1 + Ant. 3-3

Channel	Frequency	Power Density (dBm/3kHz)	Max. Limit (dBm/3kHz)	Result
1	2412 MHz	-1.76	8.00	Complies
6	2437 MHz	1.84	8.00	Complies
11	2462 MHz	-2.23	8.00	Complies

Configuration IEEE 802.11a Ant. 3-1 + Ant. 3-3

Channel	Frequency	Power Density (dBm/3kHz)	Max. Limit (dBm/3kHz)	Result
149	5745 MHz	2.03	8.00	Complies
157	5785 MHz	0.91	8.00	Complies
165	5825 MHz	0.28	8.00	Complies

<For Antenna 4>:

Temperature	21°C	Humidity	56%
Test Engineer	Johnson Chang	Configurations	Draft n / Antenna 4

For 2.4GHz Band

Configuration Draft n MCS8 20MHz Ant. 4-1 + Ant. 4-3

Channel	Frequency	Power Density (dBm/3kHz)	Max. Limit (dBm/3kHz)	Result
1	2412 MHz	-6.44	8.00	Complies
6	2437 MHz	-1.21	8.00	Complies
11	2462 MHz	-6.49	8.00	Complies

Configuration Draft n MCS8 40MHz Ant. 4-1 + Ant. 4-3

Channel	Frequency	Power Density (dBm/3kHz)	Max. Limit (dBm/3kHz)	Result
3	2422 MHz	-12.69	8.00	Complies
6	2437 MHz	-9.37	8.00	Complies
9	2452 MHz	-13.17	8.00	Complies

For 5GHz Band

Configuration 11a Draft n MCS8 20MHz Ant. 4-1 + Ant. 4-3

Channel	Frequency	Power Density (dBm/3kHz)	Max. Limit (dBm/3kHz)	Result
149	5745 MHz	-2.65	8.00	Complies
157	5785 MHz	-2.66	8.00	Complies
165	5825 MHz	-2.31	8.00	Complies

Configuration 11a Draft n MCS8 40MHz Ant. 4-1 + Ant. 4-3

Channel	Frequency	Power Density (dBm/3kHz)	Max. Limit (dBm/3kHz)	Result
151	5755 MHz	-4.70	8.00	Complies
159	5795 MHz	-3.96	8.00	Complies

Temperature	21°C	Humidity	56%
Test Engineer	Johnson Chang	Configurations	802.11a/b/g / Antenna 4

Configuration IEEE 802.11b Ant. 4-1 + Ant. 4-3

Channel	Frequency	Power Density (dBm/3kHz)	Max. Limit (dBm/3kHz)	Result
1	2412 MHz	3.75	8.00	Complies
6	2437 MHz	4.23	8.00	Complies
11	2462 MHz	3.70	8.00	Complies

Configuration IEEE 802.11g Ant. 4-1 + Ant. 4-3

Channel	Frequency	Power Density (dBm/3kHz)	Max. Limit (dBm/3kHz)	Result
1	2412 MHz	-3.61	8.00	Complies
6	2437 MHz	1.04	8.00	Complies
11	2462 MHz	-2.50	8.00	Complies

Configuration IEEE 802.11a Ant. 4-1 + Ant. 4-3

Channel	Frequency	Power Density (dBm/3kHz)	Max. Limit (dBm/3kHz)	Result
149	5745 MHz	2.03	8.00	Complies
157	5785 MHz	0.91	8.00	Complies
165	5825 MHz	0.28	8.00	Complies

<For Antenna 5>:

Temperature	21°C	Humidity	56%
Test Engineer	Johnson Chang	Configurations	Draft n / Antenna 5

For 2.4GHz Band

Configuration Draft n MCS8 20MHz Ant. 5-1 + Ant. 5-3

Channel	Frequency	Power Density (dBm/3kHz)	Max. Limit (dBm/3kHz)	Result
1	2412 MHz	-8.82	8.00	Complies
6	2437 MHz	-1.16	8.00	Complies
11	2462 MHz	-8.75	8.00	Complies

Configuration Draft n MCS8 40MHz Ant. 5-1 + Ant. 5-3

Channel	Frequency	Power Density (dBm/3kHz)	Max. Limit (dBm/3kHz)	Result
3	2422 MHz	-13.32	8.00	Complies
6	2437 MHz	-11.84	8.00	Complies
9	2452 MHz	-14.55	8.00	Complies

For 5GHz Band

Configuration 11a Draft n MCS8 20MHz Ant. 5-1 + Ant. 5-3

Channel	Frequency	Power Density (dBm/3kHz)	Max. Limit (dBm/3kHz)	Result
149	5745 MHz	-2.65	8.00	Complies
157	5785 MHz	-2.66	8.00	Complies
165	5825 MHz	-2.31	8.00	Complies

Configuration 11a Draft n MCS8 40MHz Ant. 5-1 + Ant. 5-3

Channel	Frequency	Power Density (dBm/3kHz)	Max. Limit (dBm/3kHz)	Result
151	5755 MHz	-4.70	8.00	Complies
159	5795 MHz	-3.96	8.00	Complies

Temperature	21°C	Humidity	56%
Test Engineer	Johnson Chang	Configurations	802.11a/b/g / Antenna 5

Configuration IEEE 802.11b Ant. 5-1 + Ant. 5-3

Channel	Frequency	Power Density (dBm/3kHz)	Max. Limit (dBm/3kHz)	Result
1	2412 MHz	0.30	8.00	Complies
6	2437 MHz	3.20	8.00	Complies
11	2462 MHz	1.54	8.00	Complies

Configuration IEEE 802.11g Ant. 5-1 + Ant. 5-3

Channel	Frequency	Power Density (dBm/3kHz)	Max. Limit (dBm/3kHz)	Result
1	2412 MHz	-4.26	8.00	Complies
6	2437 MHz	-0.83	8.00	Complies
11	2462 MHz	-3.54	8.00	Complies

Configuration IEEE 802.11a Ant. 5-1 + Ant. 5-3

Channel	Frequency	Power Density (dBm/3kHz)	Max. Limit (dBm/3kHz)	Result
149	5745 MHz	2.03	8.00	Complies
157	5785 MHz	0.91	8.00	Complies
165	5825 MHz	0.28	8.00	Complies

<For Antenna 6>:

Temperature	21°C	Humidity	56%
Test Engineer	Johnson Chang	Configurations	Draft n / Antenna 6

For 2.4GHz Band

Configuration Draft n MCS8 20MHz Ant. 6-1 + Ant. 6-3

Channel	Frequency	Power Density (dBm/3kHz)	Max. Limit (dBm/3kHz)	Result
1	2412 MHz	-7.74	8.00	Complies
6	2437 MHz	-1.21	8.00	Complies
11	2462 MHz	-5.77	8.00	Complies

Configuration Draft n MCS8 40MHz Ant. 6-1 + Ant. 6-3

Channel	Frequency	Power Density (dBm/3kHz)	Max. Limit (dBm/3kHz)	Result
3	2422 MHz	-13.32	8.00	Complies
6	2437 MHz	-11.43	8.00	Complies
9	2452 MHz	-12.95	8.00	Complies

For 5GHz Band

Configuration 11a Draft n MCS8 20MHz Ant. 6-1 + Ant. 6-3

Channel	Frequency	Power Density (dBm/3kHz)	Max. Limit (dBm/3kHz)	Result
149	5745 MHz	-2.65	8.00	Complies
157	5785 MHz	-2.66	8.00	Complies
165	5825 MHz	-2.31	8.00	Complies

Configuration 11a Draft n MCS8 40MHz Ant. 6-1 + Ant. 6-3

Channel	Frequency	Power Density (dBm/3kHz)	Max. Limit (dBm/3kHz)	Result
151	5755 MHz	-4.70	8.00	Complies
159	5795 MHz	-3.96	8.00	Complies

Temperature	21°C	Humidity	56%
Test Engineer	Johnson Chang	Configurations	802.11a/b/g / Antenna 6

Configuration IEEE 802.11b Ant. 6-1 + Ant. 6-3

Channel	Frequency	Power Density (dBm/3kHz)	Max. Limit (dBm/3kHz)	Result
1	2412 MHz	1.17	8.00	Complies
6	2437 MHz	3.79	8.00	Complies
11	2462 MHz	3.59	8.00	Complies

Configuration IEEE 802.11g Ant. 6-1 + Ant. 6-3

Channel	Frequency	Power Density (dBm/3kHz)	Max. Limit (dBm/3kHz)	Result
1	2412 MHz	-2.08	8.00	Complies
6	2437 MHz	1.04	8.00	Complies
11	2462 MHz	-2.84	8.00	Complies

Configuration IEEE 802.11a Ant. 6-1 + Ant. 6-3

Channel	Frequency	Power Density (dBm/3kHz)	Max. Limit (dBm/3kHz)	Result
149	5745 MHz	2.03	8.00	Complies
157	5785 MHz	0.91	8.00	Complies
165	5825 MHz	0.28	8.00	Complies

<For Antenna 1>:

Power Density Plot on Configuration Drafft n MCS8 20MHz Ant. 1-1 + Ant. 1-3 / 2412 MHz

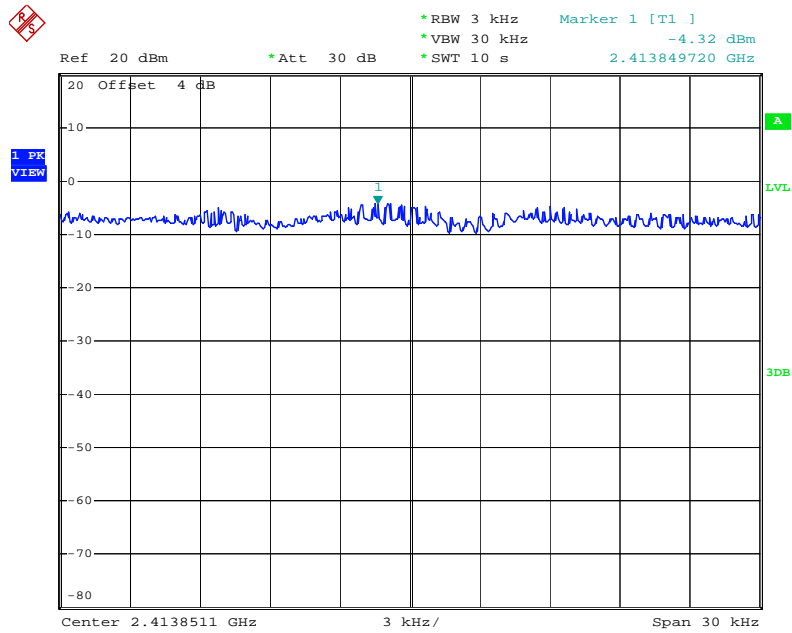

Date: 15.SEP.2009 23:21:00

Power Density Plot on Configuration Drafft n MCS8 20MHz Ant. 1-1 + Ant. 1-3 / 2437 MHz

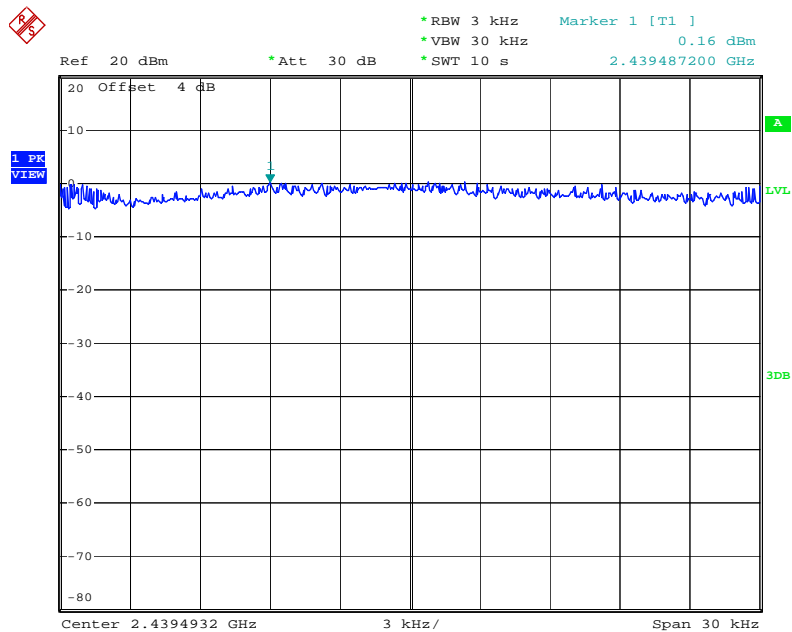

Date: 15.SEP.2009 23:28:42

Power Density Plot on Configuration Drafft n MCS8 20MHz Ant. 1-1 + Ant. 1-3 / 2462 MHz

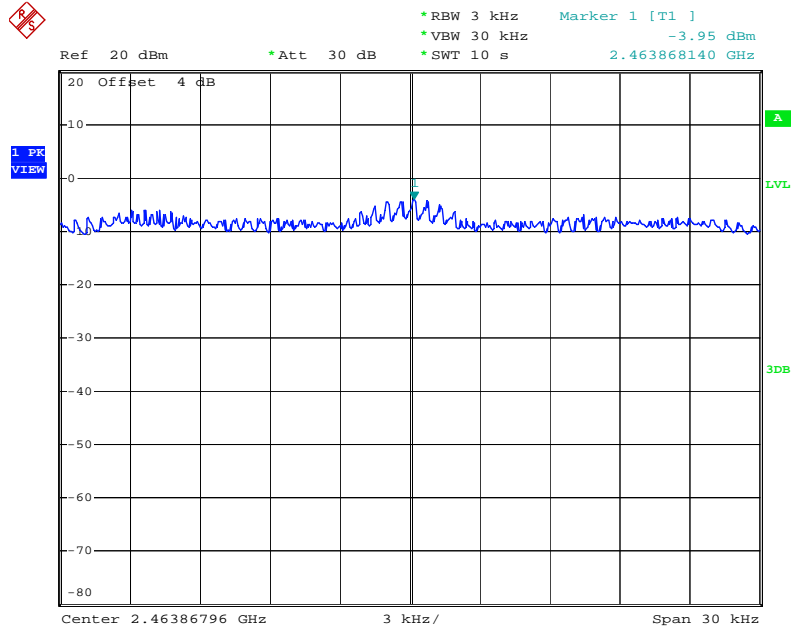

Date: 15.SEP.2009 23:37:27

Power Density Plot on Configuration Drafft n MCS8 40MHz Ant. 1-1 + Ant. 1-3 / 2422 MHz

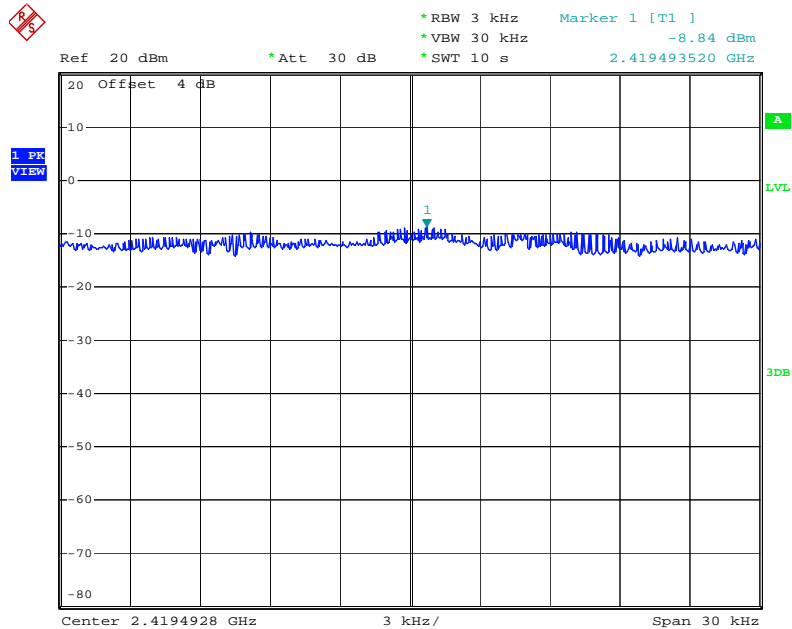

Date: 15.SEP.2009 23:49:20

Power Density Plot on Configuration Drafft n MCS8 40MHz Ant. 1-1 + Ant. 1-3 / 2437 MHz

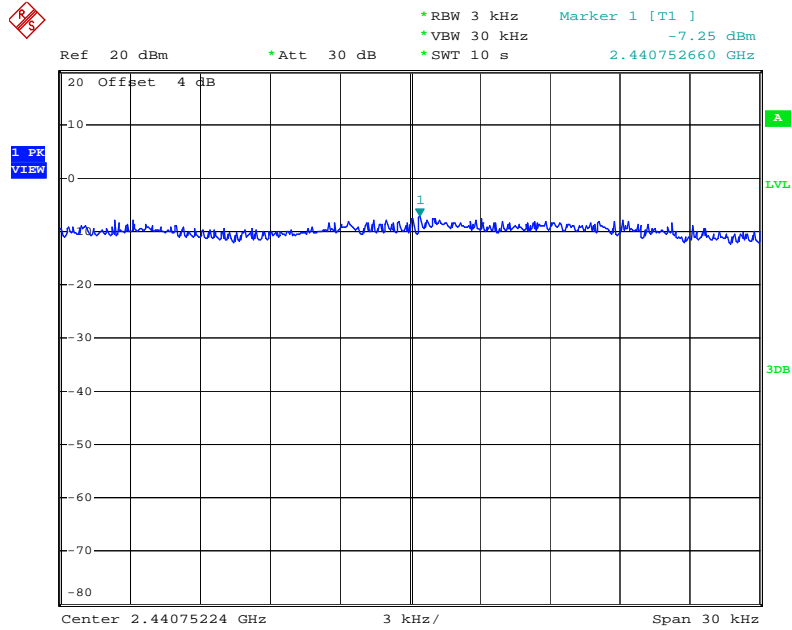

Date: 15.SEP.2009 23:55:01

Power Density Plot on Configuration Drafft n MCS8 40MHz Ant. 1-1 + Ant. 1-3 / 2452 MHz

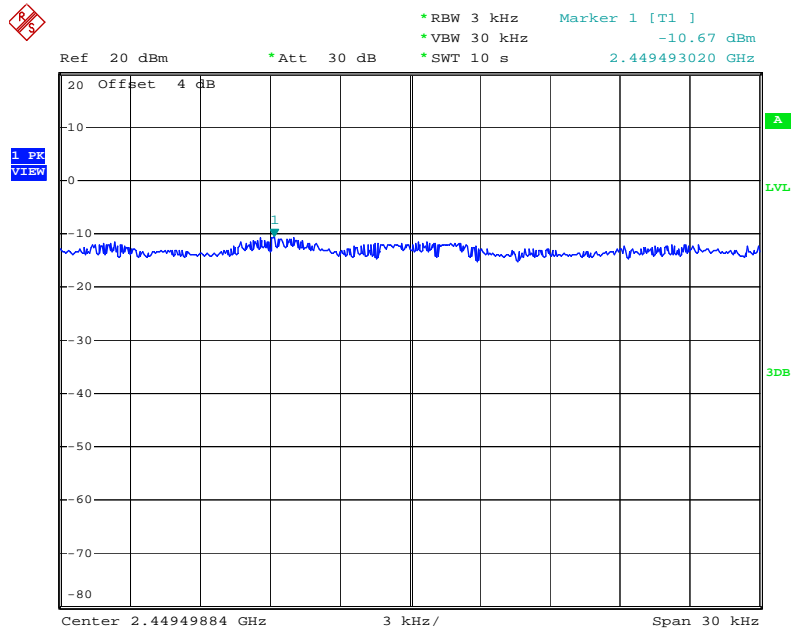

Date: 16.SEP.2009 00:06:23

Power Density Plot on Configuration 11a Draft n MCS8 20MHz Ant. 1-1 + Ant. 1-3 / 5745 MHz

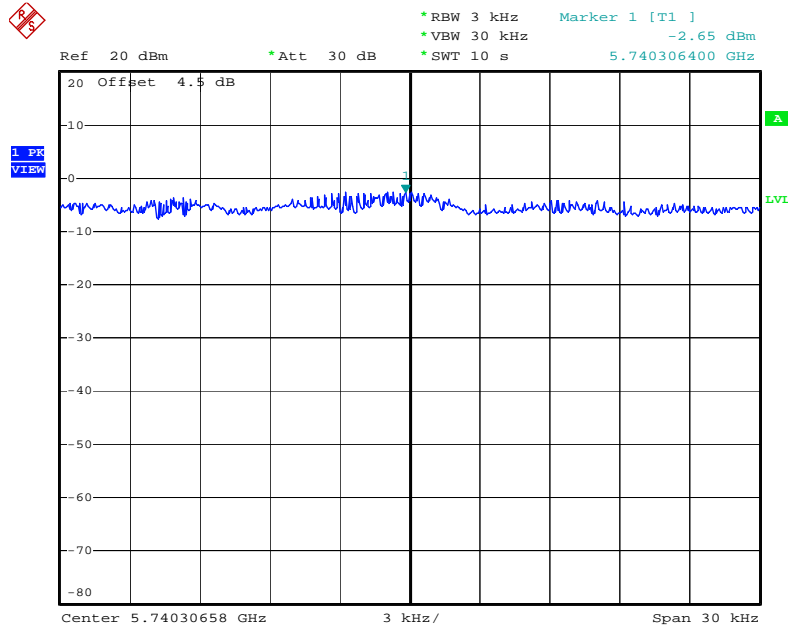

Date: 16.SEP.2009 18:18:23

Power Density Plot on Configuration 11a Draft n MCS8 20MHz Ant. 1-1 + Ant. 1-3 / 5785 MHz

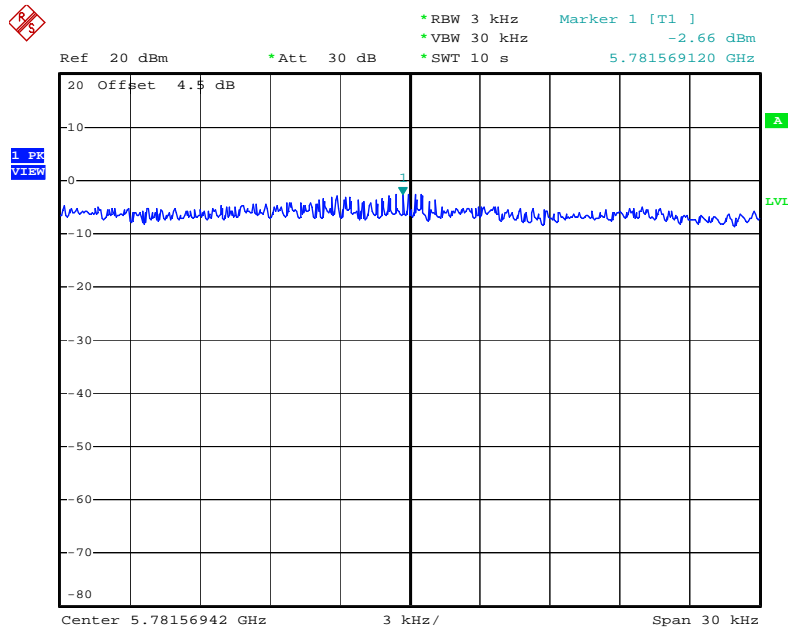

Date: 16.SEP.2009 18:15:47

Power Density Plot on Configuration 11a Draft n MCS8 20MHz Ant. 1-1 + Ant. 1-3 / 5825 MHz

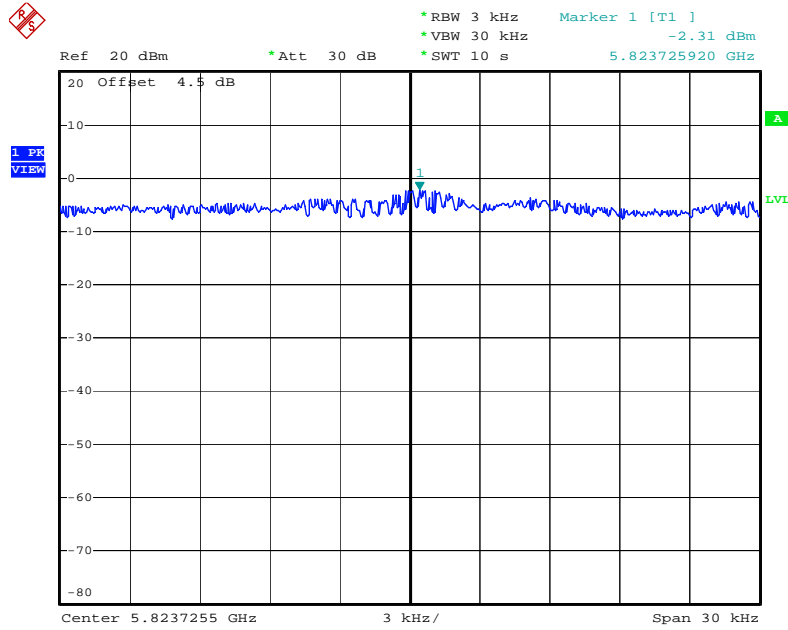

Date: 16.SEP.2009 18:13:35

Power Density Plot on Configuration 11a Draft n MCS8 40MHz Ant. 1-1 + Ant. 1-3 / 5755 MHz

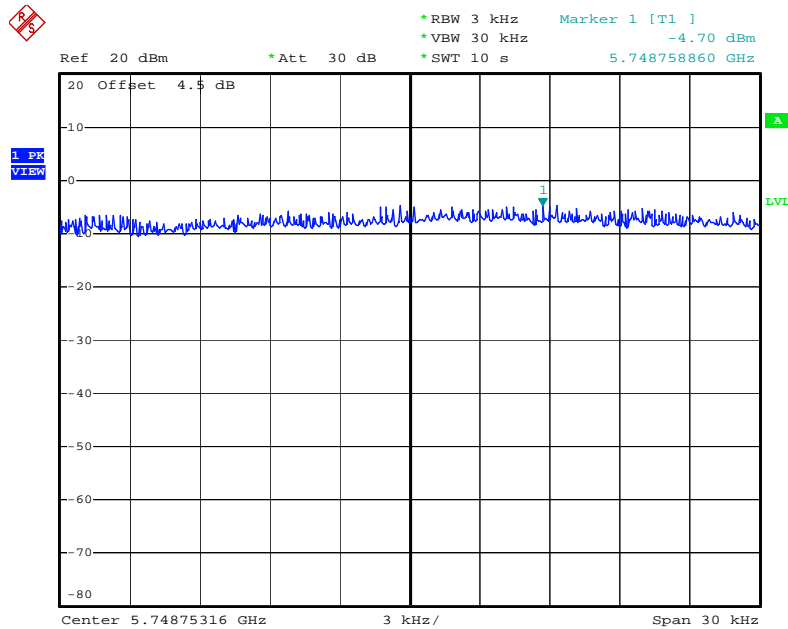

Date: 16.SEP.2009 19:20:21

Power Density Plot on Configuration 11a Draft n MCS8 40MHz Ant. 1-1 + Ant. 1-3 / 5795 MHz

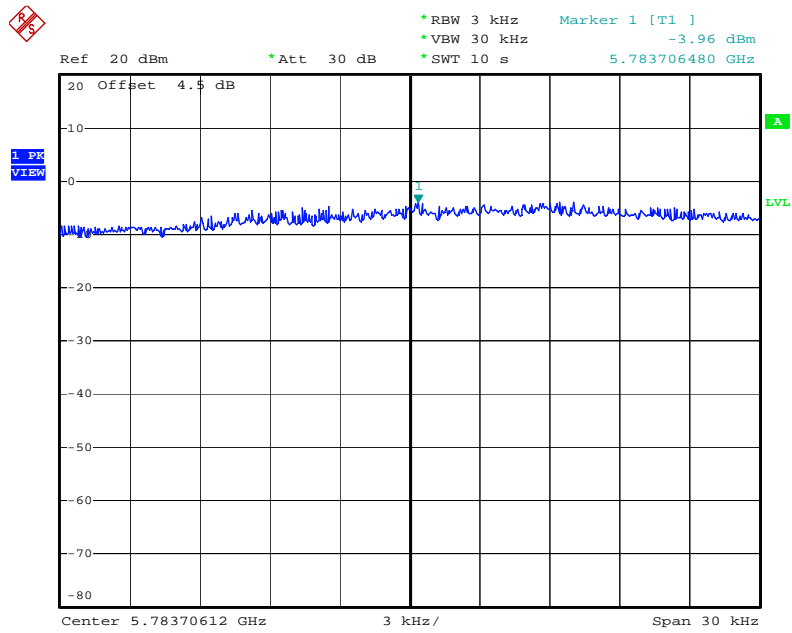

Date: 16.SEP.2009 19:23:47

Power Density Plot on Configuration IEEE 802.11b Ant. 1-1 + Ant. 1-3 / 2412 MHz

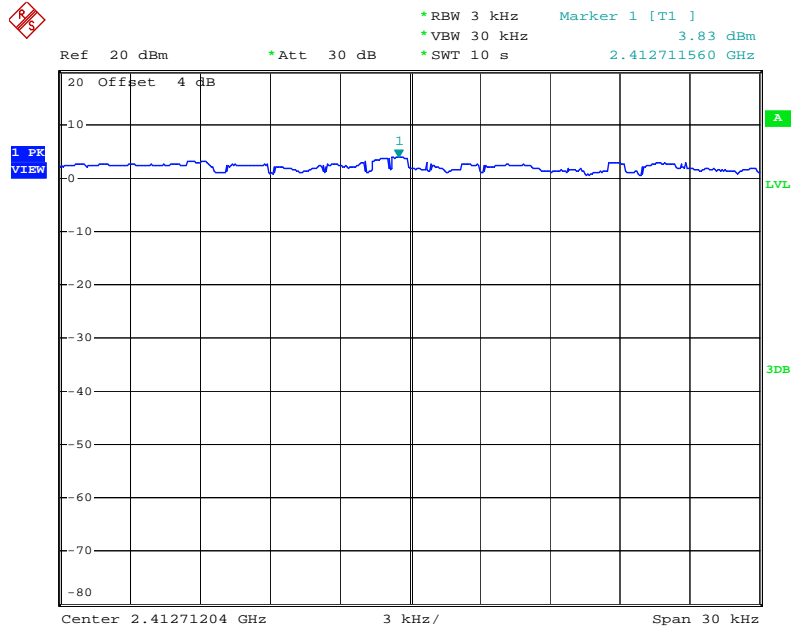

Date: 15.SEP.2009 22:26:22

Power Density Plot on Configuration IEEE 802.11b Ant. 1-1 + Ant. 1-3 / 2437 MHz

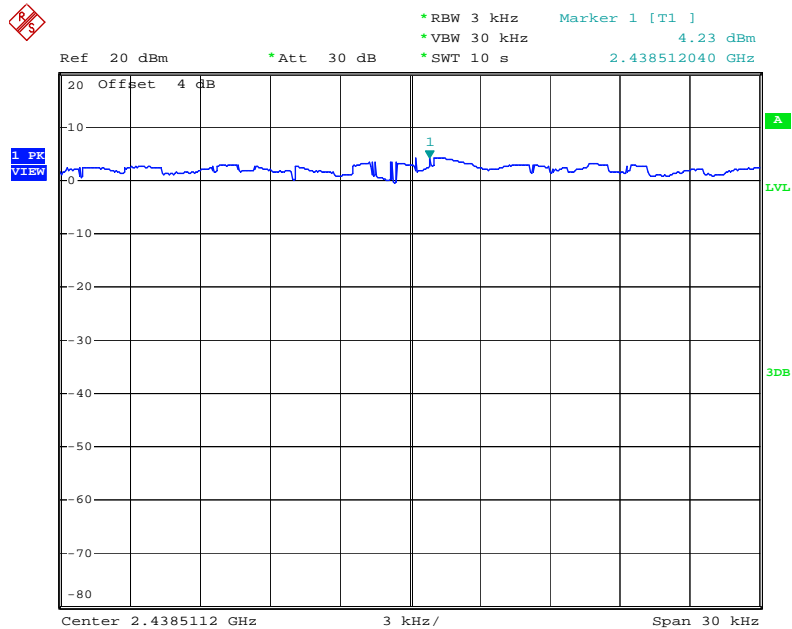

Date: 15.SEP.2009 22:32:29

Power Density Plot on Configuration IEEE 802.11b Ant. 1-1 + Ant. 1-3 / 2462 MHz

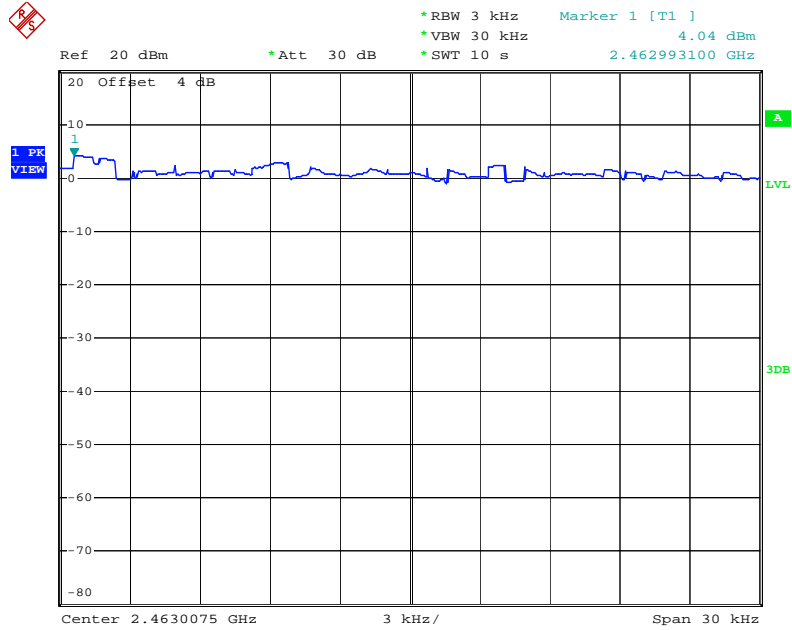

Date: 15.SEP.2009 22:44:20

Power Density Plot on Configuration IEEE 802.11g Ant. 1-1 + Ant. 1-3 / 2412 MHz

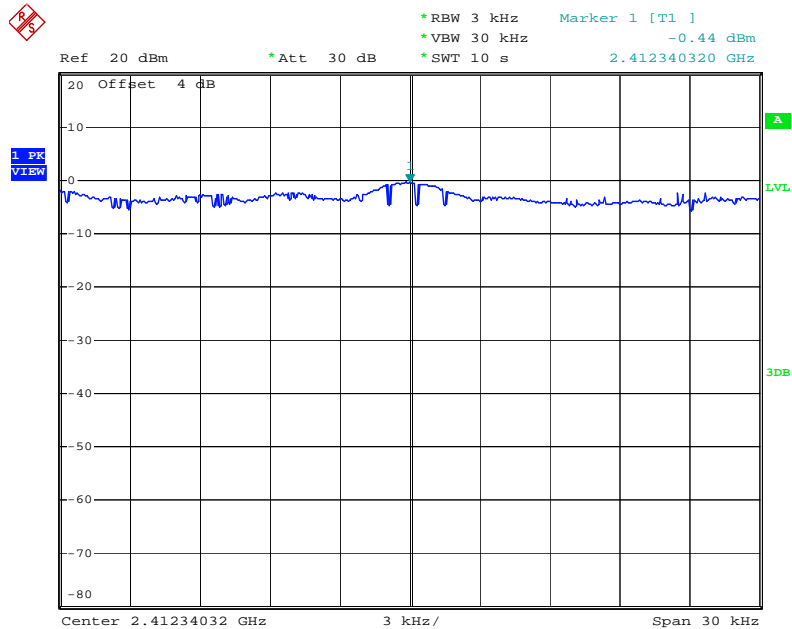

Date: 15.SEP.2009 22:46:50

Power Density Plot on Configuration IEEE 802.11g Ant. 1-1 + Ant. 1-3 / 2437 MHz

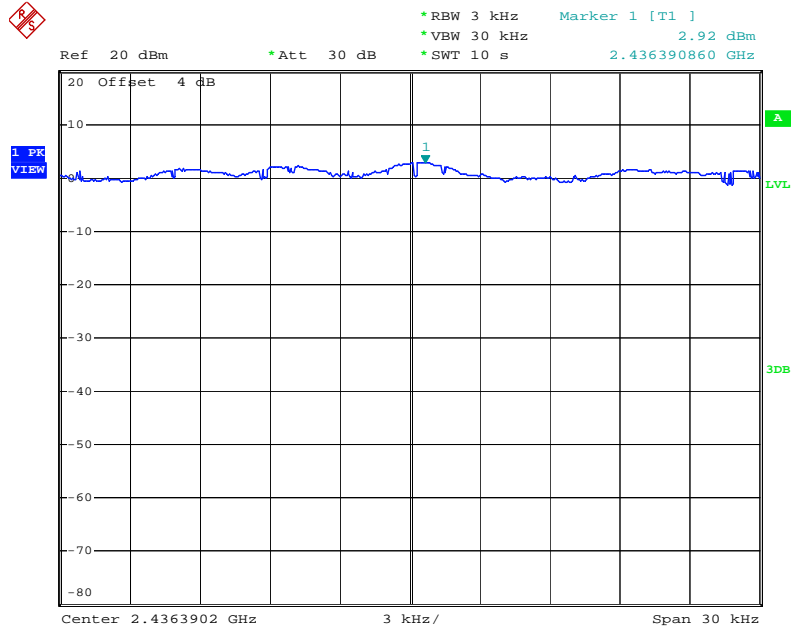

Date: 15.SEP.2009 22:59:58

Power Density Plot on Configuration IEEE 802.11g Ant. 1-1 + Ant. 1-3 / 2462 MHz

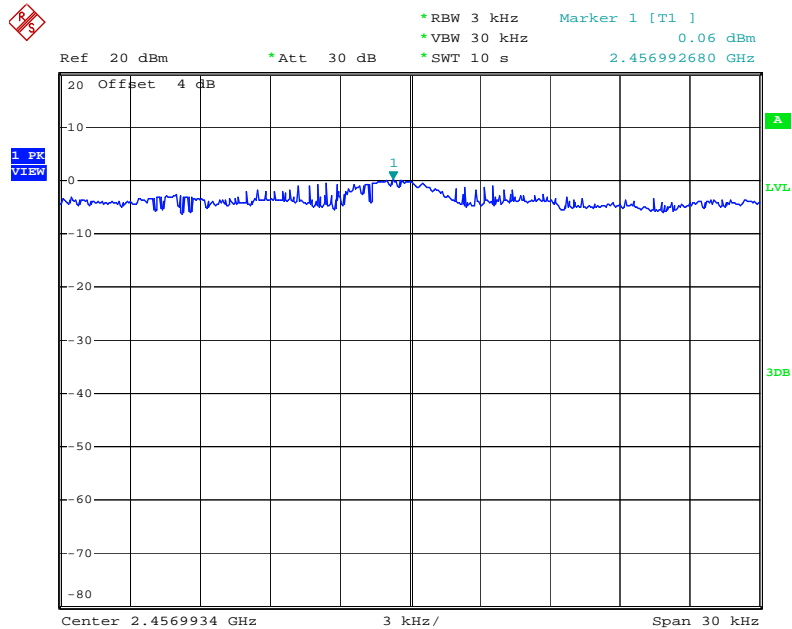

Date: 15.SEP.2009 23:13:33

Power Density Plot on Configuration IEEE 802.11a Ant. 1-1 + Ant. 1-3 / 5745 MHz

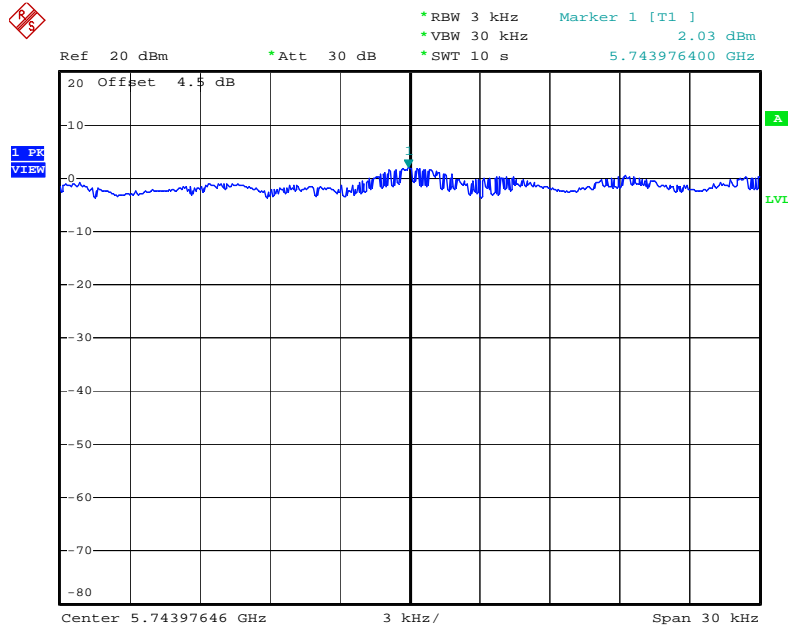

Date: 16.SEP.2009 18:06:04

Power Density Plot on Configuration IEEE 802.11a Ant. 1-1 + Ant. 1-3 / 5785 MHz

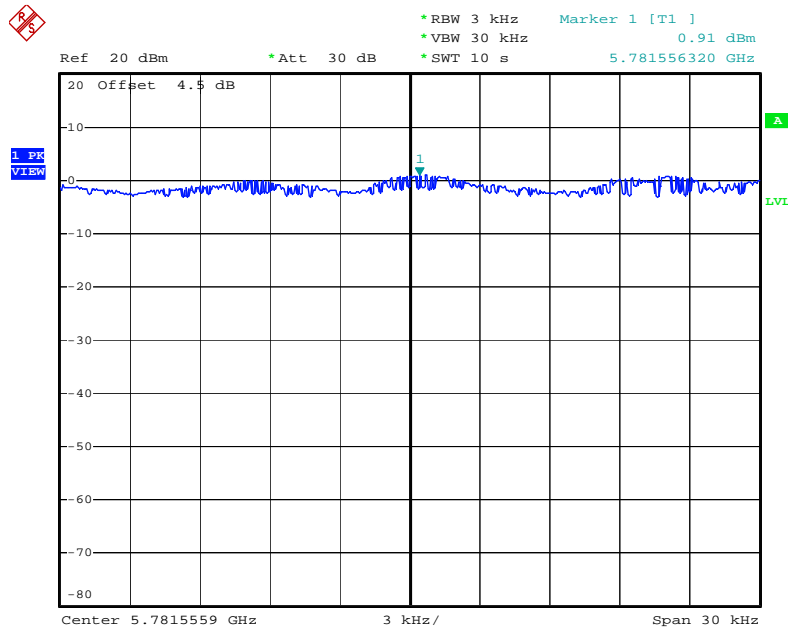

Date: 16.SEP.2009 18:08:36

Power Density Plot on Configuration IEEE 802.11a Ant. 1-1 + Ant. 1-3 / 5825 MHz

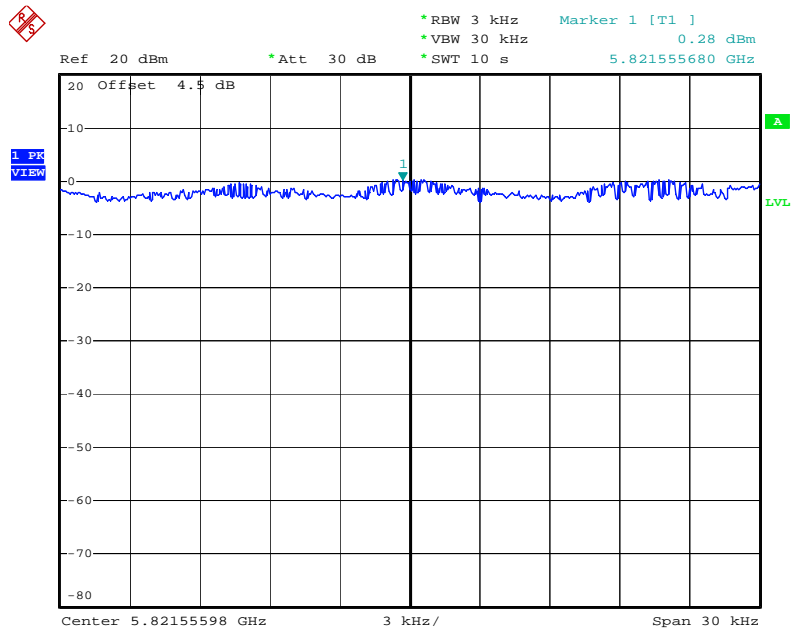

Date: 16.SEP.2009 18:10:27

<For Antenna 2>:

Power Density Plot on Configuration Drafft n MCS8 20MHz Ant. 2-1 + Ant. 2-3 / 2412 MHz

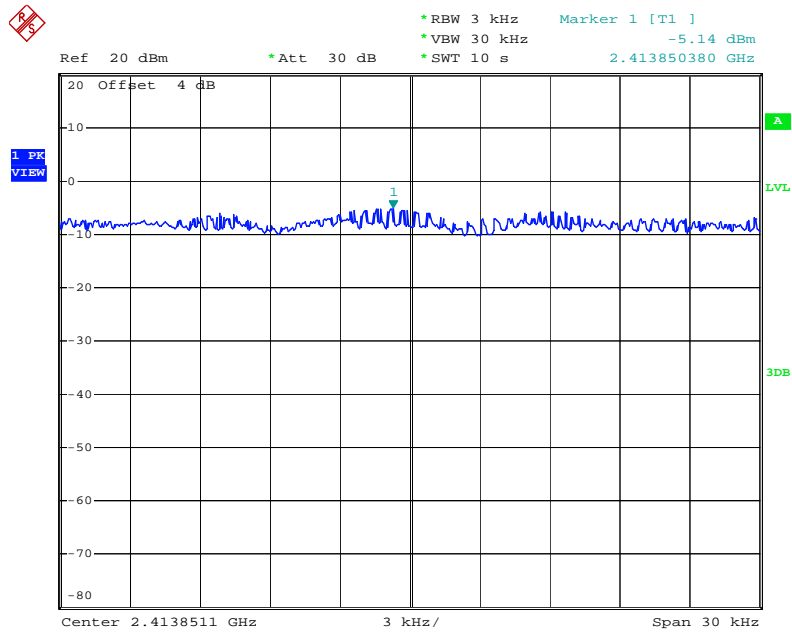

Date: 15.SEP.2009 23:20:19

Power Density Plot on Configuration Drafft n MCS8 20MHz Ant. 2-1 + Ant. 2-3 / 2437 MHz

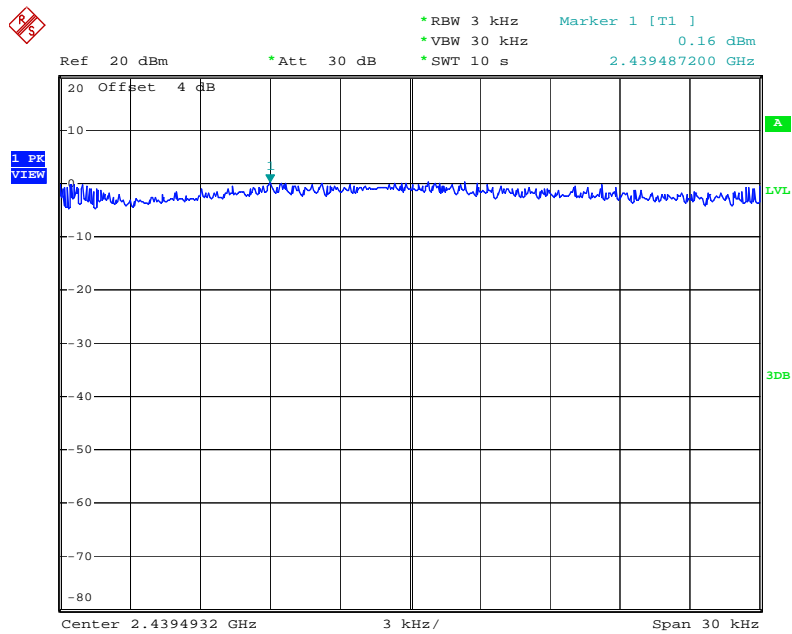

Date: 15.SEP.2009 23:28:42

Power Density Plot on Configuration Drafft n MCS8 20MHz Ant. 2-1 + Ant. 2-3 / 2462 MHz

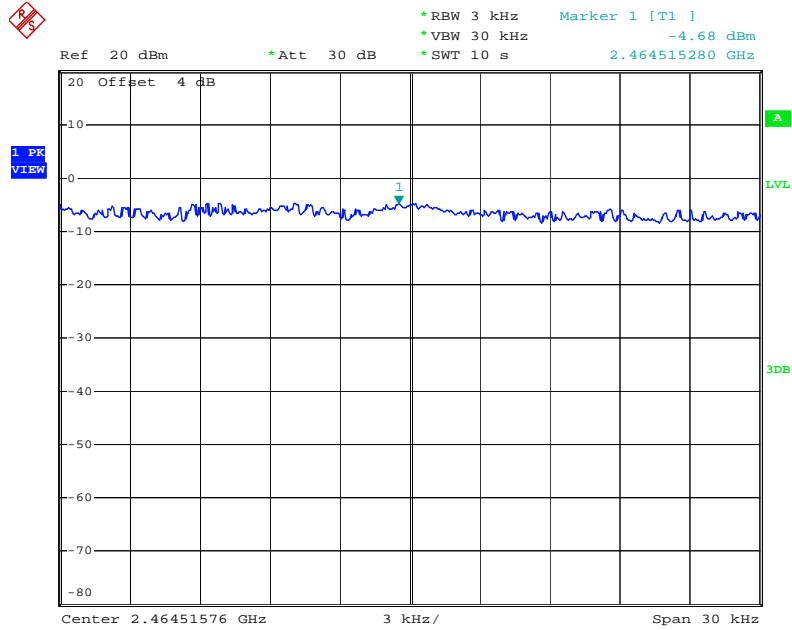

Date: 15.SEP.2009 23:40:15

Power Density Plot on Configuration Drafft n MCS8 40MHz Ant. 2-1 + Ant. 2-3 / 2422 MHz

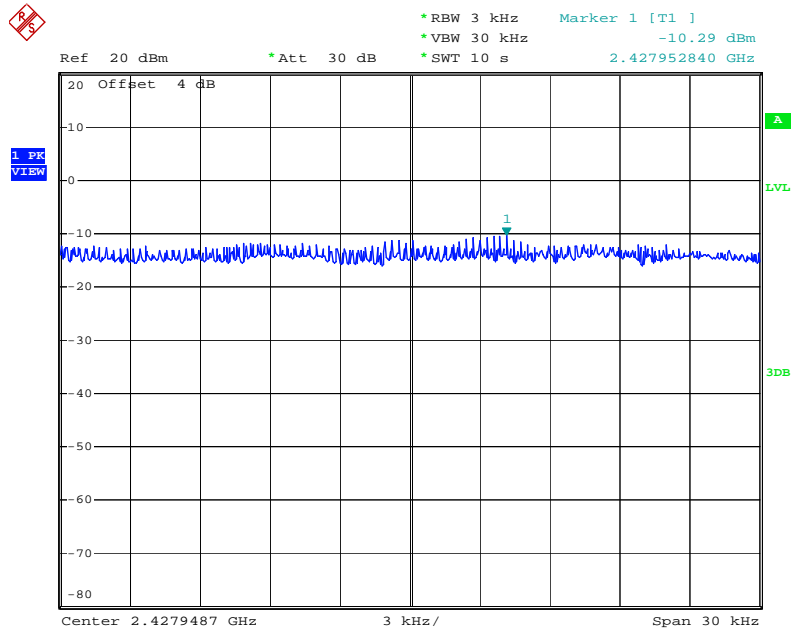

Date: 15.SEP.2009 23:47:01

Power Density Plot on Configuration Drafft n MCS8 40MHz Ant. 2-1 + Ant. 2-3 / 2437 MHz

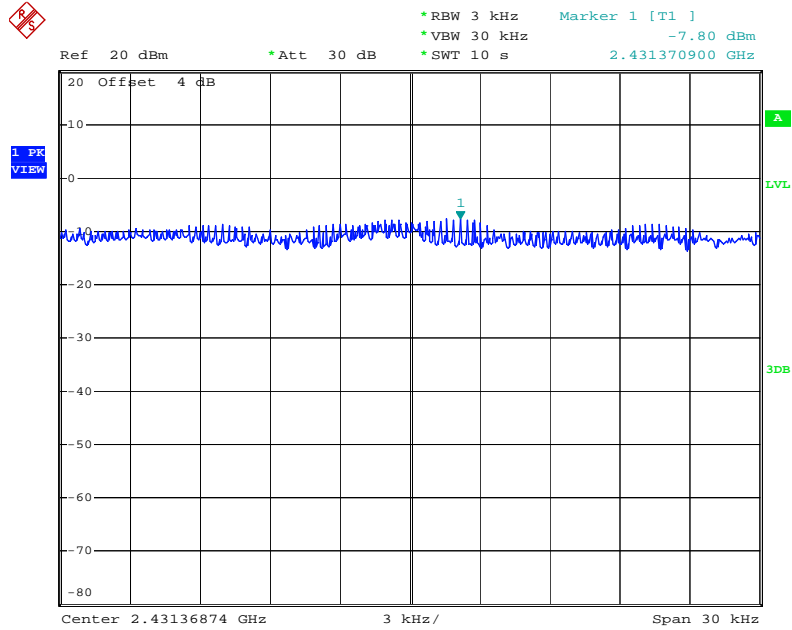

Date: 15.SEP.2009 23:57:17

Power Density Plot on Configuration Drafft n MCS8 40MHz Ant. 2-1 + Ant. 2-3 / 2452 MHz

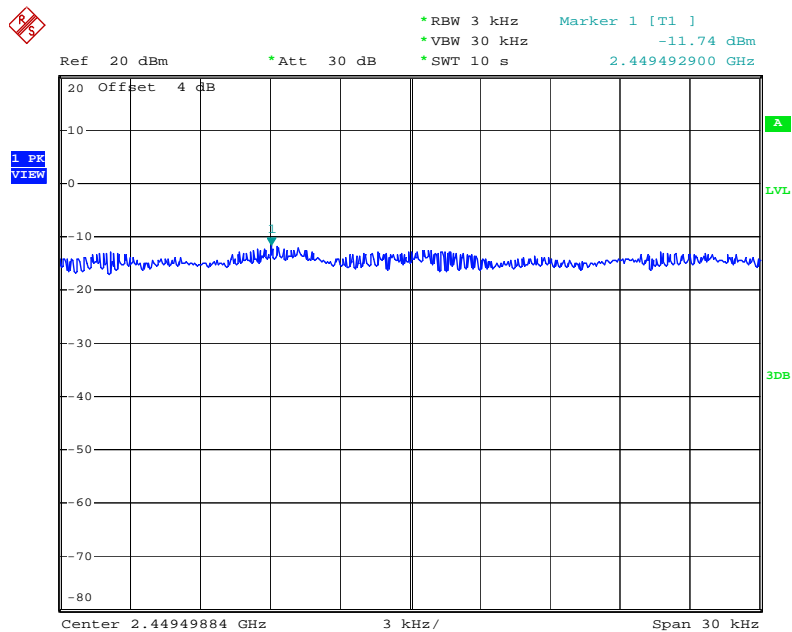

Date: 16.SEP.2009 00:05:17

Power Density Plot on Configuration 11a Draft n MCS8 20MHz Ant. 2-1 + Ant. 2-3 / 5745 MHz

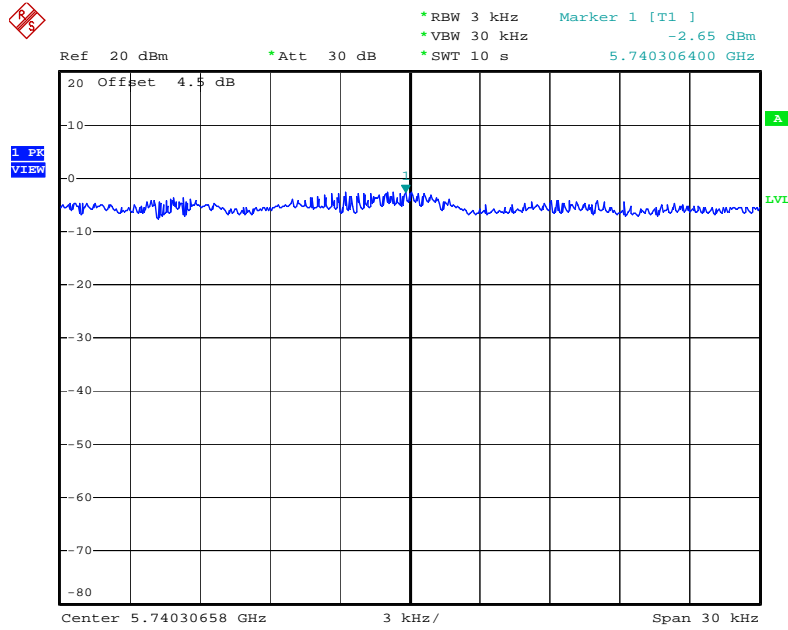

Date: 16.SEP.2009 18:18:23

Power Density Plot on Configuration 11a Draft n MCS8 20MHz Ant. 2-1 + Ant. 2-3 / 5785 MHz

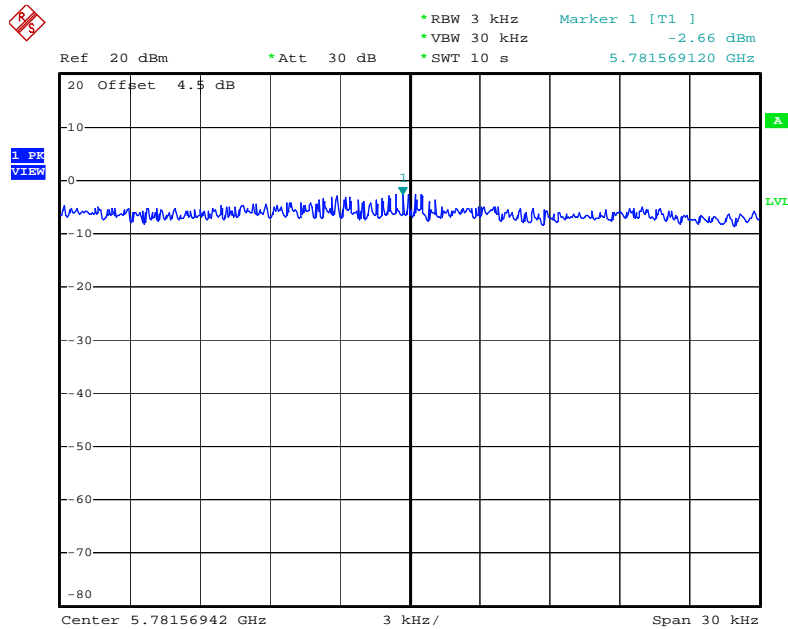

Date: 16.SEP.2009 18:15:47

Power Density Plot on Configuration 11a Draft n MCS8 20MHz Ant. 2-1 + Ant. 2-3 / 5825 MHz

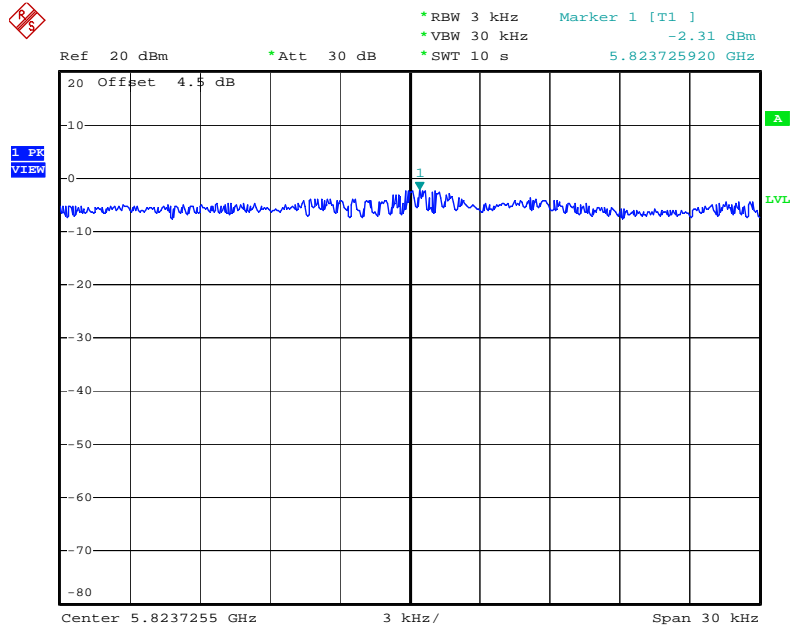

Date: 16.SEP.2009 18:13:35

Power Density Plot on Configuration 11a Draft n MCS8 40MHz Ant. 2-1 + Ant. 2-3 / 5755 MHz

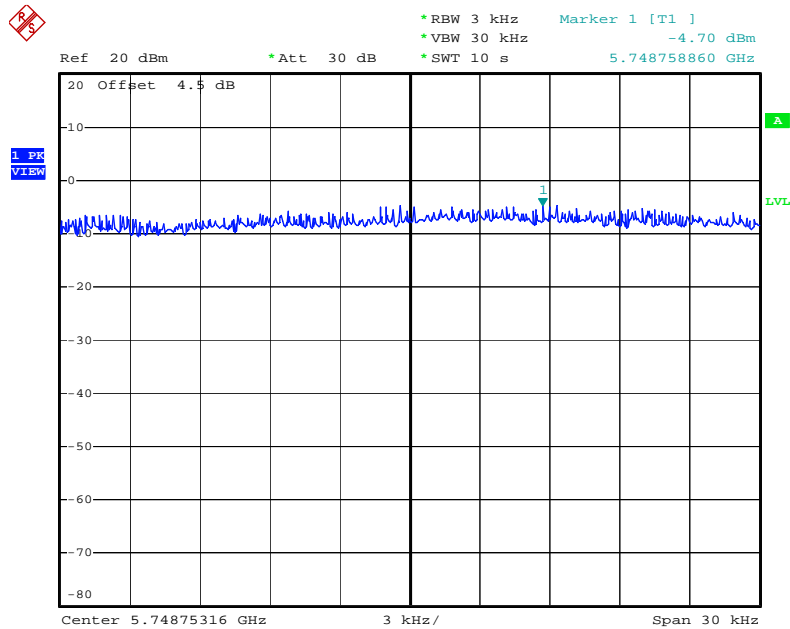

Date: 16.SEP.2009 19:20:21

Power Density Plot on Configuration 11a Draft n MCS8 40MHz Ant. 2-1 + Ant. 2-3 / 5795 MHz

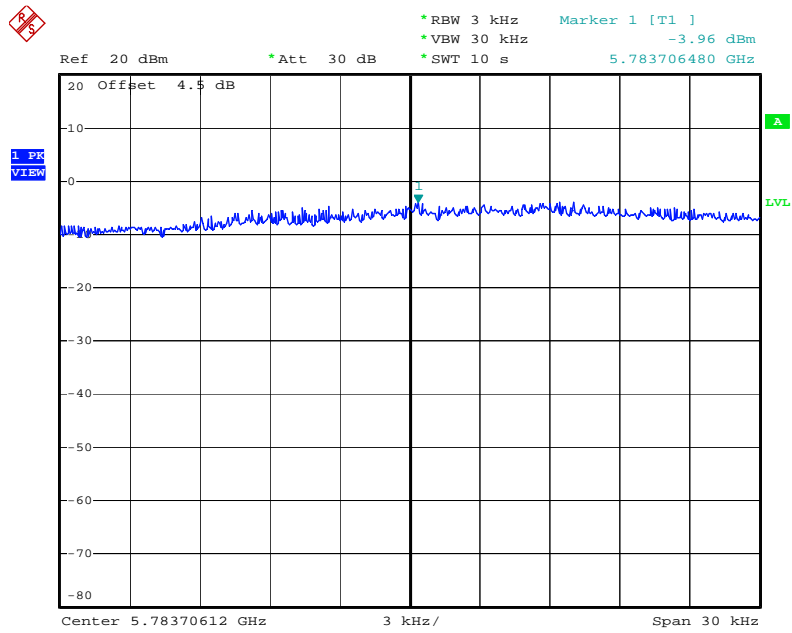

Date: 16.SEP.2009 19:23:47

Power Density Plot on Configuration IEEE 802.11b Ant. 2-1 + Ant. 2-3 / 2412 MHz

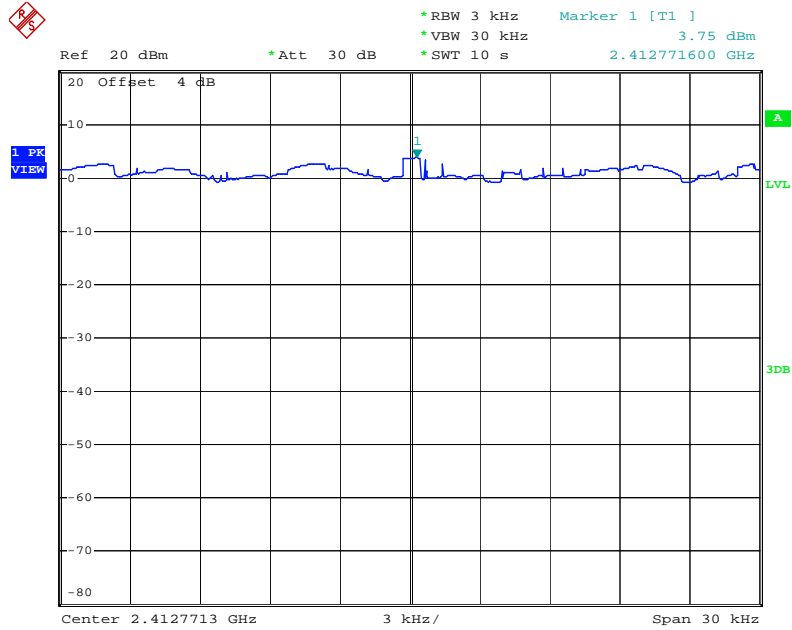

Date: 15.SEP.2009 22:24:22

Power Density Plot on Configuration IEEE 802.11b Ant. 2-1 + Ant. 2-3 / 2437 MHz

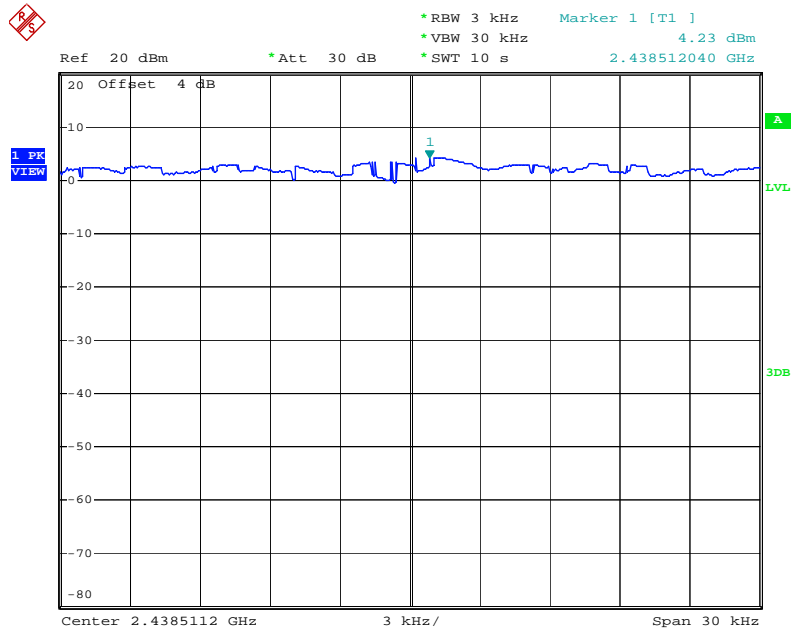

Date: 15.SEP.2009 22:32:29

Power Density Plot on Configuration IEEE 802.11b Ant. 2-1 + Ant. 2-3 / 2462 MHz

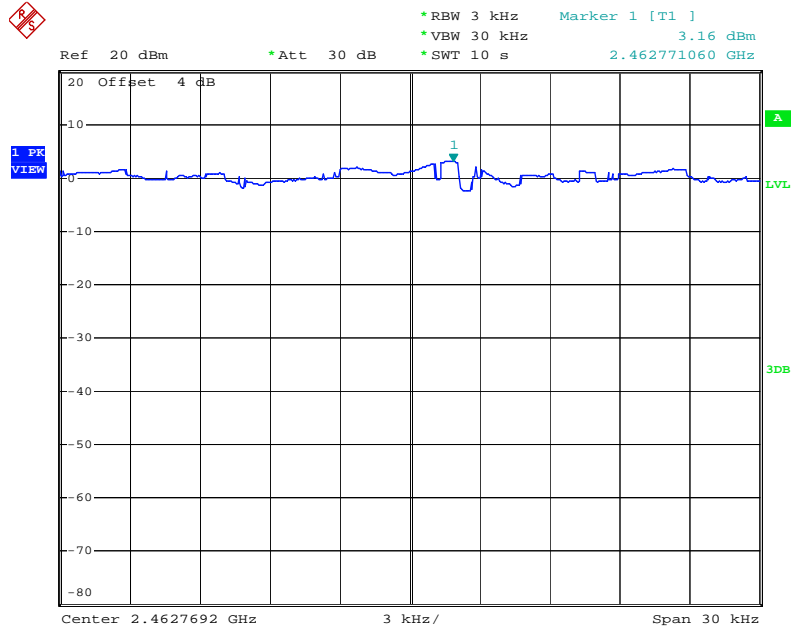

Date: 15.SEP.2009 22:37:12

Power Density Plot on Configuration IEEE 802.11g Ant. 2-1 + Ant. 2-3 / 2412 MHz

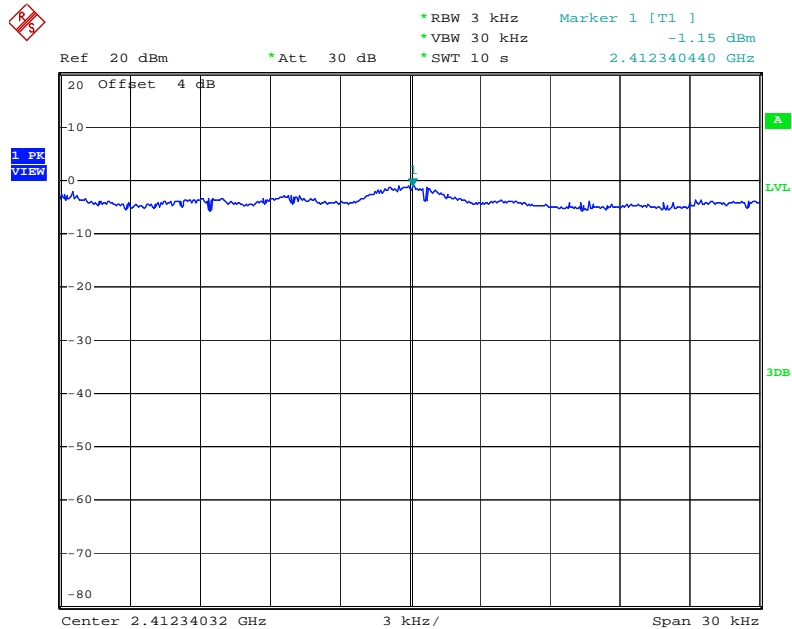

Date: 15.SEP.2009 22:48:08

Power Density Plot on Configuration IEEE 802.11g Ant. 2-1 + Ant. 2-3 / 2437 MHz

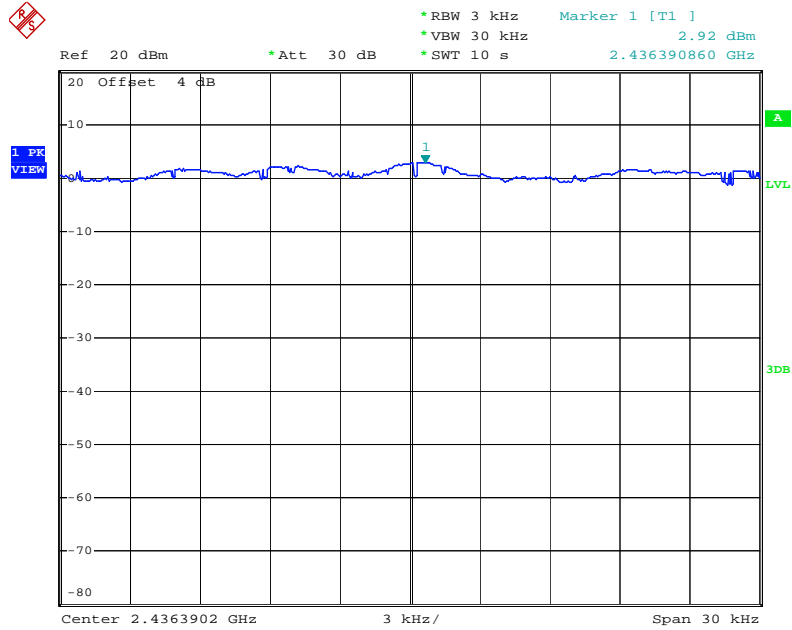

Date: 15.SEP.2009 22:59:58

Power Density Plot on Configuration IEEE 802.11g Ant. 2-1 + Ant. 2-3 / 2462 MHz

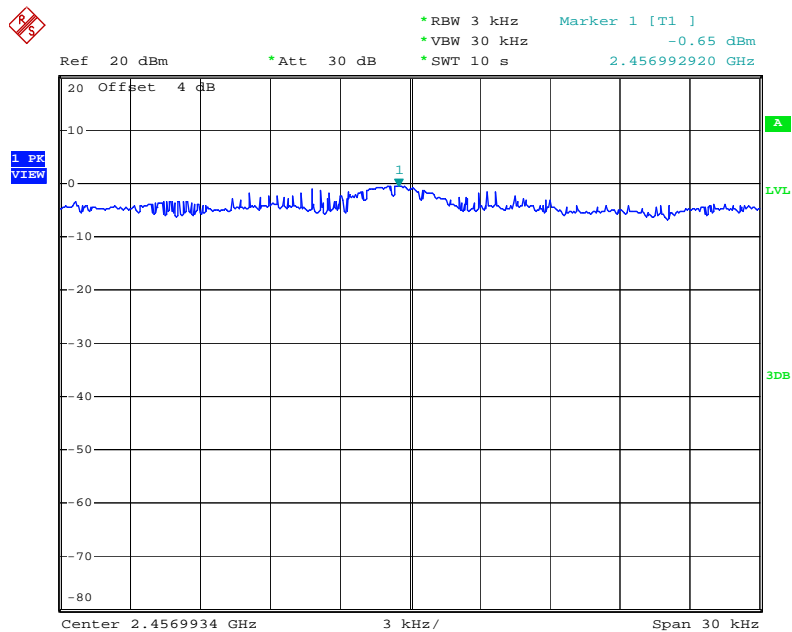

Date: 15.SEP.2009 23:12:51

Power Density Plot on Configuration IEEE 802.11a Ant. 2-1 + Ant. 2-3 / 5745 MHz

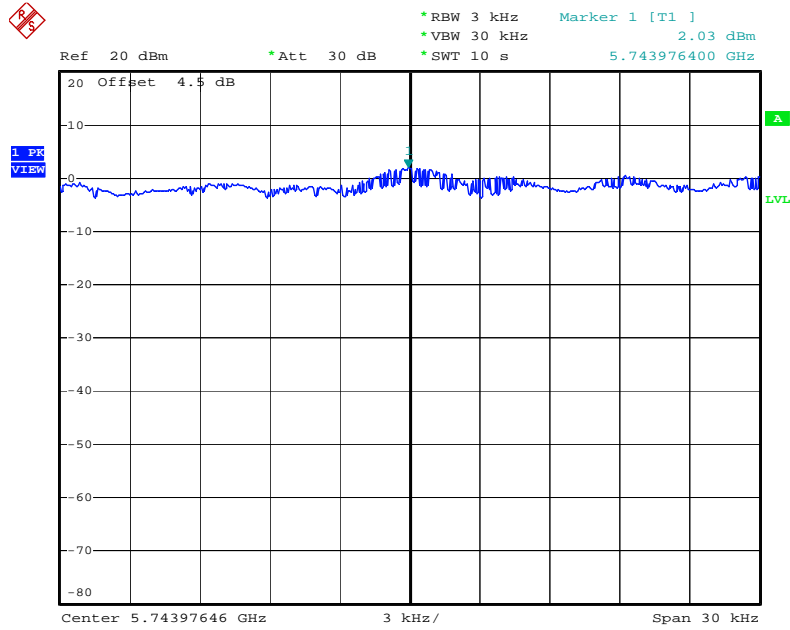

Date: 16.SEP.2009 18:06:04

Power Density Plot on Configuration IEEE 802.11a Ant. 2-1 + Ant. 2-3 / 5785 MHz

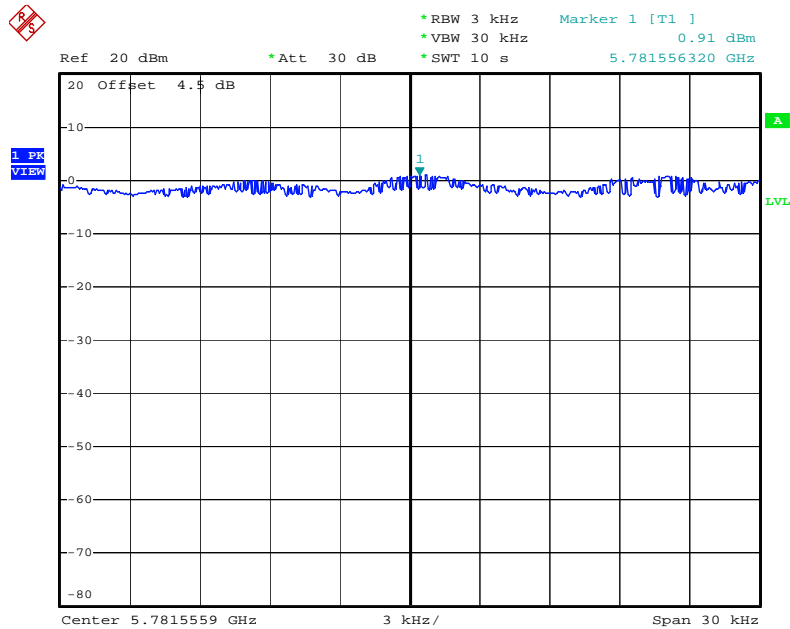

Date: 16.SEP.2009 18:08:36

Power Density Plot on Configuration IEEE 802.11a Ant. 2-1 + Ant. 2-3 / 5825 MHz

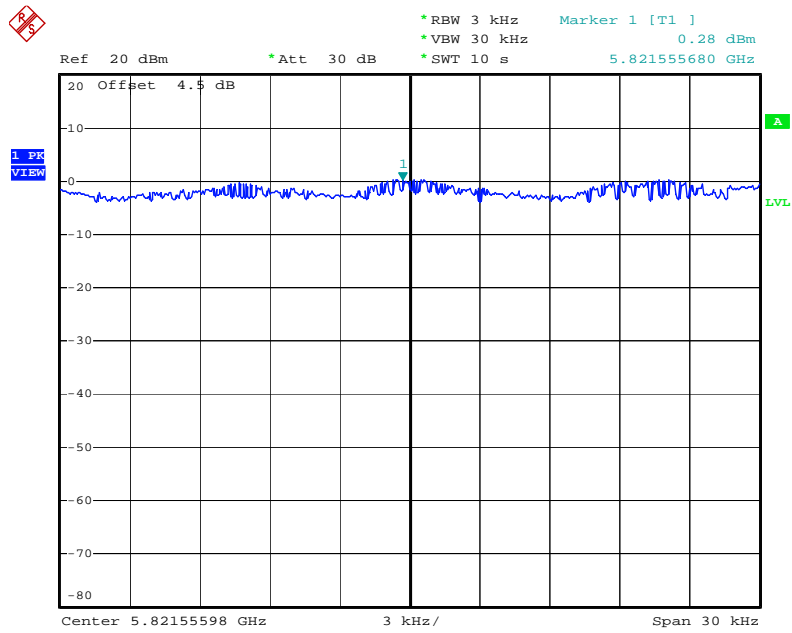

Date: 16.SEP.2009 18:10:27

<For Antenna 3>:

Power Density Plot on Configuration Drafft n MCS8 20MHz Ant. 3-1 + Ant. 3-3 / 2412 MHz

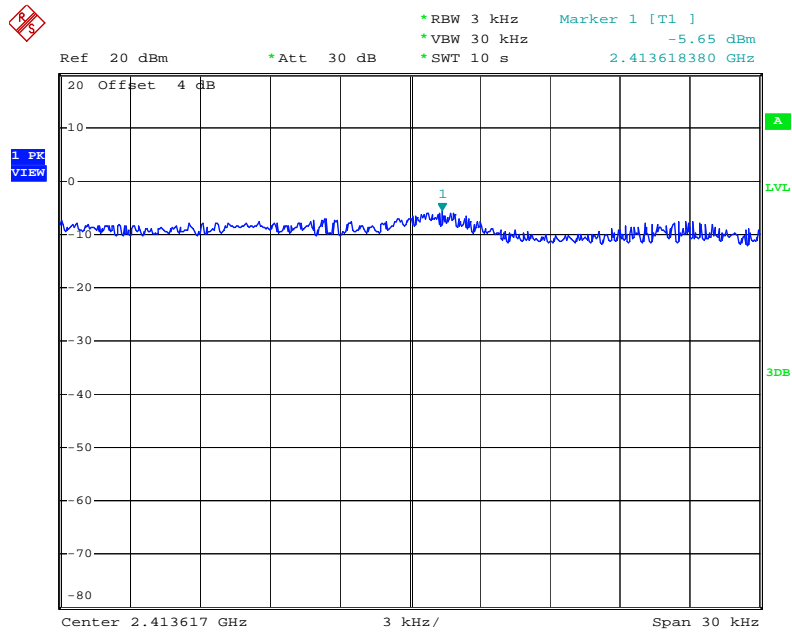

Date: 15.SEP.2009 23:19:02

Power Density Plot on Configuration Drafft n MCS8 20MHz Ant. 3-1 + Ant. 3-3 / 2437 MHz

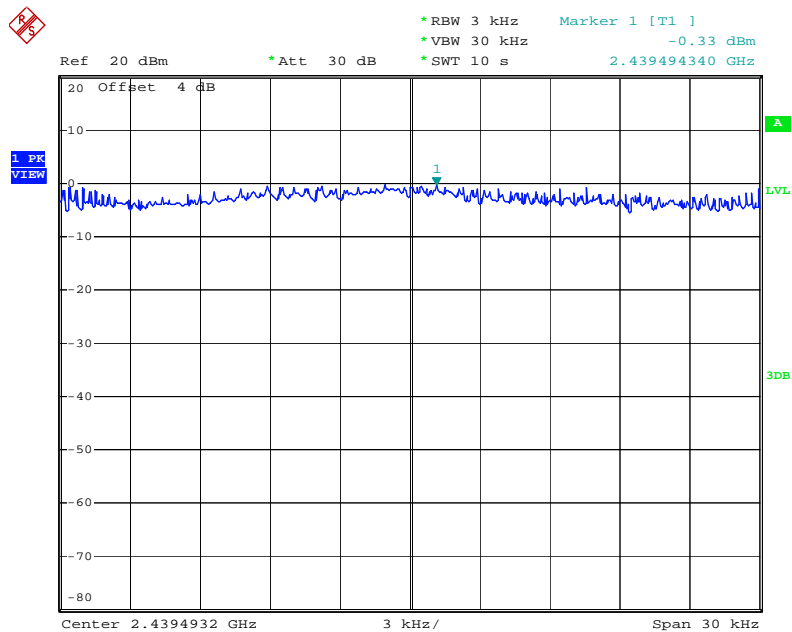

Date: 15.SEP.2009 23:28:03

Power Density Plot on Configuration Drafft n MCS8 20MHz Ant. 3-1 + Ant. 3-3 / 2462 MHz

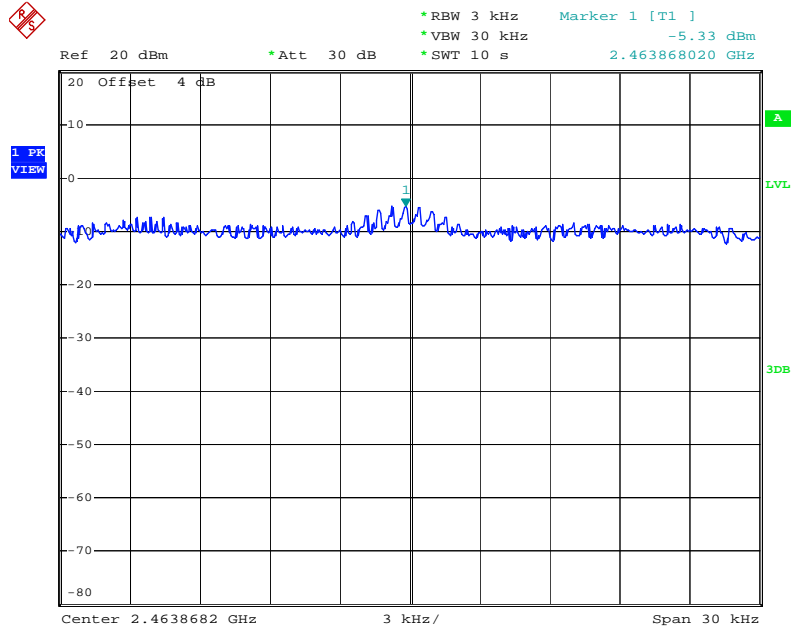

Date: 15.SEP.2009 23:33:33

Power Density Plot on Configuration Drafft n MCS8 40MHz Ant. 3-1 + Ant. 3-3 / 2422 MHz

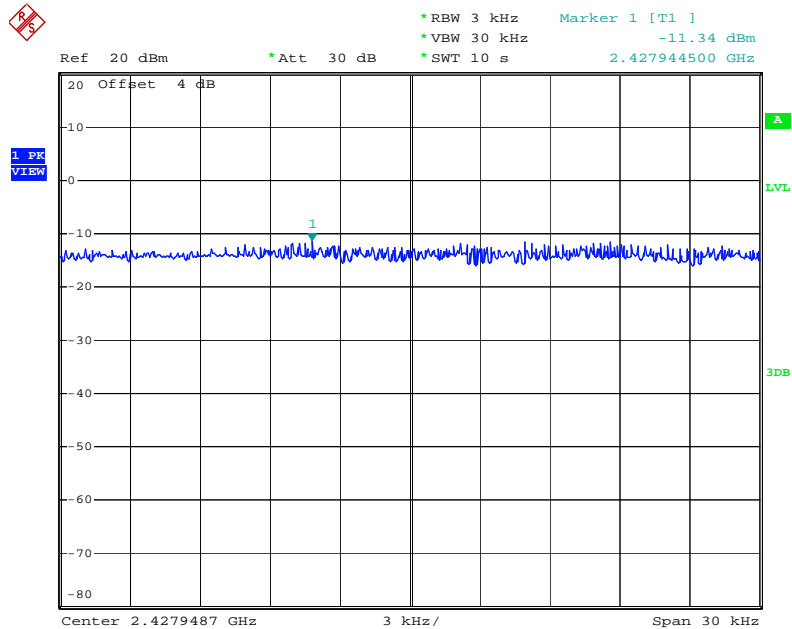

Date: 15.SEP.2009 23:46:22

Power Density Plot on Configuration Drafft n MCS8 40MHz Ant. 3-1 + Ant. 3-3 / 2437 MHz

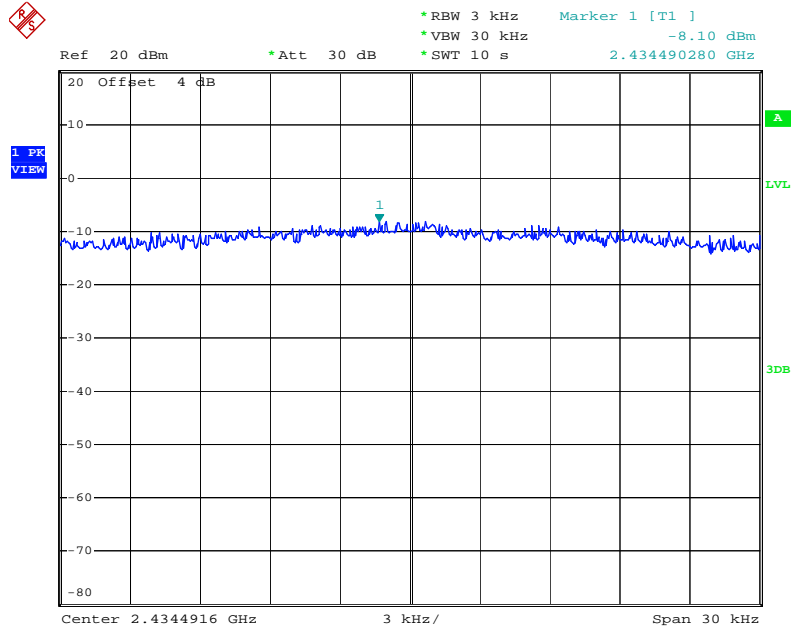

Date: 15.SEP.2009 23:52:33

Power Density Plot on Configuration Drafft n MCS8 40MHz Ant. 3-1 + Ant. 3-3 / 2452 MHz

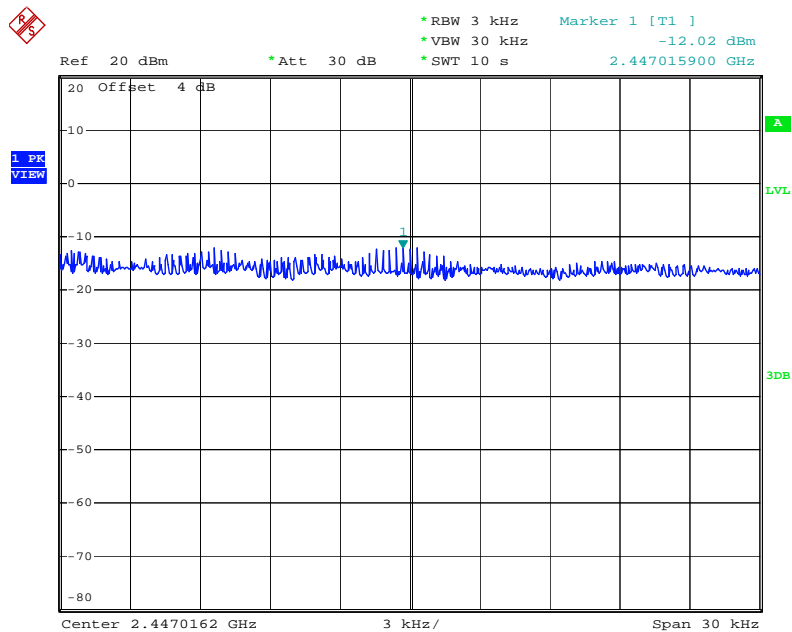

Date: 16.SEP.2009 00:02:53

Power Density Plot on Configuration 11a Draft n MCS8 20MHz Ant. 3-1 + Ant. 3-3 / 5745 MHz

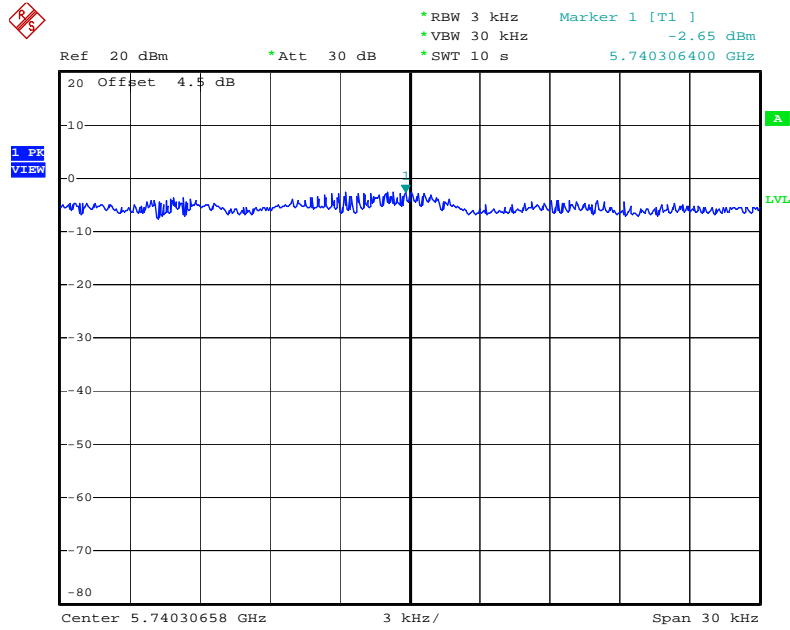

Date: 16.SEP.2009 18:18:23

Power Density Plot on Configuration 11a Draft n MCS8 20MHz Ant. 3-1 + Ant. 3-3 / 5785 MHz

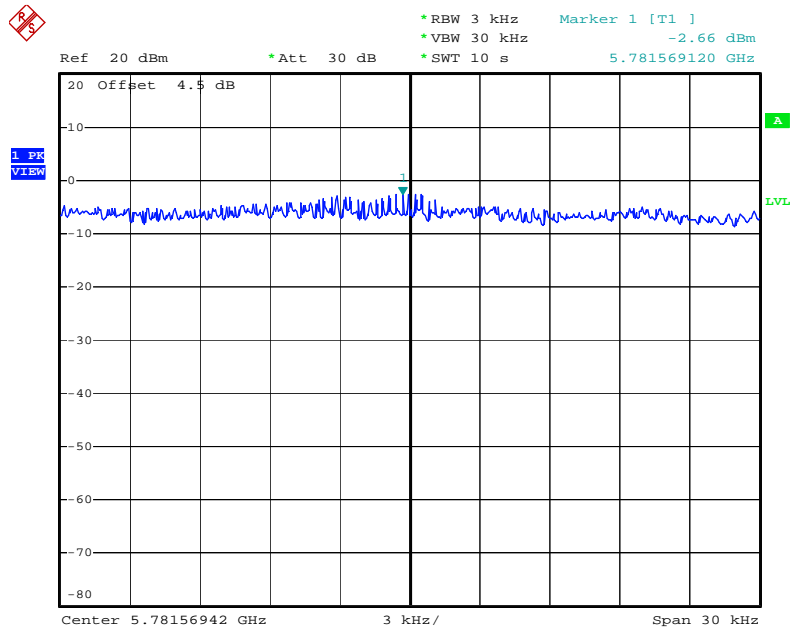

Date: 16.SEP.2009 18:15:47

Power Density Plot on Configuration 11a Draft n MCS8 20MHz Ant. 3-1 + Ant. 3-3 / 5825 MHz

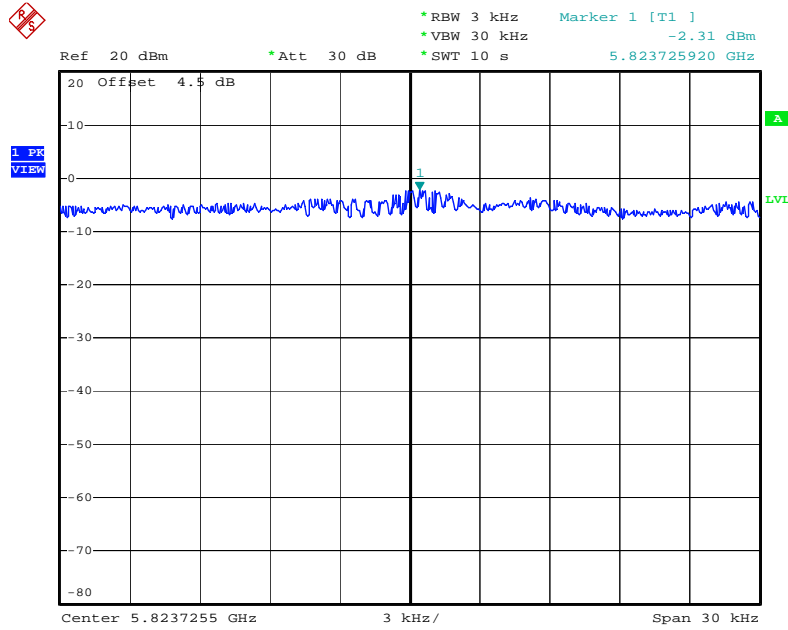

Date: 16.SEP.2009 18:13:35

Power Density Plot on Configuration 11a Draft n MCS8 40MHz Ant. 3-1 + Ant. 3-3 / 5755 MHz

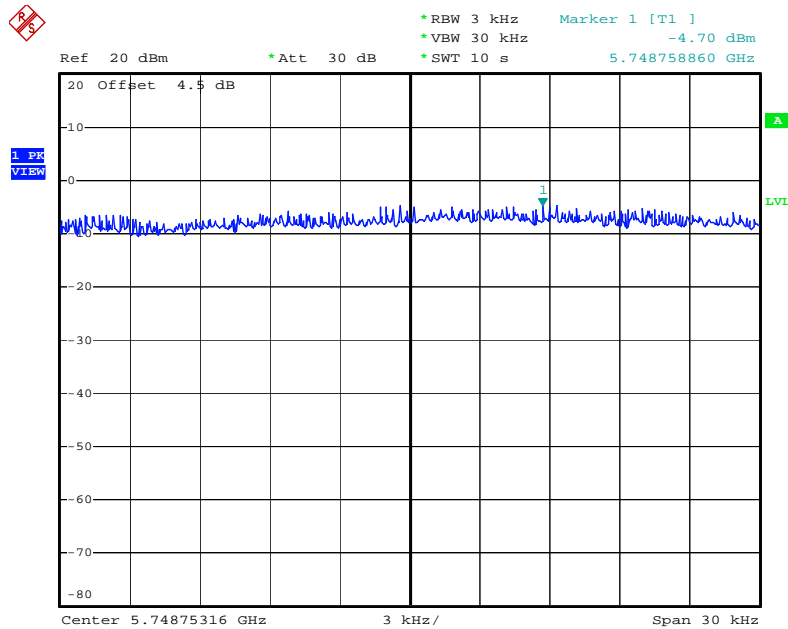

Date: 16.SEP.2009 19:20:21

Power Density Plot on Configuration 11a Draft n MCS8 40MHz Ant. 3-1 + Ant. 3-3 / 5795 MHz

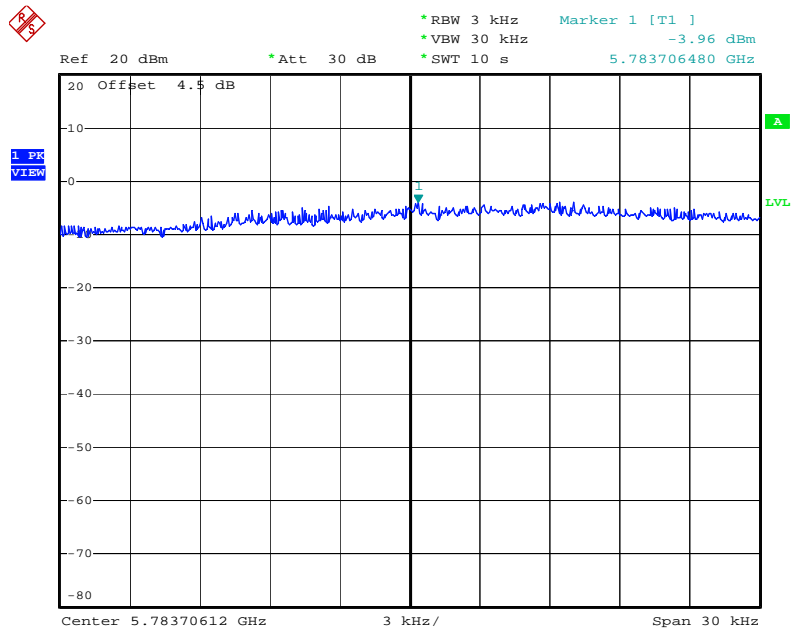

Date: 16.SEP.2009 19:23:47

Power Density Plot on Configuration IEEE 802.11b Ant. 3-1 + Ant. 3-3 / 2412 MHz

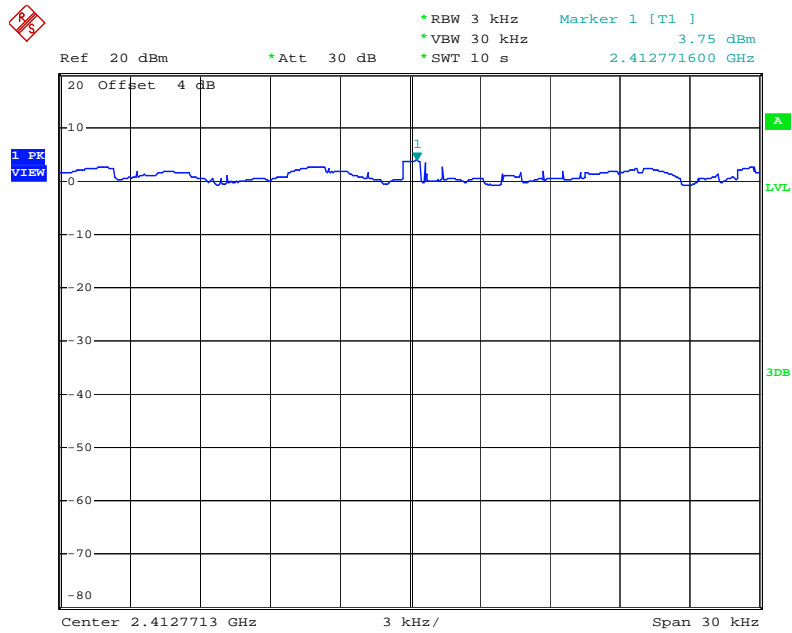

Date: 15.SEP.2009 22:24:22

Power Density Plot on Configuration IEEE 802.11b Ant. 3-1 + Ant. 3-3 / 2437 MHz

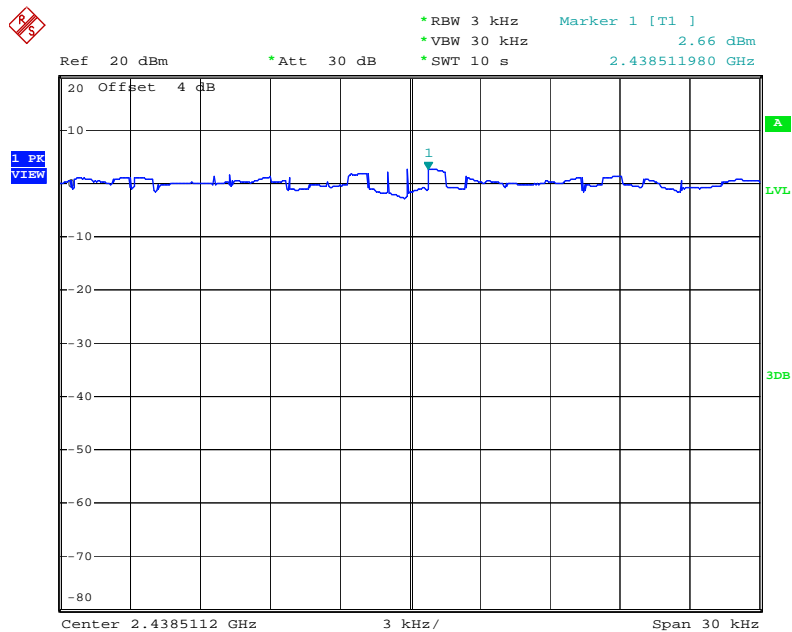

Date: 15.SEP.2009 22:34:24

Power Density Plot on Configuration IEEE 802.11b Ant. 3-1 + Ant. 3-3 / 2462 MHz

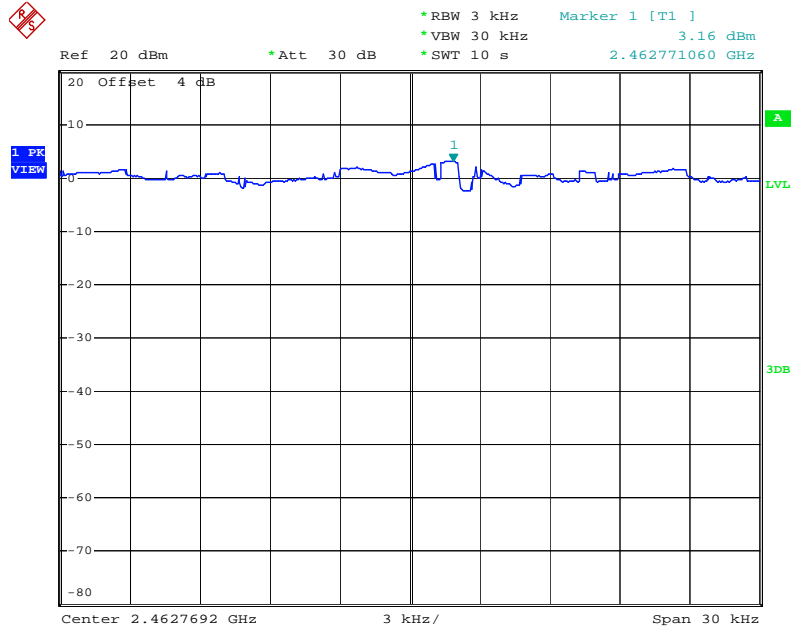

Date: 15.SEP.2009 22:37:12

Power Density Plot on Configuration IEEE 802.11g Ant. 3-1 + Ant. 3-3 / 2412 MHz

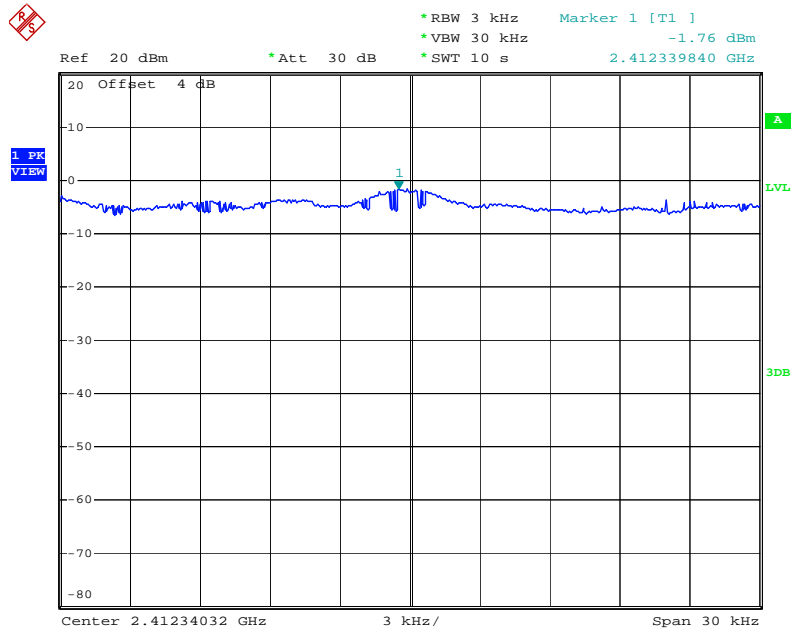

Date: 15.SEP.2009 22:49:23

Power Density Plot on Configuration IEEE 802.11g Ant. 3-1 + Ant. 3-3 / 2437 MHz

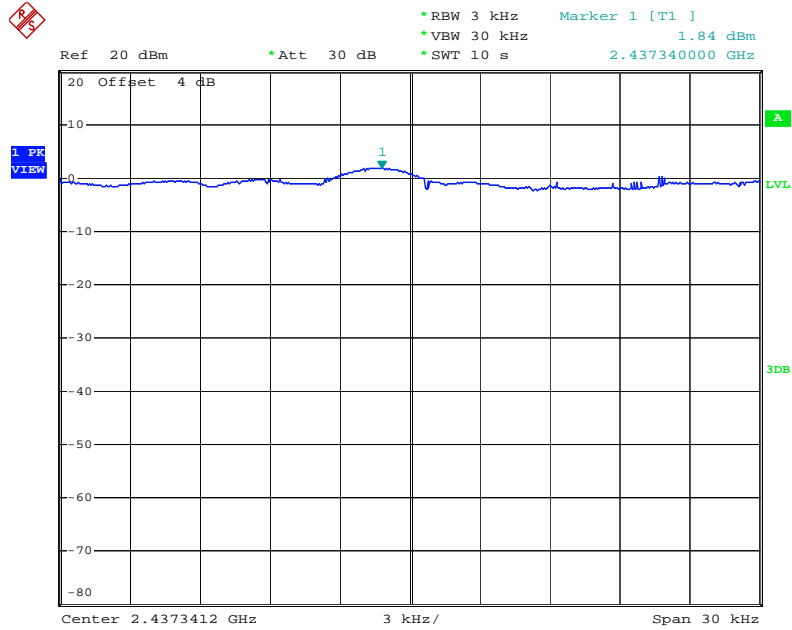

Date: 15.SEP.2009 22:57:33

Power Density Plot on Configuration IEEE 802.11g Ant. 3-1 + Ant. 3-3 / 2462 MHz

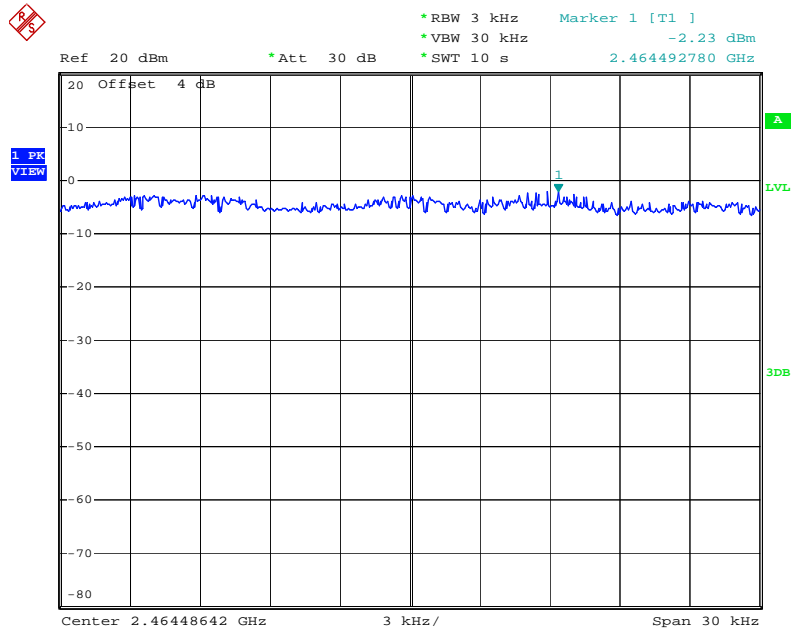

Date: 15.SEP.2009 23:11:44

Power Density Plot on Configuration IEEE 802.11a Ant. 3-1 + Ant. 3-3 / 5745 MHz

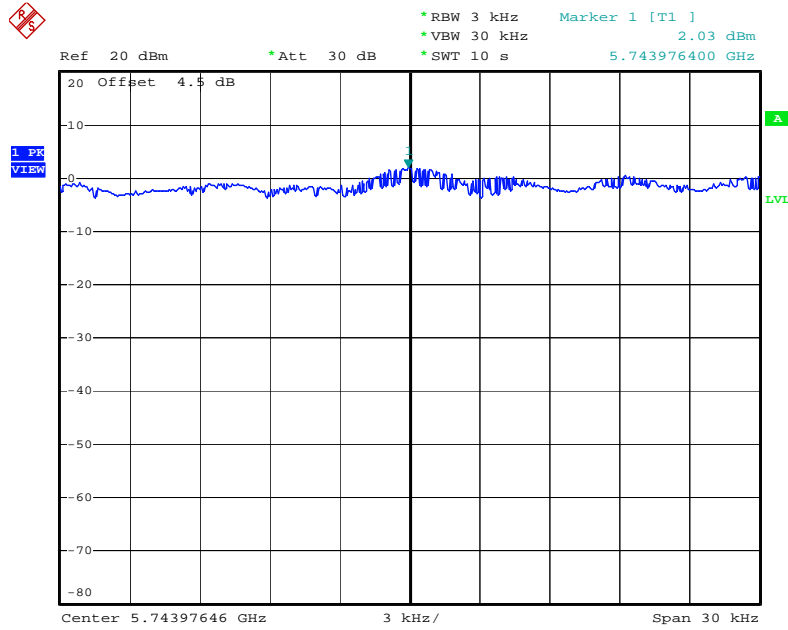

Date: 16.SEP.2009 18:06:04

Power Density Plot on Configuration IEEE 802.11a Ant. 3-1 + Ant. 3-3 / 5785 MHz

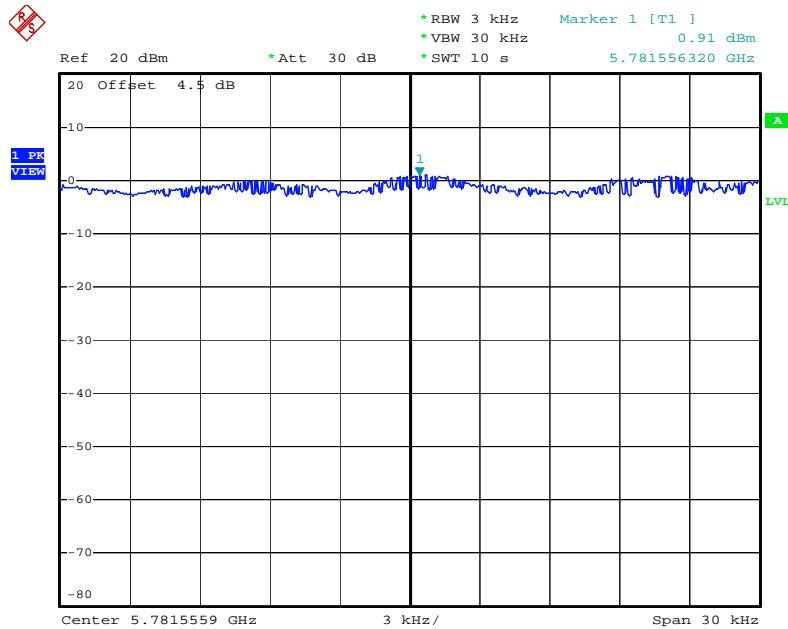

Date: 16.SEP.2009 18:08:36

Power Density Plot on Configuration IEEE 802.11a Ant. 3-1 + Ant. 3-3 / 5825 MHz

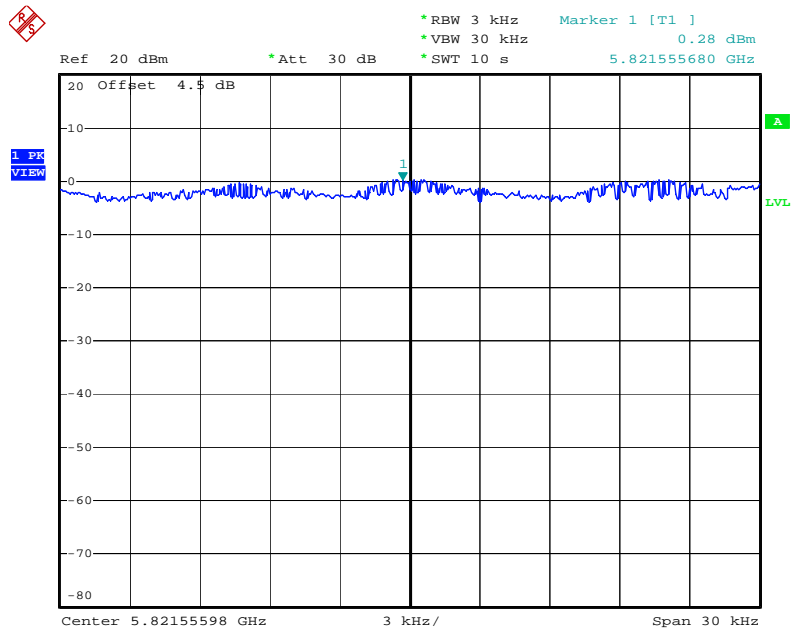

Date: 16.SEP.2009 18:10:27

<For Antenna 4>:

Power Density Plot on Configuration Drafft n MCS8 20MHz Ant. 4-1 + Ant. 4-3 / 2412 MHz

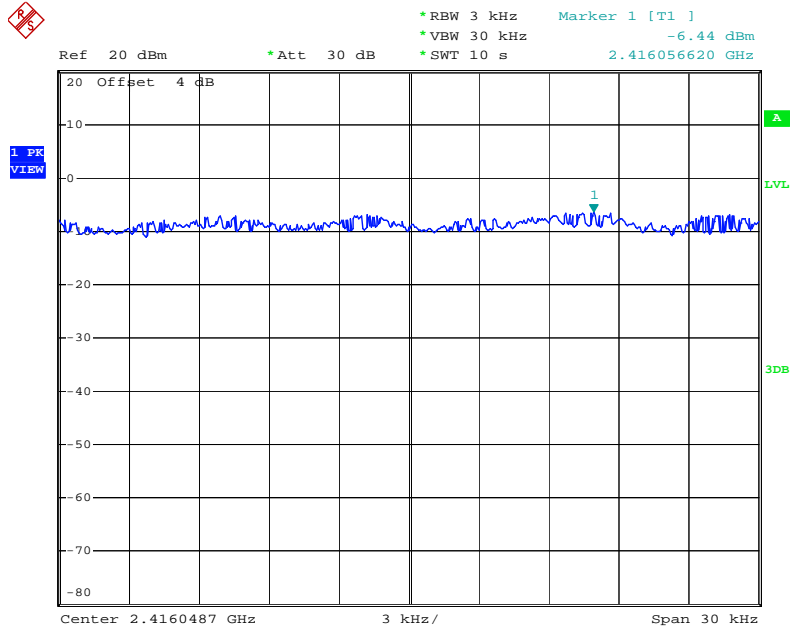

Date: 15.SEP.2009 23:16:25

Power Density Plot on Configuration Drafft n MCS8 20MHz Ant. 4-1 + Ant. 4-3 / 2437 MHz

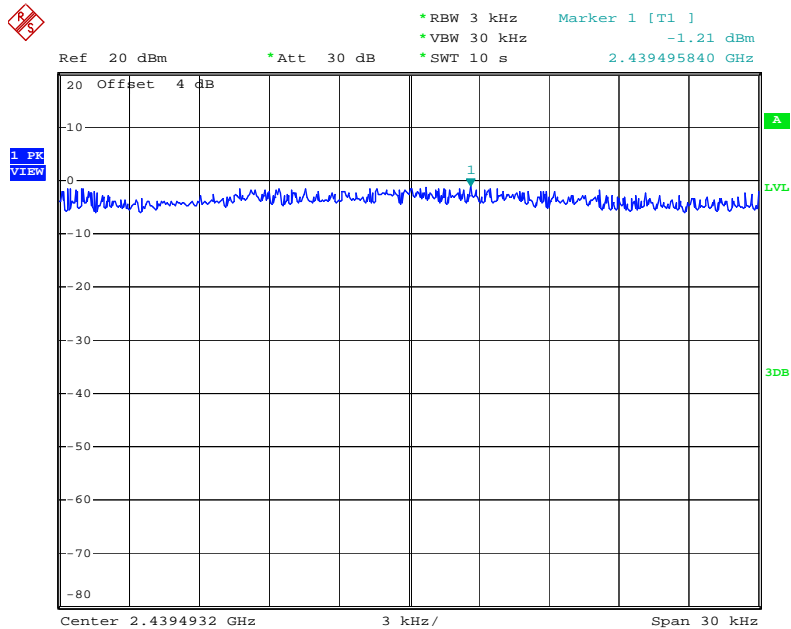

Date: 15.SEP.2009 23:27:31

Power Density Plot on Configuration Drafft n MCS8 20MHz Ant. 4-1 + Ant. 4-3 / 2462 MHz

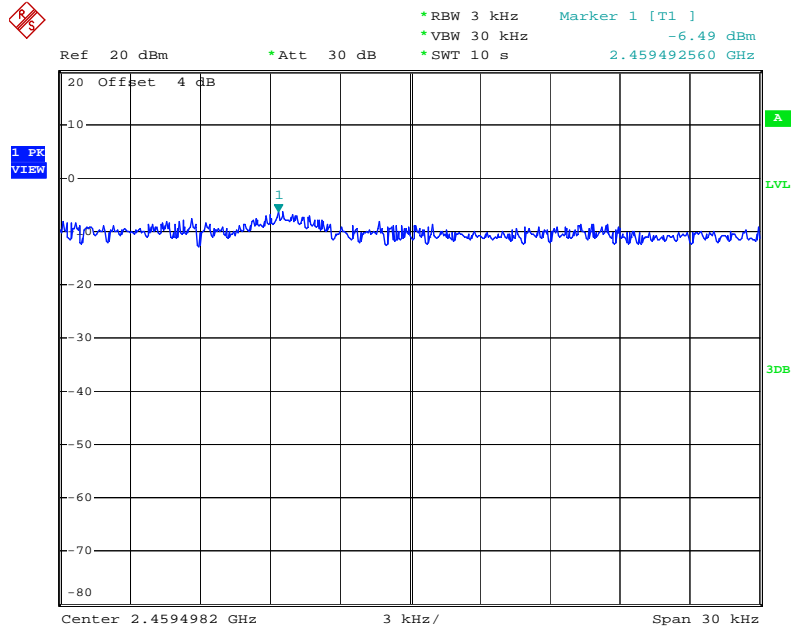

Date: 15.SEP.2009 23:30:52

Power Density Plot on Configuration Drafft n MCS8 40MHz Ant. 4-1 + Ant. 4-3 / 2422 MHz

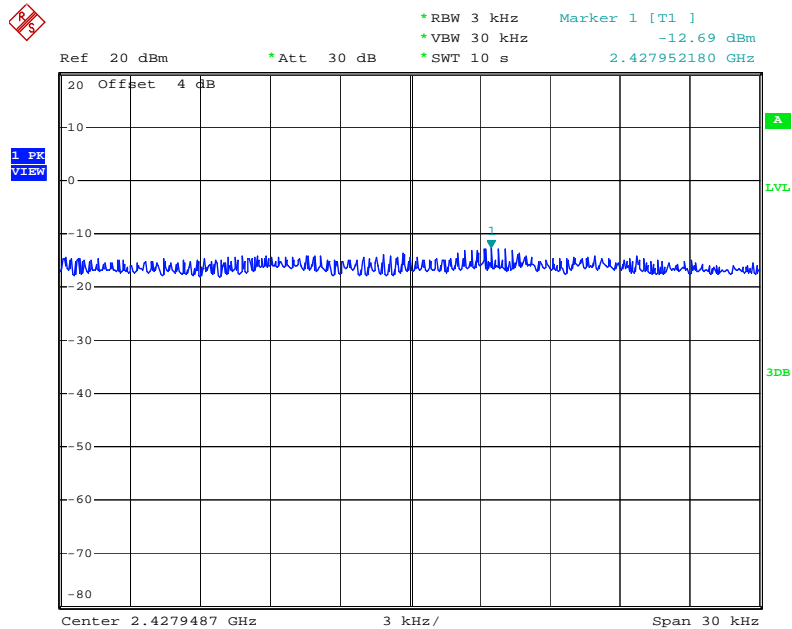

Date: 15.SEP.2009 23:45:15

Power Density Plot on Configuration Drafft n MCS8 40MHz Ant. 4-1 + Ant. 4-3 / 2437 MHz

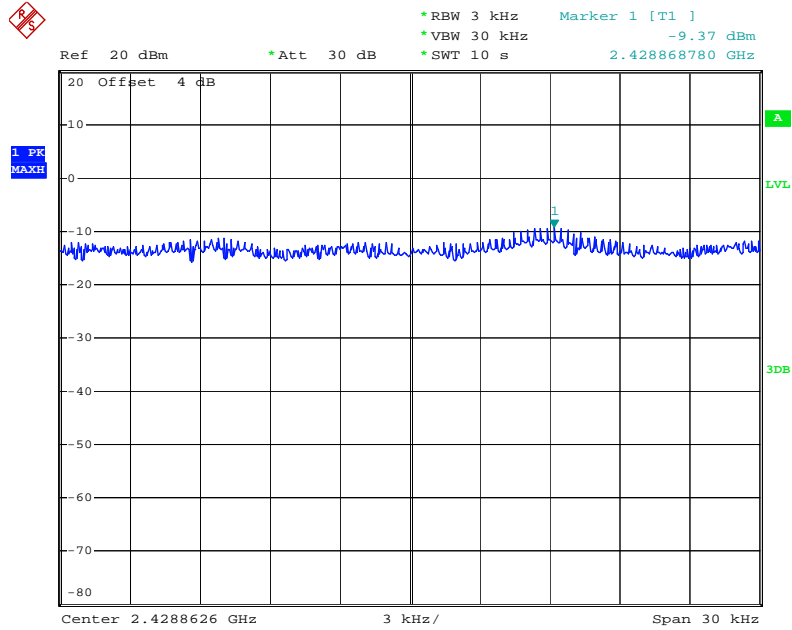

Date: 15.SEP.2009 23:51:29

Power Density Plot on Configuration Drafft n MCS8 40MHz Ant. 4-1 + Ant. 4-3 / 2452 MHz

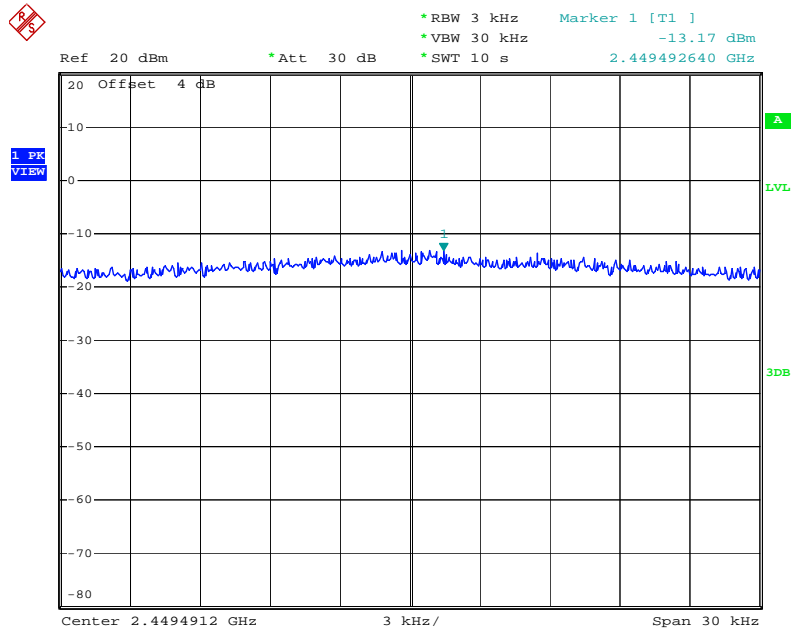

Date: 15.SEP.2009 23:58:48

Power Density Plot on Configuration 11a Draft n MCS8 20MHz Ant. 4-1 + Ant. 4-3 / 5745 MHz

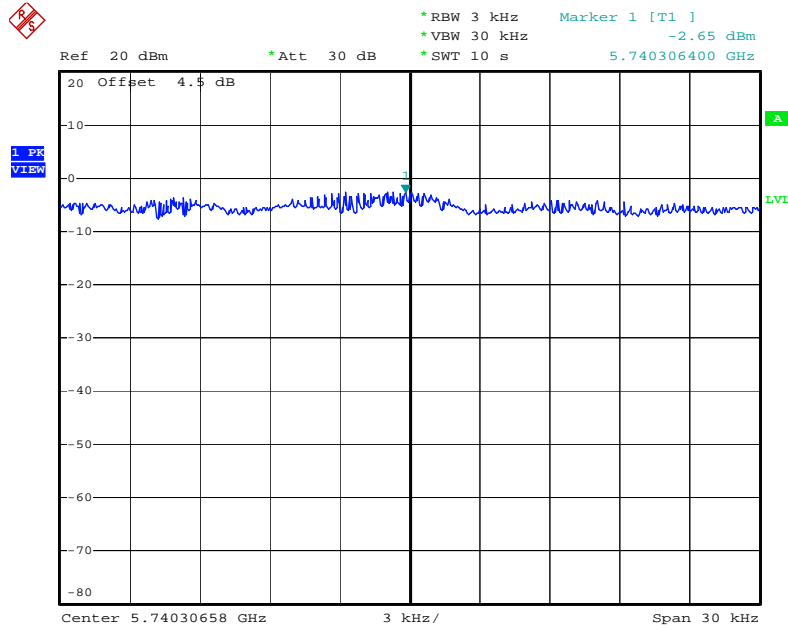

Date: 16.SEP.2009 18:18:23

Power Density Plot on Configuration 11a Draft n MCS8 20MHz Ant. 4-1 + Ant. 4-3 / 5785 MHz

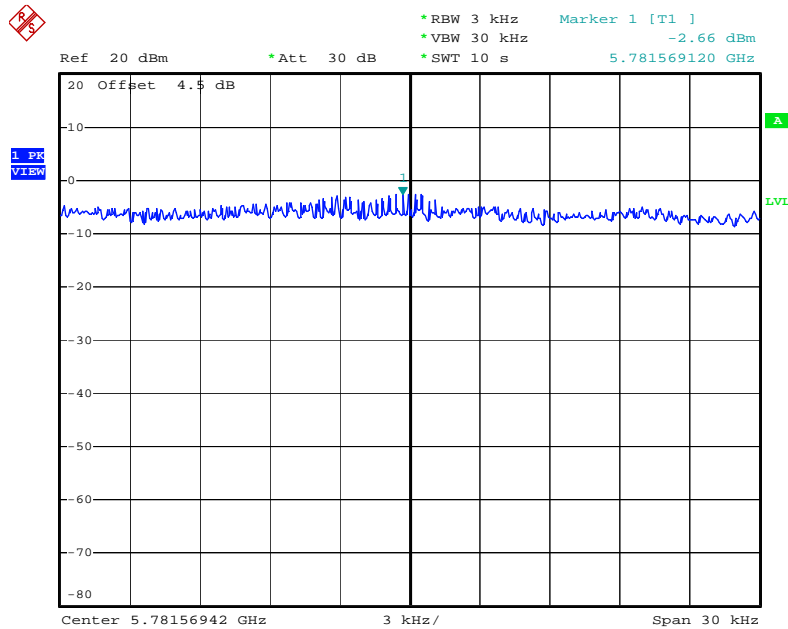

Date: 16.SEP.2009 18:15:47

Power Density Plot on Configuration 11a Draft n MCS8 20MHz Ant. 4-1 + Ant. 4-3 / 5825 MHz

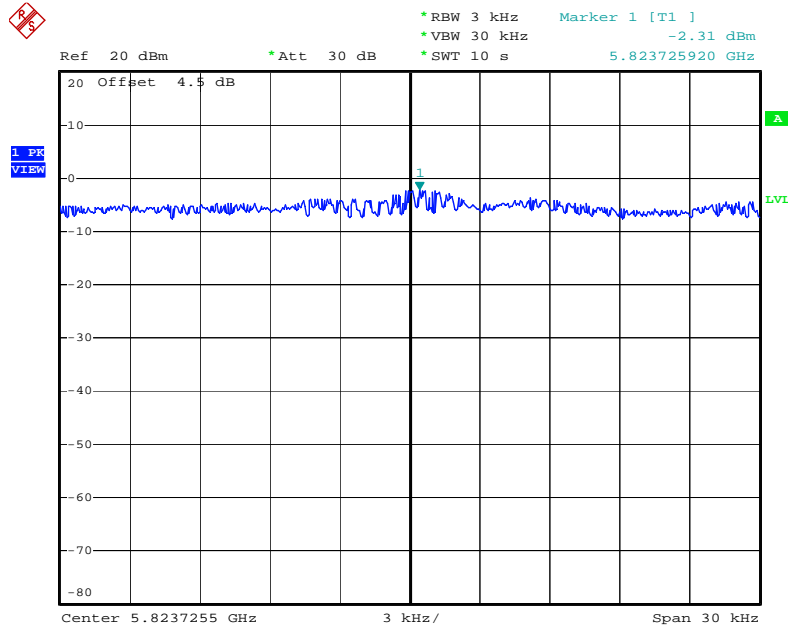

Date: 16.SEP.2009 18:13:35

Power Density Plot on Configuration 11a Draft n MCS8 40MHz Ant. 4-1 + Ant. 4-3 / 5755 MHz

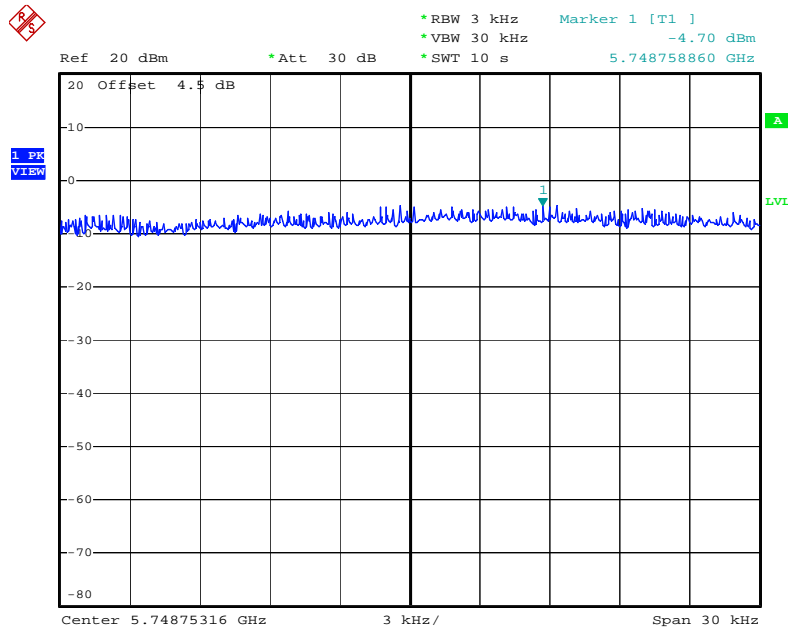

Date: 16.SEP.2009 19:20:21

Power Density Plot on Configuration 11a Draft n MCS8 40MHz Ant. 4-1 + Ant. 4-3 / 5795 MHz

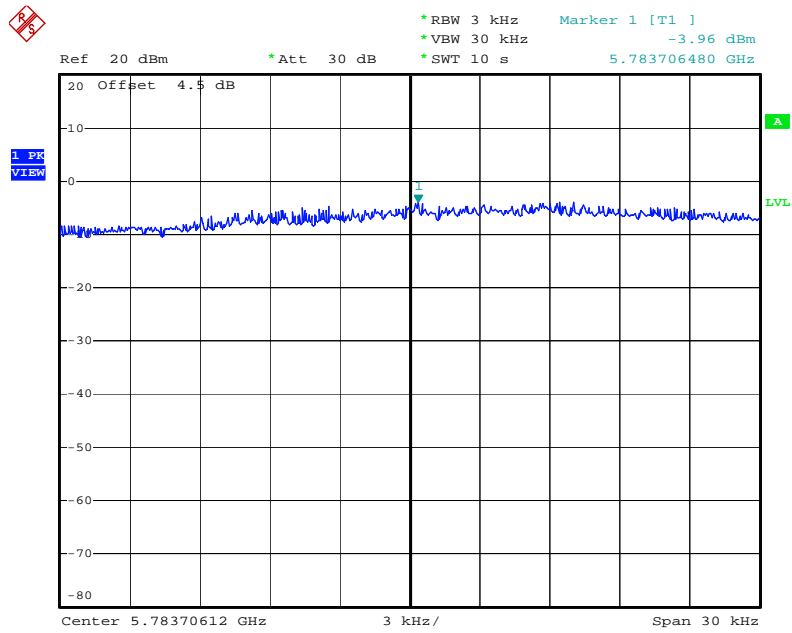

Date: 16.SEP.2009 19:23:47

Power Density Plot on Configuration IEEE 802.11b Ant. 4-1 + Ant. 4-3 / 2412 MHz

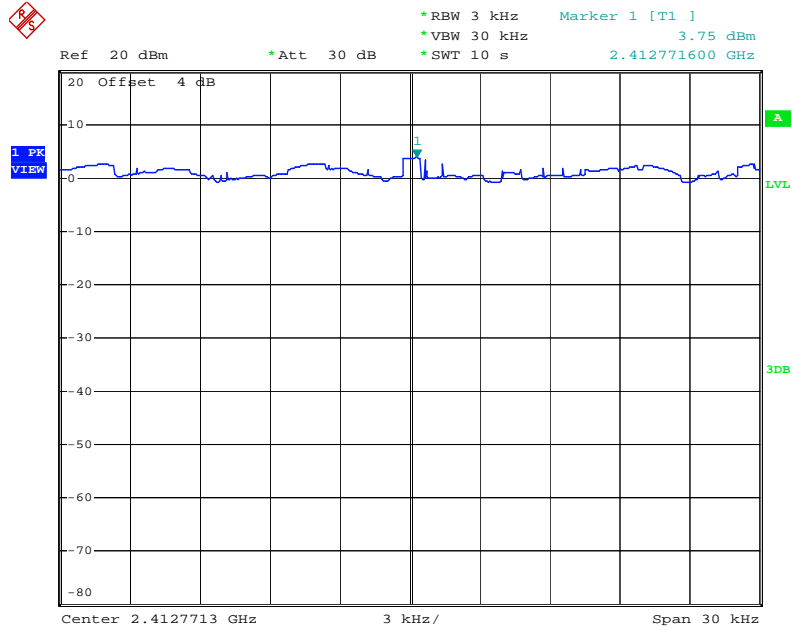

Date: 15.SEP.2009 22:24:22

Power Density Plot on Configuration IEEE 802.11b Ant. 4-1 + Ant. 4-3 / 2437 MHz

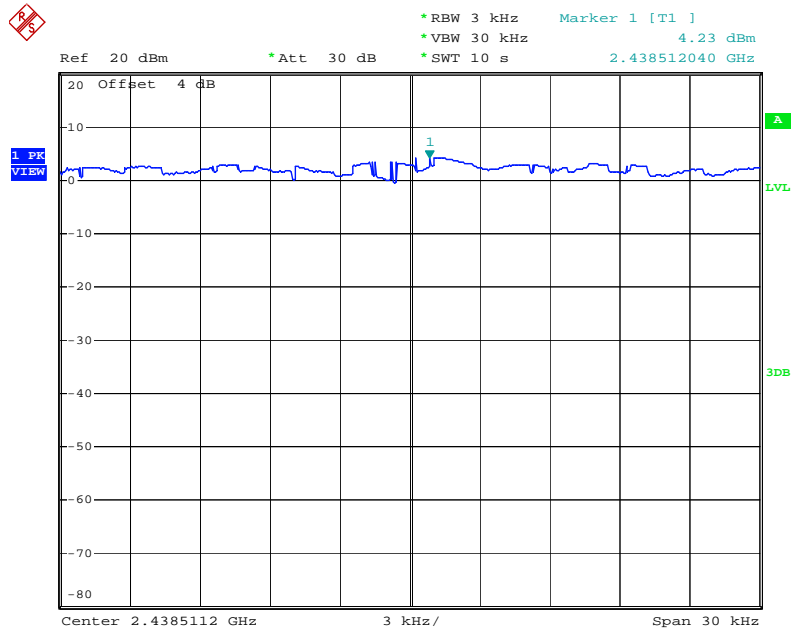

Date: 15.SEP.2009 22:32:29

Power Density Plot on Configuration IEEE 802.11b Ant. 4-1 + Ant. 4-3 / 2462 MHz

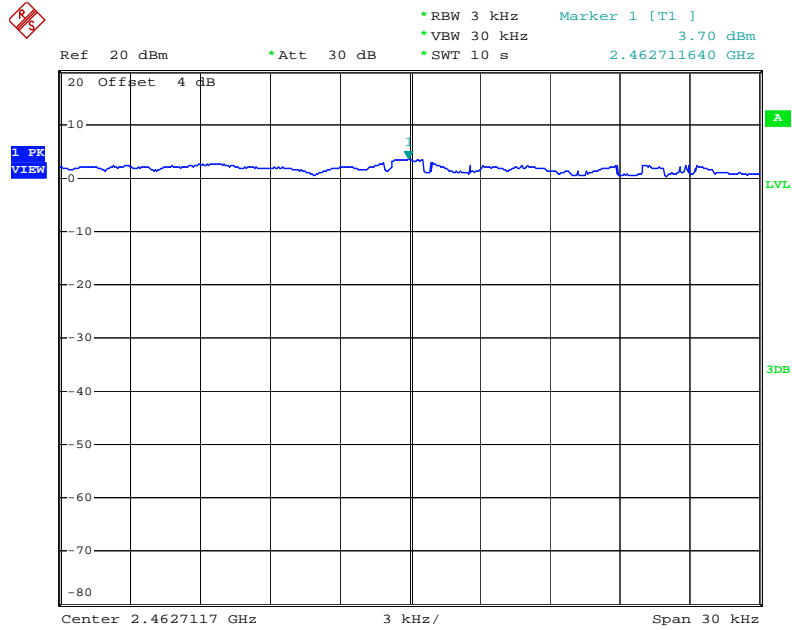

Date: 15.SEP.2009 22:42:45

Power Density Plot on Configuration IEEE 802.11g Ant. 4-1 + Ant. 4-3 / 2412 MHz

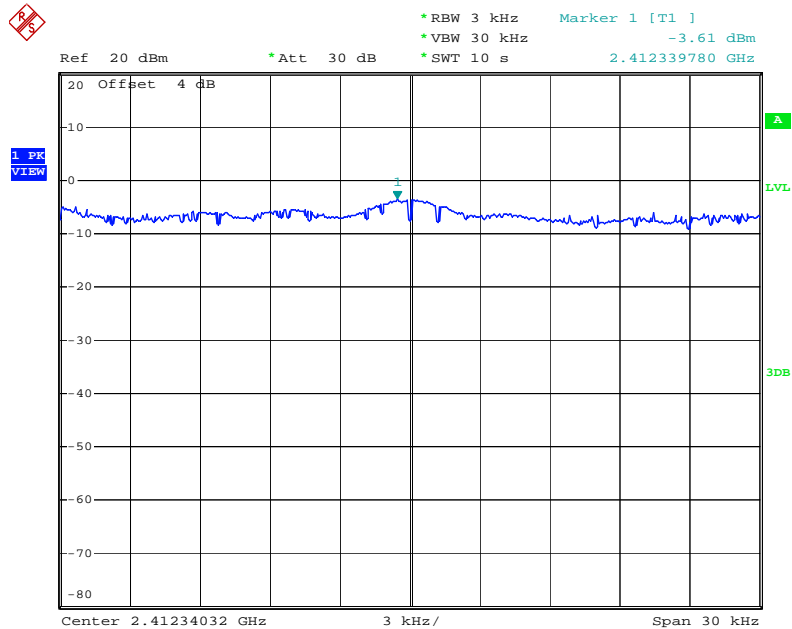

Date: 15.SEP.2009 22:51:03

Power Density Plot on Configuration IEEE 802.11g Ant. 4-1 + Ant. 4-3 / 2437 MHz

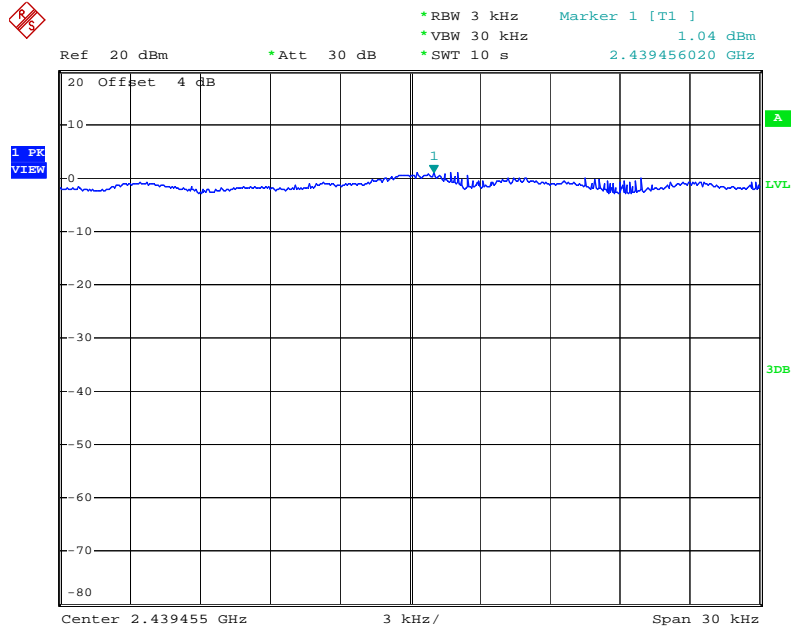

Date: 15.SEP.2009 22:56:04

Power Density Plot on Configuration IEEE 802.11g Ant. 4-1 + Ant. 4-3 / 2462 MHz

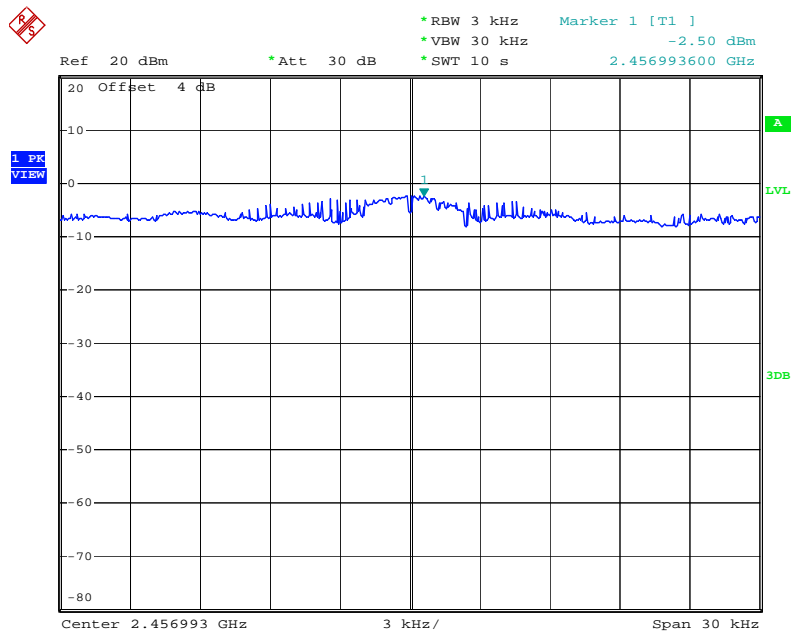

Date: 15.SEP.2009 23:03:51

Power Density Plot on Configuration IEEE 802.11a Ant. 4-1 + Ant. 4-3 / 5745 MHz

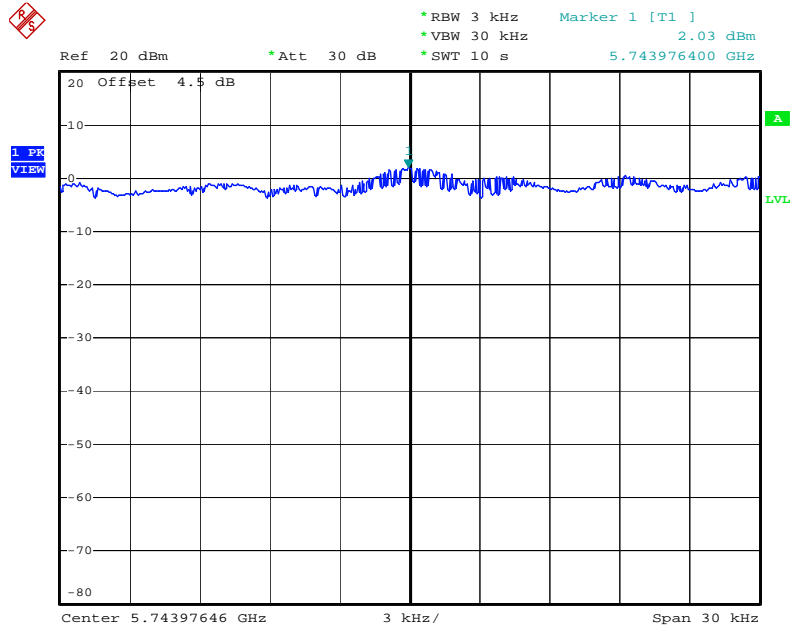

Date: 16.SEP.2009 18:06:04

Power Density Plot on Configuration IEEE 802.11a Ant. 4-1 + Ant. 4-3 / 5785 MHz

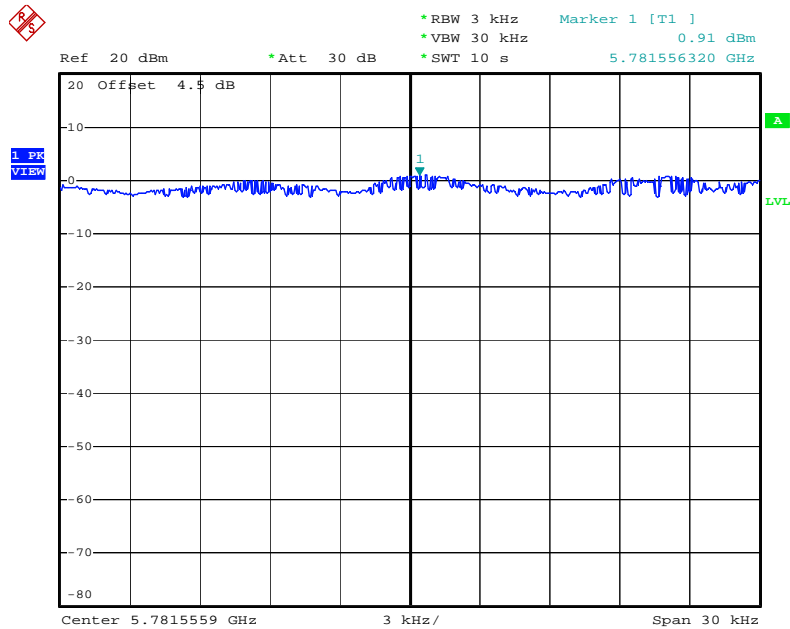

Date: 16.SEP.2009 18:08:36

Power Density Plot on Configuration IEEE 802.11a Ant. 4-1 + Ant. 4-3 / 5825 MHz

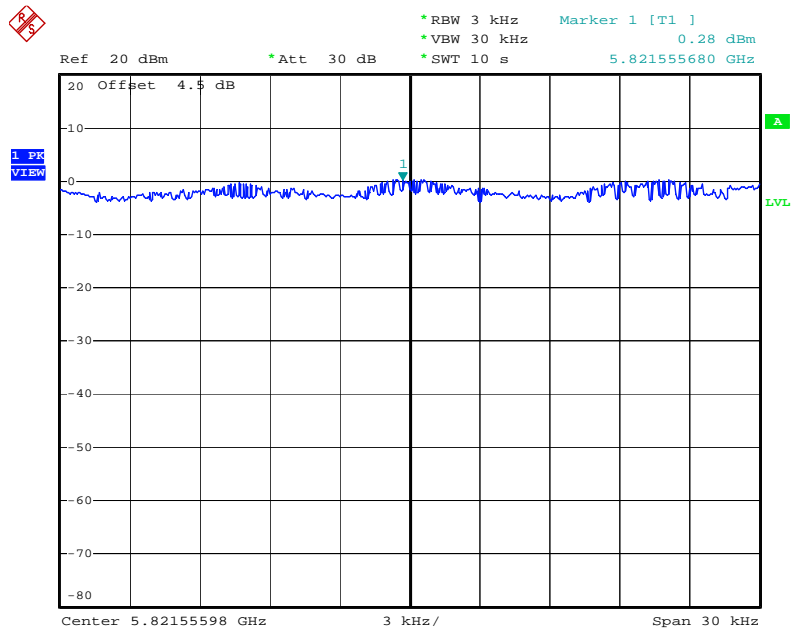

Date: 16.SEP.2009 18:10:27

<For Antenna 5>:

Power Density Plot on Configuration Drafft n MCS8 20MHz Ant. 5-1 + Ant. 5-3 / 2412 MHz

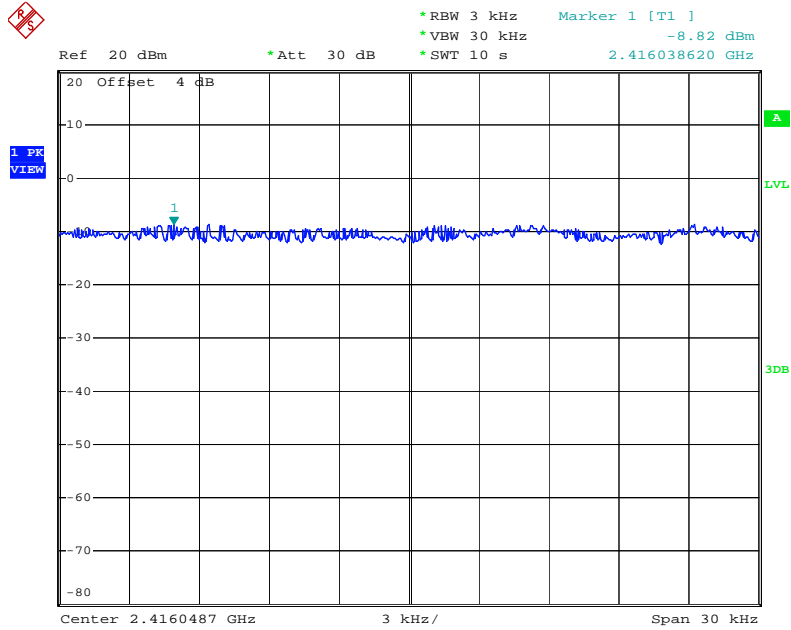

Date: 15.SEP.2009 23:15:01

Power Density Plot on Configuration Drafft n MCS8 20MHz Ant. 5-1 + Ant. 5-3 / 2437 MHz

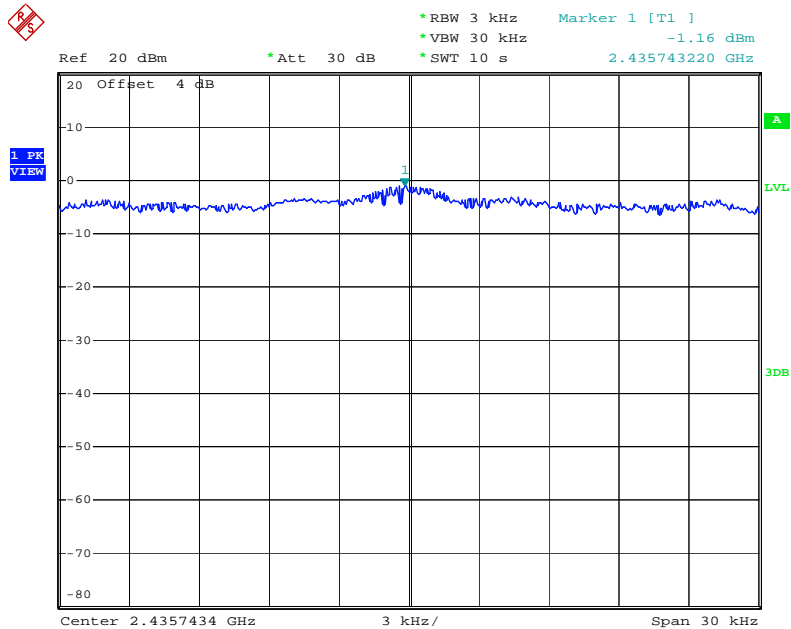

Date: 15.SEP.2009 23:23:39

Power Density Plot on Configuration Drafft n MCS8 20MHz Ant. 5-1 + Ant. 5-3 / 2462 MHz

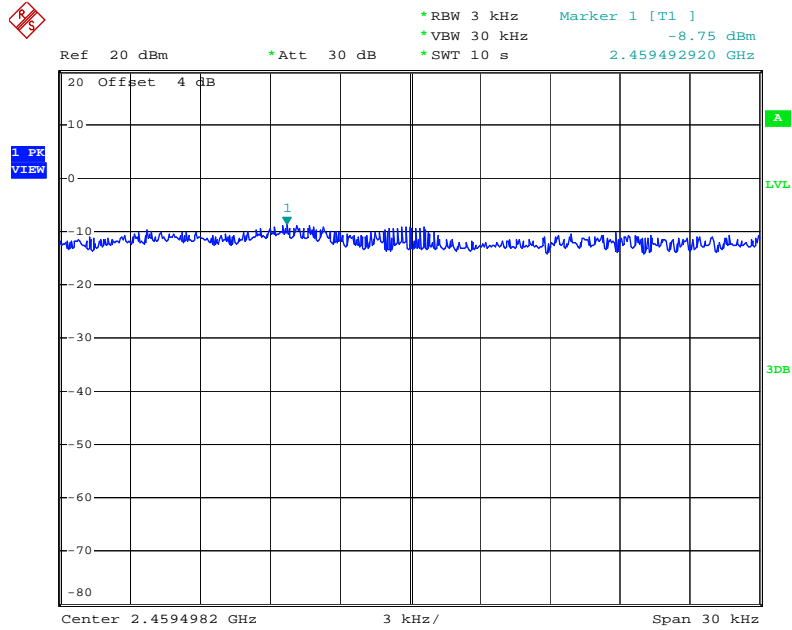

Date: 15.SEP.2009 23:30:07

Power Density Plot on Configuration Drafft n MCS8 40MHz Ant. 5-1 + Ant. 5-3 / 2422 MHz

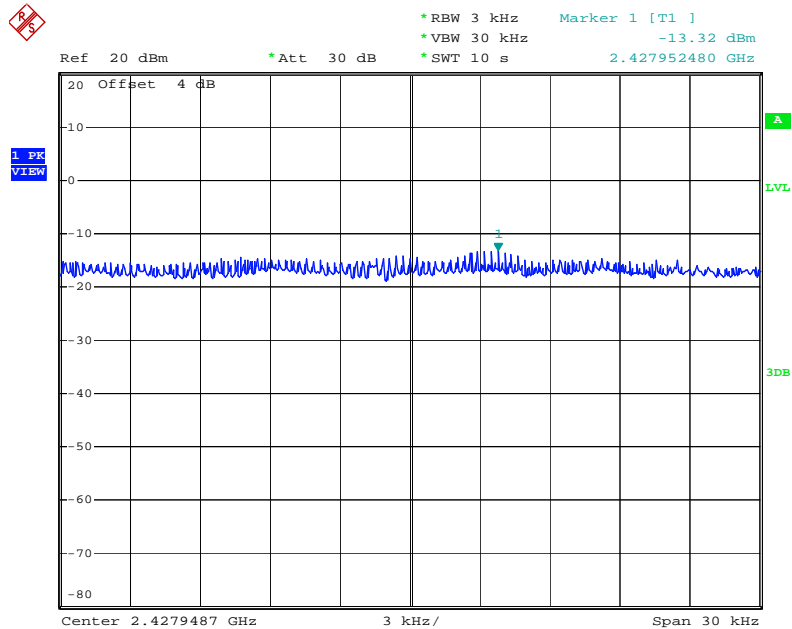

Date: 15.SEP.2009 23:44:33

Power Density Plot on Configuration Drafft n MCS8 40MHz Ant. 5-1 + Ant. 5-3 / 2437 MHz

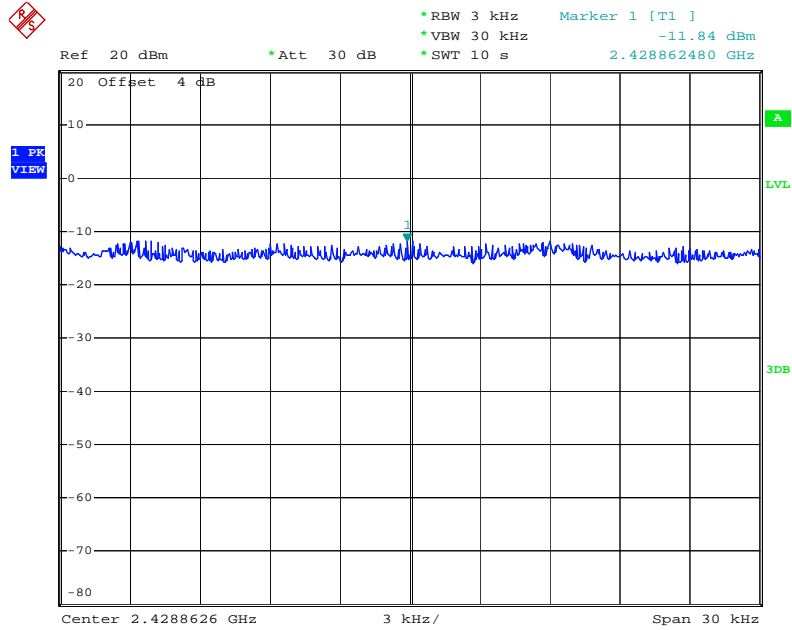

Date: 15.SEP.2009 23:50:17

Power Density Plot on Configuration Drafft n MCS8 40MHz Ant. 5-1 + Ant. 5-3 / 2452 MHz

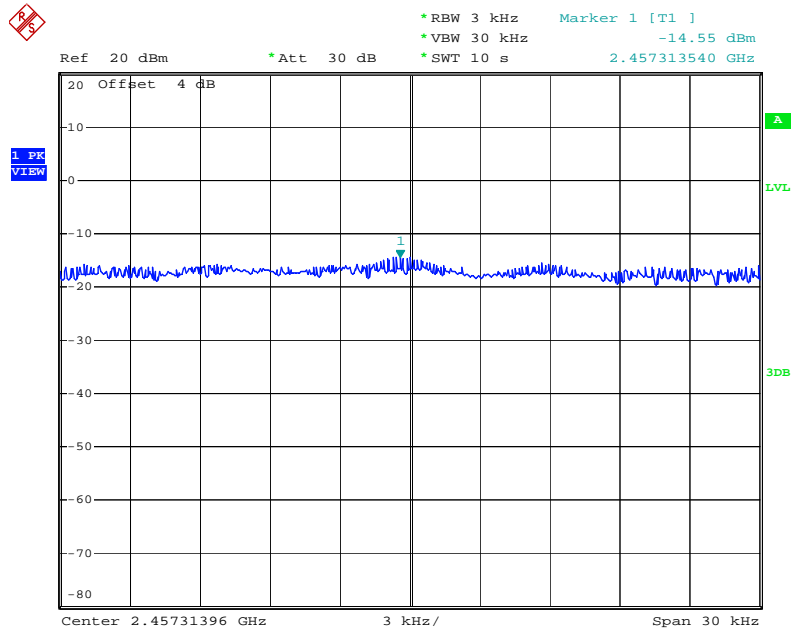

Date: 16.SEP.2009 00:00:35

Power Density Plot on Configuration 11a Draft n MCS8 20MHz Ant. 5-1 + Ant. 5-3 / 5745 MHz

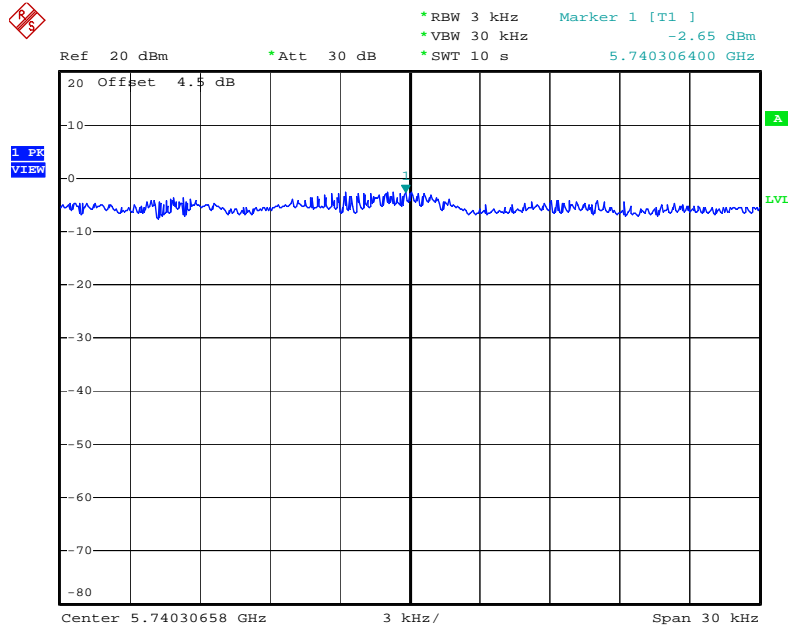

Date: 16.SEP.2009 18:18:23

Power Density Plot on Configuration 11a Draft n MCS8 20MHz Ant. 5-1 + Ant. 5-3 / 5785 MHz

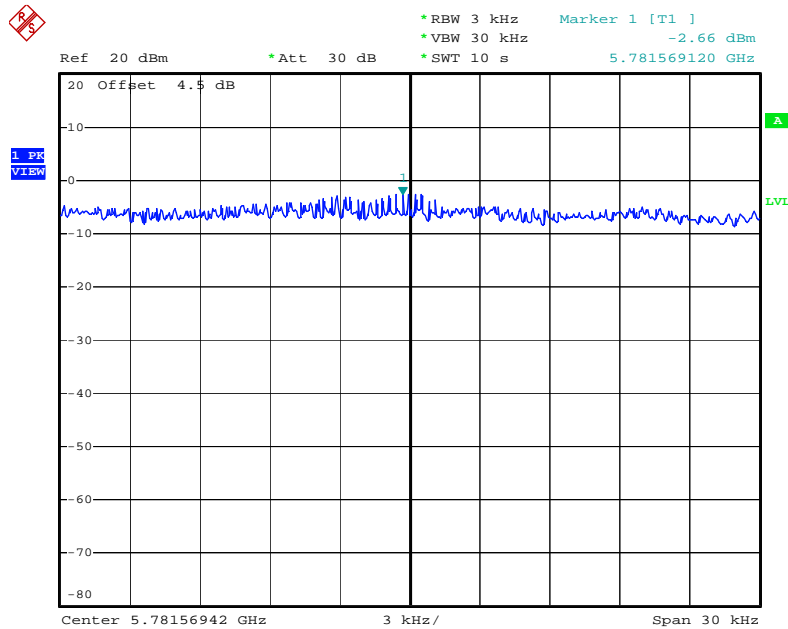

Date: 16.SEP.2009 18:15:47

Power Density Plot on Configuration 11a Draft n MCS8 20MHz Ant. 5-1 + Ant. 5-3 / 5825 MHz

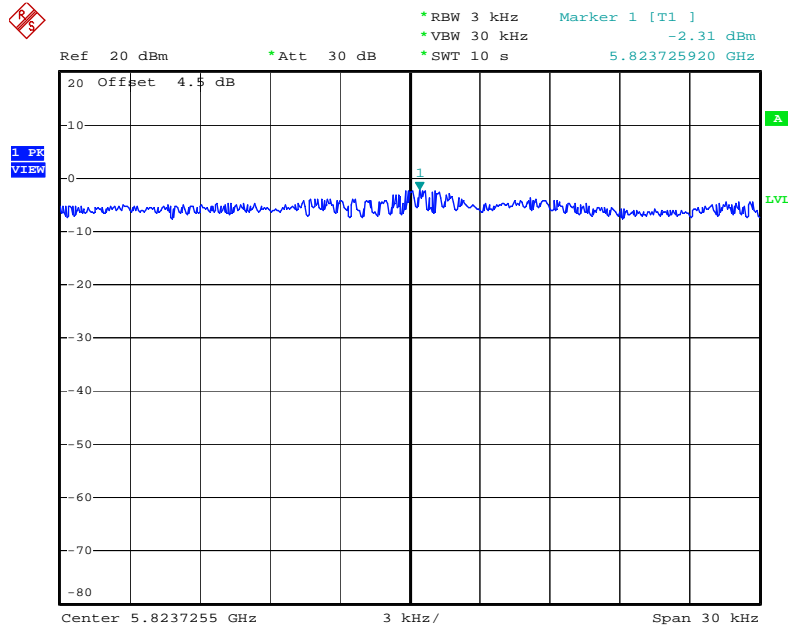

Date: 16.SEP.2009 18:13:35

Power Density Plot on Configuration 11a Draft n MCS8 40MHz Ant. 5-1 + Ant. 5-3 / 5755 MHz

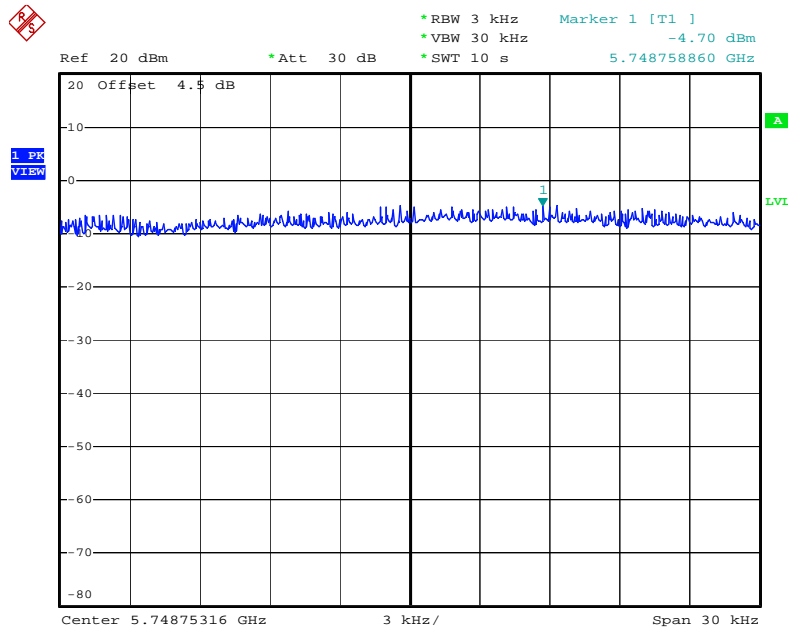

Date: 16.SEP.2009 19:20:21

Power Density Plot on Configuration 11a Draft n MCS8 40MHz Ant. 5-1 + Ant. 5-3 / 5795 MHz

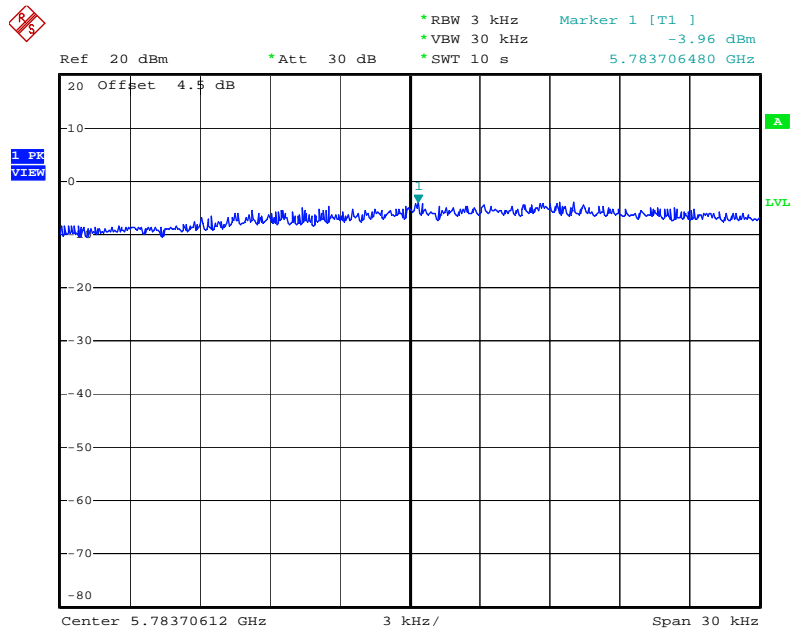

Date: 16.SEP.2009 19:23:47

Power Density Plot on Configuration IEEE 802.11b Ant. 5-1 + Ant. 5-3 / 2412 MHz

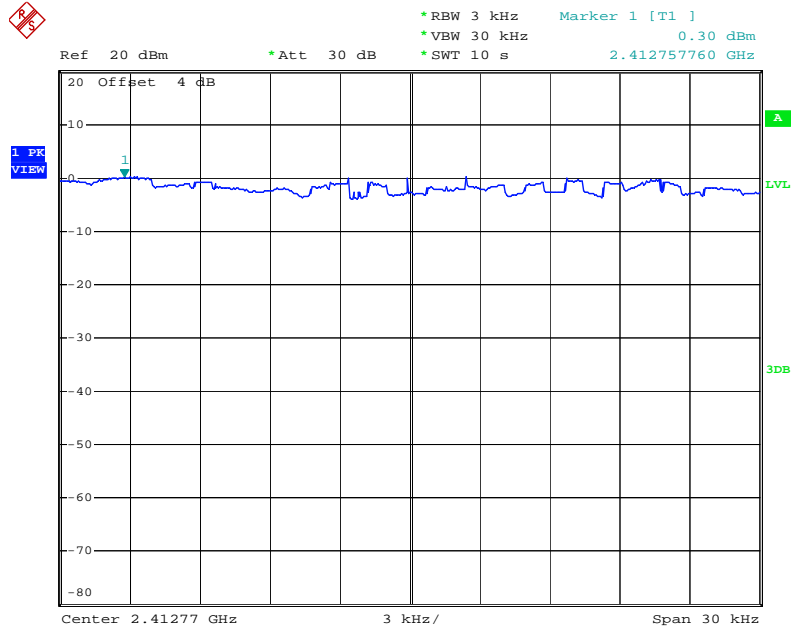

Date: 15.SEP.2009 22:28:52

Power Density Plot on Configuration IEEE 802.11b Ant. 5-1 + Ant. 5-3 / 2437 MHz

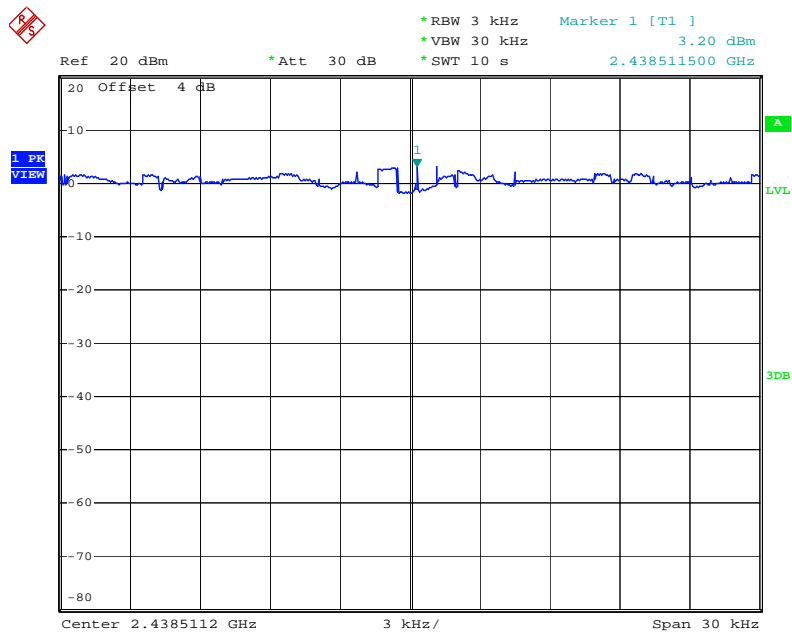

Date: 15.SEP.2009 22:33:48

Power Density Plot on Configuration IEEE 802.11b Ant. 5-1 + Ant. 5-3 / 2462 MHz

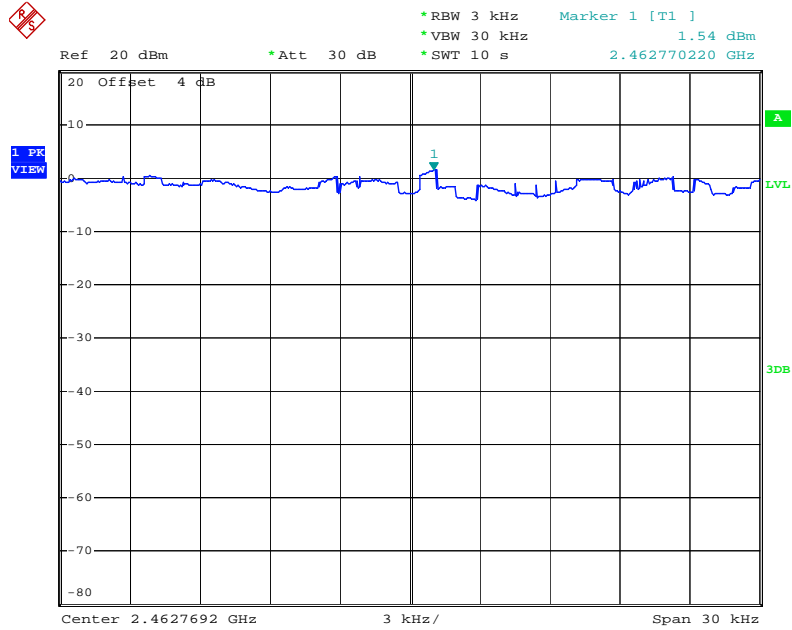

Date: 15.SEP.2009 22:36:19

Power Density Plot on Configuration IEEE 802.11g Ant. 5-1 + Ant. 5-3 / 2412 MHz

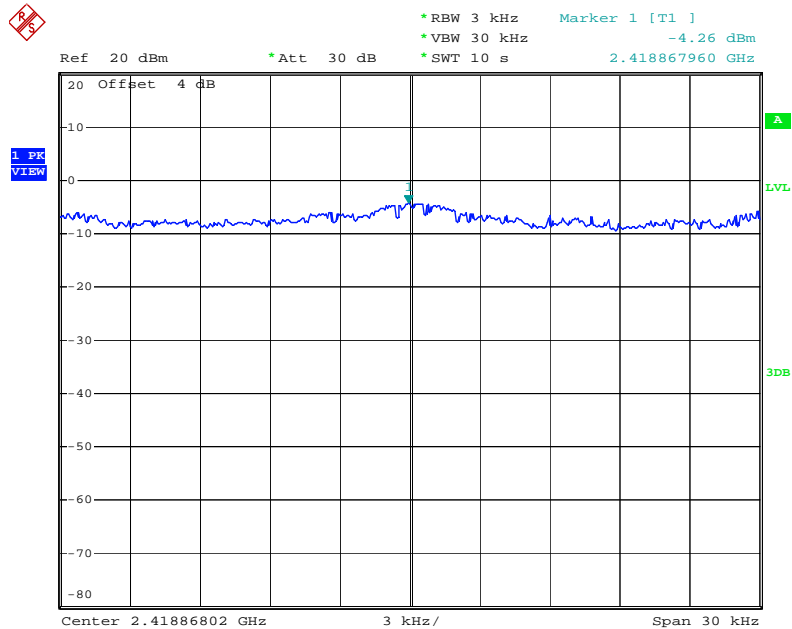

Date: 15.SEP.2009 22:52:27

Power Density Plot on Configuration IEEE 802.11g Ant. 5-1 + Ant. 5-3 / 2437 MHz

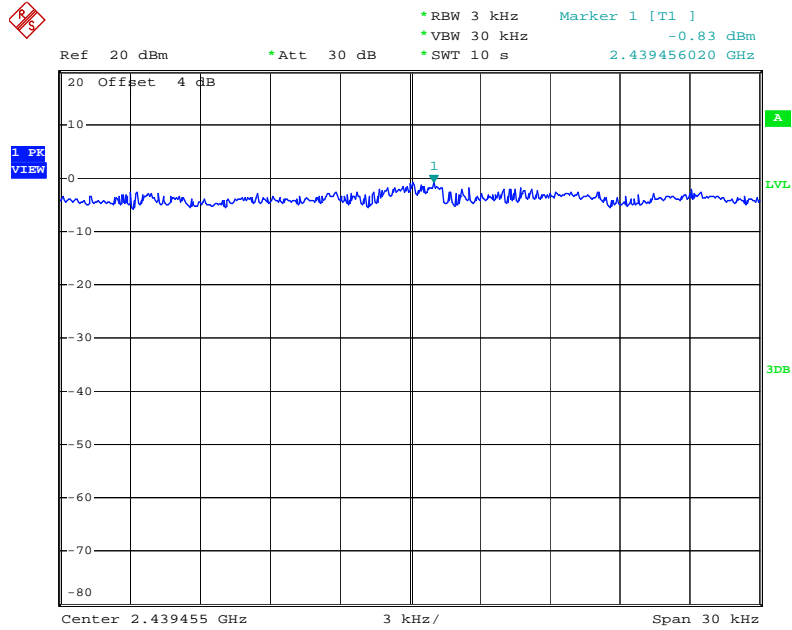

Date: 15.SEP.2009 22:54:36

Power Density Plot on Configuration IEEE 802.11g Ant. 5-1 + Ant. 5-3 / 2462 MHz

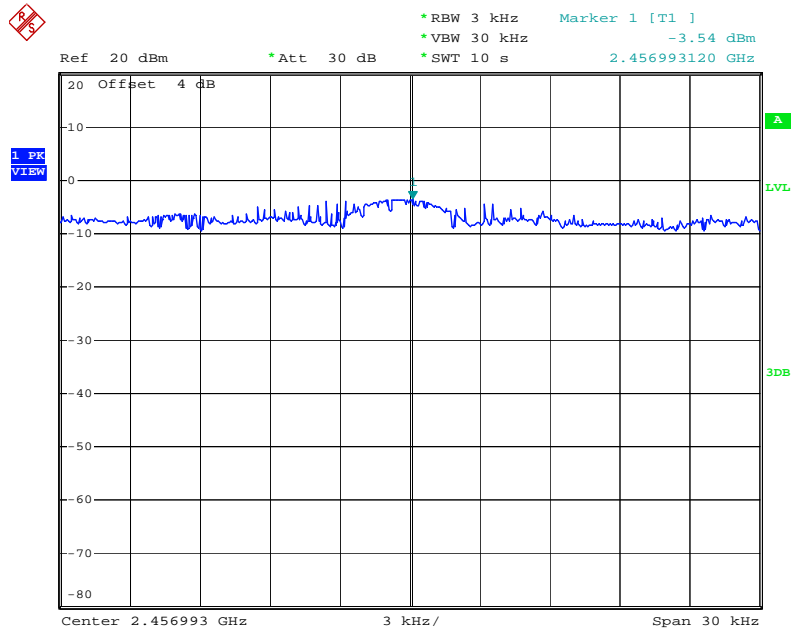

Date: 15.SEP.2009 23:01:22

Power Density Plot on Configuration IEEE 802.11a Ant. 5-1 + Ant. 5-3 / 5745 MHz

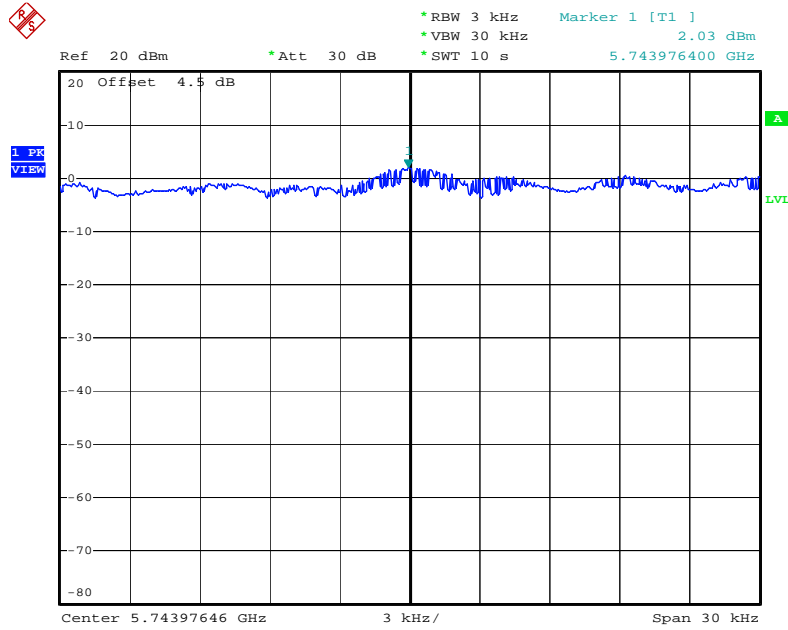

Date: 16.SEP.2009 18:06:04

Power Density Plot on Configuration IEEE 802.11a Ant. 5-1 + Ant. 5-3 / 5785 MHz

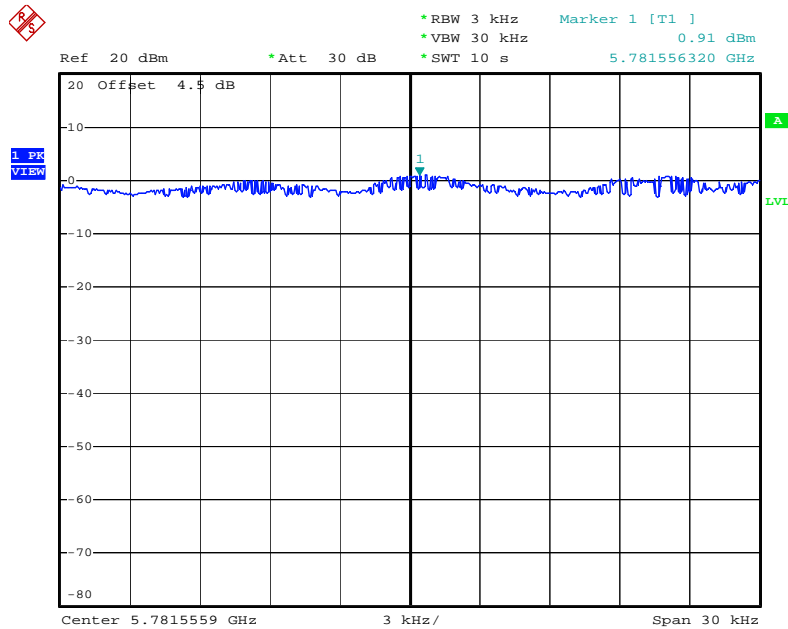

Date: 16.SEP.2009 18:08:36

Power Density Plot on Configuration IEEE 802.11a Ant. 5-1 + Ant. 5-3 / 5825 MHz

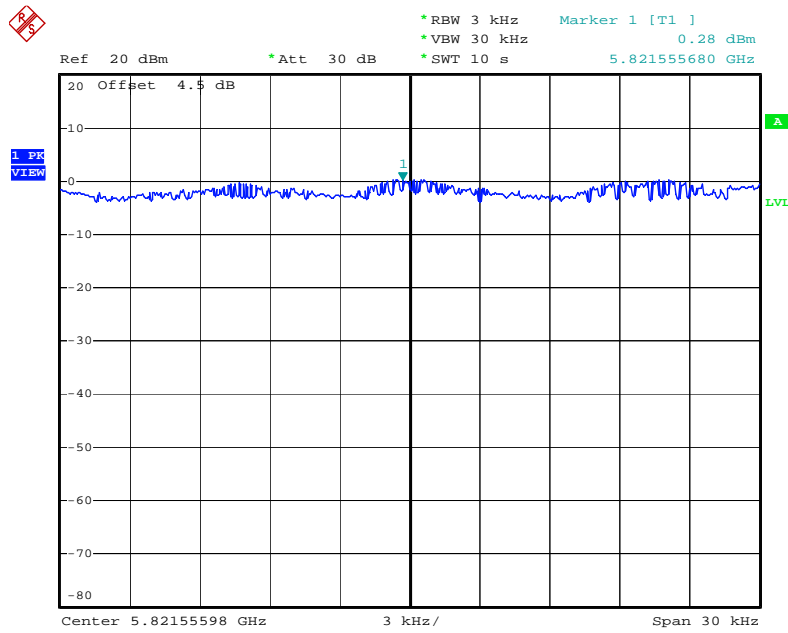

Date: 16.SEP.2009 18:10:27

<For Antenna 6>:

Power Density Plot on Configuration Drafft n MCS8 20MHz Ant. 6-1 + Ant. 6-3 / 2412 MHz

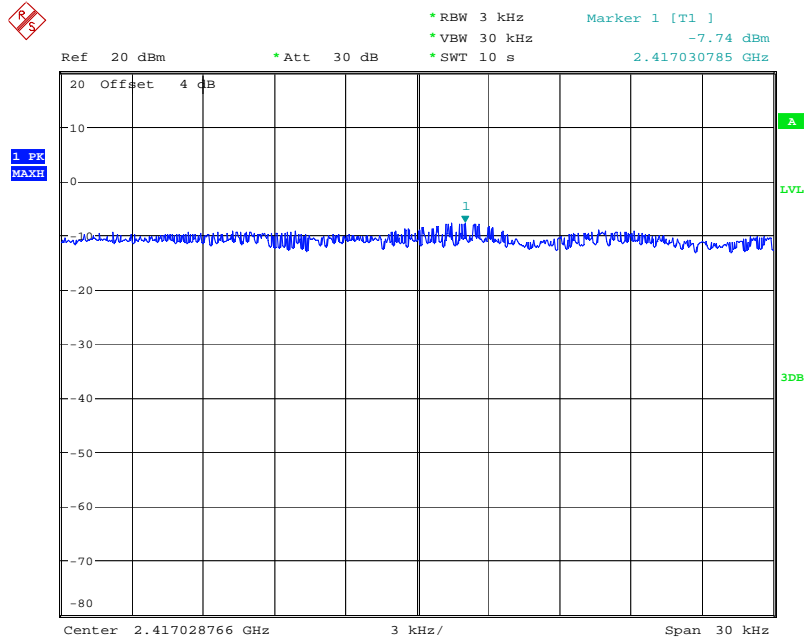

Date: 17.SEP.2009 13:50:50

Power Density Plot on Configuration Drafft n MCS8 20MHz Ant. 6-1 + Ant. 6-3 / 2437 MHz

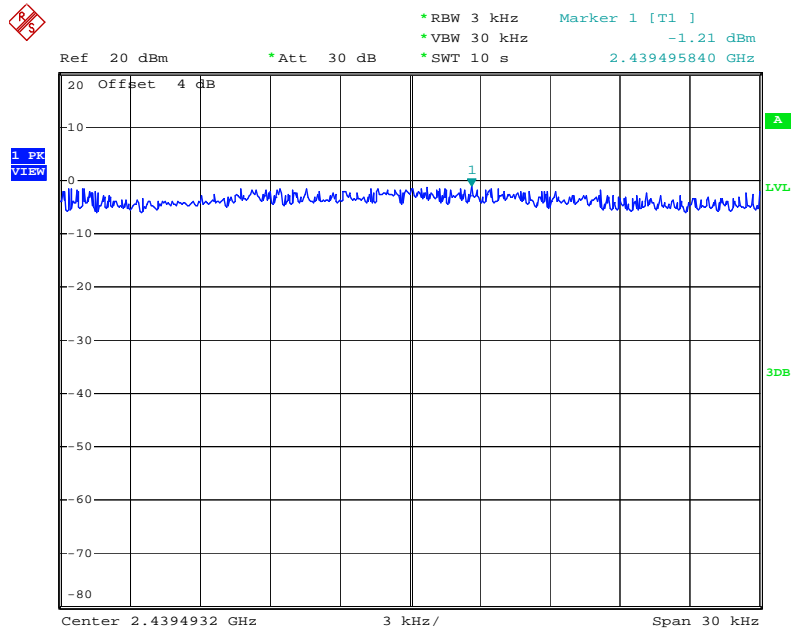

Date: 15.SEP.2009 23:27:31

Power Density Plot on Configuration Drafft n MCS8 20MHz Ant. 6-1 + Ant. 6-3 / 2462 MHz

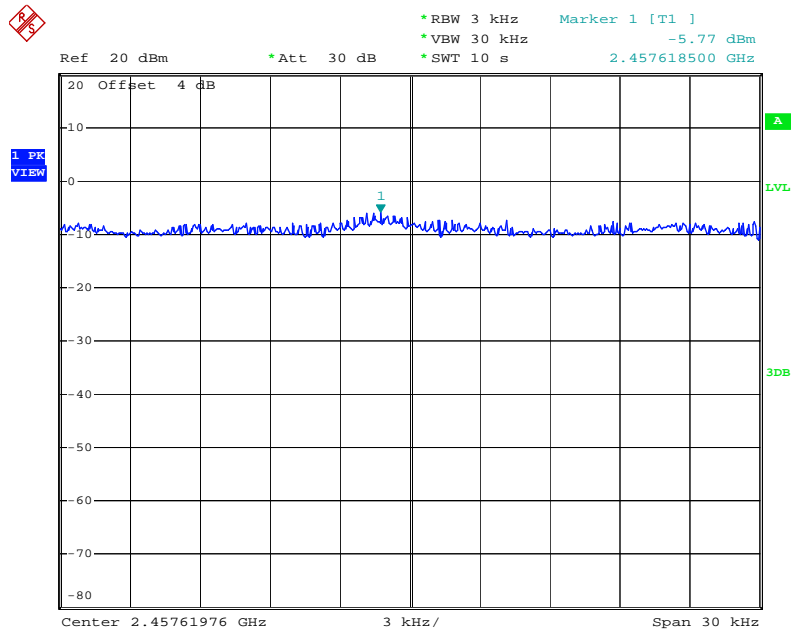

Date: 15.SEP.2009 23:42:55

Power Density Plot on Configuration Drafft n MCS8 40MHz Ant. 6-1 + Ant. 6-3 / 2422 MHz

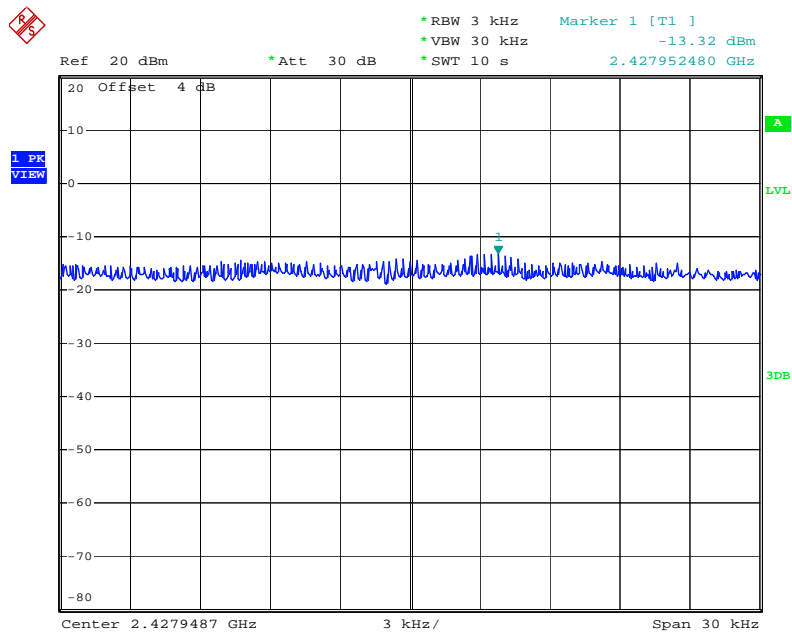

Date: 15.SEP.2009 23:44:33

Power Density Plot on Configuration Drafft n MCS8 40MHz Ant. 6-1 + Ant. 6-3 / 2437 MHz

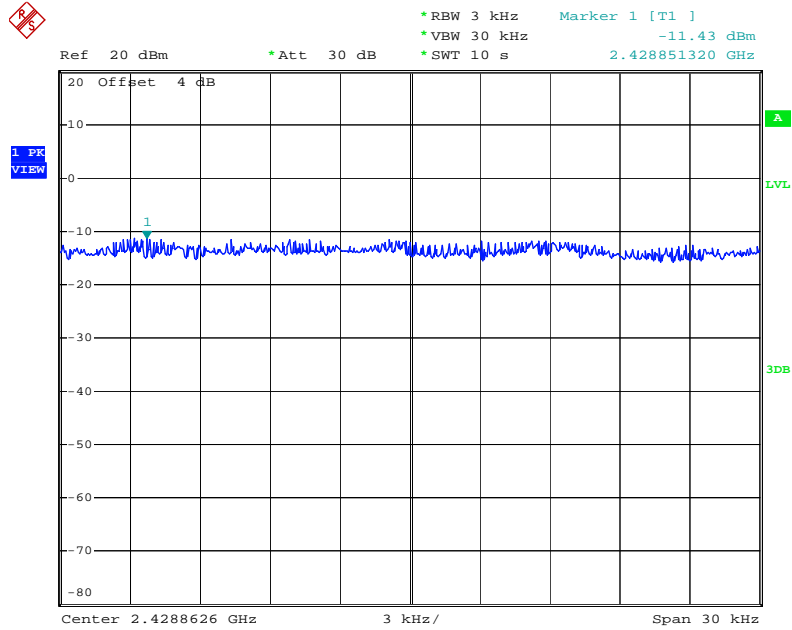

Date: 15.SEP.2009 23:50:47

Power Density Plot on Configuration Drafft n MCS8 40MHz Ant. 6-1 + Ant. 6-3 / 2452 MHz

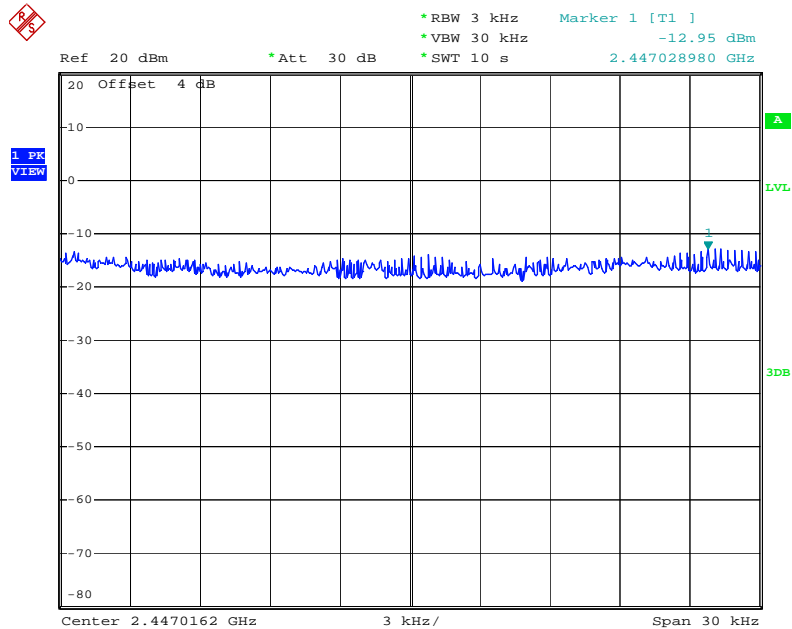

Date: 16.SEP.2009 00:01:47

Power Density Plot on Configuration 11a Draft n MCS8 20MHz Ant. 6-1 + Ant. 6-3 / 5745 MHz

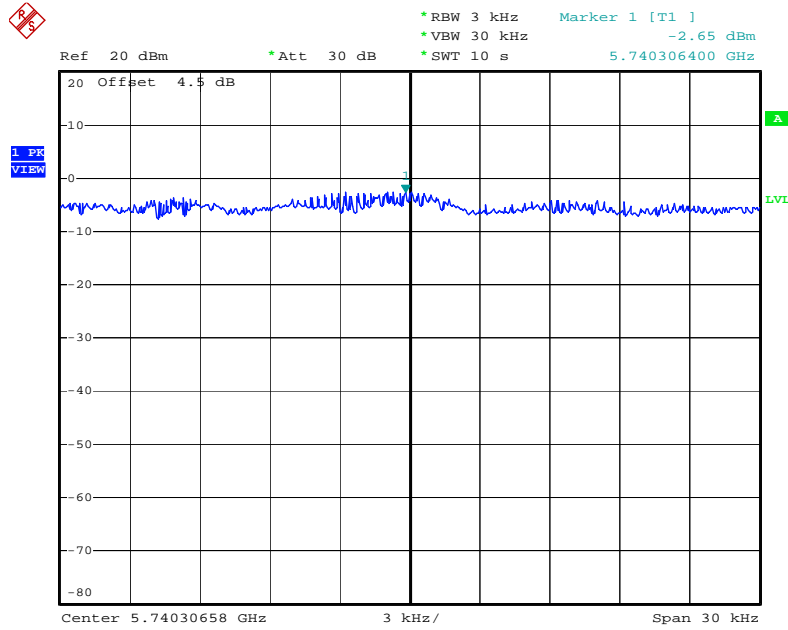

Date: 16.SEP.2009 18:18:23

Power Density Plot on Configuration 11a Draft n MCS8 20MHz Ant. 6-1 + Ant. 6-3 / 5785 MHz

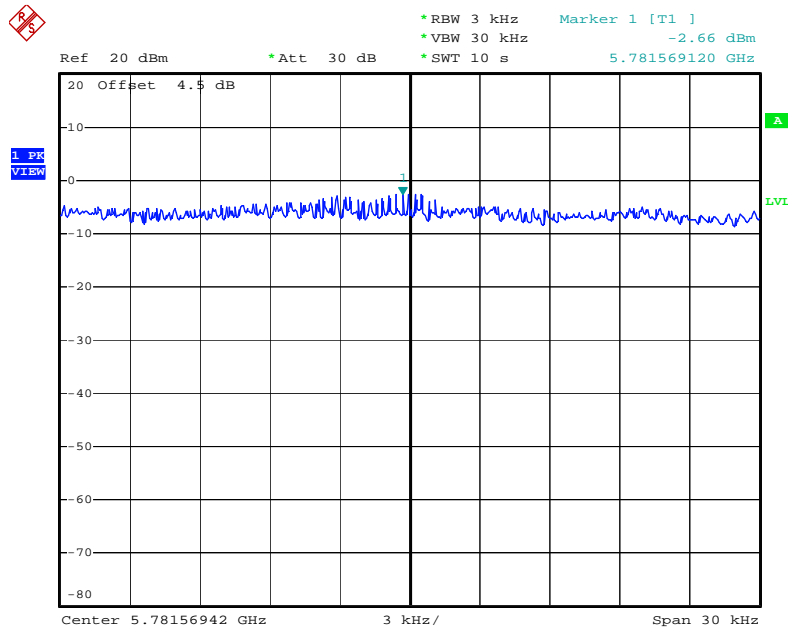

Date: 16.SEP.2009 18:15:47

Power Density Plot on Configuration 11a Draft n MCS8 20MHz Ant. 6-1 + Ant. 6-3 / 5825 MHz

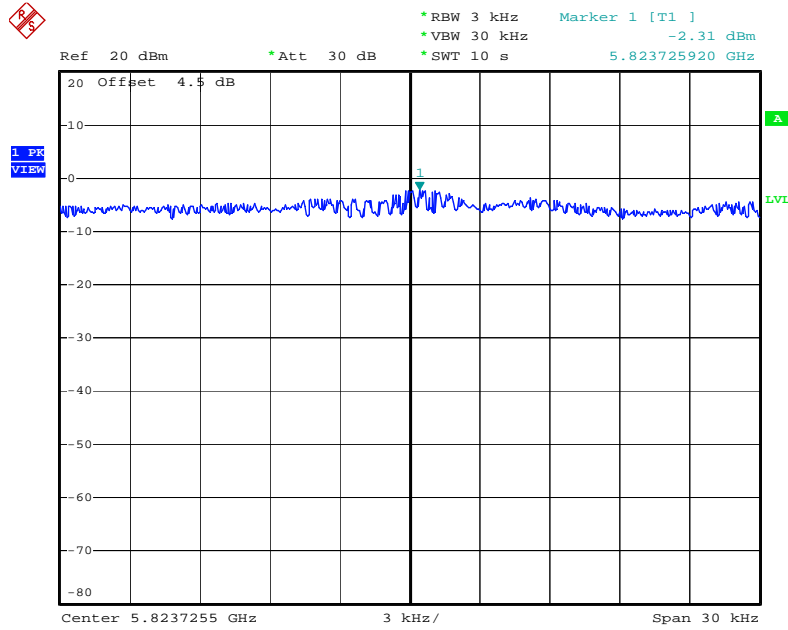

Date: 16.SEP.2009 18:13:35

Power Density Plot on Configuration 11a Draft n MCS8 40MHz Ant. 6-1 + Ant. 6-3 / 5755 MHz

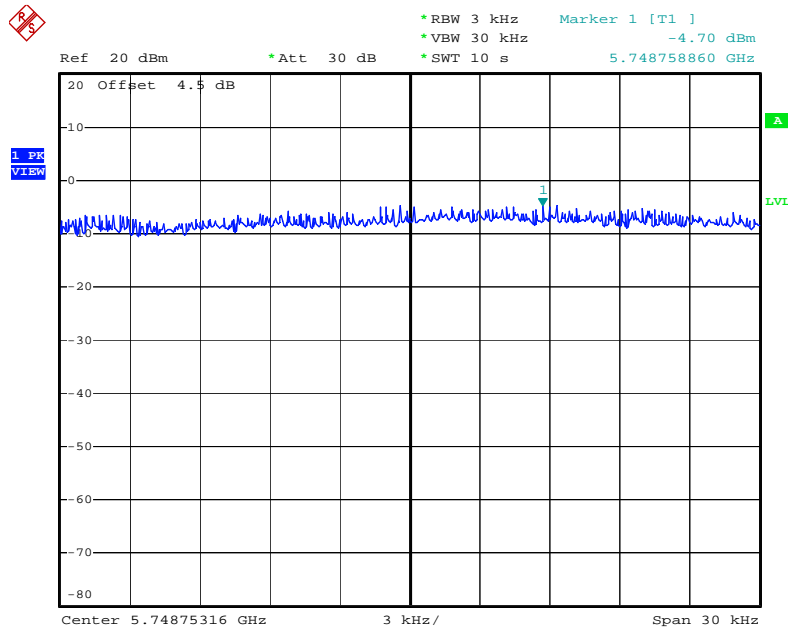

Date: 16.SEP.2009 19:20:21

Power Density Plot on Configuration 11a Draft n MCS8 40MHz Ant. 6-1 + Ant. 6-3 / 5795 MHz

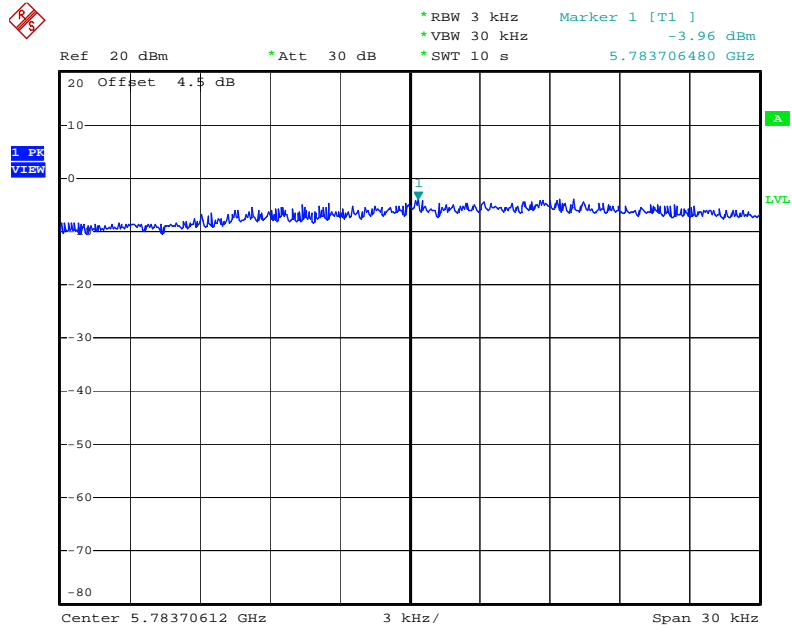

Date: 16.SEP.2009 19:23:47

Power Density Plot on Configuration IEEE 802.11b Ant. 6-1 + Ant. 6-3 / 2412 MHz

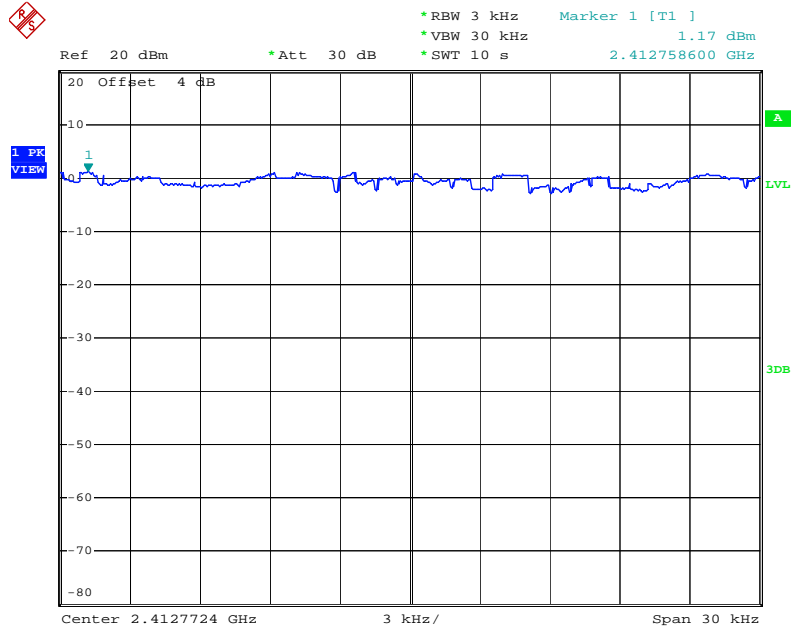

Date: 15.SEP.2009 22:27:59

Power Density Plot on Configuration IEEE 802.11b Ant. 6-1 + Ant. 6-3 / 2437 MHz

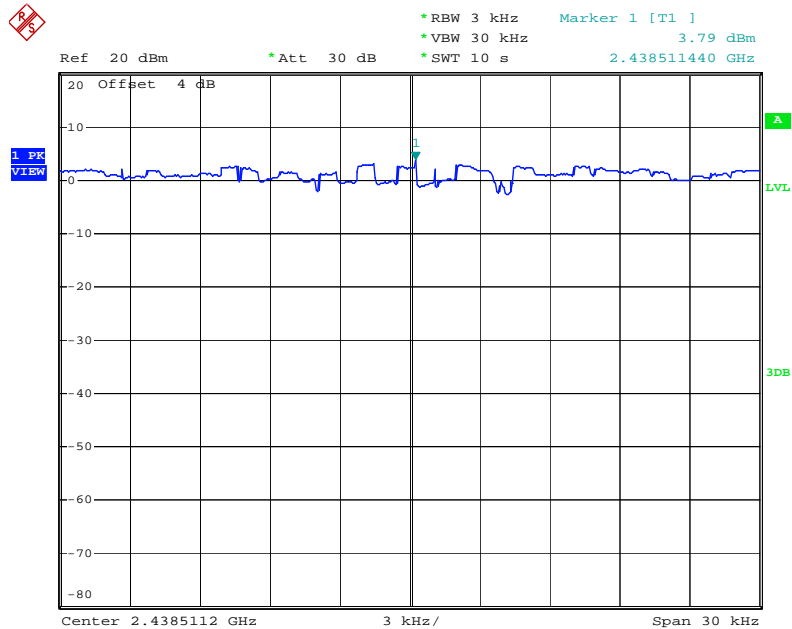

Date: 15.SEP.2009 22:33:14

Power Density Plot on Configuration IEEE 802.11b Ant. 6-1 + Ant. 6-3 / 2462 MHz

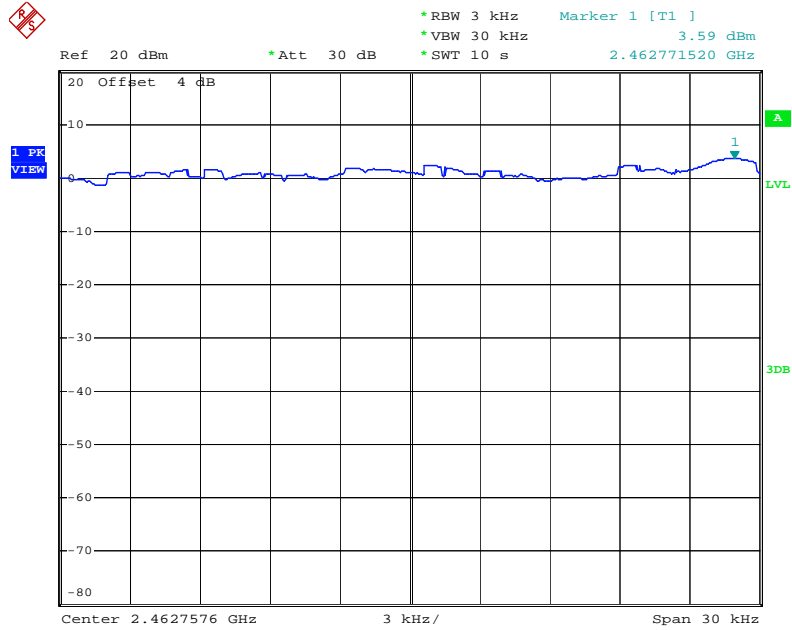

Date: 15.SEP.2009 22:40:40

Power Density Plot on Configuration IEEE 802.11g Ant. 6-1 + Ant. 6-3 / 2412 MHz

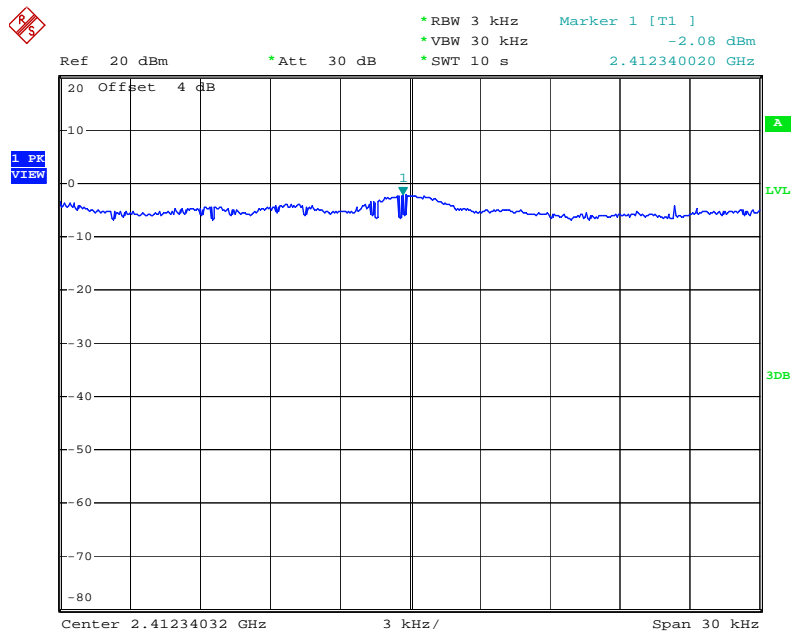

Date: 15.SEP.2009 22:50:17

Power Density Plot on Configuration IEEE 802.11g Ant. 6-1 + Ant. 6-3 / 2437 MHz

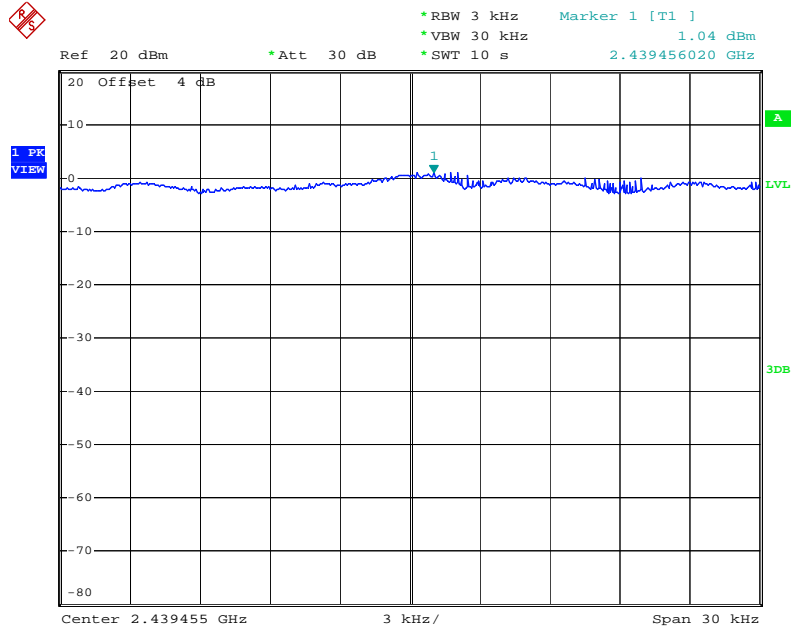

Date: 15.SEP.2009 22:56:04

Power Density Plot on Configuration IEEE 802.11g Ant. 6-1 + Ant. 6-3 / 2462 MHz

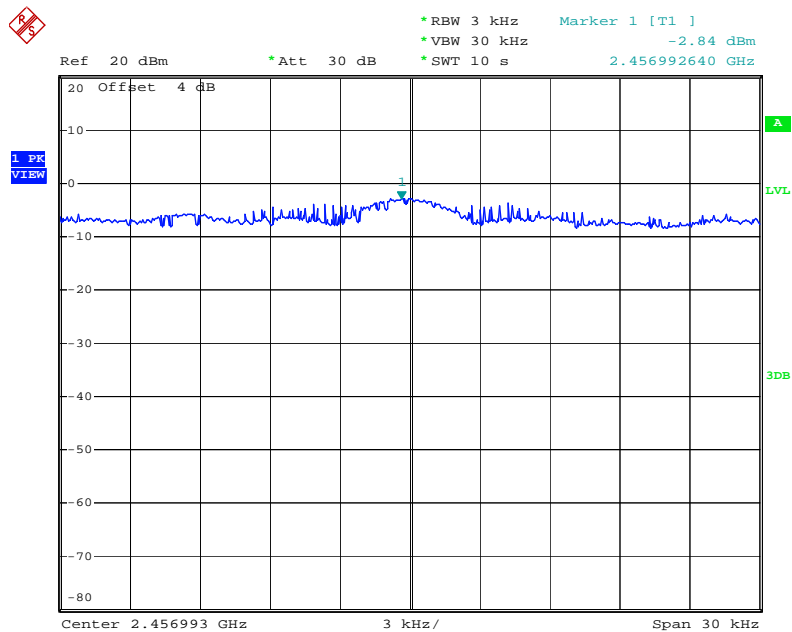

Date: 15.SEP.2009 23:02:55

Power Density Plot on Configuration IEEE 802.11a Ant. 6-1 + Ant. 6-3 / 5745 MHz

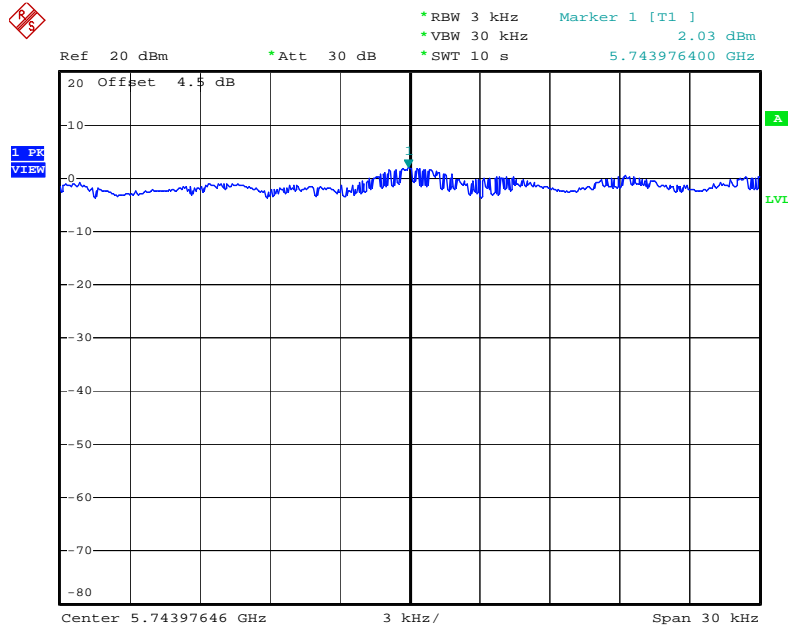

Date: 16.SEP.2009 18:06:04

Power Density Plot on Configuration IEEE 802.11a Ant. 6-1 + Ant. 6-3 / 5785 MHz

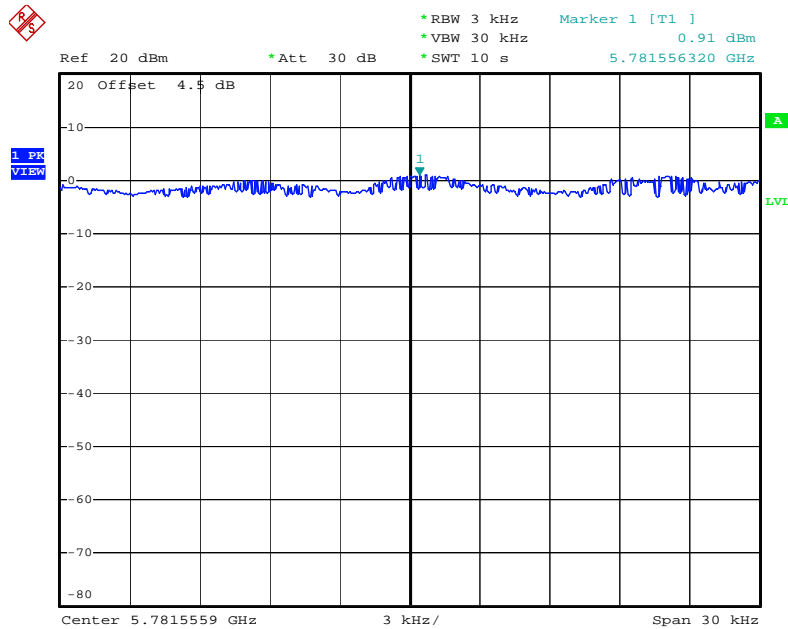

Date: 16.SEP.2009 18:08:36

Power Density Plot on Configuration IEEE 802.11a Ant. 6-1 + Ant. 6-3 / 5825 MHz

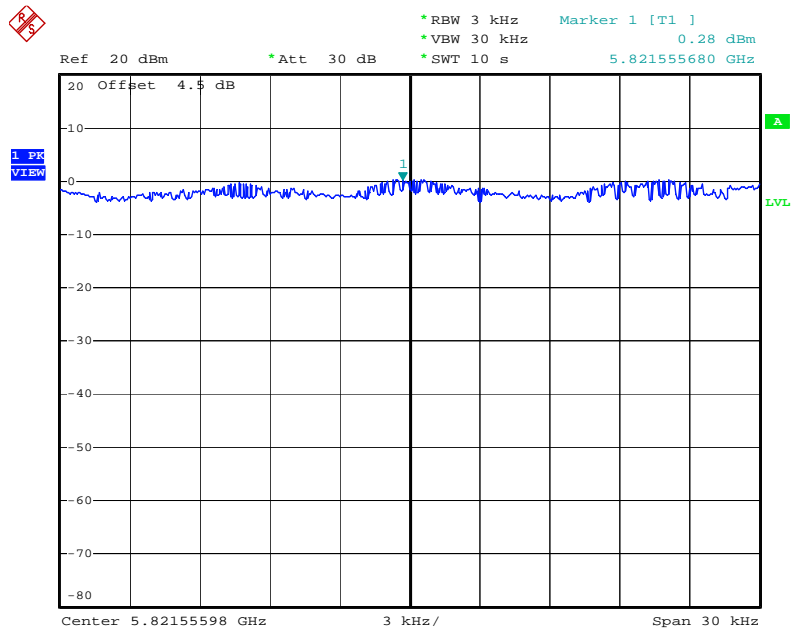

Date: 16.SEP.2009 18:10:27

4.4. 6dB Spectrum Bandwidth Measurement

4.4.1. Limit

For digital modulation systems, the minimum 6dB bandwidth shall be at least 500 kHz.

4.4.2. Measuring Instruments and Setting

Please refer to section 5 of equipments list in this report. The following table is the setting of the spectrum analyzer.

Spectrum Parameters	Setting
Attenuation	Auto
Span Frequency	> 6dB Bandwidth
RB	100 kHz
VB	100 kHz
Detector	Peak
Trace	Max Hold
Sweep Time	Auto

4.4.3. Test Procedures

1. The transmitter output (antenna port) was connected to the spectrum analyzer in peak hold mode.
2. The resolution bandwidth of 100 kHz and the video bandwidth of 100 kHz were used.
3. Measured the spectrum width with power higher than 6dB below carrier.
4. Measuring multiple antennas, the connector is required to link with spectrum analyzer through a combiner.

4.4.4. Test Setup Layout

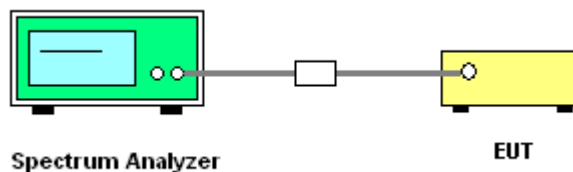

4.4.5. Test Deviation

There is no deviation with the original standard.

4.4.6. EUT Operation during Test

The EUT was programmed to be in continuously transmitting mode.

4.4.7. Test Result of 6dB Spectrum Bandwidth

<For Antenna 1>:

Temperature	21°C	Humidity	56%
Test Engineer	Johnson Chang	Configurations	Draft n / Antenna 1

For 2.4GHz Band

Configuration Draft n MCS8 20MHz Ant. 1-1 + Ant. 1-3

Channel	Frequency	6dB Bandwidth (MHz)	99% Occupied Bandwidth (MHz)	Min. Limit (kHz)	Test Result
1	2412 MHz	16.36	17.64	500	Complies
6	2437 MHz	16.04	17.60	500	Complies
11	2462 MHz	16.32	17.64	500	Complies

Configuration Draft n MCS8 40MHz Ant. 1-1 + Ant. 1-3

Channel	Frequency	6dB Bandwidth (MHz)	99% Occupied Bandwidth (MHz)	Min. Limit (kHz)	Test Result
3	2422 MHz	36.32	36.32	500	Complies
6	2437 MHz	36.08	36.32	500	Complies
9	2452 MHz	36.00	36.32	500	Complies

For 5GHz Band

Configuration 11a Draft n MCS8 20MHz Ant. 1-1 + Ant. 1-3

Channel	Frequency	6dB Bandwidth (MHz)	99% Occupied Bandwidth (MHz)	Min. Limit (kHz)	Test Result
149	5745 MHz	16.08	17.60	500	Complies
157	5785 MHz	16.36	17.64	500	Complies
165	5825 MHz	15.72	17.60	500	Complies

Configuration 11a Draft n MCS8 40MHz Ant. 1-1 + Ant. 1-3

Channel	Frequency	6dB Bandwidth (MHz)	99% Occupied Bandwidth (MHz)	Min. Limit (kHz)	Test Result
151	5755 MHz	35.68	36.32	500	Complies
159	5795 MHz	35.68	36.24	500	Complies

Temperature	21°C	Humidity	56%
Test Engineer	Johnson Chang	Configurations	802.11a/b/g / Antenna 1

Configuration IEEE 802.11b Ant. 1-1 + Ant. 1-3

Channel	Frequency	6dB Bandwidth (MHz)	99% Occupied Bandwidth (MHz)	Min. Limit (kHz)	Test Result
1	2412 MHz	5.56	14.64	500	Complies
6	2437 MHz	6.00	14.40	500	Complies
11	2462 MHz	6.56	14.72	500	Complies

Configuration IEEE 802.11g Ant. 1-1 + Ant. 1-3

Channel	Frequency	6dB Bandwidth (MHz)	99% Occupied Bandwidth (MHz)	Min. Limit (kHz)	Test Result
1	2412 MHz	16.48	16.56	500	Complies
6	2437 MHz	16.36	16.00	500	Complies
11	2462 MHz	16.40	16.60	500	Complies

Configuration IEEE 802.11a Ant. 1-1 + Ant. 1-3

Channel	Frequency	6dB Bandwidth (MHz)	99% Occupied Bandwidth (MHz)	Min. Limit (kHz)	Test Result
149	5745 MHz	15.72	16.44	500	Complies
157	5785 MHz	15.76	16.48	500	Complies
165	5825 MHz	15.76	16.48	500	Complies

<For Antenna 2>:

Temperature	21°C	Humidity	56%
Test Engineer	Johnson Chang	Configurations	Draft n / Antenna 2

For 2.4GHz Band

Configuration Draft n MCS8 20MHz Ant. 2-1 + Ant. 2-3

Channel	Frequency	6dB Bandwidth (MHz)	99% Occupied Bandwidth (MHz)	Min. Limit (kHz)	Test Result
1	2412 MHz	16.00	17.60	500	Complies
6	2437 MHz	16.04	17.60	500	Complies
11	2462 MHz	16.36	17.60	500	Complies

Configuration Draft n MCS8 40MHz Ant. 2-1 + Ant. 2-3

Channel	Frequency	6dB Bandwidth (MHz)	99% Occupied Bandwidth (MHz)	Min. Limit (kHz)	Test Result
3	2422 MHz	36.32	36.32	500	Complies
6	2437 MHz	36.08	36.32	500	Complies
9	2452 MHz	36.32	36.32	500	Complies

For 5GHz Band

Configuration 11a Draft n MCS8 20MHz Ant. 2-1 + Ant. 2-3

Channel	Frequency	6dB Bandwidth (MHz)	99% Occupied Bandwidth (MHz)	Min. Limit (kHz)	Test Result
149	5745 MHz	16.08	17.60	500	Complies
157	5785 MHz	16.36	17.64	500	Complies
165	5825 MHz	15.72	17.60	500	Complies

Configuration 11a Draft n MCS8 40MHz Ant. 2-1 + Ant. 2-3

Channel	Frequency	6dB Bandwidth (MHz)	99% Occupied Bandwidth (MHz)	Min. Limit (kHz)	Test Result
151	5755 MHz	35.68	36.32	500	Complies
159	5795 MHz	35.68	36.24	500	Complies

Temperature	21°C	Humidity	56%
Test Engineer	Johnson Chang	Configurations	802.11a/b/g / Antenna 2

Configuration IEEE 802.11b Ant. 2-1 + Ant. 2-3

Channel	Frequency	6dB Bandwidth (MHz)	99% Occupied Bandwidth (MHz)	Min. Limit (kHz)	Test Result
1	2412 MHz	6.08	14.44	500	Complies
6	2437 MHz	6.00	14.40	500	Complies
11	2462 MHz	6.08	14.28	500	Complies

Configuration IEEE 802.11g Ant. 2-1 + Ant. 2-3

Channel	Frequency	6dB Bandwidth (MHz)	99% Occupied Bandwidth (MHz)	Min. Limit (kHz)	Test Result
1	2412 MHz	16.48	16.56	500	Complies
6	2437 MHz	16.36	16.60	500	Complies
11	2462 MHz	16.36	16.60	500	Complies

Configuration IEEE 802.11a Ant. 2-1 + Ant. 2-3

Channel	Frequency	6dB Bandwidth (MHz)	99% Occupied Bandwidth (MHz)	Min. Limit (kHz)	Test Result
149	5745 MHz	15.72	16.44	500	Complies
157	5785 MHz	15.76	16.48	500	Complies
165	5825 MHz	15.76	16.48	500	Complies

<For Antenna 3>:

Temperature	21°C	Humidity	56%
Test Engineer	Johnson Chang	Configurations	Draft n / Antenna 3

For 2.4GHz Band

Configuration Draft n MCS8 20MHz Ant. 3-1 + Ant. 3-3

Channel	Frequency	6dB Bandwidth (MHz)	99% Occupied Bandwidth (MHz)	Min. Limit (kHz)	Test Result
1	2412 MHz	16.32	17.60	500	Complies
6	2437 MHz	16.12	17.60	500	Complies
11	2462 MHz	16.36	17.60	500	Complies

Configuration Draft n MCS8 40MHz Ant. 3-1 + Ant. 3-3

Channel	Frequency	6dB Bandwidth (MHz)	99% Occupied Bandwidth (MHz)	Min. Limit (kHz)	Test Result
3	2422 MHz	36.32	36.24	500	Complies
6	2437 MHz	36.08	36.32	500	Complies
9	2452 MHz	36.32	36.32	500	Complies

For 5GHz Band

Configuration 11a Draft n MCS8 20MHz Ant. 3-1 + Ant. 3-3

Channel	Frequency	6dB Bandwidth (MHz)	99% Occupied Bandwidth (MHz)	Min. Limit (kHz)	Test Result
149	5745 MHz	16.08	17.60	500	Complies
157	5785 MHz	16.36	17.64	500	Complies
165	5825 MHz	15.72	17.60	500	Complies

Configuration 11a Draft n MCS8 40MHz Ant. 3-1 + Ant. 3-3

Channel	Frequency	6dB Bandwidth (MHz)	99% Occupied Bandwidth (MHz)	Min. Limit (kHz)	Test Result
151	5755 MHz	35.68	36.32	500	Complies
159	5795 MHz	35.68	36.24	500	Complies

Temperature	21°C	Humidity	56%
Test Engineer	Johnson Chang	Configurations	802.11a/b/g / Antenna 3

Configuration IEEE 802.11b Ant. 3-1 + Ant. 3-3

Channel	Frequency	6dB Bandwidth (MHz)	99% Occupied Bandwidth (MHz)	Min. Limit (kHz)	Test Result
1	2412 MHz	6.08	14.44	500	Complies
6	2437 MHz	6.04	13.72	500	Complies
11	2462 MHz	6.08	14.28	500	Complies

Configuration IEEE 802.11g Ant. 3-1 + Ant. 3-3

Channel	Frequency	6dB Bandwidth (MHz)	99% Occupied Bandwidth (MHz)	Min. Limit (kHz)	Test Result
1	2412 MHz	16.32	16.56	500	Complies
6	2437 MHz	16.40	16.60	500	Complies
11	2462 MHz	16.32	16.56	500	Complies

Configuration IEEE 802.11a Ant. 3-1 + Ant. 3-3

Channel	Frequency	6dB Bandwidth (MHz)	99% Occupied Bandwidth (MHz)	Min. Limit (kHz)	Test Result
149	5745 MHz	15.72	16.44	500	Complies
157	5785 MHz	15.76	16.48	500	Complies
165	5825 MHz	15.76	16.48	500	Complies

<For Antenna 4>:

Temperature	21°C	Humidity	56%
Test Engineer	Johnson Chang	Configurations	Draft n / Antenna 4

For 2.4GHz Band

Configuration Draft n MCS8 20MHz Ant. 4-1 + Ant. 4-3

Channel	Frequency	6dB Bandwidth (MHz)	99% Occupied Bandwidth (MHz)	Min. Limit (kHz)	Test Result
1	2412 MHz	16.32	17.60	500	Complies
6	2437 MHz	16.04	17.60	500	Complies
11	2462 MHz	16.32	17.60	500	Complies

Configuration Draft n MCS8 40MHz Ant. 4-1 + Ant. 4-3

Channel	Frequency	6dB Bandwidth (MHz)	99% Occupied Bandwidth (MHz)	Min. Limit (kHz)	Test Result
3	2422 MHz	36.00	36.24	500	Complies
6	2437 MHz	36.08	36.32	500	Complies
9	2452 MHz	36.40	36.32	500	Complies

For 5GHz Band

Configuration 11a Draft n MCS8 20MHz Ant. 4-1 + Ant. 4-3

Channel	Frequency	6dB Bandwidth (MHz)	99% Occupied Bandwidth (MHz)	Min. Limit (kHz)	Test Result
149	5745 MHz	16.08	17.60	500	Complies
157	5785 MHz	16.36	17.64	500	Complies
165	5825 MHz	15.72	17.60	500	Complies

Configuration 11a Draft n MCS8 40MHz Ant. 4-1 + Ant. 4-3

Channel	Frequency	6dB Bandwidth (MHz)	99% Occupied Bandwidth (MHz)	Min. Limit (kHz)	Test Result
151	5755 MHz	35.68	36.32	500	Complies
159	5795 MHz	35.68	36.24	500	Complies

Temperature	21°C	Humidity	56%
Test Engineer	Johnson Chang	Configurations	802.11a/b/g / Antenna 4

Configuration IEEE 802.11b Ant. 4-1 + Ant. 4-3

Channel	Frequency	6dB Bandwidth (MHz)	99% Occupied Bandwidth (MHz)	Min. Limit (kHz)	Test Result
1	2412 MHz	6.08	14.44	500	Complies
6	2437 MHz	6.00	14.40	500	Complies
11	2462 MHz	6.08	13.68	500	Complies

Configuration IEEE 802.11g Ant. 4-1 + Ant. 4-3

Channel	Frequency	6dB Bandwidth (MHz)	99% Occupied Bandwidth (MHz)	Min. Limit (kHz)	Test Result
1	2412 MHz	16.36	16.52	500	Complies
6	2437 MHz	16.08	16.56	500	Complies
11	2462 MHz	16.44	16.52	500	Complies

Configuration IEEE 802.11a Ant. 4-1 + Ant. 4-3

Channel	Frequency	6dB Bandwidth (MHz)	99% Occupied Bandwidth (MHz)	Min. Limit (kHz)	Test Result
149	5745 MHz	15.72	16.44	500	Complies
157	5785 MHz	15.76	16.48	500	Complies
165	5825 MHz	15.76	16.48	500	Complies

<For Antenna 5>:

Temperature	21°C	Humidity	56%
Test Engineer	Johnson Chang	Configurations	Draft n / Antenna 5

For 2.4GHz Band

Configuration Draft n MCS8 20MHz Ant. 5-1 + Ant. 5-3

Channel	Frequency	6dB Bandwidth (MHz)	99% Occupied Bandwidth (MHz)	Min. Limit (kHz)	Test Result
1	2412 MHz	16.32	17.60	500	Complies
6	2437 MHz	15.76	17.60	500	Complies
11	2462 MHz	16.40	17.60	500	Complies

Configuration Draft n MCS8 40MHz Ant. 5-1 + Ant. 5-3

Channel	Frequency	6dB Bandwidth (MHz)	99% Occupied Bandwidth (MHz)	Min. Limit (kHz)	Test Result
3	2422 MHz	36.00	36.20	500	Complies
6	2437 MHz	36.32	36.32	500	Complies
9	2452 MHz	36.08	36.24	500	Complies

For 5GHz Band

Configuration 11a Draft n MCS8 20MHz Ant. 5-1 + Ant. 5-3

Channel	Frequency	6dB Bandwidth (MHz)	99% Occupied Bandwidth (MHz)	Min. Limit (kHz)	Test Result
149	5745 MHz	16.08	17.60	500	Complies
157	5785 MHz	16.36	17.64	500	Complies
165	5825 MHz	15.72	17.60	500	Complies

Configuration 11a Draft n MCS8 40MHz Ant. 5-1 + Ant. 5-3

Channel	Frequency	6dB Bandwidth (MHz)	99% Occupied Bandwidth (MHz)	Min. Limit (kHz)	Test Result
151	5755 MHz	35.68	36.32	500	Complies
159	5795 MHz	35.68	36.24	500	Complies

Temperature	21°C	Humidity	56%
Test Engineer	Johnson Chang	Configurations	802.11a/b/g / Antenna 5

Configuration IEEE 802.11b Ant. 5-1 + Ant. 5-3

Channel	Frequency	6dB Bandwidth (MHz)	99% Occupied Bandwidth (MHz)	Min. Limit (kHz)	Test Result
1	2412 MHz	5.08	14.36	500	Complies
6	2437 MHz	6.08	13.68	500	Complies
11	2462 MHz	6.04	14.40	500	Complies

Configuration IEEE 802.11g Ant. 5-1 + Ant. 5-3

Channel	Frequency	6dB Bandwidth (MHz)	99% Occupied Bandwidth (MHz)	Min. Limit (kHz)	Test Result
1	2412 MHz	16.40	16.56	500	Complies
6	2437 MHz	16.32	16.56	500	Complies
11	2462 MHz	16.36	16.60	500	Complies

Configuration IEEE 802.11a Ant. 5-1 + Ant. 5-3

Channel	Frequency	6dB Bandwidth (MHz)	99% Occupied Bandwidth (MHz)	Min. Limit (kHz)	Test Result
149	5745 MHz	15.72	16.44	500	Complies
157	5785 MHz	15.76	16.48	500	Complies
165	5825 MHz	15.76	16.48	500	Complies

<For Antenna 6>:

Temperature	21°C	Humidity	56%
Test Engineer	Johnson Chang	Configurations	Draft n / Antenna 6

For 2.4GHz Band

Configuration Draft n MCS8 20MHz Ant. 6-1 + Ant. 6-3

Channel	Frequency	6dB Bandwidth (MHz)	99% Occupied Bandwidth (MHz)	Min. Limit (kHz)	Test Result
1	2412 MHz	16.32	17.60	500	Complies
6	2437 MHz	16.04	17.60	500	Complies
11	2462 MHz	16.04	17.60	500	Complies

Configuration Draft n MCS8 40MHz Ant. 6-1 + Ant. 6-3

Channel	Frequency	6dB Bandwidth (MHz)	99% Occupied Bandwidth (MHz)	Min. Limit (kHz)	Test Result
3	2422 MHz	36.00	36.32	500	Complies
6	2437 MHz	36.00	36.32	500	Complies
9	2452 MHz	35.76	36.32	500	Complies

For 5GHz Band

Configuration 11a Draft n MCS8 20MHz Ant. 6-1 + Ant. 6-3

Channel	Frequency	6dB Bandwidth (MHz)	99% Occupied Bandwidth (MHz)	Min. Limit (kHz)	Test Result
149	5745 MHz	16.08	17.60	500	Complies
157	5785 MHz	16.36	17.64	500	Complies
165	5825 MHz	15.72	17.60	500	Complies

Configuration 11a Draft n MCS8 40MHz Ant. 6-1 + Ant. 6-3

Channel	Frequency	6dB Bandwidth (MHz)	99% Occupied Bandwidth (MHz)	Min. Limit (kHz)	Test Result
151	5755 MHz	35.68	36.32	500	Complies
159	5795 MHz	35.68	36.24	500	Complies

Temperature	21°C	Humidity	56%
Test Engineer	Johnson Chang	Configurations	802.11a/b/g / Antenna 6

Configuration IEEE 802.11b Ant. 6-1 + Ant. 6-3

Channel	Frequency	6dB Bandwidth (MHz)	99% Occupied Bandwidth (MHz)	Min. Limit (kHz)	Test Result
1	2412 MHz	6.04	14.60	500	Complies
6	2437 MHz	6.12	14.64	500	Complies
11	2462 MHz	6.56	13.84	500	Complies

Configuration IEEE 802.11g Ant. 6-1 + Ant. 6-3

Channel	Frequency	6dB Bandwidth (MHz)	99% Occupied Bandwidth (MHz)	Min. Limit (kHz)	Test Result
1	2412 MHz	16.40	16.56	500	Complies
6	2437 MHz	16.05	16.53	500	Complies
11	2462 MHz	16.36	16.56	500	Complies

Configuration IEEE 802.11a Ant. 6-1 + Ant. 6-3

Channel	Frequency	6dB Bandwidth (MHz)	99% Occupied Bandwidth (MHz)	Min. Limit (kHz)	Test Result
149	5745 MHz	15.72	16.44	500	Complies
157	5785 MHz	15.76	16.48	500	Complies
165	5825 MHz	15.76	16.48	500	Complies