



FCC RADIO TEST REPORT

FCC ID : UZ7LI4278A
Equipment : LINEAR IMAGER
Brand Name : Symbol Technologies Inc.
Model Name : LI4278A
Applicant : Zebra
1 Zebra Plaza, Holtsville, NY 11742
Manufacturer : Symbol Technologies Inc.
1 Zebra Plaza, Holtsville, NY 11742
Standard : FCC Part 15 Subpart C §15.247

The product was received on Nov. 22, 2022 and testing was performed from Dec. 07, 2022 to Jan. 31, 2023. We, Sporton International Inc. Wensan Laboratory, would like to declare that the tested sample has been evaluated in accordance with the test procedures and has been in compliance with the applicable technical standards.

The test results in this report apply exclusively to the tested model / sample. Without written approval from Sporton International Inc. Wensan Laboratory, the test report shall not be reproduced except in full.

Approved by: Louis Wu

Sporton International Inc. Wensan Laboratory

No.58, Aly. 75, Ln. 564, Wenhua 3rd, Rd., Guishan Dist., Taoyuan City 333010, Taiwan (R.O.C.)



Table of Contents

History of this test report..... 3

Summary of Test Result..... 4

1 General Description..... 5

 1.1 Product Feature of Equipment Under Test..... 5

 1.2 Product Specification of Equipment Under Test..... 5

 1.3 Modification of EUT 5

 1.4 Testing Location 6

 1.5 Applicable Standards..... 6

2 Test Configuration of Equipment Under Test 7

 2.1 Carrier Frequency Channel 7

 2.2 Test Mode..... 8

 2.3 Connection Diagram of Test System..... 9

 2.4 Support Unit used in test configuration and system 10

 2.5 EUT Operation Test Setup 10

 2.6 Measurement Results Explanation Example..... 10

3 Test Result..... 11

 3.1 Number of Channel Measurement 11

 3.2 Hopping Channel Separation Measurement 13

 3.3 Dwell Time Measurement..... 17

 3.4 20dB and 99% Bandwidth Measurement 19

 3.5 Output Power Measurement..... 26

 3.6 Conducted Band Edges Measurement..... 27

 3.7 Conducted Spurious Emission Measurement 32

 3.8 Radiated Band Edges and Spurious Emission Measurement 39

 3.9 AC Conducted Emission Measurement..... 43

 3.10 Antenna Requirements 45

4 List of Measuring Equipment 46

5 Uncertainty of Evaluation..... 48

Appendix A. Conducted Test Results

Appendix B. AC Conducted Emission Test Result

Appendix C. Radiated Spurious Emission

Appendix D. Radiated Spurious Emission Plots

Appendix E. Duty Cycle Plots

Appendix F. Setup Photographs



History of this test report

Report No.	Version	Description	Issue Date
FR261103	01	Initial issue of report	Mar. 30, 2023
FR261103	02	Revise section 3.6.6 and appendix D This report is an updated version, replacing the report issued on Mar. 30, 2023.	Apr. 07, 2023



Summary of Test Result

Report Clause	Ref Std. Clause	Test Items	Result (PASS/FAIL)	Remark
3.1	15.247(a)(1)	Number of Channels	Pass	-
3.2	15.247(a)(1)	Hopping Channel Separation	Pass	-
3.3	15.247(a)(1)	Dwell Time of Each Channel	Pass	-
3.4	15.247(a)(1)	20dB Bandwidth	Pass	-
3.4	2.1049	99% Occupied Bandwidth	Reporting only	-
3.5	15.247(b)(1) 15.247(b)(4)	Peak Output Power	Pass	-
3.6	15.247(d)	Conducted Band Edges	Pass	-
3.7	15.247(d)	Conducted Spurious Emission	Pass	-
3.8	15.247(d)	Radiated Band Edges and Radiated Spurious Emission	Pass	4.48 dB under the limit at 726.460 MHz
3.9	15.207	AC Conducted Emission	Pass	6.42 dB under the limit at 0.377 MHz
3.10	15.203	Antenna Requirement	Pass	-

Conformity Assessment Condition:

1. The test results (PASS/FAIL) with all measurement uncertainty excluded are presented against the regulation limits or in accordance with the requirements stipulated by the applicant/manufacture who shall bear all the risks of non-compliance that may potentially occur if measurement uncertainty is taken into account.
2. Please refer to the section " Uncertainty of Evaluation " for measurement uncertainty.

Disclaimer:

The product specifications of the EUT presented in the test report that may affect the test assessments are declared by the manufacturer who shall take full responsibility for the authenticity.

Reviewed by: Wei Chen**Report Producer: Rachel Hsieh**



1 General Description

1.1 Product Feature of Equipment Under Test

Product Feature	
Equipment	LINEAR IMAGER
Brand Name	Symbol Technologies Inc.
Model Name	LI4278A
FCC ID	UZ7LI4278A
EUT supports Radios application	Bluetooth BR/EDR
HW Version	DV
MFD	13OCT22
EUT Stage	Production Unit

Remark: The EUT's information above is declared by manufacturer.

Specification of Accessories				
Battery	Brand Name	Zebra	Part Number	82-67705-01
Bluetooth Presentation Cradle	Brand Name	Zebra	Part Number	CR0078
Charge only Cradle	Brand Name	Zebra	Part Number	STB4208

Supported Unit used in test configuration and system				
AC Adapter	Brand Name	Zebra	Part Number	PWR-WUA5V4W0US
RJ50 to RJ232	Brand Name	Zebra	Part Number	CBA-R01-S07PBR

1.2 Product Specification of Equipment Under Test

Product Specification is subject to this standard	
Tx/Rx Frequency Range	2402 MHz ~ 2480 MHz
Number of Channels	79
Carrier Frequency of Each Channel	2402+n*1 MHz; n=0~78
Maximum Output Power to Antenna	Bluetooth BR (1Mbps): 4.38 dBm / 0.0027 W Bluetooth EDR (2Mbps): 5.34 dBm / 0.0034 W Bluetooth EDR (3Mbps): 5.51 dBm / 0.0036 W
99% Occupied Bandwidth	Bluetooth BR (1Mbps): 0.825 MHz Bluetooth EDR (2Mbps): 1.184 MHz Bluetooth EDR (3Mbps): 1.164 MHz
Antenna Type / Gain	Chip Antenna type with gain 1.2 dBi
Type of Modulation	Bluetooth BR (1Mbps) : GFSK Bluetooth EDR (2Mbps) : $\pi/4$ -DQPSK Bluetooth EDR (3Mbps) : 8-DPSK

Remark: The EUT's information above is declared by manufacturer. Please refer to Disclaimer in report summary.

1.3 Modification of EUT

No modifications made to the EUT during the testing.



1.4 Testing Location

Test Site	Sporton International Inc. EMC & Wireless Communications Laboratory
Test Site Location	No.52, Huaya 1st Rd., Guishan Dist., Taoyuan City 333, Taiwan (R.O.C.) TEL: +886-3-327-3456 FAX: +886-3-328-4978
Test Site No.	Sporton Site No. CO05-HY (TAF Code: 1190)
Remark	The AC Conducted Emission test item subcontracted to Sporton International Inc. EMC & Wireless Communications Laboratory.

Note: The test site complies with ANSI C63.4 2014 requirement.

Test Site	Sporton International Inc. Wensan Laboratory
Test Site Location	No.58, Aly. 75, Ln. 564, Wenhua 3rd, Rd., Guishan Dist., Taoyuan City 333010, Taiwan (R.O.C.) TEL: +886-3-327-0868 FAX: +886-3-327-0855
Test Site No.	Sporton Site No. TH05-HY, 03CH15-HY

Note: The test site complies with ANSI C63.4 2014 requirement.

FCC designation No.: TW1190 and TW3786

1.5 Applicable Standards

According to the specifications declared by the manufacturer, the EUT must comply with the requirements of the following standards:

- ♦ FCC Part 15 Subpart C §15.247
- ♦ FCC KDB Publication No. 558074 D01 15.247 Meas Guidance v05r02
- ♦ FCC KDB 414788 D01 Radiated Test Site v01r01
- ♦ ANSI C63.10-2013

Remark:

1. All the test items were validated and recorded in accordance with the standards without any modification during the testing.
2. The TAF code is not including all the FCC KDB listed without accreditation.
3. This EUT has also been tested and complied with the requirements of FCC Part 15, Subpart B, recorded in a separate test report.



2 Test Configuration of Equipment Under Test

2.1 Carrier Frequency Channel

Frequency Band	Channel	Freq. (MHz)	Channel	Freq. (MHz)	Channel	Freq. (MHz)
2400-2483.5 MHz	0	2402	27	2429	54	2456
	1	2403	28	2430	55	2457
	2	2404	29	2431	56	2458
	3	2405	30	2432	57	2459
	4	2406	31	2433	58	2460
	5	2407	32	2434	59	2461
	6	2408	33	2435	60	2462
	7	2409	34	2436	61	2463
	8	2410	35	2437	62	2464
	9	2411	36	2438	63	2465
	10	2412	37	2439	64	2466
	11	2413	38	2440	65	2467
	12	2414	39	2441	66	2468
	13	2415	40	2442	67	2469
	14	2416	41	2443	68	2470
	15	2417	42	2444	69	2471
	16	2418	43	2445	70	2472
	17	2419	44	2446	71	2473
	18	2420	45	2447	72	2474
	19	2421	46	2448	73	2475
	20	2422	47	2449	74	2476
	21	2423	48	2450	75	2477
	22	2424	49	2451	76	2478
	23	2425	50	2452	77	2479
	24	2426	51	2453	78	2480
	25	2427	52	2454	-	-
	26	2428	53	2455	-	-



2.2 Test Mode

- a. The EUT has been associated with peripherals and configuration operated in a manner tended to maximize its emission characteristics in a typical application. Frequency range investigated: conduction emission (150 kHz to 30 MHz), radiation emission (9 kHz to the 10th harmonic of the highest fundamental frequency or to 40 GHz, whichever is lower). For radiated measurement, the measured emission level of the EUT was maximized by rotating the EUT on a turntable, adjusting the orientation of the EUT and EUT antenna in three orthogonal axis (X: flat, Y: portrait, Z: landscape), and adjusting the measurement antenna orientation, following C63.10 exploratory test procedures and only the worst plane, and the worst mode of radiated spurious emissions is Bluetooth 3Mbps mode, and recorded in this report.
- b. AC power line Conducted Emission was tested under maximum output power.

The following summary table is showing all test modes to demonstrate in compliance with the standard.

Summary table of Test Cases			
Test Item	Data Rate / Modulation		
Conducted Test Cases	Bluetooth BR 1Mbps GFSK	Bluetooth EDR 2Mbps $\pi/4$-DQPSK	Bluetooth EDR 3Mbps 8-DPSK
	Mode 1: CH00_2402 MHz	Mode 4: CH00_2402 MHz	Mode 7: CH00_2402 MHz
	Mode 2: CH39_2441 MHz	Mode 5: CH39_2441 MHz	Mode 8: CH39_2441 MHz
	Mode 3: CH78_2480 MHz	Mode 6: CH78_2480 MHz	Mode 9: CH78_2480 MHz
Radiated Test Cases	Bluetooth EDR 3Mbps 8-DPSK		
	Mode 1: CH00_2402 MHz		
	Mode 2: CH39_2441 MHz		
	Mode 3: CH78_2480 MHz		
AC Conducted Emission	Mode 1 :Bluetooth Link between Scanner and Cradle + EUT (Scanner) Scan + Cradle RJ50 to RS232 cable (Data Link with Notebook) + AC Adapter		
Remark:			
1. For Radiated Test Cases, the worst mode data rate 3Mbps was reported only since the highest RF output power in the preliminary tests. The conducted spurious emissions and conducted band edge measurement for other data rates were not worse than 3Mbps, and no other significantly frequencies found in conducted spurious emission.			
2. Data Link with Notebook means data application transferred mode between Cradle and Notebook.			

2.3 Connection Diagram of Test System

<AC Conducted Emission Mode>

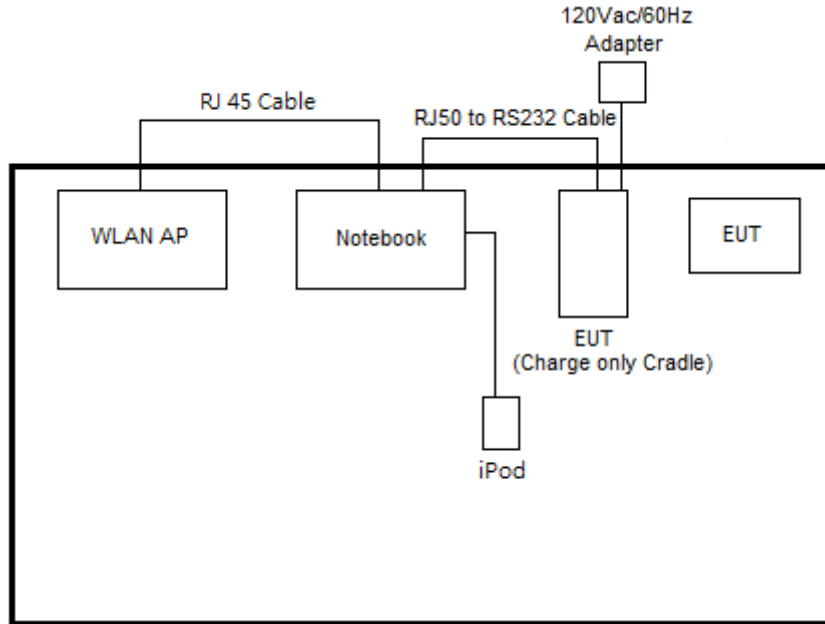

<Bluetooth Tx Mode>

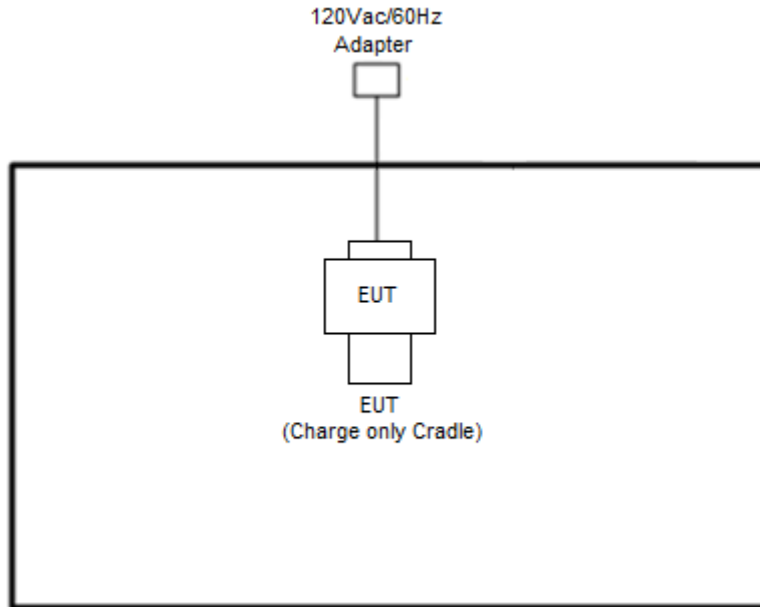

2.4 Support Unit used in test configuration and system

Item	Equipment	Brand Name	Model Name	FCC ID	Data Cable	Power Cord
1.	WLAN AP	ASUS	RT-AC66U	MSQ-RTAC66U	N/A	Unshielded, 1.8 m
2.	Notebook	DELL	Latitude 3400	FCC DoC	N/A	AC I/P: Unshielded, 1.2 m DC O/P: Shielded, 1.8 m
3.	iPod	Apple	A1285	FCC DoC	Shielded, 1.0 m	N/A

2.5 EUT Operation Test Setup

The RF test items, utility “BT Regulatory Test APP 1.3.8.1” was installed in Notebook which was programmed in order to make the EUT get into the engineering modes to provide channel selection, power level, data rate and the application type and for continuous transmitting signals.

2.6 Measurement Results Explanation Example

For all conducted test items:

The offset level is set in the spectrum analyzer to compensate the RF cable loss and attenuator factor between EUT conducted output port and spectrum analyzer. With the offset compensation, the spectrum analyzer reading level is exactly the EUT RF output level.

Example:

The spectrum analyzer offset is derived from RF cable loss and attenuator factor.

Offset = RF cable loss + attenuator factor.

Following shows an offset computation example with cable loss 4.2 dB and 10 dB attenuator.

Offset(dB) = RF cable loss(dB) + attenuator factor(dB).

$$= 4.2 + 10 = 14.2 \text{ (dB)}$$

3 Test Result

3.1 Number of Channel Measurement

3.1.1 Limits of Number of Hopping Frequency

Frequency hopping systems in the 2400-2483.5 MHz band shall use at least 15 channels.

3.1.2 Measuring Instruments

Please refer to the measuring equipment list in this test report.

3.1.3 Test Procedure

1. The testing follows ANSI C63.10-2013 clause 7.8.3.
2. The RF output of EUT is connected to the spectrum analyzer by RF cable and attenuator. The path loss is compensated to the results for each measurement.
3. Set the maximum power setting and enable the EUT to transmit continuously.
4. Enable the EUT hopping function.
5. Use the following spectrum analyzer settings: Span = the frequency band of operation; RBW = 300 kHz; VBW \geq RBW; Sweep = auto; Detector function = peak; Trace = max hold.
6. The number of hopping frequency used is defined as the number of total channel.
7. Record the measurement data derived from spectrum analyzer.

3.1.4 Test Setup





3.1.5 Test Result of Number of Hopping Frequency

Please refer to Appendix A.

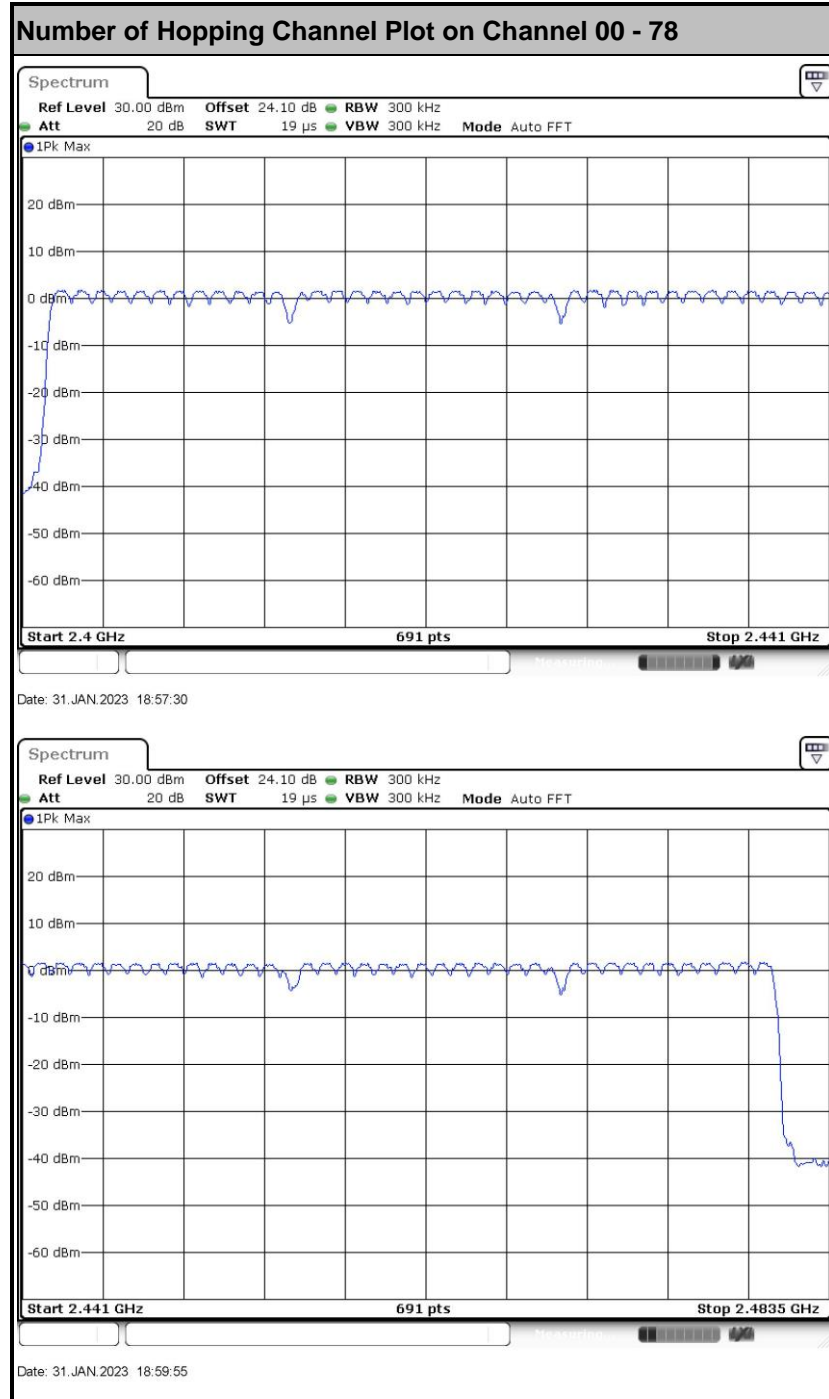

3.2 Hopping Channel Separation Measurement

3.2.1 Limit of Hopping Channel Separation

Frequency hopping systems operating in the 2400-2483.5 MHz band may have hopping channel carrier frequencies that are separated by 25 kHz or two-thirds of the 20 dB bandwidth of the hopping channel, whichever is greater.

3.2.2 Measuring Instruments

Please refer to the measuring equipment list in this test report.

3.2.3 Test Procedures

1. The testing follows ANSI C63.10-2013 clause 7.8.2.
2. The RF output of EUT is connected to the spectrum analyzer by RF cable and attenuator. The path loss is compensated to the results for each measurement.
3. Set the maximum power setting and enable the EUT to transmit continuously.
4. Enable the EUT hopping function.
5. Use the following spectrum analyzer settings:
Span = wide enough to capture the peaks of two adjacent channels;
RBW = 300 kHz; VBW \geq RBW; Sweep = auto; Detector function = peak; Trace = max hold.
6. Measure and record the results in the test report.

3.2.4 Test Setup

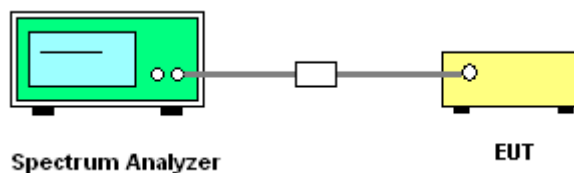

3.2.5 Test Result of Hopping Channel Separation

Please refer to Appendix A.



<1Mbps>

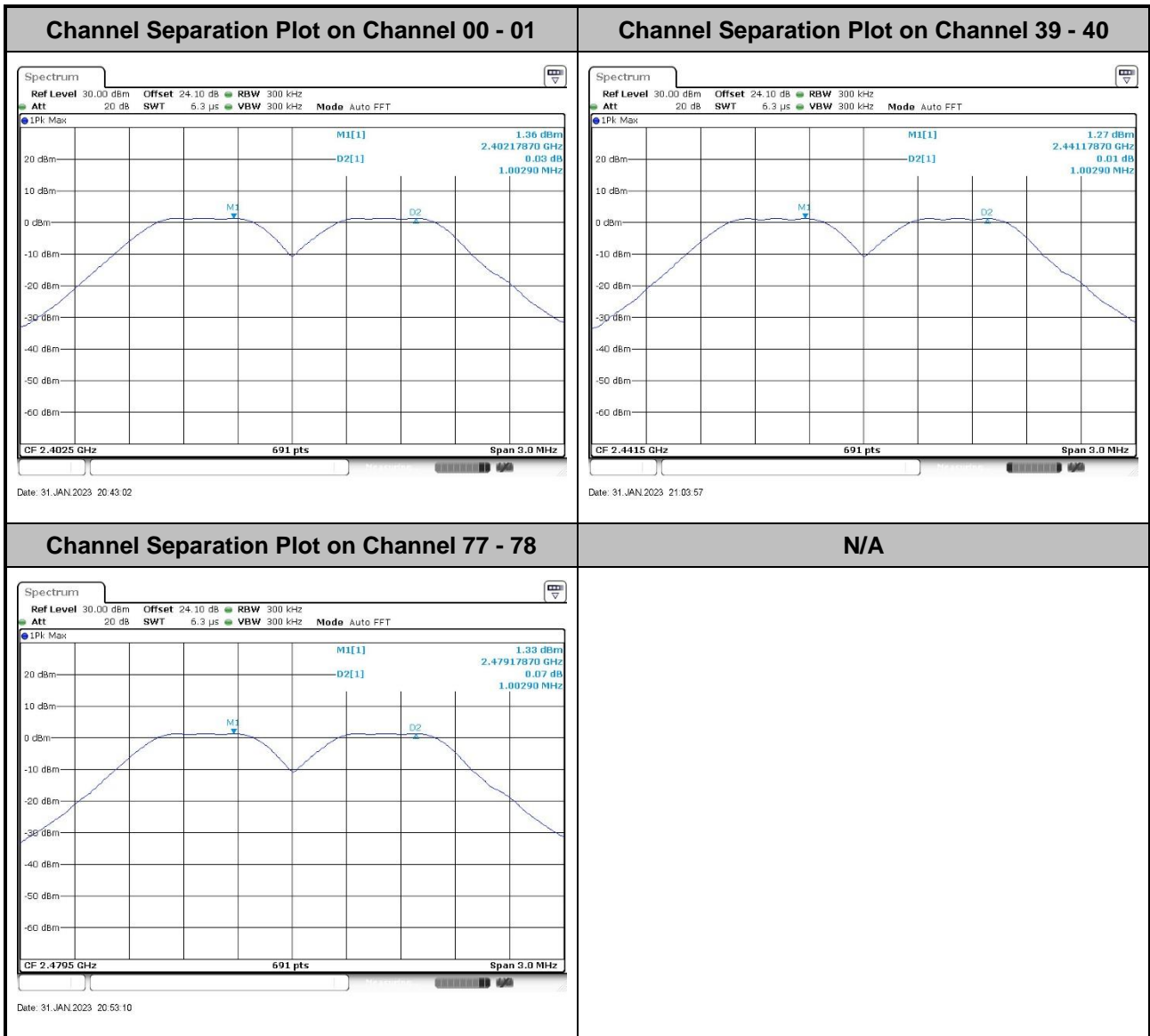



<2Mbps>

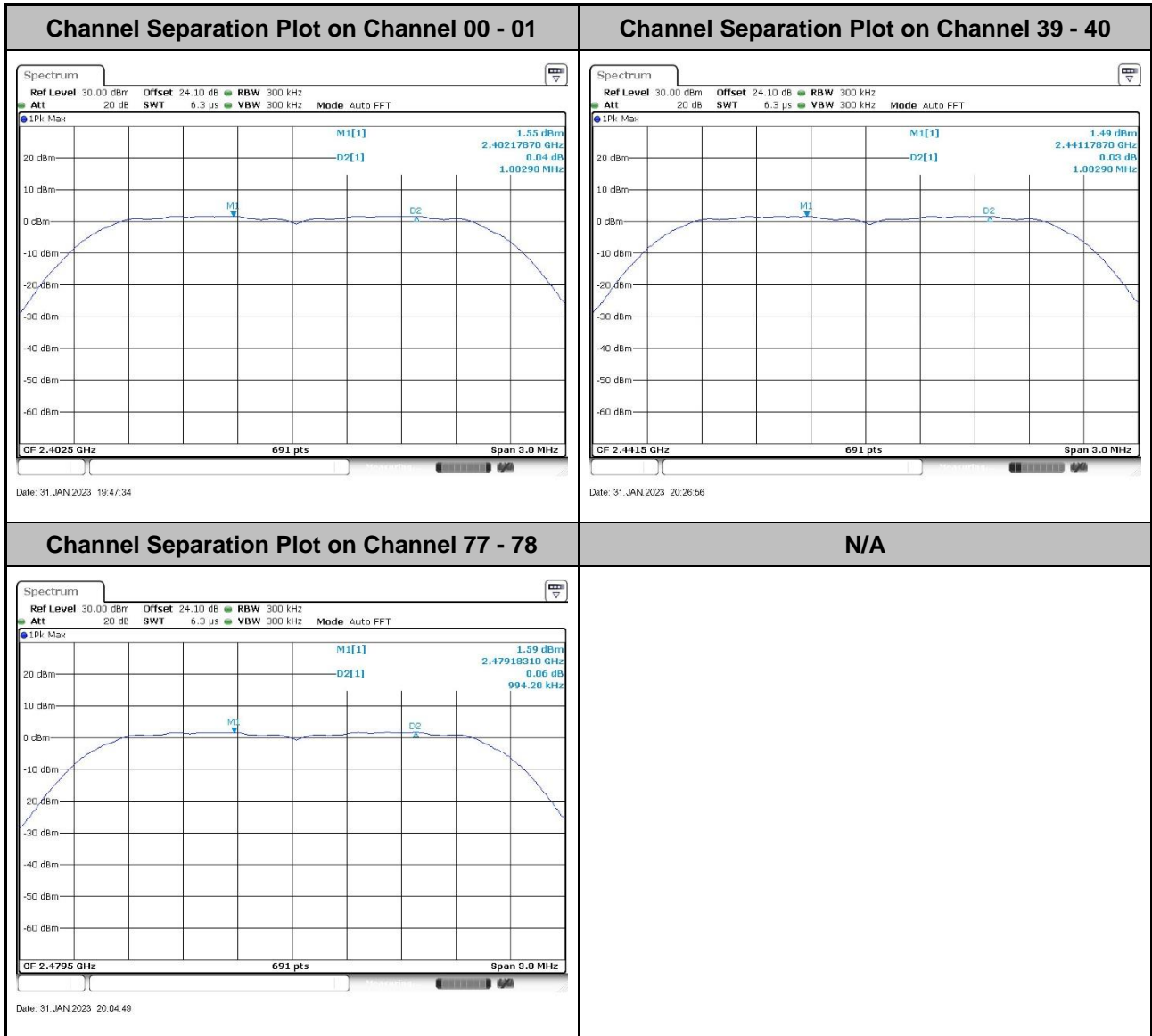



<3Mbps>

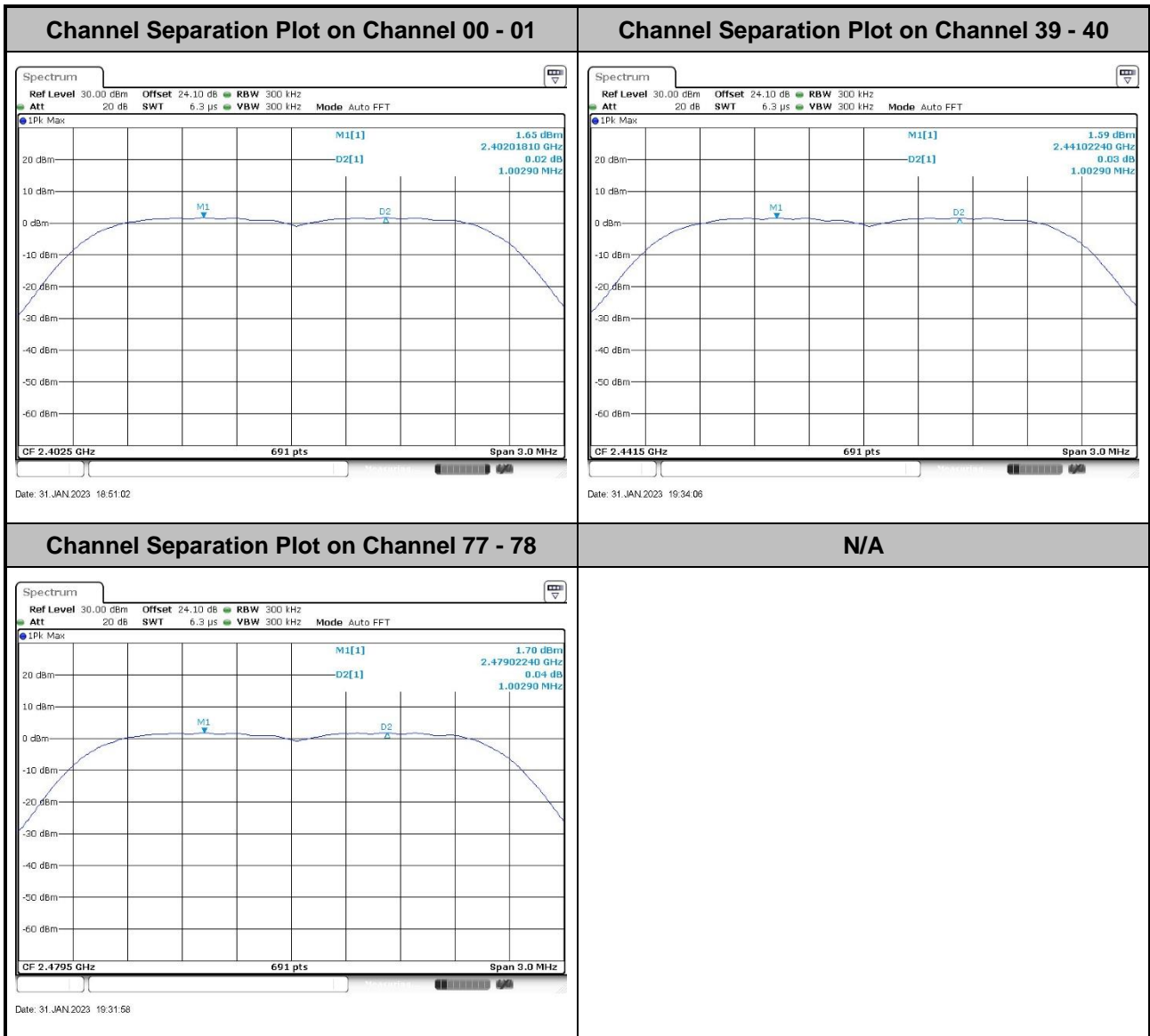

3.3 Dwell Time Measurement

3.3.1 Limit of Dwell Time

The average time of occupancy on any channel shall not be greater than 0.4 seconds within a period of 0.4 seconds multiplied by the number of hopping channels employed.

3.3.2 Measuring Instruments

Please refer to the measuring equipment list in this test report.

3.3.3 Test Procedures

1. The testing follows ANSI C63.10-2013 clause 7.8.4.
2. The RF output of EUT is connected to the spectrum analyzer by RF cable and attenuator. The path loss is compensated to the results for each measurement.
3. Set the maximum power setting and enable the EUT to transmit continuously.
4. Enable the EUT hopping function.
5. Use the following spectrum analyzer settings: Span = zero span, centered on a hopping channel; RBW = 1 MHz; VBW \geq RBW; Sweep = as necessary to capture the entire dwell time per hopping channel; Detector function = peak; Trace = max hold.
6. Measure and record the results in the test report.

3.3.4 Test Setup

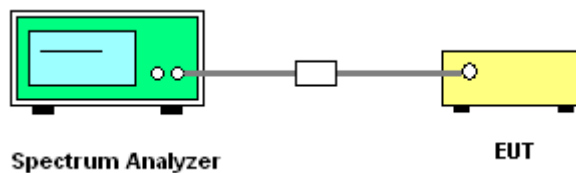

3.3.5 Test Result of Dwell Time

Please refer to Appendix A.

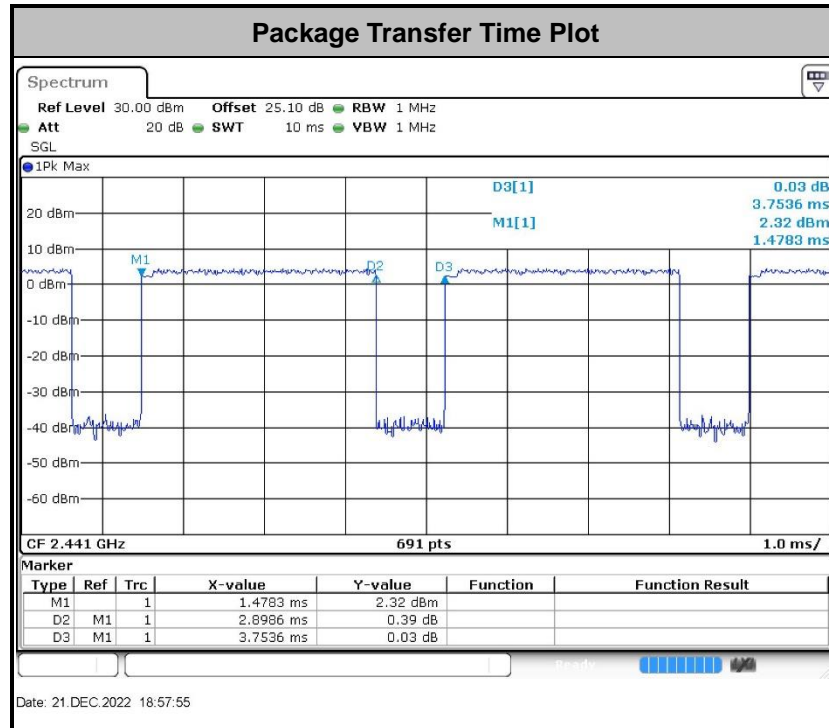

Remark:

1. In normal mode, hopping rate is 1600 hops/s with 6 slots in 79 hopping channels. With channel hopping rate (1600 / 6 / 79) in Occupancy Time Limit (0.4 x 79) (s), Hops Over Occupancy Time comes to (1600 / 6 / 79) x (0.4 x 79) = 106.67 hops.
2. In AFH mode, hopping rate is 800 hops/s with 6 slots in 20 hopping channels. With channel hopping rate (800 / 6 / 20) in Occupancy Time Limit (0.4 x 20) (s), Hops Over Occupancy Time comes to (800 / 6 / 20) x (0.4 x 20) = 53.33 hops.
3. Dwell Time(s) = Hops Over Occupancy Time (hops) x Package Transfer Time

3.4 20dB and 99% Bandwidth Measurement

3.4.1 Limit of 20dB and 99% Bandwidth

Reporting only

3.4.2 Measuring Instruments

Please refer to the measuring equipment list in this test report.

3.4.3 Test Procedures

1. The testing follows ANSI C63.10-2013 clause 6.9.2 and 6.9.3.
2. The RF output of EUT is connected to the spectrum analyzer by RF cable and attenuator. The path loss is compensated to the results for each measurement.
3. Set the maximum power setting and enable the EUT to transmit continuously.
4. Use the following spectrum analyzer settings for 20 dB Bandwidth measurement.
Span = approximately 2 to 5 times the 20 dB bandwidth, centered on a hopping channel;
RBW \geq 1% of the 20 dB bandwidth; VBW \geq RBW; Sweep = auto; Detector function = peak;
Trace = max hold.
5. Use the following spectrum analyzer settings for 99 % Bandwidth measurement.
Span = approximately 1.5 to 5 times the 99% bandwidth, centered on a hopping channel;
RBW \geq 1-5% of the 99% bandwidth; VBW \geq 3 * RBW; Sweep = auto; Detector function = peak;
Trace = max hold.
6. Measure and record the results in the test report.

3.4.4 Test Setup



3.4.5 Test Result of 20dB Bandwidth

Please refer to Appendix A.



<1Mbps>

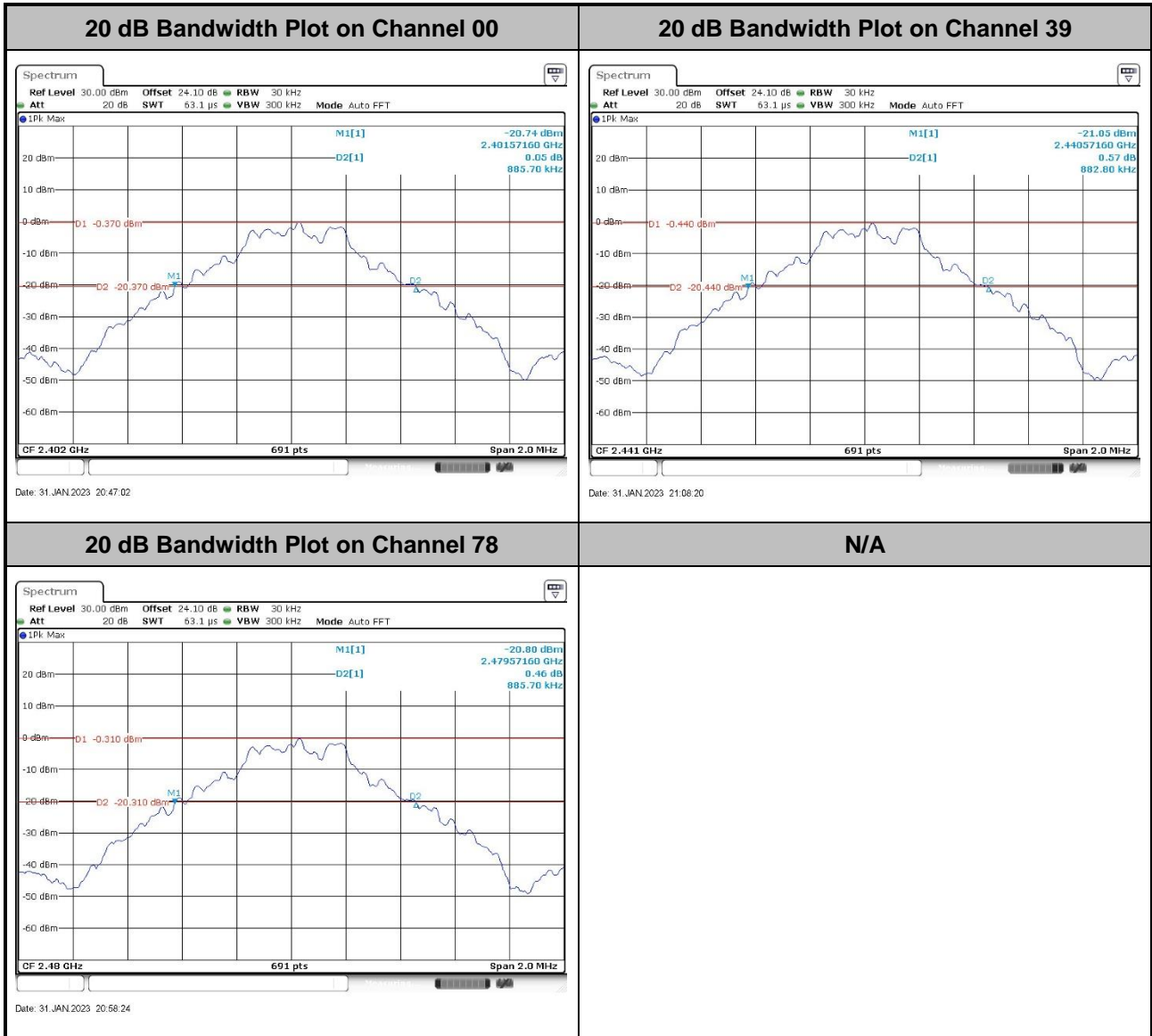



<2Mbps>

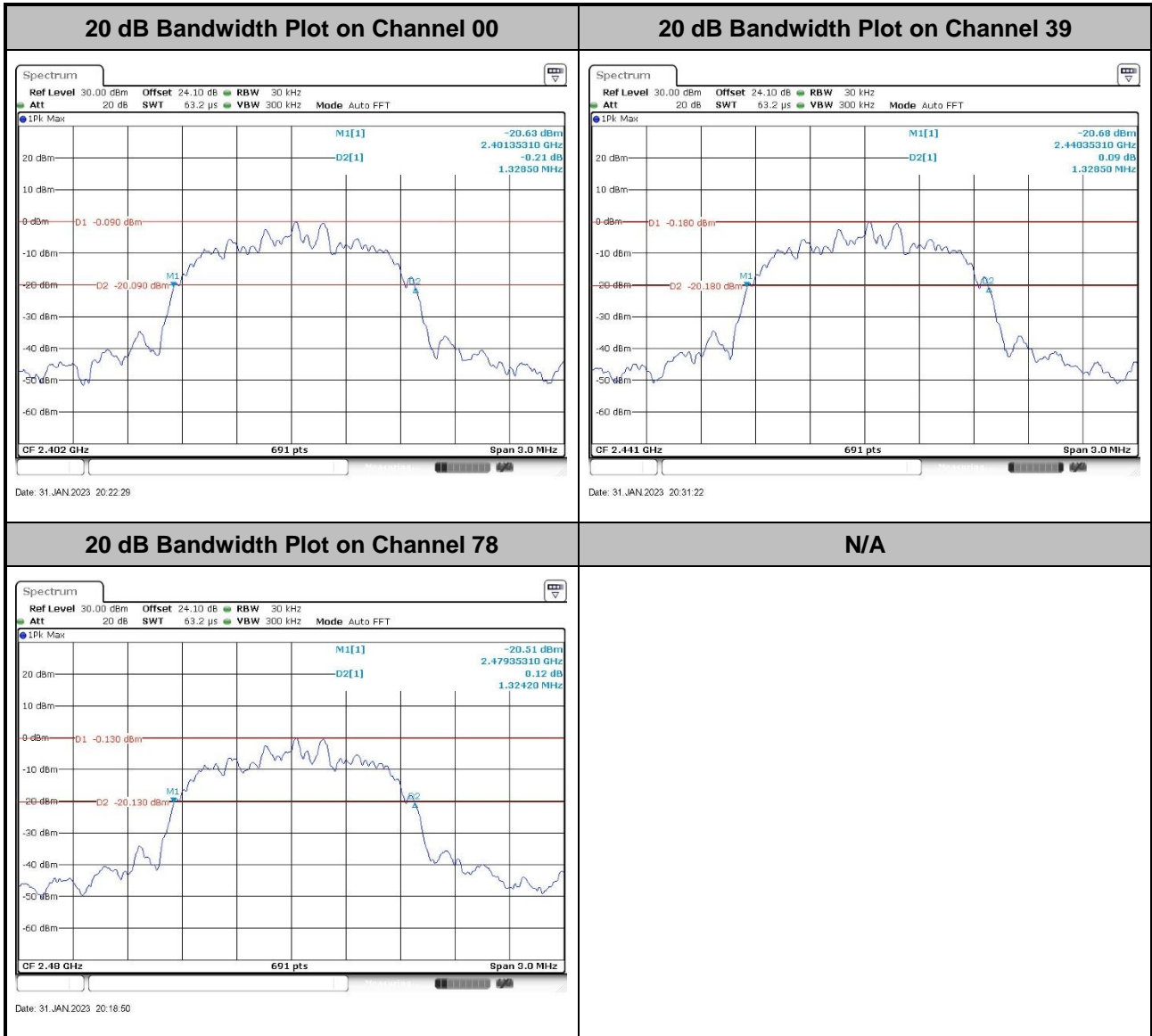



<3Mbps>

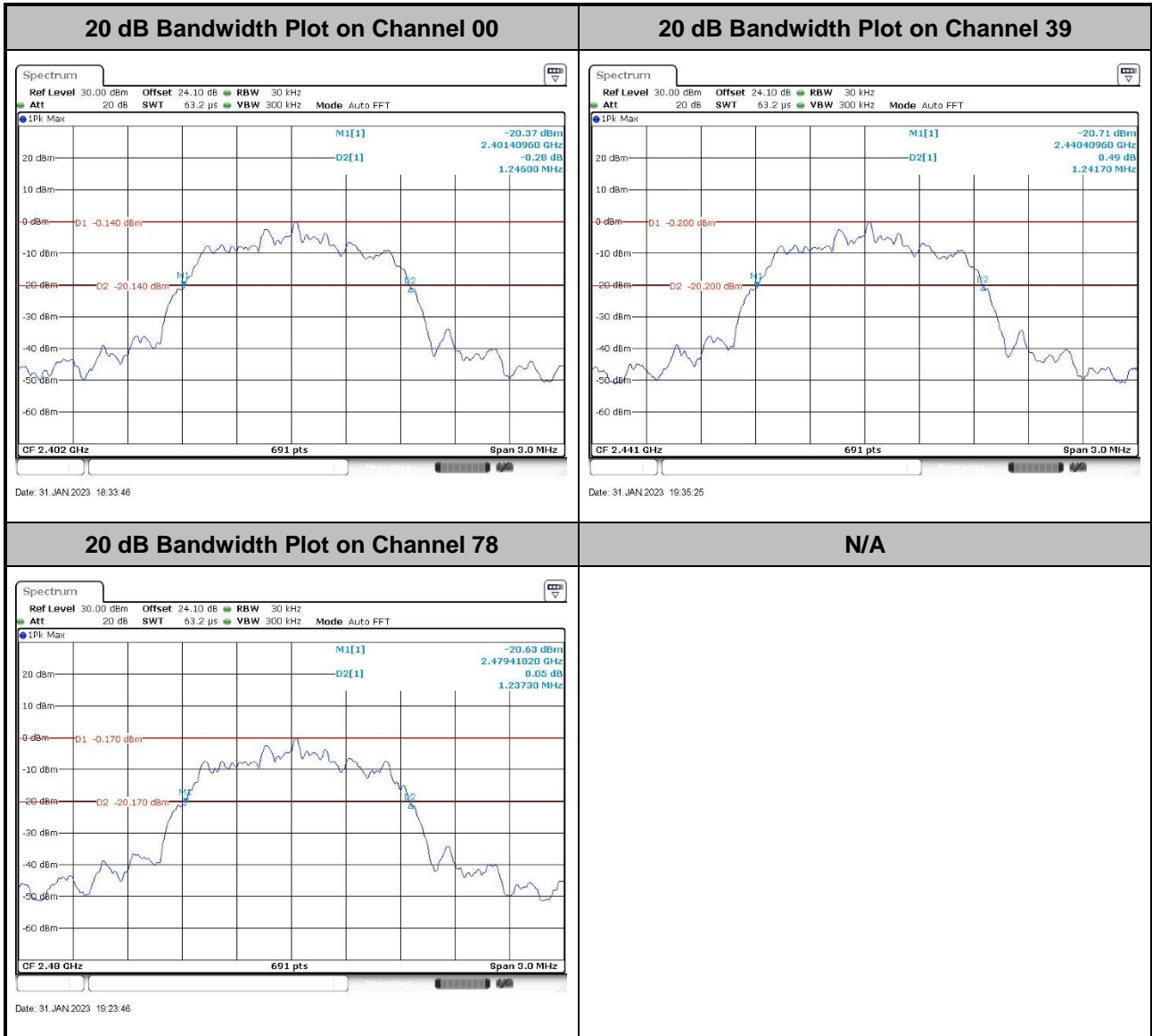



3.4.6 Test Result of 99% Occupied Bandwidth

Please refer to Appendix A.

<1Mbps

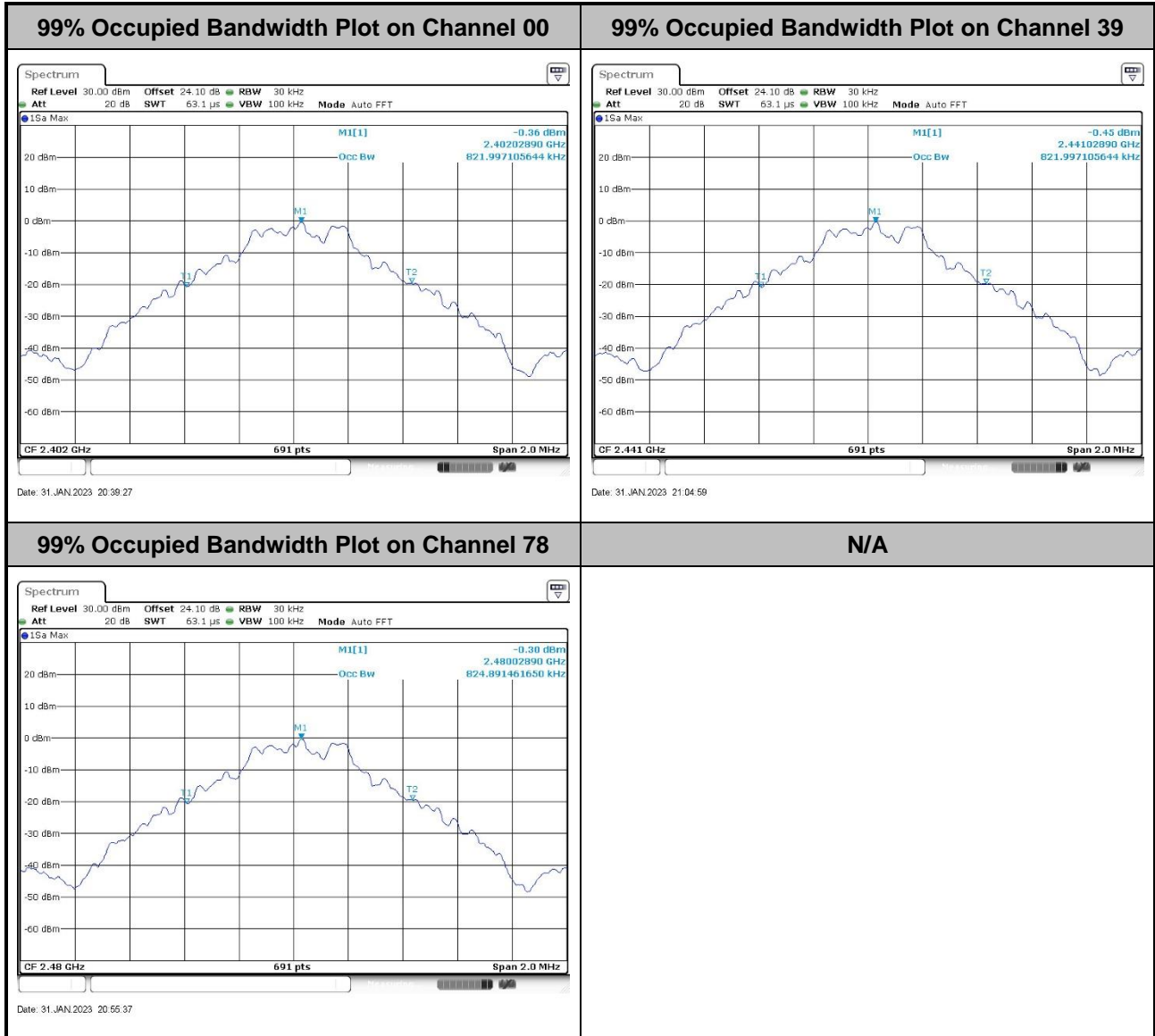

Note: The occupied channel bandwidth is maintained within the band of operation for all of the modulations.



<2Mbps>

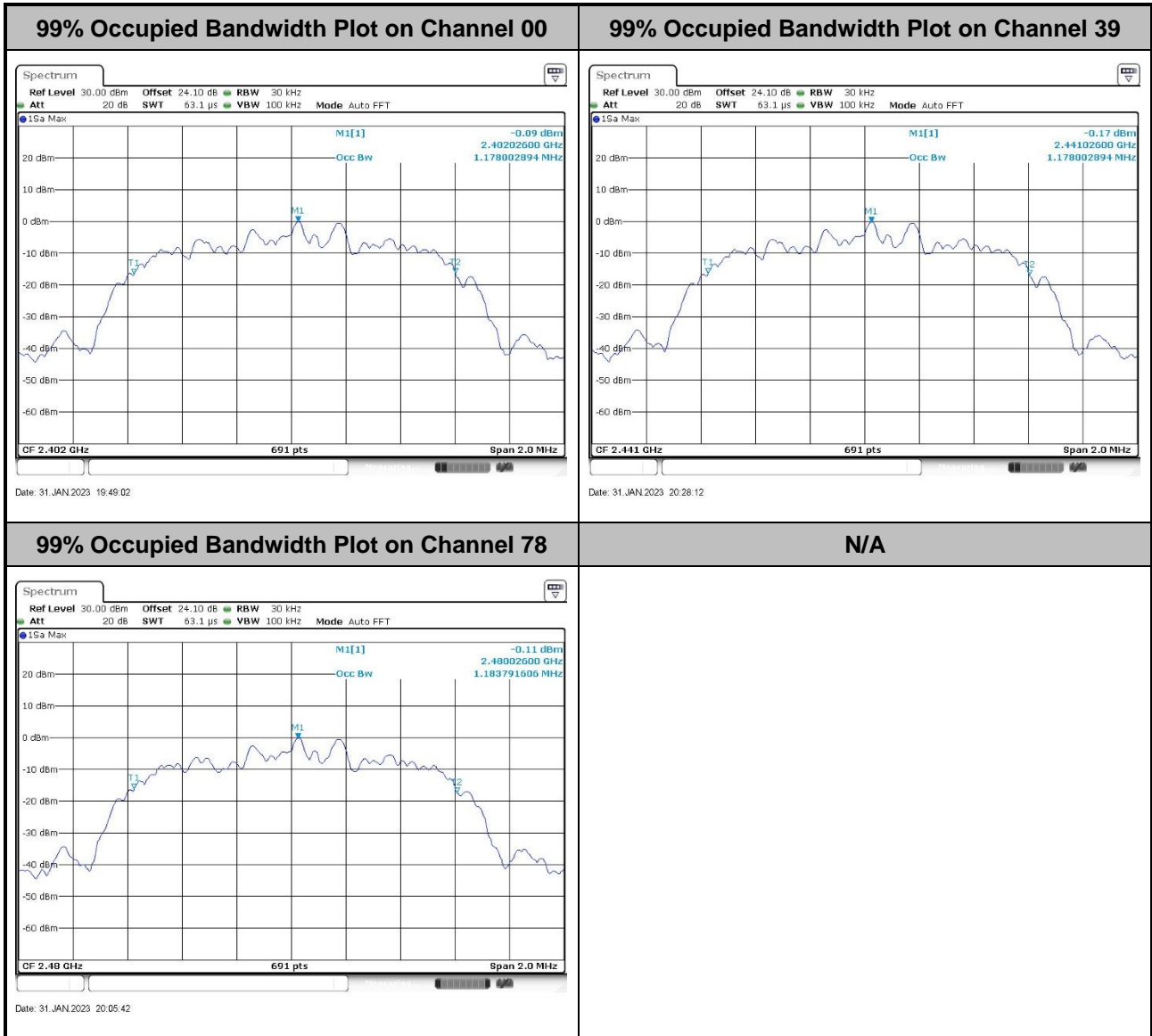

Note: The occupied channel bandwidth is maintained within the band of operation for all of the modulations.



<3Mbps>

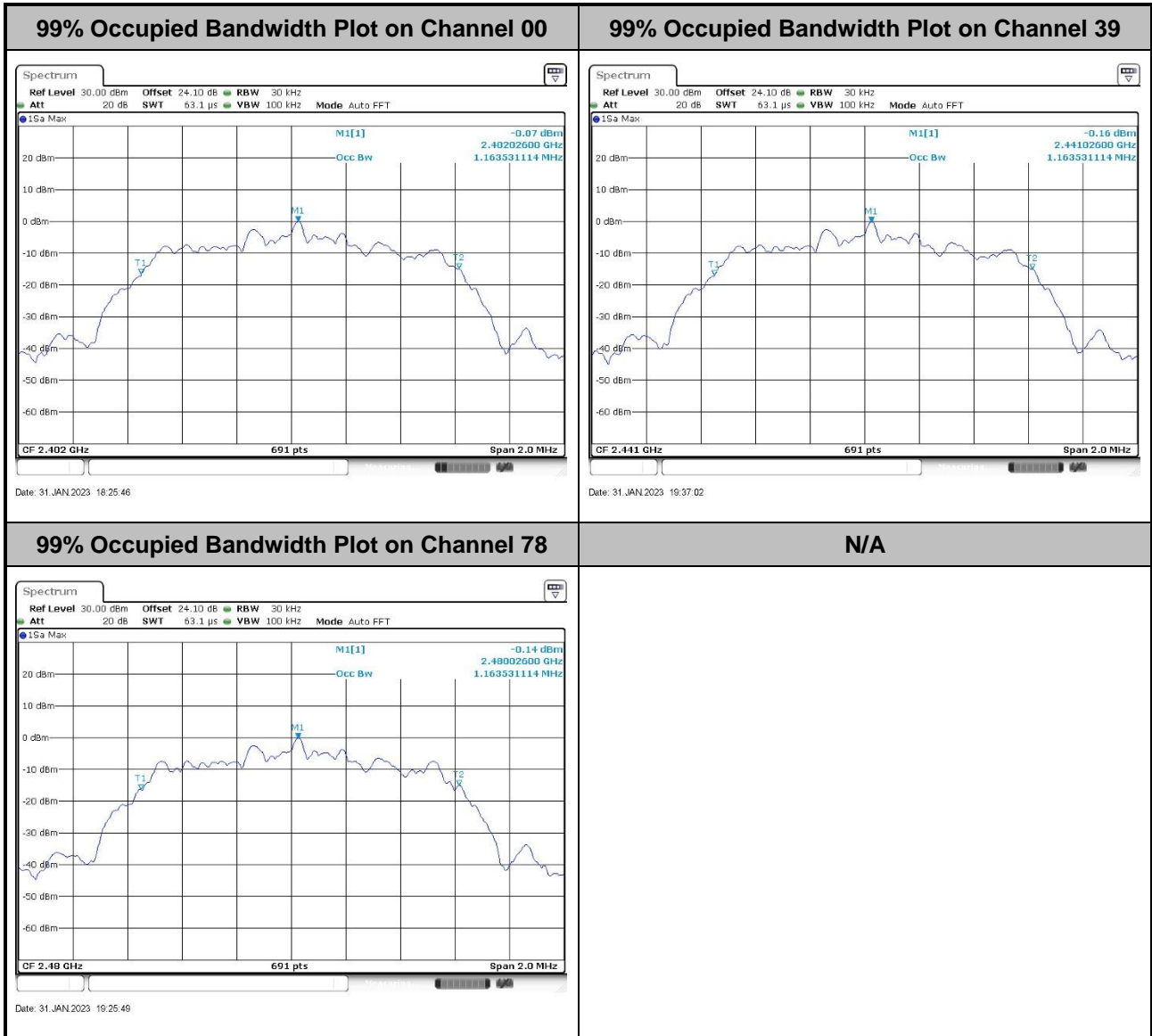

Note: The occupied channel bandwidth is maintained within the band of operation for all of the modulations.

3.5 Output Power Measurement

3.5.1 Limit of Output Power

The maximum peak conducted output power of the intentional radiator shall not exceed the following:
For frequency hopping systems operating in the 2400-2483.5 MHz band employing at least 75 non-overlapping hopping channels, and all frequency hopping systems in the 5725-5850 MHz band: 1 watt. For all other frequency hopping systems in the 2400-2483.5 MHz band 0.125 watts.
If directional gain of transmitting antennas is greater than 6 dBi, the power shall be reduced by the same level in dB comparing to gain minus 6 dBi.

3.5.2 Measuring Instruments

Please refer to the measuring equipment list in this test report.

3.5.3 Test Procedures

1. The testing follows ANSI C63.10-2013 clause 7.8.5.
2. The RF output of EUT is connected to the power meter by RF cable and attenuator. The path loss is compensated to the results for each measurement.
3. Set the maximum power setting and enable the EUT to transmit continuously.
4. Measure the conducted output power with cable loss and record the results in the test report.
5. Measure and record the results in the test report.

3.5.4 Test Setup

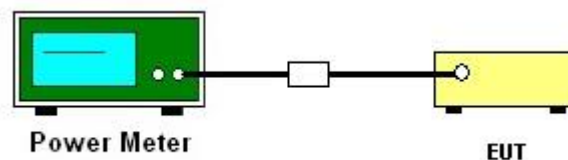

3.5.5 Test Result of Peak Output Power

Please refer to Appendix A.

3.5.6 Test Result of Average Output Power (Reporting Only)

Please refer to Appendix A.

3.6 Conducted Band Edges Measurement

3.6.1 Limit of Band Edges

In any 100 kHz bandwidth outside the intentional radiation frequency band, the radio frequency power shall be at least 20 dB below the highest level of the radiated power. In addition, radiated emissions which fall in the restricted bands must also comply with the radiated emission limits.

3.6.2 Measuring Instruments

Please refer to the measuring equipment list in this test report.

3.6.3 Test Procedures

1. The testing follows ANSI C63.10-2013 clause 7.8.6.
2. Set the maximum power setting and enable the EUT to transmit continuously.
3. Set RBW = 100 kHz, VBW = 300 kHz. Band edge emissions must be at least 20 dB down from the highest emission level within the authorized band as measured with a 100 kHz RBW. The attenuation shall be 30 dB instead of 20 dB when RMS conducted output power procedure is used.
4. Enable hopping function of the EUT and then repeat step 2 and 3.
5. Measure and record the results in the test report.

3.6.4 Test Setup

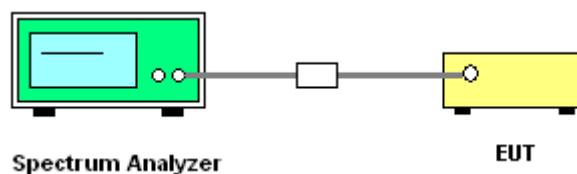



3.6.5 Test Result of Conducted Band Edges

<1Mbps>

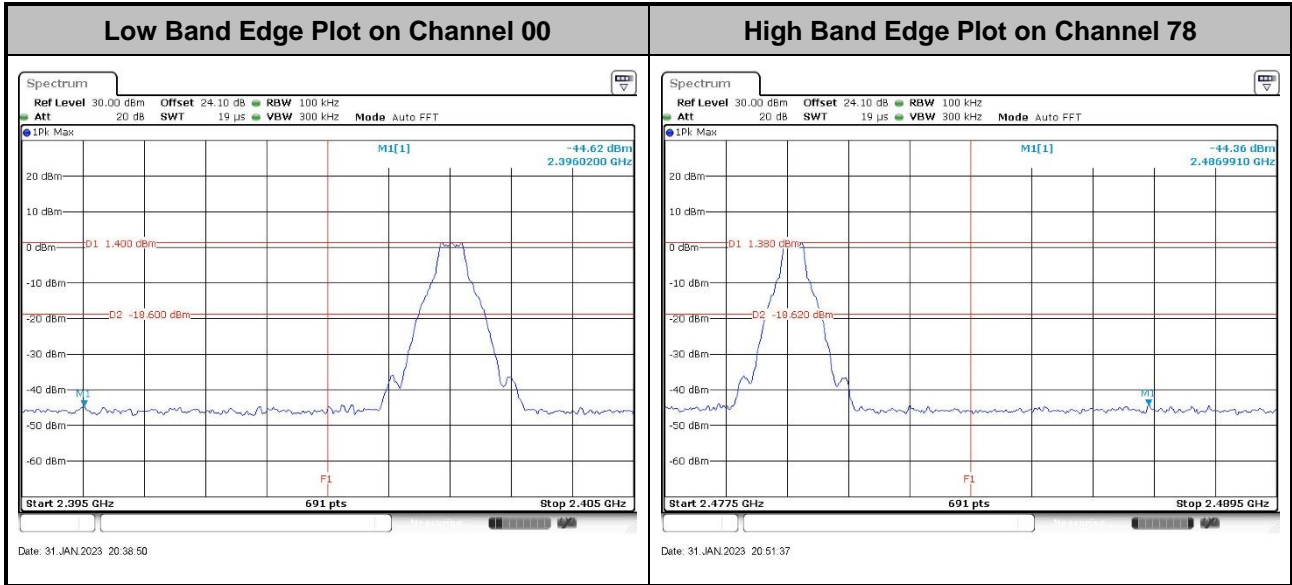

<2Mbps>

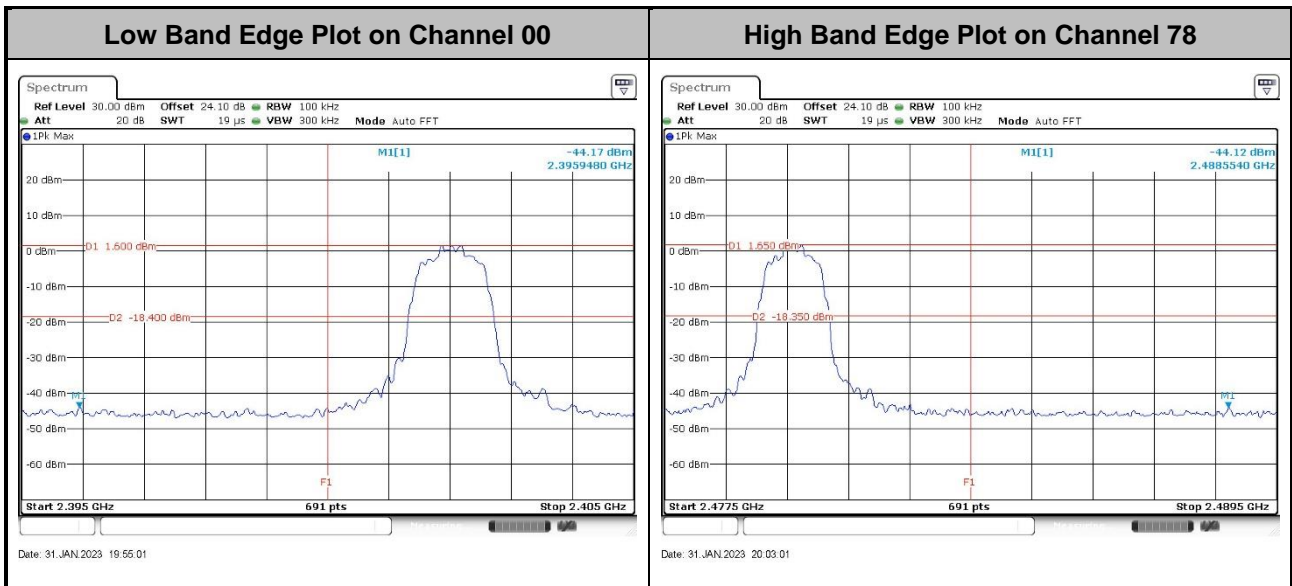



<3Mbps>

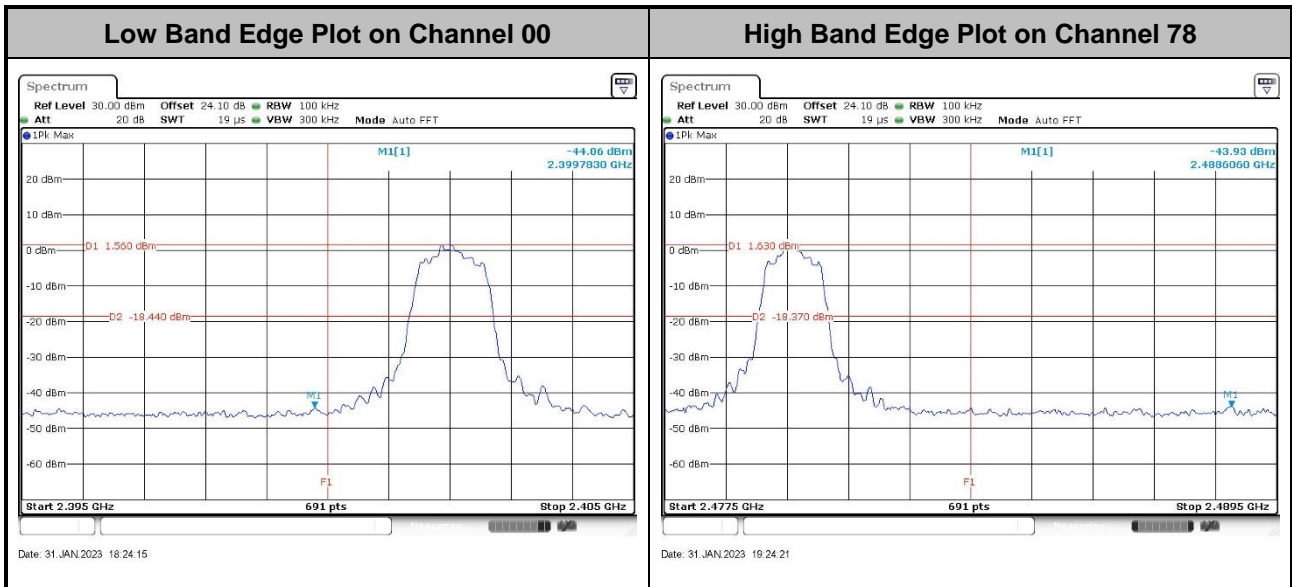



3.6.6 Test Result of Conducted Hopping Mode Band Edges

<1Mbps>

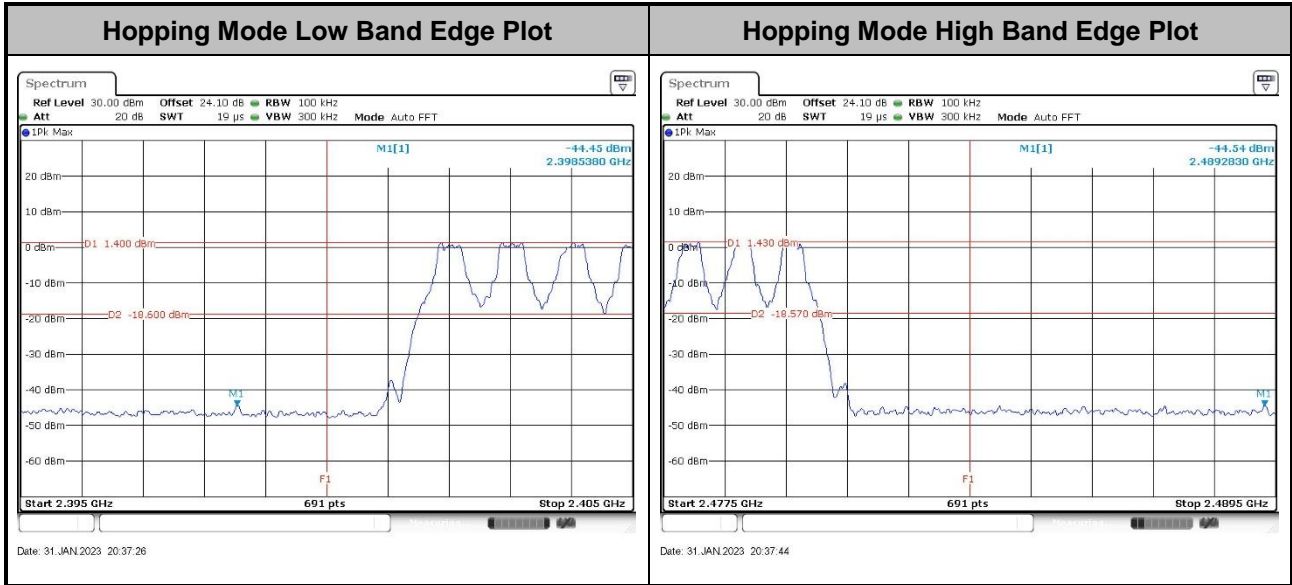

<2Mbps>

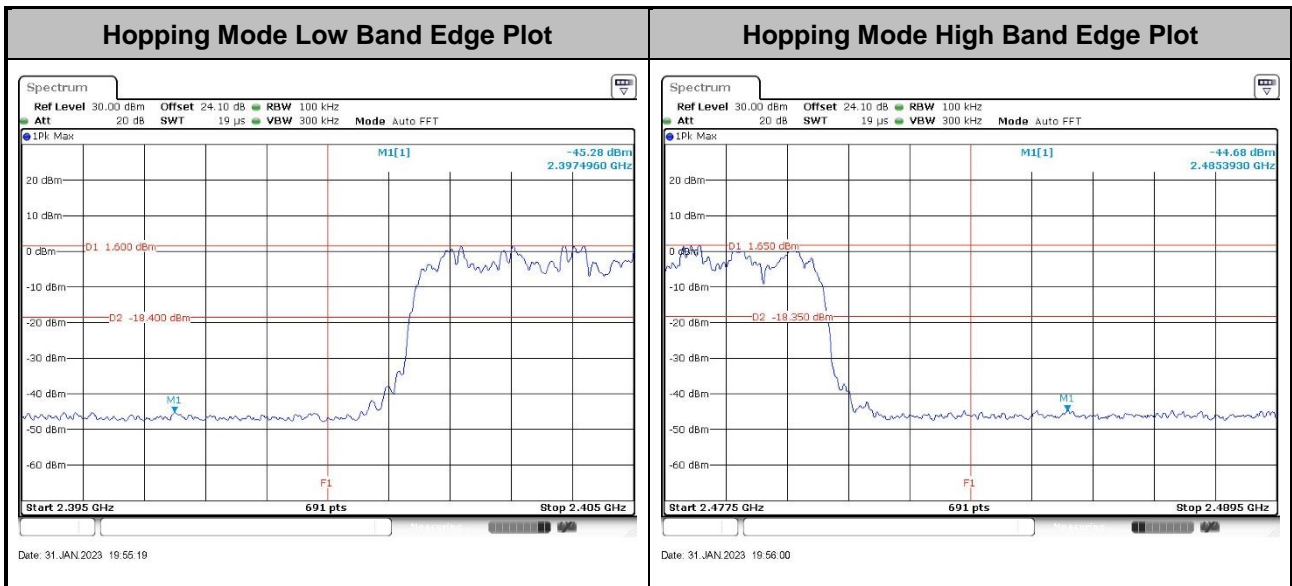



<3Mbps>

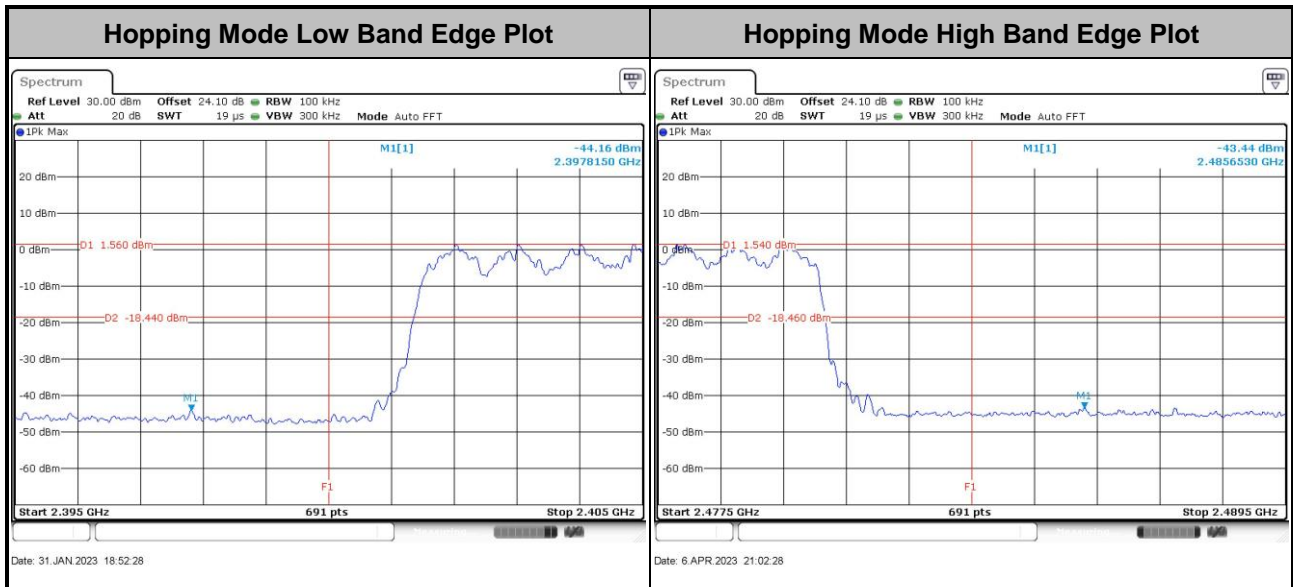

3.7 Conducted Spurious Emission Measurement

3.7.1 Limit of Spurious Emission Measurement

In any 100 kHz bandwidth outside the intentional radiation frequency band, the radio frequency power shall be at least 20 dB below the highest level of the radiated power. In addition, radiated emissions which fall in the restricted bands must also comply with the radiated emission limits.

3.7.2 Measuring Instruments

Please refer to the measuring equipment list in this test report.

3.7.3 Test Procedure

1. The testing follows ANSI C63.10-2013 clause 7.8.8.
2. The RF output of EUT is connected to the spectrum analyzer by RF cable and attenuator. The path loss is compensated to the results for each measurement.
3. Set the maximum power setting and enable the EUT to transmit continuously.
4. Set RBW = 100 kHz, VBW = 300 kHz, scan up through 10th harmonic. All harmonics / spurious must be at least 20 dB down from the highest emission level within the authorized band as measured with a 100 kHz RBW.
5. Measure and record the results in the test report.
6. The RF fundamental frequency should be excluded against the limit line in the operating frequency band.

3.7.4 Test Setup





3.7.5 Test Result of Conducted Spurious Emission

<1Mbps>

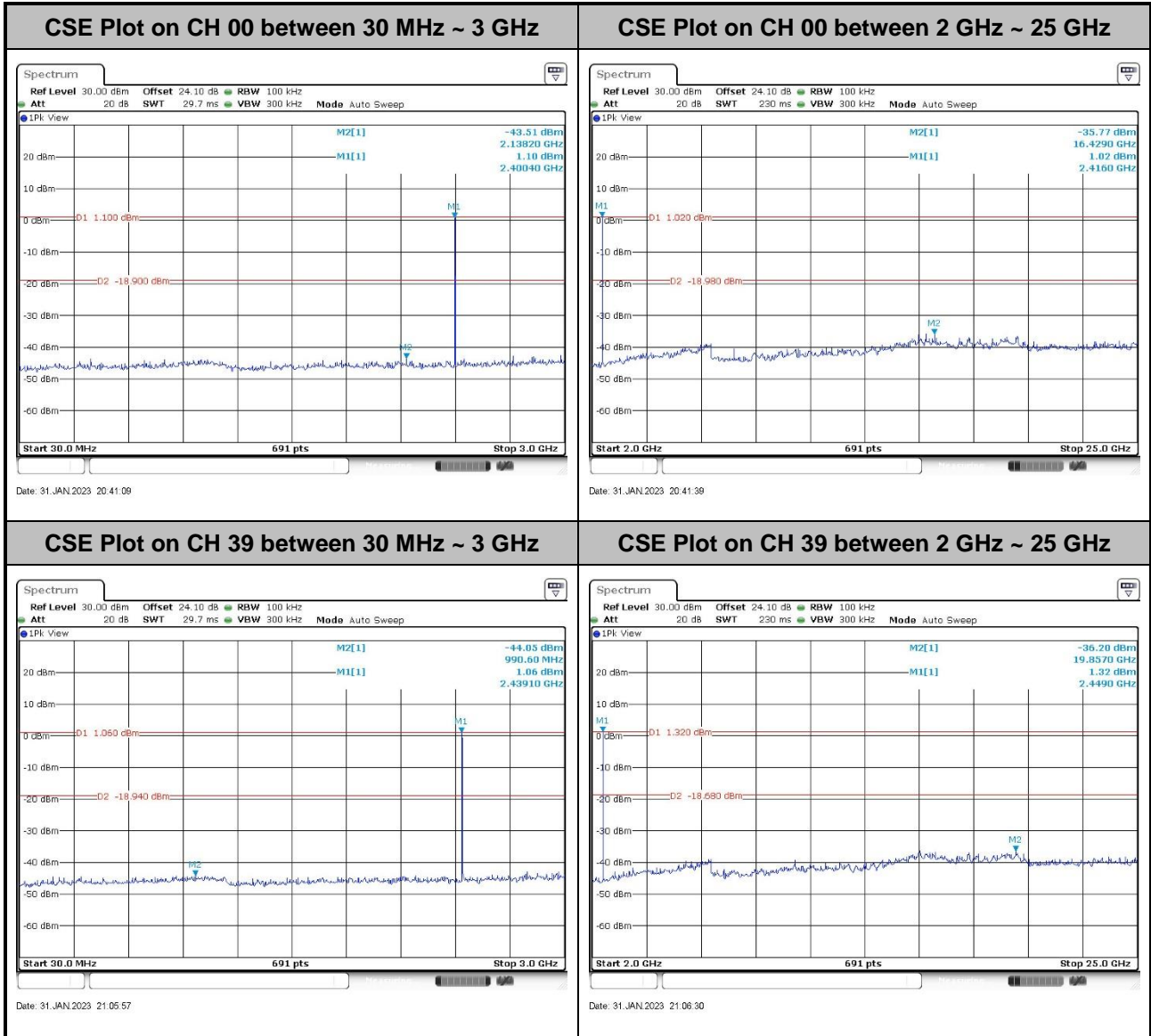

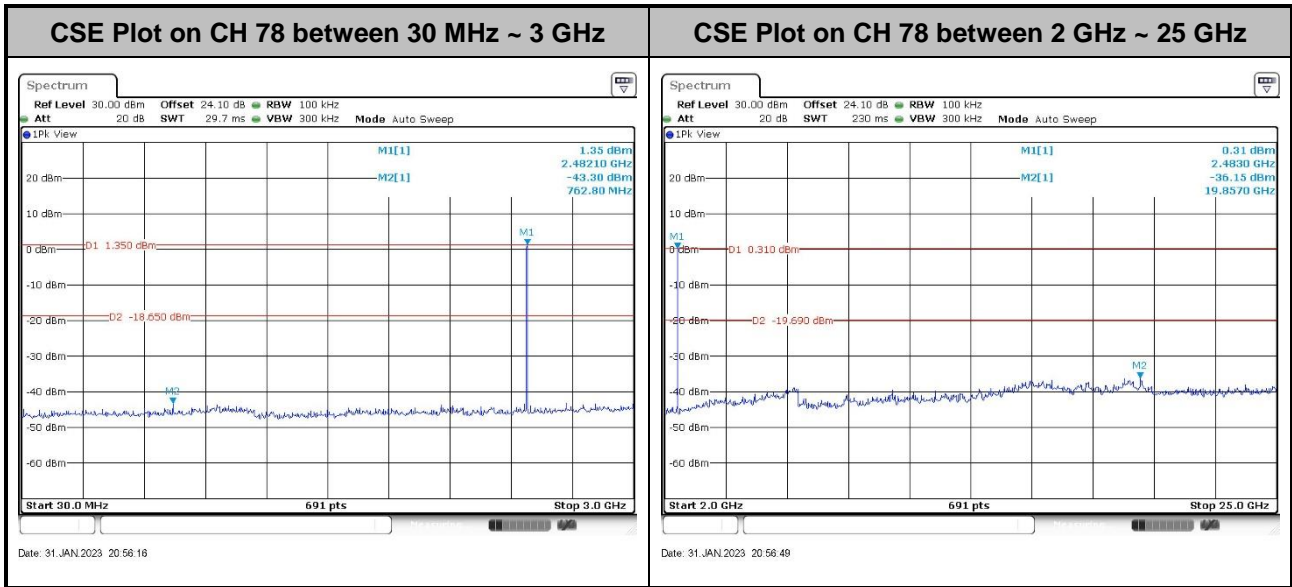



<2Mbps>

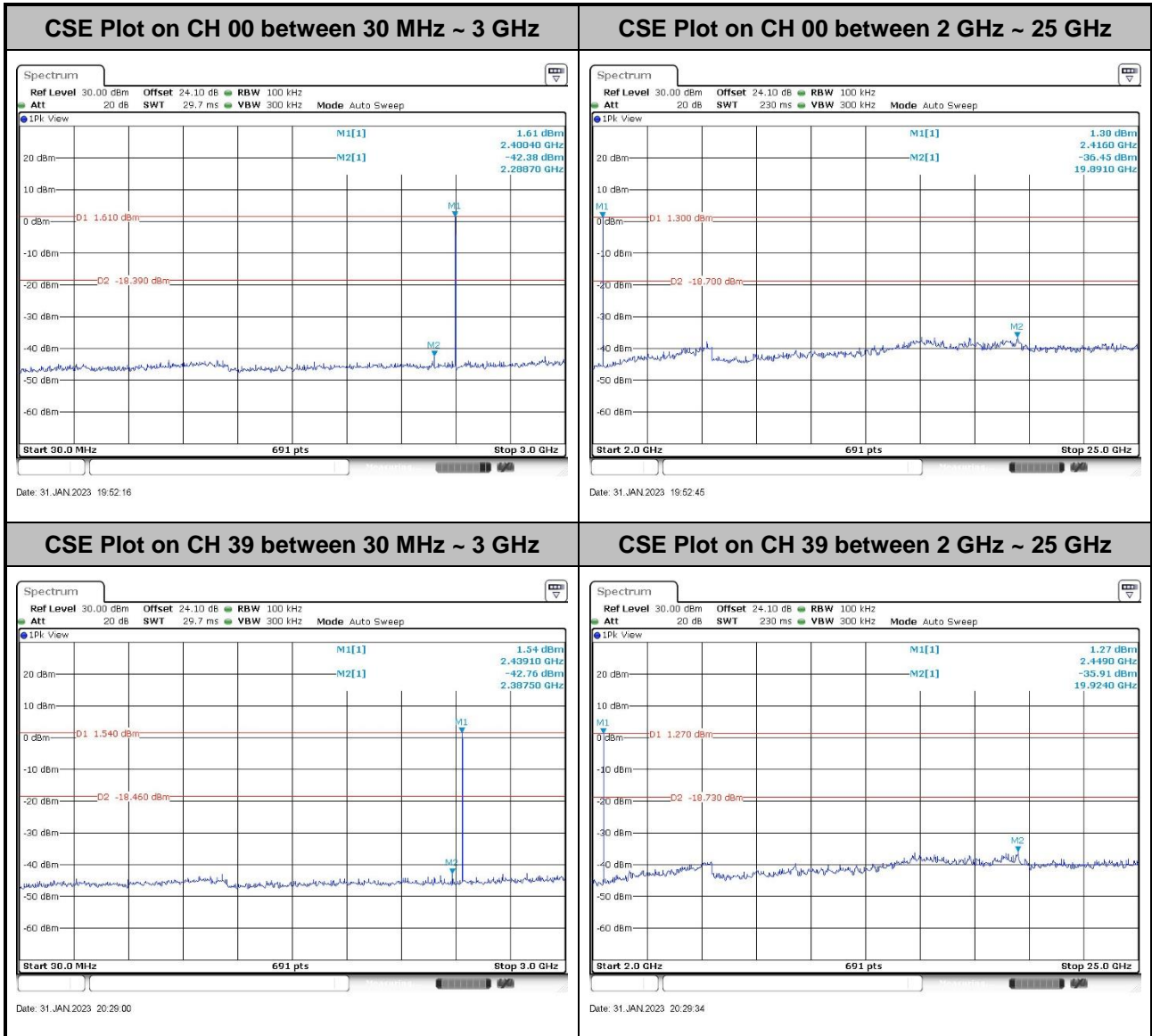

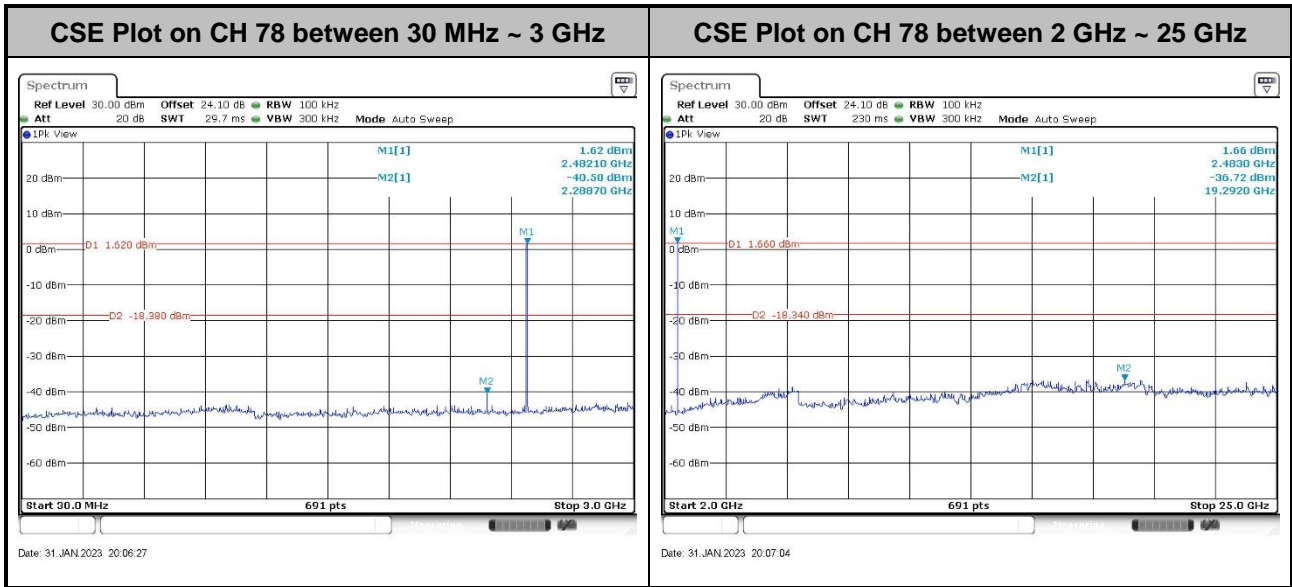



<3Mbps>

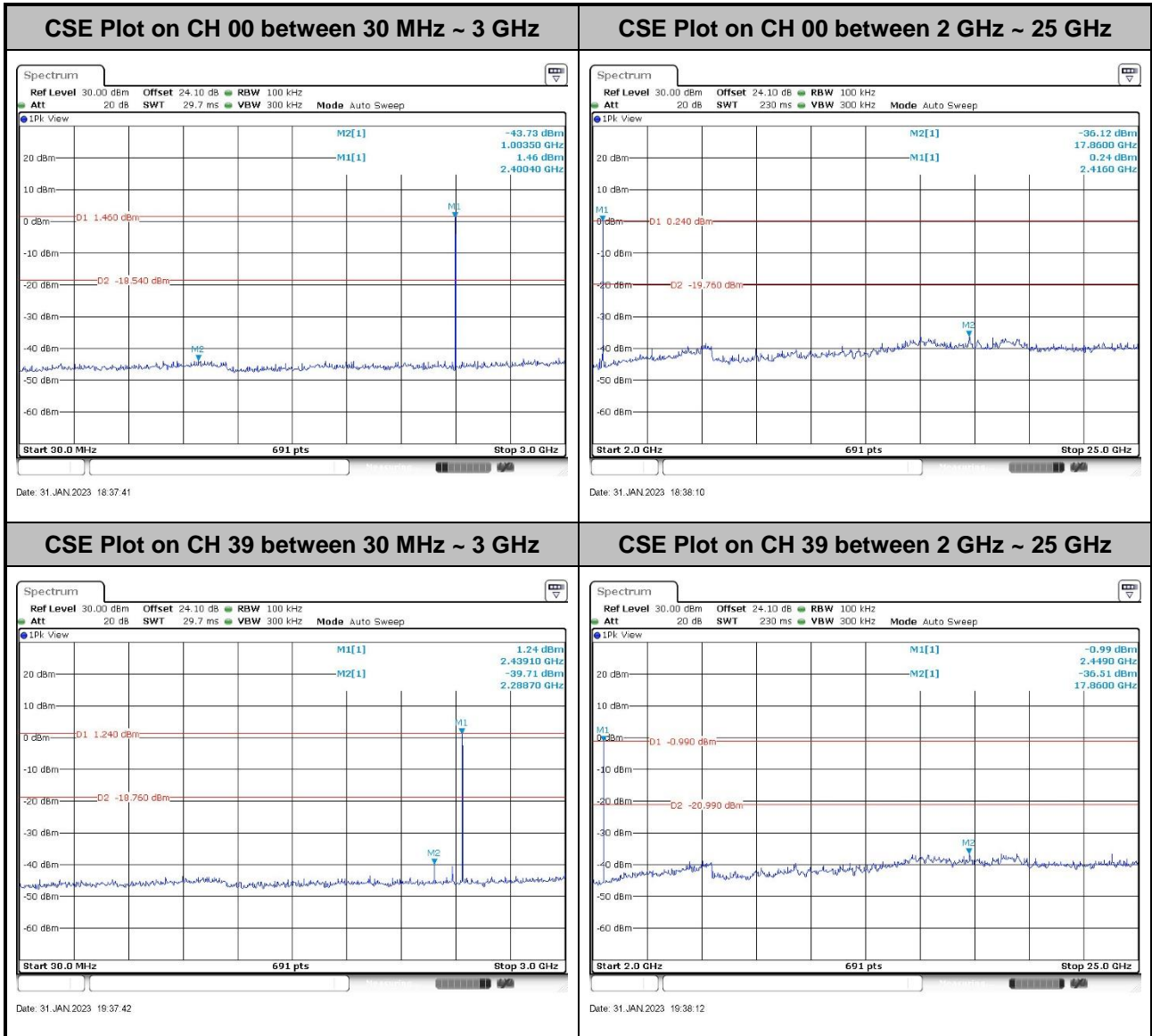

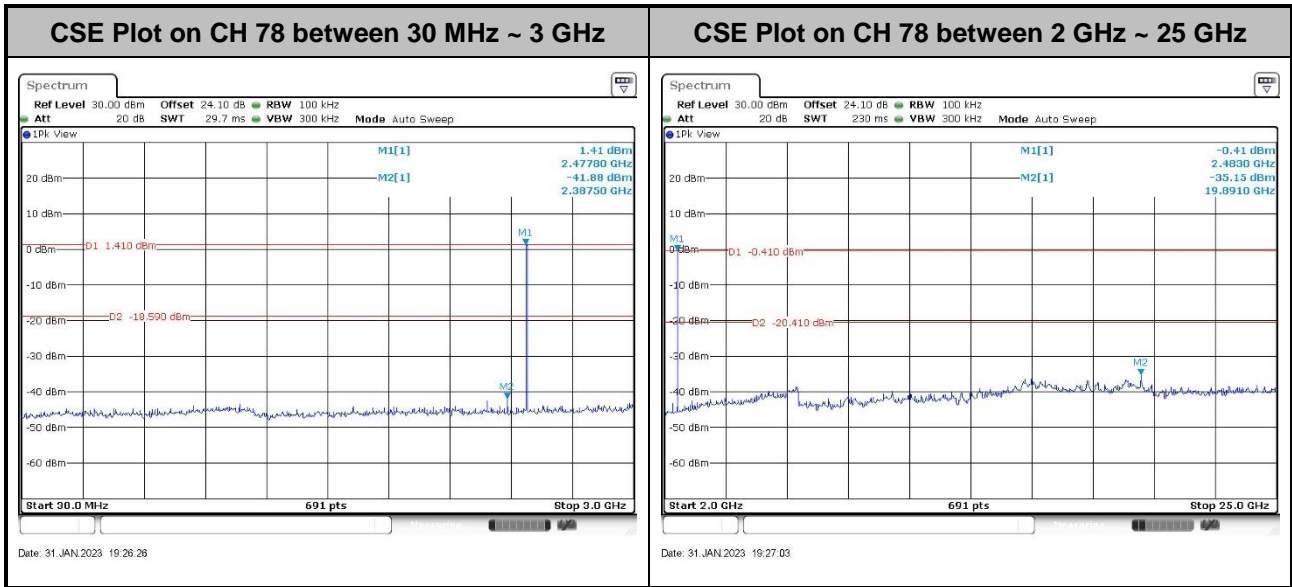



3.8 Radiated Band Edges and Spurious Emission Measurement

3.8.1 Limit of Radiated Band Edges and Spurious Emission

In any 100 kHz bandwidth outside the intentional radiator frequency band, all harmonics / spurious must be at least 20 dB below the highest emission level within the authorized band. In addition, radiated emissions which fall in the restricted bands must also comply with the limits as below.

Frequency (MHz)	Field Strength (microvolts/meter)	Measurement Distance (meters)
0.009 – 0.490	2400/F(kHz)	300
0.490 – 1.705	24000/F(kHz)	30
1.705 – 30.0	30	30
30 – 88	100	3
88 – 216	150	3
216 - 960	200	3
Above 960	500	3

3.8.2 Measuring Instruments

Please refer to the measuring equipment list in this test report.



3.8.3 Test Procedures

1. The EUT is placed on a turntable with 0.8 meter for frequency below 1 GHz and 1.5 meter for frequency above 1 GHz respectively above ground.
2. The EUT is set 3 meters away from the receiving antenna, which is mounted on the top of a variable height antenna tower.
3. For each suspected emission, the EUT is arranged to its worst case and then tune the Antenna tower (from 1 m to 4 m) and turntable (from 0 degree to 360 degrees) to find the maximum reading. A pre-amp and a high pass filter are used for the test in order to get better signal level to comply with the guidelines.
4. Set the maximum power setting and enable the EUT to transmit continuously.
5. Use the following spectrum analyzer settings:
 - (1) Span shall wide enough to fully capture the emission being measured;
 - (2) Set RBW = 100 kHz for $f < 1$ GHz, RBW = 1 MHz for $f > 1$ GHz ; VBW \geq RBW; Sweep = auto; Detector function = peak; Trace = max hold for peak
 - (3) For average measurement: use duty cycle correction factor method per 15.35(c).
Duty cycle = On time/100 milliseconds
On time = $N_1 * L_1 + N_2 * L_2 + \dots + N_{n-1} * L_{n-1} + N_n * L_n$
Where N_1 is number of type 1 pulses, L_1 is length of type 1 pulses, etc.
Average Emission Level = Peak Emission Level + $20 * \log$ (Duty cycle)
6. Corrected Reading: Antenna Factor + Cable Loss + Read Level - Preamp Factor = Level
7. Radiated testing below 1 GHz is performed by adjusting the antenna tower from 1 m to 4 m and by rotating the turn table from 0 degree to 360 degrees to find the peak maximum hold reading. When there is no suspected emission found and the emission level is with at least 6 dB margin against QP limit line, the position is marked as “-”.
8. Radiated testing above 1 GHz is performed by adjusting the antenna tower from 1 m to 4 m and by rotating the turn table from 0 degree to 360 degrees to find the peak maximum hold reading for scanning all frequencies. When there is no suspected emission found and the harmonic emission level is with at least 6 dB margin against average limit line, the position is marked as “-”.

Note: The average levels are calculated from the peak level corrected with duty cycle correction factor (-24.76dB) derived from $20 \log$ (dwell time/100ms). This correction is only for signals that hop with the fundamental signal, such as band-edge and harmonic. Other spurious signals that are independent of the hopping signal would not use this correction.

3.8.4 Test Setup

For radiated test below 30MHz

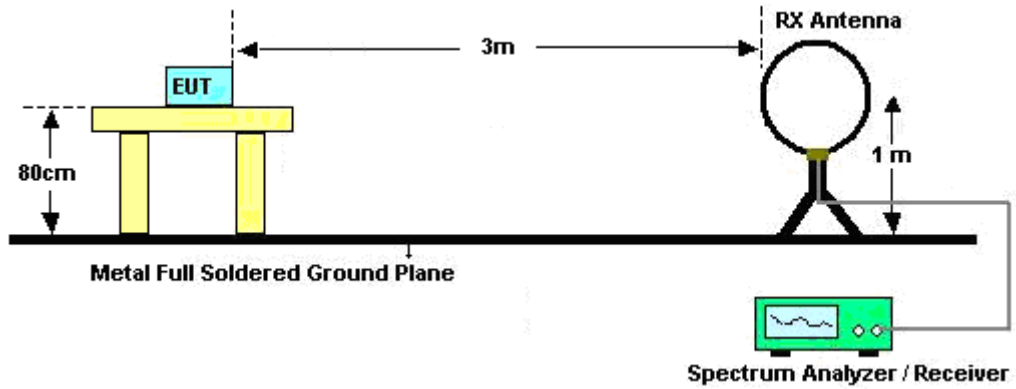

For radiated test from 30MHz to 1GHz

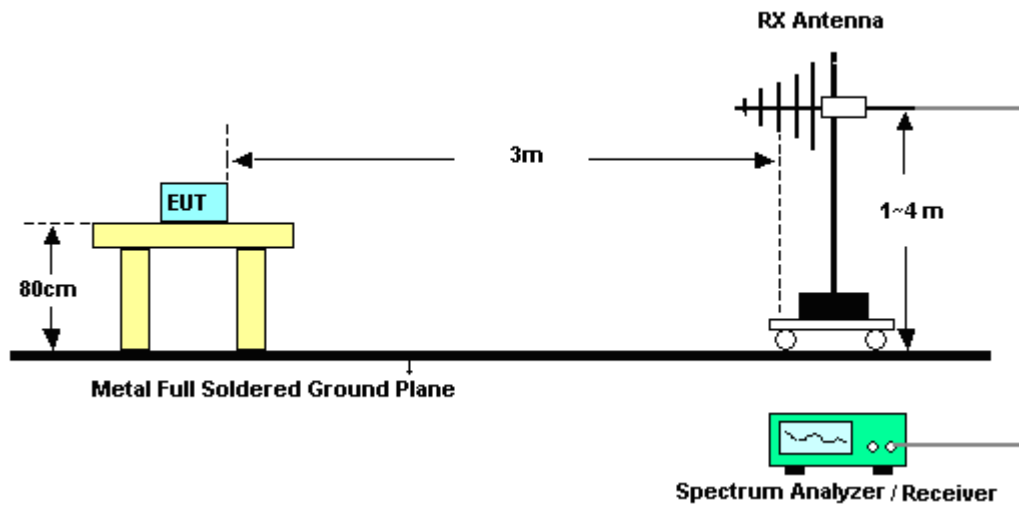

For radiated test from 1GHz to 18GHz

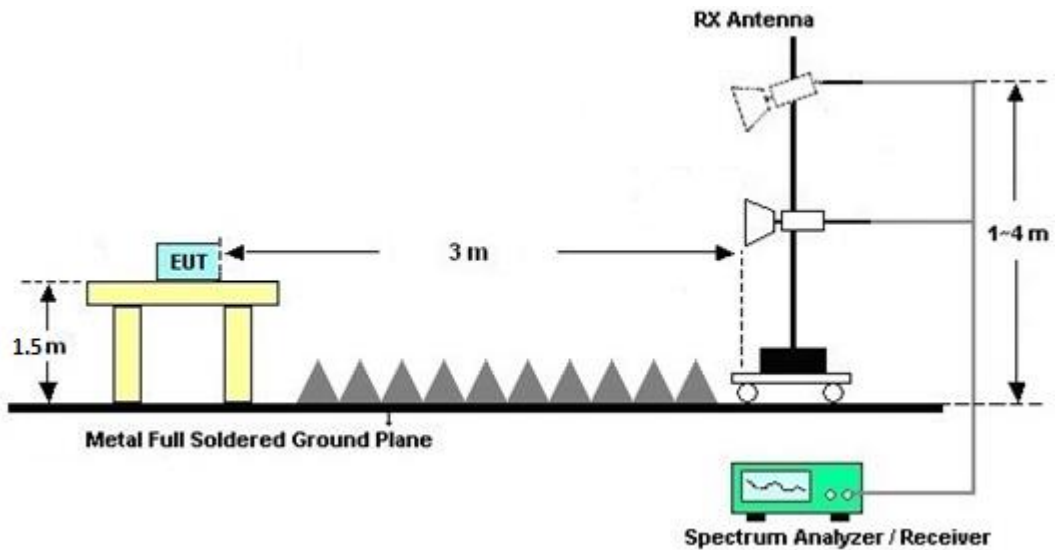

For radiated test above 18GHz

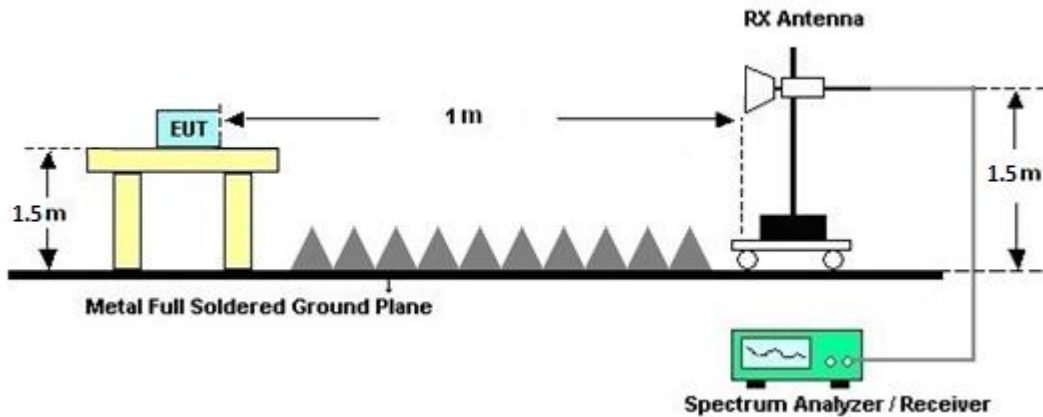

3.8.5 Test Results of Radiated Spurious Emissions (9 kHz ~ 30 MHz)

The low frequency, which starts from 9 kHz to 30 MHz, is pre-scanned and the result which is 20 dB lower than the limit line is not reported.

There is adequate comparison measurement of both open-field test site and alternative test site - semi-Anechoic chamber according to 414788 D01 Radiated Test Site v01r01, and the result comes out very similar.

3.8.6 Test Result of Radiated Spurious at Band Edges

Please refer to Appendix C and D.

3.8.7 Duty Cycle

Please refer to Appendix E.

3.8.8 Test Result of Radiated Spurious Emission (30MHz ~ 10th Harmonic)

Please refer to Appendix C and D.



3.9 AC Conducted Emission Measurement

3.9.1 Limit of AC Conducted Emission

For equipment that is designed to be connected to the public utility (AC) power line, the radio frequency voltage that is conducted back onto the AC power line on any frequency or frequencies within the band 150 kHz to 30 MHz shall not exceed the limits in the following table.

Frequency of emission (MHz)	Conducted limit (dB μ V)	
	Quasi-peak	Average
0.15-0.5	66 to 56*	56 to 46*
0.5-5	56	46
5-30	60	50

*Decreases with the logarithm of the frequency.

3.9.2 Measuring Instruments

Please refer to the measuring equipment list in this test report.

3.9.3 Test Procedures

1. The EUT is placed 0.4 meter away from the conducting wall of the shielding room, and is kept at least 80 centimeters from any other grounded conducting surface.
2. Connect EUT to the power mains through a line impedance stabilization network (LISN).
3. All the support units are connecting to the other LISN.
4. The LISN provides 50 ohm coupling impedance for the measuring instrument.
5. The FCC states that a 50 ohm, 50 microhenry LISN shall be used.
6. Both Line and Neutral shall be tested in order to find out the maximum conducted emission.
7. The frequency range from 150 kHz to 30 MHz is scanned.
8. Set the test-receiver system to Peak Detect Function and specified bandwidth (IF Bandwidth = 9 kHz) with Maximum Hold Mode. Then measurement is also conducted by Average Detector and Quasi-Peak Detector Function respectively.

3.9.4 Test Setup

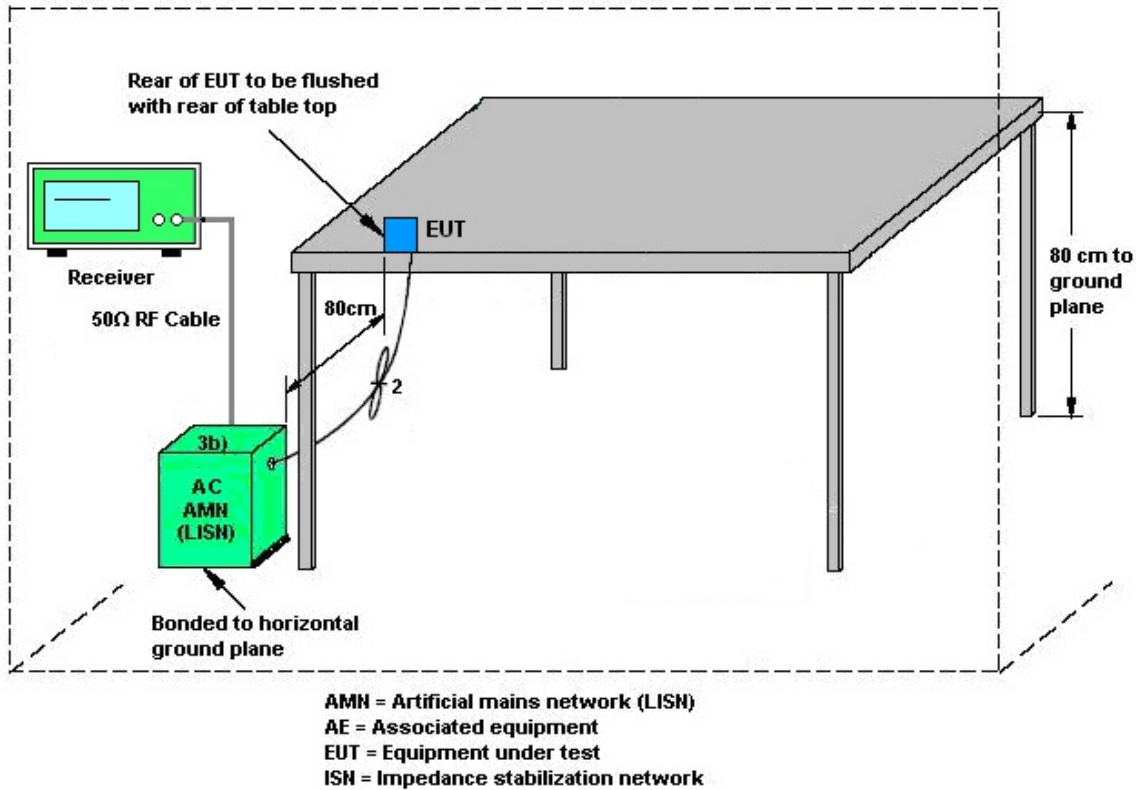

3.9.5 Test Result of AC Conducted Emission

Please refer to Appendix B.



3.10 Antenna Requirements

3.10.1 Standard Applicable

The use of a permanently attached antenna or of an antenna that uses a unique coupling to the intentional radiator shall be considered sufficient to comply with the rule.

3.10.2 Antenna Anti-Replacement Construction

An embedded-in antenna design is used.



4 List of Measuring Equipment

Instrument	Brand Name	Model No.	Serial No.	Characteristics	Calibration Date	Test Date	Due Date	Remark
Loop Antenna	TESEQ	HLA 6120	31244	9 kHz~30 MHz	Mar. 18, 2022	Dec. 25, 2022~ Dec. 26, 2022	Mar. 17, 2023	Radiation (03CH15-HY)
Bilog Antenna	TESEQ	CBL 6111D & 00800N1D01N -06	41912 & 05	30MHz~1GHz	Feb. 06, 2022	Dec. 25, 2022~ Dec. 26, 2022	Feb. 05, 2023	Radiation (03CH15-HY)
Amplifier	SONOMA	310N	363440	9kHz~1GHz	Dec. 27, 2021	Dec. 25, 2022	Dec. 26, 2022	Radiation (03CH15-HY)
Amplifier	SONOMA	310N	363440	9kHz~1GHz	Dec. 26, 2022	Dec. 26, 2022	Dec. 25, 2023	Radiation (03CH15-HY)
Horn Antenna	SCHWARZBE CK	BBHA 9120 D	9120D-02294	1GHz~18GHz	Jun. 23, 2022	Dec. 25, 2022~ Dec. 26, 2022	Jun. 22, 2023	Radiation (03CH15-HY)
SHF-EHF Horn Antenna	SCHWARZBE CK	BBHA 9170	00993	18GHz~40GHz	Nov. 24, 2022	Dec. 25, 2022~ Dec. 26, 2022	Nov. 23, 2023	Radiation (03CH15-HY)
Preamplifier	E-INSTRUME NT TECH LTD.	ERA-100M-18 G-56-01-A70	EC1900269	1GHz-18GHz	Dec. 27, 2021	Dec. 25, 2022	Dec. 26, 2022	Radiation (03CH15-HY)
Preamplifier	E-INSTRUME NT TECH LTD.	ERA-100M-18 G-56-01-A70	EC1900269	1GHz-18GHz	Dec. 26, 2022	Dec. 26, 2022	Dec. 25, 2023	Radiation (03CH15-HY)
Preamplifier	EM Electronics	EM01G18G	060801	18GHz-40GHz	Jun. 28, 2022	Dec. 25, 2022~ Dec. 26, 2022	Jun. 27, 2023	Radiation (03CH15-HY)
Preamplifier	EMEC	EM18G40G	060802	1GHz-18GHz	Mar. 08, 2022	Dec. 25, 2022~ Dec. 26, 2022	Mar. 07, 2023	Radiation (03CH15-HY)
EMI Test Receiver	Keysight	N9038A(MXE)	MY54130085	20MHz~8.4GHz	Oct. 18, 2022	Dec. 25, 2022~ Dec. 26, 2022	Oct. 17, 2023	Radiation (03CH15-HY)
Spectrum Analyzer	Keysight	N9010	MY54200485	10Hz~44GHz	May 07, 2022	Dec. 25, 2022~ Dec. 26, 2022	May 06, 2023	Radiation (03CH15-HY)
Antenna Mast	ChainTek	MBS-520-1	N/A	1m~4m	N/A	Dec. 25, 2022~ Dec. 26, 2022	N/A	Radiation (03CH15-HY)
Turn Table	ChainTek	T-200-S-1	N/A	0~360 Degree	N/A	Dec. 25, 2022~ Dec. 26, 2022	N/A	Radiation (03CH15-HY)
Software	Audix	E3 6.2009-8-24 (k5)	RK-000451	N/A	N/A	Dec. 25, 2022~ Dec. 26, 2022	N/A	Radiation (03CH15-HY)
RF Cable	HUBER + SUHNER	SUCOFLEX 104, 102E	MY582185/4, MY9838/4PE, 519228/2	30MHz~18G	Jun. 21, 2022	Dec. 25, 2022~ Dec. 26, 2022	Jun. 20, 2023	Radiation (03CH15-HY)
RF Cable	HUBER + SUHNER	SUCOFLEX 102	804011/2,804 012/2	30MHz-40GHz	Jan. 04, 2022	Dec. 25, 2022~ Dec. 26, 2022	Jan. 03, 2023	Radiation (03CH15-HY)
RF Cable	HUBER + SUHNER	SUCOFLEX 104	MY9837/4PE	9kHz~30MHz	Mar. 10, 2022	Dec. 25, 2022~ Dec. 26, 2022	Mar. 09, 2023	Radiation (03CH15-HY)
Hygrometer	TECPEL	DTM-303A	TP201996	N/A	Nov. 17, 2022	Dec. 16, 2022~ Jan. 31, 2023	Nov. 16, 2023	Conducted (TH05-HY)
Power Meter	Anritsu	ML2495A	1036004	N/A	Aug. 08, 2022	Dec. 16, 2022~ Jan. 31, 2023	Aug. 07, 2023	Conducted (TH05-HY)
Signal Analyzer	Rohde & Schwarz	FSV40	101905	10Hz - 40GHz	Aug. 03, 2022	Dec. 16, 2022~ Jan. 31, 2023	Aug. 02, 2023	Conducted (TH05-HY)



Instrument	Brand Name	Model No.	Serial No.	Characteristics	Calibration Date	Test Date	Due Date	Remark
AC Power Source	ChainTek	APC-1000W	N/A	N/A	N/A	Dec. 07, 2022	N/A	Conduction (CO05-HY)
EMI Test Receiver	Rohde & Schwarz	ESR3	102388	9kHz~3.6GHz	Dec. 01, 2022	Dec. 07, 2022	Nov. 30, 2023	Conduction (CO05-HY)
Hygrometer	Testo	608-H1	34913912	N/A	Nov. 17, 2022	Dec. 07, 2022	Nov. 16, 2023	Conduction (CO05-HY)
LISN	Rohde & Schwarz	ENV216	100080	9kHz~30MHz	Dec. 01, 2022	Dec. 07, 2022	Nov. 30, 2023	Conduction (CO05-HY)
LISN	Rohde & Schwarz	ENV216	100081	9kHz~30MHz	Nov. 17, 2022	Dec. 07, 2022	Nov. 16, 2023	Conduction (CO05-HY)
Software	Rohde & Schwarz	EMC32	N/A	N/A	N/A	Dec. 07, 2022	N/A	Conduction (CO05-HY)
Pulse Limiter	SCHWARZBECK	VTSD 9561-FN	00691	N/A	Aug. 01, 2022	Dec. 07, 2022	Jul. 31, 2023	Conduction (CO05-HY)
LISN Cable	MVE	RG-400	260260	N/A	Dec. 30, 2021	Dec. 07, 2022	Dec. 29, 2022	Conduction (CO05-HY)



5 Uncertainty of Evaluation

Uncertainty of Conducted Emission Measurement (150 kHz ~ 30 MHz)

Measuring Uncertainty for a Level of Confidence of 95% ($U = 2Uc(y)$)	3.5 dB
---	--------

Uncertainty of Radiated Emission Measurement (30 MHz ~ 1000 MHz)

Measuring Uncertainty for a Level of Confidence of 95% ($U = 2Uc(y)$)	6.3 dB
---	--------

Uncertainty of Radiated Emission Measurement (1000 MHz ~ 6000 MHz)

Measuring Uncertainty for a Level of Confidence of 95% ($U = 2Uc(y)$)	4.2 dB
---	--------

Uncertainty of Radiated Emission Measurement (6000 MHz ~ 18000 MHz)

Measuring Uncertainty for a Level of Confidence of 95% ($U = 2Uc(y)$)	5.4 dB
---	--------

Uncertainty of Radiated Emission Measurement (18000 MHz ~ 40000 MHz)

Measuring Uncertainty for a Level of Confidence of 95% ($U = 2Uc(y)$)	5.2 dB
---	--------

Appendix A. Test Result of Conducted Test Items

Test Engineer:	Ray Wang	Temperature:	21~25	°C
Test Date:	2022/12/16~2023/01/31	Relative Humidity:	51~54	%

TEST RESULTS DATA									
20dB and 99% Occupied Bandwidth and Hopping Channel Separation									
Mod.	Data Rate	NTX	CH.	Freq. (MHz)	20db BW (MHz)	99% Bandwidth (MHz)	Hopping Channel Separation Measurement (MHz)	Hopping Channel Separation Measurement Limit (MHz)	Pass/Fail
DH	1Mbps	1	0	2402	0.886	0.822	1.003	0.5905	Pass
DH	1Mbps	1	39	2441	0.883	0.822	1.003	0.5885	Pass
DH	1Mbps	1	78	2480	0.886	0.825	1.003	0.5905	Pass
2DH	2Mbps	1	0	2402	1.329	1.178	1.003	0.8857	Pass
2DH	2Mbps	1	39	2441	1.329	1.178	1.003	0.8857	Pass
2DH	2Mbps	1	78	2480	1.324	1.184	0.994	0.8828	Pass
3DH	3Mbps	1	0	2402	1.246	1.164	1.003	0.8307	Pass
3DH	3Mbps	1	39	2441	1.242	1.164	1.003	0.8278	Pass
3DH	3Mbps	1	78	2480	1.237	1.164	1.003	0.8249	Pass

TEST RESULTS DATA						
Dwell Time						
Mod.	Hopping Channel Number Rate	Hops Over Occupancy Time (hops)	Package Transfer Time (msec)	Dwell Time (sec)	Limits (sec)	Pass/Fail
3DH5	79	106.670	2.90	0.31	0.4	Pass
3DH5 (AFH)	20	53.330	2.90	0.15	0.4	Pass

TEST RESULTS DATA					
Peak Power Table					
DH	CH.	NTX	Peak Power (dBm)	Power Limit (dBm)	Test Result
DH1	0	1	4.20	30.00	Pass
	39	1	4.26	30.00	Pass
	78	1	4.38	30.00	Pass
2DH1	0	1	5.18	20.97	Pass
	39	1	5.22	20.97	Pass
	78	1	5.34	20.97	Pass
3DH1	0	1	5.37	20.97	Pass
	39	1	5.42	20.97	Pass
	78	1	5.51	20.97	Pass

TEST RESULTS DATA				
Average Power Table (Reporting Only)				
DH	CH.	NTX	Average Power (dBm)	Duty Factor (dB)
DH1	0	1	2.94	5.12
	39	1	3.29	5.12
	78	1	3.51	5.12
2DH1	0	1	3.17	5.05
	39	1	3.39	5.05
	78	1	3.52	5.05
3DH1	0	1	3.25	5.04
	39	1	3.41	5.04
	78	1	3.58	5.04

TEST RESULTS DATA			
Number of Hopping Frequency			
Number of Hopping (Channel)	Adaptive Frequency Hopping (Channel)	Limits (Channel)	Pass/Fail
79	20	> 15	Pass



Appendix B. AC Conducted Emission Test Results

Test Engineer :	Calvin Wang	Temperature :	23~26°C
		Relative Humidity :	45~55%

EUT Information

Report NO : 261103
 Test Mode : Mode 1
 Test Voltage : 120Vac/60Hz
 Phase : Line

Full Spectrum

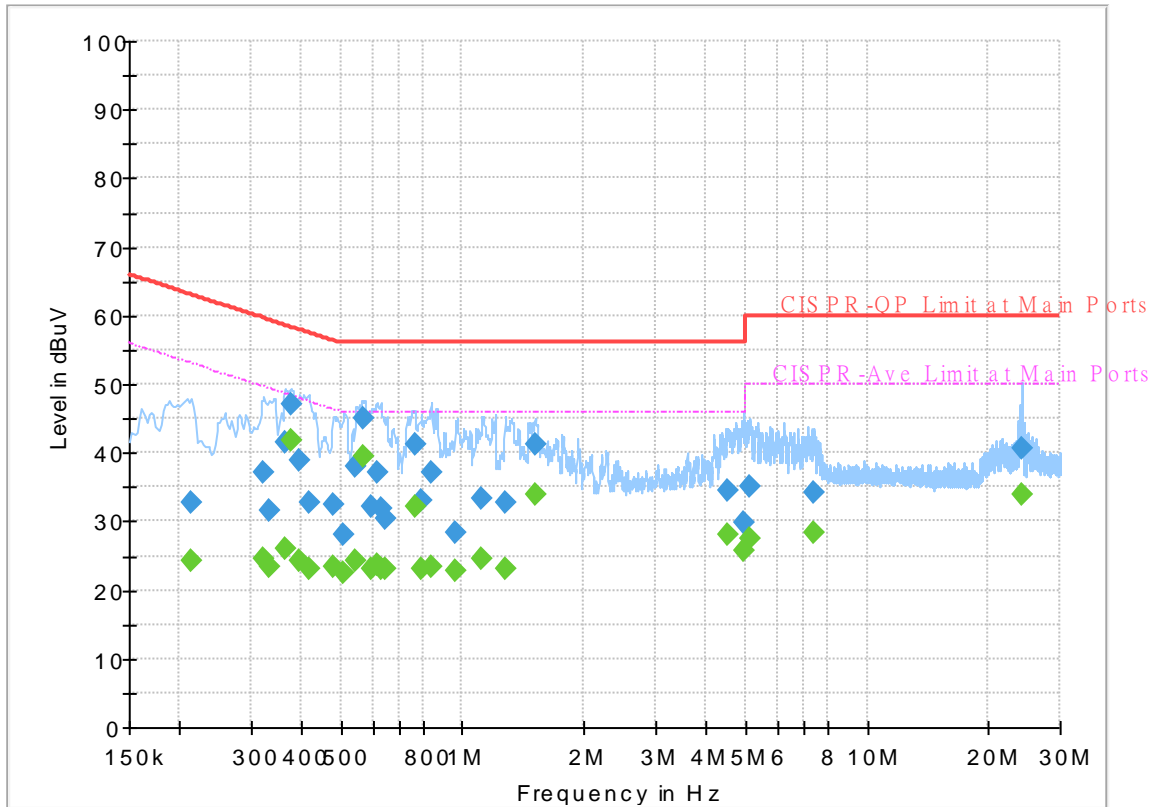

Final_Result

Frequency (MHz)	QuasiPeak (dBuV)	CAverage (dBuV)	Limit (dBuV)	Margin (dB)	Line	Filter	Corr. (dB)
0.213000	---	24.26	53.09	28.83	L1	OFF	19.8
0.213000	32.84	---	63.09	30.25	L1	OFF	19.8
0.323250	---	24.62	49.62	25.00	L1	OFF	19.8
0.323250	37.00	---	59.62	22.62	L1	OFF	19.8
0.334500	---	23.35	49.34	25.99	L1	OFF	19.8
0.334500	31.54	---	59.34	27.80	L1	OFF	19.8
0.363750	---	25.93	48.64	22.71	L1	OFF	19.8
0.363750	41.60	---	58.64	17.04	L1	OFF	19.8
0.377250	---	41.92	48.34	6.42	L1	OFF	19.8
0.377250	47.12	---	58.34	11.22	L1	OFF	19.8
0.395250	---	24.35	47.95	23.60	L1	OFF	19.8
0.395250	38.76	---	57.95	19.19	L1	OFF	19.8
0.417750	---	23.17	47.49	24.32	L1	OFF	19.8
0.417750	32.75	---	57.49	24.74	L1	OFF	19.8
0.480750	---	23.42	46.33	22.91	L1	OFF	19.8
0.480750	32.46	---	56.33	23.87	L1	OFF	19.8
0.507750	---	22.53	46.00	23.47	L1	OFF	19.8
0.507750	28.07	---	56.00	27.93	L1	OFF	19.8
0.546000	---	24.36	46.00	21.64	L1	OFF	19.8
0.546000	37.99	---	56.00	18.01	L1	OFF	19.8
0.566250	---	39.41	46.00	6.59	L1	OFF	19.8

0.566250	45.04	---	56.00	10.96	L1	OFF	19.8
0.593250	---	23.02	46.00	22.98	L1	OFF	19.8
0.593250	32.17	---	56.00	23.83	L1	OFF	19.8
0.613500	---	23.66	46.00	22.34	L1	OFF	19.8
0.613500	37.15	---	56.00	18.85	L1	OFF	19.8
0.627000	---	22.96	46.00	23.04	L1	OFF	19.8
0.627000	31.94	---	56.00	24.06	L1	OFF	19.8
0.645000	---	23.12	46.00	22.88	L1	OFF	19.8
0.645000	30.30	---	56.00	25.70	L1	OFF	19.8
0.762000	---	32.20	46.00	13.80	L1	OFF	19.8
0.762000	41.25	---	56.00	14.75	L1	OFF	19.8
0.791250	---	22.96	46.00	23.04	L1	OFF	19.8
0.791250	33.01	---	56.00	22.99	L1	OFF	19.8
0.836250	---	23.30	46.00	22.70	L1	OFF	19.8
0.836250	37.14	---	56.00	18.86	L1	OFF	19.8
0.962250	---	22.77	46.00	23.23	L1	OFF	19.8
0.962250	28.49	---	56.00	27.51	L1	OFF	19.8
1.117500	---	24.59	46.00	21.41	L1	OFF	19.8
1.117500	33.29	---	56.00	22.71	L1	OFF	19.8
1.272750	---	23.15	46.00	22.85	L1	OFF	19.8
1.272750	32.67	---	56.00	23.33	L1	OFF	19.8
1.509000	---	33.97	46.00	12.03	L1	OFF	19.9
1.509000	41.29	---	56.00	14.71	L1	OFF	19.9
4.524000	---	28.02	46.00	17.98	L1	OFF	20.0
4.524000	34.63	---	56.00	21.37	L1	OFF	20.0
4.967250	---	25.72	46.00	20.28	L1	OFF	20.0
4.967250	29.94	---	56.00	26.06	L1	OFF	20.0
5.127000	---	27.62	50.00	22.38	L1	OFF	20.0
5.127000	35.05	---	60.00	24.95	L1	OFF	20.0
7.359000	---	28.32	50.00	21.68	L1	OFF	20.1
7.359000	34.19	---	60.00	25.81	L1	OFF	20.1
24.054000	---	34.06	50.00	15.94	L1	OFF	20.6
24.054000	40.73	---	60.00	19.27	L1	OFF	20.6

EUT Information

Report NO : 261103
 Test Mode : Mode 1
 Test Voltage : 120Vac/60Hz
 Phase : Neutral

Full Spectrum

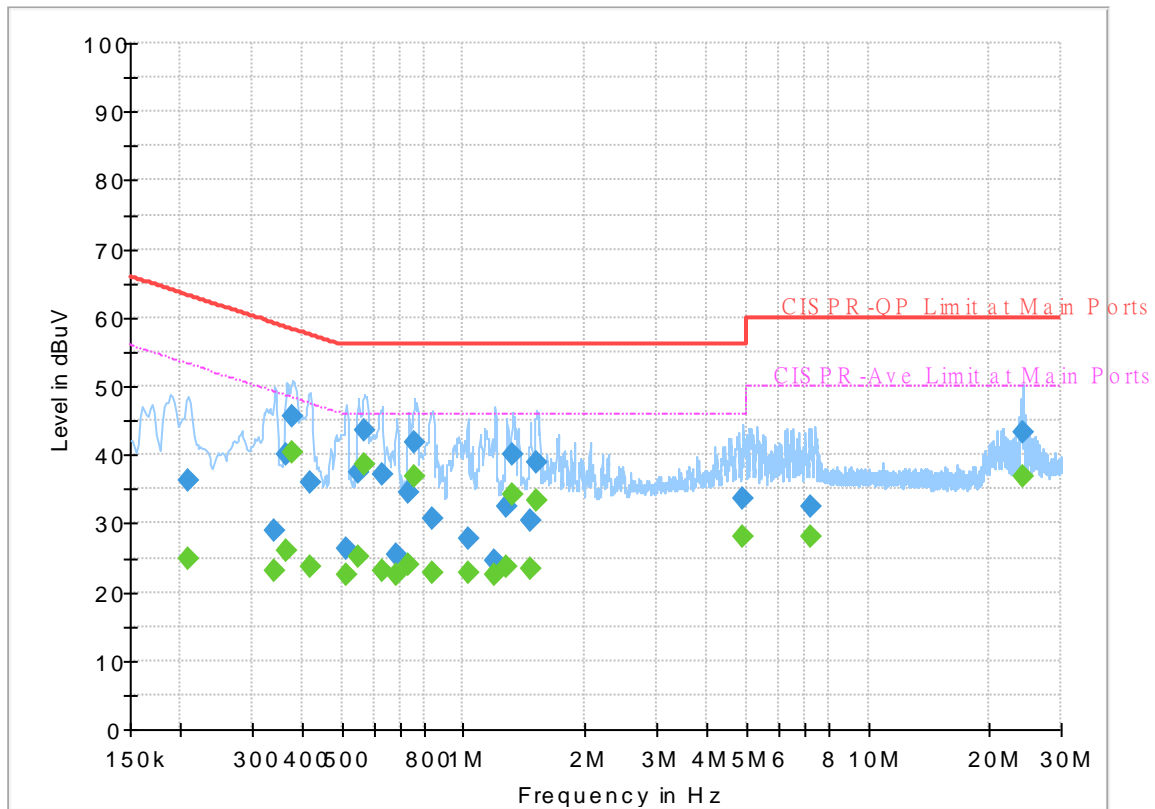

Final Result

Frequency (MHz)	QuasiPeak (dBuV)	CAverage (dBuV)	Limit (dBuV)	Margin (dB)	Line	Filter	Corr. (dB)
0.208500	---	24.74	53.27	28.53	N	OFF	19.8
0.208500	36.40	---	63.27	26.87	N	OFF	19.8
0.341250	---	23.03	49.17	26.14	N	OFF	19.8
0.341250	29.09	---	59.17	30.08	N	OFF	19.8
0.366000	---	26.03	48.59	22.56	N	OFF	19.8
0.366000	39.95	---	58.59	18.64	N	OFF	19.8
0.379500	---	40.36	48.29	7.93	N	OFF	19.8
0.379500	45.52	---	58.29	12.77	N	OFF	19.8
0.417750	---	23.54	47.49	23.95	N	OFF	19.8
0.417750	35.89	---	57.49	21.60	N	OFF	19.8
0.512250	---	22.62	46.00	23.38	N	OFF	19.8
0.512250	26.39	---	56.00	29.61	N	OFF	19.8
0.550500	---	25.11	46.00	20.89	N	OFF	19.8
0.550500	37.34	---	56.00	18.66	N	OFF	19.8
0.568500	---	38.53	46.00	7.47	N	OFF	19.8
0.568500	43.49	---	56.00	12.51	N	OFF	19.8
0.629250	---	23.16	46.00	22.84	N	OFF	19.8
0.629250	37.09	---	56.00	18.91	N	OFF	19.8
0.683250	---	22.41	46.00	23.59	N	OFF	19.8
0.683250	25.35	---	56.00	30.65	N	OFF	19.8
0.732750	---	24.02	46.00	21.98	N	OFF	19.8

0.732750	34.39	---	56.00	21.61	N	OFF	19.8
0.757500	---	36.73	46.00	9.27	N	OFF	19.8
0.757500	41.92	---	56.00	14.08	N	OFF	19.8
0.838500	---	22.81	46.00	23.19	N	OFF	19.8
0.838500	30.59	---	56.00	25.41	N	OFF	19.8
1.025250	---	22.72	46.00	23.28	N	OFF	19.8
1.025250	27.71	---	56.00	28.29	N	OFF	19.8
1.198500	---	22.49	46.00	23.51	N	OFF	19.8
1.198500	24.44	---	56.00	31.56	N	OFF	19.8
1.284000	---	23.73	46.00	22.27	N	OFF	19.8
1.284000	32.32	---	56.00	23.68	N	OFF	19.8
1.324500	---	34.08	46.00	11.92	N	OFF	19.8
1.324500	40.03	---	56.00	15.97	N	OFF	19.8
1.464000	---	23.46	46.00	22.54	N	OFF	19.8
1.464000	30.39	---	56.00	25.61	N	OFF	19.8
1.513500	---	33.35	46.00	12.65	N	OFF	19.8
1.513500	38.92	---	56.00	17.08	N	OFF	19.8
4.920000	---	28.18	46.00	17.82	N	OFF	20.0
4.920000	33.49	---	56.00	22.51	N	OFF	20.0
7.183500	---	27.99	50.00	22.01	N	OFF	20.1
7.183500	32.46	---	60.00	27.54	N	OFF	20.1
24.054000	---	36.78	50.00	13.22	N	OFF	20.7
24.054000	43.18	---	60.00	16.82	N	OFF	20.7



Appendix C. Radiated Spurious Emission

Test Engineer :	Bigshow Wang and Quentin Liu	Temperature :	21~26°C
		Relative Humidity :	45~60%

2.4GHz 2400~2483.5MHz

BT (Band Edge @ 3m)

BT	Note	Frequency (MHz)	Level (dBμV/m)	Margin (dB)	Limit Line (dBμV/m)	Read Level (dBμV)	Antenna Factor (dB/m)	Path Loss (dB)	Preamp Factor (dB)	Ant Pos (cm)	Table Pos (deg)	Peak Avg. (P/A)	Pol. (H/V)
BT CH00 2402MHz		2388.33	58.94	-15.06	74	62.38	27.31	6.11	36.86	209	171	P	H
		2388.33	34.18	-19.82	54	-	-	-	-	-	-	A	H
		2238	58.87	-15.13	74	62.58	27.32	5.84	36.87	209	169	P	H
		2238	40.06	-13.94	54	43.77	27.32	5.84	36.87	209	169	A	H
	*	2402	102.84	28.84	74	106.16	27.41	6.13	36.86	209	171	P	H
	*	2402	78.08	24.08	54	-	-	-	-	-	-	A	H
		2388.33	48.53	-25.47	74	51.97	27.31	6.11	36.86	389	307	P	V
		2388.33	23.77	-30.23	54	-	-	-	-	-	-	A	V
	*	2402	94.57	20.57	74	97.89	27.41	6.13	36.86	389	307	P	V
	*	2402	69.81	15.81	54	-	-	-	-	-	-	A	V
													V
													V



BT	Note	Frequency (MHz)	Level (dBµV/m)	Margin (dB)	Limit Line (dBµV/m)	Read Level (dBµV)	Antenna Factor (dB/m)	Path Loss (dB)	Preamp Factor (dB)	Ant Pos (cm)	Table Pos (deg)	Peak Avg. (P/A)	Pol. (H/V)	
BT CH 39 2441MHz		2381.96	59.16	-14.84	74	62.66	27.26	6.1	36.86	202	174	P	H	
		2381.96	34.4	-19.6	54	-	-	-	-	-	-	A	H	
		2238	59.98	-14.02	74	63.69	27.32	5.84	36.87	216	174	P	H	
		2238	45.41	-28.59	74	49.12	27.32	5.84	36.87	216	174	A	H	
		2382	60.39	-13.61	74	63.89	27.26	6.1	36.86	187	183	P	H	
		2382	45.78	-28.22	74	49.28	27.26	6.1	36.86	187	183	A	H	
	*	2441	103.63	29.63	74	106.64	27.65	6.19	36.85	202	174	P	H	
	*	2441	78.87	24.87	54	-	-	-	-	-	-	-	A	H
		2491.88	49.1	-24.9	74	51.81	27.87	6.27	36.85	202	174	P	H	
		2491.88	24.34	-29.66	54	-	-	-	-	-	-	-	A	H
		2381.82	50.57	-23.43	74	54.08	27.25	6.1	36.86	373	291	P	V	
		2381.82	25.81	-28.19	54	-	-	-	-	-	-	-	A	V
		2238	52.28	-21.72	74	55.99	27.32	5.84	36.87	400	317	P	V	
		2238	37.87	-36.13	74	41.58	27.32	5.84	36.87	400	317	A	V	
		2382	53.67	-20.33	74	57.17	27.26	6.1	36.86	156	211	P	V	
		2382	39.15	-34.85	74	42.65	27.26	6.1	36.86	156	211	A	V	
		2441	95.53	21.53	74	98.54	27.65	6.19	36.85	373	291	P	V	
		2441	70.77	16.77	54	-	-	-	-	-	-	-	A	V
		2484.95	41.69	-32.31	74	44.44	27.84	6.26	36.85	373	291	P	V	
		2484.95	16.93	-37.07	54	-	-	-	-	-	-	-	A	V



BT	Note	Frequency (MHz)	Level (dBμV/m)	Margin (dB)	Limit Line (dBμV/m)	Read Level (dBμV)	Antenna Factor (dB/m)	Path Loss (dB)	Preamp Factor (dB)	Ant Pos (cm)	Table Pos (deg)	Peak Avg. (P/A)	Pol. (H/V)	
BT CH 78 2480MHz	*	2238	57.54	-16.46	74	61.25	27.32	5.84	36.87	250	162	P	H	
		2238	42.73	-11.27	54	46.44	27.32	5.84	36.87	250	162	A	H	
		2382	60.94	-13.06	74	64.44	27.26	6.1	36.86	150	211	P	H	
		2382	45.81	-8.19	54	49.31	27.26	6.1	36.86	150	211	A	H	
		2480	104.25	30.25	74	107.03	27.82	6.25	36.85	202	175	P	H	
		2480	79.49	25.49	54	-	-	-	-	-	-	-	A	H
	*	2489.28	54.84	-19.16	74	57.56	27.86	6.27	36.85	202	175	P	H	
		2489.28	30.08	-23.92	54	-	-	-	-	-	-	-	A	H
		2238	51.63	-22.37	74	55.34	27.32	5.84	36.87	400	308	P	V	
		2238	37.46	-16.54	54	41.17	27.32	5.84	36.87	400	308	A	V	
		2382	53.94	-20.06	74	57.44	27.26	6.1	36.86	150	211	P	V	
		2382	38.86	-15.14	54	42.36	27.26	6.1	36.86	150	211	A	V	
		2480	95.77	21.77	74	98.55	27.82	6.25	36.85	397	312	P	V	
		2480	71.01	17.01	54	-	-	-	-	-	-	-	A	V
		2489.04	48.29	-25.71	74	51.01	27.86	6.27	36.85	397	312	P	V	
	2489.04	23.53	-30.47	54	-	-	-	-	-	-	-	A	V	
Remark	1. No other spurious found. 2. All results are PASS against Peak and Average limit line.													



2.4GHz 2400~2483.5MHz

BT (Harmonic @ 3m)

BT	Note	Frequency (MHz)	Level (dBμV/m)	Margin (dB)	Limit Line (dBμV/m)	Read Level (dBμV)	Antenna Factor (dB/m)	Path Loss (dB)	Preamp Factor (dB)	Ant Pos (cm)	Table Pos (deg)	Peak Avg. (P/A)	Pol. (H/V)	
BT CH 00 2402MHz		4804	40.68	-33.32	74	65.55	32.32	9.42	66.61	-	-	P	H	
		4804	15.92	-38.08	54	-	-	-	-	-	-	A	H	
		7206	53.14	-20.86	74	71.64	36.71	10.76	65.97	-	-	P	H	
		7206	28.38	-25.62	54	-	-	-	-	-	-	A	H	
													H	
													H	
													H	
													H	
													H	
													H	
													H	
													H	
			4804	45.9	-28.1	74	70.77	32.32	9.42	66.61	-	-	P	V
			4804	21.14	-32.86	54	-	-	-	-	-	-	A	V
			7206	54.97	-19.03	74	73.47	36.71	10.76	65.97	-	-	P	V
			7206	30.21	-23.79	54	-	-	-	-	-	-	A	V
														V
														V
														V
														V
													V	
													V	



BT	Note	Frequency (MHz)	Level (dBµV/m)	Margin (dB)	Limit Line (dBµV/m)	Read Level (dBµV)	Antenna Factor (dB/m)	Path Loss (dB)	Preamp Factor (dB)	Ant Pos (cm)	Table Pos (deg)	Peak Avg. (P/A)	Pol. (H/V)
BT CH 78 2480MHz		4960	46.58	-27.42	74	70.76	32.94	9.37	66.49	-	-	P	H
		4960	21.82	-32.18	54	-	-	-	-	-	-	A	H
		7440	53.51	-20.49	74	72.29	36.34	10.96	66.08	-	-	P	H
		7440	28.75	-25.25	54	-	-	-	-	-	-	A	H
													H
													H
													H
													H
													H
													H
													H
													H
													H
													H
													H
													H
													H
													H
													H
													H
BT CH 78 2480MHz		4960	53.79	-20.21	74	77.97	32.94	9.37	66.49	-	-	P	V
		4960	29.03	-24.97	54	-	-	-	-	-	-	A	V
		7440	52.27	-21.73	74	71.05	36.34	10.96	66.08	-	-	P	V
		7440	27.51	-26.49	54	-	-	-	-	-	-	A	V
													V
													V
													V
													V
													V
													V
													V
													V
													V
													V
													V
													V
													V
Remark	1. No other spurious found. 2. All results are PASS against Peak and Average limit line. 3. The emission position marked as "-" means no suspected emission found with sufficient margin against limit line or noise floor only.												



Emission above 18GHz

2.4GHz BT (SHF)

BT	Note	Frequency	Level	Margin	Limit	Read	Antenna	Path	Preamp	Ant	Table	Peak	Pol.
		(MHz)	(dBμV/m)	(dB)	(dBμV/m)	(dBμV)	(dB/m)	(dB)	(dB)	(cm)	(deg)	(P/A)	(H/V)
2.4GHz BT SHF		25084	42.95	-31.05	74	59	39.37	-2.32	53.1	-	-	P	H
													H
													H
													H
													H
													H
													H
													H
													H
													H
													H
													H
													H
													H
													H
													H
													H
													H
													H
			21740	40.03	-33.97	74	59.15	38.68	-3.05	54.75	-	-	P
													V
													V
													V
													V
													V
													V
													V
													V
													V
													V
													V
													V
													V
Remark	1. No other spurious found. 2. All results are PASS against limit line. 3. The emission position marked as "-" means no suspected emission found with sufficient margin against limit line or noise floor only.												



Emission below 1GHz

2.4GHz BT (LF)

BT	Note	Frequency	Level	Margin	Limit	Read	Antenna	Path	Preamp	Ant	Table	Peak	Pol.	
		(MHz)	(dBμV/m)	(dB)	(dBμV/m)	(dBμV)	(dB/m)	(dB)	(dB)	(cm)	(deg)	(P/A)	(H/V)	
2.4GHz BT LF		30	22.47	-17.53	40	29.69	24.53	0.64	32.39	-	-	P	H	
		120.21	24.16	-19.34	43.5	38	17.31	1.31	32.46	-	-	P	H	
		239.52	31.57	-14.43	46	44.9	17.15	1.92	32.4	-	-	P	H	
		600.36	30.86	-15.14	46	34.7	25.6	2.99	32.43	-	-	P	H	
		726.46	41.52	-4.48	46	43.27	27.26	3.26	32.27	400	43	Q	H	
		960.23	38.94	-15.06	54	35.12	30.9	3.85	30.93	-	-	P	H	
														H
														H
														H
														H
														H
														H
														H
			30.97	33.46	-6.54	40	40.94	24.24	0.67	32.39	-	-	P	V
			120.21	32.39	-11.11	43.5	46.23	17.31	1.31	32.46	-	-	P	V
			239.52	36.68	-9.32	46	50.01	17.15	1.92	32.4	-	-	P	V
			480.08	29.65	-16.35	46	35.63	23.8	2.61	32.39	-	-	P	V
			727.43	39.68	-6.32	46	41.36	27.33	3.26	32.27	-	-	P	V
			960.23	41.27	-12.73	54	37.45	30.9	3.85	30.93	-	-	P	V
														V
													V	
													V	
													V	
													V	
													V	

Remark

- No other spurious found.
- All results are PASS against limit line.
- The emission position marked as "-" means no suspected emission found and emission level has at least 6dB margin against limit or emission is noise floor only.



Note symbol

*	Fundamental Frequency which can be ignored. However, the level of any unwanted emissions shall not exceed the level of the fundamental frequency.
!	Test result is over limit line.
P/A	Peak or Average
H/V	Horizontal or Vertical



A calculation example for radiated spurious emission is shown as below:

BT	Note	Frequency	Level	Margin	Limit	Read	Antenna	Path	Preamp	Ant	Table	Peak	Pol.
		(MHz)	(dBµV/m)	(dB)	(dBµV/m)	(dBµV)	(dB/m)	(dB)	(dB)	(cm)	(deg)	(P/A)	(H/V)
BT CH 00 2402MHz		2390	55.45	-18.55	74	54.51	32.22	4.58	35.86	103	308	P	H
		2390	43.54	-10.46	54	42.6	32.22	4.58	35.86	103	308	A	H

1. Path Loss(dB) = Cable loss(dB) + Filter loss(dB) + Attenuator loss(dB)
2. Level(dBµV/m) =
Antenna Factor(dB/m) + Path Loss(dB) + Read Level(dBµV) - Preamp Factor(dB)
3. Margin(dB) = Level(dBµV/m) – Limit Line(dBµV/m)

For Peak Limit @ 2390MHz:

1. Level(dBµV/m)
= Antenna Factor(dB/m) + Path Loss(dB) + Read Level(dBµV) - Preamp Factor(dB)
= 32.22(dB/m) + 4.58(dB) + 54.51(dBµV) – 35.86 (dB)
= 55.45 (dBµV/m)
2. Margin(dB)
= Level(dBµV/m) – Limit Line(dBµV/m)
= 55.45(dBµV/m) – 74(dBµV/m)
= -18.55(dB)

Peak measured complies with the limit line, so test result is “PASS”.



Appendix D. Radiated Spurious Emission Plots

Test Engineer :	Bigshow Wang and Quentin Liu	Temperature :	21~26°C
		Relative Humidity :	45~60%

2.4GHz 2400~2483.5MHz

BT (Band Edge @ 3m)

BT	2.4GHz 2400~2483.5MHz Band Edge @ 3m	
	BT CH00 2402MHz	
	Horizontal	Fundamental
Peak	<p>Site : 03CH15-HV Condition : PEAK_BE_74 3m 91200_02294_220623 HORIZONTAL : RBW:1000.000KHz VBW:3000.000KHz SWT:Auto</p>	<p>Site : 03CH15-HV Condition : PEAK_74 3m 91200_02294_220623 HORIZONTAL : RBW:1000.000KHz VBW:3000.000KHz SWT:Auto</p>

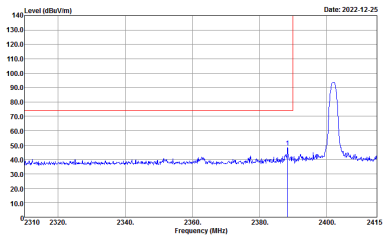
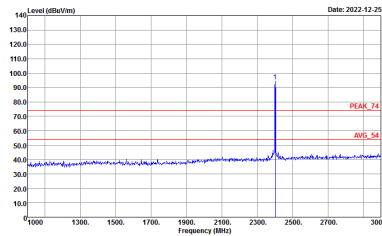

BT	2.4GHz 2400~2483.5MHz Band Edge @ 3m	
	BT CH00 2402MHz	
	Vertical	Fundamental
Peak	 <p>Site : 03CH15-HY Condition : PEAK_74 3m 91200_02294_220623 VERTICAL : RBW:1000.000KHz VBW:3000.000KHz SWT:Auto</p>	 <p>Site : 03CH15-HY Condition : PEAK_74 3m 91200_02294_220623 VERTICAL : RBW:1000.000KHz VBW:3000.000KHz SWT:Auto</p>



BT	2.4GHz 2400~2483.5MHz Band Edge @ 3m	
BT CH39 2441MHz		
Horizontal		Fundamental
Peak	<p>Site : 03CH15-HY Condition : PEAK_BE_74 3m 91200_02294_220623 HORIZONTAL : RBW:1000.000KHz VBW:3000.000KHz SWT:Auto</p>	<p>Site : 03CH15-HY Condition : PEAK_74 3m 91200_02294_220623 HORIZONTAL : RBW:1000.000KHz VBW:3000.000KHz SWT:Auto</p>
Peak	<p>Site : 03CH15-HY Condition : PEAK_BE_74 3m 91200_02294_220623 HORIZONTAL : RBW:1000.000KHz VBW:3000.000KHz SWT:Auto</p>	Left blank



BT	2.4GHz 2400~2483.5MHz Band Edge @ 3m	
	BT CH39 2441MHz	
	Vertical	Fundamental
Peak	<p>Site : 03CH15-HY Condition : PEAK_BE_74 3m 91200_02294_220623 VERTICAL : RBW:1000.000KHz VBW:3000.000KHz SWT:Auto</p>	<p>Site : 03CH15-HY Condition : PEAK_74 3m 91200_02294_220623 VERTICAL : RBW:1000.000KHz VBW:3000.000KHz SWT:Auto</p>
Peak	<p>Site : 03CH15-HY Condition : PEAK_BE_74 3m 91200_02294_220623 VERTICAL : RBW:1000.000KHz VBW:3000.000KHz SWT:Auto</p>	Left blank

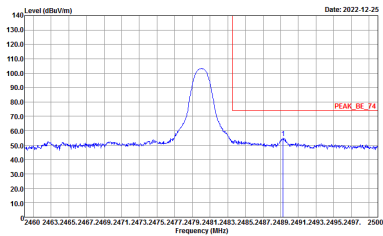
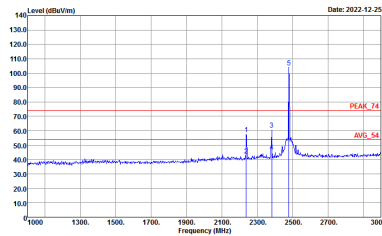

BT	2.4GHz 2400~2483.5MHz Band Edge @ 3m	
	BT CH78 2480MHz	
	Horizontal	Fundamental
Peak	 <p>Date: 2022-12-25</p> <p>Site : 03CH15-HY Condition : PEAK_BC_74 3m 91200_02294_220623 HORIZONTAL : RBW:1000.000KHz VBW:3000.000KHz SWT:Auto</p>	 <p>Date: 2022-12-25</p> <p>Site : 03CH15-HY Condition : PEAK_74 3m 91200_02294_220623 HORIZONTAL : RBW:1000.000KHz VBW:3000.000KHz SWT:Auto</p>



BT	2.4GHz 2400~2483.5MHz Band Edge @ 3m	
	BT CH78 2480MHz	
	Vertical	Fundamental
Peak	<p>Site : 03CH15-HY Condition : PEAK_BC_74 3m 91200_02294_220623 VERTICAL : RBW:1000.000KHz VBW:3000.000KHz SWT:Auto</p>	<p>Site : 03CH15-HY Condition : PEAK_74 3m 91200_02294_220623 VERTICAL : RBW:1000.000KHz VBW:3000.000KHz SWT:Auto</p>



2.4GHz 2400~2483.5MHz

BT (Harmonic @ 3m)

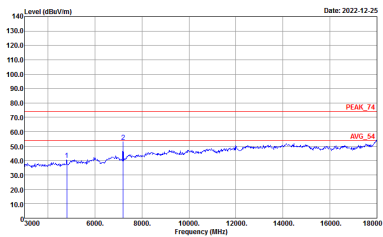
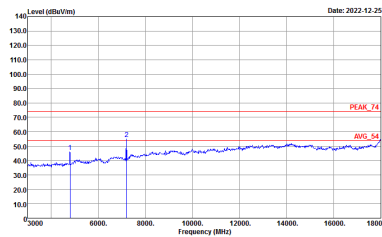
BT	2.4GHz 2400~2483.5MHz Harmonic @ 3m	
	BT CH00 2402MHz	
	Horizontal	Vertical
<p>Peak Avg.</p>	 <p>Site : 03CH15-HY Condition : PEAK_74 3m 9120D_02294_220623 HORIZONTAL</p>	 <p>Site : 03CH15-HY Condition : PEAK_74 3m 9120D_02294_220623 VERTICAL</p>

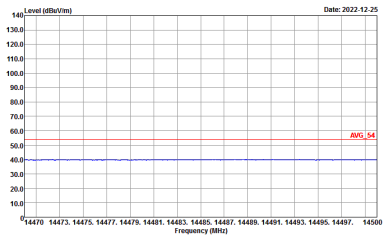
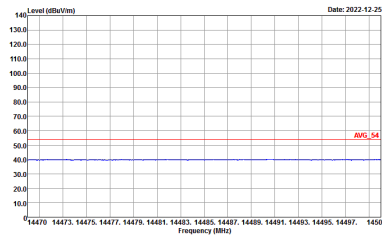
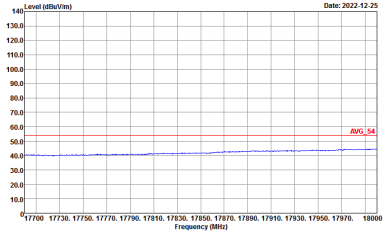
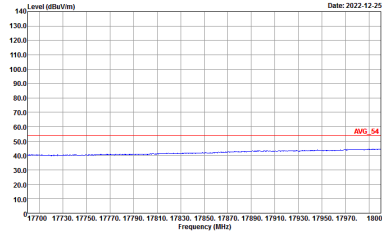

BT	2.4GHz 2400~2483.5MHz Harmonic @ 3m	
	BT CH00 2402MHz	
	Horizontal	Vertical
<p>14.47G ~14.5G Avg.</p>	 <p>Site : 03CH15-HY Condition : AV6_54 3m 91200_02294_220623 HORIZONTAL</p>	 <p>Site : 03CH15-HY Condition : AV6_54 3m 91200_02294_220623 VERTICAL</p>
<p>17.7G ~18G Avg</p>	 <p>Site : 03CH15-HY Condition : AV6_54 3m 91200_02294_220623 HORIZONTAL</p>	 <p>Site : 03CH15-HY Condition : AV6_54 3m 91200_02294_220623 VERTICAL</p>

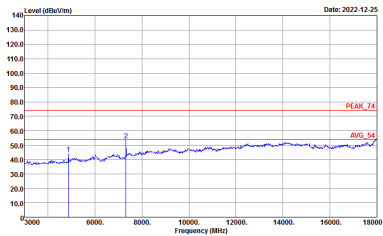
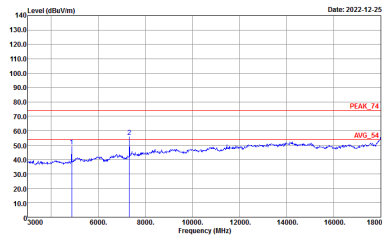

BT	2.4GHz 2400~2483.5MHz Harmonic @ 3m	
	BT CH39 2441MHz	
	Horizontal	Vertical
Peak Avg.	 <p>Site : 03CH15-HY Condition : PEAK_74 3m 9120D_02294_220623 HORIZONTAL</p>	 <p>Site : 03CH15-HY Condition : PEAK_74 3m 9120D_02294_220623 VERTICAL</p>



BT	2.4GHz 2400~2483.5MHz Harmonic @ 3m	
	BT CH39 2441MHz	
	Horizontal	Vertical
<p>14.47G ~14.5G Avg.</p>	<p>Site : 03CH15-HY Condition : AV6_54 3m 91200_02294_220623 HORIZONTAL</p>	<p>Site : 03CH15-HY Condition : AV6_54 3m 91200_02294_220623 VERTICAL</p>
<p>17.7G ~18G Avg</p>	<p>Site : 03CH15-HY Condition : AV6_54 3m 91200_02294_220623 HORIZONTAL</p>	<p>Site : 03CH15-HY Condition : AV6_54 3m 91200_02294_220623 VERTICAL</p>

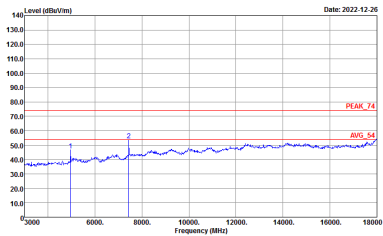
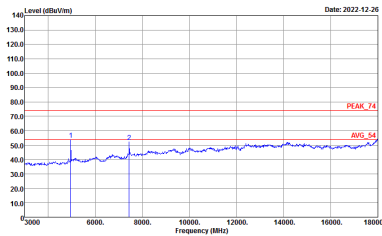

BT	2.4GHz 2400~2483.5MHz Harmonic @ 3m	
	BT CH78 2480MHz	
	Horizontal	Vertical
Peak Avg.	 <p>Site : 03CH15-HY Condition : PEAK_74 3m 9120D_02294_220623 HORIZONTAL</p>	 <p>Site : 03CH15-HY Condition : PEAK_74 3m 9120D_02294_220623 VERTICAL</p>



BT	2.4GHz 2400~2483.5MHz Harmonic @ 3m	
	BT CH78 2480MHz	
	Horizontal	Vertical
<p>14.47G ~14.5G Avg.</p>	<p>Site : 03CH15-HY Condition : AV6_54 3m 91200_02294_220623 HORIZONTAL</p>	<p>Site : 03CH15-HY Condition : AV6_54 3m 91200_02294_220623 VERTICAL</p>
<p>17.7G ~18G Avg</p>	<p>Site : 03CH15-HY Condition : AV6_54 3m 91200_02294_220623 HORIZONTAL</p>	<p>Site : 03CH15-HY Condition : AV6_54 3m 91200_02294_220623 VERTICAL</p>



Emission above 18GHz

2.4GHz BT (SHF @ 1m)

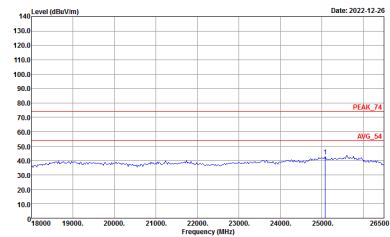
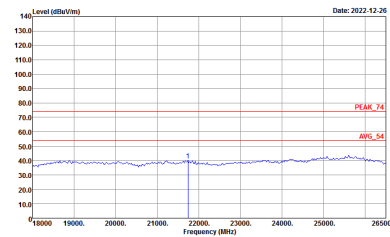
BT	2.4GHz 2400~2483.5MHz	
	BT SHF	
	Horizontal	Vertical
Peak Avg.	 <p>Site : 03CH15-HY Condition : PEAK_74 1m SHF_70576 HORIZONTAL</p>	 <p>Site : 03CH15-HY Condition : PEAK_74 1m SHF_70576 VERTICAL</p>



Emission below 1GHz

2.4GHz BT (LF)

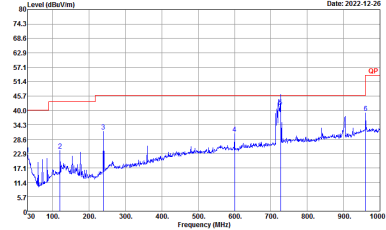
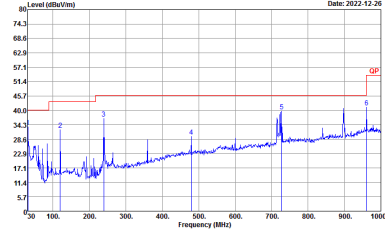
BT	2.4GHz 2400~2483.5MHz	
	BT LF	
	Horizontal	Vertical
QP / Peak	 <p>Site : 03CH15-HY Condition : QP 3m 1381L06 HORIZONTAL</p>	 <p>Site : 03CH15-HY Condition : QP 3m 1381L06 VERTICAL</p>



Appendix E. Duty Cycle Plots

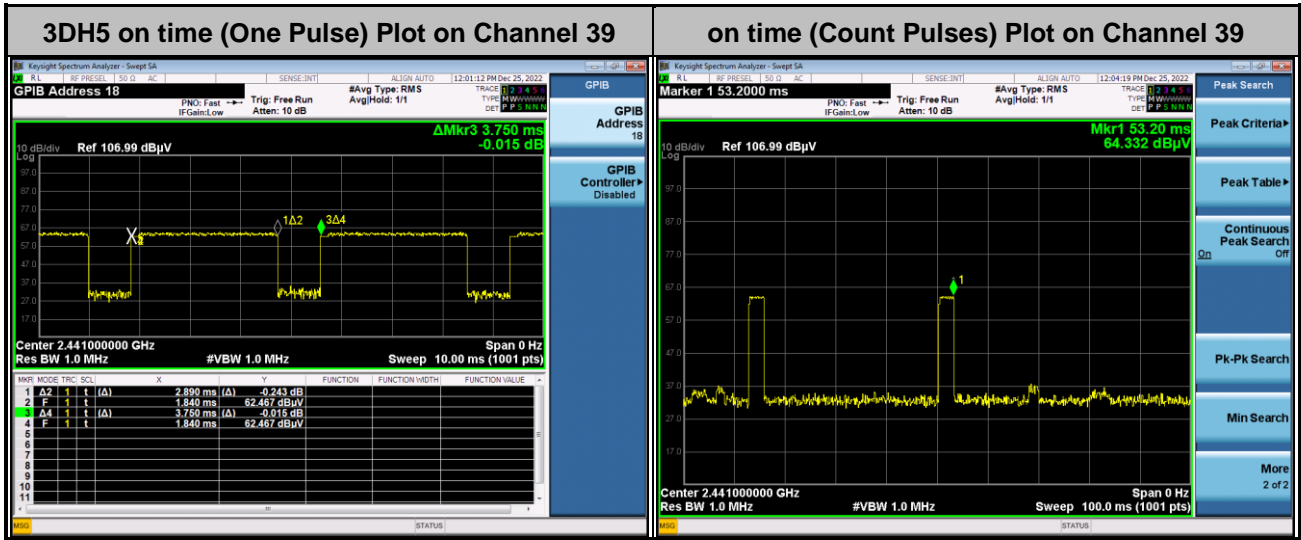

Note:

1. Worst case Duty cycle = on time/100 milliseconds = 2 * 2.89 / 100 = 5.78 %
2. Worst case Duty cycle correction factor = 20*log(Duty cycle) = -24.76 dB
3. 3DH5 has the highest duty cycle worst case and is reported.

Duty Cycle Correction Factor Consideration for AFH mode:

Bluetooth normal hopping rate is 1600Hz and reduced to 800Hz in AFH mode; due to the reduced number of hopping frequencies, with the same packet configuration the dwell time in each channel frequency within 100msec period is longer in AFH mode than normal mode.

In AFH mode, the minimum hopping frequencies are 20, to get the longest dwell time DH5 packet is observed; the on time period to have DH5 packet completing one hopping sequence is

$$2.89 \text{ ms} \times 20 \text{ channels} = 57.8 \text{ ms}$$

There cannot be 2 complete hopping sequences within 100ms period, considering the random hopping behavior, maximum 2 hops can be possibly observed within the period. [100 ms / 57.8 ms] = 2 hops

Thus, the maximum possible ON time:

$$2.89 \text{ ms} \times 2 = 5.78 \text{ ms}$$

Worst case Duty Cycle Correction factor, which is derived from the maximum possible ON time,

$$20 \times \log(5.78 \text{ ms}/100 \text{ ms}) = -24.76 \text{ dB}$$