



# SPORTON International Inc.

No. 52, Hwa Ya 1st Rd., Hwa Ya Technology Park, Kwei-Shan Hsiang, Tao Yuan Hsien, Taiwan, R.O.C.  
Ph: 886-3-327-3456 / FAX: 886-3-327-0973 / www.sporton.com.tw

## FCC RADIO TEST REPORT

Applicant's company	Motorola Solutions, Inc.
Applicant Address	One Motorola Plaza Holtsville, NY 11742 USA
FCC ID	UZ7KHAP800
Manufacturer's company	Wistron NeWeb Corporation
Manufacturer Address	20 Park Avenue II, Hsinchu Science Park, Hsinchu 308, Taiwan, R.O.C.

Product Name	802.11 a/b/g/n Module
Brand Name	MOTOROLA
Model No.	KHAP-800
Test Rule Part(s)	47 CFR FCC Part 15 Subpart E § 15.407
Test Freq. Range	5150 ~ 5350MHz / 5470 ~ 5725MHz
Received Date	Apr. 02, 2012
Final Test Date	Sep. 27, 2013
Submission Type	Class II Change
Operating Mode	Master

### Statement

Test result included is for the IEEE 802.11n and IEEE 802.11a (5150 ~ 5350MHz / 5470 ~ 5725MHz) of the product.

The test result in this report refers exclusively to the presented test model / sample.

Without written approval of SPORTON International Inc., the test report shall not be reproduced except in full.

The measurements and test results shown in this test report were made in accordance with the procedures and found in compliance with the limit given in ANSI C63.10-2009, 47 CFR FCC Part 15 Subpart E, KDB 789033 D01 v01r03, KDB 662911 D01 v02

The test equipment used to perform the test is calibrated and traceable to NML/ROC.



## Table of Contents

<b>1. CERTIFICATE OF COMPLIANCE .....</b>	<b>1</b>
<b>2. SUMMARY OF THE TEST RESULT .....</b>	<b>2</b>
<b>3. GENERAL INFORMATION .....</b>	<b>3</b>
3.1. Product Details.....	3
3.2. Accessories.....	5
3.3. Table for Filed Antenna.....	6
3.4. Table for Carrier Frequencies .....	8
3.5. Table for Product Information .....	8
3.6. Table for Test Modes .....	9
3.7. Table for Testing Locations.....	14
3.8. Table for Class II Change .....	14
3.9. Table for Supporting Units .....	14
3.10. Table for Parameters of Test Software Setting .....	15
3.11. EUT Operation during Test .....	16
3.12. Duty Cycle .....	17
3.13. Test Configurations .....	21
<b>4. TEST RESULT .....</b>	<b>22</b>
4.1. 26dB Bandwidth and 99% Occupied Bandwidth Measurement.....	22
4.2. Maximum Conducted Output Power Measurement.....	60
4.3. Power Spectral Density Measurement .....	66
4.4. Peak Excursion Measurement .....	83
4.5. Radiated Emissions Measurement .....	102
4.6. Band Edge Emissions Measurement .....	166
4.7. Frequency Stability Measurement .....	189
4.8. Antenna Requirements .....	191
<b>5. LIST OF MEASURING EQUIPMENTS .....</b>	<b>192</b>
<b>6. TEST LOCATION.....</b>	<b>194</b>
<b>7. MEASUREMENT UNCERTAINTY.....</b>	<b>195</b>
<b>APPENDIX A. TEST PHOTOS .....</b>	<b>A1 ~ A4</b>
<b>APPENDIX B. MAXIMUM PERMISSIBLE EXPOSURE .....</b>	<b>B1 ~ B12</b>



### History of This Test Report

REPORT NO.	VERSION	DESCRIPTION	ISSUED DATE
FR240223-04AB	Rev. 01	Initial issue of report	Oct. 18, 2013

## 1. CERTIFICATE OF COMPLIANCE

Product Name : 802.11 a/b/g/n Module  
Brand Name : MOTOROLA  
Model No. : KHAP-800  
Applicant : Motorola Solutions, Inc.  
Test Rule Part(s) : 47 CFR FCC Part 15 Subpart E § 15.407

Sporton International as requested by the applicant to evaluate the EMC performance of the product sample received on Apr. 02, 2012 would like to declare that the tested sample has been evaluated and found to be in compliance with the tested rule parts. The data recorded as well as the test configuration specified is true and accurate for showing the sample's EMC nature.

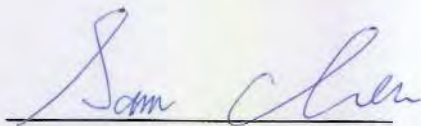

Sam Chen

SPORTON INTERNATIONAL INC.

## 2. SUMMARY OF THE TEST RESULT

Applied Standard: 47 CFR FCC Part 15 Subpart E				
Part	Rule Section	Description of Test	Result	Under Limit
-	15.207	AC Power Line Conducted Emissions	-	Note 1
4.1	15.407(a)	26dB Spectrum Bandwidth and 99% Occupied Bandwidth	Complies	-
4.2	15.407(a)	Maximum Conducted Output Power	Complies	0.08 dB
4.3	15.407(a)	Power Spectral Density	Complies	0.11 dB
4.4	15.407(a)	Peak Excursion	Complies	2.10 dB
4.5	15.407(b)	Radiated Emissions	Complies	3.08 dB
4.6	15.407(b)	Band Edge Emissions	Complies	1.01 dB
4.7	15.407(g)	Frequency Stability	Complies	-
4.8	15.203	Antenna Requirements	Complies	-

Note 1 : Please refer to section 3.8

### 3. GENERAL INFORMATION

#### 3.1. Product Details

##### IEEE 802.11n

Items	Description
Product Type	WLAN (1/2/3TX, 3RX)
Radio Type	Intentional Transceiver
Power Type	powered by PC and DC power supply
Modulation	see the below table for IEEE 802.11n
Data Modulation	OFDM (BPSK / QPSK / 16QAM / 64QAM)
Data Rate (Mbps)	see the below table for IEEE 802.11n
Frequency Range	5150 ~ 5350MHz / 5470 ~ 5725MHz
Channel Number	16 for 20MHz bandwidth ; 7 for 40MHz bandwidth
Channel Band Width (99%)	For 1TX MCS0 (20MHz): 25.12 MHz ; MCS0 (40MHz): 41.60 MHz For 2TX MCS8 (20MHz): 21.28 MHz ; MCS8 (40MHz): 38.72 MHz For 3TX MCS16 (20MHz): 18.56 MHz ; MCS16 (40MHz): 38.40 MHz
Maximum Conducted Output Power	For 1TX Band 1: MCS0 (20MHz): 16.78 dBm ; MCS0 (40MHz): 16.82 dBm Band 2: MCS0 (20MHz): 20.48 dBm ; MCS0 (40MHz): 20.88 dBm Band 3: MCS0 (20MHz): 21.39 dBm ; MCS0 (40MHz): 20.41 dBm For 2TX Band 1: MCS8 (20MHz): 16.76 dBm ; MCS8 (40MHz): 16.76 dBm Band 2: MCS8 (20MHz): 23.71 dBm ; MCS8 (40MHz): 22.54 dBm Band 3: MCS8 (20MHz): 21.86 dBm ; MCS8 (40MHz): 21.70 dBm For 3TX Band 1: MCS16 (20MHz): 16.92 dBm ; MCS16 (40MHz): 16.78 dBm Band 2: MCS16 (20MHz): 23.76 dBm ; MCS16 (40MHz): 23.25 dBm Band 3: MCS16 (20MHz): 19.91 dBm ; MCS16 (40MHz): 23.92 dBm
Carrier Frequencies	Please refer to section 3.4
Antenna	Please refer to section 3.3

**IEEE 802.11a**

Items	Description
Product Type	WLAN (1/2/3TX, 3RX) Note: PIFA Antenna (Model Name: RAI-INT-ANT and KAP-I INT ANT) only 1TX1RX of 11a function
Radio Type	Intentional Transceiver
Power Type	powered by PC and DC power supply
Modulation	OFDM for IEEE 802.11a
Data Modulation	OFDM (BPSK / QPSK / 16QAM / 64QAM)
Data Rate (Mbps)	OFDM (6/9/12/18/24/36/48/54)
Frequency Range	5150 ~ 5350MHz / 5470 ~ 5725MHz
Channel Number	16
Channel Band Width (99%)	23.20 MHz
Maximum Conducted Output Power	Band 1: 16.76 dBm ; Band 2: 20.58 dBm ; Band 3: 21.37 dBm
Carrier Frequencies	Please refer to section 3.4
Antenna	Please refer to section 3.3

**Antenna and Band width**

Antenna	Single (TX)		Two (TX)		Three (TX)	
	20 MHz	40 MHz	20 MHz	40 MHz	20 MHz	40 MHz
Band width Mode						
IEEE 802.11a	V	X	V	X	V	X
IEEE 802.11n	V	V	V	V	V	V

**IEEE 11n Spec.**

Protocol	Number of Transmit Chains (NTX)	Data Rate / MCS
802.11n (HT20)	1, 2, 3	MCS0-23
802.11n (HT40)	1, 2, 3	MCS0-23

Note 1: IEEE Std. 802.11n modulation consists of HT20 and HT40 (HT: High Throughput).

Then EUT support HT20 and HT40.

Note 2: Modulation modes consist of below configuration: HT20/HT40: IEEE 802.11n

**3.2. Accessories**

N/A



### 3.3. Table for Filed Antenna

Ant.	Model Name	Antenna Type	Chip/Radio	Antenna Gain		Cable loss		True Gain (dBi)	
				2.4GHz	5GHz	2.4GHz	5GHz	2.4GHz	5GHz
1	ML-2499-FHPA9-01R	Dipole	Radio1/2-CH1/2/3	10.5	-	1.5	-	9	-
2	ML-2499-SD3-01R	Patch	Radio1/2-CH1/2/3	4	-	1	-	3	-
3	ML-2499-BPNA3-01R	Panel	Radio1/2-CH1/2/3	15	-	1	-	14	-
4	ML-2499-BYGA2-01R	Yagi	Radio1/2-CH1/2/3	14.5	-	1	-	13.5	-
5	KAP-FACADE-ANT	Facade	Radio1/2-CH1/2/3	3.5	4	1	1.5	2.5	2.5
6	ML-5299-FHPA10-01R	Dipole	Radio1/2-CH1/2/3	-	10.5	-	2.5	-	8
7	ML-5299-PTA1-01R	Patch	Radio1/2-CH1/2/3	-	3.8	-	1.5	-	2.3
8	ML-2452-PNA7-01R	Panel	Radio1/2-CH1/2/3	8	12	-	1.5	8	10.5
9	ML-5299-BYGA15-012	Yagi	Radio1/2-CH1/2/3	-	10.5	-	2.5	-	8
10	ML-2499-5PNL-72-N	Panel	Radio1/2-CH1/2/3	6.5	-	-	-	6.5	-
11	ML-2499-APA2-01	Dipole	Radio1/2-CH1/2/3	3.2	-	-	-	3.2	-
12	ML-2499-HPA3-01R	Dipole	Radio1/2-CH1/2/3	4	-	-	-	4	-
13	ML-5299-APA1-01R	Dipole	Radio1/2-CH1/2/3	-	4	-	-	-	4
14	ML-5299-HPA1-01R	Dipole	Radio1/2-CH1/2/3	-	6	-	-	-	6
15	ML-2452-APA2-01	Dipole	Radio1/2-CH1/2/3	3	5	-	-	3	5
16	ML-2452-PNA5-01R	Panel	Radio1/2-CH1/2/3	5.5	6	-	-	5.5	6
17	ML-2452-HPA5-036	Dipole	Radio1/2-CH1/2/3	3	5	-	-	3	5
18	ML-2452-APAG2A1-01	Dipole	Radio1/2-CH1/2/3	2.7	2	-	-	2.7	2
19	RAI-INT-ANT	PIFA	Radio1/2-CH1/2/3	4.3	-	-	-	4.3	-
20	ML-2499-HPA4-01	Dipole	Radio1/2-CH1/2/3	4.5	-	1.5	-	3	-
21	ML-2499-HPA8-01	Dipole	Radio1/2-CH1/2/3	8	-	1.5	-	6.5	-
22	ML-5299-HPA5-01	Dipole	Radio1/2-CH1/2/3	-	5.6	-	2.5	-	3.1
23	ML-5299-HPA10-01	Dipole	Radio1/2-CH1/2/3	-	10.5	-	2.5	-	8
24	ML-2452-HPAG5A8-01	Dipole	Radio1/2-CH1/2/3	5	8	1.5	2.5	3.5	5.5
25	ML-2499-HPA3-02R	Dipole	Radio1/2-CH1/2/3	5	-	1	-	4	-
26	ML-2452-HPAG4A6-01	Dipole	Radio1/2-CH1/2/3	4	7.3	1.5	2.5	2.5	4.8
27	ML-2452-HPA6X6-036	Dipole	Radio1/2-CH1/2/3	4	6	1	1.5	3	4.5
28	ML-2452-HPA6M6-072	Dipole	Radio1/2-CH1/2/3	2.8	6.5	1	1.5	1.8	5
29	ML-2452-PNL9M3-036	Panel	Radio1/2-CH1/2/3	11	10.7	1	1.5	10	9.2
30	ML-2452-PTA6M6-036	Panel	Radio1/2-CH1/2/3	5	6	1	1.5	4	4.5
31	KAP-I INT ANT	PIFA	Radio1/2-CH1/2/3	4.4	4.7	-	-	4.4	4.7

Table of TX/RX Function in each antenna:

Item			Module					
			Chain 1		Chain 2		Chain 3	
			TX	RX	TX	RX	TX	RX
Ant.31	2.4GHz	11b	V	V	V	V	V	V
		11g	V	V	V	V	V	V
		11n	V	V	V	V	V	V
	5GHz	11a	V	V	V	V	V	V
		11n	V	V	V	V	V	V

Note : Marked "-" on behalf of no function.

Module	Required 1TX Port
2.4G / 5G	Chain 1

Module	Required 2TX Port
2.4G / 5G	Chain 1 and Chain 2

Module	Required 3TX Port
2.4G / 5G	Chain 1 and Chain 2 and Chain 3

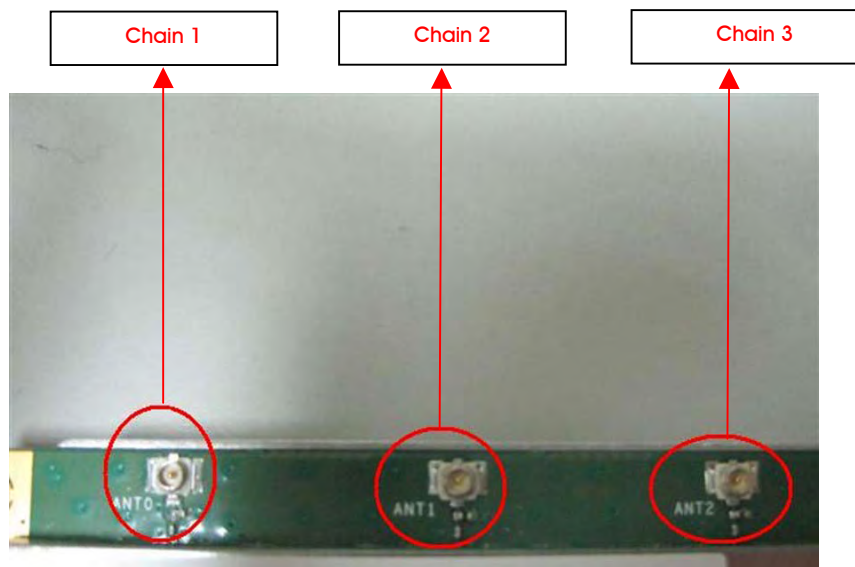

### 3.4. Table for Carrier Frequencies

The EUT has two bandwidth system.

For 20MHz bandwidth systems, use Channel 36, 40, 44, 48, 52, 56, 60, 64, 100, 104, 108, 112, 116, 132, 136, 140.

For 40MHz bandwidth systems, use Channel 38, 46, 54, 62, 102, 110, 134.

Frequency Band	Channel No.	Frequency	Channel No.	Frequency
5150~5250 MHz Band 1	36	5180 MHz	44	5220 MHz
	38	5190 MHz	46	5230 MHz
	40	5200 MHz	48	5240 MHz
5250~5350 MHz Band 2	52	5260 MHz	60	5300 MHz
	54	5270 MHz	62	5310 MHz
	56	5280 MHz	64	5320 MHz
5470~5725 MHz Band 3	100	5500 MHz	116	5580 MHz
	102	5510 MHz	132	5660 MHz
	104	5520 MHz	134	5670 MHz
	108	5540 MHz	136	5680 MHz
	110	5550 MHz	140	5700 MHz
	112	5560 MHz	-	-

### 3.5. Table for Product Information

Items	Description	
Communication Mode	<input checked="" type="checkbox"/> IP Based (Load Based)	<input type="checkbox"/> Frame Based
TPC Function	<input checked="" type="checkbox"/> With TPC	<input type="checkbox"/> Without TPC
Weather Band (5600~5650MHz)	<input type="checkbox"/> With 5600~5650MHz	<input checked="" type="checkbox"/> Without 5600~5650MHz
Beamforming Function	<input type="checkbox"/> With beamforming	<input checked="" type="checkbox"/> Without beamforming

### 3.6. Table for Test Modes

Preliminary tests were performed in different data rate to find the worst radiated emission. The data rate shown in the table below is the worst-case rate with respect to the specific test item. Investigation has been done on all the possible configurations for searching the worst cases. The following table is a list of the test modes shown in this test report.

Test Items	Mode		Data Rate	Channel	Chain
Max. Conducted Output Power	11n 20MHz	Band 1-3	MCS0	36/40/48/52/60/64 /100/116/140	1
	11n 40MHz	Band 1-3	MCS0	38/46/54/62/ 102/110/134	1
	11n 20MHz	Band 1-3	MCS8	36/40/48/52/60/64 /100/116/140	1+2
	11n 40MHz	Band 1-3	MCS8	38/46/54/62/ 102/110/134	1+2
	11n 20MHz	Band 1-3	MCS16	36/40/48/52/60/64 /100/116/140	1+2+3
	11n 40MHz	Band 1-3	MCS16	38/46/54/62/ 102/110/134	1+2+3
	11a/BPSK	Band 1-3	6Mbps	36/40/48/52/60/64 /100/116/140	1
Power Spectral Density	11n 20MHz	Band 1-3	MCS0	36/40/48/52/60/64 /100/116/140	1
	11n 40MHz	Band 1-3	MCS0	38/46/54/62/ 102/110/134	1
	11n 20MHz	Band 1-3	MCS8	36/40/48/52/60/64 /100/116/140	1+2
	11n 40MHz	Band 1-3	MCS8	38/46/54/62/ 102/110/134	1+2
	11n 20MHz	Band 1-3	MCS16	36/40/48/52/60/64 /100/116/140	1+2+3
	11n 40MHz	Band 1-3	MCS16	38/46/54/62/ 102/110/134	1+2+3
	11a/BPSK	Band 1-3	6Mbps	36/40/48/52/60/64 /100/116/140	1

26dB Spectrum Bandwidth 99% Occupied Bandwidth Measurement	11n 20MHz	Band 1-3	MCS0	36/40/48/52/60/64 /100/116/140	1
	11n 40MHz	Band 1-3	MCS0	38/46/54/62/ 102/110/134	1
	11n 20MHz	Band 1-3	MCS8	36/40/48/52/60/64 /100/116/140	1+2
	11n 40MHz	Band 1-3	MCS8	38/46/54/62/ 102/110/134	1+2
	11n 20MHz	Band 1-3	MCS16	36/40/48/52/60/64 /100/116/140	1+2+3
	11n 40MHz	Band 1-3	MCS16	38/46/54/62/ 102/110/134	1+2+3
	11a/BPSK	Band 1-3	6Mbps	36/40/48/52/60/64 /100/116/140	1
Peak Excursion	11n 20MHz	Band 1-3	MCS0	36/40/48/52/60/64 /100/116/140	1
	11n 40MHz	Band 1-3	MCS0	38/46/54/62/ 102/110/134	1
	11n 20MHz	Band 1-3	MCS8	36/40/48/52/60/64 /100/116/140	1+2
	11n 40MHz	Band 1-3	MCS8	38/46/54/62/ 102/110/134	1+2
	11n 20MHz	Band 1-3	MCS16	36/40/48/52/60/64 /100/116/140	1+2+3
	11n 40MHz	Band 1-3	MCS16	38/46/54/62/ 102/110/134	1+2+3
	11a/BPSK	Band 1-3	6Mbps	36/40/48/52/60/64 /100/116/140	1
Radiated Emission Below 1GHz	CTX		-	-	-
Radiated Emission Above 1GHz	11n 20MHz	Band 1-3	MCS0	36/40/48/52/60/64 /100/116/140	1
	11n 40MHz	Band 1-3	MCS0	38/46/54/62/ 102/110/134	1
	11n 20MHz	Band 1-3	MCS8	36/40/48/52/60/64 /100/116/140	1+2
	11n 40MHz	Band 1-3	MCS8	38/46/54/62/ 102/110/134	1+2

	11n 20MHz	Band 1-3	MCS16	36/40/48/52/60/64 /100/116/140	1+2+3
	11n 40MHz	Band 1-3	MCS16	38/46/54/62/ 102/110/134	1+2+3
	11a/BPSK	Band 1-3	6Mbps	36/40/48/52/60/64 /100/116/140	1
Band Edge Emission	11n 20MHz	Band 1-3	MCS0	36/40/48/52/60/64 /100/116/140	1
	11n 40MHz	Band 1-3	MCS0	38/46/54/62/ 102/110/134	1
	11n 20MHz	Band 1-3	MCS8	36/40/48/52/60/64 /100/116/140	1+2
	11n 40MHz	Band 1-3	MCS8	38/46/54/62/ 102/110/134	1+2
	11n 20MHz	Band 1-3	MCS16	36/40/48/52/60/64 /100/116/140	1+2+3
	11n 40MHz	Band 1-3	MCS16	38/46/54/62/ 102/110/134	1+2+3
	11a/BPSK	Band 1-3	6Mbps	36/40/48/52/60/64 /100/116/140	1
Frequency Stability	Un-modulation		-	40/60/100	N/A

The following test modes were performed for all tests:

**For Radiated Emissions 30MHz~1GHz test**

Mode 1. Module + Antenna 31

The following test modes were performed for Radiated emission above 1GHz tests:

Antenna/Radio Mode		11a 1TX	H20/40 1TX (MCS0)	H20/40 2TX (MCS8)	H20/40 3TX (MCS16)
Mode 1	PIFA-5G, Antenna 31	v	v	v	v

Note 1: For HT20/40 2TX, MCS0~7 (1-stream), MCS8~15(2-stream); For HT20/40 3TX, MCS16~23(3-stream).

### Expected Array Gain Adjustment to Antenna Directivity for 2TX / 3TX Configurations and Supported Operational Modes

In the FCC regulatory domain, conducted testing of systems with multiple transmitters (2Tx transmitter configurations) was performed in accordance with KDB 662911 requires adjustment of antenna directivity by an array gain factor. The array gain factor is dependent on correlation of the multiple tx signals, and is therefore a function of operational mode.

The following table establishes the expected array gain for the 2Tx and 3TX transmitter configuration case for each supported operational mode.

Operational Mode > Tx Config ^	11b (DSSS-CCK)	11a/g (Legacy OFDM)	HT20 1 Stream (MCS0-7)	HT40 1 Stream (MCS0-7)	HT20 2 Stream (MCS8-15)	HT40 2 Stream (MCS8-15)	HT20 3 Stream (MCS16-23)	HT40 3 Stream (MCS16-23)
2TX	3.01dB	3.01dB	3.01dB	3.01dB	NA	NA	NA	NA
3TX	4.77dB	4.77dB	4.77dB	4.77dB	3.01dB	3.01dB	NA	NA

### For MPE Test

The module (Model number: KHAP-800) is Limited Module Approval and only limited to install to the AP (MOTOROLA / AP-8132), (MOTOROLA / AP-8122), (MOTOROLA / AP-8163), (MOTOROLA / AP-8232), (MOTOROLA / AP-8222) and (MOTOROLA / AP-8263), it verified MPE test.

#### 1. MOTOROLA / AP-8132

The AP (MOTOROLA / AP-8132) could be applied with Radio A (2.4G) RF module (FCC ID: UZ7KHAP800), Radio B (5G) RF module (FCC ID: UZ7KHAP800) and 2.4G/5G USB dongle (FCC ID: UZ7KHUSB600); therefore Maximum Permissible Exposure (Please refer to Appendix B) tests are added for simultaneously transmit between 2.4GHz, 5GHz WLAN function and 2.4G, 5G USB dongle.

#### 2. MOTOROLA / AP-8122

The AP (MOTOROLA / AP-8122) could be applied with Radio A (2.4G) RF module (FCC ID: UZ7KHAP800), and Radio B (5G) RF module (FCC ID: UZ7KHAP800); therefore Maximum Permissible Exposure (Please refer to Appendix B) tests are added for simultaneously transmit between 2.4GHz and 5GHz WLAN function.

#### 3. MOTOROLA / AP-8163

The AP (MOTOROLA / AP-8163) could be applied with Radio A (2.4G) RF module (FCC ID: UZ7KHAP800), Radio B (5G) RF module (FCC ID: UZ7KHAP800) and 2.4G/5G USB dongle (FCC ID: UZ7KHUSB601); therefore Maximum Permissible Exposure (Please refer to Appendix B) tests are added for simultaneously transmit between 2.4GHz, 5GHz WLAN function and 2.4G, 5G USB dongle.

#### 4. MOTOROLA / AP-8232

The AP (MOTOROLA / AP-8232) could be applied with Radio A (2.4G) RF module (FCC ID: UZ7KHAP800), Radio B (5G) RF module (FCC ID: UZ7RAAP800) and 2.4G/5G USB dongle (FCC ID: UZ7KHUSB600); therefore Maximum Permissible Exposure (Please refer to Appendix B) tests are added for simultaneously transmit between 2.4GHz, 5GHz WLAN function and 2.4G, 5G USB dongle.

#### 5. MOTOROLA / AP-8222

The AP (MOTOROLA / AP-8222) could be applied with Radio A (2.4G) RF module (FCC ID: UZ7KHAP800), and Radio B (5G) RF module (FCC ID: UZ7RAAP800); therefore Maximum Permissible Exposure (Please refer to Appendix B) tests are added for simultaneously transmit between 2.4GHz WLAN function and 5GHz WLAN function.

#### 6. MOTOROLA / AP-8263

The AP (MOTOROLA / AP-8263) could be applied with Radio A (2.4G) RF module (FCC ID: UZ7KHAP800), Radio B (5G) RF module (FCC ID: UZ7RAAP800) and 2.4G/5G USB dongle (FCC ID: UZ7KHUSB601); therefore Maximum Permissible Exposure (Please refer to Appendix B) tests are added for simultaneously transmit between 2.4GHz, 5GHz WLAN function and 2.4G, 5G USB dongle.



### 3.7. Table for Testing Locations

Test Site No.	Site Category	Location	FCC Reg. No.	IC File No.	VCCI Reg. No
03CH01-CB	SAC	Hsin Chu	262045	IC 4086D	-
TH01-CB	OVEN Room	Hsin Chu	-	-	-

Open Area Test Site (OATS); Semi Anechoic Chamber (SAC) Please refer section 6 for Test Site Address.

### 3.8. Table for Class II Change

This product is an extension of original one reported under Sporton project number: 240223 and 240223-01

Below is the table for the change of the product with respect to the original one.

Modifications	Performance Checking
1. Adding 9 (Ant.20 ~ Ant.28) set same type of Dipole antenna with lower gain than the original Certificate.	After evaluating, it is not necessary to re-test all test items
2. Adding 2 (Ant.29 ~ Ant.30) set same type of Panel antenna with lower gain than the original Certificate.	After evaluating, it is not necessary to re-test all test items
3. Adding 2 (Ant.19 and Ant.31) PIFA antennas and it only supports 11a 1TX function.	26dB Bandwidth and 99% Occupied Bandwidth Measurement
	Maximum Conducted Output Power Measurement
	Power Spectral Density Measurement
	Peak Excursion Measurement
	Radiated Emissions Measurement
	Band Edge Emissions Measurement
	Frequency Stability Measurement
Note: Because Ant.19 & Ant.31 are the same type antennas, only the higher gain antenna "Ant.31" was tested and written in this report.	
Note: There is no hardware or electrical modification made to the applying modular transmitter itself.	

### 3.9. Table for Supporting Units

Support Unit	Brand	Model	FCC ID
Notebook	DELL	E6430	QDS-BRCM1049LE
Power Supply	Gwinstek	GPC-6030D	N/A

### 3.10. Table for Parameters of Test Software Setting

During testing, Channel and Power Controlling Software provided by the customer was used to control the operating channel as well as the output power level. The RF output power selection is for the setting of RF output power expected by the customer and is going to be fixed on the firmware of the final end product.

**Test Mode: Mode 1 (Ant.31 PIFA antenna / 4.7dBi)**

For 1TX

#### Power Parameters of IEEE 802.11n MCS0 20MHz

Test Software Version	ART2-GUI 2.3								
Frequency	5180 MHz	5200 MHz	5240 MHz	5260 MHz	5300 MHz	5320 MHz	5500 MHz	5580 MHz	5700 MHz
MCS0 20MHz	14.5	15	15	19.5	19.5	16	15.5	21.5	13.5

#### Power Parameters of IEEE 802.11n MCS0 40MHz

Test Software Version	ART2-GUI 2.3						
Frequency	5190 MHz	5230 MHz	5270 MHz	5310 MHz	5510 MHz	5550 MHz	5670 MHz
MCS0 40MHz	9	14.5	19.5	10	10	20.5	17.5

For 2TX

#### Power Parameters of IEEE 802.11n MCS8 20MHz

Test Software Version	ART2-GUI 2.3								
Frequency	5180 MHz	5200 MHz	5240 MHz	5260 MHz	5300 MHz	5320 MHz	5500 MHz	5580 MHz	5700 MHz
MCS8 20MHz	12	12	12	18.5	19.5	14.5	14	18	14

#### Power Parameters of IEEE 802.11n MCS8 40MHz

Test Software Version	ART2-GUI 2.3						
Frequency	5190 MHz	5230 MHz	5270 MHz	5310 MHz	5510 MHz	5550 MHz	5670 MHz
MCS8 40MHz	6.5	11.5	18	9.5	8.5	18	17

For 3TX

#### Power Parameters of IEEE 802.11n MCS16 20MHz

Test Software Version	ART2-GUI 2.3								
Frequency	5180 MHz	5200 MHz	5240 MHz	5260 MHz	5300 MHz	5320 MHz	5500 MHz	5580 MHz	5700 MHz
MCS16 20MHz	10.5	10	10.5	16	17.5	13	12.5	13.5	13

#### Power Parameters of IEEE 802.11n MCS16 40MHz

Test Software Version	ART2-GUI 2.3						
Frequency	5190 MHz	5230 MHz	5270 MHz	5310 MHz	5510 MHz	5550 MHz	5670 MHz
MCS16 40MHz	6	10	17	9	8	19	10

**Power Parameters of IEEE 802.11a**

Test Software Version	ART2-GUI 2.3								
Frequency	5180 MHz	5200 MHz	5240 MHz	5260 MHz	5300 MHz	5320 MHz	5500 MHz	5580 MHz	5700 MHz
802.11a	14.5	14.5	15	19.5	19.5	17	16.5	21.5	15

**3.11. EUT Operation during Test**

The EUT was programmed to be in continuously transmitting mode.

### 3.12. Duty Cycle

Test Mode: Mode 1 (Ant.31 PIFA antenna / 4.7dBi)

IEEE 802.11n MCS0 20MHz / Chain 1

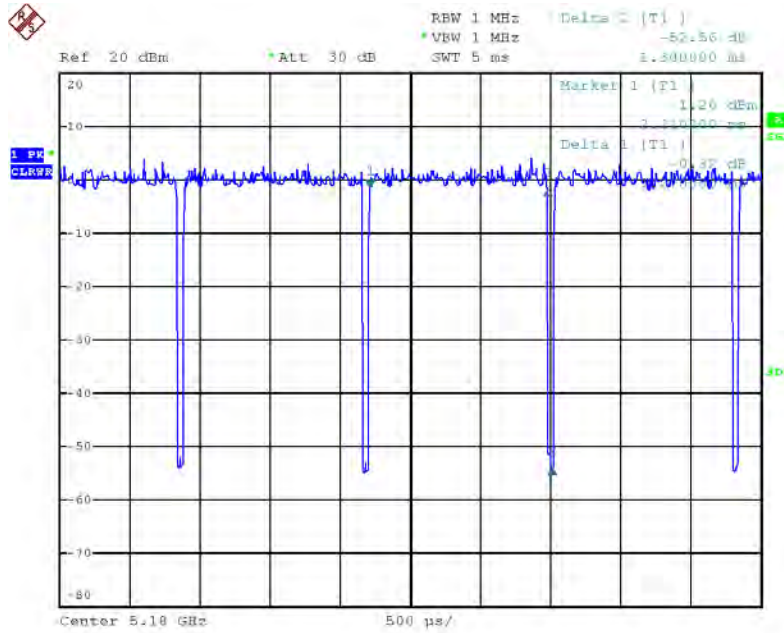

Date: 20.SEP.2013 17:40:43

IEEE 802.11n MCS0 40MHz / Chain 1

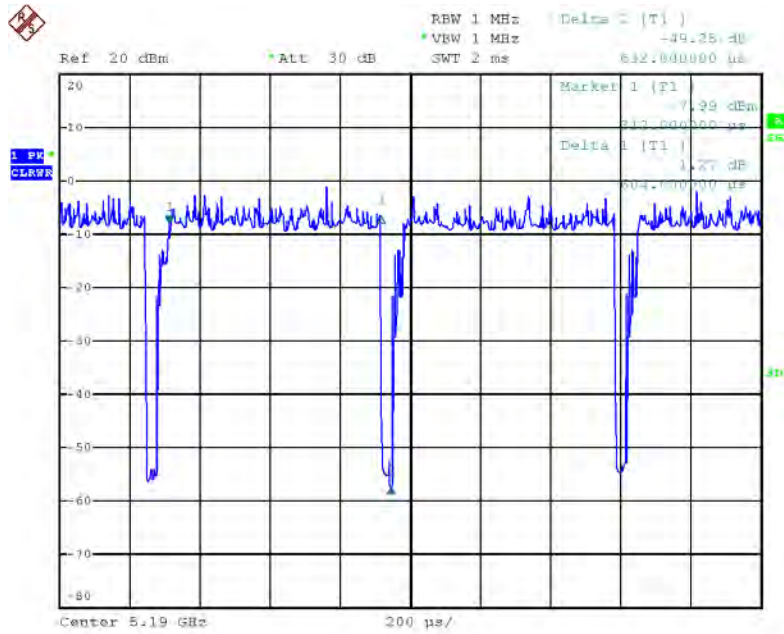

Date: 20.SEP.2013 17:39:52

IEEE 802.11n MCS8 20MHz / Chain 1 + Chain 2

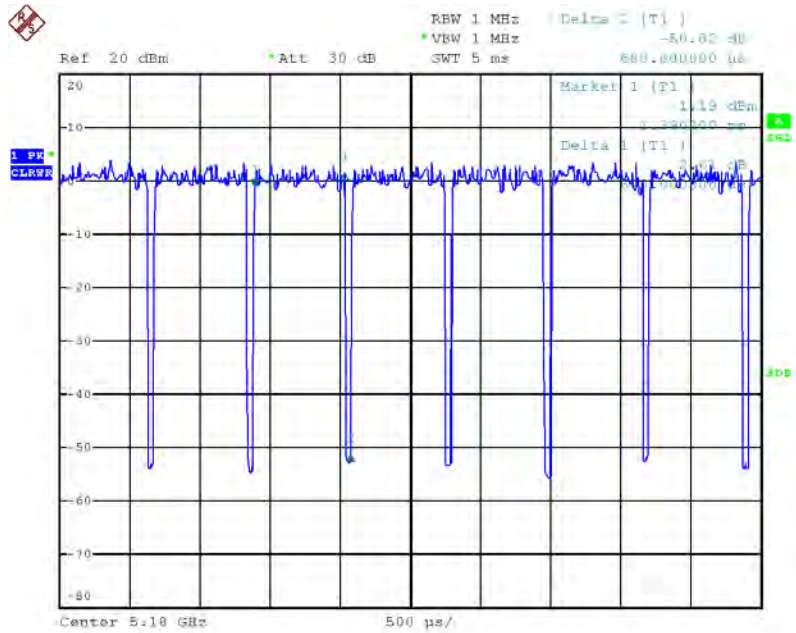

Date: 20.SEP.2013 17:52:32

IEEE 802.11n MCS8 40MHz / Chain 1 + Chain 2

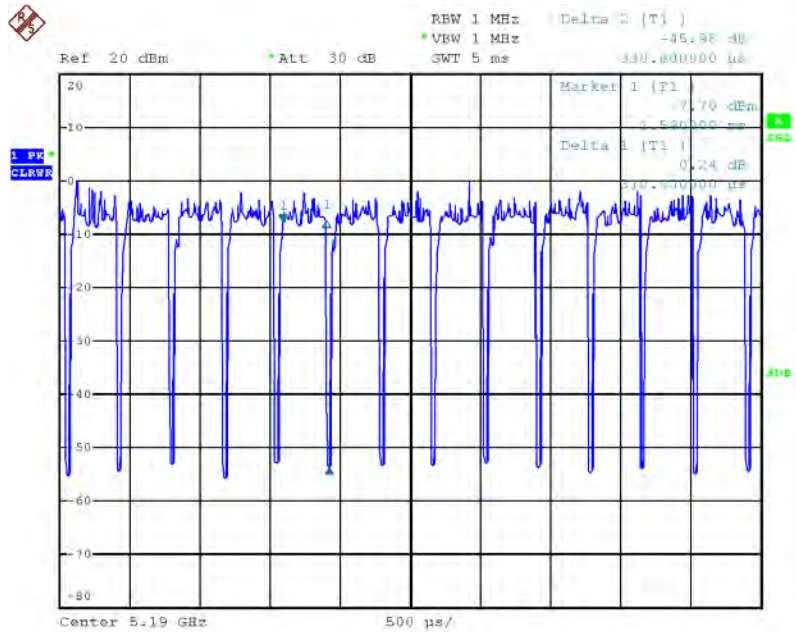

Date: 20.SEP.2013 17:50:59

IEEE 802.11n MCS16 20MHz / Chain 1 + Chain 2 + Chain 3

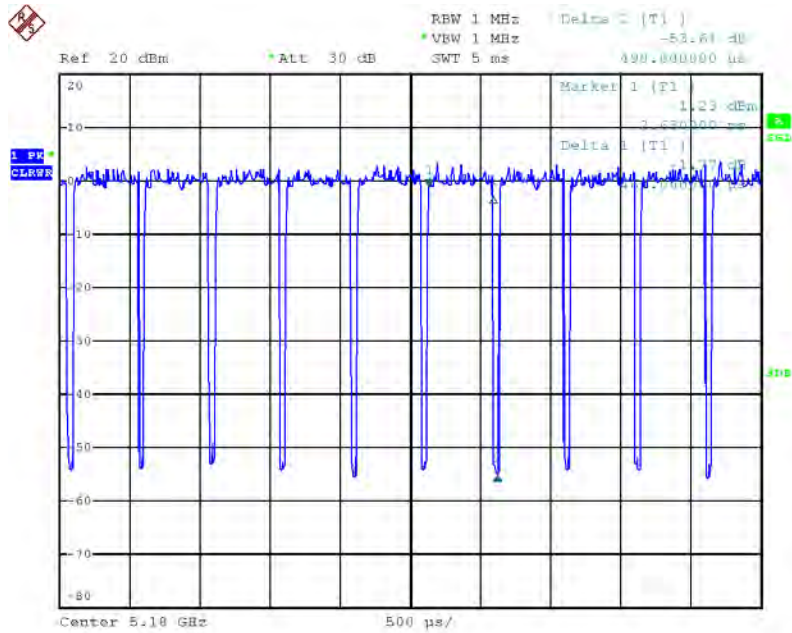

Date: 20.SEP.2013 17:53:18

IEEE 802.11n MCS16 40MHz / Chain 1 + Chain 2 + Chain 3

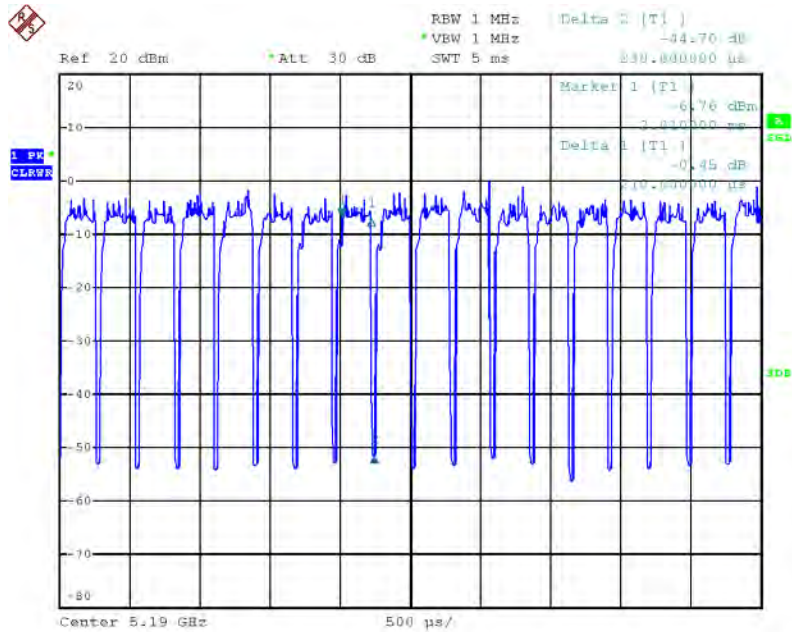

Date: 20.SEP.2013 17:51:44

IEEE 802.11a

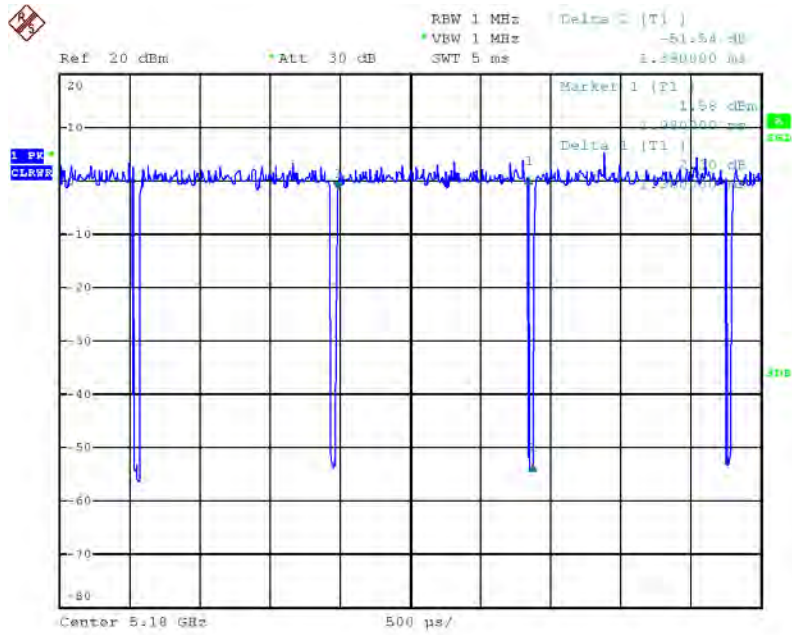

Date: 20.SEP.2013 17:41:27



### 3.13. Test Configurations

#### 3.13.1. Radiation Emissions Test Configuration

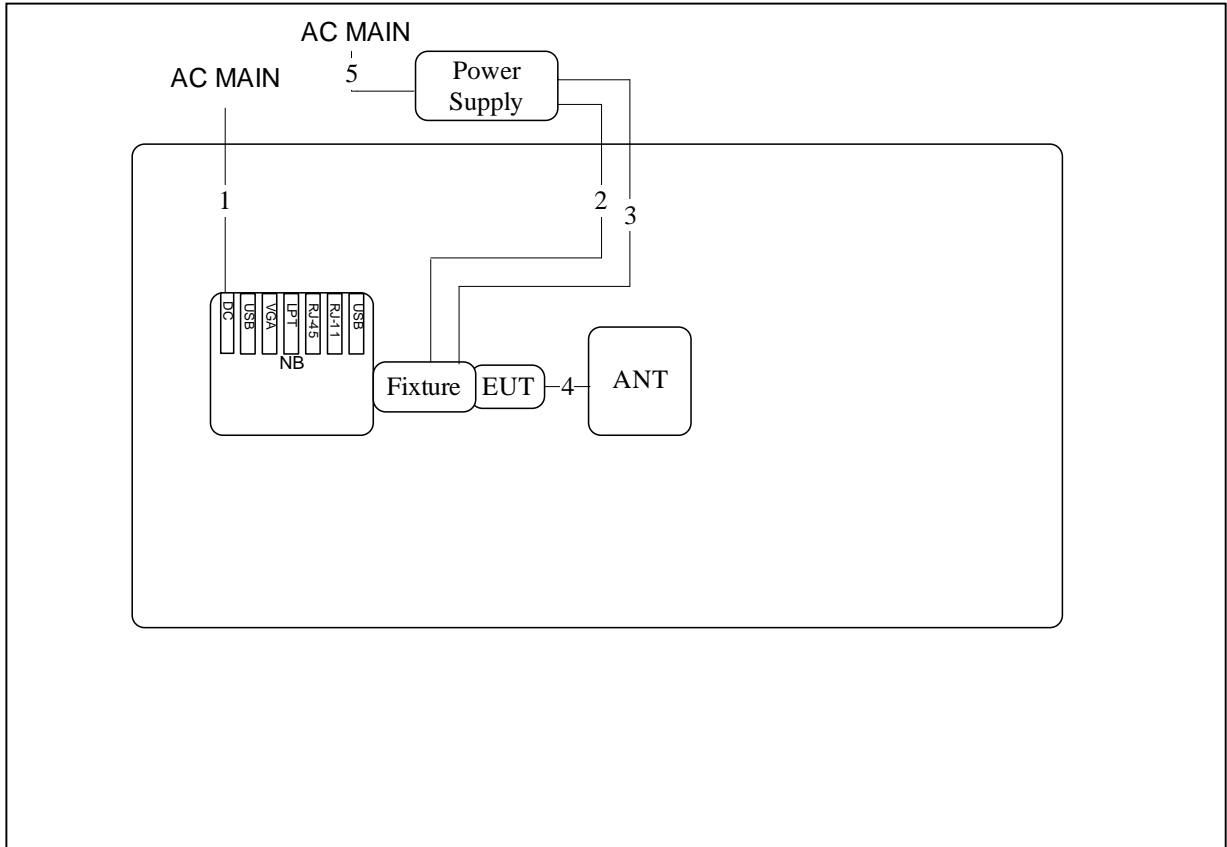

Item	Connection	Shielded	Length(m)
1	Power cable	No	1.8m
2	Power supply cable	No	1.1m
3	Power supply cable	No	1.1m
4	RF cable*3	Yes	0.15m
5	Power cable	No	1.8m



## 4. TEST RESULT

### 4.1. 26dB Bandwidth and 99% Occupied Bandwidth Measurement

#### 4.1.1. Limit

No restriction limits.

#### 4.1.2. Measuring Instruments and Setting

Please refer to section 5 of equipments list in this report. The following table is the setting of the spectrum analyzer.

26dB Bandwidth	
Spectrum Parameters	Setting
Attenuation	Auto
Span Frequency	> 26dB Bandwidth
RBW	Approximately 1% of the emission bandwidth
VBW	VBW > RBW
Detector	Peak
Trace	Max Hold
Sweep Time	Auto
99% Occupied Bandwidth	
Spectrum Parameters	Setting
Span	1.5 times to 5.0 times the OBW
RBW	1 % to 5 % of the OBW
VBW	$\geq 3 \times \text{RBW}$
Detector	Peak
Trace	Max Hold

#### 4.1.3. Test Procedures

1. The transmitter output (antenna port) was connected to the spectrum analyzer in peak hold mode.
2. Measure the maximum width of the emission that is 26 dB down from the peak of the emission. Compare this with the RBW setting of the analyzer. Readjust RBW and repeat measurement as needed until the RBW/EBW ratio is approximately 1%.

#### 4.1.4. Test Setup Layout

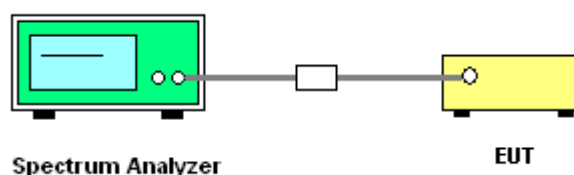

#### 4.1.5. Test Deviation

There is no deviation with the original standard.

#### 4.1.6. EUT Operation during Test

The EUT was programmed to be in continuously transmitting mode.

#### 4.1.7. Test Result of 26dB Bandwidth and 99% Occupied Bandwidth

Temperature	24°C	Humidity	61%
Test Engineer	Kenneth Huang	Configurations	IEEE 802.11n

For 1TX

Configuration IEEE 802.11n MCS0 20MHz / Chain 1

Channel	Frequency	26dB Bandwidth (MHz)	99% Occupied Bandwidth (MHz)
36	5180 MHz	25.44	18.72
40	5200 MHz	25.92	18.56
48	5240 MHz	25.12	18.72
52	5260 MHz	38.56	20.16
60	5300 MHz	39.84	20.32
64	5320 MHz	26.24	18.72
100	5500 MHz	25.12	18.56
116	5580 MHz	44.32	25.12
140	5700 MHz	27.04	18.56

Configuration IEEE 802.11n MCS0 40MHz / Chain 1

Channel	Frequency	26dB Bandwidth (MHz)	99% Occupied Bandwidth (MHz)
38	5190 MHz	53.12	38.72
46	5230 MHz	56.64	39.36
54	5270 MHz	83.20	41.60
62	5310 MHz	47.36	36.80
102	5510 MHz	49.28	36.80
110	5550 MHz	78.40	40.32
134	5670 MHz	67.52	37.76

For 2TX

Configuration IEEE 802.11n MCS8 20MHz / Chain 1 + Chain 2

Channel	Frequency	26dB Bandwidth (MHz)	99% Occupied Bandwidth (MHz)
36	5180 MHz	23.68	18.24
40	5200 MHz	25.44	18.24
48	5240 MHz	24.16	18.24
52	5260 MHz	30.56	19.04
60	5300 MHz	34.56	21.28
64	5320 MHz	24.96	18.40
100	5500 MHz	24.00	18.24
116	5580 MHz	29.76	18.88
140	5700 MHz	23.84	18.24

Configuration IEEE 802.11n MCS8 40MHz / Chain 1 + Chain 2

Channel	Frequency	26dB Bandwidth (MHz)	99% Occupied Bandwidth (MHz)
38	5190 MHz	51.52	38.40
46	5230 MHz	51.84	38.72
54	5270 MHz	73.60	38.72
62	5310 MHz	46.08	36.80
102	5510 MHz	44.80	37.12
110	5550 MHz	75.20	37.76
134	5670 MHz	72.00	37.12

For 3TX

Configuration IEEE 802.11n MCS16 20MHz / Chain 1 + Chain 2 + Chain 3

Channel	Frequency	26dB Bandwidth (MHz)	99% Occupied Bandwidth (MHz)
36	5180 MHz	22.56	18.24
40	5200 MHz	23.68	18.08
48	5240 MHz	23.84	18.24
52	5260 MHz	23.52	18.24
60	5300 MHz	26.40	18.56
64	5320 MHz	23.52	18.24
100	5500 MHz	23.68	18.24
116	5580 MHz	22.72	18.08
140	5700 MHz	24.16	18.24

Configuration IEEE 802.11n MCS16 40MHz / Chain 1 + Chain 2 + Chain 3

Channel	Frequency	26dB Bandwidth (MHz)	99% Occupied Bandwidth (MHz)
38	5190 MHz	49.92	38.40
46	5230 MHz	49.92	37.76
54	5270 MHz	71.68	37.44
62	5310 MHz	45.76	36.48
102	5510 MHz	44.16	36.80
110	5550 MHz	73.92	37.44
134	5670 MHz	44.80	36.80



<b>Temperature</b>	24°C	<b>Humidity</b>	61%
<b>Test Engineer</b>	Kenneth Huang	<b>Configurations</b>	IEEE 802.11a

**Configuration IEEE 802.11a / Chain 1**

<b>Channel</b>	<b>Frequency</b>	<b>26dB Bandwidth (MHz)</b>	<b>99% Occupied Bandwidth (MHz)</b>
36	5180 MHz	24.64	17.44
40	5200 MHz	24.32	17.44
48	5240 MHz	24.48	17.60
52	5260 MHz	39.04	19.52
60	5300 MHz	38.08	19.20
64	5320 MHz	27.68	17.76
100	5500 MHz	25.60	17.44
116	5580 MHz	42.08	23.20
140	5700 MHz	24.64	17.60

For 1TX

26dB Bandwidth and 99% Occupied Bandwidth Plot on Configuration IEEE 802.11n MCS0 20MHz / Chain 1 / 5180 MHz

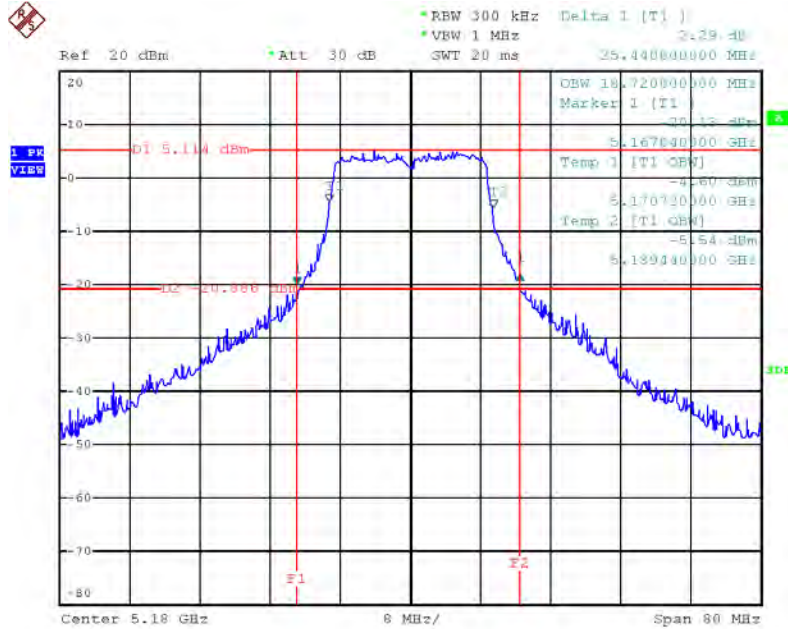

Date: 17.SEP.2013 20:16:28

26dB Bandwidth and 99% Occupied Bandwidth Plot on Configuration IEEE 802.11n MCS0 20MHz / Chain 1 / 5200 MHz

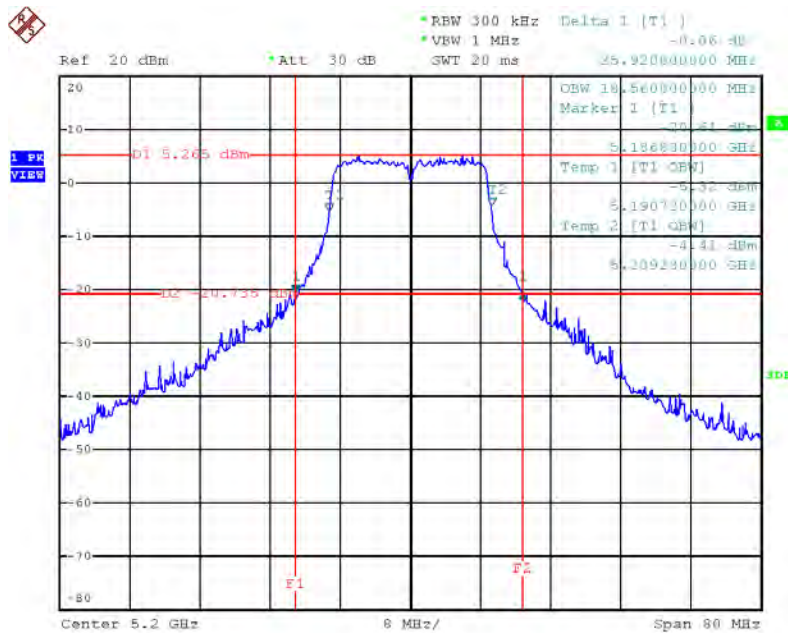

Date: 17.SEP.2013 20:16:59

**26dB Bandwidth and 99% Occupied Bandwidth Plot on Configuration IEEE 802.11n MCS0 20MHz / Chain 1 / 5240 MHz**

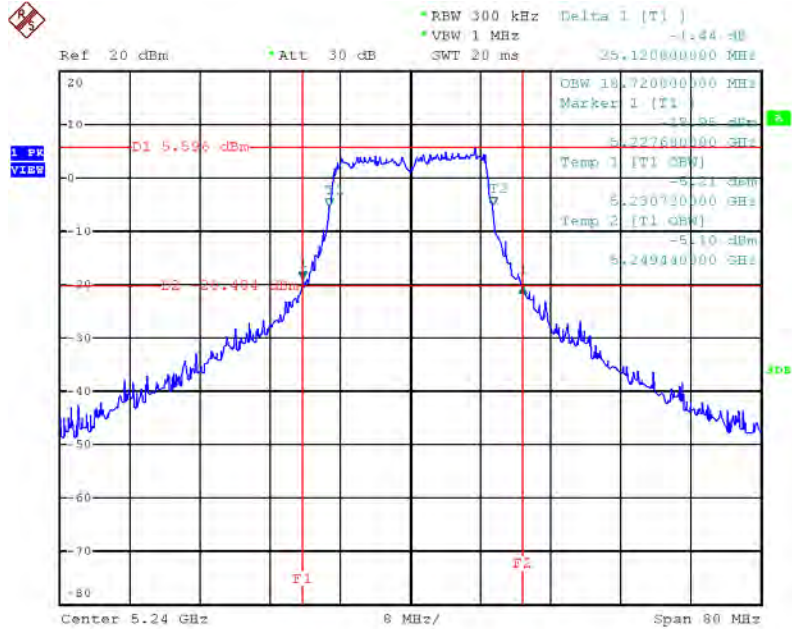

Date: 17.SEP.2013 20:17:31

**26dB Bandwidth and 99% Occupied Bandwidth Plot on Configuration IEEE 802.11n MCS0 20MHz / Chain 1 / 5260 MHz**

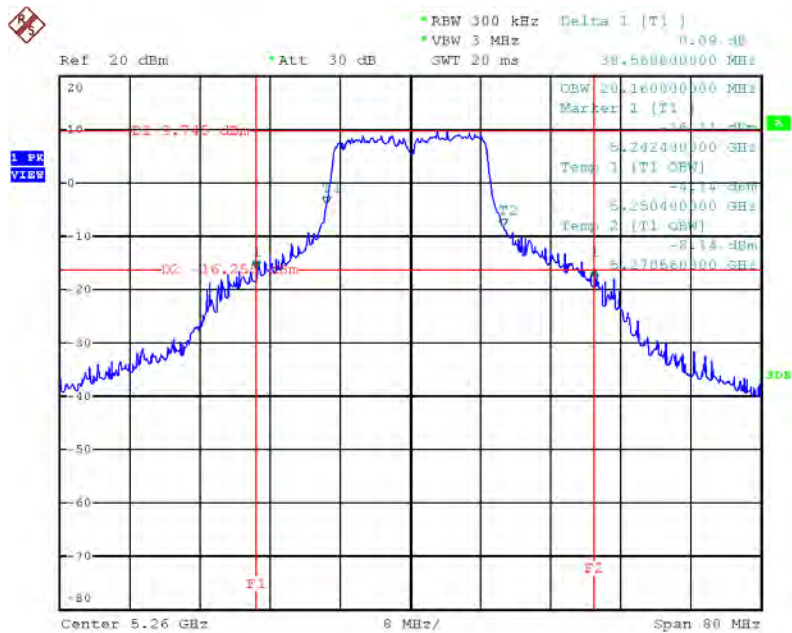

Date: 17.SEP.2013 20:18:02



**26dB Bandwidth and 99% Occupied Bandwidth Plot on Configuration IEEE 802.11n MCS0 20MHz / Chain 1 / 5300 MHz**

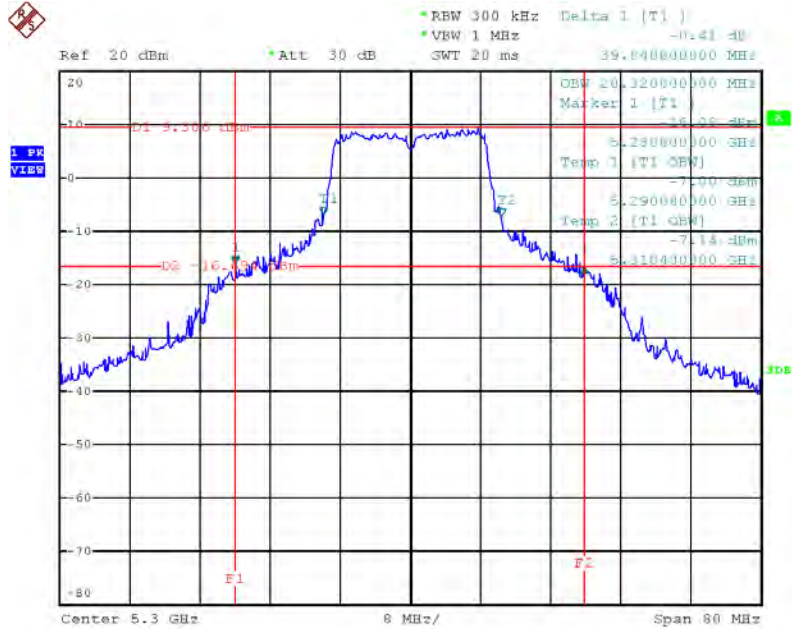

Date: 17.SEP.2013 20:18:33

**26dB Bandwidth and 99% Occupied Bandwidth Plot on Configuration IEEE 802.11n MCS0 20MHz / Chain 1 / 5320 MHz**

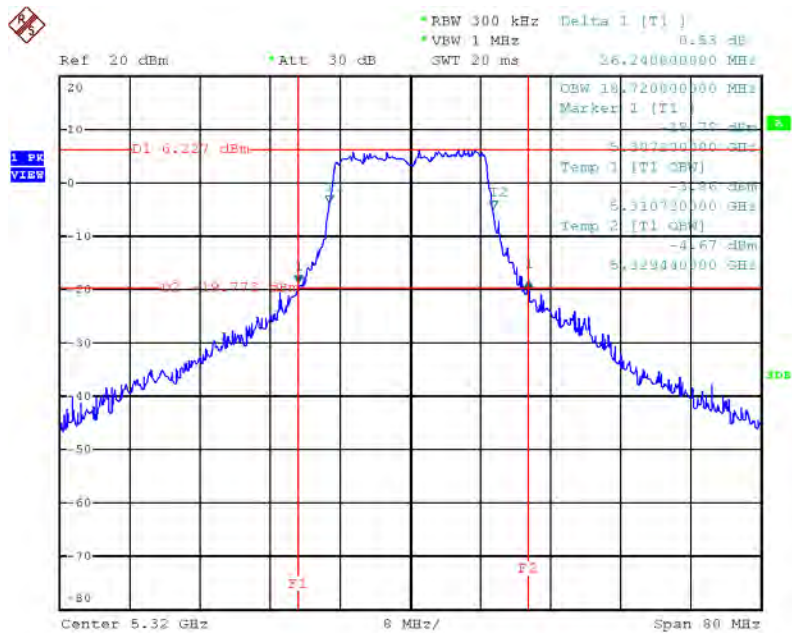

Date: 17.SEP.2013 20:19:08

**26dB Bandwidth and 99% Occupied Bandwidth Plot on Configuration IEEE 802.11n MCS0 20MHz / Chain 1 / 5500 MHz**

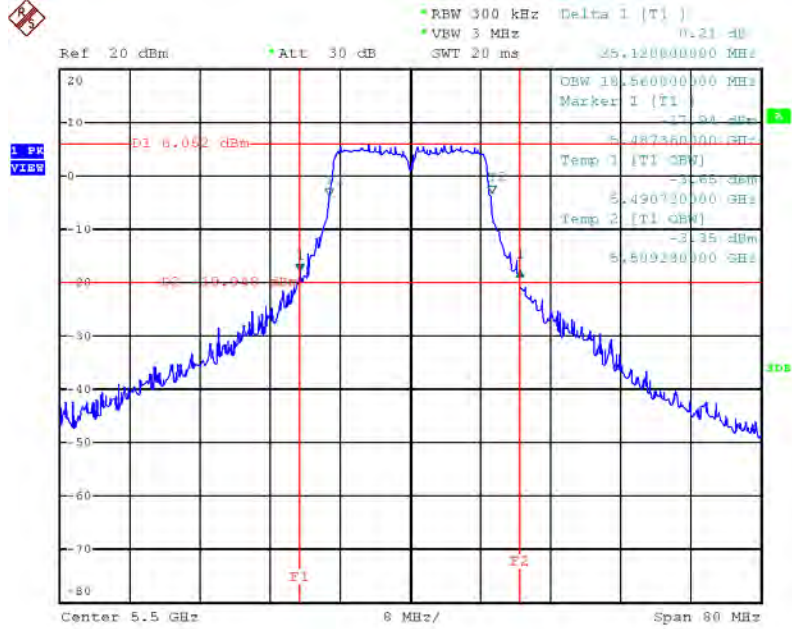

Date: 17.SEP.2013 20:19:47

**26dB Bandwidth and 99% Occupied Bandwidth Plot on Configuration IEEE 802.11n MCS0 20MHz / Chain 1 / 5580 MHz**

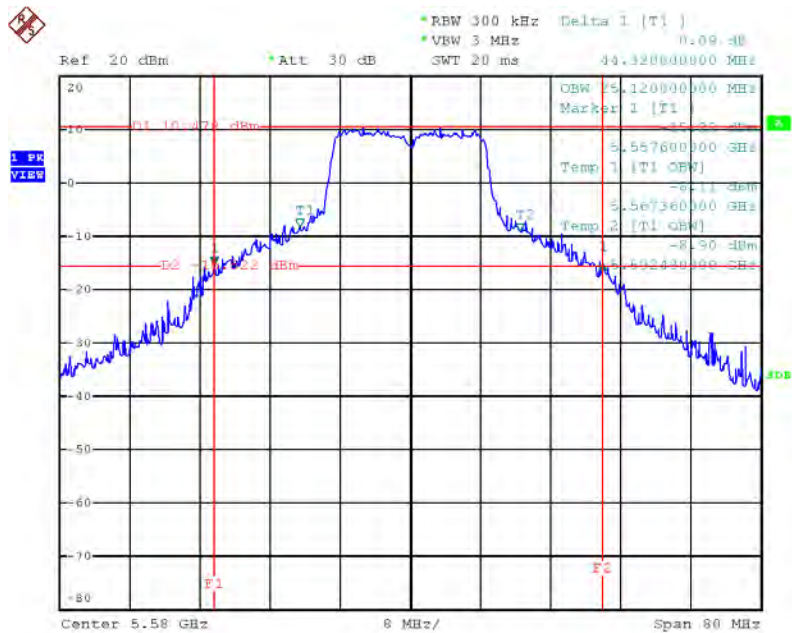

Date: 17.SEP.2013 20:20:22

26dB Bandwidth and 99% Occupied Bandwidth Plot on Configuration IEEE 802.11n MCS0 20MHz / Chain 1 / 5700 MHz

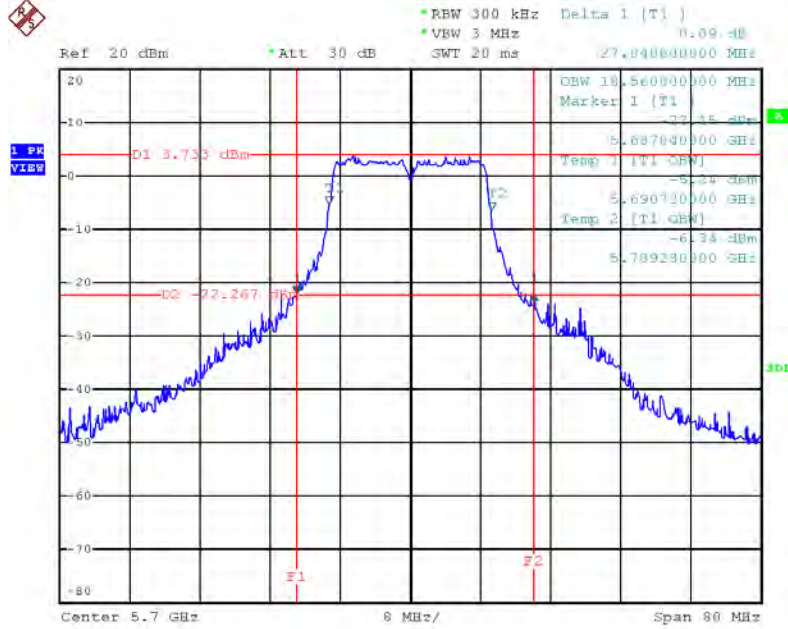

Date: 17.SEP.2013 20:20:59

**26dB Bandwidth and 99% Occupied Bandwidth Plot on Configuration IEEE 802.11n MCS0 40MHz / Chain 1 / 5190 MHz**

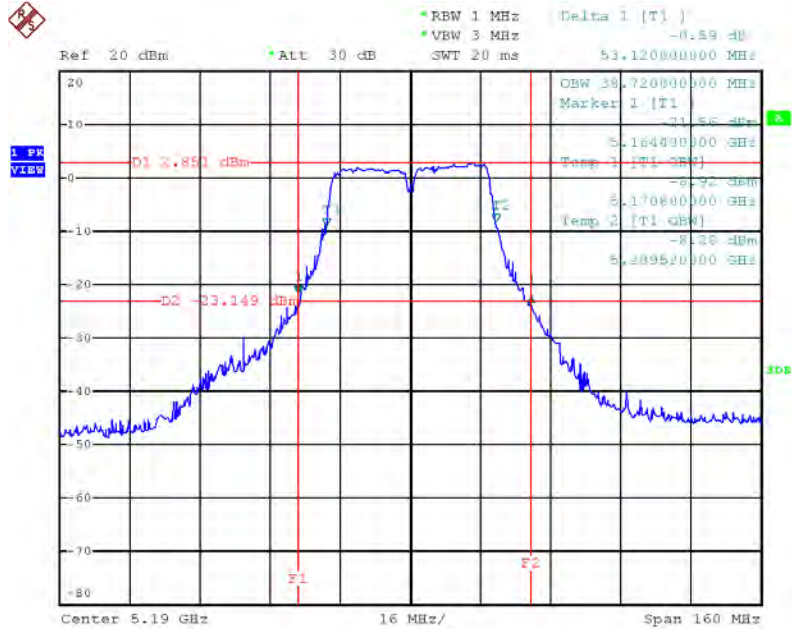

Date: 17.SEP.2013 20:22:11

**26dB Bandwidth and 99% Occupied Bandwidth Plot on Configuration IEEE 802.11n MCS0 40MHz / Chain 1 / 5230 MHz**

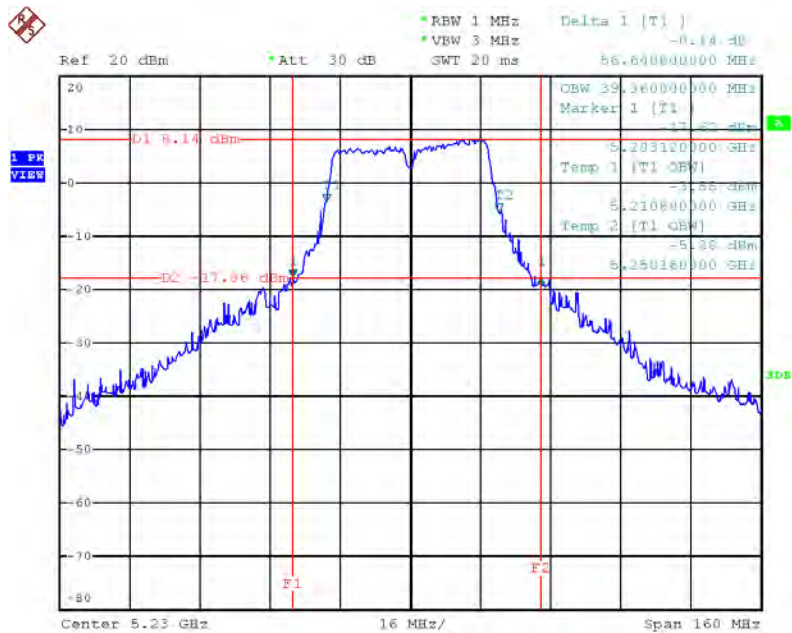

Date: 17.SEP.2013 20:22:52



**26dB Bandwidth and 99% Occupied Bandwidth Plot on Configuration IEEE 802.11n MCS0 40MHz / Chain 1 / 5270 MHz**

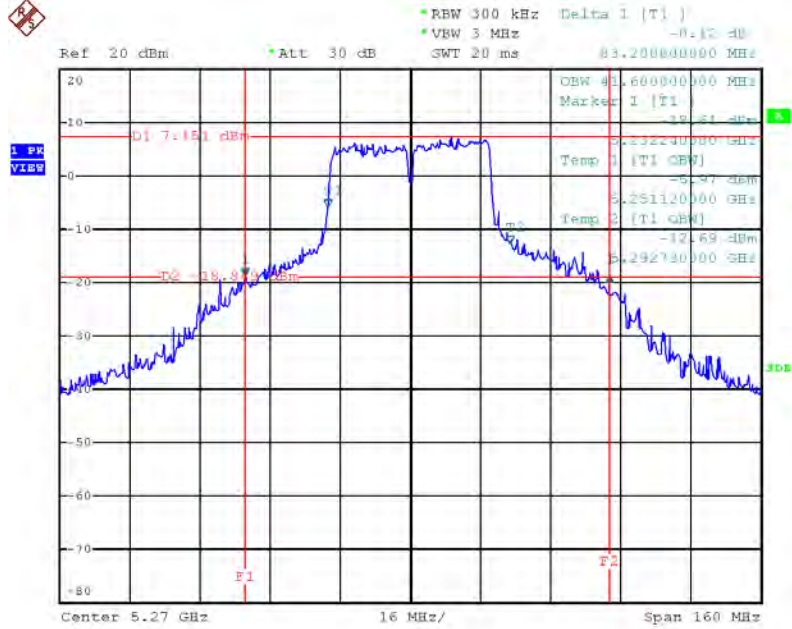

Date: 17.SEP.2013 20:23:25

**26dB Bandwidth and 99% Occupied Bandwidth Plot on Configuration IEEE 802.11n MCS0 40MHz / Chain 1 / 5310 MHz**

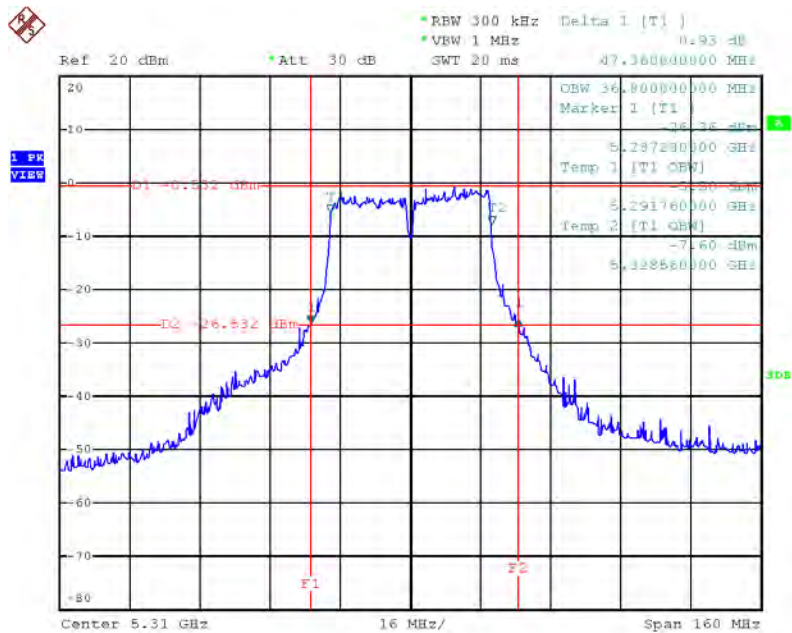

Date: 17.SEP.2013 20:24:00

**26dB Bandwidth and 99% Occupied Bandwidth Plot on Configuration IEEE 802.11n MCS0 40MHz / Chain 1 / 5510 MHz**

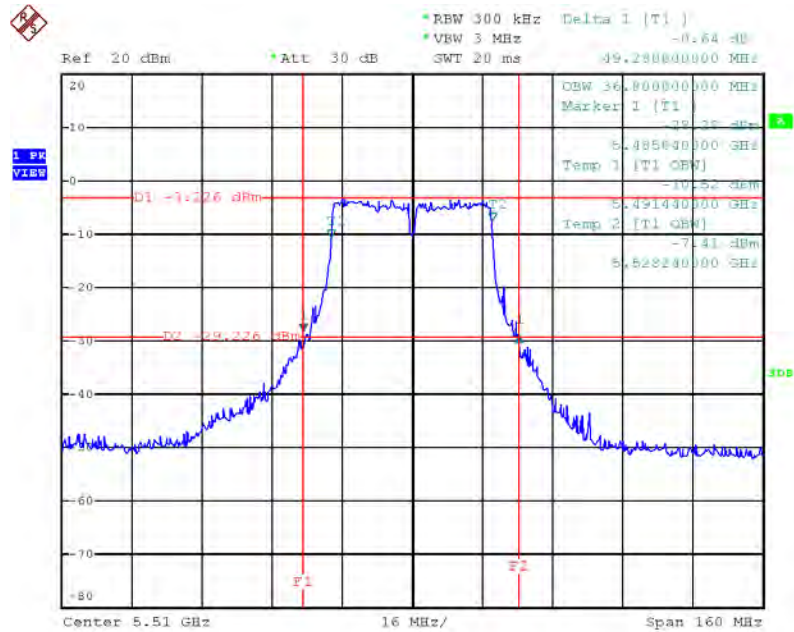

Date: 17.SEP.2013 20:24:35

**26dB Bandwidth and 99% Occupied Bandwidth Plot on Configuration IEEE 802.11n MCS0 40MHz / Chain 1 / 5550 MHz**

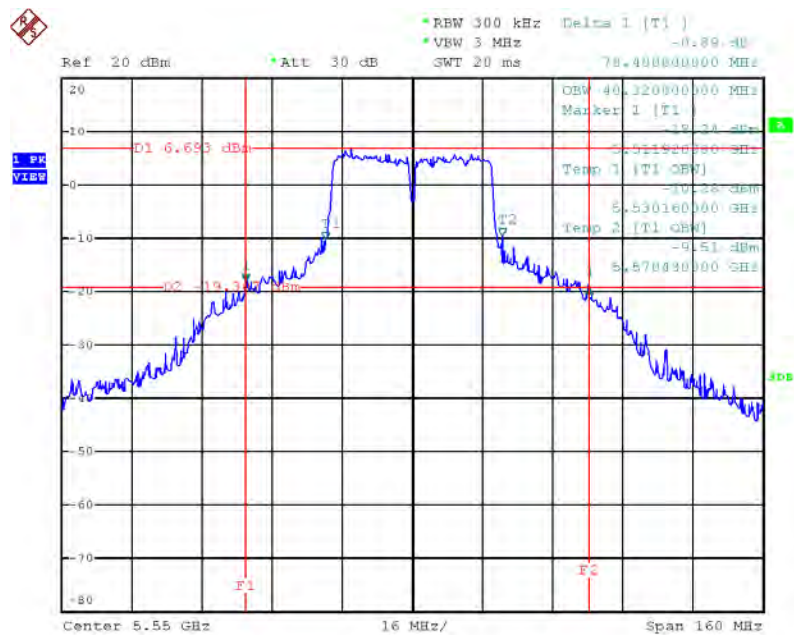

Date: 17.SEP.2013 20:25:11

26dB Bandwidth and 99% Occupied Bandwidth Plot on Configuration IEEE 802.11n MCS0 40MHz / Chain 1 / 5670 MHz

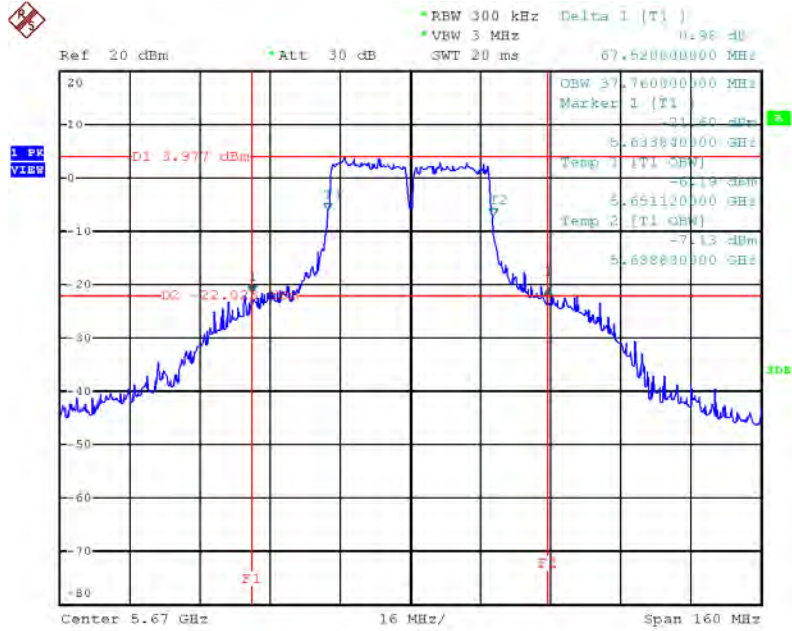

Date: 17.SEP.2013 20:25:45

For 2TX

26dB Bandwidth and 99% Occupied Bandwidth Plot on Configuration IEEE 802.11n MCS8 20MHz / Chain 1 + Chain 2 / 5180 MHz

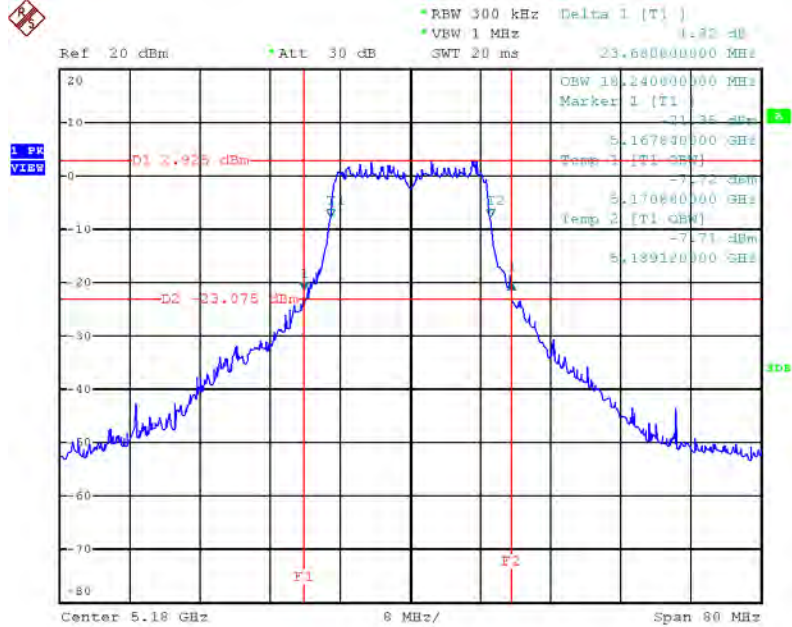

Date: 17.SEP.2013 20:30:42

26dB Bandwidth and 99% Occupied Bandwidth Plot on Configuration IEEE 802.11n MCS8 20MHz / Chain 1 + Chain 2 / 5200 MHz

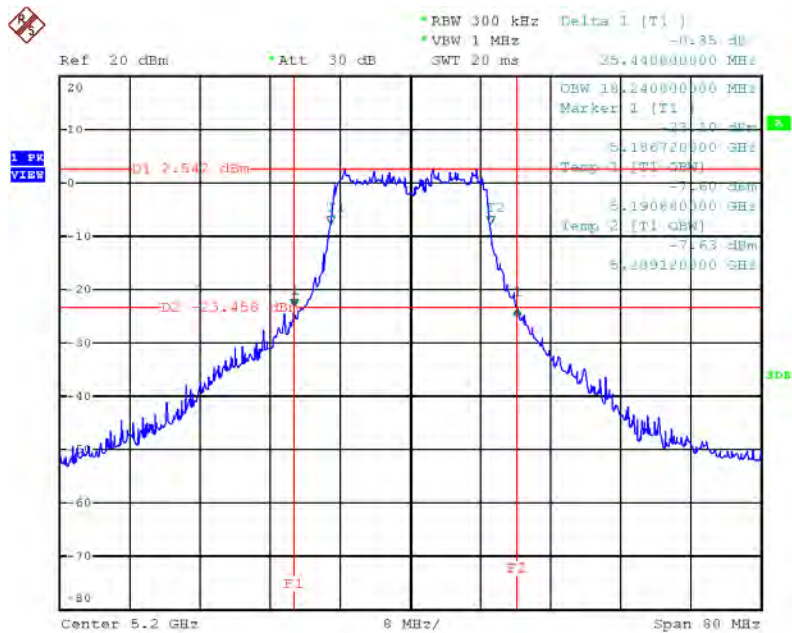

Date: 17.SEP.2013 20:31:16



**26dB Bandwidth and 99% Occupied Bandwidth Plot on Configuration IEEE 802.11n MCS8 20MHz / Chain 1 + Chain 2 / 5240 MHz**

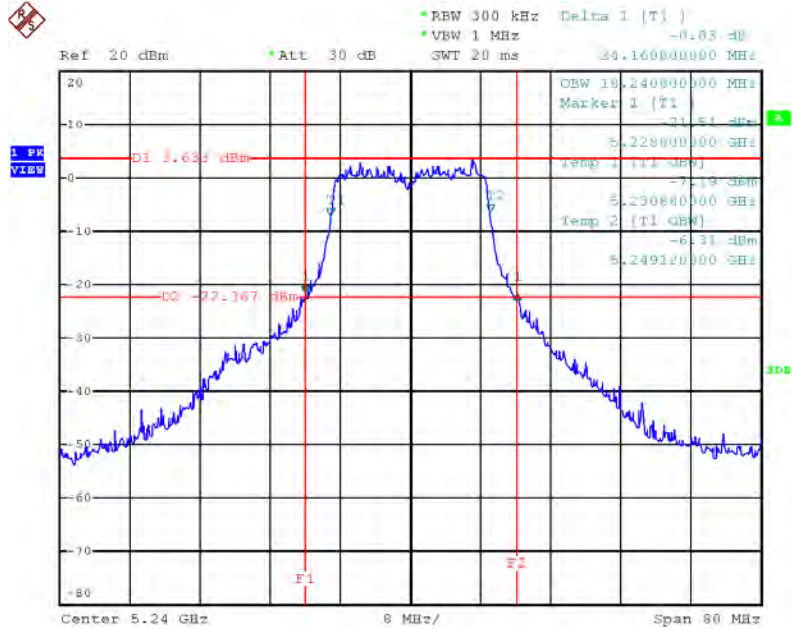

Date: 17.SEP.2013 20:31:49

**26dB Bandwidth and 99% Occupied Bandwidth Plot on Configuration IEEE 802.11n MCS8 20MHz / Chain 1 + Chain 2 / 5260 MHz**

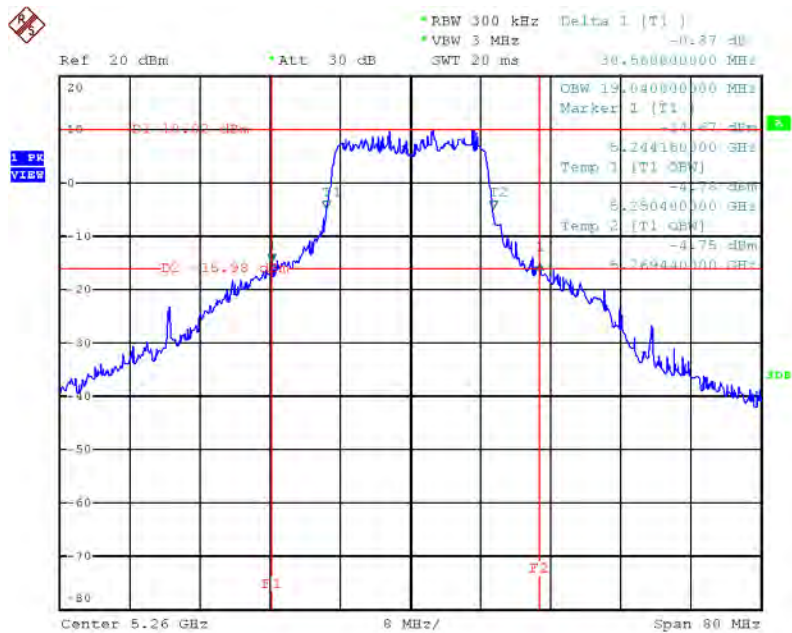

Date: 17.SEP.2013 20:32:23

**26dB Bandwidth and 99% Occupied Bandwidth Plot on Configuration IEEE 802.11n MCS8 20MHz / Chain 1 + Chain 2 / 5300 MHz**

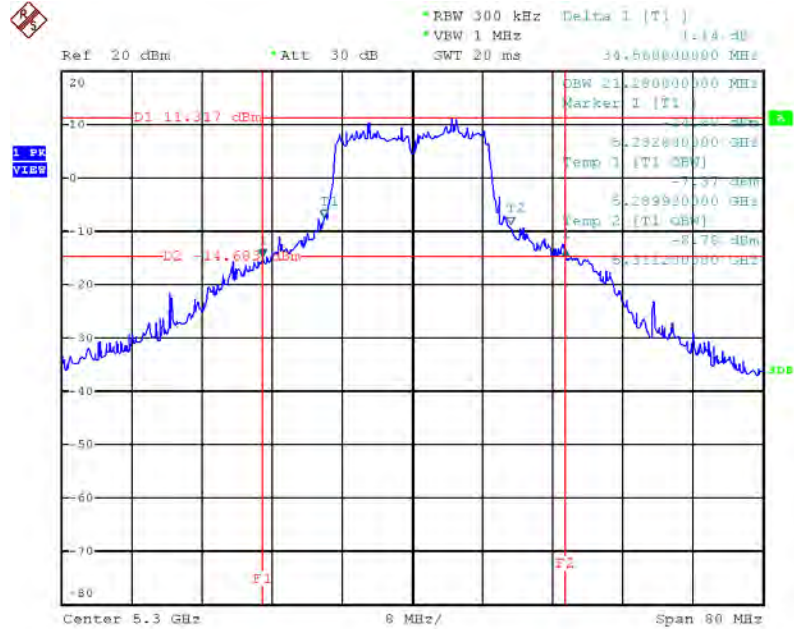

Date: 17.SEP.2013 20:32:56

**26dB Bandwidth and 99% Occupied Bandwidth Plot on Configuration IEEE 802.11n MCS8 20MHz / Chain 1 + Chain 2 / 5320 MHz**

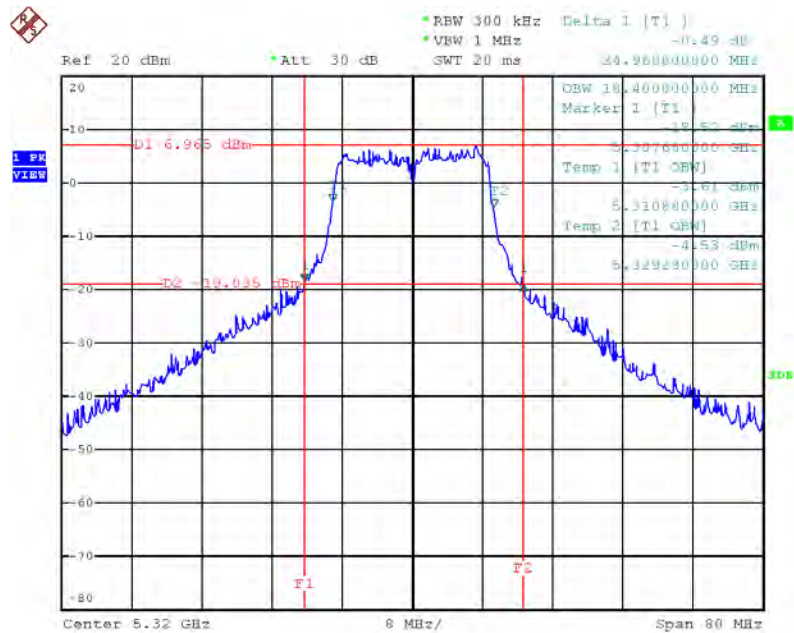

Date: 17.SEP.2013 20:33:28

### 26dB Bandwidth and 99% Occupied Bandwidth Plot on Configuration IEEE 802.11n MCS8 20MHz / Chain 1 + Chain 2 / 5500 MHz

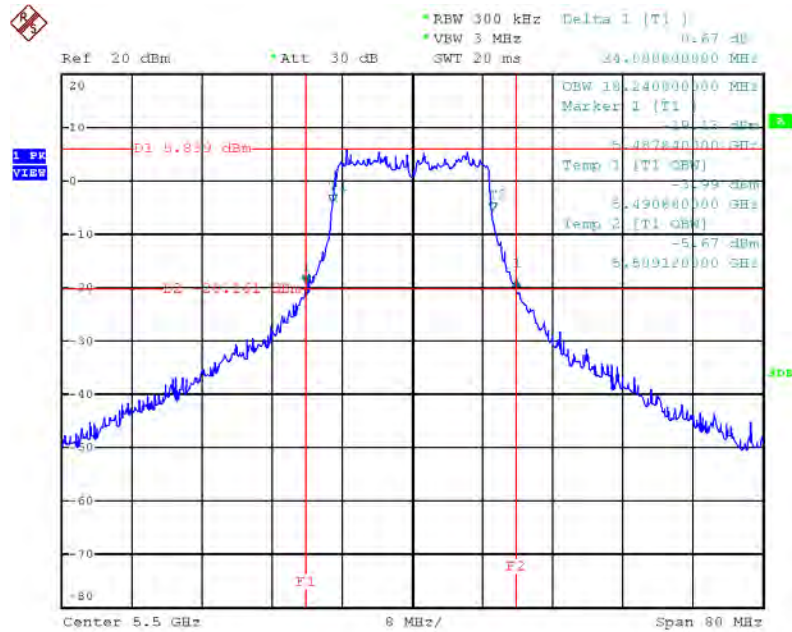

Date: 17.SEP.2013 20:34:15

### 26dB Bandwidth and 99% Occupied Bandwidth Plot on Configuration IEEE 802.11n MCS8 20MHz / Chain 1 + Chain 2 / 5580 MHz

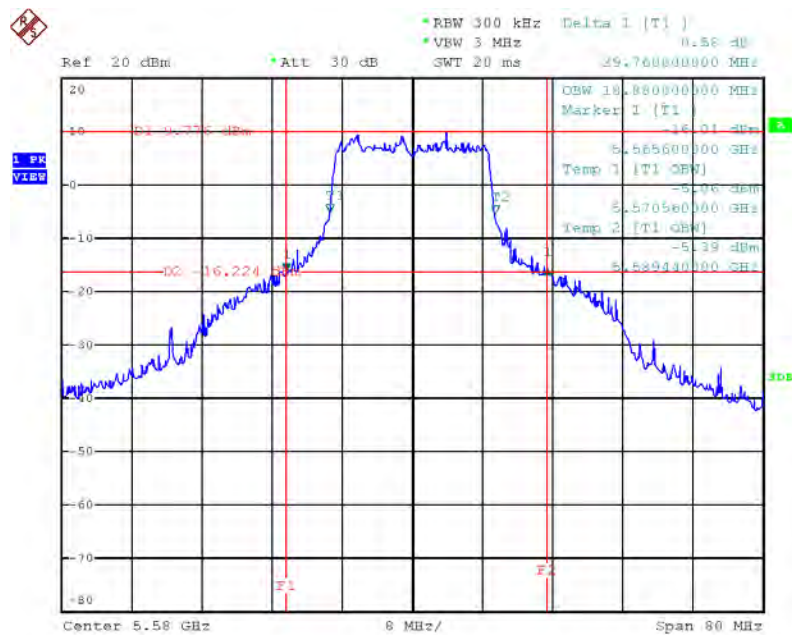

Date: 17.SEP.2013 20:34:44

**26dB Bandwidth and 99% Occupied Bandwidth Plot on Configuration IEEE 802.11n MCS8 20MHz / Chain 1 + Chain 2 / 5700 MHz**

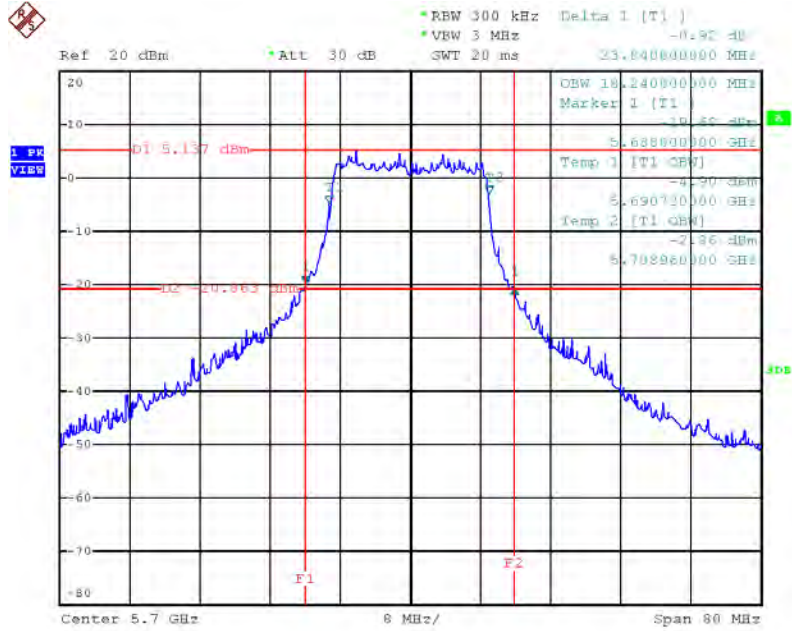

Date: 17.SEP.2013 20:35:17



**26dB Bandwidth and 99% Occupied Bandwidth Plot on Configuration IEEE 802.11n MCS8 40MHz / Chain 1 + Chain 2 / 5190 MHz**

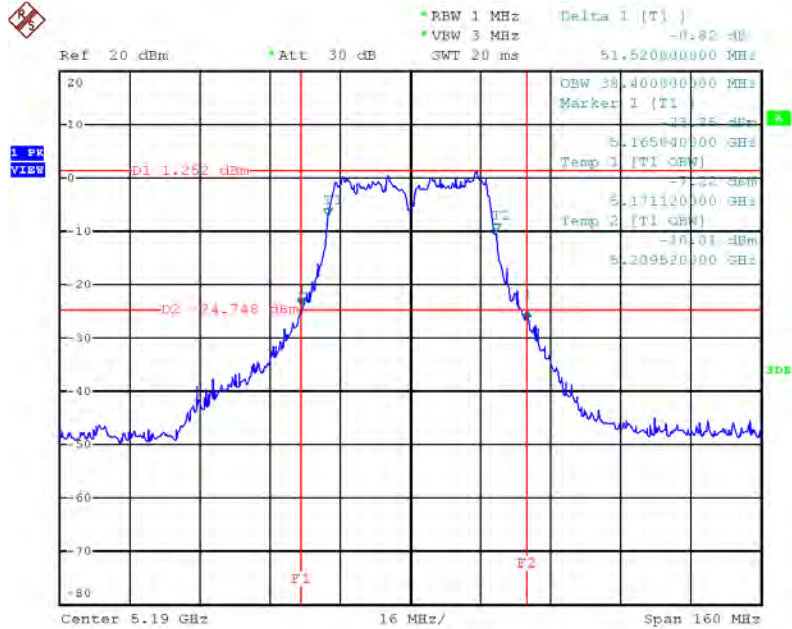

Date: 17.SEP.2013 20:36:07

**26dB Bandwidth and 99% Occupied Bandwidth Plot on Configuration IEEE 802.11n MCS8 40MHz / Chain 1 + Chain 2 / 5230 MHz**

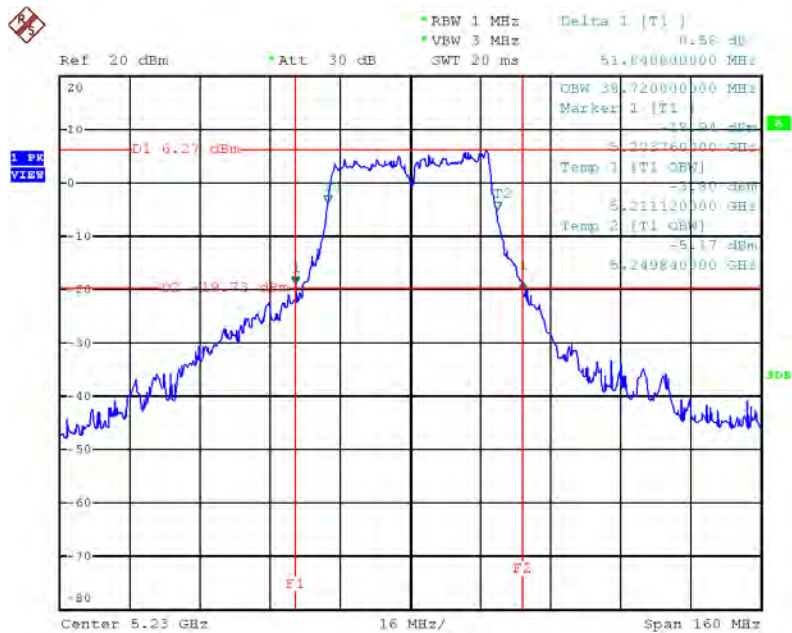

Date: 17.SEP.2013 20:36:39

**26dB Bandwidth and 99% Occupied Bandwidth Plot on Configuration IEEE 802.11n MCS8 40MHz / Chain 1 + Chain 2 / 5270 MHz**

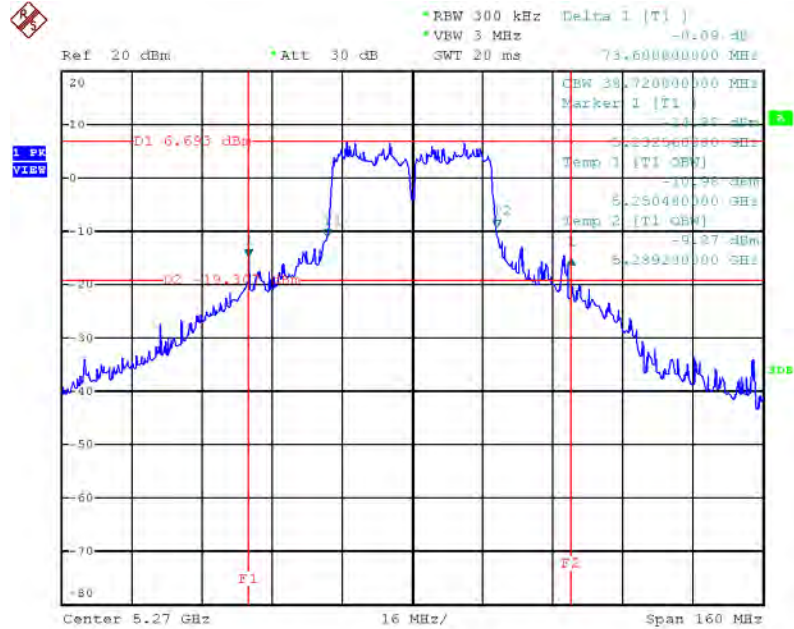

Date: 17.SEP.2013 20:37:11

**26dB Bandwidth and 99% Occupied Bandwidth Plot on Configuration IEEE 802.11n MCS8 40MHz / Chain 1 + Chain 2 / 5310 MHz**

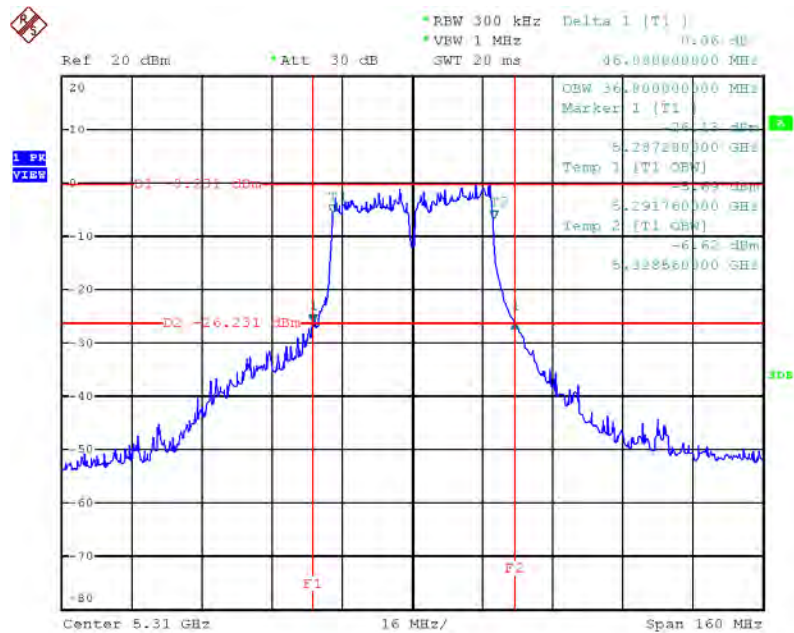

Date: 17.SEP.2013 20:37:43

**26dB Bandwidth and 99% Occupied Bandwidth Plot on Configuration IEEE 802.11n MCS8 40MHz / Chain 1 + Chain 2 / 5510 MHz**

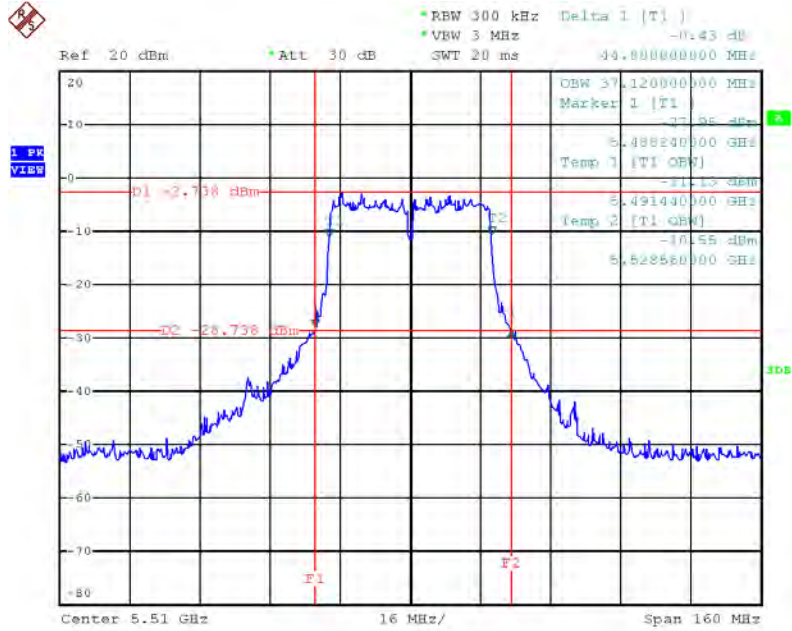

Date: 17.SEP.2013 20:38:46

**26dB Bandwidth and 99% Occupied Bandwidth Plot on Configuration IEEE 802.11n MCS8 40MHz / Chain 1 + Chain 2 / 5550 MHz**

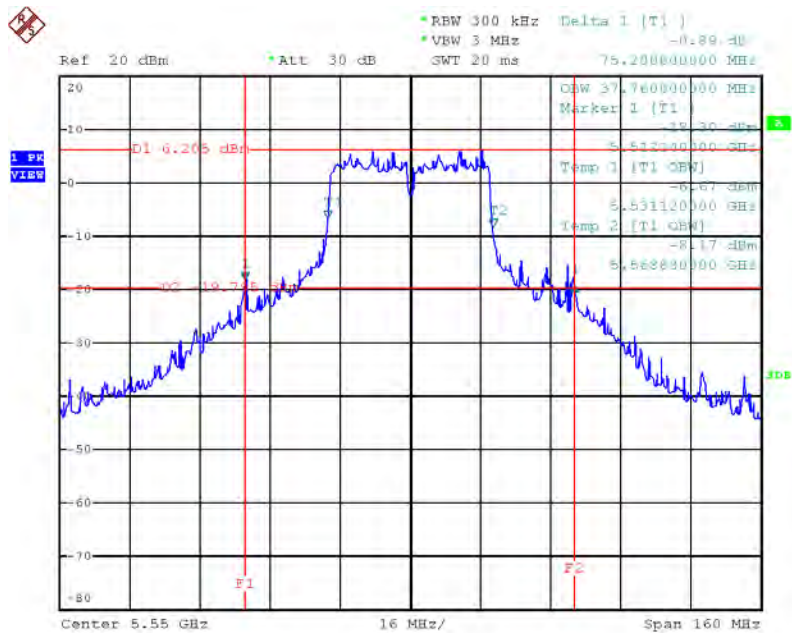

Date: 17.SEP.2013 20:39:20

26dB Bandwidth and 99% Occupied Bandwidth Plot on Configuration IEEE 802.11n MCS8 40MHz / Chain 1 + Chain 2 / 5670 MHz

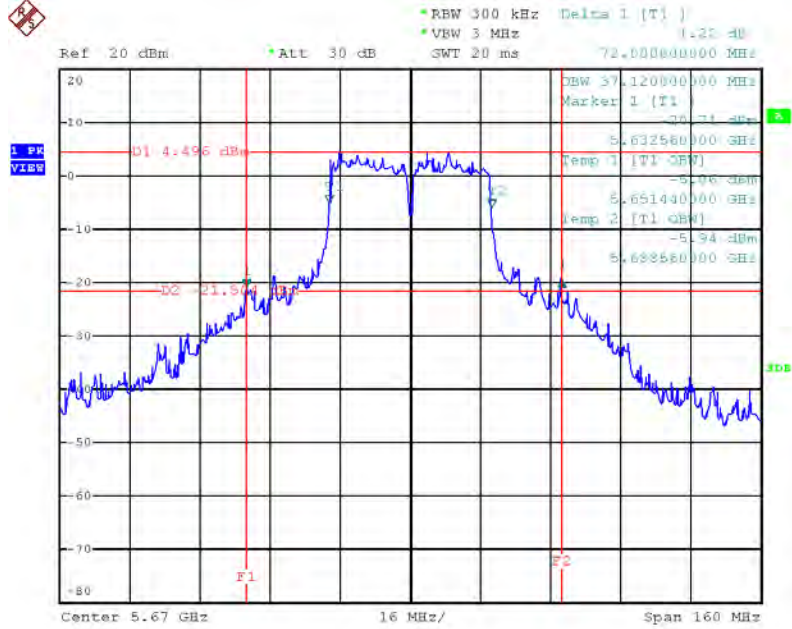

Date: 17.SEP.2013 20:40:11



For 3TX

26dB Bandwidth and 99% Occupied Bandwidth Plot on Configuration IEEE 802.11n MCS16 20MHz / Chain 1 + Chain 2 + Chain 3 / 5180 MHz

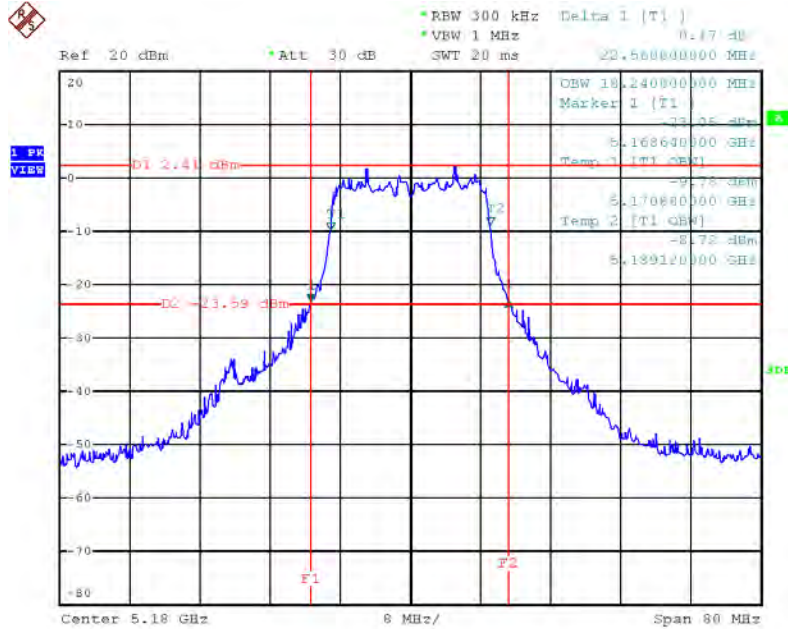

Date: 17.SEP.2013 21:17:31

26dB Bandwidth and 99% Occupied Bandwidth Plot on Configuration IEEE 802.11n MCS16 20MHz / Chain 1 + Chain 2 + Chain 3 / 5200 MHz

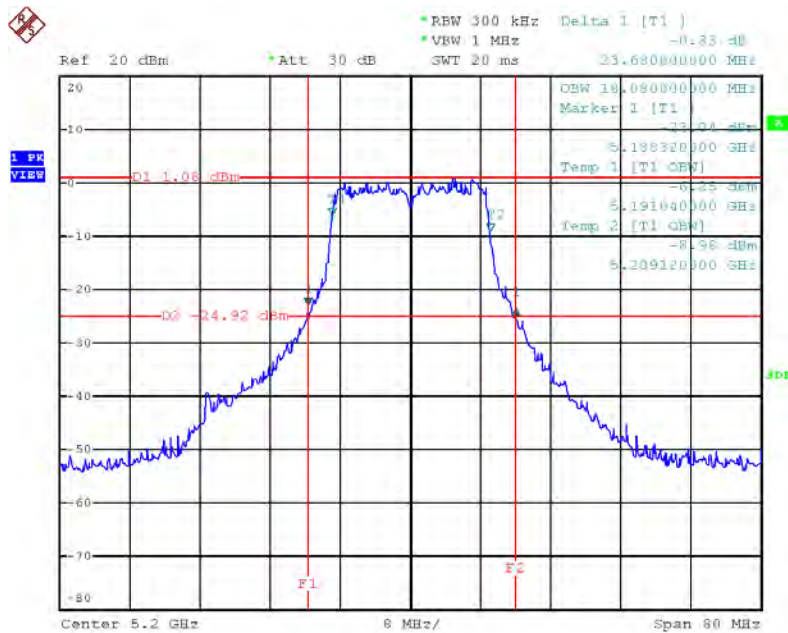

Date: 17.SEP.2013 21:18:00

**26dB Bandwidth and 99% Occupied Bandwidth Plot on Configuration IEEE 802.11n MCS16 20MHz / Chain 1 + Chain 2 + Chain 3 / 5240 MHz**

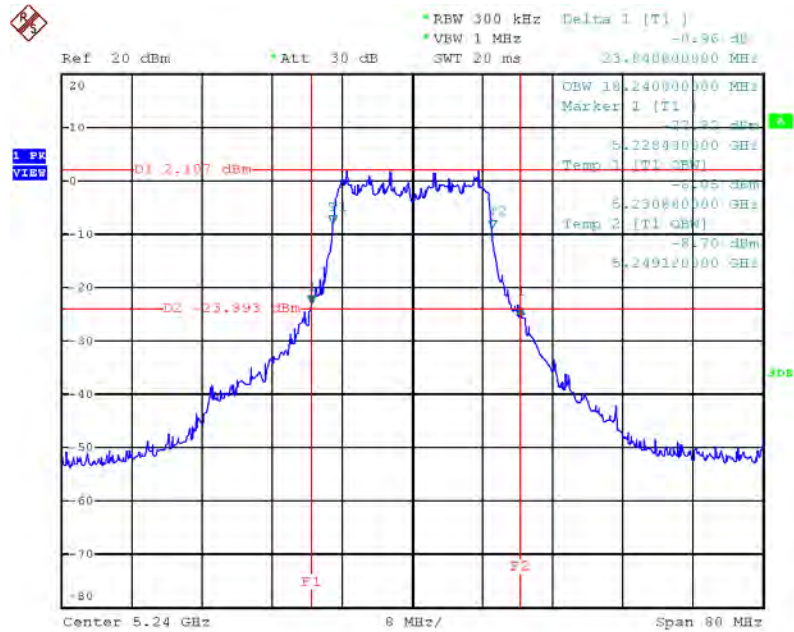

Date: 17.SEP.2013 21:18:29

**26dB Bandwidth and 99% Occupied Bandwidth Plot on Configuration IEEE 802.11n MCS16 20MHz / Chain 1 + Chain 2 + Chain 3 / 5260 MHz**

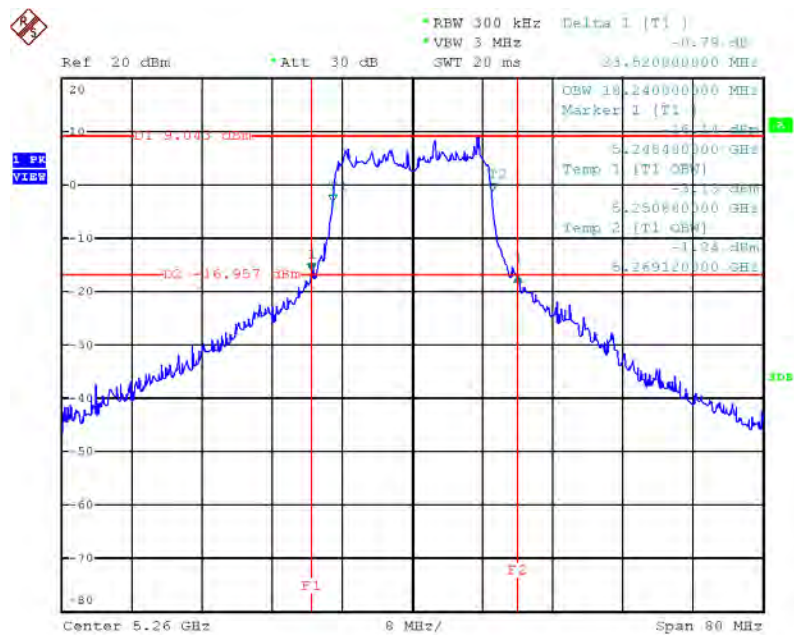

Date: 17.SEP.2013 21:18:58

**26dB Bandwidth and 99% Occupied Bandwidth Plot on Configuration IEEE 802.11n MCS16 20MHz / Chain 1 + Chain 2 + Chain 3 / 5300 MHz**

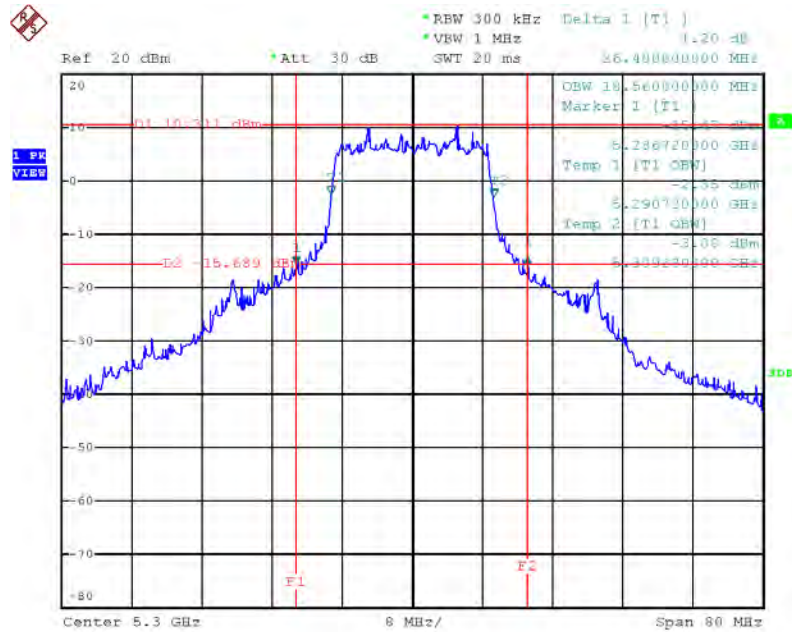

Date: 17.SEP.2013 21:19:30

**26dB Bandwidth and 99% Occupied Bandwidth Plot on Configuration IEEE 802.11n MCS16 20MHz / Chain 1 + Chain 2 + Chain 3 / 5320 MHz**

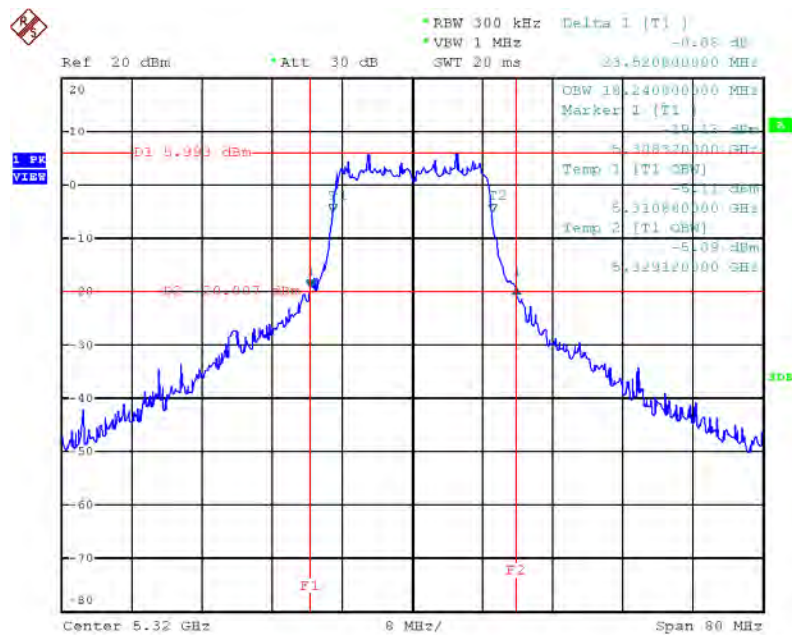

Date: 17.SEP.2013 21:20:01

**26dB Bandwidth and 99% Occupied Bandwidth Plot on Configuration IEEE 802.11n MCS16 20MHz / Chain 1 + Chain 2 + Chain 3 / 5500 MHz**

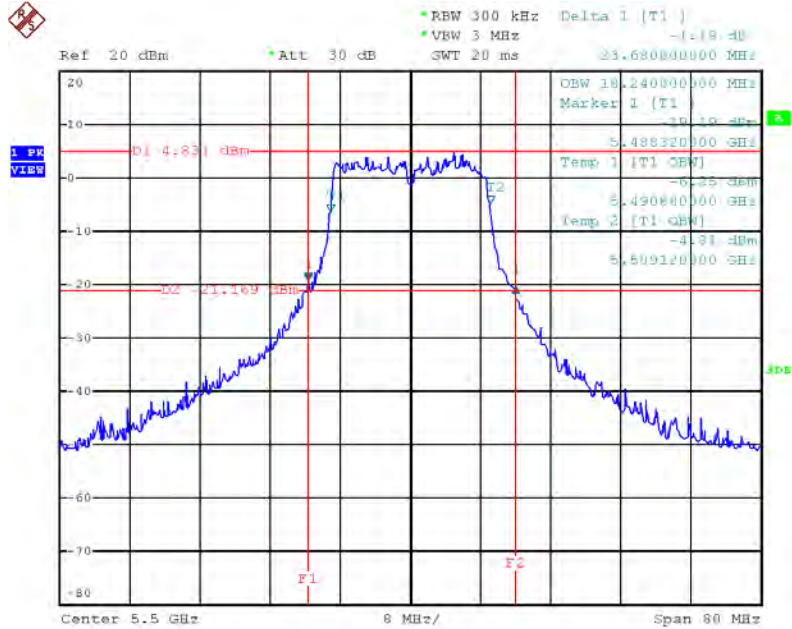

Date: 17.SEP.2013 21:20:43

**26dB Bandwidth and 99% Occupied Bandwidth Plot on Configuration IEEE 802.11n MCS16 20MHz / Chain 1 + Chain 2 + Chain 3 / 5580 MHz**

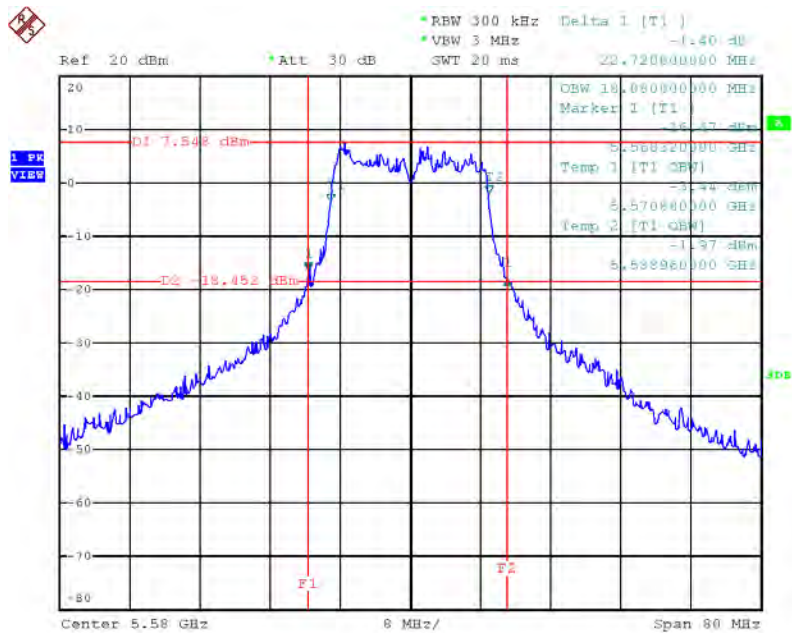

Date: 17.SEP.2013 21:21:10



**26dB Bandwidth and 99% Occupied Bandwidth Plot on Configuration IEEE 802.11n MCS16 20MHz / Chain 1 + Chain 2 + Chain 3 / 5700 MHz**

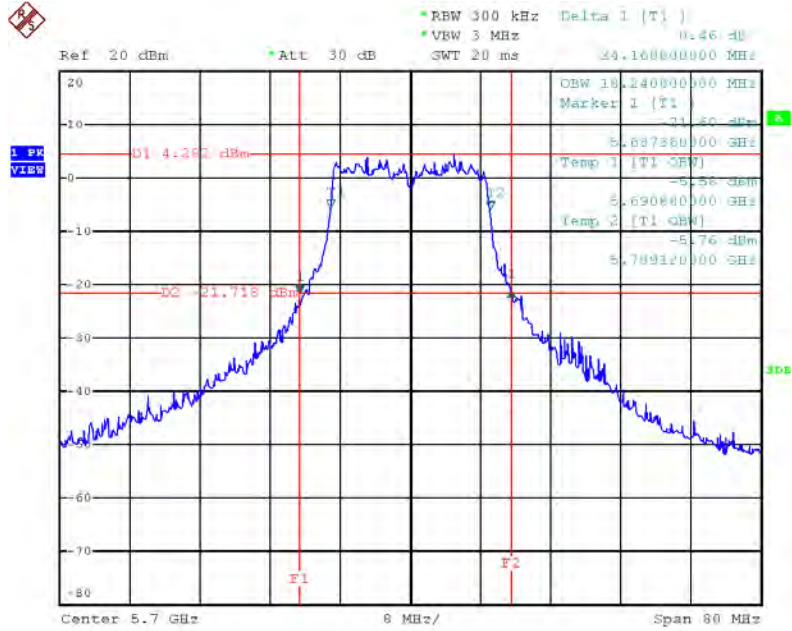

Date: 17.SEP.2013 21:21:41

**26dB Bandwidth and 99% Occupied Bandwidth Plot on Configuration IEEE 802.11n MCS16 40MHz / Chain 1 + Chain 2 + Chain 3 / 5190 MHz**

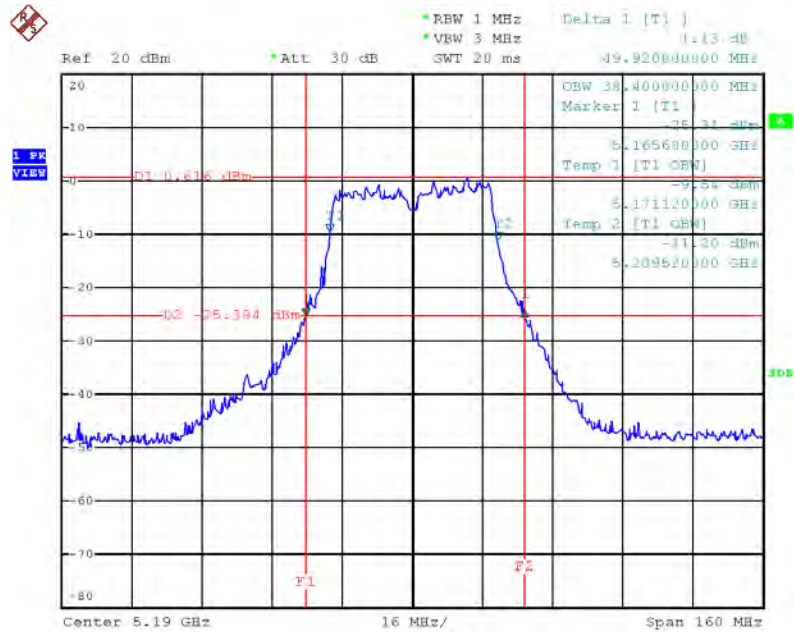

Date: 17.SEP.2013 21:22:49

**26dB Bandwidth and 99% Occupied Bandwidth Plot on Configuration IEEE 802.11n MCS16 40MHz / Chain 1 + Chain 2 + Chain 3 / 5230 MHz**

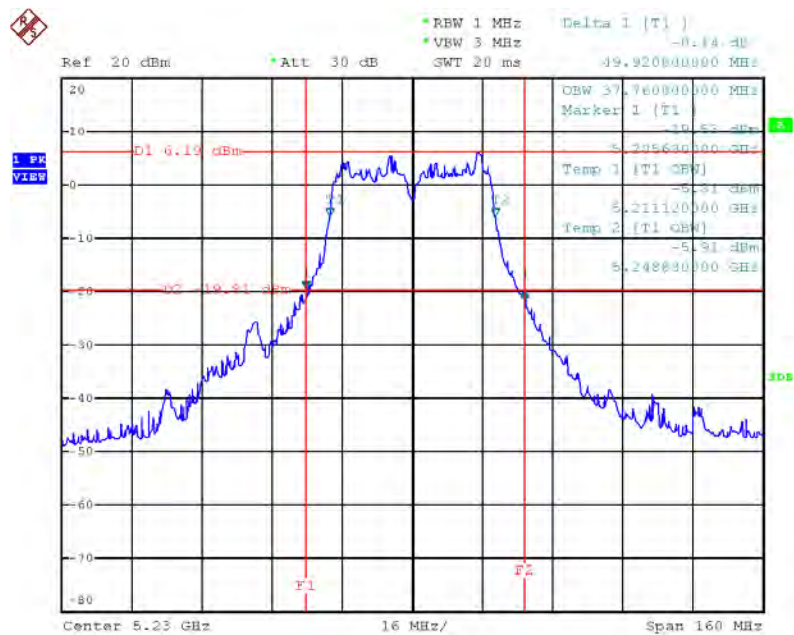

Date: 17.SEP.2013 21:23:16

**26dB Bandwidth and 99% Occupied Bandwidth Plot on Configuration IEEE 802.11n MCS16 40MHz / Chain 1 + Chain 2 + Chain 3 / 5270 MHz**

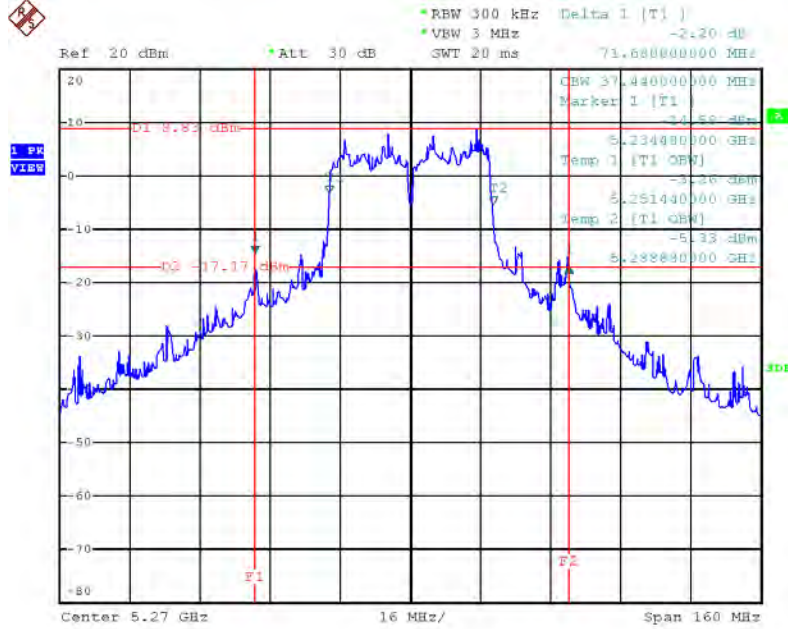

Date: 17.SEP.2013 21:23:54

**26dB Bandwidth and 99% Occupied Bandwidth Plot on Configuration IEEE 802.11n MCS16 40MHz / Chain 1 + Chain 2 + Chain 3 / 5310 MHz**

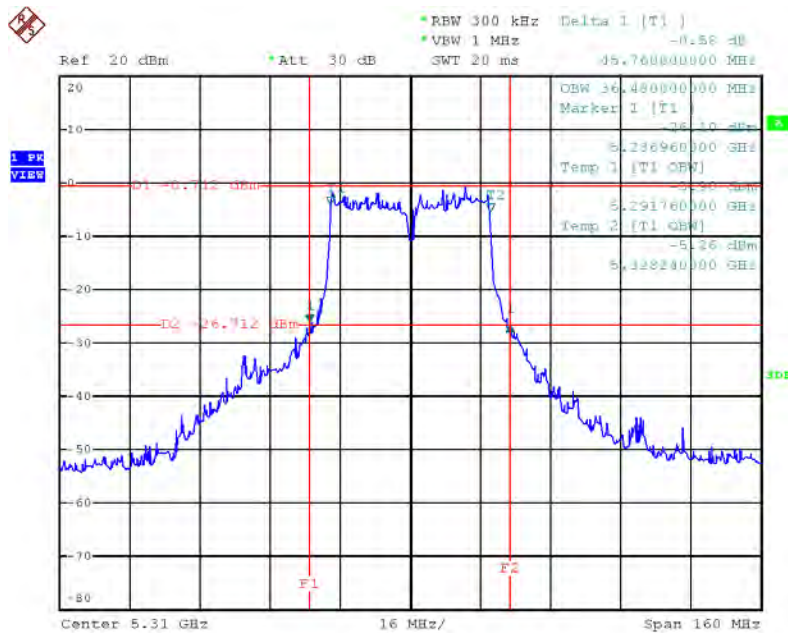

Date: 17.SEP.2013 21:24:28

**26dB Bandwidth and 99% Occupied Bandwidth Plot on Configuration IEEE 802.11n MCS16 40MHz / Chain 1 + Chain 2 + Chain 3 / 5510 MHz**

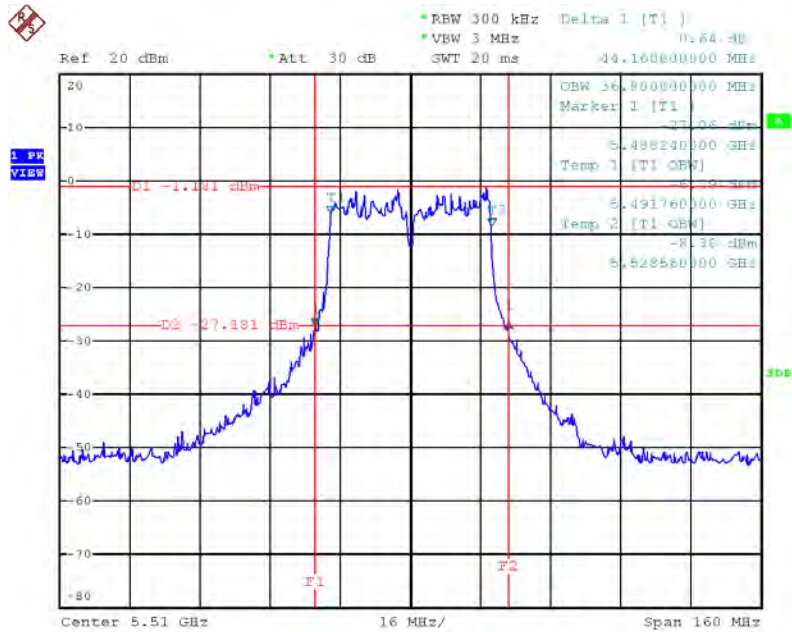

Date: 17.SEP.2013 21:25:08

**26dB Bandwidth and 99% Occupied Bandwidth Plot on Configuration IEEE 802.11n MCS16 40MHz / Chain 1 + Chain 2 + Chain 3 / 5550 MHz**

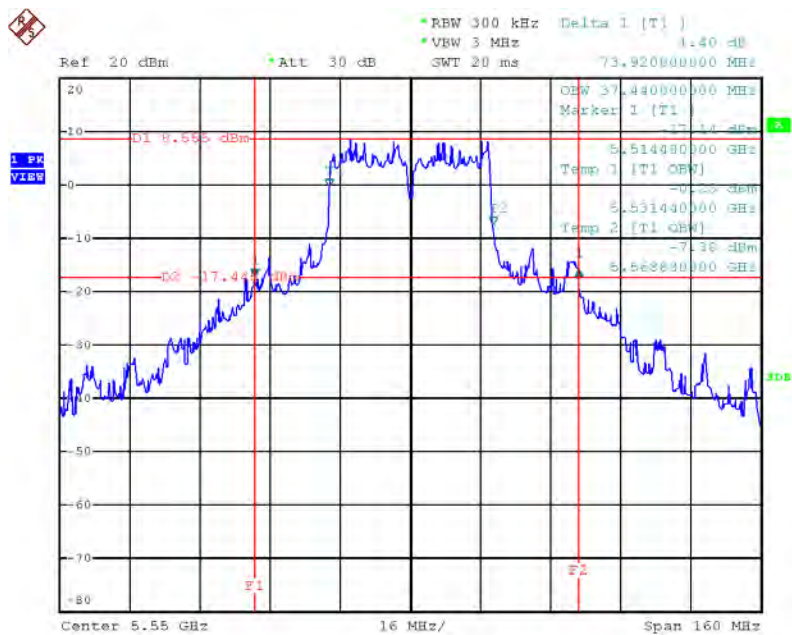

Date: 17.SEP.2013 21:25:39



**26dB Bandwidth and 99% Occupied Bandwidth Plot on Configuration IEEE 802.11n MCS16 40MHz / Chain 1 + Chain 2 + Chain 3 / 5670 MHz**

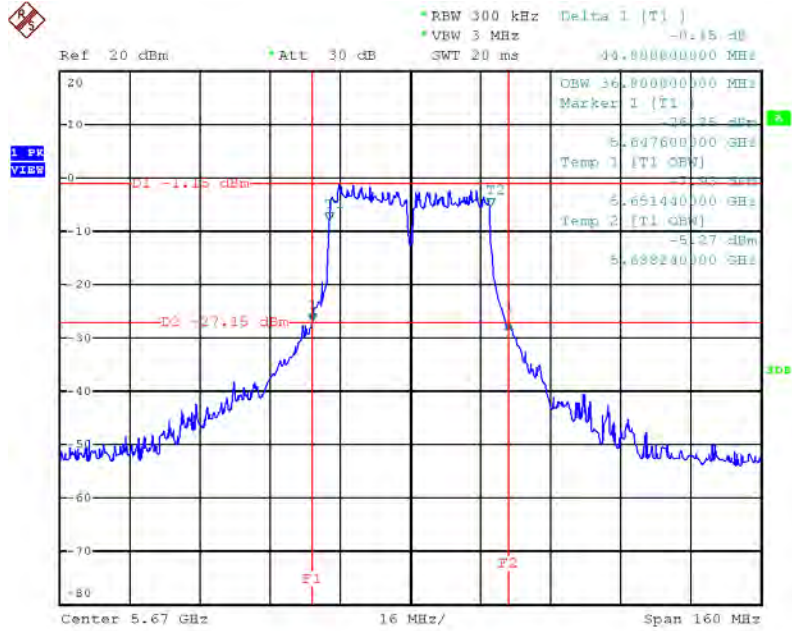

Date: 17.SEP.2013 21:26:13

26dB Bandwidth and 99% Occupied Bandwidth Plot on Configuration IEEE 802.11a / Chain 1 / 5180 MHz

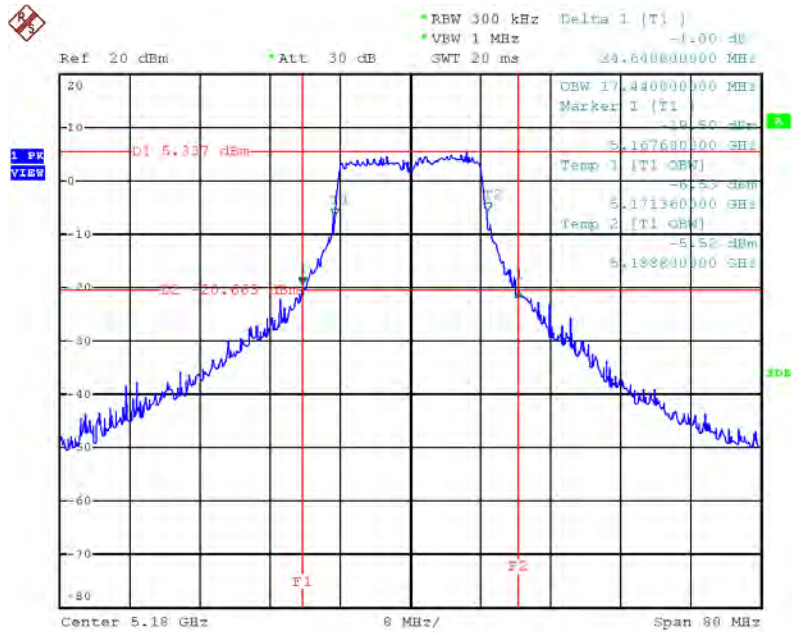

Date: 17.SEP.2013 20:07:57

26dB Bandwidth and 99% Occupied Bandwidth Plot on Configuration IEEE 802.11a / Chain 1 / 5200 MHz

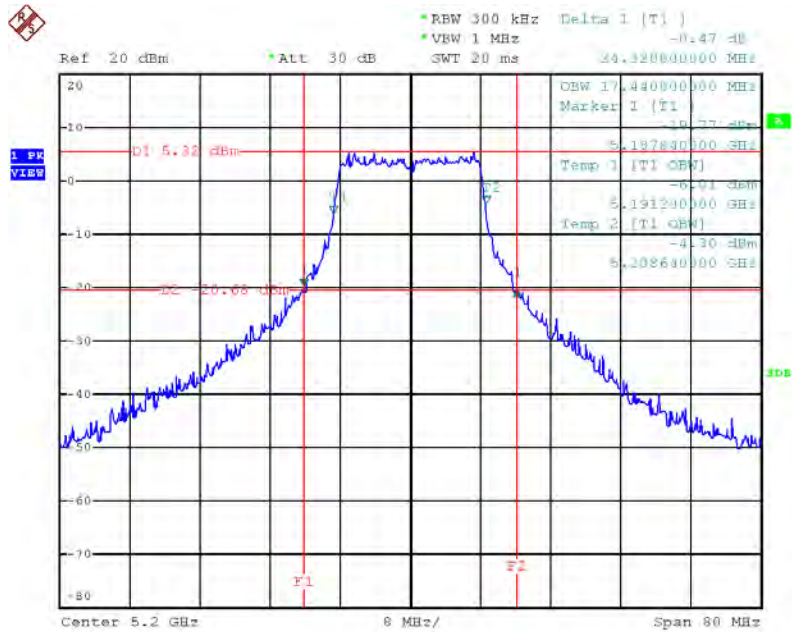

Date: 17.SEP.2013 20:08:34

26dB Bandwidth and 99% Occupied Bandwidth Plot on Configuration IEEE 802.11a / Chain 1 / 5240 MHz

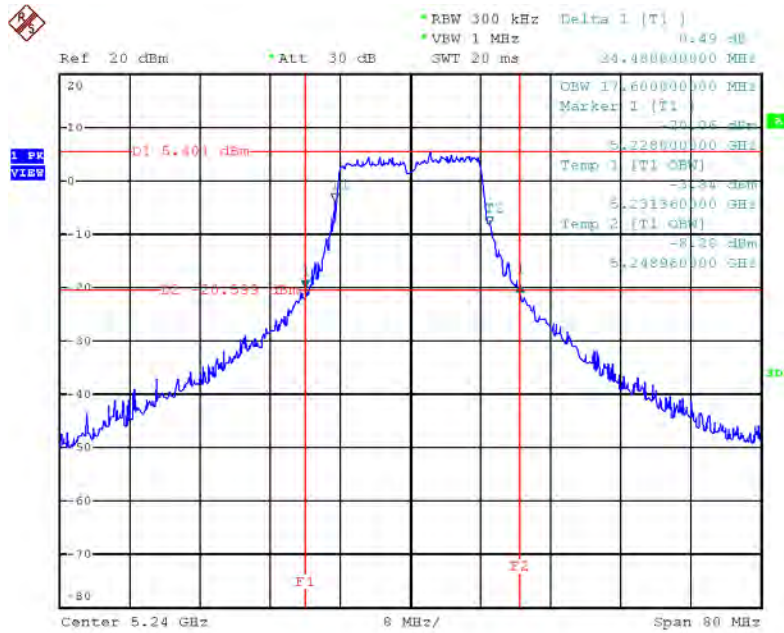

Date: 17.SEP.2013 20:09:08

26dB Bandwidth and 99% Occupied Bandwidth Plot on Configuration IEEE 802.11a / Chain 1 / 5260 MHz

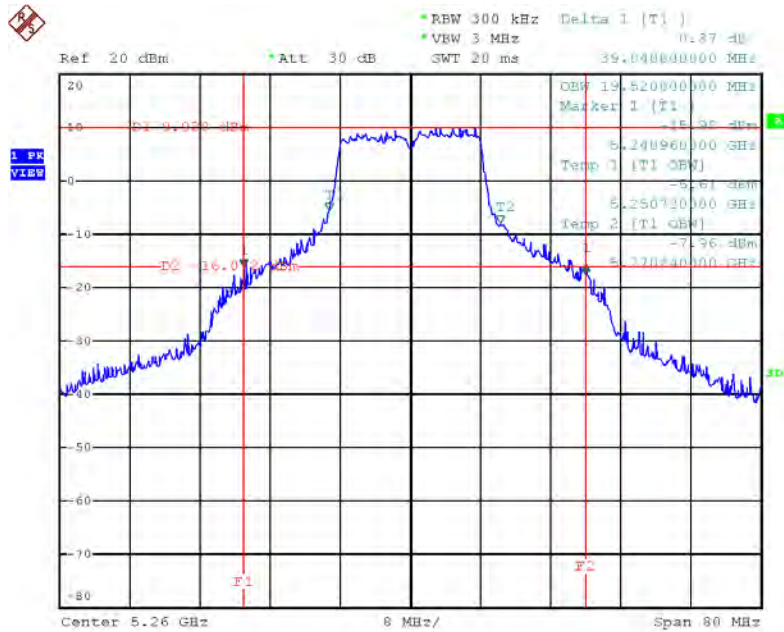

Date: 17.SEP.2013 20:10:41

26dB Bandwidth and 99% Occupied Bandwidth Plot on Configuration IEEE 802.11a / Chain 1 / 5300 MHz

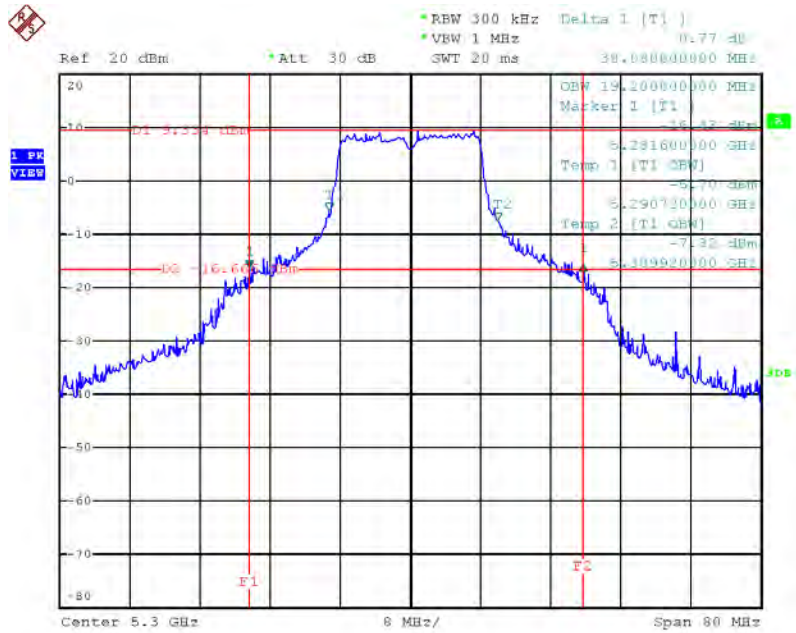

Date: 17.SEP.2013 20:11:20

26dB Bandwidth and 99% Occupied Bandwidth Plot on Configuration IEEE 802.11a / Chain 1 / 5320 MHz

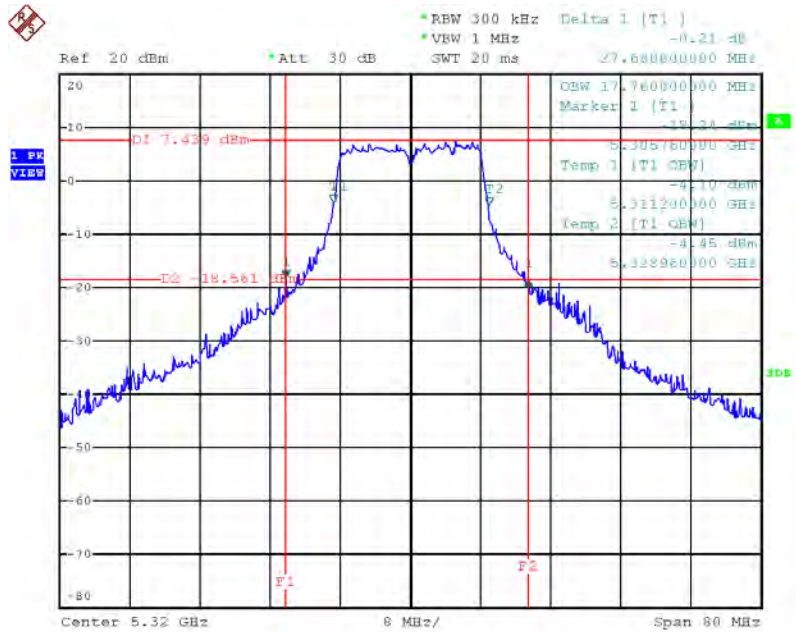

Date: 17.SEP.2013 20:11:57



26dB Bandwidth and 99% Occupied Bandwidth Plot on Configuration IEEE 802.11a / Chain 1 / 5500 MHz

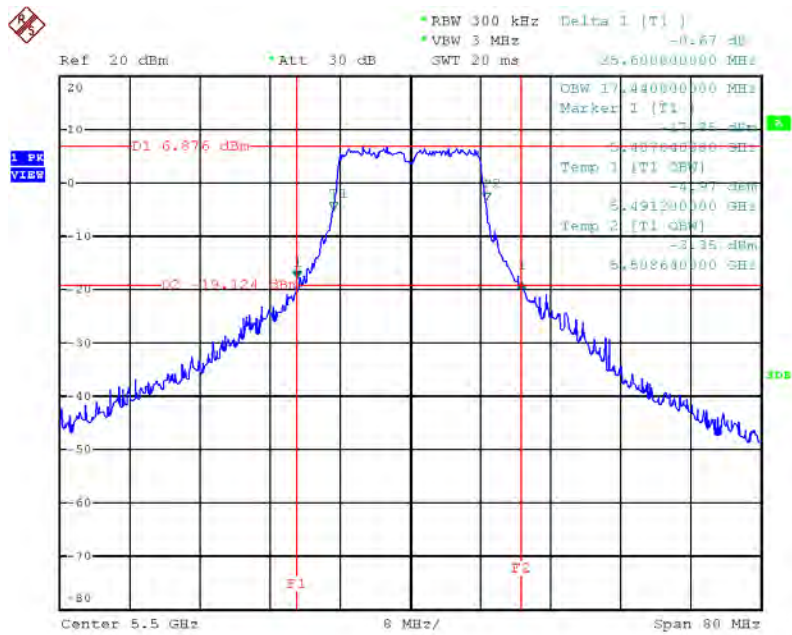

Date: 17.SEP.2013 20:12:45

26dB Bandwidth and 99% Occupied Bandwidth Plot on Configuration IEEE 802.11a / Chain 1 / 5580 MHz

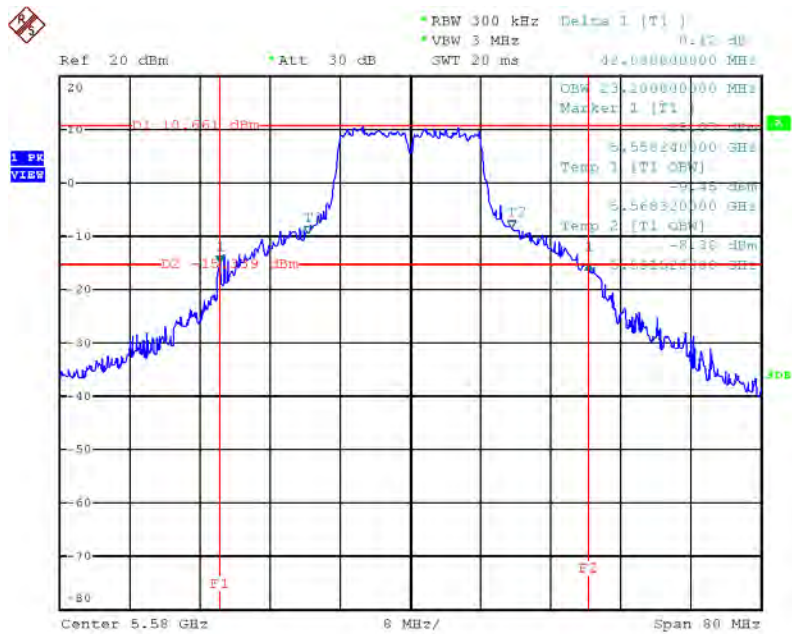

Date: 17.SEP.2013 20:13:53

26dB Bandwidth and 99% Occupied Bandwidth Plot on Configuration IEEE 802.11a / Chain 1 / 5700 MHz

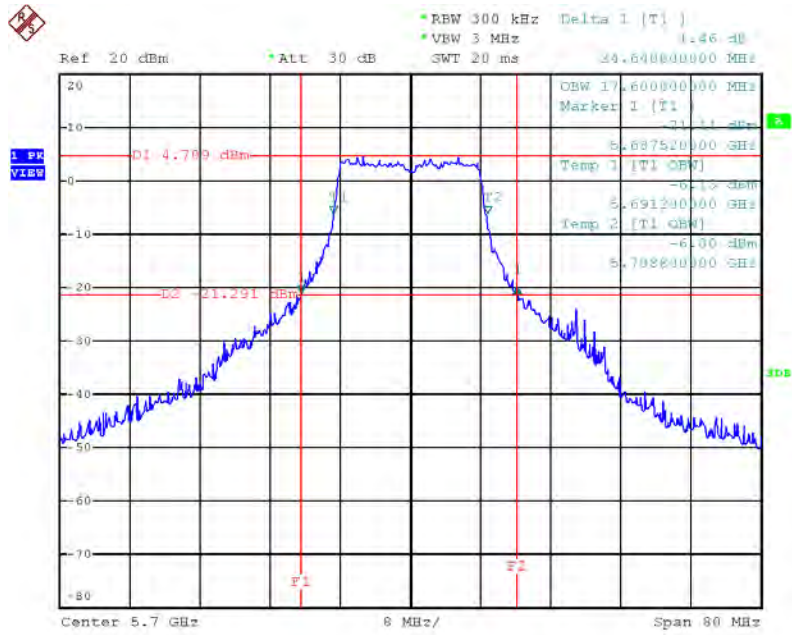

Date: 17.SEP.2013 20:15:25

## 4.2. Maximum Conducted Output Power Measurement

### 4.2.1. Limit

For the band 5.15~5.25 GHz, the maximum conducted output power over the frequency band of operation shall not exceed the lesser of 50 mW (17dBm) or  $4 \text{ dBm} + 10\log B$ , where B is the 26 dB emissions bandwidth in MHz. If transmitting antennas of directional gain greater than 6 dBi are used, both the maximum conducted output power and the peak power spectral density shall be reduced by the amount in dB that the directional gain of the antenna exceeds 6 dBi.

For the 5.25-5.35 GHz and 5.470-5.725 GHz bands, the maximum conducted output power over the frequency bands of operation shall not exceed the lesser of 250 mW (24dBm) or  $11 \text{ dBm} + 10\log B$ , where B is the 26-dB emission bandwidth in MHz. If transmitting antennas of directional gain greater than 6 dBi are used, both the maximum conducted output power and the peak power spectral density shall be reduced by the amount in dB that the directional gain of the antenna exceeds 6 dBi.

For the band 5.725~5.825 GHz, the maximum conducted output power over the frequency band of operation shall not exceed the lesser of 1 W or  $17 \text{ dBm} + 10 \log B$ , where B is the 26-dB emission bandwidth in MHz. In addition, the peak power spectral density shall not exceed 17 dBm in any 1 MHz band. If transmitting antennas of directional gain greater than 6 dBi are used, both the maximum conducted output power and the peak power spectral density shall be reduced by the amount in dB that the directional gain of the antenna exceeds 6 dBi. However, fixed point-to-point U-NII devices operating in this band may employ transmitting antennas with directional gain up to 23 dBi without any corresponding reduction in the transmitter peak output power or peak power spectral density. For fixed, point-to-point U-NII transmitters that employ a directional antenna gain greater than 23 dBi, a 1 dB reduction in peak transmitter power and peak power spectral density for each 1 dB of antenna gain in excess of 23 dBi would be required.

### 4.2.2. Measuring Instruments and Setting

The following table is the setting of the peak power meter.

Power Meter Parameter	Setting
Bandwidth	50MHz bandwidth is greater than the EUT emission bandwidth
Detector	AVERAGE



### 4.2.3. Test Procedures

1. The transmitter output (antenna port) was connected to the power meter.
2. Test was performed in accordance with KDB 789033 D01 v01r03 for Compliance Testing of Unlicensed National Information Infrastructure (U-NII) Devices - Part 15, Subpart E, section (E) Maximum conducted output power =>(3) Method PM (Measurement using an RF average power meter) Multiple antenna systems was performed in accordance with KDB 662911 D01 v02 Emissions Testing of Transmitters with Multiple Outputs in the Same Band.
3. When measuring maximum conducted output power with multiple antenna systems, add every result of the values by mathematic formula.

### 4.2.4. Test Setup Layout

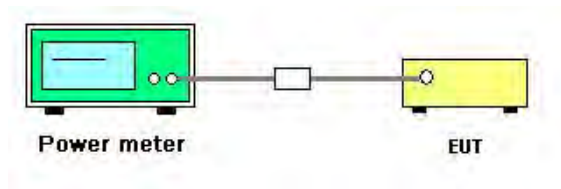

### 4.2.5. Test Deviation

There is no deviation with the original standard.

### 4.2.6. EUT Operation during Test

The EUT was programmed to be in continuously transmitting mode.

#### 4.2.7. Test Result of Maximum Conducted Output Power

Temperature	24°C	Humidity	61%
Test Engineer	Kenneth Huang	Configurations	IEEE 802.11n
Test Date	Sep. 17, 2013 ~ Sep. 20, 2013		
Test Mode	Mode 1 (Ant.31 PIFA antenna / 4.7dBi)		

For 1TX

Configuration IEEE 802.11n MCS0 20MHz

Channel	Frequency	Conducted Power (dBm)	Max. Limit (dBm)	Result
36	5180 MHz	16.61	17.00	Complies
40	5200 MHz	16.78	17.00	Complies
48	5240 MHz	16.54	17.00	Complies
52	5260 MHz	20.36	24.00	Complies
60	5300 MHz	20.48	24.00	Complies
64	5320 MHz	17.62	24.00	Complies
100	5500 MHz	16.52	24.00	Complies
116	5580 MHz	21.39	24.00	Complies
140	5700 MHz	16.25	24.00	Complies

Configuration IEEE 802.11n MCS0 40MHz

Channel	Frequency	Conducted Power (dBm)	Max. Limit (dBm)	Result
38	5190 MHz	11.82	17.00	Complies
46	5230 MHz	16.82	17.00	Complies
54	5270 MHz	20.88	24.00	Complies
62	5310 MHz	12.78	24.00	Complies
102	5510 MHz	11.06	24.00	Complies
110	5550 MHz	20.41	24.00	Complies
134	5670 MHz	18.68	24.00	Complies

For 2TX

## Configuration IEEE 802.11n MCS8 20MHz

Channel	Frequency	Conducted Power (dBm)			Max. Limit (dBm)	Result
		Chain 1	Chain 2	Total		
36	5180 MHz	14.02	13.46	16.76	17.00	Complies
40	5200 MHz	13.98	13.32	16.67	17.00	Complies
48	5240 MHz	13.68	13.42	16.56	17.00	Complies
52	5260 MHz	19.45	19.72	22.60	24.00	Complies
60	5300 MHz	20.17	21.18	23.71	24.00	Complies
64	5320 MHz	16.12	17.32	19.77	24.00	Complies
100	5500 MHz	14.85	15.51	18.20	24.00	Complies
116	5580 MHz	18.52	19.16	21.86	24.00	Complies
140	5700 MHz	15.73	15.31	18.54	24.00	Complies

## Configuration IEEE 802.11n MCS8 40MHz

Channel	Frequency	Conducted Power (dBm)			Max. Limit (dBm)	Result
		Chain 1	Chain 2	Total		
38	5190 MHz	9.41	8.33	11.91	17.00	Complies
46	5230 MHz	14.21	13.24	16.76	17.00	Complies
54	5270 MHz	19.44	19.62	22.54	24.00	Complies
62	5310 MHz	12.41	11.94	15.19	24.00	Complies
102	5510 MHz	9.14	10.38	12.81	24.00	Complies
110	5550 MHz	18.31	19.03	21.70	24.00	Complies
134	5670 MHz	17.94	17.43	20.70	24.00	Complies

For 3TX

## Configuration IEEE 802.11n MCS16 20MHz

Channel	Frequency	Conducted Power (dBm)				Max. Limit (dBm)	Result
		Chain 1	Chain 2	Chain 3	Total		
36	5180 MHz	12.62	11.48	12.28	16.92	17.00	Complies
40	5200 MHz	12.08	11.43	12.72	16.88	17.00	Complies
48	5240 MHz	12.06	11.58	12.24	16.74	17.00	Complies
52	5260 MHz	17.34	17.62	17.03	22.11	24.00	Complies
60	5300 MHz	18.48	19.42	19.03	23.76	24.00	Complies
64	5320 MHz	14.38	16.03	15.54	20.14	24.00	Complies
100	5500 MHz	13.02	14.26	14.46	18.73	24.00	Complies
116	5580 MHz	14.86	15.28	15.26	19.91	24.00	Complies
140	5700 MHz	13.96	13.45	14.16	18.64	24.00	Complies

## Configuration IEEE 802.11n MCS16 40MHz

Channel	Frequency	Conducted Power (dBm)				Max. Limit (dBm)	Result
		Chain 1	Chain 2	Chain 3	Total		
38	5190 MHz	8.65	7.71	9.01	13.26	17.00	Complies
46	5230 MHz	12.58	11.42	11.96	16.78	17.00	Complies
54	5270 MHz	18.22	18.70	18.49	23.25	24.00	Complies
62	5310 MHz	12.22	11.95	11.37	16.63	24.00	Complies
102	5510 MHz	7.88	10.28	9.81	14.21	24.00	Complies
110	5550 MHz	19.29	19.78	18.22	23.92	24.00	Complies
134	5670 MHz	12.42	12.18	12.35	17.09	24.00	Complies

<b>Temperature</b>	24°C	<b>Humidity</b>	61%
<b>Test Engineer</b>	Kenneth Huang	<b>Configurations</b>	IEEE 802.11a
<b>Test Date</b>	Sep. 20, 2013		
<b>Test Mode</b>	Mode 1 (Ant.31 PIFA antenna / 4.7dBi)		

**Configuration IEEE 802.11a**

Channel	Frequency	Conducted Power (dBm)	Max. Limit (dBm)	Result
36	5180 MHz	16.57	17.00	Complies
40	5200 MHz	16.54	17.00	Complies
48	5240 MHz	16.76	17.00	Complies
52	5260 MHz	20.58	24.00	Complies
60	5300 MHz	20.52	24.00	Complies
64	5320 MHz	18.64	24.00	Complies
100	5500 MHz	17.48	24.00	Complies
116	5580 MHz	21.37	24.00	Complies
140	5700 MHz	16.78	24.00	Complies

### 4.3. Power Spectral Density Measurement

#### 4.3.1. Limit

The power spectral density is defined as the highest level of power in dBm per MHz generated by the transmitter within the power envelope. The following table is power spectral density limits and decrease power density limit rule refer to section 4.3.1.

Frequency Range	Power Spectral Density limit (dBm/MHz)
5.15~5.25 GHz	4
5.25-5.35 GHz	11
5.470-5.725 GHz	11

#### 4.3.2. Measuring Instruments and Setting

Please refer to section 5 of equipments list in this report. The following table is the setting of the spectrum analyzer.

Spectrum Parameter	Setting
Attenuation	Auto
Span Frequency	Encompass the entire emissions bandwidth (EBW) of the signal
RBW	1000 kHz
VBW	3000 kHz
Detector	RMS
Trace	AVERAGE
Sweep Time	Auto
Trace Average	100 times

#### 4.3.3. Test Procedures

1. The transmitter output (antenna port) was connected RF switch to the spectrum analyzer.
2. Test was performed in accordance with KDB 789033 D01 v01r03 for Compliance Testing of Unlicensed National Information Infrastructure (U-NII) Devices - Part 15, Subpart E, section (C) Maximum conducted output power => (d) Method SA-2 (trace averaging across on and off times of the EUT transmissions, followed by duty cycle correction).
3. Multiple antenna systems was performed in accordance KDB 662911 D01 v02 in-Band Power Spectral Density (PSD) Measurements (a) Measure and sum the spectra across the outputs.
4. When measuring first spectral bin of output 1 is summed with that in the first spectral bin of output 2 and that from the first spectral bin of output 3 and so on up to the Nth output to obtain the value for the first frequency bin of the summed spectrum. The summed spectrum value for each of the other frequency bins is computed in the same way.

#### 4.3.4. Test Setup Layout

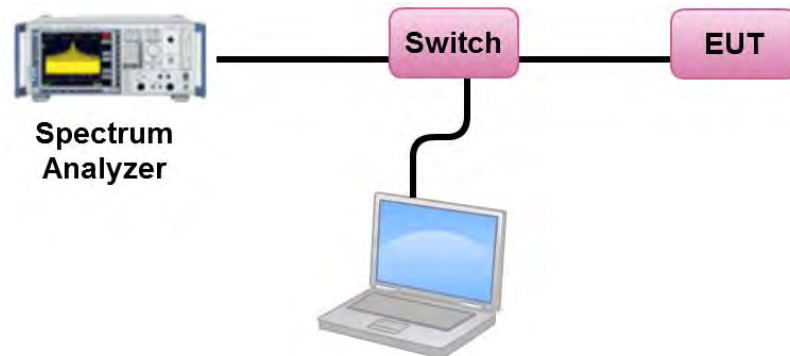

#### 4.3.5. Test Deviation

There is no deviation with the original standard.

#### 4.3.6. EUT Operation during Test

The EUT was programmed to be in continuously transmitting mode.



#### 4.3.7. Test Result of Power Spectral Density

Temperature	24°C	Humidity	61%
Test Engineer	Kenneth Huang	Configurations	IEEE 802.11n
Test Date	Sep. 17, 2013 ~ Sep. 20, 2013		
Test Mode	Mode 1 (Ant.31 PIFA antenna / 4.7dBi)		

For 1TX

Configuration IEEE 802.11n MCS0 20MHz / Chain 1

Channel	Frequency	Total Power Density (dBm/MHz)	Max. Limit (dBm/MHz)	Result
36	5180 MHz	2.57	4.00	Complies
40	5200 MHz	2.91	4.00	Complies
48	5240 MHz	2.89	4.00	Complies
52	5260 MHz	6.89	11.00	Complies
60	5300 MHz	7.32	11.00	Complies
64	5320 MHz	4.36	11.00	Complies
100	5500 MHz	3.54	11.00	Complies
116	5580 MHz	8.19	11.00	Complies
140	5700 MHz	1.99	11.00	Complies

Configuration IEEE 802.11n MCS0 40MHz / Chain 1

Channel	Frequency	Total Power Density (dBm/MHz)	Max. Limit (dBm/MHz)	Result
38	5190 MHz	-5.15	4.00	Complies
46	5230 MHz	0.61	4.00	Complies
54	5270 MHz	3.60	11.00	Complies
62	5310 MHz	-3.81	11.00	Complies
102	5510 MHz	-4.77	11.00	Complies
110	5550 MHz	4.56	11.00	Complies
134	5670 MHz	1.76	11.00	Complies

For 2TX

## Configuration IEEE 802.11n MCS8 20MHz / Chain 1 + Chain 2

Channel	Frequency	Total Power Density (dBm/MHz)	Max. Limit (dBm/MHz)	Result
36	5180 MHz	2.68	4.00	Complies
40	5200 MHz	2.81	4.00	Complies
48	5240 MHz	3.02	4.00	Complies
52	5260 MHz	9.44	11.00	Complies
60	5300 MHz	10.89	11.00	Complies
64	5320 MHz	7.38	11.00	Complies
100	5500 MHz	5.57	11.00	Complies
116	5580 MHz	8.66	11.00	Complies
140	5700 MHz	4.62	11.00	Complies

## Configuration IEEE 802.11n MCS8 40MHz / Chain 1 + Chain 2

Channel	Frequency	Total Power Density (dBm/MHz)	Max. Limit (dBm/MHz)	Result
38	5190 MHz	-4.84	4.00	Complies
46	5230 MHz	0.18	4.00	Complies
54	5270 MHz	6.93	11.00	Complies
62	5310 MHz	-0.19	11.00	Complies
102	5510 MHz	-3.02	11.00	Complies
110	5550 MHz	5.70	11.00	Complies
134	5670 MHz	4.25	11.00	Complies

For 3TX

## Configuration IEEE 802.11n MCS16 20MHz / Chain 1 + Chain 2 + Chain 3

Channel	Frequency	Total Power Density (dBm/MHz)	Max. Limit (dBm/MHz)	Result
36	5180 MHz	3.09	4.00	Complies
40	5200 MHz	3.30	4.00	Complies
48	5240 MHz	3.12	4.00	Complies
52	5260 MHz	8.83	11.00	Complies
60	5300 MHz	10.65	11.00	Complies
64	5320 MHz	7.14	11.00	Complies
100	5500 MHz	5.56	11.00	Complies
116	5580 MHz	6.95	11.00	Complies
140	5700 MHz	4.81	11.00	Complies

## Configuration IEEE 802.11n MCS16 40MHz / Chain 1 + Chain 2 + Chain 3

Channel	Frequency	Total Power Density (dBm/MHz)	Max. Limit (dBm/MHz)	Result
38	5190 MHz	-3.28	4.00	Complies
46	5230 MHz	0.60	4.00	Complies
54	5270 MHz	7.58	11.00	Complies
62	5310 MHz	0.94	11.00	Complies
102	5510 MHz	-1.74	11.00	Complies
110	5550 MHz	7.68	11.00	Complies
134	5670 MHz	0.25	11.00	Complies

<b>Temperature</b>	24°C	<b>Humidity</b>	61%
<b>Test Engineer</b>	Kenneth Huang	<b>Configurations</b>	IEEE 802.11a
<b>Test Date</b>	Sep. 20, 2013		
<b>Test Mode</b>	Mode 1 (Ant.31 PIFA antenna / 4.7dBi)		

**Configuration IEEE 802.11a / Chain 1**

Channel	Frequency	Total Power Density (dBm/MHz)	Max. Limit (dBm/MHz)	Result
36	5180 MHz	3.25	4.00	Complies
40	5200 MHz	3.05	4.00	Complies
48	5240 MHz	3.11	4.00	Complies
52	5260 MHz	7.08	11.00	Complies
60	5300 MHz	6.97	11.00	Complies
64	5320 MHz	5.03	11.00	Complies
100	5500 MHz	4.34	11.00	Complies
116	5580 MHz	8.34	11.00	Complies
140	5700 MHz	2.90	11.00	Complies

Note: All the test values were listed in the report.

For plots, only the channel with worse result was shown.

For 1TX

Power Density Plot on Configuration IEEE 802.11n MCS0 20MHz / Chain 1 / 5200 MHz

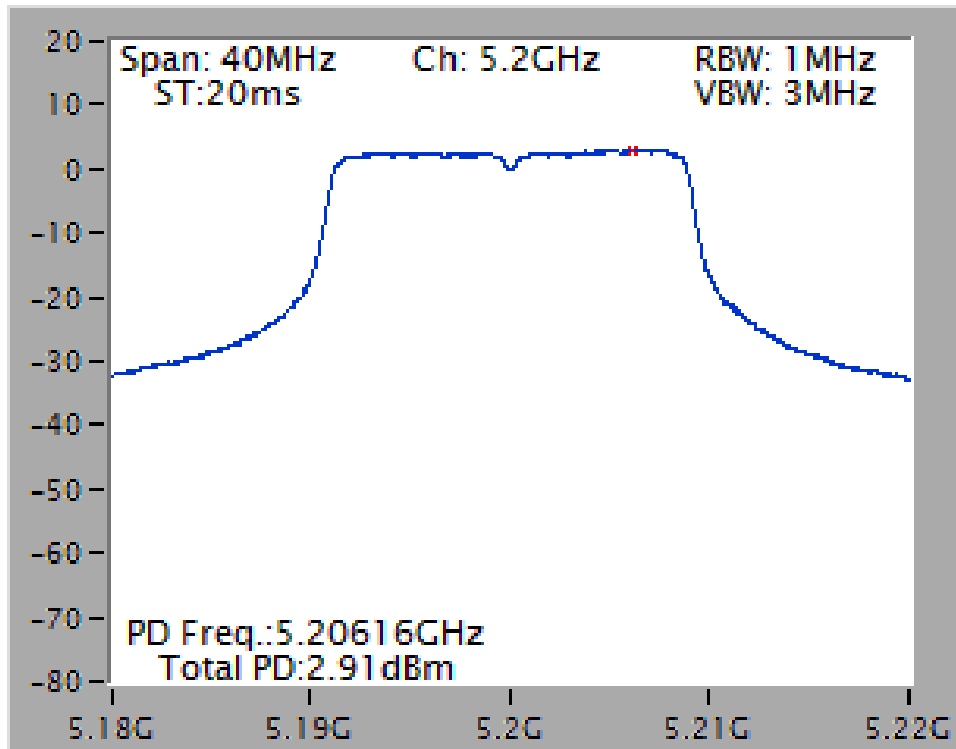

Power Density Plot on Configuration IEEE 802.11n MCS0 20MHz / Chain 1 / 5300 MHz

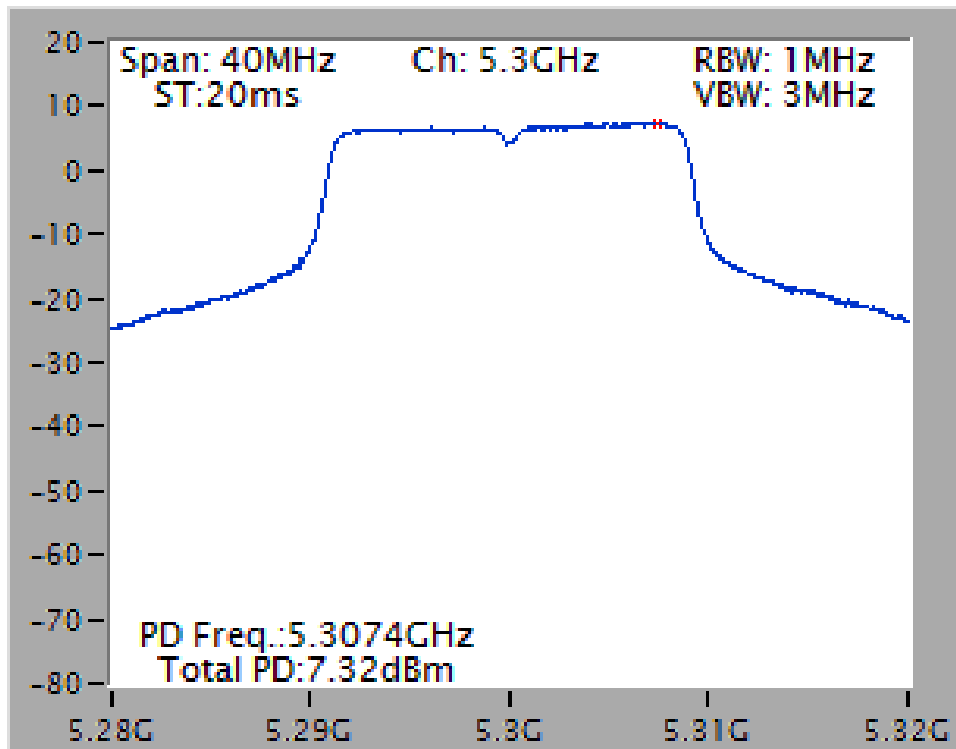

Power Density Plot on Configuration IEEE 802.11n MCS0 20MHz / Chain 1 / 5580 MHz

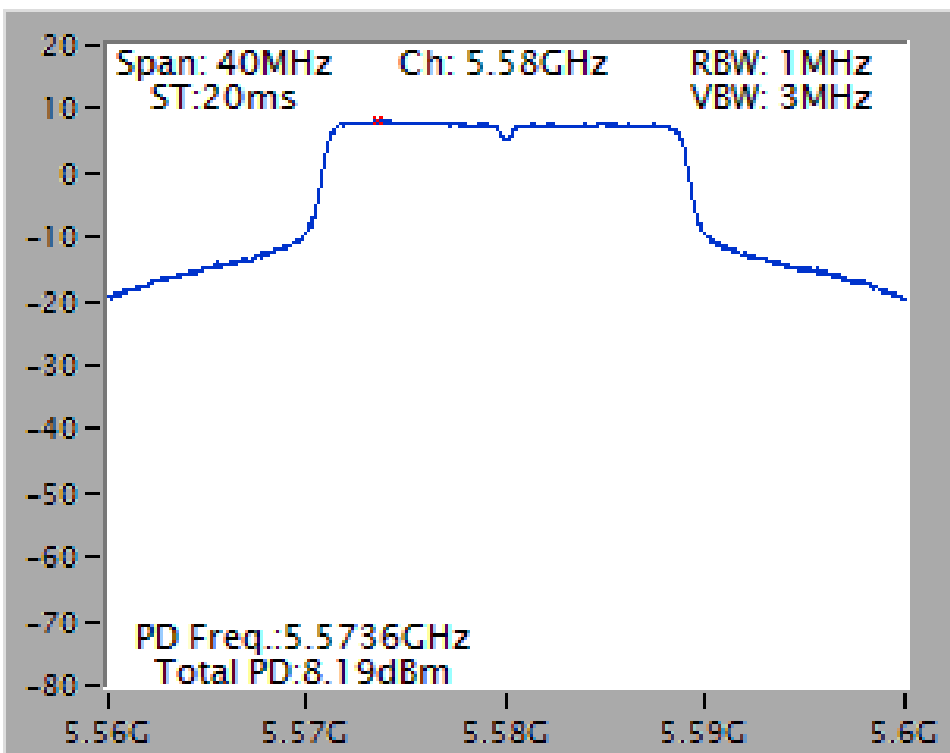

Power Density Plot on Configuration IEEE 802.11n MCS0 40MHz / Chain 1 / 5230 MHz

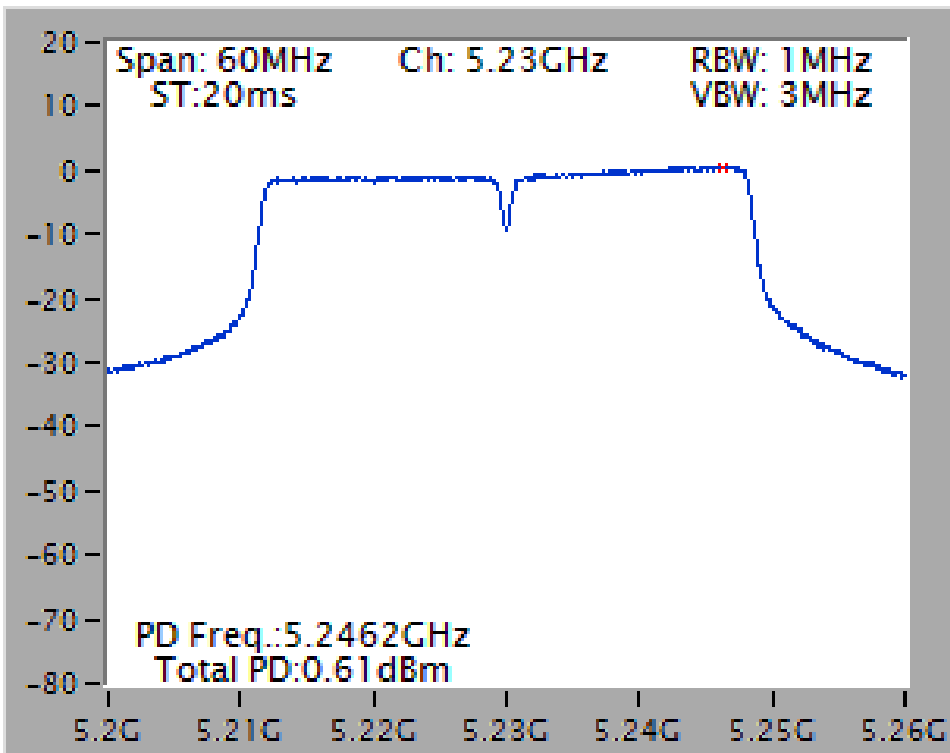



Power Density Plot on Configuration IEEE 802.11n MCS0 40MHz / Chain 1 / 5270 MHz

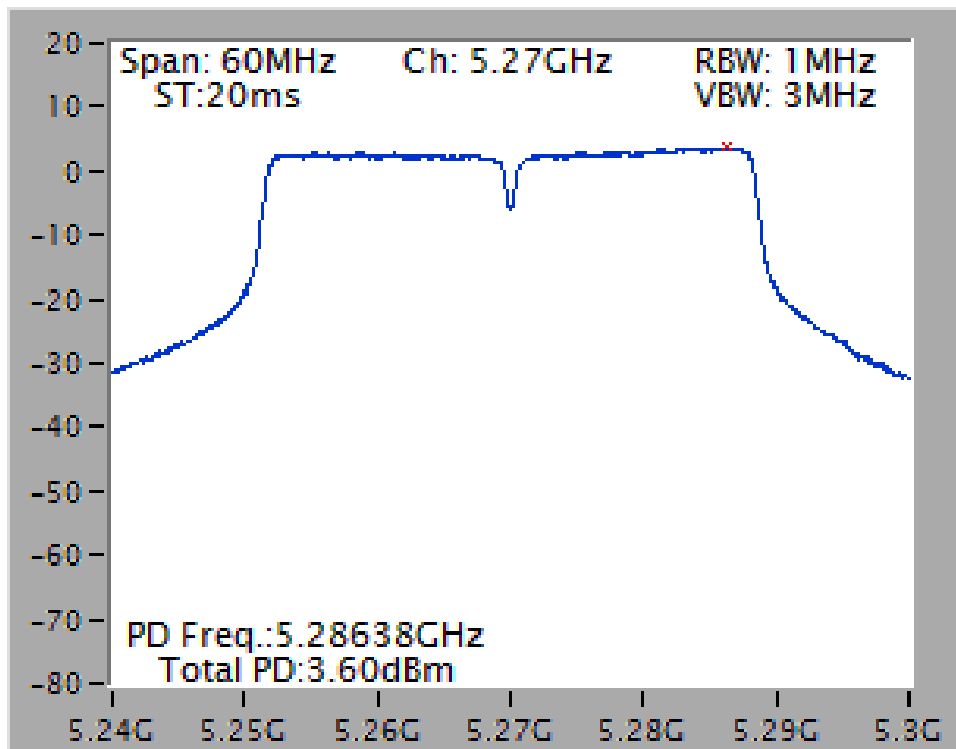

Power Density Plot on Configuration IEEE 802.11n MCS0 40MHz / Chain 1 / 5550 MHz

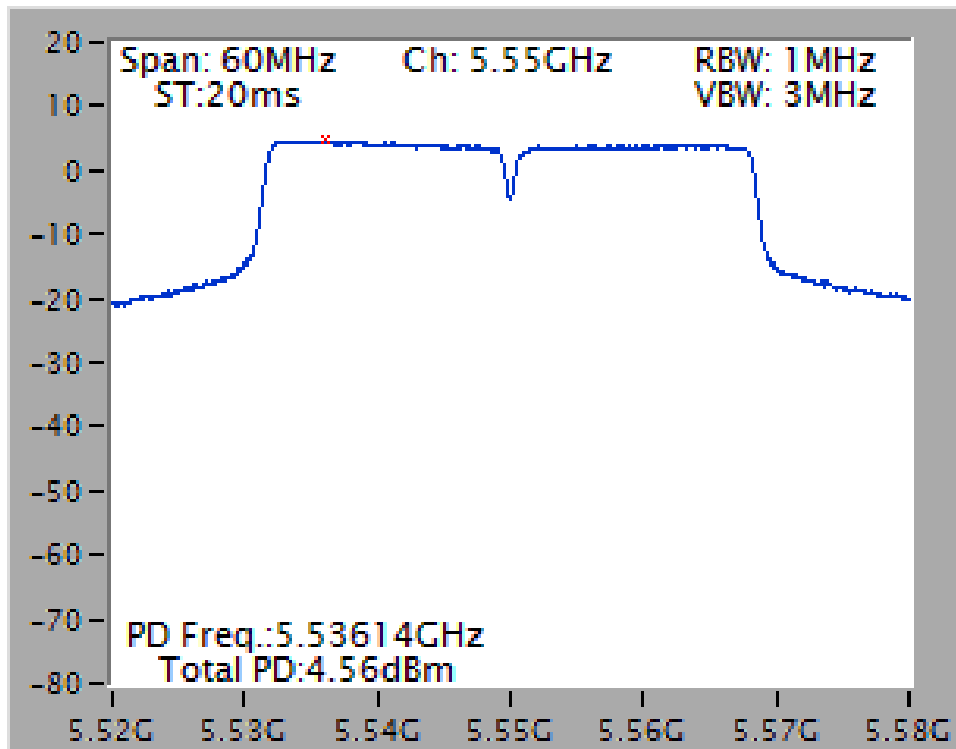

For 2TX

Power Density Plot on Configuration IEEE 802.11n MCS8 20MHz / Chain 1 + Chain 2 / 5240 MHz

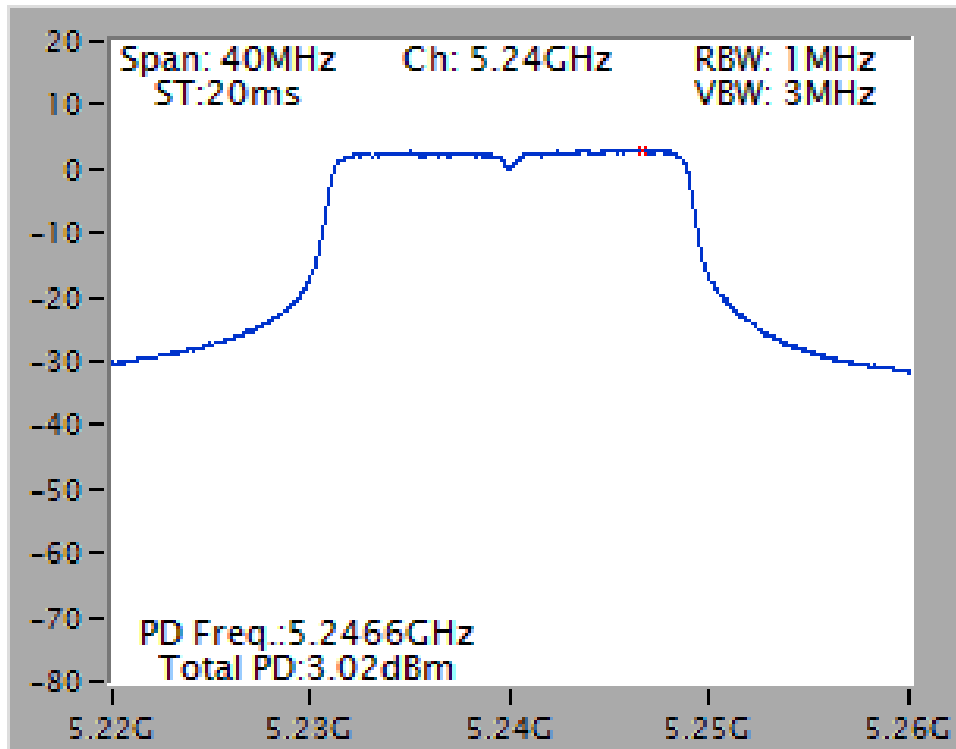

Power Density Plot on Configuration IEEE 802.11n MCS8 20MHz / Chain 1 + Chain 2 / 5300 MHz

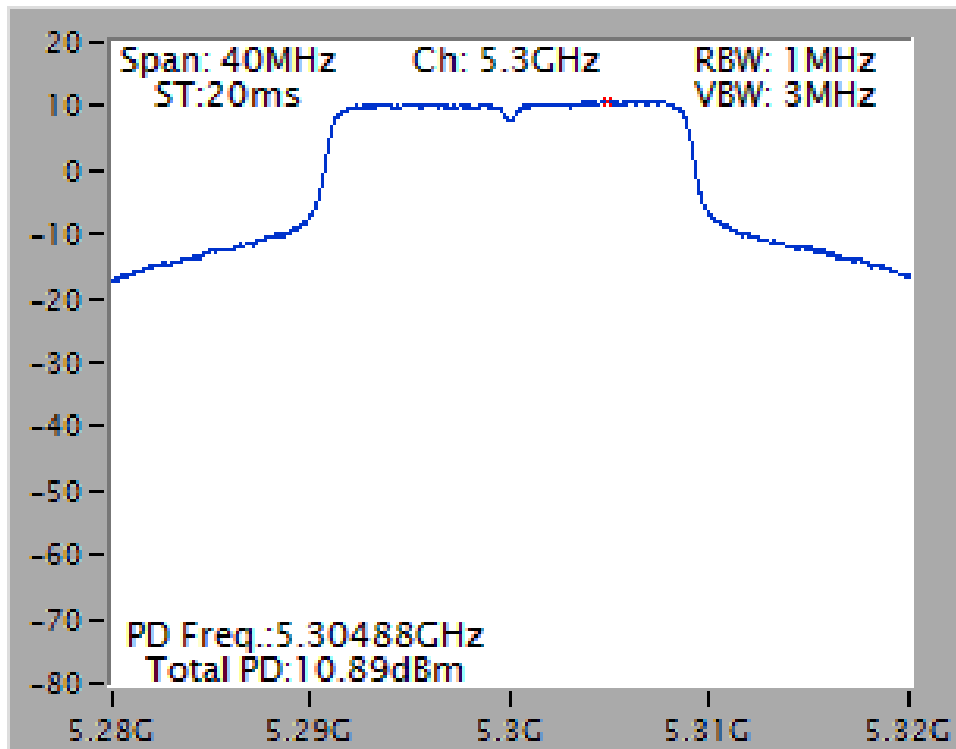

Power Density Plot on Configuration IEEE 802.11n MCS8 20MHz / Chain 1 + Chain 2 / 5580 MHz

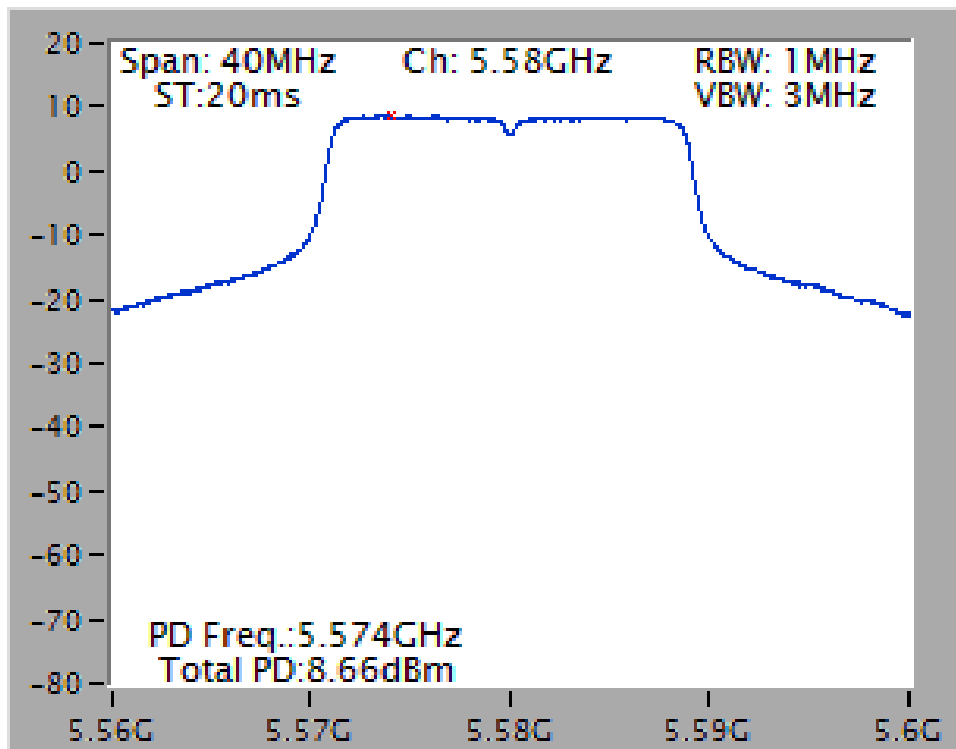

Power Density Plot on Configuration IEEE 802.11n MCS8 40MHz / Chain 1 + Chain 2 / 5230 MHz

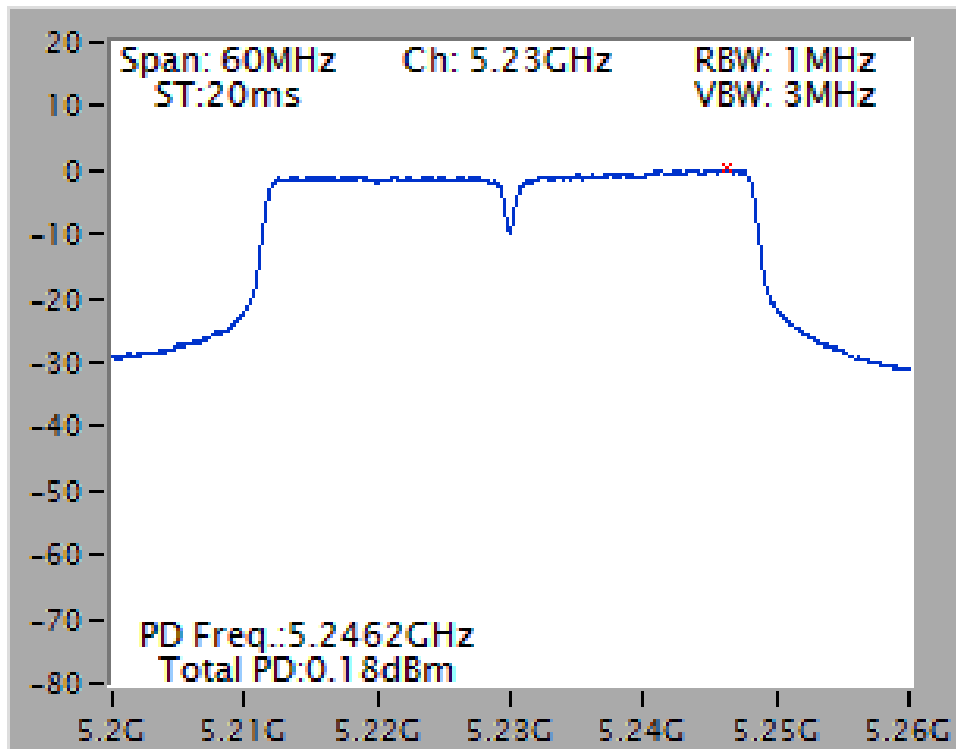

Power Density Plot on Configuration IEEE 802.11n MCS8 40MHz / Chain 1 + Chain 2 / 5270 MHz

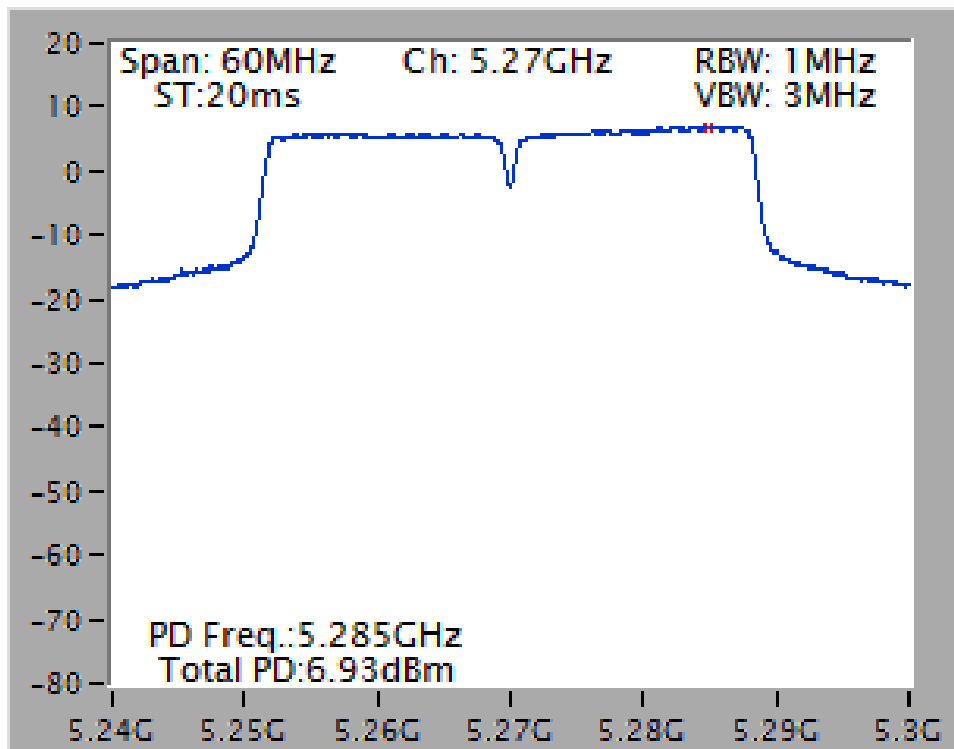

Power Density Plot on Configuration IEEE 802.11n MCS8 40MHz / Chain 1 + Chain 2 / 5550 MHz

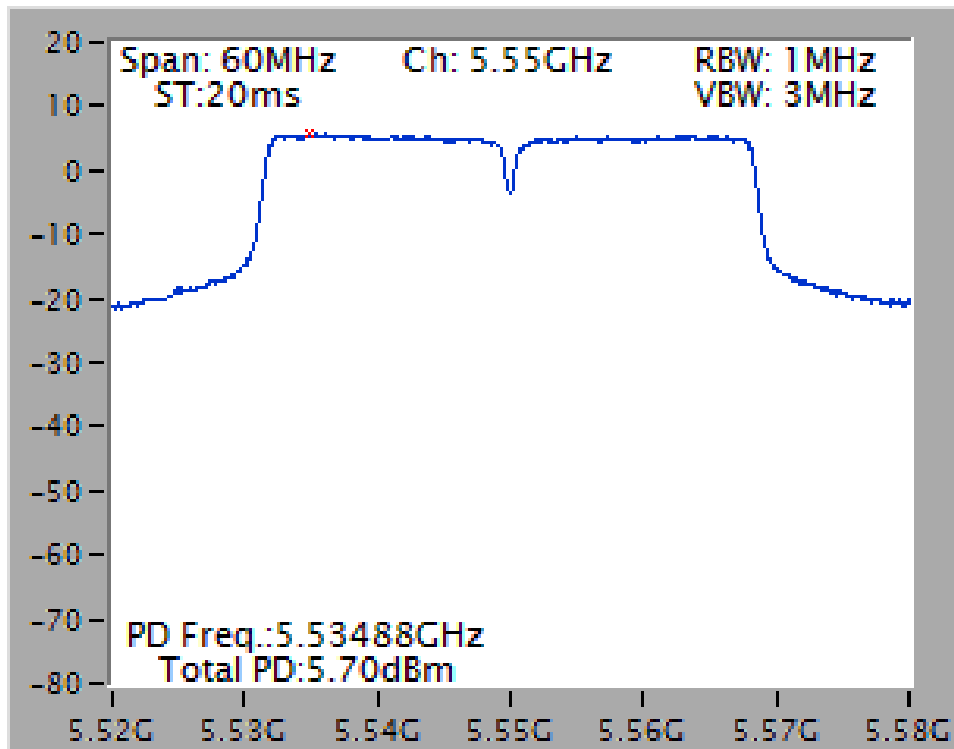

For 3TX

Power Density Plot on Configuration IEEE 802.11n MCS16 20MHz / Chain 1 + Chain 2 + Chain 3  
/ 5200 MHz

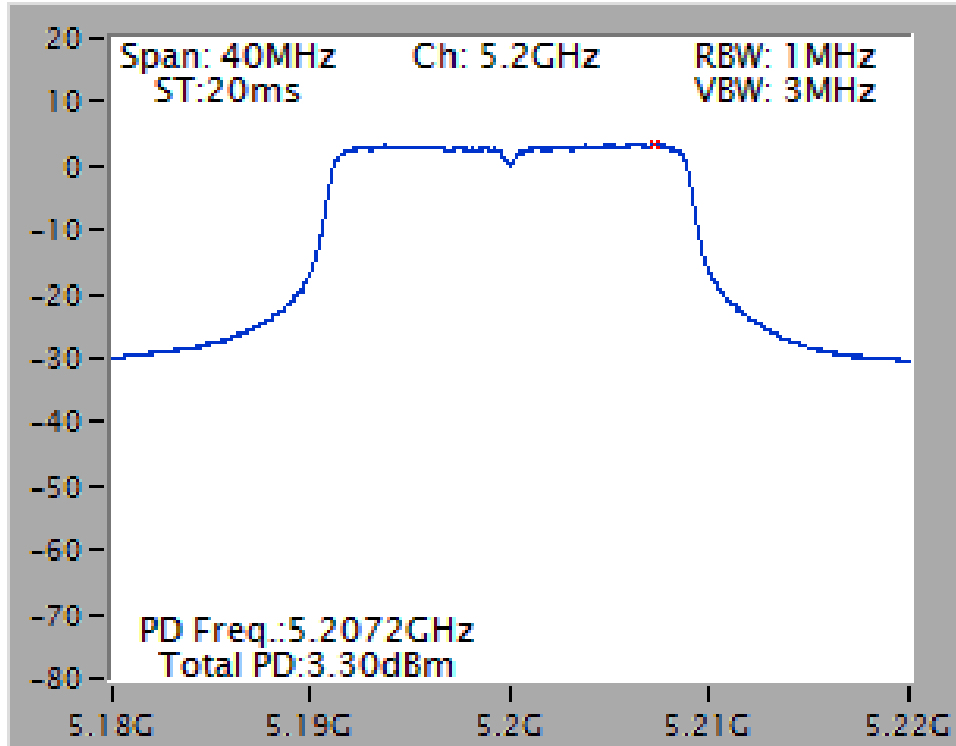

Power Density Plot on Configuration IEEE 802.11n MCS16 20MHz / Chain 1 + Chain 2 + Chain 3  
/ 5300 MHz

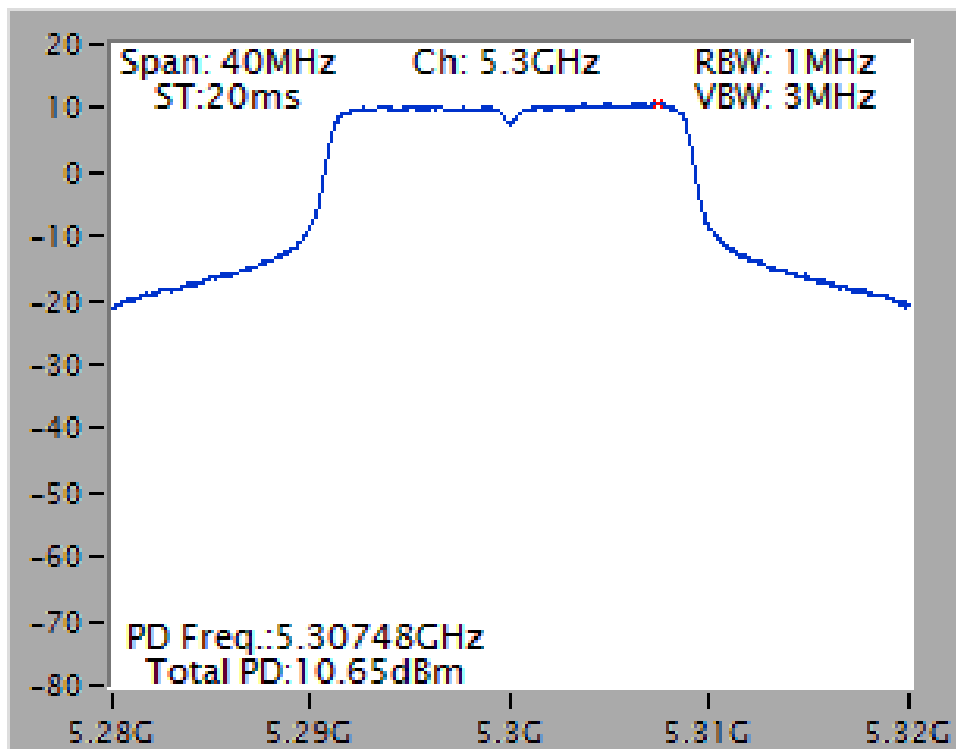

Power Density Plot on Configuration IEEE 802.11n MCS16 20MHz / Chain 1 + Chain 2 + Chain 3  
/ 5580 MHz

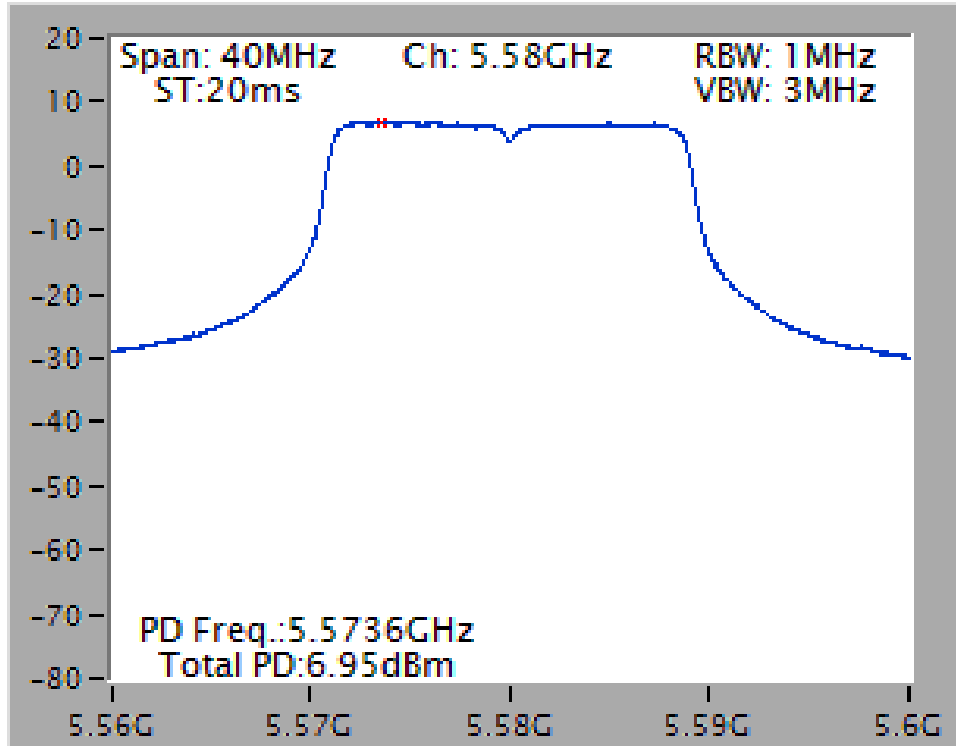

Power Density Plot on Configuration IEEE 802.11n MCS16 40MHz / Chain 1 + Chain 2 + Chain 3  
/ 5230 MHz

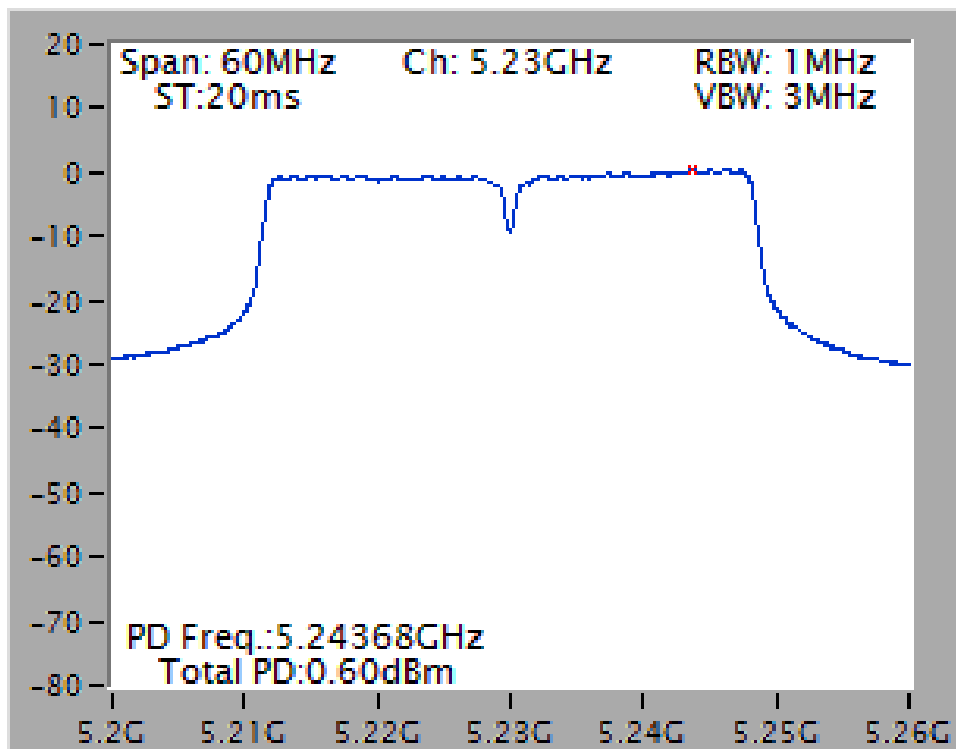



Power Density Plot on Configuration IEEE 802.11n MCS16 40MHz / Chain 1 + Chain 2 + Chain 3  
/ 5270 MHz

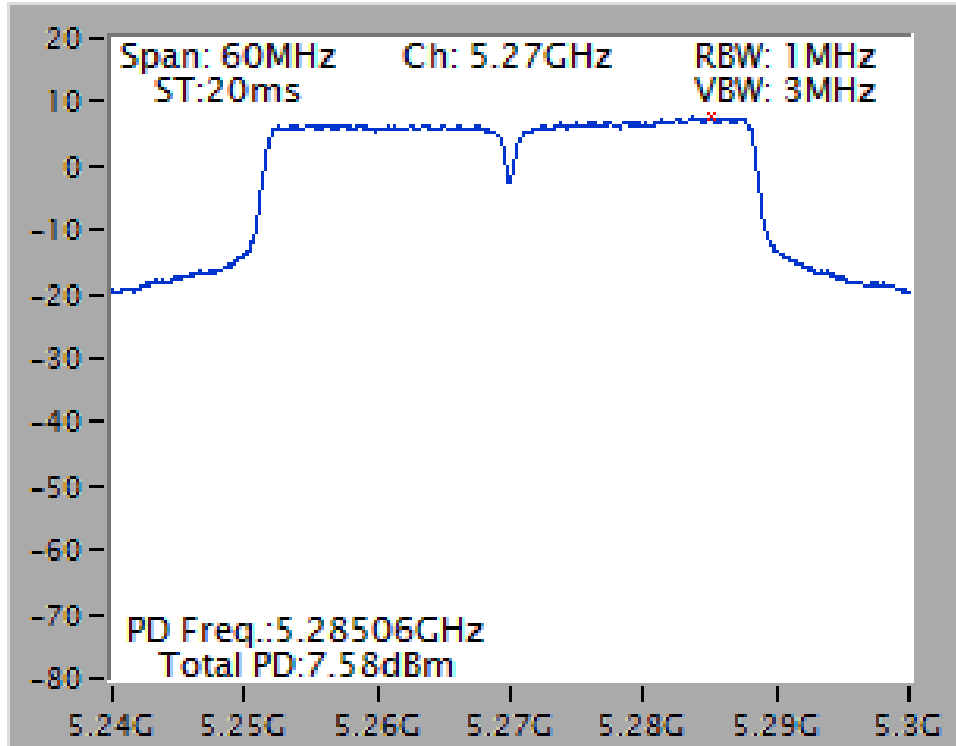

Power Density Plot on Configuration IEEE 802.11n MCS16 40MHz / Chain 1 + Chain 2 + Chain 3  
/ 5550 MHz

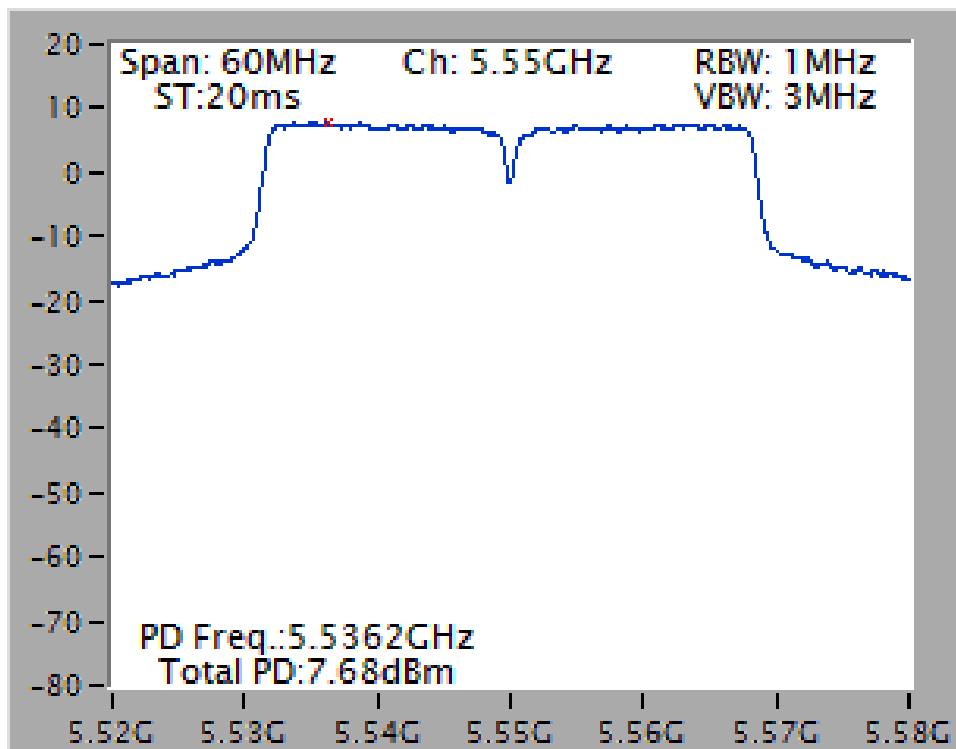

Power Density Plot on Configuration IEEE 802.11a / Chain 1 / 5180 MHz

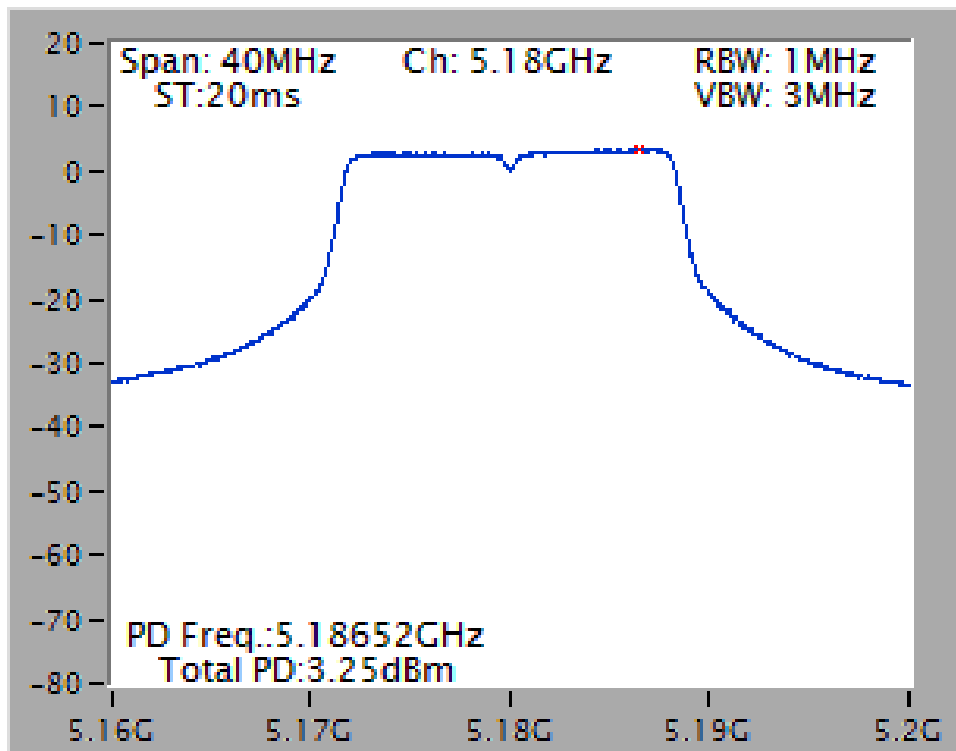

Power Density Plot on Configuration IEEE 802.11a / Chain 1 / 5260 MHz

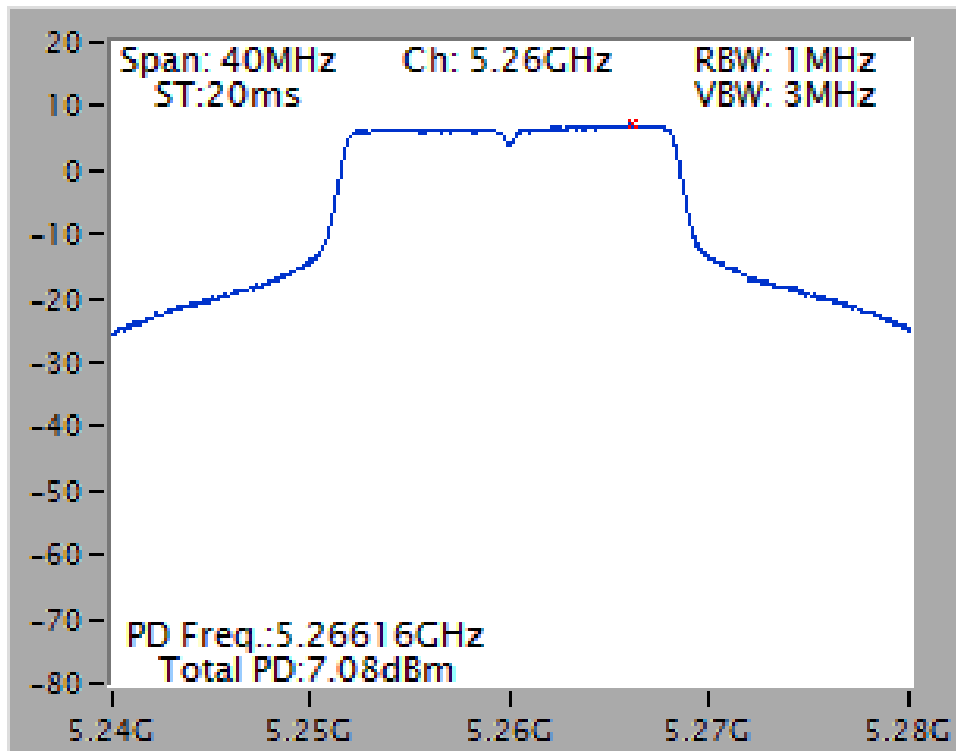

Power Density Plot on Configuration IEEE 802.11a / Chain 1 / 5580 MHz

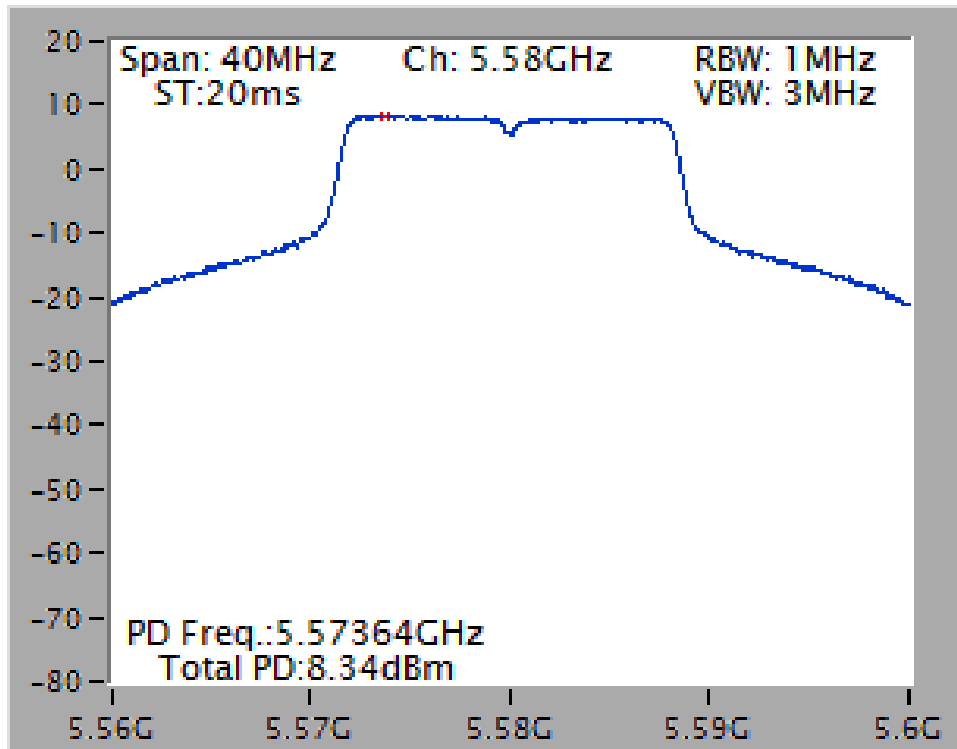

## 4.4. Peak Excursion Measurement

### 4.4.1. Limit

The ratio of the peak excursion of the modulation envelope (measured using a peak hold function) to the maximum conducted output power (measured as specified above) shall not exceed 13 dB across any 1 MHz bandwidth or the emissions bandwidth whichever is less.

### 4.4.2. Measuring Instruments and Setting

Please refer to section 5 of equipments list in this report. The following table is the setting of the spectrum analyzer.

Spectrum Parameter	Setting
Attenuation	Auto
Span Frequency	Encompass the entire emissions bandwidth (EBW) of the signal
RBW	1 MHz (Peak Trace) / 1 MHz (Average Trace)
VBW	≥ 3 MHz (Peak Trace) / ≥ 3 MHz (Average Trace)
Detector	Peak (Peak Trace) / RMS (Average Trace)
Trace	Trace: Max hold (Peak Trace) / Trace Average Sweep Count 100 (Average Trace)
Sweep Time	AUTO

### 4.4.3. Test Procedures

1. Trace A, Set RBW = 1MHz, VBW = 3MHz, Span >26dB bandwidth, Max. hold.
2. Delta Mark trace A Maximum frequency and trace B same frequency.
3. Repeat the above procedure until measurements for all frequencies were complete.
4. Testing each modulation mode on a single channel in single operating band at single output port.  
All signal types need test (DSSS, OFDM). All modulation types need test (BPSK, QPSK, 16-QAM, 64-QAM). All bandwidth modes need test.

### 4.4.4. Test Setup Layout

This test setup layout is the same as that shown in section 4.3.4.

### 4.4.5. Test Deviation

There is no deviation with the original standard.

### 4.4.6. EUT Operation during Test

The EUT was programmed to be in continuously transmitting mode.

#### 4.4.7. Test Result of Peak Excursion

<b>Temperature</b>	24°C	<b>Humidity</b>	61%
<b>Test Engineer</b>	Kenneth Huang	<b>Configurations</b>	IEEE 802.11n

For 1TX

Configuration IEEE 802.11n 20MHz / Chain 1

Modulation	Frequency	Peak Excursion (dB)	Max. Limit (dB)	Result
BPSK (MCS0)	5200MHz	8.92	13	Complies
QPSK (MCS1)	5200MHz	8.65	13	Complies
16QAM (MCS3)	5200MHz	9.27	13	Complies
64QAM (MCS5)	5200MHz	10.19	13	Complies
BPSK (MCS0)	5300MHz	8.52	13	Complies
QPSK (MCS1)	5300MHz	8.56	13	Complies
16QAM (MCS3)	5300MHz	8.92	13	Complies
64QAM (MCS5)	5300MHz	8.85	13	Complies
BPSK (MCS0)	5580MHz	8.96	13	Complies
QPSK (MCS1)	5580MHz	8.28	13	Complies
16QAM (MCS3)	5580MHz	9.80	13	Complies
64QAM (MCS5)	5580MHz	9.58	13	Complies

**Configuration IEEE 802.11n 40MHz / Chain 1**

Modulation	Frequency	Peak Excursion (dB)	Max. Limit (dB)	Result
BPSK (MCS0)	5230MHz	8.50	13	Complies
QPSK (MCS1)	5230MHz	8.68	13	Complies
16QAM (MCS3)	5230MHz	10.39	13	Complies
64QAM (MCS5)	5230MHz	9.77	13	Complies
BPSK (MCS0)	5270MHz	8.40	13	Complies
QPSK (MCS1)	5270MHz	9.02	13	Complies
16QAM (MCS3)	5270MHz	9.00	13	Complies
64QAM (MCS5)	5270MHz	9.26	13	Complies
BPSK (MCS0)	5550MHz	8.92	13	Complies
QPSK (MCS1)	5550MHz	9.02	13	Complies
16QAM (MCS3)	5550MHz	9.42	13	Complies
64QAM (MCS5)	5550MHz	10.28	13	Complies



For 2TX

Configuration IEEE 802.11n 20MHz / Chain 1 + Chain 2

Modulation	Frequency	Peak Excursion (dB)	Max. Limit (dB)	Result
BPSK (MCS8)	5180MHz	10.04	13	Complies
QPSK (MCS9)	5180MHz	10.30	13	Complies
16QAM (MCS11)	5180MHz	10.15	13	Complies
64QAM (MCS13)	5180MHz	10.27	13	Complies
BPSK (MCS8)	5300MHz	9.10	13	Complies
QPSK (MCS9)	5300MHz	9.26	13	Complies
16QAM (MCS11)	5300MHz	9.56	13	Complies
64QAM (MCS13)	5300MHz	10.15	13	Complies
BPSK (MCS8)	5580MHz	9.57	13	Complies
QPSK (MCS9)	5580MHz	9.33	13	Complies
16QAM (MCS11)	5580MHz	10.18	13	Complies
64QAM (MCS13)	5580MHz	10.35	13	Complies

**Configuration IEEE 802.11n 40MHz / Chain 1 + Chain 2**

Modulation	Frequency	Peak Excursion (dB)	Max. Limit (dB)	Result
BPSK (MCS8)	5230MHz	9.41	13	Complies
QPSK (MCS9)	5230MHz	10.90	13	Complies
16QAM (MCS11)	5230MHz	9.75	13	Complies
64QAM (MCS13)	5230MHz	10.02	13	Complies
BPSK (MCS8)	5270MHz	9.20	13	Complies
QPSK (MCS9)	5270MHz	9.95	13	Complies
16QAM (MCS11)	5270MHz	10.32	13	Complies
64QAM (MCS13)	5270MHz	9.62	13	Complies
BPSK (MCS8)	5550MHz	9.54	13	Complies
QPSK (MCS9)	5550MHz	9.60	13	Complies
16QAM (MCS11)	5550MHz	9.58	13	Complies
64QAM (MCS13)	5550MHz	10.03	13	Complies

For 3TX

Configuration IEEE 802.11n 20MHz / Chain 1 + Chain 2 + Chain 3

Modulation	Frequency	Peak Excursion (dB)	Max. Limit (dB)	Result
BPSK (MCS16)	5180MHz	8.86	13	Complies
QPSK (MCS17)	5180MHz	9.19	13	Complies
16QAM (MCS19)	5180MHz	9.72	13	Complies
64QAM (MCS21)	5180MHz	10.30	13	Complies
BPSK (MCS16)	5300MHz	10.02	13	Complies
QPSK (MCS17)	5300MHz	10.52	13	Complies
16QAM (MCS19)	5300MHz	9.99	13	Complies
64QAM (MCS21)	5300MHz	10.16	13	Complies
BPSK (MCS16)	5580MHz	9.91	13	Complies
QPSK (MCS17)	5580MHz	10.24	13	Complies
16QAM (MCS19)	5580MHz	9.92	13	Complies
64QAM (MCS21)	5580MHz	10.31	13	Complies

**Configuration IEEE 802.11n 40MHz / Chain 1 + Chain 2 + Chain 3**

Modulation	Frequency	Peak Excursion (dB)	Max. Limit (dB)	Result
BPSK (MCS16)	5230MHz	8.77	13	Complies
QPSK (MCS17)	5230MHz	8.28	13	Complies
16QAM (MCS19)	5230MHz	9.28	13	Complies
64QAM (MCS21)	5230MHz	8.83	13	Complies
BPSK (MCS16)	5270MHz	8.59	13	Complies
QPSK (MCS17)	5270MHz	9.27	13	Complies
16QAM (MCS19)	5270MHz	9.05	13	Complies
64QAM (MCS21)	5270MHz	8.74	13	Complies
BPSK (MCS16)	5550MHz	9.26	13	Complies
QPSK (MCS17)	5550MHz	9.37	13	Complies
16QAM (MCS19)	5550MHz	9.97	13	Complies
64QAM (MCS21)	5550MHz	9.66	13	Complies

<b>Temperature</b>	24°C	<b>Humidity</b>	61%
<b>Test Engineer</b>	Kenneth Huang	<b>Configurations</b>	IEEE 802.11a

**Configuration IEEE 802.11a / Chain 1**

Modulation	Frequency	Peak Excursion (dB)	Max. Limit (dB)	Result
BPSK (6Mbps)	5240MHz	8.50	13	Complies
QPSK (12Mbps)	5240MHz	9.70	13	Complies
16QAM (24Mbps)	5240MHz	9.45	13	Complies
64QAM (48Mbps)	5240MHz	9.42	13	Complies
BPSK (6Mbps)	5260MHz	8.45	13	Complies
QPSK (12Mbps)	5260MHz	9.26	13	Complies
16QAM (24Mbps)	5260MHz	9.53	13	Complies
64QAM (48Mbps)	5260MHz	9.59	13	Complies
BPSK (6Mbps)	5580MHz	8.84	13	Complies
QPSK (12Mbps)	5580MHz	10.26	13	Complies
16QAM (24Mbps)	5580MHz	9.68	13	Complies
64QAM (48Mbps)	5580MHz	9.78	13	Complies

Note: All the test values were listed in the report.

For plots, only the modulation with worse result was shown.

For ITX

Peak Excursion Plot on Configuration IEEE 802.11n 20MHz / Chain 1 / 64QAM (MCS5) / 5200 MHz

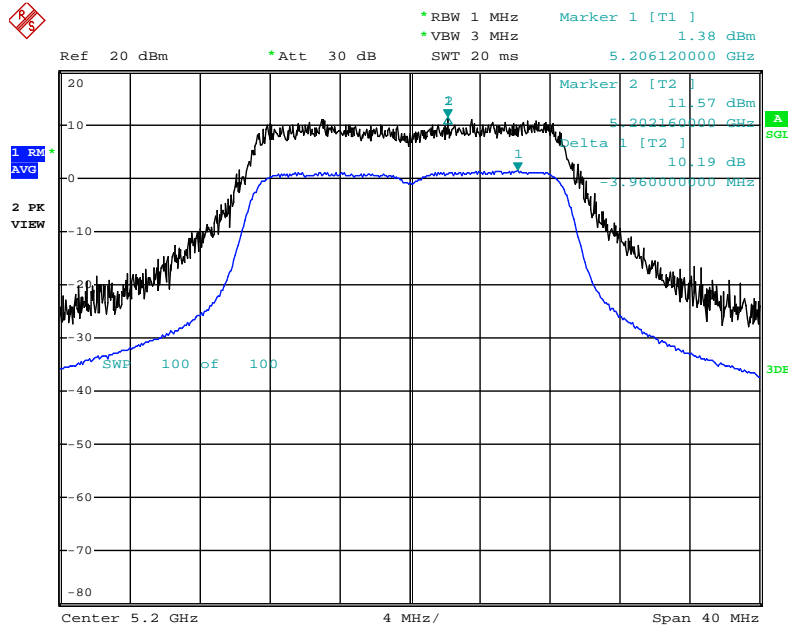

Date: 18.SEP.2013 12:30:08

Peak Excursion Plot on Configuration IEEE 802.11n 20MHz / Chain 1 / 16QAM (MCS3) / 5300 MHz

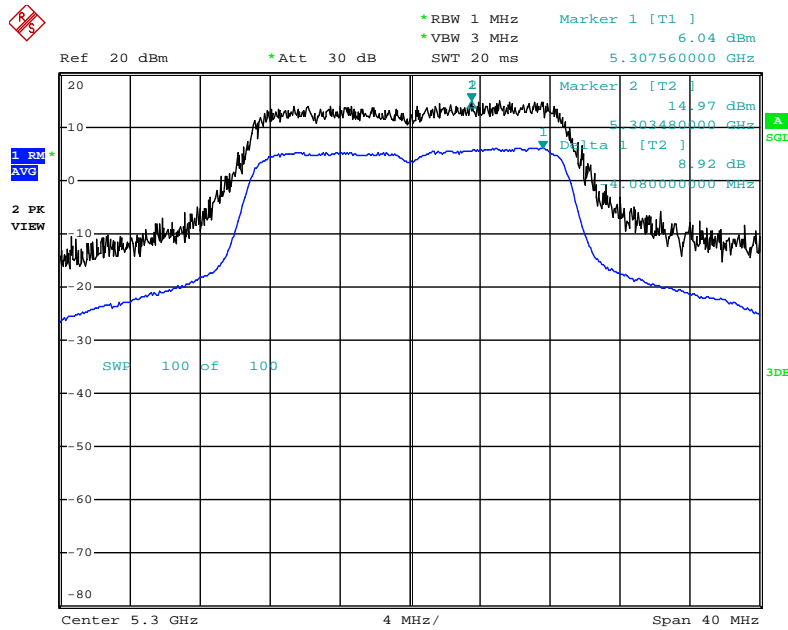

Date: 18.SEP.2013 12:31:34



Peak Excursion Plot on Configuration IEEE 802.11n 20MHz / Chain 1 / 16QAM (MCS3) / 5580 MHz

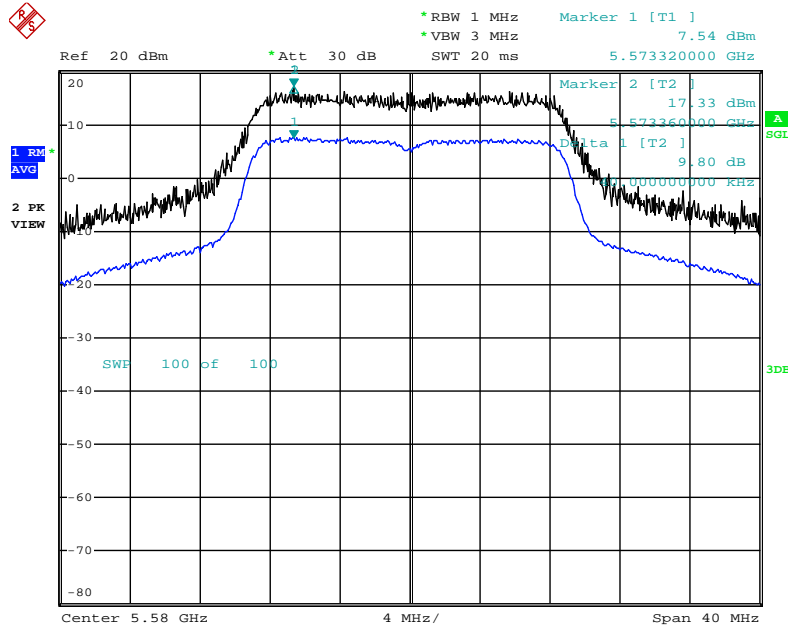

Date: 18.SEP.2013 12:34:52

Peak Excursion Plot on Configuration IEEE 802.11n 40MHz / Chain 1 / 16QAM (MCS3) / 5230 MHz

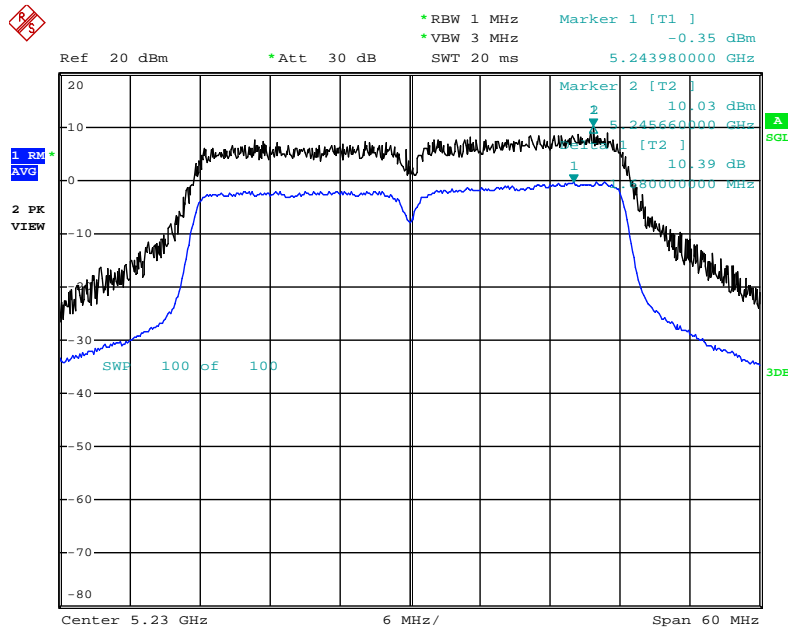

Date: 18.SEP.2013 12:41:08

Peak Excursion Plot on Configuration IEEE 802.11n 40MHz / Chain 1 / 64QAM (MCS5) / 5270 MHz

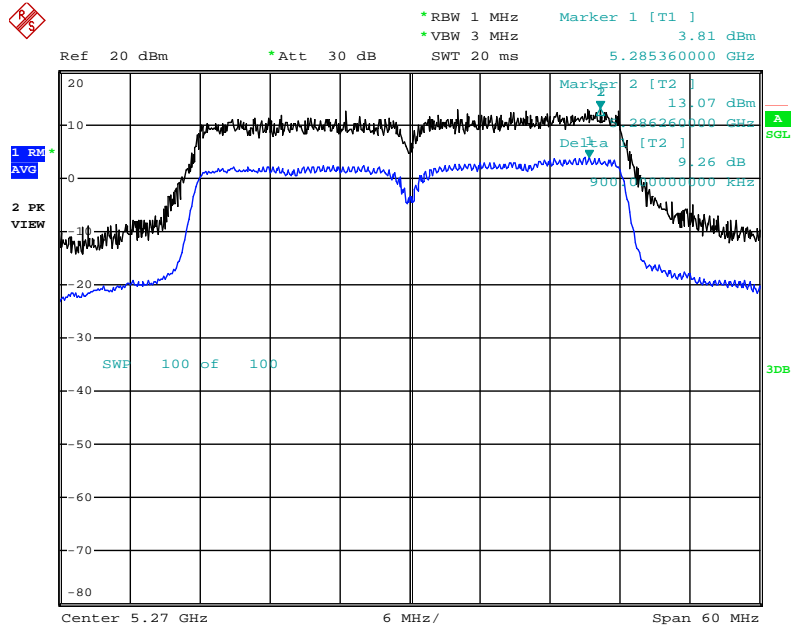

Date: 18.SEP.2013 12:42:27

Peak Excursion Plot on Configuration IEEE 802.11n 40MHz / Chain 1 / 64QAM (MCS5) / 5550 MHz

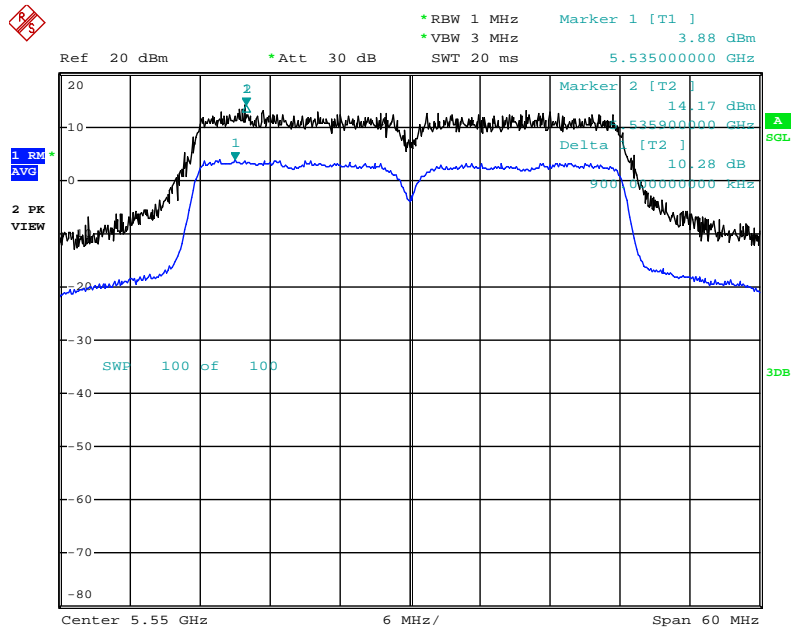

Date: 18.SEP.2013 12:38:35

For 2TX

Peak Excursion Plot on Configuration IEEE 802.11n 20MHz / Chain 1 + Chain 2 / QPSK (MCS9)  
/ 5180 MHz

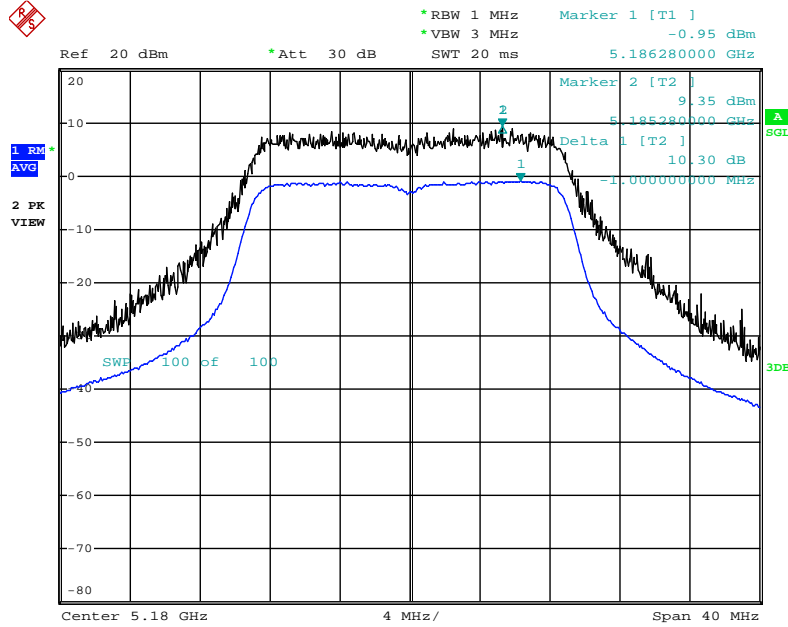

Date: 18.SEP.2013 12:49:42

Peak Excursion Plot on Configuration IEEE 802.11n 20MHz / Chain 1 + Chain 2 / 64QAM (MCS13)  
/ 5300 MHz

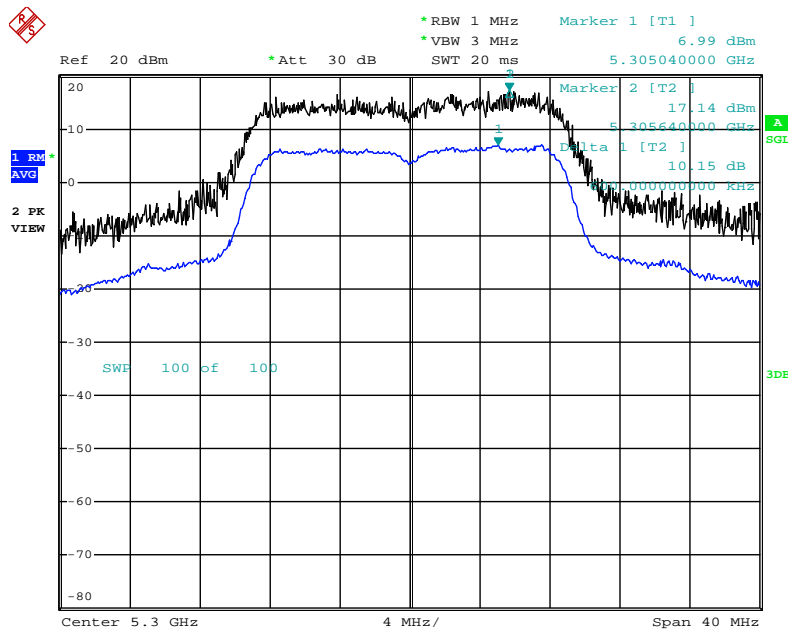

Date: 18.SEP.2013 12:53:09

**Peak Excursion Plot on Configuration IEEE 802.11n 20MHz / Chain 1 + Chain 2 / 64QAM (MCS13)  
/ 5580 MHz**

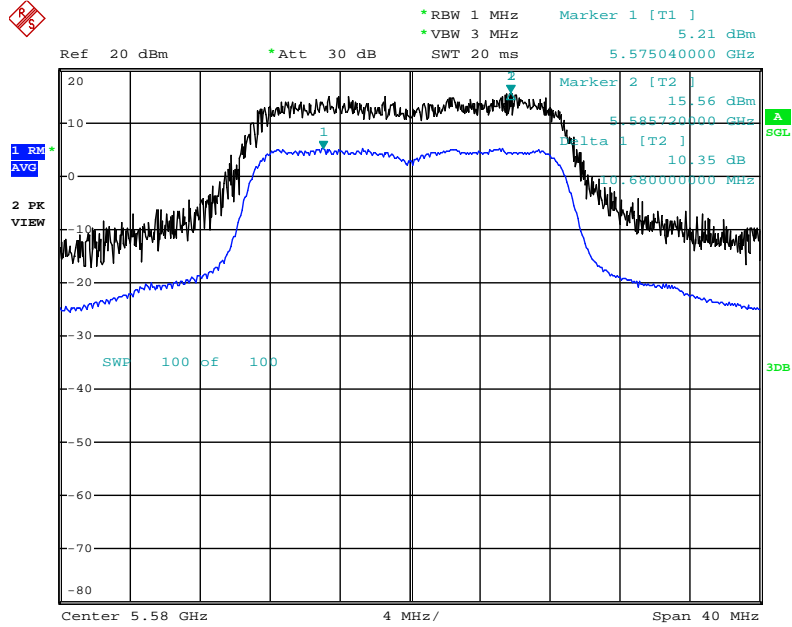

Date: 18.SEP.2013 12:57:26

**Peak Excursion Plot on Configuration IEEE 802.11n 40MHz / Chain 1 + Chain 2 / QPSK (MCS9)  
/ 5230 MHz**

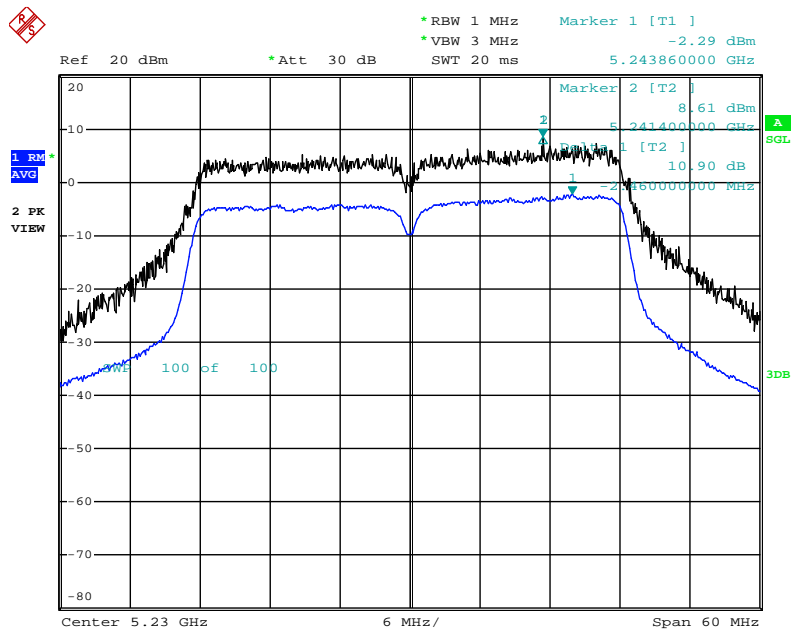

Date: 18.SEP.2013 13:02:34

**Peak Excursion Plot on Configuration IEEE 802.11n 40MHz / Chain 1 + Chain 2 / 16QAM (MCS11)  
/ 5270 MHz**

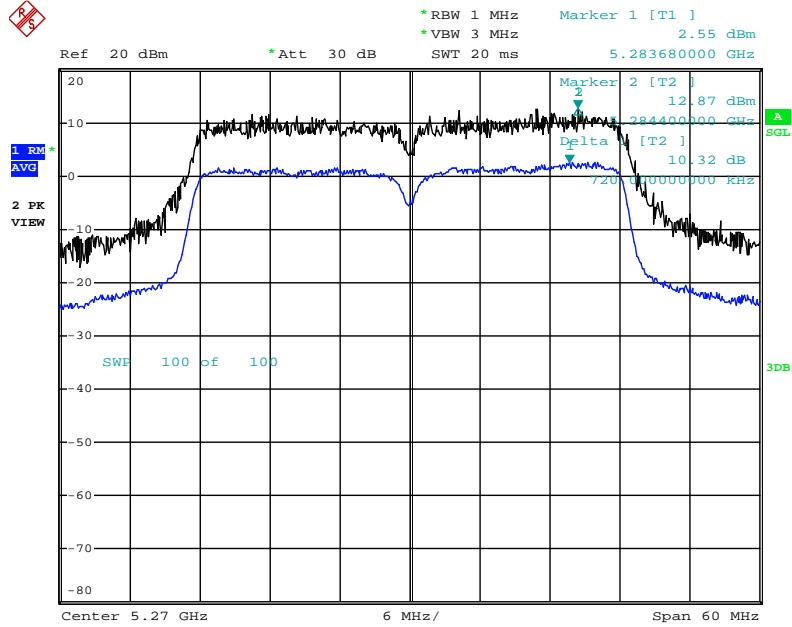

Date: 18.SEP.2013 13:05:13

**Peak Excursion Plot on Configuration IEEE 802.11n 40MHz / Chain 1 + Chain 2 / 64QAM (MCS13)  
/ 5550 MHz**

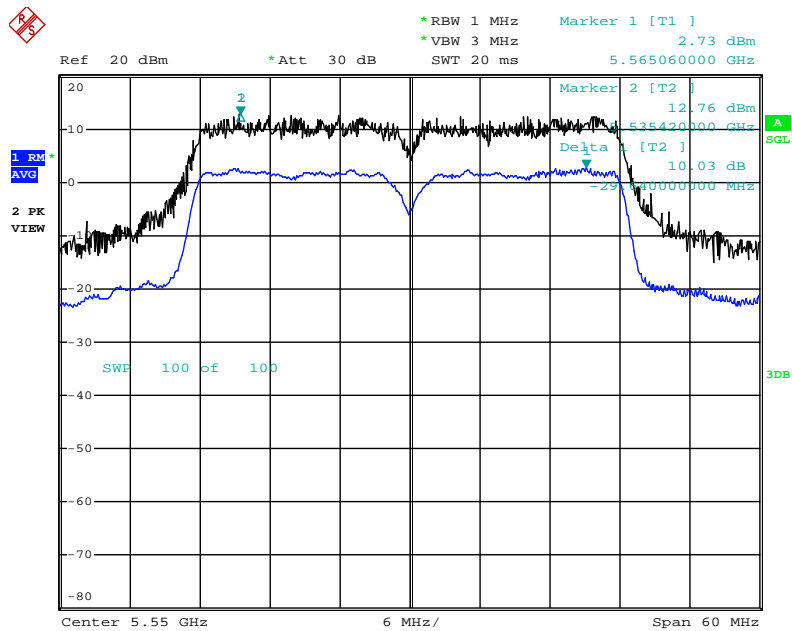

Date: 18.SEP.2013 12:59:52

For 3TX

Peak Excursion Plot on Configuration IEEE 802.11n 20MHz / Chain 1 + Chain 2 + Chain 3  
/ 64QAM (MCS21) / 5180 MHz

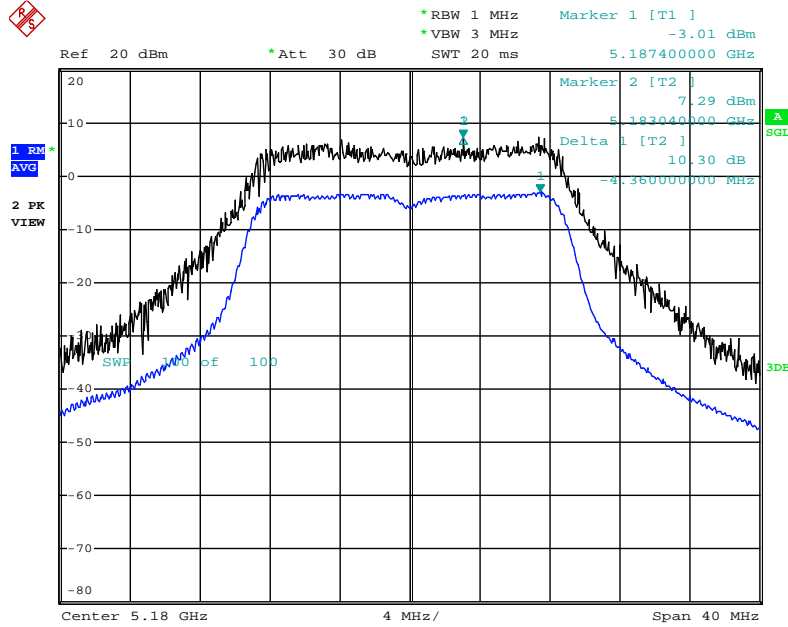

Date: 18.SEP.2013 13:12:37

Peak Excursion Plot on Configuration IEEE 802.11n 20MHz / Chain 1 + Chain 2 + Chain 3  
/ QPSK (MCS17) / 5300 MHz

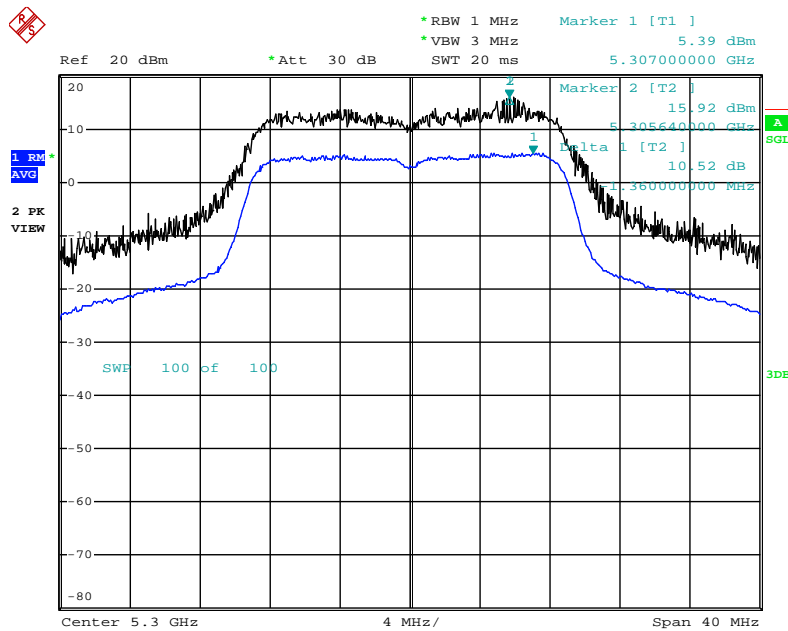

Date: 18.SEP.2013 13:14:33

**Peak Excursion Plot on Configuration IEEE 802.11n 20MHz / Chain 1 + Chain 2 + Chain 3  
/ 64QAM (MCS21) / 5580 MHz**

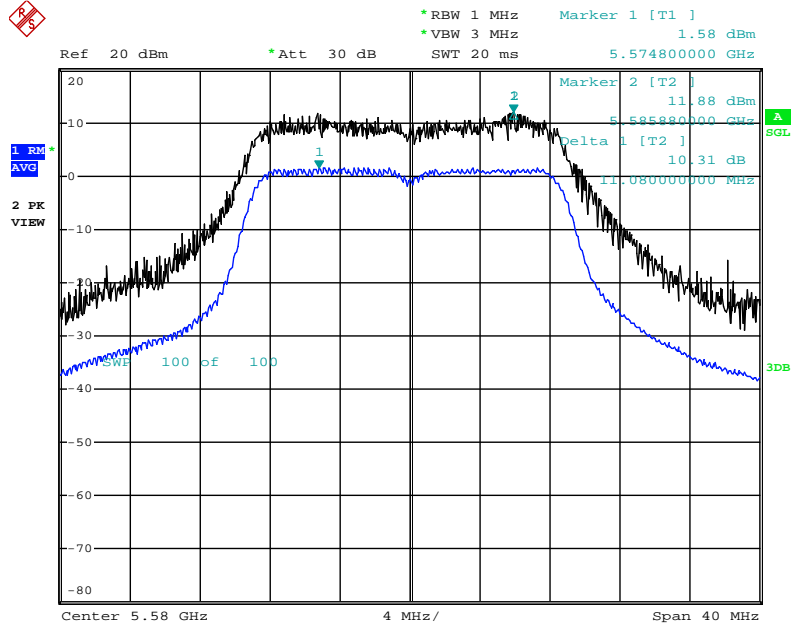

Date: 18.SEP.2013 13:16:31

**Peak Excursion Plot on Configuration IEEE 802.11n 40MHz / Chain 1 + Chain 2 + Chain 3  
/ 16QAM (MCS19) / 5230 MHz**

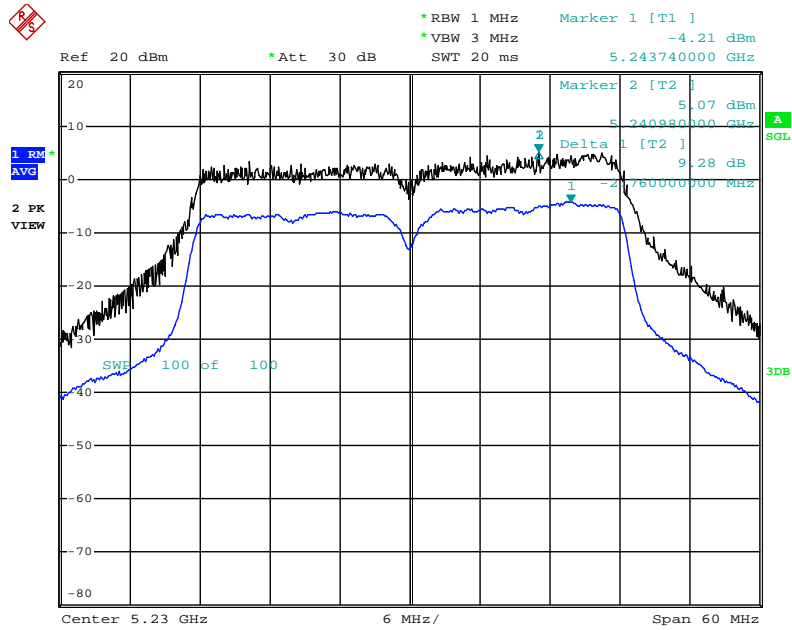

Date: 18.SEP.2013 13:24:12

**Peak Excursion Plot on Configuration IEEE 802.11n 40MHz / Chain 1 + Chain 2 + Chain 3  
/ QPSK (MCS17) / 5270 MHz**

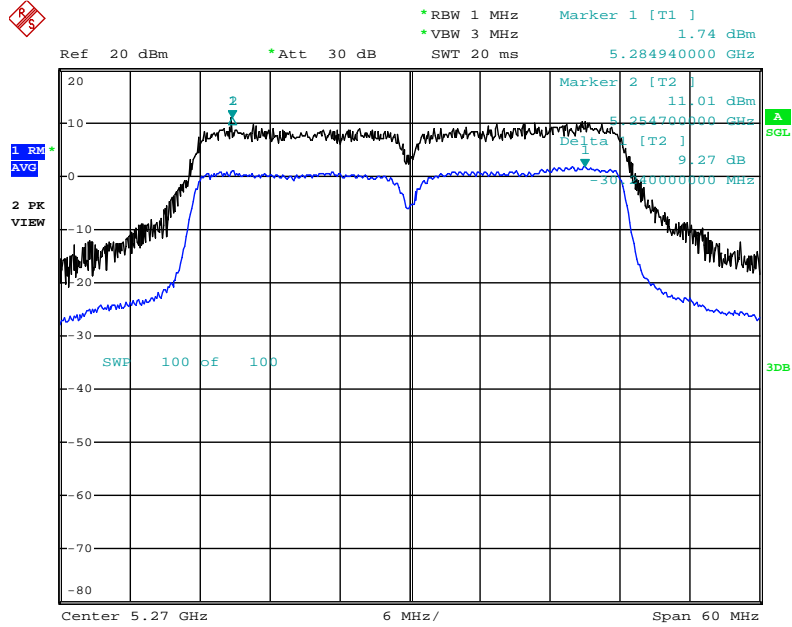

Date: 18.SEP.2013 13:26:51

**Peak Excursion Plot on Configuration IEEE 802.11n 40MHz / Chain 1 + Chain 2 + Chain 3  
/ 16QAM (MCS19) / 5550 MHz**

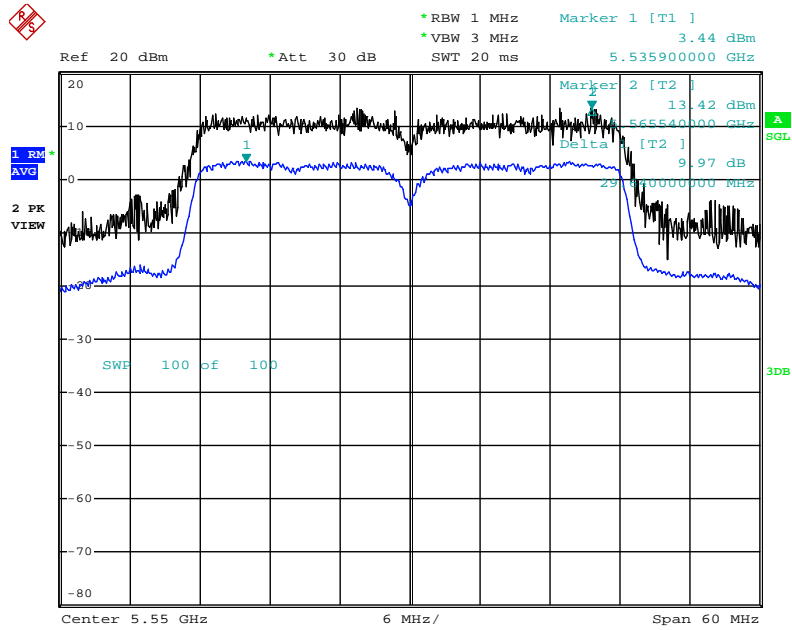

Date: 18.SEP.2013 13:21:43



Peak Excursion Plot on Configuration IEEE 802.11a / Chain 1 / QPSK (12Mbps) / 5240 MHz

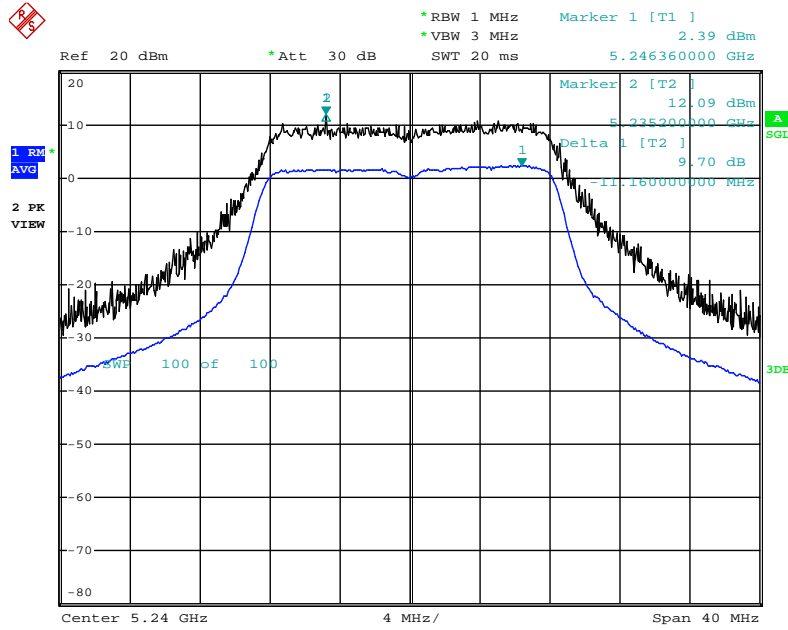

Date: 18.SEP.2013 12:11:35

Peak Excursion Plot on Configuration IEEE 802.11a / Chain 1 / 64QAM (48Mbps) / 5260 MHz

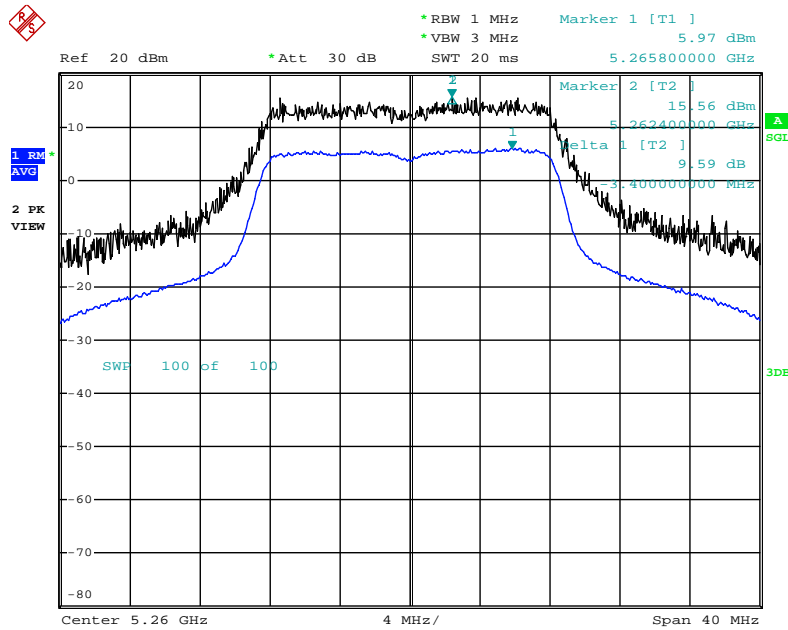

Date: 18.SEP.2013 12:13:41

Peak Excursion Plot on Configuration IEEE 802.11a / Chain 1 / QPSK (12Mbps) / 5580 MHz

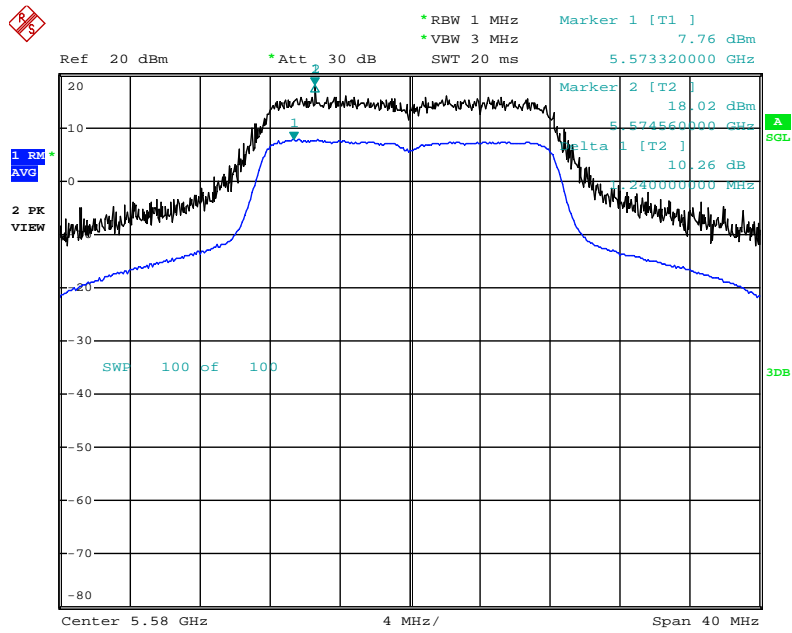

Date: 18.SEP.2013 12:23:49

## 4.5. Radiated Emissions Measurement

### 4.5.1. Limit

For transmitters operating in the 5.15-5.35 GHz band: all emissions outside of the 5.15-5.35 GHz band shall not exceed a -27dBm peak limit or average 54dBuV/m and peak 74dBuV/m limits. For transmitters operating in the 5.470-5.725 GHz band: all emissions outside of the 5.470-5.725 GHz band shall not exceed a -27dBm peak limit or average 54dBuV/m and peak 74dBuV/m limits. For transmitters operating in the 5.725-5.825 GHz band: all emissions within the frequency range from the band edge to 10 MHz above or below the band edge shall not exceed an EIRP of -17 dBm/MHz (78.3dBuV/m at 3m). In addition, In case the emission fall within the restricted band specified on 15.205(a), then the 15.209(a) limit in the table below has to be followed.

Frequencies (MHz)	Field Strength (micorvolts/meter)	Measurement Distance (meters)
0.009~0.490	2400/F(kHz)	300
0.490~1.705	24000/F(kHz)	30
1.705~30.0	30	30
30~88	100	3
88~216	150	3
216~960	200	3
Above 960	500	3

### 4.5.2. Measuring Instruments and Setting

Please refer to section 5 of equipments list in this report. The following table is the setting of spectrum analyzer and receiver.

Spectrum Parameter	Setting
Attenuation	Auto
Start Frequency	1000 MHz
Stop Frequency	40 GHz
RBW / VBW (Emission in restricted band)	1 MHz / 3MHz for Peak, 1MHz / 10Hz for Average
RBW / VBW (Emission in non-restricted band)	1MHz / 3MHz for peak

Receiver Parameter	Setting
Attenuation	Auto
Start ~ Stop Frequency	9kHz~150kHz / RBW 200Hz for QP
Start ~ Stop Frequency	150kHz~30MHz / RBW 9kHz for QP
Start ~ Stop Frequency	30MHz~1000MHz / RBW 120kHz for QP

### 4.5.3. Test Procedures

1. Configure the EUT according to ANSI C63.10. The EUT was placed on the top of the turntable 0.8 meter above ground. The phase center of the receiving antenna mounted on the top of a height-variable antenna tower was placed 3 meters far away from the turntable.
2. Power on the EUT and all the supporting units. The turntable was rotated by 360 degrees to determine the position of the highest radiation.
3. The height of the broadband receiving antenna was varied between one meter and four meters above ground to find the maximum emissions field strength of both horizontal and vertical polarization.
4. For each suspected emissions, the antenna tower was scan (from 1 M to 4 M) and then the turntable was rotated (from 0 degree to 360 degrees) to find the maximum reading.
5. Set the test-receiver system to Peak or CISPR quasi-peak Detect Function with specified bandwidth under Maximum Hold Mode.
6. For emissions above 1GHz, use 1MHz VBW and RBW for peak reading. Then 1MHz RBW and 10Hz VBW for average reading in spectrum analyzer.
7. When the radiated emissions limits are expressed in terms of the average value of the emissions, and pulsed operation is employed, the measurement field strength shall be determined by averaging over one complete pulse train, including blanking intervals, as long as the pulse train does not exceed 0.1 seconds. As an alternative (provided the transmitter operates for longer than 0.1 seconds) or in cases where the pulse train exceeds 0.1 seconds, the measured field strength shall be determined from the average absolute voltage during a 0.1 second interval during which the field strength is at its maximum value.
8. If the emissions level of the EUT in peak mode was 3 dB lower than the average limit specified, then testing will be stopped and peak values of EUT will be reported, otherwise, the emissions which do not have 3 dB margin will be repeated one by one using the quasi-peak method for below 1GHz.
9. For testing above 1GHz, the emissions level of the EUT in peak mode was lower than average limit (that means the emissions level in peak mode also complies with the limit in average mode), then testing will be stopped and peak values of EUT will be reported, otherwise, the emissions will be measured in average mode again and reported.
10. In case the emission is lower than 30MHz, loop antenna has to be used for measurement and the recorded data should be QP measured by receiver. High – Low scan is not required in this case.

#### 4.5.4. Test Setup Layout

For Radiated Emissions: 9kHz ~30MHz

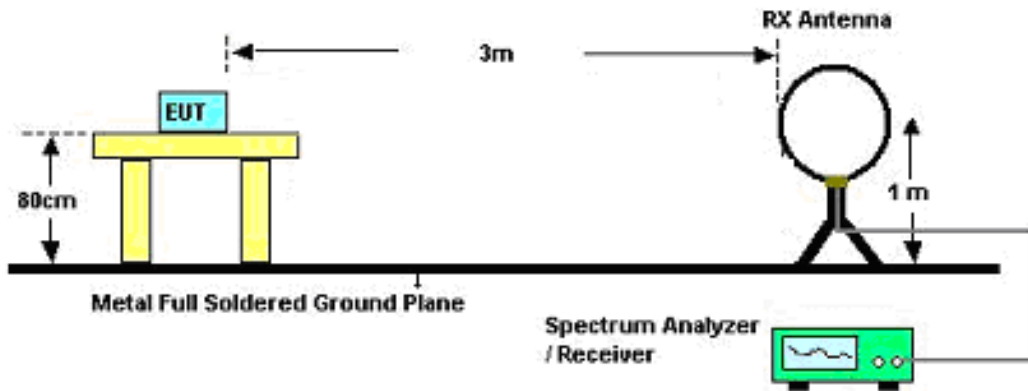

For Radiated Emissions: 30MHz~1GHz

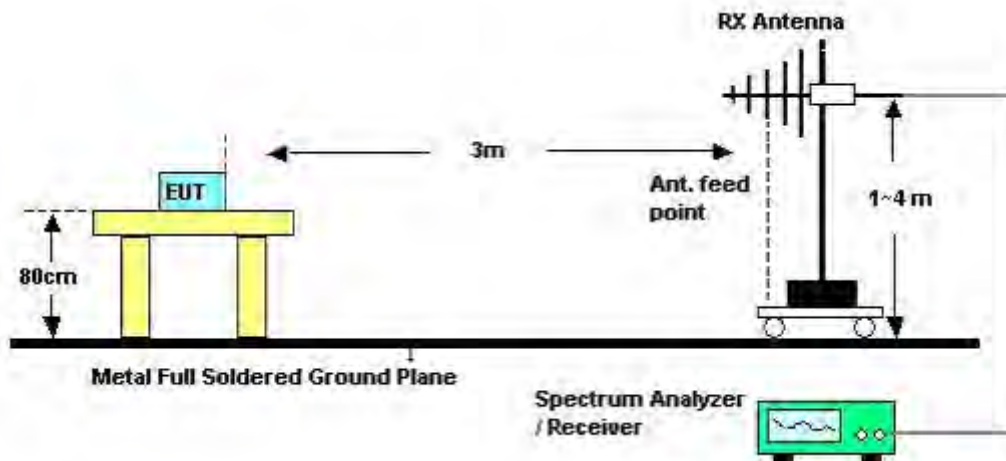

For Radiated Emissions: Above 1GHz

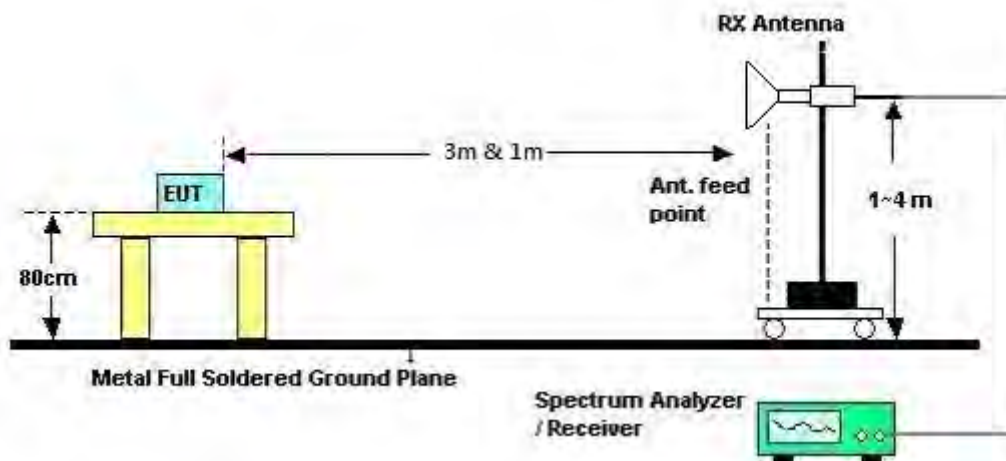

#### 4.5.5. Test Deviation

There is no deviation with the original standard.

#### 4.5.6. EUT Operation during Test

The EUT was programmed to be in continuously transmitting mode.

#### 4.5.7. Results of Radiated Emissions (9kHz~30MHz)

Temperature	25°C	Humidity	54%
Test Engineer	Jim Huang	Configurations	CTX
Test Date	Sep. 23, 2013	Test Mode	Mode 1

Freq. (MHz)	Level (dBuV)	Over Limit (dB)	Limit Line (dBuV)	Remark
-	-	-	-	See Note

Note:

The amplitude of spurious emissions that are attenuated by more than 20dB below the permissible value has no need to be reported.

Distance extrapolation factor =  $40 \log(\text{specific distance} / \text{test distance})$  (dB);

Limit line = specific limits (dBuV) + distance extrapolation factor.

4.5.8. Results of Radiated Emissions (30MHz~1GHz)

Temperature	25°C	Humidity	54%
Test Engineer	Jim Huang	Configurations	CTX
Test Mode	Mode 1		

Horizontal

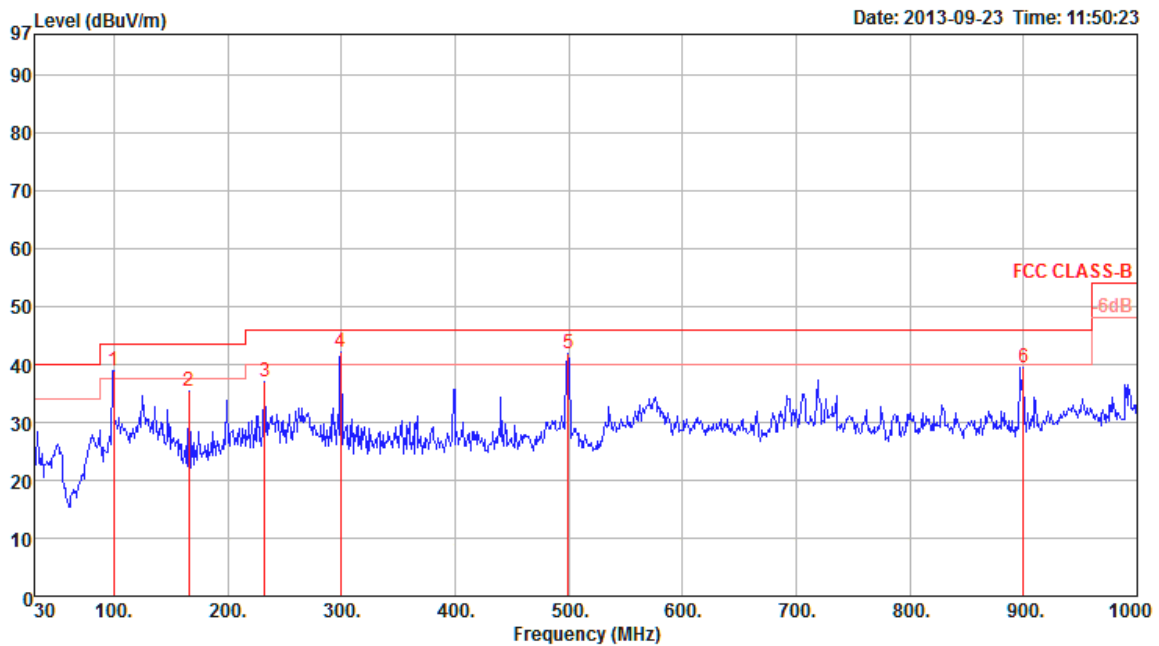

	Freq	Level	Limit Line	Over Limit	Read Level	Cable Loss	Preamp Factor	Antenna Factor	Remark	T/Pos	A/Pos	Pol/Phase
	MHz	dBuV/m	dBuV/m	dB	dBuV	dB	dB	dB/m		deg	cm	
1	99.84	38.97	43.50	-4.53	53.89	1.50	27.82	11.40	Peak	0	400	HORIZONTAL
2	165.80	35.48	43.50	-8.02	50.55	1.92	27.41	10.42	Peak	0	400	HORIZONTAL
3	232.73	36.97	46.00	-9.03	50.15	2.29	27.01	11.54	Peak	0	400	HORIZONTAL
4	299.66	42.04	46.00	-3.96	52.56	2.51	26.83	13.80	Peak	0	400	HORIZONTAL
5	499.48	41.88	46.00	-4.12	48.65	3.38	27.93	17.78	Peak	0	400	HORIZONTAL
6	900.09	39.55	46.00	-6.45	40.28	4.60	26.83	21.50	Peak	0	400	HORIZONTAL



**Vertical**

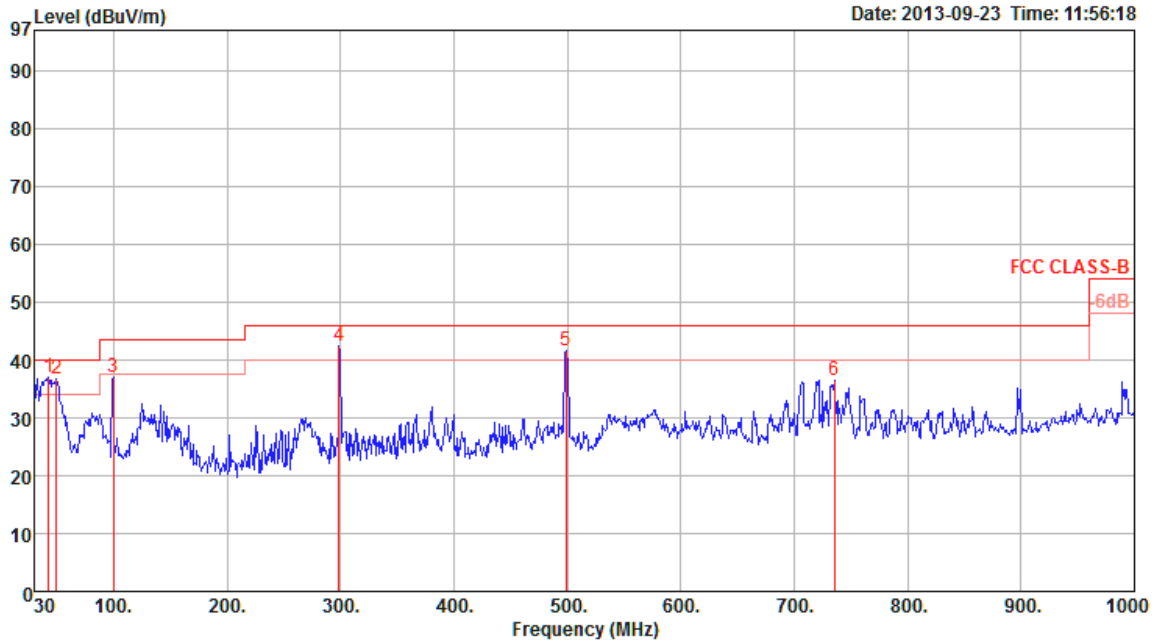

	Freq	Level	Limit	Over	Read	Cable	Preamp	Antenna	Remark	T/Pos	A/Pos	Pol/Phase
	MHz	dBuV/m	dBuV/m	dB	dBuV	dB	dB	dB/m		deg	cm	
1	42.61	36.92	40.00	-3.08	51.92	1.00	27.96	11.96	Peak	0	100	VERTICAL
2	49.40	36.73	40.00	-3.27	54.55	1.05	27.92	9.05	Peak	0	100	VERTICAL
3	99.84	36.96	43.50	-6.54	51.88	1.50	27.82	11.40	Peak	0	100	VERTICAL
4	298.69	42.37	46.00	-3.63	52.89	2.51	26.83	13.80	Peak	0	100	VERTICAL
5	498.51	41.60	46.00	-4.40	48.38	3.38	27.93	17.77	Peak	0	100	VERTICAL
6	735.19	36.59	46.00	-9.41	39.37	4.19	27.11	20.14	Peak	0	100	VERTICAL

**Note:**

The amplitude of spurious emissions that are attenuated by more than 20dB below the permissible value has no need to be reported.

Emission level (dBuV/m) = 20 log Emission level (uV/m).

Corrected Reading: Antenna Factor + Cable Loss + Read Level - Preamp Factor = Level.

#### 4.5.9. Results for Radiated Emissions (1GHz~40GHz)

<b>Temperature</b>	25°C	<b>Humidity</b>	54%
<b>Test Engineer</b>	Serway Li	<b>Configurations</b>	IEEE 802.11n MCS0 20MHz CH 36 1TX / Chain 1
<b>Test Date</b>	Aug. 31, 2013	<b>Test Mode</b>	Mode 1 (Ant.31 PIFA antenna / 4.4dBi)

##### Horizontal

	Freq	Level	Limit Line	Over Limit	Read Level	Cable Loss	Antenna Factor	Preamp Factor	Remark	A/Pos	T/Pos	Pol/Phase
	MHz	dBuV/m	dBuV/m	dB	dBuV	dB	dB/m	dB		cm	deg	
1	15539.87	39.87	54.00	-14.13	31.40	6.13	37.65	35.31	Average	114	330	HORIZONTAL
2	15540.16	54.02	74.00	-19.98	45.55	6.13	37.65	35.31	Peak	114	330	HORIZONTAL

##### Vertical

	Freq	Level	Limit Line	Over Limit	Read Level	Cable Loss	Antenna Factor	Preamp Factor	Remark	A/Pos	T/Pos	Pol/Phase
	MHz	dBuV/m	dBuV/m	dB	dBuV	dB	dB/m	dB		cm	deg	
1	15540.05	38.25	54.00	-15.75	29.74	6.13	37.69	35.31	Average	100	69	VERTICAL
2	15540.32	50.40	74.00	-23.60	41.89	6.13	37.69	35.31	Peak	100	69	VERTICAL



<b>Temperature</b>	25°C	<b>Humidity</b>	54%
<b>Test Engineer</b>	Serway Li	<b>Configurations</b>	IEEE 802.11n MCS0 20MHz CH 40 1TX / Chain 1
<b>Test Date</b>	Aug. 31, 2013	<b>Test Mode</b>	Mode 1 (Ant.31 PIFA antenna / 4.4dBi)

**Horizontal**

	Freq	Level	Limit	Over	Read	CableAntenna	Preamp	Remark	A/Pos	T/Pos	Pol/Phase
	MHz	dBuV/m	dBuV/m	dB	dBuV	dB	dB/m	dB	cm	deg	
1	15601.36	45.52	54.00	-8.48	37.13	6.13	37.60	35.34	Average	100	330 HORIZONTAL
2	15606.09	59.15	74.00	-14.85	50.78	6.13	37.58	35.34	Peak	100	330 HORIZONTAL

**Vertical**

	Freq	Level	Limit	Over	Read	CableAntenna	Preamp	Remark	A/Pos	T/Pos	Pol/Phase
	MHz	dBuV/m	dBuV/m	dB	dBuV	dB	dB/m	dB	cm	deg	
1	15599.20	56.96	74.00	-17.04	48.57	6.13	37.60	35.34	Peak	113	329 VERTICAL
2	15603.37	42.62	54.00	-11.38	34.23	6.13	37.60	35.34	Average	113	329 VERTICAL



<b>Temperature</b>	25°C	<b>Humidity</b>	54%
<b>Test Engineer</b>	Serway Li	<b>Configurations</b>	IEEE 802.11n MCS0 20MHz CH 48 1TX / Chain 1
<b>Test Date</b>	Aug. 31, 2013	<b>Test Mode</b>	Mode 1 (Ant.31 PIFA antenna / 4.4dBi)

**Horizontal**

	Freq	Level	Limit Line	Over Limit	Read Level	Cable Loss	Antenna Factor	Preamp Factor	Remark	A/Pos	T/Pos	Pol/Phase
	MHz	dBuV/m	dBuV/m	dB	dBuV	dB	dB/m	dB		cm	deg	
1	15716.71	65.62	74.00	-8.38	57.39	6.14	37.48	35.39	Peak	107	325	HORIZONTAL
2	15719.60	50.73	54.00	-3.27	42.50	6.14	37.48	35.39	Average	107	325	HORIZONTAL

**Vertical**

	Freq	Level	Limit Line	Over Limit	Read Level	Cable Loss	Antenna Factor	Preamp Factor	Remark	A/Pos	T/Pos	Pol/Phase
	MHz	dBuV/m	dBuV/m	dB	dBuV	dB	dB/m	dB		cm	deg	
1	15723.21	46.18	54.00	-7.82	37.95	6.14	37.48	35.39	Average	120	325	VERTICAL
2	15723.21	59.50	74.00	-14.50	51.27	6.14	37.48	35.39	Peak	120	325	VERTICAL

<b>Temperature</b>	25°C	<b>Humidity</b>	54%
<b>Test Engineer</b>	Serway Li	<b>Configurations</b>	IEEE 802.11n MCS0 20MHz CH 52 1TX / Chain 1
<b>Test Date</b>	Aug. 31, 2013	<b>Test Mode</b>	Mode 1 (Ant.31 PIFA antenna / 4.4dBi)

### Horizontal

	Freq	Level	Limit Line	Over Limit	Read Level	CableAntenna Loss	Antenna Factor	Preamp Factor	Remark	A/Pos	T/Pos	Pol/Phase
	MHz	dBuV/m	dBuV/m	dB	dBuV	dB	dB/m	dB		cm	deg	
1	15781.76	64.59	74.00	-9.41	56.46	6.14	37.41	35.42	Peak	104	334	HORIZONTAL
2	15782.40	50.77	54.00	-3.23	42.64	6.14	37.41	35.42	Average	104	334	HORIZONTAL

### Vertical

	Freq	Level	Limit Line	Over Limit	Read Level	CableAntenna Loss	Antenna Factor	Preamp Factor	Remark	A/Pos	T/Pos	Pol/Phase
	MHz	dBuV/m	dBuV/m	dB	dBuV	dB	dB/m	dB		cm	deg	
1	15780.88	59.63	74.00	-14.37	51.50	6.14	37.41	35.42	Peak	100	118	VERTICAL
2	15788.73	45.30	54.00	-8.70	37.17	6.14	37.41	35.42	Average	100	118	VERTICAL



<b>Temperature</b>	25°C	<b>Humidity</b>	54%
<b>Test Engineer</b>	Serway Li	<b>Configurations</b>	IEEE 802.11n MCS0 20MHz CH 60 1TX / Chain 1
<b>Test Date</b>	Aug. 31, 2013	<b>Test Mode</b>	Mode 1 (Ant.31 PIFA antenna / 4.4dBi)

**Horizontal**

	Freq	Level	Limit	Over	Read	CableAntenna	Preamp	Remark	A/Pos	T/Pos	PoI/Phase
	MHz	dBuV/m	dBuV/m	dB	dBuV	dB	dB/m	dB	cm	deg	
1	10600.02	36.30	54.00	-17.70	28.33	5.01	38.38	35.42	Average	100	133 HORIZONTAL
2	10600.02	47.53	74.00	-26.47	39.56	5.01	38.38	35.42	Peak	100	133 HORIZONTAL
3	15895.91	63.24	74.00	-10.76	55.24	6.15	37.29	35.44	Peak	100	326 HORIZONTAL
4	15899.60	47.81	54.00	-6.19	39.81	6.15	37.29	35.44	Average	100	326 HORIZONTAL

**Vertical**

	Freq	Level	Limit	Over	Read	CableAntenna	Preamp	Remark	A/Pos	T/Pos	PoI/Phase
	MHz	dBuV/m	dBuV/m	dB	dBuV	dB	dB/m	dB	cm	deg	
1	10600.04	36.05	54.00	-17.95	28.08	5.01	38.38	35.42	Average	100	215 VERTICAL
2	10600.05	47.67	74.00	-26.33	39.70	5.01	38.38	35.42	Peak	100	215 VERTICAL
3	15897.76	44.12	54.00	-9.88	36.12	6.15	37.29	35.44	Average	111	118 VERTICAL
4	15900.88	58.98	74.00	-15.02	50.98	6.15	37.29	35.44	Peak	111	118 VERTICAL



<b>Temperature</b>	25°C	<b>Humidity</b>	54%
<b>Test Engineer</b>	Serway Li	<b>Configurations</b>	IEEE 802.11n MCS0 20MHz CH 64 1TX / Chain 1
<b>Test Date</b>	Aug. 31, 2013	<b>Test Mode</b>	Mode 1 (Ant.31 PIFA antenna / 4.4dBi)

**Horizontal**

	Freq	Level	Limit	Over	Read	CableAntenna	Preamp	Remark	A/Pos	T/Pos	Pol/Phase
	MHz	dBuV/m	dBuV/m	dB	dBuV	dB	dB/m	dB	cm	deg	
1	10639.50	49.64	74.00	-24.36	41.65	5.01	38.37	35.39	Peak	100	245 HORIZONTAL
2	10639.79	36.44	54.00	-17.56	28.45	5.01	38.37	35.39	Average	100	245 HORIZONTAL
3	15954.07	52.73	74.00	-21.27	44.79	6.15	37.23	35.44	Peak	118	199 HORIZONTAL
4	15958.40	39.61	54.00	-14.39	31.67	6.15	37.23	35.44	Average	118	199 HORIZONTAL

**Vertical**

	Freq	Level	Limit	Over	Read	CableAntenna	Preamp	Remark	A/Pos	T/Pos	Pol/Phase
	MHz	dBuV/m	dBuV/m	dB	dBuV	dB	dB/m	dB	cm	deg	
1	10639.60	49.31	74.00	-24.69	41.32	5.01	38.37	35.39	Peak	100	167 VERTICAL
2	10640.44	36.60	54.00	-17.40	28.61	5.01	38.37	35.39	Average	100	167 VERTICAL
3	15960.15	37.39	54.00	-16.61	29.45	6.15	37.23	35.44	Average	100	49 VERTICAL
4	15960.41	49.43	74.00	-24.57	41.49	6.15	37.23	35.44	Peak	100	49 VERTICAL



<b>Temperature</b>	25°C	<b>Humidity</b>	54%
<b>Test Engineer</b>	Serway Li	<b>Configurations</b>	IEEE 802.11n MCS0 20MHz CH 100 1TX / Chain 1
<b>Test Date</b>	Aug. 31, 2013	<b>Test Mode</b>	Mode 1 (Ant.31 PIFA antenna / 4.4dBi)

**Horizontal**

	Freq	Level	Limit	Over	Read	CableAntenna	Preamp		A/Pos	T/Pos	Pol/Phase
	MHz	dBuV/m	dBuV/m	dB	dBuV	dB	dB/m	dB	cm	deg	
1	10999.78	36.52	54.00	-17.48	28.29	5.01	38.32	35.10	100	164	HORIZONTAL
2	11000.36	50.48	74.00	-23.52	42.25	5.01	38.32	35.10	100	164	HORIZONTAL

**Vertical**

	Freq	Level	Limit	Over	Read	CableAntenna	Preamp		A/Pos	T/Pos	Pol/Phase
	MHz	dBuV/m	dBuV/m	dB	dBuV	dB	dB/m	dB	cm	deg	
1	11000.21	50.25	74.00	-23.75	42.04	5.01	38.30	35.10	100	251	VERTICAL
2	11000.33	36.32	54.00	-17.68	28.11	5.01	38.30	35.10	100	251	VERTICAL





<b>Temperature</b>	25°C	<b>Humidity</b>	54%
<b>Test Engineer</b>	Serway Li	<b>Configurations</b>	IEEE 802.11n MCS0 20MHz CH 116 1TX / Chain 1
<b>Test Date</b>	Aug. 31, 2013	<b>Test Mode</b>	Mode 1 (Ant.31 PIFA antenna / 4.4dBi)

**Horizontal**

	Freq	Level	Limit	Over	Read	CableAntenna	Preamp		A/Pos	T/Pos	Pol/Phase	
	MHz	dBuV/m	dBuV/m	dB	dBuV	Loss	Factor	Factor	Remark	cm	deg	
1	11159.64	41.07	54.00	-12.93	32.73	5.04	38.47	35.17	Average	120	293	HORIZONTAL
2	11160.17	54.70	74.00	-19.30	46.36	5.04	38.47	35.17	Peak	120	293	HORIZONTAL

**Vertical**

	Freq	Level	Limit	Over	Read	CableAntenna	Preamp		A/Pos	T/Pos	Pol/Phase	
	MHz	dBuV/m	dBuV/m	dB	dBuV	Loss	Factor	Factor	Remark	cm	deg	
1	11159.80	53.36	74.00	-20.64	45.02	5.04	38.47	35.17	Peak	132	230	VERTICAL
2	11160.25	39.92	54.00	-14.08	31.58	5.04	38.47	35.17	Average	132	230	VERTICAL

<b>Temperature</b>	25°C	<b>Humidity</b>	54%
<b>Test Engineer</b>	Serway Li	<b>Configurations</b>	IEEE 802.11n MCS0 20MHz CH 140 1TX / Chain 1
<b>Test Date</b>	Aug. 31, 2013	<b>Test Mode</b>	Mode 1 (Ant.31 PIFA antenna / 4.4dBi)

### Horizontal

	Freq	Level	Limit	Over	Read	CableAntenna	Preamp	Remark	A/Pos	T/Pos	PoI/Phase
	MHz	dBuV/m	dBuV/m	dB	dBuV	dB	dB/m	dB	cm	deg	
1	11399.68	49.57	74.00	-24.43	41.02	5.10	38.70	35.25 Peak	100	177	HORIZONTAL
2	11400.15	37.21	54.00	-16.79	28.66	5.10	38.70	35.25 Average	100	177	HORIZONTAL

### Vertical

	Freq	Level	Limit	Over	Read	CableAntenna	Preamp	Remark	A/Pos	T/Pos	PoI/Phase
	MHz	dBuV/m	dBuV/m	dB	dBuV	dB	dB/m	dB	cm	deg	
1	11399.65	51.11	74.00	-22.89	42.56	5.10	38.70	35.25 Peak	100	274	VERTICAL
2	11399.74	36.99	54.00	-17.01	28.44	5.10	38.70	35.25 Average	100	274	VERTICAL



<b>Temperature</b>	25°C	<b>Humidity</b>	54%
<b>Test Engineer</b>	Serway Li	<b>Configurations</b>	IEEE 802.11n MCS0 40MHz CH 38 1TX / Chain 1
<b>Test Date</b>	Aug. 31, 2013	<b>Test Mode</b>	Mode 1 (Ant.31 PIFA antenna / 4.4dBi)

**Horizontal**

	Freq	Level	Limit Line	Over Limit	Read Level	CableAntenna Loss	Antenna Factor	Preamp Factor	Remark	A/Pos	T/Pos	Pol/Phase
	MHz	dBuV/m	dBuV/m	dB	dBuV	dB	dB/m	dB		cm	deg	
1	15569.80	37.63	54.00	-16.37	29.20	6.13	37.63	35.33	Average	100	180	HORIZONTAL
2	15569.86	50.35	74.00	-23.65	41.92	6.13	37.63	35.33	Peak	100	180	HORIZONTAL

**Vertical**

	Freq	Level	Limit Line	Over Limit	Read Level	CableAntenna Loss	Antenna Factor	Preamp Factor	Remark	A/Pos	T/Pos	Pol/Phase
	MHz	dBuV/m	dBuV/m	dB	dBuV	dB	dB/m	dB		cm	deg	
1	15570.33	50.29	74.00	-23.71	41.84	6.13	37.65	35.33	Peak	100	252	VERTICAL
2	15570.38	37.37	54.00	-16.63	28.92	6.13	37.65	35.33	Average	100	252	VERTICAL



<b>Temperature</b>	25°C	<b>Humidity</b>	54%
<b>Test Engineer</b>	Serway Li	<b>Configurations</b>	IEEE 802.11n MCS0 40MHz CH 46 1TX / Chain 1
<b>Test Date</b>	Aug. 31, 2013	<b>Test Mode</b>	Mode 1 (Ant.31 PIFA antenna / 4.4dBi)

**Horizontal**

	Freq	Level	Limit	Over	Read	CableAntenna	Preamp	Remark	A/Pos	T/Pos	Pol/Phase
	MHz	dBuV/m	dBuV/m	dB	dBuV	dB	dB/m	dB	cm	deg	
1	15693.53	43.62	54.00	-10.38	35.37	6.14	37.49	35.38 Average	119	207	HORIZONTAL
2	15696.17	58.26	74.00	-15.74	50.01	6.14	37.49	35.38 Peak	119	207	HORIZONTAL

**Vertical**

	Freq	Level	Limit	Over	Read	CableAntenna	Preamp	Remark	A/Pos	T/Pos	Pol/Phase
	MHz	dBuV/m	dBuV/m	dB	dBuV	dB	dB/m	dB	cm	deg	
1	15690.64	52.77	74.00	-21.23	44.50	6.14	37.51	35.38 Peak	100	274	VERTICAL
2	15704.90	41.14	54.00	-12.86	32.89	6.14	37.49	35.38 Average	100	274	VERTICAL

<b>Temperature</b>	25°C	<b>Humidity</b>	54%
<b>Test Engineer</b>	Serway Li	<b>Configurations</b>	IEEE 802.11n MCS0 40MHz CH 54 1TX / Chain 1
<b>Test Date</b>	Aug. 31, 2013	<b>Test Mode</b>	Mode 1 (Ant.31 PIFA antenna / 4.4dBi)

### Horizontal

	Freq	Level	Limit	Over	Read	CableAntenna	Preamp	Remark	A/Pos	T/Pos	Pol/Phase
	MHz	dBuV/m	dBuV/m	dB	dBuV	dB	dB/m	dB	cm	deg	
1	15801.19	60.82	74.00	-13.18	52.72	6.14	37.39	35.43	Peak	119	206 HORIZONTAL
2	15813.77	46.97	54.00	-7.03	38.89	6.14	37.37	35.43	Average	119	206 HORIZONTAL

### Vertical

	Freq	Level	Limit	Over	Read	CableAntenna	Preamp	Remark	A/Pos	T/Pos	Pol/Phase
	MHz	dBuV/m	dBuV/m	dB	dBuV	dB	dB/m	dB	cm	deg	
1	15810.56	55.99	74.00	-18.01	47.91	6.14	37.37	35.43	Peak	119	328 VERTICAL
2	15816.25	43.01	54.00	-10.99	34.93	6.14	37.37	35.43	Average	119	328 VERTICAL



<b>Temperature</b>	25°C	<b>Humidity</b>	54%
<b>Test Engineer</b>	Serway Li	<b>Configurations</b>	IEEE 802.11n MCS0 40MHz CH 62 1TX / Chain 1
<b>Test Date</b>	Aug. 31, 2013	<b>Test Mode</b>	Mode 1 (Ant.31 PIFA antenna / 4.4dBi)

**Horizontal**

	Freq	Level	Limit Line	Over Limit	Read Level	CableAntenna Loss	Antenna Factor	Preamp Factor	Remark	A/Pos	T/Pos	Pol/Phase
	MHz	dBuV/m	dBuV/m	dB	dBuV	dB	dB/m	dB		cm	deg	
1	10620.20	49.17	74.00	-24.83	41.20	5.01	38.38	35.42	Peak	100	194	HORIZONTAL
2	10620.32	36.41	54.00	-17.59	28.44	5.01	38.38	35.42	Average	100	194	HORIZONTAL

**Vertical**

	Freq	Level	Limit Line	Over Limit	Read Level	CableAntenna Loss	Antenna Factor	Preamp Factor	Remark	A/Pos	T/Pos	Pol/Phase
	MHz	dBuV/m	dBuV/m	dB	dBuV	dB	dB/m	dB		cm	deg	
1	10619.58	49.55	74.00	-24.45	41.58	5.01	38.38	35.42	Peak	100	312	VERTICAL
2	10619.71	36.36	54.00	-17.64	28.39	5.01	38.38	35.42	Average	100	312	VERTICAL



<b>Temperature</b>	25°C	<b>Humidity</b>	54%
<b>Test Engineer</b>	Serway Li	<b>Configurations</b>	IEEE 802.11n MCS0 40MHz CH 102 1TX / Chain 1
<b>Test Date</b>	Aug. 31, 2013	<b>Test Mode</b>	Mode 1 (Ant.31 PIFA antenna / 4.4dBi)

**Horizontal**

	Freq	Level	Limit Line	Over Limit	Read Level	CableAntenna Loss	Antenna Factor	Preamp Factor	Remark	A/Pos	T/Pos	Pol/Phase
	MHz	dBuV/m	dBuV/m	dB	dBuV	dB	dB/m	dB		cm	deg	
1	11019.65	49.47	74.00	-24.53	41.23	5.02	38.33	35.11	Peak	100	258	HORIZONTAL
2	11019.87	36.63	54.00	-17.37	28.39	5.02	38.33	35.11	Average	100	258	HORIZONTAL

**Vertical**

	Freq	Level	Limit Line	Over Limit	Read Level	CableAntenna Loss	Antenna Factor	Preamp Factor	Remark	A/Pos	T/Pos	Pol/Phase
	MHz	dBuV/m	dBuV/m	dB	dBuV	dB	dB/m	dB		cm	deg	
1	11019.53	36.54	54.00	-17.46	28.31	5.02	38.32	35.11	Average	100	122	VERTICAL
2	11019.89	49.76	74.00	-24.24	41.53	5.02	38.32	35.11	Peak	100	122	VERTICAL

<b>Temperature</b>	25°C	<b>Humidity</b>	54%
<b>Test Engineer</b>	Serway Li	<b>Configurations</b>	IEEE 802.11n MCS0 40MHz CH 110 1TX / Chain 1
<b>Test Date</b>	Aug. 31, 2013	<b>Test Mode</b>	Mode 1 (Ant.31 PIFA antenna / 4.4dBi)

### Horizontal

	Freq	Level	Limit	Over	Read	CableAntenna	Preamp		A/Pos	T/Pos	Pol/Phase
	MHz	dBuV/m	dBuV/m	dB	dBuV	dB	dB/m	dB	cm	deg	
1	11099.82	36.74	54.00	-17.26	28.45	5.03	38.40	35.14	Average	100	204 HORIZONTAL
2	11099.90	49.97	74.00	-24.03	41.68	5.03	38.40	35.14	Peak	100	204 HORIZONTAL

### Vertical

	Freq	Level	Limit	Over	Read	CableAntenna	Preamp		A/Pos	T/Pos	Pol/Phase
	MHz	dBuV/m	dBuV/m	dB	dBuV	dB	dB/m	dB	cm	deg	
1	11099.66	52.99	74.00	-21.01	44.70	5.03	38.40	35.14	Peak	100	119 VERTICAL
2	11099.67	39.68	54.00	-14.32	31.39	5.03	38.40	35.14	Average	100	119 VERTICAL





<b>Temperature</b>	25°C	<b>Humidity</b>	54%
<b>Test Engineer</b>	Serway Li	<b>Configurations</b>	IEEE 802.11n MCS0 40MHz CH 134 1TX / Chain 1
<b>Test Date</b>	Aug. 31, 2013	<b>Test Mode</b>	Mode 1 (Ant.31 PIFA antenna / 4.4dBi)

**Horizontal**

	Freq	Level	Limit Line	Over Limit	Read Level	CableAntenna Loss	Antenna Factor	Preamp Factor	Remark	A/Pos	T/Pos	Pol/Phase
	MHz	dBuV/m	dBuV/m	dB	dBuV	dB	dB/m	dB		cm	deg	
1	11339.67	50.94	74.00	-23.06	42.47	5.08	38.63	35.24	Peak	100	306	HORIZONTAL
2	11340.47	37.20	54.00	-16.80	28.72	5.09	38.63	35.24	Average	100	306	HORIZONTAL

**Vertical**

	Freq	Level	Limit Line	Over Limit	Read Level	CableAntenna Loss	Antenna Factor	Preamp Factor	Remark	A/Pos	T/Pos	Pol/Phase
	MHz	dBuV/m	dBuV/m	dB	dBuV	dB	dB/m	dB		cm	deg	
1	11339.95	49.93	74.00	-24.07	41.46	5.08	38.63	35.24	Peak	100	201	VERTICAL
2	11340.18	37.51	54.00	-16.49	29.04	5.08	38.63	35.24	Average	100	201	VERTICAL

**Note:**

The amplitude of spurious emissions that are attenuated by more than 20dB below the permissible value has no need to be reported.

Emission level (dBuV/m) = 20 log Emission level (uV/m).

Corrected Reading: Antenna Factor + Cable Loss + Read Level - Preamp Factor = Level.



<b>Temperature</b>	25°C	<b>Humidity</b>	54%
<b>Test Engineer</b>	Nick Peng	<b>Configurations</b>	IEEE 802.11n MCS8 20MHz CH 36 2TX / Chain 1 + Chain 2
<b>Test Date</b>	Sep. 03, 2013	<b>Test Mode</b>	Mode 1 (Ant.31 PIFA antenna / 4.4dBi)

**Horizontal**

	Freq	Level	Limit	Over	Read	CableAntenna	Preamp	Remark	A/Pos	T/Pos	PoI/Phase
	MHz	dBuV/m	dBuV/m	dB	dBuV	dB	dB/m	dB	cm	deg	
1	6906.50	51.76	74.00	-22.24	48.06	3.99	35.09	35.38	Peak	101	145 HORIZONTAL
2	6906.70	48.65	54.00	-5.35	44.95	3.99	35.09	35.38	Average	101	145 HORIZONTAL
3	15541.60	39.78	54.00	-14.22	31.31	6.13	37.65	35.31	Average	100	88 HORIZONTAL
4	15548.40	52.35	74.00	-21.65	43.88	6.13	37.65	35.31	Peak	100	88 HORIZONTAL

**Vertical**

	Freq	Level	Limit	Over	Read	CableAntenna	Preamp	Remark	A/Pos	T/Pos	PoI/Phase
	MHz	dBuV/m	dBuV/m	dB	dBuV	dB	dB/m	dB	cm	deg	
1	6906.60	51.49	74.00	-22.51	47.79	3.99	35.09	35.38	Peak	100	53 VERTICAL
2	6906.70	48.18	54.00	-5.82	44.48	3.99	35.09	35.38	Average	100	53 VERTICAL
3	15540.52	52.29	74.00	-21.71	43.78	6.13	37.69	35.31	Peak	100	151 VERTICAL
4	15540.72	39.45	54.00	-14.55	30.94	6.13	37.69	35.31	Average	100	151 VERTICAL

<b>Temperature</b>	25°C	<b>Humidity</b>	54%
<b>Test Engineer</b>	Nick Peng	<b>Configurations</b>	IEEE 802.11n MCS8 20MHz CH 40 2TX / Chain 1 + Chain 2
<b>Test Date</b>	Sep. 03, 2013	<b>Test Mode</b>	Mode 1 (Ant.31 PIFA antenna / 4.4dBi)

### Horizontal

	Freq	Level	Limit Line	Over Limit	Read Level	CableAntenna Loss	Antenna Factor	Preamp Factor	Remark	A/Pos	T/Pos	PoI/Phase
	MHz	dBuV/m	dBuV/m	dB	dBuV	dB	dB/m	dB		cm	deg	
1	6933.34	47.09	54.00	-6.91	43.31	4.01	35.16	35.39	Average	100	144	HORIZONTAL
2	6933.40	51.33	74.00	-22.67	47.55	4.01	35.16	35.39	Peak	100	144	HORIZONTAL
3	15596.88	39.22	54.00	-14.78	30.83	6.13	37.60	35.34	Average	100	78	HORIZONTAL
4	15601.78	51.87	74.00	-22.13	43.48	6.13	37.60	35.34	Peak	100	78	HORIZONTAL

### Vertical

	Freq	Level	Limit Line	Over Limit	Read Level	CableAntenna Loss	Antenna Factor	Preamp Factor	Remark	A/Pos	T/Pos	PoI/Phase
	MHz	dBuV/m	dBuV/m	dB	dBuV	dB	dB/m	dB		cm	deg	
1	6933.30	50.10	74.00	-23.90	46.32	4.01	35.16	35.39	Peak	100	55	VERTICAL
2	6933.34	47.13	54.00	-6.87	43.35	4.01	35.16	35.39	Average	100	55	VERTICAL
3	15596.72	38.93	54.00	-15.07	30.54	6.13	37.60	35.34	Average	100	142	VERTICAL
4	15596.72	51.57	74.00	-22.43	43.18	6.13	37.60	35.34	Peak	100	142	VERTICAL

<b>Temperature</b>	25°C	<b>Humidity</b>	54%
<b>Test Engineer</b>	Nick Peng	<b>Configurations</b>	IEEE 802.11n MCS8 20MHz CH 48 2TX / Chain 1 + Chain 2
<b>Test Date</b>	Sep. 03, 2013	<b>Test Mode</b>	Mode 1 (Ant.31 PIFA antenna / 4.4dBi)

### Horizontal

	Freq	Level	Limit	Over	Read	CableAntenna	Preamp	Remark	A/Pos	T/Pos	Pol/Phase
	MHz	dBuV/m	dBuV/m	dB	dBuV	dB	dB/m	dB	cm	deg	
1	6986.50	49.01	74.00	-24.99	45.10	4.04	35.27	35.40 Peak	101	141	HORIZONTAL
2	6986.66	44.36	54.00	-9.64	40.45	4.04	35.27	35.40 Average	101	141	HORIZONTAL
3	15717.64	45.84	54.00	-8.16	37.61	6.14	37.48	35.39 Average	101	166	HORIZONTAL
4	15718.84	57.91	74.00	-16.09	49.68	6.14	37.48	35.39 Peak	101	166	HORIZONTAL

### Vertical

	Freq	Level	Limit	Over	Read	CableAntenna	Preamp	Remark	A/Pos	T/Pos	Pol/Phase
	MHz	dBuV/m	dBuV/m	dB	dBuV	dB	dB/m	dB	cm	deg	
1	6986.64	47.20	54.00	-6.80	43.29	4.04	35.27	35.40 Average	102	70	VERTICAL
2	6986.66	50.78	74.00	-23.22	46.87	4.04	35.27	35.40 Peak	102	70	VERTICAL
3	15719.06	58.75	74.00	-15.25	50.52	6.14	37.48	35.39 Peak	101	140	VERTICAL
4	15720.68	43.93	54.00	-10.07	35.70	6.14	37.48	35.39 Average	101	140	VERTICAL

<b>Temperature</b>	25°C	<b>Humidity</b>	54%
<b>Test Engineer</b>	Nick Peng	<b>Configurations</b>	IEEE 802.11n MCS8 20MHz CH 52 2TX / Chain 1 + Chain 2
<b>Test Date</b>	Sep. 03, 2013	<b>Test Mode</b>	Mode 1 (Ant.31 PIFA antenna / 4.4dBi)

### Horizontal

	Freq	Level	Limit	Over	Read	CableAntenna	Preamp	Remark	A/Pos	T/Pos	Pol/Phase
	MHz	dBuV/m	dBuV/m	dB	dBuV	dB	dB/m	dB	cm	deg	
1	7013.30	49.88	74.00	-24.12	45.94	4.04	35.30	35.40	101	141	HORIZONTAL
2	7013.32	45.33	54.00	-8.67	41.39	4.04	35.30	35.40	101	141	HORIZONTAL
3	15782.98	56.95	74.00	-17.05	48.82	6.14	37.41	35.42	101	163	HORIZONTAL
4	15783.24	42.74	54.00	-11.26	34.61	6.14	37.41	35.42	101	163	HORIZONTAL

### Vertical

	Freq	Level	Limit	Over	Read	CableAntenna	Preamp	Remark	A/Pos	T/Pos	Pol/Phase
	MHz	dBuV/m	dBuV/m	dB	dBuV	dB	dB/m	dB	cm	deg	
1	7013.32	46.96	54.00	-7.04	43.02	4.04	35.30	35.40	102	73	VERTICAL
2	7013.38	50.79	74.00	-23.21	46.85	4.04	35.30	35.40	102	73	VERTICAL
3	15776.94	54.82	74.00	-19.18	46.69	6.14	37.41	35.42	100	298	VERTICAL
4	15777.22	41.45	54.00	-12.55	33.32	6.14	37.41	35.42	100	298	VERTICAL

<b>Temperature</b>	25°C	<b>Humidity</b>	54%
<b>Test Engineer</b>	Nick Peng	<b>Configurations</b>	IEEE 802.11n MCS8 20MHz CH 60 2TX / Chain 1 + Chain 2
<b>Test Date</b>	Sep. 03, 2013	<b>Test Mode</b>	Mode 1 (Ant.31 PIFA antenna / 4.4dBi)

### Horizontal

	Freq	Level	Limit	Over	Read	CableAntenna	Preamp	Remark	A/Pos	T/Pos	Pol/Phase
	MHz	dBuV/m	dBuV/m	dB	dBuV	dB	dB/m	dB	cm	deg	
1	7066.58	47.52	74.00	-26.48	43.48	4.04	35.40	35.40	100	142	HORIZONTAL
2	7066.68	40.09	54.00	-13.91	36.05	4.04	35.40	35.40	100	142	HORIZONTAL
3	10600.40	36.49	54.00	-17.51	28.52	5.01	38.38	35.42	100	33	HORIZONTAL
4	10600.40	47.51	74.00	-26.49	39.54	5.01	38.38	35.42	100	33	HORIZONTAL
5	15901.72	38.77	54.00	-15.23	30.77	6.15	37.29	35.44	100	160	HORIZONTAL
6	15903.12	51.99	74.00	-22.01	43.99	6.15	37.29	35.44	100	160	HORIZONTAL

### Vertical

	Freq	Level	Limit	Over	Read	CableAntenna	Preamp	Remark	A/Pos	T/Pos	Pol/Phase
	MHz	dBuV/m	dBuV/m	dB	dBuV	dB	dB/m	dB	cm	deg	
1	7066.62	41.96	54.00	-12.04	37.92	4.04	35.40	35.40	100	77	VERTICAL
2	7066.62	48.63	74.00	-25.37	44.59	4.04	35.40	35.40	100	77	VERTICAL
3	10606.90	37.59	54.00	-16.41	29.62	5.01	38.38	35.42	100	107	VERTICAL
4	10608.36	50.01	74.00	-23.99	42.04	5.01	38.38	35.42	100	107	VERTICAL
5	15898.08	52.33	74.00	-21.67	44.33	6.15	37.29	35.44	100	182	VERTICAL
6	15903.24	38.47	54.00	-15.53	30.47	6.15	37.29	35.44	100	182	VERTICAL

<b>Temperature</b>	25°C	<b>Humidity</b>	54%
<b>Test Engineer</b>	Nick Peng	<b>Configurations</b>	IEEE 802.11n MCS8 20MHz CH 64 2TX / Chain 1 + Chain 2
<b>Test Date</b>	Sep. 03, 2013	<b>Test Mode</b>	Mode 1 (Ant.31 PIFA antenna / 4.4dBi)

### Horizontal

	Freq	Level	Limit	Over	Read	CableAntenna	Preamp	Remark	A/Pos	T/Pos	PoI/Phase
	MHz	dBuV/m	dBuV/m	dB	dBuV	dB	dB/m	dB	cm	deg	
1	10642.20	48.69	74.00	-25.31	40.70	5.01	38.37	35.39	Peak	100	143 HORIZONTAL
2	10643.66	36.12	54.00	-17.88	28.13	5.01	38.37	35.39	Average	100	143 HORIZONTAL
3	15964.04	38.70	54.00	-15.30	30.77	6.15	37.22	35.44	Average	100	213 HORIZONTAL
4	15964.82	51.90	74.00	-22.10	43.97	6.15	37.22	35.44	Peak	100	213 HORIZONTAL

### Vertical

	Freq	Level	Limit	Over	Read	CableAntenna	Preamp	Remark	A/Pos	T/Pos	PoI/Phase
	MHz	dBuV/m	dBuV/m	dB	dBuV	dB	dB/m	dB	cm	deg	
1	10635.64	36.42	54.00	-17.58	28.43	5.01	38.37	35.39	Average	100	118 VERTICAL
2	10638.22	49.37	74.00	-24.63	41.38	5.01	38.37	35.39	Peak	100	118 VERTICAL
3	15959.32	38.75	54.00	-15.25	30.81	6.15	37.23	35.44	Average	100	162 VERTICAL
4	15962.98	51.06	74.00	-22.94	43.12	6.15	37.23	35.44	Peak	100	162 VERTICAL

<b>Temperature</b>	25°C	<b>Humidity</b>	54%
<b>Test Engineer</b>	Nick Peng	<b>Configurations</b>	IEEE 802.11n MCS8 20MHz CH 100 2TX / Chain 1 + Chain 2
<b>Test Date</b>	Sep. 03, 2013	<b>Test Mode</b>	Mode 1 (Ant.31 PIFA antenna / 4.4dBi)

**Horizontal**

	Freq	Level	Limit Line	Over Limit	Read Level	Cable Loss	Antenna Factor	Preamp Factor	Remark	A/Pos	T/Pos	Pol/Phase
	MHz	dBuV/m	dBuV/m	dB	dBuV	dB	dB/m	dB		cm	deg	
1	10996.56	47.90	74.00	-26.10	39.67	5.01	38.32	35.10	Peak	100	201	HORIZONTAL
2	11004.58	35.18	54.00	-18.82	26.95	5.01	38.32	35.10	Average	100	201	HORIZONTAL

**Vertical**

	Freq	Level	Limit Line	Over Limit	Read Level	Cable Loss	Antenna Factor	Preamp Factor	Remark	A/Pos	T/Pos	Pol/Phase
	MHz	dBuV/m	dBuV/m	dB	dBuV	dB	dB/m	dB		cm	deg	
1	10995.90	47.78	74.00	-26.22	39.57	5.01	38.30	35.10	Peak	100	117	VERTICAL
2	10999.16	35.34	54.00	-18.66	27.13	5.01	38.30	35.10	Average	100	117	VERTICAL



<b>Temperature</b>	25°C	<b>Humidity</b>	54%
<b>Test Engineer</b>	Nick Peng	<b>Configurations</b>	IEEE 802.11n MCS8 20MHz CH 116 2TX / Chain 1 + Chain 2
<b>Test Date</b>	Sep. 03, 2013	<b>Test Mode</b>	Mode 1 (Ant.31 PIFA antenna / 4.4dBi)

### Horizontal

	Freq	Level	Limit Line	Over Limit	Read Level	CableAntenna Loss	Antenna Factor	Preamp Factor	Remark	A/Pos	T/Pos	Pol/Phase
	MHz	dBuV/m	dBuV/m	dB	dBuV	dB	dB/m	dB		cm	deg	
1	11156.40	50.14	74.00	-23.86	41.81	5.04	38.45	35.16	Peak	100	207	HORIZONTAL
2	11159.54	37.54	54.00	-16.46	29.20	5.04	38.47	35.17	Average	100	207	HORIZONTAL

### Vertical

	Freq	Level	Limit Line	Over Limit	Read Level	CableAntenna Loss	Antenna Factor	Preamp Factor	Remark	A/Pos	T/Pos	Pol/Phase
	MHz	dBuV/m	dBuV/m	dB	dBuV	dB	dB/m	dB		cm	deg	
1	11159.80	37.53	54.00	-16.47	29.19	5.04	38.47	35.17	Average	100	48	VERTICAL
2	11160.22	50.06	74.00	-23.94	41.72	5.04	38.47	35.17	Peak	100	48	VERTICAL



<b>Temperature</b>	25°C	<b>Humidity</b>	54%
<b>Test Engineer</b>	Nick Peng	<b>Configurations</b>	IEEE 802.11n MCS8 20MHz CH 140 2TX / Chain 1 + Chain 2
<b>Test Date</b>	Sep. 03, 2013	<b>Test Mode</b>	Mode 1 (Ant.31 PIFA antenna / 4.4dBi)

**Horizontal**

	Freq	Level	Limit	Over	Read	CableAntenna	Preamp		A/Pos	T/Pos	Pol/Phase
	MHz	dBuV/m	dBuV/m	dB	dBuV	dB	dB/m	dB	cm	deg	
1	11395.56	35.26	54.00	-18.74	26.73	5.10	38.68	35.25	Average	100	80 HORIZONTAL
2	11404.78	48.30	74.00	-25.70	39.75	5.10	38.70	35.25	Peak	100	80 HORIZONTAL

**Vertical**

	Freq	Level	Limit	Over	Read	CableAntenna	Preamp		A/Pos	T/Pos	Pol/Phase
	MHz	dBuV/m	dBuV/m	dB	dBuV	dB	dB/m	dB	cm	deg	
1	11396.52	47.95	74.00	-26.05	39.42	5.10	38.68	35.25	Peak	100	0 VERTICAL
2	11397.18	35.38	54.00	-18.62	26.83	5.10	38.70	35.25	Average	100	0 VERTICAL

<b>Temperature</b>	25°C	<b>Humidity</b>	54%
<b>Test Engineer</b>	Nick Peng	<b>Configurations</b>	IEEE 802.11n MCS8 40MHz CH 38 2TX / Chain 1 + Chain 2
<b>Test Date</b>	Sep. 03, 2013	<b>Test Mode</b>	Mode 1 (Ant.31 PIFA antenna / 4.4dBi)

### Horizontal

	Freq	Level	Limit	Over	Read	CableAntenna	Preamp	Remark	A/Pos	T/Pos	Pol/Phase	
	MHz	dBuV/m	dBuV/m	dB	dBuV	dB	dB/m	dB	cm	deg		
1	6919.98	48.10	54.00	-5.90	44.36	3.99	35.13	35.38	Average	107	123	HORIZONTAL
2	6920.02	51.23	74.00	-22.77	47.49	3.99	35.13	35.38	Peak	107	123	HORIZONTAL
3	15566.26	38.67	54.00	-15.33	30.24	6.13	37.63	35.33	Average	101	296	HORIZONTAL
4	15573.58	51.14	74.00	-22.86	42.73	6.13	37.61	35.33	Peak	101	296	HORIZONTAL

### Vertical

	Freq	Level	Limit	Over	Read	CableAntenna	Preamp	Remark	A/Pos	T/Pos	Pol/Phase	
	MHz	dBuV/m	dBuV/m	dB	dBuV	dB	dB/m	dB	cm	deg		
1	6919.96	47.00	54.00	-7.00	43.26	3.99	35.13	35.38	Average	101	56	VERTICAL
2	6920.06	50.40	74.00	-23.60	46.66	3.99	35.13	35.38	Peak	101	56	VERTICAL
3	15565.96	52.09	74.00	-21.91	43.64	6.13	37.65	35.33	Peak	101	211	VERTICAL
4	15569.26	38.89	54.00	-15.11	30.44	6.13	37.65	35.33	Average	101	211	VERTICAL

<b>Temperature</b>	25°C	<b>Humidity</b>	54%
<b>Test Engineer</b>	Nick Peng	<b>Configurations</b>	IEEE 802.11n MCS8 40MHz CH 46 2TX / Chain 1 + Chain 2
<b>Test Date</b>	Sep. 03, 2013	<b>Test Mode</b>	Mode 1 (Ant.31 PIFA antenna / 4.4dBi)

### Horizontal

	Freq	Level	Limit	Over	Read	CableAntenna	Preamp	Remark	A/Pos	T/Pos	Pol/Phase
	MHz	dBuV/m	dBuV/m	dB	dBuV	dB	dB/m	dB	cm	deg	
1	6973.18	51.06	74.00	-22.94	47.20	4.02	35.23	35.39 Peak	100	144	HORIZONTAL
2	6973.36	47.42	54.00	-6.58	43.56	4.02	35.23	35.39 Average	100	144	HORIZONTAL
3	15686.36	51.89	74.00	-22.11	43.61	6.14	37.51	35.37 Peak	100	105	HORIZONTAL
4	15694.12	39.11	54.00	-14.89	30.86	6.14	37.49	35.38 Average	100	105	HORIZONTAL

### Vertical

	Freq	Level	Limit	Over	Read	CableAntenna	Preamp	Remark	A/Pos	T/Pos	Pol/Phase
	MHz	dBuV/m	dBuV/m	dB	dBuV	dB	dB/m	dB	cm	deg	
1	6973.34	48.36	54.00	-5.64	44.50	4.02	35.23	35.39 Average	102	38	VERTICAL
2	6973.34	51.61	74.00	-22.39	47.75	4.02	35.23	35.39 Peak	102	38	VERTICAL
3	15690.52	39.80	54.00	-14.20	31.52	6.14	37.51	35.37 Average	100	84	VERTICAL
4	15691.40	52.98	74.00	-21.02	44.73	6.14	37.49	35.38 Peak	100	84	VERTICAL



<b>Temperature</b>	25°C	<b>Humidity</b>	54%
<b>Test Engineer</b>	Nick Peng	<b>Configurations</b>	IEEE 802.11n MCS8 40MHz CH 54 2TX / Chain 1 + Chain 2
<b>Test Date</b>	Sep. 03, 2013	<b>Test Mode</b>	Mode 1 (Ant.31 PIFA antenna / 4.4dBi)

**Horizontal**

	Freq	Level	Limit	Over	Read	CableAntenna	Preamp	Remark	A/Pos	T/Pos	PoI/Phase
	MHz	dBuV/m	dBuV/m	dB	dBuV	dB	dB/m	dB	cm	deg	
1	7026.56	44.76	54.00	-9.24	40.79	4.04	35.33	35.40 Average	101	146	HORIZONTAL
2	7026.80	49.90	74.00	-24.10	45.93	4.04	35.33	35.40 Peak	101	146	HORIZONTAL
3	15810.84	41.73	54.00	-12.27	33.65	6.14	37.37	35.43 Average	101	38	HORIZONTAL
4	15812.40	55.56	74.00	-18.44	47.48	6.14	37.37	35.43 Peak	101	38	HORIZONTAL

**Vertical**

	Freq	Level	Limit	Over	Read	CableAntenna	Preamp	Remark	A/Pos	T/Pos	PoI/Phase
	MHz	dBuV/m	dBuV/m	dB	dBuV	dB	dB/m	dB	cm	deg	
1	7026.60	50.96	74.00	-23.04	46.99	4.04	35.33	35.40 Peak	101	75	VERTICAL
2	7026.68	46.79	54.00	-7.21	42.82	4.04	35.33	35.40 Average	101	75	VERTICAL
3	15805.02	40.02	54.00	-13.98	31.92	6.14	37.39	35.43 Average	101	128	VERTICAL
4	15807.16	52.52	74.00	-21.48	44.42	6.14	37.39	35.43 Peak	101	128	VERTICAL

<b>Temperature</b>	25°C	<b>Humidity</b>	54%
<b>Test Engineer</b>	Nick Peng	<b>Configurations</b>	IEEE 802.11n MCS8 40MHz CH 62 2TX / Chain 1 + Chain 2
<b>Test Date</b>	Sep. 03, 2013	<b>Test Mode</b>	Mode 1 (Ant.31 PIFA antenna / 4.4dBi)

### Horizontal

	Freq	Level	Limit	Over	Read	CableAntenna	Preamp	Remark	A/Pos	T/Pos	PoI/Phase
	MHz	dBuV/m	dBuV/m	dB	dBuV	dB	dB/m	dB	cm	deg	
1	7080.02	47.67	74.00	-26.33	43.59	4.04	35.44	35.40 Peak	101	154	HORIZONTAL
2	7080.04	40.70	54.00	-13.30	36.62	4.04	35.44	35.40 Average	101	154	HORIZONTAL
3	10615.12	36.61	54.00	-17.39	28.64	5.01	38.38	35.42 Average	101	157	HORIZONTAL
4	10616.82	49.47	74.00	-24.53	41.50	5.01	38.38	35.42 Peak	101	157	HORIZONTAL
5	15925.08	51.21	74.00	-22.79	43.23	6.15	37.27	35.44 Peak	100	120	HORIZONTAL
6	15927.52	38.59	54.00	-15.41	30.61	6.15	37.27	35.44 Average	100	120	HORIZONTAL

### Vertical

	Freq	Level	Limit	Over	Read	CableAntenna	Preamp	Remark	A/Pos	T/Pos	PoI/Phase
	MHz	dBuV/m	dBuV/m	dB	dBuV	dB	dB/m	dB	cm	deg	
1	7079.78	48.78	74.00	-25.22	44.70	4.04	35.44	35.40 Peak	101	77	VERTICAL
2	7079.94	42.89	54.00	-11.11	38.81	4.04	35.44	35.40 Average	101	77	VERTICAL
3	10615.34	36.76	54.00	-17.24	28.79	5.01	38.38	35.42 Average	101	97	VERTICAL
4	10617.66	50.05	74.00	-23.95	42.08	5.01	38.38	35.42 Peak	101	97	VERTICAL
5	15925.16	38.62	54.00	-15.38	30.64	6.15	37.27	35.44 Average	100	49	VERTICAL
6	15927.54	50.90	74.00	-23.10	42.92	6.15	37.27	35.44 Peak	100	49	VERTICAL

<b>Temperature</b>	25°C	<b>Humidity</b>	54%
<b>Test Engineer</b>	Nick Peng	<b>Configurations</b>	IEEE 802.11n MCS8 40MHz CH 102 2TX / Chain 1 + Chain 2
<b>Test Date</b>	Sep. 03, 2013	<b>Test Mode</b>	Mode 1 (Ant.31 PIFA antenna / 4.4dBi)

### Horizontal

	Freq	Level	Limit	Over	Read	CableAntenna	Preamp	Remark	A/Pos	T/Pos	Pol/Phase
	MHz	dBuV/m	dBuV/m	dB	dBuV	dB	dB/m	dB	cm	deg	
1	11015.58	48.00	74.00	-26.00	39.76	5.02	38.33	35.11	Peak	100	173 HORIZONTAL
2	11024.88	35.53	54.00	-18.47	27.28	5.02	38.34	35.11	Average	100	173 HORIZONTAL

### Vertical

	Freq	Level	Limit	Over	Read	CableAntenna	Preamp	Remark	A/Pos	T/Pos	Pol/Phase
	MHz	dBuV/m	dBuV/m	dB	dBuV	dB	dB/m	dB	cm	deg	
1	11017.96	48.69	74.00	-25.31	40.46	5.02	38.32	35.11	Peak	100	84 VERTICAL
2	11021.68	35.43	54.00	-18.57	27.20	5.02	38.32	35.11	Average	100	84 VERTICAL

<b>Temperature</b>	25°C	<b>Humidity</b>	54%
<b>Test Engineer</b>	Nick Peng	<b>Configurations</b>	IEEE 802.11n MCS8 40MHz CH 110 2TX / Chain 1 + Chain 2
<b>Test Date</b>	Sep. 03, 2013	<b>Test Mode</b>	Mode 1 (Ant.31 PIFA antenna / 4.4dBi)

#### Horizontal

	Freq	Level	Limit	Over	Read	Cable	Antenna	Preamp	Remark	A/Pos	T/Pos	Pol/Phase
	MHz	dBuV/m	dBuV/m	dB	dBuV	dB	dB/m	dB		cm	deg	
1	11100.98	36.67	54.00	-17.33	28.38	5.03	38.40	35.14	Average	100	173	HORIZONTAL
2	11104.94	49.37	74.00	-24.63	41.08	5.03	38.40	35.14	Peak	100	173	HORIZONTAL

#### Vertical

	Freq	Level	Limit	Over	Read	Cable	Antenna	Preamp	Remark	A/Pos	T/Pos	Pol/Phase
	MHz	dBuV/m	dBuV/m	dB	dBuV	dB	dB/m	dB		cm	deg	
1	11095.66	36.74	54.00	-17.26	28.45	5.03	38.40	35.14	Average	100	247	VERTICAL
2	11102.08	49.88	74.00	-24.12	41.59	5.03	38.40	35.14	Peak	100	247	VERTICAL



<b>Temperature</b>	25°C	<b>Humidity</b>	54%
<b>Test Engineer</b>	Nick Peng	<b>Configurations</b>	IEEE 802.11n MCS8 40MHz CH 134 2TX / Chain 1 + Chain 2
<b>Test Date</b>	Sep. 03, 2013	<b>Test Mode</b>	Mode 1 (Ant.31 PIFA antenna / 4.4dBi)

#### Horizontal

	Freq	Level	Limit Line	Over Limit	Read Level	CableAntenna Loss	Antenna Factor	Preamp Factor	Remark	A/Pos	T/Pos	Pol/Phase
	MHz	dBuV/m	dBuV/m	dB	dBuV	dB	dB/m	dB		cm	deg	
1	11338.88	35.73	54.00	-18.27	27.26	5.08	38.63	35.24	Average	100	116	HORIZONTAL
2	11343.50	48.62	74.00	-25.38	40.14	5.09	38.63	35.24	Peak	100	116	HORIZONTAL

#### Vertical

	Freq	Level	Limit Line	Over Limit	Read Level	CableAntenna Loss	Antenna Factor	Preamp Factor	Remark	A/Pos	T/Pos	Pol/Phase
	MHz	dBuV/m	dBuV/m	dB	dBuV	dB	dB/m	dB		cm	deg	
1	11340.30	48.64	74.00	-25.36	40.16	5.09	38.63	35.24	Peak	100	74	VERTICAL
2	11342.26	35.61	54.00	-18.39	27.13	5.09	38.63	35.24	Average	100	74	VERTICAL

#### Note:

The amplitude of spurious emissions that are attenuated by more than 20dB below the permissible value has no need to be reported.

Emission level (dBuV/m) = 20 log Emission level (uV/m).

Corrected Reading: Antenna Factor + Cable Loss + Read Level - Preamp Factor = Level.



<b>Temperature</b>	25°C	<b>Humidity</b>	54%
<b>Test Engineer</b>	Jim Huang	<b>Configurations</b>	IEEE 802.11n MCS16 20MHz CH 36 3TX / Chain 1 + Chain 2 + Chain 3
<b>Test Date</b>	Aug. 27, 2013	<b>Test Mode</b>	Mode 1 (Ant.31 PIFA antenna / 4.4dBi)

**Horizontal**

	Freq	Level	Limit Line	Over Limit	Read Level	Cable Loss	Antenna Factor	Preamp Factor	Remark	A/Pos	T/Pos	Pol/Phase
	MHz	dBuV/m	dBuV/m	dB	dBuV	dB	dB/m	dB		cm	deg	
1	15530.13	50.38	74.00	-23.62	41.87	6.13	37.67	35.29	Peak	100	73	HORIZONTAL
2	15541.76	38.17	54.00	-15.83	29.70	6.13	37.65	35.31	Average	100	73	HORIZONTAL

**Vertical**

	Freq	Level	Limit Line	Over Limit	Read Level	Cable Loss	Antenna Factor	Preamp Factor	Remark	A/Pos	T/Pos	Pol/Phase
	MHz	dBuV/m	dBuV/m	dB	dBuV	dB	dB/m	dB		cm	deg	
1	15537.82	50.85	74.00	-23.15	42.32	6.13	37.69	35.29	Peak	100	226	VERTICAL
2	15539.55	38.23	54.00	-15.77	29.72	6.13	37.69	35.31	Average	100	226	VERTICAL



<b>Temperature</b>	25°C	<b>Humidity</b>	54%
<b>Test Engineer</b>	Jim Huang	<b>Configurations</b>	IEEE 802.11n MCS16 20MHz CH 40 3TX / Chain 1 + Chain 2 + Chain 3
<b>Test Date</b>	Aug. 27, 2013	<b>Test Mode</b>	Mode 1 (Ant.31 PIFA antenna / 4.4dBi)

**Horizontal**

	Freq	Level	Limit	Over	Read	CableAntenna	Preamp		A/Pos	T/Pos	Pol/Phase
	MHz	dBuV/m	dBuV/m	dB	dBuV	dB	dB/m	dB	cm	deg	
1	15602.66	37.86	54.00	-16.14	29.47	6.13	37.60	35.34	Average	100	313 HORIZONTAL
2	15605.93	50.49	74.00	-23.51	42.12	6.13	37.58	35.34	Peak	100	313 HORIZONTAL

**Vertical**

	Freq	Level	Limit	Over	Read	CableAntenna	Preamp		A/Pos	T/Pos	Pol/Phase
	MHz	dBuV/m	dBuV/m	dB	dBuV	dB	dB/m	dB	cm	deg	
1	15593.78	50.79	74.00	-23.21	42.40	6.13	37.60	35.34	Peak	100	207 VERTICAL
2	15599.94	37.90	54.00	-16.10	29.51	6.13	37.60	35.34	Average	100	207 VERTICAL

<b>Temperature</b>	25°C	<b>Humidity</b>	54%
<b>Test Engineer</b>	Jim Huang	<b>Configurations</b>	IEEE 802.11n MCS16 20MHz CH 48 3TX / Chain 1 + Chain 2 + Chain 3
<b>Test Date</b>	Aug. 27, 2013	<b>Test Mode</b>	Mode 1 (Ant.31 PIFA antenna / 4.4dBi)

#### Horizontal

	Freq	Level	Limit	Over	Read	CableAntenna	Preamp		A/Pos	T/Pos	Pol/Phase	
	MHz	dBuV/m	dBuV/m	dB	dBuV	dB	dB/m	dB	cm	deg		
1	15716.35	44.22	54.00	-9.78	35.99	6.14	37.48	35.39	Average	138	198	HORIZONTAL
2	15718.53	59.23	74.00	-14.77	51.00	6.14	37.48	35.39	Peak	138	198	HORIZONTAL

#### Vertical

	Freq	Level	Limit	Over	Read	CableAntenna	Preamp		A/Pos	T/Pos	Pol/Phase	
	MHz	dBuV/m	dBuV/m	dB	dBuV	dB	dB/m	dB	cm	deg		
1	15718.01	55.48	74.00	-18.52	47.25	6.14	37.48	35.39	Peak	176	320	VERTICAL
2	15720.67	42.30	54.00	-11.70	34.07	6.14	37.48	35.39	Average	176	320	VERTICAL



<b>Temperature</b>	25°C	<b>Humidity</b>	54%
<b>Test Engineer</b>	Jim Huang	<b>Configurations</b>	IEEE 802.11n MCS16 20MHz CH 52 3TX / Chain 1 + Chain 2 + Chain 3
<b>Test Date</b>	Aug. 27, 2013	<b>Test Mode</b>	Mode 1 (Ant.31 PIFA antenna / 4.4dBi)

**Horizontal**

	Freq	Level	Limit	Over	Read	CableAntenna	Preamp		A/Pos	T/Pos	Pol/Phase
	MHz	dBuV/m	dBuV/m	dB	dBuV	dB	dB/m	dB	cm	deg	
1	15774.36	37.67	54.00	-16.33	29.53	6.14	37.42	35.42	Average	100	69 HORIZONTAL
2	15788.01	50.43	74.00	-23.57	42.30	6.14	37.41	35.42	Peak	100	69 HORIZONTAL

**Vertical**

	Freq	Level	Limit	Over	Read	CableAntenna	Preamp		A/Pos	T/Pos	Pol/Phase
	MHz	dBuV/m	dBuV/m	dB	dBuV	dB	dB/m	dB	cm	deg	
1	15775.87	50.87	74.00	-23.13	42.73	6.14	37.42	35.42	Peak	100	168 VERTICAL
2	15779.42	37.81	54.00	-16.19	29.68	6.14	37.41	35.42	Average	100	168 VERTICAL



<b>Temperature</b>	25°C	<b>Humidity</b>	54%
<b>Test Engineer</b>	Jim Huang	<b>Configurations</b>	IEEE 802.11n MCS16 20MHz CH 60 3TX / Chain 1 + Chain 2 + Chain 3
<b>Test Date</b>	Aug. 27, 2013	<b>Test Mode</b>	Mode 1 (Ant.31 PIFA antenna / 4.4dBi)

**Horizontal**

	Freq	Level	Limit	Over	Read	CableAntenna	Preamp	Remark	A/Pos	T/Pos	Pol/Phase	
	MHz	dBuV/m	dBuV/m	dB	dBuV	dB	dB/m	dB	cm	deg		
1	10605.38	37.21	54.00	-16.79	29.24	5.01	38.38	35.42	Average	100	330	HORIZONTAL
2	10608.72	50.68	74.00	-23.32	42.71	5.01	38.38	35.42	Peak	100	330	HORIZONTAL
3	15895.22	62.69	74.00	-11.31	54.68	6.15	37.30	35.44	Peak	135	220	HORIZONTAL
4	15900.13	45.77	54.00	-8.23	37.77	6.15	37.29	35.44	Average	135	220	HORIZONTAL

**Vertical**

	Freq	Level	Limit	Over	Read	CableAntenna	Preamp	Remark	A/Pos	T/Pos	Pol/Phase	
	MHz	dBuV/m	dBuV/m	dB	dBuV	dB	dB/m	dB	cm	deg		
1	10598.62	50.51	74.00	-23.49	42.54	5.01	38.38	35.42	Peak	108	75	VERTICAL
2	10599.90	38.88	54.00	-15.12	30.91	5.01	38.38	35.42	Average	108	75	VERTICAL
3	15897.47	42.84	54.00	-11.16	34.84	6.15	37.29	35.44	Average	170	332	VERTICAL
4	15898.17	57.52	74.00	-16.48	49.52	6.15	37.29	35.44	Peak	170	332	VERTICAL



<b>Temperature</b>	25°C	<b>Humidity</b>	54%
<b>Test Engineer</b>	Jim Huang	<b>Configurations</b>	IEEE 802.11n MCS16 20MHz CH 64 3TX / Chain 1 + Chain 2 + Chain 3
<b>Test Date</b>	Aug. 27, 2013	<b>Test Mode</b>	Mode 1 (Ant.31 PIFA antenna / 4.4dBi)

**Horizontal**

	Freq	Level	Limit	Over	Read	CableAntenna	Preamp	Remark	A/Pos	T/Pos	PoI/Phase
	MHz	dBuV/m	dBuV/m	dB	dBuV	dB	dB/m	dB	cm	deg	
1	10640.96	36.88	54.00	-17.12	28.89	5.01	38.37	35.39	Average	100	138 HORIZONTAL
2	10648.14	49.61	74.00	-24.39	41.62	5.01	38.37	35.39	Peak	100	138 HORIZONTAL
3	15951.25	50.23	74.00	-23.77	42.29	6.15	37.23	35.44	Peak	100	201 HORIZONTAL
4	15969.81	37.47	54.00	-16.53	29.54	6.15	37.22	35.44	Average	100	201 HORIZONTAL

**Vertical**

	Freq	Level	Limit	Over	Read	CableAntenna	Preamp	Remark	A/Pos	T/Pos	PoI/Phase
	MHz	dBuV/m	dBuV/m	dB	dBuV	dB	dB/m	dB	cm	deg	
1	10637.76	49.30	74.00	-24.70	41.31	5.01	38.37	35.39	Peak	100	203 VERTICAL
2	10639.20	36.93	54.00	-17.07	28.94	5.01	38.37	35.39	Average	100	203 VERTICAL
3	15963.53	50.13	74.00	-23.87	42.19	6.15	37.23	35.44	Peak	100	116 VERTICAL
4	15968.91	37.33	54.00	-16.67	29.40	6.15	37.22	35.44	Average	100	116 VERTICAL



<b>Temperature</b>	25°C	<b>Humidity</b>	54%
<b>Test Engineer</b>	Jim Huang	<b>Configurations</b>	IEEE 802.11n MCS16 20MHz CH 100 3TX / Chain 1 + Chain 2 + Chain 3
<b>Test Date</b>	Aug. 27, 2013	<b>Test Mode</b>	Mode 1 (Ant.31 PIFA antenna / 4.4dBi)

**Horizontal**

	Freq	Level	Limit Line	Over Limit	Read Level	Cable Loss	Antenna Factor	Preamp Factor	Remark	A/Pos	T/Pos	Pol/Phase
	MHz	dBuV/m	dBuV/m	dB	dBuV	dB	dB/m	dB		cm	deg	
1	10999.20	49.60	74.00	-24.40	41.37	5.01	38.32	35.10	Peak	100	284	HORIZONTAL
2	11002.69	36.79	54.00	-17.21	28.56	5.01	38.32	35.10	Average	100	284	HORIZONTAL

**Vertical**

	Freq	Level	Limit Line	Over Limit	Read Level	Cable Loss	Antenna Factor	Preamp Factor	Remark	A/Pos	T/Pos	Pol/Phase
	MHz	dBuV/m	dBuV/m	dB	dBuV	dB	dB/m	dB		cm	deg	
1	10997.92	37.36	54.00	-16.64	29.15	5.01	38.30	35.10	Average	100	200	VERTICAL
2	11000.29	49.36	74.00	-24.64	41.15	5.01	38.30	35.10	Peak	100	200	VERTICAL





<b>Temperature</b>	25°C	<b>Humidity</b>	54%
<b>Test Engineer</b>	Jim Huang	<b>Configurations</b>	IEEE 802.11n MCS16 20MHz CH 116 3TX / Chain 1 + Chain 2 + Chain 3
<b>Test Date</b>	Aug. 27, 2013	<b>Test Mode</b>	Mode 1 (Ant.31 PIFA antenna / 4.4dBi)

**Horizontal**

	Freq	Level	Limit	Over	Read	CableAntenna	Preamp	Remark	A/Pos	T/Pos	Pol/Phase
	MHz	dBuV/m	dBuV/m	dB	dBuV	dB	dB/m	dB	cm	deg	
1	11158.40	49.22	74.00	-24.78	40.90	5.04	38.45	35.17	Peak	100	222 HORIZONTAL
2	11163.62	36.93	54.00	-17.07	28.58	5.05	38.47	35.17	Average	100	222 HORIZONTAL

**Vertical**

	Freq	Level	Limit	Over	Read	CableAntenna	Preamp	Remark	A/Pos	T/Pos	Pol/Phase
	MHz	dBuV/m	dBuV/m	dB	dBuV	dB	dB/m	dB	cm	deg	
1	11159.29	36.99	54.00	-17.01	28.65	5.04	38.47	35.17	Average	100	137 VERTICAL
2	11162.05	49.82	74.00	-24.18	41.47	5.05	38.47	35.17	Peak	100	137 VERTICAL



<b>Temperature</b>	25°C	<b>Humidity</b>	54%
<b>Test Engineer</b>	Jim Huang	<b>Configurations</b>	IEEE 802.11n MCS16 20MHz CH 140 3TX / Chain 1 + Chain 2 + Chain 3
<b>Test Date</b>	Aug. 27, 2013	<b>Test Mode</b>	Mode 1 (Ant.31 PIFA antenna / 4.4dBi)

**Horizontal**

	Freq	Level	Limit Line	Over Limit	Read Level	Cable Loss	Antenna Factor	Preamp Factor	Remark	A/Pos	T/Pos	Pol/Phase
	MHz	dBuV/m	dBuV/m	dB	dBuV	dB	dB/m	dB		cm	deg	
1	11408.08	50.06	74.00	-23.94	41.51	5.10	38.70	35.25	Peak	100	75	HORIZONTAL
2	11409.55	37.43	54.00	-16.57	28.88	5.10	38.70	35.25	Average	100	75	HORIZONTAL

**Vertical**

	Freq	Level	Limit Line	Over Limit	Read Level	Cable Loss	Antenna Factor	Preamp Factor	Remark	A/Pos	T/Pos	Pol/Phase
	MHz	dBuV/m	dBuV/m	dB	dBuV	dB	dB/m	dB		cm	deg	
1	11398.65	50.83	74.00	-23.17	42.28	5.10	38.70	35.25	Peak	100	167	VERTICAL
2	11403.27	37.52	54.00	-16.48	28.97	5.10	38.70	35.25	Average	100	167	VERTICAL



<b>Temperature</b>	25°C	<b>Humidity</b>	54%
<b>Test Engineer</b>	Jim Huang	<b>Configurations</b>	IEEE 802.11n MCS16 40MHz CH 38 3TX / Chain 1 + Chain 2 + Chain 3
<b>Test Date</b>	Aug. 27, 2013	<b>Test Mode</b>	Mode 1 (Ant.31 PIFA antenna / 4.4dBi)

**Horizontal**

	Freq	Level	Limit Line	Over Limit	Read Level	CableAntenna Loss	Antenna Factor	Preamp Factor	Remark	A/Pos	T/Pos	Pol/Phase
	MHz	dBuV/m	dBuV/m	dB	dBuV	dB	dB/m	dB		cm	deg	
1	15560.99	51.04	74.00	-22.96	42.59	6.13	37.63	35.31	Peak	100	123	HORIZONTAL
2	15571.28	38.15	54.00	-15.85	29.72	6.13	37.63	35.33	Average	100	123	HORIZONTAL

**Vertical**

	Freq	Level	Limit Line	Over Limit	Read Level	CableAntenna Loss	Antenna Factor	Preamp Factor	Remark	A/Pos	T/Pos	Pol/Phase
	MHz	dBuV/m	dBuV/m	dB	dBuV	dB	dB/m	dB		cm	deg	
1	15560.61	50.94	74.00	-23.06	42.47	6.13	37.65	35.31	Peak	100	217	VERTICAL
2	15572.88	38.06	54.00	-15.94	29.65	6.13	37.61	35.33	Average	100	217	VERTICAL



<b>Temperature</b>	25°C	<b>Humidity</b>	54%
<b>Test Engineer</b>	Jim Huang	<b>Configurations</b>	IEEE 802.11n MCS16 40MHz CH 46 3TX / Chain 1 + Chain 2 + Chain 3
<b>Test Date</b>	Aug. 27, 2013	<b>Test Mode</b>	Mode 1 (Ant.31 PIFA antenna / 4.4dBi)

**Horizontal**

	Freq	Level	Limit Line	Over Limit	Read Level	Cable Loss	Antenna Factor	Preamp Factor	Remark	A/Pos	T/Pos	Pol/Phase
	MHz	dBuV/m	dBuV/m	dB	dBuV	dB	dB/m	dB		cm	deg	
1	15683.81	54.25	74.00	-19.75	45.97	6.14	37.51	35.37	Peak	138	200	HORIZONTAL
2	15694.81	40.72	54.00	-13.28	32.47	6.14	37.49	35.38	Average	138	200	HORIZONTAL

**Vertical**

	Freq	Level	Limit Line	Over Limit	Read Level	Cable Loss	Antenna Factor	Preamp Factor	Remark	A/Pos	T/Pos	Pol/Phase
	MHz	dBuV/m	dBuV/m	dB	dBuV	dB	dB/m	dB		cm	deg	
1	15695.54	38.49	54.00	-15.51	30.24	6.14	37.49	35.38	Average	100	285	VERTICAL
2	15696.44	51.37	74.00	-22.63	43.12	6.14	37.49	35.38	Peak	100	285	VERTICAL



<b>Temperature</b>	25°C	<b>Humidity</b>	54%
<b>Test Engineer</b>	Jim Huang	<b>Configurations</b>	IEEE 802.11n MCS16 40MHz CH 54 3TX / Chain 1 + Chain 2 + Chain 3
<b>Test Date</b>	Aug. 27, 2013	<b>Test Mode</b>	Mode 1 (Ant.31 PIFA antenna / 4.4dBi)

**Horizontal**

	Freq	Level	Limit	Over	Read	Cable	Antenna	Preamp	Remark	A/Pos	T/Pos	Pol/Phase
	MHz	dBuV/m	dBuV/m	dB	dBuV	Loss	Factor	Factor		cm	deg	
1	15803.53	41.57	54.00	-12.43	33.47	6.14	37.39	35.43	Average	124	196	HORIZONTAL
2	15803.56	55.65	74.00	-18.35	47.55	6.14	37.39	35.43	Peak	124	196	HORIZONTAL

**Vertical**

	Freq	Level	Limit	Over	Read	Cable	Antenna	Preamp	Remark	A/Pos	T/Pos	Pol/Phase
	MHz	dBuV/m	dBuV/m	dB	dBuV	Loss	Factor	Factor		cm	deg	
1	15800.03	38.05	54.00	-15.95	29.95	6.14	37.39	35.43	Average	100	168	VERTICAL
2	15802.95	50.69	74.00	-23.31	42.59	6.14	37.39	35.43	Peak	100	168	VERTICAL



<b>Temperature</b>	25°C	<b>Humidity</b>	54%
<b>Test Engineer</b>	Jim Huang	<b>Configurations</b>	IEEE 802.11n MCS16 40MHz CH 62 3TX / Chain 1 + Chain 2 + Chain 3
<b>Test Date</b>	Aug. 27, 2013	<b>Test Mode</b>	Mode 1 (Ant.31 PIFA antenna / 4.4dBi)

**Horizontal**

	Freq	Level	Limit	Over	Read	CableAntenna	Preamp	Remark	A/Pos	T/Pos	PoI/Phase
	MHz	dBuV/m	dBuV/m	dB	dBuV	dB	dB/m	dB	cm	deg	
1	10615.48	49.77	74.00	-24.23	41.80	5.01	38.38	35.42	Peak	100	249 HORIZONTAL
2	10620.06	37.03	54.00	-16.97	29.06	5.01	38.38	35.42	Average	100	249 HORIZONTAL
3	15928.37	37.52	54.00	-16.48	29.54	6.15	37.27	35.44	Average	100	291 HORIZONTAL
4	15928.88	50.21	74.00	-23.79	42.23	6.15	37.27	35.44	Peak	100	291 HORIZONTAL

**Vertical**

	Freq	Level	Limit	Over	Read	CableAntenna	Preamp	Remark	A/Pos	T/Pos	PoI/Phase
	MHz	dBuV/m	dBuV/m	dB	dBuV	dB	dB/m	dB	cm	deg	
1	10618.11	37.03	54.00	-16.97	29.06	5.01	38.38	35.42	Average	100	148 VERTICAL
2	10623.30	49.67	74.00	-24.33	41.70	5.01	38.38	35.42	Peak	100	148 VERTICAL
3	15926.70	37.67	54.00	-16.33	29.69	6.15	37.27	35.44	Average	100	218 VERTICAL
4	15928.08	50.61	74.00	-23.39	42.63	6.15	37.27	35.44	Peak	100	218 VERTICAL



<b>Temperature</b>	25°C	<b>Humidity</b>	54%
<b>Test Engineer</b>	Jim Huang	<b>Configurations</b>	IEEE 802.11n MCS16 40MHz CH 102 3TX / Chain 1 + Chain 2 + Chain 3
<b>Test Date</b>	Aug. 27, 2013	<b>Test Mode</b>	Mode 1 (Ant.31 PIFA antenna / 4.4dBi)

**Horizontal**

	Freq	Level	Limit	Over	Read	Cable	Antenna	Preamp	Remark	A/Pos	T/Pos	Pol/Phase
	MHz	dBuV/m	dBuV/m	dB	dBuV	dB	dB/m	dB		cm	deg	
1	11014.39	36.93	54.00	-17.07	28.69	5.02	38.33	35.11	Average	100	131	HORIZONTAL
2	11028.97	50.07	74.00	-23.93	41.82	5.02	38.34	35.11	Peak	100	131	HORIZONTAL

**Vertical**

	Freq	Level	Limit	Over	Read	Cable	Antenna	Preamp	Remark	A/Pos	T/Pos	Pol/Phase
	MHz	dBuV/m	dBuV/m	dB	dBuV	dB	dB/m	dB		cm	deg	
1	11010.99	36.94	54.00	-17.06	28.71	5.02	38.32	35.11	Average	100	209	VERTICAL
2	11014.07	49.93	74.00	-24.07	41.70	5.02	38.32	35.11	Peak	100	209	VERTICAL



<b>Temperature</b>	25°C	<b>Humidity</b>	54%
<b>Test Engineer</b>	Jim Huang	<b>Configurations</b>	IEEE 802.11n MCS16 40MHz CH 110 3TX / Chain 1 + Chain 2 + Chain 3
<b>Test Date</b>	Aug. 27, 2013	<b>Test Mode</b>	Mode 1 (Ant.31 PIFA antenna / 4.4dBi)

**Horizontal**

	Freq	Level	Limit	Over	Read	CableAntenna	Preamp	Remark	A/Pos	T/Pos	Pol/Phase
	MHz	dBuV/m	dBuV/m	dB	dBuV	dB	dB/m	dB	cm	deg	
1	11095.13	49.67	74.00	-24.33	41.38	5.03	38.40	35.14	Peak	100	315 HORIZONTAL
2	11101.22	37.20	54.00	-16.80	28.91	5.03	38.40	35.14	Average	100	315 HORIZONTAL

**Vertical**

	Freq	Level	Limit	Over	Read	CableAntenna	Preamp	Remark	A/Pos	T/Pos	Pol/Phase
	MHz	dBuV/m	dBuV/m	dB	dBuV	dB	dB/m	dB	cm	deg	
1	11106.86	37.52	54.00	-16.48	29.23	5.03	38.40	35.14	Average	100	234 VERTICAL
2	11107.31	50.61	74.00	-23.39	42.33	5.03	38.40	35.15	Peak	100	234 VERTICAL





<b>Temperature</b>	25°C	<b>Humidity</b>	54%
<b>Test Engineer</b>	Jim Huang	<b>Configurations</b>	IEEE 802.11n MCS16 40MHz CH 134 3TX / Chain 1 + Chain 2 + Chain 3
<b>Test Date</b>	Aug. 27, 2013	<b>Test Mode</b>	Mode 1 (Ant.31 PIFA antenna / 4.4dBi)

**Horizontal**

	Freq	Level	Limit	Over	Read	Cable	Antenna	Preamp	Remark	A/Pos	T/Pos	Pol/Phase
	MHz	dBuV/m	dBuV/m	dB	dBuV	Loss	Factor	Factor		cm	deg	
1	11334.94	37.50	54.00	-16.50	29.02	5.08	38.63	35.23	Average	100	176	HORIZONTAL
2	11348.72	50.07	74.00	-23.93	41.57	5.09	38.65	35.24	Peak	100	176	HORIZONTAL

**Vertical**

	Freq	Level	Limit	Over	Read	Cable	Antenna	Preamp	Remark	A/Pos	T/Pos	Pol/Phase
	MHz	dBuV/m	dBuV/m	dB	dBuV	Loss	Factor	Factor		cm	deg	
1	11344.58	37.52	54.00	-16.48	29.04	5.09	38.63	35.24	Average	100	283	VERTICAL
2	11349.29	50.43	74.00	-23.57	41.93	5.09	38.65	35.24	Peak	100	283	VERTICAL

**Note:**

The amplitude of spurious emissions that are attenuated by more than 20dB below the permissible value has no need to be reported.

Emission level (dBuV/m) = 20 log Emission level (uV/m).

Corrected Reading: Antenna Factor + Cable Loss + Read Level - Preamp Factor = Level.



<b>Temperature</b>	25°C	<b>Humidity</b>	54%
<b>Test Engineer</b>	Jim Huang	<b>Configurations</b>	IEEE 802.11a CH 36 / 1TX / Chain 1
<b>Test Date</b>	Sep. 27, 2013	<b>Test Mode</b>	Mode 1 (Ant.31 PIFA antenna / 4.4dBi)

**Horizontal**

	Freq	Level	Limit Line	Over Limit	Read Level	Cable Loss	Antenna Factor	Preamp Factor	Remark	A/Pos	T/Pos	Pol/Phase
	MHz	dBuV/m	dBuV/m	dB	dBuV	dB	dB/m	dB		cm	deg	
1	15542.60	51.89	74.00	-22.11	43.42	6.13	37.65	35.31	Peak	100	324	HORIZONTAL
2	15544.39	38.95	54.00	-15.05	30.48	6.13	37.65	35.31	Average	100	324	HORIZONTAL

**Vertical**

	Freq	Level	Limit Line	Over Limit	Read Level	Cable Loss	Antenna Factor	Preamp Factor	Remark	A/Pos	T/Pos	Pol/Phase
	MHz	dBuV/m	dBuV/m	dB	dBuV	dB	dB/m	dB		cm	deg	
1	15543.08	39.22	54.00	-14.78	30.71	6.13	37.69	35.31	Average	100	231	VERTICAL
2	15548.78	51.85	74.00	-22.15	43.34	6.13	37.69	35.31	Peak	100	231	VERTICAL



<b>Temperature</b>	25°C	<b>Humidity</b>	54%
<b>Test Engineer</b>	Jim Huang	<b>Configurations</b>	IEEE 802.11a CH 40 / 1TX / Chain 1
<b>Test Date</b>	Sep. 27, 2013	<b>Test Mode</b>	Mode 1 (Ant.31 PIFA antenna / 4.4dBi)

**Horizontal**

	Freq	Level	Limit Line	Over Limit	Read Level	CableAntenna Loss	Antenna Factor	Preamp Factor	Remark	A/Pos	T/Pos	Pol/Phase
	MHz	dBuV/m	dBuV/m	dB	dBuV	dB	dB/m	dB		cm	deg	
1	15599.60	64.01	74.00	-9.99	55.62	6.13	37.60	35.34	Peak	109	149	HORIZONTAL
2	15599.68	47.76	54.00	-6.24	39.37	6.13	37.60	35.34	Average	109	149	HORIZONTAL

**Vertical**

	Freq	Level	Limit Line	Over Limit	Read Level	CableAntenna Loss	Antenna Factor	Preamp Factor	Remark	A/Pos	T/Pos	Pol/Phase
	MHz	dBuV/m	dBuV/m	dB	dBuV	dB	dB/m	dB		cm	deg	
1	15602.69	44.44	54.00	-9.56	36.05	6.13	37.60	35.34	Average	100	34	VERTICAL
2	15604.65	59.63	74.00	-14.37	51.24	6.13	37.60	35.34	Peak	100	34	VERTICAL



<b>Temperature</b>	25°C	<b>Humidity</b>	54%
<b>Test Engineer</b>	Jim Huang	<b>Configurations</b>	IEEE 802.11a CH 48 / 1TX / Chain 1
<b>Test Date</b>	Sep. 27, 2013	<b>Test Mode</b>	Mode 1 (Ant.31 PIFA antenna / 4.4dBi)

**Horizontal**

	Freq	Level	Limit Line	Over Limit	Read Level	CableAntenna Loss	Antenna Factor	Preamp Factor	Remark	A/Pos	T/Pos	Pol/Phase
	MHz	dBuV/m	dBuV/m	dB	dBuV	dB	dB/m	dB		cm	deg	
1	15725.37	50.83	54.00	-3.17	42.62	6.14	37.46	35.39	Average	114	141	HORIZONTAL
2	15726.81	67.10	74.00	-6.90	58.89	6.14	37.46	35.39	Peak	114	141	HORIZONTAL

**Vertical**

	Freq	Level	Limit Line	Over Limit	Read Level	CableAntenna Loss	Antenna Factor	Preamp Factor	Remark	A/Pos	T/Pos	Pol/Phase
	MHz	dBuV/m	dBuV/m	dB	dBuV	dB	dB/m	dB		cm	deg	
1	15714.39	47.06	54.00	-6.94	38.82	6.14	37.48	35.38	Average	100	35	VERTICAL
2	15716.15	62.65	74.00	-11.35	54.42	6.14	37.48	35.39	Peak	100	35	VERTICAL



<b>Temperature</b>	25°C	<b>Humidity</b>	54%
<b>Test Engineer</b>	Jim Huang	<b>Configurations</b>	IEEE 802.11a CH 52 / 1TX / Chain 1
<b>Test Date</b>	Sep. 27, 2013	<b>Test Mode</b>	Mode 1 (Ant.31 PIFA antenna / 4.4dBi)

**Horizontal**

	Freq	Level	Limit Line	Over Limit	Read Level	CableAntenna Loss	Antenna Factor	Preamp Factor	Remark	A/Pos	T/Pos	Pol/Phase
	MHz	dBuV/m	dBuV/m	dB	dBuV	dB	dB/m	dB		cm	deg	
1	15778.40	50.50	54.00	-3.50	42.37	6.14	37.41	35.42	Average	109	149	HORIZONTAL
2	15778.96	66.09	74.00	-7.91	57.96	6.14	37.41	35.42	Peak	109	149	HORIZONTAL

**Vertical**

	Freq	Level	Limit Line	Over Limit	Read Level	CableAntenna Loss	Antenna Factor	Preamp Factor	Remark	A/Pos	T/Pos	Pol/Phase
	MHz	dBuV/m	dBuV/m	dB	dBuV	dB	dB/m	dB		cm	deg	
1	15777.92	46.04	54.00	-7.96	37.91	6.14	37.41	35.42	Average	114	286	VERTICAL
2	15778.21	62.04	74.00	-11.96	53.91	6.14	37.41	35.42	Peak	114	286	VERTICAL



<b>Temperature</b>	25°C	<b>Humidity</b>	54%
<b>Test Engineer</b>	Jim Huang	<b>Configurations</b>	IEEE 802.11a CH 60 / 1TX / Chain 1
<b>Test Date</b>	Sep. 27, 2013	<b>Test Mode</b>	Mode 1 (Ant.31 PIFA antenna / 4.4dBi)

**Horizontal**

	Freq	Level	Limit	Over	Read	Cable	Antenna	Preamp	Remark	A/Pos	T/Pos	Pol/Phase
	MHz	dBuV/m	dBuV/m	dB	dBuV	Loss	Factor	Factor		cm	deg	
1	10604.89	37.92	54.00	-16.08	29.95	5.01	38.38	35.42	Average	100	252	HORIZONTAL
2	10605.29	49.20	74.00	-24.80	41.23	5.01	38.38	35.42	Peak	100	252	HORIZONTAL
3	15893.59	65.59	74.00	-8.41	57.58	6.15	37.30	35.44	Peak	112	141	HORIZONTAL
4	15895.43	50.08	54.00	-3.92	42.07	6.15	37.30	35.44	Average	112	141	HORIZONTAL

**Vertical**

	Freq	Level	Limit	Over	Read	Cable	Antenna	Preamp	Remark	A/Pos	T/Pos	Pol/Phase
	MHz	dBuV/m	dBuV/m	dB	dBuV	Loss	Factor	Factor		cm	deg	
1	10609.54	37.82	54.00	-16.18	29.85	5.01	38.38	35.42	Average	100	331	VERTICAL
2	10610.10	49.46	74.00	-24.54	41.49	5.01	38.38	35.42	Peak	100	331	VERTICAL
3	15892.47	59.61	74.00	-14.39	51.60	6.15	37.30	35.44	Peak	100	298	VERTICAL
4	15894.63	43.23	54.00	-10.77	35.22	6.15	37.30	35.44	Average	100	298	VERTICAL



<b>Temperature</b>	25°C	<b>Humidity</b>	54%
<b>Test Engineer</b>	Jim Huang	<b>Configurations</b>	IEEE 802.11a CH 64 / 1TX / Chain 1
<b>Test Date</b>	Sep. 27, 2013	<b>Test Mode</b>	Mode 1 (Ant.31 PIFA antenna / 4.4dBi)

**Horizontal**

	Freq	Level	Limit	Over	Read	CableAntenna	Preamp	Remark	A/Pos	T/Pos	PoI/Phase
	MHz	dBuV/m	dBuV/m	dB	dBuV	dB	dB/m	dB	cm	deg	
1	10643.94	49.46	74.00	-24.54	41.47	5.01	38.37	35.39 Peak	100	73	HORIZONTAL
2	10644.01	37.86	54.00	-16.14	29.87	5.01	38.37	35.39 Average	100	73	HORIZONTAL
3	15956.55	39.98	54.00	-14.02	32.04	6.15	37.23	35.44 Average	100	146	HORIZONTAL
4	15958.16	53.50	74.00	-20.50	45.56	6.15	37.23	35.44 Peak	100	146	HORIZONTAL

**Vertical**

	Freq	Level	Limit	Over	Read	CableAntenna	Preamp	Remark	A/Pos	T/Pos	PoI/Phase
	MHz	dBuV/m	dBuV/m	dB	dBuV	dB	dB/m	dB	cm	deg	
1	10643.81	49.52	74.00	-24.48	41.53	5.01	38.37	35.39 Peak	100	169	VERTICAL
2	10643.94	37.32	54.00	-16.68	29.33	5.01	38.37	35.39 Average	100	169	VERTICAL
3	15953.37	51.22	74.00	-22.78	43.28	6.15	37.23	35.44 Peak	100	295	VERTICAL
4	15963.14	38.77	54.00	-15.23	30.83	6.15	37.23	35.44 Average	100	295	VERTICAL



<b>Temperature</b>	25°C	<b>Humidity</b>	54%
<b>Test Engineer</b>	Jim Huang	<b>Configurations</b>	IEEE 802.11a CH 100 / 1TX / Chain 1
<b>Test Date</b>	Sep. 27, 2013	<b>Test Mode</b>	Mode 1 (Ant.31 PIFA antenna / 4.4dBi)

**Horizontal**

	Freq	Level	Limit Line	Over Limit	Read Level	CableAntenna Loss	Antenna Factor	Preamp Factor	Remark	A/Pos	T/Pos	Pol/Phase
	MHz	dBuV/m	dBuV/m	dB	dBuV	dB	dB/m	dB		cm	deg	
1	10992.21	50.17	74.00	-23.83	41.94	5.01	38.32	35.10	Peak	100	156	HORIZONTAL
2	11000.99	38.67	54.00	-15.33	30.44	5.01	38.32	35.10	Average	100	156	HORIZONTAL

**Vertical**

	Freq	Level	Limit Line	Over Limit	Read Level	CableAntenna Loss	Antenna Factor	Preamp Factor	Remark	A/Pos	T/Pos	Pol/Phase
	MHz	dBuV/m	dBuV/m	dB	dBuV	dB	dB/m	dB		cm	deg	
1	10995.61	51.95	74.00	-22.05	43.74	5.01	38.30	35.10	Peak	100	274	VERTICAL
2	10996.38	38.19	54.00	-15.81	29.98	5.01	38.30	35.10	Average	100	274	VERTICAL





<b>Temperature</b>	25°C	<b>Humidity</b>	54%
<b>Test Engineer</b>	Jim Huang	<b>Configurations</b>	IEEE 802.11a CH 116 / 1TX / Chain 1
<b>Test Date</b>	Sep. 27, 2013	<b>Test Mode</b>	Mode 1 (Ant.31 PIFA antenna / 4.4dBi)

**Horizontal**

	Freq	Level	Limit Line	Over Limit	Read Level	CableAntenna Loss	Antenna Factor	Preamp Factor	Remark	A/Pos	T/Pos	Pol/Phase
	MHz	dBuV/m	dBuV/m	dB	dBuV	dB	dB/m	dB		cm	deg	
1	11165.58	38.12	54.00	-15.88	29.77	5.05	38.47	35.17	Average	100	91	HORIZONTAL
2	11169.74	51.88	74.00	-22.12	43.53	5.05	38.47	35.17	Peak	100	91	HORIZONTAL

**Vertical**

	Freq	Level	Limit Line	Over Limit	Read Level	CableAntenna Loss	Antenna Factor	Preamp Factor	Remark	A/Pos	T/Pos	Pol/Phase
	MHz	dBuV/m	dBuV/m	dB	dBuV	dB	dB/m	dB		cm	deg	
1	11164.55	38.73	54.00	-15.27	30.38	5.05	38.47	35.17	Average	100	274	VERTICAL
2	11166.54	50.31	74.00	-23.69	41.96	5.05	38.47	35.17	Peak	100	274	VERTICAL



<b>Temperature</b>	25°C	<b>Humidity</b>	54%
<b>Test Engineer</b>	Jim Huang	<b>Configurations</b>	IEEE 802.11a CH 140 / 1TX / Chain 1
<b>Test Date</b>	Sep. 27, 2013	<b>Test Mode</b>	Mode 1 (Ant.31 PIFA antenna / 4.4dBi)

**Horizontal**

	Freq	Level	Limit Line	Over Limit	Read Level	CableAntenna Loss	Antenna Factor	Preamp Factor	Remark	A/Pos	T/Pos	Pol/Phase
	MHz	dBuV/m	dBuV/m	dB	dBuV	dB	dB/m	dB		cm	deg	
1	11396.41	51.04	74.00	-22.96	42.51	5.10	38.68	35.25	Peak	100	173	HORIZONTAL
2	11404.42	38.38	54.00	-15.62	29.83	5.10	38.70	35.25	Average	100	173	HORIZONTAL

**Vertical**

	Freq	Level	Limit Line	Over Limit	Read Level	CableAntenna Loss	Antenna Factor	Preamp Factor	Remark	A/Pos	T/Pos	Pol/Phase
	MHz	dBuV/m	dBuV/m	dB	dBuV	dB	dB/m	dB		cm	deg	
1	11396.41	51.04	74.00	-22.96	42.51	5.10	38.68	35.25	Peak	100	173	HORIZONTAL
2	11404.42	38.38	54.00	-15.62	29.83	5.10	38.70	35.25	Average	100	173	HORIZONTAL

**Note:**

The amplitude of spurious emissions that are attenuated by more than 20dB below the permissible value has no need to be reported.

Emission level (dBuV/m) = 20 log Emission level (uV/m).

Corrected Reading: Antenna Factor + Cable Loss + Read Level - Preamp Factor = Level.

## 4.6. Band Edge Emissions Measurement

### 4.6.1. Limit

For transmitters operating in the 5.15-5.35 GHz band: all emissions outside of the 5.15-5.35 GHz band shall not exceed a -27dBm peak limit or average 54dBuV/m and peak 74dBuV/m limits. For transmitters operating in the 5.470-5.725 GHz band: all emissions outside of the 5.470-5.725 GHz band shall not exceed a -27dBm peak limit or average 54dBuV/m and peak 74dBuV/m limits. For transmitters operating in the 5.725-5.825 GHz band: all emissions within the frequency range from the band edge to 10 MHz above or below the band edge shall not exceed an EIRP of -17 dBm/MHz (78.3dBuV/m at 3m). In addition, In case the emission fall within the restricted band specified on 15.205(a), then the 15.209(a) limit in the table below has to be followed.

Frequencies (MHz)	Field Strength (microvolts/meter)	Measurement Distance (meters)
0.009~0.490	2400/F(kHz)	300
0.490~1.705	24000/F(kHz)	30
1.705~30.0	30	30
30~88	100	3
88~216	150	3
216~960	200	3
Above 960	500	3

### 4.6.2. Measuring Instruments and Setting

Please refer to section 5 of equipments list in this report. The following table is the setting of the spectrum analyzer.

Spectrum Parameter	Setting
Attenuation	Auto
Span Frequency	100 MHz
RBW / VBW (Emission in restricted band)	1 MHz / 3MHz for Peak, 1 MHz / 10Hz for Average
RBW / VBW (Emission in non-restricted band)	1 MHz / 3MHz for Peak

### 4.6.3. Test Procedures

1. The test procedure is the same as section 4.5.3, only the frequency range investigated is limited to 100MHz around bandedges.

### 4.6.4. Test Setup Layout

This test setup layout is the same as that shown in section 4.5.4.

#### 4.6.5. Test Deviation

There is no deviation with the original standard.

#### 4.6.6. EUT Operation during Test

The EUT was programmed to be in continuously transmitting mode.

#### 4.6.7. Test Result of Band Edge and Fundamental Emissions

<b>Temperature</b>	25°C	<b>Humidity</b>	54%
<b>Test Engineer</b>	Serway Li	<b>Configurations</b>	IEEE 802.11n MCS0 20MHz CH 36, 40, 48 / 1TX / Chain 1
<b>Test Date</b>	Aug. 30, 2013	<b>Test Mode</b>	Mode 1 (Ant.31 PIFA antenna / 4.4dBi)

##### Channel 36

	Freq	Level	Limit Line	Over Limit	Read Level	CableAntenna Loss	Antenna Factor	Preamp Factor	Remark	A/Pos	T/Pos	Pol/Phase
	MHz	dBuV/m	dBuV/m	dB	dBuV	dB	dB/m	dB		cm	deg	
1	5146.47	69.98	74.00	-4.02	32.88	3.43	33.67	0.00	Peak	178	283	VERTICAL
2	5150.00	52.73	54.00	-1.27	15.63	3.43	33.67	0.00	Average	178	283	VERTICAL
3	5183.69	99.12			61.95	3.44	33.73	0.00	Average	178	283	VERTICAL
4	5184.01	112.22			75.05	3.44	33.73	0.00	Peak	178	283	VERTICAL

Item 3, 4 are the fundamental frequency at 5180 MHz.

##### Channel 40

	Freq	Level	Limit Line	Over Limit	Read Level	CableAntenna Loss	Antenna Factor	Preamp Factor	Remark	A/Pos	T/Pos	Pol/Phase
	MHz	dBuV/m	dBuV/m	dB	dBuV	dB	dB/m	dB		cm	deg	
1	5149.68	70.26	74.00	-3.74	33.16	3.43	33.67	0.00	Peak	148	288	VERTICAL
2	5150.00	52.62	54.00	-1.38	15.52	3.43	33.67	0.00	Average	148	288	VERTICAL
3	5204.81	116.57			79.36	3.45	33.76	0.00	Peak	148	288	VERTICAL
4	5206.73	103.80			66.59	3.45	33.76	0.00	Average	148	288	VERTICAL

Item 3, 4 are the fundamental frequency at 5200 MHz.

##### Channel 48

	Freq	Level	Limit Line	Over Limit	Read Level	CableAntenna Loss	Antenna Factor	Preamp Factor	Remark	A/Pos	T/Pos	Pol/Phase
	MHz	dBuV/m	dBuV/m	dB	dBuV	dB	dB/m	dB		cm	deg	
1	5146.64	61.43	74.00	-12.57	24.33	3.43	33.67	0.00	Peak	161	263	VERTICAL
2	5150.00	44.62	54.00	-9.38	7.52	3.43	33.67	0.00	Average	161	263	VERTICAL
3	5244.81	104.56			67.28	3.46	33.82	0.00	Average	161	263	VERTICAL
4	5245.77	117.67			80.36	3.46	33.85	0.00	Peak	161	263	VERTICAL
5	5350.00	44.80	54.00	-9.20	7.28	3.49	34.03	0.00	Average	161	263	VERTICAL
6	5352.40	58.71	74.00	-15.29	21.19	3.49	34.03	0.00	Peak	161	263	VERTICAL

Item 3, 4 are the fundamental frequency at 5240 MHz.

<b>Temperature</b>	25°C	<b>Humidity</b>	54%
<b>Test Engineer</b>	Serway Li	<b>Configurations</b>	IEEE 802.11n MCS0 20MHz CH 52, 60, 64 / 1TX / Chain 1
<b>Test Date</b>	Aug. 30, 2013	<b>Test Mode</b>	Mode 1 (Ant.31 PIFA antenna / 4.4dBi)

### Channel 52

	Freq	Level	Limit	Over	Read	CableAntenna	Preamp	Remark	A/Pos	T/Pos	PoI/Phase
	MHz	dBuV/m	dBuV/m	dB	dBuV	dB	dB/m	dB	cm	deg	
1	5147.12	58.18	74.00	-15.82	21.08	3.43	33.67	0.00 Peak	162	279	VERTICAL
2	5150.00	42.63	54.00	-11.37	5.53	3.43	33.67	0.00 Average	162	279	VERTICAL
3	5256.64	118.10			80.79	3.46	33.85	0.00 Peak	162	279	VERTICAL
4	5257.60	104.43			67.12	3.46	33.85	0.00 Average	162	279	VERTICAL
5	5354.33	46.40	54.00	-7.60	8.88	3.49	34.03	0.00 Average	162	279	VERTICAL
6	5356.25	65.16	74.00	-8.84	27.64	3.49	34.03	0.00 Peak	162	279	VERTICAL

Item 3, 4 are the fundamental frequency at 5260 MHz.

### Channel 60

	Freq	Level	Limit	Over	Read	CableAntenna	Preamp	Remark	A/Pos	T/Pos	PoI/Phase
	MHz	dBuV/m	dBuV/m	dB	dBuV	dB	dB/m	dB	cm	deg	
1	5303.21	117.12			79.70	3.48	33.94	0.00 Peak	158	289	VERTICAL
2	5304.81	104.37			66.95	3.48	33.94	0.00 Average	158	289	VERTICAL
3	5350.00	52.14	54.00	-1.86	14.62	3.49	34.03	0.00 Average	158	289	VERTICAL
4	5350.00	67.62	74.00	-6.38	30.10	3.49	34.03	0.00 Peak	158	289	VERTICAL

Item 1, 2 are the fundamental frequency at 5300 MHz.

### Channel 64

	Freq	Level	Limit	Over	Read	CableAntenna	Preamp	Remark	A/Pos	T/Pos	PoI/Phase
	MHz	dBuV/m	dBuV/m	dB	dBuV	dB	dB/m	dB	cm	deg	
1	5314.55	112.63			75.18	3.48	33.97	0.00 Peak	158	288	VERTICAL
2	5327.05	99.88			62.42	3.49	33.97	0.00 Average	158	288	VERTICAL
3	5350.00	52.37	54.00	-1.63	14.85	3.49	34.03	0.00 Average	158	288	VERTICAL
4	5350.48	69.05	74.00	-4.95	31.53	3.49	34.03	0.00 Peak	158	288	VERTICAL

Item 1, 2 are the fundamental frequency at 5320 MHz.

<b>Temperature</b>	25°C	<b>Humidity</b>	54%
<b>Test Engineer</b>	Serway Li	<b>Configurations</b>	IEEE 802.11n MCS0 20MHz CH 100, 140 / 1TX / Chain 1
<b>Test Date</b>	Aug. 30, 2013	<b>Test Mode</b>	Mode 1 (Ant.31 PIFA antenna / 4.4dBi)

**Channel 100**

	Freq	Level	Limit Line	Over Limit	Read Level	CableAntenna Loss	Antenna Factor	Preamp Factor	Remark	A/Pos	T/Pos	Pol/Phase
	MHz	dBuV/m	dBuV/m	dB	dBuV	dB	dB/m	dB		cm	deg	
1	5457.76	65.77	74.00	-8.23	28.04	3.52	34.21	0.00	Peak	183	284	VERTICAL
2	5460.00	47.06	54.00	-6.94	9.33	3.52	34.21	0.00	Average	183	284	VERTICAL
3	5470.00	52.78	54.00	-1.22	15.02	3.52	34.24	0.00	Average	183	284	VERTICAL
4	5470.00	71.67	74.00	-2.33	33.91	3.52	34.24	0.00	Peak	183	284	VERTICAL
5	5493.59	99.28			61.49	3.53	34.26	0.00	Average	183	284	VERTICAL
6	5496.80	112.07			74.28	3.53	34.26	0.00	Peak	183	284	VERTICAL

Item 5, 6 are the fundamental frequency at 5500 MHz.

**Channel 140**

	Freq	Level	Limit Line	Over Limit	Read Level	CableAntenna Loss	Antenna Factor	Preamp Factor	Remark	A/Pos	T/Pos	Pol/Phase
	MHz	dBuV/m	dBuV/m	dB	dBuV	dB	dB/m	dB		cm	deg	
1	5693.59	97.98			60.05	3.59	34.34	0.00	Average	182	331	HORIZONTAL
2	5705.77	110.67			72.73	3.60	34.34	0.00	Peak	182	331	HORIZONTAL
3	5725.00	52.55	54.00	-1.45	14.61	3.60	34.34	0.00	Average	182	331	HORIZONTAL
4	5725.00	70.89	74.00	-3.11	32.95	3.60	34.34	0.00	Peak	182	331	HORIZONTAL

Item 1, 2 are the fundamental frequency at 5700 MHz.

<b>Temperature</b>	25°C	<b>Humidity</b>	54%
<b>Test Engineer</b>	Serway Li	<b>Configurations</b>	IEEE 802.11n MCS0 40MHz CH 38, 46 / 1TX / Chain 1
<b>Test Date</b>	Aug. 30, 2013	<b>Test Mode</b>	Mode 1 (Ant.31 PIFA antenna / 4.4dBi)

**Channel 38**

	Freq	Level	Limit	Over	Read	CableAntenna	Preamp	Remark	A/Pos	T/Pos	Pol/Phase
	MHz	dBuV/m	dBuV/m	dB	dBuV	dB	dB/m	dB	cm	deg	
1	5148.08	69.78	74.00	-4.22	32.68	3.43	33.67	0.00 Peak	148	289	VERTICAL
2	5150.00	52.56	54.00	-1.44	15.46	3.43	33.67	0.00 Average	148	289	VERTICAL
3	5202.18	103.78			66.57	3.45	33.76	0.00 Peak	148	289	VERTICAL
4	5207.31	90.98			53.77	3.45	33.76	0.00 Average	148	289	VERTICAL

Item 3, 4 are the fundamental frequency at 5190 MHz.

**Channel 46**

	Freq	Level	Limit	Over	Read	CableAntenna	Preamp	Remark	A/Pos	T/Pos	Pol/Phase
	MHz	dBuV/m	dBuV/m	dB	dBuV	dB	dB/m	dB	cm	deg	
1	5150.00	52.46	54.00	-1.54	15.36	3.43	33.67	0.00 Average	161	278	VERTICAL
2	5150.00	68.44	74.00	-5.56	31.34	3.43	33.67	0.00 Peak	161	278	VERTICAL
3	5243.78	100.17			62.89	3.46	33.82	0.00 Average	161	278	VERTICAL
4	5245.39	113.59			76.31	3.46	33.82	0.00 Peak	161	278	VERTICAL

Item 3, 4 are the fundamental frequency at 5230 MHz.



<b>Temperature</b>	25°C	<b>Humidity</b>	54%
<b>Test Engineer</b>	Serway Li	<b>Configurations</b>	IEEE 802.11n MCS0 40MHz CH 54, 62 / 1TX / Chain 1
<b>Test Date</b>	Aug. 30, 2013	<b>Test Mode</b>	Mode 1 (Ant.31 PIFA antenna / 4.4dBi)

#### Channel 54

	Freq	Level	Limit	Over	Read	CableAntenna	Preamp	Remark	A/Pos	T/Pos	Pol/Phase
	MHz	dBuV/m	dBuV/m	dB	dBuV	dB	dB/m	dB	cm	deg	
1	5272.56	113.19			75.84	3.47	33.88	0.00 Peak	159	306	VERTICAL
2	5277.37	99.89			62.54	3.47	33.88	0.00 Average	159	306	VERTICAL
3	5350.00	52.15	54.00	-1.85	14.63	3.49	34.03	0.00 Average	159	306	VERTICAL
4	5350.64	67.62	74.00	-6.38	30.10	3.49	34.03	0.00 Peak	159	306	VERTICAL

Item 1, 2 are the fundamental frequency at 5270 MHz.

#### Channel 62

	Freq	Level	Limit	Over	Read	CableAntenna	Preamp	Remark	A/Pos	T/Pos	Pol/Phase
	MHz	dBuV/m	dBuV/m	dB	dBuV	dB	dB/m	dB	cm	deg	
1	5314.49	104.46			67.01	3.48	33.97	0.00 Peak	157	287	VERTICAL
2	5327.31	92.22			54.76	3.49	33.97	0.00 Average	157	287	VERTICAL
3	5350.00	52.14	54.00	-1.86	14.62	3.49	34.03	0.00 Average	157	287	VERTICAL
4	5350.00	67.02	74.00	-6.98	29.50	3.49	34.03	0.00 Peak	157	287	VERTICAL

Item 1, 2 are the fundamental frequency at 5310 MHz.

<b>Temperature</b>	25°C	<b>Humidity</b>	54%
<b>Test Engineer</b>	Serway Li	<b>Configurations</b>	IEEE 802.11n MCS0 40MHz CH 102, 110, 134 / 1TX / Chain 1
<b>Test Date</b>	Aug. 31, 2013	<b>Test Mode</b>	Mode 1 (Ant.31 PIFA antenna / 4.4dBi)

### Channel 102

	Freq	Level	Limit	Over	Read	CableAntenna	Preamp	Remark	A/Pos	T/Pos	Pol/Phase	
	MHz	dBuV/m	dBuV/m	dB	dBuV	dB	dB/m	dB	cm	deg		
1	5460.00	46.72	54.00	-7.28	8.99	3.52	34.21	0.00	Average	182	286	VERTICAL
2	5460.00	61.58	74.00	-12.42	23.85	3.52	34.21	0.00	Peak	182	286	VERTICAL
3	5469.36	68.72	74.00	-5.28	30.96	3.52	34.24	0.00	Peak	182	286	VERTICAL
4	5470.00	52.31	54.00	-1.69	14.55	3.52	34.24	0.00	Average	182	286	VERTICAL
5	5492.69	90.27			52.48	3.53	34.26	0.00	Average	182	286	VERTICAL
6	5493.97	103.03			65.24	3.53	34.26	0.00	Peak	182	286	VERTICAL

Item 5, 6 are the fundamental frequency at 5510 MHz.

### Channel 110

	Freq	Level	Limit	Over	Read	CableAntenna	Preamp	Remark	A/Pos	T/Pos	Pol/Phase	
	MHz	dBuV/m	dBuV/m	dB	dBuV	dB	dB/m	dB	cm	deg		
1	5460.00	50.35	54.00	-3.65	12.62	3.52	34.21	0.00	Average	158	281	VERTICAL
2	5460.00	65.27	74.00	-8.73	27.54	3.52	34.21	0.00	Peak	158	281	VERTICAL
3	5470.00	52.71	54.00	-1.29	14.95	3.52	34.24	0.00	Average	158	281	VERTICAL
4	5470.00	65.30	74.00	-8.70	27.54	3.52	34.24	0.00	Peak	158	281	VERTICAL
5	5540.71	110.13			72.27	3.55	34.31	0.00	Peak	158	281	VERTICAL
6	5542.31	97.55			59.69	3.55	34.31	0.00	Average	158	281	VERTICAL

Item 5, 6 are the fundamental frequency at 5550 MHz.

### Channel 134

	Freq	Level	Limit	Over	Read	CableAntenna	Preamp	Remark	A/Pos	T/Pos	Pol/Phase	
	MHz	dBuV/m	dBuV/m	dB	dBuV	dB	dB/m	dB	cm	deg		
1	5680.26	108.59			70.67	3.59	34.33	0.00	Peak	160	316	HORIZONTAL
2	5685.06	95.43			57.51	3.59	34.33	0.00	Average	160	316	HORIZONTAL
3	5725.00	52.12	54.00	-1.88	14.18	3.60	34.34	0.00	Average	160	316	HORIZONTAL
4	5725.00	68.94	74.00	-5.06	31.00	3.60	34.34	0.00	Peak	160	316	HORIZONTAL

Item 1, 2 are the fundamental frequency at 5670 MHz.

Note:

Emission level (dBuV/m) = 20 log Emission level (uV/m)

Corrected Reading: Antenna Factor + Cable Loss + Read Level - Preamp Factor = Level

<b>Temperature</b>	25°C	<b>Humidity</b>	54%
<b>Test Engineer</b>	Serway Li	<b>Configurations</b>	IEEE 802.11n MCS8 20MHz CH 36, 40, 48 / 2TX / Chain 1 + Chain 2
<b>Test Date</b>	Sep. 02, 2013	<b>Test Mode</b>	Mode 1 (Ant.31 PIFA antenna / 4.4dBi)

### Channel 36

	Freq	Level	Limit	Over	Read	CableAntenna	Preamp	Remark	A/Pos	T/Pos	Pol/Phase
	MHz	dBuV/m	dBuV/m	dB	dBuV	dB	dB/m	dB	cm	deg	
1	5149.60	68.56	74.00	-5.44	31.46	3.43	33.67	0.00 Peak	118	105	VERTICAL
2	5150.00	52.67	54.00	-1.33	15.57	3.43	33.67	0.00 Average	118	105	VERTICAL
3	5173.60	100.64			63.50	3.44	33.70	0.00 Average	118	105	VERTICAL
4	5181.20	115.86			78.69	3.44	33.73	0.00 Peak	118	105	VERTICAL

Item 3, 4 are the fundamental frequency at 5180 MHz.

### Channel 40

	Freq	Level	Limit	Over	Read	CableAntenna	Preamp	Remark	A/Pos	T/Pos	Pol/Phase
	MHz	dBuV/m	dBuV/m	dB	dBuV	dB	dB/m	dB	cm	deg	
1	5000.00	52.37	54.00	-1.63	15.58	3.39	33.40	0.00 Average	121	106	VERTICAL
2	5115.00	62.51	74.00	-11.49	25.48	3.42	33.61	0.00 Peak	121	106	VERTICAL
3	5195.00	100.88			63.67	3.45	33.76	0.00 Average	121	106	VERTICAL
4	5201.00	115.71			78.50	3.45	33.76	0.00 Peak	121	106	VERTICAL

Item 3, 4 are the fundamental frequency at 5200 MHz.

### Channel 48

	Freq	Level	Limit	Over	Read	CableAntenna	Preamp	Remark	A/Pos	T/Pos	Pol/Phase
	MHz	dBuV/m	dBuV/m	dB	dBuV	dB	dB/m	dB	cm	deg	
1	4999.00	52.03	54.00	-1.97	15.24	3.39	33.40	0.00 Average	130	104	VERTICAL
2	5000.00	59.28	74.00	-14.72	22.49	3.39	33.40	0.00 Peak	130	104	VERTICAL
3	5246.00	103.75			66.44	3.46	33.85	0.00 Average	130	104	VERTICAL
4	5246.00	120.09			82.78	3.46	33.85	0.00 Peak	130	104	VERTICAL
5	5400.00	52.21	54.00	-1.79	14.58	3.51	34.12	0.00 Average	130	104	VERTICAL
6	5401.00	61.12	74.00	-12.88	23.49	3.51	34.12	0.00 Peak	130	104	VERTICAL

Item 3, 4 are the fundamental frequency at 5240 MHz.

<b>Temperature</b>	25°C	<b>Humidity</b>	54%
<b>Test Engineer</b>	Serway Li	<b>Configurations</b>	IEEE 802.11n MCS8 20MHz CH 52, 60, 64 / 2TX / Chain 1 + Chain 2
<b>Test Date</b>	Sep. 02, 2013	<b>Test Mode</b>	Mode 1 (Ant.31 PIFA antenna / 4.4dBi)

### Channel 52

	Freq	Level	Limit	Over	Read	CableAntenna	Preamp	Remark	A/Pos	T/Pos	Pol/Phase
	MHz	dBuV/m	dBuV/m	dB	dBuV	dB	dB/m	dB	cm	deg	
1	5254.00	118.24			80.93	3.46	33.85	0.00 Peak	116	108	VERTICAL
2	5256.00	107.23			69.92	3.46	33.85	0.00 Average	116	108	VERTICAL
3	5400.00	52.83	54.00	-1.17	15.20	3.51	34.12	0.00 Average	116	108	VERTICAL
4	5400.00	58.91	74.00	-15.09	21.28	3.51	34.12	0.00 Peak	116	108	VERTICAL

Item 1, 2 are the fundamental frequency at 5260 MHz.

### Channel 60

	Freq	Level	Limit	Over	Read	CableAntenna	Preamp	Remark	A/Pos	T/Pos	Pol/Phase
	MHz	dBuV/m	dBuV/m	dB	dBuV	dB	dB/m	dB	cm	deg	
1	5304.80	121.81			84.39	3.48	33.94	0.00 Peak	117	105	VERTICAL
2	5307.20	105.53			68.11	3.48	33.94	0.00 Average	117	105	VERTICAL
3	5350.00	52.72	54.00	-1.28	15.20	3.49	34.03	0.00 Average	117	105	VERTICAL
4	5353.20	72.03	74.00	-1.97	34.51	3.49	34.03	0.00 Peak	117	105	VERTICAL

Item 1, 2 are the fundamental frequency at 5300 MHz.

### Channel 64

	Freq	Level	Limit	Over	Read	CableAntenna	Preamp	Remark	A/Pos	T/Pos	Pol/Phase
	MHz	dBuV/m	dBuV/m	dB	dBuV	dB	dB/m	dB	cm	deg	
1	5324.00	117.56			80.10	3.49	33.97	0.00 Peak	115	89	VERTICAL
2	5326.80	102.32			64.86	3.49	33.97	0.00 Average	115	89	VERTICAL
3	5350.00	52.99	54.00	-1.01	15.47	3.49	34.03	0.00 Average	115	89	VERTICAL
4	5350.00	69.95	74.00	-4.05	32.43	3.49	34.03	0.00 Peak	115	89	VERTICAL

Item 1, 2 are the fundamental frequency at 5320 MHz.

<b>Temperature</b>	25°C	<b>Humidity</b>	54%
<b>Test Engineer</b>	Serway Li	<b>Configurations</b>	IEEE 802.11n MCS8 20MHz CH 100, 116, 140 / 2TX / Chain 1 + Chain 2
<b>Test Date</b>	Sep. 02, 2013	<b>Test Mode</b>	Mode 1 (Ant.31 PIFA antenna / 4.4dBi)

### Channel 100

	Freq	Level	Limit	Over	Read	CableAntenna	Preamp	Remark	A/Pos	T/Pos	Pol/Phase
	MHz	dBuV/m	dBuV/m	dB	dBuV	dB	dB/m	dB	cm	deg	
1	5440.00	51.56	54.00	-2.44	13.86	3.52	34.18	0.00 Average	100	143	VERTICAL
2	5454.80	62.14	74.00	-11.86	24.41	3.52	34.21	0.00 Peak	100	143	VERTICAL
3	5469.20	71.12	74.00	-2.88	33.36	3.52	34.24	0.00 Peak	100	143	VERTICAL
4	5470.00	52.82	54.00	-1.18	15.06	3.52	34.24	0.00 Average	100	143	VERTICAL
5	5504.40	116.21			78.39	3.54	34.28	0.00 Peak	100	143	VERTICAL
6	5507.20	100.24			62.42	3.54	34.28	0.00 Average	100	143	VERTICAL

Item 5, 6 are the fundamental frequency at 5500 MHz.

### Channel 116

	Freq	Level	Limit	Over	Read	CableAntenna	Preamp	Remark	A/Pos	T/Pos	Pol/Phase
	MHz	dBuV/m	dBuV/m	dB	dBuV	dB	dB/m	dB	cm	deg	
1	5400.00	52.13	54.00	-1.87	14.50	3.51	34.12	0.00 Average	122	89	VERTICAL
2	5400.00	61.96	74.00	-12.04	24.33	3.51	34.12	0.00 Peak	122	89	VERTICAL
3	5470.00	46.35	54.00	-7.65	8.59	3.52	34.24	0.00 Average	122	89	VERTICAL
4	5470.00	58.92	74.00	-15.08	21.16	3.52	34.24	0.00 Peak	122	89	VERTICAL
5	5573.00	119.09			81.23	3.55	34.31	0.00 Peak	122	89	VERTICAL
6	5577.00	102.69			64.83	3.55	34.31	0.00 Average	122	89	VERTICAL

Item 5, 6 are the fundamental frequency at 5580 MHz.

### Channel 140

	Freq	Level	Limit	Over	Read	CableAntenna	Preamp	Remark	A/Pos	T/Pos	Pol/Phase
	MHz	dBuV/m	dBuV/m	dB	dBuV	dB	dB/m	dB	cm	deg	
1	5694.20	115.51			77.58	3.59	34.34	0.00 Peak	109	105	VERTICAL
2	5695.20	99.41			61.48	3.59	34.34	0.00 Average	109	105	VERTICAL
3	5725.00	52.11	54.00	-1.89	14.17	3.60	34.34	0.00 Average	109	105	VERTICAL
4	5725.60	72.91	74.00	-1.09	34.97	3.60	34.34	0.00 Peak	109	105	VERTICAL

Item 1, 2 are the fundamental frequency at 5700 MHz.

<b>Temperature</b>	25°C	<b>Humidity</b>	54%
<b>Test Engineer</b>	Serway Li	<b>Configurations</b>	IEEE 802.11n MCS8 40MHz CH 38, 46 / 2TX / Chain 1 + Chain 2
<b>Test Date</b>	Sep. 02, 2013	<b>Test Mode</b>	Mode 1 (Ant.31 PIFA antenna / 4.4dBi)

### Channel 38

	Freq	Level	Limit Line	Over Limit	Read Level	CableAntenna Loss	Antenna Factor	Preamp Factor	Remark	A/Pos	T/Pos	Pol/Phase
	MHz	dBuV/m	dBuV/m	dB	dBuV	dB	dB/m	dB		cm	deg	
1	5148.40	68.10	74.00	-5.90	31.00	3.43	33.67	0.00	Peak	117	105	VERTICAL
2	5150.00	52.93	54.00	-1.07	15.83	3.43	33.67	0.00	Average	117	105	VERTICAL
3	5176.40	91.22			54.08	3.44	33.70	0.00	Average	117	105	VERTICAL
4	5202.00	107.26			70.05	3.45	33.76	0.00	Peak	117	105	VERTICAL

Item 3, 4 are the fundamental frequency at 5190 MHz.

### Channel 46

	Freq	Level	Limit Line	Over Limit	Read Level	CableAntenna Loss	Antenna Factor	Preamp Factor	Remark	A/Pos	T/Pos	Pol/Phase
	MHz	dBuV/m	dBuV/m	dB	dBuV	dB	dB/m	dB		cm	deg	
1	5148.00	67.82	74.00	-6.18	30.72	3.43	33.67	0.00	Peak	100	105	VERTICAL
2	5150.00	52.68	54.00	-1.32	15.58	3.43	33.67	0.00	Average	100	105	VERTICAL
3	5245.00	97.64			60.36	3.46	33.82	0.00	Average	100	105	VERTICAL
4	5245.00	114.27			76.99	3.46	33.82	0.00	Peak	100	105	VERTICAL

Item 3, 4 are the fundamental frequency at 5230 MHz.



<b>Temperature</b>	25°C	<b>Humidity</b>	54%
<b>Test Engineer</b>	Serway Li	<b>Configurations</b>	IEEE 802.11n MCS8 40MHz CH 54, 62 / 2TX / Chain 1 + Chain 2
<b>Test Date</b>	Sep. 02, 2013	<b>Test Mode</b>	Mode 1 (Ant.31 PIFA antenna / 4.4dBi)

#### Channel 54

	Freq	Level	Limit	Over	Read	CableAntenna	Preamp	Remark	A/Pos	T/Pos	Pol/Phase
	MHz	dBuV/m	dBuV/m	dB	dBuV	dB	dB/m	dB	cm	deg	
1	5281.00	115.49			78.11	3.47	33.91	0.00 Peak	113	97	VERTICAL
2	5282.00	99.05			61.67	3.47	33.91	0.00 Average	113	97	VERTICAL
3	5350.00	52.38	54.00	-1.62	14.86	3.49	34.03	0.00 Average	113	97	VERTICAL
4	5350.00	67.16	74.00	-6.84	29.64	3.49	34.03	0.00 Peak	113	97	VERTICAL

Item 1, 2 are the fundamental frequency at 5270 MHz.

#### Channel 62

	Freq	Level	Limit	Over	Read	CableAntenna	Preamp	Remark	A/Pos	T/Pos	Pol/Phase
	MHz	dBuV/m	dBuV/m	dB	dBuV	dB	dB/m	dB	cm	deg	
1	5325.60	111.02			73.56	3.49	33.97	0.00 Peak	100	88	VERTICAL
2	5326.20	94.09			56.63	3.49	33.97	0.00 Average	100	88	VERTICAL
3	5350.00	52.95	54.00	-1.05	15.43	3.49	34.03	0.00 Average	100	88	VERTICAL
4	5350.00	68.64	74.00	-5.36	31.12	3.49	34.03	0.00 Peak	100	88	VERTICAL

Item 1, 2 are the fundamental frequency at 5310 MHz.

<b>Temperature</b>	25°C	<b>Humidity</b>	54%
<b>Test Engineer</b>	Serway Li	<b>Configurations</b>	IEEE 802.11n MCS8 40MHz CH 102, 110, 134 / 2TX / Chain 1 + Chain 2
<b>Test Date</b>	Sep. 02, 2013	<b>Test Mode</b>	Mode 1 (Ant.31 PIFA antenna / 4.4dBi)

### Channel 102

	Freq	Level	Limit	Over	Read	CableAntenna	Preamp	Remark	A/Pos	T/Pos	Pol/Phase
	MHz	dBuV/m	dBuV/m	dB	dBuV	dB	dB/m	dB	cm	deg	
1	5440.00	48.96	54.00	-5.04	11.26	3.52	34.18	0.00	100	142	VERTICAL
2	5460.00	62.03	74.00	-11.97	24.30	3.52	34.21	0.00	100	142	VERTICAL
3	5468.80	69.01	74.00	-4.99	31.25	3.52	34.24	0.00	100	142	VERTICAL
4	5470.00	52.47	54.00	-1.53	14.71	3.52	34.24	0.00	100	142	VERTICAL
5	5497.60	108.12			70.33	3.53	34.26	0.00	100	142	VERTICAL
6	5525.60	91.96			54.12	3.54	34.30	0.00	100	142	VERTICAL

Item 5, 6 are the fundamental frequency at 5510 MHz.

### Channel 110

	Freq	Level	Limit	Over	Read	CableAntenna	Preamp	Remark	A/Pos	T/Pos	Pol/Phase
	MHz	dBuV/m	dBuV/m	dB	dBuV	dB	dB/m	dB	cm	deg	
1	5439.60	50.69	54.00	-3.31	12.99	3.52	34.18	0.00	100	143	VERTICAL
2	5459.40	66.64	74.00	-7.36	28.91	3.52	34.21	0.00	100	143	VERTICAL
3	5470.00	52.50	54.00	-1.50	14.74	3.52	34.24	0.00	100	143	VERTICAL
4	5470.00	68.61	74.00	-5.39	30.85	3.52	34.24	0.00	100	143	VERTICAL
5	5535.00	99.47			61.62	3.55	34.30	0.00	100	143	VERTICAL
6	5537.40	116.40			78.54	3.55	34.31	0.00	100	143	VERTICAL

Item 5, 6 are the fundamental frequency at 5550 MHz.

### Channel 134

	Freq	Level	Limit	Over	Read	CableAntenna	Preamp	Remark	A/Pos	T/Pos	Pol/Phase
	MHz	dBuV/m	dBuV/m	dB	dBuV	dB	dB/m	dB	cm	deg	
1	5656.40	97.38			59.46	3.59	34.33	0.00	130	95	VERTICAL
2	5665.20	114.03			76.11	3.59	34.33	0.00	130	95	VERTICAL
3	5726.60	52.89	54.00	-1.11	14.95	3.60	34.34	0.00	130	95	VERTICAL
4	5726.60	70.23	74.00	-3.77	32.29	3.60	34.34	0.00	130	95	VERTICAL

Item 1, 2 are the fundamental frequency at 5670 MHz.

Note:

Emission level (dBuV/m) = 20 log Emission level (uV/m)

Corrected Reading: Antenna Factor + Cable Loss + Read Level - Preamp Factor = Level



<b>Temperature</b>	25°C	<b>Humidity</b>	54%
<b>Test Engineer</b>	Jim Huang	<b>Configurations</b>	IEEE 802.11n MCS16 20MHz CH 36, 40, 48 / 3TX / Chain 1 + Chain 2 + Chain 3
<b>Test Date</b>	Aug. 26, 2013	<b>Test Mode</b>	Mode 1 (Ant.31 PIFA antenna / 4.4dBi)

### Channel 36

	Freq	Level	Limit Line	Over Limit	Read Level	CableAntenna Loss	Antenna Factor	Preamp Factor	Remark	A/Pos	T/Pos	Pol/Phase
	MHz	dBuV/m	dBuV/m	dB	dBuV	dB	dB/m	dB		cm	deg	
1	5149.04	71.61	74.00	-2.39	34.51	3.43	33.67	0.00	Peak	113	257	VERTICAL
2	5150.00	52.73	54.00	-1.27	15.63	3.43	33.67	0.00	Average	113	257	VERTICAL
3	5177.92	117.50			80.33	3.44	33.73	0.00	Peak	113	257	VERTICAL
4	5184.97	99.85			62.68	3.44	33.73	0.00	Average	113	257	VERTICAL

Item 3, 4 are the fundamental frequency at 5180 MHz.

### Channel 40

	Freq	Level	Limit Line	Over Limit	Read Level	CableAntenna Loss	Antenna Factor	Preamp Factor	Remark	A/Pos	T/Pos	Pol/Phase
	MHz	dBuV/m	dBuV/m	dB	dBuV	dB	dB/m	dB		cm	deg	
1	5000.00	52.31	54.00	-1.69	15.52	3.39	33.40	0.00	Average	100	255	VERTICAL
2	5000.00	63.13	74.00	-10.87	26.34	3.39	33.40	0.00	Peak	100	255	VERTICAL
3	5193.59	99.25			62.08	3.44	33.73	0.00	Average	100	255	VERTICAL
4	5205.61	116.45			79.24	3.45	33.76	0.00	Peak	100	255	VERTICAL
5	5440.00	52.79	54.00	-1.21	15.09	3.52	34.18	0.00	Average	100	255	VERTICAL
6	5440.00	60.88	74.00	-13.12	23.18	3.52	34.18	0.00	Peak	100	255	VERTICAL

Item 3, 4 are the fundamental frequency at 5200 MHz.

### Channel 48

	Freq	Level	Limit Line	Over Limit	Read Level	CableAntenna Loss	Antenna Factor	Preamp Factor	Remark	A/Pos	T/Pos	Pol/Phase
	MHz	dBuV/m	dBuV/m	dB	dBuV	dB	dB/m	dB		cm	deg	
1	5040.00	52.63	54.00	-1.37	15.77	3.40	33.46	0.00	Average	100	259	VERTICAL
2	5040.00	60.50	74.00	-13.50	23.64	3.40	33.46	0.00	Peak	100	259	VERTICAL
3	5238.40	103.98			66.70	3.46	33.82	0.00	Average	100	259	VERTICAL
4	5245.61	121.70			84.39	3.46	33.85	0.00	Peak	100	259	VERTICAL
5	5440.00	48.84	54.00	-5.16	11.14	3.52	34.18	0.00	Average	100	259	VERTICAL
6	5440.00	58.30	74.00	-15.70	20.60	3.52	34.18	0.00	Peak	100	259	VERTICAL

Item 3, 4 are the fundamental frequency at 5240 MHz.

<b>Temperature</b>	25°C	<b>Humidity</b>	54%
<b>Test Engineer</b>	Jim Huang	<b>Configurations</b>	IEEE 802.11n MCS16 20MHz CH 52, 60, 64 / 3TX / Chain 1 + Chain 2 + Chain 3
<b>Test Date</b>	Aug. 26, 2013	<b>Test Mode</b>	Mode 1 (Ant.31 PIFA antenna / 4.4dBi)

### Channel 52

	Freq	Level	Limit	Over	Read	CableAntenna	Preamp	Remark	A/Pos	T/Pos	PoI/Phase
	MHz	dBuV/m	dBuV/m	dB	dBuV	dB	dB/m	dB	cm	deg	
1	5040.00	52.69	54.00	-1.31	15.83	3.40	33.46	0.00 Average	100	258	VERTICAL
2	5040.00	60.30	74.00	-13.70	23.44	3.40	33.46	0.00 Peak	100	258	VERTICAL
3	5255.99	102.08			64.77	3.46	33.85	0.00 Average	100	258	VERTICAL
4	5266.41	120.99			83.65	3.46	33.88	0.00 Peak	100	258	VERTICAL
5	5440.55	48.80	54.00	-5.20	11.10	3.52	34.18	0.00 Average	100	258	VERTICAL
6	5440.55	58.01	74.00	-15.99	20.31	3.52	34.18	0.00 Peak	100	258	VERTICAL

Item 3, 4 are the fundamental frequency at 5260 MHz.

### Channel 60

	Freq	Level	Limit	Over	Read	CableAntenna	Preamp	Remark	A/Pos	T/Pos	PoI/Phase
	MHz	dBuV/m	dBuV/m	dB	dBuV	dB	dB/m	dB	cm	deg	
1	5295.51	123.16			85.78	3.47	33.91	0.00 Peak	110	257	VERTICAL
2	5304.81	104.52			67.10	3.48	33.94	0.00 Average	110	257	VERTICAL
3	5350.00	52.44	54.00	-1.56	14.92	3.49	34.03	0.00 Average	110	257	VERTICAL
4	5352.24	71.12	74.00	-2.88	33.60	3.49	34.03	0.00 Peak	110	257	VERTICAL

Item 1, 2 are the fundamental frequency at 5300 MHz.

### Channel 64

	Freq	Level	Limit	Over	Read	CableAntenna	Preamp	Remark	A/Pos	T/Pos	PoI/Phase
	MHz	dBuV/m	dBuV/m	dB	dBuV	dB	dB/m	dB	cm	deg	
1	5315.03	117.81			80.36	3.48	33.97	0.00 Peak	109	258	VERTICAL
2	5321.12	100.29			62.84	3.48	33.97	0.00 Average	109	258	VERTICAL
3	5350.00	52.40	54.00	-1.60	14.88	3.49	34.03	0.00 Average	109	258	VERTICAL
4	5350.16	70.04	74.00	-3.96	32.52	3.49	34.03	0.00 Peak	109	258	VERTICAL

Item 1, 2 are the fundamental frequency at 5320 MHz.

<b>Temperature</b>	25°C	<b>Humidity</b>	54%
<b>Test Engineer</b>	Jim Huang	<b>Configurations</b>	IEEE 802.11n MCS16 20MHz CH 100, 116, 140 / 3TX / Chain 1 + Chain 2 + Chain 3
<b>Test Date</b>	Aug. 26, 2013	<b>Test Mode</b>	Mode 1 (Ant.31 PIFA antenna / 4.4dBi)

### Channel 100

	Freq	Level	Limit	Over	Read	Cable	Antenna	Preamp	Remark	A/Pos	T/Pos	Pol/Phase
	MHz	dBuV/m	dBuV/m	dB	dBuV	dB	dB/m	dB		cm	deg	
1	5439.74	50.92	54.00	-3.08	13.22	3.52	34.18	0.00	Average	106	256	VERTICAL
2	5439.74	59.33	74.00	-14.67	21.63	3.52	34.18	0.00	Peak	106	256	VERTICAL
3	5469.68	70.05	74.00	-3.95	32.29	3.52	34.24	0.00	Peak	106	256	VERTICAL
4	5470.00	52.19	54.00	-1.81	14.43	3.52	34.24	0.00	Average	106	256	VERTICAL
5	5498.72	98.65			60.86	3.53	34.26	0.00	Average	106	256	VERTICAL
6	5502.24	115.70			77.88	3.54	34.28	0.00	Peak	106	256	VERTICAL

Item 5, 6 are the fundamental frequency at 5500 MHz.

### Channel 116

	Freq	Level	Limit	Over	Read	Cable	Antenna	Preamp	Remark	A/Pos	T/Pos	Pol/Phase
	MHz	dBuV/m	dBuV/m	dB	dBuV	dB	dB/m	dB		cm	deg	
1	5439.97	52.70	54.00	-1.30	15.00	3.52	34.18	0.00	Average	100	289	VERTICAL
2	5440.00	59.73	74.00	-14.27	22.03	3.52	34.18	0.00	Peak	100	289	VERTICAL
3	5575.19	99.44			61.58	3.55	34.31	0.00	Average	100	289	VERTICAL
4	5586.41	118.89			81.01	3.56	34.32	0.00	Peak	100	289	VERTICAL

Item 3, 4 are the fundamental frequency at 5580 MHz.

### Channel 140

	Freq	Level	Limit	Over	Read	Cable	Antenna	Preamp	Remark	A/Pos	T/Pos	Pol/Phase
	MHz	dBuV/m	dBuV/m	dB	dBuV	dB	dB/m	dB		cm	deg	
1	5439.81	52.65	54.00	-1.35	14.95	3.52	34.18	0.00	Average	100	288	VERTICAL
2	5439.81	60.24	74.00	-13.76	22.54	3.52	34.18	0.00	Peak	100	288	VERTICAL
3	5693.27	98.57			60.64	3.59	34.34	0.00	Average	100	288	VERTICAL
4	5694.23	114.87			76.94	3.59	34.34	0.00	Peak	100	288	VERTICAL
5	5725.00	52.38	54.00	-1.62	14.44	3.60	34.34	0.00	Average	100	288	VERTICAL
6	5725.00	70.32	74.00	-3.68	32.38	3.60	34.34	0.00	Peak	100	288	VERTICAL

Item 3, 4 are the fundamental frequency at 5700 MHz.

<b>Temperature</b>	25°C	<b>Humidity</b>	54%
<b>Test Engineer</b>	Jim Huang	<b>Configurations</b>	IEEE 802.11n MCS16 40MHz CH 38, 46 / 3TX / Chain 1 + Chain 2 + Chain 3
<b>Test Date</b>	Aug. 26, 2013	<b>Test Mode</b>	Mode 1 (Ant.31 PIFA antenna / 4.4dBi)

### Channel 38

	Freq	Level	Limit	Over	Read	CableAntenna	Preamp	Remark	A/Pos	T/Pos	Pol/Phase
	MHz	dBuV/m	dBuV/m	dB	dBuV	dB	dB/m	dB	cm	deg	
1	5150.00	52.67	54.00	-1.33	15.57	3.43	33.67	0.00 Average	112	258	VERTICAL
2	5150.00	67.88	74.00	-6.12	30.78	3.43	33.67	0.00 Peak	112	258	VERTICAL
3	5173.33	90.84			53.70	3.44	33.70	0.00 Average	112	258	VERTICAL
4	5203.78	109.47			72.26	3.45	33.76	0.00 Peak	112	258	VERTICAL

Item 3, 4 are the fundamental frequency at 5190 MHz.

### Channel 46

	Freq	Level	Limit	Over	Read	CableAntenna	Preamp	Remark	A/Pos	T/Pos	Pol/Phase
	MHz	dBuV/m	dBuV/m	dB	dBuV	dB	dB/m	dB	cm	deg	
1	5145.99	67.50	74.00	-6.50	30.40	3.43	33.67	0.00 Peak	111	263	VERTICAL
2	5150.00	52.41	54.00	-1.59	15.31	3.43	33.67	0.00 Average	111	263	VERTICAL
3	5243.62	118.17			80.89	3.46	33.82	0.00 Peak	111	263	VERTICAL
4	5244.42	98.91			61.63	3.46	33.82	0.00 Average	111	263	VERTICAL

Item 3, 4 are the fundamental frequency at 5230 MHz.

<b>Temperature</b>	25°C	<b>Humidity</b>	54%
<b>Test Engineer</b>	Jim Huang	<b>Configurations</b>	IEEE 802.11n MCS16 40MHz CH 54, 62 / 3TX / Chain 1 + Chain 2 + Chain 3
<b>Test Date</b>	Aug. 26, 2013	<b>Test Mode</b>	Mode 1 (Ant.31 PIFA antenna / 4.4dBi)

#### Channel 54

	Freq	Level	Limit	Over	Read	CableAntenna	Preamp	Remark	A/Pos	T/Pos	Pol/Phase
	MHz	dBuV/m	dBuV/m	dB	dBuV	dB	dB/m	dB	cm	deg	
1	5039.14	52.37	54.00	-1.63	15.51	3.40	33.46	0.00 Average	100	262	VERTICAL
2	5040.00	60.83	74.00	-13.17	23.97	3.40	33.46	0.00 Peak	100	262	VERTICAL
3	5258.78	99.13			61.82	3.46	33.85	0.00 Average	100	262	VERTICAL
4	5259.58	117.37			80.06	3.46	33.85	0.00 Peak	100	262	VERTICAL
5	5350.00	50.70	54.00	-3.30	13.18	3.49	34.03	0.00 Average	100	262	VERTICAL
6	5359.62	66.02	74.00	-7.98	28.50	3.49	34.03	0.00 Peak	100	262	VERTICAL

Item 3, 4 are the fundamental frequency at 5270 MHz.

#### Channel 62

	Freq	Level	Limit	Over	Read	CableAntenna	Preamp	Remark	A/Pos	T/Pos	Pol/Phase
	MHz	dBuV/m	dBuV/m	dB	dBuV	dB	dB/m	dB	cm	deg	
1	5298.14	110.78			73.36	3.48	33.94	0.00 Peak	111	259	VERTICAL
2	5318.65	92.83			55.38	3.48	33.97	0.00 Average	111	259	VERTICAL
3	5350.00	52.44	54.00	-1.56	14.92	3.49	34.03	0.00 Average	111	259	VERTICAL
4	5350.00	68.68	74.00	-5.32	31.16	3.49	34.03	0.00 Peak	111	259	VERTICAL

Item 1, 2 are the fundamental frequency at 5310 MHz.

<b>Temperature</b>	25°C	<b>Humidity</b>	54%
<b>Test Engineer</b>	Jim Huang	<b>Configurations</b>	IEEE 802.11n MCS16 40MHz CH 102, 110, 134 / 3TX / Chain 1 + Chain 2 + Chain 3
<b>Test Date</b>	Aug. 26, 2013	<b>Test Mode</b>	Mode 1 (Ant.31 PIFA antenna / 4.4dBi)

### Channel 102

	Freq	Level	Limit Line	Over Limit	Read Level	Cable Loss	Antenna Factor	Preamp Factor	Remark	A/Pos	T/Pos	Pol/Phase
	MHz	dBuV/m	dBuV/m	dB	dBuV	dB	dB/m	dB		cm	deg	
1	5439.81	48.25	54.00	-5.75	10.55	3.52	34.18	0.00	Average	105	262	VERTICAL
2	5439.81	58.27	74.00	-15.73	20.57	3.52	34.18	0.00	Peak	105	262	VERTICAL
3	5470.00	52.59	54.00	-1.41	14.83	3.52	34.24	0.00	Average	105	262	VERTICAL
4	5470.00	69.89	74.00	-4.11	32.13	3.52	34.24	0.00	Peak	105	262	VERTICAL
5	5496.22	91.05			53.26	3.53	34.26	0.00	Average	105	262	VERTICAL
6	5525.06	110.27			72.43	3.54	34.30	0.00	Peak	105	262	VERTICAL

Item 5, 6 are the fundamental frequency at 5510 MHz.

### Channel 110

	Freq	Level	Limit Line	Over Limit	Read Level	Cable Loss	Antenna Factor	Preamp Factor	Remark	A/Pos	T/Pos	Pol/Phase
	MHz	dBuV/m	dBuV/m	dB	dBuV	dB	dB/m	dB		cm	deg	
1	5454.39	67.84	74.00	-6.16	30.11	3.52	34.21	0.00	Peak	116	265	VERTICAL
2	5460.00	50.08	54.00	-3.92	12.35	3.52	34.21	0.00	Average	116	265	VERTICAL
3	5465.99	67.66	74.00	-6.34	29.93	3.52	34.21	0.00	Peak	116	265	VERTICAL
4	5470.00	52.84	54.00	-1.16	15.08	3.52	34.24	0.00	Average	116	265	VERTICAL
5	5538.78	99.05			61.19	3.55	34.31	0.00	Average	116	265	VERTICAL
6	5541.19	117.40			79.54	3.55	34.31	0.00	Peak	116	265	VERTICAL

Item 5, 6 are the fundamental frequency at 5550 MHz.

### Channel 134

	Freq	Level	Limit Line	Over Limit	Read Level	Cable Loss	Antenna Factor	Preamp Factor	Remark	A/Pos	T/Pos	Pol/Phase
	MHz	dBuV/m	dBuV/m	dB	dBuV	dB	dB/m	dB		cm	deg	
1	5439.20	51.93	54.00	-2.07	14.23	3.52	34.18	0.00	Average	100	291	VERTICAL
2	5439.20	58.51	74.00	-15.49	20.81	3.52	34.18	0.00	Peak	100	291	VERTICAL
3	5654.78	93.16			55.24	3.59	34.33	0.00	Average	100	291	VERTICAL
4	5679.62	111.07			73.15	3.59	34.33	0.00	Peak	100	291	VERTICAL
5	5759.46	49.49	54.00	-4.51	11.52	3.62	34.35	0.00	Average	100	291	VERTICAL
6	5760.26	58.63	74.00	-15.37	20.66	3.62	34.35	0.00	Peak	100	291	VERTICAL

Item 3, 4 are the fundamental frequency at 5670 MHz.

Note:

Emission level (dBuV/m) = 20 log Emission level (uV/m)

Corrected Reading: Antenna Factor + Cable Loss + Read Level - Preamp Factor = Level



<b>Temperature</b>	25°C	<b>Humidity</b>	54%
<b>Test Engineer</b>	Serway Li	<b>Configurations</b>	IEEE 802.11a CH 36, 40, 48 / 1TX / Chain 1
<b>Test Date</b>	Aug. 30, 2013	<b>Test Mode</b>	Mode 1 (Ant.31 PIFA antenna / 4.4dBi)

### Channel 36

	Freq	Level	Limit	Over	Read	CableAntenna	Preamp	Remark	A/Pos	T/Pos	Pol/Phase
	MHz	dBuV/m	dBuV/m	dB	dBuV	dB	dB/m	dB	cm	deg	
1	5149.84	71.63	74.00	-2.37	34.53	3.43	33.67	0.00 Peak	105	288	VERTICAL
2	5150.00	52.30	54.00	-1.70	15.20	3.43	33.67	0.00 Average	105	288	VERTICAL
3	5174.23	112.30			75.16	3.44	33.70	0.00 Peak	105	288	VERTICAL
4	5186.41	99.81			62.64	3.44	33.73	0.00 Average	105	288	VERTICAL

Item 3, 4 are the fundamental frequency at 5180 MHz.

### Channel 40

	Freq	Level	Limit	Over	Read	CableAntenna	Preamp	Remark	A/Pos	T/Pos	Pol/Phase
	MHz	dBuV/m	dBuV/m	dB	dBuV	dB	dB/m	dB	cm	deg	
1	5149.68	68.91	74.00	-5.09	31.81	3.43	33.67	0.00 Peak	148	291	VERTICAL
2	5150.00	52.70	54.00	-1.30	15.60	3.43	33.67	0.00 Average	148	291	VERTICAL
3	5205.13	116.66			79.45	3.45	33.76	0.00 Peak	148	291	VERTICAL
4	5207.05	104.48			67.27	3.45	33.76	0.00 Average	148	291	VERTICAL

Item 3, 4 are the fundamental frequency at 5200 MHz.

### Channel 48

	Freq	Level	Limit	Over	Read	CableAntenna	Preamp	Remark	A/Pos	T/Pos	Pol/Phase
	MHz	dBuV/m	dBuV/m	dB	dBuV	dB	dB/m	dB	cm	deg	
1	5150.00	45.84	54.00	-8.16	8.74	3.43	33.67	0.00 Average	147	290	VERTICAL
2	5150.00	61.06	74.00	-12.94	23.96	3.43	33.67	0.00 Peak	147	290	VERTICAL
3	5238.56	119.00			81.72	3.46	33.82	0.00 Peak	147	290	VERTICAL
4	5246.25	108.46			71.15	3.46	33.85	0.00 Average	147	290	VERTICAL
5	5350.00	57.85	74.00	-16.15	20.33	3.49	34.03	0.00 Peak	147	290	VERTICAL
6	5352.89	44.69	54.00	-9.31	7.17	3.49	34.03	0.00 Average	147	290	VERTICAL

Item 3, 4 are the fundamental frequency at 5240 MHz.

<b>Temperature</b>	25°C	<b>Humidity</b>	54%
<b>Test Engineer</b>	Serway Li	<b>Configurations</b>	IEEE 802.11a CH 52, 60, 64 / 1TX / Chain 1
<b>Test Date</b>	Aug. 30, 2013	<b>Test Mode</b>	Mode 1 (Ant.31 PIFA antenna / 4.4dBi)

### Channel 52

	Freq	Level	Limit	Over	Read	CableAntenna	Preamp	Remark	A/Pos	T/Pos	Pol/Phase
	MHz	dBuV/m	dBuV/m	dB	dBuV	dB	dB/m	dB	cm	deg	
1	5149.04	57.25	74.00	-16.75	20.15	3.43	33.67	0.00 Peak	164	264	VERTICAL
2	5150.00	41.57	54.00	-12.43	4.47	3.43	33.67	0.00 Average	164	264	VERTICAL
3	5260.48	117.45			80.14	3.46	33.85	0.00 Peak	164	264	VERTICAL
4	5262.89	104.97			67.63	3.46	33.88	0.00 Average	164	264	VERTICAL
5	5350.00	45.69	54.00	-8.31	8.17	3.49	34.03	0.00 Average	164	264	VERTICAL
6	5354.81	61.37	74.00	-12.63	23.85	3.49	34.03	0.00 Peak	164	264	VERTICAL

Item 3, 4 are the fundamental frequency at 5260 MHz.

### Channel 60

	Freq	Level	Limit	Over	Read	CableAntenna	Preamp	Remark	A/Pos	T/Pos	Pol/Phase
	MHz	dBuV/m	dBuV/m	dB	dBuV	dB	dB/m	dB	cm	deg	
1	5304.49	107.54			70.12	3.48	33.94	0.00 Average	158	280	VERTICAL
2	5305.13	117.51			80.09	3.48	33.94	0.00 Peak	158	280	VERTICAL
3	5350.00	52.69	54.00	-1.31	15.17	3.49	34.03	0.00 Average	158	280	VERTICAL
4	5352.24	69.94	74.00	-4.06	32.42	3.49	34.03	0.00 Peak	158	280	VERTICAL

Item 1, 2 are the fundamental frequency at 5300 MHz.

### Channel 64

	Freq	Level	Limit	Over	Read	CableAntenna	Preamp	Remark	A/Pos	T/Pos	Pol/Phase
	MHz	dBuV/m	dBuV/m	dB	dBuV	dB	dB/m	dB	cm	deg	
1	5315.83	114.58			77.13	3.48	33.97	0.00 Peak	160	289	VERTICAL
2	5317.44	101.58			64.13	3.48	33.97	0.00 Average	160	289	VERTICAL
3	5350.00	52.88	54.00	-1.12	15.36	3.49	34.03	0.00 Average	160	289	VERTICAL
4	5350.64	68.30	74.00	-5.70	30.78	3.49	34.03	0.00 Peak	160	289	VERTICAL

Item 1, 2 are the fundamental frequency at 5320 MHz.



<b>Temperature</b>	25°C	<b>Humidity</b>	54%
<b>Test Engineer</b>	Serway Li	<b>Configurations</b>	IEEE 802.11a CH 100, 140 / 1TX / Chain 1
<b>Test Date</b>	Aug. 30, 2013	<b>Test Mode</b>	Mode 1 (Ant.31 PIFA antenna / 4.4dBi)

**Channel 100**

	Freq	Level	Limit Line	Over Limit	Read Level	CableAntenna Loss	Antenna Factor	Preamp Factor	Remark	A/Pos	T/Pos	Pol/Phase
	MHz	dBuV/m	dBuV/m	dB	dBuV	dB	dB/m	dB		cm	deg	
1	5459.36	61.81	74.00	-12.19	24.08	3.52	34.21	0.00	Peak	100	286	VERTICAL
2	5460.00	46.40	54.00	-7.60	8.67	3.52	34.21	0.00	Average	100	286	VERTICAL
3	5467.76	68.88	74.00	-5.12	31.12	3.52	34.24	0.00	Peak	100	286	VERTICAL
4	5470.00	52.26	54.00	-1.74	14.50	3.52	34.24	0.00	Average	100	286	VERTICAL
5	5494.87	99.41			61.62	3.53	34.26	0.00	Average	100	286	VERTICAL
6	5503.53	113.71			75.89	3.54	34.28	0.00	Peak	100	286	VERTICAL

Item 5, 6 are the fundamental frequency at 5500 MHz.

**Channel 140**

	Freq	Level	Limit Line	Over Limit	Read Level	CableAntenna Loss	Antenna Factor	Preamp Factor	Remark	A/Pos	T/Pos	Pol/Phase
	MHz	dBuV/m	dBuV/m	dB	dBuV	dB	dB/m	dB		cm	deg	
1	5694.55	99.15			61.22	3.59	34.34	0.00	Average	182	331	HORIZONTAL
2	5698.40	110.87			72.94	3.59	34.34	0.00	Peak	182	331	HORIZONTAL
3	5725.00	52.74	54.00	-1.26	14.80	3.60	34.34	0.00	Average	182	331	HORIZONTAL
4	5725.00	70.99	74.00	-3.01	33.05	3.60	34.34	0.00	Peak	182	331	HORIZONTAL

Item 1, 2 are the fundamental frequency at 5700 MHz.

Note:

Emission level (dBuV/m) = 20 log Emission level (uV/m)

Corrected Reading: Antenna Factor + Cable Loss + Read Level - Preamp Factor = Level

## 4.7. Frequency Stability Measurement

### 4.7.1. Limit

In-band emission is maintained within the band of operation under all conditions of normal operation as specified in the user's manual.

The transmitter center frequency tolerance shall be  $\pm 20$  ppm maximum for the 5 GHz band (IEEE 802.11n specification).

### 4.7.2. Measuring Instruments and Setting

Please refer to section 5 of equipments list in this report. The following table is the setting of the spectrum analyzer.

Spectrum Parameter	Setting
Attenuation	Auto
Span Frequency	Entire absence of modulation emissions bandwidth
RBW	10 kHz
VBW	10 kHz
Sweep Time	Auto

### 4.7.3. Test Procedures

1. The transmitter output (antenna port) was connected to the spectrum analyzer.
2. EUT have transmitted absence of modulation signal and fixed channelize.
3. Set the spectrum analyzer span to view the entire absence of modulation emissions bandwidth.
4. Set RBW = 10 kHz, VBW = 10 kHz with peak detector and maxhold settings.
5.  $f_c$  is declaring of channel frequency. Then the frequency error formula is  $(f_c - f) / f_c \times 10^6$  ppm and the limit is less than  $\pm 20$  ppm (IEEE 802.11n specification).
6. The test extreme voltage is to change the primary supply voltage from 85 to 115 percent of the nominal value
7. Extreme temperature is  $-30^\circ\text{C} \sim 50^\circ\text{C}$ .

### 4.7.4. Test Setup Layout

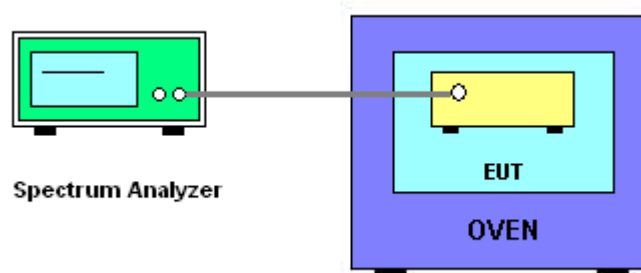

#### 4.7.5. Test Deviation

There is no deviation with the original standard.

#### 4.7.6. EUT Operation during Test

The EUT was programmed to be in continuously un-modulation transmitting mode.

#### 4.7.7. Test Result of Frequency Stability

<b>Temperature</b>	24°C	<b>Humidity</b>	61%
<b>Test Engineer</b>	Kenneth Huang	<b>Test Date</b>	Sep. 20, 2013
<b>Test Mode</b>	Mode 1 (Ant.31 PIFA antenna / 4.7dBi)		

#### Voltage vs. Frequency Stability

Voltage (V)	Measurement Frequency (MHz)		
	5200 MHz	5300 MHz	5500 MHz
126.50	5200.0003	5300.0022	5500.0001
110.00	5199.9694	5299.9574	5500.0033
93.50	5199.9634	5299.9474	5500.0122
Max. Deviation (MHz)	<b>0.036600</b>	<b>0.052600</b>	<b>0.012200</b>
Max. Deviation (ppm)	<b>7.04</b>	<b>9.92</b>	<b>2.22</b>

#### Temperature vs. Frequency Stability

Temperature (°C)	Measurement Frequency (MHz)		
	5200 MHz	5300 MHz	5500 MHz
-30	5199.9996	5300.0008	5500.0006
-20	5199.9644	5299.9912	5500.0069
-10	5199.9864	5299.9964	5500.0111
0	5199.9712	5299.9634	5500.0012
10	5199.9666	5299.9633	5500.0670
20	5199.9694	5299.9574	5500.0033
30	5200.0011	5300.0008	5499.9967
40	5200.0088	5300.0021	5499.9911
50	5199.9764	5300.0101	5500.0032
Max. Deviation (MHz)	<b>0.035600</b>	<b>0.042600</b>	<b>0.067000</b>
Max. Deviation (ppm)	<b>6.85</b>	<b>8.04</b>	<b>12.18</b>

## 4.8. Antenna Requirements

### 4.8.1. Limit

Except for special regulations, the Low-power Radio-frequency Devices must not be equipped with any jacket for installing an antenna with extension cable. An intentional radiator shall be designed to ensure that no antenna other than that furnished by the responsible party shall be used with the device. The use of a permanently attached antenna or of an antenna that uses a unique coupling to the intentional radiator shall be considered sufficient to comply with the provisions of this Section. The manufacturer may design the unit so that the user can replace a broken antenna, but the use of a standard antenna jack or electrical connector is prohibited. Further, this requirement does not apply to intentional radiators that must be professionally installed.

### 4.8.2. Antenna Connector Construction

Please refer to section 3.3 in this test report; antenna connector complied with the requirements.

## 5. LIST OF MEASURING EQUIPMENTS

Instrument	Manufacturer	Model No.	Serial No.	Characteristics	Calibration Date	Remark
BILOG ANTENNA	Schaffner	CBL6112D	22021	20MHz ~ 2GHz	Apr. 16, 2013	Radiation (03CH01-CB)
Loop Antenna	Teseq	HLA 6120	24155	9 kHz - 30 MHz	Nov. 05, 2012*	Radiation (03CH01-CB)
Horn Antenna	EMCO	3115	00075790	750MHz~18GHz	Nov. 27, 2012	Radiation (03CH01-CB)
Horn Antenna	SCHWARZBEAK	BBHA 9170	BBHA9170252	15GHz ~ 40GHz	Nov. 23, 2012	Radiation (03CH01-CB)
Pre-Amplifier	Agilent	8447D	2944A10991	0.1MHz ~ 1.3GHz	Nov. 27, 2012	Radiation (03CH01-CB)
Pre-Amplifier	Agilent	8449B	3008A02310	1GHz ~ 26.5GHz	Nov. 23, 2012	Radiation (03CH01-CB)
Pre-Amplifier	WM	TF-130N-R1	923365	26.5GHz ~ 40GHz	Jul. 31, 2013	Radiation (03CH01-CB)
Spectrum analyzer	R&S	FSP40	100056	9kHz~40GHz	Nov. 16, 2012	Radiation (03CH01-CB)
EMI Test Receiver	R&S	ESCS 30	100355	9kHz ~ 2.75GHz	Apr. 12, 2013	Radiation (03CH01-CB)
Turn Table	INN CO	CO 2000	N/A	0 ~ 360 degree	N.C.R	Radiation (03CH01-CB)
Antenna Mast	INN CO	CO2000	N/A	1 m - 4 m	N.C.R	Radiation (03CH01-CB)
RF Cable-low	Woken	Low Cable-1	N/A	30 MHz - 1 GHz	Nov. 18, 2012	Radiation (03CH01-CB)
RF Cable-high	Woken	High Cable-1	N/A	1 GHz - 26.5 GHz	Nov. 18, 2012	Radiation (03CH01-CB)
RF Cable-high	Woken	High Cable-2	N/A	1 GHz - 26.5 GHz	Nov. 18, 2012	Radiation (03CH01-CB)
RF Cable-high	Woken	High Cable-3	N/A	1 GHz - 40 GHz	Nov. 18, 2012	Radiation (03CH01-CB)
RF Cable-high	Woken	High Cable-4	N/A	1 GHz - 40 GHz	Nov. 18, 2012	Radiation (03CH01-CB)
Signal analyzer	R&S	FSV40	100979	9kHz~40GHz	Oct. 08, 2012	Conducted (TH01-CB)
Temp. and Humidity Chamber	Ten Billion	TTH-D3SP	TBN-931011	-30~100 degree	Jun. 04, 2013	Conducted (TH01-CB)
RF Power Divider	Woken	2 Way	0120A02056002D	2GHz ~ 18GHz	Nov. 18, 2012	Conducted (TH01-CB)
RF Power Divider	Woken	3 Way	MDC2366	2GHz ~ 18GHz	Nov. 18, 2012	Conducted (TH01-CB)
RF Power Divider	Woken	4 Way	0120A04056002D	2GHz ~ 18GHz	Nov. 18, 2012	Conducted (TH01-CB)
RF Cable-high	Woken	High Cable-7	-	1 GHz - 26.5 GHz	Nov. 19, 2012	Conducted (TH01-CB)
RF Cable-high	Woken	High Cable-8	-	1 GHz - 26.5 GHz	Nov. 19, 2012	Conducted (TH01-CB)
RF Cable-high	Woken	High Cable-9	-	1 GHz - 26.5 GHz	Nov. 19, 2012	Conducted (TH01-CB)
RF Cable-high	Woken	High Cable-10	-	1 GHz - 26.5 GHz	Nov. 19, 2012	Conducted (TH01-CB)
RF Cable-high	Woken	High Cable-11	-	1 GHz - 26.5 GHz	Nov. 19, 2012	Conducted (TH01-CB)



Instrument	Manufacturer	Model No.	Serial No.	Characteristics	Calibration Date	Remark
Power Sensor	Anritsu	MA2411B	0917223	300MHz~40GHz	Sep. 18, 2013	Conducted (TH01-CB)
Power Sensor	Anritsu	MA2411B	0917223	300MHz~40GHz	Sep. 18, 2012	Conducted (TH01-CB)
Power Meter	Anritsu	ML2495A	1035008	300MHz~40GHz	Nov. 27, 2012	Conducted (TH01-CB)

Note: Calibration Interval of instruments listed above is one year.

“\*” Calibration Interval of instruments listed above is two years.

NCR means Non-Calibration required.

## 6. TEST LOCATION

SHIJR	ADD : 6Fl., No. 106, Sec. 1, Shintai 5th Rd., Shijr City, Taipei, Taiwan 221, R.O.C. TEL : 886-2-2696-2468 FAX : 886-2-2696-2255
HWA YA	ADD : No. 52, Hwa Ya 1st Rd., Kwei-Shan Hsiang, Tao Yuan Hsien, Taiwan, R.O.C. TEL : 886-3-327-3456 FAX : 886-3-318-0055
LINKOU	ADD : No. 30-2, Dingfu Tsuen, Linkou Shiang, Taipei, Taiwan 244, R.O.C TEL : 886-2-2601-1640 FAX : 886-2-2601-1695
DUNGHU	ADD : No. 3, Lane 238, Kangle St., Neihu Chiu, Taipei, Taiwan 114, R.O.C. TEL : 886-2-2631-4739 FAX : 886-2-2631-9740
JUNGHE	ADD : 7Fl., No. 758, Jungjeng Rd., Junghe City, Taipei, Taiwan 235, R.O.C. TEL : 886-2-8227-2020 FAX : 886-2-8227-2626
NEIHU	ADD : 4Fl., No. 339, Hsin Hu 2 <sup>nd</sup> Rd., Taipei 114, Taiwan, R.O.C. TEL : 886-2-2794-8886 FAX : 886-2-2794-9777
JHUBEI	ADD : No.8, Lane 724, Bo-ai St., Jhubei City, HsinChu County 302, Taiwan, R.O.C. TEL : 886-3-656-9065 FAX : 886-3-656-9085

## 7. MEASUREMENT UNCERTAINTY

### Uncertainty of Radiated Emission Measurement (30MHz ~ 1,000MHz)

Contribution	Uncertainty of $x_i$			$u(x_i)$
	Value	Unit	Probability Distribution k	
Receiver reading	±0.173	dB	K=1	0.086
Cable loss	±0.174	dB	K=2	0.087
Antenna gain	±0.169	dB	K=2	0.084
Site imperfection	±0.433	dB	Triangular	0.214
Pre-amplifier gain	±0.366	dB	K=2	0.183
Transmitter antenna	±1.200	dB	Rectangular	0.600
Signal generator	±0.461	dB	Rectangular	0.231
Mismatch	±0.080	dB	U-shape	0.040
Spectrum analyzer	±0.500	dB	Rectangular	0.250
Combined standard uncertainty $U_c(y)$				1.778
Measuring uncertainty for a level of confidence of 95% $U=2U_c(y)$				3.555

### Uncertainty of Radiated Emission Measurement (1GHz ~ 18GHz)

Contribution	Uncertainty of $x_i$			$u(x_i)$
	Value	Unit	Probability Distribution k	
Receiver reading	±0.191	dB	K=1	0.095
Cable loss	±0.169	dB	K=2	0.084
Antenna gain	±0.191	dB	K=2	0.096
Site imperfection	±0.582	dB	Triangular	0.291
Pre-amplifier gain	±0.304	dB	K=2	0.152
Transmitter antenna	±1.200	dB	Rectangular	0.600
Signal generator	±0.461	dB	Rectangular	0.231
Mismatch	±0.080	dB	U-shape	0.040
Spectrum analyzer	±0.500	dB	Rectangular	0.250
Combined standard uncertainty $U_c(y)$				1.839
Measuring uncertainty for a level of confidence of 95% $U=2U_c(y)$				3.678



**Uncertainty of Radiated Emission Measurement (18GHz ~ 40GHz)**

Contribution	Uncertainty of $x_i$			$u(x_i)$
	Value	Unit	Probability Distribution k	
Receiver reading	±0.186	dB	K=1	0.093
Cable loss	±0.167	dB	K=2	0.083
Antenna gain	±0.190	dB	K=2	0.095
Site imperfection	±0.488	dB	Triangular	0.244
Pre-amplifier gain	±0.269	dB	K=2	0.134
Transmitter antenna	±1.200	dB	Rectangular	0.600
Signal generator	±0.461	dB	Rectangular	0.231
Mismatch	±0.080	dB	U-shape	0.040
Spectrum analyzer	±0.500	dB	Rectangular	0.250
Combined standard uncertainty $U_c(y)$				1.771
Measuring uncertainty for a level of confidence of 95% $U=2U_c(y)$				3.541

**Uncertainty of Conducted Emission Measurement**

Contribution	Uncertainty of $x_i$			$u(x_i)$
	Value	Unit	Probability Distribution k	
Cable loss	±0.038	dB	K=2	0.019
Attenuator	±0.047	dB	K=2	0.024
Power Meter specification	±0.300	dB	Triangular	0.150
Power Sensor specification	±0.300	dB	Rectangular	0.150
Signal generator	±0.461	dB	Rectangular	0.231
Mismatch	±0.080	dB	U-shape	0.040
Spectrum analyzer	±0.500	dB	Rectangular	0.250
Combined standard uncertainty $U_c(y)$				0.863
Measuring uncertainty for a level of confidence of 95% $U=2U_c(y)$				1.726