



SPORTON International Inc.

No. 52, Hwa Ya 1st Rd., Kwei-Shan Hsiang, TaoYuan Hsien, Taiwan, R.O.C.
Ph: 886-3-327-3456 / FAX: 886-3-327-0973 / www.sporton.com.tw

FCC Dynamic Frequency Selection Test Report

Applicant's company	Motorola Solutions, Inc.
Applicant Address	One Motorola Plaza Holtsville, NY 11742 USA
FCC ID	UZ7KHAP800
Manufacturer's company	Wistron NeWeb Corporation
Manufacturer Address	20 Park Avenue II, Hsinchu Science Park, Hsinchu 308, Taiwan, R.O.C.

Product Name	802.11 a/b/g/n Module
Brand Name	MOTOROLA
Model Name	KHAP-800
Test Standard(s)	47 CFR FCC Part 15 Subpart E § 15.407
Test Freq. Range	5250~5350 / 5470~5725MHz
Received Date	Apr. 02, 2012
Final Test Date	May 14, 2012
Submission Type	Class II Change
Operating Mode	Master

Statement

The test result in this report refers exclusively to the presented test model / sample.

Without written approval of SPORTON International Inc., the test report shall not be reproduced except in full.

The measurements and test results shown in this test report were made in accordance with the procedures and found in compliance with the limit given in FCC OET Order 06-96A (2006), 47 CFR FCC Part 15 Subpart E § 15.407 and KDB 789033 D01 v01r03.

The test equipment used to perform the test is calibrated and traceable to NML/ROC.



Table of Contents

1. CERTIFICATE OF COMPLIANCE	1
2. SUMMARY OF THE TEST RESULT	2
3. GENERAL INFORMATION	3
3.1. Standard Requirement	3
3.2. Product Specification Table.....	3
3.3. Accessories.....	5
3.4. Manufacturer Statement.....	5
3.5. Table for DFS Band Carrier Frequencies	5
3.6. Table for Class II Change	6
3.7. Antenna Information.....	7
4. DFS DETECTION THRESHOLDS AND RADAR TEST WAVEFORMS	9
4.1. Interference Threshold values, Master or Client incorporating In-Service Monitoring	9
4.2. DFS Response requirement values.....	9
4.3. Radar Test Waveforms Minimum Step.....	9
4.4. Short Pulse Radar Test Waveforms	10
4.5. Long Pulse Radar Test Waveform.....	11
4.6. Frequency Hopping Radar Test Waveform.....	14
4.7. Radiated Calibration Setup.....	16
4.8. Radar Waveform Calibration Procedure	17
4.9. Calibration Deviation.....	17
4.10. Radar Waveform Calibration Result	18
5. TEST SETUP AND TEST RESULT.....	24
5.1. Test setup	24
5.2. UNII Detection Bandwidth Measurement	29
5.3. Initial Channel Availability Check Time Measurement	48
5.4. Radar Burst at the Beginning of the Channel Availability Check Time Measurement	51
5.5. Radar Burst at the End of the Channel Availability Check Time Measurement	53
5.6. In-Service Monitoring for Channel Move Time, Channel Closing Transmission Time and Non-Occupancy Period Measurement...55	
5.7. Statistical Performance Check Measurement	63
6. LIST OF MEASURING EQUIPMENTS	76
7. TEST LOCATION.....	77
8. MEASUREMENT UNCERTAINTY.....	78
APPENDIX A. TEST PHOTOS	A1 ~ A2



History of This Test Report

REPORT NO.	VERSION	DESCRIPTION	ISSUED DATE
FZ240223-04	Rev. 01	Initial issue of report	Oct. 11, 2013

1. CERTIFICATE OF COMPLIANCE

Product Name : 802.11 a/b/g/n Module
Brand Name : MOTOROLA
Model Name : KHAP-800
Applicant : Motorola Solutions, Inc.
Test Rule Part(s) : 47 CFR FCC Part 15 Subpart E § 15.407

Sporton International as requested by the applicant to evaluate the EMC performance of the product sample received on Apr. 02, 2012 would like to declare that the tested sample has been evaluated and found to be in compliance with the tested rule parts. The data recorded as well as the test configuration specified is true and accurate for showing the sample's EMC nature.

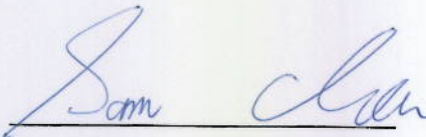

Sam Chen

SPORTON INTERNATIONAL INC.

2. SUMMARY OF THE TEST RESULT

Applied Standard: OET Order 06-96A (2006)			
Part	Appendix	Description of Test	Result
5.2	7.8.1	UNII Detection Bandwidth Measurement	Complies
5.3	7.8.2.1	Initial Channel Availability Check Time	Complies
5.4	7.8.2.2	Radar Burst at the Beginning of the Channel Availability Check Time	Complies
5.5	7.8.2.3	Radar Burst at the End of the Channel Availability Check Time	Complies
5.6	7.8.3	In-Service Monitoring for Channel Move Time, Channel Closing Transmission Time and Non-Occupancy Period	Complies
5.7	7.4	Statistical Performance Check	Complies

Note 1:

The EUT (Model Name: KHAP-800) will be installed into AP (MOTOROLA / AP-8132, AP-8122, AP-8163, AP-8232, AP-8222 and AP-8263). AP (MOTOROLA / AP-8132, AP-8122, AP-8163) are identical in main board, UNII Module and DFS algorithm, so that AP (MOTOROLA / AP-8132) was selected as representative model for the DFS test. AP (MOTOROLA / AP-8232, AP-8222, AP-8263) are identical in main board, UNII Module and DFS algorithm, so that AP (MOTOROLA / AP-8232) was selected as representative model for the DFS test.

3. GENERAL INFORMATION

3.1. Standard Requirement

47 CFR FCC Part 15 Subpart E § 15.407: U-NII devices operating in the 5250~5350 / 5470~5725 MHz shall employ a TPC mechanism. The U-NII device is required to have the capability to operate at least 6 dB below the mean EIRP value of 30 dBm. A TPC mechanism is not required for systems with an e.i.r.p. of less than 500 mW.

U-NII devices operating in the 5250~5350 / 5470~5725 MHz shall employ a DFS radar detection mechanism to detect the presence of radar systems and to avoid co-channel operation with radar systems.

3.2. Product Specification Table

Specification Items	Description
Product Type	802.11a/n: WLAN (1/2/3TX, 3RX) Note: PIFA Antenna (Model Name: RAI-INT-ANT and KAP-I INT ANT) only 1TX1RX of 11a function
Radio Type	Intentional Transceiver
Power Type	From Power Adapter or POE
Modulation	see the below table for 802.11n OFDM (BPSK / QPSK / 16QAM / 64QAM) for IEEE 802.11a
Data Rate (Mbps)	see the below table for 802.11n OFDM (6/9/12/18/24/36/48/54) for IEEE 802.11a
Operating Frequency Range	5250~5350 / 5470~5725 MHz
Channel Bandwidth	20/40 MHz operating channel bandwidth
DFS Function	5260~5320 MHz ; 5500~5700 MHz
Max. Con. Power (DFS band)	Band 2: 23.93 dBm ; Band 3: 23.99 dBm
Min. Con. Power (DFS band)	Band 2: 17.93 dBm ; Band 3: 17.99 dBm
Max. EIRP Power (DFS band)	Band 2: 25.93 dBm ; Band 3: 25.99 dBm
Min. EIRP Power (DFS band)	Band 2: 19.93 dBm ; Band 3: 19.99 dBm
TPC Function	5260~5320 MHz ; 5500~5700 MHz
Operating Mode	Master
Communication Mode	IP based system
Power-on cycle	802.11n: Requires 84 seconds to complete its power-on cycle. 11a: Requires 84 seconds to complete its power-on cycle.
Uniform Spreading	For the 5250-5350 MHz and 5470-5725 MHz bands, the Master device provides, on aggregate, uniform loading of the spectrum across all devices by selecting an operating channel among the available channels using a random algorithm.
Firmware Version	Primary software version 5.2.6.0-147410Y
Carrier Frequencies	Please refer to section 3.5
Antenna	Please refer to section 3.7

Note 1: For HT20/40 2TX, MCS0~7(1-stream), MCS8~15(2-stream); For HT20/40 3TX, MCS16~23(3-stream)

Antenna & Band width

Antenna	Single (TX)		Two (TX)		Three (TX)	
	20 MHz	40 MHz	20 MHz	40 MHz	20 MHz	40 MHz
IEEE 802.11a	V	X	V	X	V	X
IEEE 802.11n	V	V	V	V	V	V

802.11n spec

MCS Index	Nss	Modulation	R	NBPS	NCBPS		NDBPS		Datarate(Mbps)			
					20MHz	40MHz	20MHz	40MHz	800nsGI		400nsGI	
									20MHz	40MHz	20MHz	40MHz
0	1	BPSK	1/2	1	52	108	26	54	6.5	13.5	7.200	15
1	1	QPSK	1/2	2	104	216	52	108	13.0	27.0	14.400	30
2	1	QPSK	3/4	2	104	216	78	162	19.5	40.5	21.700	45
3	1	16-QAM	1/2	4	208	432	104	216	26.0	54.0	28.900	60
4	1	16-QAM	3/4	4	208	432	156	324	39.0	81.0	43.300	90
5	1	64-QAM	2/3	6	312	648	208	432	52.0	108.0	57.800	120
6	1	64-QAM	3/4	6	312	648	234	486	58.5	121.5	65.000	135
7	1	64-QAM	5/6	6	312	648	260	540	65.0	135.0	72.200	150
8	2	BPSK	1/2	1	104	216	52	108	13.0	27.0	14.444	30
9	2	QPSK	1/2	2	208	432	104	216	26.0	54.0	28.889	60
10	2	QPSK	3/4	2	208	432	156	324	39.0	81.0	43.333	90
11	2	16-QAM	1/2	4	416	864	208	432	52.0	108.0	57.778	120
12	2	16-QAM	3/4	4	416	864	312	648	78.0	162.0	86.667	180
13	2	64-QAM	2/3	6	624	1296	416	864	104.0	216.0	115.556	240
14	2	64-QAM	3/4	6	624	1296	468	972	117.0	243.0	130.000	270
15	2	64-QAM	5/6	6	624	1296	520	1080	130.0	270.0	144.444	300
16	3	BPSK	1/2	1	208	432	104	216	19.5	40.5	21.7	45
17	3	QPSK	1/2	2	416	864	208	432	39	81	43.3	90
18	3	QPSK	3/4	2	416	864	208	432	58.5	121.5	65	135
19	3	16-QAM	1/2	4	832	1728	416	864	78	162	86.7	180
20	3	16-QAM	3/4	4	832	1728	416	864	117	243	130	270
21	3	64-QAM	2/3	6	1248	2592	624	1296	156	324	173.3	360
22	3	64-QAM	3/4	6	1248	2592	624	1296	175.5	364.5	195	405
23	3	64-QAM	5/6	6	1248	2592	624	1296	195	405	216.7	450

Symbol	Explanation
NSS	Number of spatial streams
R	Code rate
NBPSC	Number of coded bits per single carrier
NCBPS	Number of coded bits per symbol
NDBPS	Number of data bits per symbol
GI	guard interval

3.3. Accessories

N/A

3.4. Manufacturer Statement

Manufacturer statement confirming that information regarding the parameters of the detected *Radar Waveforms* are not available to the end user.

3.5. Table for DFS Band Carrier Frequencies

There are two bandwidth systems for 802.11n.

For both 20MHz bandwidth systems, use Channel 52, 56, 60, 64, 100, 104, 108, 112, 116, 120, 124, 128, 132, 136, 140.

For both 40MHz bandwidth systems, use Channel 54, 62, 102, 110, 118, 126, 134.

There is one bandwidth system for IEEE 802.11a.

For both 20MHz bandwidth systems, use Channel 52, 56, 60, 64, 100, 104, 108, 112, 116, 120, 124, 128, 132, 136, 140.

Frequency Band	Channel No.	Frequency	Channel No.	Frequency
5250~5350 MHz Band 2	52	5260 MHz	60	5300 MHz
	54	5270 MHz	62	5310 MHz
	56	5280 MHz	64	5320 MHz
5470~5725 MHz Band 3	100	5500 MHz	116	5580 MHz
	102	5510 MHz	132	5660 MHz
	104	5520 MHz	134	5670 MHz
	108	5540 MHz	136	5680 MHz
	110	5550 MHz	140	5700 MHz
	112	5560 MHz	-	-

3.6. Table for Class II Change

This product is an extension of original one reported under Sporton project number: 240223-01

Below is the table for the change of the product with respect to the original one.

Modifications	Performance Checking
1. Adding 9 (Ant.20 ~ Ant.28) set same type of Dipole antenna with lower gain than the original Certificate.	After evaluating, it is not necessary to re-test all test items
2. Adding 2 (Ant.29 ~ Ant.30) set same type of Panel antenna with lower gain than the original Certificate.	After evaluating, it is not necessary to re-test all test items
3. Adding 2 (Ant.19 and Ant.31) PIFA antennas and it only supports 11a 1TX function.	Ant. 18 is the lowest gain (2dBi) of original certificate, and it is selected to execute DFS test. The antenna gain of additional antennas is higher than Ant. 18, so it is not necessary to execute DFS test.
Note: There is no hardware or electrical modification made to the applying modular transmitter itself.	

3.7. Antenna Information

Ant.	Model Name	Antenna Type	Chip/Radio	Antenna Gain		Cable loss		True Gain (dBi)	
				2.4GHz	5GHz	2.4GHz	5GHz	2.4GHz	5GHz
1	ML-2499-FHPA9-01R	Dipole	Radio1/2-CH1/2/3	10.5	-	1.5	-	9	-
2	ML-2499-SD3-01R	Patch	Radio1/2-CH1/2/3	4	-	1	-	3	-
3	ML-2499-BPNA3-01R	Panel	Radio1/2-CH1/2/3	15	-	1	-	14	-
4	ML-2499-BYGA2-01R	Yagi	Radio1/2-CH1/2/3	14.5	-	1	-	13.5	-
5	KAP-FACADE-ANT	Facade	Radio1/2-CH1/2/3	3.5	4	1	1.5	2.5	2.5
6	ML-5299-FHPA10-01R	Dipole	Radio1/2-CH1/2/3	-	10.5	-	2.5	-	8
7	ML-5299-PTA1-01R	Patch	Radio1/2-CH1/2/3	-	3.8	-	1.5	-	2.3
8	ML-2452-PNA7-01R	Panel	Radio1/2-CH1/2/3	8	12	-	1.5	8	10.5
9	ML-5299-BYGA15-012	Yagi	Radio1/2-CH1/2/3	-	10.5	-	2.5	-	8
10	ML-2499-5PNL-72-N	Panel	Radio1/2-CH1/2/3	6.5	-	-	-	6.5	-
11	ML-2499-APA2-01	Dipole	Radio1/2-CH1/2/3	3.2	-	-	-	3.2	-
12	ML-2499-HPA3-01R	Dipole	Radio1/2-CH1/2/3	4	-	-	-	4	-
13	ML-5299-APA1-01R	Dipole	Radio1/2-CH1/2/3	-	4	-	-	-	4
14	ML-5299-HPA1-01R	Dipole	Radio1/2-CH1/2/3	-	6	-	-	-	6
15	ML-2452-APA2-01	Dipole	Radio1/2-CH1/2/3	3	5	-	-	3	5
16	ML-2452-PNA5-01R	Panel	Radio1/2-CH1/2/3	5.5	6	-	-	5.5	6
17	ML-2452-HPA5-036	Dipole	Radio1/2-CH1/2/3	3	5	-	-	3	5
18	ML-2452-APAG2A1-01	Dipole	Radio1/2-CH1/2/3	2.7	2	-	-	2.7	2
19	RAI-INT-ANT	PIFA	Radio1/2-CH1/2/3	4.3	-	-	-	4.3	-
20	ML-2499-HPA4-01	Dipole	Radio1/2-CH1/2/3	4.5	-	1.5	-	3	-
21	ML-2499-HPA8-01	Dipole	Radio1/2-CH1/2/3	8	-	1.5	-	6.5	-
22	ML-5299-HPA5-01	Dipole	Radio1/2-CH1/2/3	-	5.6	-	2.5	-	3.1
23	ML-5299-HPA10-01	Dipole	Radio1/2-CH1/2/3	-	10.5	-	2.5	-	8
24	ML-2452-HPAG5A8-01	Dipole	Radio1/2-CH1/2/3	5	8	1.5	2.5	3.5	5.5
25	ML-2499-HPA3-02R	Dipole	Radio1/2-CH1/2/3	5	-	1	-	4	-
26	ML-2452-HPAG4A6-01	Dipole	Radio1/2-CH1/2/3	4	7.3	1.5	2.5	2.5	4.8
27	ML-2452-HPA6X6-036	Dipole	Radio1/2-CH1/2/3	4	6	1	1.5	3	4.5
28	ML-2452-HPA6M6-072	Dipole	Radio1/2-CH1/2/3	2.8	6.5	1	1.5	1.8	5
29	ML-2452-PNL9M3-036	Panel	Radio1/2-CH1/2/3	11	10.7	1	1.5	10	9.2
30	ML-2452-PTA6M6-036	Panel	Radio1/2-CH1/2/3	5	6	1	1.5	4	4.5
31	KAP-I INT ANT	PIFA	Radio1/2-CH1/2/3	4.4	4.7	-	-	4.4	4.7

Note:

1. There are 31 antennas in the antenna table list, Antenna 18 is the lowest antenna gain in DFS band so that chose it as the representative as the worse case to test.

Table of TX/RX Function in each antenna:

Item			Module					
			Chain 1		Chain 2		Chain 3	
			TX	RX	TX	RX	TX	RX
Ant.18	2.4GHz	11b	V	V	V	V	V	V
		11g	V	V	V	V	V	V
		11n	V	V	V	V	V	V
	5GHz	11a	V	V	V	V	V	V
		11n	V	V	V	V	V	V

Note : Marked "-" on behalf of no function.

Module	Required 1TX Port
2.4G / 5G	Chain 1

Module	Required 2TX Port
2.4G / 5G	Chain 1 and Chain 2

Module	Required 3TX Port
2.4G / 5G	Chain 1 and Chain 2 and Chain 3

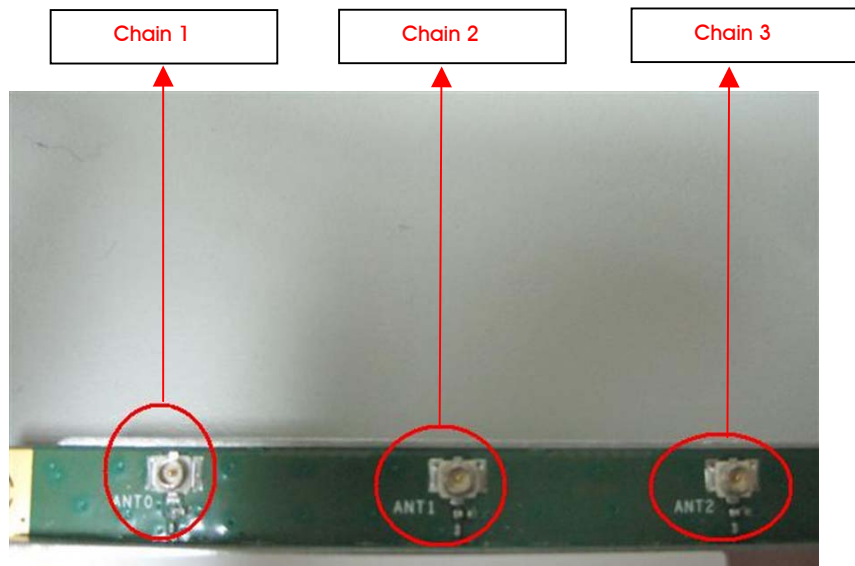

4. DFS DETECTION THRESHOLDS AND RADAR TEST WAVEFORMS

4.1. Interference Threshold values, Master or Client incorporating In-Service Monitoring

Maximum Transmit Power	Value (see note)
≥ 200 milliwatt	-64 dBm
< 200 milliwatt	-62 dBm

Note 1: This is the level at the input of the receiver assuming a 0 dBi receive antenna.

Note 2: Throughout these test procedures an additional 1 dB has been added to the amplitude of the test transmission waveforms to account for variations in measurement equipment. This will ensure that the test signal is at or above the detection threshold level to trigger a DFS response.

The radar *Detection Threshold*, lowest antenna gain is the parameter of Interference *radar DFS detection threshold*, The Interference *Detection Threshold* is the $(-64\text{dBm}) + (0) [\text{dBi}] + 1 \text{ dB} = -63\text{dBm}$.

4.2. DFS Response requirement values

Parameter	Value
<i>Non-occupancy period</i>	Minimum 30 minutes
<i>Channel Availability Check Time</i>	60 seconds
<i>Channel Move Time</i>	10 seconds See Note 1.
<i>Channel Closing Transmission Time</i>	200 milliseconds + an aggregate of 60 milliseconds over remaining 10 second period. See Notes 1 and 2.
<i>U-NII Detection Bandwidth</i>	Minimum 80% of the 99% power bandwidth See Note 3.

Note 1: The instant that the *Channel Move Time* and the *Channel Closing Transmission Time* begins is as follows:

- For the Short pulse radar Test Signals this instant is the end of the *Burst*.
- For the Frequency Hopping radar Test Signal, this instant is the end of the last radar *Burst* generated.
- For the Long Pulse radar Test Signal this instant is the end of the 12 second period defining the radar transmission.

Note 2: The *Channel Closing Transmission Time* is comprised of 200 milliseconds starting at the beginning of the *Channel Move Time* plus any additional intermittent control signals required to facilitate *Channel* changes (an aggregate of 60 milliseconds) during the remainder of the 10 second period. The aggregate duration of control signals will not count quiet periods in between transmissions.

Note 3: During the *U-NII Detection Bandwidth* detection test, radar type 1 is used and for each frequency step the minimum percentage of detection is 90%. Measurements are performed with no data traffic.

4.3. Radar Test Waveforms Minimum Step

Step intervals of 0.1 microsecond for Pulse Width, 1 microsecond for PRI, 1 MHz for chirp width and 1 for the number of pulses will be utilized for the random determination of specific test waveforms.

4.4. Short Pulse Radar Test Waveforms

Radar Type	Pulse Width (μsec)	PRI (μsec)	Number of Pulses	Minimum Percentage of Successful Detection	Minimum Trials
1	1	1428	18	60%	30
2	1-5	150-230	23-29	60%	30
3	6-10	200-500	16-18	60%	30
4	11-20	200-500	12-16	60%	30
Aggregate (Radar Types 1-4)				80%	120

A minimum of 30 unique waveforms are required for each of the short pulse radar types 2 through 4. For short pulse radar type 1, the same waveform is used a minimum of 30 times. If more than 30 waveforms are used for short pulse radar types 2 through 4, then each additional waveform must also be unique and not repeated from the previous waveforms. The aggregate is the average of the percentage of successful detections of short pulse radar types 1-4.

Radar Types (1~4) System Diagram

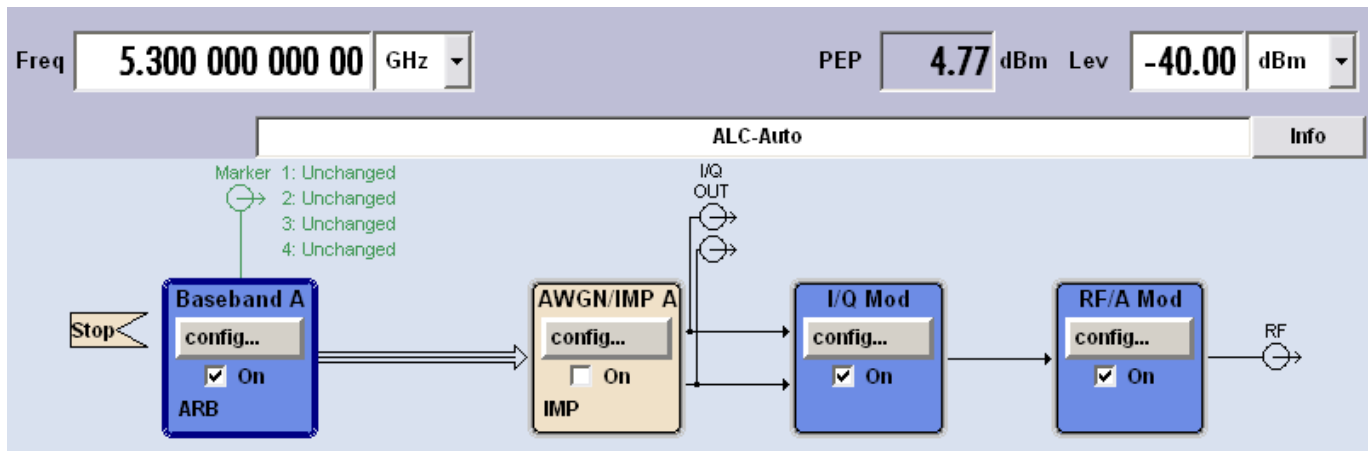

Used R&S SMU200A (Vector SG with one ARB) or SG + ARB

B11: Base-band Generator with ARB (16 M samples) and Digital Modulation

B13: Base-band Main Module

B106: frequency range (100 kHz to 6 GHz)

For selecting the waveform parameters from within the bounds of the signal type, system were random selection using uniform distribution.

4.5. Long Pulse Radar Test Waveform

Radar Type	Pulse Width (μsec)	Chirp Width (MHz)	PRI (μsec)	Number of Pulses per Burst	Number of Bursts	Minimum Percentage of Successful Detection	Minimum Trials
5	50-100	5-20	1000-2000	1-3	8-20	80%	30

The parameters for this waveform are randomly chosen. Thirty unique waveforms are required for the Long Pulse radar test signal. If more than 30 waveforms are used for the Long Pulse radar test signal, then each additional waveform must also be unique and not repeated from the previous waveforms. Each waveform is defined as follows:

- (1) The transmission period for the Long Pulse Radar test signal is 12 seconds.
- (2) There are a total of 8 to 20 Bursts in the 12 second period, with the number of Bursts being randomly chosen. This number is Burst_Count.
- (3) Each Burst consists of 1 to 3 pulses, with the number of pulses being randomly chosen. Each Burst within the 12 second sequence may have a different number of pulses.
- (4) The pulse width is between 50 and 100 microseconds, with the pulse width being randomly chosen. Each pulse within a Burst will have the same pulse width. Pulses in different Bursts may have different pulse widths.
- (5) Each pulse has a linear FM chirp between 5 and 20 MHz, with the chirp width being randomly chosen. Each pulse within a Burst will have the same chirp width. Pulses in different Bursts may have different chirp widths. The chirp is centered on the pulse. For example, with a radar frequency of 5300 MHz and a 20 MHz chirped signal, the chirp starts at 5290 MHz and ends at 5310 MHz.
- (6) If more than one pulse is present in a Burst, the time between the pulses will be between 1000 and 2000 microseconds, with the time being randomly chosen. If three pulses are present in a Burst, the time between the first and second pulses is chosen independently of the time between the second and third pulses.
- (7) The 12 second transmission period is divided into even intervals. The number of intervals is equal to Burst_Count. Each interval is of length $(12,000,000 / \text{Burst_Count})$ microseconds. Each interval contains one Burst. The start time for the Burst, relative to the beginning of the interval, is between 1 and $[(12,000,000 / \text{Burst_Count}) - (\text{Total Burst Length}) + (\text{One Random PRI Interval})]$ microseconds, with the start time being randomly chosen. The step interval for the start time is 1 microsecond. The start time for each Burst is chosen independently.

A representative example of a Long Pulse radar test waveform:

- (1) The total test signal length is 12 seconds.
- (2) 8 Bursts are randomly generated for the Burst_Count.
- (3) Burst 1 has 2 randomly generated pulses.
- (4) The pulse width (for both pulses) is randomly selected to be 75 microseconds.
- (5) The PRI is randomly selected to be at 1213 microseconds.

- (6) Bursts 2 through 8 are generated using steps 3 – 5.
- (7) Each Burst is contained in even intervals of 1,500,000 microseconds. The starting location for Pulse 1, Burst 1 is randomly generated (1 to 1,500,000 minus the total Burst 1 length + 1 random PRI interval) at the 325,001 microsecond step. Bursts 2 through 8 randomly fall in successive 1,500,000 microsecond intervals (i.e. Burst 2 falls in the 1,500,001 – 3,000,000 microsecond range).

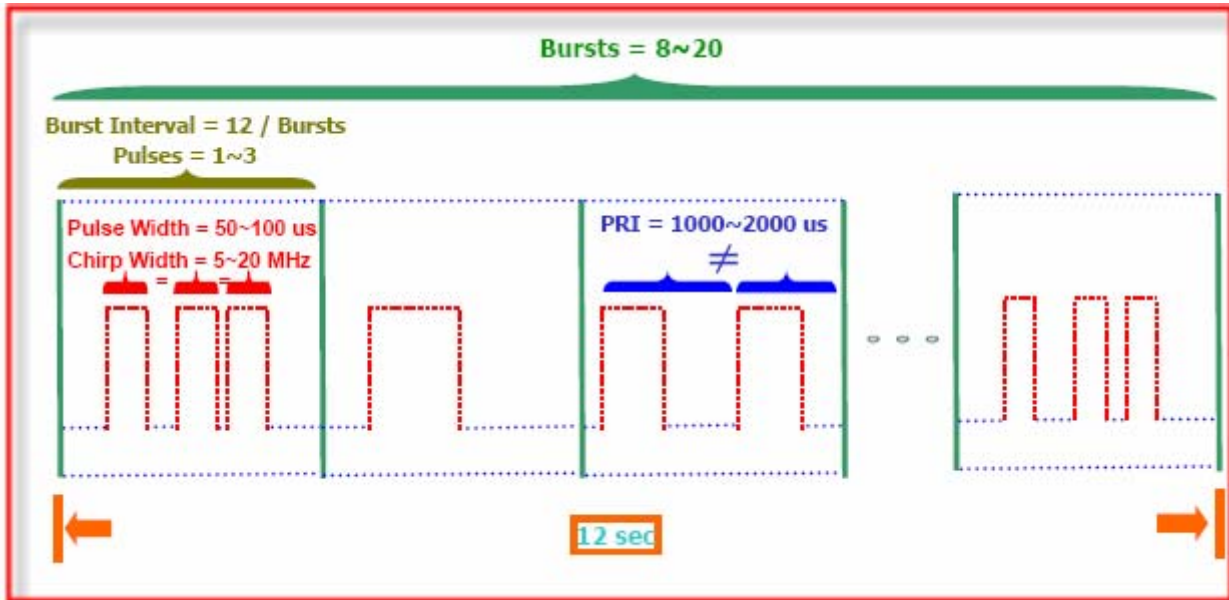

Radar Types (5) System Diagram

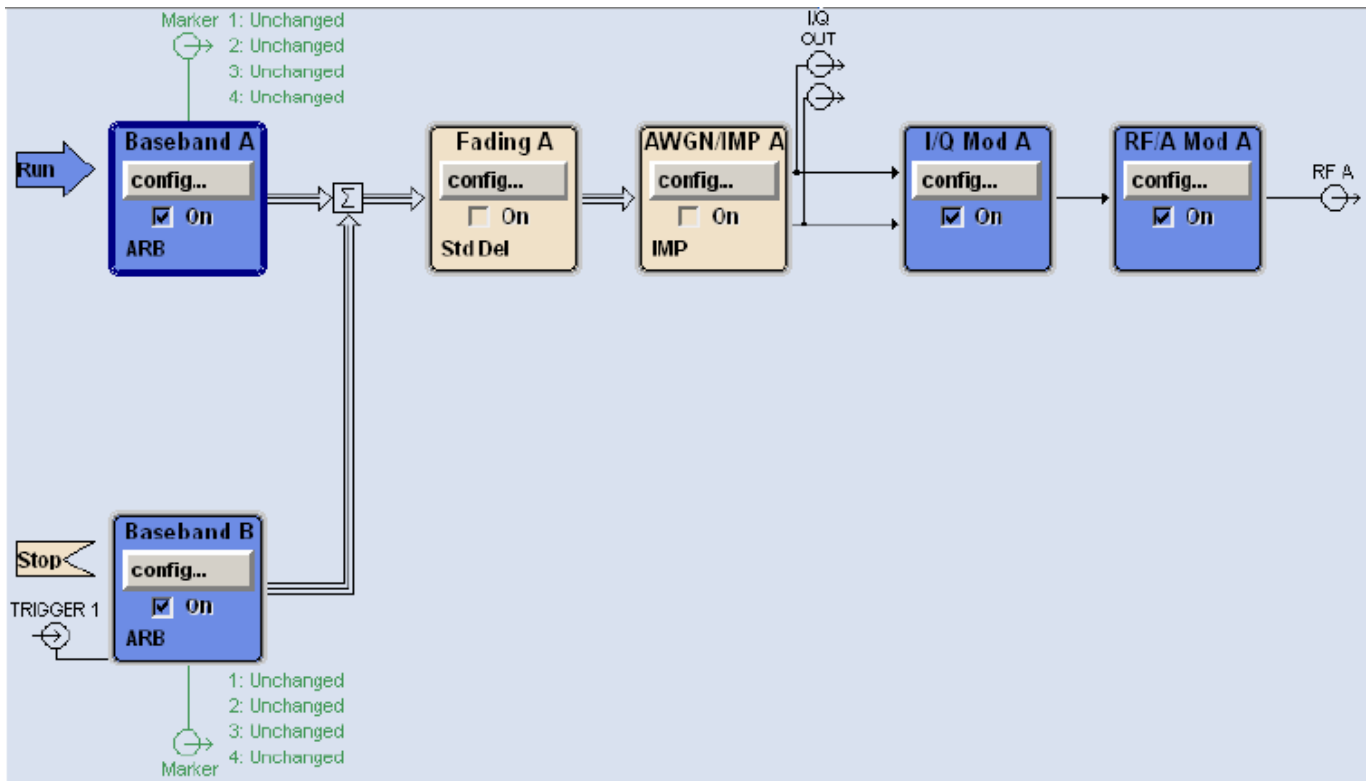

Used R&S SMU200A (Vector SG with two ARB)

Path A / Path B Two B11: Base-band Generator with ARB (16 M samples) and Digital Modulation

B13: Base-band Main Module

B106: frequency range (100 kHz to 6 GHz)

For selecting the waveform parameters from within the bounds of the signal type, system was random selection using uniform distribution.

4.6. Frequency Hopping Radar Test Waveform

Radar Type	Pulse Width (μsec)	PRI (μsec)	Pulses per Hop	Hopping Rate (kHz)	Hopping Sequence Length (msec)	Minimum Percentage of Successful Detection	Minimum Trials
6	1	333	9	0.333	300	70%	30

For the Frequency Hopping Radar Type, the same Burst parameters are used for each waveform. The hopping sequence is different for each waveform and a 100-length segment is selected from the hopping sequence defined by the following algorithm:

The first frequency in a hopping sequence is selected randomly from the group of 475 integer frequencies from 5250 – 5724 MHz. Next, the frequency that was just chosen is removed from the group and a frequency is randomly selected from the remaining 474 frequencies in the group. This process continues until all 475 frequencies are chosen for the set. For selection of a random frequency, the frequencies remaining within the group are always treated as equally likely.

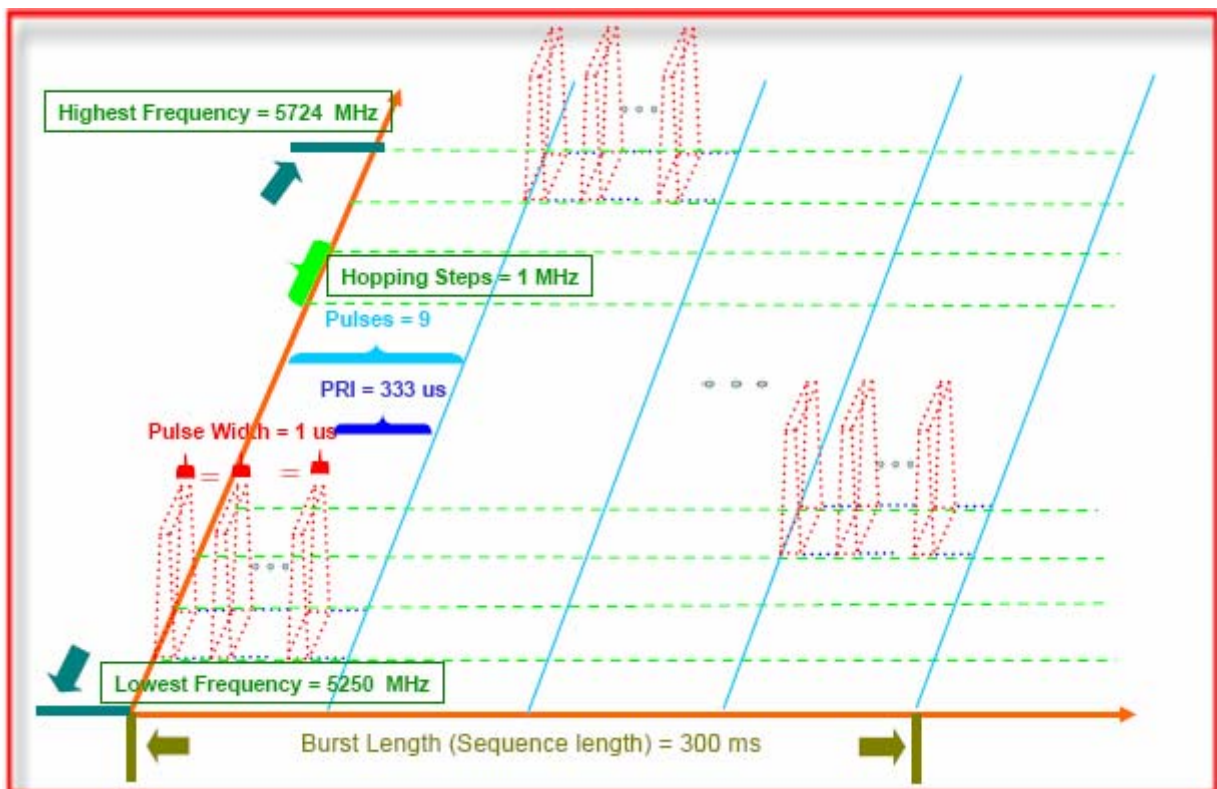

Radar Types (6) System Diagram

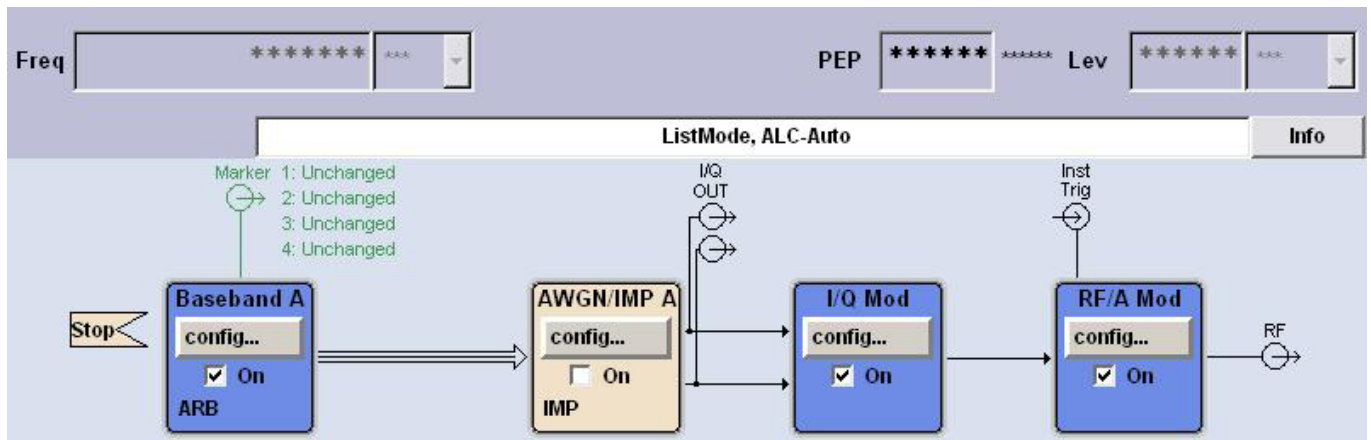

Used R&S SMU200A (Vector SG with one ARB)

B11: Base-band Generator with ARB (16 M samples) and Digital Modulation

B13: Base-band Main Module

B106: frequency range (100 kHz to 6 GHz)

For selecting the waveform parameters from within the bounds of the signal type, system were random selection using uniform distribution.

4.7. Radiated Calibration Setup

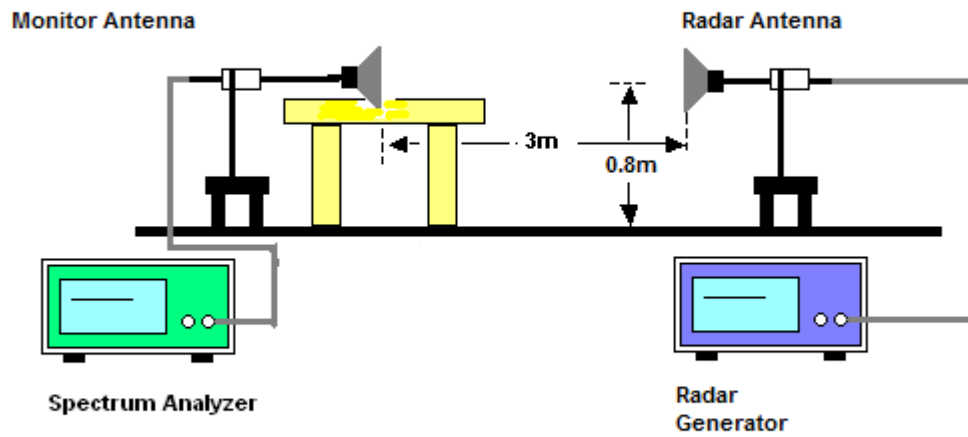

4.8. Radar Waveform Calibration Procedure

The Interference Radar Detection Threshold Level is $(-64\text{dBm}) + (0) [\text{dBi}] + 1 \text{ dB} = -63\text{dBm}$ that had been taken into account the output power range and antenna gain. The above equipment setup was used to calibrate the conducted Radar Waveform. A vector signal generator was utilized to establish the test signal level for each radar type. During this process there were replace 50ohm terminal form Master and Client device and no transmissions by either the Master or Client Device. The spectrum analyzer was switched to the zero span (Time Domain) at the frequency of the Radar Waveform generator. Peak detection was used. The spectrum analyzer resolution bandwidth (RBW) and video bandwidth (VBW) were set to at least 3 MHz. The vector signal generator amplitude was set so that the power level measured at the spectrum analyzer was $(-64\text{dBm}) + (0) [\text{dBi}] + 1 \text{ dB} = -63\text{dBm}$. Capture the spectrum analyzer plots on short pulse radar types, long pulse radar type and hopping radar waveform.

4.9. Calibration Deviation

There is no deviation with the original standard.

4.10. Radar Waveform Calibration Result

<20MHz>

Radar #1 DFS detection threshold level and the burst of pulses on the Channel frequency

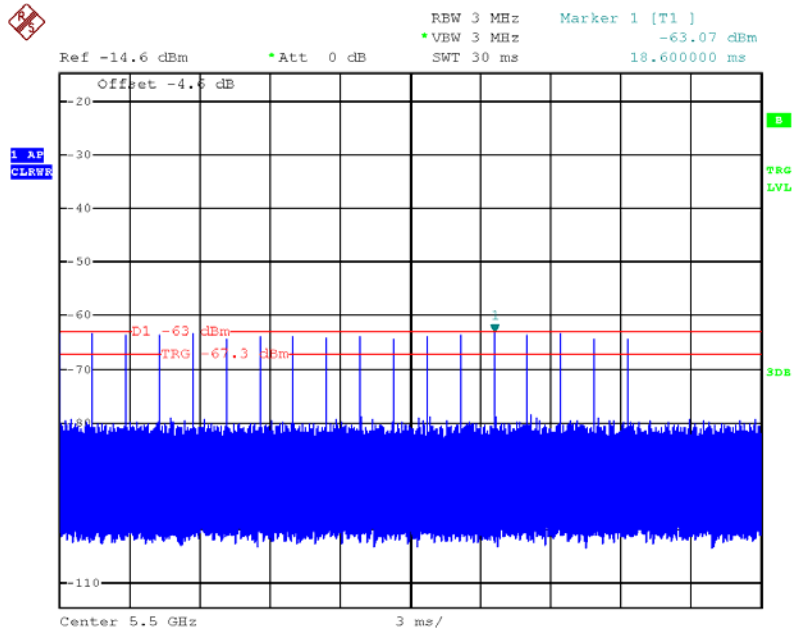

Date: 27.APR.2012 12:30:53

Radar #2 DFS detection threshold level and the burst of pulses on the Channel frequency

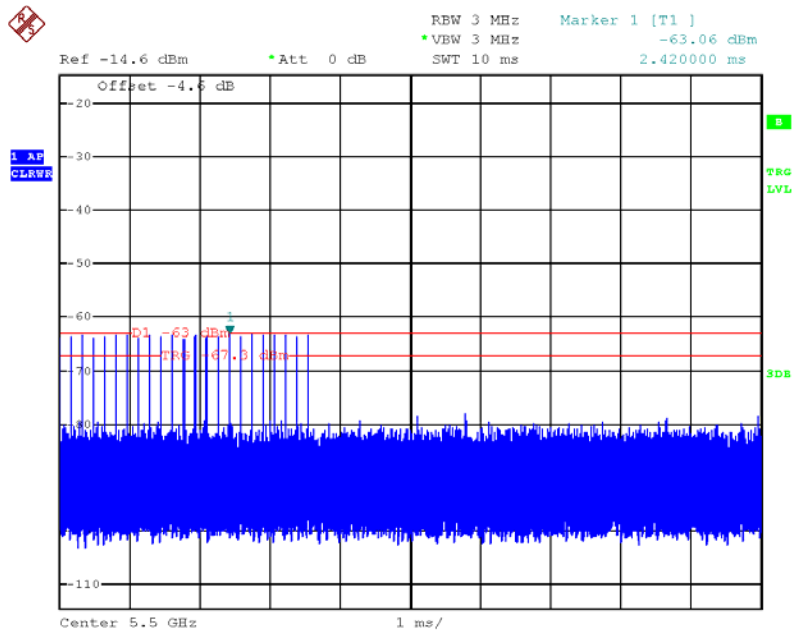

Date: 27.APR.2012 12:31:52

Radar #3 DFS detection threshold level and the burst of pulses on the Channel frequency

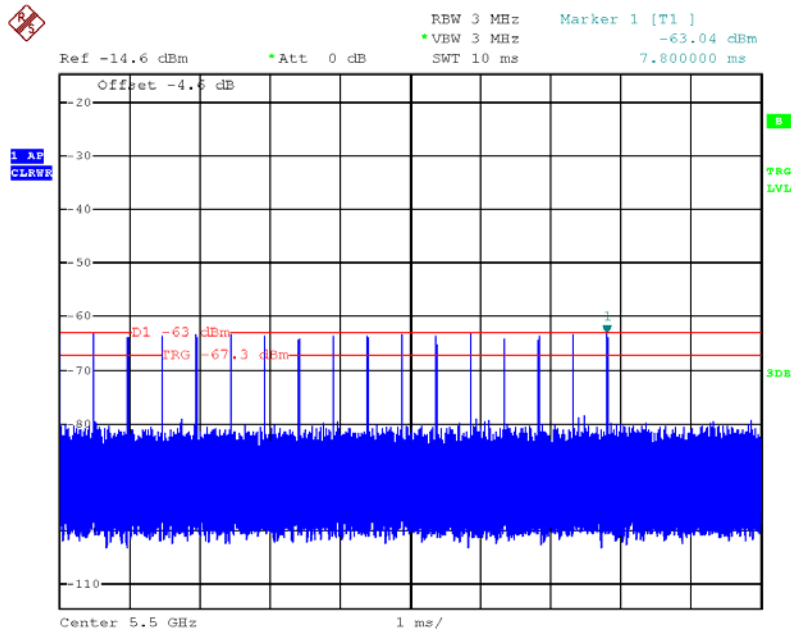

Date: 27.APR.2012 12:34:15

Radar #4 DFS detection threshold level and the burst of pulses on the Channel frequency

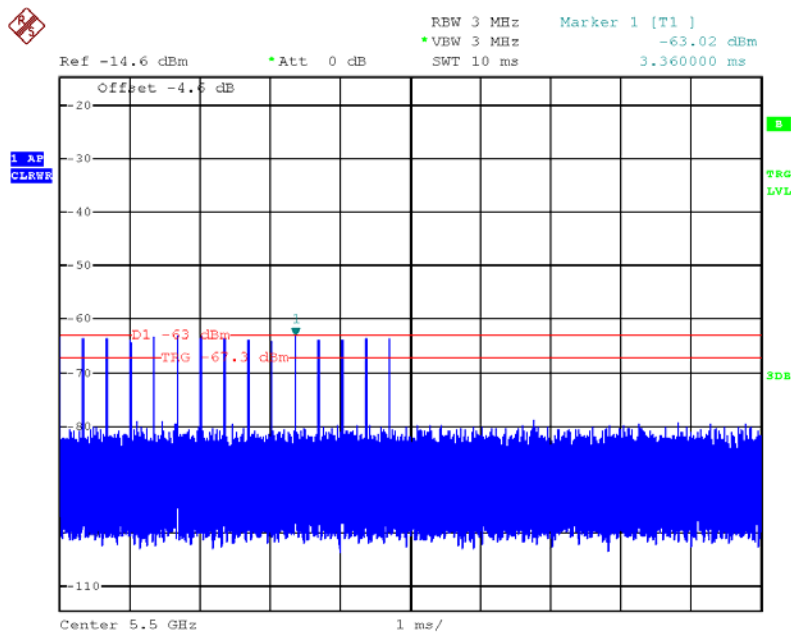

Date: 27.APR.2012 12:36:14

Radar #5 DFS detection threshold level and 12sec long burst on the Channel frequency

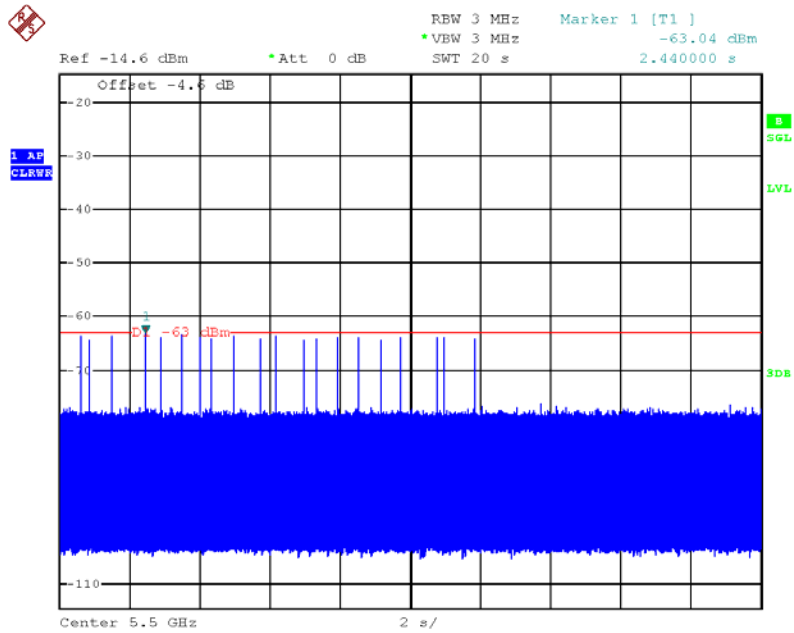

Date: 27.APR.2012 12:29:00

Radar #6 DFS detection threshold level and a single hop (9 pulses) on the Channel frequency within UNII detection bandwidth.

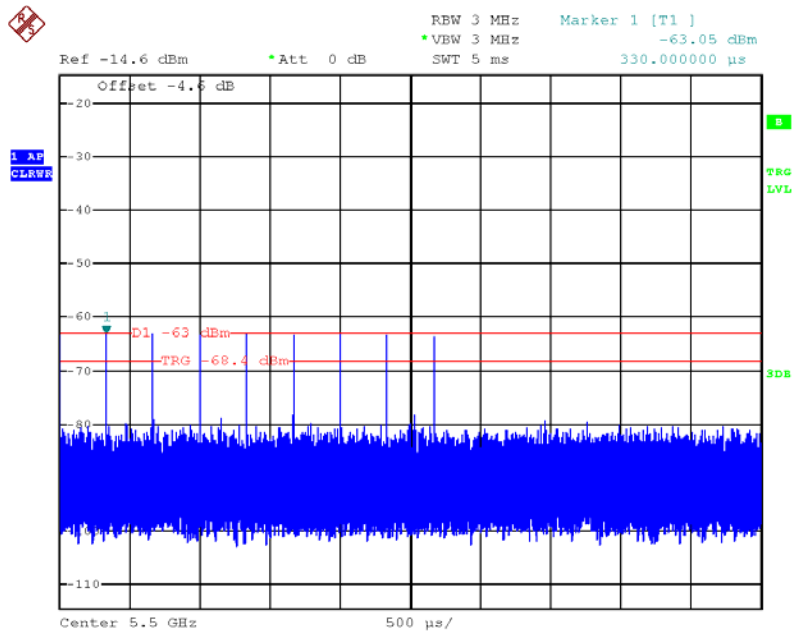

Date: 27.APR.2012 12:21:55

<40MHz>

Radar #1 DFS detection threshold level and the burst of pulses on the Channel frequency

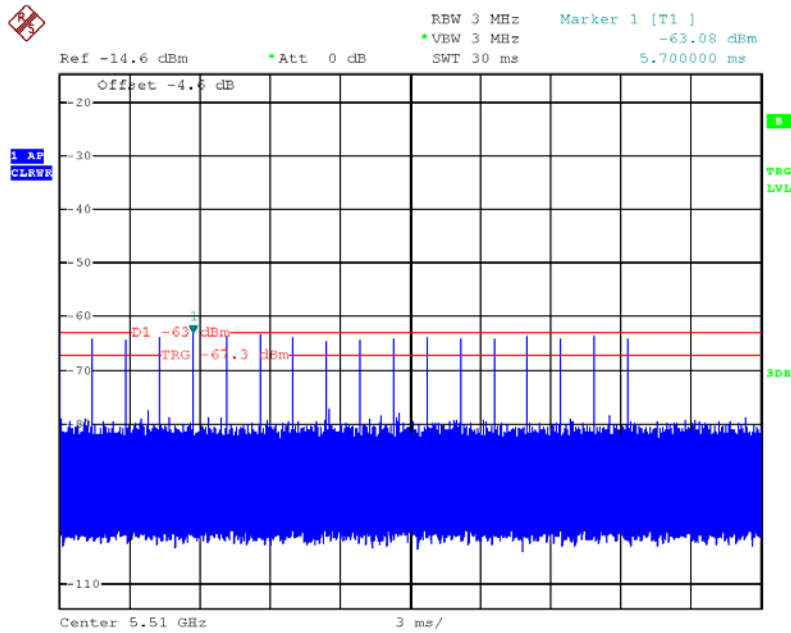

Date: 27.APR.2012 12:40:38

Radar #2 DFS detection threshold level and the burst of pulses on the Channel frequency

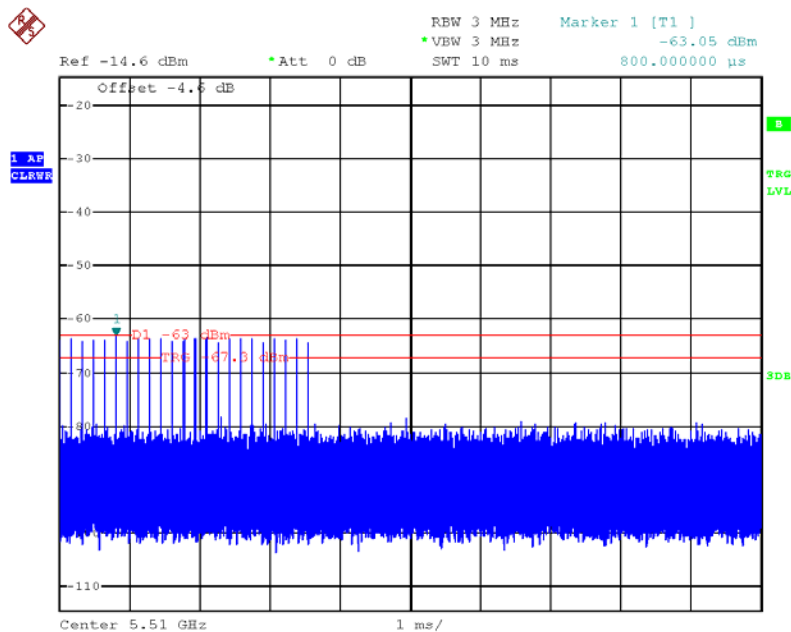

Date: 27.APR.2012 12:39:53

Radar #3 DFS detection threshold level and the burst of pulses on the Channel frequency

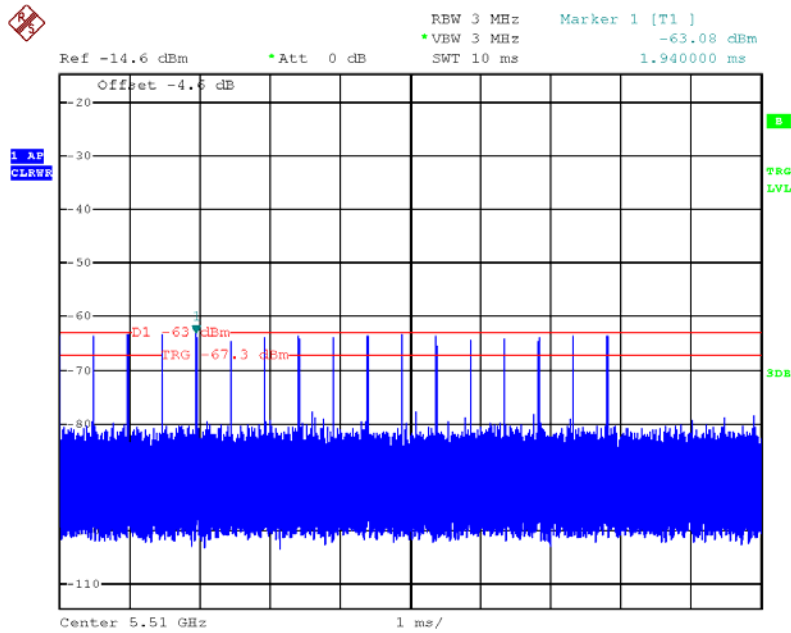

Date: 27.APR.2012 12:39:03

Radar #4 DFS detection threshold level and the burst of pulses on the Channel frequency

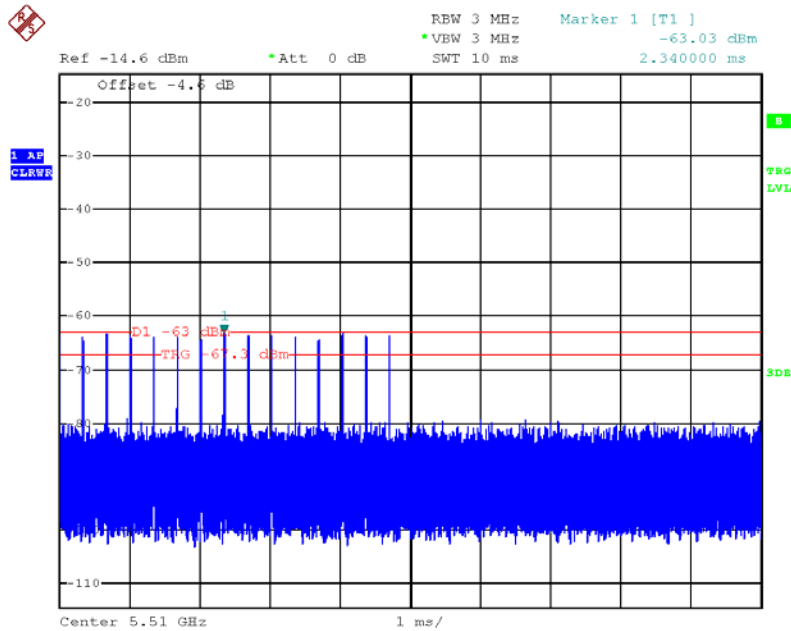

Date: 27.APR.2012 12:38:12

Radar #5 DFS detection threshold level and 12sec long burst on the Channel frequency

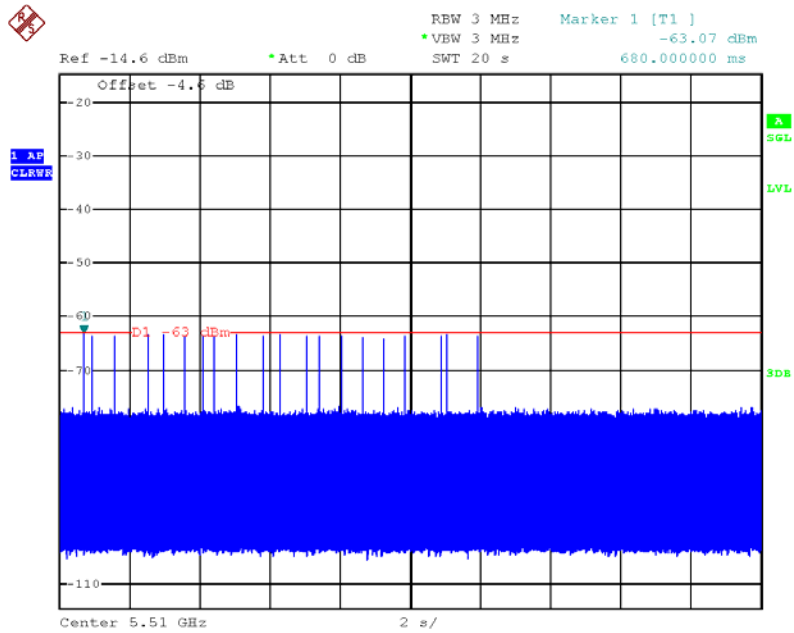

Date: 27.APR.2012 12:52:36

Radar #6 DFS detection threshold level and a single hop (9 pulses) on the Channel frequency within UNII detection bandwidth.

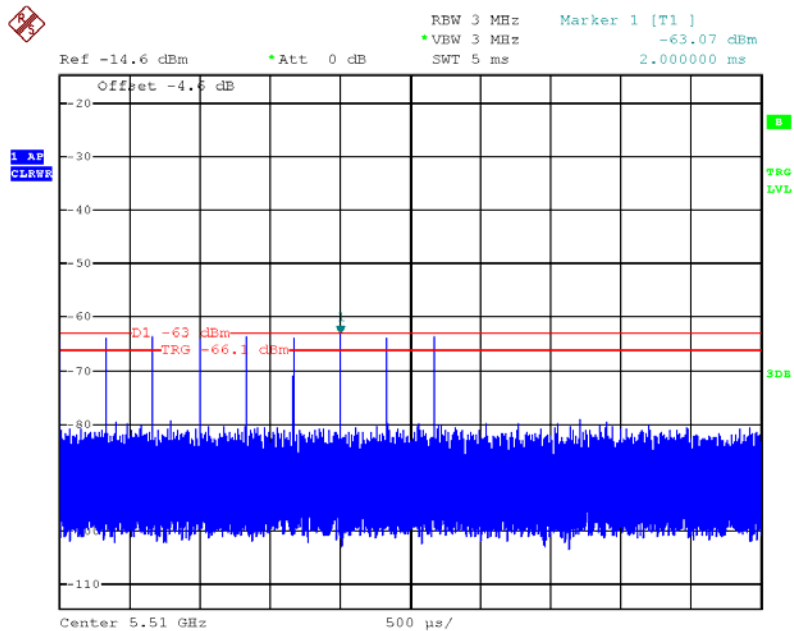

Date: 27.APR.2012 12:14:49

5. TEST SETUP AND TEST RESULT

5.1. Test setup

5.1.1. Test Setup Diagram

Following is the test setup for generate the radar waveforms and used to monitor UNII device.

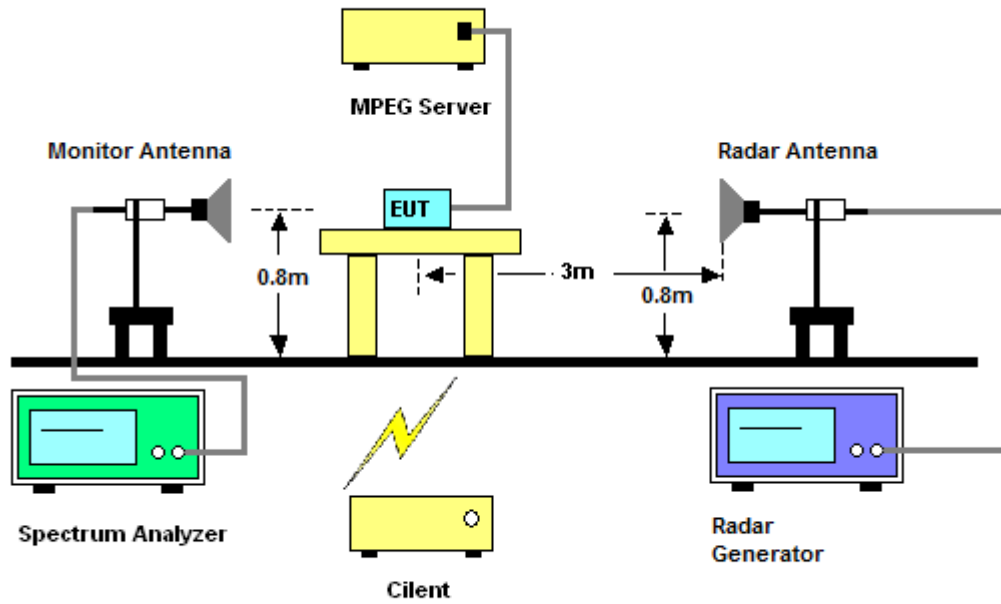

EUT Data Traffic Plot (20 MHz)

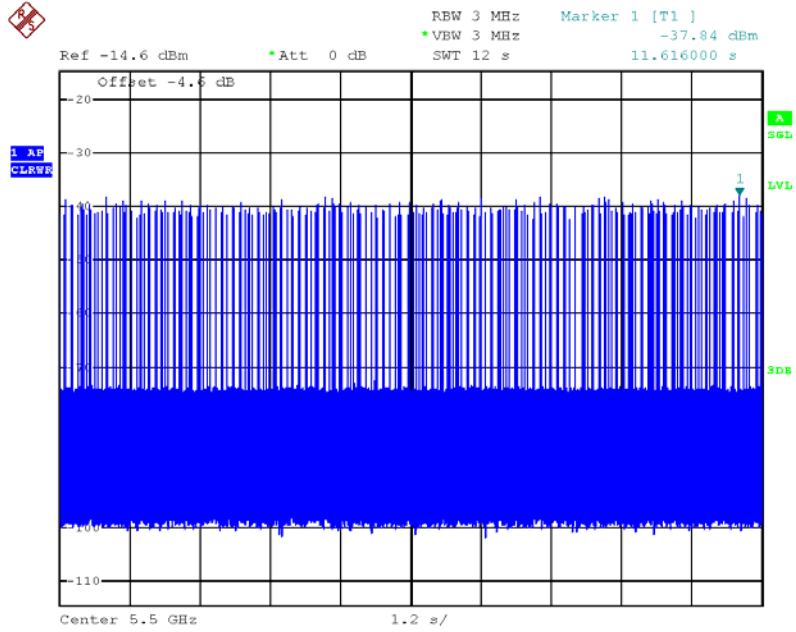

Date: 14.MAY.2012 12:39:48

EUT Data Traffic Plot (40 MHz)

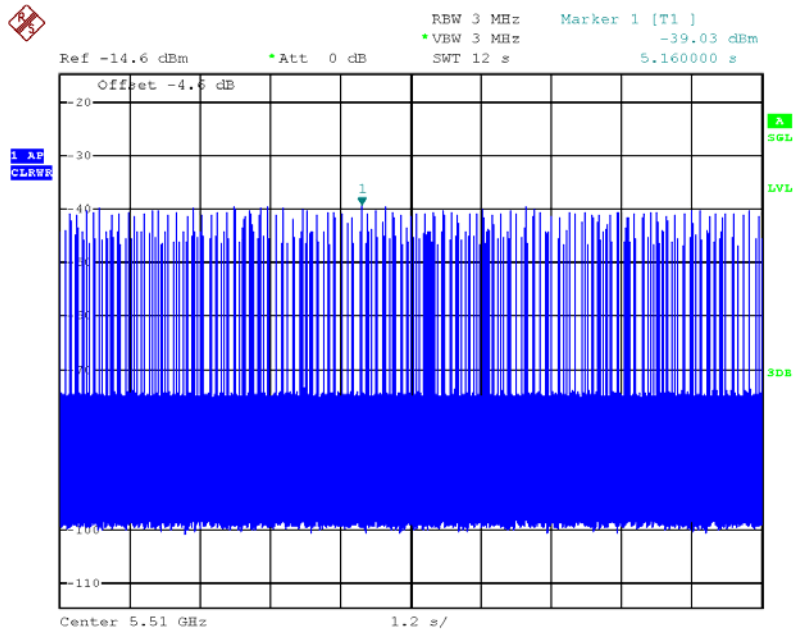

Date: 12.MAY.2012 18:02:17

Slave Data Traffic Plot (20MHz)

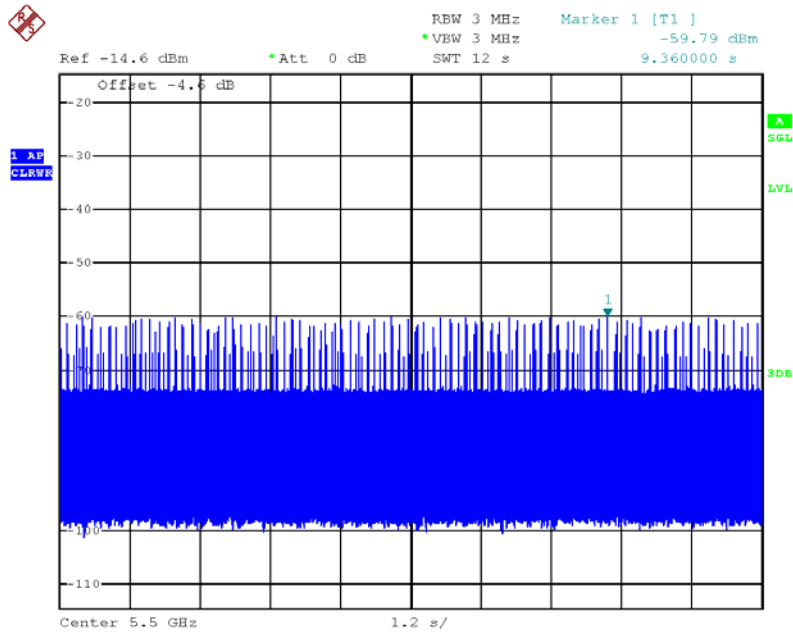

Date: 14.MAY.2012 12:41:03

Slave Data Traffic Plot (40MHz)

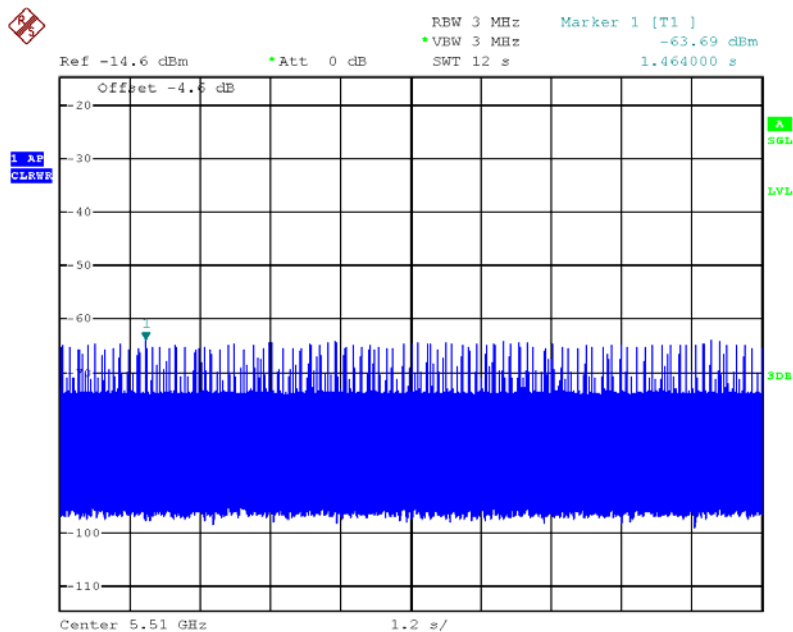

Date: 12.MAY.2012 18:04:20

Without Data Traffic Plot (Noise Plot) (20MHz)

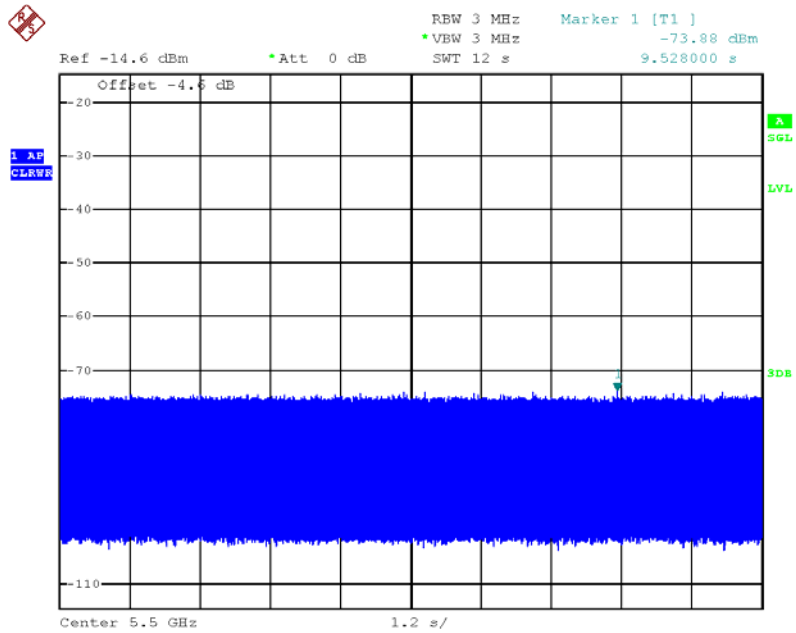

Date: 14.MAY.2012 12:44:47

Without Data Traffic Plot (Noise Plot) (40MHz)

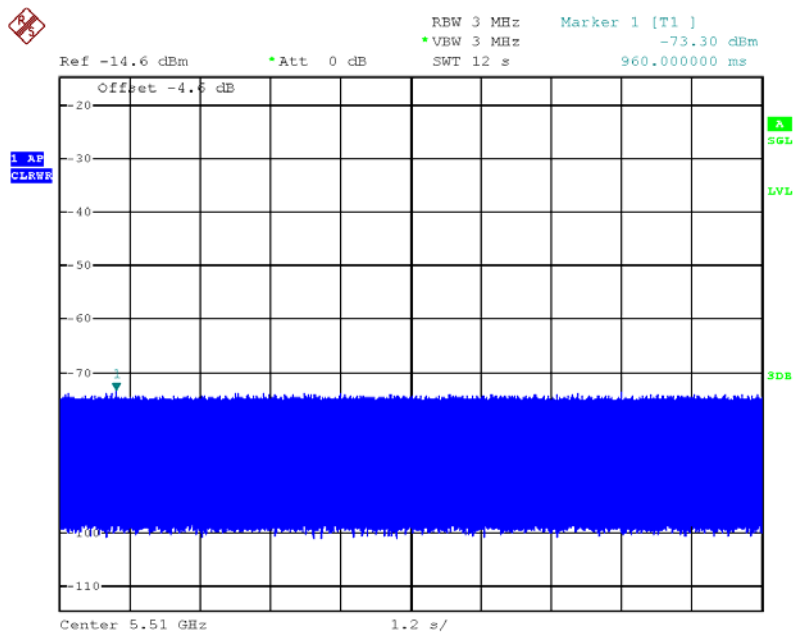

Date: 12.MAY.2012 18:11:18

5.1.2. Supporting Units

Support Units	Brand	Model No.	Serial No.	FCC ID	Software Version
Notebook	DELL	D520	NB-A	E2KWM3945ABG	Win XP SP2
Notebook	DELL	D520	NB-B	E2KWM3945ABG	Win XP SP2
abgn Cardbus	Wistron	DNBA-81	N/A	NKR-DNBA81	STA6.0.3.120

5.1.3. Test Setup Operation

System testing was performed with the designated MPEG test file that streams full motion video from the Access Point to the Client in full motion video mode using the media player with the V2.61 Codec package.. This file is used by IP and Frame based systems for loading the test channel during the In-service compliance testing of the U-NII device.

The waveform parameters from within the bounds of the signal type are selected randomly using uniform distribution.

A spectrum analyzer is used as a monitor to verify that the EUT has vacated the Channel within the (Channel Closing Transmission Time and Channel Move Time, and does not transmit on a Channel during the Non-Occupancy Period after the detection and Channel move. It is also used to monitor EUT transmissions during the Channel Availability Check Time.

5.2. UNII Detection Bandwidth Measurement

5.2.1. Limit

Minimum 80% of the UNII 99% transmission power bandwidth. During the *U-NII Detection Bandwidth* detection test, radar type 1 is used and for each frequency step the minimum percentage of detection is 90 percent. Measurements are performed with no data traffic.

5.2.2. Test Procedures

1. Adjust the equipment to produce a single Burst of the Short Pulse Radar Type 1 at the center frequency of the EUT Operating Channel at the specified DFS Detection Threshold level.
2. The generating equipment is configured as shown in the Conducted Test Setup above section 4.1.1.
3. The EUT is set up as a stand-alone device (no associated Client and no traffic). Frame based systems will be set to a talk/listen ratio of 0%/100% during this test.
4. Generate single radar Burst, and note the response of the EUT. Repeat for a minimum of 10 trials. The EUT must detect the Radar Waveform using the specified U-NII Detection Bandwidth criterion.
5. Starting at the center frequency of the EUT operating Channel, increase the radar frequency in 1 MHz steps, repeating the above item 4 test sequence, until the detection rate falls below the U-NII Detection Bandwidth criterion. Record the highest frequency (denote as FH) at which detection is greater than or equal to the U-NII Detection Bandwidth criterion. Recording the detection rate at frequencies above FH is not required to demonstrate compliance.
6. Starting at the center frequency of the EUT operating Channel, decrease the radar frequency in 1 MHz steps, repeating the above item 4 test sequence, until the detection rate falls below the U-NII Detection Bandwidth criterion. Record the lowest frequency (denote as FL) at which detection is greater than or equal to the U-NII Detection Bandwidth criterion. Recording the detection rate at frequencies below FL is not required to demonstrate compliance.
7. The U-NII Detection Bandwidth is calculated as follows: $U\text{-NII Detection Bandwidth} = FH - FL$
8. The U-NII Detection Bandwidth must be at least 80% of the EUT transmitter 99% power, otherwise, the EUT does not comply with DFS requirements.

5.2.3. Test Deviation

There is no deviation with the original standard.

5.2.4. Test Result for UNII Detection Bandwidth

For 20MHz / Type 1

EUT Frequency=5500MHz											
Radar Frequency (MHz)	DFS Detection Trials (1=Detection, 0= No Detection)										Detection Rate (%)
	1	2	3	4	5	6	7	8	9	10	
5487	0	0	0	0	0	0	0	0	0	0	0
5488	0	0	0	0	0	0	0	0	0	0	0
5489	1	1	1	1	1	1	1	1	1	1	1
5490	1	1	1	1	1	1	1	1	1	1	1
5491	1	1	1	1	1	1	1	1	1	1	1
5492	1	1	1	1	1	1	1	1	1	1	1
5493	1	1	1	1	1	1	1	1	1	1	1
5494	1	1	1	1	1	1	1	1	1	1	1
5495	1	1	1	1	1	1	1	1	1	1	1
5496	1	1	1	1	1	1	1	1	1	1	1
5497	1	1	1	1	1	1	1	1	1	1	1
5498	1	1	1	1	1	1	1	1	1	1	1
5499	1	1	1	1	1	1	1	1	1	1	1
5500	1	1	1	1	1	1	1	1	1	1	1
5501	1	1	1	1	1	1	1	1	1	1	1
5502	1	1	1	1	1	1	1	1	1	1	1
5503	1	1	1	1	1	1	1	1	1	1	1
5504	1	1	1	1	1	1	1	1	1	1	1
5505	1	1	1	1	1	1	1	1	1	1	1
5506	1	1	1	1	1	1	1	1	1	1	1
5507	1	1	1	1	1	1	1	1	1	1	1
5508	1	1	1	1	1	1	1	1	1	1	1
5509	1	1	1	1	1	1	1	1	1	1	1
5510	1	1	1	1	1	1	1	1	1	1	1
5511	1	1	1	1	1	1	1	1	1	1	1
5512	0	0	0	0	0	0	0	0	0	0	0
5513	0	0	0	0	0	0	0	0	0	0	0
Detection Bandwidth = FH-FL = 5511MHz-5489MHz = 23MHz											
EUT 99% Bandwidth = 20MHz (see note)											
UNII Detection Bandwidth Min. Limit (MHz): 20MHz x 80% = 16MHz											

For 20MHz / Type 2

EUT Frequency=5500MHz											
Radar Frequency (MHz)	DFS Detection Trials (1=Detection, 0= No Detection)										Detection Rate (%)
	1	2	3	4	5	6	7	8	9	10	
5487	0	0	0	0	0	0	0	0	0	0	0
5488	0	0	0	0	0	0	0	0	0	0	0
5489	0	0	0	0	0	0	0	0	0	0	0
5490	1	1	1	1	1	1	1	1	1	1	100
5491	1	1	1	1	1	1	1	1	1	1	100
5492	1	1	1	1	1	1	1	1	1	1	100
5493	1	1	1	1	1	1	1	1	1	1	100
5494	1	1	1	1	1	1	1	1	1	1	100
5495	1	1	1	1	1	1	1	1	1	1	100
5496	1	1	1	1	1	1	1	1	1	1	100
5497	1	1	1	1	1	1	1	1	1	1	100
5498	1	1	1	1	1	1	1	1	1	1	100
5499	1	1	1	1	1	1	1	1	1	1	100
5500	1	1	1	1	1	1	1	1	1	1	100
5501	1	1	1	1	1	1	1	1	1	1	100
5502	1	1	1	1	1	1	1	1	1	1	100
5503	1	1	1	1	1	1	1	1	1	1	100
5504	1	1	1	1	1	1	1	1	1	1	100
5505	1	1	1	1	1	1	1	1	1	1	100
5506	1	1	1	1	1	1	1	1	1	1	100
5507	1	1	1	1	1	1	1	1	1	1	100
5508	1	1	1	1	1	1	1	1	1	1	100
5509	1	1	1	1	1	1	1	1	1	1	100
5510	1	1	1	1	1	1	1	1	1	1	100
5511	0	0	0	0	0	0	0	0	0	0	0
5512	0	0	0	0	0	0	0	0	0	0	0
5513	0	0	0	0	0	0	0	0	0	0	0
Detection Bandwidth = FH-FL = 5510MHz-5490MHz = 21MHz											
EUT 99% Bandwidth = 20MHz (see note)											
UNII Detection Bandwidth Min. Limit (MHz): 20MHz x 80% = 16MHz											

For 20MHz / Type 3

EUT Frequency=5500MHz											
Radar Frequency (MHz)	DFS Detection Trials (1=Detection, 0= No Detection)										Detection Rate (%)
	1	2	3	4	5	6	7	8	9	10	
5487	0	0	0	0	0	0	0	0	0	0	0
5488	0	0	0	0	0	0	0	0	0	0	0
5489	0	0	0	0	0	0	0	0	0	0	0
5490	1	1	1	1	1	1	1	1	1	1	100
5491	1	1	1	1	1	1	1	1	1	1	100
5492	1	1	1	1	1	1	1	1	1	1	100
5493	1	1	1	1	1	1	1	1	1	1	100
5494	1	1	1	1	1	1	1	1	1	1	100
5495	1	1	1	1	1	1	1	1	1	1	100
5496	1	1	1	1	1	1	1	1	1	1	100
5497	1	1	1	1	1	1	1	1	1	1	100
5498	1	1	1	1	1	1	1	1	1	1	100
5499	1	1	1	1	1	1	1	1	1	1	100
5500	1	1	1	1	1	1	1	1	1	1	100
5501	1	1	1	1	1	1	1	1	1	1	100
5502	1	1	1	1	1	1	1	1	1	1	100
5503	1	1	1	1	1	1	1	1	1	1	100
5504	1	1	1	1	1	1	1	1	1	1	100
5505	1	1	1	1	1	1	1	1	1	1	100
5506	1	1	1	1	1	1	1	1	1	1	100
5507	1	1	1	1	1	1	1	1	1	1	100
5508	1	1	1	1	1	1	1	1	1	1	100
5509	1	1	1	1	1	1	1	1	1	1	100
5510	1	1	1	1	1	1	1	1	1	1	100
5511	0	0	0	0	0	0	0	0	0	0	0
5512	0	0	0	0	0	0	0	0	0	0	0
5513	0	0	0	0	0	0	0	0	0	0	0
Detection Bandwidth = FH-FL = 5510MHz-5490MHz = 21MHz											
EUT 99% Bandwidth = 20MHz (see note)											
UNII Detection Bandwidth Min. Limit (MHz): 20MHz x 80% = 16MHz											

For 20MHz / Type 4

EUT Frequency=5500MHz											
Radar Frequency (MHz)	DFS Detection Trials (1=Detection, 0= No Detection)										Detection Rate (%)
	1	2	3	4	5	6	7	8	9	10	
5487	0	0	0	0	0	0	0	0	0	0	0
5488	0	0	0	0	0	0	0	0	0	0	0
5489	0	0	0	0	0	0	0	0	0	0	0
5490	1	1	1	1	1	1	1	1	1	1	100
5491	1	1	1	1	1	1	1	1	1	1	100
5492	1	1	1	1	1	1	1	1	1	1	100
5493	1	1	1	1	1	1	1	1	1	1	100
5494	1	1	1	1	1	1	1	1	1	1	100
5495	1	1	1	1	1	1	1	1	1	1	100
5496	1	1	1	1	1	1	1	1	1	1	100
5497	1	1	1	1	1	1	1	1	1	1	100
5498	1	1	1	1	1	1	1	1	1	1	100
5499	1	1	1	1	1	1	1	1	1	1	100
5500	1	1	1	1	1	1	1	1	1	1	100
5501	1	1	1	1	1	1	1	1	1	1	100
5502	1	1	1	1	1	1	1	1	1	1	100
5503	1	1	1	1	1	1	1	1	1	1	100
5504	1	1	1	1	1	1	1	1	1	1	100
5505	1	1	1	1	1	1	1	1	1	1	100
5506	1	1	1	1	1	1	1	1	1	1	100
5507	1	1	1	1	1	1	1	1	1	1	100
5508	1	1	1	1	1	1	1	1	1	1	100
5509	1	1	1	1	1	1	1	1	1	1	100
5510	1	1	1	1	1	1	1	1	1	1	100
5511	0	0	0	0	0	0	0	0	0	0	0
5512	0	0	0	0	0	0	0	0	0	0	0
5513	0	0	0	0	0	0	0	0	0	0	0
Detection Bandwidth = FH-FL = 5510MHz-5490MHz = 21MHz											
EUT 99% Bandwidth = 20MHz (see note)											
UNII Detection Bandwidth Min. Limit (MHz): 20MHz x 80% = 16MHz											

For 20MHz / Type 5

EUT Frequency=5500MHz											
Radar Frequency (MHz)	DFS Detection Trials (1=Detection, 0= No Detection)										Detection Rate (%)
	1	2	3	4	5	6	7	8	9	10	
5487	0	0	0	0	0	0	0	0	0	0	0
5488	0	0	0	0	0	0	0	0	0	0	0
5489	0	0	0	0	0	0	0	0	0	0	0
5490	0	0	0	0	0	0	0	0	0	0	0
5491	0	0	0	0	0	0	0	0	0	0	0
5492	0	0	0	0	0	0	0	0	0	0	0
5493	0	0	0	0	0	0	0	0	0	0	0
5494	1	1	1	1	1	0	1	1	1	1	90
5495	1	1	1	1	1	1	1	1	1	1	100
5496	1	1	1	1	1	1	1	1	1	1	100
5497	1	1	1	1	1	1	1	1	1	1	100
5498	1	1	1	1	1	1	1	1	1	1	100
5499	1	1	1	1	1	1	1	1	1	1	100
5500	1	1	1	1	1	1	1	1	1	1	100
5501	1	1	1	1	1	1	1	1	1	1	100
5502	1	1	1	1	1	1	1	1	1	1	100
5503	1	1	1	1	1	1	1	1	1	1	100
5504	1	1	1	1	1	1	1	1	1	1	100
5505	1	1	1	1	1	1	1	1	1	1	100
5506	1	1	1	1	1	1	1	1	1	1	100
5507	1	1	1	1	1	1	1	1	1	1	100
5508	1	1	1	1	1	1	1	1	1	1	100
5509	1	1	1	1	1	1	1	1	1	1	100
5510	0	0	0	0	0	0	0	0	0	0	0
5511	0	0	0	0	0	0	0	0	0	0	0
5512	0	0	0	0	0	0	0	0	0	0	0
5513	0	0	0	0	0	0	0	0	0	0	0
Detection Bandwidth = FH-FL = 5509MHz-5494MHz = 16MHz											
EUT 99% Bandwidth = 20MHz (see note)											
UNII Detection Bandwidth Min. Limit (MHz): 20MHz x 80% = 16MHz											

For 20MHz / Type 6

EUT Frequency=5500MHz											
Radar Frequency (MHz)	DFS Detection Trials (1=Detection, 0= No Detection)										Detection Rate (%)
	1	2	3	4	5	6	7	8	9	10	
5487	0	0	0	0	0	0	0	0	0	0	0
5488	0	0	0	0	0	0	0	0	0	0	0
5489	1	1	1	1	1	1	1	1	1	1	100
5490	1	1	1	1	1	1	1	1	1	1	100
5491	1	1	1	1	1	1	1	1	1	1	100
5492	1	1	1	1	1	1	1	1	1	1	100
5493	1	1	1	1	1	1	1	1	1	1	100
5494	1	1	1	1	1	1	1	1	1	1	100
5495	1	1	1	1	1	1	1	1	1	1	100
5496	1	1	1	1	1	1	1	1	1	1	100
5497	1	1	1	1	1	1	1	1	1	1	100
5498	1	1	1	1	1	1	1	1	1	1	100
5499	1	1	1	1	1	1	1	1	1	1	100
5500	1	1	1	1	1	1	1	1	1	1	100
5501	1	1	1	1	1	1	1	1	1	1	100
5502	1	1	1	1	1	1	1	1	1	1	100
5503	1	1	1	1	1	1	1	1	1	1	100
5504	1	1	1	1	1	1	1	1	1	1	100
5505	1	1	1	1	1	1	1	1	1	1	100
5506	1	1	1	1	1	1	1	1	1	1	100
5507	1	1	1	1	1	1	1	1	1	1	100
5508	1	1	1	1	1	1	1	1	1	1	100
5509	1	1	1	1	1	1	1	1	1	1	100
5510	1	1	1	1	1	1	1	1	1	1	100
5511	1	1	1	1	1	1	1	1	1	1	100
5512	0	0	0	0	0	0	0	0	0	0	0
5513	0	0	0	0	0	0	0	0	0	0	0
Detection Bandwidth = FH-FL = 5511MHz-5489MHz = 23MHz											
EUT 99% Bandwidth = 20MHz (see note)											
UNII Detection Bandwidth Min. Limit (MHz): 20MHz x 80% = 16MHz											

For 40MHz / Type 1

EUT Frequency=5510MHz											
Radar Frequency (MHz)	DFS Detection Trials (1=Detection, 0= No Detection)										Detection Rate (%)
	1	2	3	4	5	6	7	8	9	10	
5487	0	0	0	0	0	0	0	0	0	0	0
5488	0	0	0	0	0	0	0	0	0	0	0
5489	0	0	0	0	0	0	0	0	0	0	0
5490	1	1	1	1	1	1	1	1	1	1	100
5491	1	1	1	1	1	1	1	1	1	1	100
5492	1	1	1	1	1	1	1	1	1	1	100
5493	1	1	1	1	1	1	1	1	1	1	100
5494	1	1	1	1	1	1	1	1	1	1	100
5495	1	1	1	1	1	1	1	1	1	1	100
5496	1	1	1	1	1	1	1	1	1	1	100
5497	1	1	1	1	1	1	1	1	1	1	100
5498	1	1	1	1	1	1	1	1	1	1	100
5499	1	1	1	1	1	1	1	1	1	1	100
5500	1	1	1	1	1	1	1	1	1	1	100
5501	1	1	1	1	1	1	1	1	1	1	100
5502	1	1	1	1	1	1	1	1	1	1	100
5503	1	1	1	1	1	1	1	1	1	1	100
5504	1	1	1	1	1	1	1	1	1	1	100
5505	1	1	1	1	1	1	1	1	1	1	100
5506	1	1	1	1	1	1	1	1	1	1	100
5507	1	1	1	1	1	1	1	1	1	1	100
5508	1	1	1	1	1	1	1	1	1	1	100
5509	1	1	1	1	1	1	1	1	1	1	100
5510	1	1	1	1	1	1	1	1	1	1	100
5511	1	1	1	1	1	1	1	1	1	1	100
5512	1	1	1	1	1	1	1	1	1	1	100
5513	1	1	1	1	1	1	1	1	1	1	100
5514	1	1	1	1	1	1	1	1	1	1	100
5515	1	1	1	1	1	1	1	1	1	1	100
5516	1	1	1	1	1	1	1	1	1	1	100
5517	1	1	1	1	1	1	1	1	1	1	100
5518	1	1	1	1	1	1	1	1	1	1	100

5519	1	1	1	1	1	1	1	1	1	1	100
5520	1	1	1	1	1	1	1	1	1	1	100
5521	1	1	1	1	1	1	1	1	1	1	100
5522	1	1	1	1	1	1	1	1	1	1	100
5523	1	1	1	1	1	1	1	1	1	1	100
5524	1	1	1	1	1	1	1	1	1	1	100
5525	1	1	1	1	1	1	1	1	1	1	100
5526	1	1	1	1	1	1	1	1	1	1	100
5527	1	1	1	1	1	1	1	1	1	1	100
5528	1	1	1	1	1	1	1	1	1	1	100
5529	1	1	1	1	1	1	1	1	1	1	100
5530	1	1	1	1	1	1	1	1	1	1	100
5531	0	0	0	0	0	0	0	0	0	0	0
5532	0	0	0	0	0	0	0	0	0	0	0
5533	0	0	0	0	0	0	0	0	0	0	0
Detection Bandwidth = FH-FL = 5530MHz-5490MHz = 41MHz											
EUT 99% Bandwidth = 40MHz (see note)											
UNII Detection Bandwidth Min. Limit (MHz): 40MHz x 80% = 32MHz											

For 40MHz / Type 2

EUT Frequency=5510MHz											
Radar Frequency (MHz)	DFS Detection Trials (1=Detection, 0= No Detection)										Detection Rate (%)
	1	2	3	4	5	6	7	8	9	10	
5487	0	0	0	0	0	0	0	0	0	0	0
5488	0	0	0	0	0	0	0	0	0	0	0
5489	0	0	0	0	0	0	0	0	0	0	0
5490	1	1	1	1	1	1	1	1	1	1	100
5491	1	1	1	1	1	1	1	1	1	1	100
5492	1	1	1	1	1	1	1	1	1	1	100
5493	1	1	1	1	1	1	1	1	1	1	100
5494	1	1	1	1	1	1	1	1	1	1	100
5495	1	1	1	1	1	1	1	1	1	1	100
5496	1	1	1	1	1	1	1	1	1	1	100
5497	1	1	1	1	1	1	1	1	1	1	100
5498	1	1	1	1	1	1	1	1	1	1	100
5499	1	1	1	1	1	1	1	1	1	1	100
5500	1	1	1	1	1	1	1	1	1	1	100
5501	1	1	1	1	1	1	1	1	1	1	100
5502	1	1	1	1	1	1	1	1	1	1	100
5503	1	1	1	1	1	1	1	1	1	1	100
5504	1	1	1	1	1	1	1	1	1	1	100
5505	1	1	1	1	1	1	1	1	1	1	100
5506	1	1	1	1	1	1	1	1	1	1	100
5507	1	1	1	1	1	1	1	1	1	1	100
5508	1	1	1	1	1	1	1	1	1	1	100
5509	1	1	1	1	1	1	1	1	1	1	100
5510	1	1	1	1	1	1	1	1	1	1	100
5511	1	1	1	1	1	1	1	1	1	1	100
5512	1	1	1	1	1	1	1	1	1	1	100
5513	1	1	1	1	1	1	1	1	1	1	100
5514	1	1	1	1	1	1	1	1	1	1	100
5515	1	1	1	1	1	1	1	1	1	1	100
5516	1	1	1	1	1	1	1	1	1	1	100
5517	1	1	1	1	1	1	1	1	1	1	100
5518	1	1	1	1	1	1	1	1	1	1	100

5519	1	1	1	1	1	1	1	1	1	1	100
5520	1	1	1	1	1	1	1	1	1	1	100
5521	1	1	1	1	1	1	1	1	1	1	100
5522	1	1	1	1	1	1	1	1	1	1	100
5523	1	1	1	1	1	1	1	1	1	1	100
5524	1	1	1	1	1	1	1	1	1	1	100
5525	1	1	1	1	1	1	1	1	1	1	100
5526	1	1	1	1	1	1	1	1	1	1	100
5527	1	1	1	1	1	1	1	1	1	1	100
5528	1	1	1	1	1	1	1	1	1	1	100
5529	1	1	1	1	1	1	1	1	1	1	100
5530	1	1	1	1	1	1	1	1	1	1	100
5531	0	0	0	0	0	0	0	0	0	0	0
5532	0	0	0	0	0	0	0	0	0	0	0
5533	0	0	0	0	0	0	0	0	0	0	0

Detection Bandwidth = FH-FL = 5530MHz-5490MHz = 41MHz

EUT 99% Bandwidth = 40MHz (see note)

UNII Detection Bandwidth Min. Limit (MHz): 40MHz x 80% = 32MHz

For 40MHz / Type 3

EUT Frequency=5510MHz											
Radar Frequency (MHz)	DFS Detection Trials (1=Detection, 0= No Detection)										Detection Rate (%)
	1	2	3	4	5	6	7	8	9	10	
5487	0	0	0	0	0	0	0	0	0	0	0
5488	0	0	0	0	0	0	0	0	0	0	0
5489	0	0	0	0	0	0	0	0	0	0	0
5490	1	1	1	1	1	1	1	1	1	1	100
5491	1	1	1	1	1	1	1	1	1	1	100
5492	1	1	1	1	1	1	1	1	1	1	100
5493	1	1	1	1	1	1	1	1	1	1	100
5494	1	1	1	1	1	1	1	1	1	1	100
5495	1	1	1	1	1	1	1	1	1	1	100
5496	1	1	1	1	1	1	1	1	1	1	100
5497	1	1	1	1	1	1	1	1	1	1	100
5498	1	1	1	1	1	1	1	1	1	1	100
5499	1	1	1	1	1	1	1	1	1	1	100
5500	1	1	1	1	1	1	1	1	1	1	100
5501	1	1	1	1	1	1	1	1	1	1	100
5502	1	1	1	1	1	1	1	1	1	1	100
5503	1	1	1	1	1	1	1	1	1	1	100
5504	1	1	1	1	1	1	1	1	1	1	100
5505	1	1	1	1	1	1	1	1	1	1	100
5506	1	1	1	1	1	1	1	1	1	1	100
5507	1	1	1	1	1	1	1	1	1	1	100
5508	1	1	1	1	1	1	1	1	1	1	100
5509	1	1	1	1	1	1	1	1	1	1	100
5510	1	1	1	1	1	1	1	1	1	1	100
5511	1	1	1	1	1	1	1	1	1	1	100
5512	1	1	1	1	1	1	1	1	1	1	100
5513	1	1	1	1	1	1	1	1	1	1	100
5514	1	1	1	1	1	1	1	1	1	1	100
5515	1	1	1	1	1	1	1	1	1	1	100
5516	1	1	1	1	1	1	1	1	1	1	100
5517	1	1	1	1	1	1	1	1	1	1	100
5518	1	1	1	1	1	1	1	1	1	1	100

5519	1	1	1	1	1	1	1	1	1	1	100
5520	1	1	1	1	1	1	1	1	1	1	100
5521	1	1	1	1	1	1	1	1	1	1	100
5522	1	1	1	1	1	1	1	1	1	1	100
5523	1	1	1	1	1	1	1	1	1	1	100
5524	1	1	1	1	1	1	1	1	1	1	100
5525	1	1	1	1	1	1	1	1	1	1	100
5526	1	1	1	1	1	1	1	1	1	1	100
5527	1	1	1	1	1	1	1	1	1	1	100
5528	1	1	1	1	1	1	1	1	1	1	100
5529	1	1	1	1	1	1	1	1	1	1	100
5530	1	1	1	1	1	1	1	1	1	1	100
5531	0	0	0	0	0	0	0	0	0	0	0
5532	0	0	0	0	0	0	0	0	0	0	0
5533	0	0	0	0	0	0	0	0	0	0	0
Detection Bandwidth = FH-FL = 5530MHz-5490MHz = 41MHz											
EUT 99% Bandwidth = 40MHz (see note)											
UNII Detection Bandwidth Min. Limit (MHz): 40MHz x 80% = 32MHz											

For 40MHz / Type 4

EUT Frequency=5510MHz											
Radar Frequency (MHz)	DFS Detection Trials (1=Detection, 0= No Detection)										Detection Rate (%)
	1	2	3	4	5	6	7	8	9	10	
5487	0	0	0	0	0	0	0	0	0	0	0
5488	0	0	0	0	0	0	0	0	0	0	0
5489	0	0	0	0	0	0	0	0	0	0	0
5490	1	1	1	1	1	1	1	1	1	1	100
5491	1	1	1	1	1	1	1	1	1	1	100
5492	1	1	1	1	1	1	1	1	1	1	100
5493	1	1	1	1	1	1	1	1	1	1	100
5494	1	1	1	1	1	1	1	1	1	1	100
5495	1	1	1	1	1	1	1	1	1	1	100
5496	1	1	1	1	1	1	1	1	1	1	100
5497	1	1	1	1	1	1	1	1	1	1	100
5498	1	1	1	1	1	1	1	1	1	1	100
5499	1	1	1	1	1	1	1	1	1	1	100
5500	1	1	1	1	1	1	1	1	1	1	100
5501	1	1	1	1	1	1	1	1	1	1	100
5502	1	1	1	1	1	1	1	1	1	1	100
5503	1	1	1	1	1	1	1	1	1	1	100
5504	1	1	1	1	1	1	1	1	1	1	100
5505	1	1	1	1	1	1	1	1	1	1	100
5506	1	1	1	1	1	1	1	1	1	1	100
5507	1	1	1	1	1	1	1	1	1	1	100
5508	1	1	1	1	1	1	1	1	1	1	100
5509	1	1	1	1	1	1	1	1	1	1	100
5510	1	1	1	1	1	1	1	1	1	1	100
5511	1	1	1	1	1	1	1	1	1	1	100
5512	1	1	1	1	1	1	1	1	1	1	100
5513	1	1	1	1	1	1	1	1	1	1	100
5514	1	1	1	1	1	1	1	1	1	1	100
5515	1	1	1	1	1	1	1	1	1	1	100
5516	1	1	1	1	1	1	1	1	1	1	100
5517	1	1	1	1	1	1	1	1	1	1	100
5518	1	1	1	1	1	1	1	1	1	1	100

5519	1	1	1	1	1	1	1	1	1	1	100
5520	1	1	1	1	1	1	1	1	1	1	100
5521	1	1	1	1	1	1	1	1	1	1	100
5522	1	1	1	1	1	1	1	1	1	1	100
5523	1	1	1	1	1	1	1	1	1	1	100
5524	1	1	1	1	1	1	1	1	1	1	100
5525	1	1	1	1	1	1	1	1	1	1	100
5526	1	1	1	1	1	1	1	1	1	1	100
5527	1	1	1	1	1	1	1	1	1	1	100
5528	1	1	1	1	1	1	1	1	1	1	100
5529	1	1	1	1	1	1	1	1	1	1	100
5530	1	1	1	1	1	1	1	1	1	1	100
5531	0	0	0	0	0	0	0	0	0	0	0
5532	0	0	0	0	0	0	0	0	0	0	0
5533	0	0	0	0	0	0	0	0	0	0	0
Detection Bandwidth = FH-FL = 5530MHz-5490MHz = 41MHz											
EUT 99% Bandwidth = 40MHz (see note)											
UNII Detection Bandwidth Min. Limit (MHz): 40MHz x 80% = 32MHz											

For 40MHz / Type 5

EUT Frequency=5510MHz											
Radar Frequency (MHz)	DFS Detection Trials (1=Detection, 0= No Detection)										Detection Rate (%)
	1	2	3	4	5	6	7	8	9	10	
5487	0	0	0	0	0	0	0	0	0	0	0
5488	0	0	0	0	0	0	0	0	0	0	0
5489	0	0	0	0	0	0	0	0	0	0	0
5490	1	1	1	1	1	1	1	1	1	1	100
5491	1	1	1	1	1	1	1	1	1	1	100
5492	1	1	1	1	1	1	1	1	1	1	100
5493	1	1	1	1	1	1	1	1	1	1	100
5494	1	1	1	1	1	1	1	1	1	1	100
5495	1	1	1	1	1	1	1	1	1	1	100
5496	1	1	1	1	1	1	1	1	1	1	100
5497	1	1	1	1	1	1	1	1	1	1	100
5498	1	1	1	1	1	1	1	1	1	1	100
5499	1	1	1	1	1	1	1	1	1	1	100
5500	1	1	1	1	1	1	1	1	1	1	100
5501	1	1	1	1	1	1	1	1	1	1	100
5502	1	1	1	1	1	1	1	1	1	1	100
5503	1	1	1	1	1	1	1	1	1	1	100
5504	1	1	1	1	1	1	1	1	1	1	100
5505	1	1	1	1	1	1	1	1	1	1	100
5506	1	1	1	1	1	1	1	1	1	1	100
5507	1	1	1	1	1	1	1	1	1	1	100
5508	1	1	1	1	1	1	1	1	1	1	100
5509	1	1	1	1	1	1	1	1	1	1	100
5510	1	1	1	1	1	1	1	1	1	1	100
5511	1	1	1	1	1	1	1	1	1	0	90
5512	1	1	1	1	1	1	1	1	1	1	100
5513	1	1	1	1	1	1	1	1	1	1	100
5514	1	1	1	1	1	1	1	1	1	1	100
5515	1	1	1	1	1	1	1	1	1	1	100
5516	1	1	1	1	1	1	1	1	1	1	100
5517	1	1	1	1	1	1	1	1	1	1	100
5518	1	1	1	1	1	1	1	1	1	1	100

5519	1	1	1	1	1	1	1	1	1	1	100
5520	1	1	1	1	1	1	1	1	1	1	100
5521	1	1	1	1	1	1	1	1	1	1	100
5522	1	1	1	1	1	1	1	1	1	1	100
5523	1	1	1	1	1	1	1	1	1	1	100
5524	1	1	1	1	1	1	1	1	1	1	100
5525	1	1	1	1	1	1	1	1	1	1	100
5526	1	1	1	1	1	1	1	1	1	1	100
5527	1	1	1	1	1	1	1	1	1	1	100
5528	1	1	1	1	1	1	1	1	1	1	100
5529	1	1	1	1	1	1	1	1	1	1	100
5530	1	1	1	1	1	1	1	1	1	1	100
5531	0	0	0	0	0	0	0	0	0	0	0
5532	0	0	0	0	0	0	0	0	0	0	0
5533	0	0	0	0	0	0	0	0	0	0	0

Detection Bandwidth = FH-FL = 5530MHz-5490MHz = 41MHz

EUT 99% Bandwidth = 40MHz (see note)

UNII Detection Bandwidth Min. Limit (MHz): 40MHz x 80% = 32MHz

For 40MHz / Type 6

EUT Frequency=5510MHz											
Radar Frequency (MHz)	DFS Detection Trials (1=Detection, 0= No Detection)										Detection Rate (%)
	1	2	3	4	5	6	7	8	9	10	
5487	0	0	0	0	0	0	0	0	0	0	0
5488	0	0	0	0	0	0	0	0	0	0	0
5489	0	0	0	0	0	0	0	0	0	0	0
5490	1	1	1	1	1	1	1	1	1	1	100
5491	1	1	1	1	1	1	1	1	1	1	100
5492	1	1	1	1	1	1	1	1	1	1	100
5493	1	1	1	1	1	1	1	1	1	1	100
5494	1	1	1	1	1	1	1	1	1	1	100
5495	1	1	1	1	1	1	1	1	1	1	100
5496	1	1	1	1	1	1	1	1	1	1	100
5497	1	1	1	1	1	1	1	1	1	1	100
5498	1	1	1	1	1	1	1	1	1	1	100
5499	1	1	1	1	1	1	1	1	1	1	100
5500	1	1	1	1	1	1	1	1	1	1	100
5501	1	1	1	1	1	1	1	1	1	1	100
5502	1	1	1	1	1	1	1	1	1	1	100
5503	1	1	1	1	1	1	1	1	1	1	100
5504	1	1	1	1	1	1	1	1	1	1	100
5505	1	1	1	1	1	1	1	1	1	1	100
5506	1	1	1	1	1	1	1	1	1	1	100
5507	1	1	1	1	1	1	1	1	1	1	100
5508	1	1	1	1	1	1	1	1	1	1	100
5509	1	1	1	1	1	1	1	1	1	1	100
5510	1	1	1	1	1	1	1	1	1	1	100
5511	1	1	1	1	1	1	1	1	1	1	100
5512	1	1	1	1	1	1	1	1	1	1	100
5513	1	1	1	1	1	1	1	1	1	1	100
5514	1	1	1	1	1	1	1	1	1	1	100
5515	1	1	1	1	1	1	1	1	1	1	100
5516	1	1	1	1	1	1	1	1	1	1	100
5517	1	1	1	1	1	1	1	1	1	1	100
5518	1	1	1	1	1	1	1	1	1	1	100



5519	1	1	1	1	1	1	1	1	1	1	100
5520	1	1	1	1	1	1	1	1	1	1	100
5521	1	1	1	1	1	1	1	1	1	1	100
5522	1	1	1	1	1	1	1	1	1	1	100
5523	1	1	1	1	1	1	1	1	1	1	100
5524	1	1	1	1	1	1	1	1	1	1	100
5525	1	1	1	1	1	1	1	1	1	1	100
5526	1	1	1	1	1	1	1	1	1	1	100
5527	1	1	1	1	1	1	1	1	1	1	100
5528	1	1	1	1	1	1	1	1	1	1	100
5529	1	1	1	1	1	1	1	1	1	1	100
5530	1	1	1	1	1	1	1	1	1	1	100
5531	0	0	0	0	0	0	0	0	0	0	0
5532	0	0	0	0	0	0	0	0	0	0	0
5533	0	0	0	0	0	0	0	0	0	0	0

Detection Bandwidth = FH-FL = 5530MHz-5490MHz = 41MHz

EUT 99% Bandwidth = 40MHz (see note)

UNII Detection Bandwidth Min. Limit (MHz): 40MHz x 80% = 32MHz

5.3. Initial Channel Availability Check Time Measurement

5.3.1. Limit

The EUT shall perform a Channel Availability Check to ensure that there is no radar operating on the channel. After power-up sequence, receive at least 1 minute on the intended operating frequency.

5.3.2. Test Procedures

1. The U-NII devices will be powered on and be instructed to operate on the appropriate 5500MHz (for 20MHz), 5510MHz (for 40MHz). The spectrum analyzer will be set to zero span mode with a 3 MHz RBW and 3 MHz VBW on the *Channel* occupied by the radar (Chr) with a 2.5 minute sweep time. The spectrum analyzer's sweep will be started at the same time power is applied to the U-NII device.
2. The EUT should not transmit any beacon or data transmissions until at least 1 minute after the completion of the power-on cycle. Measurement system showing its nominal noise floor is marker 1.

5.3.3. Test Deviation

There is no deviation with the original standard.

5.3.4. Test Result for Initial Channel Availability Check Time

For 20MHz

The EUT does not transmit any beacon or data transmissions until at least 1 minute after the completion of the power-on cycle (94.8 sec). The initial power up time of the EUT is indicated by marker 1 (94.8 sec). Initial beacons/data transmissions are indicated by marker 2 (154.8 sec).

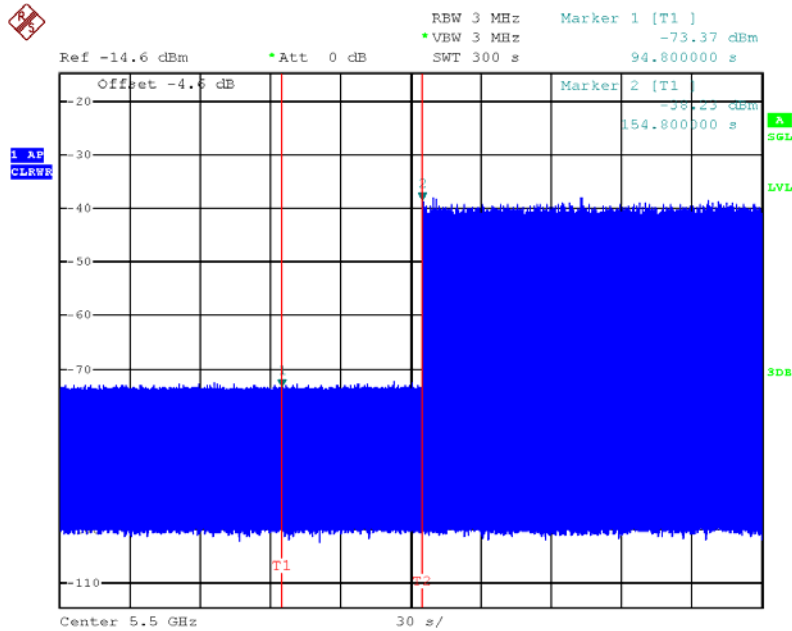

Date: 14.MAY.2012 12:35:16

For 40MHz

The EUT does not transmit any beacon or data transmissions until at least 1 minute after the completion of the power-on cycle (95.4 sec). The initial power up time of the EUT is indicated by marker 1 (95.4 sec). Initial beacons/data transmissions are indicated by marker 2 (155.4 sec).

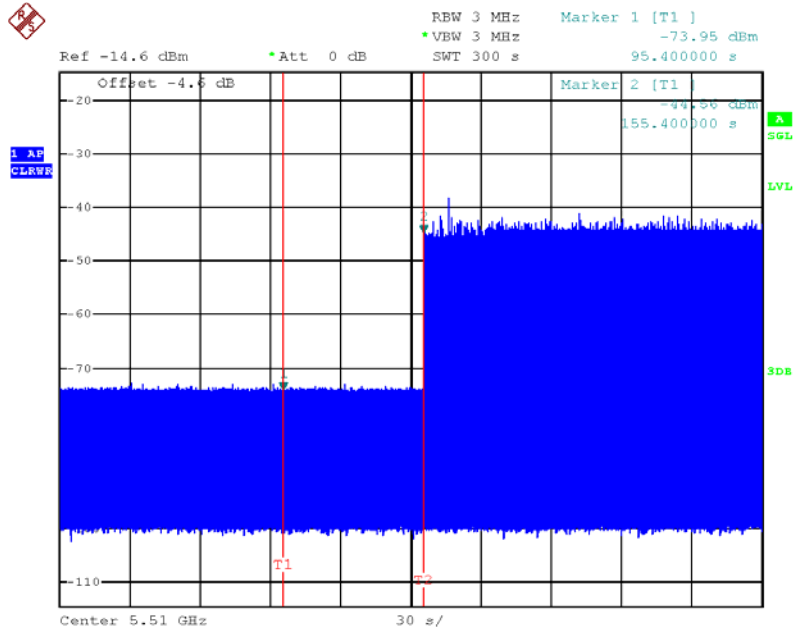

Date: 12.MAY.2012 18:23:45

5.4. Radar Burst at the Beginning of the Channel Availability Check Time Measurement

5.4.1. Limit

In beginning of the Channel Availability Check (CAC) Time, radar is detected on this channel, select another intended channel and perform a CAC on that channel.

5.4.2. Test Procedures

1. The steps below define the procedure to verify successful radar detection on the selected Channel during a period equal to the Channel Availability Check Time and avoidance of operation on that Channel when a radar Burst with a level equal to the DFS Detection Threshold + 1 dB occurs at the beginning of the Channel Availability Check Time.
2. The EUT is in completion power-up cycle (from T0 to T1). T1 denotes the instant when the EUT has completed its power-up sequence. The Channel Availability Check Time commences at instant T1 and will end no sooner than $T1 + 60$ seconds. A single Burst of short pulse of radar type 1 at DFS Detection Threshold + 1 dB will commence within a 6 second window starting at T1.
3. Visual indication on the EUT of successful detection of the radar Burst will be recorded and reported. Observation of emissions at 5500MHz (for 20MHz), 5510 (for 40MHz) will continue for 97.8 seconds (for 20MHz), 97.8 seconds (for 40MHz) after the radar Burst has been generated. Verify that during the 2.5 minutes measurement window no EUT transmissions occurred at 5500MHz (for 20MHz), 5510 (for 40MHz).

5.4.3. Test Deviation

There is no deviation with the original standard.

5.4.4. Results of Radar Burst at the Beginning of the Channel Availability Check Time

For 20MHz

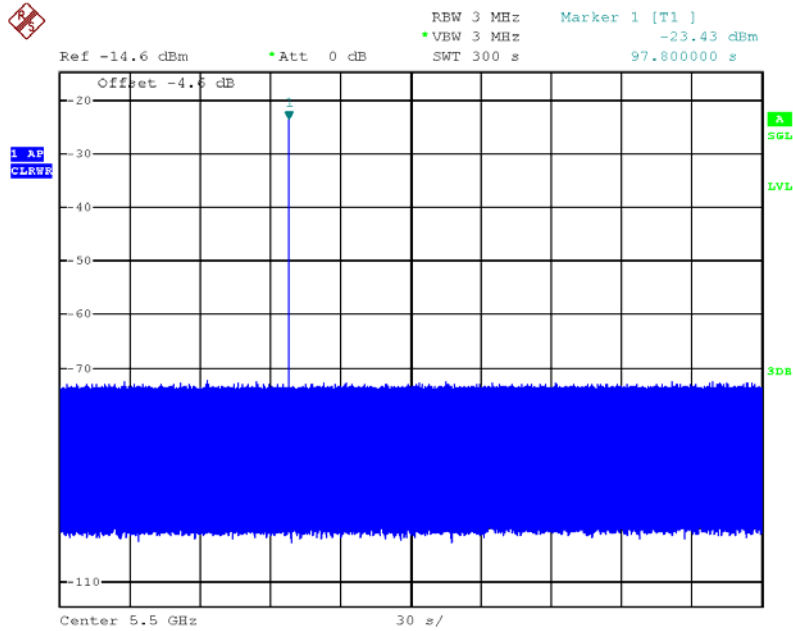

Date: 14.MAY.2012 12:52:01

For 40MHz

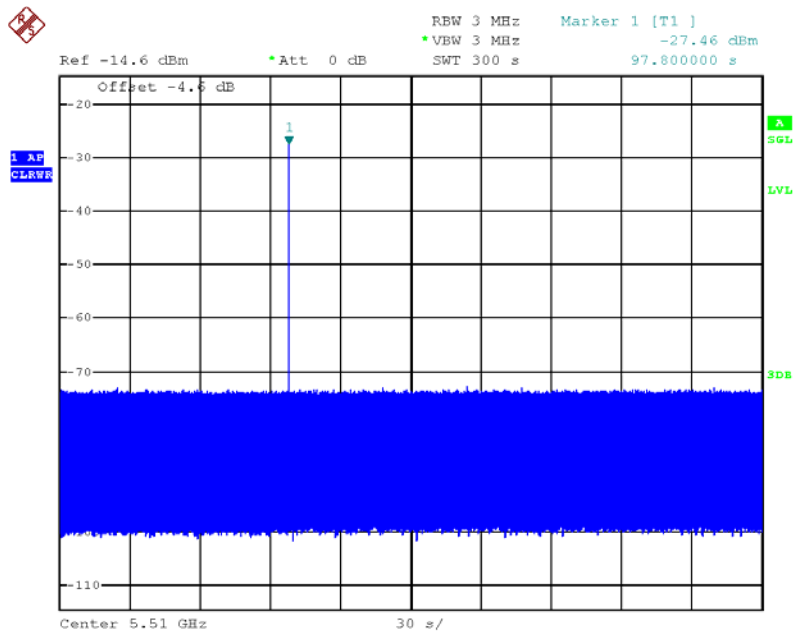

Date: 12.MAY.2012 18:34:22

5.5. Radar Burst at the End of the Channel Availability Check Time Measurement

5.5.1. Limit

In the end of Channel Availability Check (CAC) Time, radar is detected on this channel, select another intended channel and perform a CAC on that channel.

5.5.2. Test Procedures

1. The steps below define the procedure to verify successful radar detection on the selected Channel during a period equal to the Channel Availability Check Time and avoidance of operation on that Channel when a radar Burst with a level equal to the DFS Detection Threshold + 1 dB occurs at the end of the Channel Availability Check Time.
2. The EUT is powered on at T0. T1 denotes the instant when the EUT has completed its power-up sequence. The Channel Availability Check Time commences at instant T1 and will end no sooner than T1 + 60 seconds. A single Burst of short pulse of radar type 1 at DFS Detection Threshold + 1 dB will commence within a 6 second window starting at T1 + 54 seconds.
3. Visual indication on the EUT of successful detection of the radar Burst will be recorded and reported. Observation of emissions at 5500MHz (for 20MHz), 5510 (for 40MHz) will continue for 104 seconds (for 20MHz), 152.4 seconds (for 40MHz) after the radar Burst has been generated. Verify that during the 2.5 minutes measurement window no EUT transmissions occurred at 5500MHz (for 20MHz), 5510 (for 40MHz).

5.5.3. Test Deviation

There is no deviation with the original standard.

5.5.4. Results of Radar Burst at the end of the Channel Availability Check Time

For 20MHz

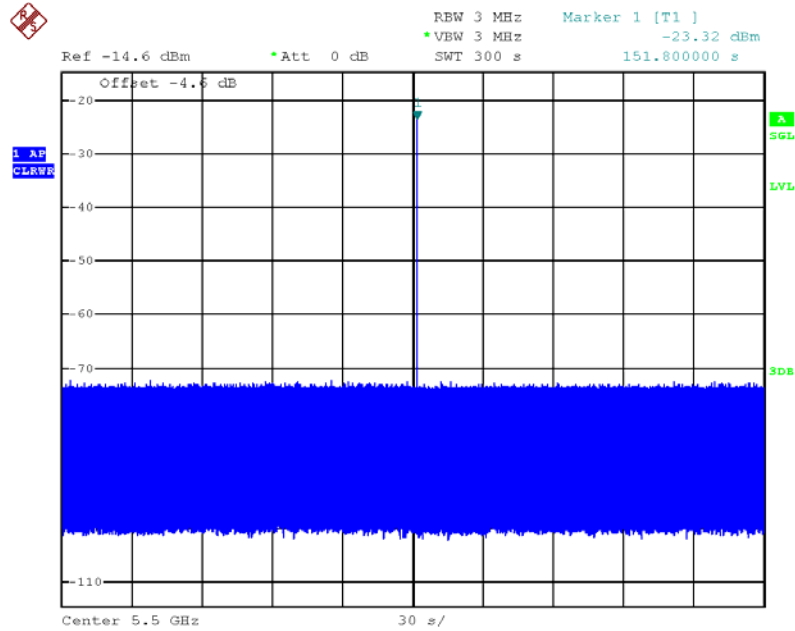

Date: 14.MAY.2012 12:57:44

For 40MHz

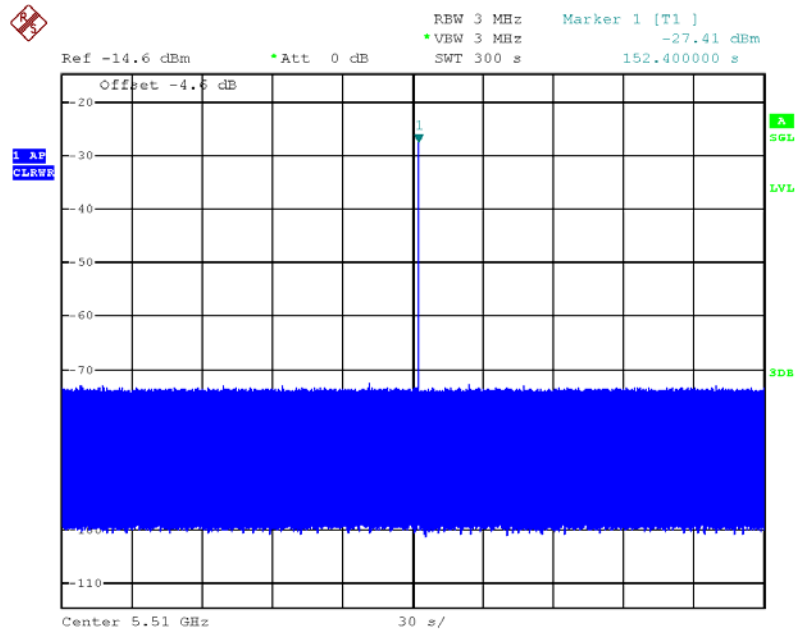

Date: 12.MAY.2012 18:37:18

5.6. In-Service Monitoring for Channel Move Time, Channel Closing Transmission Time and Non-Occupancy Period Measurement

5.6.1. Limit

The EUT has In-Service Monitoring function to continuously monitor the radar signals, If radar is detected, must leave the channel (Shutdown). The Channel Move Time to cease all transmissions on the current Channel upon detection of a Radar Waveform above the DFS Detection Threshold within 10 sec. The total duration of Channel Closing Transmission Time is 260ms, consisting of data signals and the aggregate of control signals, by a U-NII device during the Channel Move Time. The Non-Occupancy Period time is 30 minute during which a Channel will not be utilized after a Radar Waveform is detected on that Channel.

5.6.2. Test Procedures

1. When a radar Burst with a level equal to the DFS Detection Threshold + 1dB is generated on the Operating Channel of the U-NII device. A U-NII device operating as a Client Device will associate with the Master at Channel. Stream the MPEG test file from the Master Device to the Client Device on the selected Channel for the entire period of the test. At time T₀ the Radar Waveform generator sends a Burst of pulses for each of the radar types at Detection Threshold + 1dB.
2. Observe the transmissions of the EUT at the end of the radar Burst on the Operating Channel. Measure and record the transmissions from the EUT during the observation time (Channel Move Time). One 10 second plot been reported for the Short Pulse Radar Types 1-4 and one for the Long Pulse Radar Type test in a 22 second plot. The plot for the Short Pulse Radar Types start at the end of the radar burst. The *Channel Move Time* will be calculated based on the plot of the Short Pulse Radar Type. The Long Pulse Radar Type plot show the device ceased transmissions within the 10 second window after detection has occurred. The plot for the Long Pulse Radar Type should start at the beginning of the 12 second waveform.
3. Measurement of the aggregate duration of the Channel Closing Transmission Time method. With the spectrum analyzer set to zero span tuned to the center frequency of the EUT operating channel at the radar simulated frequency, peak detection, and max hold, the dwell time per bin is given by: **Dwell (0.375ms) = S (3 sec) / B (8000)** ; where **Dwell** is the dwell time per spectrum analyzer sampling bin, **S** is the sweep time and **B** is the number of spectrum analyzer sampling bins. An upper bound of the aggregate duration of the intermittent control signals of *Channel Closing Transmission Time* is calculated by: **20MHz: C (12 ms) = N (32) X Dwell (0.375 ms)**, **40MHz: C (13.875 ms) = N (37) X Dwell (0.375 ms)**; where **C** is the Closing Time, **N** is the number of spectrum analyzer sampling bins (intermittent control signals) showing a U-NII transmission and **Dwell** is the dwell time per bin.
4. Measure the EUT for more than 30 minutes following the channel close/move time to verify that the EUT does not resume any transmissions on this Channel.

5.6.3. Test Deviation

There is no deviation with the original standard.

5.6.4. Result of Channel Move Time, Channel Closing Transmission Time and Non-Occupancy Period

For 20MHz

Parameter	Test Result		Limit
	Type 1	Type 5	
Test Channel (MHz)	5500	5500	-
Channel Move Time (sec)	1.968	0	< 10s
Channel Closing Transmission Time (ms) (Note)	12	0	< 60ms
Non-Occupancy Period (min.)	≥ 30	-	≥ 30 min

Note: The Channel Closing Transmission Time is comprised of 200 milliseconds starting at the beginning of the Channel Move Time plus any additional intermittent control signals required to facilitate a Channel move (an aggregate of 60 milliseconds) during the remainder of the 10 seconds period. The aggregate duration of control signals will not count quiet periods in between transmissions.

For 40MHz

Parameter	Test Result		Limit
	Type 1	Type 5	
Test Channel (MHz)	5510	5510	-
Channel Move Time (sec)	1.896	0	< 10s
Channel Closing Transmission Time (ms) (Note)	13.875	0	< 60ms
Non-Occupancy Period (min.)	≥ 30	-	≥ 30 min

Note: The Channel Closing Transmission Time is comprised of 200 milliseconds starting at the beginning of the Channel Move Time plus any additional intermittent control signals required to facilitate a Channel move (an aggregate of 60 milliseconds) during the remainder of the 10 seconds period. The aggregate duration of control signals will not count quiet periods in between transmissions.

5.6.5. Channel Move Time Plot

For 20MHz

Radar #1 Channel Move Time

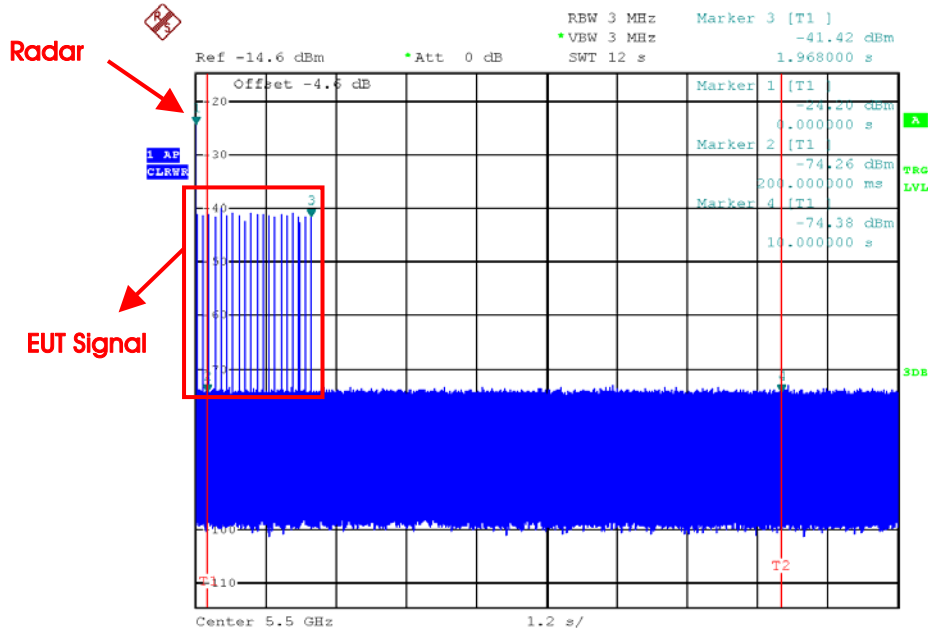

Date: 14.MAY.2012 12:29:22

Radar #5 Channel Move Time

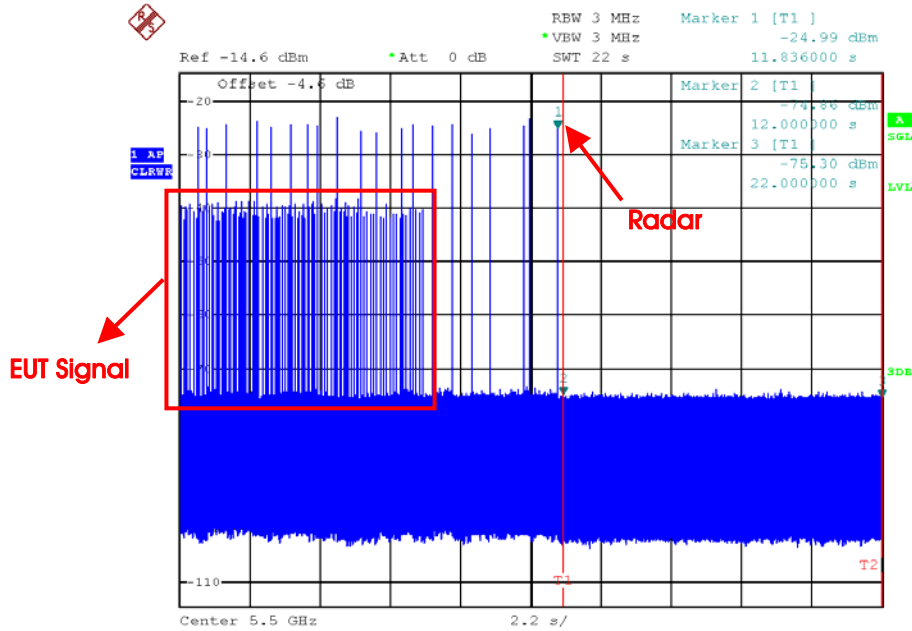

Date: 14.MAY.2012 12:43:45

For 40MHz

Radar #1 Channel Move Time

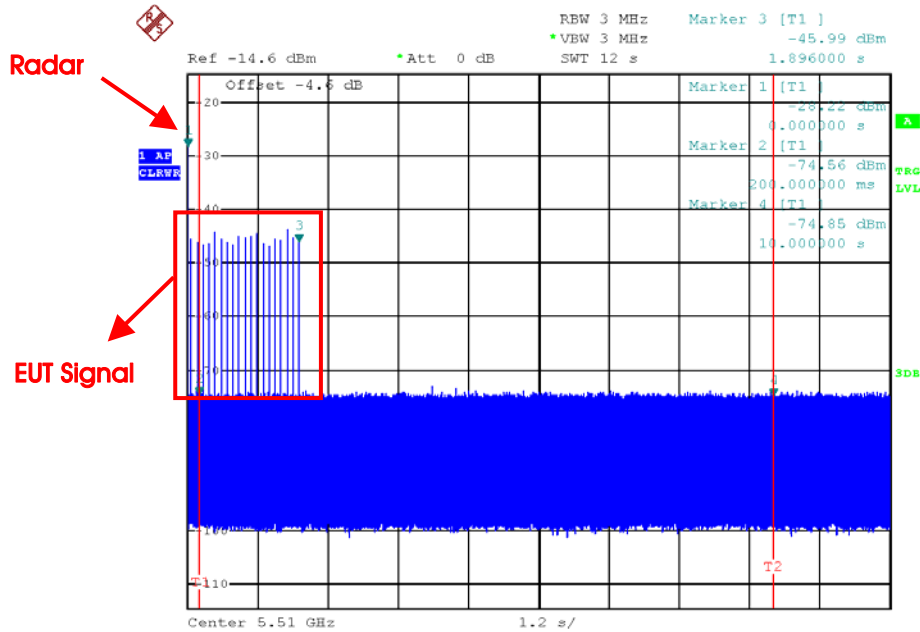

Date: 12.MAY.2012 18:09:42

Radar #5 Channel Move Time

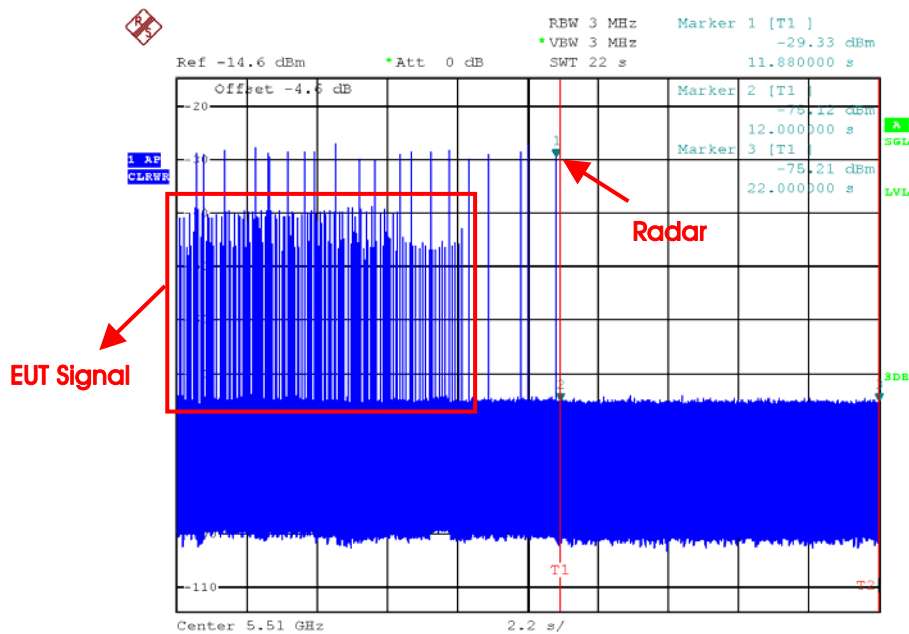

Date: 12.MAY.2012 18:27:34

5.6.6. Channel Closing Transmission Time Plot

For 20MHz

Radar #1 Channel Closing Transmission Time is comprised of 200 ms starting at the beginning of the Channel Move Time plus 60ms additional intermittent control signals

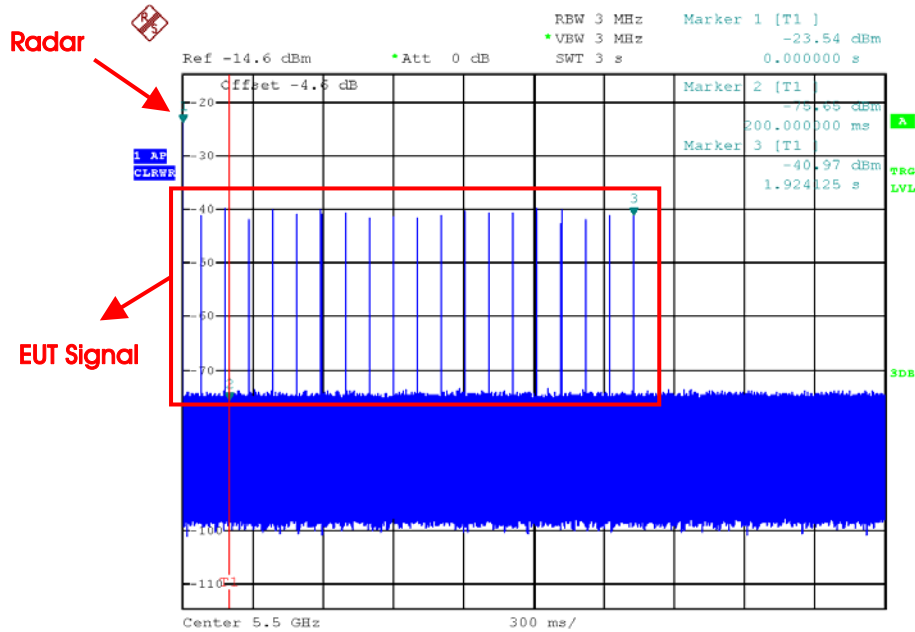

Date: 14.MAY.2012 12:37:18

Dwell is the dwell time per spectrum analyzer sampling bin.

S is the sweep time

B is the number of spectrum analyzer sampling bins

C is the intermittent control signals of Channel Closing Transmission Time

N is the number of spectrum analyzer sampling bins (intermittent control signals) showing a U-NII transmission

$$\text{Dwell (0.375 ms)} = \text{S (3 sec)} / \text{B (8000)}$$

$$\text{C (12 ms)} = \text{N (32)} \times \text{Dwell (0.375 ms)}$$

For 40MHz

Radar #1 Channel Closing Transmission Time is comprised of 200 ms starting at the beginning of the Channel Move Time plus 60ms additional intermittent control signals

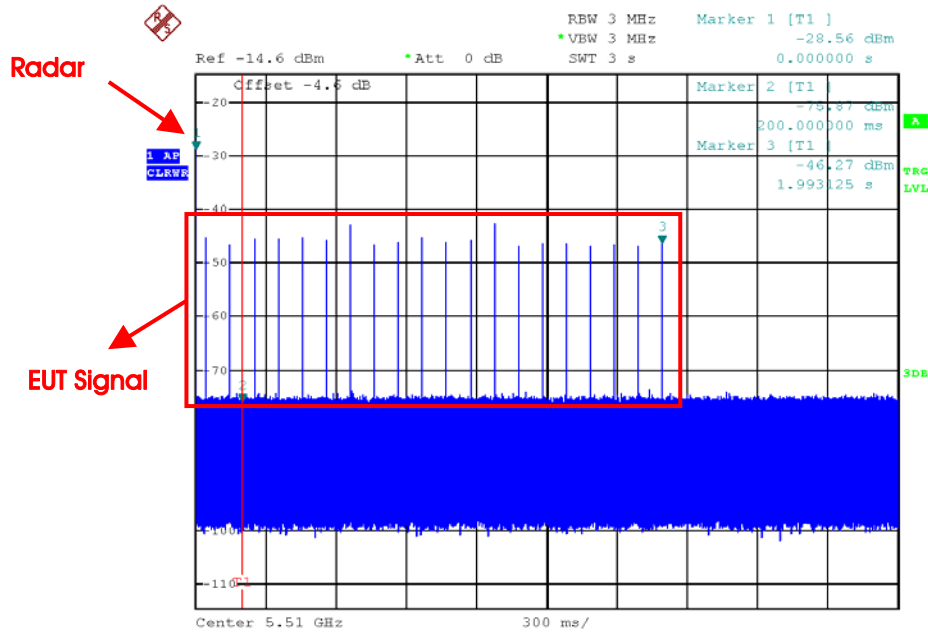

Date: 12.MAY.2012 18:14:01

Dwell is the dwell time per spectrum analyzer sampling bin.

S is the sweep time

B is the number of spectrum analyzer sampling bins

C is the intermittent control signals of Channel Closing Transmission Time

N is the number of spectrum analyzer sampling bins (intermittent control signals) showing a U-NII transmission

$$\text{Dwell (0.375 ms)} = S (3 \text{ sec}) / B (8000)$$

$$C (13.875 \text{ ms}) = N (37) \times \text{Dwell (0.375 ms)}$$

5.6.7. Non-Occupancy Period Plot

For 20MHz

Non-Occupancy Period

During the 30 minutes observation time, UUT did not make any transmissions on a channel after a radar signal was detected on that channel by either the Channel Availability Check or the In-Service Monitoring.

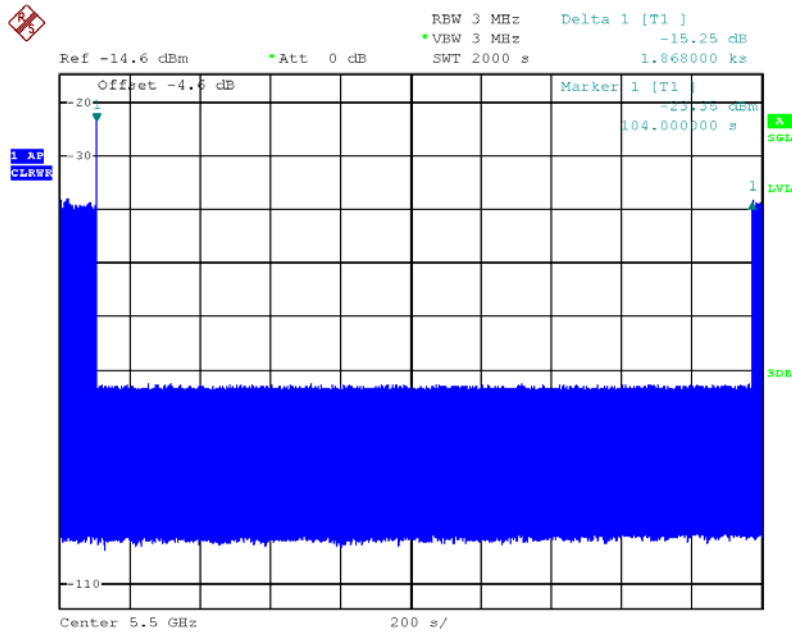

Date: 14.MAY.2012 13:41:51

For 40MHz

Non-Occupancy Period

During the 30 minutes observation time, UUT did not make any transmissions on a channel after a radar signal was detected on that channel by either the Channel Availability Check or the In-Service Monitoring.

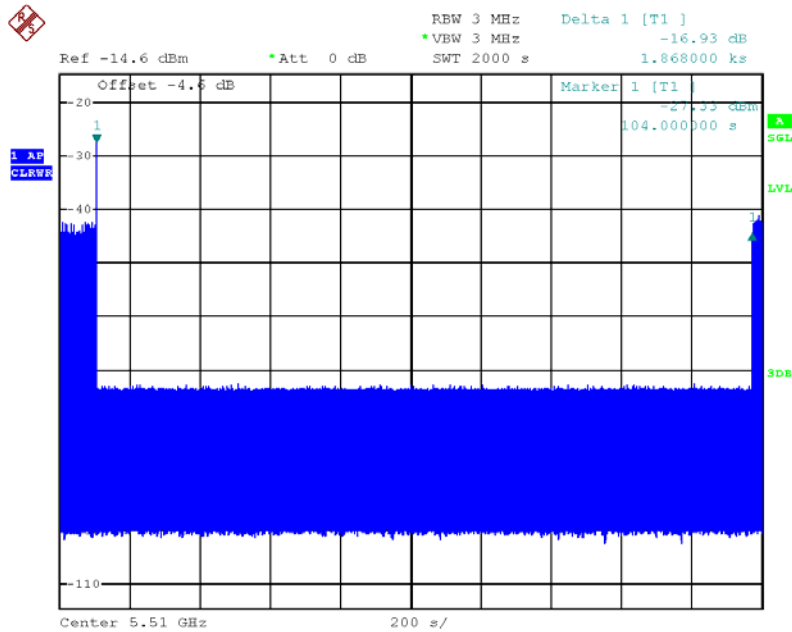

Date: 12.MAY.2012 19:20:05

5.7. Statistical Performance Check Measurement

5.7.1. Limit

The minimum percentage of successful detection requirements found in below table when a radar burst with a level equal to the DFS Detection Threshold + 1dB is generated on the Operating Channel of the U-NII device (In- Service Monitoring).

Radar Type	Minimum Number of Trails	Detection Probability
1	30	Pd > 60%
2	30	Pd > 60%
3	30	Pd > 60%
4	30	Pd > 60%
Aggregate (Radar Types 1-4)	120	Pd > 80%
5	30	Pd > 80%
6	30	Pd > 70%

The percentage of successful detection is calculated by:

$$\frac{\text{TotalWaveformDetections}}{\text{TotalWaveformTrails}} \times 100 = \text{Probability of Detection Radar Waveform}$$

In addition an aggregate

minimum percentage of successful detection across all Short Pulse Radar Types 1-4 is required and is

calculated as follows:
$$\frac{Pd1 + Pd2 + Pd3 + Pd4}{4}$$

5.7.2. Test Procedures

1. Stream the MPEG test file from the Master Device to the Client Device on the test Channel for the entire period of the test.
2. At time T0 the Radar Waveform generator sends the individual waveform for each of the Radar Types 1-6, at levels equal to the DFS Detection Threshold + 1dB, on the Operating Channel.
3. Observe the transmissions of the EUT at the end of the Burst on the Operating Channel for duration greater than 10 seconds for Short Pulse Radar Types 1-4 and 6 to ensure detection occurs.
4. Observe the transmissions of the EUT at the end of the Burst on the Operating Channel for duration greater than 22 seconds for Long Pulse Radar Type 5 to ensure detection occurs.
5. The device can utilize a test mode to demonstrate when detection occurs to prevent the need to reset the device between trial runs.
6. The Minimum number of trails, minimum percentage of successful detection and the average minimum percentage of successful detection are found in below table.

5.7.3. Test Deviation

There is no deviation with the original standard.

5.7.4. Test Result of Statistical Performance Check

For 20MHz

Type 1 Radar Statistical Performance

Trail #	Test Freq. (MHz)	Pulse Width (us)	PRI (us)	Pulses / Burst	1 = Detection 0 = No Detection
1	5493	1	1428	18	1
2	5494	1	1428	18	1
3	5495	1	1428	18	1
4	5496	1	1428	18	1
5	5497	1	1428	18	1
6	5498	1	1428	18	1
7	5499	1	1428	18	1
8	5500	1	1428	18	1
9	5501	1	1428	18	1
10	5502	1	1428	18	1
11	5503	1	1428	18	1
12	5504	1	1428	18	1
13	5505	1	1428	18	1
14	5506	1	1428	18	1
15	5507	1	1428	18	1
16	5506	1	1428	18	1
17	5505	1	1428	18	1
18	5504	1	1428	18	1
19	5503	1	1428	18	1
20	5502	1	1428	18	1
21	5501	1	1428	18	1
22	5500	1	1428	18	1
23	5499	1	1428	18	1
24	5498	1	1428	18	1
25	5497	1	1428	18	1
26	5496	1	1428	18	1
27	5495	1	1428	18	1
28	5494	1	1428	18	1
29	5493	1	1428	18	1
30	5494	1	1428	18	1
Detection Percentage (%)					100.00



Type 2 Radar Statistical Performance

Trail #	Test Freq. (MHz)	Pulse Width (us)	PRI (us)	Pulses / Burst	1 =Detection 0=No Detection
1	5493	2.6	221	23	1
2	5494	4.6	198	27	1
3	5495	1.1	184	29	1
4	5496	4.8	203	24	1
5	5497	2.4	162	25	1
6	5498	3.4	204	28	1
7	5499	2.3	170	27	1
8	5500	3.5	184	23	1
9	5501	4.9	150	27	1
10	5502	4.6	211	29	1
11	5503	2.9	158	23	1
12	5504	2.6	226	27	1
13	5505	1.6	204	26	1
14	5506	3.9	181	25	1
15	5507	4.6	202	24	1
16	5506	4.1	194	27	1
17	5505	2.3	193	28	1
18	5504	3.9	173	29	1
19	5503	4.3	188	23	1
20	5502	1.5	215	26	1
21	5501	4.9	227	27	1
22	5500	1.1	199	23	1
23	5499	4.5	155	29	1
24	5498	4.0	190	27	1
25	5497	2.4	151	23	1
26	5496	2.5	180	28	1
27	5495	2.5	228	23	1
28	5494	2.5	203	25	1
29	5493	1.5	188	25	1
30	5494	1.9	217	24	1
Detection Percentage (%)					100.00

Type 3 Radar Statistical Performance

Trail #	Test Freq. (MHz)	Pulse Width (us)	PRI (us)	Pulses / Burst	1=Detection ; 0=No Detection
1	5493	8.0	205	16	1
2	5494	6.7	382	18	1
3	5495	8.6	418	16	1
4	5496	9.4	351	17	1
5	5497	7.4	383	18	1
6	5498	9.8	232	16	1
7	5499	9.1	377	17	1
8	5500	9.6	457	16	1
9	5501	8.0	471	18	1
10	5502	9.0	304	18	1
11	5503	8.0	316	17	1
12	5504	9.8	325	16	1
13	5505	8.0	409	17	1
14	5506	9.9	200	17	1
15	5507	8.8	458	16	1
16	5506	8.0	232	18	1
17	5505	8.3	250	16	1
18	5504	8.7	270	16	1
19	5503	7.7	350	17	1
20	5502	7.1	230	16	1
21	5501	7.3	416	18	1
22	5500	7.6	498	18	1
23	5499	7.3	286	17	1
24	5498	7.3	287	16	1
25	5497	7.5	462	17	1
26	5496	6.2	300	17	1
27	5495	6.4	323	18	1
28	5494	7.1	420	16	1
29	5493	7.2	395	18	1
30	5494	8.4	377	16	1
Detection Percentage (%)					100.00

Type 4 Radar Statistical Performance

Trail #	Test Freq. (MHz)	Pulse Width (us)	PRI (us)	Pulses / Burst	1=Detection 0=No Detection
1	5493	18.0	242	15	1
2	5494	19.9	279	12	1
3	5495	12.9	487	14	1
4	5496	15.0	452	13	1
5	5497	16.3	230	12	1
6	5498	19.8	238	13	1
7	5499	18.2	420	16	1
8	5500	16.3	452	15	1
9	5501	14.2	495	12	1
10	5502	17.8	228	16	1
11	5503	19.1	211	16	1
12	5504	18.4	283	15	1
13	5505	11.8	411	12	1
14	5506	14.2	284	13	0
15	5507	13.9	202	12	1
16	5506	17.8	340	14	1
17	5505	15.6	290	16	1
18	5504	14.6	250	16	1
19	5503	14.4	484	15	1
20	5502	18.9	387	13	1
21	5501	11.1	348	15	0
22	5500	13.8	291	16	1
23	5499	14.3	295	12	1
24	5498	12.5	300	12	1
25	5497	12.5	322	14	1
26	5496	12.5	383	13	1
27	5495	15.7	322	16	1
28	5494	19.8	469	13	1
29	5493	18.6	406	15	1
30	5494	15.9	238	14	1
Detection Percentage (%)					93.33

Total Type 1~4 Radar Statistical Performance

Radar Type #	Detection Percentage (%)
1	100.00
2	100.00
3	100.00
4	93.33
Total 1~4	98.33

Type 5 Radar Statistical Performance

Trail #	Test Freq. (MHz)	1=Detection 0=No Detection	Trail #	Test Freq. (MHz)	1=Detection 0=No Detection	Trail #	Test Freq. (MHz)	1=Detection 0=No Detection
1	5493	0	11	5503	1	21	5501	1
2	5494	0	12	5504	1	22	5500	1
3	5495	1	13	5505	1	23	5499	1
4	5496	1	14	5506	1	24	5498	1
5	5497	1	15	5507	1	25	5497	1
6	5498	1	16	5506	1	26	5496	1
7	5499	1	17	5505	1	27	5495	1
8	5500	1	18	5504	1	28	5494	0
9	5501	1	19	5503	1	29	5493	0
10	5502	1	20	5502	1	30	5494	0
Detection Percentage (%)						83.33		

**Type 6 Radar Statistical Performance**

Trail #	Test Freq. (MHz)	Pulses / Hop	Pulse Width (us)	PRI (us)	1 = Detection 0 = No Detection
1	5500	9	1	333	1
2	5500	9	1	333	1
3	5500	9	1	333	1
4	5500	9	1	333	1
5	5500	9	1	333	1
6	5500	9	1	333	1
7	5500	9	1	333	1
8	5500	9	1	333	1
9	5500	9	1	333	1
10	5500	9	1	333	1
11	5500	9	1	333	1
12	5500	9	1	333	1
13	5500	9	1	333	1
14	5500	9	1	333	1
15	5500	9	1	333	1
16	5500	9	1	333	1
17	5500	9	1	333	1
18	5500	9	1	333	1
19	5500	9	1	333	1
20	5500	9	1	333	1
21	5500	9	1	333	1
22	5500	9	1	333	1
23	5500	9	1	333	1
24	5500	9	1	333	1
25	5500	9	1	333	1
26	5500	9	1	333	1
27	5500	9	1	333	1
28	5500	9	1	333	1
29	5500	9	1	333	1
30	5500	9	1	333	1
Detection Percentage (%)					100.00

For 40MHz

Type 1 Radar Statistical Performance

Trail #	Test Freq. (MHz)	Pulse Width (us)	PRI (us)	Pulses / Burst	1=Detection 0=No Detection
1	5496	1	1428	18	1
2	5497	1	1428	18	1
3	5498	1	1428	18	1
4	5499	1	1428	18	1
5	5500	1	1428	18	1
6	5501	1	1428	18	1
7	5502	1	1428	18	1
8	5503	1	1428	18	1
9	5504	1	1428	18	1
10	5505	1	1428	18	1
11	5506	1	1428	18	1
12	5507	1	1428	18	1
13	5508	1	1428	18	1
14	5509	1	1428	18	1
15	5510	1	1428	18	1
16	5511	1	1428	18	1
17	5512	1	1428	18	1
18	5513	1	1428	18	1
19	5514	1	1428	18	1
20	5515	1	1428	18	1
21	5516	1	1428	18	1
22	5517	1	1428	18	1
23	5518	1	1428	18	1
24	5519	1	1428	18	1
25	5520	1	1428	18	1
26	5521	1	1428	18	1
27	5522	1	1428	18	1
28	5523	1	1428	18	1
29	5524	1	1428	18	1
30	5525	1	1428	18	1
Detection Percentage (%)					100.00



Type 2 Radar Statistical Performance

Trail #	Test Freq. (MHz)	Pulse Width (us)	PRI (us)	Pulses / Burst	1=Detection 0=No Detection
1	5496	2.6	221	23	1
2	5497	4.6	198	27	1
3	5498	1.1	184	29	1
4	5499	4.8	203	24	1
5	5500	2.4	162	25	1
6	5501	3.4	204	28	0
7	5502	2.3	170	27	1
8	5503	3.5	184	23	1
9	5504	4.9	150	27	1
10	5505	4.6	211	29	1
11	5506	2.9	158	23	1
12	5507	2.6	226	27	1
13	5508	1.6	204	26	1
14	5509	3.9	181	25	1
15	5510	4.6	202	24	1
16	5511	4.1	194	27	1
17	5512	2.3	193	28	0
18	5513	3.9	173	29	1
19	5514	4.3	188	23	1
20	5515	1.5	215	26	1
21	5516	4.9	227	27	1
22	5517	1.1	199	23	1
23	5518	4.5	155	29	1
24	5519	4.0	190	27	1
25	5520	2.4	151	23	1
26	5521	2.5	180	28	1
27	5522	2.5	228	23	1
28	5523	2.5	203	25	1
29	5524	1.5	188	25	1
30	5525	1.9	217	24	1
Detection Percentage (%)					93.33



Type 3 Radar Statistical Performance

Trail #	Test Freq. (MHz)	Pulse Width (us)	PRI (us)	Pulses / Burst	1=Detection 0=No Detection
1	5496	8.0	205	16	1
2	5497	6.7	382	18	1
3	5498	8.6	418	16	1
4	5499	9.4	351	17	1
5	5500	7.4	383	18	0
6	5501	9.8	232	16	1
7	5502	9.1	377	17	1
8	5503	9.6	457	16	1
9	5504	8.0	471	18	1
10	5505	9.0	304	18	1
11	5506	8.0	316	17	1
12	5507	9.8	325	16	1
13	5508	8.0	409	17	1
14	5509	9.9	200	17	0
15	5510	8.8	458	16	0
16	5511	8.0	232	18	1
17	5512	8.3	250	16	1
18	5513	8.7	270	16	0
19	5514	7.7	350	17	1
20	5515	7.1	230	16	1
21	5516	7.3	416	18	1
22	5517	7.6	498	18	1
23	5518	7.3	286	17	1
24	5519	7.3	287	16	1
25	5520	7.5	462	17	1
26	5521	6.2	300	17	1
27	5522	6.4	323	18	1
28	5523	7.1	420	16	1
29	5524	7.2	395	18	1
30	5525	8.4	377	16	1
Detection Percentage (%)					86.67



Type 4 Radar Statistical Performance

Trail #	Test Freq. (MHz)	Pulse Width (us)	PRI (us)	Pulses / Burst	1=Detection 0=No Detection
1	5496	18.0	242	15	1
2	5497	19.9	279	12	1
3	5498	12.9	487	14	1
4	5499	15.0	452	13	1
5	5500	16.3	230	12	1
6	5501	19.8	238	13	1
7	5502	18.2	420	16	1
8	5503	16.3	452	15	1
9	5504	14.2	495	12	1
10	5505	17.8	228	16	0
11	5506	19.1	211	16	1
12	5507	18.4	283	15	1
13	5508	11.8	411	12	1
14	5509	14.2	284	13	1
15	5510	13.9	202	12	1
16	5511	17.8	340	14	1
17	5512	15.6	290	16	1
18	5513	14.6	250	16	1
19	5514	14.4	484	15	1
20	5515	18.9	387	13	1
21	5516	11.1	348	15	1
22	5517	13.8	291	16	1
23	5518	14.3	295	12	1
24	5519	12.5	300	12	1
25	5520	12.5	322	14	1
26	5521	12.5	383	13	0
27	5522	15.7	322	16	1
28	5523	19.8	469	13	1
29	5524	18.6	406	15	1
30	5525	15.9	238	14	1
Detection Percentage (%)					93.33

Total Type 1~4 Radar Statistical Performance

Radar Type #	Detection Percentage (%)
1	100.00
2	93.33
3	86.67
4	93.33
Total 1~4	93.33

Type 5 Radar Statistical Performance

Trail #	Test Freq. (MHz)	1=Detection 0=No Detection	Trail #	Test Freq. (MHz)	1=Detection 0=No Detection	Trail #	Test Freq. (MHz)	1=Detection 0=No Detection
1	5496	1	11	5506	1	21	5516	1
2	5497	1	12	5507	1	22	5517	1
3	5498	1	13	5508	1	23	5518	1
4	5499	1	14	5509	1	24	5519	1
5	5500	1	15	5510	1	25	5520	1
6	5501	1	16	5511	1	26	5521	1
7	5502	1	17	5512	1	27	5522	1
8	5503	1	18	5513	1	28	5523	1
9	5504	1	19	5514	1	29	5524	1
10	5505	1	20	5515	1	30	5525	1
Detection Percentage (%)							100.00	



Type 6 Radar Statistical Performance

Trail #	Test Freq. (MHz)	Pulses / Hop	Pulse Width (us)	PRI (us)	1=Detection 0=No Detection
1	5510	9	1	333	1
2	5510	9	1	333	1
3	5510	9	1	333	1
4	5510	9	1	333	1
5	5510	9	1	333	1
6	5510	9	1	333	1
7	5510	9	1	333	1
8	5510	9	1	333	1
9	5510	9	1	333	1
10	5510	9	1	333	1
11	5510	9	1	333	1
12	5510	9	1	333	1
13	5510	9	1	333	1
14	5510	9	1	333	1
15	5510	9	1	333	1
16	5510	9	1	333	1
17	5510	9	1	333	1
18	5510	9	1	333	1
19	5510	9	1	333	1
20	5510	9	1	333	1
21	5510	9	1	333	1
22	5510	9	1	333	1
23	5510	9	1	333	1
24	5510	9	1	333	1
25	5510	9	1	333	1
26	5510	9	1	333	1
27	5510	9	1	333	1
28	5510	9	1	333	1
29	5510	9	1	333	1
30	5510	9	1	333	1
Detection Percentage (%)					100.00

6. LIST OF MEASURING EQUIPMENTS

Instrument	Manufacturer	Model No.	Serial No.	Characteristics	Calibration Date	Remark
Signal analyzer	R&S	FSV40	100979	9KHz~40GHz	Sep. 26, 2011	Conducted (TH01-CB)
Temp. and Humidity Chamber	Ten Billion	TTH-D3SP	TBN-931011	-30~100 degree	May 20, 2011	Conducted (TH01-CB)
Thermo-Hygro Meter	N/A	HC 520	#1	15~70 degree	Nov. 02, 2011	Conducted (TH01-CB)
Signal Generator	R&S	SMR40	100302	10MHz-40GHz	Nov. 22, 2011	Conducted (TH01-CB)
RF Power Divider	HP	11636A	00306	2GHz ~ 18GHz	N/A	Conducted (TH01-CB)
RF Power Splitter	Anaren	44100	1839	2GHz ~ 18GHz	N/A	Conducted (TH01-CB)
RF Power Splitter	Anaren	42100	17930	2GHz ~ 18GHz	N/A	Conducted (TH01-CB)
Signal generator	R&S	SMU200A	102782	10MHz-40GHz	Jun. 07, 2011	Conducted (TH01-CB)
Horn Antenna	COM-POWER	AH-118	071187	1GHz – 18GHz	Mar. 18, 2012	Conducted (TH01-CB)
Horn Antenna	COM-POWER	AH-118	071042	1GHz – 18GHz	Nov. 01, 2011	Conducted (TH01-CB))
RF Cable-high	Woken	High Cable-7	-	1 GHz – 26.5 GHz	Nov. 17, 2011	Conducted (TH01-CB)
RF Cable-high	Woken	High Cable-8	-	1 GHz – 26.5 GHz	Nov. 17, 2011	Conducted (TH01-CB)
RF Cable-high	Woken	High Cable-9	-	1 GHz – 26.5 GHz	Nov. 17, 2011	Conducted (TH01-CB)
RF Cable-high	Woken	High Cable-10	-	1 GHz – 26.5 GHz	Nov. 17, 2011	Conducted (TH01-CB)
RF Cable-high	Woken	High Cable-11	-	1 GHz – 26.5 GHz	Nov. 17, 2011	Conducted (TH01-CB)
RF Cable-high	Woken	High Cable-12	-	1 GHz – 26.5 GHz	Nov. 17, 2011	Conducted (TH01-CB)
RF Cable-high	Woken	High Cable-13	-	1 GHz – 26.5 GHz	Nov. 17, 2011	Conducted (TH01-CB)
Power Sensor	Anritsu	MA2411B	0917223	300MHz~40GHz	Nov. 01, 2011	Conducted (TH01-CB)
Power Meter	Anritsu	ML2495A	1035008	300MHz~40GHz	Nov. 01, 2011	Conducted (TH01-CB)

Note: Calibration Interval of instruments listed above is one year.

* Calibration Interval of instruments listed above is two year.

NCR means Non-Calibration required.

7. TEST LOCATION

SHIJR	ADD : 6Fl., No. 106, Sec. 1, Shintai 5th Rd., Shijr City, Taipei, Taiwan 221, R.O.C. TEL : 886-2-2696-2468 FAX : 886-2-2696-2255
HWA YA	ADD : No. 52, Hwa Ya 1st Rd., Kwei-Shan Hsiang, Tao Yuan Hsien, Taiwan, R.O.C. TEL : 886-3-327-3456 FAX : 886-3-318-0055
LINKOU	ADD : No. 30-2, Dingfu Tsuen, Linkou Shiang, Taipei, Taiwan 244, R.O.C TEL : 886-2-2601-1640 FAX : 886-2-2601-1695
DUNGHU	ADD : No. 3, Lane 238, Kangle St., Neihu Chiu, Taipei, Taiwan 114, R.O.C. TEL : 886-2-2631-4739 FAX : 886-2-2631-9740
JUNGHE	ADD : 7Fl., No. 758, Jungjeng Rd., Junghe City, Taipei, Taiwan 235, R.O.C. TEL : 886-2-8227-2020 FAX : 886-2-8227-2626
NEIHU	ADD : 4Fl., No. 339, Hsin Hu 2 nd Rd., Taipei 114, Taiwan, R.O.C. TEL : 886-2-2794-8886 FAX : 886-2-2794-9777
JHUBEI	ADD : No.8, Lane 724, Bo-ai St., Jhubei City, HsinChu County 302, Taiwan, R.O.C. TEL : 886-3-656-9065 FAX : 886-3-656-9085

8. MEASUREMENT UNCERTAINTY

Uncertainty of Radiated Emission Measurement

Contribution	Uncertainty of x_i			$u(x_i)$
	Value	Unit	Probability Distribution k	
Receiver reading	±0.165	dB	K=1	0.165
Cable loss	±0.171	dB	K=2	0.086
Antenna gain	±0.182	dB	K=2	0.091
Site imperfection	±0.356	dB	Triangular	0.178
Transmitter antenna	±0.868	dB	Rectangular	0.434
Signal generator	±0.461	dB	Rectangular	0.231
Mismatch	±0.080	dB	U-shape	0.040
Spectrum analyzer	±0.500	dB	Rectangular	0.250
Combined standard uncertainty $U_c(y)$				1.474
Measuring uncertainty for a level of confidence of 95% $U=2U_c(y)$				2.949

Appendix A. Test Photos

1. Photographs of Test Configuration

FRONT VIEW



REAR VIEW

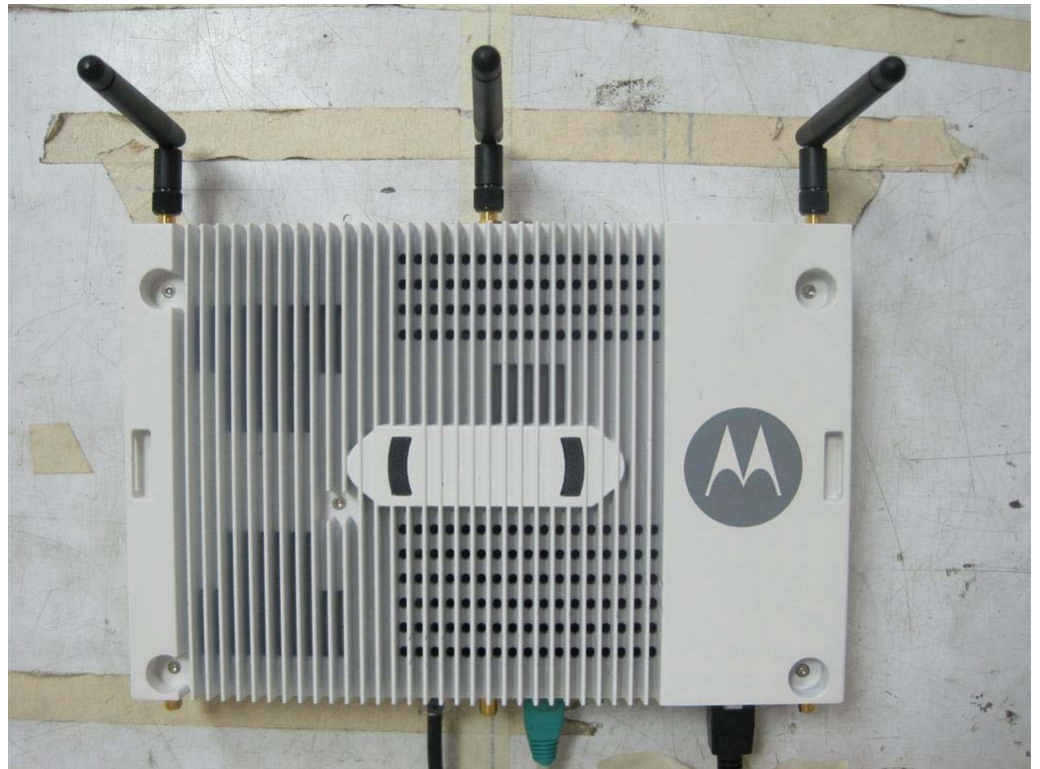

Appendix A. Test Photos

1. Photographs of Test Configuration

FRONT VIEW



REAR VIEW

