



FCC RF Test Report

APPLICANT : Zebra Technologies Corporation
EQUIPMENT : Enhanced Bluetooth Headset
BRAND NAME : Zebra
MODEL NAME : HS3100
MARKETING NAME : HS3100
FCC ID : UZ7HS3100
STANDARD : FCC Part 15 Subpart C §15.247
CLASSIFICATION : (DSS) Spread Spectrum Transmitter

The product was received on May 13, 2016 and testing was completed on Jun. 10, 2016. We, SPORTON INTERNATIONAL INC., would like to declare that the tested sample has been evaluated in accordance with the test procedures and has been in compliance with the applicable technical standards.

The test results in this report apply exclusively to the tested model / sample. Without written approval of SPORTON INTERNATIONAL INC., the test report shall not be reproduced except in full.

Reviewed by: Joseph Lin / Supervisor

Approved by: Jones Tsai / Manager



SPORTON INTERNATIONAL INC.

No. 52, Hwa Ya 1st Rd., Hwa Ya Technology Park, Kwei-Shan District, Tao Yuan City, Taiwan, R.O.C.



TABLE OF CONTENTS

REVISION HISTORY..... 3

SUMMARY OF TEST RESULT 4

1 GENERAL DESCRIPTION..... 5

1.1 Applicant 5

1.2 Manufacturer..... 5

1.3 Product Feature of Equipment Under Test..... 5

1.4 Product Specification of Equipment Under Test..... 6

1.5 Modification of EUT 6

1.6 Testing Location 6

1.7 Applicable Standards..... 7

2 TEST CONFIGURATION OF EQUIPMENT UNDER TEST..... 8

2.1 Descriptions of Test Mode 8

2.2 Test Mode..... 9

2.3 Connection Diagram of Test System..... 10

2.4 Support Unit used in test configuration and system 11

2.5 EUT Operation Test Setup 11

2.6 Measurement Results Explanation Example..... 11

3 TEST RESULT 12

3.1 Number of Channel Measurement 12

3.2 Hopping Channel Separation Measurement 14

3.3 Dwell Time Measurement..... 21

3.4 20dB and 99% Bandwidth Measurement 23

3.5 Peak Output Power Measurement 36

3.6 Conducted Band Edges Measurement..... 38

3.7 Conducted Spurious Emission Measurement 45

3.8 Radiated Band Edges and Spurious Emission Measurement 55

3.9 AC Conducted Emission Measurement..... 61

3.10 Antenna Requirements..... 65

4 LIST OF MEASURING EQUIPMENT..... 66

5 UNCERTAINTY OF EVALUATION..... 67

APPENDIX A. RADIATED SPURIOUS EMISSION

APPENDIX B. RADIATED SPURIOUS EMISSION PLOT

APPENDIX C. SETUP PHOTOGRAPHS



SUMMARY OF TEST RESULT

Report Section	FCC Rule	Description	Limit	Result	Remark
3.1	15.247(a)(1)	Number of Channels	≥ 15Chs	Pass	-
3.2	15.247(a)(1)	Hopping Channel Separation	≥ 2/3 of 20dB BW	Pass	-
3.3	15.247(a)(1)	Dwell Time of Each Channel	≤ 0.4sec in 31.6sec period	Pass	-
3.4	15.247(a)(1)	20dB Bandwidth	NA	Pass	-
3.4	-	99% Bandwidth	-	Pass	-
3.5	15.247(b)(1)	Peak Output Power	≤ 125 mW	Pass	-
3.6	15.247(d)	Conducted Band Edges	≤ 20dBc	Pass	-
3.7	15.247(d)	Conducted Spurious Emission	≤ 20dBc	Pass	-
3.8	15.247(d)	Radiated Band Edges and Radiated Spurious Emission	15.209(a) & 15.247(d)	Pass	Under limit 12.53 dB at 956.600 MHz
3.9	15.207	AC Conducted Emission	15.207(a)	Pass	Under limit 8.90 dB at 0.190 MHz
3.10	15.203 & 15.247(b)	Antenna Requirement	N/A	Pass	-



1 General Description

1.1 Applicant

Zebra Technologies Corporation
1 Zebra Plaza, Holtsville, NY 11742-1300, USA

1.2 Manufacturer

Zebra Technologies Corporation
1 Zebra Plaza, Holtsville, NY 11742-1300, USA

1.3 Product Feature of Equipment Under Test

Product Feature	
Equipment	Enhanced Bluetooth Headset
Brand Name	Zebra
Model Name	HS3100
Marketing Name	HS3100
FCC ID	UZ7HS3100
EUT supports Radios application	Bluetooth v4.0 EDR/LE
HW Version	V2.0
SW Version	V2.0
EUT Stage	Identical Prototype

Remark: The above EUT's information was declared by manufacturer. Please refer to the specifications or user's manual for more detailed description.



1.4 Product Specification of Equipment Under Test

Standards-related Product Specification	
Tx/Rx Frequency Range	2402 MHz ~ 2480 MHz
Number of Channels	79
Carrier Frequency of Each Channel	2402+n*1 MHz; n=0~78
Maximum Output Power to Antenna	Bluetooth BR(1Mbps) : 4.87 dBm (0.0031 W) Bluetooth EDR (2Mbps) : 6.05 dBm (0.0040 W) Bluetooth EDR (3Mbps) : 6.65 dBm (0.0046 W)
99% Occupied Bandwidth	Bluetooth BR(1Mbps) : 0.844MHz Bluetooth EDR (2Mbps) : 1.172MHz Bluetooth EDR (3Mbps) : 1.140MHz
Antenna Type	Monopole Antenna type with gain -1.90 dBi
Type of Modulation	Bluetooth BR (1Mbps) : GFSK Bluetooth EDR (2Mbps) : $\pi/4$ -DQPSK Bluetooth EDR (3Mbps) : 8-DPSK

1.5 Modification of EUT

No modifications are made to the EUT during all test items.

1.6 Testing Location

Sporton Lab is accredited to ISO 17025 by Taiwan Accreditation Foundation (TAF code : 1190) and the FCC designation No. TW1022 under the FCC 2.948(e) by Mutual Recognition Agreement (MRA) in FCC Test.

Test Site	SPORTON INTERNATIONAL INC.		
Test Site Location	No. 52, Hwa Ya 1 st Rd., Hwa Ya Technology Park, Kwei-Shan District, Tao Yuan City, Taiwan, R.O.C. TEL: +886-3-327-3456 FAX: +886-3-328-4978		
Test Site No.	Sporton Site No.		
	TH02-HY	CO05-HY	03CH07-HY

Note: The test site complies with ANSI C63.4 2014 requirement.



1.7 Applicable Standards

According to the specifications of the manufacturer, the EUT must comply with the requirements of the following standards:

- ♦ FCC Part 15 Subpart C §15.247
- ♦ ANSI C63.10-2013

Remark:

1. All test items were verified and recorded according to the standards and without any deviation during the test.
2. This EUT has also been tested and complied with the requirements of FCC Part 15, Subpart B, recorded in a separate test report.

2 Test Configuration of Equipment Under Test

2.1 Descriptions of Test Mode

Preliminary tests were performed in different data rates and recorded the RF output power in the following table:

Channel	Frequency	Bluetooth RF Peak Output Power		
		GFSK / 1Mbps		
		DH1	DH3	DH5
Ch00	2402MHz	4.87 dBm	4.77 dBm	4.76 dBm
Ch39	2441MHz	4.85 dBm	4.84 dBm	4.84 dBm
Ch78	2480MHz	4.82 dBm	4.76 dBm	4.72 dBm

Channel	Frequency	Bluetooth RF Peak Output Power		
		π /4-DQPSK / 2Mbps		
		2DH1	2DH3	2DH5
Ch00	2402MHz	6.05 dBm	6.04 dBm	6.00 dBm
Ch39	2441MHz	6.02 dBm	6.00 dBm	5.98 dBm
Ch78	2480MHz	6.04 dBm	6.03 dBm	6.02 dBm

Channel	Frequency	Bluetooth RF Peak Output Power		
		8-DPSK / 3Mbps		
		3DH1	3DH3	3DH5
Ch00	2402MHz	6.41 dBm	6.35 dBm	6.30 dBm
Ch39	2441MHz	6.42 dBm	6.31 dBm	6.27 dBm
Ch78	2480MHz	6.65 dBm	6.61 dBm	6.64 dBm

Remark: The data rate was set in 3Mbps for all the test items due to the highest RF output power.

- a. The EUT has been associated with peripherals and configuration operated in a manner tended to maximize its emission characteristics in a typical application. Frequency range investigated: conduction (150 kHz to 30 MHz), radiation (9 kHz to the 10th harmonic of the highest fundamental frequency or to 40 GHz, whichever is lower). Pre-scanned tests, X, Y, Z in three orthogonal panels, and different data rates were conducted to determine the final configuration (Y plane as worst plane) from all possible combinations, and the worst mode of radiated spurious emissions is Bluetooth 3Mbps mode, and recorded in this report.
- b. AC power line Conducted Emission was tested under maximum output power.



2.2 Test Mode

The following summary table is showing all test modes to demonstrate in compliance with the standard.

Summary table of Test Cases			
Test Item	Data Rate / Modulation		
	Bluetooth BR 1Mbps GFSK	Bluetooth EDR 2Mbps $\pi/4$ -DQPSK	Bluetooth EDR 3Mbps 8-DPSK
Conducted Test Cases	Mode 1: CH00_2402 MHz	Mode 4: CH00_2402 MHz	Mode 7: CH00_2402 MHz
	Mode 2: CH39_2441 MHz	Mode 5: CH39_2441 MHz	Mode 8: CH39_2441 MHz
	Mode 3: CH78_2480 MHz	Mode 6: CH78_2480 MHz	Mode 9: CH78_2480 MHz
Radiated Test Cases	Bluetooth EDR 3Mbps 8-DPSK		
	Mode 1: CH00_2402 MHz		
	Mode 2: CH39_2441 MHz		
	Mode 3: CH78_2480 MHz		
AC Conducted Emission	Mode 1 :Bluetooth Link + EUT with USB Cable (Charging from Notebook)		
<p>Remark: For radiated test cases, the worst mode data rate 3Mbps was reported only, because this data rate has the highest RF output power at preliminary tests, and the conducted spurious emissions and conducted band edge measurement for each data rate are no worse than 3Mbps, and no other significantly frequencies found in conducted spurious emission.</p>			

2.3 Connection Diagram of Test System

<Bluetooth Tx Mode>



<AC Conducted Emission Mode>

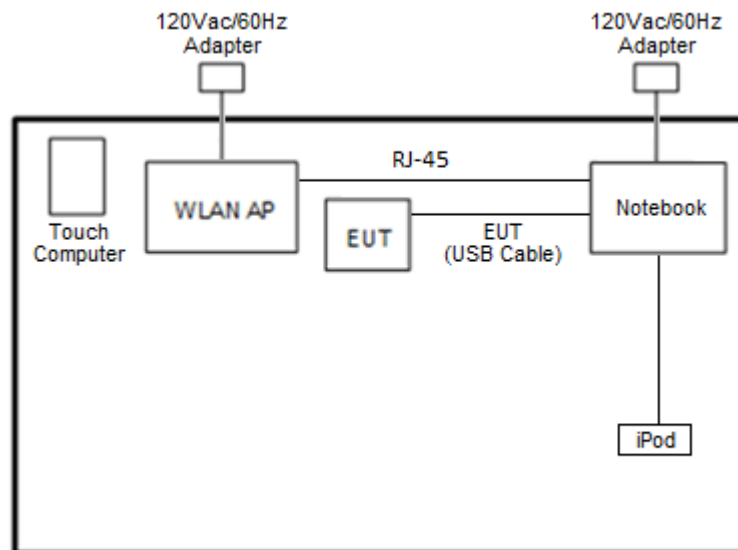



2.4 Support Unit used in test configuration and system

Item	Equipment	Trade Name	Model Name	FCC ID	Data Cable	Power Cord
1.	WLAN AP	D-Link	DIR-628	KA2DIR628A2	N/A	Unshielded, 1.8 m
2.	Notebook	DELL	Latitude E6320	FCC DoC/ Contains FCC ID: QDS-BRCM1054	N/A	AC I/P: Unshielded, 1.2 m DC O/P: Shielded, 1.8 m
3.	iPod	Apple	A1285	FCC DoC	Shielded, 1.0 m	N/A
4.	Touch Computer	Symbol	TC55AH	UZ7TC55AH	N/A	N/A

2.5 EUT Operation Test Setup

For Bluetooth function, programmed RF utility installed in the Notebook make the EUT provide functions like channel selection and power level for continuous transmitting and receiving signals.

2.6 Measurement Results Explanation Example

For all conducted test items:

The offset level is set in the spectrum analyzer to compensate the RF cable loss and attenuator factor between EUT conducted output port and spectrum analyzer. With the offset compensation, the spectrum analyzer reading level is exactly the EUT RF output level.

Example:

The spectrum analyzer offset is derived from RF cable loss and attenuator factor.

Offset = RF cable loss + attenuator factor.

Following shows an offset computation example with cable loss 4.2 dB and 10dB attenuator.

$$\begin{aligned} \text{Offset(dB)} &= \text{RF cable loss(dB)} + \text{attenuator factor(dB)}. \\ &= 4.2 + 10 = 14.2 \text{ (dB)} \end{aligned}$$

3 Test Result

3.1 Number of Channel Measurement

3.1.1 Limits of Number of Hopping Frequency

Frequency hopping systems in the 2400-2483.5 MHz band shall use at least 15 channels.

3.1.2 Measuring Instruments

The measuring equipment is listed in the section 4 of this test report.

3.1.3 Test Procedure

1. The testing follows ANSI C63.10-2013 clause 7.8.3.
2. The RF output of EUT was connected to the spectrum analyzer by RF cable and attenuator. The path loss was compensated to the results for each measurement.
3. Set to the maximum power setting and enable the EUT transmit continuously.
4. Enable the EUT hopping function.
5. Use the following spectrum analyzer settings: Span = the frequency band of operation; RBW = 300kHz; VBW \geq RBW; Sweep = auto; Detector function = peak; Trace = max hold.
6. The number of hopping frequency used is defined as the number of total channel.
7. Record the measurement data derived from spectrum analyzer.

3.1.4 Test Setup

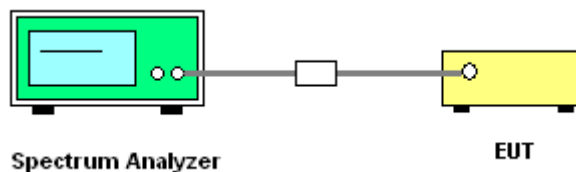

3.1.5 Test Result of Number of Hopping Frequency

Test Mode :	3Mbps	Temperature :	24~26°C
Test Engineer :	AC Chang	Relative Humidity :	48~51%
Number of Hopping (Channel)	Adaptive Frequency Hopping (Channel)	Limits (Channel)	Pass/Fail
79	20	> 15	Pass



Number of Hopping Channel Plot on Channel 00 - 78

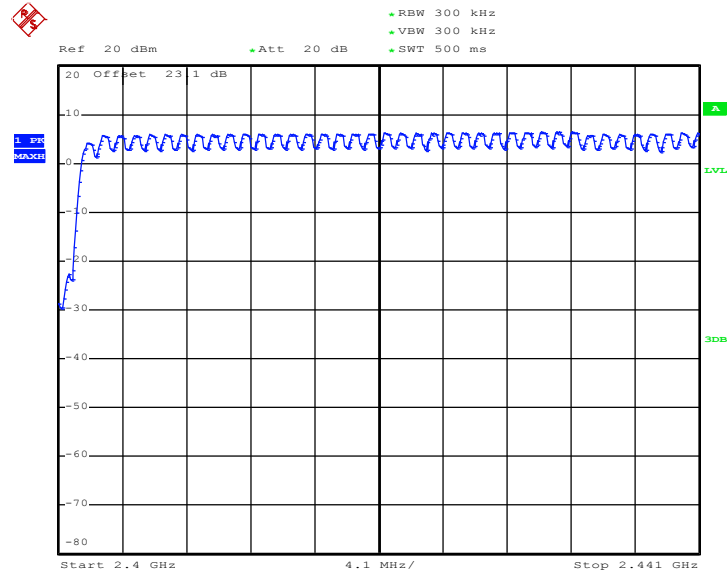

Date: 10.JUN.2016 11:58:17

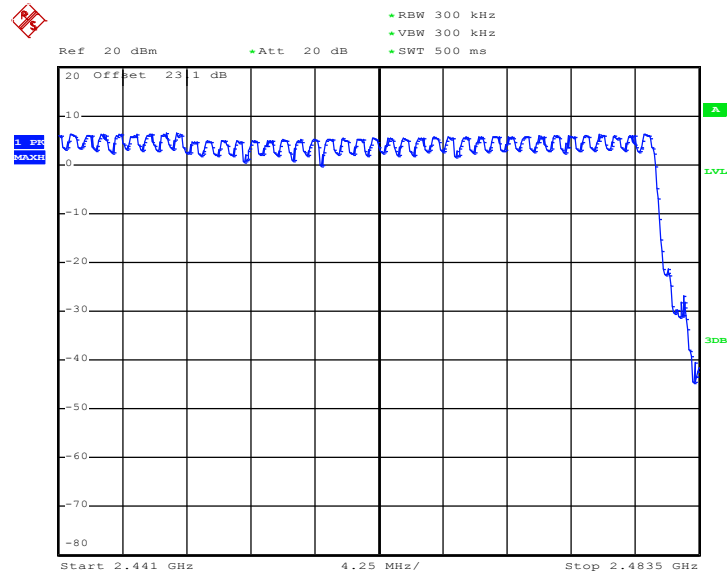

Date: 10.JUN.2016 12:00:07

3.2 Hopping Channel Separation Measurement

3.2.1 Limit of Hopping Channel Separation

Frequency hopping systems operating in the 2400-2483.5 MHz band may have hopping channel carrier frequencies that are separated by 25 kHz or two-thirds of the 20 dB bandwidth of the hopping channel, whichever is greater.

3.2.2 Measuring Instruments

The measuring equipment is listed in the section 4 of this test report.

3.2.3 Test Procedures

1. The testing follows ANSI C63.10-2013 clause 7.8.2.
2. The RF output of EUT was connected to the spectrum analyzer by RF cable and attenuator. The path loss was compensated to the results for each measurement.
3. Set to the maximum power setting and enable the EUT transmit continuously.
4. Enable the EUT hopping function.
5. Use the following spectrum analyzer settings:
Span = wide enough to capture the peaks of two adjacent channels;
RBW = 300kHz; VBW \geq RBW; Sweep = auto; Detector function = peak; Trace = max hold.
6. Measure and record the results in the test report.

3.2.4 Test Setup

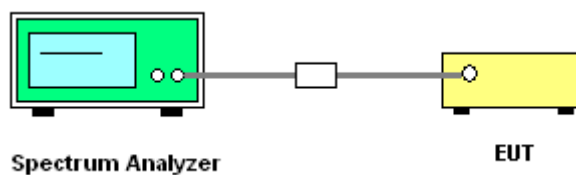



3.2.5 Test Result of Hopping Channel Separation

Test Mode :	1Mbps	Temperature :	24~26°C
Test Engineer :	AC Chang	Relative Humidity :	48~51%

Channel	Frequency (MHz)	Frequency Separation (MHz)	(2/3 of 20dB BW) Limits (MHz)	Pass/Fail
00	2402	1.014	0.5600	Pass
39	2441	0.996	0.5760	Pass
78	2480	1.008	0.5787	Pass

Channel Separation Plot on Channel 00 - 01

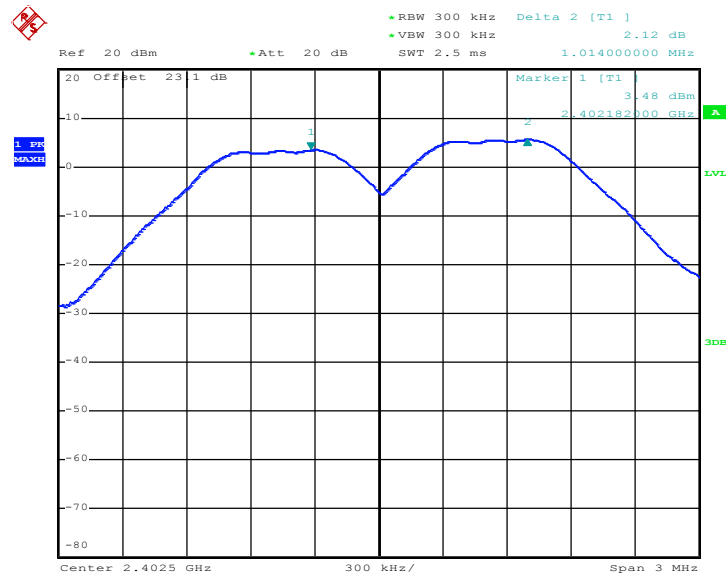

Date: 1.JUN.2016 17:26:15



Channel Separation Plot on Channel 39 - 40

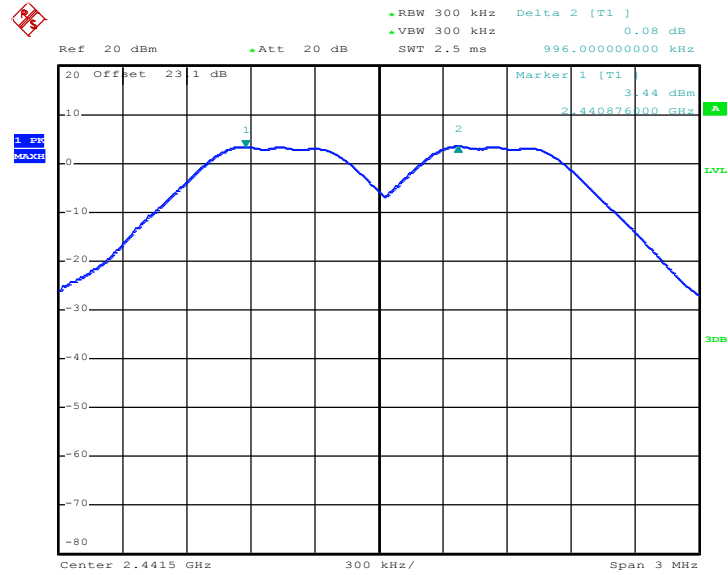

Date: 1.JUN.2016 17:30:13

Channel Separation Plot on Channel 77 - 78

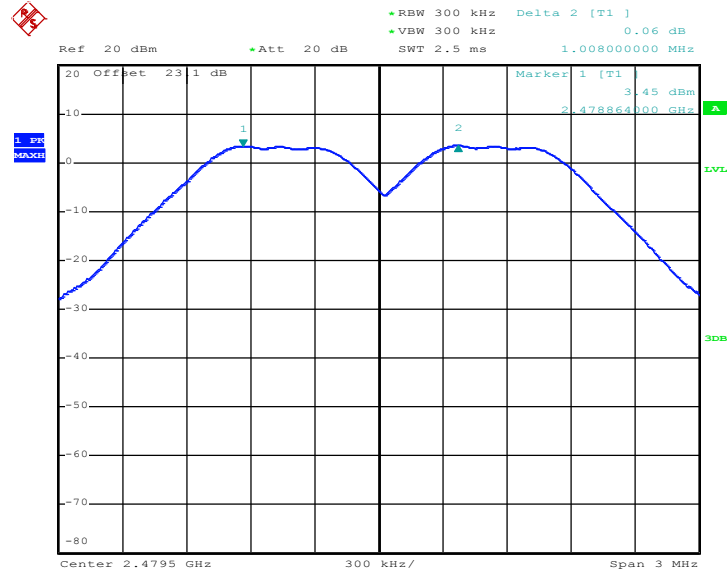

Date: 1.JUN.2016 17:33:20



Test Mode :	2Mbps	Temperature :	24~26°C
Test Engineer :	AC Chang	Relative Humidity :	48~51%

Channel	Frequency (MHz)	Frequency Separation (MHz)	(2/3 of 20dB BW) Limits (MHz)	Pass/Fail
00	2402	0.990	0.8080	Pass
39	2441	0.990	0.8120	Pass
78	2480	0.996	0.8120	Pass

Channel Separation Plot on Channel 00 - 01

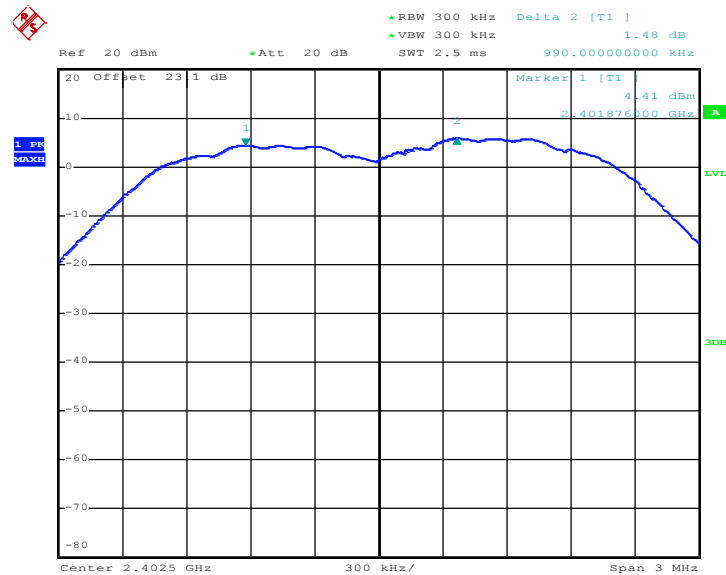

Date: 1.JUN.2016 17:39:16



Channel Separation Plot on Channel 39 - 40

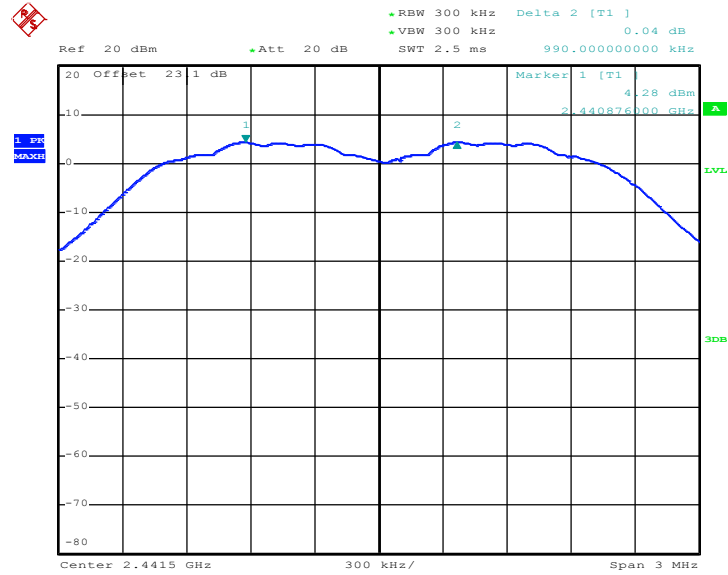

Date: 1.JUN.2016 17:43:29

Channel Separation Plot on Channel 77 - 78

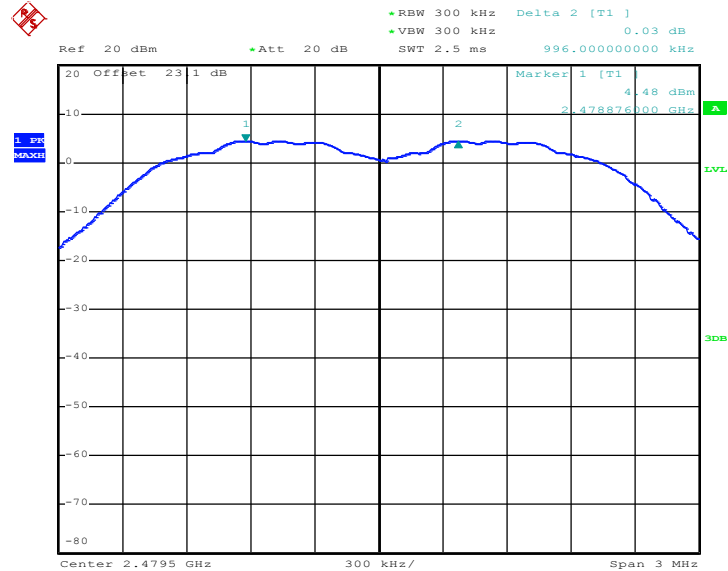

Date: 1.JUN.2016 17:47:07



Test Mode :	3Mbps	Temperature :	24~26°C
Test Engineer :	AC Chang	Relative Humidity :	48~51%

Channel	Frequency (MHz)	Frequency Separation (MHz)	(2/3 of 20dB BW) Limits (MHz)	Pass/Fail
00	2402	1.008	0.8200	Pass
39	2441	1.014	0.8000	Pass
78	2480	1.008	0.8000	Pass

Channel Separation Plot on Channel 00 - 01

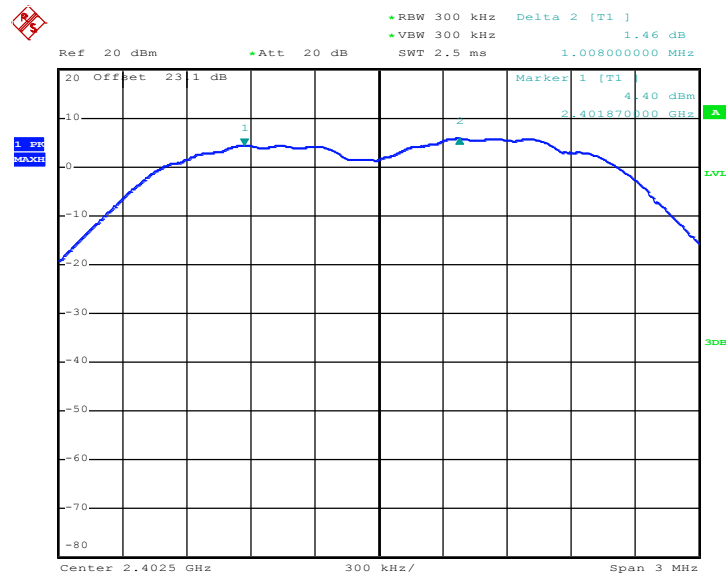

Date: 1.JUN.2016 17:51:29



Channel Separation Plot on Channel 39 - 40

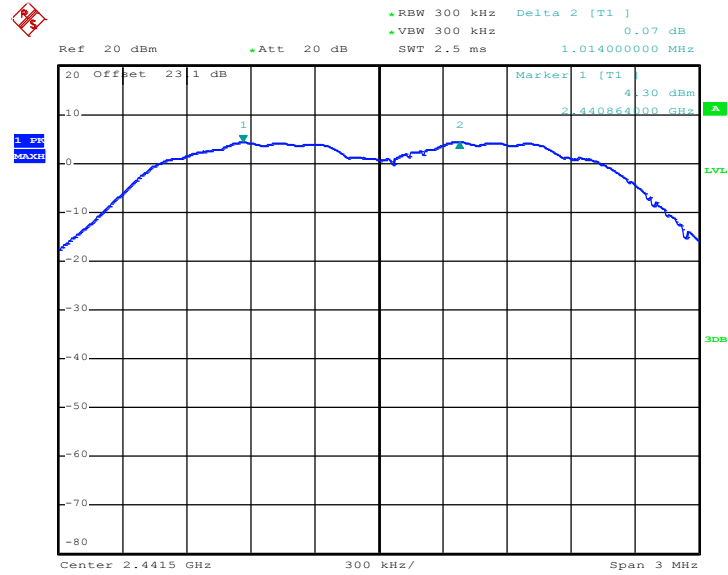

Date: 1.JUN.2016 17:57:38

Channel Separation Plot on Channel 77 - 78

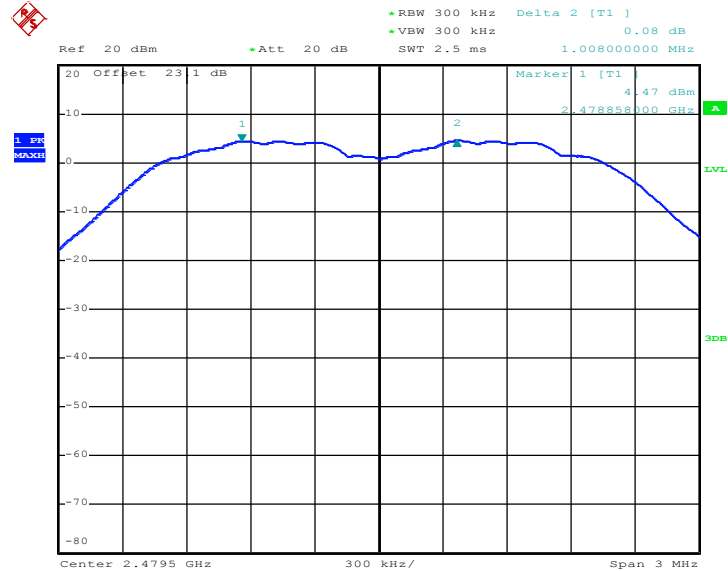

Date: 1.JUN.2016 18:01:34

3.3 Dwell Time Measurement

3.3.1 Limit of Dwell Time

The average time of occupancy on any channel shall not be greater than 0.4 seconds within a period of 0.4 seconds multiplied by the number of hopping channels employed.

3.3.2 Measuring Instruments

The measuring equipment is listed in the section 4 of this test report.

3.3.3 Test Procedures

1. The testing follows ANSI C63.10-2013 clause 7.8.4.
2. The RF output of EUT was connected to the spectrum analyzer by RF cable and attenuator. The path loss was compensated to the results for each measurement.
3. Set to the maximum power setting and enable the EUT transmit continuously.
4. Enable the EUT hopping function.
5. Use the following spectrum analyzer settings: Span = zero span, centered on a hopping channel; RBW = 1 MHz; VBW \geq RBW; Sweep = as necessary to capture the entire dwell time per hopping channel; Detector function = peak; Trace = max hold.
6. Measure and record the results in the test report.

3.3.4 Test Setup

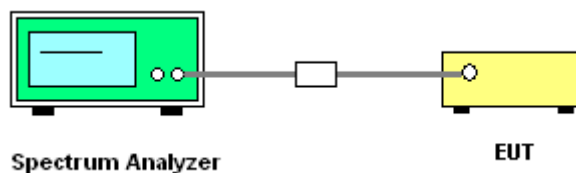



3.3.5 Test Result of Dwell Time

Test Mode :	DH5	Temperature :	24~26°C
Test Engineer :	AC Chang	Relative Humidity :	48~51%

Mode	Hopping Channel Number	Hops Over Occupancy Time(hops)	Package Transfer Time (msec)	Dwell Time (sec)	Limits (sec)	Pass/Fail
Normal	79	106.67	2.92	0.31	0.4	Pass
AFH	20	53.33	2.92	0.16	0.4	Pass

Remark:

- In normal mode, hopping rate is 1600 hops/s with 6 slots in 79 hopping channels.
With channel hopping rate (1600 / 6 / 79) in Occupancy Time Limit (0.4 x 79) (s),
Hops Over Occupancy Time comes to (1600 / 6 / 79) x (0.4 x 79) = 106.67 hops.
- In AFH mode, hopping rate is 800 hops/s with 6 slots in 20 hopping channels.
With channel hopping rate (800 / 6 / 20) in Occupancy Time Limit (0.4 x 20) (s),
Hops Over Occupancy Time comes to (800 / 6 / 20) x (0.4 x 20) = 53.33 hops.
- Dwell Time(s) = Hops Over Occupancy Time (hops) x Package Transfer Time

Package Transfer Time Plot

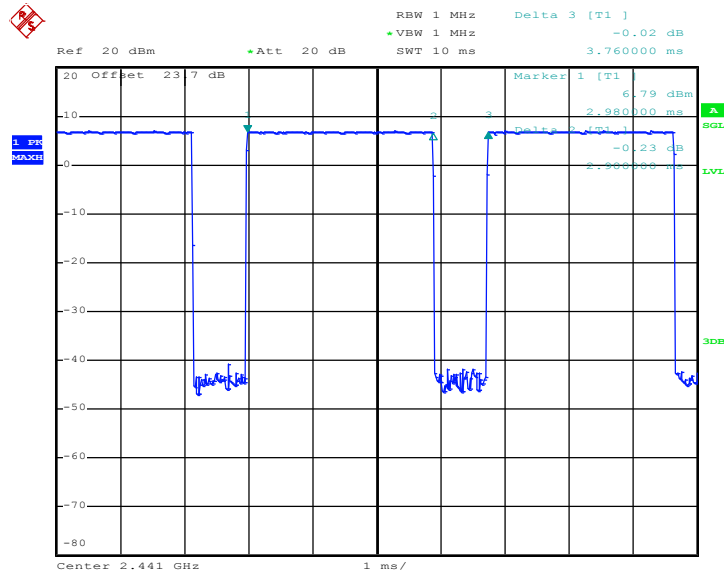

Date: 17.MAY.2016 22:32:49

3.4 20dB and 99% Bandwidth Measurement

3.4.1 Limit of 20dB and 99% Bandwidth

Reporting only

3.4.2 Measuring Instruments

The measuring equipment is listed in the section 4 of this test report.

3.4.3 Test Procedures

1. The testing follows ANSI C63.10-2013 clause 6.9.2 and 6.9.3.
2. The RF output of EUT was connected to the spectrum analyzer by RF cable and attenuator. The path loss was compensated to the results for each measurement.
3. Set to the maximum power setting and enable the EUT transmit continuously.
4. Use the following spectrum analyzer settings for 20dB Bandwidth measurement.
Span = approximately 2 to 5 times the 20 dB bandwidth, centered on a hopping channel;
RBW \geq 1% of the 20 dB bandwidth; VBW \geq RBW; Sweep = auto; Detector function = peak;
Trace = max hold.
5. Use the following spectrum analyzer settings for 99 % Bandwidth measurement.
Span = approximately 1.5 to 5 times the 99% bandwidth, centered on a hopping channel;
RBW \geq 1% of the 99% bandwidth; VBW \geq RBW; Sweep = auto; Detector function = peak;
Trace = max hold.
6. Measure and record the results in the test report.

3.4.4 Test Setup





3.4.5 Test Result of 20dB Bandwidth

Test Mode :	1Mbps	Temperature :	24~26°C
Test Engineer :	AC Chang	Relative Humidity :	48~51%

Channel	Frequency (MHz)	20dB Bandwidth (MHz)
00	2402	0.840
39	2441	0.864
78	2480	0.868

20 dB Bandwidth Plot on Channel 00

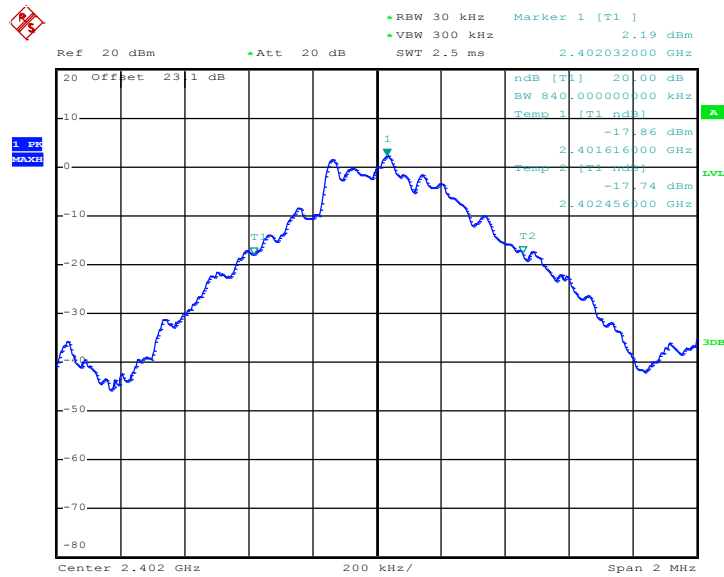

Date: 1.JUN.2016 17:26:39



20 dB Bandwidth Plot on Channel 39

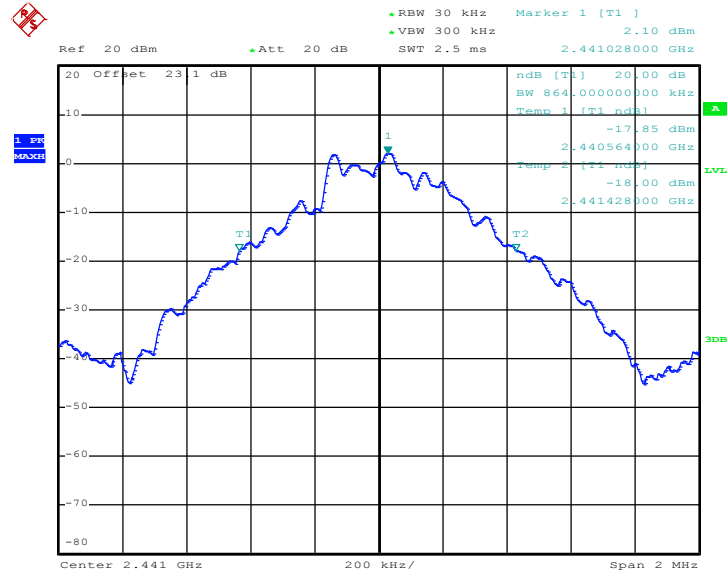

Date: 1.JUN.2016 17:30:40

20 dB Bandwidth Plot on Channel 78

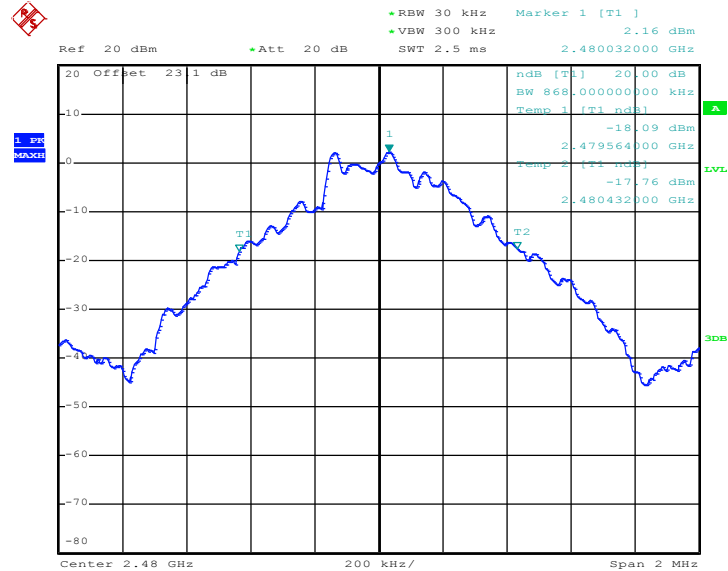

Date: 1.JUN.2016 17:35:32



Test Mode :	2Mbps	Temperature :	24~26°C
Test Engineer :	AC Chang	Relative Humidity :	48~51%

Channel	Frequency (MHz)	20dB Bandwidth (MHz)
00	2402	1.212
39	2441	1.218
78	2480	1.218

20 dB Bandwidth Plot on Channel 00

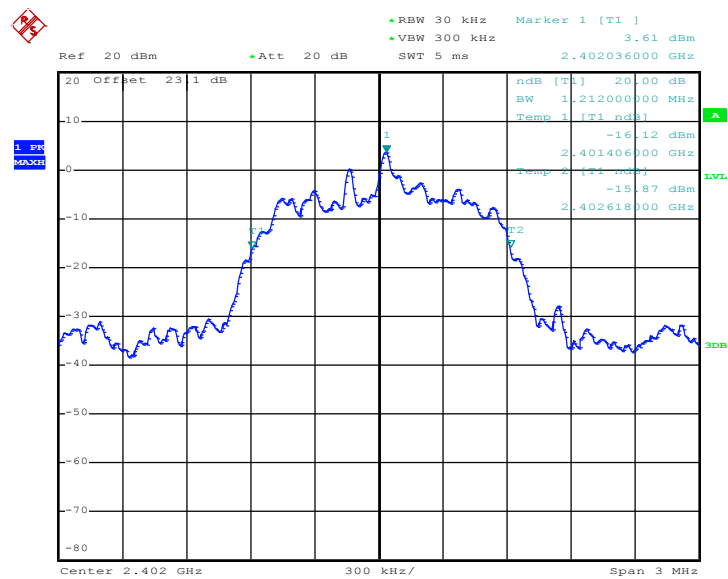

Date: 1.JUN.2016 17:39:52



Test Mode :	3Mbps	Temperature :	24~26°C
Test Engineer :	AC Chang	Relative Humidity :	48~51%

Channel	Frequency (MHz)	20dB Bandwidth (MHz)
00	2402	1.230
39	2441	1.200
78	2480	1.200

20 dB Bandwidth Plot on Channel 00

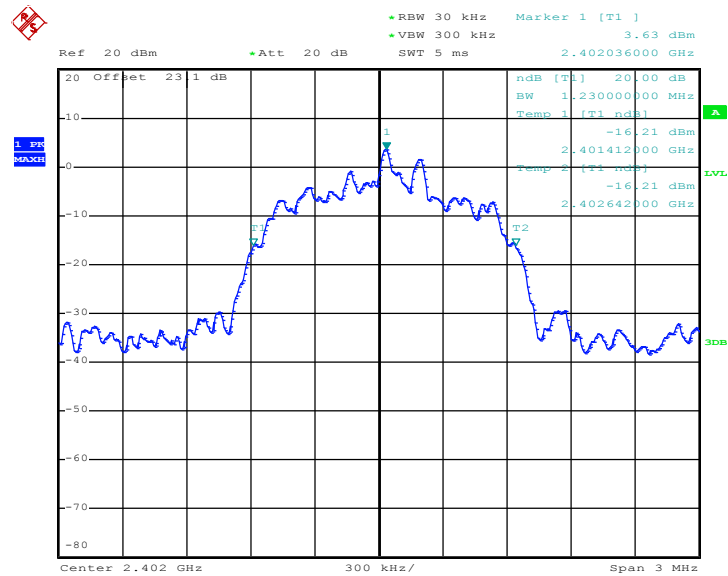

Date: 1.JUN.2016 17:52:39



20 dB Bandwidth Plot on Channel 39

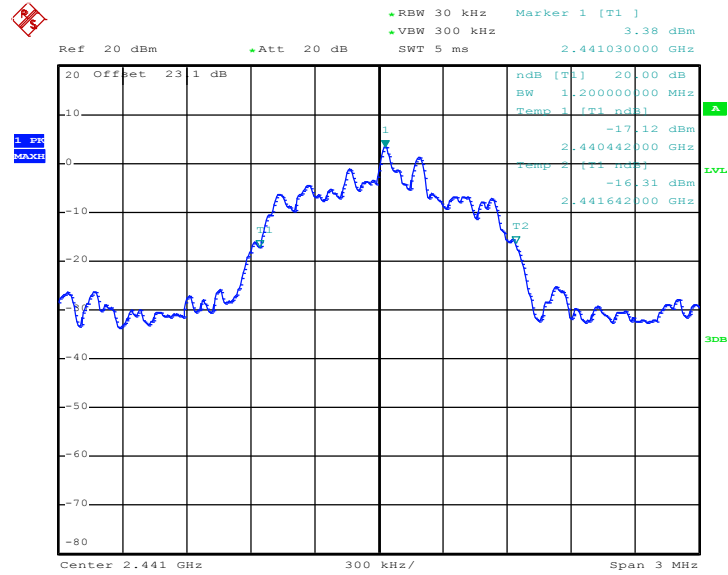

Date: 1.JUN.2016 17:58:22

20 dB Bandwidth Plot on Channel 78

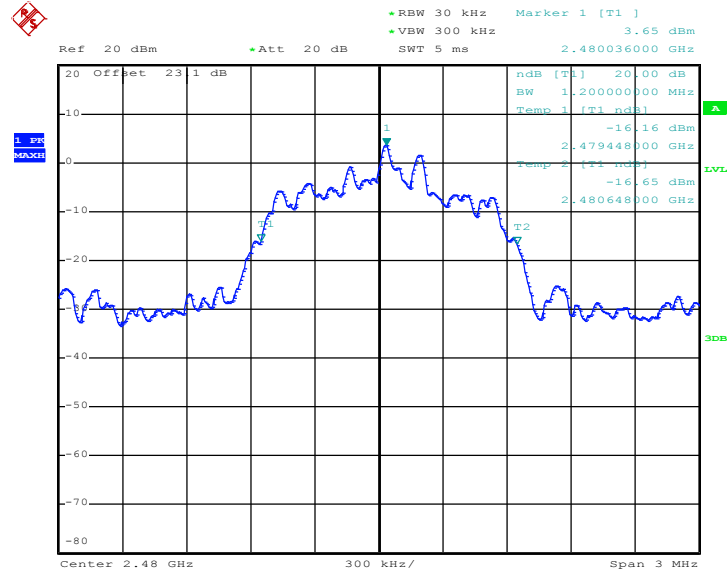

Date: 1.JUN.2016 18:02:10



3.4.6 Test Result of 99% Occupied Bandwidth

Test Mode :	1Mbps	Temperature :	24~26°C
Test Engineer :	AC Chang	Relative Humidity :	48~51%

Channel	Frequency (MHz)	99% Occupied Bandwidth (MHz)
00	2402	0.844
39	2441	0.832
78	2480	0.836

99% Occupied Bandwidth Plot on Channel 00

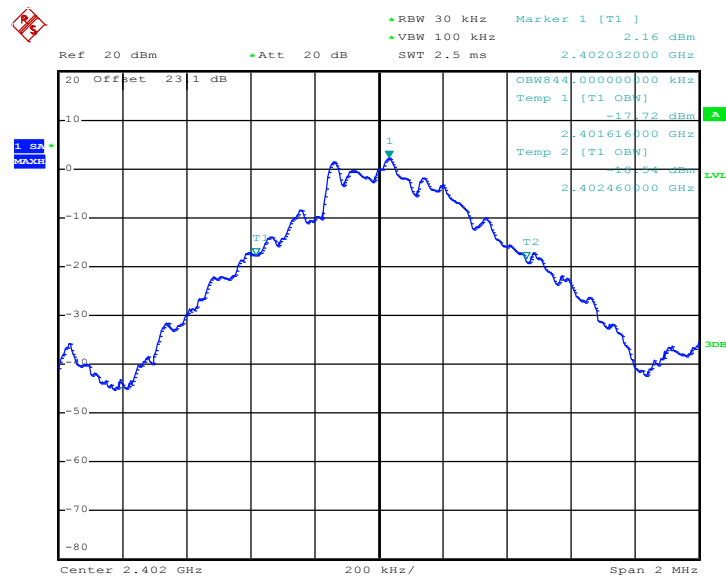

Date: 1.JUN.2016 17:27:43



99% Occupied Bandwidth Plot on Channel 39

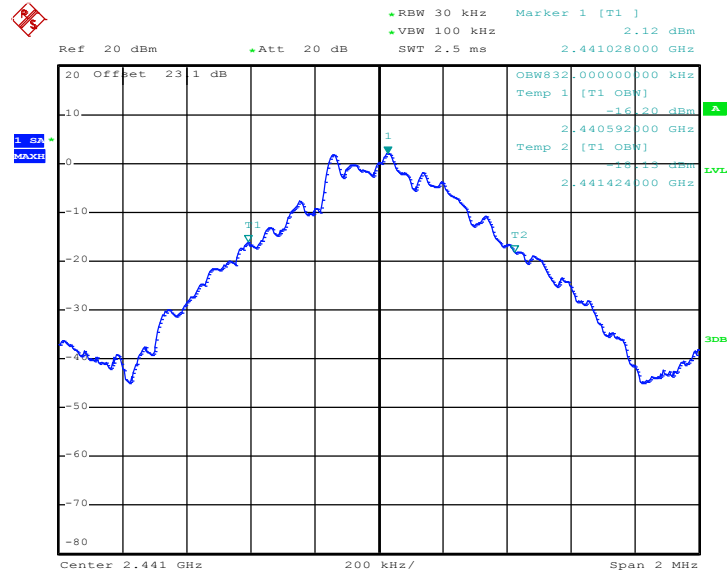

Date: 1.JUN.2016 17:31:26

99% Occupied Bandwidth Plot on Channel 78

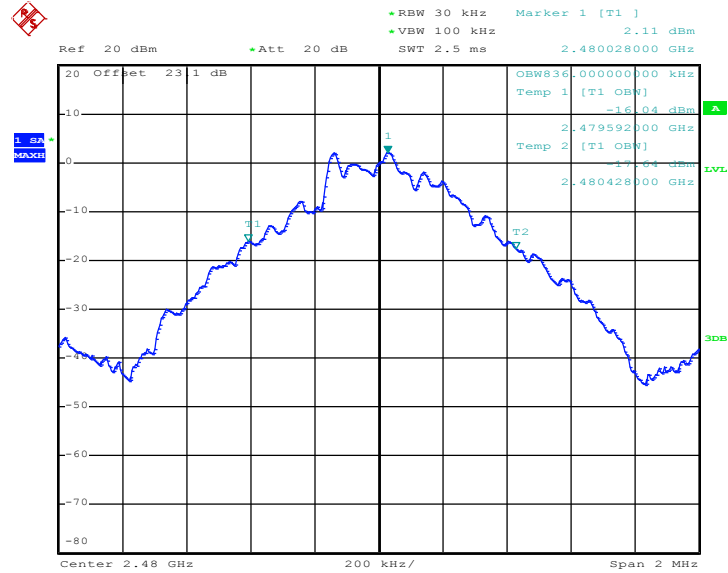

Date: 1.JUN.2016 17:36:11



Test Mode :	2Mbps	Temperature :	24~26°C
Test Engineer :	AC Chang	Relative Humidity :	48~51%

Channel	Frequency (MHz)	99% Occupied Bandwidth (MHz)
00	2402	1.164
39	2441	1.172
78	2480	1.172

99% Occupied Bandwidth Plot on Channel 00

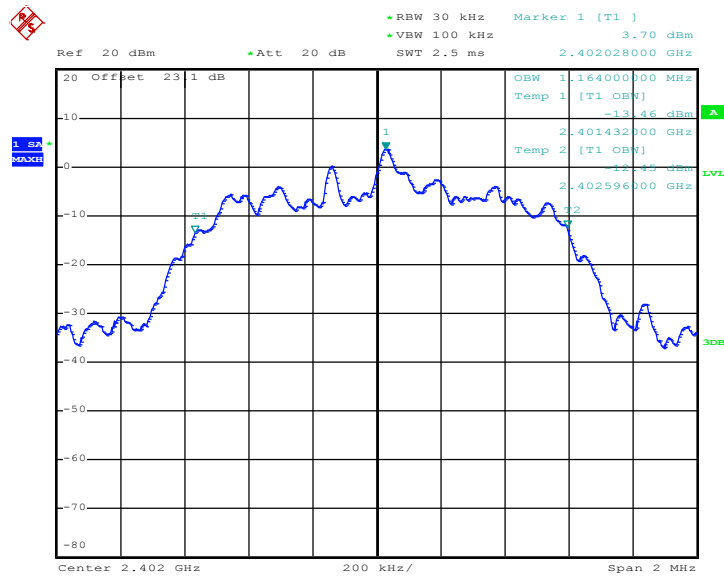

Date: 1.JUN.2016 17:40:44



99% Occupied Bandwidth Plot on Channel 39

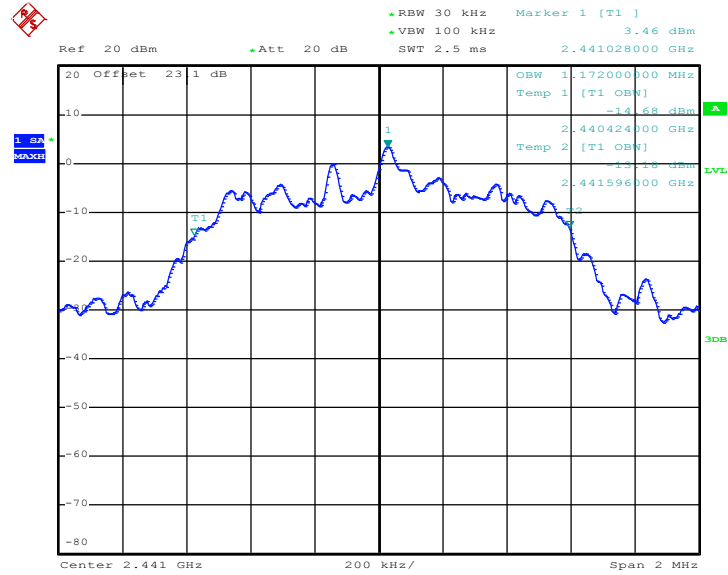

Date: 1.JUN.2016 17:44:45

99% Occupied Bandwidth Plot on Channel 78

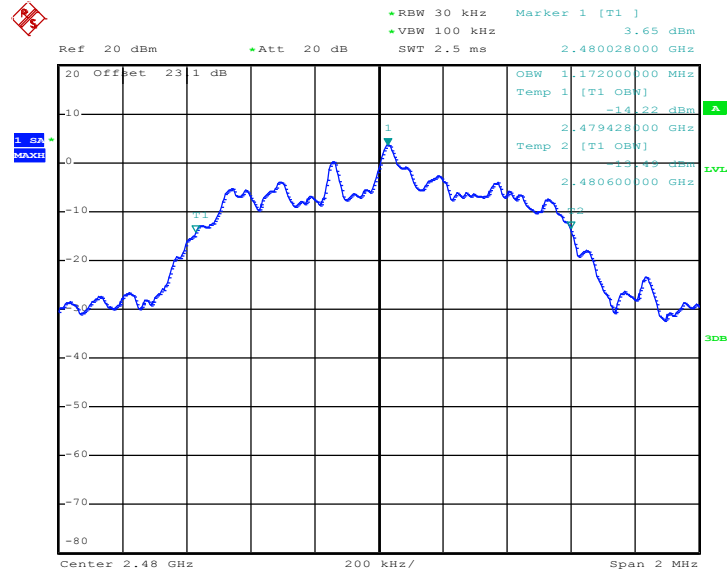

Date: 1.JUN.2016 17:48:27



Test Mode :	3Mbps	Temperature :	24~26°C
Test Engineer :	AC Chang	Relative Humidity :	48~51%

Channel	Frequency (MHz)	99% Occupied Bandwidth (MHz)
00	2402	1.128
39	2441	1.140
78	2480	1.140

99% Occupied Bandwidth Plot on Channel 00

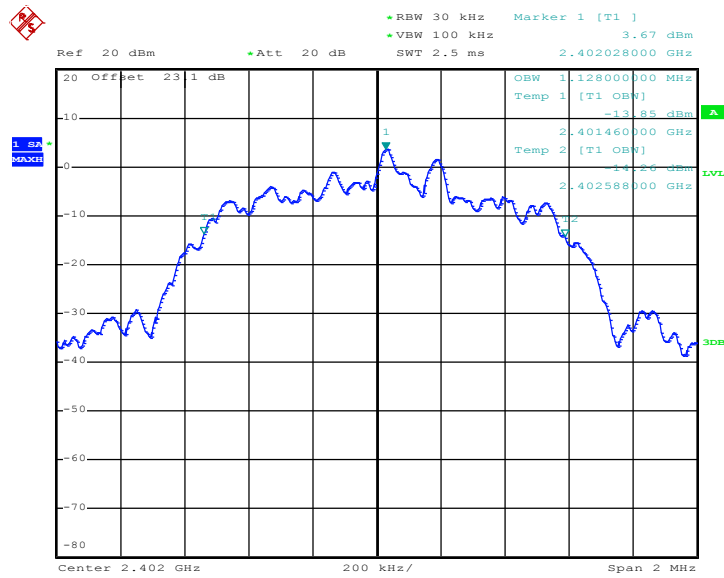

Date: 1.JUN.2016 17:53:39



99% Occupied Bandwidth Plot on Channel 39

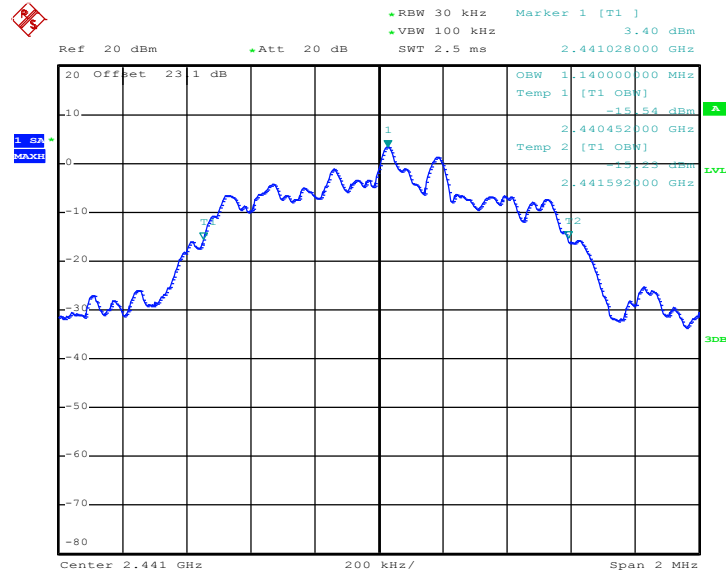

Date: 1.JUN.2016 17:59:11

99% Occupied Bandwidth Plot on Channel 78

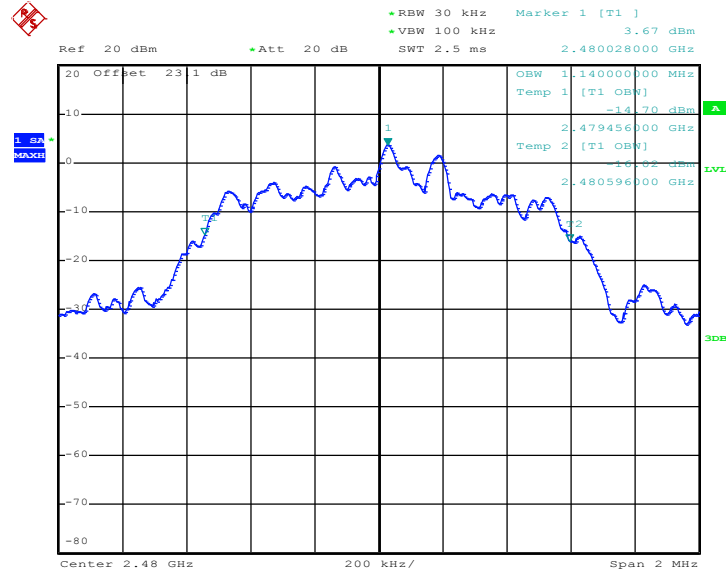

Date: 1.JUN.2016 18:02:55

Note: The occupied channel bandwidth is maintained within the band of operation for all of the modulations.

3.5 Peak Output Power Measurement

3.5.1 Limit of Peak Output Power

Section 15.247 (b) The maximum peak conducted output power of the intentional radiator shall not exceed the following: (1) For frequency hopping systems operating in the 2400-2483.5 MHz band employing at least 75 non-overlapping hopping channels, and all frequency hopping systems in the 5725-5850 MHz band: 1 watt. For all other frequency hopping systems in the 2400-2483.5 MHz band 0.125 watts. The power limit for 1Mbps is 1watt, and for 2Mbps, 3Mbps and AFH are 0.125 watts.

3.5.2 Measuring Instruments

The measuring equipment is listed in the section 4 of this test report.

3.5.3 Test Procedures

1. The testing follows ANSI C63.10-2013 clause 7.8.5.
2. The RF output of EUT was connected to the power meter by RF cable and attenuator. The path loss was compensated to the results for each measurement.
3. Set to the maximum power setting and enable the EUT transmit continuously.
4. Measure the conducted output power with cable loss and record the results in the test report.
5. Measure and record the results in the test report.

3.5.4 Test Setup

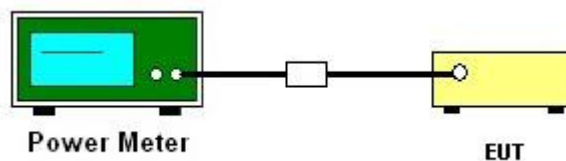



3.5.5 Test Result of Peak Output Power

Test Mode :	1Mbps	Temperature :	24~26°C
Test Engineer :	AC Chang	Relative Humidity :	48~51%

Channel	Frequency (MHz)	RF Power (dBm)		
		GFSK	Max. Limits (dBm)	Pass/Fail
		1 Mbps		
00	2402	4.87	20.97	Pass
39	2441	4.85	20.97	Pass
78	2480	4.82	20.97	Pass

Note: For AFH mode using 20 hopping channels, the maximum output power limit is 20.97dBm.

Test Mode :	2Mbps	Temperature :	24~26°C
Test Engineer :	AC Chang	Relative Humidity :	48~51%

Channel	Frequency (MHz)	RF Power (dBm)		
		$\pi/4$ -DQPSK	Max. Limits (dBm)	Pass/Fail
		2 Mbps		
00	2402	6.05	20.97	Pass
39	2441	6.02	20.97	Pass
78	2480	6.04	20.97	Pass

Test Mode :	3Mbps	Temperature :	24~26°C
Test Engineer :	AC Chang	Relative Humidity :	48~51%

Channel	Frequency (MHz)	RF Power (dBm)		
		8-DPSK	Max. Limits (dBm)	Pass/Fail
		3 Mbps		
00	2402	6.41	20.97	Pass
39	2441	6.42	20.97	Pass
78	2480	6.65	20.97	Pass

3.6 Conducted Band Edges Measurement

3.6.1 Limit of Band Edges

In any 100 kHz bandwidth outside the intentional radiation frequency band, the radio frequency power shall be at least 20 dB below the highest level of the radiated power. In addition, radiated emissions which fall in the restricted bands must also comply with the radiated emission limits.

3.6.2 Measuring Instruments

The measuring equipment is listed in the section 4 of this test report.

3.6.3 Test Procedures

1. The testing follows ANSI C63.10-2013 clause 7.8.6.
2. Set to the maximum power setting and enable the EUT transmit continuously.
3. Set RBW = 100kHz, VBW = 300kHz. Band edge emissions must be at least 20 dB down from the highest emission level within the authorized band as measured with a 100kHz RBW. The attenuation shall be 30 dB instead of 20 dB when RMS conducted output power procedure is used.
4. Enable hopping function of the EUT and then repeat step 2. and 3.
5. Measure and record the results in the test report.

3.6.4 Test Setup

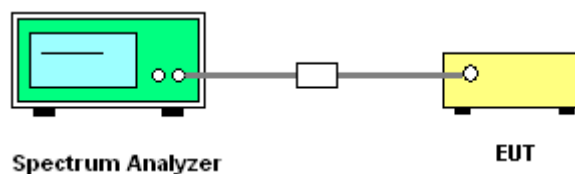



3.6.5 Test Result of Conducted Band Edges

Test Mode :	1Mbps	Temperature :	24~26°C
Test Channel :	00 and 78	Relative Humidity :	48~51%
		Test Engineer :	AC Chang

Low Band Edge Plot on Channel 00

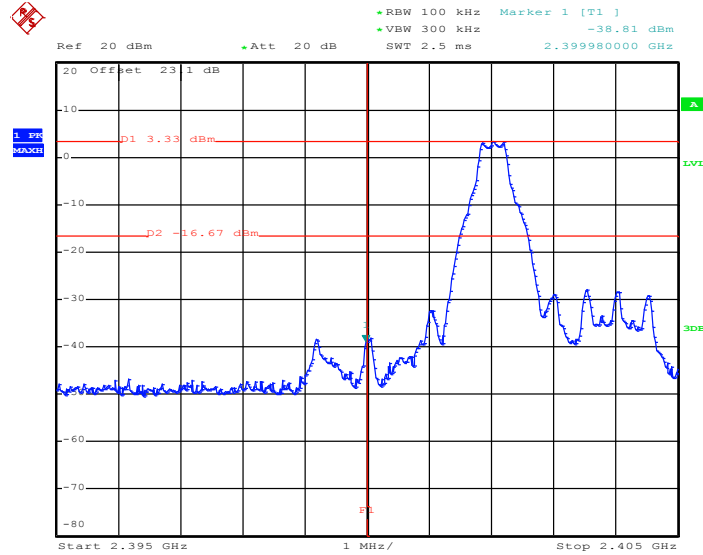

Date: 1.JUN.2016 18:25:13

High Band Edge Plot on Channel 78

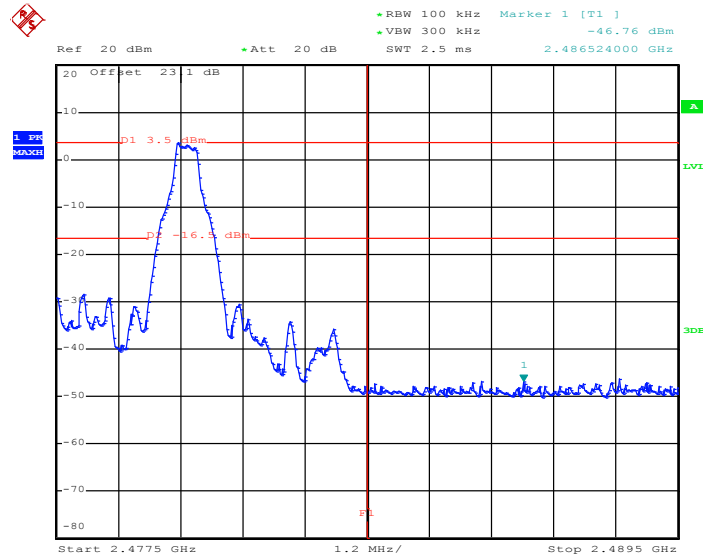

Date: 1.JUN.2016 18:25:45



Test Mode :	2Mbps	Temperature :	24~26°C
Test Channel :	00 and 78	Relative Humidity :	48~51%
		Test Engineer :	AC Chang

Low Band Edge Plot on Channel 00

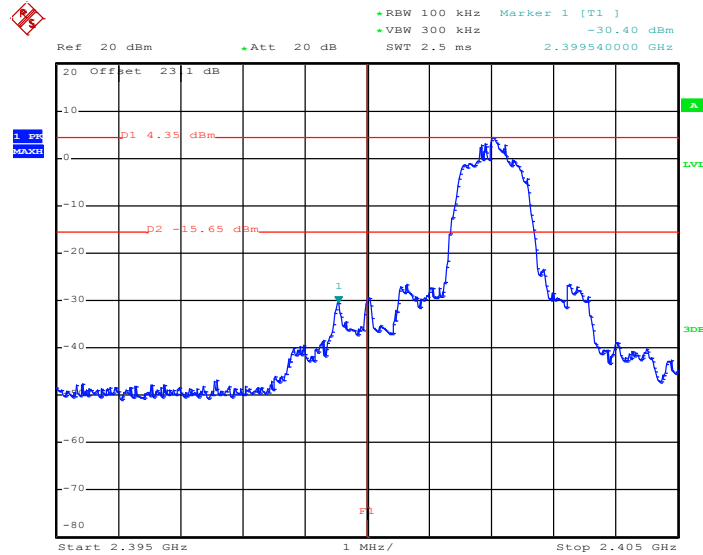

Date: 1.JUN.2016 18:28:50

High Band Edge Plot on Channel 78

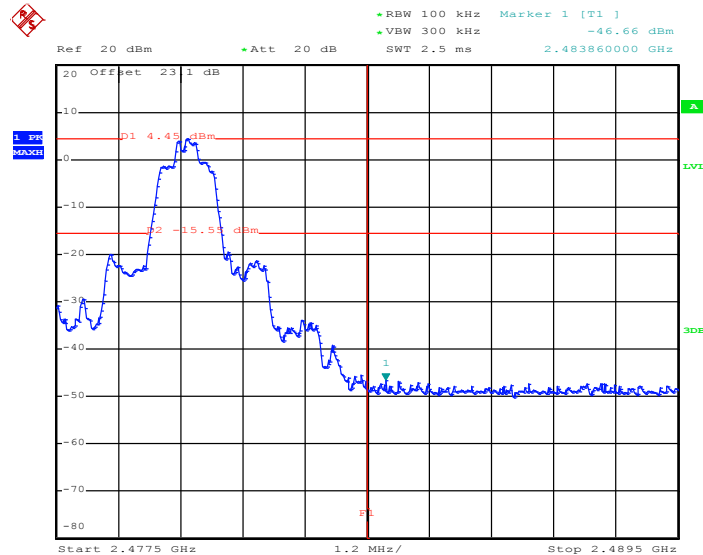

Date: 1.JUN.2016 18:29:30



Test Mode :	3Mbps	Temperature :	24~26°C
Test Channel :	00 and 78	Relative Humidity :	48~51%
		Test Engineer :	AC Chang

Low Band Edge Plot on Channel 00

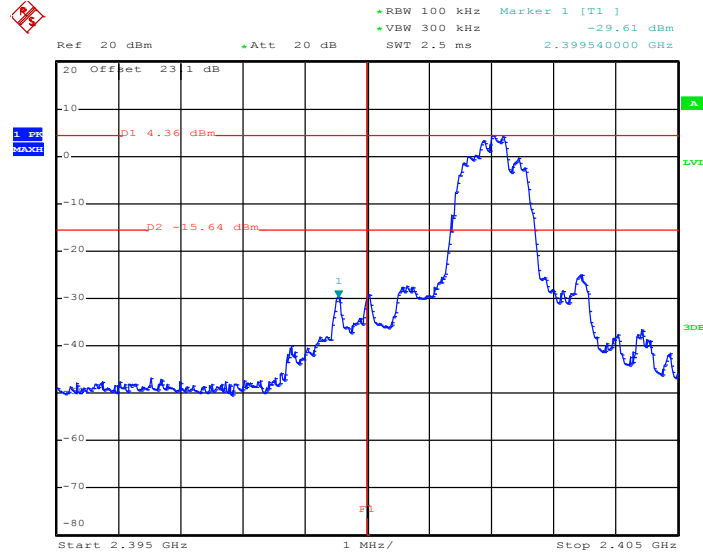

Date: 1.JUN.2016 18:30:40

High Band Edge Plot on Channel 78

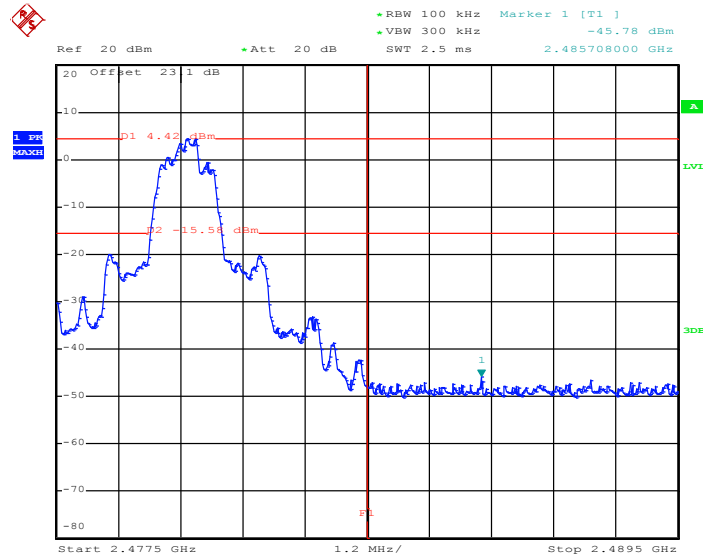

Date: 1.JUN.2016 18:31:13



3.6.6 Test Result of Conducted Hopping Mode Band Edges

Test Mode :	1Mbps	Temperature :	24~26°C
Test Engineer :	AC Chang	Relative Humidity :	48~51%

1Mbps Hopping Mode Low Band Edge Plot

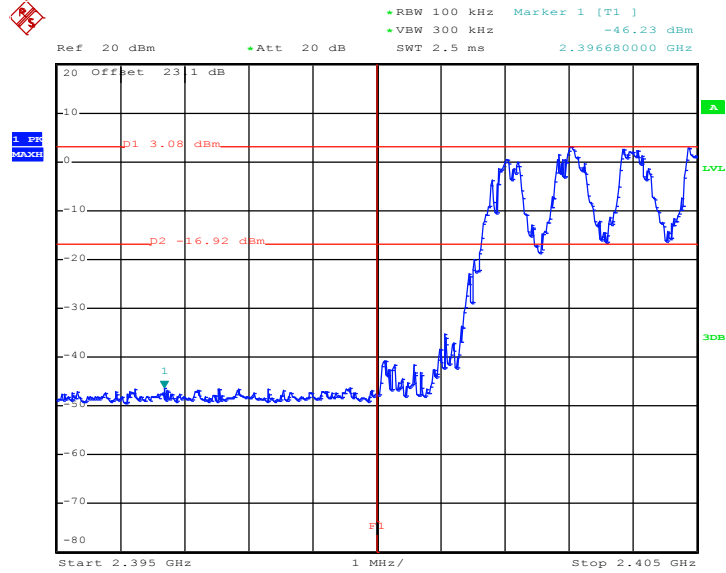

Date: 1.JUN.2016 18:16:40

1Mbps Hopping Mode High Band Edge Plot

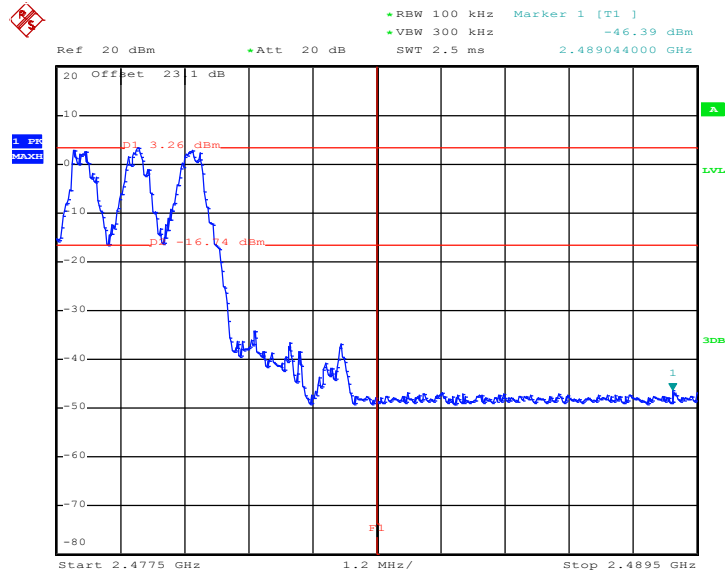

Date: 1.JUN.2016 18:17:38



Test Mode :	2Mbps	Temperature :	24~26°C
Test Engineer :	AC Chang	Relative Humidity :	48~51%

2Mbps Hopping Mode Low Band Edge Plot

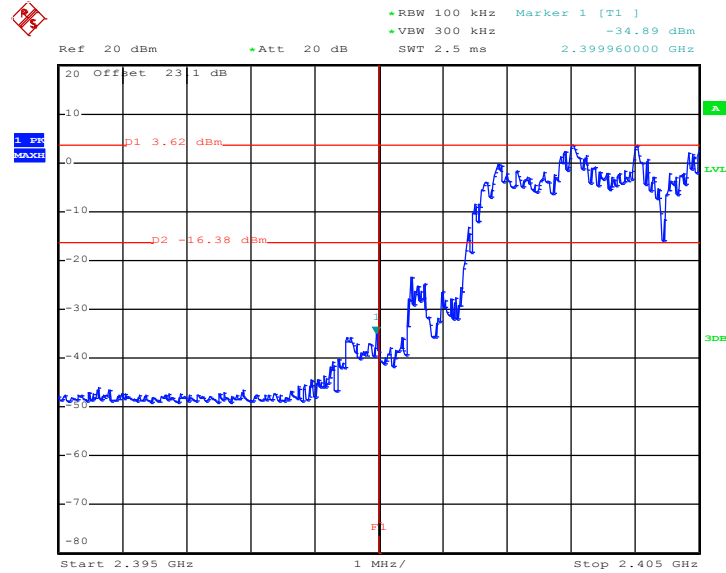

Date: 1.JUN.2016 18:19:47

2Mbps Hopping Mode High Band Edge Plot

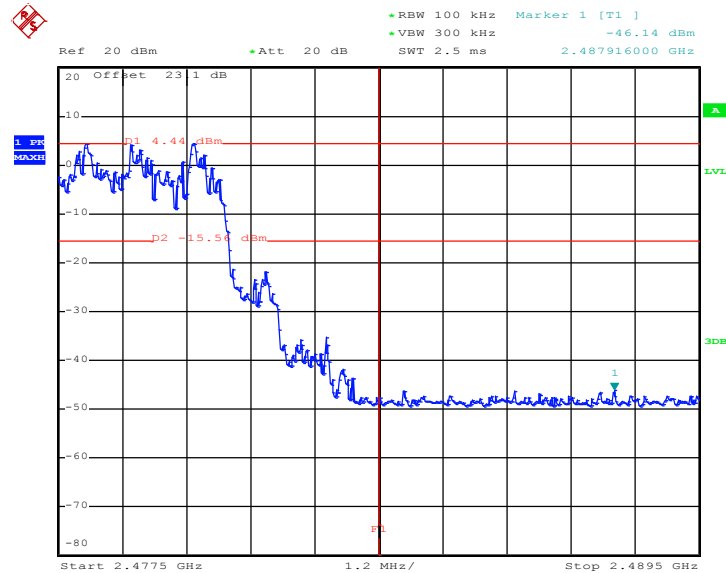

Date: 1.JUN.2016 18:20:38



Test Mode :	3Mbps	Temperature :	24~26°C
Test Engineer :	AC Chang	Relative Humidity :	48~51%

3Mbps Hopping Mode Low Band Edge Plot

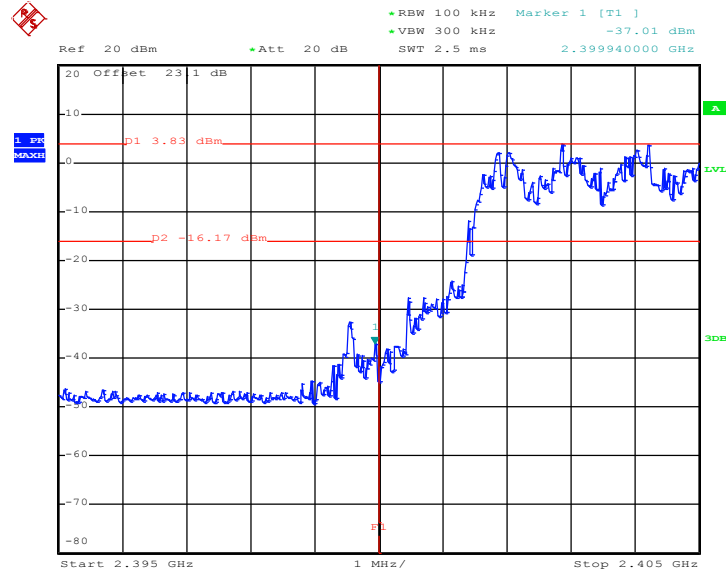

Date: 1.JUN.2016 18:22:40

3Mbps Hopping Mode High Band Edge Plot

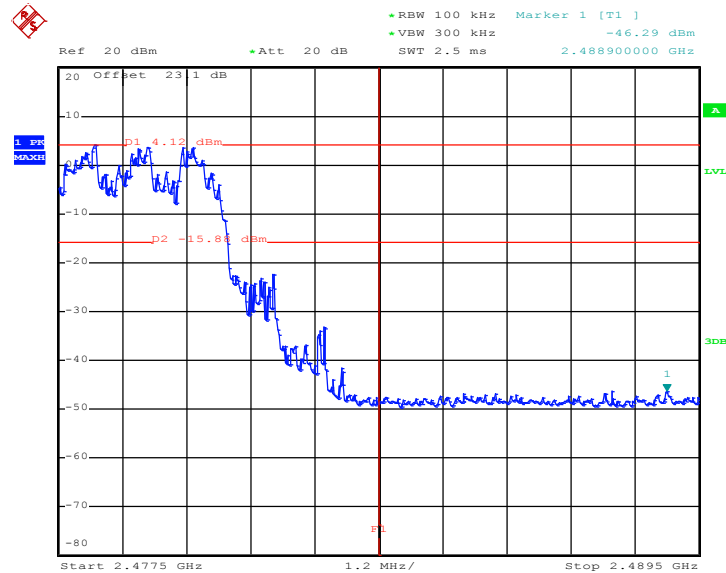

Date: 1.JUN.2016 18:23:29

3.7 Conducted Spurious Emission Measurement

3.7.1 Limit of Spurious Emission Measurement

In any 100 kHz bandwidth outside the intentional radiation frequency band, the radio frequency power shall be at least 20 dB below the highest level of the radiated power. In addition, radiated emissions which fall in the restricted bands must also comply with the radiated emission limits.

3.7.2 Measuring Instruments

The measuring equipment is listed in the section 4 of this test report.

3.7.3 Test Procedure

1. The testing follows ANSI C63.10-2013 clause 7.8.8.
2. The RF output of EUT was connected to the spectrum analyzer by RF cable and attenuator. The path loss was compensated to the results for each measurement.
3. Set to the maximum power setting and enable the EUT transmit continuously.
4. Set RBW = 100 kHz, VBW = 300kHz, scan up through 10th harmonic. All harmonics / spurs must be at least 20 dB down from the highest emission level within the authorized band as measured with a 100 kHz RBW.
5. Measure and record the results in the test report.
6. The RF fundamental frequency should be excluded against the limit line in the operating frequency band.

3.7.4 Test Setup

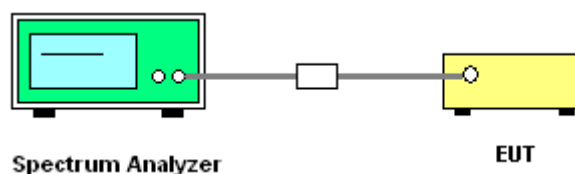



3.7.5 Test Result of Conducted Spurious Emission

Test Mode :	1Mbps	Temperature :	24~26°C
Test Channel :	00	Relative Humidity :	48~51%
		Test Engineer :	AC Chang

1Mbps CSE Plot on Ch 00 between 30MHz ~ 3 GHz

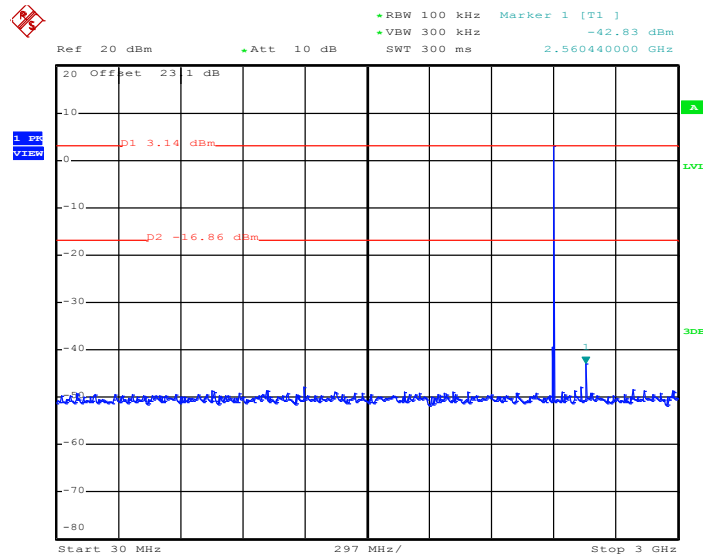

Date: 1.JUN.2016 17:28:28

1Mbps CSE Plot on Ch 00 between 2 GHz ~ 25 GHz

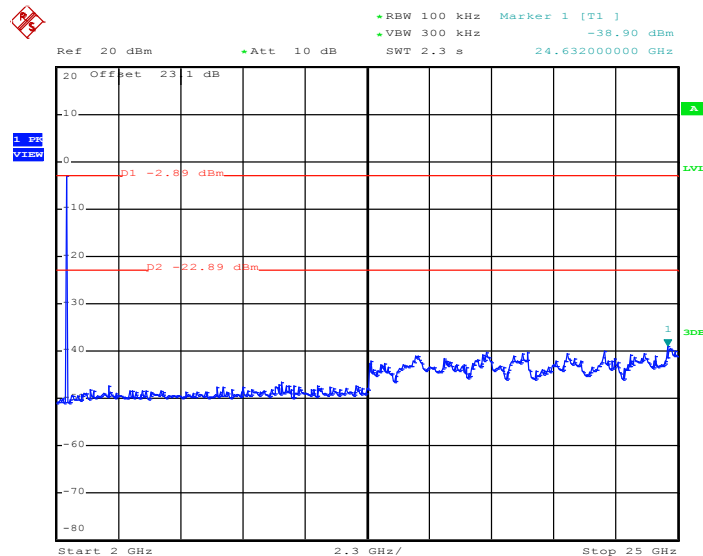

Date: 1.JUN.2016 17:28:49



Test Mode :	1Mbps	Temperature :	24~26°C
Test Channel :	39	Relative Humidity :	48~51%
		Test Engineer :	AC Chang

1Mbps CSE Plot on Ch 39 between 30MHz ~ 3 GHz

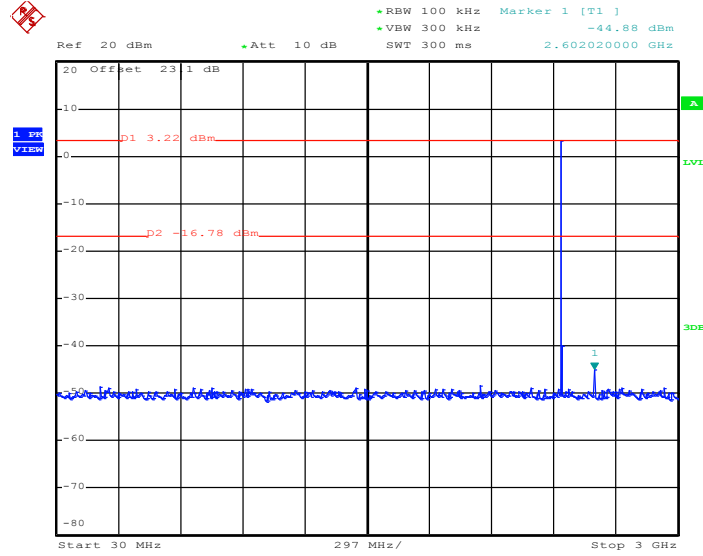

Date: 1.JUN.2016 17:31:48

1Mbps CSE Plot on Ch 39 between 2 GHz ~ 25 GHz

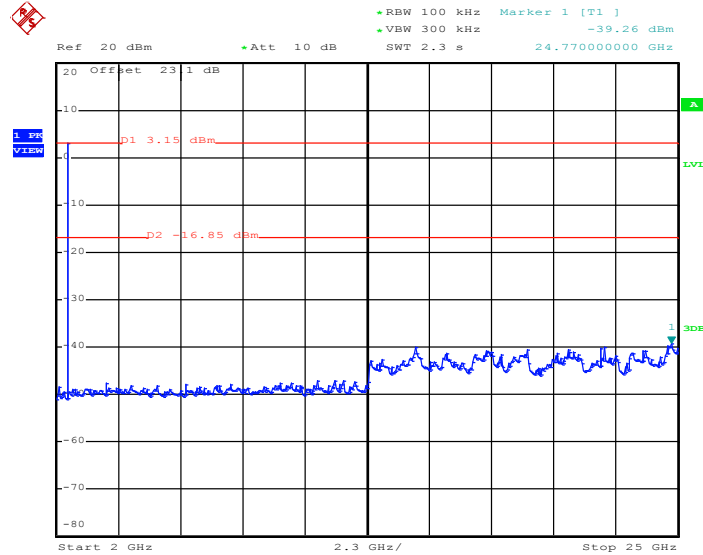

Date: 1.JUN.2016 17:32:10



Test Mode :	1Mbps	Temperature :	24~26°C
Test Channel :	78	Relative Humidity :	48~51%
		Test Engineer :	AC Chang

1Mbps CSE Plot on Ch 78 between 30MHz ~ 3 GHz

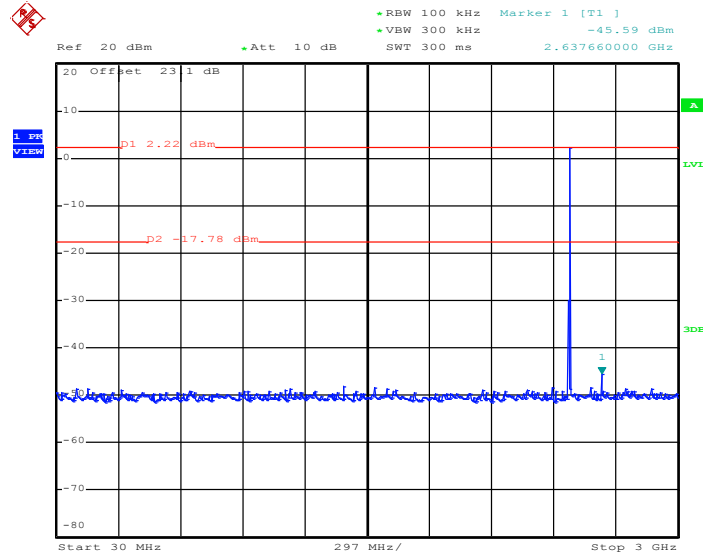

Date: 1.JUN.2016 17:36:37

1Mbps CSE Plot on Ch 78 between 2 GHz ~ 25 GHz

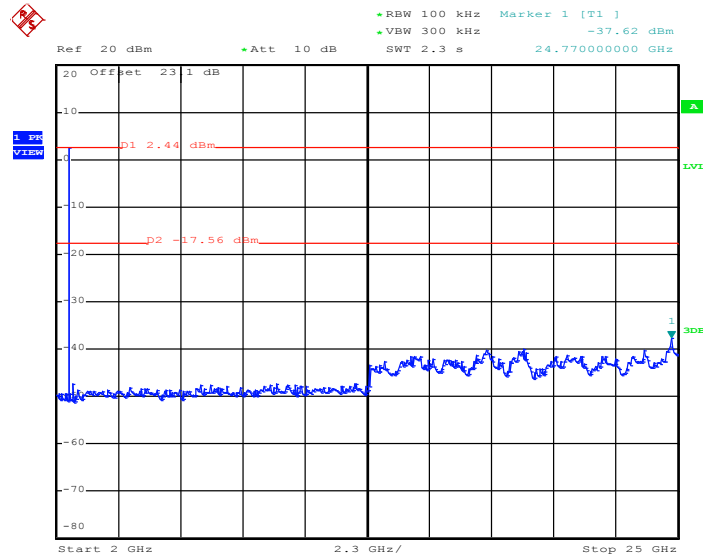

Date: 1.JUN.2016 17:36:59



Test Mode :	2Mbps	Temperature :	24~26°C
Test Channel :	00	Relative Humidity :	48~51%
		Test Engineer :	AC Chang

2Mbps CSE Plot on Ch 00 between 30MHz ~ 3 GHz

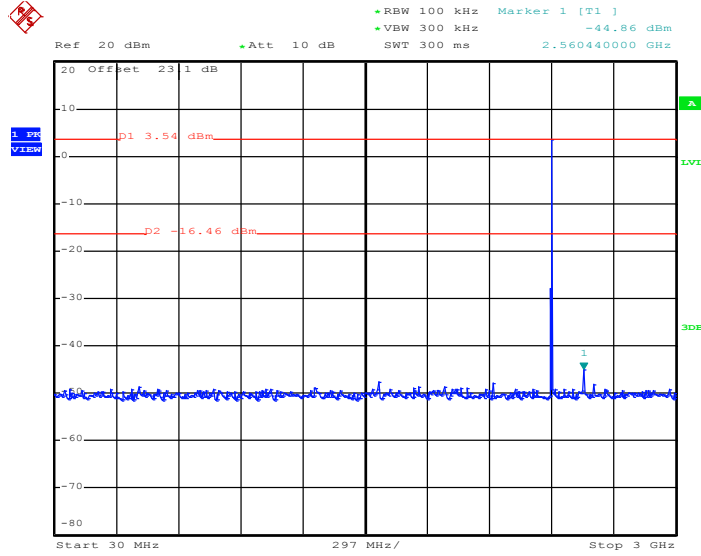

Date: 1.JUN.2016 17:41:30

2Mbps CSE Plot on Ch 00 between 2 GHz ~ 25 GHz

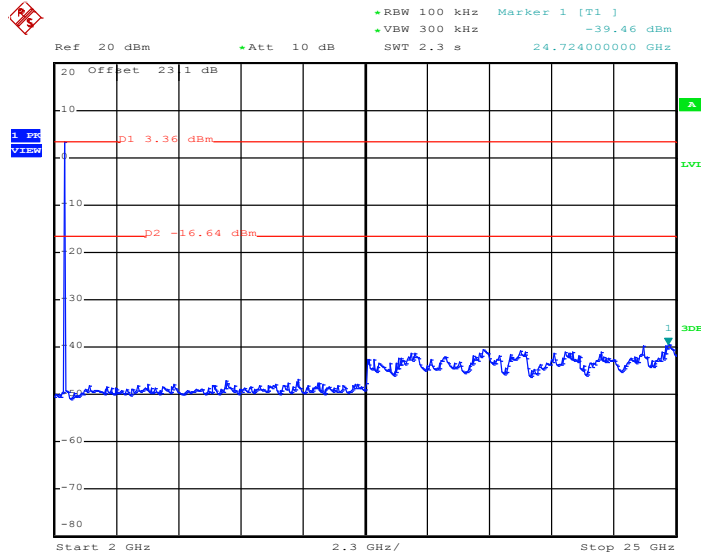

Date: 1.JUN.2016 17:41:52



Test Mode :	2Mbps	Temperature :	24~26°C
Test Channel :	39	Relative Humidity :	48~51%
		Test Engineer :	AC Chang

2Mbps CSE Plot on Ch 39 between 30MHz ~ 3 GHz

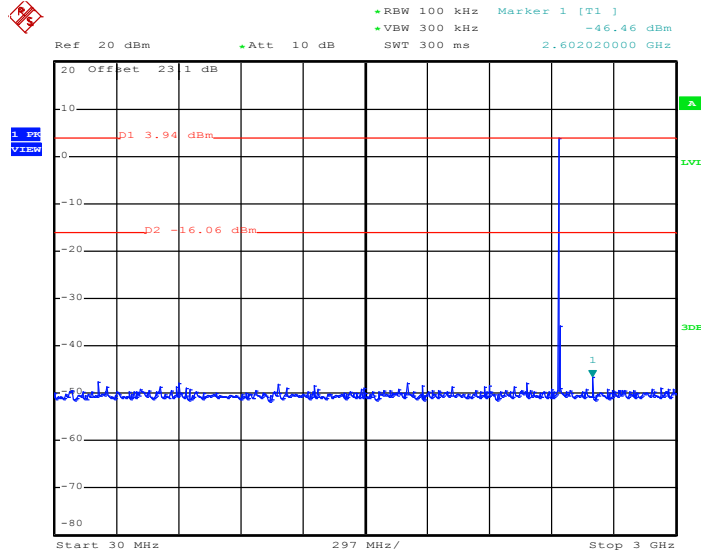

Date: 1.JUN.2016 17:45:12

2Mbps CSE Plot on Ch 39 between 2 GHz ~ 25 GHz

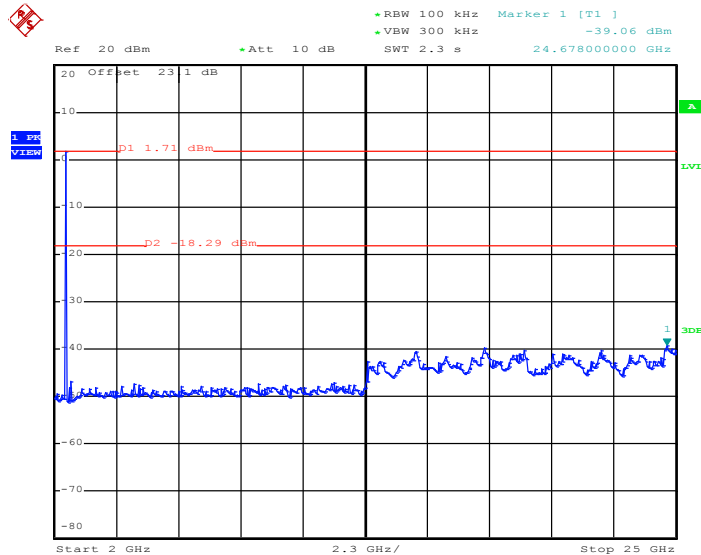

Date: 1.JUN.2016 17:45:33



Test Mode :	2Mbps	Temperature :	24~26°C
Test Channel :	78	Relative Humidity :	48~51%
		Test Engineer :	AC Chang

2Mbps CSE Plot on Ch 78 between 30MHz ~ 3 GHz

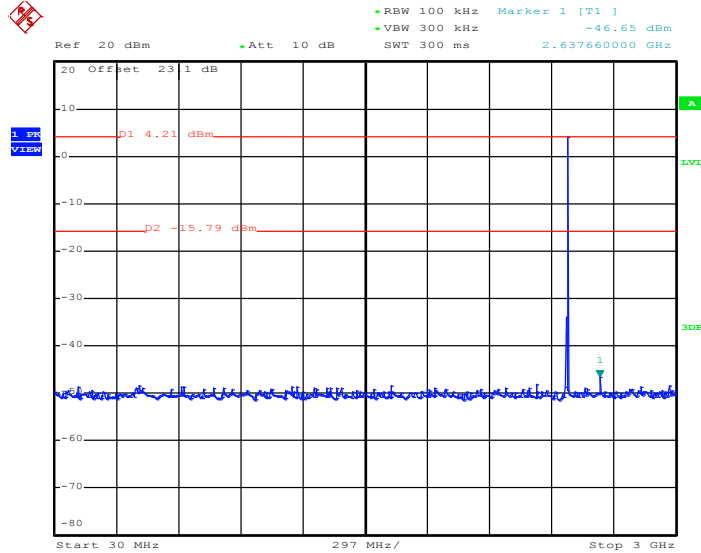

Date: 1.JUN.2016 17:49:05

2Mbps CSE Plot on Ch 78 between 2 GHz ~ 25 GHz

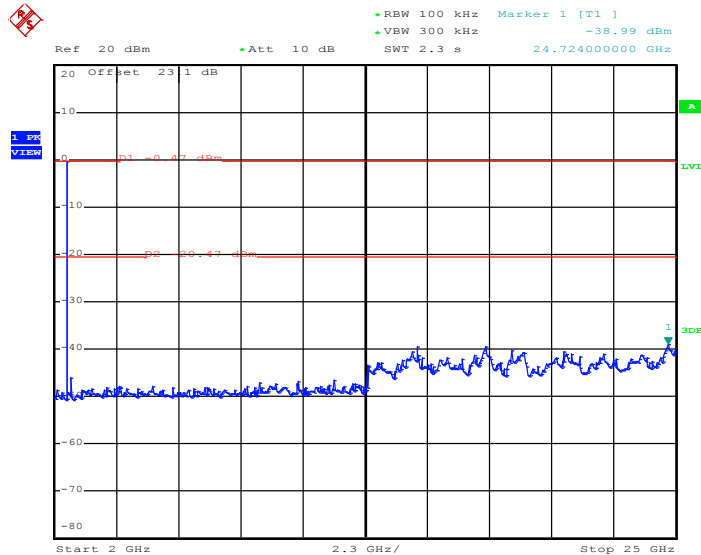

Date: 1.JUN.2016 17:49:27



Test Mode :	3Mbps	Temperature :	24~26°C
Test Channel :	00	Relative Humidity :	48~51%
		Test Engineer :	AC Chang

3Mbps CSE Plot on Ch 00 between 30MHz ~ 3 GHz

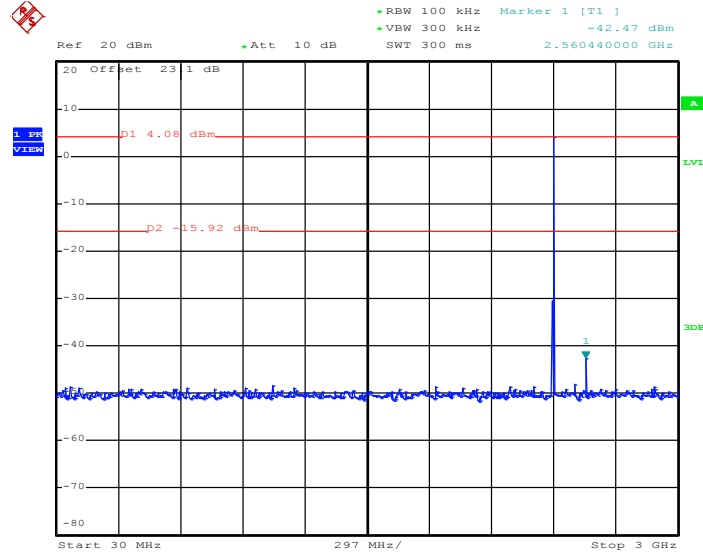

Date: 1.JUN.2016 17:54:17

3Mbps CSE Plot on Ch 00 between 2 GHz ~ 25 GHz

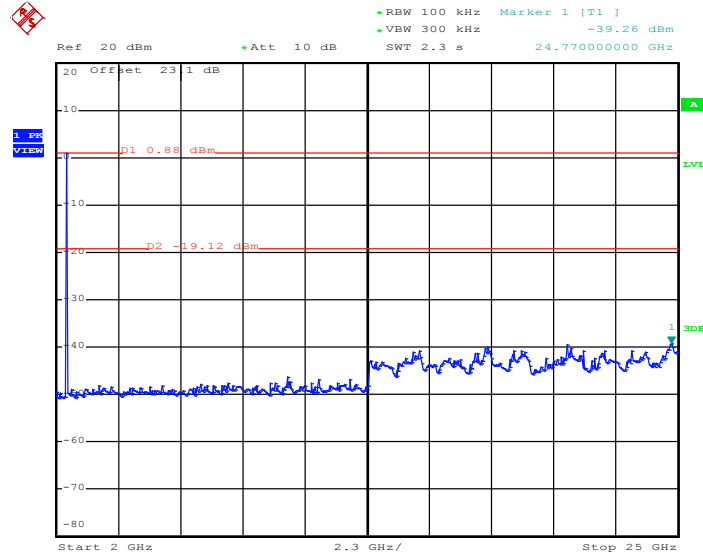

Date: 1.JUN.2016 17:54:38



Test Mode :	3Mbps	Temperature :	24~26°C
Test Channel :	39	Relative Humidity :	48~51%
		Test Engineer :	AC Chang

3Mbps CSE Plot on Ch 39 between 30MHz ~ 3 GHz

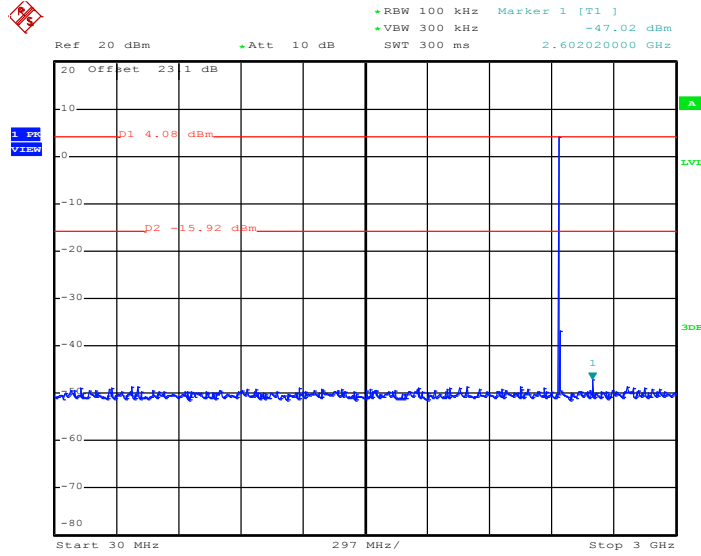

Date: 1.JUN.2016 18:00:09

3Mbps CSE Plot on Ch 39 between 2 GHz ~ 25 GHz

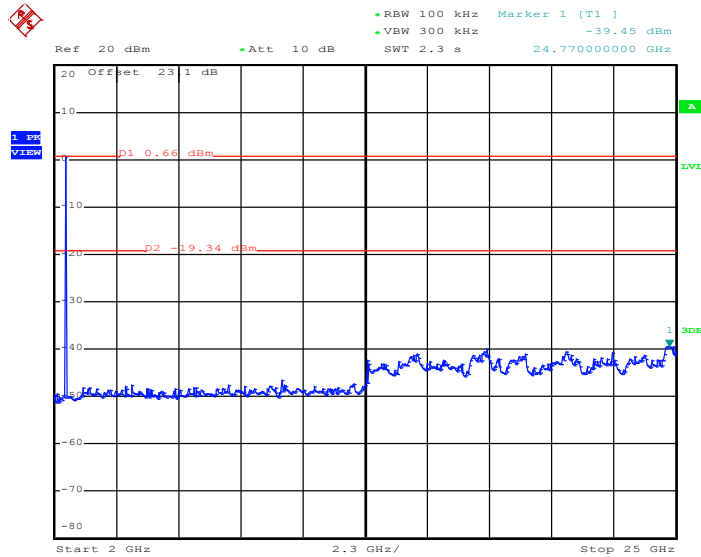

Date: 1.JUN.2016 18:00:30



Test Mode :	3Mbps	Temperature :	24~26°C
Test Channel :	78	Relative Humidity :	48~51%
		Test Engineer :	AC Chang

3Mbps CSE Plot on Ch 78 between 30MHz ~ 3 GHz

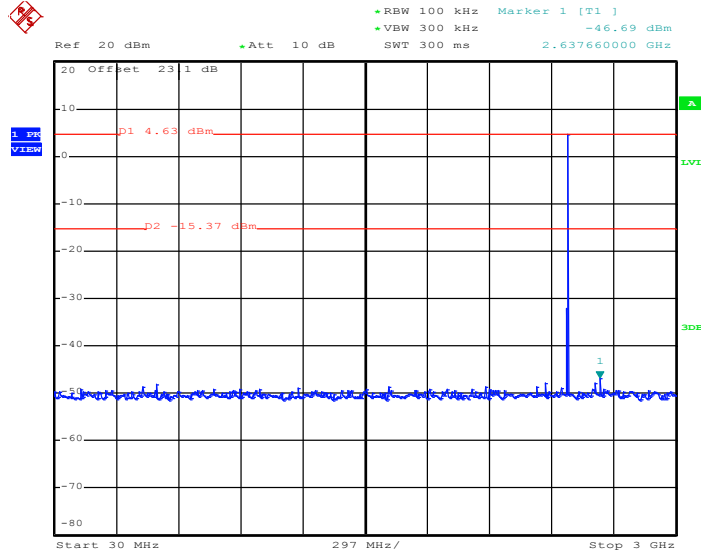

Date: 1.JUN.2016 18:04:21

3Mbps CSE Plot on Ch 78 between 2 GHz ~ 25 GHz

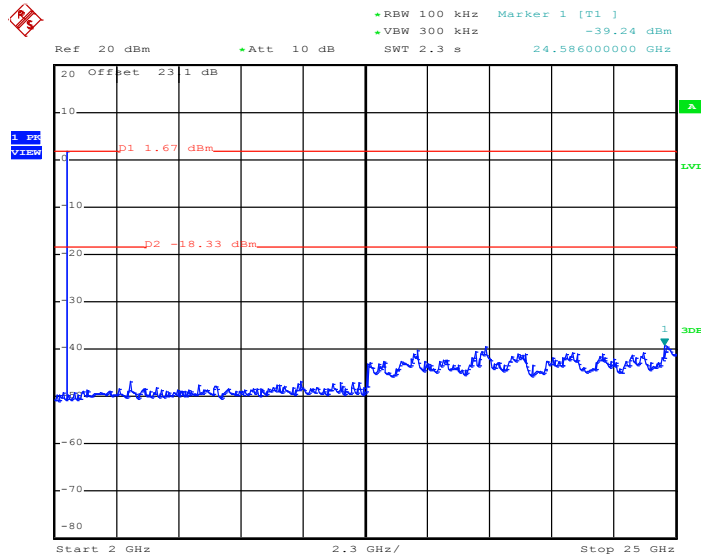

Date: 1.JUN.2016 18:04:42



3.8 Radiated Band Edges and Spurious Emission Measurement

3.8.1 Limit of Radiated Band Edges and Spurious Emission

In any 100 kHz bandwidth outside the intentional radiator frequency band, all harmonics/spurious must be at least 20 dB below the highest emission level within the authorized band. In addition, radiated emissions which fall in the restricted bands must also comply with the FCC section 15.209 limits as below.

Frequency (MHz)	Field Strength (microvolts/meter)	Measurement Distance (meters)
0.009 – 0.490	2400/F(kHz)	300
0.490 – 1.705	24000/F(kHz)	30
1.705 – 30.0	30	30
30 – 88	100	3
88 – 216	150	3
216 - 960	200	3
Above 960	500	3

3.8.2 Measuring Instruments

The measuring equipment is listed in the section 4 of this test report.



3.8.3 Test Procedures

1. The EUT was placed on a turntable with 0.8 meter for frequency below 1GHz and 1.5 meter for frequency above 1GHz respectively above ground.
2. The EUT was set 3 meters from the interference receiving antenna, which was mounted on the top of a variable height antenna tower.
3. For each suspected emission, the EUT was arranged to its worst case and then tune the Antenna tower (from 1 m to 4 m) and turntable (from 0 degree to 360 degrees) to find the maximum reading. A pre-amp and a high pass filter are used for the test in order to get better signal level to comply with the guidelines.
4. Set to the maximum power setting and enable the EUT transmit continuously.
5. Use the following spectrum analyzer settings:
 - (1) Span shall wide enough to fully capture the emission being measured;
 - (2) Set RBW=100 kHz for $f < 1$ GHz, RBW=1MHz for $f > 1$ GHz ; VBW \geq RBW; Sweep = auto; Detector function = peak; Trace = max hold for peak
 - (3) For average measurement: use duty cycle correction factor method per 15.35(c).
Duty cycle = On time/100 milliseconds
On time = $N_1 * L_1 + N_2 * L_2 + \dots + N_{n-1} * L_{n-1} + N_n * L_n$
Where N_1 is number of type 1 pulses, L_1 is length of type 1 pulses, etc.
Average Emission Level = Peak Emission Level + $20 * \log(\text{Duty cycle})$
6. Corrected Reading: Antenna Factor + Cable Loss + Read Level - Preamp Factor = Level

Note: The average levels were calculated from the peak level corrected with duty cycle correction factor (-24.76dB) derived from $20 \log(\text{dwell time}/100\text{ms})$. This correction is only for signals that hop with the fundamental signal, such as band-edge and harmonic. Other spurious signals that are independent of the hopping signal would not use this correction.

3.8.4 Test Setup

For radiated emissions below 30MHz

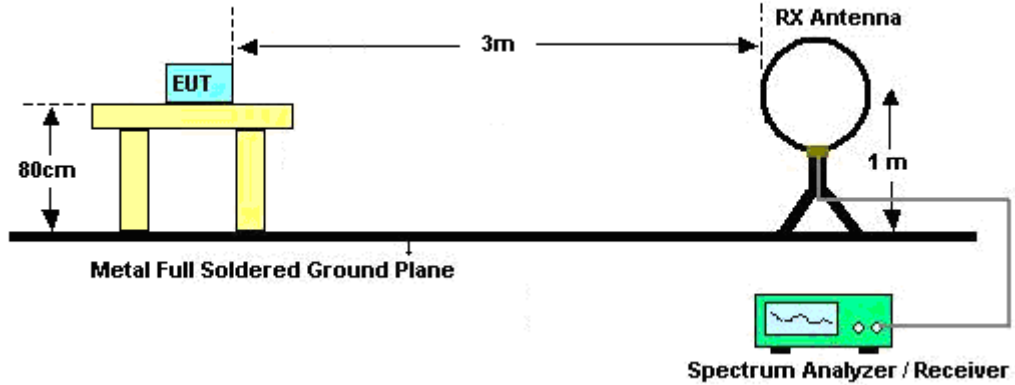

For radiated emissions from 30MHz to 1GHz

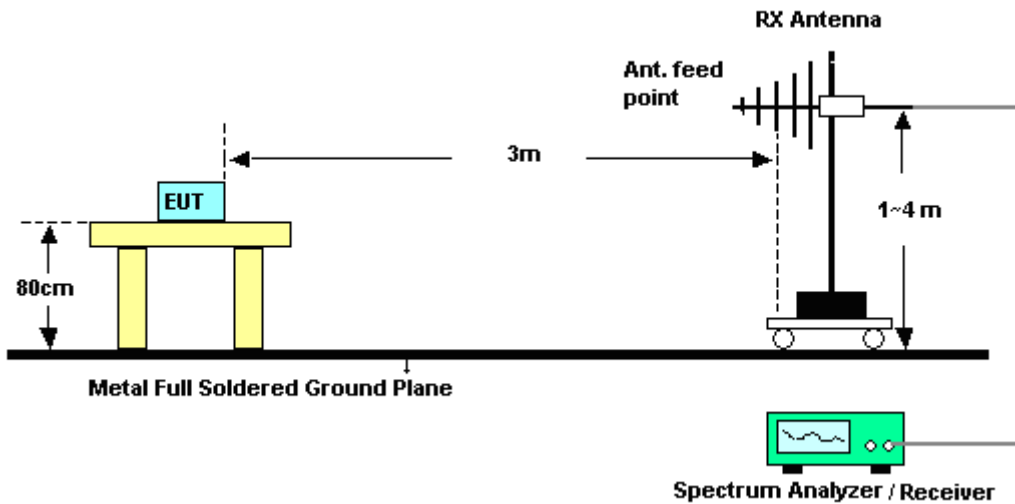

For radiated emissions above 1GHz

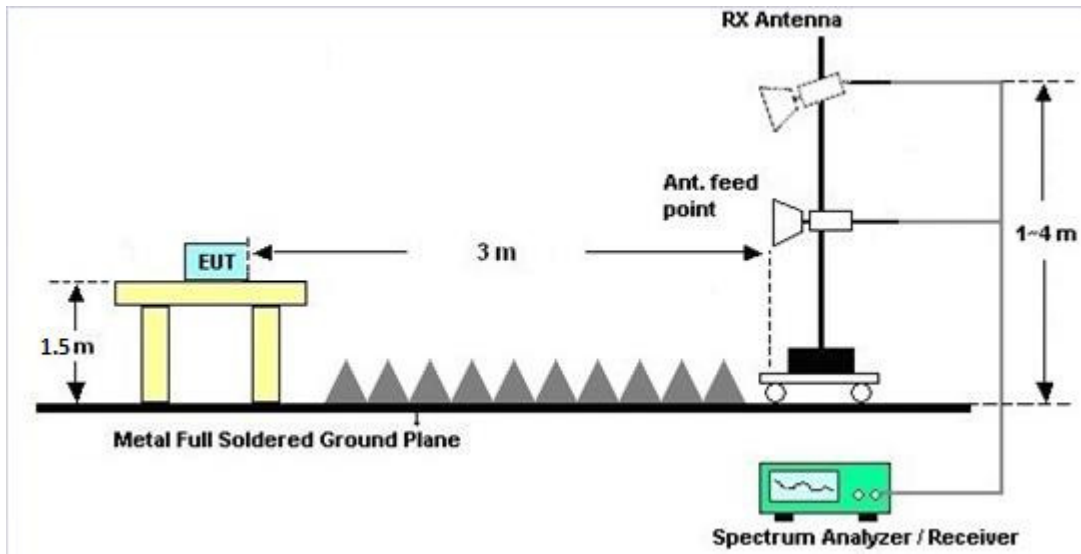

3.8.5 Test Results of Radiated Spurious Emissions (9 kHz ~ 30 MHz)

The low frequency, which started from 9 kHz to 30MHz, was pre-scanned and the result which was 20dB lower than the limit line per 15.31(o) was not reported.



3.8.6 Duty cycle correction factor for average measurement

3DH5 on time (One Pulse) Plot on Channel 39

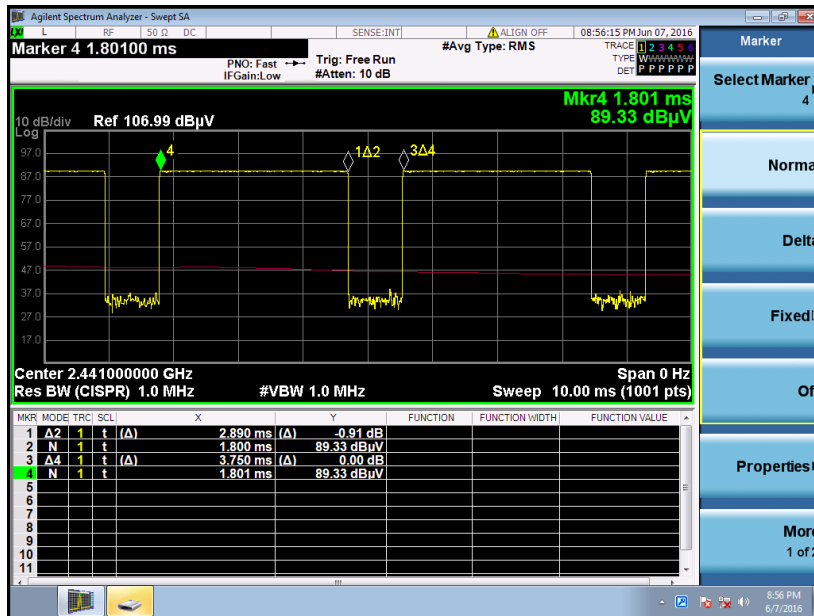

3DH5 on time (Count Pulses) Plot on Channel 39

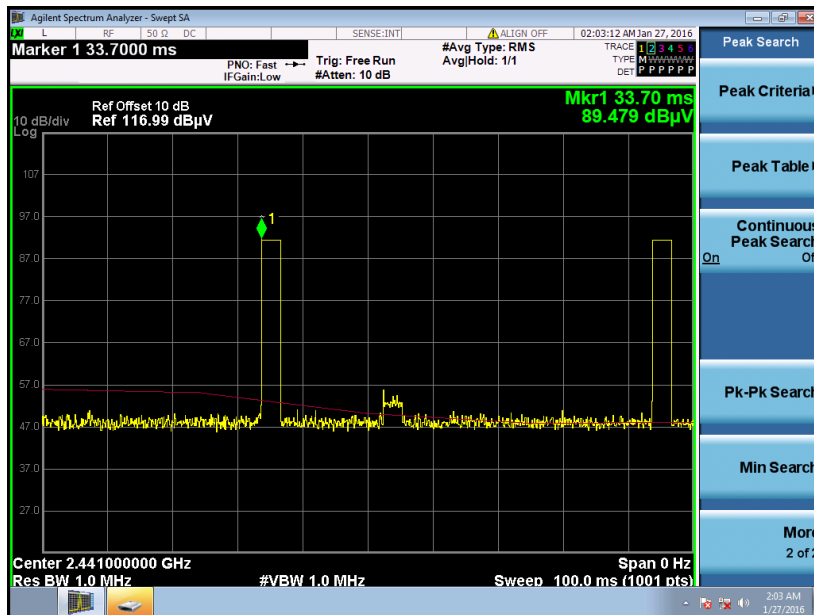

Note:

1. Worst case Duty cycle = on time/100 milliseconds = $2 * 2.89 / 100 = 5.78 \%$
2. Worst case Duty cycle correction factor = $20 * \log(\text{Duty cycle}) = -24.76 \text{ dB}$
3. 3DH5 has the highest duty cycle worst case and is reported.



Duty Cycle Correction Factor Consideration for AFH mode:

Bluetooth normal hopping rate is 1600Hz and reduced to 800Hz in AFH mode; due to the reduced number of hopping frequencies, with the same packet configuration the dwell time in each channel frequency within 100msec period is longer in AFH mode than normal mode.

In AFH mode, the minimum hopping frequencies are 20, to get the longest dwell time DH5 packet is observed; the period to have DH5 packet completing one hopping sequence is

$$2.89 \text{ ms} \times 20 \text{ channels} = 57.8 \text{ ms}$$

There cannot be 2 complete hopping sequences within 100ms period, considering the random hopping behavior, maximum 2 hops can be possibly observed within the period. $[100\text{ms} / 57.6\text{ms}] = 2 \text{ hops}$

Thus, the maximum possible ON time:

$$2.89 \text{ ms} \times 2 = 5.78 \text{ ms}$$

Worst case Duty Cycle Correction factor, which is derived from the maximum possible ON time,

$$20 \times \log(5.78 \text{ ms}/100\text{ms}) = -24.76 \text{ dB}$$

3.8.7 Test Result of Radiated Spurious at Band Edges

Please refer to Appendix A and B.

3.8.8 Test Result of Radiated Spurious Emission (30MHz ~ 10th Harmonic)

Please refer to Appendix A and B.



3.9 AC Conducted Emission Measurement

3.9.1 Limit of AC Conducted Emission

For equipment that is designed to be connected to the public utility (AC) power line, the radio frequency voltage that is conducted back onto the AC power line on any frequency or frequencies within the band 150 kHz to 30 MHz shall not exceed the limits in the following table.

Frequency of emission (MHz)	Conducted limit (dBµV)	
	Quasi-peak	Average
0.15-0.5	66 to 56*	56 to 46*
0.5-5	56	46
5-30	60	50

*Decreases with the logarithm of the frequency.

3.9.2 Measuring Instruments

The measuring equipment is listed in the section 4 of this test report.

3.9.3 Test Procedures

1. The EUT was placed 0.4 meter from the conducting wall of the shielding room was kept at least 80 centimeters from any other grounded conducting surface.
2. Connect EUT to the power mains through a line impedance stabilization network (LISN).
3. All the support units are connecting to the other LISN.
4. The LISN provides 50 ohm coupling impedance for the measuring instrument.
5. The FCC states that a 50 ohm, 50 microhenry LISN should be used.
6. Both sides of AC line were checked for maximum conducted interference.
7. The frequency range from 150 kHz to 30 MHz was searched.
8. Set the test-receiver system to Peak Detect Function and specified bandwidth (IF Bandwidth = 9kHz) with Maximum Hold Mode. Then measurement is also conducted by Average Detector and Quasi-Peak Detector Function respectively.

3.9.4 Test Setup

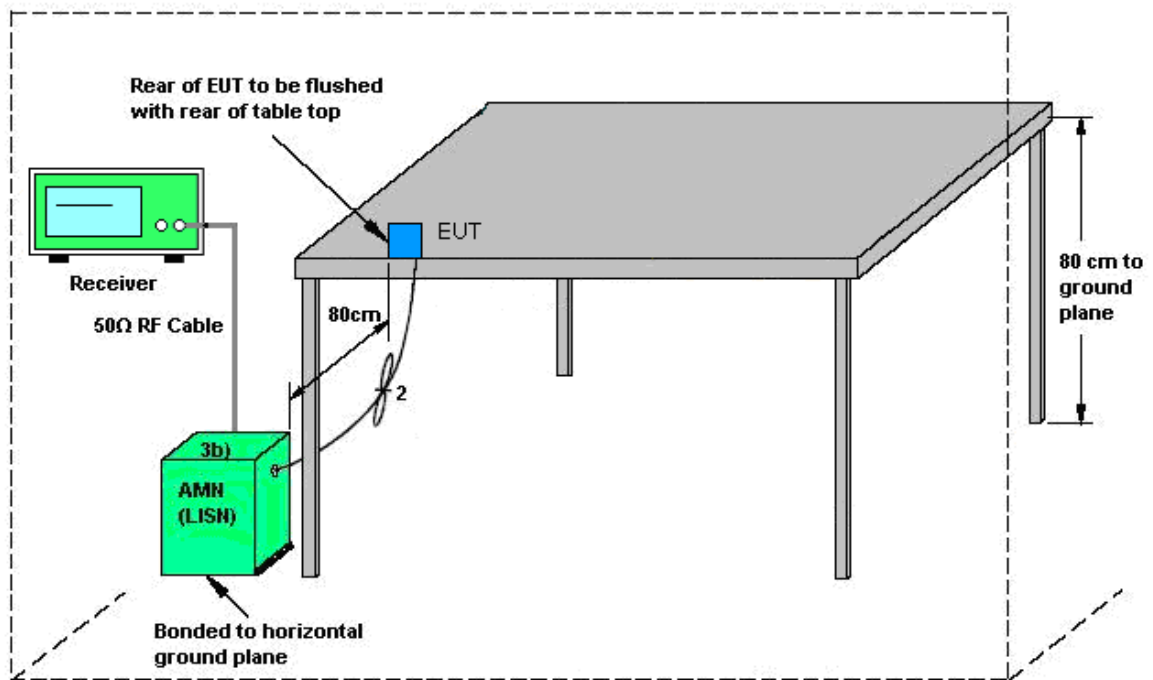

AMN = Artificial mains network (LISN)
AE = Associated equipment
EUT = Equipment under test
ISN = Impedance stabilization network

3.9.5 Test Result of AC Conducted Emission

Test Mode :	Mode 1	Temperature :	22~24°C
Test Engineer :	Eric Shih	Relative Humidity :	51~54%
Test Voltage :	120Vac / 60Hz	Phase :	Line
Function Type :	Bluetooth Link + EUT with USB Cable (Charging from Notebook)		

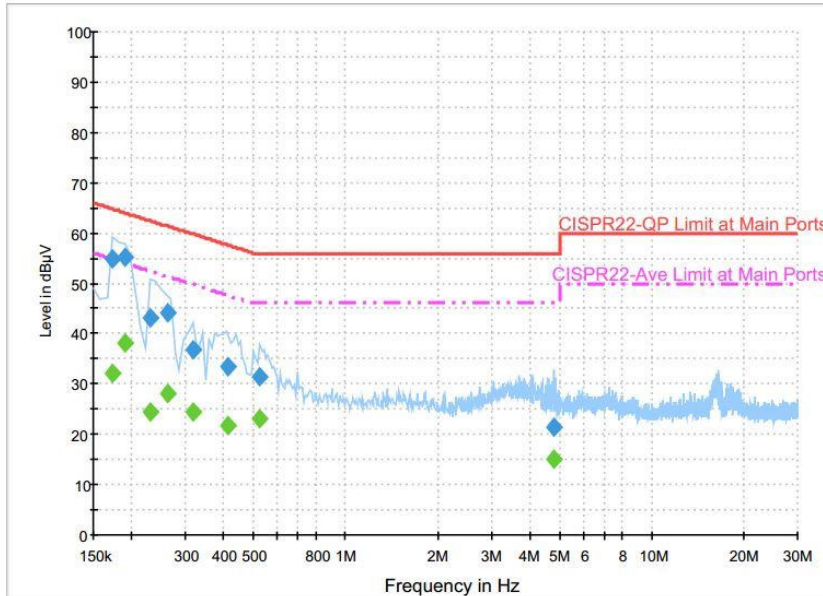

Final Result : Quasi-Peak

Frequency (MHz)	Quasi-Peak (dBµV)	Filter	Line	Corr. (dB)	Margin (dB)	Limit (dBµV)
0.174000	54.7	Off	L1	19.6	10.1	64.8
0.190000	55.1	Off	L1	19.6	8.9	64.0
0.230000	43.0	Off	L1	19.6	19.4	62.4
0.262000	44.0	Off	L1	19.6	17.4	61.4
0.318000	36.7	Off	L1	19.6	23.1	59.8
0.414000	33.4	Off	L1	19.6	24.2	57.6
0.526000	31.3	Off	L1	19.6	24.7	56.0
4.782000	21.5	Off	L1	19.7	34.5	56.0

Final Result : Average

Frequency (MHz)	Average (dBµV)	Filter	Line	Corr. (dB)	Margin (dB)	Limit (dBµV)
0.174000	32.3	Off	L1	19.6	22.5	54.8
0.190000	38.1	Off	L1	19.6	15.9	54.0
0.230000	24.5	Off	L1	19.6	27.9	52.4
0.262000	28.2	Off	L1	19.6	23.2	51.4
0.318000	24.5	Off	L1	19.6	25.3	49.8
0.414000	21.7	Off	L1	19.6	25.9	47.6
0.526000	23.0	Off	L1	19.6	23.0	46.0
4.782000	15.1	Off	L1	19.7	30.9	46.0



Test Mode :	Mode 1	Temperature :	22~24°C
Test Engineer :	Eric Shih	Relative Humidity :	51~54%
Test Voltage :	120Vac / 60Hz	Phase :	Neutral
Function Type :	Bluetooth Link + EUT with USB Cable (Charging from Notebook)		

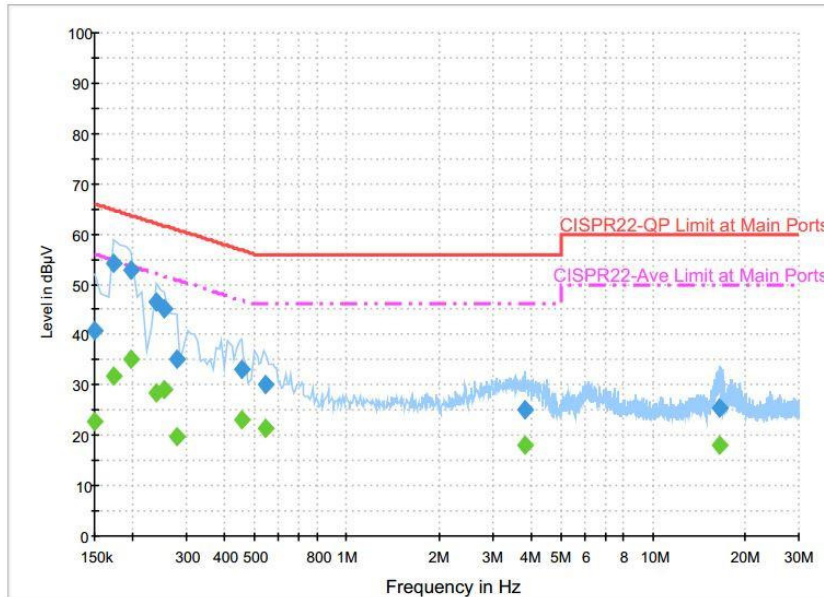

Final Result : Quasi-Peak

Frequency (MHz)	Quasi-Peak (dBµV)	Filter	Line	Corr. (dB)	Margin (dB)	Limit (dBµV)
0.150000	40.8	Off	N	19.6	25.2	66.0
0.174000	54.1	Off	N	19.6	10.7	64.8
0.198000	52.8	Off	N	19.6	10.9	63.7
0.238000	46.4	Off	N	19.6	15.8	62.2
0.254000	45.2	Off	N	19.6	16.4	61.6
0.278000	35.2	Off	N	19.6	25.7	60.9
0.454000	33.2	Off	N	19.6	23.6	56.8
0.542000	30.1	Off	N	19.6	25.9	56.0
3.830000	25.0	Off	N	19.6	31.0	56.0
16.518000	25.5	Off	N	19.9	34.5	60.0

Final Result : Average

Frequency (MHz)	Average (dBµV)	Filter	Line	Corr. (dB)	Margin (dB)	Limit (dBµV)
0.150000	22.9	Off	N	19.6	33.1	56.0
0.174000	31.8	Off	N	19.6	23.0	54.8
0.198000	35.1	Off	N	19.6	18.6	53.7
0.238000	28.5	Off	N	19.6	23.7	52.2
0.254000	29.2	Off	N	19.6	22.4	51.6
0.278000	19.8	Off	N	19.6	31.1	50.9
0.454000	23.1	Off	N	19.6	23.7	46.8
0.542000	21.5	Off	N	19.6	24.5	46.0
3.830000	17.9	Off	N	19.6	28.1	46.0
16.518000	18.0	Off	N	19.9	32.0	50.0



3.10 Antenna Requirements

3.10.1 Standard Applicable

If directional gain of transmitting antennas is greater than 6dBi, the power shall be reduced by the same level in dB comparing to gain minus 6dBi. The use of a permanently attached antenna or of an antenna that uses a unique coupling to the intentional radiator shall be considered sufficient to comply with the FCC rule.

3.10.2 Antenna Anti-Replacement Construction

An embedded-in antenna design is used.

3.10.3 Antenna Gain

The antenna peak gain of EUT is less than 6 dBi. Therefore, it is not necessary to reduce maximum peak output power limit.



4 List of Measuring Equipment

Instrument	Manufacturer	Model No.	Serial No.	Characteristics	Calibration Date	Test Date	Due Date	Remark
DC Power Supply	TOPWARD	3303D	740889	N/A	May 20, 2016	May 24, 2016 ~ Jun. 10, 2016	May 19, 2017	Conducted (TH02-HY)
Power Meter	Agilent	E4416A	GB41292344	300MHz~40GHz	Jan. 08, 2016	May 24, 2016 ~ Jun. 10, 2016	Jan. 07, 2017	Conducted (TH02-HY)
Power Sensor	Agilent	E9327A	US40441548	300MHz~40GHz	Jan. 07, 2016	May 24, 2016 ~ Jun. 10, 2016	Jan. 06, 2017	Conducted (TH02-HY)
Spectrum Analyzer	Rohde & Schwarz	FSP40	100055	9kHz~40GHz	Jun. 18, 2015	May 24, 2016 ~ Jun. 10, 2016	Jun. 17, 2016	Conducted (TH02-HY)
AC Power Source	ChainTek	APC-1000W	N/A	N/A	N/A	Jun. 09, 2016	N/A	Conduction (CO05-HY)
EMI Test Receiver	Rohde & Schwarz	ESCI 7	100724	9kHz~7GHz	Aug. 26, 2015	Jun. 09, 2016	Aug. 25, 2016	Conduction (CO05-HY)
LISN	Rohde & Schwarz	ENV216	100080	9kHz~30MHz	Dec. 02, 2015	Jun. 09, 2016	Dec. 01, 2016	Conduction (CO05-HY)
LISN	Rohde & Schwarz	ENV216	100081	9kHz~30MHz	Dec. 14, 2015	Jun. 09, 2016	Dec. 13, 2016	Conduction (CO05-HY)
Bilog Antenna	TESEQ	CBL 6111D	35419	30MHz to 1GHz	Jan. 13, 2016	Jun. 07, 2016 ~ Jun. 08, 2016	Jan. 12, 2017	Radiation (03CH07-HY)
Double Ridge Horn Antenna	ESCO	3117	00075962	1GHz ~ 18GHz	Aug. 21, 2015	Jun. 07, 2016 ~ Jun. 08, 2016	Aug. 20, 2016	Radiation (03CH07-HY)
EMI Test Receiver	Keysight	N9038A(MXE)	MY54130085	20Hz ~ 8.4GHz	Nov. 04, 2015	Jun. 07, 2016 ~ Jun. 08, 2016	Nov. 03, 2016	Radiation (03CH07-HY)
Loop Antenna	Rohde & Schwarz	HFH2-Z2	100315	9 kHz~30 MHz	Sep. 02, 2015	Jun. 07, 2016 ~ Jun. 08, 2016	Sep. 01, 2016	Radiation (03CH07-HY)
Preamplifier	COM-POWER	PA-103A	161241	10MHz-1GHz	Mar. 18, 2016	Jun. 07, 2016 ~ Jun. 08, 2016	Mar. 17, 2017	Radiation (03CH07-HY)
Preamplifier	Agilent	8449B	3008A02362	1GHz~ 26.5GHz	Oct. 19, 2015	Jun. 07, 2016 ~ Jun. 08, 2016	Oct. 18, 2016	Radiation (03CH07-HY)
Spectrum Analyzer	Agilent	N9010A	MY53470118	10Hz~44GHz	Feb. 27, 2016	Jun. 07, 2016 ~ Jun. 08, 2016	Feb. 26, 2017	Radiation (03CH07-HY)
Antenna Mast	Max-Full	MFA520BS	N/A	1m~4m	N/A	Jun. 07, 2016 ~ Jun. 08, 2016	N/A	Radiation (03CH07-HY)
Turn Table	ChainTek	Chaintek 3000	N/A	0~360 Degree	N/A	Jun. 07, 2016 ~ Jun. 08, 2016	N/A	Radiation (03CH07-HY)
SHF-EHF Horn Antenna	SCHWARZBECK	BBHA 9170	BBHA9170584	18GHz- 40GHz	Nov. 02, 2015	Jun. 07, 2016 ~ Jun. 08, 2016	Nov. 01, 2016	Radiation (03CH07-HY)
Preamplifier	MITEQ	TTA0204	1872107	18GHz ~ 40GHz	Feb. 15, 2016	Jun. 07, 2016 ~ Jun. 08, 2016	Feb. 14, 2017	Radiation (03CH07-HY)
Preamplifier	MITEQ	AMF-7D-00101 800-30-10P	1590075	1GHz~18GHz	Apr. 15, 2015	Jun. 07, 2016 ~ Jun. 08, 2016	Apr. 14, 2017	Radiation (03CH07-HY)



5 Uncertainty of Evaluation

Uncertainty of Conducted Emission Measurement (150 kHz ~ 30 MHz)

Measuring Uncertainty for a Level of Confidence of 95% ($U = 2Uc(y)$)	2.26
---	------

Uncertainty of Radiated Emission Measurement (30 MHz ~ 1000 MHz)

Measuring Uncertainty for a Level of Confidence of 95% ($U = 2Uc(y)$)	5.60
---	------



Appendix A. Radiated Spurious Emission

Test Engineer :	Derreck Chen and James Chiu	Temperature :	19~23°C
		Relative Humidity :	55~60%

2.4GHz 2400~2483.5MHz

BT (Band Edge @ 3m)

BT	Note	Frequency	Level	Over	Limit	Read	Antenna	Cable	Preamp	Ant	Table	Peak	Pol.	
		(MHz)	(dBμV/m)	(dB)	(dBμV/m)	(dBμV)	(dB/m)	(dB)	(dB)	(cm)	(deg)	(P/A)	(H/V)	
BT CH00 2402MHz		2365.44	45.87	-28.13	74	41.16	31.84	7.24	34.37	100	40	P	H	
		2365.44	21.11	-32.89	54	-	-	-	-	-	-	A	H	
	*	2402	94.83	-	-	89.9	31.93	7.31	34.31	100	40	P	H	
	*	2402	70.07	-	-	-	-	-	-	-	-	A	H	
													H	
														H
			2377.05	45.34	-28.66	74	40.56	31.89	7.24	34.35	100	132	P	V
			2377.05	20.58	-33.42	54	-	-	-	-	-	-	A	V
	*		2402	94.45	-	-	89.52	31.93	7.31	34.31	100	132	P	V
	*		2402	69.69	-	-	-	-	-	-	-	-	A	V
														V
													V	
BT CH 39 2441MHz		2380.56	45.36	-28.64	74	40.51	31.89	7.31	34.35	100	38	P	H	
		2380.56	20.6	20.6	54	-	-	-	-	-	-	A	H	
	*	2442	94.9	-	-	89.72	32.07	7.36	34.25	100	38	P	H	
	*	2442	70.14	-	-	-	-	-	-	-	-	A	H	
			2494.12	45.35	-28.65	74	39.91	32.2	7.4	34.16	100	38	P	H
			2494.12	20.59	20.59	54	-	-	-	-	-	-	A	H
			2332.95	46.04	-27.96	74	41.54	31.75	7.18	34.43	100	318	P	V
			2332.95	21.28	21.28	54	-	-	-	-	-	-	A	V
	*		2442	93.57	-	-	88.39	32.07	7.36	34.25	100	318	P	V
	*		2442	68.81	-	-	-	-	-	-	-	-	A	V
			2495.52	46.38	-27.62	74	40.94	32.2	7.4	34.16	100	318	P	V
		2495.52	21.62	21.62	54	-	-	-	-	-	-	A	V	



BT CH 78 2480MHz	*	2480	95.02	-	-	89.64	32.16	7.4	34.18	124	37	P	H
	*	2480	70.26	-	-	-	-	-	-	-	-	A	H
		2483.52	53.24	-20.76	74	47.86	32.16	7.4	34.18	124	37	P	H
		2483.52	28.48	-25.52	54	-	-	-	-	-	-	A	H
													H
													H
	*	2480	94.61	-	-	89.23	32.16	7.4	34.18	100	142	P	V
	*	2480	69.85	-	-	-	-	-	-	-	-	A	V
		2483.52	51.81	-22.19	74	46.43	32.16	7.4	34.18	100	142	P	V
		2483.52	27.05	-26.95	54	-	-	-	-	-	-	A	V
													V
													V
Remark	1. No other spurious found. 2. All results are PASS against Peak and Average limit line.												



2.4GHz 2400~2483.5MHz
BT (Harmonic @ 3m)

BT	Note	Frequency (MHz)	Level (dBμV/m)	Over Limit (dB)	Limit Line (dBμV/m)	Read Level (dBμV)	Antenna Factor (dB/m)	Cable Loss (dB)	Preamp Factor (dB)	Ant Pos (cm)	Table Pos (deg)	Peak Avg. (P/A)	Pol. (H/V)	
BT CH 00 2402MHz		4806	58.18	-15.82	74	71.24	34.19	11.83	59.08	100	0	P	H	
		4806	33.42	-20.58	54	-	-	-	-	-	-	A	H	
													H	
													H	
		4806	56.1	-17.9	74	69.16	34.19	11.83	59.08	100	0	P	V	
		4806	31.34	-22.66	54	-	-	-	-	-	-	-	A	V
														V
														V
BT CH 39 2441MHz		4884	56.6	-17.4	74	69.78	34.23	11.53	58.94	100	0	P	H	
		4884	31.84	-22.16	54	-	-	-	-	-	-	A	H	
		7326	44.48	-29.52	74	53.03	35.6	13.81	57.96	100	0	P	H	
		7326	19.72	-34.28	54	-	-	-	-	-	-	A	H	
		4884	56.64	-17.36	74	69.82	34.23	11.53	58.94	100	0	P	V	
		4884	31.88	-22.12	54	-	-	-	-	-	-	-	A	V
		7326	41.81	-32.19	74	50.36	35.6	13.81	57.96	100	0	P	V	
		7326	17.05	-36.95	54	-	-	-	-	-	-	-	A	V
BT CH 78 2480MHz		4962	56.78	-17.22	74	70.05	34.28	11.22	58.77	100	0	P	H	
		4962	32.02	-21.98	54	-	-	-	-	-	-	A	H	
		7440	46.15	-27.85	74	54.63	35.6	14.05	58.13	100	0	P	H	
		7440	21.39	-32.61	54	-	-	-	-	-	-	A	H	
		4962	56.81	-17.19	74	70.08	34.28	11.22	58.77	100	0	P	V	
		4962	32.05	-21.95	54	-	-	-	-	-	-	A	V	
		7440	42.21	-31.79	74	50.69	35.6	14.05	58.13	100	0	P	V	
		7440	17.45	-36.55	54	-	-	-	-	-	-	-	A	V
Remark	1. No other spurious found. 2. All results are PASS against Peak and Average limit line.													



Emission below 1GHz

2.4GHz BT (LF)

BT	Note	Frequency	Level	Over	Limit	Read	Antenna	Cable	Preamp	Ant	Table	Peak	Pol.	
		(MHz)	(dBμV/m)	(dB)	(dBμV/m)	(dBμV)	(dB/m)	(dB)	(dB)	(cm)	(deg)	(P/A)	(H/V)	
2.4GHz BT LF		31.08	26.97	-13.03	40	31.8	25.46	1.07	31.36	-	-	P	H	
		137.73	19.15	-24.35	43.5	31.04	18.06	1.55	31.5	-	-	P	H	
		267.33	22.16	-23.84	46	31.66	19.52	2.32	31.34	-	-	P	H	
		407.8	26.72	-19.28	46	32.7	22.51	2.67	31.16	-	-	P	H	
		710.9	30.23	-15.77	46	30.63	26.57	3.74	30.71	-	-	P	H	
		956.6	33.47	-12.53	46	29.72	30.21	4.07	30.53	100	0	P	H	
														H
														H
														H
														H
														H
														H
			32.97	26.19	-13.81	40	32.13	24.38	1.07	31.39	100	0	P	V
			62.94	25.19	-14.81	40	43.28	12.21	1.28	31.58	-	-	P	V
			206.04	17.95	-25.55	43.5	31.39	16.16	1.87	31.47	-	-	P	V
			452.6	25.56	-20.44	46	30.6	23.16	2.89	31.09	-	-	P	V
			765.5	30.71	-15.29	46	30.18	27.35	3.82	30.64	-	-	P	V
			960.1	33.72	-20.28	54	29.96	30.22	4.07	30.53	-	-	P	V
														V
														V
													V	
													V	
													V	
													V	
Remark	1. No other spurious found. 2. All results are PASS against limit line.													



Note symbol

*	Fundamental Frequency which can be ignored. However, the level of any unwanted emissions shall not exceed the level of the fundamental frequency.
!	Test result is over limit line.
P/A	Peak or Average
H/V	Horizontal or Vertical



A calculation example for radiated spurious emission is shown as below:

WIFI	Note	Frequency	Level	Over	Limit	Read	Antenna	Cable	Preamp	Ant	Table	Peak	Pol.
Ant.				Limit	Line	Level	Factor	Loss	Factor	Pos	Pos	Avg.	
1+2		(MHz)	(dBμV/m)	(dB)	(dBμV/m)	(dBμV)	(dB/m)	(dB)	(dB)	(cm)	(deg)	(P/A)	(H/V)
802.11b		2390	55.45	-18.55	74	54.51	32.22	4.58	35.86	103	308	P	H
CH 01													
2412MHz		2390	43.54	-10.46	54	42.6	32.22	4.58	35.86	103	308	A	H

- Level(dBμV/m) =
Antenna Factor(dB/m) + Cable Loss(dB) + Read Level(dBμV) - Preamp Factor(dB)
- Over Limit(dB) = Level(dBμV/m) – Limit Line(dBμV/m)

For Peak Limit @ 2390MHz:

- Level(dBμV/m)
= Antenna Factor(dB/m) + Cable Loss(dB) + Read Level(dBμV) - Preamp Factor(dB)
= 32.22(dB/m) + 4.58(dB) + 54.51(dBμV) – 35.86 (dB)
= 55.45 (dBμV/m)
- Over Limit(dB)
= Level(dBμV/m) – Limit Line(dBμV/m)
= 55.45(dBμV/m) – 74(dBμV/m)
= -18.55(dB)

For Average Limit @ 2390MHz:

- Level(dBμV/m)
= Antenna Factor(dB/m) + Cable Loss(dB) + Read Level(dBμV) - Preamp Factor(dB)
= 32.22(dB/m) + 4.58(dB) + 42.6(dBμV) – 35.86 (dB)
= 43.54 (dBμV/m)
- Over Limit(dB)
= Level(dBμV/m) – Limit Line(dBμV/m)
= 43.54(dBμV/m) – 54(dBμV/m)
= -10.46(dB)

Both peak and average measured complies with the limit line, so test result is “PASS”.



Appendix B. Radiated Spurious Emission Plots

Test Engineer :	Derreck Chen and James Chiu	Temperature :	19~23°C
		Relative Humidity :	55~60%

Note symbol

-L	Low channel location
-R	High channel location



2.4GHz 2400~2483.5MHz

BT (Band Edge @ 3m)

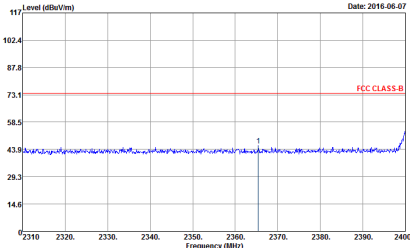
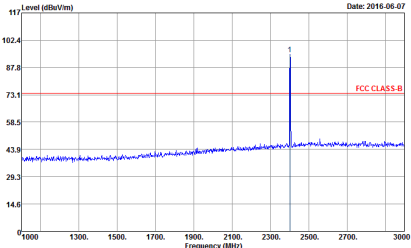
BT	2.4GHz 2400~2483.5MHz Band Edge @ 3m	
ANT	BT CH00 2402MHz	
1	Horizontal	Fundamental
Peak	 <p>Date: 2016-06-07</p> <p>Site : 03CH07.HY Condition : FCC CLASS-B 3m HF-ANT_130829 HORIZONTAL RBW:1000.000kHz VBW:3000.000kHz SWT:Auto Detector : Peak Project : 651311 Mode : 1</p>	 <p>Date: 2016-06-07</p> <p>Site : 03CH07.HY Condition : FCC CLASS-B 3m HF-ANT_130829 HORIZONTAL RBW:1000.000kHz VBW:3000.000kHz SWT:Auto Detector : Peak Project : 651311 Mode : 1</p>

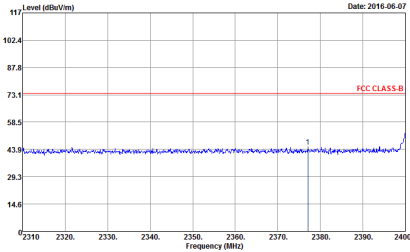
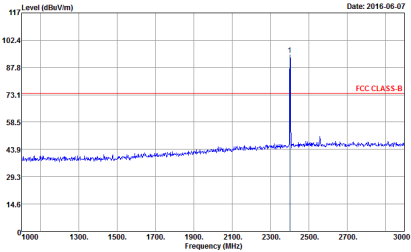

BT	2.4GHz 2400~2483.5MHz Band Edge @ 3m	
ANT	BT CH00 2402MHz	
1	Vertical	Fundamental
Peak	 <p data-bbox="347 748 590 813">Site : 03CH07.HY Condition : FCC CLASS-B 3m HF-ANT_130829 VERTICAL Detector : Peak Project : 651311 Mode : 1</p>	 <p data-bbox="944 748 1187 813">Site : 03CH07.HY Condition : FCC CLASS-B 3m HF-ANT_130829 VERTICAL Detector : Peak Project : 651311 Mode : 1</p>



BT	2.4GHz 2400~2483.5MHz Band Edge @ 3m	
ANT	BT CH39 2441MHz	
1	Horizontal	Fundamental
Peak	<p>Date: 2016-06-07</p> <p>Site : 03CH07.HY Condition : FCC CLASS-B 3m HF-ANT_130829 HORIZONTAL RBW:1000.000kHz VBW:3000.000kHz SWT:Auto Detector : Peak Project : 651311 Mode : 2</p>	<p>Date: 2016-06-07</p> <p>Site : 03CH07.HY Condition : FCC CLASS-B 3m HF-ANT_130829 HORIZONTAL RBW:1000.000kHz VBW:3000.000kHz SWT:Auto Detector : Peak Project : 651311 Mode : 2</p>
Peak	<p>Date: 2016-06-07</p> <p>Site : 03CH07.HY Condition : FCC CLASS-B 3m HF-ANT_130829 HORIZONTAL RBW:1000.000kHz VBW:3000.000kHz SWT:Auto Detector : Peak Project : 651311 Mode : 2</p>	Left blank

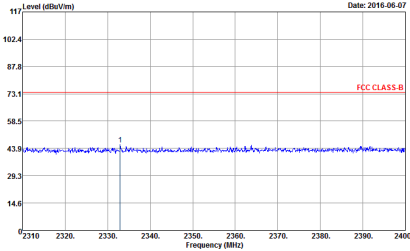
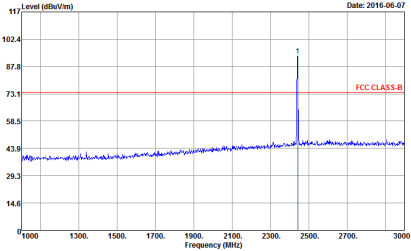
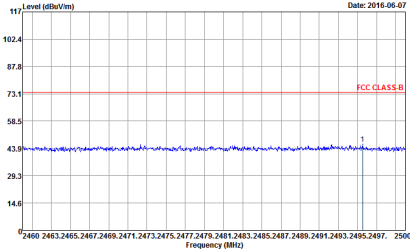

BT	2.4GHz 2400~2483.5MHz Band Edge @ 3m	
ANT	BT CH39 2441MHz	
1	<p style="text-align: center;">Vertical</p>  <p style="font-size: small;">Date: 2016-06-07</p> <p>Site : 03CH07.HY Condition : FCC CLASS-B 3m HF-ANT_130829 VERTICAL Detector : Peak Project : 651311 Mode : 2</p>	<p style="text-align: center;">Fundamental</p>  <p style="font-size: small;">Date: 2016-06-07</p> <p>Site : 03CH07.HY Condition : FCC CLASS-B 3m HF-ANT_130829 VERTICAL Detector : Peak Project : 651311 Mode : 2</p>
Peak	 <p style="font-size: small;">Date: 2016-06-07</p> <p>Site : 03CH07.HY Condition : FCC CLASS-B 3m HF-ANT_130829 VERTICAL Detector : Peak Project : 651311 Mode : 2</p>	<p style="text-align: center;">Left blank</p>



BT	2.4GHz 2400~2483.5MHz Band Edge @ 3m	
ANT	BT CH78 2480MHz	
1	Horizontal	Fundamental
Peak	<p>Site : 03CH07.HY Condition : FCC CLASS-B 3m HF-ANT_130829 HORIZONTAL Detector : Peak Project : 651311 Mode : 3</p>	<p>Site : 03CH07.HY Condition : FCC CLASS-B 3m HF-ANT_130829 HORIZONTAL Detector : Peak Project : 651311 Mode : 3</p>

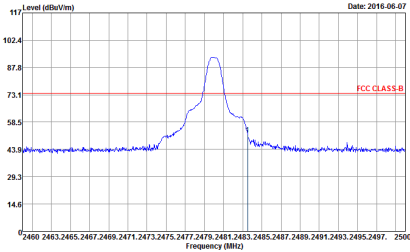
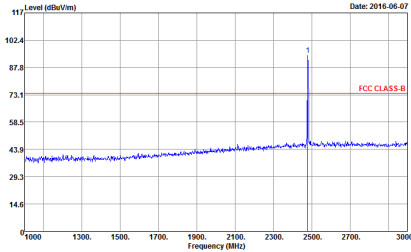

BT	2.4GHz 2400~2483.5MHz Band Edge @ 3m	
ANT	BT CH78 2480MHz	
1	Vertical	Fundamental
Peak	 <p data-bbox="347 748 759 813">Date: 2016-06-07 Site : 03CH07.HY Condition : FCC CLASS-B 3m HF-ANT_130829 VERTICAL Detector : Peak Project : 651311 Mode : 3</p>	 <p data-bbox="941 748 1353 813">Date: 2016-06-07 Site : 03CH07.HY Condition : FCC CLASS-B 3m HF-ANT_130829 VERTICAL Detector : Peak Project : 651311 Mode : 3</p>



2.4GHz 2400~2483.5MHz

BT (Harmonic @ 3m)

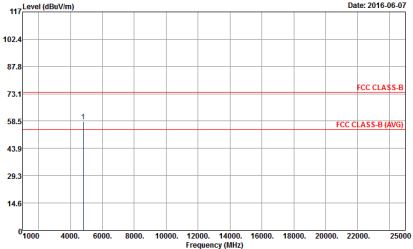
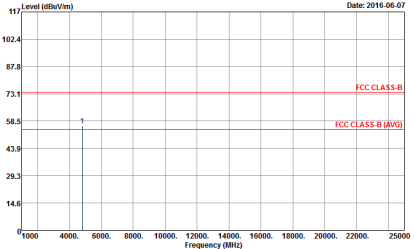
BT	2.4GHz 2400~2483.5MHz Harmonic @ 3m	
ANT	BT CH00 2402MHz	
1	Horizontal	Vertical
Peak Avg.	 <p>Site : 03CH67.HY Condition : FCC CLASS-B 3m SHF-EHF_131029 HORIZONTAL Detector : Peak Project : 651311 Mode : 1</p>	 <p>Site : 03CH67.HY Condition : FCC CLASS-B 3m SHF-EHF_131029 VERTICAL Detector : Peak Project : 651311 Mode : 1</p>

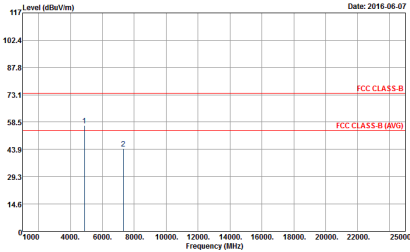
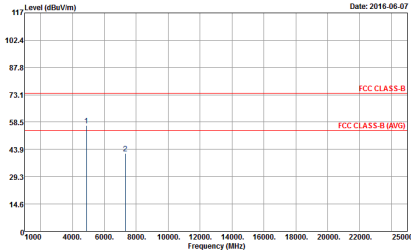

BT	2.4GHz 2400~2483.5MHz Harmonic @ 3m	
ANT	BT CH39 2441MHz	
1	Horizontal	Vertical
<p>Peak Avg.</p>	 <p>Site : 03CH07.HY Condition : FCC CLASS-B 3m SHF_EHF_131029 HORIZONTAL Detector : Peak Project : 651311 Mode : 2</p>	 <p>Site : 03CH07.HY Condition : FCC CLASS-B 3m SHF_EHF_131029 VERTICAL Detector : Peak Project : 651311 Mode : 2</p>

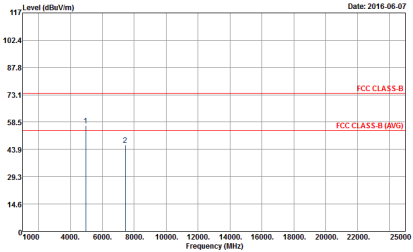
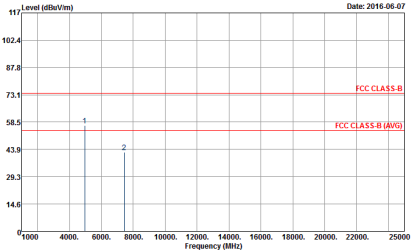

BT	2.4GHz 2400~2483.5MHz Harmonic @ 3m	
ANT	BT CH78 2480MHz	
1	Horizontal	Vertical
Peak Avg.	 <p style="font-size: small;">Date: 2016-06-07</p> <p style="font-size: x-small;">Site : 03CH07.HY Condition : FCC CLASS-B 3m SHF-EHF_131029 HORIZONTAL Detector : Peak Project : 651311 Mode : 3</p>	 <p style="font-size: small;">Date: 2016-06-07</p> <p style="font-size: x-small;">Site : 03CH07.HY Condition : FCC CLASS-B 3m SHF-EHF_131029 VERTICAL Detector : Peak Project : 651311 Mode : 3</p>



Emission below 1GHz

2.4GHz BT (LF)

BT	2.4GHz 2400~2483.5MHz	
ANT	BT LF	
1	Horizontal	Vertical
QP / Peak	<p>Site : 03CH67.HY Condition : FCC CLASS B 3m LF-ANT-35419(6) HORIZONTAL Detector : Peak Project : 650395 Mode : 4</p>	<p>Site : 03CH67.HY Condition : FCC CLASS B 3m LF-ANT-35419(6) VERTICAL Detector : Peak Project : 650395 Mode : 4</p>