



FCC RADIO TEST REPORT

FCC ID : UZ7FXR9001
Equipment : Industrial Fixed RFID Reader
Brand Name : ZEBRA
Model Name : FXR9001
Applicant : Zebra Technologies Corporation
1 Zebra Plaza, Holtsville, NY 11742
Manufacturer : Zebra Technologies Corporation
1 Zebra Plaza, Holtsville, NY 11742
Standard : FCC Part 15 Subpart E §15.407

The product was received on Aug. 16, 2023 and testing was performed from Sep. 14, 2023 to Nov. 01, 2023. We, Sporton International Inc. EMC & Wireless Communications Laboratory, would like to declare that the tested sample has been evaluated in accordance with the test procedures and has been in compliance with the applicable technical standards.

The test results in this report apply exclusively to the tested model / sample. Without written approval from Sporton International Inc. EMC & Wireless Communications Laboratory, the test report shall not be reproduced except in full.

Louis Wu

Approved by: Louis Wu

Sporton International Inc. EMC & Wireless Communications Laboratory
No. 52, Huaya 1st Rd., Guishan Dist., Taoyuan City 333, Taiwan (R.O.C.)



Table of Contents

History of this test report.....	3
Summary of Test Result.....	4
1 General Description	5
1.1 Product Feature of Equipment Under Test.....	5
1.2 Product Specification of Equipment Under Test.....	8
1.3 Modification of EUT	13
1.4 Testing Location	13
1.5 Applicable Standards.....	13
2 Test Configuration of Equipment Under Test	14
2.1 Carrier Frequency and Channel	14
2.2 Test Mode.....	16
2.3 Connection Diagram of Test System.....	18
2.4 Support Unit used in test configuration and system	20
2.5 EUT Operation Test Setup	20
2.6 Measurement Results Explanation Example.....	20
3 Test Result	21
3.1 26dB & 99% Occupied Bandwidth Measurement	21
3.2 Maximum Conducted Output Power Measurement	25
3.3 Power Spectral Density Measurement	27
3.4 Unwanted Emissions Measurement.....	33
3.5 AC Conducted Emission Measurement.....	38
3.6 Antenna Requirements.....	40
4 List of Measuring Equipment.....	41
5 Measurement Uncertainty	43
Appendix A. Conducted Test Results	
Appendix B. AC Conducted Emission Test Result	
Appendix C. Radiated Spurious Emission	
Appendix D. Radiated Spurious Emission Plots	
Appendix E. Duty Cycle Plots	
Appendix F. Setup Photographs	



Summary of Test Result

Report Clause	Ref Std. Clause	Test Items	Result (PASS/FAIL)	Remark
3.1	15.403(i)	26dB Bandwidth	Pass	-
3.1	2.1049	99% Occupied Bandwidth	Reporting only	-
3.2	15.407(a)	Maximum Conducted Output Power	Pass	-
3.3	15.407(a)	Power Spectral Density	Pass	-
3.4	15.407(b)	Unwanted Emissions	Pass	2.51 dB under the limit at 5356.56 MHz
3.5	15.207	AC Conducted Emission	Pass	28.43 dB under the limit at 0.41 MHz
3.6	15.203	Antenna Requirement	Pass	-

Conformity Assessment Condition:

1. The test results (PASS/FAIL) with all measurement uncertainty excluded are presented against the regulation limits or in accordance with the requirements stipulated by the applicant/manufacturer who shall bear all the risks of non-compliance that may potentially occur if measurement uncertainty is taken into account.
2. The measurement uncertainty please refer to each test result in the section "Measurement Uncertainty".

Disclaimer:

The product specifications of the EUT presented in the test report that may affect the test assessments are declared by the manufacturer who shall take full responsibility for the authenticity.

Reviewed by: Wei Chen

Report Producer: Clio Lo



1 General Description

1.1 Product Feature of Equipment Under Test

Product Feature	
Equipment	Industrial Fixed RFID Reader
Brand Name	ZEBRA
Model Name	FXR9001
FCC ID	UZ7FXR9001
Sample 1	FXR90011-400000-WR 4+1 Port & Bolt-on: BT, WLAN
Sample 2	FXR90010-800000-WR 8-Port: BT, WLAN
Sample 3	FXR90010-400000-WR 4-Port: BT, WLAN
EUT supports Radios application	RFID WLAN 11a/b/g/n HT20/HT40 WLAN 11ac VHT20/VHT40/VHT80 WLAN 11ax HE20/HE40/HE80 Bluetooth BR/EDR/LE
HW Version	EV2
SW Version	0.4.11
MFD	01AUG23
EUT Stage	Identical Prototype

Remark: The EUT's information above is declared by manufacturer.

Supported Unit Used in Test Configuration and System				
Cable, 3-way USB Splitter	Brand Name	ZEBRA	Model Name	ADP-USB0010-M12
Cable, USB-C Host, 5ft.	Brand Name	ZEBRA	Model Name	CBL-USBCHST015-M12
Cable, USB-C Host, 15ft.	Brand Name	ZEBRA	Model Name	CBL-USBCHST035-M12
Cable, USB-C Client, 5ft.	Brand Name	ZEBRA	Model Name	CBL-USBCCLT015-M12
Cable, USB-C Client, 15ft.	Brand Name	ZEBRA	Model Name	CBL-USBCCLT035-M12
Cable, USB-A Client, 5ft.	Brand Name	ZEBRA	Model Name	CBL-USBACLT015-M12
Cable, USB-A Client, 15ft.	Brand Name	ZEBRA	Model Name	CBL-USBACLT035-M12
Cable, GPIO	Brand Name	ZEBRA	Model Name	CBL-GP0050-M12M12A
Cable, 12V (Cigarette Lighter) Power Adapter, 3.5 meter	Brand Name	ZEBRA	Model Name	CBL-PWRD035-M12CL
Cable, DC Power Cord (Flying Leads), 3.5m	Brand Name	ZEBRA	Model Name	CBL-PWRD035-M1200
Cable, DC Power Cord (Flying Leads), 10m	Brand Name	ZEBRA	Model Name	CBL-PWRD100-M1200
Cable, Power Supply Output Adapter, 3.5m	Brand Name	ZEBRA	Model Name	CBL-PWRD035-M12M12
Cable, Power Supply Output Adapter, 10m	Brand Name	ZEBRA	Model Name	CBL-PWRD100-M12M12

Supported Unit Used in Test Configuration and System				
Cable, DC-DC Power Supply Input	Brand Name	ZEBRA	Model Name	CBL-PWRD150-M12M00
Cable, AC-DC Power Supply Input (Flying Leads)	Brand Name	ZEBRA	Model Name	CBL-PWRA150-M1200
Cable, AC-DC Power Supply Input (IEC plug)	Brand Name	ZEBRA	Model Name	CBL-PWRA035-M12IEC
CBL: RF, N STR PLUG TO RP-TNC STR PLUG ON LMR-240, 68", IP67 Sealed	Brand Name	ZEBRA	Model Name	CBLRD-3B4000680R
CBL: RF, N STR PLUG TO RP-TNC STR PLUG ON LMR-240, 180", IP67 Sealed	Brand Name	ZEBRA	Model Name	CBLRD-3B4001800R
CBL: RF, N STR PLUG TO RP-TNC STR PLUG ON LMR-240, 240", IP67 Sealed	Brand Name	ZEBRA	Model Name	CBLRD-3B4002400R
CBL: RF, N STR PLUG TO RP-TNC STR PLUG ON LMR-240, 360", IP67 Sealed	Brand Name	ZEBRA	Model Name	CBLRD-3B4003600R
CBL: RF, N STR PLUG TO RP-TNC STR PLUG ON LMR-240, 68", IP67 Sealed	Brand Name	ZEBRA	Model Name	CBLRD-1B4000680R
CBL: RF, N STR PLUG TO RP-TNC STR PLUG ON LMR-240, 180", IP67 Sealed	Brand Name	ZEBRA	Model Name	CBLRD-1B4001800R
CBL: RF, N STR PLUG TO RP-TNC STR PLUG ON LMR-240, 240", IP67 Sealed	Brand Name	ZEBRA	Model Name	CBLRD-1B4002400R
CBL: RF, N STR PLUG TO RP-TNC STR PLUG ON LMR-240, 360", IP67 Sealed	Brand Name	ZEBRA	Model Name	CBLRD-1B4003600R
CHIMERA ETHERNET CABLE 5M	Brand Name	ZEBRA	Model Name	CBL-ENT00500-M1200
CHIMERA ETHERNET CABLE 15M	Brand Name	ZEBRA	Model Name	CBL-ENT01500-M1200
Outdoor AC-DC PSU	Brand Name	ZEBRA	Model Name	PWR-BGA24V90W0WW (Spec PD-007875-01)
Forklift DC-DC PSU	Brand Name	ZEBRA	Model Name	PWR-BGA24V90W1WW (Spec PD-007876-01)
Indoor AC-DC PSU	Brand Name	ZEBRA	Model Name	PWR-BGA24V78W3WW (Spec PD-007877-01)
PoE adaptor	Brand Name	ZEBRA	Model Name	PD-9001GR/AT/AC



Supported Unit Used in Test Configuration and System				
External RFID Antenna	Brand Name	ZEBRA	Model Name	AN480
External RFID Antenna	Brand Name	ZEBRA	Model Name	AN650
External RFID Antenna	Brand Name	ZEBRA	Model Name	SR5502
External RFID Antenna	Brand Name	ZEBRA	Model Name	AN510
External RFID Antenna	Brand Name	ZEBRA	Model Name	AN520
External RFID Antenna	Brand Name	ZEBRA	Model Name	AN610
External RFID Antenna	Brand Name	ZEBRA	Model Name	AN620
External RFID Antenna	Brand Name	ZEBRA	Model Name	AN720
External RFID Antenna	Brand Name	ZEBRA	Model Name	AN440
External RFID Antenna	Brand Name	ZEBRA	Model Name	SP5504
BT/WLAN_ External Antenna	Brand Name	Amphenol	Model Name	ST0228-30-502-A
BT/WLAN_ External Antenna	Brand Name	Amphenol	Model Name	ZB511A-02-001-C
AN650 Antenna cable(5ft/1524mm)	Brand Name	ZEBRA	Model Name	CBLRD-1C4000600R
AN650 Antenna cable(20ft/6096mm)	Brand Name	ZEBRA	Model Name	CBLRD-1C4002400R
AN650 Antenna cable(15ft/4572mm)	Brand Name	ZEBRA	Model Name	CBLRD-1C4001800R
AN650 Antenna cable(30ft/9144mm)	Brand Name	ZEBRA	Model Name	CBLRD-1C4003600R
AN650 Antenna cable(10ft/3048mm)	Brand Name	ZEBRA	Model Name	CBLRD-1C4001200R



1.2 Product Specification of Equipment Under Test

Product Specification is subject to this standard	
Tx/Rx Frequency Range	5180 MHz ~ 5240 MHz 5260 MHz ~ 5320 MHz 5500 MHz ~ 5720 MHz
Maximum Output Power to Antenna	<p><5180 MHz ~ 5240 MHz> <Internal Antenna (Right)> 802.11a: 14.90 dBm / 0.0309 W <Internal Antenna (Left)> 802.11a: 14.80 dBm / 0.0302 W MIMO <Internal Antenna (Right) + Internal Antenna (Left)> 802.11n HT20: 15.77 dBm / 0.0378 W 802.11n HT40: 15.88 dBm / 0.0387 W 802.11ac VHT20: 15.77 dBm / 0.0378 W 802.11ac VHT40: 15.88 dBm / 0.0387 W 802.11ac VHT80: 11.51 dBm / 0.0142 W 802.11ax HE20: 15.87 dBm / 0.0386 W 802.11ax HE40: 15.98 dBm / 0.0396 W 802.11ax HE80: 11.61 dBm / 0.0145 W</p> <p><5260 MHz ~ 5320 MHz> <Internal Antenna (Right)> 802.11a: 14.80 dBm / 0.0302 W <Internal Antenna (Left)> 802.11a: 14.60 dBm / 0.0288 W MIMO <Internal Antenna (Right) + Internal Antenna (Left)> 802.11n HT20: 15.82 dBm / 0.0382 W 802.11n HT40: 15.55 dBm / 0.0359 W 802.11ac VHT20: 15.82 dBm / 0.0382 W 802.11ac VHT40: 15.55 dBm / 0.0359 W 802.11ac VHT80: 11.60 dBm / 0.0145 W 802.11ax HE20: 15.92 dBm / 0.0391 W 802.11ax HE40: 15.65 dBm / 0.0367 W 802.11ax HE80: 11.70 dBm / 0.0148 W</p> <p><5500 MHz ~ 5720 MHz> <Internal Antenna (Right)> 802.11a: 14.80 dBm / 0.0302 W <Internal Antenna (Left)> 802.11a: 14.60 dBm / 0.0288 W MIMO <Internal Antenna (Right) + Internal Antenna (Left)> 802.11n HT20: 15.72 dBm / 0.0373 W 802.11n HT40: 15.61 dBm / 0.0364 W 802.11ac VHT20: 15.72 dBm / 0.0373 W 802.11ac VHT40: 15.61 dBm / 0.0364 W 802.11ac VHT80: 11.75 dBm / 0.0150 W 802.11ax HE20: 15.82 dBm / 0.0382 W 802.11ax HE40: 15.71 dBm / 0.0372 W 802.11ax HE80: 11.85 dBm / 0.0153 W</p>



Product Specification is subject to this standard	
99% Occupied Bandwidth	<Internal Antenna (Right)> 802.11a: 16.73 MHz 802.11ax HE20: 18.83 MHz 802.11ax HE40: 37.76 MHz 802.11ax HE80: 77.56 MHz <Internal Antenna (Left)> 802.11a: 16.78 MHz 802.11ax HE20: 18.83 MHz 802.11ax HE40: 37.86 MHz 802.11ax HE80: 77.68 MHz
Antenna Type	<Internal Antenna (Left)>: PIFA Antenna <Internal Antenna (Right)>: PIFA Antenna <External Antenna 1>: Dipole Antenna <External Antenna 2>: Dipole Antenna
Antenna Gain <Internal Antenna (Left)>	<5150 MHz ~ 5250 MHz>: 5.51 dBi <5250 MHz ~ 5350 MHz>: 5.05 dBi <5470 MHz ~ 5725 MHz> : 4.95 dBi
Antenna Gain <Internal Antenna (Right)>	<5150 MHz ~ 5250 MHz>: 6.30 dBi <5250 MHz ~ 5350 MHz>: 6.39 dBi <5470 MHz ~ 5725 MHz> : 6.52 dBi
Antenna Gain <External Antenna 1>	<5150 MHz ~ 5250 MHz>: 4.22 dBi <5250 MHz ~ 5350 MHz>: 4.37 dBi <5470 MHz ~ 5725 MHz> : 4.15 dBi
Antenna Gain <External Antenna 2>	<5150 MHz ~ 5250 MHz>: 2.60 dBi <5250 MHz ~ 5350 MHz>: 3.09 dBi <5470 MHz ~ 5725 MHz> : 3.70 dBi



Product Specification is subject to this standard			
Type of Modulation	802.11a/n: OFDM (BPSK/QPSK/16QAM/64QAM) 802.11ac: OFDM (BPSK/QPSK/16QAM/64QAM/256QAM) 802.11ax: OFDMA (BPSK/QPSK/16QAM/64QAM/256QAM/1024QAM)		
Antenna Function Description		Internal Antenna (Left)	Internal Antenna (Right)
	802.11 a/n/ac/ax	V	V
	802.11 n/ac/ax MIMO	V	V
		External Antenna 1	External Antenna 2
	802.11 a/n/ac/ax	V	V
	802.11 n/ac/ax MIMO	V	V

Remark:

1. MIMO Internal Antenna (Right) + Internal Antenna (Left) Directional Gain is a calculated result from MIMO Internal Antenna (Right) + Internal Antenna (Left). The formula used in calculation is documented in section 1.2.1.
2. Power of MIMO Internal Antenna (Right) + Internal Antenna (Left) is a calculated result from sum of the power MIMO Internal Antenna (Right) + Internal Antenna (Left).
3. Power of MIMO External Antenna 1 + External Antenna 2 is a calculated result from sum of the power MIMO External Antenna 1 + External Antenna 2.
4. The EUT's information above is declared by manufacturer. Please refer to Disclaimer in report summary.

1.2.1 Antenna Directional Gain

<For CDD Mode>

Follows FCC KDB 662911 D01 Multiple Transmitter Output v02r01 F2)f)ii)

Directional gain = G_{ANT} + Array Gain, where Array Gain is as follows:

For power measurements on IEEE 802.11 devices,

Array Gain = 0 dB (i.e., no array gain) for $N_{ANT} \leq 4$.

G_{ANT} is set equal to the gain of the antenna having the highest gain.

For PSD measurements, the directional gain calculation.

$$DirectionalGain = 10 \cdot \log \left[\frac{\sum_{j=1}^{N_{SS}} \left\{ \sum_{k=1}^{N_{ANT}} g_{j,k} \right\}^2}{N_{ANT}} \right]$$

where

Each antenna is driven by no more than one spatial stream;

N_{SS} = the number of independent spatial streams of data;

N_{ANT} = the total number of antennas

$g_{j,k} = 10^{G_k/20}$ if the k th antenna is being fed by spatial stream j , or zero if it is not;
 G_k is the gain in dBi of the k th antenna.

As minimum $N_{SS}=1$ is supported by EUT, the formula can be simplified as:

$$Directional\ gain = 10 \cdot \log \left[\left(10^{G_1/20} + 10^{G_2/20} + \dots + 10^{G_N/20} \right)^2 / N_{ANT} \right] \text{ dBi}$$

Where G_1, G_2, \dots, G_N denote single antenna gain.



The directional gain "DG" is calculated as following table.

			DG	DG	Power	PSD
			for	for	Limit	Limit
	Internal Antenna (Right)	Internal Antenna (Left)	Power	PSD	Reduction	Reduction
	(dBi)	(dBi)	(dBi)	(dBi)	(dB)	(dB)
Band I	6.30	5.51	6.30	8.92	0.30	2.92
Band II	6.39	5.05	6.39	8.76	0.39	2.76
Band III	6.52	4.95	6.52	8.78	0.52	2.78

Calculation example:

If a device has two antenna, $G_{ANT7}= 6.30\text{dBi}$; $G_{ANT8}=5.51\text{dBi}$

Directional gain of power measurement = $\max(6.30, 5.51) + 0 = 6.30 \text{ dBi}$

Directional gain of PSD derived from formula which is

$$10 \times \log \left\{ \left[10^{(6.30 \text{ dBi} / 20)} + 10^{(5.51 \text{ dBi} / 20)} \right]^2 / 2 \right\}$$

$$= 8.92 \text{ dBi}$$

Power and PSD limit reduction = Composite gain – 6dBi, (min = 0)



1.3 Modification of EUT

No modifications made to the EUT during the testing.

1.4 Testing Location

Test Site	Sporton International Inc. EMC & Wireless Communications Laboratory
Test Site Location	No.52, Huaya 1st Rd., Guishan Dist., Taoyuan City 333, Taiwan (R.O.C.) TEL: +886-3-327-3456 FAX: +886-3-328-4978
Test Site No.	Sporton Site No. CO05-HY, 03CH07-HY

Note: The test site complies with ANSI C63.4 2014 requirement.

Test Site	Sporton International Inc. Wensan Laboratory
Test Site Location	No.58, Aly. 75, Ln. 564, Wenhua 3rd, Rd., Guishan Dist., Taoyuan City 333010, Taiwan (R.O.C.) TEL: +886-3-327-0868 FAX: +886-3-327-0855
Test Site No.	Sporton Site No. TH05-HY (TAF Code: 3786)
Remark	The Conducted test item subcontracted to Sporton International Inc. Wensan Laboratory.

FCC designation No.: TW1190 and TW3786

1.5 Applicable Standards

According to the specifications declared by the manufacturer, the EUT must comply with the requirements of the following standards:

- ♦ FCC Part 15 Subpart E
- ♦ FCC KDB 789033 D02 General UNII Test Procedures New Rules v02r01.
- ♦ FCC KDB 414788 D01 Radiated Test Site v01r01.
- ♦ FCC KDB 662911 D01 Multiple Transmitter Output v02r01.
- ♦ ANSI C63.10-2013

Remark:

1. All the test items were validated and recorded in accordance with the standards without any modification during the testing.
2. The TAF code is not including all the FCC KDB listed without accreditation.
3. This EUT has also been tested and complied with the requirements of FCC Part 15, Subpart B, recorded in a separate test report.



2 Test Configuration of Equipment Under Test

- a. The EUT has been associated with peripherals and configuration operated in a manner tended to maximize its emission characteristics in a typical application. Frequency range investigated: conduction emission (150 kHz to 30 MHz), radiation emission (9 kHz to the 10th harmonic of the highest fundamental frequency or to 40 GHz, whichever is lower). For radiated measurement, the measured emission level of the EUT was maximized by rotating the EUT on a turntable, adjusting the orientation of the EUT and EUT antenna in three orthogonal axis (X: flat, Y: portrait, Z: landscape), and adjusting the measurement antenna orientation, following C63.10 exploratory test procedures and only the worst case emissions were reported in this report.
- b. AC power line Conducted Emission was tested under maximum output power.

2.1 Carrier Frequency and Channel

Frequency Band	Channel	Freq. (MHz)	Channel	Freq. (MHz)
5150-5250 MHz Band 1 (U-NII-1)	36	5180	44	5220
	38*	5190	46*	5230
	40	5200	48	5240
	42 [#]	5210		

Frequency Band	Channel	Freq. (MHz)	Channel	Freq. (MHz)
5250-5350 MHz Band 2 (U-NII-2A)	52	5260	60	5300
	54*	5270	62*	5310
	56	5280	64	5320
	58 [#]	5290		

Frequency Band	Channel	Freq. (MHz)	Channel	Freq. (MHz)
5470-5725 MHz Band 3 (U-NII-2C)	100	5500	112	5560
	102*	5510	116	5580
	104	5520	132	5660
	106 [#]	5530	134*	5670
	108	5540	136	5680
	110*	5550	140	5700



Frequency Band	Channel	Freq. (MHz)	Channel	Freq. (MHz)
TDWR Channel	118*	5590	124	5620
	120	5600	126*	5630
	122 [#]	5610	128	5640

Frequency Band	Channel	Freq. (MHz)	Channel	Freq. (MHz)
Straddle Channel	138 [#]	5690	144	5720
	142*	5710		

Note:

1. The above Frequency and Channel with "*" are 802.11n HT40 and 802.11ac VHT40 and 802.11ax HE40.
2. The above Frequency and Channel with "[#]" are 802.11ac VHT80 and 802.11ax HE80.



2.2 Test Mode

The power for 802.11n and 802.11ac mode is smaller than 802.11ax mode, so all other conducted and radiated test is covered by 802.11ax mode.

The final test modes include the worst data rates for each modulation shown in the table below.

Single Mode

Modulation	Data Rate
802.11a	6 Mbps

MIMO Mode

Modulation	Data Rate
802.11n HT20 (Covered by HE20)	MCS0
802.11n HT40 (Covered by HE40)	MCS0
802.11ac VHT20 (Covered by HE20)	MCS0
802.11ac VHT40 (Covered by HE40)	MCS0
802.11ac VHT80 (Covered by HE80)	MCS0
802.11ax HE20	MCS0
802.11ax HE40	MCS0
802.11ax HE80	MCS0



Test Cases	
AC Conducted Emission	Mode 1 : WLAN 5G Link + ADP-USB0010-M12 (3-way USB Splitter) (2) + CBL-GP0050-M12M12A, 5m (GPIO Extension) (7) + PS OUTPUT CABLE + PWR-BGA24V78W3WW (Indoor AC-DC PSU) (30) + BT link + CBL-USBCNST015-M12, 1.5m (3) load with USB dongle + CBL-ENT01500-M1200,15M (27) data link with NB + RFID link + CBL-USBCNST035-M12, 3.5m (23) load with USB dongle + CBL-USBCCLT015-M12, 1.5m (5) load with NB for Sample 2
Remark:	
1. For Radiated Test Cases, the tests were performed with Sample 1 and Sample 2.	
2. Data Link with Notebook means data application transferred mode between EUT and Notebook.	

<Sample 1>

Ch. #		Band II : 5250-5350 MHz
		802.11ax HE80
L	Low	-
M	Middle	58
H	High	-

<Sample 2>

Ch. #		Band I : 5150-5250 MHz	Band II : 5250-5350 MHz	Band III : 5470-5725MHz
		802.11a	802.11a	802.11a
L	Low	36	52	100
M	Middle	44	60	116
H	High	48	64	140
Straddle		-	-	144

Ch. #		Band I : 5150-5250 MHz	Band II : 5250-5350 MHz	Band III : 5470-5725MHz
		802.11ax HE20	802.11ax HE20	802.11ax HE20
L	Low	36	52	100
M	Middle	44	60	116
H	High	48	64	140
Straddle		-	-	144

Ch. #		Band I : 5150-5250 MHz	Band II : 5250-5350 MHz	Band III : 5470-5725MHz
		802.11ax HE40	802.11ax HE40	802.11ax HE40
L	Low	38	54	102
M	Middle	-	-	110
H	High	46	62	134
Straddle		-	-	142

Ch. #		Band I : 5150-5250 MHz	Band II : 5250-5350 MHz	Band III : 5470-5725MHz
		802.11ax HE80	802.11ax HE80	802.11ax HE80
L	Low	-	-	106
M	Middle	42	58	-
H	High	-	-	122
Straddle		-	-	138

Remark: For radiation spurious emission, the modulation and the data rate picked for testing are determined by the Max. RF conducted power.

2.3 Connection Diagram of Test System

<AC Conducted Emission Mode>

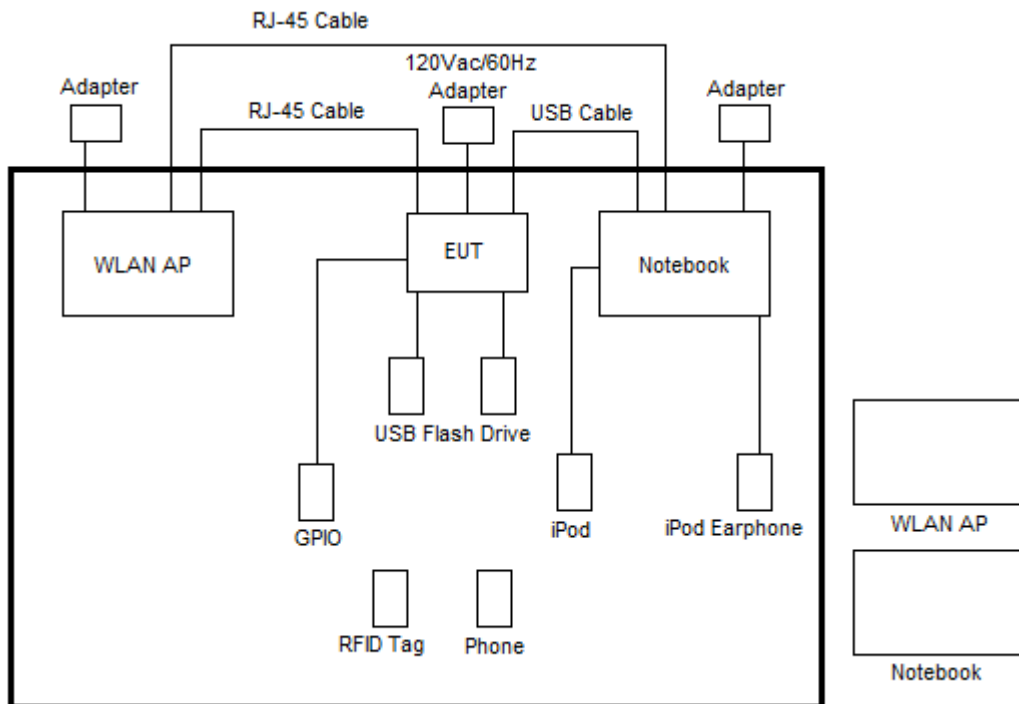

<WLAN Tx Mode for Internal Antenna>

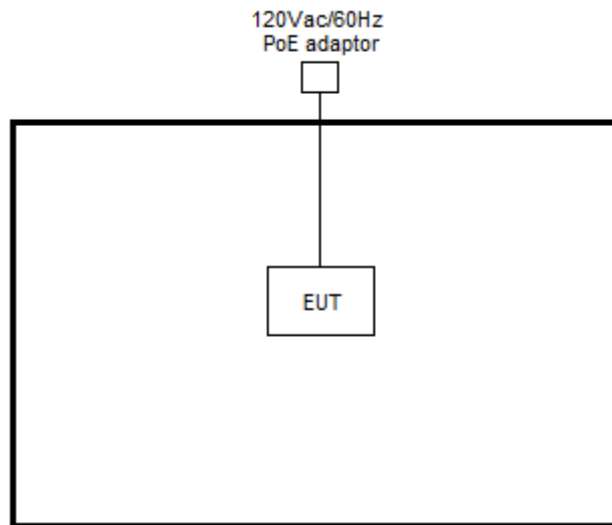

<WLAN Tx Mode for External Antenna>

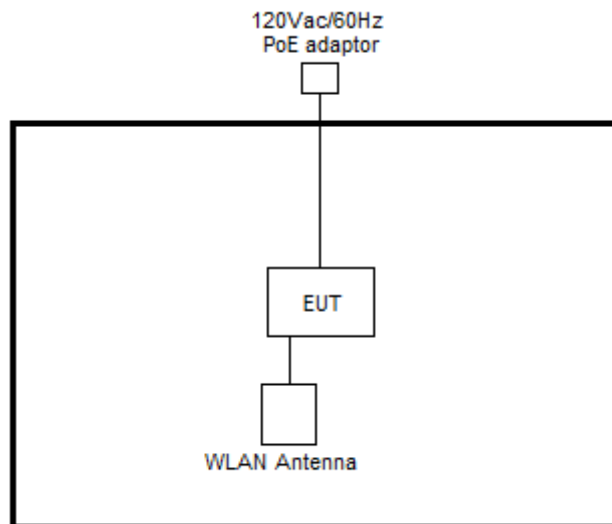



2.4 Support Unit used in test configuration and system

Item	Equipment	Brand Name	Model Name	FCC ID	Data Cable	Power Cord
1.	WLAN AP	ASUS	RT-AC66U	MSQ-RTAC66U	N/A	Unshielded, 1.8 m
2.	Notebook	Dell	Latitude 3420	FCC DoC	N/A	AC I/P: Unshielded, 1.2 m DC O/P: Shielded, 1.8 m
3.	iPod	Apple	A1285	DoC	Shielded, 1.0m	N/A
4.	iPod Earphone	Apple	N/A	Verification	Unshielded, 1.0 m	N/A
5.	USB Flash Drive	SanDisk	E8BOC	N/A	N/A	N/A
6.	Phone	ZEBRA	TC26	N/A	N/A	N/A

2.5 EUT Operation Test Setup

The RF test items, utility “Tera Term Version 4.95” was installed in Notebook which was programmed in order to make the EUT get into the engineering modes to provide channel selection, power level, data rate and the application type and for continuous transmitting signals.

2.6 Measurement Results Explanation Example

For all conducted test items:

The offset level is set in the spectrum analyzer to compensate the RF cable loss and attenuator factor between EUT conducted output port and spectrum analyzer. With the offset compensation, the spectrum analyzer reading level is exactly the EUT RF output level.

Example :

The spectrum analyzer offset is derived from RF cable loss and attenuator factor.

Offset = RF cable loss + attenuator factor.

Following shows an offset computation example with cable loss 4.2 dB and 10 dB attenuator.

$$\begin{aligned} \text{Offset(dB)} &= \text{RF cable loss(dB)} + \text{attenuator factor(dB)} \\ &= 4.2 + 10 = 14.2 \text{ (dB)} \end{aligned}$$

3 Test Result

3.1 26dB & 99% Occupied Bandwidth Measurement

3.1.1 Description of 26dB & 99% Occupied Bandwidth

This section is for reporting purpose only.

There is no restriction limits for bandwidth.

For Straddle Channel, according to KDB 789033 D02 General UNII Test Procedures New Rules v02r01, if the power and PSD of the devices are uniform and comply with the lower limits specified for the U-NII-2 bands, a single measurement over the entire emission bandwidth can be performed to show compliance.

3.1.2 Measuring Instruments

Please refer to the measuring equipment list in this test report.

3.1.3 Test Procedures

1. The testing follows FCC KDB 789033 D02 General UNII Test Procedures New Rules v02r01. Section C) Emission bandwidth
2. Set RBW = approximately 1% of the emission bandwidth.
3. Set the VBW > RBW.
4. Detector = Peak.
5. Trace mode = max hold
6. Measure the maximum width of the emission that is 26 dB down from the peak of the emission. Compare this with the RBW setting of the analyzer. Readjust RBW and repeat measurement as needed until the RBW/EBW ratio is approximately 1%.
7. For 99% Bandwidth Measurement, the spectrum analyzer's resolution bandwidth (RBW) is set 1-5% of the emission bandwidth and set the Video bandwidth (VBW) $\geq 3 * RBW$.
8. Measure and record the results in the test report.

3.1.4 Test Setup

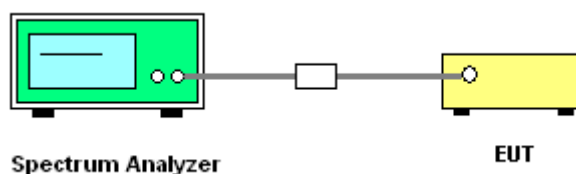

3.1.5 Test Result of 26dB & 99% Occupied Bandwidth

Please refer to Appendix A.



<Internal Antenna (Right)>

<802.11a>

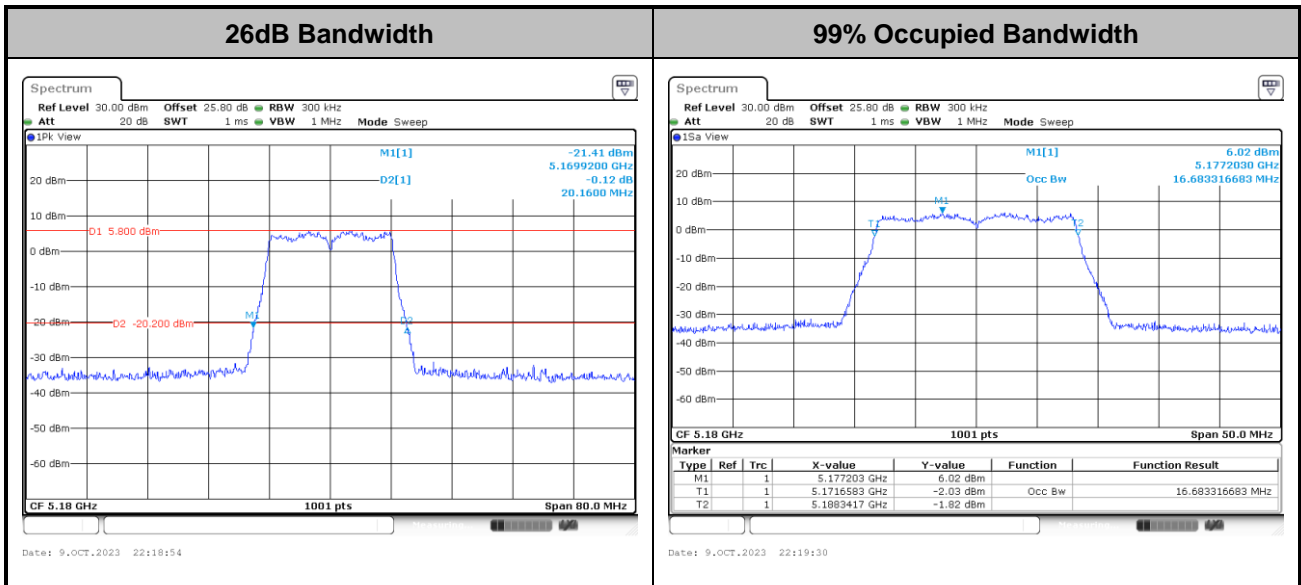

Note: The occupied channel bandwidth is maintained within the band of operation for all of the modulations.

<Internal Antenna (Left)>

<802.11a>

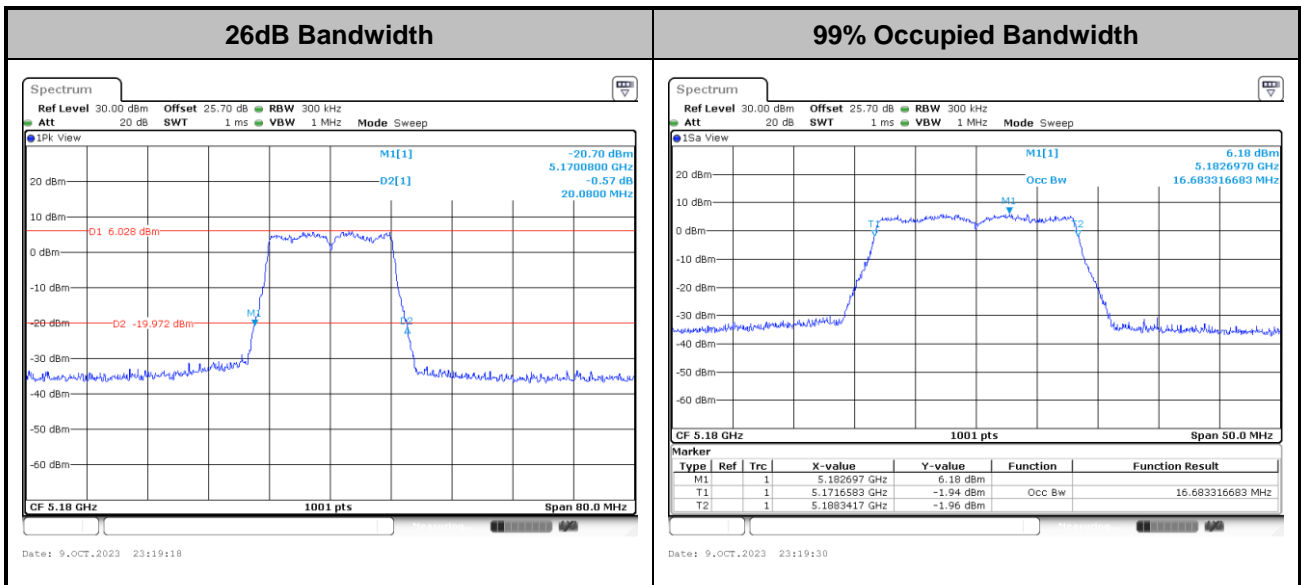

Note: The occupied channel bandwidth is maintained within the band of operation for all of the modulations.



MIMO <Internal Antenna (Right) + Internal Antenna (Left)>

<802.11ax HE20>

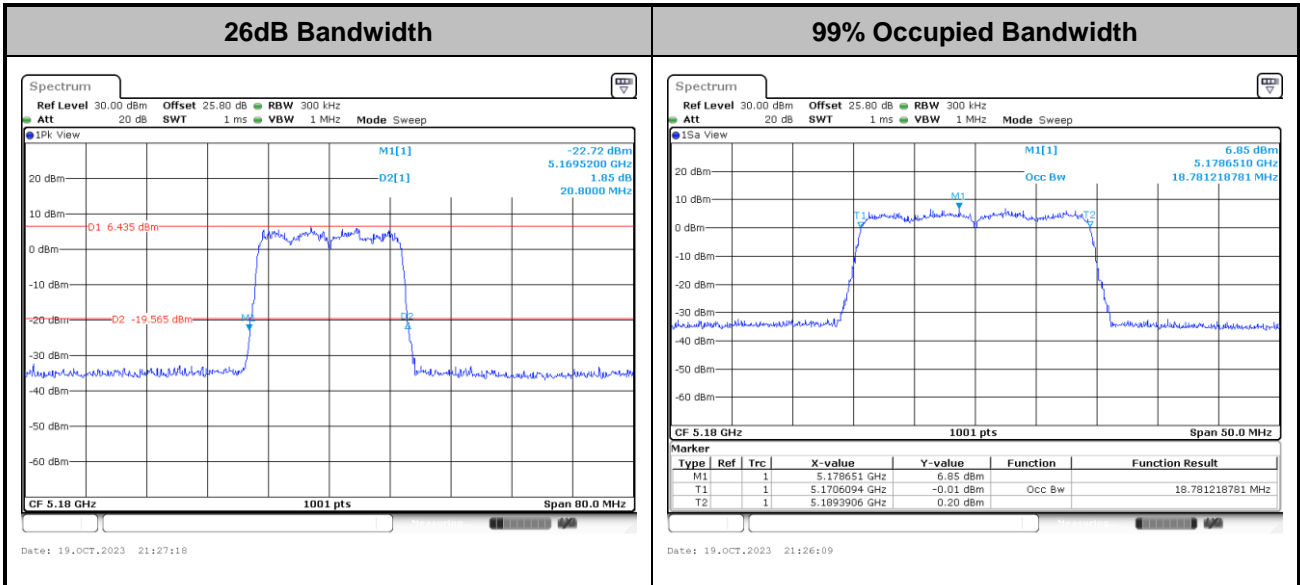

Note: The occupied channel bandwidth is maintained within the band of operation for all of the modulations.

<802.11ax HE40>

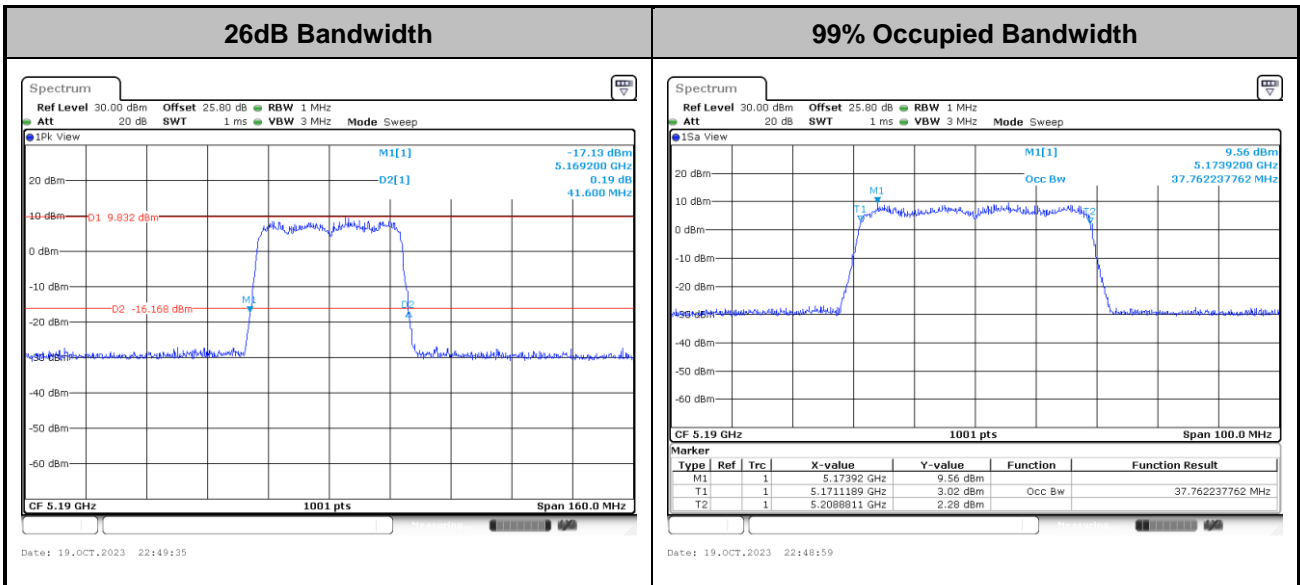

Note: The occupied channel bandwidth is maintained within the band of operation for all of the modulations.



<802.11ax HE80>

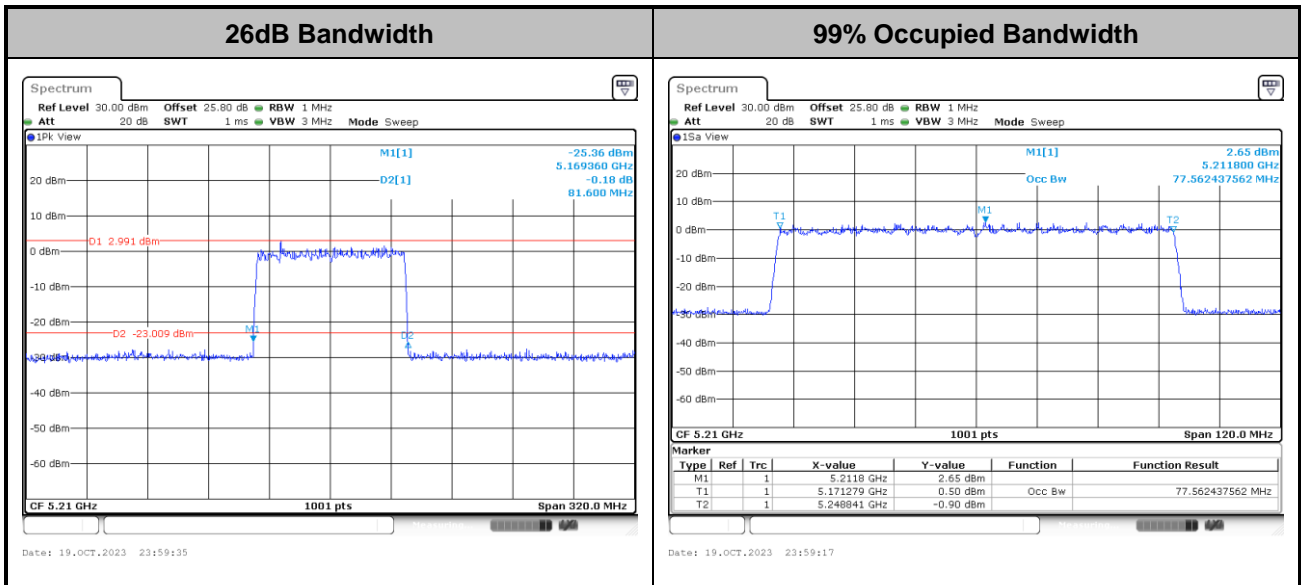

Note: The occupied channel bandwidth is maintained within the band of operation for all of the modulations.



3.2 Maximum Conducted Output Power Measurement

3.2.1 Limit of Maximum Conducted Output Power

<FCC 14-30 CFR 15.407>

For the 5.15–5.25 GHz bands:

■ For mobile and portable client devices in the 5.15–5.25 GHz band, the maximum conducted output power over the frequency band of operation shall not exceed 250 mW. For an indoor access point operating in the band 5.15-5.25 GHz, the maximum conducted output power over the frequency band of operation shall not exceed 1 W.

For the 5.25–5.725 GHz bands:

■ The maximum conducted output power over the frequency bands of operation shall not exceed the lesser of 250 mW or $11 \text{ dBm} + 10 \log B$, where B is the 26 dB emission bandwidth in megahertz.

For Straddle Channel, according to KDB 789033 D02 General UNII Test Procedures New Rules v02r01, if the power and PSD of the devices are uniform and comply with the lower limits specified for the U-NII-2 bands, a single measurement over the entire emission bandwidth can be performed to show compliance.

If transmitting antennas of directional gain greater than 6 dBi are used, the peak output power shall be reduced by the amount in dB that the directional gain of the antenna exceeds 6 dBi.

Note that U-NII-2 band, devices with a maximum e.i.r.p. greater than 500 mW shall implement TPC in order to have the capability to operate at least 6 dB below the maximum permitted e.i.r.p. of 1 W.

3.2.2 Measuring Instruments

Please refer to the measuring equipment list in this test report.

3.2.3 Test Procedures

The testing follows Method PM-G of FCC KDB 789033 D02 General UNII Test Procedures New Rules v02r01.

Method PM-G (Measurement using a gated RF average power meter):

1. Measurement is performed using a wideband RF power meter.
2. The EUT is configured to transmit at its maximum power control level.
3. Measure the average power of the transmitter.
4. Since the measurement is made only during the ON time of the transmitter, no duty cycle correction factor is required.
5. For MIMO mode, calculation method follows FCC KDB 662911 D01 Multiple Transmitter Output v02r01

For Straddle Channel, according to KDB 789033 D02 General UNII Test Procedures New Rules v02r01, if the power and PSD of the devices are uniform and comply with the lower limits specified for the U-NII-2 bands, a single measurement over the entire emission bandwidth can be performed to show compliance.

3.2.4 Test Setup

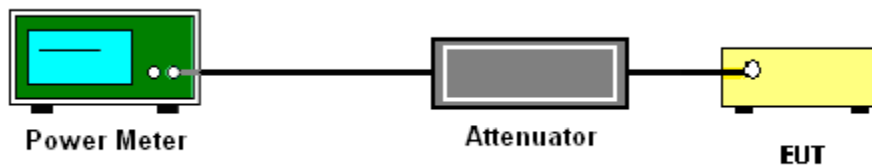

3.2.5 Test Result of Maximum Conducted Output Power

Please refer to Appendix A.



3.3 Power Spectral Density Measurement

3.3.1 Limit of Power Spectral Density

<FCC 14-30 CFR 15.407>

For the 5.15–5.25 GHz bands:

For mobile and portable client devices in the 5.15–5.25 GHz band, the maximum power spectral density shall not exceed 11 dBm in any 1.0 MHz band. For an indoor access point operating in the band 5.15-5.25 GHz, the maximum power spectral density shall not exceed 17 dBm in any 1.0 MHz band.

For the 5.25–5.725 GHz bands:

The maximum power spectral density shall not exceed 11 dBm in any 1.0 MHz band.

For Straddle Channel, according to KDB 789033 D02 General UNII Test Procedures New Rules v02r01, if the power and PSD of the devices are uniform and comply with the lower limits specified for the U-NII-2 bands, a single measurement over the entire emission bandwidth can be performed to show compliance.

If transmitting antennas of directional gain greater than 6 dBi are used, the peak output power shall be reduced by the amount in dB that the directional gain of the antenna exceeds 6 dBi.

3.3.2 Measuring Instruments

Please refer to the measuring equipment list in this test report.

3.3.3 Test Procedures

The testing follows FCC KDB 789033 D02 General UNII Test Procedures New Rules v02r01.
Section F) Maximum power spectral density.

Method SA-2

(trace averaging across on and off times of the EUT transmissions, followed by duty cycle correction).

- Measure the duty cycle.
 - Set span to encompass the entire emission bandwidth (EBW) of the signal.
 - Set RBW = 1 MHz.
 - Set VBW \geq 3 MHz.
 - Number of points in sweep \geq 2 Span / RBW.
 - Sweep time = auto.
 - Detector = RMS
 - Trace average at least 100 traces in power averaging mode.
 - Add $10 \log(1/x)$, where x is the duty cycle, to the measured power in order to compute the average power during the actual transmission times. For example, add $10 \log(1/0.25) = 6$ dB if the duty cycle is 25 percent.
1. The RF output of EUT is connected to the spectrum analyzer by a low loss cable.
 2. Each plot has already offset with cable loss, and attenuator loss. Measure the PPSD and record it.
 3. For MIMO mode, calculation method follows FCC KDB 662911 D01 Multiple Transmitter Output v02r01.

Method (a): Measure and sum the spectra across the outputs.

The total final Power Spectral Density is from a device with 2 transmitter outputs. The spectrum measurements of the individual outputs are all performed with the same span and number of points; the spectrum value in the first spectral bin of output 1 is summed with that in the first spectral bin of output 2 to obtain the value for the first frequency bin of the summed spectrum.

3.3.4 Test Setup

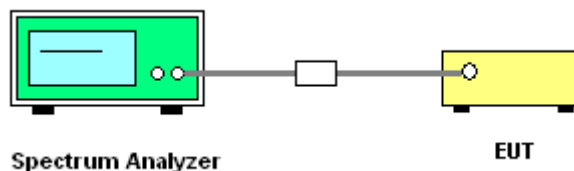

3.3.5 Test Result of Power Spectral Density

Please refer to Appendix A.



<Internal Antenna (Right)>

<802.11a>

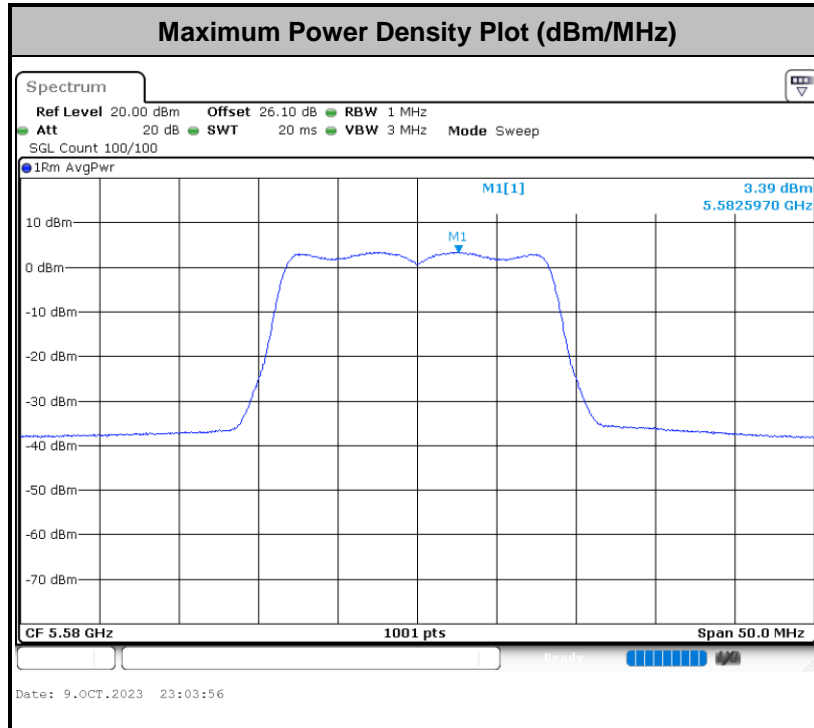

<Internal Antenna (Left)>

<802.11a>

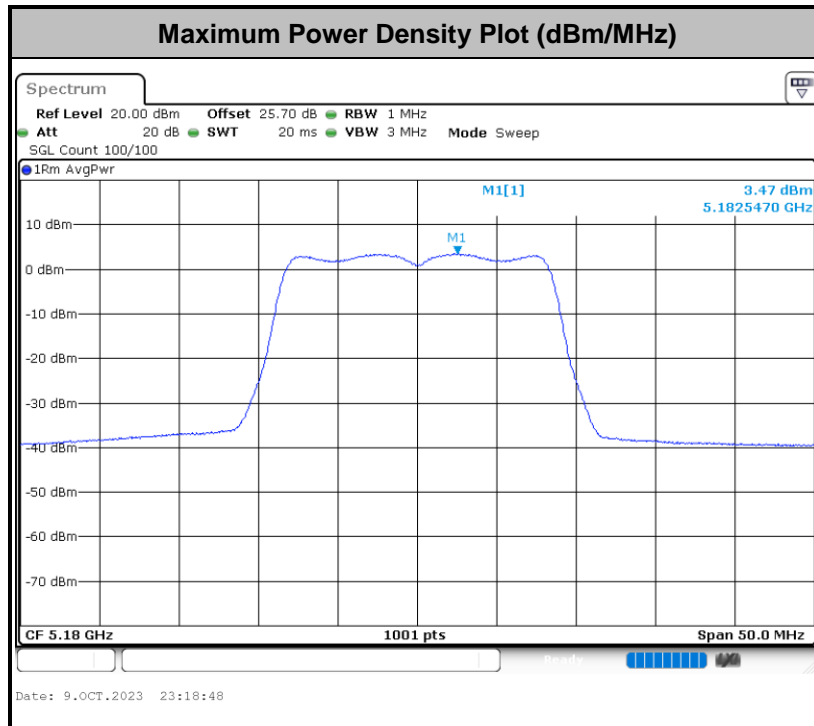



<802.11ax HE20>

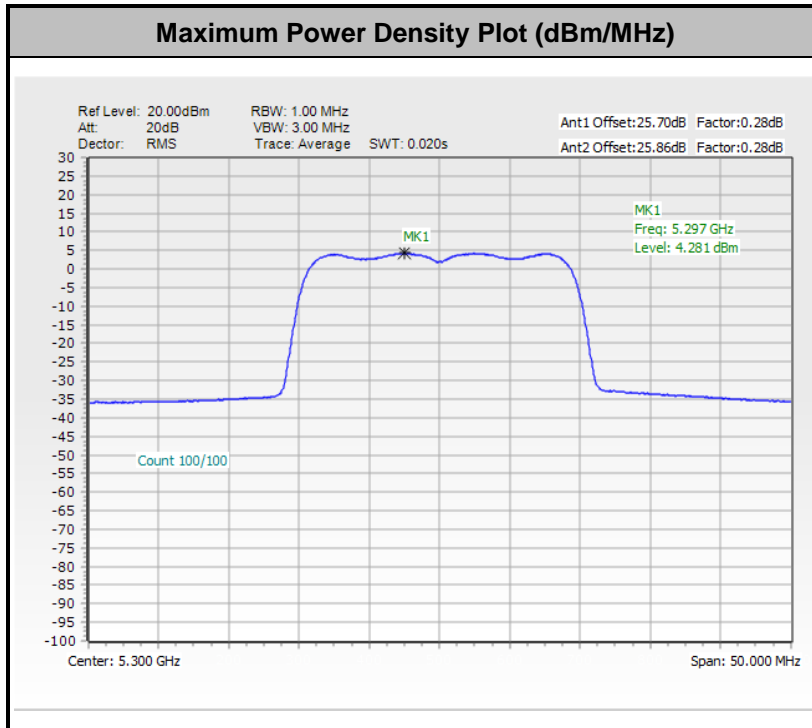

Remark: The test plot is showing a bin by bin combined result mathematically adds two traces.

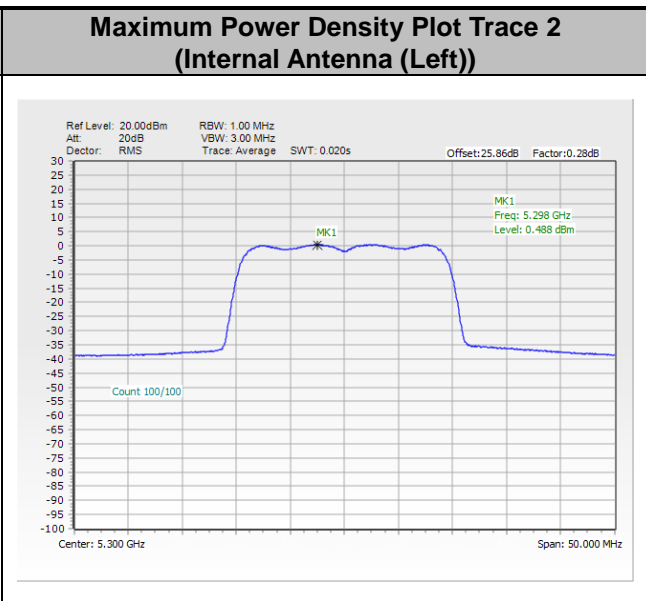
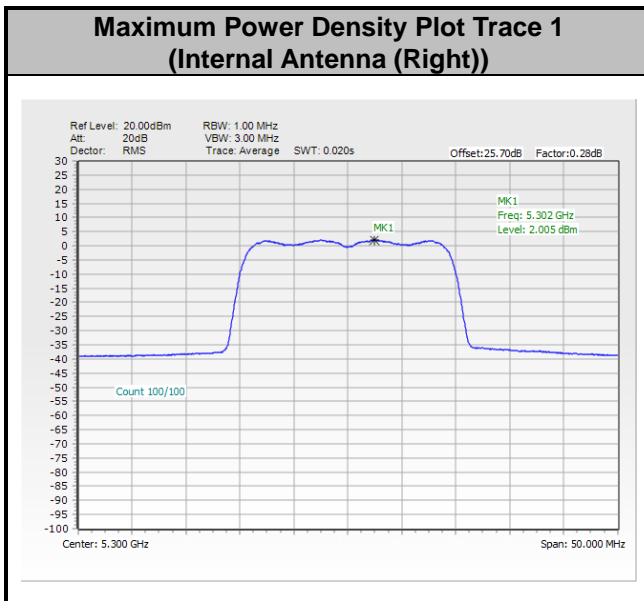



<802.11ax HE40>

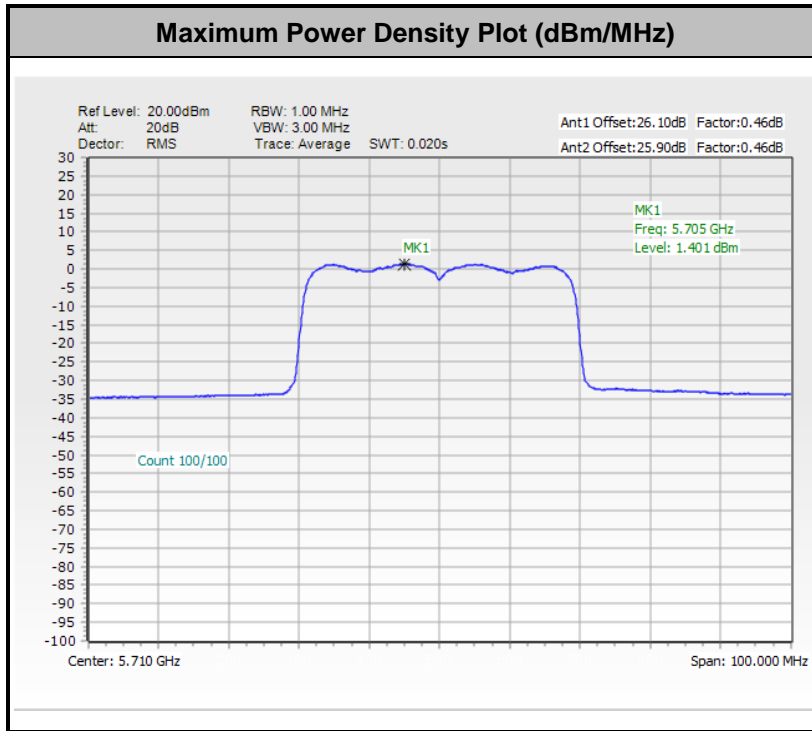

Remark: The test plot is showing a bin by bin combined result mathematically adds two traces.

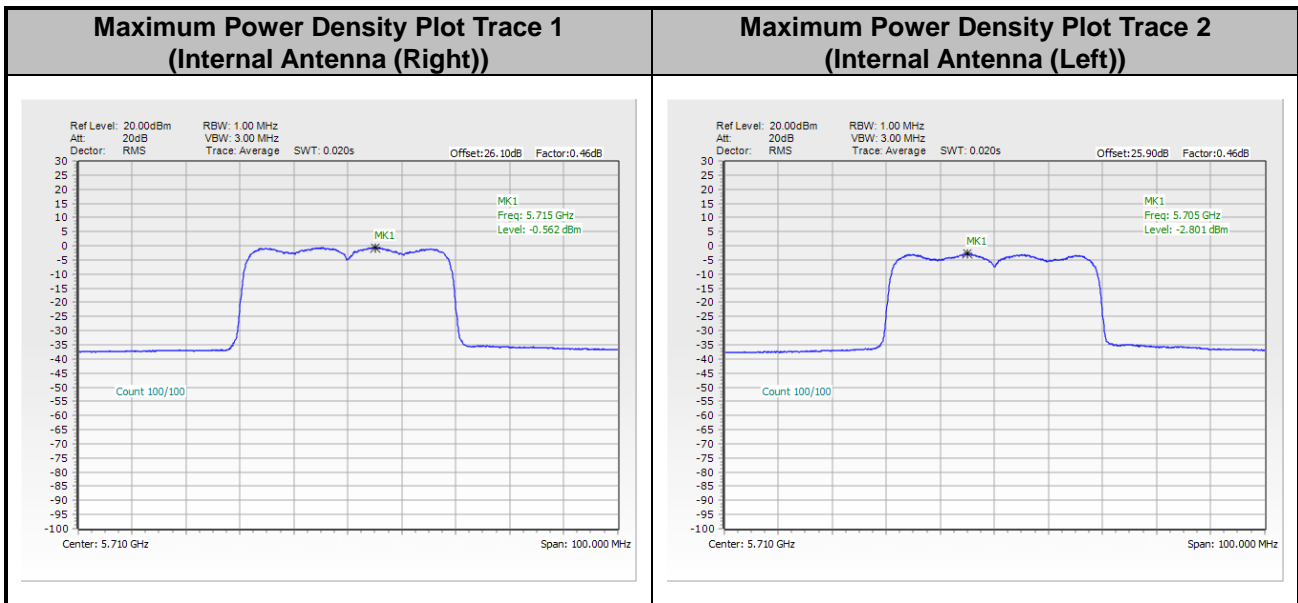



<802.11ax HE80>

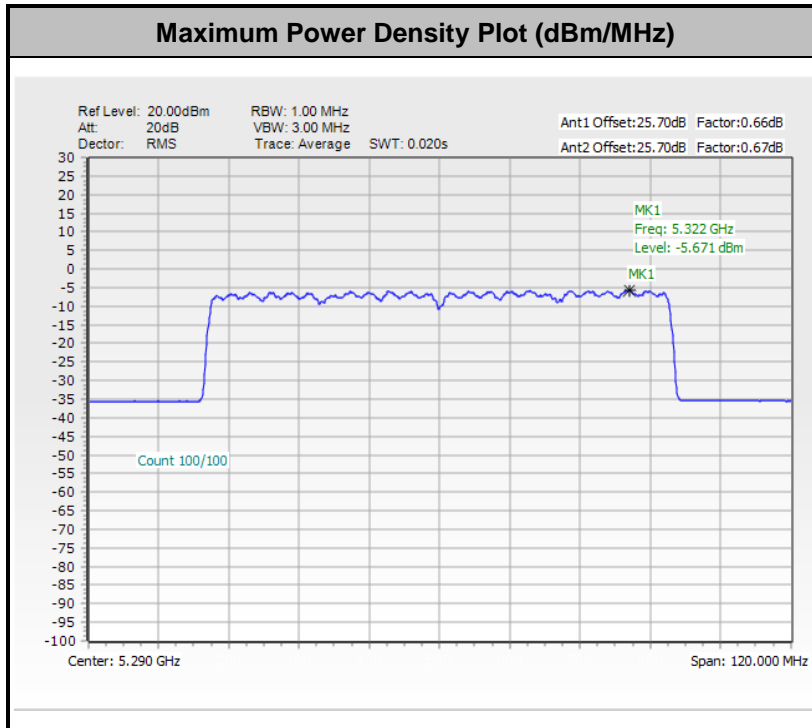

Remark: The test plot is showing a bin by bin combined result mathematically adds two traces.

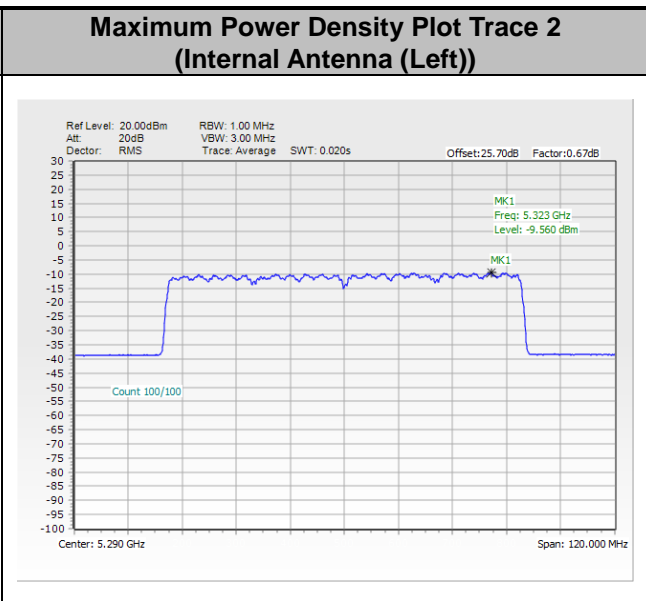
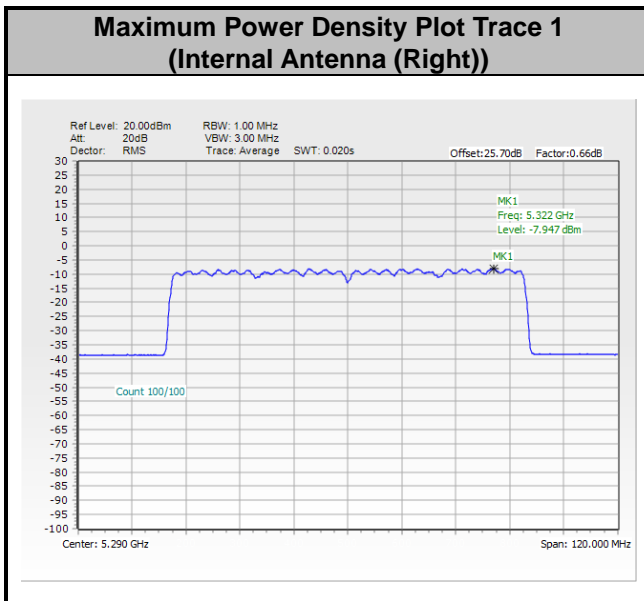



3.4 Unwanted Emissions Measurement

This section is to measure unwanted emissions through radiated measurement for band edge spurious emissions and out of band emissions measurement.

3.4.1 Limit of Unwanted Emissions

- (1) For transmitters operating in the 5150-5250 MHz band: all emissions outside of the 5150-5350 MHz band shall not exceed an EIRP of -27dBm/MHz.

For transmitters operating in the 5250-5350 MHz band: all emissions outside of the 5150-5350 MHz band shall not exceed an EIRP of -27 dBm/MHz. Devices operating in the 5250-5350 MHz band that generate emissions in the 5150-5250 MHz band must meet all applicable technical requirements for operation in the 5150-5250 MHz band (including indoor use) or alternatively meet an out-of-band emission EIRP limit of -27 dBm/MHz in the 5150-5250 MHz band.

For transmitters operating in the 5470-5600 MHz and 5650-5725MHz band: all emissions outside of the 5470-5600 MHz and 5650-5725MHz band shall not exceed an EIRP of -27 dBm/MHz.

- (2) Unwanted spurious emissions falls in restricted bands shall comply with the general field strength limits as below table:

Frequency (MHz)	Field Strength (microvolts/meter)	Measurement Distance (meters)
0.009 – 0.490	2400/F(kHz)	300
0.490 – 1.705	24000/F(kHz)	30
1.705 – 30.0	30	30
30 – 88	100	3
88 – 216	150	3
216 - 960	200	3
Above 960	500	3

Note: The following formula is used to convert the EIRP to field strength.

$$E = \frac{1000000\sqrt{30P}}{3} \mu\text{V/m, where P is the eirp (Watts)}$$



EIRP (dBm)	Field Strength at 3m (dBμV/m)
- 27	68.3

(3) KDB789033 D02 v02r01 G)2)c)

(i) Sections 15.407(b)(1-3) specifies the unwanted emissions limit for the U-NII-1 and U-NII-2 bands. As specified, emissions above 1000 MHz that are outside of the restricted bands are subject to a peak emission limit of -27 dBm/MHz.

(ii) Section 15.407(b)(4) specifies the unwanted emissions limit for the U-NII-3 band. A band emissions mask is specified in Section 15.407(b)(4)(i). The emission limits are based on the use of a peak detector.

3.4.2 Measuring Instruments

Please refer to the measuring equipment list in this test report.

3.4.3 Test Procedures

1. The testing follows FCC KDB 789033 D02 General UNII Test Procedures New Rules v02r01. Section G) Unwanted emissions measurement.

(1) Procedure for Unwanted Emissions Measurements Below 1000 MHz

- RBW = 120 kHz
- VBW = 300 kHz
- Detector = Peak
- Trace mode = max hold

(2) Procedure for Peak Unwanted Emissions Measurements Above 1000 MHz

- RBW = 1 MHz
- VBW ≥ 3 MHz
- Detector = Peak
- Sweep time = auto
- Trace mode = max hold

(3) Procedures for Average Unwanted Emissions Measurements Above 1000 MHz

- RBW = 1 MHz
- VBW = 10 Hz, when duty cycle is no less than 98 percent.
- $VBW \geq 1/T$, when duty cycle is less than 98 percent where T is the minimum transmission duration over which the transmitter is on and is transmitting at its maximum power control level for the tested mode of operation.

2. The EUT is placed on a turntable with 0.8 meter for frequency below 1 GHz and 1.5 meter for frequency above 1 GHz respectively above ground.
3. The EUT is set 3 meters away from the receiving antenna which is mounted on the top of a variable height antenna tower.
4. The antenna is a broadband antenna and its height is adjusted between one meter and four meters above ground to find the maximum value of the field strength for both horizontal polarization and vertical polarization of the antenna.
5. For each suspected emission, the EUT is arranged to its worst case and then adjust the antenna tower (from 1 m to 4 m) and turntable (from 0 degree to 360 degrees) to find the maximum reading.
6. Radiated testing below 1 GHz is performed by adjusting the antenna tower from 1 m to 4 m and by rotating the turn table from 0 degree to 360 degrees to find the peak maximum hold reading. When there is no suspected emission found and the emission level is with at least 6 dB margin against QP limit line, the position is marked as “-”.
7. Radiated testing above 1 GHz is performed by adjusting the antenna tower from 1 m to 4 m and by rotating the turn table from 0 degree to 360 degrees to find the peak maximum hold reading for scanning all frequencies. When there is no suspected emission found and the harmonic emission level is with at least 6 dB margin against average limit line, the position is marked as “-”.

3.4.4 Test Setup

For radiated emissions below 30MHz

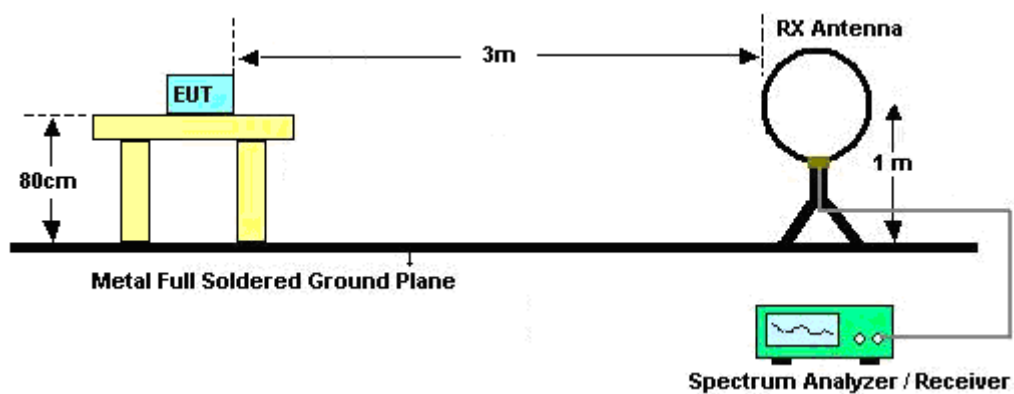

For radiated emissions from 30MHz to 1GHz

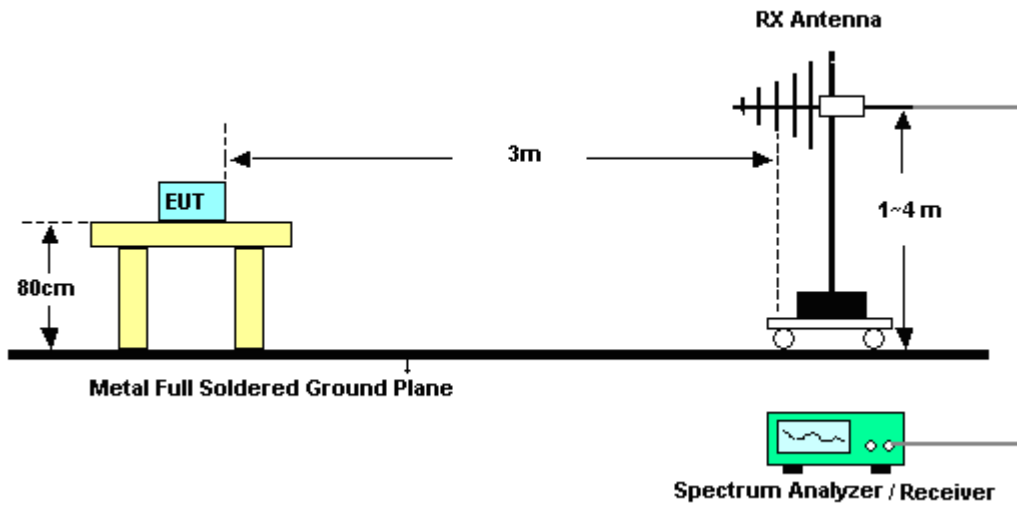

For radiated test from 1GHz to 18GHz

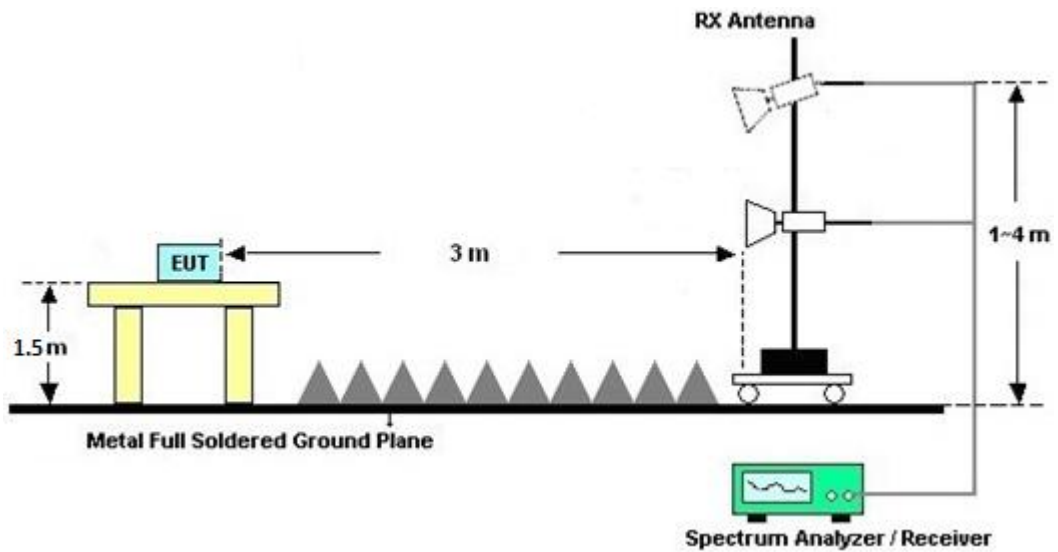

For radiated test above 18GHz

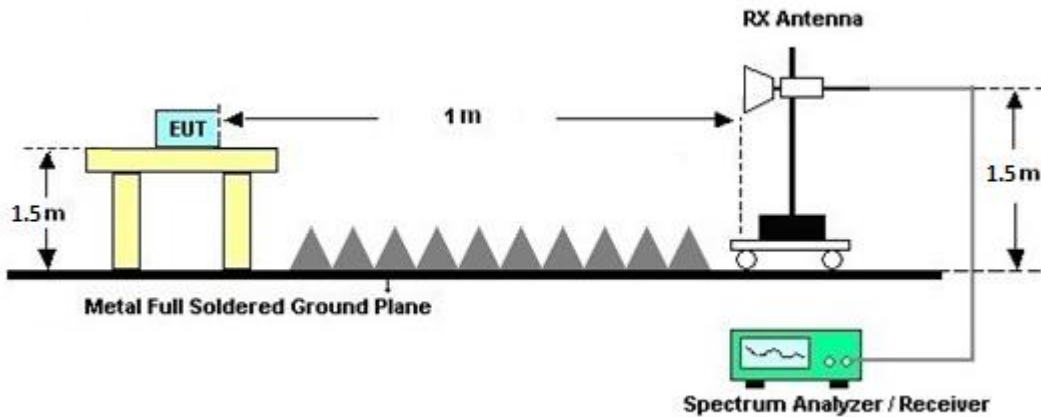

3.4.5 Test Results of Radiated Spurious Emissions (9 kHz ~ 30 MHz)

The low frequency, which starts from 9 kHz to 30 MHz, is pre-scanned and the result which is 20 dB lower than the limit line is not reported.

There is adequate comparison measurement of both open-field test site and alternative test site - semi-Anechoic chamber according to 414788 D01 Radiated Test Site v01r01, and the result came out very similar.

3.4.6 Test Result of Radiated Spurious at Band Edges

Please refer to Appendix C and D.

3.4.7 Duty Cycle

Please refer to Appendix E.

3.4.8 Test Result of Radiated Spurious Emissions (30MHz ~ 10th Harmonic)

Please refer to Appendix C and D.



3.5 AC Conducted Emission Measurement

3.5.1 Limit of AC Conducted Emission

For equipment that is designed to be connected to the public utility (AC) power line, the radio frequency voltage that is conducted back onto the AC power line on any frequency or frequencies within the band 150 kHz to 30 MHz shall not exceed the limits in the following table.

Frequency of emission (MHz)	Conducted limit (dB μ V)	
	Quasi-peak	Average
0.15-0.5	66 to 56*	56 to 46*
0.5-5	56	46
5-30	60	50

*Decreases with the logarithm of the frequency.

3.5.2 Measuring Instruments

Please refer to the measuring equipment list in this test report.

3.5.3 Test Procedures

1. The EUT is placed 0.4 meter away from the conducting wall of the shielding room, and is kept at least 80 centimeters from any other grounded conducting surface.
2. Connect EUT to the power mains through a line impedance stabilization network (LISN).
3. All the support units are connecting to the other LISN.
4. The LISN provides 50 ohm coupling impedance for the measuring instrument.
5. The FCC states that a 50 ohm, 50 microhenry LISN shall be used.
6. Both Line and Neutral shall be tested in order to find out the maximum conducted emission.
7. The frequency range from 150 kHz to 30 MHz is scanned.
8. Set the test-receiver system to Peak Detect Function and specified bandwidth with Maximum Hold Mode.

3.5.4 Test Setup

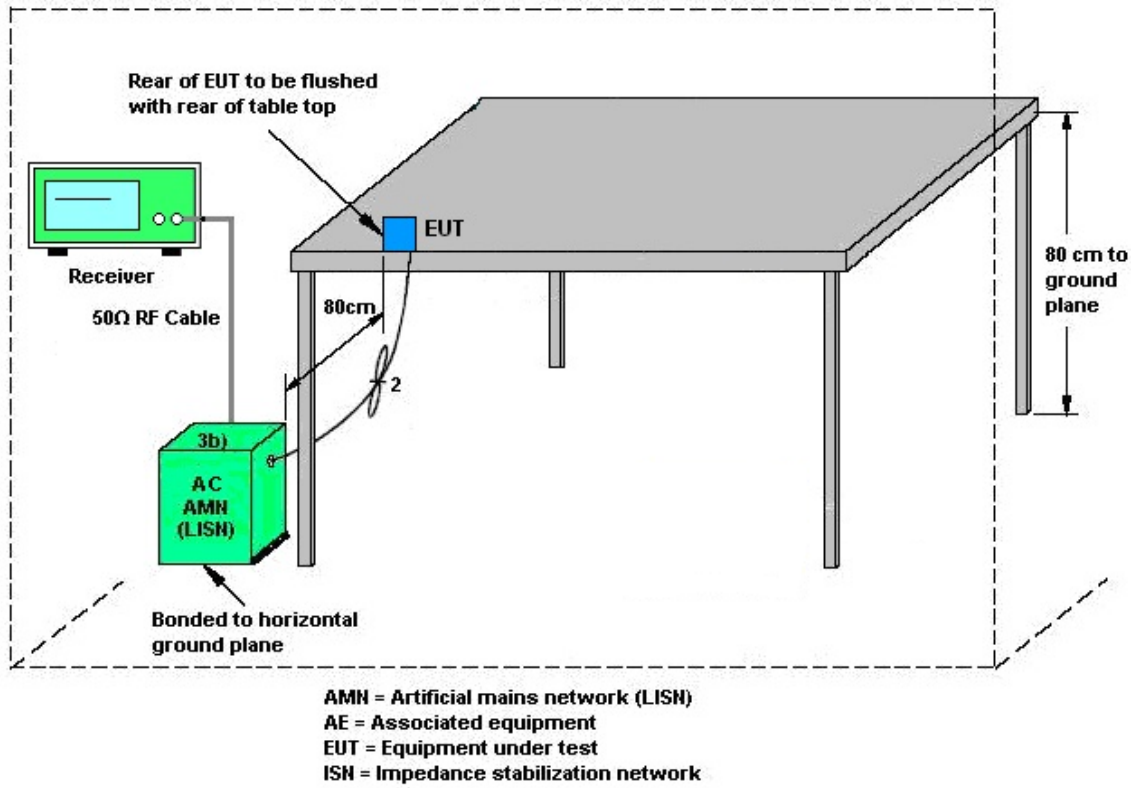

3.5.5 Test Result of AC Conducted Emission

Please refer to Appendix B.



3.6 Antenna Requirements

3.6.1 Standard Applicable

The use of a permanently attached antenna or of an antenna that uses a unique coupling to the intentional radiator shall be considered sufficient to comply with the rule.

3.6.2 Antenna Anti-Replacement Construction

An embedded-in antenna design is used.



4 List of Measuring Equipment

Instrument	Brand Name	Model No.	Serial No.	Characteristics	Calibration Date	Test Date	Due Date	Remark
Bilog Antenna	TESEQ	CBL 6111D & 00800N1D01N-06	35419 & 03	30MHz~1GHz	Apr. 23, 2023	Sep. 21, 2023~Nov. 01, 2023	Apr. 22, 2024	Radiation (03CH07-HY)
Double Ridge Horn Antenna	ESCO	3117	00075962	1GHz ~ 18GHz	Dec. 01, 2022	Sep. 21, 2023~Nov. 01, 2023	Nov. 30, 2023	Radiation (03CH07-HY)
Loop Antenna	Rohde & Schwarz	HFH2-Z2	100315	9 kHz~30 MHz	Feb. 28, 2023	Sep. 21, 2023~Nov. 01, 2023	Feb. 27, 2024	Radiation (03CH07-HY)
Preamplifier	MITEQ	AMF-7D-0010 1800-30-10P	1590075	1GHz~18GHz	Apr. 20, 2023	Sep. 21, 2023~Nov. 01, 2023	Apr. 19, 2024	Radiation (03CH07-HY)
Preamplifier	COM-POWER	PA-103A	161241	10MHz~1GHz	Oct. 03, 2022	Sep. 21, 2023~Oct. 01, 2023	Oct. 02, 2023	Radiation (03CH07-HY)
Preamplifier	COM-POWER	PA-103A	161241	10MHz~1GHz	Oct. 02, 2023	Oct. 02, 2023~Nov. 01, 2023	Oct. 01, 2024	Radiation (03CH07-HY)
Preamplifier	Agilent	8449B	3008A02362	1GHz~26.5GHz	Mar. 24, 2023	Sep. 21, 2023~Nov. 01, 2023	Mar. 23, 2024	Radiation (03CH07-HY)
Spectrum Analyzer	Agilent	N9030A	MY52350276	3Hz~44GHz	Mar. 28, 2023	Sep. 21, 2023~Nov. 01, 2023	Mar. 27, 2024	Radiation (03CH07-HY)
RF Cable	HUBER + SUHNER	SUCOFLEX 104	MY15682/4	30MHz to 18GHz	Feb. 22, 2023	Sep. 21, 2023~Nov. 01, 2023	Feb. 21, 2024	Radiation (03CH07-HY)
RF Cable	HUBER + SUHNER	SUCOFLEX 104	MY24971/4	9kHz to 18GHz	Feb. 22, 2023	Sep. 21, 2023~Nov. 01, 2023	Feb. 21, 2024	Radiation (03CH07-HY)
RF Cable	HUBER + SUHNER	SUCOFLEX 104	MY28655/4	9kHz to 18GHz	Feb. 22, 2023	Sep. 21, 2023~Nov. 01, 2023	Feb. 21, 2024	Radiation (03CH07-HY)
RF Cable	HUBER + SUHNER	SUCOFLEX 126	532078/126E	30MHz~18GHz	Sep. 15, 2023	Sep. 21, 2023~Nov. 01, 2023	Sep. 14, 2024	Radiation (03CH07-HY)
RF Cable	HUBER + SUHNER	SUCOFLEX 102	MY2858/2	18GHz~40GHz	Feb. 22, 2023	Sep. 21, 2023~Nov. 01, 2023	Feb. 21, 2024	Radiation (03CH07-HY)
RF Cable	HUBER + SUHNER	SUCOFLEX 102	801606/2	9KHz ~ 40GHz	Apr. 20, 2023	Sep. 21, 2023~Nov. 01, 2023	Apr. 19, 2024	Radiation (03CH07-HY)
Controller	EMEC	EM1000	N/A	Control Ant Mast	N/A	Sep. 21, 2023~Nov. 01, 2023	N/A	Radiation (03CH07-HY)
Controller	MF	MF-7802	N/A	Control Turn table	N/A	Sep. 21, 2023~Nov. 01, 2023	N/A	Radiation (03CH07-HY)
Antenna Mast	EMEC	AM-BS-4500E	N/A	Boresight mast 1M~4M	N/A	Sep. 21, 2023~Nov. 01, 2023	N/A	Radiation (03CH07-HY)
Turn Table	ChainTek	Chaintek 3000	N/A	0~360 Degree	N/A	Sep. 21, 2023~Nov. 01, 2023	N/A	Radiation (03CH07-HY)
Software	Audix	E3	N/A	N/A	N/A	Sep. 21, 2023~Nov. 01, 2023	N/A	Radiation (03CH07-HY)
USB Data Logger	TECPEL	TR-32	HE17XB2495	N/A	Mar. 14, 2023	Sep. 21, 2023~Nov. 01, 2023	Mar. 13, 2024	Radiation (03CH07-HY)
Preamplifier	EMEC	EM18G40G	060801	18GHz~40GHz	Jun. 27, 2023	Sep. 21, 2023~Nov. 01, 2023	Jun. 26, 2024	Radiation (03CH07-HY)
SHF-EHF Horn Antenna	SCHWARZBECK	BBHA 9170	BBHA9170251	18GHz~40GHz	Nov. 24, 2022	Sep. 21, 2023~Nov. 01, 2023	Nov. 23, 2023	Radiation (03CH07-HY)



Instrument	Brand Name	Model No.	Serial No.	Characteristics	Calibration Date	Test Date	Due Date	Remark
AC Power Source	ChainTek	APC-1000W	N/A	N/A	N/A	Sep. 14, 2023	N/A	Conduction (CO05-HY)
EMI Test Receiver	Rohde & Schwarz	ESR3	102388	9kHz~3.6GHz	Dec. 01, 2022	Sep. 14, 2023	Nov. 30, 2023	Conduction (CO05-HY)
Hygrometer	Testo	608-H1	34913912	N/A	Nov. 17, 2022	Sep. 14, 2023	Nov. 16, 2023	Conduction (CO05-HY)
LISN	Rohde & Schwarz	ENV216	100080	9kHz~30MHz	Dec. 01, 2022	Sep. 14, 2023	Nov. 30, 2023	Conduction (CO05-HY)
LISN	Rohde & Schwarz	ENV216	100081	9kHz~30MHz	Nov. 17, 2022	Sep. 14, 2023	Nov. 16, 2023	Conduction (CO05-HY)
Software	Rohde & Schwarz	EMC32	N/A	N/A	N/A	Sep. 14, 2023	N/A	Conduction (CO05-HY)
Pulse Limiter	SCHWARZBECK	VTSD 9561-F N	00691	9kHz-200MHz	Jul. 28, 2023	Sep. 14, 2023	Jul. 27, 2024	Conduction (CO05-HY)
LISN Cable	MVE	RG-400	260260	N/A	Dec. 29, 2022	Sep. 14, 2023	Dec. 28, 2023	Conduction (CO05-HY)
Hygrometer	TECPEL	DTM-303A	TP201996	N/A	Nov. 17, 2022	Sep. 21, 2023~ Oct. 24, 2023	Nov. 16, 2023	Conducted (TH05-HY)
Power Sensor	DARE	RPR3006W	16I00054SN O12 (NO:113)	10MHz~6GHz	Dec. 13, 2022	Sep. 21, 2023~ Oct. 24, 2023	Dec. 12, 2023	Conducted (TH05-HY)
Signal Analyzer	Rohde & Schwarz	FSV40	101565	10Hz ~ 40GHz	Dec. 26, 2022	Sep. 21, 2023~ Oct. 24, 2023	Dec. 25, 2023	Conducted (TH05-HY)



5 Measurement Uncertainty

Uncertainty of Conducted Emission Measurement (150kHz ~ 30MHz)

Measuring Uncertainty for a Level of Confidence of 95% ($U = 2Uc(y)$)	3.5 dB
---	--------

Uncertainty of Radiated Emission Measurement (30 MHz ~ 1000 MHz)

Measuring Uncertainty for a Level of Confidence of 95% ($U = 2Uc(y)$)	6.3 dB
---	--------

Uncertainty of Radiated Emission Measurement (1000 MHz ~ 6000 MHz)

Measuring Uncertainty for a Level of Confidence of 95% ($U = 2Uc(y)$)	4.6 dB
---	--------

Uncertainty of Radiated Emission Measurement (6000 MHz ~ 18000 MHz)

Measuring Uncertainty for a Level of Confidence of 95% ($U = 2Uc(y)$)	4.3 dB
---	--------

Uncertainty of Radiated Emission Measurement (18000 MHz ~ 40000 MHz)

Measuring Uncertainty for a Level of Confidence of 95% ($U = 2Uc(y)$)	5.3 dB
---	--------

Appendix A. Test Result of Conducted Test Items

Test Engineer:	Ray Wang	Temperature:	21~25	°C
Test Date:	2023/09/21~2023/10/24	Relative Humidity:	51~54	%
Remark: For Conducted Test Items, Ant. 1 means Internal Antenna (Right) and Ant. 2 means Internal Antenna (Left).				

TEST RESULTS DATA
26dB and 99% OBW

U-NII-1 single antenna													
Mod.	Data Rate	N _{TX}	CH.	Freq. (MHz)	99% Bandwidth (MHz)		26 dB Bandwidth (MHz)		IC 99% Bandwidth Power Limit (dBm)		IC 99% Bandwidth EIRP Limit (dBm)		Note
					Ant 1	Ant 2	Ant 1	Ant 2	Ant 1	Ant 2	Ant 1	Ant 2	
11a	6Mbps	1	36	5180	16.68	16.68	20.16	20.08	-	-	22.22	22.22	
11a	6Mbps	1	44	5220	16.68	16.68	20.00	19.92	-	-	22.22	22.22	-
11a	6Mbps	1	48	5240	16.73	16.68	20.00	20.00	-	-	22.24	22.22	

TEST RESULTS DATA
Average Power Table

FCC U-NII-1 single antenna													
Mod.	Data Rate	N _{TX}	CH.	Freq. (MHz)	Average Conducted Power (dBm)			FCC Conducted Power Limit (dBm)		DG (dBi)			Pass/Fail
					Ant 1	Ant 2	SUM	Ant 1	Ant 2	Ant 1	Ant 2		
11a	6Mbps	1	36	5180	14.90	14.80	-	23.70	24.00	6.30	5.51	-	Pass
11a	6Mbps	1	44	5220	14.30	14.10		23.70	24.00	6.30	5.51	-	Pass
11a	6Mbps	1	48	5240	14.60	14.40		23.70	24.00	6.30	5.51	-	Pass

FCC U-NII-1 MIMO													
Mod.	Data Rate	N _{TX}	CH.	Freq. (MHz)	Average Conducted Power (dBm)			FCC Conducted Power Limit (dBm)		DG (dBi)			Pass/Fail
					Ant 1	Ant 2	SUM	Ant 1	Ant 2	Ant 1	Ant 2		
HT20	MCS0	2	36	5180	13.20	11.70	15.52	23.70	6.30	-		Pass	
HT20	MCS0	2	44	5220	13.40	12.00	15.77	23.70	6.30		Pass		
HT20	MCS0	2	48	5240	12.50	11.20	14.91	23.70	6.30		Pass		
HT40	MCS0	2	38	5190	13.20	11.70	15.52	23.70	6.30		Pass		
HT40	MCS0	2	46	5230	13.60	12.00	15.88	23.70	6.30		Pass		
VHT20	MCS0	2	36	5180	13.20	11.70	15.52	23.70	6.30		Pass		
VHT20	MCS0	2	44	5220	13.40	12.00	15.77	23.70	6.30		Pass		
VHT20	MCS0	2	48	5240	12.50	11.20	14.91	23.70	6.30		Pass		
VHT40	MCS0	2	38	5190	13.20	11.70	15.52	23.70	6.30		Pass		
VHT40	MCS0	2	46	5230	13.60	12.00	15.88	23.70	6.30		Pass		
VHT80	MCS0	2	42	5210	9.10	7.80	11.51	23.70	6.30	Pass			

TEST RESULTS DATA
Power Spectral Density

FCC U-NII-1 single antenna														
Mod.	Data Rate	N _{rx}	CH.	Freq. (MHz)	Duty Factor (dB)		Average Power Density with Duty Factor (dBm/MHz)			Average PSD Limit (dBm/MHz)		DG (dBi)		Pass /Fail
					Ant 1	Ant 2	Ant 1	Ant 2	SUM	Ant 1	Ant 2	Ant 1	Ant 2	
11a	6Mbps	1	36	5180	0.25	0.23	3.51	3.70		10.70	11.00	6.30	5.51	Pass
11a	6Mbps	1	44	5220	0.25	0.23	2.69	2.63	-	10.70	11.00	6.30	5.51	Pass
11a	6Mbps	1	48	5240	0.25	0.23	3.02	2.89		10.70	11.00	6.30	5.51	Pass

TEST RESULTS DATA
26dB and 99% OBW

U-NII-2A single antenna															
Mod.	Data Rate	N _{TX}	CH.	Freq. (MHz)	99% Bandwidth (MHz)		26 dB Bandwidth (MHz)		IC 99% Bandwidth Power Limit (dBm)		IC 99% Bandwidth EIRP Limit (dBm)		FCC 26dB Bandwidth Power Limit (dBm)		Note
					Ant 1	Ant 2	Ant 1	Ant 2	Ant 1	Ant 2	Ant 1	Ant 2	Ant 1	Ant 2	
11a	6Mbps	1	52	5260	16.73	16.68	19.68	19.92	23.24	23.22	29.24	29.22	23.94	23.98	-
11a	6Mbps	1	60	5300	16.68	16.68	19.84	20.00	23.22	23.22	29.22	29.22	23.98	23.98	
11a	6Mbps	1	64	5320	16.68	16.68	20.00	20.08	23.22	23.22	29.22	29.22	23.98	23.98	

TEST RESULTS DATA
Average Power Table

FCC U-NII-2A single antenna													
Mod.	Data Rate	N _{TX}	CH.	Freq. (MHz)	Average Conducted Power (dBm)			FCC Conducted Power Limit (dBm)		DG (dBi)		EIRP Power Limit (dBm)	Pass/Fail
					Ant 1	Ant 2	SUM	Ant 1	Ant 2	Ant 1	Ant 2		
11a	6Mbps	1	52	5260	14.30	14.60	-	23.55	23.98	6.39	5.05	30	Pass
11a	6Mbps	1	60	5300	14.50	14.20		23.59	23.98	6.39	5.05	30	Pass
11a	6Mbps	1	64	5320	14.80	14.40		23.59	23.98	6.39	5.05	30	Pass

FCC U-NII-2A MIMO													
Mod.	Data Rate	N _{TX}	CH.	Freq. (MHz)	Average Conducted Power (dBm)			FCC Conducted Power Limit (dBm)		DG (dBi)		EIRP Power Limit (dBm)	Pass/Fail
					Ant 1	Ant 2	SUM	Ant 1	Ant 2	Ant 1	Ant 2		
HT20	MCS0	2	52	5260	13.40	11.30	15.49	23.59		6.39		30	Pass
HT20	MCS0	2	60	5300	13.70	11.70	15.82	23.59		6.39		30	Pass
HT20	MCS0	2	64	5320	12.70	11.00	14.94	23.59		6.39		30	Pass
HT40	MCS0	2	54	5270	13.50	11.30	15.55	23.59		6.39		30	Pass
HT40	MCS0	2	62	5310	12.40	10.90	14.72	23.59		6.39		30	Pass
VHT20	MCS0	2	52	5260	13.40	11.30	15.49	23.59		6.39		30	Pass
VHT20	MCS0	2	60	5300	13.70	11.70	15.82	23.59		6.39		30	Pass
VHT20	MCS0	2	64	5320	12.70	11.00	14.94	23.59		6.39		30	Pass
VHT40	MCS0	2	54	5270	13.50	11.30	15.55	23.59		6.39		30	Pass
VHT40	MCS0	2	62	5310	12.40	10.90	14.72	23.59		6.39		30	Pass
VHT80	MCS0	2	58	5290	9.40	7.60	11.60	23.59		6.39		30	Pass

TEST RESULTS DATA
Power Spectral Density

U-NII-2A single antenna														
Mod.	Data Rate	N _{rx}	CH.	Freq. (MHz)	Duty Factor (dB)		Average Power Density with Duty Factor (dBm/MHz)			Average PSD Limit (dBm/MHz)		DG (dBi)		Pass /Fail
					Ant 1	Ant 2	Ant 1	Ant 2	SUM	Ant 1	Ant 2	Ant 1	Ant 2	
11a	6Mbps	1	52	5260	0.25	0.23	2.82	2.96		10.61	11.00	6.39	5.05	Pass
11a	6Mbps	1	60	5300	0.25	0.23	2.98	2.53	-	10.61	11.00	6.39	5.05	Pass
11a	6Mbps	1	64	5320	0.25	0.23	3.32	2.77		10.61	11.00	6.39	5.05	Pass

TEST RESULTS DATA
26dB and 99% OBW

U-NII-2C single antenna																
Mod.	Data Rate	N _{rx}	CH.	Freq. (MHz)	99% Bandwidth In U-NII 2C (MHz)		26 dB Bandwidth In U-NII 2C (MHz)		IC 99% Bandwidth Power Limit (dBm)		IC 99% Bandwidth EIRP Limit (dBm)		FCC 26dB Bandwidth Power Limit (dBm)		6 dB Bandwidth for Straddle Channel (MHz)	
					Ant 1	Ant 2	Ant 1	Ant 2	Ant 1	Ant 2	Ant 1	Ant 2	Ant 1	Ant 2	Ant 1	Ant 2
11a	6Mbps	1	100	5500	16.68	16.78	20.16	22.00	23.22	23.25	29.22	29.25	23.98	23.98	----	----
11a	6Mbps	1	116	5580	16.68	16.78	19.84	23.44	23.22	23.25	29.22	29.25	23.98	23.98	----	----
11a	6Mbps	1	140	5700	16.68	16.68	19.92	20.00	23.22	23.22	29.22	29.22	23.98	23.98	----	----

U-NII-2C straddle channel single antenna																
Mod.	Data Rate	N _{rx}	CH.	Freq. (MHz)	99% Bandwidth In U-NII 2C (MHz)		26 dB Bandwidth In U-NII 2C (MHz)		IC 99% Bandwidth Power Limit (dBm)		IC 99% Bandwidth EIRP Limit (dBm)		FCC 26dB Bandwidth Power Limit (dBm)		6 dB Bandwidth for Straddle Channel (MHz)	
					Ant 1	Ant 2	Ant 1	Ant 2	Ant 1	Ant 2	Ant 1	Ant 2	Ant 1	Ant 2	Ant 1	Ant 2
11a	6Mbps	1	144	5720	13.34	13.34	14.92	15.08	22.25	22.25	28.25	28.25	22.74	22.78	3.25	3.25

TEST RESULTS DATA
Average Power Table

FCC U-NII-2C single antenna													
Mod.	Data Rate	N _{TX}	CH.	Freq. (MHz)	Average Conducted Power (dBm)			FCC Conducted Power Limit (dBm)		DG (dBi)		EIRP Power Limit (dBm)	Pass/Fail
					Ant 1	Ant 2	SUM	Ant 1	Ant 2	Ant 1	Ant 2		
11a	6Mbps	1	100	5500	14.70	14.60	-	23.46	23.98	6.52	4.95	30	Pass
11a	6Mbps	1	116	5580	14.80	14.60		23.46	23.98	6.52	4.95	30	Pass
11a	6Mbps	1	140	5700	14.80	14.60		23.46	23.98	6.52	4.95	30	Pass

FCC U-NII-2C MIMO													
Mod.	Data Rate	N _{TX}	CH.	Freq. (MHz)	Average Conducted Power (dBm)			FCC Conducted Power Limit (dBm)		DG (dBi)		EIRP Power Limit (dBm)	Pass/Fail
					Ant 1	Ant 2	SUM	Ant 1	Ant 2	Ant 1	Ant 2		
HT20	MCS0	2	100	5500	12.70	11.30	15.07	23.46		6.52		30	Pass
HT20	MCS0	2	116	5580	13.10	11.90	15.55	23.46		6.52		30	Pass
HT20	MCS0	2	140	5700	13.50	11.70	15.70	23.46		6.52		30	Pass
HT40	MCS0	2	102	5510	12.70	11.40	15.11	23.46		6.52		30	Pass
HT40	MCS0	2	110	5550	13.00	11.80	15.45	23.46		6.52		30	Pass
HT40	MCS0	2	134	5670	13.20	11.90	15.61	23.46		6.52		30	Pass
VHT20	MCS0	2	100	5500	12.70	11.30	15.07	23.46		6.52		30	Pass
VHT20	MCS0	2	116	5580	13.10	11.90	15.55	23.46		6.52		30	Pass
VHT20	MCS0	2	140	5700	13.50	11.70	15.70	23.46		6.52		30	Pass
VHT40	MCS0	2	102	5510	12.70	11.40	15.11	23.46		6.52		30	Pass
VHT40	MCS0	2	110	5550	13.00	11.80	15.45	23.46		6.52		30	Pass
VHT40	MCS0	2	134	5670	13.20	11.90	15.61	23.46		6.52		30	Pass
VHT80	MCS0	2	106	5530	9.00	7.60	11.37	23.46		6.52		30	Pass
VHT80	MCS0	2	122	5610	9.30	8.10	11.75	23.46		6.52		30	Pass

FCC U-NII-2C straddle channel single antenna													
Mod.	Data Rate	N _{TX}	CH.	Freq. (MHz)	Average Conducted Power (dBm)			FCC Conducted Power Limit (dBm)		DG (dBi)		EIRP Power Limit (dBm)	Pass/Fail
					Ant 1	Ant 2	SUM	Ant 1	Ant 2	Ant 1	Ant 2		
11a	6Mbps	1	144	5720	14.80	14.50	-	22.22	22.78	6.52	4.95	30	Pass

FCC U-NII-2C straddle channel MIMO													
Mod.	Data Rate	N _{TX}	CH.	Freq. (MHz)	Average Conducted Power (dBm)			FCC Conducted Power Limit (dBm)		DG (dBi)		EIRP Power Limit (dBm)	Pass/Fail
					Ant 1	Ant 2	SUM	Ant 1	Ant 2	Ant 1	Ant 2		
HT20	MCS0	2	144	5720	13.60	11.60	15.72	23.46		6.52		30	Pass
HT40	MCS0	2	142	5710	13.40	11.60	15.60	23.46		6.52		30	Pass
VHT20	MCS0	2	144	5720	13.60	11.60	15.72	23.46		6.52		30	Pass
VHT40	MCS0	2	142	5710	13.40	11.60	15.60	23.46		6.52		30	Pass
VHT80	MCS0	2	138	5690	9.40	7.90	11.72	23.46		6.52		30	Pass

TEST RESULTS DATA
Power Spectral Density

U-NII-2C single antenna														
Mod.	Data Rate	N _{TX}	CH.	Freq. (MHz)	Duty Factor (dB)		Average Power Density with Duty Factor (dBm/MHz)			Average PSD Limit (dBm/MHz)		DG (dBi)		Pass /Fail
					Ant 1	Ant 2	Ant 1	Ant 2	SUM	Ant 1	Ant 2	Ant 1	Ant 2	
11a	6Mbps	1	100	5500	0.25	0.23	3.07	2.95	-	10.48	11.00	6.52	4.95	Pass
11a	6Mbps	1	116	5580	0.25	0.23	3.64	2.95	-	10.48	11.00	6.52	4.95	Pass
11a	6Mbps	1	140	5700	0.25	0.23	3.18	3.03	-	10.48	11.00	6.52	4.95	Pass

U-NII-2C straddle channel single antenna														
Mod.	Data Rate	N _{TX}	CH.	Freq. (MHz)	Duty Factor (dB)		Average Power Density (dBm/MHz)			Average PSD Limit (dBm/MHz)		DG (dBi)		Pass /Fail
					Ant 1	Ant 2	Ant 1	Ant 2	SUM	Ant 1	Ant 2	Ant 1	Ant 2	
11a	6Mbps	1	144	5720	0.25	0.23	3.18	3.05	-	10.48	11.00	6.52	4.95	Pass

TEST RESULTS DATA
26dB and 99% OBW

U-NII-1 MIMO														
Mod.	Data Rate	N _{TX}	CH.	Freq. (MHz)	RU Config	99% Bandwidth (MHz)		26 dB Bandwidth (MHz)		IC 99% Bandwidth Power Limit (dBm)		IC 99% Bandwidth EIRP Limit (dBm)		Note
						Ant 1	Ant 2	Ant 1	Ant 2	Ant 1	Ant 2	Ant 1	Ant 2	
HE20	MCS0	2	36	5180	Full	18.78	18.78	20.80	20.64	-	-	22.74	-	-
HE20	MCS0	2	44	5220	Full	18.78	18.78	20.72	20.56	-	-	22.74	-	-
HE20	MCS0	2	48	5240	Full	18.78	18.78	20.72	20.64	-	-	22.74	-	-
HE40	MCS0	2	38	5190	Full	37.76	37.76	41.60	41.76	-	-	23.01	-	-
HE40	MCS0	2	46	5230	Full	37.76	37.76	41.44	41.60	-	-	23.01	-	-
HE80	MCS0	2	42	5210	Full	77.56	77.68	81.60	81.60	-	-	23.01	-	-

TEST RESULTS DATA
Average Power Table

FCC U-NII-1 MIMO													
Mod.	Data Rate	N _{TX}	CH.	Freq. (MHz)	RU Config	Average Conducted Power (dBm)			FCC Conducted Power Limit (dBm)		DG (dBi)		Pass/Fail
						Ant 1	Ant 2	SUM	Ant 1	Ant 2	Ant 1	Ant 2	
HE20	MCS0	2	36	5180	Full	13.30	11.80	15.62	23.70	23.70	6.30	6.30	Pass
HE20	MCS0	2	44	5220	Full	13.50	12.10	15.87	23.70	23.70	6.30	6.30	Pass
HE20	MCS0	2	48	5240	Full	12.60	11.30	15.01	23.70	23.70	6.30	6.30	Pass
HE40	MCS0	2	38	5190	Full	13.30	11.80	15.62	23.70	23.70	6.30	6.30	Pass
HE40	MCS0	2	46	5230	Full	13.70	12.10	15.98	23.70	23.70	6.30	6.30	Pass
HE80	MCS0	2	42	5210	Full	9.20	7.90	11.61	23.70	23.70	6.30	6.30	Pass

TEST RESULTS DATA
Power Spectral Density

FCC U-NII-1 MIMO															
Mod.	Data Rate	N _{rx}	CH.	Freq. (MHz)	RU Config	Duty Factor (dB)		Average Power Density with Duty Factor (dBm/MHz)			Average PSD Limit (dBm/MHz)		DG (dBi)		Pass /Fail
						Ant 1	Ant 2	Ant 1	Ant 2	SUM	Ant 1	Ant 2	Ant 1	Ant 2	
HE20	MCS0	2	36	5180	Full	0.28	0.28	-		3.82	8.08	8.92		Pass	
HE20	MCS0	2	44	5220	Full	0.28	0.28		4.02	8.08	8.92	Pass			
HE20	MCS0	2	48	5240	Full	0.28	0.28		3.23	8.08	8.92	Pass			
HE40	MCS0	2	38	5190	Full	0.46	0.46		0.96	8.08	8.92	Pass			
HE40	MCS0	2	46	5230	Full	0.46	0.46		1.38	8.08	8.92	Pass			
HE80	MCS0	2	42	5210	Full	0.66	0.67		-5.86	8.08	8.92	Pass			

TEST RESULTS DATA
26dB and 99% OBW

U-NII-2A MIMO																
Mod.	Data Rate	N _{TX}	CH.	Freq. (MHz)	RU Config	99% Bandwidth (MHz)		26 dB Bandwidth (MHz)		IC 99% Bandwidth Power Limit (dBm)		IC 99% Bandwidth EIRP Limit (dBm)		FCC 26dB Bandwidth Power Limit (dBm)		Note
						Ant 1	Ant 2	Ant 1	Ant 2	Ant 1	Ant 2	Ant 1	Ant 2	Ant 1	Ant 2	
HE20	MCS0	2	52	5260	Full	18.78	18.78	20.56	20.64	23.74	29.74	23.98				
HE20	MCS0	2	60	5300	Full	18.83	18.78	20.88	20.88	23.74	29.74	23.98				
HE20	MCS0	2	64	5320	Full	18.78	18.78	20.80	20.48	23.74	29.74	23.98				
HE40	MCS0	2	54	5270	Full	37.76	37.86	41.76	41.44	23.98	30.00	23.98				
HE40	MCS0	2	62	5310	Full	37.76	37.76	41.76	41.60	23.98	30.00	23.98				
HE80	MCS0	2	58	5290	Full	77.56	77.56	81.60	81.60	23.98	30.00	23.98				

TEST RESULTS DATA
Average Power Table

FCC U-NII-2A MIMO														
Mod.	Data Rate	N _{TX}	CH.	Freq. (MHz)	RU Config	Average Conducted Power (dBm)			FCC Conducted Power Limit (dBm)		DG (dBi)		EIRP Power Limit (dBm)	Pass/Fail
						Ant 1	Ant 2	SUM	Ant 1	Ant 2	Ant 1	Ant 2		
HE20	MCS0	2	52	5260	Full	13.50	11.40	15.59	23.59		6.39		30	Pass
HE20	MCS0	2	60	5300	Full	13.80	11.80	15.92	23.59		6.39		30	Pass
HE20	MCS0	2	64	5320	Full	12.80	11.10	15.04	23.59		6.39		30	Pass
HE40	MCS0	2	54	5270	Full	13.60	11.40	15.65	23.59		6.39		30	Pass
HE40	MCS0	2	62	5310	Full	12.50	11.00	14.82	23.59		6.39		30	Pass
HE80	MCS0	2	58	5290	Full	9.50	7.70	11.70	23.59		6.39		30	Pass

TEST RESULTS DATA
Power Spectral Density

U-NII-2A MIMO															
Mod.	Data Rate	N _{rx}	CH.	Freq. (MHz)	RU Config	Duty Factor (dB)		Average Power Density with Duty Factor (dBm/MHz)			Average PSD Limit (dBm/MHz)		DG (dBi)		Pass /Fail
						Ant 1	Ant 2	Ant 1	Ant 2	SUM	Ant 1	Ant 2	Ant 1	Ant 2	
HE20	MCS0	2	52	5260	Full	0.28	0.28	-		3.81	8.24	8.76		Pass	
HE20	MCS0	2	60	5300	Full	0.28	0.28		4.28	8.24	8.76	Pass			
HE20	MCS0	2	64	5320	Full	0.28	0.28		2.89	8.24	8.76	Pass			
HE40	MCS0	2	54	5270	Full	0.46	0.46		0.95	8.24	8.76	Pass			
HE40	MCS0	2	62	5310	Full	0.46	0.46		0.43	8.24	8.76	Pass			
HE80	MCS0	2	58	5290	Full	0.66	0.67		-5.67	8.24	8.76	Pass			

TEST RESULTS DATA
26dB and 99% OBW

U-NII-2C MIMO																	
Mod.	Data Rate	N _{TX}	CH.	Freq. (MHz)	RU Config	99% Bandwidth In U-NII 2C (MHz)		26 dB Bandwidth In U-NII 2C (MHz)		IC 99% Bandwidth Power Limit (dBm)		IC 99% Bandwidth EIRP Limit (dBm)		FCC 26dB Bandwidth Power Limit (dBm)		6 dB Bandwidth for Straddle Channel (MHz)	
						Ant 1	Ant 2	Ant 1	Ant 2	Ant 1	Ant 2	Ant 1	Ant 2	Ant 1	Ant 2	Ant 1	Ant 2
HE20	MCS0	2	100	5500	Full	18.78	18.83	20.64	20.64	23.74		29.74		23.98		----	----
HE20	MCS0	2	116	5580	Full	18.78	18.78	20.80	20.80	23.74		29.74		23.98		----	----
HE20	MCS0	2	140	5700	Full	18.78	18.78	20.80	20.72	23.74		29.74		23.98		----	----
HE40	MCS0	2	102	5510	Full	37.76	37.76	41.76	41.60	23.98		30.00		23.98		----	----
HE40	MCS0	2	110	5550	Full	37.66	37.86	41.60	41.92	23.98		30.00		23.98		----	----
HE40	MCS0	2	134	5670	Full	37.76	37.76	41.92	41.60	23.98		30.00		23.98		----	----
HE80	MCS0	2	106	5530	Full	77.56	77.68	81.60	81.60	23.98		30.00		23.98		----	----
HE80	MCS0	2	122	5610	Full	77.56	77.56	81.60	81.60	23.98		30.00		23.98		----	----

U-NII-2C straddle channel MIMO																	
Mod.	Data Rate	N _{TX}	CH.	Freq. (MHz)	RU Config	99% Bandwidth In U-NII 2C (MHz)		26 dB Bandwidth In U-NII 2C (MHz)		IC 99% Bandwidth Power Limit (dBm)		IC 99% Bandwidth EIRP Limit (dBm)		FCC 26dB Bandwidth Power Limit (dBm)		6 dB Bandwidth for Straddle Channel (MHz)	
						Ant 1	Ant 2	Ant 1	Ant 2	Ant 1	Ant 2	Ant 1	Ant 2	Ant 1	Ant 2	Ant 1	Ant 2
HE20	MCS0	2	144	5720	Full	14.39	14.39	15.56	15.32	22.58		28.58		22.85		4.1	4.1
HE40	MCS0	2	142	5710	Full	33.88	33.88	35.80	35.64	23.98		30.00		23.98		3.45	2.91
HE80	MCS0	2	138	5690	Full	73.84	73.84	75.64	75.64	23.98		30.00		23.98		4.2	4.04

TEST RESULTS DATA
Average Power Table

FCC U-NII-2C MIMO														
Mod.	Data Rate	N _{TX}	CH.	Freq. (MHz)	RU Config	Average Conducted Power (dBm)			FCC Conducted Power Limit (dBm)		DG (dBi)		EIRP Power Limit (dBm)	Pass/Fail
						Ant 1	Ant 2	SUM	Ant 1	Ant 2	Ant 1	Ant 2		
HE20	MCS0	2	100	5500	Full	12.80	11.40	15.17	23.46		6.52		30	Pass
HE20	MCS0	2	116	5580	Full	13.20	12.00	15.65	23.46		6.52		30	Pass
HE20	MCS0	2	140	5700	Full	13.60	11.80	15.80	23.46		6.52		30	Pass
HE40	MCS0	2	102	5510	Full	12.80	11.50	15.21	23.46		6.52		30	Pass
HE40	MCS0	2	110	5550	Full	13.10	11.90	15.55	23.46		6.52		30	Pass
HE40	MCS0	2	134	5670	Full	13.30	12.00	15.71	23.46		6.52		30	Pass
HE80	MCS0	2	106	5530	Full	9.10	7.70	11.47	23.46		6.52		30	Pass
HE80	MCS0	2	122	5610	Full	9.40	8.20	11.85	23.46		6.52		30	Pass

FCC U-NII-2C straddle channel MIMO														
Mod.	Data Rate	N _{TX}	CH.	Freq. (MHz)	RU Config	Average Conducted Power (dBm)			FCC Conducted Power Limit (dBm)		DG (dBi)		EIRP Power Limit (dBm)	Pass/Fail
						Ant 1	Ant 2	SUM	Ant 1	Ant 2	Ant 1	Ant 2		
HE20	MCS0	2	144	5720	Full	13.70	11.70	15.82	22.33		6.52		30	Pass
HE40	MCS0	2	142	5710	Full	13.50	11.70	15.70	23.46		6.52		30	Pass
HE80	MCS0	2	138	5690	Full	9.50	8.00	11.82	23.46		6.52		30	Pass

TEST RESULTS DATA
Power Spectral Density

U-NII-2C MIMO															
Mod.	Data Rate	N _{rx}	CH.	Freq. (MHz)	RU Config	Duty Factor (dB)		Average Power Density with Duty Factor (dBm/MHz)			Average PSD Limit (dBm/MHz)		DG (dBi)		Pass /Fail
						Ant 1	Ant 2	Ant 1	Ant 2	SUM	Ant 1	Ant 2	Ant 1	Ant 2	
HE20	MCS0	2	100	5500	Full	0.28	0.28	-		3.15	8.22	8.78		Pass	
HE20	MCS0	2	116	5580	Full	0.28	0.28		3.88	8.22	8.78		Pass		
HE20	MCS0	2	140	5700	Full	0.28	0.28		3.67	8.22	8.78		Pass		
HE40	MCS0	2	102	5510	Full	0.46	0.46		0.40	8.22	8.78		Pass		
HE40	MCS0	2	110	5550	Full	0.46	0.46		0.84	8.22	8.78		Pass		
HE40	MCS0	2	134	5670	Full	0.46	0.46		1.05	8.22	8.78		Pass		
HE80	MCS0	2	106	5530	Full	0.66	0.67		-6.05	8.22	8.78		Pass		
HE80	MCS0	2	122	5610	Full	0.66	0.67		-5.81	8.22	8.78		Pass		

U-NII-2C straddle channel MIMO															
Mod.	Data Rate	N _{rx}	CH.	Freq. (MHz)	RU Config	Duty Factor (dB)		Average Power Density (dBm/MHz)			Average PSD Limit (dBm/MHz)		DG (dBi)		Pass /Fail
						Ant 1	Ant 2	Ant 1	Ant 2	SUM	Ant 1	Ant 2	Ant 1	Ant 2	
HE20	MCS0	2	144	5720	Full	0.28	0.28	-		3.53	8.22	8.78		Pass	
HE40	MCS0	2	142	5710	Full	0.46	0.46		1.40	8.22	8.78		Pass		
HE80	MCS0	2	138	5690	Full	0.66	0.67		-5.92	8.22	8.78		Pass		



Appendix B. AC Conducted Emission Test Results

Test Engineer :	Calvin Wang	Temperature :	23~26°C
		Relative Humidity :	45~55%

EUT Information

Report NO : 381616
 Test Mode : Mode 1
 Test Voltage : 120Vac/60Hz
 Phase : Line

Full Spectrum

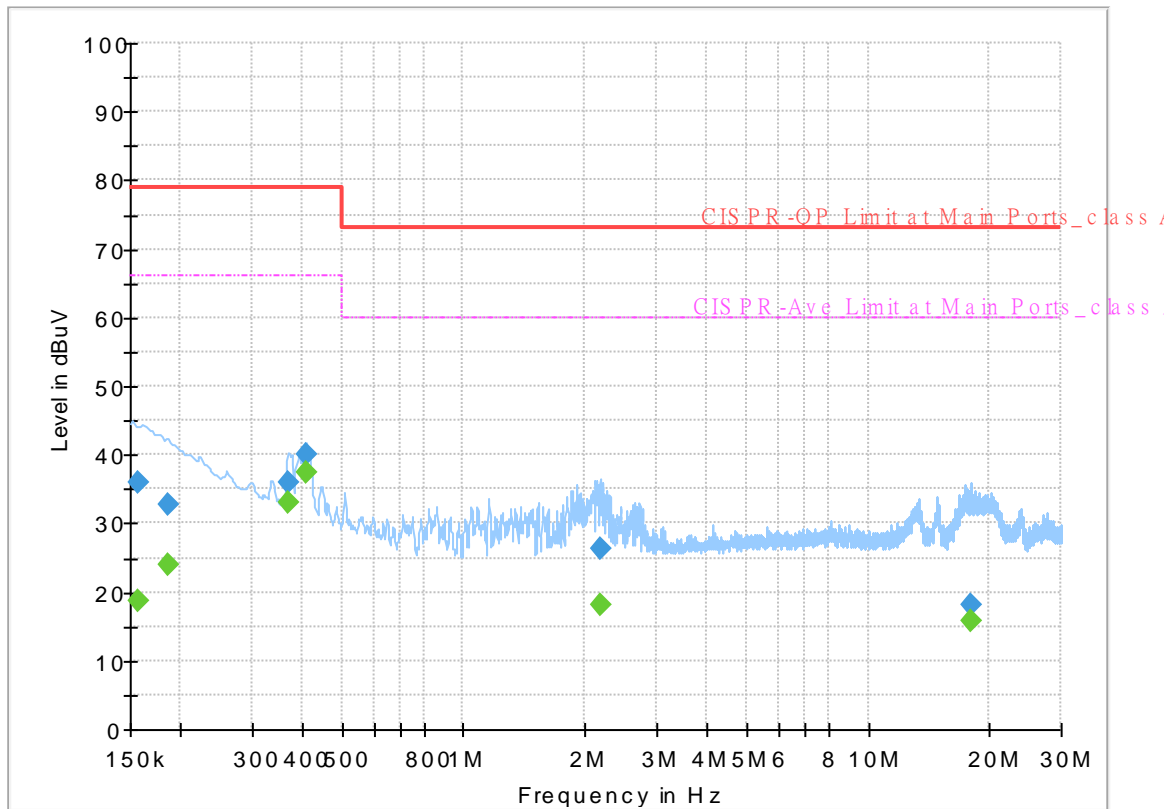

Final_Result

Frequency (MHz)	QuasiPeak (dBuV)	CAverage (dBuV)	Limit (dBuV)	Margin (dB)	Line	Filter	Corr. (dB)
0.156750	---	18.60	66.00	47.40	L1	OFF	19.8
0.156750	36.08	---	79.00	42.92	L1	OFF	19.8
0.186000	---	23.93	66.00	42.07	L1	OFF	19.8
0.186000	32.86	---	79.00	46.14	L1	OFF	19.8
0.370500	---	33.16	66.00	32.84	L1	OFF	19.8
0.370500	36.08	---	79.00	42.92	L1	OFF	19.8
0.411000	---	37.57	66.00	28.43	L1	OFF	19.8
0.411000	40.04	---	79.00	38.96	L1	OFF	19.8
2.170500	---	18.13	60.00	41.87	L1	OFF	19.9
2.170500	26.24	---	73.00	46.76	L1	OFF	19.9
17.875500	---	15.66	60.00	44.34	L1	OFF	19.9
17.875500	18.26	---	73.00	54.74	L1	OFF	19.9

EUT Information

Report NO : 381616
 Test Mode : Mode 1
 Test Voltage : 120Vac/60Hz
 Phase : Neutral

Full Spectrum

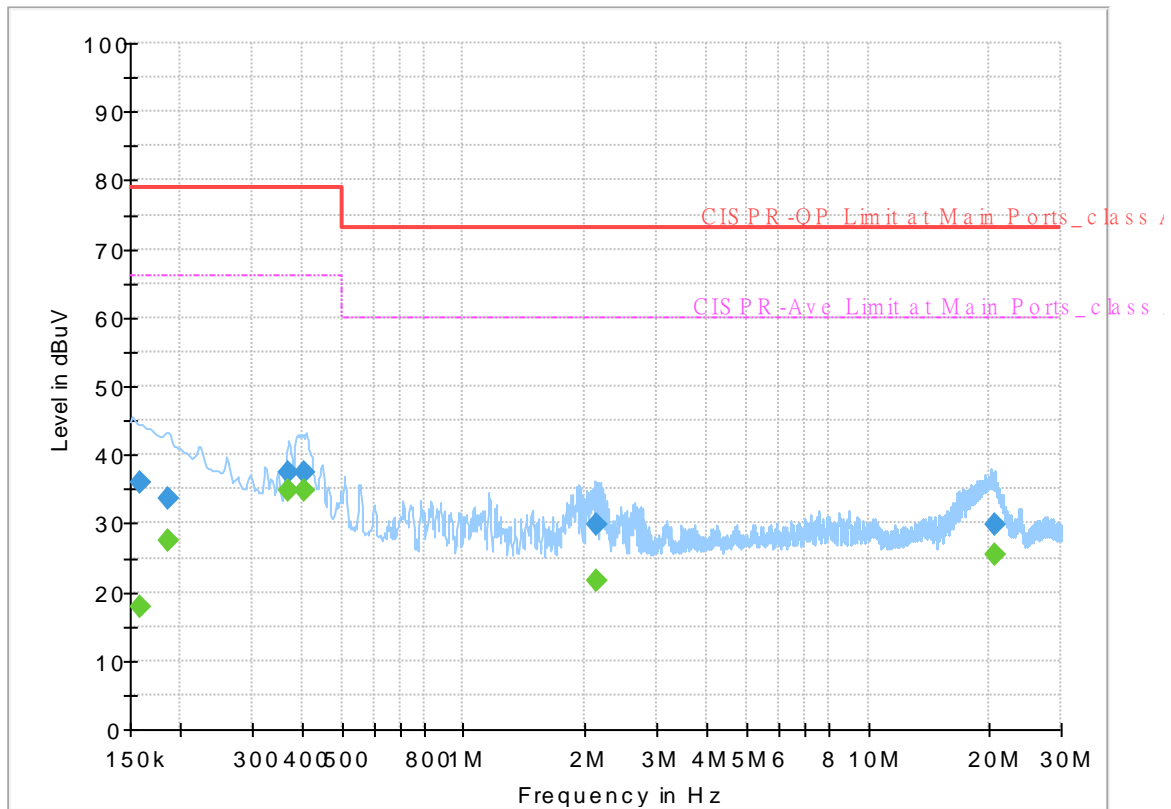

Final Result

Frequency (MHz)	QuasiPeak (dBuV)	CAverage (dBuV)	Limit (dBuV)	Margin (dB)	Line	Filter	Corr. (dB)
0.159000	---	17.84	66.00	48.16	N	OFF	19.8
0.159000	35.90	---	79.00	43.10	N	OFF	19.8
0.186000	---	27.46	66.00	38.54	N	OFF	19.8
0.186000	33.66	---	79.00	45.34	N	OFF	19.8
0.370500	---	34.77	66.00	31.23	N	OFF	19.8
0.370500	37.56	---	79.00	41.44	N	OFF	19.8
0.406500	---	34.81	66.00	31.19	N	OFF	19.8
0.406500	37.52	---	79.00	41.48	N	OFF	19.8
2.123250	---	21.74	60.00	38.26	N	OFF	19.8
2.123250	29.73	---	73.00	43.27	N	OFF	19.8
20.627250	---	25.39	60.00	34.61	N	OFF	20.1
20.627250	29.71	---	73.00	43.29	N	OFF	20.1



Appendix C. Radiated Spurious Emission

Test Engineer :	Jesse Wang, Stan Hsieh and Ken Wu	Temperature :	23.2~27.6°C
		Relative Humidity :	42.5~74%

Remark: For Radiated Spurious Emission Test Data, Internal Ant. 1 means Internal Antenna (Right) and Internal Ant. 2 means Internal Antenna (Left).

<Internal Antenna>

<Sample 1>

Band 2 - 5250~5350MHz
WIFI 802.11ax HE80 Full (Band Edge @ 3m)

WIFI Ant.	Note	Frequency	Level	Margin	Limit Line	Read Level	Antenna Factor	Path Loss	Preamp Factor	Ant Pos	Table Pos	Peak Avg.	Pol.
1+2		(MHz)	(dBμV/m)	(dB)	(dBμV/m)	(dBμV)	(dB/m)	(dB)	(dB)	(cm)	(deg)	(P/A)	(H/V)
802.11ax HE80 Full CH 58 5290MHz		5111.3	51.39	-22.61	74	39.28	34.02	11.98	33.89	299	44	P	H
		5111.65	44.21	-9.79	54	32.09	34.02	11.99	33.89	299	44	A	H
	*	5290	97.82	-	-	85.19	34.4	12.11	33.88	299	44	P	H
	*	5290	90.28	-	-	77.65	34.4	12.11	33.88	299	44	A	H
		5355.12	53.99	-20.01	74	41.35	34.4	12.12	33.88	299	44	P	H
		5353.92	49.19	-4.81	54	36.55	34.4	12.12	33.88	299	44	A	H
		5136.85	51.19	-22.81	74	38.99	34.07	12.02	33.89	369	282	P	V
		5084.35	44.08	-9.92	54	31.99	34.03	11.95	33.89	369	282	A	V
	*	5290	96.1	-	-	83.47	34.4	12.11	33.88	369	282	P	V
	*	5290	88.78	-	-	76.15	34.4	12.11	33.88	369	282	A	V
	5363.04	53.29	-20.71	74	40.65	34.4	12.12	33.88	369	282	P	V	
	5358.24	47.64	-6.36	54	35	34.4	12.12	33.88	369	282	A	V	
Remark	1. No other spurious found. 2. All results are PASS against Peak and Average limit line.												



Band 2 5250~5350MHz
WIFI 802.11ax HE80 Full (Harmonic @ 3m)

WIFI Ant.	Note	Frequency	Level	Margin	Limit Line	Read Level	Antenna Factor	Path Loss	Preamp Factor	Ant Pos	Table Pos	Peak Avg.	Pol.	
1+2		(MHz)	(dBμV/m)	(dB)	(dBμV/m)	(dBμV)	(dB/m)	(dB)	(dB)	(cm)	(deg)	(P/A)	(H/V)	
802.11ax HE80 Full CH 58 5290MHz		10580	43.73	-24.47	68.2	46.26	37.38	18.78	58.69	-	-	P	H	
		15870	47.8	-26.2	74	40.68	40.84	22.68	56.4	-	-	P	H	
													H	
													H	
													H	
													H	
													H	
													H	
													H	
													H	
													H	
													H	
													H	
													H	
													H	
													H	
	802.11ax HE80 Full CH 58 5290MHz		10580	44.64	-23.56	68.2	47.17	37.38	18.78	58.69	-	-	P	V
			15870	47.81	-26.19	74	40.69	40.84	22.68	56.4	-	-	P	V
													V	
													V	
													V	
													V	
													V	
													V	
													V	
													V	
													V	
													V	
													V	
													V	
													V	
													V	
													V	
Remark		<ol style="list-style-type: none"> No other spurious found. All results are PASS against Peak and Average limit line. The emission position marked as "-" means no suspected emission found with sufficient margin against limit line or noise floor only. 												



Emission below 1GHz

WIFI 802.11ax HE80 Full (LF @ 3m)

WIFI Ant. 1+2	Note	Frequency (MHz)	Level (dBμV/m)	Margin (dB)	Limit Line (dBμV/m)	Read Level (dBμV)	Antenna Factor (dB/m)	Path Loss (dB)	Preamp Factor (dB)	Ant Pos (cm)	Table Pos (deg)	Peak Avg. (P/A)	Pol. (H/V)	
802.11ax HE80 Full LF		30	27.97	-12.03	40	32.35	24.51	1.05	29.94	-	-	P	H	
		42.96	25.34	-14.66	40	36.07	17.92	1.28	29.93	-	-	P	H	
		205.77	23.72	-19.78	43.5	36.04	15	2.51	29.83	-	-	P	H	
		760.6	30	-16	46	26.89	27.72	4.83	29.44	-	-	P	H	
		871.9	31.65	-14.35	46	26.7	28.74	5.24	29.03	-	-	P	H	
		950.3	32.84	-13.16	46	25.69	30.32	5.51	28.68	-	-	P	H	
														H
														H
														H
														H
														H
														H
			30	33.16	-6.84	40	37.54	24.51	1.05	29.94	-	-	P	V
			46.2	21.85	-18.15	40	34.29	16.16	1.33	29.93	-	-	P	V
			205.77	21.64	-21.86	43.5	33.96	15	2.51	29.83	-	-	P	V
			796.3	29.88	-16.12	46	26.34	27.84	4.99	29.29	-	-	P	V
			887.3	31.81	-14.19	46	26.75	28.63	5.35	28.92	-	-	P	V
			958	33.49	-12.51	46	25.91	30.65	5.53	28.6	-	-	P	V
													V	
													V	
													V	
													V	
													V	
													V	
Remark	<ol style="list-style-type: none"> No other spurious found. All results are PASS against limit line. The emission position marked as “-” means no suspected emission found and emission level has at least 6dB margin against limit or emission is noise floor only. 													



<Sample 2>

Band 1 - 5150~5250MHz
WIFI 802.11a (Band Edge @ 3m)

WIFI Ant. 1	Note	Frequency (MHz)	Level (dBμV/m)	Margin (dB)	Limit Line (dBμV/m)	Read Level (dBμV)	Antenna Factor (dB/m)	Path Loss (dB)	Preamp Factor (dB)	Ant Pos (cm)	Table Pos (deg)	Peak Avg. (P/A)	Pol. (H/V)	
802.11a CH 36 5180MHz		5147.68	54.7	-19.3	74	42.46	34.1	12.03	33.89	387	53	P	H	
		5150	44.48	-9.52	54	32.24	34.1	12.03	33.89	387	53	A	H	
	*	5180	109.11	-	-	96.65	34.28	12.07	33.89	387	53	P	H	
	*	5180	102.31	-	-	89.85	34.28	12.07	33.89	387	53	A	H	
													H	
														H
			5119.86	51.61	-22.39	74	39.46	34.04	12	33.89	383	58	P	V
			5145.86	44.95	-9.05	54	32.72	34.09	12.03	33.89	383	58	A	V
	*		5180	107.57	-	-	95.11	34.28	12.07	33.89	383	58	P	V
	*		5180	100.01	-	-	87.55	34.28	12.07	33.89	383	58	A	V
														V
														V
802.11a CH 44 5220MHz		5147.16	50.77	-23.23	74	38.54	34.09	12.03	33.89	355	51	P	H	
		5135.98	42.72	-11.28	54	30.52	34.07	12.02	33.89	355	51	A	H	
	*	5220	108.15	-	-	95.54	34.4	12.1	33.89	355	51	P	H	
	*	5220	101.68	-	-	89.07	34.4	12.1	33.89	355	51	A	H	
			5367.88	50.78	-23.22	74	38.13	34.4	12.13	33.88	355	51	P	H
			5444.6	42.29	-11.71	54	29.29	34.67	12.2	33.87	355	51	A	H
			5079.82	51.15	-22.85	74	39.07	34.04	11.94	33.9	400	60	P	V
			5070.72	42.63	-11.37	54	30.54	34.06	11.93	33.9	400	60	A	V
	*		5220	106.42	-	-	93.81	34.4	12.1	33.89	400	60	P	V
	*		5220	99.32	-	-	86.71	34.4	12.1	33.89	400	60	A	V
			5458.88	49.35	-24.65	74	36.25	34.74	12.23	33.87	400	60	P	V
			5458.88	41.97	-12.03	54	28.87	34.74	12.23	33.87	400	60	A	V



802.11a CH 48 5240MHz		5061.62	50.05	-23.95	74	37.95	34.08	11.92	33.9	352	52	P	H
		5090.22	42.52	-11.48	54	30.43	34.02	11.96	33.89	352	52	A	H
	*	5240	108.65	-	-	96.03	34.4	12.11	33.89	352	52	P	H
	*	5240	102.23	-	-	89.61	34.4	12.11	33.89	352	52	A	H
		5408.76	49.57	-24.43	74	36.86	34.45	12.14	33.88	352	52	P	H
		5442.36	42.35	-11.65	54	29.37	34.65	12.2	33.87	352	52	A	H
		5125.06	50.46	-23.54	74	38.3	34.05	12	33.89	374	56	P	V
		5131.82	42.3	-11.7	54	30.12	34.06	12.01	33.89	374	56	A	V
	*	5240	106.87	-	-	94.25	34.4	12.11	33.89	374	56	P	V
	*	5240	99.92	-	-	87.3	34.4	12.11	33.89	374	56	A	V
		5447.96	49.76	-24.24	74	36.73	34.69	12.21	33.87	374	56	P	V
		5454.68	41.87	-12.13	54	28.8	34.72	12.22	33.87	374	56	A	V
Remark	1. No other spurious found. 2. All results are PASS against Peak and Average limit line.												



Band 1 5150~5250MHz
WIFI 802.11a (Harmonic @ 3m)

WIFI Ant.	Note	Frequency	Level	Margin	Limit Line	Read Level	Antenna Factor	Path Loss	Preamp Factor	Ant Pos	Table Pos	Peak Avg.	Pol.
1		(MHz)	(dBμV/m)	(dB)	(dBμV/m)	(dBμV)	(dB/m)	(dB)	(dB)	(cm)	(deg)	(P/A)	(H/V)
802.11a CH 36 5180MHz		10360	43.7	-24.5	68.2	46.79	37.3	18.56	58.95	-	-	P	H
		15540	47.15	-26.85	74	40.72	40.2	22.49	56.26	-	-	P	H
													H
													H
													H
													H
													H
													H
													H
													H
													H
													H
													H
													H
													H
													H
													H
													H
													H
			10360	43.4	-24.8	68.2	46.49	37.3	18.56	58.95	-	-	P
		15540	46.04	-27.96	74	39.61	40.2	22.49	56.26	-	-	P	V
													V
													V
													V
													V
													V
													V
													V
													V
													V
													V
													V
													V
													V
													V
													V



WIFI Ant.	Note	Frequency	Level	Margin	Limit Line	Read Level	Antenna Factor	Path Loss	Preamp Factor	Ant Pos	Table Pos	Peak Avg.	Pol.
1		(MHz)	(dBµV/m)	(dB)	(dBµV/m)	(dBµV)	(dB/m)	(dB)	(dB)	(cm)	(deg)	(P/A)	(H/V)
802.11a CH 44 5220MHz		10440	44.52	-23.68	68.2	47.44	37.3	18.64	58.86	-	-	P	H
		15660	46.4	-27.6	74	39.77	40.38	22.56	56.31	-	-	P	H
													H
													H
													H
													H
													H
													H
													H
													H
													H
													H
													H
													H
													H
													H
													H
													H
													H
			10440	43.96	-24.24	68.2	46.88	37.3	18.64	58.86	-	-	P
		15660	45.84	-28.16	74	39.21	40.38	22.56	56.31	-	-	P	V
													V
													V
													V
													V
													V
													V
													V
													V
													V
													V
													V
													V
													V
													V



WIFI Ant.	Note	Frequency	Level	Margin	Limit Line	Read Level	Antenna Factor	Path Loss	Preamp Factor	Ant Pos	Table Pos	Peak Avg.	Pol.
1		(MHz)	(dBµV/m)	(dB)	(dBµV/m)	(dBµV)	(dB/m)	(dB)	(dB)	(cm)	(deg)	(P/A)	(H/V)
802.11a CH 48 5240MHz		10480	45.54	-22.66	68.2	48.39	37.3	18.67	58.82	-	-	P	H
		15720	46.96	-27.04	74	40.16	40.54	22.59	56.33	-	-	P	H
													H
													H
													H
													H
													H
													H
													H
													H
													H
													H
													H
													H
													H
													H
													H
													H
													H
			10480	44.32	-23.88	68.2	47.17	37.3	18.67	58.82	-	-	P
		15720	47.45	-26.55	74	40.65	40.54	22.59	56.33	-	-	P	V
													V
													V
													V
													V
													V
													V
													V
													V
													V
													V
													V
													V
													V
Remark	<ol style="list-style-type: none"> No other spurious found. All results are PASS against Peak and Average limit line. The emission position marked as "-" means no suspected emission found with sufficient margin against limit line or noise floor only. 												



Band 2 - 5250~5350MHz
WIFI 802.11a (Band Edge @ 3m)

WIFI Ant.	Note	Frequency	Level	Margin	Limit Line	Read Level	Antenna Factor	Path Loss	Preamp Factor	Ant Pos	Table Pos	Peak Avg.	Pol.
1		(MHz)	(dBμV/m)	(dB)	(dBμV/m)	(dBμV)	(dB/m)	(dB)	(dB)	(cm)	(deg)	(P/A)	(H/V)
802.11a CH 52 5260MHz		5104.3	50.82	-23.18	74	38.72	34.01	11.98	33.89	330	52	P	H
		5088.55	42.53	-11.47	54	30.44	34.02	11.96	33.89	330	52	A	H
	*	5260	109.42	-	-	96.79	34.4	12.11	33.88	330	52	P	H
	*	5260	101.87	-	-	89.24	34.4	12.11	33.88	330	52	A	H
		5410.8	50.83	-23.17	74	38.1	34.46	12.15	33.88	330	52	P	H
		5454.72	42.17	-11.83	54	29.1	34.72	12.22	33.87	330	52	A	H
		5146.3	51.4	-22.6	74	39.17	34.09	12.03	33.89	350	55	P	V
		5145.25	42.51	-11.49	54	30.28	34.09	12.03	33.89	350	55	A	V
	*	5260	106.66	-	-	94.03	34.4	12.11	33.88	350	55	P	V
	*	5260	99.83	-	-	87.2	34.4	12.11	33.88	350	55	A	V
		5373.36	50.08	-23.92	74	37.43	34.4	12.13	33.88	350	55	P	V
		5459.52	42	-12	54	28.9	34.74	12.23	33.87	350	55	A	V
802.11a CH 60 5300MHz		5058.45	51.32	-22.68	74	39.22	34.08	11.92	33.9	328	52	P	H
		5083.3	42.48	-11.52	54	30.4	34.03	11.95	33.9	328	52	A	H
	*	5300	108.43	-	-	95.8	34.4	12.11	33.88	328	52	P	H
	*	5300	101.48	-	-	88.85	34.4	12.11	33.88	328	52	A	H
		5385.84	50.42	-23.58	74	37.77	34.4	12.13	33.88	328	52	P	H
		5352	42.47	-11.53	54	29.83	34.4	12.12	33.88	328	52	A	H
		5087.5	51.41	-22.59	74	39.32	34.03	11.95	33.89	386	57	P	V
		5134.4	42.46	-11.54	54	30.27	34.07	12.01	33.89	386	57	A	V
	*	5300	106.67	-	-	94.04	34.4	12.11	33.88	386	57	P	V
	*	5300	99.68	-	-	87.05	34.4	12.11	33.88	386	57	A	V
		5432.64	49.81	-24.19	74	36.9	34.6	12.18	33.87	386	57	P	V
		5446.32	42.31	-11.69	54	29.29	34.68	12.21	33.87	386	57	A	V



802.11a CH 64 5320MHz	*	5320	107.58	-	-	94.94	34.4	12.12	33.88	384	52	P	H
	*	5320	101.73	-	-	89.09	34.4	12.12	33.88	384	52	A	H
		5351.68	50.72	-23.28	74	38.08	34.4	12.12	33.88	384	52	P	H
		5350.56	44.66	-9.34	54	32.02	34.4	12.12	33.88	384	52	A	H
													H
													H
	*	5320	106.68	-	-	94.04	34.4	12.12	33.88	385	57	P	V
	*	5320	99.72	-	-	87.08	34.4	12.12	33.88	385	57	A	V
		5350.88	50.04	-23.96	74	37.4	34.4	12.12	33.88	385	57	P	V
		5350.4	43.25	-10.75	54	30.61	34.4	12.12	33.88	385	57	A	V
													V
													V
Remark	1. No other spurious found. 2. All results are PASS against Peak and Average limit line.												



Band 2 5250~5350MHz
WIFI 802.11a (Harmonic @ 3m)

WIFI Ant.	Note	Frequency	Level	Margin	Limit Line	Read Level	Antenna Factor	Path Loss	Preamp Factor	Ant Pos	Table Pos	Peak Avg.	Pol.
1		(MHz)	(dBμV/m)	(dB)	(dBμV/m)	(dBμV)	(dB/m)	(dB)	(dB)	(cm)	(deg)	(P/A)	(H/V)
802.11a CH 52 5260MHz		10520	44.01	-24.19	68.2	46.75	37.32	18.71	58.77	-	-	P	H
		15780	48.35	-25.65	74	41.43	40.66	22.62	56.36	-	-	P	H
													H
													H
													H
													H
													H
													H
													H
													H
													H
													H
													H
													H
													H
													H
													H
													H
													H
			10520	43.84	-24.36	68.2	46.58	37.32	18.71	58.77	-	-	P
		15780	46.97	-27.03	74	40.05	40.66	22.62	56.36	-	-	P	V
													V
													V
													V
													V
													V
													V
													V
													V
													V
													V
													V
													V
													V
													V



WIFI Ant.	Note	Frequency	Level	Margin	Limit Line	Read Level	Antenna Factor	Path Loss	Preamp Factor	Ant Pos	Table Pos	Peak Avg.	Pol.
1		(MHz)	(dBμV/m)	(dB)	(dBμV/m)	(dBμV)	(dB/m)	(dB)	(dB)	(cm)	(deg)	(P/A)	(H/V)
802.11a CH 60 5300MHz		10600	43.48	-30.52	74	45.94	37.4	18.8	58.66	-	-	P	H
		15900	46.94	-27.06	74	39.76	40.9	22.69	56.41	-	-	P	H
													H
													H
													H
													H
													H
													H
													H
													H
													H
													H
													H
													H
													H
													H
													H
													H
													H
			10600	43.97	-30.03	74	46.43	37.4	18.8	58.66	-	-	P
		15900	48.11	-25.89	74	40.93	40.9	22.69	56.41	-	-	P	V
													V
													V
													V
													V
													V
													V
													V
													V
													V
													V
													V
													V
													V
													V



WIFI Ant.	Note	Frequency	Level	Margin	Limit Line	Read Level	Antenna Factor	Path Loss	Preamp Factor	Ant Pos	Table Pos	Peak Avg.	Pol.
1		(MHz)	(dBµV/m)	(dB)	(dBµV/m)	(dBµV)	(dB/m)	(dB)	(dB)	(cm)	(deg)	(P/A)	(H/V)
802.11a CH 64 5320MHz		10640	43.92	-30.08	74	46.21	37.48	18.83	58.6	-	-	P	H
		15960	45.63	-28.37	74	38.43	40.9	22.73	56.43	-	-	P	H
													H
													H
													H
													H
													H
													H
													H
													H
													H
													H
													H
													H
													H
													H
													H
													H
													H
			10640	43.29	-30.71	74	45.58	37.48	18.83	58.6	-	-	P
		15960	45.65	-28.35	74	38.45	40.9	22.73	56.43	-	-	P	V
													V
													V
													V
													V
													V
													V
													V
													V
													V
													V
													V
													V
													V
Remark	1. No other spurious found.												
	2. All results are PASS against Peak and Average limit line.												
	3. The emission position marked as "-" means no suspected emission found with sufficient margin against limit line or noise floor only.												



Band 3 - 5470~5725MHz
WIFI 802.11a (Band Edge @ 3m)

WIFI Ant.	Note	Frequency	Level	Margin	Limit Line	Read Level	Antenna Factor	Path Loss	Preamp Factor	Ant Pos	Table Pos	Peak Avg.	Pol.	
1		(MHz)	(dBμV/m)	(dB)	(dBμV/m)	(dBμV)	(dB/m)	(dB)	(dB)	(cm)	(deg)	(P/A)	(H/V)	
802.11a CH 100 5500MHz		5449.2	50.93	-23.07	74	37.89	34.7	12.21	33.87	301	51	P	H	
		5469.52	52.05	-16.15	68.2	38.9	34.78	12.24	33.87	301	51	P	H	
		5457.84	44.55	-9.45	54	31.46	34.73	12.23	33.87	301	51	A	H	
	*	5500	108.56	-	-	95.23	34.9	12.3	33.87	301	51	P	H	
	*	5500	101.4	-	-	88.07	34.9	12.3	33.87	301	51	A	H	
														H
			5459.44	51.13	-22.87	74	38.03	34.74	12.23	33.87	301	61	P	V
			5469.04	51.01	-17.19	68.2	37.86	34.78	12.24	33.87	301	61	P	V
			5458	42.98	-11.02	54	29.89	34.73	12.23	33.87	301	61	A	V
	*		5500	106.69	-	-	93.36	34.9	12.3	33.87	301	61	P	V
	*		5500	99.05	-	-	85.72	34.9	12.3	33.87	301	61	A	V
														V
802.11a CH 116 5580MHz		5432.08	50.29	-23.71	74	37.39	34.59	12.18	33.87	385	52	P	H	
		5464	49	-19.2	68.2	35.87	34.76	12.24	33.87	385	52	P	H	
		5458.48	42.47	-11.53	54	29.38	34.73	12.23	33.87	385	52	A	H	
	*	5580	110.32	-	-	96.88	34.9	12.43	33.89	385	52	P	H	
	*	5580	103.71	-	-	90.27	34.9	12.43	33.89	385	52	A	H	
			5754.605	49.89	-18.31	68.2	36.22	35.1	12.51	33.94	385	52	P	H
			5419.84	50.83	-23.17	74	38.02	34.52	12.16	33.87	385	59	P	V
			5469.04	48.99	-19.21	68.2	35.84	34.78	12.24	33.87	385	59	P	V
			5458.24	42.31	-11.69	54	29.22	34.73	12.23	33.87	385	59	A	V
	*		5580	107.62	-	-	94.18	34.9	12.43	33.89	385	59	P	V
	*		5580	101	-	-	87.56	34.9	12.43	33.89	385	59	A	V
			5758.7	50.15	-18.05	68.2	36.47	35.1	12.52	33.94	385	59	P	V



802.11a CH 140 5700MHz	*	5700	108.47	-	-	94.9	35	12.49	33.92	388	53	P	H
	*	5700	102.41	-	-	88.84	35	12.49	33.92	388	53	A	H
		5727.56	57.46	-10.74	68.2	43.83	35.06	12.5	33.93	388	53	P	H
													H
													H
													H
	*	5700	105.69	-	-	92.12	35	12.49	33.92	389	60	P	V
	*	5700	99.47	-	-	85.9	35	12.49	33.92	389	60	A	V
		5726.92	53.77	-14.43	68.2	40.15	35.05	12.5	33.93	389	60	P	V
													V
													V
													V
Remark	1. No other spurious found. 2. All results are PASS against Peak and Average limit line.												



**Band 3 - 5470~5725MHz
WIFI 802.11a (Harmonic @ 3m)**

WIFI Ant.	Note	Frequency	Level	Margin	Limit Line	Read Level	Antenna Factor	Path Loss	Preamp Factor	Ant Pos	Table Pos	Peak Avg.	Pol.
1		(MHz)	(dBμV/m)	(dB)	(dBμV/m)	(dBμV)	(dB/m)	(dB)	(dB)	(cm)	(deg)	(P/A)	(H/V)
802.11a CH 100 5500MHz		11000	44.73	-29.27	74	45.85	37.8	19.17	58.09	-	-	P	H
		16500	48.55	-19.65	68.2	39.92	41.8	23.16	56.33	-	-	P	H
													H
													H
													H
													H
													H
													H
													H
													H
													H
													H
													H
													H
													H
													H
													H
													H
													H
			11000	45.11	-28.89	74	46.23	37.8	19.17	58.09	-	-	P
		16500	48.2	-20	68.2	39.57	41.8	23.16	56.33	-	-	P	V
													V
													V
													V
													V
													V
													V
													V
													V
													V
													V
													V
													V
													V
													V
													V



WIFI Ant.	Note	Frequency	Level	Margin	Limit Line	Read Level	Antenna Factor	Path Loss	Preamp Factor	Ant Pos	Table Pos	Peak Avg.	Pol.
1		(MHz)	(dBμV/m)	(dB)	(dBμV/m)	(dBμV)	(dB/m)	(dB)	(dB)	(cm)	(deg)	(P/A)	(H/V)
802.11a CH 116 5580MHz		11160	45.11	-28.89	74	45.67	37.86	19.34	57.76	-	-	P	H
		16740	47.92	-20.28	68.2	38.59	41.98	23.34	55.99	-	-	P	H
													H
													H
													H
													H
													H
													H
													H
													H
													H
													H
													H
													H
													H
													H
													H
													H
													H
			11160	44.51	-29.49	74	45.07	37.86	19.34	57.76	-	-	P
		16740	48.83	-19.37	68.2	39.5	41.98	23.34	55.99	-	-	P	V
													V
													V
													V
													V
													V
													V
													V
													V
													V
													V
													V
													V
													V
													V



WIFI Ant.	Note	Frequency	Level	Margin	Limit Line	Read Level	Antenna Factor	Path Loss	Preamp Factor	Ant Pos	Table Pos	Peak Avg.	Pol.
1		(MHz)	(dBμV/m)	(dB)	(dBμV/m)	(dBμV)	(dB/m)	(dB)	(dB)	(cm)	(deg)	(P/A)	(H/V)
802.11a CH 140 5700MHz		11400	44.62	-29.38	74	44.21	38.1	19.57	57.26	-	-	P	H
		17100	49.36	-18.84	68.2	39.75	41.6	23.64	55.63	-	-	P	H
													H
													H
													H
													H
													H
													H
													H
													H
													H
													H
													H
													H
													H
													H
													H
													H
													H
	802.11a CH 140 5700MHz		11400	44.59	-29.41	74	44.18	38.1	19.57	57.26	-	-	P
		17100	49.43	-18.77	68.2	39.82	41.6	23.64	55.63	-	-	P	V
													V
													V
													V
													V
													V
													V
													V
													V
Remark	1. No other spurious found.												
	2. All results are PASS against Peak and Average limit line.												
	3. The emission position marked as "-" means no suspected emission found with sufficient margin against limit line or noise floor only.												



Band 3 - Straddle Channel
WIFI 802.11a (Band Edge @ 3m)

WIFI Ant. 1	Note	Frequency (MHz)	Level (dBμV/m)	Margin (dB)	Limit Line (dBμV/m)	Read Level (dBμV)	Antenna Factor (dB/m)	Path Loss (dB)	Preamp Factor (dB)	Ant Pos (cm)	Table Pos (deg)	Peak Avg. (P/A)	Pol. (H/V)
802.11a CH 144 5720MHz		5435.41	48.99	-25.01	74	36.06	34.61	12.19	33.87	385	54	P	H
		5468.56	49.16	-19.04	68.2	36.02	34.77	12.24	33.87	385	54	P	H
		5457.25	42.14	-11.86	54	29.06	34.73	12.22	33.87	385	54	A	H
	*	5720	108.55	-	-	94.94	35.04	12.5	33.93	385	54	P	H
	*	5720	101.68	-	-	88.07	35.04	12.5	33.93	385	54	A	H
		5944.25	52.58	-15.62	68.2	38.57	35.2	12.8	33.99	385	54	P	H
		5415.91	49.92	-24.08	74	37.14	34.5	12.16	33.88	386	60	P	V
		5470	49.21	-18.99	68.2	36.05	34.78	12.25	33.87	386	60	P	V
		5441.65	41.95	-12.05	54	28.97	34.65	12.2	33.87	386	60	A	V
	*	5720	106.03	-	-	92.42	35.04	12.5	33.93	386	60	P	V
	*	5720	98.52	-	-	84.91	35.04	12.5	33.93	386	60	A	V
		5948.5	51.37	-16.83	68.2	37.36	35.2	12.8	33.99	386	60	P	V
Remark	1. No other spurious found. 2. All results are PASS against Peak and Average limit line.												



Band 3 - Straddle Channel
WIFI 802.11a (Harmonic @ 3m)

WIFI Ant.	Note	Frequency	Level	Margin	Limit Line	Read Level	Antenna Factor	Path Loss	Preamp Factor	Ant Pos	Table Pos	Peak Avg.	Pol.
1		(MHz)	(dBμV/m)	(dB)	(dBμV/m)	(dBμV)	(dB/m)	(dB)	(dB)	(cm)	(deg)	(P/A)	(H/V)
802.11a CH 144 5720MHz		11440	44.69	-29.31	74	44.11	38.14	19.61	57.17	-	-	P	H
		17160	51.19	-17.01	68.2	41.66	41.48	23.68	55.63	-	-	P	H
													H
													H
													H
													H
													H
													H
													H
													H
													H
													H
													H
													H
													H
													H
													H
													H
													H
			11440	44.45	-29.55	74	43.87	38.14	19.61	57.17	-	-	P
		17160	50.17	-18.03	68.2	40.64	41.48	23.68	55.63	-	-	P	V
													V
													V
													V
													V
													V
													V
													V
													V
													V
													V
													V
													V
													V
													V
Remark	1. No other spurious found. 2. All results are PASS against Peak and Average limit line. 3. The emission position marked as "-" means no suspected emission found with sufficient margin against limit line or noise floor only.												



Emission below 1GHz

WIFI 802.11a (LF @ 3m)

WIFI Ant. 1	Note	Frequency (MHz)	Level (dBµV/m)	Margin (dB)	Limit Line (dBµV/m)	Read Level (dBµV)	Antenna Factor (dB/m)	Path Loss (dB)	Preamp Factor (dB)	Ant Pos (cm)	Table Pos (deg)	Peak Avg. (P/A)	Pol. (H/V)
		48.63	32.29	-7.71	40	45.96	14.9	1.35	29.92	-	-	P	H
		174.45	29.34	-14.16	43.5	41.47	15.32	2.38	29.83	-	-	P	H
		199.83	35.43	-8.07	43.5	47.78	14.99	2.49	29.83	-	-	P	H
		897.8	32.57	-13.43	46	27.35	28.66	5.41	28.85	-	-	P	H
		925.1	34.51	-11.49	46	28.67	29.13	5.47	28.76	-	-	P	H
		969.9	34.76	-19.24	54	26.79	30.89	5.57	28.49	-	-	P	H
													H
													H
													H
													H
													H
													H
802.11a LF		30	32.76	-7.24	40	37.54	24.11	1.05	29.94	-	-	P	V
		49.44	33.65	-6.35	40	47.64	14.56	1.37	29.92	-	-	P	V
		218.19	31.45	-14.55	46	43.56	15.18	2.54	29.83	-	-	P	V
		859.3	36.05	-9.95	46	31.04	28.96	5.16	29.11	-	-	P	V
		939.8	36.69	-9.31	46	30.3	29.6	5.5	28.71	-	-	P	V
		961.5	38.53	-15.47	54	30.77	30.79	5.54	28.57	-	-	P	V
													V
													V
													V
													V
													V
													V
													V
													V
Remark	1. No other spurious found. 2. All results are PASS against limit line. 3. The emission position marked as "-" means no suspected emission found with sufficient margin against limit line or noise floor only.												



Band 1 - 5150~5250MHz
WIFI 802.11a (Band Edge @ 3m)

WIFI Ant. 2	Note	Frequency (MHz)	Level (dBµV/m)	Margin (dB)	Limit Line (dBµV/m)	Read Level (dBµV)	Antenna Factor (dB/m)	Path Loss (dB)	Preamp Factor (dB)	Ant Pos (cm)	Table Pos (deg)	Peak Avg. (P/A)	Pol. (H/V)	
802.11a CH 36 5180MHz		5094.9	51.13	-22.87	74	39.05	34.01	11.96	33.89	100	142	P	H	
		5147.68	42.99	-11.01	54	30.75	34.1	12.03	33.89	100	142	A	H	
	*	5180	103.76	-	-	91.3	34.28	12.07	33.89	100	142	P	H	
	*	5180	95.77	-	-	83.31	34.28	12.07	33.89	100	142	A	H	
													H	
														H
			5147.42	51.74	-22.26	74	39.51	34.09	12.03	33.89	383	172	P	V
			5149.76	44.83	-9.17	54	32.59	34.1	12.03	33.89	383	172	A	V
	*		5180	106.93	-	-	94.47	34.28	12.07	33.89	383	172	P	V
	*		5180	99.31	-	-	86.85	34.28	12.07	33.89	383	172	A	V
														V
														V
802.11a CH 44 5220MHz		5114.4	50.43	-23.57	74	38.3	34.03	11.99	33.89	100	314	P	H	
		5132.08	42.79	-11.21	54	30.61	34.06	12.01	33.89	100	314	A	H	
	*	5220	103.87	-	-	91.26	34.4	12.1	33.89	100	314	P	H	
	*	5220	95.75	-	-	83.14	34.4	12.1	33.89	100	314	A	H	
			5436.48	50.48	-23.52	74	37.54	34.62	12.19	33.87	100	314	P	H
			5446.56	42.38	-11.62	54	29.36	34.68	12.21	33.87	100	314	A	H
			5078.78	51.91	-22.09	74	39.83	34.04	11.94	33.9	400	182	P	V
			5119.86	44.32	-9.68	54	32.17	34.04	12	33.89	400	182	A	V
	*		5220	107.57	-	-	94.96	34.4	12.1	33.89	400	182	P	V
	*		5220	99.76	-	-	87.15	34.4	12.1	33.89	400	182	A	V
			5449.08	49.32	-24.68	74	36.29	34.69	12.21	33.87	400	182	P	V
			5447.68	42.29	-11.71	54	29.26	34.69	12.21	33.87	400	182	A	V



802.11a CH 48 5240MHz		5046.2	51.14	-22.86	74	39.02	34.12	11.9	33.9	108	142	P	H
		5120.05	42.74	-11.26	54	30.59	34.04	12	33.89	108	142	A	H
	*	5240	102.66	-	-	90.04	34.4	12.11	33.89	108	142	P	H
	*	5240	95.57	-	-	82.95	34.4	12.11	33.89	108	142	A	H
		5444.16	50.25	-23.75	74	37.26	34.66	12.2	33.87	108	142	P	H
		5414.64	42.01	-11.99	54	29.25	34.49	12.15	33.88	108	142	A	H
		5054.25	50.94	-23.06	74	38.84	34.09	11.91	33.9	397	183	P	V
		5120.05	43.81	-10.19	54	31.66	34.04	12	33.89	397	183	A	V
	*	5240	106.95	-	-	94.33	34.4	12.11	33.89	397	183	P	V
	*	5240	99.42	-	-	86.8	34.4	12.11	33.89	397	183	A	V
		5438.4	49.8	-24.2	74	36.85	34.63	12.19	33.87	397	183	P	V
		5460	42.17	-11.83	54	29.07	34.74	12.23	33.87	397	183	A	V
Remark	1. No other spurious found. 2. All results are PASS against Peak and Average limit line.												



Band 1 5150~5250MHz
WIFI 802.11a (Harmonic @ 3m)

WIFI Ant.	Note	Frequency	Level	Margin	Limit Line	Read Level	Antenna Factor	Path Loss	Preamp Factor	Ant Pos	Table Pos	Peak Avg.	Pol.
2		(MHz)	(dBμV/m)	(dB)	(dBμV/m)	(dBμV)	(dB/m)	(dB)	(dB)	(cm)	(deg)	(P/A)	(H/V)
802.11a CH 36 5180MHz		10360	45.55	-22.65	68.2	48.64	37.3	18.56	58.95	-	-	P	H
		15540	47.55	-26.45	74	41.12	40.2	22.49	56.26	-	-	P	H
													H
													H
													H
													H
													H
													H
													H
													H
													H
													H
													H
													H
													H
													H
													H
													H
													H
			10360	44.09	-24.11	68.2	47.18	37.3	18.56	58.95	-	-	P
		15540	47.6	-26.4	74	41.17	40.2	22.49	56.26	-	-	P	V
													V
													V
													V
													V
													V
													V
													V
													V
													V
													V
													V
													V
													V
													V
													V



WIFI Ant.	Note	Frequency	Level	Margin	Limit Line	Read Level	Antenna Factor	Path Loss	Preamp Factor	Ant Pos	Table Pos	Peak Avg.	Pol.	
2		(MHz)	(dBµV/m)	(dB)	(dBµV/m)	(dBµV)	(dB/m)	(dB)	(dB)	(cm)	(deg)	(P/A)	(H/V)	
802.11a CH 44 5220MHz		10440	44.76	-23.44	68.2	47.68	37.3	18.64	58.86	-	-	P	H	
		15660	47.34	-26.66	74	40.71	40.38	22.56	56.31	-	-	P	H	
													H	
													H	
													H	
													H	
													H	
													H	
													H	
													H	
													H	
													H	
													H	
													H	
													H	
													H	
													H	
													H	
			10440	45.57	-22.63	68.2	48.49	37.3	18.64	58.86	-	-	P	V
			15660	47.19	-26.81	74	40.56	40.38	22.56	56.31	-	-	P	V
													V	
													V	
													V	
													V	
													V	
													V	
													V	
													V	
													V	
													V	



WIFI Ant.	Note	Frequency	Level	Margin	Limit Line	Read Level	Antenna Factor	Path Loss	Preamp Factor	Ant Pos	Table Pos	Peak Avg.	Pol.
2		(MHz)	(dBµV/m)	(dB)	(dBµV/m)	(dBµV)	(dB/m)	(dB)	(dB)	(cm)	(deg)	(P/A)	(H/V)
802.11a CH 48 5240MHz		10480	44.78	-23.42	68.2	47.63	37.3	18.67	58.82	-	-	P	H
		15720	48.48	-25.52	74	41.68	40.54	22.59	56.33	-	-	P	H
													H
													H
													H
													H
													H
													H
													H
													H
													H
													H
													H
													H
													H
													H
													H
													H
													H
	802.11a CH 48 5240MHz		10480	45	-23.2	68.2	47.85	37.3	18.67	58.82	-	-	P
		15720	48.93	-25.07	74	42.13	40.54	22.59	56.33	-	-	P	V
													V
													V
													V
													V
													V
													V
													V
													V
Remark	<ol style="list-style-type: none"> No other spurious found. All results are PASS against Peak and Average limit line. The emission position marked as "-" means no suspected emission found with sufficient margin against limit line or noise floor only. 												



Band 2 - 5250~5350MHz
WIFI 802.11a (Band Edge @ 3m)

WIFI Ant.	Note	Frequency	Level	Margin	Limit Line	Read Level	Antenna Factor	Path Loss	Preamp Factor	Ant Pos	Table Pos	Peak Avg.	Pol.
2		(MHz)	(dBμV/m)	(dB)	(dBμV/m)	(dBμV)	(dB/m)	(dB)	(dB)	(cm)	(deg)	(P/A)	(H/V)
802.11a CH 52 5260MHz		5041.3	51.02	-22.98	74	38.9	34.13	11.89	33.9	100	141	P	H
		5100.8	42.77	-11.23	54	30.69	34	11.97	33.89	100	141	A	H
	*	5260	103.22	-	-	90.59	34.4	12.11	33.88	100	141	P	H
	*	5260	95.66	-	-	83.03	34.4	12.11	33.88	100	141	A	H
		5418.24	50.14	-23.86	74	37.34	34.51	12.16	33.87	100	141	P	H
		5453.04	42.17	-11.83	54	29.11	34.71	12.22	33.87	100	141	A	H
		5112.7	51.29	-22.71	74	39.16	34.03	11.99	33.89	389	185	P	V
		5119.7	43.39	-10.61	54	31.24	34.04	12	33.89	389	185	A	V
	*	5260	106.48	-	-	93.85	34.4	12.11	33.88	389	185	P	V
	*	5260	99.21	-	-	86.58	34.4	12.11	33.88	389	185	A	V
		5362.32	50.33	-23.67	74	37.69	34.4	12.12	33.88	389	185	P	V
		5448.72	42.21	-11.79	54	29.18	34.69	12.21	33.87	389	185	A	V
802.11a CH 60 5300MHz		5095.9	51.59	-22.41	74	39.51	34.01	11.96	33.89	100	141	P	H
		5064.4	42.59	-11.41	54	30.5	34.07	11.92	33.9	100	141	A	H
	*	5300	103.18	-	-	90.55	34.4	12.11	33.88	100	141	P	H
	*	5300	95.69	-	-	83.06	34.4	12.11	33.88	100	141	A	H
		5431.68	49.96	-24.04	74	37.06	34.59	12.18	33.87	100	141	P	H
		5453.52	42.19	-11.81	54	29.13	34.71	12.22	33.87	100	141	A	H
		5005.95	51.44	-22.56	74	39.21	34.28	11.85	33.9	389	181	P	V
		5120.05	43.26	-10.74	54	31.11	34.04	12	33.89	389	181	A	V
	*	5300	105.37	-	-	92.74	34.4	12.11	33.88	389	181	P	V
	*	5300	98.15	-	-	85.52	34.4	12.11	33.88	389	181	A	V
		5352.24	50.67	-23.33	74	38.03	34.4	12.12	33.88	389	181	P	V
		5351.04	42.46	-11.54	54	29.82	34.4	12.12	33.88	389	181	A	V



802.11a CH 64 5320MHz	*	5320	102.19	-	-	89.55	34.4	12.12	33.88	399	172	P	H
	*	5320	94.93	-	-	82.29	34.4	12.12	33.88	399	172	A	H
		5423.36	50.29	-23.71	74	37.45	34.54	12.17	33.87	399	172	P	H
		5350.56	42.6	-11.4	54	29.96	34.4	12.12	33.88	399	172	A	H
													H
													H
	*	5320	105.78	-	-	93.14	34.4	12.12	33.88	400	182	P	V
	*	5320	98.43	-	-	85.79	34.4	12.12	33.88	400	182	A	V
		5350.56	51.92	-22.08	74	39.28	34.4	12.12	33.88	400	182	P	V
		5351.2	44.01	-9.99	54	31.37	34.4	12.12	33.88	400	182	A	V
													V
													V
Remark	1. No other spurious found. 2. All results are PASS against Peak and Average limit line.												



Band 2 5250~5350MHz
WIFI 802.11a (Harmonic @ 3m)

WIFI Ant.	Note	Frequency	Level	Margin	Limit Line	Read Level	Antenna Factor	Path Loss	Preamp Factor	Ant Pos	Table Pos	Peak Avg.	Pol.
2		(MHz)	(dBμV/m)	(dB)	(dBμV/m)	(dBμV)	(dB/m)	(dB)	(dB)	(cm)	(deg)	(P/A)	(H/V)
802.11a CH 52 5260MHz		10520	45.04	-23.16	68.2	47.78	37.32	18.71	58.77	-	-	P	H
		15780	48.58	-25.42	74	41.66	40.66	22.62	56.36	-	-	P	H
													H
													H
													H
													H
													H
													H
													H
													H
													H
													H
													H
													H
													H
													H
													H
													H
													H
			10520	44.43	-23.77	68.2	47.17	37.32	18.71	58.77	-	-	P
		15780	47.96	-26.04	74	41.04	40.66	22.62	56.36	-	-	P	V
													V
													V
													V
													V
													V
													V
													V
													V
													V
													V
													V
													V
													V
													V
													V



WIFI Ant.	Note	Frequency	Level	Margin	Limit Line	Read Level	Antenna Factor	Path Loss	Preamp Factor	Ant Pos	Table Pos	Peak Avg.	Pol.
2		(MHz)	(dBμV/m)	(dB)	(dBμV/m)	(dBμV)	(dB/m)	(dB)	(dB)	(cm)	(deg)	(P/A)	(H/V)
802.11a CH 60 5300MHz		10600	44.2	-29.8	74	46.66	37.4	18.8	58.66	-	-	P	H
		15900	47.71	-26.29	74	40.53	40.9	22.69	56.41	-	-	P	H
													H
													H
													H
													H
													H
													H
													H
													H
													H
													H
													H
													H
													H
													H
													H
													H
													H
			10600	44.45	-29.55	74	46.91	37.4	18.8	58.66	-	-	P
		15900	47.91	-26.09	74	40.73	40.9	22.69	56.41	-	-	P	V
													V
													V
													V
													V
													V
													V
													V
													V
													V
													V
													V
													V
													V
													V
													V



WIFI Ant.	Note	Frequency	Level	Margin	Limit Line	Read Level	Antenna Factor	Path Loss	Preamp Factor	Ant Pos	Table Pos	Peak Avg.	Pol.
2		(MHz)	(dBµV/m)	(dB)	(dBµV/m)	(dBµV)	(dB/m)	(dB)	(dB)	(cm)	(deg)	(P/A)	(H/V)
802.11a CH 64 5320MHz		10640	46.02	-27.98	74	48.31	37.48	18.83	58.6	-	-	P	H
		15960	47.15	-26.85	74	39.95	40.9	22.73	56.43	-	-	P	H
													H
													H
													H
													H
													H
													H
													H
													H
													H
													H
													H
													H
													H
													H
													H
													H
													H
			10640	44.88	-29.12	74	47.17	37.48	18.83	58.6	-	-	P
		15960	46.97	-27.03	74	39.77	40.9	22.73	56.43	-	-	P	V
													V
													V
													V
													V
													V
													V
													V
													V
													V
													V
													V
													V
													V
Remark	1. No other spurious found.												
	2. All results are PASS against Peak and Average limit line.												
	3. The emission position marked as "-" means no suspected emission found with sufficient margin against limit line or noise floor only.												



Band 3 - 5470~5725MHz
WIFI 802.11a (Band Edge @ 3m)

WIFI Ant.	Note	Frequency	Level	Margin	Limit Line	Read Level	Antenna Factor	Path Loss	Preamp Factor	Ant Pos	Table Pos	Peak Avg.	Pol.	
2		(MHz)	(dBµV/m)	(dB)	(dBµV/m)	(dBµV)	(dB/m)	(dB)	(dB)	(cm)	(deg)	(P/A)	(H/V)	
802.11a CH 100 5500MHz		5456.56	53.98	-20.02	74	40.9	34.73	12.22	33.87	300	169	P	H	
		5469.84	56.46	-11.74	68.2	43.3	34.78	12.25	33.87	300	169	P	H	
		5459.44	46.44	-7.56	54	33.34	34.74	12.23	33.87	300	169	A	H	
	*	5500	107.02	-	-	93.69	34.9	12.3	33.87	300	169	P	H	
	*	5500	100.82	-	-	87.49	34.9	12.3	33.87	300	169	A	H	
														H
			5459.76	54.29	-19.71	74	41.19	34.74	12.23	33.87	319	164	P	V
			5462.48	55.97	-12.23	68.2	42.86	34.75	12.23	33.87	319	164	P	V
			5459.12	47.47	-6.53	54	34.37	34.74	12.23	33.87	319	164	A	V
	*		5500	109.24	-	-	95.91	34.9	12.3	33.87	319	164	P	V
	*		5500	101.38	-	-	88.05	34.9	12.3	33.87	319	164	A	V
														V
802.11a CH 116 5580MHz		5400.4	49.35	-24.65	74	36.7	34.4	12.13	33.88	302	236	P	H	
		5463.28	50.58	-17.62	68.2	37.47	34.75	12.23	33.87	302	236	P	H	
		5452.48	42.27	-11.73	54	29.21	34.71	12.22	33.87	302	236	A	H	
	*	5580	105.29	-	-	91.85	34.9	12.43	33.89	302	236	P	H	
	*	5580	98.46	-	-	85.02	34.9	12.43	33.89	302	236	A	H	
			5729.405	50.45	-17.75	68.2	36.81	35.06	12.51	33.93	302	236	P	H
			5449.6	50.32	-23.68	74	37.28	34.7	12.21	33.87	339	108	P	V
			5466.64	51.12	-17.08	68.2	37.98	34.77	12.24	33.87	339	108	P	V
			5433.28	42.39	-11.61	54	29.48	34.6	12.18	33.87	339	108	A	V
	*		5580	107.28	-	-	93.84	34.9	12.43	33.89	339	108	P	V
	*		5580	100.37	-	-	86.93	34.9	12.43	33.89	339	108	A	V
			5756.495	51.37	-16.83	68.2	37.7	35.1	12.51	33.94	339	108	P	V



802.11a CH 140 5700MHz	*	5700	107	-	-	93.43	35	12.49	33.92	292	164	P	H
	*	5700	99.65	-	-	86.08	35	12.49	33.92	292	164	A	H
		5725.08	61.02	-7.18	68.2	47.4	35.05	12.5	33.93	292	164	P	H
													H
													H
													H
	*	5700	107.06	-	-	93.49	35	12.49	33.92	331	167	P	V
	*	5700	100.73	-	-	87.16	35	12.49	33.92	331	167	A	V
		5725.08	59.34	-8.86	68.2	45.72	35.05	12.5	33.93	331	167	P	V
													V
													V
													V
Remark	1. No other spurious found. 2. All results are PASS against Peak and Average limit line.												



Band 3 - 5470~5725MHz
WIFI 802.11a (Harmonic @ 3m)

WIFI Ant.	Note	Frequency	Level	Margin	Limit Line	Read Level	Antenna Factor	Path Loss	Preamp Factor	Ant Pos	Table Pos	Peak Avg.	Pol.
2		(MHz)	(dBμV/m)	(dB)	(dBμV/m)	(dBμV)	(dB/m)	(dB)	(dB)	(cm)	(deg)	(P/A)	(H/V)
802.11a CH 100 5500MHz		11000	46.34	-27.66	74	47.46	37.8	19.17	58.09	-	-	P	H
		16500	49.39	-18.81	68.2	40.76	41.8	23.16	56.33	-	-	P	H
													H
													H
													H
													H
													H
													H
													H
													H
													H
													H
													H
													H
													H
													H
													H
													H
													H
			11000	45.12	-28.88	74	46.24	37.8	19.17	58.09	-	-	P
		16500	49.73	-18.47	68.2	41.1	41.8	23.16	56.33	-	-	P	V
													V
													V
													V
													V
													V
													V
													V
													V
													V
													V
													V
													V
													V
													V
													V



WIFI Ant.	Note	Frequency	Level	Margin	Limit Line	Read Level	Antenna Factor	Path Loss	Preamp Factor	Ant Pos	Table Pos	Peak Avg.	Pol.
2		(MHz)	(dBµV/m)	(dB)	(dBµV/m)	(dBµV)	(dB/m)	(dB)	(dB)	(cm)	(deg)	(P/A)	(H/V)
802.11a CH 116 5580MHz		11160	45.94	-28.06	74	46.5	37.86	19.34	57.76	-	-	P	H
		16740	49.55	-18.65	68.2	40.22	41.98	23.34	55.99	-	-	P	H
													H
													H
													H
													H
													H
													H
													H
													H
													H
													H
													H
													H
													H
													H
													H
													H
													H
			11160	45.78	-28.22	74	46.34	37.86	19.34	57.76	-	-	P
		16740	48.56	-19.64	68.2	39.23	41.98	23.34	55.99	-	-	P	V
													V
													V
													V
													V
													V
													V
													V
													V
													V
													V
													V
													V
													V
													V
													V



WIFI Ant.	Note	Frequency	Level	Margin	Limit Line	Read Level	Antenna Factor	Path Loss	Preamp Factor	Ant Pos	Table Pos	Peak Avg.	Pol.
2		(MHz)	(dBµV/m)	(dB)	(dBµV/m)	(dBµV)	(dB/m)	(dB)	(dB)	(cm)	(deg)	(P/A)	(H/V)
802.11a CH 140 5700MHz		11400	46.49	-27.51	74	46.08	38.1	19.57	57.26	-	-	P	H
		17100	49.69	-18.51	68.2	40.08	41.6	23.64	55.63	-	-	P	H
													H
													H
													H
													H
													H
													H
													H
													H
													H
													H
													H
													H
													H
													H
													H
													H
													H
			11400	46.24	-27.76	74	45.83	38.1	19.57	57.26	-	-	P
		17100	50.24	-17.96	68.2	40.63	41.6	23.64	55.63	-	-	P	V
													V
													V
													V
													V
													V
													V
													V
													V
													V
													V
													V
													V
													V
Remark	<ol style="list-style-type: none"> No other spurious found. All results are PASS against Peak and Average limit line. The emission position marked as "-" means no suspected emission found with sufficient margin against limit line or noise floor only. 												



Band 3 - Straddle Channel
WIFI 802.11a (Band Edge @ 3m)

WIFI Ant. 2	Note	Frequency (MHz)	Level (dBμV/m)	Margin (dB)	Limit Line (dBμV/m)	Read Level (dBμV)	Antenna Factor (dB/m)	Path Loss (dB)	Preamp Factor (dB)	Ant Pos (cm)	Table Pos (deg)	Peak Avg. (P/A)	Pol. (H/V)
802.11a CH 144 5720MHz		5417.08	50.23	-23.77	74	37.44	34.5	12.16	33.87	288	164	P	H
		5468.56	49.45	-18.75	68.2	36.31	34.77	12.24	33.87	288	164	P	H
		5456.47	42.48	-11.52	54	29.4	34.73	12.22	33.87	288	164	A	H
	*	5720	105.38	-	-	91.77	35.04	12.5	33.93	288	164	P	H
	*	5720	99.36	-	-	85.75	35.04	12.5	33.93	288	164	A	H
		5877.75	51.78	-16.42	68.2	37.92	35.16	12.67	33.97	288	164	P	H
		5418.64	49.93	-24.07	74	37.13	34.51	12.16	33.87	332	168	P	V
		5460.76	49.98	-18.22	68.2	36.88	34.74	12.23	33.87	332	168	P	V
		5452.96	42.31	-11.69	54	29.25	34.71	12.22	33.87	332	168	A	V
	*	5720	107.12	-	-	93.51	35.04	12.5	33.93	332	168	P	V
	*	5720	100.55	-	-	86.94	35.04	12.5	33.93	332	168	A	V
			5926.25	51.84	-16.36	68.2	37.86	35.2	12.76	33.98	332	168	P
Remark	1. No other spurious found. 2. All results are PASS against Peak and Average limit line.												



Band 3 - Straddle Channel
WIFI 802.11a (Harmonic @ 3m)

WIFI Ant.	Note	Frequency	Level	Margin	Limit Line	Read Level	Antenna Factor	Path Loss	Preamp Factor	Ant Pos	Table Pos	Peak Avg.	Pol.
2		(MHz)	(dBμV/m)	(dB)	(dBμV/m)	(dBμV)	(dB/m)	(dB)	(dB)	(cm)	(deg)	(P/A)	(H/V)
802.11a CH 144 5720MHz		11440	46.99	-27.01	74	46.41	38.14	19.61	57.17	-	-	P	H
		17160	50.16	-18.04	68.2	40.63	41.48	23.68	55.63	-	-	P	H
													H
													H
													H
													H
													H
													H
													H
													H
													H
													H
													H
													H
													H
													H
													H
													H
													H
	802.11a CH 144 5720MHz		11440	47.29	-26.71	74	46.71	38.14	19.61	57.17	-	-	P
		17160	50.56	-17.64	68.2	41.03	41.48	23.68	55.63	-	-	P	V
													V
													V
													V
													V
													V
													V
													V
													V
													V
													V
													V
													V
													V
													V
													V
													V
													V
													V
Remark	1. No other spurious found. 2. All results are PASS against Peak and Average limit line. 3. The emission position marked as "-" means no suspected emission found with sufficient margin against limit line or noise floor only.												



Emission below 1GHz

WIFI 802.11a (LF @ 3m)

WIFI Ant. 2	Note	Frequency (MHz)	Level (dBμV/m)	Margin (dB)	Limit Line (dBμV/m)	Read Level (dBμV)	Antenna Factor (dB/m)	Path Loss (dB)	Preamp Factor (dB)	Ant Pos (cm)	Table Pos (deg)	Peak Avg. (P/A)	Pol. (H/V)
802.11a LF		30	23.79	-16.21	40	28.17	24.51	1.05	29.94	-	-	P	H
		214.95	26.53	-16.97	43.5	38.97	14.86	2.53	29.83	-	-	P	H
		261.39	29.18	-16.82	46	36.7	19.6	2.7	29.82	-	-	P	H
		823.6	31.42	-14.58	46	27.91	27.69	5.05	29.23	-	-	P	H
		899.2	32.35	-13.65	46	27.1	28.67	5.43	28.85	-	-	P	H
		985.3	34.09	-19.91	54	26.43	30.4	5.61	28.35	-	-	P	H
													H
													H
													H
													H
													H
													H
													H
													H
													H
													H
													H
			30	32.69	-7.31	40	37.07	24.51	1.05	29.94	-	-	P
		63.21	27.92	-12.08	40	44.5	11.77	1.55	29.9	-	-	P	V
		256.8	30.63	-15.37	46	38.69	19.09	2.67	29.82	-	-	P	V
		742.4	35.8	-10.2	46	32.99	27.55	4.76	29.5	-	-	P	V
		920.2	35.21	-10.79	46	29.63	28.9	5.46	28.78	-	-	P	V
		979.7	37.02	-16.98	54	29.15	30.68	5.59	28.4	-	-	P	V
													V
													V
													V
													V
													V
													V
Remark	<ol style="list-style-type: none"> No other spurious found. All results are PASS against limit line. The emission position marked as "-" means no suspected emission found and emission level has at least 6dB margin against limit or emission is noise floor only. 												



Band 1 - 5150~5250MHz

WIFI 802.11ax HE20 Full (Band Edge @ 3m)

WIFI Ant. 1+2	Note	Frequency (MHz)	Level (dBμV/m)	Margin (dB)	Limit Line (dBμV/m)	Read Level (dBμV)	Antenna Factor (dB/m)	Path Loss (dB)	Preamp Factor (dB)	Ant Pos (cm)	Table Pos (deg)	Peak Avg. (P/A)	Pol. (H/V)	
802.11ax HE20 Full CH 36 5180MHz		5081.9	51.37	-22.63	74	39.28	34.04	11.95	33.9	341	49	P	H	
		5144.82	44.2	-9.8	54	31.97	34.09	12.03	33.89	341	49	A	H	
	*	5180	108.86	-	-	96.4	34.28	12.07	33.89	341	49	P	H	
	*	5180	101.41	-	-	88.95	34.28	12.07	33.89	341	49	A	H	
													H	
														H
			5127.4	50.45	-23.55	74	38.28	34.05	12.01	33.89	400	281	P	V
			5120.12	43.66	-10.34	54	31.51	34.04	12	33.89	400	281	A	V
		*	5180	106.81	-	-	94.35	34.28	12.07	33.89	400	281	P	V
		*	5180	99.11	-	-	86.65	34.28	12.07	33.89	400	281	A	V
													V	
													V	
802.11ax HE20 Full CH 44 5220MHz		5147.68	50.38	-23.62	74	38.14	34.1	12.03	33.89	336	49	P	H	
		5085.8	42.87	-11.13	54	30.78	34.03	11.95	33.89	336	49	A	H	
	*	5220	109.34	-	-	96.73	34.4	12.1	33.89	336	49	P	H	
	*	5220	101.95	-	-	89.34	34.4	12.1	33.89	336	49	A	H	
			5431.44	49.56	-24.44	74	36.66	34.59	12.18	33.87	336	49	P	H
			5443.48	42.51	-11.49	54	29.52	34.66	12.2	33.87	336	49	A	H
			5145.86	51.31	-22.69	74	39.08	34.09	12.03	33.89	400	285	P	V
			5119.86	43.73	-10.27	54	31.58	34.04	12	33.89	400	285	A	V
		*	5220	107.6	-	-	94.99	34.4	12.1	33.89	400	285	P	V
		*	5220	99.91	-	-	87.3	34.4	12.1	33.89	400	285	A	V
		5440.96	49.61	-24.39	74	36.63	34.65	12.2	33.87	400	285	P	V	
		5439	42.22	-11.78	54	29.27	34.63	12.19	33.87	400	285	A	V	



802.11ax HE20 Full CH 48 5240MHz		5029.38	49.98	-24.02	74	37.82	34.18	11.88	33.9	400	36	P	H
		5093.08	42.6	-11.4	54	30.52	34.01	11.96	33.89	400	36	A	H
	*	5240	107.45	-	-	94.83	34.4	12.11	33.89	400	36	P	H
	*	5240	100.93	-	-	88.31	34.4	12.11	33.89	400	36	A	H
		5399.52	49.34	-24.66	74	36.69	34.4	12.13	33.88	400	36	P	H
		5440.4	42.45	-11.55	54	29.48	34.64	12.2	33.87	400	36	A	H
		5121.68	50.56	-23.44	74	38.41	34.04	12	33.89	400	56	P	V
		5056.94	42.74	-11.26	54	30.64	34.09	11.91	33.9	400	56	A	V
	*	5240	107.19	-	-	94.57	34.4	12.11	33.89	400	56	P	V
	*	5240	99.9	-	-	87.28	34.4	12.11	33.89	400	56	A	V
		5379.92	49.86	-24.14	74	37.21	34.4	12.13	33.88	400	56	P	V
	5449.08	42.28	-11.72	54	29.25	34.69	12.21	33.87	400	56	A	V	
Remark	1. No other spurious found. 2. All results are PASS against Peak and Average limit line.												



Band 1 5150~5250MHz

WIFI 802.11ax HE20 Full (Harmonic @ 3m)

WIFI Ant.	Note	Frequency	Level	Margin	Limit Line	Read Level	Antenna Factor	Path Loss	Preamp Factor	Ant Pos	Table Pos	Peak Avg.	Pol.
1+2		(MHz)	(dBμV/m)	(dB)	(dBμV/m)	(dBμV)	(dB/m)	(dB)	(dB)	(cm)	(deg)	(P/A)	(H/V)
802.11ax HE20 Full		10360	43.81	-24.39	68.2	46.9	37.3	18.56	58.95	-	-	P	H
		15540	46.89	-27.11	74	40.46	40.2	22.49	56.26	-	-	P	H
													H
													H
													H
													H
													H
													H
													H
													H
CH 36 5180MHz		10360	43.9	-24.3	68.2	46.99	37.3	18.56	58.95	-	-	P	V
		15540	46.84	-27.16	74	40.41	40.2	22.49	56.26	-	-	P	V
													V
													V
													V
													V
													V
													V
													V
													V



WIFI Ant.	Note	Frequency	Level	Margin	Limit Line	Read Level	Antenna Factor	Path Loss	Preamp Factor	Ant Pos	Table Pos	Peak Avg.	Pol.
1+2		(MHz)	(dBµV/m)	(dB)	(dBµV/m)	(dBµV)	(dB/m)	(dB)	(dB)	(cm)	(deg)	(P/A)	(H/V)
802.11ax HE20 Full CH 44 5220MHz		10440	44.44	-23.76	68.2	47.36	37.3	18.64	58.86	-	-	P	H
		15660	48.17	-25.83	74	41.54	40.38	22.56	56.31	-	-	P	H
													H
													H
													H
													H
													H
													H
													H
													H
													H
													H
													H
													H
													H
													H
													H
													H
													H
			10440	45.02	-23.18	68.2	47.94	37.3	18.64	58.86	-	-	P
		15660	47.11	-26.89	74	40.48	40.38	22.56	56.31	-	-	P	V
													V
													V
													V
													V
													V
													V
													V
													V
													V
													V
													V
													V
													V
													V



WIFI Ant.	Note	Frequency	Level	Margin	Limit Line	Read Level	Antenna Factor	Path Loss	Preamp Factor	Ant Pos	Table Pos	Peak Avg.	Pol.
1+2		(MHz)	(dBµV/m)	(dB)	(dBµV/m)	(dBµV)	(dB/m)	(dB)	(dB)	(cm)	(deg)	(P/A)	(H/V)
802.11ax HE20 Full CH 48 5240MHz		10480	44.52	-23.68	68.2	47.37	37.3	18.67	58.82	-	-	P	H
		15720	48.74	-25.26	74	41.94	40.54	22.59	56.33	-	-	P	H
													H
													H
													H
													H
													H
													H
													H
													H
													H
													H
													H
													H
													H
													H
													H
													H
													H
	802.11ax HE20 Full CH 48 5240MHz		10480	45.25	-22.95	68.2	48.1	37.3	18.67	58.82	-	-	P
		15720	48.61	-25.39	74	41.81	40.54	22.59	56.33	-	-	P	V
													V
													V
													V
													V
													V
													V
													V
													V
Remark	<ol style="list-style-type: none"> No other spurious found. All results are PASS against Peak and Average limit line. The emission position marked as "-" means no suspected emission found with sufficient margin against limit line or noise floor only. 												



Band 1 5150~5250MHz
WIFI 802.11ax HE40 Full (Band Edge @ 3m)

WIFI Ant.	Note	Frequency	Level	Margin	Limit Line	Read Level	Antenna Factor	Path Loss	Preamp Factor	Ant Pos	Table Pos	Peak Avg.	Pol.
1+2		(MHz)	(dBμV/m)	(dB)	(dBμV/m)	(dBμV)	(dB/m)	(dB)	(dB)	(cm)	(deg)	(P/A)	(H/V)
802.11ax HE40 Full CH 38 5190MHz		5148.72	56.14	-17.86	74	43.9	34.1	12.03	33.89	337	48	P	H
		5148.72	51.2	-2.8	54	38.96	34.1	12.03	33.89	337	48	A	H
	*	5190	106.48	-	-	93.94	34.34	12.09	33.89	337	48	P	H
	*	5190	99.13	-	-	86.59	34.34	12.09	33.89	337	48	A	H
		5433.4	49.26	-24.74	74	36.34	34.6	12.19	33.87	337	48	P	H
		5449.08	43.17	-10.83	54	30.14	34.69	12.21	33.87	337	48	A	H
		5148.98	56.48	-17.52	74	44.24	34.1	12.03	33.89	379	285	P	V
		5149.76	50.12	-3.88	54	37.88	34.1	12.03	33.89	379	285	A	V
	*	5190	105.38	-	-	92.84	34.34	12.09	33.89	379	285	P	V
	*	5190	97.88	-	-	85.34	34.34	12.09	33.89	379	285	A	V
		5410.44	50.95	-23.05	74	38.22	34.46	12.15	33.88	379	285	P	V
		5455.8	43.33	-10.67	54	30.26	34.72	12.22	33.87	379	285	A	V
802.11ax HE40 Full CH 46 5230MHz		5123.76	50.28	-23.72	74	38.12	34.05	12	33.89	380	41	P	H
		5129.22	43.52	-10.48	54	31.34	34.06	12.01	33.89	380	41	A	H
	*	5230	105.35	-	-	92.74	34.4	12.1	33.89	380	41	P	H
	*	5230	97.41	-	-	84.8	34.4	12.1	33.89	380	41	A	H
		5360.88	50.64	-23.36	74	38	34.4	12.12	33.88	380	41	P	H
		5455.8	43.57	-10.43	54	30.5	34.72	12.22	33.87	380	41	A	H
		5079.82	50.12	-23.88	74	38.04	34.04	11.94	33.9	400	41	P	V
		5081.12	43.55	-10.45	54	31.46	34.04	11.95	33.9	400	41	A	V
	*	5230	104.36	-	-	91.75	34.4	12.1	33.89	400	41	P	V
	*	5230	97.55	-	-	84.94	34.4	12.1	33.89	400	41	A	V
	5374.04	50.6	-23.4	74	37.95	34.4	12.13	33.88	400	41	P	V	
	5450.76	42.77	-11.23	54	29.73	34.7	12.21	33.87	400	41	A	V	
Remark	1. No other spurious found. 2. All results are PASS against Peak and Average limit line.												



Band 1 5150~5250MHz

WIFI 802.11ax HE40 Full (Harmonic @ 3m)

WIFI Ant.	Note	Frequency	Level	Margin	Limit Line	Read Level	Antenna Factor	Path Loss	Preamp Factor	Ant Pos	Table Pos	Peak Avg.	Pol.
1+2		(MHz)	(dBμV/m)	(dB)	(dBμV/m)	(dBμV)	(dB/m)	(dB)	(dB)	(cm)	(deg)	(P/A)	(H/V)
802.11ax HE40 Full CH 38 5190MHz		10380	44.52	-23.68	68.2	47.57	37.3	18.58	58.93	-	-	P	H
		15570	48.13	-25.87	74	41.69	40.2	22.51	56.27	-	-	P	H
													H
													H
													H
													H
													H
													H
													H
													H
		10380	43.77	-24.43	68.2	46.82	37.3	18.58	58.93	-	-	P	V
		15570	48.36	-25.64	74	41.92	40.2	22.51	56.27	-	-	P	V
													V
													V
													V
													V
													V
													V
													V
													V
													V



WIFI Ant.	Note	Frequency	Level	Margin	Limit Line	Read Level	Antenna Factor	Path Loss	Preamp Factor	Ant Pos	Table Pos	Peak Avg.	Pol.	
1+2		(MHz)	(dBµV/m)	(dB)	(dBµV/m)	(dBµV)	(dB/m)	(dB)	(dB)	(cm)	(deg)	(P/A)	(H/V)	
802.11ax HE40 Full CH 46 5230MHz		10460	44.96	-23.24	68.2	47.85	37.3	18.65	58.84	-	-	P	H	
		15690	48.09	-25.91	74	41.36	40.47	22.58	56.32	-	-	P	H	
													H	
													H	
													H	
													H	
													H	
													H	
													H	
													H	
													H	
													H	
													H	
													H	
													H	
													H	
													H	
													H	
	Remark	<ol style="list-style-type: none"> 1. No other spurious found. 2. All results are PASS against Peak and Average limit line. 3. The emission position marked as "-" means no suspected emission found with sufficient margin against limit line or noise floor only. 												



**Band 1 5150~5250MHz
WIFI 802.11ax HE80 Full (Band Edge @ 3m)**

WIFI Ant. 1+2	Note	Frequency (MHz)	Level (dBμV/m)	Margin (dB)	Limit Line (dBμV/m)	Read Level (dBμV)	Antenna Factor (dB/m)	Path Loss (dB)	Preamp Factor (dB)	Ant Pos (cm)	Table Pos (deg)	Peak Avg. (P/A)	Pol. (H/V)
802.11ax HE80 Full CH 42 5210MHz		5126.62	52.75	-21.25	74	40.59	34.05	12	33.89	333	45	P	H
		5125.84	47.28	-6.72	54	35.12	34.05	12	33.89	333	45	A	H
	*	5210	99.59	-	-	86.98	34.4	12.1	33.89	333	45	P	H
	*	5210	93.43	-	-	80.82	34.4	12.1	33.89	333	45	A	H
		5455.8	50.44	-23.56	74	37.37	34.72	12.22	33.87	333	45	P	H
		5447.96	43.6	-10.4	54	30.57	34.69	12.21	33.87	333	45	A	H
		5131.56	55.35	-18.65	74	43.17	34.06	12.01	33.89	399	279	P	V
		5131.82	48.72	-5.28	54	36.54	34.06	12.01	33.89	399	279	A	V
	*	5210	98.71	-	-	86.1	34.4	12.1	33.89	399	279	P	V
	*	5210	91.43	-	-	78.82	34.4	12.1	33.89	399	279	A	V
		5365.92	50.17	-23.83	74	37.53	34.4	12.12	33.88	399	279	P	V
		5457.2	43.49	-10.51	54	30.41	34.73	12.22	33.87	399	279	A	V
Remark	1. No other spurious found. 2. All results are PASS against Peak and Average limit line.												



**Band 1 5150~5250MHz
WIFI 802.11ax HE80 Full (Harmonic @ 3m)**

WIFI Ant.	Note	Frequency	Level	Margin	Limit Line	Read Level	Antenna Factor	Path Loss	Preamp Factor	Ant Pos	Table Pos	Peak Avg.	Pol.	
1+2		(MHz)	(dBμV/m)	(dB)	(dBμV/m)	(dBμV)	(dB/m)	(dB)	(dB)	(cm)	(deg)	(P/A)	(H/V)	
802.11ax HE80 Full CH 42 5210MHz		10420	45.37	-22.83	68.2	48.33	37.3	18.62	58.88	-	-	P	H	
		15630	47.2	-26.8	74	40.66	40.29	22.54	56.29	-	-	P	H	
													H	
													H	
													H	
													H	
													H	
													H	
													H	
													H	
													H	
													H	
													H	
													H	
													H	
													H	
			10420	43.91	-24.29	68.2	46.87	37.3	18.62	58.88	-	-	P	V
			15630	46.41	-27.59	74	39.87	40.29	22.54	56.29	-	-	P	V
													V	
													V	
													V	
													V	
													V	
													V	
													V	
													V	
													V	
													V	
													V	
Remark	1. No other spurious found. 2. All results are PASS against Peak and Average limit line. 3. The emission position marked as "-" means no suspected emission found with sufficient margin against limit line or noise floor only.													



Band 2 - 5250~5350MHz

WIFI 802.11ax HE20 Full (Band Edge @ 3m)

WIFI Ant.	Note	Frequency	Level	Margin	Limit Line	Read Level	Antenna Factor	Path Loss	Preamp Factor	Ant Pos	Table Pos	Peak Avg.	Pol.
1+2		(MHz)	(dBμV/m)	(dB)	(dBμV/m)	(dBμV)	(dB/m)	(dB)	(dB)	(cm)	(deg)	(P/A)	(H/V)
802.11ax HE20 Full CH 52 5260MHz		5019.95	50.87	-23.13	74	38.68	34.22	11.87	33.9	400	36	P	H
		5103.95	42.83	-11.17	54	30.73	34.01	11.98	33.89	400	36	A	H
	*	5260	108.97	-	-	96.34	34.4	12.11	33.88	400	36	P	H
	*	5260	100.65	-	-	88.02	34.4	12.11	33.88	400	36	A	H
		5451.84	49.7	-24.3	74	36.64	34.71	12.22	33.87	400	36	P	H
		5381.76	42.38	-11.62	54	29.73	34.4	12.13	33.88	400	36	A	H
		5100.1	50.58	-23.42	74	38.5	34	11.97	33.89	400	58	P	V
		5055.65	42.78	-11.22	54	30.68	34.09	11.91	33.9	400	58	A	V
	*	5260	106.67	-	-	94.04	34.4	12.11	33.88	400	58	P	V
	*	5260	99.27	-	-	86.64	34.4	12.11	33.88	400	58	A	V
		5370.24	49.58	-24.42	74	36.93	34.4	12.13	33.88	400	58	P	V
		5441.04	42.69	-11.31	54	29.71	34.65	12.2	33.87	400	58	A	V
802.11ax HE20 Full CH 60 5300MHz		5066.5	50.5	-23.5	74	38.4	34.07	11.93	33.9	324	48	P	H
		5116.2	42.95	-11.05	54	30.82	34.03	11.99	33.89	324	48	A	H
	*	5300	110.62	-	-	97.99	34.4	12.11	33.88	324	48	P	H
	*	5300	101.79	-	-	89.16	34.4	12.11	33.88	324	48	A	H
		5442.24	50.16	-23.84	74	37.18	34.65	12.2	33.87	324	48	P	H
		5457.6	42.61	-11.39	54	29.52	34.73	12.23	33.87	324	48	A	H
		5026.95	50.86	-23.14	74	38.69	34.19	11.88	33.9	400	282	P	V
		5120.05	43.57	-10.43	54	31.42	34.04	12	33.89	400	282	A	V
	*	5300	106.07	-	-	93.44	34.4	12.11	33.88	400	282	P	V
	*	5300	98.4	-	-	85.77	34.4	12.11	33.88	400	282	A	V
		5434.56	51.39	-22.61	74	38.46	34.61	12.19	33.87	400	282	P	V
		5434.08	42.72	-11.28	54	29.8	34.6	12.19	33.87	400	282	A	V



802.11ax HE20 Full CH 64 5320MHz	*	5320	105.26	-	-	92.62	34.4	12.12	33.88	400	281	P	V
	*	5320	98.81	-	-	86.17	34.4	12.12	33.88	400	281	A	V
		5364	50.01	-23.99	74	37.37	34.4	12.12	33.88	400	281	P	V
		5351.04	44.24	-9.76	54	31.6	34.4	12.12	33.88	400	281	A	V
													H
													H
	*	5320	109.26	-	-	96.62	34.4	12.12	33.88	342	47	P	H
	*	5320	101.74	-	-	89.1	34.4	12.12	33.88	342	47	A	H
		5361.6	50.64	-23.36	74	38	34.4	12.12	33.88	342	47	P	H
		5350.56	44.45	-9.55	54	31.81	34.4	12.12	33.88	342	47	A	H
												V	
												V	
Remark	1. No other spurious found. 2. All results are PASS against Peak and Average limit line.												



Band 2 5250~5350MHz

WIFI 802.11ax HE20 Full (Harmonic @ 3m)

WIFI Ant.	Note	Frequency	Level	Margin	Limit Line	Read Level	Antenna Factor	Path Loss	Preamp Factor	Ant Pos	Table Pos	Peak Avg.	Pol.
1+2		(MHz)	(dBμV/m)	(dB)	(dBμV/m)	(dBμV)	(dB/m)	(dB)	(dB)	(cm)	(deg)	(P/A)	(H/V)
802.11ax HE20 Full		10520	44.64	-23.56	68.2	47.38	37.32	18.71	58.77	-	-	P	H
		15780	47.95	-26.05	74	41.03	40.66	22.62	56.36	-	-	P	H
													H
													H
													H
													H
													H
													H
													H
													H
CH 52 5260MHz		10520	44.38	-23.82	68.2	47.12	37.32	18.71	58.77	-	-	P	V
		15780	47.73	-26.27	74	40.81	40.66	22.62	56.36	-	-	P	V
													V
													V
													V
													V
													V
													V
													V
													V



WiFi Ant.	Note	Frequency	Level	Margin	Limit Line	Read Level	Antenna Factor	Path Loss	Preamp Factor	Ant Pos	Table Pos	Peak Avg.	Pol.
1+2		(MHz)	(dBµV/m)	(dB)	(dBµV/m)	(dBµV)	(dB/m)	(dB)	(dB)	(cm)	(deg)	(P/A)	(H/V)
802.11ax HE20 Full CH 60 5300MHz		10600	44.31	-29.69	74	46.77	37.4	18.8	58.66	-	-	P	H
		15900	47.8	-26.2	74	40.62	40.9	22.69	56.41	-	-	P	H
													H
													H
													H
													H
													H
													H
													H
													H
													H
													H
													V
													V
													V
													V
													V
													V



WIFI Ant.	Note	Frequency	Level	Margin	Limit Line	Read Level	Antenna Factor	Path Loss	Preamp Factor	Ant Pos	Table Pos	Peak Avg.	Pol.
1+2		(MHz)	(dBµV/m)	(dB)	(dBµV/m)	(dBµV)	(dB/m)	(dB)	(dB)	(cm)	(deg)	(P/A)	(H/V)
802.11ax HE20 Full CH 64 5320MHz		10640	45.94	-28.06	74	48.23	37.48	18.83	58.6	-	-	P	H
		15960	46.37	-27.63	74	39.17	40.9	22.73	56.43	-	-	P	H
													H
													H
													H
													H
													H
													H
													H
													H
													H
													H
													H
													H
													H
													H
													H
													H
													H
	CH 64 5320MHz		10640	45.26	-28.74	74	47.55	37.48	18.83	58.6	-	-	P
		15960	46.76	-27.24	74	39.56	40.9	22.73	56.43	-	-	P	V
													V
													V
													V
													V
													V
													V
													V
													V
													V
													V

Remark

- No other spurious found.
- All results are PASS against Peak and Average limit line.
- The emission position marked as "-" means no suspected emission found with sufficient margin against limit line or noise floor only.



Band 2 5250~5350MHz
WIFI 802.11ax HE40 Full (Band Edge @ 3m)

WIFI Ant.	Note	Frequency	Level	Margin	Limit Line	Read Level	Antenna Factor	Path Loss	Preamp Factor	Ant Pos	Table Pos	Peak Avg.	Pol.
1+2		(MHz)	(dBμV/m)	(dB)	(dBμV/m)	(dBμV)	(dB/m)	(dB)	(dB)	(cm)	(deg)	(P/A)	(H/V)
802.11ax HE40 Full CH 54 5270MHz		5144.55	50.71	-23.29	74	38.48	34.09	12.03	33.89	400	36	P	H
		5134.75	43.72	-10.28	54	31.52	34.07	12.02	33.89	400	36	A	H
	*	5270	106.49	-	-	93.86	34.4	12.11	33.88	400	36	P	H
	*	5270	98.07	-	-	85.44	34.4	12.11	33.88	400	36	A	H
		5366.64	50.52	-23.48	74	37.88	34.4	12.12	33.88	400	36	P	H
		5362.8	43.47	-10.53	54	30.83	34.4	12.12	33.88	400	36	A	H
		5007	51.1	-22.9	74	38.88	34.27	11.85	33.9	394	42	P	V
		5091.35	43.59	-10.41	54	31.5	34.02	11.96	33.89	394	42	A	V
	*	5270	104.67	-	-	92.04	34.4	12.11	33.88	394	42	P	V
	*	5270	97.31	-	-	84.68	34.4	12.11	33.88	394	42	A	V
		5371.44	49.78	-24.22	74	37.13	34.4	12.13	33.88	394	42	P	V
		5452.8	43.16	-10.84	54	30.1	34.71	12.22	33.87	394	42	A	V
802.11ax HE40 Full CH 62 5310MHz		5021	51.04	-22.96	74	38.85	34.22	11.87	33.9	390	35	P	H
		5049	43.45	-10.55	54	31.35	34.1	11.9	33.9	390	35	A	H
	*	5314	106.1	-	-	93.46	34.4	12.12	33.88	390	35	P	H
	*	5314	98.76	-	-	86.12	34.4	12.12	33.88	390	35	A	H
		5351.28	57.41	-16.59	74	44.77	34.4	12.12	33.88	390	35	P	H
		5350.08	50.79	-3.21	54	38.15	34.4	12.12	33.88	390	35	A	H
		5148.4	50.92	-23.08	74	38.68	34.1	12.03	33.89	384	284	P	V
		5120.05	44.15	-9.85	54	32	34.04	12	33.89	384	284	A	V
	*	5310	104.62	-	-	91.98	34.4	12.12	33.88	384	284	P	V
	*	5310	97.07	-	-	84.43	34.4	12.12	33.88	384	284	A	V
	5353.2	60.55	-13.45	74	47.91	34.4	12.12	33.88	384	284	P	V	
	5352.72	51.18	-2.82	54	38.54	34.4	12.12	33.88	384	284	A	V	
Remark	1. No other spurious found. 2. All results are PASS against Peak and Average limit line.												



Band 2 5250~5350MHz

WIFI 802.11ax HE40 Full (Harmonic @ 3m)

WIFI Ant.	Note	Frequency	Level	Margin	Limit Line	Read Level	Antenna Factor	Path Loss	Preamp Factor	Ant Pos	Table Pos	Peak Avg.	Pol.
1+2		(MHz)	(dBμV/m)	(dB)	(dBμV/m)	(dBμV)	(dB/m)	(dB)	(dB)	(cm)	(deg)	(P/A)	(H/V)
802.11ax HE40 Full		10540	44.7	-23.5	68.2	47.37	37.34	18.73	58.74	-	-	P	H
		15810	47.15	-26.85	74	40.16	40.72	22.64	56.37	-	-	P	H
													H
													H
													H
													H
													H
													H
													H
													H
CH 54 5270MHz		10540	43.89	-24.31	68.2	46.56	37.34	18.73	58.74	-	-	P	V
		15810	47.21	-26.79	74	40.22	40.72	22.64	56.37	-	-	P	V
													V
													V
													V
													V
													V
													V
													V
													V



WIFI Ant.	Note	Frequency	Level	Margin	Limit Line	Read Level	Antenna Factor	Path Loss	Preamp Factor	Ant Pos	Table Pos	Peak Avg.	Pol.
1+2		(MHz)	(dBµV/m)	(dB)	(dBµV/m)	(dBµV)	(dB/m)	(dB)	(dB)	(cm)	(deg)	(P/A)	(H/V)
802.11ax HE40 Full CH 62 5310MHz		10620	44.54	-29.46	74	46.91	37.44	18.82	58.63	-	-	P	H
		15930	47.51	-26.49	74	40.31	40.9	22.72	56.42	-	-	P	H
													H
													H
													H
													H
													H
													H
													H
													H
		10620	44.84	-29.16	74	47.21	37.44	18.82	58.63	-	-	P	V
		15930	47.29	-26.71	74	40.09	40.9	22.72	56.42	-	-	P	V
													V
													V
													V
													V
													V
													V
													V
													V
													V
Remark	<ol style="list-style-type: none"> No other spurious found. All results are PASS against Peak and Average limit line. The emission position marked as "-" means no suspected emission found with sufficient margin against limit line or noise floor only. 												



**Band 2 5250~5350MHz
WIFI 802.11ax HE80 Full (Band Edge @ 3m)**

WIFI Ant.	Note	Frequency	Level	Margin	Limit Line	Read Level	Antenna Factor	Path Loss	Preamp Factor	Ant Pos	Table Pos	Peak Avg.	Pol.
1+2		(MHz)	(dBμV/m)	(dB)	(dBμV/m)	(dBμV)	(dB/m)	(dB)	(dB)	(cm)	(deg)	(P/A)	(H/V)
802.11ax HE80 Full CH 58 5290MHz		5149.45	51.93	-22.07	74	39.69	34.1	12.03	33.89	319	46	P	H
		5125.3	44.49	-9.51	54	32.33	34.05	12	33.89	319	46	A	H
	*	5290	100.36	-	-	87.73	34.4	12.11	33.88	319	46	P	H
	*	5290	93.29	-	-	80.66	34.4	12.11	33.88	319	46	A	H
		5357.28	58.89	-15.11	74	46.25	34.4	12.12	33.88	319	46	P	H
		5356.56	51.49	-2.51	54	38.85	34.4	12.12	33.88	319	46	A	H
		5032.2	52.5	-21.5	74	40.35	34.17	11.88	33.9	355	281	P	V
		5120.05	44.72	-9.28	54	32.57	34.04	12	33.89	355	281	A	V
	*	5290	99.18	-	-	86.55	34.4	12.11	33.88	355	281	P	V
	*	5290	91.16	-	-	78.53	34.4	12.11	33.88	355	281	A	V
		5356.56	56.99	-17.01	74	44.35	34.4	12.12	33.88	355	281	P	V
		5355.12	49.95	-4.05	54	37.31	34.4	12.12	33.88	355	281	A	V
Remark	1. No other spurious found. 2. All results are PASS against Peak and Average limit line.												



Band 2 5250~5350MHz
WIFI 802.11ax HE80 Full (Harmonic @ 3m)

WIFI Ant.	Note	Frequency	Level	Margin	Limit Line	Read Level	Antenna Factor	Path Loss	Preamp Factor	Ant Pos	Table Pos	Peak Avg.	Pol.
1+2		(MHz)	(dBμV/m)	(dB)	(dBμV/m)	(dBμV)	(dB/m)	(dB)	(dB)	(cm)	(deg)	(P/A)	(H/V)
802.11ax HE80 Full CH 58 5290MHz		10580	44.82	-23.38	68.2	47.35	37.38	18.78	58.69	-	-	P	H
		15870	47.69	-26.31	74	40.57	40.84	22.68	56.4	-	-	P	H
													H
													H
													H
													H
													H
													H
													H
													H
													H
													H
													H
													H
													H
													H
													H
	Remark	1. No other spurious found.											
2. All results are PASS against Peak and Average limit line.													
3. The emission position marked as "-" means no suspected emission found with sufficient margin against limit line or noise floor only.													



Band 3 - 5470~5725MHz
WIFI 802.11ax HE20 Full (Band Edge @ 3m)

WIFI Ant.	Note	Frequency	Level	Margin	Limit Line	Read Level	Antenna Factor	Path Loss	Preamp Factor	Ant Pos	Table Pos	Peak Avg.	Pol.
1+2		(MHz)	(dBµV/m)	(dB)	(dBµV/m)	(dBµV)	(dB/m)	(dB)	(dB)	(cm)	(deg)	(P/A)	(H/V)
802.11ax HE20 Full CH 100 5500MHz		5427.6	49.97	-24.03	74	37.09	34.57	12.18	33.87	304	20	P	H
		5461.04	49.29	-18.91	68.2	36.19	34.74	12.23	33.87	304	20	P	H
		5457.2	43.31	-10.69	54	30.23	34.73	12.22	33.87	304	20	A	H
	*	5500	107.42	-	-	94.09	34.9	12.3	33.87	304	20	P	H
	*	5500	100.37	-	-	87.04	34.9	12.3	33.87	304	20	A	H
		5357.2	50.26	-23.74	74	37.62	34.4	12.12	33.88	400	64	P	V
		5464.56	51.66	-16.54	68.2	38.53	34.76	12.24	33.87	400	64	P	V
		5458.16	42.98	-11.02	54	29.89	34.73	12.23	33.87	400	64	A	V
	*	5500	105.83	-	-	92.5	34.9	12.3	33.87	400	64	P	V
	*	5500	98.37	-	-	85.04	34.9	12.3	33.87	400	64	A	V
													V
													V
802.11ax HE20 Full CH 116 5580MHz		5444.08	49.78	-24.22	74	36.79	34.66	12.2	33.87	291	39	P	H
		5461.36	50.29	-17.91	68.2	37.18	34.75	12.23	33.87	291	39	P	H
		5453.2	43.27	-10.73	54	30.21	34.71	12.22	33.87	291	39	A	H
	*	5580	109.35	-	-	95.91	34.9	12.43	33.89	291	39	P	H
	*	5580	102.75	-	-	89.31	34.9	12.43	33.89	291	39	A	H
		5727.515	50.59	-17.61	68.2	36.96	35.06	12.5	33.93	291	39	P	H
		5385.28	50.26	-23.74	74	37.61	34.4	12.13	33.88	382	77	P	V
		5469.04	48.9	-19.3	68.2	35.75	34.78	12.24	33.87	382	77	P	V
		5452.72	42.87	-11.13	54	29.81	34.71	12.22	33.87	382	77	A	V
	*	5580	106.54	-	-	93.1	34.9	12.43	33.89	382	77	P	V
	*	5580	100.36	-	-	86.92	34.9	12.43	33.89	382	77	A	V
		5725.94	51.34	-16.86	68.2	37.72	35.05	12.5	33.93	382	77	P	V



802.11ax HE20 Full CH 140 5700MHz	*	5700	108.39	-	-	94.82	35	12.49	33.92	298	38	P	H
	*	5700	101.47	-	-	87.9	35	12.49	33.92	298	38	A	H
		5725.8	61.48	-6.72	68.2	47.86	35.05	12.5	33.93	298	38	P	H
													H
													H
													H
	*	5700	107.75	-	-	94.18	35	12.49	33.92	393	60	P	V
	*	5700	100.62	-	-	87.05	35	12.49	33.92	393	60	A	V
		5725.24	59.63	-8.57	68.2	46.01	35.05	12.5	33.93	393	60	P	V
													V
												V	
												V	
Remark	1. No other spurious found. 2. All results are PASS against Peak and Average limit line.												



Band 3 5470~5725MHz

WIFI 802.11ax HE20 (Harmonic @ 3m)

WIFI Ant.	Note	Frequency	Level	Margin	Limit Line	Read Level	Antenna Factor	Path Loss	Preamp Factor	Ant Pos	Table Pos	Peak Avg.	Pol.
1+2		(MHz)	(dBμV/m)	(dB)	(dBμV/m)	(dBμV)	(dB/m)	(dB)	(dB)	(cm)	(deg)	(P/A)	(H/V)
802.11ax HE20 Full CH 100 5500MHz		11100	45.06	-28.94	74	45.86	37.8	19.28	57.88	-	-	P	H
		16650	49.23	-18.97	68.2	40.38	41.7	23.27	56.12	-	-	P	H
													H
													H
													H
													H
													H
													H
													H
													H
		11100	45.32	-28.68	74	46.12	37.8	19.28	57.88	-	-	P	V
		16650	49.1	-19.1	68.2	40.25	41.7	23.27	56.12	-	-	P	V
													V
													V
													V
													V
													V
													V
													V
													V
													V



WIFI Ant.	Note	Frequency	Level	Margin	Limit Line	Read Level	Antenna Factor	Path Loss	Preamp Factor	Ant Pos	Table Pos	Peak Avg.	Pol.
1+2		(MHz)	(dBµV/m)	(dB)	(dBµV/m)	(dBµV)	(dB/m)	(dB)	(dB)	(cm)	(deg)	(P/A)	(H/V)
802.11ax HE20 Full		11160	45.71	-28.29	74	46.27	37.86	19.34	57.76	-	-	P	H
		16740	48.77	-19.43	68.2	39.44	41.98	23.34	55.99	-	-	P	H
													H
													H
													H
													H
													H
													H
													H
													H
CH 116 5580MHz		11160	45.15	-28.85	74	45.71	37.86	19.34	57.76	-	-	P	V
		16740	49.35	-18.85	68.2	40.02	41.98	23.34	55.99	-	-	P	V
													V
													V
													V
													V
													V
													V
													V
													V



WIFI Ant.	Note	Frequency	Level	Margin	Limit Line	Read Level	Antenna Factor	Path Loss	Preamp Factor	Ant Pos	Table Pos	Peak Avg.	Pol.
1+2		(MHz)	(dBµV/m)	(dB)	(dBµV/m)	(dBµV)	(dB/m)	(dB)	(dB)	(cm)	(deg)	(P/A)	(H/V)
802.11ax HE20 Full CH 140 5700MHz		11400	45.8	-28.2	74	45.39	38.1	19.57	57.26	-	-	P	H
		17100	50.43	-17.77	68.2	40.82	41.6	23.64	55.63	-	-	P	H
													H
													H
													H
													H
													H
													H
													H
													H
													H
													H
													H
													H
													H
													H
													H
													H
													H
	802.11ax HE20 Full CH 140 5700MHz		11400	45.86	-28.14	74	45.45	38.1	19.57	57.26	-	-	P
		17100	49.52	-18.68	68.2	39.91	41.6	23.64	55.63	-	-	P	V
													V
													V
													V
													V
													V
													V
													V
													V
Remark	<ol style="list-style-type: none"> No other spurious found. All results are PASS against Peak and Average limit line. The emission position marked as "-" means no suspected emission found with sufficient margin against limit line or noise floor only. 												



Band 3 5470~5725MHz
WIFI 802.11ax HE40 Full (Band Edge @ 3m)

WIFI Ant.	Note	Frequency	Level	Margin	Limit Line	Read Level	Antenna Factor	Path Loss	Preamp Factor	Ant Pos	Table Pos	Peak Avg.	Pol.
1+2		(MHz)	(dBμV/m)	(dB)	(dBμV/m)	(dBμV)	(dB/m)	(dB)	(dB)	(cm)	(deg)	(P/A)	(H/V)
802.11ax HE40 Full CH 102 5510MHz		5457.04	53.81	-20.19	74	40.73	34.73	12.22	33.87	333	50	P	H
		5465.2	54.1	-14.1	68.2	40.97	34.76	12.24	33.87	333	50	P	H
		5459.44	46.33	-7.67	54	33.23	34.74	12.23	33.87	333	50	A	H
	*	5510	104.67	-	-	91.33	34.9	12.31	33.87	333	50	P	H
	*	5510	97.56	-	-	84.22	34.9	12.31	33.87	333	50	A	H
		5749.25	52.71	-15.49	68.2	39.03	35.1	12.51	33.93	333	50	P	H
		5459.92	51.86	-22.14	74	38.76	34.74	12.23	33.87	369	79	P	V
		5467.12	54.49	-13.71	68.2	41.35	34.77	12.24	33.87	369	79	P	V
		5459.44	45.59	-8.41	54	32.49	34.74	12.23	33.87	369	79	A	V
	*	5510	103.57	-	-	90.23	34.9	12.31	33.87	369	79	P	V
	*	5510	96.82	-	-	83.48	34.9	12.31	33.87	369	79	A	V
		5759.33	51.25	-16.95	68.2	37.57	35.1	12.52	33.94	369	79	P	V
802.11ax HE40 Full CH 110 5550MHz		5454.16	51.32	-22.68	74	38.25	34.72	12.22	33.87	327	48	P	H
		5462.08	50.64	-17.56	68.2	37.53	34.75	12.23	33.87	327	48	P	H
		5453.68	43.82	-10.18	54	30.76	34.71	12.22	33.87	327	48	A	H
	*	5550	104.56	-	-	91.16	34.9	12.38	33.88	327	48	P	H
	*	5550	97.89	-	-	84.49	34.9	12.38	33.88	327	48	A	H
		5744.525	51.91	-16.29	68.2	38.24	35.09	12.51	33.93	327	48	P	H
		5449.12	50.55	-23.45	74	37.52	34.69	12.21	33.87	400	72	P	V
		5462.56	50.91	-17.29	68.2	37.8	34.75	12.23	33.87	400	72	P	V
		5453.2	43.79	-10.21	54	30.73	34.71	12.22	33.87	400	72	A	V
	*	5550	103.48	-	-	90.08	34.9	12.38	33.88	400	72	P	V
	*	5550	96.63	-	-	83.23	34.9	12.38	33.88	400	72	A	V
		5740.43	50.84	-17.36	68.2	37.18	35.08	12.51	33.93	400	72	P	V



802.11ax HE40 Full CH 134 5670MHz		5445.55	50.09	-23.91	74	37.08	34.67	12.21	33.87	322	58	P	H
		5467.25	49.22	-18.98	68.2	36.08	34.77	12.24	33.87	322	58	P	H
		5459.2	43.34	-10.66	54	30.24	34.74	12.23	33.87	322	58	A	H
	*	5670	105.05	-	-	91.54	34.94	12.48	33.91	322	58	P	H
	*	5670	98.12	-	-	84.61	34.94	12.48	33.91	322	58	A	H
		5725.275	54.36	-13.84	68.2	40.74	35.05	12.5	33.93	322	58	P	H
		5447.3	49.73	-24.27	74	36.71	34.68	12.21	33.87	283	281	P	V
		5465.85	48.76	-19.44	68.2	35.63	34.76	12.24	33.87	283	281	P	V
		5453.25	43.26	-10.74	54	30.2	34.71	12.22	33.87	283	281	A	V
	*	5670	104.68	-	-	91.17	34.94	12.48	33.91	283	281	P	V
	*	5670	97.77	-	-	84.26	34.94	12.48	33.91	283	281	A	V
		5725.275	58.6	-9.6	68.2	44.98	35.05	12.5	33.93	283	281	P	V
Remark	1. No other spurious found. 2. All results are PASS against Peak and Average limit line.												



Band 3 5470~5725MHz

WIFI 802.11ax HE40 Full (Harmonic @ 3m)

WIFI Ant.	Note	Frequency	Level	Margin	Limit Line	Read Level	Antenna Factor	Path Loss	Preamp Factor	Ant Pos	Table Pos	Peak Avg.	Pol.
1+2		(MHz)	(dBμV/m)	(dB)	(dBμV/m)	(dBμV)	(dB/m)	(dB)	(dB)	(cm)	(deg)	(P/A)	(H/V)
802.11ax HE40 Full		11020	45.7	-28.3	74	46.75	37.8	19.2	58.05	-	-	P	H
		16530	49.15	-19.05	68.2	40.55	41.71	23.18	56.29	-	-	P	H
													H
													H
													H
													H
													H
													H
													H
													H
CH 102 5510MHz		11020	45.34	-28.66	74	46.39	37.8	19.2	58.05	-	-	P	V
		16530	48.55	-19.65	68.2	39.95	41.71	23.18	56.29	-	-	P	V
													V
													V
													V
													V
													V
													V
													V
													V



WiFi Ant.	Note	Frequency	Level	Margin	Limit Line	Read Level	Antenna Factor	Path Loss	Preamp Factor	Ant Pos	Table Pos	Peak Avg.	Pol.
1+2		(MHz)	(dBµV/m)	(dB)	(dBµV/m)	(dBµV)	(dB/m)	(dB)	(dB)	(cm)	(deg)	(P/A)	(H/V)
802.11ax HE40 Full		11100	45.27	-28.73	74	46.07	37.8	19.28	57.88	-	-	P	H
		16650	48.61	-19.59	68.2	39.76	41.7	23.27	56.12	-	-	P	H
													H
													H
													H
													H
													H
													H
													H
													H
CH 110 5550MHz		11100	45.23	-28.77	74	46.03	37.8	19.28	57.88	-	-	P	V
		16650	49.03	-19.17	68.2	40.18	41.7	23.27	56.12	-	-	P	V
													V
													V
													V
													V
													V
													V
													V
													V



WIFI Ant.	Note	Frequency	Level	Margin	Limit Line	Read Level	Antenna Factor	Path Loss	Preamp Factor	Ant Pos	Table Pos	Peak Avg.	Pol.
1+2		(MHz)	(dBµV/m)	(dB)	(dBµV/m)	(dBµV)	(dB/m)	(dB)	(dB)	(cm)	(deg)	(P/A)	(H/V)
802.11ax HE40 Full CH 134 5670MHz		11340	45.21	-28.79	74	45.09	37.98	19.52	57.38	-	-	P	H
		17010	50.06	-18.14	68.2	40.44	41.69	23.56	55.63	-	-	P	H
													H
													H
													H
													H
													H
													H
													H
													H
													H
													H
													H
													H
													H
													H
													H
													H
													H
	Remark	1. No other spurious found. 2. All results are PASS against Peak and Average limit line. 3. The emission position marked as "-" means no suspected emission found with sufficient margin against limit line or noise floor only.											



Band 3 5470~5725MHz
WIFI 802.11ax HE80 Full (Band Edge @ 3m)

WIFI Ant.	Note	Frequency	Level	Margin	Limit Line	Read Level	Antenna Factor	Path Loss	Preamp Factor	Ant Pos	Table Pos	Peak Avg.	Pol.
1+2		(MHz)	(dBμV/m)	(dB)	(dBμV/m)	(dBμV)	(dB/m)	(dB)	(dB)	(cm)	(deg)	(P/A)	(H/V)
802.11ax HE80 Full CH 106 5530MHz		5445.52	52.56	-21.44	74	39.55	34.67	12.21	33.87	328	46	P	H
		5468.56	51.49	-16.71	68.2	38.35	34.77	12.24	33.87	328	46	P	H
		5455.12	46.72	-7.28	54	33.65	34.72	12.22	33.87	328	46	A	H
	*	5530	98.57	-	-	85.21	34.9	12.34	33.88	328	46	P	H
	*	5530	92.34	-	-	78.98	34.9	12.34	33.88	328	46	A	H
		5729.72	50.03	-18.17	68.2	36.39	35.06	12.51	33.93	328	46	P	H
		5453.44	50.87	-23.13	74	37.81	34.71	12.22	33.87	400	68	P	V
		5461.84	51.38	-16.82	68.2	38.27	34.75	12.23	33.87	400	68	P	V
		5458.72	45.84	-8.16	54	32.75	34.73	12.23	33.87	400	68	A	V
	*	5530	97.45	-	-	84.09	34.9	12.34	33.88	400	68	P	V
	*	5530	90.47	-	-	77.11	34.9	12.34	33.88	400	68	A	V
		5765	50.54	-17.66	68.2	36.86	35.1	12.52	33.94	400	68	P	V
802.11ax HE80 Full CH 122 5610MHz		5453.92	50.86	-23.14	74	37.79	34.72	12.22	33.87	322	46	P	H
		5469.04	50.46	-17.74	68.2	37.31	34.78	12.24	33.87	322	46	P	H
		5454.16	44.23	-9.77	54	31.16	34.72	12.22	33.87	322	46	A	H
	*	5610	99.58	-	-	86.12	34.9	12.46	33.9	322	46	P	H
	*	5610	93.02	-	-	79.56	34.9	12.46	33.9	322	46	A	H
		5736.65	50.37	-17.83	68.2	36.72	35.07	12.51	33.93	322	46	P	H
		5405.44	50.7	-23.3	74	38.01	34.43	12.14	33.88	322	288	P	V
		5466.4	48.82	-19.38	68.2	35.68	34.77	12.24	33.87	322	288	P	V
		5433.04	44.22	-9.78	54	31.31	34.6	12.18	33.87	322	288	A	V
	*	5610	98.01	-	-	84.55	34.9	12.46	33.9	322	288	P	V
*	5610	91.29	-	-	77.83	34.9	12.46	33.9	322	288	A	V	
	5742.32	51.39	-16.81	68.2	37.73	35.08	12.51	33.93	322	288	P	V	
Remark	1. No other spurious found. 2. All results are PASS against Peak and Average limit line.												



Band 3 5470~5725MHz

WIFI 802.11ax HE80 Full (Harmonic @ 3m)

WIFI Ant.	Note	Frequency	Level	Margin	Limit Line	Read Level	Antenna Factor	Path Loss	Preamp Factor	Ant Pos	Table Pos	Peak Avg.	Pol.
1+2		(MHz)	(dBμV/m)	(dB)	(dBμV/m)	(dBμV)	(dB/m)	(dB)	(dB)	(cm)	(deg)	(P/A)	(H/V)
802.11ax HE80 Full CH 106		11060	46.29	-27.71	74	47.22	37.8	19.24	57.97	-	-	P	H
		16590	49.55	-18.65	68.2	41	41.53	23.22	56.2	-	-	P	H
													H
													H
													H
													H
													H
													H
													H
													H
5530MHz		11060	45.34	-28.66	74	46.27	37.8	19.24	57.97	-	-	P	V
		16590	47.88	-20.32	68.2	39.33	41.53	23.22	56.2	-	-	P	V
													V
													V
													V
													V
													V
													V
													V
													V



WIFI Ant.	Note	Frequency	Level	Margin	Limit Line	Read Level	Antenna Factor	Path Loss	Preamp Factor	Ant Pos	Table Pos	Peak Avg.	Pol.	
1+2		(MHz)	(dBµV/m)	(dB)	(dBµV/m)	(dBµV)	(dB/m)	(dB)	(dB)	(cm)	(deg)	(P/A)	(H/V)	
802.11ax HE80 Full CH 122 5610MHz		11220	46.05	-27.95	74	46.39	37.9	19.39	57.63	-	-	P	H	
		16830	49.95	-18.25	68.2	40.27	42.13	23.42	55.87	-	-	P	H	
													H	
													H	
													H	
													H	
													H	
													H	
													H	
													H	
													H	
													H	
													H	
													H	
													H	
													H	
													H	
													H	
	Remark	1. No other spurious found. 2. All results are PASS against Peak and Average limit line. 3. The emission position marked as "-" means no suspected emission found with sufficient margin against limit line or noise floor only.												



Band 3 - Straddle Channel

WIFI 802.11ax HE20 Full (Band Edge @ 3m)

WIFI Ant. 1+2	Note	Frequency (MHz)	Level (dBμV/m)	Margin (dB)	Limit Line (dBμV/m)	Read Level (dBμV)	Antenna Factor (dB/m)	Path Loss (dB)	Preamp Factor (dB)	Ant Pos (cm)	Table Pos (deg)	Peak Avg. (P/A)	Pol. (H/V)
802.11ax HE20 Full CH 144 5720MHz		5364.04	50.23	-23.77	74	37.59	34.4	12.12	33.88	295	38	P	H
		5462.71	48.75	-19.45	68.2	35.64	34.75	12.23	33.87	295	38	P	H
		5448.28	42.86	-11.14	54	29.83	34.69	12.21	33.87	295	38	A	H
	*	5720	107.52	-	-	93.91	35.04	12.5	33.93	295	38	P	H
	*	5720	100.97	-	-	87.36	35.04	12.5	33.93	295	38	A	H
		5894.75	52.24	-15.96	68.2	38.31	35.19	12.71	33.97	295	38	P	H
		5376.13	49.69	-24.31	74	37.04	34.4	12.13	33.88	389	59	P	V
		5469.34	48.48	-19.72	68.2	35.33	34.78	12.24	33.87	389	59	P	V
		5455.69	42.52	-11.48	54	29.45	34.72	12.22	33.87	389	59	A	V
	*	5720	107.86	-	-	94.25	35.04	12.5	33.93	389	59	P	V
	*	5720	99.89	-	-	86.28	35.04	12.5	33.93	389	59	A	V
			5883.25	52.04	-16.16	68.2	38.16	35.17	12.68	33.97	389	59	P
Remark	1. No other spurious found. 2. All results are PASS against Peak and Average limit line.												



Band 3 - Straddle Channel
WIFI 802.11ax HE20 Full (Harmonic @ 3m)

WIFI Ant.	Note	Frequency	Level	Margin	Limit Line	Read Level	Antenna Factor	Path Loss	Preamp Factor	Ant Pos	Table Pos	Peak Avg.	Pol.
1+2		(MHz)	(dBμV/m)	(dB)	(dBμV/m)	(dBμV)	(dB/m)	(dB)	(dB)	(cm)	(deg)	(P/A)	(H/V)
802.11ax HE20 Full CH 144 5720MHz		11440	46.26	-27.74	74	45.68	38.14	19.61	57.17	-	-	P	H
		17160	50.31	-17.89	68.2	40.78	41.48	23.68	55.63	-	-	P	H
													H
													H
													H
													H
													H
													H
													H
													H
													H
													H
													H
													H
													H
													H
													H
													H
													H
	Remark	1. No other spurious found.											
2. All results are PASS against Peak and Average limit line.													
	3. The emission position marked as "-" means no suspected emission found with sufficient margin against limit line or noise floor only.												



**Band 3 - Straddle Channel
WIFI 802.11ax HE40 Full (Band Edge @ 3m)**

WIFI Ant. 1+2	Note	Frequency (MHz)	Level (dBμV/m)	Margin (dB)	Limit Line (dBμV/m)	Read Level (dBμV)	Antenna Factor (dB/m)	Path Loss (dB)	Preamp Factor (dB)	Ant Pos (cm)	Table Pos (deg)	Peak Avg. (P/A)	Pol. (H/V)
802.11ax HE40 Full CH 142 5710MHz		5412.4	50.27	-23.73	74	37.53	34.47	12.15	33.88	302	54	P	H
		5460.37	50.19	-18.01	68.2	37.09	34.74	12.23	33.87	302	54	P	H
		5447.89	42.91	-11.09	54	29.88	34.69	12.21	33.87	302	54	A	H
	*	5710	104.68	-	-	91.08	35.02	12.5	33.92	302	54	P	H
	*	5710	98.17	-	-	84.57	35.02	12.5	33.92	302	54	A	H
		5921	52.09	-16.11	68.2	38.12	35.2	12.75	33.98	302	54	P	H
		5352.34	50.52	-23.48	74	37.88	34.4	12.12	33.88	297	282	P	V
		5467.39	48.76	-19.44	68.2	35.62	34.77	12.24	33.87	297	282	P	V
		5457.25	43.04	-10.96	54	29.96	34.73	12.22	33.87	297	282	A	V
	*	5710	104.03	-	-	90.43	35.02	12.5	33.92	297	282	P	V
	*	5710	97.19	-	-	83.59	35.02	12.5	33.92	297	282	A	V
		5922.5	52.88	-15.32	68.2	38.9	35.2	12.76	33.98	297	282	P	V
Remark	1. No other spurious found. 2. All results are PASS against Peak and Average limit line.												



Band 3 - Straddle Channel
WIFI 802.11ax HE40 Full (Harmonic @ 3m)

WIFI Ant.	Note	Frequency	Level	Margin	Limit Line	Read Level	Antenna Factor	Path Loss	Preamp Factor	Ant Pos	Table Pos	Peak Avg.	Pol.	
1+2		(MHz)	(dBμV/m)	(dB)	(dBμV/m)	(dBμV)	(dB/m)	(dB)	(dB)	(cm)	(deg)	(P/A)	(H/V)	
802.11ax HE40 Full CH 142 5710MHz		11420	45.68	-28.32	74	45.19	38.12	19.59	57.22	-	-	P	H	
		17130	50.3	-17.9	68.2	40.73	41.54	23.66	55.63	-	-	P	H	
													H	
													H	
													H	
													H	
													H	
													H	
													H	
													H	
													H	
													H	
													H	
													H	
													H	
													H	
			11420	45.7	-28.3	74	45.21	38.12	19.59	57.22	-	-	P	V
			17130	49.98	-18.22	68.2	40.41	41.54	23.66	55.63	-	-	P	V
													V	
													V	
													V	
													V	
													V	
													V	
													V	
													V	
													V	
													V	
													V	
Remark	1. No other spurious found. 2. All results are PASS against Peak and Average limit line. 3. The emission position marked as "-" means no suspected emission found with sufficient margin against limit line or noise floor only.													



**Band 3 Straddle Channel
WIFI 802.11ax HE80 Full (Band Edge @ 3m)**

WIFI Ant. 1+2	Note	Frequency (MHz)	Level (dBμV/m)	Margin (dB)	Limit Line (dBμV/m)	Read Level (dBμV)	Antenna Factor (dB/m)	Path Loss (dB)	Preamp Factor (dB)	Ant Pos (cm)	Table Pos (deg)	Peak Avg. (P/A)	Pol. (H/V)
802.11ax HE80 Full CH 138 5690MHz		5447.5	49.75	-24.25	74	36.72	34.69	12.21	33.87	370	43	P	H
		5462.71	49.92	-18.28	68.2	36.81	34.75	12.23	33.87	370	43	P	H
		5422.93	43.85	-10.15	54	31.01	34.54	12.17	33.87	370	43	A	H
	*	5690	98.57	-	-	85.02	34.98	12.49	33.92	370	43	P	H
	*	5690	92.27	-	-	78.72	34.98	12.49	33.92	370	43	A	H
		5907.1	52.39	-15.81	68.2	38.44	35.2	12.73	33.98	370	43	P	H
		5428.78	50.13	-23.87	74	37.25	34.57	12.18	33.87	293	286	P	V
		5468.17	49.99	-18.21	68.2	36.85	34.77	12.24	33.87	293	286	P	V
		5450.23	43.59	-10.41	54	30.55	34.7	12.21	33.87	293	286	A	V
	*	5690	96.72	-	-	83.17	34.98	12.49	33.92	293	286	P	V
	*	5690	90.84	-	-	77.29	34.98	12.49	33.92	293	286	A	V
		5949.1	51.29	-16.91	68.2	37.27	35.2	12.81	33.99	293	286	P	V
Remark	1. No other spurious found. 2. All results are PASS against Peak and Average limit line.												



**Band 3 - Straddle Channel
WIFI 802.11ax HE80 Full (Harmonic @ 3m)**

WIFI Ant.	Note	Frequency	Level	Margin	Limit Line	Read Level	Antenna Factor	Path Loss	Preamp Factor	Ant Pos	Table Pos	Peak Avg.	Pol.	
1+2		(MHz)	(dBμV/m)	(dB)	(dBμV/m)	(dBμV)	(dB/m)	(dB)	(dB)	(cm)	(deg)	(P/A)	(H/V)	
802.11ax HE80 Full CH 138 5690MHz		11380	45.66	-28.34	74	45.35	38.06	19.55	57.3	-	-	P	H	
		17070	49.66	-18.54	68.2	40.05	41.63	23.61	55.63	-	-	P	H	
													H	
													H	
													H	
													H	
													H	
													H	
													H	
													H	
													H	
													H	
													H	
													H	
													H	
													H	
	802.11ax HE80 Full CH 138 5690MHz		11380	45.98	-28.02	74	45.67	38.06	19.55	57.3	-	-	P	V
			17070	49.65	-18.55	68.2	40.04	41.63	23.61	55.63	-	-	P	V
													V	
													V	
													V	
													V	
													V	
													V	
													V	
													V	
													V	
													V	
													V	
													V	
													V	
													V	
													V	
Remark		<ol style="list-style-type: none"> No other spurious found. All results are PASS against Peak and Average limit line. The emission position marked as "-" means no suspected emission found with sufficient margin against limit line or noise floor only. 												



Emission below 1GHz
WIFI 802.11ax HE80 Full (LF @ 3m)

WIFI Ant. 1+2	Note	Frequency (MHz)	Level (dBμV/m)	Margin (dB)	Limit Line (dBμV/m)	Read Level (dBμV)	Antenna Factor (dB/m)	Path Loss (dB)	Preamp Factor (dB)	Ant Pos (cm)	Table Pos (deg)	Peak Avg. (P/A)	Pol. (H/V)
		49.71	28.59	-11.41	40	42.65	14.49	1.37	29.92	-	-	P	H
		117.21	24.99	-18.51	43.5	35.73	17.22	1.92	29.88	-	-	P	H
		193.35	34.04	-9.46	43.5	46.67	14.73	2.47	29.83	-	-	P	H
		848.8	32.22	-13.78	46	27.57	28.72	5.1	29.17	-	-	P	H
		922.3	32.28	-13.72	46	26.65	28.93	5.47	28.77	-	-	P	H
		979	34.71	-19.29	54	26.84	30.69	5.59	28.41	-	-	P	H
													H
													H
													H
													H
													H
													H
802.11ax HE80 Full LF		30	33.05	-6.95	40	37.43	24.51	1.05	29.94	-	-	P	V
		49.98	32.8	-7.2	40	46.98	14.37	1.37	29.92	-	-	P	V
		207.39	33.31	-10.19	43.5	45.64	14.99	2.51	29.83	100	258	Q	V
		858.6	36.65	-9.35	46	31.7	28.9	5.16	29.11	-	-	P	V
		955.9	37.69	-8.31	46	30.17	30.61	5.53	28.62	-	-	P	V
		987.4	38.19	-15.81	54	30.56	30.35	5.61	28.33	-	-	P	V
													V
													V
													V
													V
													V
													V
													V
													V
													V
													V
Remark	<ol style="list-style-type: none"> No other spurious found. All results are PASS against limit line. The emission position marked as "-" means no suspected emission found and emission level has at least 6dB margin against limit or emission is noise floor only. 												



<External Antenna>

<Sample 1>

Band 2 5250~5350MHz
WIFI 802.11ax HE80 Full (Band Edge @ 3m)

WIFI Ant.	Note	Frequency	Level	Margin	Limit Line	Read Level	Antenna Factor	Path Loss	Preamp Factor	Ant Pos	Table Pos	Peak Avg.	Pol.
1+2		(MHz)	(dBμV/m)	(dB)	(dBμV/m)	(dBμV)	(dB/m)	(dB)	(dB)	(cm)	(deg)	(P/A)	(H/V)
802.11ax HE80 Full CH 58 5290MHz		5137.9	51.05	-22.95	74	38.84	34.08	12.02	33.89	100	272	P	H
		5046.9	44.29	-9.71	54	32.18	34.11	11.9	33.9	100	272	A	H
	*	5290	89.95	-	-	77.32	34.4	12.11	33.88	100	272	P	H
	*	5290	82.36	-	-	69.73	34.4	12.11	33.88	100	272	A	H
		5455.44	50.64	-23.36	74	37.57	34.72	12.22	33.87	100	272	P	H
		5459.28	43.77	-10.23	54	30.67	34.74	12.23	33.87	100	272	A	H
		5148.4	50.89	-23.11	74	38.65	34.1	12.03	33.89	327	4	P	V
		5100.8	44.48	-9.52	54	32.4	34	11.97	33.89	327	4	A	V
	*	5290	97.96	-	-	85.33	34.4	12.11	33.88	327	4	P	V
	*	5290	89.08	-	-	76.45	34.4	12.11	33.88	327	4	A	V
		5352	54.22	-19.78	74	41.58	34.4	12.12	33.88	327	4	P	V
	5352.48	48.9	-5.1	54	36.26	34.4	12.12	33.88	327	4	A	V	
Remark	1. No other spurious found. 2. All results are PASS against Peak and Average limit line.												



Band 2 5250~5350MHz

WIFI 802.11ax HE80 Full (Harmonic @ 3m)

WIFI Ant.	Note	Frequency	Level	Margin	Limit Line	Read Level	Antenna Factor	Path Loss	Preamp Factor	Ant Pos	Table Pos	Peak Avg.	Pol.	
1+2		(MHz)	(dBμV/m)	(dB)	(dBμV/m)	(dBμV)	(dB/m)	(dB)	(dB)	(cm)	(deg)	(P/A)	(H/V)	
802.11ax HE80 Full CH 58 5290MHz		10580	44.11	-24.09	68.2	46.64	37.38	18.78	58.69	-	-	P	H	
		15870	47.66	-26.34	74	40.54	40.84	22.68	56.4	-	-	P	H	
													H	
													H	
													H	
													H	
													H	
													H	
													H	
													H	
													H	
													H	
													H	
													H	
													H	
													H	
	802.11ax HE80 Full CH 58 5290MHz		10580	43.93	-24.27	68.2	46.46	37.38	18.78	58.69	-	-	P	V
			15870	47.3	-26.7	74	40.18	40.84	22.68	56.4	-	-	P	V
													V	
													V	
													V	
													V	
													V	
													V	
													V	
													V	
													V	
													V	
													V	
													V	
													V	
													V	
													V	
Remark		<ol style="list-style-type: none"> No other spurious found. All results are PASS against Peak and Average limit line. The emission position marked as "-" means no suspected emission found with sufficient margin against limit line or noise floor only. 												



Emission below 1GHz

WIFI 802.11ax HE80 Full (LF @ 3m)

WIFI Ant. 1+2	Note	Frequency (MHz)	Level (dBμV/m)	Margin (dB)	Limit Line (dBμV/m)	Read Level (dBμV)	Antenna Factor (dB/m)	Path Loss (dB)	Preamp Factor (dB)	Ant Pos (cm)	Table Pos (deg)	Peak Avg. (P/A)	Pol. (H/V)	
802.11ax HE80 Full LF		30.54	22.8	-17.2	40	27.7	23.98	1.06	29.94	-	-	P	H	
		205.77	23.69	-19.81	43.5	35.82	15.19	2.51	29.83	-	-	P	H	
		237.36	24.47	-21.53	46	34.81	16.89	2.59	29.82	-	-	P	H	
		791.4	31.23	-14.77	46	27.7	27.88	4.96	29.31	-	-	P	H	
		887.3	32.76	-13.24	46	27.62	28.71	5.35	28.92	-	-	P	H	
		956.6	33.2	-12.8	46	25.83	30.46	5.53	28.62	-	-	P	H	
														H
														H
														H
														H
														H
														H
			30	32.01	-7.99	40	36.79	24.11	1.05	29.94	-	-	P	V
			48.09	22.51	-17.49	40	35.91	15.18	1.34	29.92	-	-	P	V
			205.77	21.75	-21.75	43.5	33.88	15.19	2.51	29.83	-	-	P	V
			804.7	30.69	-15.31	46	27.25	27.7	5.01	29.27	-	-	P	V
			863.5	31.61	-14.39	46	26.56	28.94	5.19	29.08	-	-	P	V
			943.3	34.35	-11.65	46	27.66	29.89	5.5	28.7	-	-	P	V
														V
													V	
													V	
													V	
													V	
													V	
													V	
Remark	1. No other spurious found. 2. All results are PASS against limit line. 3. The emission position marked as “-” means no suspected emission found and emission level has at least 6dB margin against limit or emission is noise floor only.													



<Sample 2>

Band 1 - 5150~5250MHz
WIFI 802.11a (Band Edge @ 3m)

WIFI Ant. 1	Note	Frequency (MHz)	Level (dBμV/m)	Margin (dB)	Limit Line (dBμV/m)	Read Level (dBμV)	Antenna Factor (dB/m)	Path Loss (dB)	Preamp Factor (dB)	Ant Pos (cm)	Table Pos (deg)	Peak Avg. (P/A)	Pol. (H/V)	
802.11a CH 36 5180MHz		5044.72	51.08	-22.92	74	38.96	34.12	11.9	33.9	400	39	P	H	
		5150	44.15	-9.85	54	31.91	34.1	12.03	33.89	400	39	A	H	
	*	5180	106.37	-	-	93.91	34.28	12.07	33.89	400	39	P	H	
	*	5180	100.63	-	-	88.17	34.28	12.07	33.89	400	39	A	H	
													H	
														H
			5072.02	50.91	-23.09	74	38.82	34.06	11.93	33.9	381	346	P	V
			5150	43.61	-10.39	54	31.37	34.1	12.03	33.89	381	346	A	V
	*		5180	106.95	-	-	94.49	34.28	12.07	33.89	381	346	P	V
	*		5180	100.45	-	-	87.99	34.28	12.07	33.89	381	346	A	V
														V
														V
802.11a CH 44 5220MHz		5147.42	51.41	-22.59	74	39.18	34.09	12.03	33.89	400	64	P	H	
		5143.26	42.92	-11.08	54	30.69	34.09	12.03	33.89	400	64	A	H	
	*	5220	107.36	-	-	94.75	34.4	12.1	33.89	400	64	P	H	
	*	5220	100.89	-	-	88.28	34.4	12.1	33.89	400	64	A	H	
			5454.96	49.87	-24.13	74	36.8	34.72	12.22	33.87	400	64	P	H
			5451.32	42.36	-11.64	54	29.31	34.71	12.21	33.87	400	64	A	H
			5105.04	51.14	-22.86	74	39.04	34.01	11.98	33.89	398	344	P	V
			5109.46	42.74	-11.26	54	30.63	34.02	11.98	33.89	398	344	A	V
	*		5220	107.27	-	-	94.66	34.4	12.1	33.89	398	344	P	V
	*		5220	100.2	-	-	87.59	34.4	12.1	33.89	398	344	A	V
			5454.96	50.97	-23.03	74	37.9	34.72	12.22	33.87	398	344	P	V
			5459.44	42.39	-11.61	54	29.29	34.74	12.23	33.87	398	344	A	V



802.11a CH 48 5240MHz		5016.38	51.23	-22.77	74	39.04	34.23	11.86	33.9	400	66	P	H
		5087.1	42.92	-11.08	54	30.83	34.03	11.95	33.89	400	66	A	H
	*	5240	107.54	-	-	94.92	34.4	12.11	33.89	400	66	P	H
	*	5240	101	-	-	88.38	34.4	12.11	33.89	400	66	A	H
		5449.92	50.17	-23.83	74	37.13	34.7	12.21	33.87	400	66	P	H
		5447.96	42.29	-11.71	54	29.26	34.69	12.21	33.87	400	66	A	H
		5115.96	51.44	-22.56	74	39.31	34.03	11.99	33.89	395	344	P	V
		5131.3	42.79	-11.21	54	30.61	34.06	12.01	33.89	395	344	A	V
	*	5240	106.55	-	-	93.93	34.4	12.11	33.89	395	344	P	V
	*	5240	99.72	-	-	87.1	34.4	12.11	33.89	395	344	A	V
		5378.52	50.55	-23.45	74	37.9	34.4	12.13	33.88	395	344	P	V
		5457.76	42.47	-11.53	54	29.38	34.73	12.23	33.87	395	344	A	V
Remark	<ol style="list-style-type: none"> 1. No other spurious found. 2. All results are PASS against Peak and Average limit line. 												



**Band 1 5150~5250MHz
WIFI 802.11a (Harmonic @ 3m)**

WIFI Ant.	Note	Frequency	Level	Margin	Limit Line	Read Level	Antenna Factor	Path Loss	Preamp Factor	Ant Pos	Table Pos	Peak Avg.	Pol.
1		(MHz)	(dBμV/m)	(dB)	(dBμV/m)	(dBμV)	(dB/m)	(dB)	(dB)	(cm)	(deg)	(P/A)	(H/V)
802.11a CH 36 5180MHz		10360	44.21	-23.99	68.2	47.3	37.3	18.56	58.95	-	-	P	H
		15540	47.3	-26.7	74	40.87	40.2	22.49	56.26	-	-	P	H
													H
													H
													H
													H
													H
													H
													H
													H
													H
													H
													H
													H
													H
													H
													H
													H
													H
			10360	44.84	-23.36	68.2	47.93	37.3	18.56	58.95	-	-	P
		15540	47.14	-26.86	74	40.71	40.2	22.49	56.26	-	-	P	V
													V
													V
													V
													V
													V
													V
													V
													V
													V
													V
													V
													V
													V
													V
													V



WIFI Ant.	Note	Frequency	Level	Margin	Limit Line	Read Level	Antenna Factor	Path Loss	Preamp Factor	Ant Pos	Table Pos	Peak Avg.	Pol.
1		(MHz)	(dBμV/m)	(dB)	(dBμV/m)	(dBμV)	(dB/m)	(dB)	(dB)	(cm)	(deg)	(P/A)	(H/V)
802.11a CH 44 5220MHz		10440	46.68	-21.52	68.2	49.6	37.3	18.64	58.86	-	-	P	H
		15660	47.63	-26.37	74	41	40.38	22.56	56.31	-	-	P	H
													H
													H
													H
													H
													H
													H
													H
													H
													H
													H
													H
													H
													H
													H
													H
													H
													H
			10440	45.75	-22.45	68.2	48.67	37.3	18.64	58.86	-	-	P
		15660	48.62	-25.38	74	41.99	40.38	22.56	56.31	-	-	P	V
													V
													V
													V
													V
													V
													V
													V
													V
													V
													V
													V
													V
													V
													V



WIFI Ant.	Note	Frequency	Level	Margin	Limit Line	Read Level	Antenna Factor	Path Loss	Preamp Factor	Ant Pos	Table Pos	Peak Avg.	Pol.
1		(MHz)	(dBμV/m)	(dB)	(dBμV/m)	(dBμV)	(dB/m)	(dB)	(dB)	(cm)	(deg)	(P/A)	(H/V)
802.11a CH 48 5240MHz		10480	45.57	-22.63	68.2	48.42	37.3	18.67	58.82	-	-	P	H
		15720	48.08	-25.92	74	41.28	40.54	22.59	56.33	-	-	P	H
													H
													H
													H
													H
													H
													H
													H
													H
													H
													H
													H
													H
													H
													H
													H
													H
													H
			10480	46.23	-21.97	68.2	49.08	37.3	18.67	58.82	-	-	P
		15720	48.59	-25.41	74	41.79	40.54	22.59	56.33	-	-	P	V
													V
													V
													V
													V
													V
													V
													V
													V
													V
													V
													V
													V
Remark	<ol style="list-style-type: none"> No other spurious found. All results are PASS against Peak and Average limit line. The emission position marked as "-" means no suspected emission found with sufficient margin against limit line or noise floor only. 												



Band 2 - 5250~5350MHz
WIFI 802.11a (Band Edge @ 3m)

WIFI Ant.	Note	Frequency	Level	Margin	Limit Line	Read Level	Antenna Factor	Path Loss	Preamp Factor	Ant Pos	Table Pos	Peak Avg.	Pol.
1		(MHz)	(dBµV/m)	(dB)	(dBµV/m)	(dBµV)	(dB/m)	(dB)	(dB)	(cm)	(deg)	(P/A)	(H/V)
802.11a CH 52 5260MHz		5059.15	51.73	-22.27	74	39.63	34.08	11.92	33.9	394	66	P	H
		5144.2	43.13	-10.87	54	30.9	34.09	12.03	33.89	394	66	A	H
	*	5260	108.69	-	-	96.06	34.4	12.11	33.88	394	66	P	H
	*	5260	100.98	-	-	88.35	34.4	12.11	33.88	394	66	A	H
		5361.12	50.03	-23.97	74	37.39	34.4	12.12	33.88	394	66	P	H
		5448	42.45	-11.55	54	29.42	34.69	12.21	33.87	394	66	A	H
		5007	51.94	-22.06	74	39.72	34.27	11.85	33.9	392	346	P	V
		5135.8	42.92	-11.08	54	30.72	34.07	12.02	33.89	392	346	A	V
	*	5260	106.83	-	-	94.2	34.4	12.11	33.88	392	346	P	V
	*	5260	99.34	-	-	86.71	34.4	12.11	33.88	392	346	A	V
		5405.76	50.35	-23.65	74	37.66	34.43	12.14	33.88	392	346	P	V
		5456.4	42.55	-11.45	54	29.47	34.73	12.22	33.87	392	346	A	V
802.11a CH 60 5300MHz		5141.75	50.8	-23.2	74	38.59	34.08	12.02	33.89	400	304	P	H
		5144.2	42.93	-11.07	54	30.7	34.09	12.03	33.89	400	304	A	H
	*	5300	106.54	-	-	93.91	34.4	12.11	33.88	400	304	P	H
	*	5300	99.84	-	-	87.21	34.4	12.11	33.88	400	304	A	H
		5445.84	50.53	-23.47	74	37.51	34.68	12.21	33.87	400	304	P	H
		5364.72	42.56	-11.44	54	29.92	34.4	12.12	33.88	400	304	A	H
		5067.2	51.07	-22.93	74	38.97	34.07	11.93	33.9	400	9	P	V
		5076.65	42.9	-11.1	54	30.81	34.05	11.94	33.9	400	9	A	V
	*	5300	105.14	-	-	92.51	34.4	12.11	33.88	400	9	P	V
	*	5300	98.3	-	-	85.67	34.4	12.11	33.88	400	9	A	V
		5419.92	50.75	-23.25	74	37.94	34.52	12.16	33.87	400	9	P	V
		5459.28	42.42	-11.58	54	29.32	34.74	12.23	33.87	400	9	A	V



802.11a CH 64 5320MHz	*	5320	106.42	-	-	93.78	34.4	12.12	33.88	400	300	P	H
	*	5320	100.86	-	-	88.22	34.4	12.12	33.88	400	300	A	H
		5352.64	54.28	-19.72	74	41.64	34.4	12.12	33.88	400	300	P	H
		5350.72	45.52	-8.48	54	32.88	34.4	12.12	33.88	400	300	A	H
													H
													H
	*	5320	104.78	-	-	92.14	34.4	12.12	33.88	400	1	P	V
	*	5320	98.88	-	-	86.24	34.4	12.12	33.88	400	1	A	V
		5360.96	49.52	-24.48	74	36.88	34.4	12.12	33.88	400	1	P	V
		5350.08	44.1	-9.9	54	31.46	34.4	12.12	33.88	400	1	A	V
													V
													V
Remark	1. No other spurious found. 2. All results are PASS against Peak and Average limit line.												



Band 2 5250~5350MHz
WIFI 802.11a (Harmonic @ 3m)

WIFI Ant.	Note	Frequency	Level	Margin	Limit Line	Read Level	Antenna Factor	Path Loss	Preamp Factor	Ant Pos	Table Pos	Peak Avg.	Pol.
1		(MHz)	(dBμV/m)	(dB)	(dBμV/m)	(dBμV)	(dB/m)	(dB)	(dB)	(cm)	(deg)	(P/A)	(H/V)
802.11a CH 52 5260MHz		10520	44.67	-23.53	68.2	47.41	37.32	18.71	58.77	-	-	P	H
		15780	47.34	-26.66	74	40.42	40.66	22.62	56.36	-	-	P	H
													H
													H
													H
													H
													H
													H
													H
													H
													H
													H
													H
													H
													H
													H
													H
													H
													H
			10520	44.29	-23.91	68.2	47.03	37.32	18.71	58.77	-	-	P
		15780	47.81	-26.19	74	40.89	40.66	22.62	56.36	-	-	P	V
													V
													V
													V
													V
													V
													V
													V
													V
													V
													V
													V
													V
													V
													V
													V
													V



WIFI Ant.	Note	Frequency	Level	Margin	Limit Line	Read Level	Antenna Factor	Path Loss	Preamp Factor	Ant Pos	Table Pos	Peak Avg.	Pol.
1		(MHz)	(dBμV/m)	(dB)	(dBμV/m)	(dBμV)	(dB/m)	(dB)	(dB)	(cm)	(deg)	(P/A)	(H/V)
802.11a CH 60 5300MHz		10600	44.48	-29.52	74	46.94	37.4	18.8	58.66	-	-	P	H
		15900	48.2	-25.8	74	41.02	40.9	22.69	56.41	-	-	P	H
													H
													H
													H
													H
													H
													H
													H
													H
													H
													H
													H
													H
													H
													H
													H
													H
													H
			10600	43.94	-30.06	74	46.4	37.4	18.8	58.66	-	-	P
		15900	48.63	-25.37	74	41.45	40.9	22.69	56.41	-	-	P	V
													V
													V
													V
													V
													V
													V
													V
													V
													V
													V
													V
													V
													V
													V



WIFI Ant.	Note	Frequency	Level	Margin	Limit Line	Read Level	Antenna Factor	Path Loss	Preamp Factor	Ant Pos	Table Pos	Peak Avg.	Pol.
1		(MHz)	(dBµV/m)	(dB)	(dBµV/m)	(dBµV)	(dB/m)	(dB)	(dB)	(cm)	(deg)	(P/A)	(H/V)
802.11a CH 64 5320MHz		10640	44.79	-29.21	74	47.08	37.48	18.83	58.6	-	-	P	H
		15960	46.83	-27.17	74	39.63	40.9	22.73	56.43	-	-	P	H
													H
													H
													H
													H
													H
													H
													H
													H
													H
													H
													H
													H
													H
													H
													H
													H
													H
			10640	46.12	-27.88	74	48.41	37.48	18.83	58.6	-	-	P
		15960	46.23	-27.77	74	39.03	40.9	22.73	56.43	-	-	P	V
													V
													V
													V
													V
													V
													V
													V
													V
													V
													V
													V
													V
													V
Remark	1. No other spurious found.												
	2. All results are PASS against Peak and Average limit line.												
	3. The emission position marked as "-" means no suspected emission found with sufficient margin against limit line or noise floor only.												



Band 3 - 5470~5725MHz
WIFI 802.11a (Band Edge @ 3m)

WIFI Ant.	Note	Frequency	Level	Margin	Limit Line	Read Level	Antenna Factor	Path Loss	Preamp Factor	Ant Pos	Table Pos	Peak Avg.	Pol.	
1		(MHz)	(dBμV/m)	(dB)	(dBμV/m)	(dBμV)	(dB/m)	(dB)	(dB)	(cm)	(deg)	(P/A)	(H/V)	
802.11a CH 100 5500MHz		5451.76	50.63	-23.37	74	37.57	34.71	12.22	33.87	400	62	P	H	
		5467.76	50.56	-17.64	68.2	37.42	34.77	12.24	33.87	400	62	P	H	
		5458.16	43.47	-10.53	54	30.38	34.73	12.23	33.87	400	62	A	H	
	*	5500	106.71	-	-	93.38	34.9	12.3	33.87	400	62	P	H	
	*	5500	99.5	-	-	86.17	34.9	12.3	33.87	400	62	A	H	
														H
			5370.96	50.46	-23.54	74	37.81	34.4	12.13	33.88	400	328	P	V
			5463.6	49.4	-18.8	68.2	36.29	34.75	12.23	33.87	400	328	P	V
			5459.12	42.52	-11.48	54	29.42	34.74	12.23	33.87	400	328	A	V
	*		5500	103.93	-	-	90.6	34.9	12.3	33.87	400	328	P	V
	*		5500	95.88	-	-	82.55	34.9	12.3	33.87	400	328	A	V
														V
802.11a CH 116 5580MHz		5456.56	50.25	-23.75	74	37.17	34.73	12.22	33.87	397	259	P	H	
		5460	49.09	-19.11	68.2	35.99	34.74	12.23	33.87	397	259	P	H	
		5452.72	42.7	-11.3	54	29.64	34.71	12.22	33.87	397	259	A	H	
	*	5580	106.68	-	-	93.24	34.9	12.43	33.89	397	259	P	H	
	*	5580	100.91	-	-	87.47	34.9	12.43	33.89	397	259	A	H	
			5757.755	50.95	-17.25	68.2	37.27	35.1	12.52	33.94	397	259	P	H
			5444.32	49.68	-24.32	74	36.68	34.67	12.2	33.87	400	26	P	V
			5470	50.56	-17.64	68.2	37.4	34.78	12.25	33.87	400	26	P	V
			5452	42.42	-11.58	54	29.36	34.71	12.22	33.87	400	26	A	V
	*		5580	101.02	-	-	87.58	34.9	12.43	33.89	400	26	P	V
	*		5580	95.65	-	-	82.21	34.9	12.43	33.89	400	26	A	V
			5749.88	52.11	-16.09	68.2	38.43	35.1	12.51	33.93	400	26	P	V



802.11a CH 140 5700MHz	*	5700	108.17	-	-	94.6	35	12.49	33.92	398	90	P	H
	*	5700	101.81	-	-	88.24	35	12.49	33.92	398	90	A	H
		5726.6	57.27	-10.93	68.2	43.65	35.05	12.5	33.93	398	90	P	H
													H
													H
													H
	*	5700	101.71	-	-	88.14	35	12.49	33.92	400	28	P	V
	*	5700	94.31	-	-	80.74	35	12.49	33.92	400	28	A	V
		5736.92	50.91	-17.29	68.2	37.26	35.07	12.51	33.93	400	28	P	V
													V
													V
													V
Remark	1. No other spurious found. 2. All results are PASS against Peak and Average limit line.												



Band 3 - 5470~5725MHz
WIFI 802.11a (Harmonic @ 3m)

WIFI Ant.	Note	Frequency	Level	Margin	Limit Line	Read Level	Antenna Factor	Path Loss	Preamp Factor	Ant Pos	Table Pos	Peak Avg.	Pol.
1		(MHz)	(dBμV/m)	(dB)	(dBμV/m)	(dBμV)	(dB/m)	(dB)	(dB)	(cm)	(deg)	(P/A)	(H/V)
802.11a CH 100 5500MHz		11000	45.87	-28.13	74	46.99	37.8	19.17	58.09	-	-	P	H
		16500	49.18	-19.02	68.2	40.55	41.8	23.16	56.33	-	-	P	H
													H
													H
													H
													H
													H
													H
													H
													H
													H
													H
													H
													H
													H
													H
													H
													H
													H
			11000	45.79	-28.21	74	46.91	37.8	19.17	58.09	-	-	P
		16500	49.15	-19.05	68.2	40.52	41.8	23.16	56.33	-	-	P	V
													V
													V
													V
													V
													V
													V
													V
													V
													V
													V
													V
													V
													V
													V
													V



WIFI Ant.	Note	Frequency	Level	Margin	Limit Line	Read Level	Antenna Factor	Path Loss	Preamp Factor	Ant Pos	Table Pos	Peak Avg.	Pol.
1		(MHz)	(dBμV/m)	(dB)	(dBμV/m)	(dBμV)	(dB/m)	(dB)	(dB)	(cm)	(deg)	(P/A)	(H/V)
802.11a CH 116 5580MHz		11160	46.15	-27.85	74	46.71	37.86	19.34	57.76	-	-	P	H
		16740	48.7	-19.5	68.2	39.37	41.98	23.34	55.99	-	-	P	H
													H
													H
													H
													H
													H
													H
													H
													H
													H
													H
													H
													H
													H
													H
													H
													H
													H
			11160	45.95	-28.05	74	46.51	37.86	19.34	57.76	-	-	P
		16740	49.88	-18.32	68.2	40.55	41.98	23.34	55.99	-	-	P	V
													V
													V
													V
													V
													V
													V
													V
													V
													V
													V
													V
													V
													V
													V
													V



WIFI Ant.	Note	Frequency	Level	Margin	Limit Line	Read Level	Antenna Factor	Path Loss	Preamp Factor	Ant Pos	Table Pos	Peak Avg.	Pol.
1		(MHz)	(dBµV/m)	(dB)	(dBµV/m)	(dBµV)	(dB/m)	(dB)	(dB)	(cm)	(deg)	(P/A)	(H/V)
802.11a CH 140 5700MHz		11400	45.73	-28.27	74	45.32	38.1	19.57	57.26	-	-	P	H
		17100	49.67	-18.53	68.2	40.06	41.6	23.64	55.63	-	-	P	H
													H
													H
													H
													H
													H
													H
													H
													H
													H
													H
													H
													H
													H
													H
													H
													H
													H
			11400	46.42	-27.58	74	46.01	38.1	19.57	57.26	-	-	P
		17100	49.97	-18.23	68.2	40.36	41.6	23.64	55.63	-	-	P	V
													V
													V
													V
													V
													V
													V
													V
													V
													V
													V
													V
													V
													V
Remark	<ol style="list-style-type: none"> No other spurious found. All results are PASS against Peak and Average limit line. The emission position marked as "-" means no suspected emission found with sufficient margin against limit line or noise floor only. 												



Band 3 - Straddle Channel
WIFI 802.11a (Band Edge @ 3m)

WIFI Ant. 1	Note	Frequency (MHz)	Level (dBµV/m)	Margin (dB)	Limit Line (dBµV/m)	Read Level (dBµV)	Antenna Factor (dB/m)	Path Loss (dB)	Preamp Factor (dB)	Ant Pos (cm)	Table Pos (deg)	Peak Avg. (P/A)	Pol. (H/V)
802.11a CH 144 5720MHz		5445.16	50.89	-23.11	74	37.89	34.67	12.2	33.87	395	90	P	H
		5465.83	48.48	-19.72	68.2	35.35	34.76	12.24	33.87	395	90	P	H
		5458.03	42.15	-11.85	54	29.06	34.73	12.23	33.87	395	90	A	H
	*	5720	108.16	-	-	94.55	35.04	12.5	33.93	395	90	P	H
	*	5720	101.88	-	-	88.27	35.04	12.5	33.93	395	90	A	H
		5874.5	52.89	-15.31	68.2	39.04	35.15	12.67	33.97	395	90	P	H
		5449.45	50.02	-23.98	74	36.98	34.7	12.21	33.87	397	28	P	V
		5470	50.02	-18.18	68.2	36.86	34.78	12.25	33.87	397	28	P	V
		5440.48	42.27	-11.73	54	29.3	34.64	12.2	33.87	397	28	A	V
	*	5720	99.81	-	-	86.2	35.04	12.5	33.93	397	28	P	V
	*	5720	93.37	-	-	79.76	35.04	12.5	33.93	397	28	A	V
		5898	52.38	-15.82	68.2	38.44	35.2	12.71	33.97	397	28	P	V
Remark	1. No other spurious found. 2. All results are PASS against Peak and Average limit line.												



**Band 3 - Straddle Channel
WIFI 802.11a (Harmonic @ 3m)**

WIFI Ant.	Note	Frequency	Level	Margin	Limit Line	Read Level	Antenna Factor	Path Loss	Preamp Factor	Ant Pos	Table Pos	Peak Avg.	Pol.
1		(MHz)	(dBµV/m)	(dB)	(dBµV/m)	(dBµV)	(dB/m)	(dB)	(dB)	(cm)	(deg)	(P/A)	(H/V)
802.11a CH 144 5720MHz		11440	45.91	-28.09	74	45.33	38.14	19.61	57.17	-	-	P	H
		17160	52.13	-16.07	68.2	42.6	41.48	23.68	55.63	-	-	P	H
													H
													H
													H
													H
													H
													H
													H
													H
													H
													H
													H
													H
													H
													H
													H
													H
													H
			11440	46.75	-27.25	74	46.17	38.14	19.61	57.17	-	-	P
		17160	50.74	-17.46	68.2	41.21	41.48	23.68	55.63	-	-	P	V
													V
													V
													V
													V
													V
													V
													V
													V
													V
													V
													V
													V
													V
													V
													V
Remark	1. No other spurious found. 2. All results are PASS against Peak and Average limit line. 3. The emission position marked as "-" means no suspected emission found with sufficient margin against limit line or noise floor only.												



Emission below 1GHz
WIFI 802.11a (LF @ 3m)

WIFI Ant. 1	Note	Frequency (MHz)	Level (dBµV/m)	Margin (dB)	Limit Line (dBµV/m)	Read Level (dBµV)	Antenna Factor (dB/m)	Path Loss (dB)	Preamp Factor (dB)	Ant Pos (cm)	Table Pos (deg)	Peak Avg. (P/A)	Pol. (H/V)
		49.44	29.08	-10.92	40	43.07	14.56	1.37	29.92	-	-	P	H
		193.89	33.25	-10.25	43.5	45.65	14.96	2.47	29.83	-	-	P	H
		214.95	33.22	-10.28	43.5	45.48	15.04	2.53	29.83	-	-	P	H
		738.2	32.24	-13.76	46	29.59	27.42	4.74	29.51	-	-	P	H
		955.9	33.06	-12.94	46	25.73	30.42	5.53	28.62	-	-	P	H
		969.2	35.27	-18.73	54	27.31	30.89	5.57	28.5	-	-	P	H
													H
													H
													H
													H
													H
													H
802.11a LF		30.27	33.49	-6.51	40	38.33	24.04	1.06	29.94	-	-	P	V
		49.44	32.52	-7.48	40	46.51	14.56	1.37	29.92	-	-	P	V
		120.72	25.46	-18.04	43.5	35.84	17.54	1.96	29.88	-	-	P	V
		746.6	31.5	-14.5	46	28.58	27.64	4.77	29.49	-	-	P	V
		855.1	32.49	-13.51	46	27.56	28.94	5.13	29.14	-	-	P	V
		948.2	33.69	-12.31	46	26.7	30.17	5.51	28.69	-	-	P	V
													V
													V
													V
													V
													V
													V
													V
													V
Remark	<ol style="list-style-type: none"> No other spurious found. All results are PASS against limit line. The emission position marked as "-" means no suspected emission found and emission level has at least 6dB margin against limit or emission is noise floor only. 												



Band 1 - 5150~5250MHz
WIFI 802.11a (Band Edge @ 3m)

WIFI Ant. 2	Note	Frequency (MHz)	Level (dBμV/m)	Margin (dB)	Limit Line (dBμV/m)	Read Level (dBμV)	Antenna Factor (dB/m)	Path Loss (dB)	Preamp Factor (dB)	Ant Pos (cm)	Table Pos (deg)	Peak Avg. (P/A)	Pol. (H/V)	
802.11a CH 36 5180MHz		5144.3	53.12	-20.88	74	40.89	34.09	12.03	33.89	105	298	P	H	
		5149.76	45.89	-8.11	54	33.65	34.1	12.03	33.89	105	298	A	H	
	*	5180	108.56	-	-	96.1	34.28	12.07	33.89	105	298	P	H	
	*	5180	102	-	-	89.54	34.28	12.07	33.89	105	298	A	H	
													H	
														H
			5107.12	51.49	-22.51	74	39.39	34.01	11.98	33.89	376	0	P	V
			5148.46	42.77	-11.23	54	30.53	34.1	12.03	33.89	376	0	A	V
	*		5180	105.76	-	-	93.3	34.28	12.07	33.89	376	0	P	V
	*		5180	98.34	-	-	85.88	34.28	12.07	33.89	376	0	A	V
														V
														V
802.11a CH 44 5220MHz		5028.6	51.42	-22.58	74	39.25	34.19	11.88	33.9	100	300	P	H	
		5120.12	43.94	-10.06	54	31.79	34.04	12	33.89	100	300	A	H	
	*	5220	108.8	-	-	96.19	34.4	12.1	33.89	100	300	P	H	
	*	5220	101.91	-	-	89.3	34.4	12.1	33.89	100	300	A	H	
			5449.64	49.18	-24.82	74	36.14	34.7	12.21	33.87	100	300	P	H
			5448.24	42.56	-11.44	54	29.53	34.69	12.21	33.87	100	300	A	H
			5075.92	51.47	-22.53	74	39.38	34.05	11.94	33.9	349	353	P	V
			5148.98	42.59	-11.41	54	30.35	34.1	12.03	33.89	349	353	A	V
	*		5220	105.52	-	-	92.91	34.4	12.1	33.89	349	353	P	V
	*		5220	98.14	-	-	85.53	34.4	12.1	33.89	349	353	A	V
			5436.2	49.44	-24.56	74	36.5	34.62	12.19	33.87	349	353	P	V
			5456.64	42.18	-11.82	54	29.1	34.73	12.22	33.87	349	353	A	V



802.11a CH 48 5240MHz		5068.64	50.9	-23.1	74	38.81	34.06	11.93	33.9	100	299	P	H
		5119.86	43.74	-10.26	54	31.59	34.04	12	33.89	100	299	A	H
	*	5240	109.44	-	-	96.82	34.4	12.11	33.89	100	299	P	H
	*	5240	102.04	-	-	89.42	34.4	12.11	33.89	100	299	A	H
		5422.48	50.87	-23.13	74	38.04	34.53	12.17	33.87	100	299	P	H
		5454.96	42.37	-11.63	54	29.3	34.72	12.22	33.87	100	299	A	H
		5051.48	51.27	-22.73	74	39.16	34.1	11.91	33.9	345	0	P	V
		5120.12	42.84	-11.16	54	30.69	34.04	12	33.89	345	0	A	V
	*	5240	105.08	-	-	92.46	34.4	12.11	33.89	345	0	P	V
	*	5240	98.21	-	-	85.59	34.4	12.11	33.89	345	0	A	V
		5444.88	49.71	-24.29	74	36.71	34.67	12.2	33.87	345	0	P	V
		5456.08	42.63	-11.37	54	29.56	34.72	12.22	33.87	345	0	A	V
Remark	1. No other spurious found. 2. All results are PASS against Peak and Average limit line.												



Band 1 5150~5250MHz
WIFI 802.11a (Harmonic @ 3m)

WIFI Ant.	Note	Frequency	Level	Margin	Limit Line	Read Level	Antenna Factor	Path Loss	Preamp Factor	Ant Pos	Table Pos	Peak Avg.	Pol.
2		(MHz)	(dBμV/m)	(dB)	(dBμV/m)	(dBμV)	(dB/m)	(dB)	(dB)	(cm)	(deg)	(P/A)	(H/V)
802.11a CH 36 5180MHz		10360	59.3	-8.9	68.2	62.39	37.3	18.56	58.95	326	326	P	H
		15540	48.77	-25.23	74	42.34	40.2	22.49	56.26	-	-	P	H
													H
													H
													H
													H
													H
													H
													H
													H
													H
													H
													H
													H
													H
													H
													H
			10360	59.38	-8.82	68.2	62.47	37.3	18.56	58.95	221	313	P
		15540	56.9	-17.1	74	50.47	40.2	22.49	56.26	400	263	P	V
		15540	44.77	-9.23	54	38.34	40.2	22.49	56.26	400	263	A	V
													V
													V
													V
													V
													V
													V
													V
													V
													V
													V
													V



WIFI Ant.	Note	Frequency	Level	Margin	Limit Line	Read Level	Antenna Factor	Path Loss	Preamp Factor	Ant Pos	Table Pos	Peak Avg.	Pol.	
2		(MHz)	(dBµV/m)	(dB)	(dBµV/m)	(dBµV)	(dB/m)	(dB)	(dB)	(cm)	(deg)	(P/A)	(H/V)	
802.11a CH 44 5220MHz		10440	53.72	-14.48	68.2	56.64	37.3	18.64	58.86	337	326	P	H	
		15660	47.49	-26.51	74	40.86	40.38	22.56	56.31	-	-	P	H	
													H	
													H	
													H	
													H	
													H	
													H	
													H	
													H	
													H	
													H	
													H	
													H	
													H	
													H	
													H	
													H	
			10440	53.92	-14.28	68.2	56.84	37.3	18.64	58.86	100	236	P	V
			15660	48.55	-25.45	74	41.92	40.38	22.56	56.31	-	-	P	V
													V	
													V	
													V	
													V	
													V	
													V	
													V	
													V	
													V	
													V	



WIFI Ant.	Note	Frequency	Level	Margin	Limit Line	Read Level	Antenna Factor	Path Loss	Preamp Factor	Ant Pos	Table Pos	Peak Avg.	Pol.
2		(MHz)	(dBμV/m)	(dB)	(dBμV/m)	(dBμV)	(dB/m)	(dB)	(dB)	(cm)	(deg)	(P/A)	(H/V)
802.11a CH 48 5240MHz		10480	46.09	-22.11	68.2	48.94	37.3	18.67	58.82	-	-	P	H
		15720	49.1	-24.9	74	42.3	40.54	22.59	56.33	-	-	P	H
													H
													H
													H
													H
													H
													H
													H
													H
													H
													H
													H
													H
													H
													H
													H
													H
													H
			10480	47.29	-20.91	68.2	50.14	37.3	18.67	58.82	-	-	P
		15720	49.01	-24.99	74	42.21	40.54	22.59	56.33	-	-	P	V
													V
													V
													V
													V
													V
													V
													V
													V
													V
													V
													V
													V
Remark	<ol style="list-style-type: none"> No other spurious found. All results are PASS against Peak and Average limit line. The emission position marked as "-" means no suspected emission found with sufficient margin against limit line or noise floor only. 												



Band 2 - 5250~5350MHz
WIFI 802.11a (Band Edge @ 3m)

WIFI Ant.	Note	Frequency	Level	Margin	Limit Line	Read Level	Antenna Factor	Path Loss	Preamp Factor	Ant Pos	Table Pos	Peak Avg.	Pol.
2		(MHz)	(dBμV/m)	(dB)	(dBμV/m)	(dBμV)	(dB/m)	(dB)	(dB)	(cm)	(deg)	(P/A)	(H/V)
802.11a CH 52 5260MHz		5119.35	51.92	-22.08	74	39.77	34.04	12	33.89	321	319	P	H
		5120.05	43.47	-10.53	54	31.32	34.04	12	33.89	321	319	A	H
	*	5260	109.3	-	-	96.67	34.4	12.11	33.88	321	319	P	H
	*	5260	101.78	-	-	89.15	34.4	12.11	33.88	321	319	A	H
		5454.72	50.41	-23.59	74	37.34	34.72	12.22	33.87	321	319	P	H
		5453.76	42.77	-11.23	54	29.7	34.72	12.22	33.87	321	319	A	H
		5077	51.39	-22.61	74	39.3	34.05	11.94	33.9	343	0	P	V
		5119.7	43.03	-10.97	54	30.88	34.04	12	33.89	343	0	A	V
	*	5260	106.29	-	-	93.66	34.4	12.11	33.88	343	0	P	V
	*	5260	98.92	-	-	86.29	34.4	12.11	33.88	343	0	A	V
		5452.56	49.35	-24.65	74	36.29	34.71	12.22	33.87	343	0	P	V
		5454.24	42.28	-11.72	54	29.21	34.72	12.22	33.87	343	0	A	V
802.11a CH 60 5300MHz		5083.3	52.63	-21.37	74	40.55	34.03	11.95	33.9	296	316	P	H
		5120.05	43.6	-10.4	54	31.45	34.04	12	33.89	296	316	A	H
	*	5300	108.11	-	-	95.48	34.4	12.11	33.88	296	316	P	H
	*	5300	101.3	-	-	88.67	34.4	12.11	33.88	296	316	A	H
		5353.92	51.87	-22.13	74	39.23	34.4	12.12	33.88	296	316	P	H
		5353.44	42.63	-11.37	54	29.99	34.4	12.12	33.88	296	316	A	H
		5116.9	50.71	-23.29	74	38.58	34.03	11.99	33.89	399	354	P	V
		5144.2	42.8	-11.2	54	30.57	34.09	12.03	33.89	399	354	A	V
	*	5300	105.68	-	-	93.05	34.4	12.11	33.88	399	354	P	V
	*	5300	98.46	-	-	85.83	34.4	12.11	33.88	399	354	A	V
		5455.92	50.24	-23.76	74	37.17	34.72	12.22	33.87	399	354	P	V
		5448.72	42.34	-11.66	54	29.31	34.69	12.21	33.87	399	354	A	V



802.11a CH 64 5320MHz	*	5320	108.25	-	-	95.61	34.4	12.12	33.88	280	311	P	H
	*	5320	101.23	-	-	88.59	34.4	12.12	33.88	280	311	A	H
		5352.48	53.63	-20.37	74	40.99	34.4	12.12	33.88	280	311	P	H
		5350.56	47.04	-6.96	54	34.4	34.4	12.12	33.88	280	311	A	H
													H
													H
	*	5320	105.43	-	-	92.79	34.4	12.12	33.88	399	354	P	V
	*	5320	98.36	-	-	85.72	34.4	12.12	33.88	399	354	A	V
		5394.4	50.31	-23.69	74	37.66	34.4	12.13	33.88	399	354	P	V
		5350.08	43.97	-10.03	54	31.33	34.4	12.12	33.88	399	354	A	V
													V
													V
Remark	1. No other spurious found. 2. All results are PASS against Peak and Average limit line.												



Band 2 5250~5350MHz
WIFI 802.11a (Harmonic @ 3m)

WIFI Ant.	Note	Frequency	Level	Margin	Limit Line	Read Level	Antenna Factor	Path Loss	Preamp Factor	Ant Pos	Table Pos	Peak Avg.	Pol.
2		(MHz)	(dBμV/m)	(dB)	(dBμV/m)	(dBμV)	(dB/m)	(dB)	(dB)	(cm)	(deg)	(P/A)	(H/V)
802.11a CH 52 5260MHz		10520	45.13	-23.07	68.2	47.87	37.32	18.71	58.77	-	-	P	H
		15780	48.5	-25.5	74	41.58	40.66	22.62	56.36	-	-	P	H
													H
													H
													H
													H
													H
													H
													H
													H
													H
													H
													H
													H
													H
													H
													H
													H
													H
			10520	46.16	-22.04	68.2	48.9	37.32	18.71	58.77	-	-	P
		15780	47.72	-26.28	74	40.8	40.66	22.62	56.36	-	-	P	V
													V
													V
													V
													V
													V
													V
													V
													V
													V
													V
													V
													V
													V
													V
													V



WIFI Ant.	Note	Frequency	Level	Margin	Limit Line	Read Level	Antenna Factor	Path Loss	Preamp Factor	Ant Pos	Table Pos	Peak Avg.	Pol.
2		(MHz)	(dBμV/m)	(dB)	(dBμV/m)	(dBμV)	(dB/m)	(dB)	(dB)	(cm)	(deg)	(P/A)	(H/V)
802.11a CH 60 5300MHz		10600	44.46	-29.54	74	46.92	37.4	18.8	58.66	-	-	P	H
		15900	48.05	-25.95	74	40.87	40.9	22.69	56.41	-	-	P	H
													H
													H
													H
													H
													H
													H
													H
													H
													H
													H
													H
													H
													H
													H
													H
													H
													H
			10600	44.67	-29.33	74	47.13	37.4	18.8	58.66	-	-	P
		15900	49.59	-24.41	74	42.41	40.9	22.69	56.41	-	-	P	V
													V
													V
													V
													V
													V
													V
													V
													V
													V
													V
													V
													V
													V
													V



WIFI Ant.	Note	Frequency	Level	Margin	Limit Line	Read Level	Antenna Factor	Path Loss	Preamp Factor	Ant Pos	Table Pos	Peak Avg.	Pol.
2		(MHz)	(dBμV/m)	(dB)	(dBμV/m)	(dBμV)	(dB/m)	(dB)	(dB)	(cm)	(deg)	(P/A)	(H/V)
802.11a CH 64 5320MHz		10640	44.56	-29.44	74	46.85	37.48	18.83	58.6	-	-	P	H
		15960	46.88	-27.12	74	39.68	40.9	22.73	56.43	-	-	P	H
													H
													H
													H
													H
													H
													H
													H
													H
													H
													H
													H
													H
													H
													H
													H
													H
													H
			10640	45.36	-28.64	74	47.65	37.48	18.83	58.6	-	-	P
		15960	47.22	-26.78	74	40.02	40.9	22.73	56.43	-	-	P	V
													V
													V
													V
													V
													V
													V
													V
													V
													V
													V
													V
													V
													V
Remark	1. No other spurious found. 2. All results are PASS against Peak and Average limit line.												



Band 3 - 5470~5725MHz
WIFI 802.11a (Band Edge @ 3m)

WIFI Ant.	Note	Frequency	Level	Margin	Limit Line	Read Level	Antenna Factor	Path Loss	Preamp Factor	Ant Pos	Table Pos	Peak Avg.	Pol.	
2		(MHz)	(dBμV/m)	(dB)	(dBμV/m)	(dBμV)	(dB/m)	(dB)	(dB)	(cm)	(deg)	(P/A)	(H/V)	
802.11a CH 100 5500MHz		5459.76	52.59	-21.41	74	39.49	34.74	12.23	33.87	377	64	P	H	
		5469.52	53.82	-14.38	68.2	40.67	34.78	12.24	33.87	377	64	P	H	
		5459.92	44.4	-9.6	54	31.3	34.74	12.23	33.87	377	64	A	H	
	*	5500	106.4	-	-	93.07	34.9	12.3	33.87	377	64	P	H	
	*	5500	100.5	-	-	87.17	34.9	12.3	33.87	377	64	A	H	
														H
			5423.92	50.71	-23.29	74	37.87	34.54	12.17	33.87	400	20	P	V
			5468.4	51.76	-16.44	68.2	38.62	34.77	12.24	33.87	400	20	P	V
			5459.92	43.34	-10.66	54	30.24	34.74	12.23	33.87	400	20	A	V
	*		5500	102.23	-	-	88.9	34.9	12.3	33.87	400	20	P	V
	*		5500	96.35	-	-	83.02	34.9	12.3	33.87	400	20	A	V
														V
802.11a CH 116 5580MHz		5455.6	51.41	-22.59	74	38.34	34.72	12.22	33.87	386	63	P	H	
		5461.84	49.88	-18.32	68.2	36.77	34.75	12.23	33.87	386	63	P	H	
		5459.92	42.67	-11.33	54	29.57	34.74	12.23	33.87	386	63	A	H	
	*	5580	107.8	-	-	94.36	34.9	12.43	33.89	386	63	P	H	
	*	5580	102.53	-	-	89.09	34.9	12.43	33.89	386	63	A	H	
			5750.195	51.36	-16.84	68.2	37.69	35.1	12.51	33.94	386	63	P	H
			5459.68	50.24	-23.76	74	37.14	34.74	12.23	33.87	400	7	P	V
			5468.8	48.98	-19.22	68.2	35.83	34.78	12.24	33.87	400	7	P	V
			5449.36	42.61	-11.39	54	29.57	34.7	12.21	33.87	400	7	A	V
	*		5584	102.28	-	-	88.84	34.9	12.43	33.89	400	7	P	V
	*		5578	95.95	-	-	82.52	34.9	12.42	33.89	400	7	A	V
			5764.37	50.83	-17.37	68.2	37.15	35.1	12.52	33.94	400	7	P	V



802.11a CH 140 5700MHz	*	5700	108.56	-	-	94.99	35	12.49	33.92	370	64	P	H
	*	5700	102.18	-	-	88.61	35	12.49	33.92	370	64	A	H
		5725.48	64.29	-3.91	68.2	50.67	35.05	12.5	33.93	370	64	P	H
													H
													H
													H
	*	5700	103.86	-	-	90.29	35	12.49	33.92	398	36	P	V
	*	5700	96.87	-	-	83.3	35	12.49	33.92	398	36	A	V
		5727.24	59.37	-8.83	68.2	45.75	35.05	12.5	33.93	398	36	P	V
													V
													V
													V
Remark	1. No other spurious found. 2. All results are PASS against Peak and Average limit line.												



Band 3 - 5470~5725MHz
WIFI 802.11a (Harmonic @ 3m)

WIFI Ant.	Note	Frequency	Level	Margin	Limit Line	Read Level	Antenna Factor	Path Loss	Preamp Factor	Ant Pos	Table Pos	Peak Avg.	Pol.
2		(MHz)	(dBμV/m)	(dB)	(dBμV/m)	(dBμV)	(dB/m)	(dB)	(dB)	(cm)	(deg)	(P/A)	(H/V)
802.11a CH 100 5500MHz		11000	46.52	-27.48	74	47.64	37.8	19.17	58.09	-	-	P	H
													H
													H
													H
													H
													H
													H
													H
													H
													H
													H
													H
													H
													H
													H
													H
													H
			16500	49.67	-18.53	68.2	41.04	41.8	23.16	56.33	-	-	P
		11000	45.49	-28.51	74	46.61	37.8	19.17	58.09	-	-	P	V
		16500	48.82	-19.38	68.2	40.19	41.8	23.16	56.33	-	-	P	V
													V
													V
													V
													V
													V
													V
													V
													V
													V
													V
													V



WIFI Ant.	Note	Frequency	Level	Margin	Limit Line	Read Level	Antenna Factor	Path Loss	Preamp Factor	Ant Pos	Table Pos	Peak Avg.	Pol.
2		(MHz)	(dBµV/m)	(dB)	(dBµV/m)	(dBµV)	(dB/m)	(dB)	(dB)	(cm)	(deg)	(P/A)	(H/V)
802.11a CH 116 5580MHz		11160	46.3	-27.7	74	46.86	37.86	19.34	57.76	-	-	P	H
		16740	48.37	-19.83	68.2	39.04	41.98	23.34	55.99	-	-	P	H
													H
													H
													H
													H
													H
													H
													H
													H
													H
													H
													H
													H
													H
													H
													H
													H
													H
			11160	46.21	-27.79	74	46.77	37.86	19.34	57.76	-	-	P
		16740	49.2	-19	68.2	39.87	41.98	23.34	55.99	-	-	P	V
													V
													V
													V
													V
													V
													V
													V
													V
													V
													V
													V
													V
													V
													V
													V



WIFI Ant.	Note	Frequency	Level	Margin	Limit Line	Read Level	Antenna Factor	Path Loss	Preamp Factor	Ant Pos	Table Pos	Peak Avg.	Pol.
2		(MHz)	(dBμV/m)	(dB)	(dBμV/m)	(dBμV)	(dB/m)	(dB)	(dB)	(cm)	(deg)	(P/A)	(H/V)
802.11a CH 140 5700MHz		11400	46.25	-27.75	74	45.84	38.1	19.57	57.26	-	-	P	H
		17100	50.58	-17.62	68.2	40.97	41.6	23.64	55.63	-	-	P	H
													H
													H
													H
													H
													H
													H
													H
													H
													H
													H
													H
													H
													H
													H
													H
													H
													H
			11400	45.94	-28.06	74	45.53	38.1	19.57	57.26	-	-	P
		17100	50.07	-18.13	68.2	40.46	41.6	23.64	55.63	-	-	P	V
													V
													V
													V
													V
													V
													V
													V
													V
													V
													V
													V
													V
													V
Remark	1. No other spurious found.												
	2. All results are PASS against Peak and Average limit line.												
	3. The emission position marked as "-" means no suspected emission found with sufficient margin against limit line or noise floor only.												



Band 3 - Straddle Channel
WIFI 802.11a (Band Edge @ 3m)

Table with 14 columns: WIFI Ant. 2, Note, Frequency (MHz), Level (dBµV/m), Margin (dB), Limit Line (dBµV/m), Read Level (dBµV), Antenna Factor (dB/m), Path Loss (dB), Preamp Factor (dB), Ant Pos (cm), Table Pos (deg), Peak Avg. (P/A), Pol. (H/V). Rows include frequency measurements from 5366.77 to 5947.75 MHz and a Remark section.



Band 3 - Straddle Channel
WIFI 802.11a (Harmonic @ 3m)

WIFI Ant.	Note	Frequency	Level	Margin	Limit Line	Read Level	Antenna Factor	Path Loss	Preamp Factor	Ant Pos	Table Pos	Peak Avg.	Pol.
2		(MHz)	(dBμV/m)	(dB)	(dBμV/m)	(dBμV)	(dB/m)	(dB)	(dB)	(cm)	(deg)	(P/A)	(H/V)
802.11a CH 144 5720MHz		11440	47.38	-26.62	74	46.8	38.14	19.61	57.17	-	-	P	H
		17160	50.53	-17.67	68.2	41	41.48	23.68	55.63	-	-	P	H
													H
													H
													H
													H
													H
													H
													H
													H
													H
													H
													H
													H
													H
													H
													H
													H
													H
			11440	45.65	-28.35	74	45.07	38.14	19.61	57.17	-	-	P
		17160	50.65	-17.55	68.2	41.12	41.48	23.68	55.63	-	-	P	V
													V
													V
													V
													V
													V
													V
													V
													V
													V
													V
													V
													V
													V
													V
Remark	1. No other spurious found. 2. All results are PASS against Peak and Average limit line. 3. The emission position marked as "-" means no suspected emission found with sufficient margin against limit line or noise floor only.												



Emission below 1GHz
WIFI 802.11a (LF @ 3m)

WIFI Ant. 2	Note	Frequency (MHz)	Level (dBµV/m)	Margin (dB)	Limit Line (dBµV/m)	Read Level (dBµV)	Antenna Factor (dB/m)	Path Loss (dB)	Preamp Factor (dB)	Ant Pos (cm)	Table Pos (deg)	Peak Avg. (P/A)	Pol. (H/V)	
802.11a LF		47.55	29.12	-10.88	40	42.21	15.49	1.34	29.92	-	-	P	H	
		193.89	32.22	-11.28	43.5	44.62	14.96	2.47	29.83	-	-	P	H	
		215.49	32.45	-11.05	43.5	44.72	15.03	2.53	29.83	-	-	P	H	
		819.4	31.14	-14.86	46	27.72	27.62	5.04	29.24	-	-	P	H	
		894.3	32.79	-13.21	46	27.53	28.75	5.39	28.88	-	-	P	H	
		957.3	33.37	-12.63	46	25.93	30.52	5.53	28.61	-	-	P	H	
														H
														H
														H
														H
														H
														H
			30.27	30.75	-9.25	40	35.59	24.04	1.06	29.94	-	-	P	V
			49.71	31.76	-8.24	40	45.85	14.46	1.37	29.92	-	-	P	V
			63.21	25.87	-14.13	40	42.57	11.65	1.55	29.9	-	-	P	V
			738.2	30.58	-15.42	46	27.93	27.42	4.74	29.51	-	-	P	V
			855.8	32.69	-13.31	46	27.72	28.96	5.14	29.13	-	-	P	V
			958	33.6	-12.4	46	26.1	30.57	5.53	28.6	-	-	P	V
													V	
													V	
													V	
													V	
													V	
													V	
													V	
Remark	<ol style="list-style-type: none"> No other spurious found. All results are PASS against limit line. The emission position marked as “-” means no suspected emission found and emission level has at least 6dB margin against limit or emission is noise floor only. 													



Band 1 - 5150~5250MHz

WIFI 802.11ax HE20 Full (Band Edge @ 3m)

WIFI Ant. 1+2	Note	Frequency (MHz)	Level (dBμV/m)	Margin (dB)	Limit Line (dBμV/m)	Read Level (dBμV)	Antenna Factor (dB/m)	Path Loss (dB)	Preamp Factor (dB)	Ant Pos (cm)	Table Pos (deg)	Peak Avg. (P/A)	Pol. (H/V)	
802.11ax HE20 Full CH 36 5180MHz		5143.78	50.58	-23.42	74	38.35	34.09	12.03	33.89	273	37	P	H	
		5134.42	42.71	-11.29	54	30.52	34.07	12.01	33.89	273	37	A	H	
	*	5180	101.92	-	-	89.46	34.28	12.07	33.89	273	37	P	H	
	*	5180	94.52	-	-	82.06	34.28	12.07	33.89	273	37	A	H	
													H	
														H
			5144.82	53.89	-20.11	74	41.66	34.09	12.03	33.89	280	43	P	V
			5148.98	44.83	-9.17	54	32.59	34.1	12.03	33.89	280	43	A	V
		*	5180	109.42	-	-	96.96	34.28	12.07	33.89	280	43	P	V
		*	5180	101.5	-	-	89.04	34.28	12.07	33.89	280	43	A	V
													V	
													V	
802.11ax HE20 Full CH 44 5220MHz		5150	51.39	-22.61	74	39.15	34.1	12.03	33.89	286	38	P	H	
		5127.14	42.68	-11.32	54	30.51	34.05	12.01	33.89	286	38	A	H	
	*	5220	103.39	-	-	90.78	34.4	12.1	33.89	286	38	P	H	
	*	5220	94.73	-	-	82.12	34.4	12.1	33.89	286	38	A	H	
			5450.76	48.75	-25.25	74	35.71	34.7	12.21	33.87	286	38	P	H
			5458.88	42.36	-11.64	54	29.26	34.74	12.23	33.87	286	38	A	H
			5035.36	50.49	-23.51	74	38.34	34.16	11.89	33.9	400	327	P	V
			5067.86	43.08	-10.92	54	30.99	34.06	11.93	33.9	400	327	A	V
		*	5220	108.74	-	-	96.13	34.4	12.1	33.89	400	327	P	V
		*	5220	101.98	-	-	89.37	34.4	12.1	33.89	400	327	A	V
		5433.12	49.48	-24.52	74	36.57	34.6	12.18	33.87	400	327	P	V	
		5454.4	42.49	-11.51	54	29.42	34.72	12.22	33.87	400	327	A	V	



802.11ax HE20 Full CH 48 5240MHz		5032.5	50.54	-23.46	74	38.39	34.17	11.88	33.9	100	274	P	H
		5135.46	42.91	-11.09	54	30.71	34.07	12.02	33.89	100	274	A	H
	*	5240	101.98	-	-	89.36	34.4	12.11	33.89	100	274	P	H
	*	5240	94.96	-	-	82.34	34.4	12.11	33.89	100	274	A	H
		5412.96	50.42	-23.58	74	37.67	34.48	12.15	33.88	100	274	P	H
		5455.52	42.38	-11.62	54	29.31	34.72	12.22	33.87	100	274	A	H
		5107.9	49.88	-24.12	74	37.77	34.02	11.98	33.89	400	42	P	V
		5138.32	42.79	-11.21	54	30.58	34.08	12.02	33.89	400	42	A	V
	*	5240	109.57	-	-	96.95	34.4	12.11	33.89	400	42	P	V
	*	5240	101.75	-	-	89.13	34.4	12.11	33.89	400	42	A	V
		5361.72	50.98	-23.02	74	38.34	34.4	12.12	33.88	400	42	P	V
	5447.68	42.4	-11.6	54	29.37	34.69	12.21	33.87	400	42	A	V	
Remark	1. No other spurious found. 2. All results are PASS against Peak and Average limit line.												



Band 1 5150~5250MHz

WIFI 802.11ax HE20 Full (Harmonic @ 3m)

WIFI Ant.	Note	Frequency	Level	Margin	Limit Line	Read Level	Antenna Factor	Path Loss	Preamp Factor	Ant Pos	Table Pos	Peak Avg.	Pol.	
1+2		(MHz)	(dBμV/m)	(dB)	(dBμV/m)	(dBμV)	(dB/m)	(dB)	(dB)	(cm)	(deg)	(P/A)	(H/V)	
802.11ax HE20 Full		10360	50.72	-17.48	68.2	53.81	37.3	18.56	58.95	285	324	P	H	
		10360	40.35	-13.65	54	43.44	37.3	18.56	58.95	285	324	A	H	
		15540	46.83	-27.17	74	40.4	40.2	22.49	56.26	-	-	P	H	
													H	
													H	
													H	
														H
														H
														H
														H
CH 36 5180MHz		10360	52.76	-15.44	68.2	55.85	37.3	18.56	58.95	100	301	P	V	
		10360	43.26	-10.74	54	46.35	37.3	18.56	58.95	100	301	A	V	
		15540	47.34	-26.66	74	40.91	40.2	22.49	56.26	-	-	P	V	
													V	
													V	
													V	
													V	
													V	
													V	
													V	



WiFi Ant.	Note	Frequency	Level	Margin	Limit Line	Read Level	Antenna Factor	Path Loss	Preamp Factor	Ant Pos	Table Pos	Peak Avg.	Pol.	
1+2		(MHz)	(dBμV/m)	(dB)	(dBμV/m)	(dBμV)	(dB/m)	(dB)	(dB)	(cm)	(deg)	(P/A)	(H/V)	
802.11ax HE20 Full CH 44 5220MHz		10440	49.25	-18.95	68.2	52.17	37.3	18.64	58.86	276	320	P	H	
		10440	40.4	-13.6	54	43.32	37.3	18.64	58.86	276	320	A	H	
		15660	47.05	-26.95	74	40.42	40.38	22.56	56.31	-	-	P	H	
													H	
													H	
													H	
													H	
													H	
													H	
													H	
													H	
													H	
													H	
													H	
													H	
													H	
													H	
													H	
			10440	51.48	-16.72	68.2	54.4	37.3	18.64	58.86	100	310	P	V
			10440	41.89	-12.11	54	44.81	37.3	18.64	58.86	100	310	A	V
		15660	47.53	-26.47	74	40.9	40.38	22.56	56.31	-	-	P	V	
													V	
													V	
													V	
													V	
													V	
													V	
													V	
													V	
													V	



WiFi Ant.	Note	Frequency	Level	Margin	Limit Line	Read Level	Antenna Factor	Path Loss	Preamp Factor	Ant Pos	Table Pos	Peak Avg.	Pol.	
1+2		(MHz)	(dBµV/m)	(dB)	(dBµV/m)	(dBµV)	(dB/m)	(dB)	(dB)	(cm)	(deg)	(P/A)	(H/V)	
802.11ax HE20 Full CH 48 5240MHz		10480	45.83	-22.37	68.2	48.68	37.3	18.67	58.82	-	-	P	H	
		15720	48.1	-25.9	74	41.3	40.54	22.59	56.33	-	-	P	H	
													H	
													H	
													H	
													H	
													H	
													H	
													H	
													H	
													H	
													H	
													H	
													H	
													H	
													H	
													H	
			10480	50.76	-17.44	68.2	53.61	37.3	18.67	58.82	100	304	P	V
			10480	41.2	-12.8	54	44.05	37.3	18.67	58.82	100	304	A	V
		15720	48.64	-25.36	74	41.84	40.54	22.59	56.33	-	-	P	V	
													V	
													V	
													V	
													V	
													V	
													V	
													V	
													V	
													V	
Remark	<ol style="list-style-type: none"> No other spurious found. All results are PASS against Peak and Average limit line. The emission position marked as "-" means no suspected emission found with sufficient margin against limit line or noise floor only. 													



Band 1 5150~5250MHz
WIFI 802.11ax HE40 Full (Band Edge @ 3m)

WIFI Ant.	Note	Frequency	Level	Margin	Limit Line	Read Level	Antenna Factor	Path Loss	Preamp Factor	Ant Pos	Table Pos	Peak Avg.	Pol.
1+2		(MHz)	(dBμV/m)	(dB)	(dBμV/m)	(dBμV)	(dB/m)	(dB)	(dB)	(cm)	(deg)	(P/A)	(H/V)
802.11ax HE40 Full CH 38 5190MHz		5149.76	52.02	-21.98	74	39.78	34.1	12.03	33.89	100	304	P	H
		5146.38	45.58	-8.42	54	33.35	34.09	12.03	33.89	100	304	A	H
	*	5190	96.15	-	-	83.61	34.34	12.09	33.89	100	304	P	H
	*	5190	88.19	-	-	75.65	34.34	12.09	33.89	100	304	A	H
		5427.24	50.06	-23.94	74	37.2	34.56	12.17	33.87	100	304	P	H
		5436.76	42.83	-11.17	54	29.89	34.62	12.19	33.87	100	304	A	H
		5148.72	53.86	-20.14	74	41.62	34.1	12.03	33.89	304	3	P	V
		5149.76	48.49	-5.51	54	36.25	34.1	12.03	33.89	304	3	A	V
	*	5190	102.03	-	-	89.49	34.34	12.09	33.89	304	3	P	V
	*	5190	94.42	-	-	81.88	34.34	12.09	33.89	304	3	A	V
		5448.24	49.18	-24.82	74	36.15	34.69	12.21	33.87	304	3	P	V
		5446.56	42.61	-11.39	54	29.59	34.68	12.21	33.87	304	3	A	V
802.11ax HE40 Full CH 46 5230MHz		5081.64	50.37	-23.63	74	38.28	34.04	11.95	33.9	100	306	P	H
		5131.3	43.14	-10.86	54	30.96	34.06	12.01	33.89	100	306	A	H
	*	5230	98.77	-	-	86.16	34.4	12.1	33.89	100	306	P	H
	*	5230	88.65	-	-	76.04	34.4	12.1	33.89	100	306	A	H
		5453.28	49.35	-24.65	74	36.29	34.71	12.22	33.87	100	306	P	H
		5451.6	42.51	-11.49	54	29.45	34.71	12.22	33.87	100	306	A	H
		5093.08	50.68	-23.32	74	38.6	34.01	11.96	33.89	290	3	P	V
		5135.2	43.32	-10.68	54	31.12	34.07	12.02	33.89	290	3	A	V
	*	5230	102.23	-	-	89.62	34.4	12.1	33.89	290	3	P	V
	*	5230	94.84	-	-	82.23	34.4	12.1	33.89	290	3	A	V
	5395.88	49.68	-24.32	74	37.03	34.4	12.13	33.88	290	3	P	V	
	5448.52	42.63	-11.37	54	29.6	34.69	12.21	33.87	290	3	A	V	
Remark	1. No other spurious found. 2. All results are PASS against Peak and Average limit line.												



Band 1 5150~5250MHz

WIFI 802.11ax HE40 Full (Harmonic @ 3m)

WIFI Ant.	Note	Frequency	Level	Margin	Limit Line	Read Level	Antenna Factor	Path Loss	Preamp Factor	Ant Pos	Table Pos	Peak Avg.	Pol.
1+2		(MHz)	(dBμV/m)	(dB)	(dBμV/m)	(dBμV)	(dB/m)	(dB)	(dB)	(cm)	(deg)	(P/A)	(H/V)
802.11ax HE40 Full		10380	44.13	-24.07	68.2	47.18	37.3	18.58	58.93	-	-	P	H
		15570	47.4	-26.6	74	40.96	40.2	22.51	56.27	-	-	P	H
													H
													H
													H
													H
													H
													H
													H
													H
CH 38 5190MHz		10380	43.72	-24.48	68.2	46.77	37.3	18.58	58.93	-	-	P	V
		15570	47.4	-26.6	74	40.96	40.2	22.51	56.27	-	-	P	V
													V
													V
													V
													V
													V
													V
													V
													V



WIFI Ant.	Note	Frequency	Level	Margin	Limit Line	Read Level	Antenna Factor	Path Loss	Preamp Factor	Ant Pos	Table Pos	Peak Avg.	Pol.
1+2		(MHz)	(dBµV/m)	(dB)	(dBµV/m)	(dBµV)	(dB/m)	(dB)	(dB)	(cm)	(deg)	(P/A)	(H/V)
802.11ax HE40 Full CH 46 5230MHz		10460	45.67	-22.53	68.2	48.56	37.3	18.65	58.84	-	-	P	H
		15690	47.55	-26.45	74	40.82	40.47	22.58	56.32	-	-	P	H
													H
													H
													H
													H
													H
													H
													H
													H
													H
													H
													H
													H
													H
													H
													H
													H
													H
	Remark	1. No other spurious found.											
2. All results are PASS against Peak and Average limit line.													
3. The emission position marked as "-" means no suspected emission found with sufficient margin against limit line or noise floor only.													



Band 1 5150~5250MHz
WIFI 802.11ax HE80 Full (Band Edge @ 3m)

WIFI Ant. 1+2	Note	Frequency (MHz)	Level (dBμV/m)	Margin (dB)	Limit Line (dBμV/m)	Read Level (dBμV)	Antenna Factor (dB/m)	Path Loss (dB)	Preamp Factor (dB)	Ant Pos (cm)	Table Pos (deg)	Peak Avg. (P/A)	Pol. (H/V)
802.11ax HE80 Full CH 42 5210MHz		5145.86	50.49	-23.51	74	38.26	34.09	12.03	33.89	100	274	P	H
		5148.46	44.4	-9.6	54	32.16	34.1	12.03	33.89	100	274	A	H
	*	5210	91.43	-	-	78.82	34.4	12.1	33.89	100	274	P	H
	*	5210	84.83	-	-	72.22	34.4	12.1	33.89	100	274	A	H
		5437.04	49.48	-24.52	74	36.54	34.62	12.19	33.87	100	274	P	H
		5449.36	43.23	-10.77	54	30.19	34.7	12.21	33.87	100	274	A	H
		5115.18	53.17	-20.83	74	41.04	34.03	11.99	33.89	393	354	P	V
		5143.78	47.59	-6.41	54	35.36	34.09	12.03	33.89	393	354	A	V
	*	5210	98.47	-	-	85.86	34.4	12.1	33.89	393	354	P	V
	*	5210	92.44	-	-	79.83	34.4	12.1	33.89	393	354	A	V
		5355.56	49.41	-24.59	74	36.77	34.4	12.12	33.88	393	354	P	V
		5441.8	43.5	-10.5	54	30.52	34.65	12.2	33.87	393	354	A	V
Remark	1. No other spurious found. 2. All results are PASS against Peak and Average limit line.												



Band 1 5150~5250MHz
WIFI 802.11ax HE80 Full (Harmonic @ 3m)

WIFI Ant.	Note	Frequency	Level	Margin	Limit Line	Read Level	Antenna Factor	Path Loss	Preamp Factor	Ant Pos	Table Pos	Peak Avg.	Pol.	
1+2		(MHz)	(dBμV/m)	(dB)	(dBμV/m)	(dBμV)	(dB/m)	(dB)	(dB)	(cm)	(deg)	(P/A)	(H/V)	
802.11ax HE80 Full CH 42 5210MHz		10420	44.68	-23.52	68.2	47.64	37.3	18.62	58.88	-	-	P	H	
		15630	47.61	-26.39	74	41.07	40.29	22.54	56.29	-	-	P	H	
													H	
													H	
													H	
													H	
													H	
													H	
													H	
													H	
													H	
													H	
													H	
													H	
													H	
													H	
	Remark	1. No other spurious found.												
		2. All results are PASS against Peak and Average limit line.												
3. The emission position marked as "-" means no suspected emission found with sufficient margin against limit line or noise floor only.														



Band 2 - 5250~5350MHz

WIFI 802.11ax HE20 Full (Band Edge @ 3m)

WIFI Ant.	Note	Frequency	Level	Margin	Limit Line	Read Level	Antenna Factor	Path Loss	Preamp Factor	Ant Pos	Table Pos	Peak Avg.	Pol.
1+2		(MHz)	(dBμV/m)	(dB)	(dBμV/m)	(dBμV)	(dB/m)	(dB)	(dB)	(cm)	(deg)	(P/A)	(H/V)
802.11ax HE20 Full CH 52 5260MHz		5128.8	50.79	-23.21	74	38.61	34.06	12.01	33.89	100	274	P	H
		5086.45	42.71	-11.29	54	30.62	34.03	11.95	33.89	100	274	A	H
	*	5260	101.87	-	-	89.24	34.4	12.11	33.88	100	274	P	H
	*	5260	93.6	-	-	80.97	34.4	12.11	33.88	100	274	A	H
		5457.84	50.13	-23.87	74	37.04	34.73	12.23	33.87	100	274	P	H
		5448.24	42.38	-11.62	54	29.35	34.69	12.21	33.87	100	274	A	H
		5138.95	51.69	-22.31	74	39.48	34.08	12.02	33.89	400	296	P	V
		5133	43.1	-10.9	54	30.91	34.07	12.01	33.89	400	296	A	V
	*	5260	109.28	-	-	96.65	34.4	12.11	33.88	400	296	P	V
	*	5260	101.43	-	-	88.8	34.4	12.11	33.88	400	296	A	V
		5442.96	49.5	-24.5	74	36.51	34.66	12.2	33.87	400	296	P	V
		5418.96	42.15	-11.85	54	29.35	34.51	12.16	33.87	400	296	A	V
802.11ax HE20 Full CH 60 5300MHz		5084.35	50.52	-23.48	74	38.43	34.03	11.95	33.89	218	210	P	H
		5067.55	42.92	-11.08	54	30.83	34.06	11.93	33.9	218	210	A	H
	*	5300	101.46	-	-	88.83	34.4	12.11	33.88	218	210	P	H
	*	5300	94.36	-	-	81.73	34.4	12.11	33.88	218	210	A	H
		5437.92	49.56	-24.44	74	36.61	34.63	12.19	33.87	218	210	P	H
		5411.28	42.1	-11.9	54	29.36	34.47	12.15	33.88	218	210	A	H
		5091	50.91	-23.09	74	38.82	34.02	11.96	33.89	400	274	P	V
		5120.05	42.92	-11.08	54	30.77	34.04	12	33.89	400	274	A	V
	*	5300	108.24	-	-	95.61	34.4	12.11	33.88	400	274	P	V
	*	5300	101.01	-	-	88.38	34.4	12.11	33.88	400	274	A	V
		5455.68	51.04	-22.96	74	37.97	34.72	12.22	33.87	400	274	P	V
		5459.76	42.37	-11.63	54	29.27	34.74	12.23	33.87	400	274	A	V



802.11ax HE20 Full CH 64 5320MHz	*	5320	102.25	-	-	89.61	34.4	12.12	33.88	100	273	P	H
	*	5320	94.7	-	-	82.06	34.4	12.12	33.88	100	273	A	H
		5443.04	49.59	-24.41	74	36.6	34.66	12.2	33.87	100	273	P	H
		5350.24	42.62	-11.38	54	29.98	34.4	12.12	33.88	100	273	A	H
													H
													H
	*	5320	109.22	-	-	96.58	34.4	12.12	33.88	297	42	P	V
	*	5320	102.5	-	-	89.86	34.4	12.12	33.88	297	42	A	V
		5353.12	53.41	-20.59	74	40.77	34.4	12.12	33.88	297	42	P	V
		5352.64	45.82	-8.18	54	33.18	34.4	12.12	33.88	297	42	A	V
												V	
												V	
Remark	1. No other spurious found. 2. All results are PASS against Peak and Average limit line.												



Band 2 5250~5350MHz

WIFI 802.11ax HE20 Full (Harmonic @ 3m)

WIFI Ant.	Note	Frequency	Level	Margin	Limit Line	Read Level	Antenna Factor	Path Loss	Preamp Factor	Ant Pos	Table Pos	Peak Avg.	Pol.
1+2		(MHz)	(dBμV/m)	(dB)	(dBμV/m)	(dBμV)	(dB/m)	(dB)	(dB)	(cm)	(deg)	(P/A)	(H/V)
802.11ax HE20 Full		10520	45.2	-23	68.2	47.94	37.32	18.71	58.77	-	-	P	H
		15780	48.38	-25.62	74	41.46	40.66	22.62	56.36	-	-	P	H
													H
													H
													H
													H
													H
													H
													H
													H
CH 52 5260MHz		10520	45.23	-22.97	68.2	47.97	37.32	18.71	58.77	-	-	P	V
		15780	47.72	-26.28	74	40.8	40.66	22.62	56.36	-	-	P	V
													V
													V
													V
													V
													V
													V
													V
													V



WIFI Ant.	Note	Frequency	Level	Margin	Limit Line	Read Level	Antenna Factor	Path Loss	Preamp Factor	Ant Pos	Table Pos	Peak Avg.	Pol.
1+2		(MHz)	(dBμV/m)	(dB)	(dBμV/m)	(dBμV)	(dB/m)	(dB)	(dB)	(cm)	(deg)	(P/A)	(H/V)
802.11ax HE20 Full CH 60 5300MHz		10600	45.46	-28.54	74	47.92	37.4	18.8	58.66	-	-	P	H
		15900	48.63	-25.37	74	41.45	40.9	22.69	56.41	-	-	P	H
													H
													H
													H
													H
													H
													H
													H
													H
													H
													H
													H
													H
													H
													H
													H
													H
													H
			10600	50.48	-23.52	74	52.94	37.4	18.8	58.66	400	101	P
		10600	39.29	-14.71	54	41.75	37.4	18.8	58.66	400	101	A	V
		15900	48.21	-25.79	74	41.03	40.9	22.69	56.41	-	-	P	V
													V
													V
													V
													V
													V
													V
													V
													V
													V



WIFI Ant.	Note	Frequency	Level	Margin	Limit Line	Read Level	Antenna Factor	Path Loss	Preamp Factor	Ant Pos	Table Pos	Peak Avg.	Pol.
1+2		(MHz)	(dBµV/m)	(dB)	(dBµV/m)	(dBµV)	(dB/m)	(dB)	(dB)	(cm)	(deg)	(P/A)	(H/V)
802.11ax HE20 Full CH 64 5320MHz		10640	46.14	-27.86	74	48.43	37.48	18.83	58.6	-	-	P	H
		15960	46.53	-27.47	74	39.33	40.9	22.73	56.43	-	-	P	H
													H
													H
													H
													H
													H
													H
													H
													H
													H
													H
													H
													H
													H
													H
													H
													H
													H
	Remark	1. No other spurious found. 2. All results are PASS against Peak and Average limit line. 3. The emission position marked as "-" means no suspected emission found with sufficient margin against limit line or noise floor only.											



Band 2 5250~5350MHz
WIFI 802.11ax HE40 Full (Band Edge @ 3m)

WIFI Ant.	Note	Frequency	Level	Margin	Limit Line	Read Level	Antenna Factor	Path Loss	Preamp Factor	Ant Pos	Table Pos	Peak Avg.	Pol.
1+2		(MHz)	(dBμV/m)	(dB)	(dBμV/m)	(dBμV)	(dB/m)	(dB)	(dB)	(cm)	(deg)	(P/A)	(H/V)
802.11ax HE40 Full CH 54 5270MHz		5098.7	51.21	-22.79	74	39.13	34	11.97	33.89	100	304	P	H
		5124.25	43.36	-10.64	54	31.2	34.05	12	33.89	100	304	A	H
	*	5270	96.67	-	-	84.04	34.4	12.11	33.88	100	304	P	H
	*	5270	88.8	-	-	76.17	34.4	12.11	33.88	100	304	A	H
		5436.72	50	-24	74	37.06	34.62	12.19	33.87	100	304	P	H
		5458.32	42.64	-11.36	54	29.55	34.73	12.23	33.87	100	304	A	H
		5111.3	51.39	-22.61	74	39.28	34.02	11.98	33.89	285	5	P	V
		5104.3	43.31	-10.69	54	31.21	34.01	11.98	33.89	285	5	A	V
	*	5270	103.43	-	-	90.8	34.4	12.11	33.88	285	5	P	V
	*	5270	94.58	-	-	81.95	34.4	12.11	33.88	285	5	A	V
		5439.12	50.65	-23.35	74	37.7	34.63	12.19	33.87	285	5	P	V
		5459.28	42.94	-11.06	54	29.84	34.74	12.23	33.87	285	5	A	V
802.11ax HE40 Full CH 62 5310MHz		5094.15	50.35	-23.65	74	38.27	34.01	11.96	33.89	107	305	P	H
		5043.4	43.32	-10.68	54	31.19	34.13	11.9	33.9	107	305	A	H
	*	5310	96.53	-	-	83.89	34.4	12.12	33.88	107	305	P	H
	*	5310	87.63	-	-	74.99	34.4	12.12	33.88	107	305	A	H
		5351.28	53.1	-20.9	74	40.46	34.4	12.12	33.88	107	305	P	H
		5350.32	46.08	-7.92	54	33.44	34.4	12.12	33.88	107	305	A	H
		5112	51.21	-22.79	74	39.09	34.02	11.99	33.89	288	9	P	V
		5091.35	43.4	-10.6	54	31.31	34.02	11.96	33.89	288	9	A	V
	*	5310	99.58	-	-	86.94	34.4	12.12	33.88	288	9	P	V
	*	5310	92.05	-	-	79.41	34.4	12.12	33.88	288	9	A	V
	5351.52	59.19	-14.81	74	46.55	34.4	12.12	33.88	288	9	P	V	
	5350.32	50.24	-3.76	54	37.6	34.4	12.12	33.88	288	9	A	V	
Remark	1. No other spurious found. 2. All results are PASS against Peak and Average limit line.												



Band 2 5250~5350MHz

WIFI 802.11ax HE40 Full (Harmonic @ 3m)

WIFI Ant.	Note	Frequency	Level	Margin	Limit Line	Read Level	Antenna Factor	Path Loss	Preamp Factor	Ant Pos	Table Pos	Peak Avg.	Pol.	
1+2		(MHz)	(dBμV/m)	(dB)	(dBμV/m)	(dBμV)	(dB/m)	(dB)	(dB)	(cm)	(deg)	(P/A)	(H/V)	
802.11ax HE40 Full CH 54 5270MHz		10540	51.11	-17.09	68.2	53.78	37.34	18.73	58.74	100	341	P	H	
		10540	41.54	-12.46	54	44.21	37.34	18.73	58.74	100	341	A	H	
		15810	47.73	-26.27	74	40.74	40.72	22.64	56.37	-	-	P	H	
													H	
													H	
													H	
													H	
													H	
													H	
													H	
													H	
			10540	53.58	-14.62	68.2	56.25	37.34	18.73	58.74	100	305	P	V
			10540	43.66	-10.34	54	46.33	37.34	18.73	58.74	100	305	A	V
			15810	47.64	-26.36	74	40.65	40.72	22.64	56.37	-	-	P	V
														V
													V	
													V	
													V	
													V	
													V	
													V	



**Band 2 5250~5350MHz
WIFI 802.11ax HE80 Full (Band Edge @ 3m)**

WIFI Ant.	Note	Frequency	Level	Margin	Limit Line	Read Level	Antenna Factor	Path Loss	Preamp Factor	Ant Pos	Table Pos	Peak Avg.	Pol.
1+2		(MHz)	(dBμV/m)	(dB)	(dBμV/m)	(dBμV)	(dB/m)	(dB)	(dB)	(cm)	(deg)	(P/A)	(H/V)
802.11ax HE80 Full CH 58 5290MHz		5075.95	51.17	-22.83	74	39.08	34.05	11.94	33.9	100	273	P	H
		5080.5	44.61	-9.39	54	32.53	34.04	11.94	33.9	100	273	A	H
	*	5290	91.32	-	-	78.69	34.4	12.11	33.88	100	273	P	H
	*	5290	84.87	-	-	72.24	34.4	12.11	33.88	100	273	A	H
		5361.84	51.19	-22.81	74	38.55	34.4	12.12	33.88	100	273	P	H
		5357.28	45.01	-8.99	54	32.37	34.4	12.12	33.88	100	273	A	H
		5136.15	50.52	-23.48	74	38.32	34.07	12.02	33.89	271	2	P	V
		5064.75	44.14	-9.86	54	32.05	34.07	11.92	33.9	271	2	A	V
	*	5290	99.88	-	-	87.25	34.4	12.11	33.88	271	2	P	V
	*	5290	92.53	-	-	79.9	34.4	12.11	33.88	271	2	A	V
		5352.24	55.67	-18.33	74	43.03	34.4	12.12	33.88	271	2	P	V
		5351.28	50.91	-3.09	54	38.27	34.4	12.12	33.88	271	2	A	V
Remark	1. No other spurious found. 2. All results are PASS against Peak and Average limit line.												



Band 2 5250~5350MHz

WIFI 802.11ax HE80 Full (Harmonic @ 3m)

WIFI Ant.	Note	Frequency	Level	Margin	Limit Line	Read Level	Antenna Factor	Path Loss	Preamp Factor	Ant Pos	Table Pos	Peak Avg.	Pol.	
1+2		(MHz)	(dBμV/m)	(dB)	(dBμV/m)	(dBμV)	(dB/m)	(dB)	(dB)	(cm)	(deg)	(P/A)	(H/V)	
802.11ax HE80 Full CH 58 5290MHz		10580	43.81	-24.39	68.2	46.34	37.38	18.78	58.69	-	-	P	H	
		15870	47.83	-26.17	74	40.71	40.84	22.68	56.4	-	-	P	H	
													H	
													H	
													H	
													H	
													H	
													H	
													H	
													H	
													H	
													H	
													H	
													H	
													H	
													H	
	802.11ax HE80 Full CH 58 5290MHz		10580	44.25	-23.95	68.2	46.78	37.38	18.78	58.69	-	-	P	V
			15870	47.48	-26.52	74	40.36	40.84	22.68	56.4	-	-	P	V
													V	
													V	
													V	
													V	
													V	
													V	
													V	
													V	
													V	
													V	
													V	
													V	
													V	
													V	
													V	
Remark		<ol style="list-style-type: none"> No other spurious found. All results are PASS against Peak and Average limit line. The emission position marked as "-" means no suspected emission found with sufficient margin against limit line or noise floor only. 												



Band 3 - 5470~5725MHz

WIFI 802.11ax HE20 Full (Band Edge @ 3m)

WIFI Ant.	Note	Frequency	Level	Margin	Limit Line	Read Level	Antenna Factor	Path Loss	Preamp Factor	Ant Pos	Table Pos	Peak Avg.	Pol.
1+2		(MHz)	(dBµV/m)	(dB)	(dBµV/m)	(dBµV)	(dB/m)	(dB)	(dB)	(cm)	(deg)	(P/A)	(H/V)
802.11ax HE20 Full CH 100 5500MHz		5456.56	50.53	-23.47	74	37.45	34.73	12.22	33.87	301	72	P	H
		5469.04	49.06	-19.14	68.2	35.91	34.78	12.24	33.87	301	72	P	H
		5458.8	42.81	-11.19	54	29.71	34.74	12.23	33.87	301	72	A	H
	*	5500	99.92	-	-	86.59	34.9	12.3	33.87	301	72	P	H
	*	5500	93.32	-	-	79.99	34.9	12.3	33.87	301	72	A	H
		5454	50.77	-23.23	74	37.7	34.72	12.22	33.87	299	294	P	V
		5467.12	50.41	-17.79	68.2	37.27	34.77	12.24	33.87	299	294	P	V
		5458.64	44.18	-9.82	54	31.09	34.73	12.23	33.87	299	294	A	V
	*	5500	107.79	-	-	94.46	34.9	12.3	33.87	299	294	P	V
	*	5500	101.42	-	-	88.09	34.9	12.3	33.87	299	294	A	V
												V	
												V	
802.11ax HE20 Full CH 116 5580MHz		5430.4	50.32	-23.68	74	37.43	34.58	12.18	33.87	312	73	P	H
		5463.28	50.38	-17.82	68.2	37.27	34.75	12.23	33.87	312	73	P	H
		5457.04	42.76	-11.24	54	29.68	34.73	12.22	33.87	312	73	A	H
	*	5580	103.81	-	-	90.37	34.9	12.43	33.89	312	73	P	H
	*	5580	94.91	-	-	81.47	34.9	12.43	33.89	312	73	A	H
		5726.57	51.15	-17.05	68.2	37.53	35.05	12.5	33.93	312	73	P	H
		5446.96	49.8	-24.2	74	36.78	34.68	12.21	33.87	316	291	P	V
		5466.4	49.79	-18.41	68.2	36.65	34.77	12.24	33.87	316	291	P	V
		5458.48	42.95	-11.05	54	29.86	34.73	12.23	33.87	316	291	A	V
	*	5580	108.62	-	-	95.18	34.9	12.43	33.89	316	291	P	V
*	5580	103.04	-	-	89.6	34.9	12.43	33.89	316	291	A	V	
	5750.825	51.52	-16.68	68.2	37.85	35.1	12.51	33.94	316	291	P	V	



802.11ax HE20 Full CH 140 5700MHz	*	5700	101.86	-	-	88.29	35	12.49	33.92	328	83	P	H
	*	5700	94.73	-	-	81.16	35	12.49	33.92	328	83	A	H
		5726.52	50.82	-17.38	68.2	37.2	35.05	12.5	33.93	328	83	P	H
													H
													H
													H
	*	5700	108.11	-	-	94.54	35	12.49	33.92	327	69	P	V
	*	5700	102.61	-	-	89.04	35	12.49	33.92	327	69	A	V
		5726.2	59.38	-8.82	68.2	45.76	35.05	12.5	33.93	327	69	P	V
													V
												V	
												V	
Remark	1. No other spurious found. 2. All results are PASS against Peak and Average limit line.												



Band 3 5470~5725MHz

WIFI 802.11ax HE20 (Harmonic @ 3m)

WIFI Ant.	Note	Frequency	Level	Margin	Limit Line	Read Level	Antenna Factor	Path Loss	Preamp Factor	Ant Pos	Table Pos	Peak Avg.	Pol.
1+2		(MHz)	(dBμV/m)	(dB)	(dBμV/m)	(dBμV)	(dB/m)	(dB)	(dB)	(cm)	(deg)	(P/A)	(H/V)
802.11ax HE20 Full CH 100 5500MHz		11000	45.71	-28.29	74	46.83	37.8	19.17	58.09	-	-	P	H
		16500	49.15	-19.05	68.2	40.52	41.8	23.16	56.33	-	-	P	H
													H
													H
													H
													H
													H
													H
													H
													H
		11000	46.02	-27.98	74	47.14	37.8	19.17	58.09	-	-	P	V
		16500	48.7	-19.5	68.2	40.07	41.8	23.16	56.33	-	-	P	V
													V
													V
													V
													V
													V
													V
													V
													V
													V



WiFi Ant.	Note	Frequency	Level	Margin	Limit Line	Read Level	Antenna Factor	Path Loss	Preamp Factor	Ant Pos	Table Pos	Peak Avg.	Pol.
1+2		(MHz)	(dBµV/m)	(dB)	(dBµV/m)	(dBµV)	(dB/m)	(dB)	(dB)	(cm)	(deg)	(P/A)	(H/V)
802.11ax HE20 Full CH 140 5700MHz		11400	47.09	-26.91	74	46.68	38.1	19.57	57.26	-	-	P	H
		17100	50.15	-18.05	68.2	40.54	41.6	23.64	55.63	-	-	P	H
													H
													H
													H
													H
													H
													H
													H
													H
													H
													H
													H
													H
													H
													H
													H
													H
													H
	802.11ax HE20 Full CH 140 5700MHz		11400	45.4	-28.6	74	44.99	38.1	19.57	57.26	-	-	P
		17100	49.69	-18.51	68.2	40.08	41.6	23.64	55.63	-	-	P	V
													V
													V
													V
													V
													V
													V
													V
													V
Remark	<ol style="list-style-type: none"> No other spurious found. All results are PASS against Peak and Average limit line. The emission position marked as "-" means no suspected emission found with sufficient margin against limit line or noise floor only. 												



Band 3 5470~5725MHz
WIFI 802.11ax HE40 Full (Band Edge @ 3m)

WIFI Ant.	Note	Frequency	Level	Margin	Limit Line	Read Level	Antenna Factor	Path Loss	Preamp Factor	Ant Pos	Table Pos	Peak Avg.	Pol.
1+2		(MHz)	(dBμV/m)	(dB)	(dBμV/m)	(dBμV)	(dB/m)	(dB)	(dB)	(cm)	(deg)	(P/A)	(H/V)
802.11ax HE40 Full CH 102 5510MHz		5433.52	50.9	-23.1	74	37.98	34.6	12.19	33.87	308	56	P	H
		5467.36	53.03	-15.17	68.2	39.89	34.77	12.24	33.87	308	56	P	H
		5456.8	43.86	-10.14	54	30.78	34.73	12.22	33.87	308	56	A	H
	*	5510	93.83	-	-	80.49	34.9	12.31	33.87	308	56	P	H
	*	5510	87.93	-	-	74.59	34.9	12.31	33.87	308	56	A	H
		5725	50.73	-17.47	68.2	37.11	35.05	12.5	33.93	308	56	P	H
		5458.96	54.3	-19.7	74	41.2	34.74	12.23	33.87	296	50	P	V
		5469.04	58.99	-9.21	68.2	45.84	34.78	12.24	33.87	296	50	P	V
		5455.84	46.91	-7.09	54	33.84	34.72	12.22	33.87	296	50	A	V
	*	5510	101.39	-	-	88.05	34.9	12.31	33.87	296	50	P	V
	*	5510	94.46	-	-	81.12	34.9	12.31	33.87	296	50	A	V
		5753.03	50.1	-18.1	68.2	36.43	35.1	12.51	33.94	296	50	P	V
802.11ax HE40 Full CH 110 5550MHz		5437.12	49.92	-24.08	74	36.98	34.62	12.19	33.87	320	73	P	H
		5462.08	50.32	-17.88	68.2	37.21	34.75	12.23	33.87	320	73	P	H
		5455.36	43.14	-10.86	54	30.07	34.72	12.22	33.87	320	73	A	H
	*	5550	96.33	-	-	82.93	34.9	12.38	33.88	320	73	P	H
	*	5550	89.34	-	-	75.94	34.9	12.38	33.88	320	73	A	H
		5730.035	50.54	-17.66	68.2	36.9	35.06	12.51	33.93	320	73	P	H
		5361.28	50.71	-23.29	74	38.07	34.4	12.12	33.88	318	70	P	V
		5465.68	50.87	-17.33	68.2	37.74	34.76	12.24	33.87	318	70	P	V
		5458.96	43.72	-10.28	54	30.62	34.74	12.23	33.87	318	70	A	V
	*	5550	102.59	-	-	89.19	34.9	12.38	33.88	318	70	P	V
	*	5550	96.58	-	-	83.18	34.9	12.38	33.88	318	70	A	V
		5757.755	51.34	-16.86	68.2	37.66	35.1	12.52	33.94	318	70	P	V



802.11ax HE40 Full CH 134 5670MHz		5445.55	49.63	-24.37	74	36.62	34.67	12.21	33.87	321	56	P	H
		5466.2	48.76	-19.44	68.2	35.63	34.76	12.24	33.87	321	56	P	H
		5432.25	43.2	-10.8	54	30.3	34.59	12.18	33.87	321	56	A	H
	*	5670	97.29	-	-	83.78	34.94	12.48	33.91	321	56	P	H
	*	5670	91.21	-	-	77.7	34.94	12.48	33.91	321	56	A	H
		5726.85	51.92	-16.28	68.2	38.3	35.05	12.5	33.93	321	56	P	H
		5441	49.57	-24.43	74	36.59	34.65	12.2	33.87	300	73	P	V
		5463.4	48.91	-19.29	68.2	35.8	34.75	12.23	33.87	300	73	P	V
		5448.35	43.25	-10.75	54	30.22	34.69	12.21	33.87	300	73	A	V
	*	5670	105.4	-	-	91.89	34.94	12.48	33.91	300	73	P	V
	*	5670	97	-	-	83.49	34.94	12.48	33.91	300	73	A	V
		5726.5	55.5	-12.7	68.2	41.88	35.05	12.5	33.93	300	73	P	V
Remark	1. No other spurious found. 2. All results are PASS against Peak and Average limit line.												



Band 3 5470~5725MHz

WIFI 802.11ax HE40 Full (Harmonic @ 3m)

WIFI Ant.	Note	Frequency	Level	Margin	Limit Line	Read Level	Antenna Factor	Path Loss	Preamp Factor	Ant Pos	Table Pos	Peak Avg.	Pol.
1+2		(MHz)	(dBμV/m)	(dB)	(dBμV/m)	(dBμV)	(dB/m)	(dB)	(dB)	(cm)	(deg)	(P/A)	(H/V)
802.11ax HE40 Full CH 102		11020	45.31	-28.69	74	46.36	37.8	19.2	58.05	-	-	P	H
		16530	48.83	-19.37	68.2	40.23	41.71	23.18	56.29	-	-	P	H
													H
													H
													H
													H
													H
													H
													H
													H
5510MHz		11020	45.58	-28.42	74	46.63	37.8	19.2	58.05	-	-	P	V
		16530	49.51	-18.69	68.2	40.91	41.71	23.18	56.29	-	-	P	V
													V
													V
													V
													V
													V
													V
													V
													V



WIFI Ant.	Note	Frequency	Level	Margin	Limit Line	Read Level	Antenna Factor	Path Loss	Preamp Factor	Ant Pos	Table Pos	Peak Avg.	Pol.
1+2		(MHz)	(dBµV/m)	(dB)	(dBµV/m)	(dBµV)	(dB/m)	(dB)	(dB)	(cm)	(deg)	(P/A)	(H/V)
802.11ax HE40 Full		11100	46.82	-27.18	74	47.62	37.8	19.28	57.88	-	-	P	H
		16650	48.76	-19.44	68.2	39.91	41.7	23.27	56.12	-	-	P	H
													H
													H
													H
													H
													H
													H
													H
													H
CH 110 5550MHz		11100	45.48	-28.52	74	46.28	37.8	19.28	57.88	-	-	P	V
		16650	48.48	-19.72	68.2	39.63	41.7	23.27	56.12	-	-	P	V
													V
													V
													V
													V
													V
													V
													V
													V



WIFI Ant.	Note	Frequency	Level	Margin	Limit Line	Read Level	Antenna Factor	Path Loss	Preamp Factor	Ant Pos	Table Pos	Peak Avg.	Pol.
1+2		(MHz)	(dBµV/m)	(dB)	(dBµV/m)	(dBµV)	(dB/m)	(dB)	(dB)	(cm)	(deg)	(P/A)	(H/V)
802.11ax HE40 Full CH 134 5670MHz		11340	45.31	-28.69	74	45.19	37.98	19.52	57.38	-	-	P	H
		17010	50.17	-18.03	68.2	40.55	41.69	23.56	55.63	-	-	P	H
													H
													H
													H
													H
													H
													H
													H
													H
													H
													H
													H
													H
													H
													H
													H
													H
													H
	802.11ax HE40 Full CH 134 5670MHz		11340	45.53	-28.47	74	45.41	37.98	19.52	57.38	-	-	P
		17010	50.08	-18.12	68.2	40.46	41.69	23.56	55.63	-	-	P	V
													V
													V
													V
													V
													V
													V
													V
													V
Remark	<ol style="list-style-type: none"> No other spurious found. All results are PASS against Peak and Average limit line. The emission position marked as "-" means no suspected emission found with sufficient margin against limit line or noise floor only. 												



Band 3 5470~5725MHz
WIFI 802.11ax HE80 Full (Band Edge @ 3m)

WIFI Ant.	Note	Frequency	Level	Margin	Limit Line	Read Level	Antenna Factor	Path Loss	Preamp Factor	Ant Pos	Table Pos	Peak Avg.	Pol.
1+2		(MHz)	(dBμV/m)	(dB)	(dBμV/m)	(dBμV)	(dB/m)	(dB)	(dB)	(cm)	(deg)	(P/A)	(H/V)
802.11ax HE80 Full CH 106 5530MHz		5420.32	49.99	-24.01	74	37.18	34.52	12.16	33.87	100	337	P	H
		5466.64	50.33	-17.87	68.2	37.19	34.77	12.24	33.87	100	337	P	H
		5457.04	44.46	-9.54	54	31.38	34.73	12.22	33.87	100	337	A	H
	*	5530	91.13	-	-	77.77	34.9	12.34	33.88	100	337	P	H
	*	5530	84.52	-	-	71.16	34.9	12.34	33.88	100	337	A	H
		5738.54	49.98	-18.22	68.2	36.32	35.08	12.51	33.93	100	337	P	H
		5449.12	53.08	-20.92	74	40.05	34.69	12.21	33.87	317	68	P	V
		5466.4	52.81	-15.39	68.2	39.67	34.77	12.24	33.87	317	68	P	V
		5457.28	47.76	-6.24	54	34.68	34.73	12.22	33.87	317	68	A	V
	*	5530	98.15	-	-	84.79	34.9	12.34	33.88	317	68	P	V
	*	5530	93.23	-	-	79.87	34.9	12.34	33.88	317	68	A	V
		5763.74	50.86	-17.34	68.2	37.18	35.1	12.52	33.94	317	68	P	V
802.11ax HE80 Full CH 122 5610MHz		5409.5	49.01	-24.99	74	36.28	34.46	12.15	33.88	100	333	P	H
		5463.75	48.87	-19.33	68.2	35.74	34.76	12.24	33.87	100	333	P	H
		5453.6	43.75	-10.25	54	30.69	34.71	12.22	33.87	100	333	A	H
	*	5610	93.8	-	-	80.34	34.9	12.46	33.9	100	333	P	H
	*	5610	86.29	-	-	72.83	34.9	12.46	33.9	100	333	A	H
		5728.775	50.19	-18.01	68.2	36.55	35.06	12.51	33.93	100	333	P	H
		5400.05	49.33	-24.67	74	36.68	34.4	12.13	33.88	319	67	P	V
		5466.55	49.77	-18.43	68.2	36.63	34.77	12.24	33.87	319	67	P	V
		5459.55	44.01	-9.99	54	30.91	34.74	12.23	33.87	319	67	A	V
	*	5610	100.94	-	-	87.48	34.9	12.46	33.9	319	67	P	V
*	5610	94.47	-	-	81.01	34.9	12.46	33.9	319	67	A	V	
	5743.825	50.39	-17.81	68.2	36.72	35.09	12.51	33.93	319	67	P	V	
Remark	1. No other spurious found. 2. All results are PASS against Peak and Average limit line.												



Band 3 5470~5725MHz

WIFI 802.11ax HE80 Full (Harmonic @ 3m)

WIFI Ant.	Note	Frequency	Level	Margin	Limit Line	Read Level	Antenna Factor	Path Loss	Preamp Factor	Ant Pos	Table Pos	Peak Avg.	Pol.
1+2		(MHz)	(dBμV/m)	(dB)	(dBμV/m)	(dBμV)	(dB/m)	(dB)	(dB)	(cm)	(deg)	(P/A)	(H/V)
802.11ax HE80 Full		11060	45.38	-28.62	74	46.31	37.8	19.24	57.97	-	-	P	H
		16590	47.93	-20.27	68.2	39.38	41.53	23.22	56.2	-	-	P	H
													H
													H
													H
													H
													H
													H
													H
													H
CH 106 5530MHz		11060	46.33	-27.67	74	47.26	37.8	19.24	57.97	-	-	P	V
		16590	48.05	-20.15	68.2	39.5	41.53	23.22	56.2	-	-	P	V
													V
													V
													V
													V
													V
													V
													V
													V



WiFi Ant.	Note	Frequency	Level	Margin	Limit Line	Read Level	Antenna Factor	Path Loss	Preamp Factor	Ant Pos	Table Pos	Peak Avg.	Pol.	
1+2		(MHz)	(dBµV/m)	(dB)	(dBµV/m)	(dBµV)	(dB/m)	(dB)	(dB)	(cm)	(deg)	(P/A)	(H/V)	
802.11ax HE80 Full CH 122 5610MHz		11220	45.96	-28.04	74	46.3	37.9	19.39	57.63	-	-	P	H	
		16830	49.9	-18.3	68.2	40.22	42.13	23.42	55.87	-	-	P	H	
													H	
													H	
													H	
													H	
													H	
													H	
													H	
													H	
													H	
													H	
													H	
													H	
													H	
													H	
													H	
													H	
	802.11ax HE80 Full CH 122 5610MHz		11220	45.67	-28.33	74	46.01	37.9	19.39	57.63	-	-	P	V
			16830	49.11	-19.09	68.2	39.43	42.13	23.42	55.87	-	-	P	V
													V	
													V	
													V	
													V	
													V	
													V	
													V	
													V	
Remark	<ol style="list-style-type: none"> No other spurious found. All results are PASS against Peak and Average limit line. The emission position marked as "-" means no suspected emission found with sufficient margin against limit line or noise floor only. 													



Band 3 - Straddle Channel

WIFI 802.11ax HE20 Full (Band Edge @ 3m)

WIFI Ant. 1+2	Note	Frequency (MHz)	Level (dBμV/m)	Margin (dB)	Limit Line (dBμV/m)	Read Level (dBμV)	Antenna Factor (dB/m)	Path Loss (dB)	Preamp Factor (dB)	Ant Pos (cm)	Table Pos (deg)	Peak Avg. (P/A)	Pol. (H/V)
802.11ax HE20 Full CH 144 5720MHz		5430.34	49.6	-24.4	74	36.71	34.58	12.18	33.87	316	56	P	H
		5467	48.69	-19.51	68.2	35.55	34.77	12.24	33.87	316	56	P	H
		5432.68	42.33	-11.67	54	29.42	34.6	12.18	33.87	316	56	A	H
	*	5720	101.57	-	-	87.96	35.04	12.5	33.93	316	56	P	H
	*	5720	94.91	-	-	81.3	35.04	12.5	33.93	316	56	A	H
		5906.25	52.46	-15.74	68.2	38.51	35.2	12.73	33.98	316	56	P	H
		5432.29	50.55	-23.45	74	37.65	34.59	12.18	33.87	313	311	P	V
		5464.66	50.21	-17.99	68.2	37.08	34.76	12.24	33.87	313	311	P	V
		5447.89	42.78	-11.22	54	29.75	34.69	12.21	33.87	313	311	A	V
	*	5720	108.86	-	-	95.25	35.04	12.5	33.93	313	311	P	V
	*	5720	103.27	-	-	89.66	35.04	12.5	33.93	313	311	A	V
		5910.5	51.97	-16.23	68.2	38.02	35.2	12.73	33.98	313	311	P	V
Remark	1. No other spurious found. 2. All results are PASS against Peak and Average limit line.												



Band 3 - Straddle Channel
WIFI 802.11ax HE20 Full (Harmonic @ 3m)

WIFI Ant.	Note	Frequency	Level	Margin	Limit Line	Read Level	Antenna Factor	Path Loss	Preamp Factor	Ant Pos	Table Pos	Peak Avg.	Pol.	
1+2		(MHz)	(dBµV/m)	(dB)	(dBµV/m)	(dBµV)	(dB/m)	(dB)	(dB)	(cm)	(deg)	(P/A)	(H/V)	
802.11ax HE20 Full CH 144 5720MHz		11440	45.92	-28.08	74	45.34	38.14	19.61	57.17	-	-	P	H	
		17160	50.59	-17.61	68.2	41.06	41.48	23.68	55.63	-	-	P	H	
													H	
													H	
													H	
													H	
													H	
													H	
													H	
													H	
													H	
													H	
													H	
													H	
													H	
													H	
													H	
	802.11ax HE20 Full CH 144 5720MHz		11440	47.13	-26.87	74	46.55	38.14	19.61	57.17	-	-	P	V
			17160	50.67	-17.53	68.2	41.14	41.48	23.68	55.63	-	-	P	V
													V	
													V	
													V	
													V	
													V	
													V	
													V	
													V	
													V	
													V	
													V	

Remark

- No other spurious found.
- All results are PASS against Peak and Average limit line.
- The emission position marked as "-" means no suspected emission found with sufficient margin against limit line or noise floor only.



**Band 3 - Straddle Channel
WIFI 802.11ax HE40 Full (Band Edge @ 3m)**

WIFI Ant. 1+2	Note	Frequency (MHz)	Level (dBμV/m)	Margin (dB)	Limit Line (dBμV/m)	Read Level (dBμV)	Antenna Factor (dB/m)	Path Loss (dB)	Preamp Factor (dB)	Ant Pos (cm)	Table Pos (deg)	Peak Avg. (P/A)	Pol. (H/V)
802.11ax HE40 Full CH 142 5710MHz		5404.6	49.83	-24.17	74	37.14	34.43	12.14	33.88	304	57	P	H
		5468.95	49.77	-18.43	68.2	36.62	34.78	12.24	33.87	304	57	P	H
		5459.2	42.96	-11.04	54	29.86	34.74	12.23	33.87	304	57	A	H
	*	5710	96.46	-	-	82.86	35.02	12.5	33.92	304	57	P	H
	*	5710	89.49	-	-	75.89	35.02	12.5	33.92	304	57	A	H
		5915.25	52.79	-15.41	68.2	38.83	35.2	12.74	33.98	304	57	P	H
		5451.79	49.76	-24.24	74	36.7	34.71	12.22	33.87	275	53	P	V
		5466.22	49.02	-19.18	68.2	35.89	34.76	12.24	33.87	275	53	P	V
		5430.34	43.24	-10.76	54	30.35	34.58	12.18	33.87	275	53	A	V
	*	5710	105.37	-	-	91.77	35.02	12.5	33.92	275	53	P	V
	*	5710	96.82	-	-	83.22	35.02	12.5	33.92	275	53	A	V
		5919.5	52.57	-15.63	68.2	38.6	35.2	12.75	33.98	275	53	P	V
Remark	1. No other spurious found. 2. All results are PASS against Peak and Average limit line.												



Band 3 - Straddle Channel
WIFI 802.11ax HE40 Full (Harmonic @ 3m)

WIFI Ant.	Note	Frequency	Level	Margin	Limit Line	Read Level	Antenna Factor	Path Loss	Preamp Factor	Ant Pos	Table Pos	Peak Avg.	Pol.	
1+2		(MHz)	(dBμV/m)	(dB)	(dBμV/m)	(dBμV)	(dB/m)	(dB)	(dB)	(cm)	(deg)	(P/A)	(H/V)	
802.11ax HE40 Full CH 142 5710MHz		11420	45.75	-28.25	74	45.26	38.12	19.59	57.22	-	-	P	H	
		17130	50.3	-17.9	68.2	40.73	41.54	23.66	55.63	-	-	P	H	
													H	
													H	
													H	
													H	
													H	
													H	
													H	
													H	
													H	
													H	
													H	
													H	
													H	
													H	
													H	
			11420	46.4	-27.6	74	45.91	38.12	19.59	57.22	-	-	P	V
			17130	50.56	-17.64	68.2	40.99	41.54	23.66	55.63	-	-	P	V
													V	
													V	
													V	
													V	
													V	
													V	
													V	
													V	
													V	
													V	
													V	
													V	
Remark	1. No other spurious found. 2. All results are PASS against Peak and Average limit line. 3. The emission position marked as "-" means no suspected emission found with sufficient margin against limit line or noise floor only.													



**Band 3 Straddle Channel
WIFI 802.11ax HE80 Full (Band Edge @ 3m)**

WIFI Ant. 1+2	Note	Frequency (MHz)	Level (dBμV/m)	Margin (dB)	Limit Line (dBμV/m)	Read Level (dBμV)	Antenna Factor (dB/m)	Path Loss (dB)	Preamp Factor (dB)	Ant Pos (cm)	Table Pos (deg)	Peak Avg. (P/A)	Pol. (H/V)
802.11ax HE80 Full CH 138 5690MHz		5424.1	49.78	-24.22	74	36.94	34.54	12.17	33.87	104	336	P	H
		5461.15	50.37	-17.83	68.2	37.27	34.74	12.23	33.87	104	336	P	H
		5440.87	43.11	-10.89	54	30.13	34.65	12.2	33.87	104	336	A	H
	*	5690	92.88	-	-	79.33	34.98	12.49	33.92	104	336	P	H
	*	5690	85.82	-	-	72.27	34.98	12.49	33.92	104	336	A	H
		5938.9	51.96	-16.24	68.2	37.95	35.2	12.79	33.98	104	336	P	H
		5442.43	49.25	-24.75	74	36.27	34.65	12.2	33.87	327	68	P	V
		5470	48.69	-19.51	68.2	35.53	34.78	12.25	33.87	327	68	P	V
		5449.45	43.36	-10.64	54	30.32	34.7	12.21	33.87	327	68	A	V
	*	5690	99.41	-	-	85.86	34.98	12.49	33.92	327	68	P	V
	*	5690	93.7	-	-	80.15	34.98	12.49	33.92	327	68	A	V
		5940.1	51.75	-16.45	68.2	37.74	35.2	12.79	33.98	327	68	P	V
Remark	1. No other spurious found. 2. All results are PASS against Peak and Average limit line.												



Band 3 - Straddle Channel
WIFI 802.11ax HE80 Full (Harmonic @ 3m)

WIFI Ant.	Note	Frequency	Level	Margin	Limit Line	Read Level	Antenna Factor	Path Loss	Preamp Factor	Ant Pos	Table Pos	Peak Avg.	Pol.	
1+2		(MHz)	(dBμV/m)	(dB)	(dBμV/m)	(dBμV)	(dB/m)	(dB)	(dB)	(cm)	(deg)	(P/A)	(H/V)	
802.11ax HE80 Full CH 138 5690MHz		11380	45.58	-28.42	74	45.27	38.06	19.55	57.3	-	-	P	H	
		17070	49.87	-18.33	68.2	40.26	41.63	23.61	55.63	-	-	P	H	
													H	
													H	
													H	
													H	
													H	
													H	
													H	
													H	
													H	
													H	
													H	
													H	
													H	
													H	
	802.11ax HE80 Full CH 138 5690MHz		11380	45.9	-28.1	74	45.59	38.06	19.55	57.3	-	-	P	V
			17070	49.99	-18.21	68.2	40.38	41.63	23.61	55.63	-	-	P	V
													V	
													V	
													V	
													V	
													V	
													V	
													V	
													V	

Remark

- No other spurious found.
- All results are PASS against Peak and Average limit line.
- The emission position marked as "-" means no suspected emission found with sufficient margin against limit line or noise floor only.



Emission below 1GHz

WIFI 802.11ax HE80 Full (LF @ 3m)

WIFI Ant. 1+2	Note	Frequency (MHz)	Level (dBµV/m)	Margin (dB)	Limit Line (dBµV/m)	Read Level (dBµV)	Antenna Factor (dB/m)	Path Loss (dB)	Preamp Factor (dB)	Ant Pos (cm)	Table Pos (deg)	Peak Avg. (P/A)	Pol. (H/V)	
802.11ax HE80 Full LF		49.71	28.76	-11.24	40	42.85	14.46	1.37	29.92	-	-	P	H	
		199.02	33.08	-10.42	43.5	45.43	14.99	2.49	29.83	-	-	P	H	
		215.49	32.24	-11.26	43.5	44.51	15.03	2.53	29.83	-	-	P	H	
		808.9	30.57	-15.43	46	27.19	27.62	5.02	29.26	-	-	P	H	
		878.9	31.9	-14.1	46	26.71	28.88	5.29	28.98	-	-	P	H	
		952.4	33.38	-12.62	46	26.17	30.35	5.52	28.66	-	-	P	H	
														H
														H
														H
														H
														H
														H
			30	33.45	-6.55	40	38.23	24.11	1.05	29.94	-	-	P	V
			49.71	33.78	-6.22	40	47.87	14.46	1.37	29.92	-	-	P	V
			63.21	25.84	-14.16	40	42.54	11.65	1.55	29.9	-	-	P	V
			751.5	30.49	-15.51	46	27.32	27.85	4.79	29.47	-	-	P	V
			839	32.58	-13.42	46	28.27	28.43	5.07	29.19	-	-	P	V
			954.5	33.42	-12.58	46	26.15	30.39	5.52	28.64	-	-	P	V
														V
														V
													V	
													V	
													V	
													V	
Remark	<ol style="list-style-type: none"> No other spurious found. All results are PASS against limit line. The emission position marked as “-” means no suspected emission found and emission level has at least 6dB margin against limit or emission is noise floor only. 													



Note symbol

*	Fundamental Frequency which can be ignored. However, the level of any unwanted emissions shall not exceed the level of the fundamental frequency.
!	Test result is Margin line.
P/A	Peak or Average
H/V	Horizontal or Vertical



A calculation example for radiated spurious emission is shown as below:

WIFI Ant. 1+2	Note	Frequency (MHz)	Level (dBμV/m)	Margin (dB)	Limit Line (dBμV/m)	Read Level (dBμV)	Antenna Factor (dB/m)	Path Loss (dB)	Preamp Factor (dB)	Ant Pos (cm)	Table Pos (deg)	Peak Avg. (P/A)	Pol. (H/V)
802.11a		5150	55.45	-18.55	74	54.51	32.22	4.58	35.86	103	308	P	H
CH 36		5150	43.54	-10.46	54	42.6	32.22	4.58	35.86	103	308	A	H
5180MHz													

1. Path Loss(dB) = Cable loss(dB) + Filter loss(dB) + Attenuator loss(dB)
2. Level(dBμV/m) = Antenna Factor(dB/m) + Path Loss(dB) + Read Level(dBμV) - Preamp Factor(dB)
3. Margin(dB) = Level(dBμV/m) – Limit Line(dBμV/m)

For Peak Limit @ 5150MHz:

1. Level(dBμV/m)
= Antenna Factor(dB/m) + Path Loss(dB) + Read Level(dBμV) - Preamp Factor(dB)
= 32.22(dB/m) + 4.58(dB) + 54.51(dBμV) – 35.86 (dB)
= 55.45 (dBμV/m)
2. Margin(dB)
= Level(dBμV/m) – Limit Line(dBμV/m)
= 55.45(dBμV/m) – 74(dBμV/m)
= -18.55(dB)

For Average Limit @ 5150MHz:

1. Level(dBμV/m)
= Antenna Factor(dB/m) + Path Loss(dB) + Read Level(dBμV) - Preamp Factor(dB)
= 32.22(dB/m) + 4.58(dB) + 42.6(dBμV) – 35.86 (dB)
= 43.54 (dBμV/m)
2. Margin(dB) = Level(dBμV/m) – Limit Line(dBμV/m)
= 43.54(dBμV/m) – 54(dBμV/m)
= -10.46(dB)

Both peak and average measured complies with the limit line, so test result is “PASS”.



Appendix D. Radiated Spurious Emission Plots

Test Engineer :	Jesse Wang, Stan Hsieh and Ken Wu	Temperature :	23.2~27.6°C
		Relative Humidity :	42.5~74%

Remark: For Radiated Spurious Emission Plots Test Data, Internal Ant. 1 means Internal Antenna (Right) and Internal Ant. 2 means Internal Antenna (Left).

Note symbol

-L	Low channel location
-R	High channel location



<Internal Antenna>

<Sample 1>

Band 2 5250~5350MHz
WIFI 802.11ax HE80 Full (Band Edge @ 3m)

WIFI	Band 2 5250~5350MHz Band Edge @ 3m	
ANT	802.11ax HE80 Full CH58 5290MHz - L	
1+2	Horizontal	Fundamental
Peak	<p>Site Condition : 03CH07-HY : PEAK_BE_74 3m HF_ANT_00075962 HORIZONTAL : RBW:1000.000kHz VBW:3000.000kHz SWTA:Auto</p>	<p>Site Condition : 03CH07-HY : PEAK(LIN1) 3m HF_ANT_00075962 HORIZONTAL : RBW:1000.000kHz VBW:3000.000kHz SWTA:Auto</p>
Avg.	<p>Site Condition : 03CH07-HY : AVG_BE_54 3m HF_ANT_00075962 HORIZONTAL : RBW:1000.000kHz VBW:3.100kHz SWTA:Auto</p>	<p>Site Condition : 03CH07-HY : AVG_54 3m HF_ANT_00075962 HORIZONTAL : RBW:1000.000kHz VBW:10.000kHz SWTA:Auto</p>



WIFI	Band 2 5250~5350MHz Band Edge @ 3m	
ANT	802.11ax HE80 Full CH58 5290MHz - R	
1+2	Horizontal	Fundamental
Peak	<p>Site : 03CHK7-HY Condition : PEAK_BE_74 3m HF ANT_00070962 HORIZONTAL : RBW:1000.000kHz VBW:3000.000kHz SWT:Auto</p>	Left blank
Avg.	<p>Site : 03CHK7-HY Condition : AVG_BE_54 3m HF ANT_00070962 HORIZONTAL : RBW:1000.000kHz VBW:3.000kHz SWT:Auto</p>	Left blank



WIFI	Band 2 5250~5350MHz Band Edge @ 3m	
ANT	802.11ax HE80 Full CH58 5290MHz - L	
1+2	Vertical	Fundamental
Peak	<p>Site Condition : 03CH07-HY : PEAK_BE_74 3m HF_ANT_00075962 VERTICAL : RBW:1000.000kHz VBW:3000.000kHz SWT:Auto</p>	<p>Site Condition : 03CH07-HY : PEAK(LNB) 3m HF_ANT_00075962 VERTICAL : RBW:1000.000kHz VBW:3000.000kHz SWT:Auto</p>
Avg.	<p>Site Condition : 03CH07-HY : AVG_BE_54 3m HF_ANT_00075962 VERTICAL : RBW:1000.000kHz VBW:3.000kHz SWT:Auto</p>	<p>Site Condition : 03CH07-HY : AVG_54 3m HF_ANT_00075962 VERTICAL : RBW:1000.000kHz VBW:10.000kHz SWT:Auto</p>

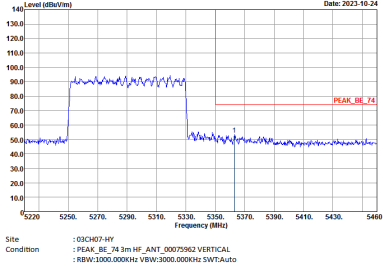
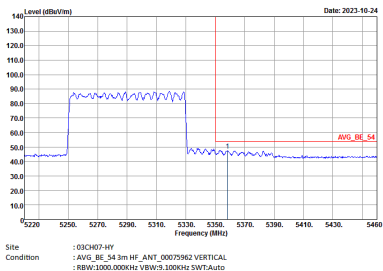

WIFI	Band 2 5250~5350MHz Band Edge @ 3m	
ANT	802.11ax HE80 Full CH58 5290MHz - R	
1+2	Vertical	Fundamental
Peak		Left blank
Avg.		Left blank



Band 2 5250~5350MHz
WIFI 802.11ax HE80 Full (Harmonic @ 3m)

Table with 2 columns: Horizontal and Vertical. Rows include: WIFI (Band 2 5250~5350MHz Harmonic @ 3m), ANT (802.11ax HE80 Full CH58 5290MHz), 1+2 (Peak, Avg.), and two spectral plots (Horizontal and Vertical) showing Level (dBm/1m) vs Frequency (MHz) with Peak and Avg. markers.



Emission below 1GHz
5GHz WIFI 802.11ax HE80 Full (LF)

WIFI	5GHz WIFI	
ANT	802.11ax HE80 Full LF	
1+2	Horizontal	Vertical
QP / Peak	<p>Site : 03C807-HY Condition : QP 3m LF-ANT-35413(6) HORIZONTAL</p>	<p>Site : 03C807-HY Condition : QP 3m LF-ANT-35413(6) VERTICAL</p>



<Sample 2>

Band 1 - 5150~5250MHz
WIFI 802.11a (Band Edge @ 3m)

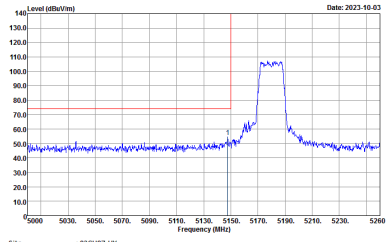
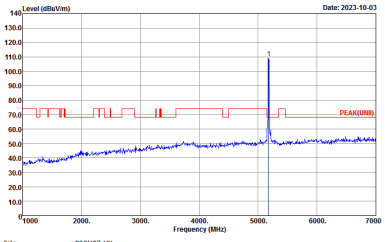
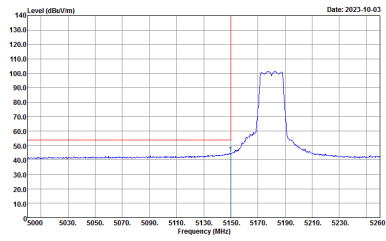
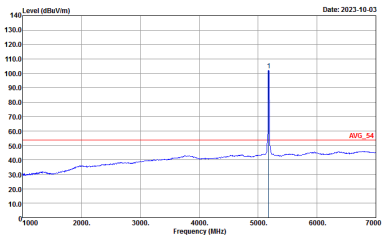
WIFI	Band 1 5150~5250MHz Band Edge @ 3m	
ANT	802.11a CH36 5180MHz	
1	Horizontal	Fundamental
Peak	 <p>Site Condition : 03CH07-HY : PEAK_BE_34 3m HF_ANT_00075962 HORIZONTAL : RBW:1000.000kHz VBW:3000.000kHz SWT:Auto</p>	 <p>Site Condition : 03CH07-HY : PEAK(FUN)1 3m HF_ANT_00075962 HORIZONTAL : RBW:1000.000kHz VBW:3000.000kHz SWT:Auto</p>
Avg.	 <p>Site Condition : 03CH07-HY : AVG_BE_34 3m HF_ANT_00075962 HORIZONTAL : RBW:1000.000kHz VBW:3.000kHz SWT:Auto</p>	 <p>Site Condition : 03CH07-HY : AVG_34 3m HF_ANT_00075962 HORIZONTAL : RBW:1000.000kHz VBW:3.000kHz SWT:Auto</p>

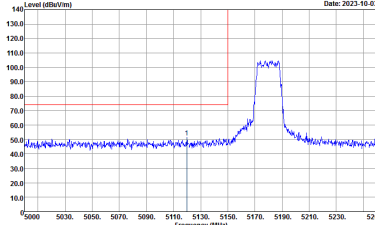
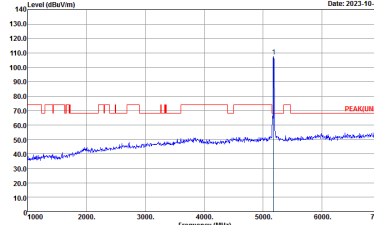
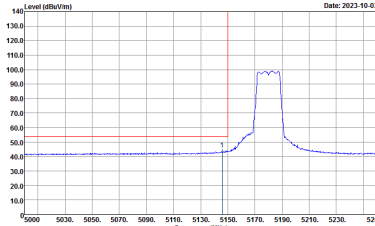
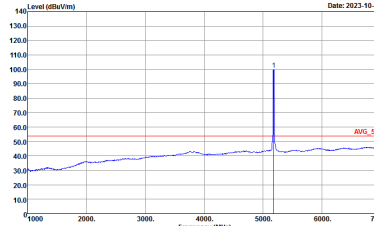

WIFI	Band 1 5150~5250MHz Band Edge @ 3m	
ANT	802.11a CH36 5180MHz	
1	Vertical	Fundamental
Peak	 <p>Site Condition : 03CH07-HY : PEAK_BE_74 3m HF_ANT_00075962 VERTICAL : RBW:1000.000kHz VBW:3000.000kHz SWT:Auto</p>	 <p>Site Condition : 03CH07-HY : PEAK(LIN)1 3m HF_ANT_00075962 VERTICAL : RBW:1000.000kHz VBW:3000.000kHz SWT:Auto</p>
Avg.	 <p>Site Condition : 03CH07-HY : AVG_BE_54 3m HF_ANT_00075962 VERTICAL : RBW:1000.000kHz VBW:3.000kHz SWT:Auto</p>	 <p>Site Condition : 03CH07-HY : AVG_54 3m HF_ANT_00075962 VERTICAL : RBW:1000.000kHz VBW:3.000kHz SWT:Auto</p>

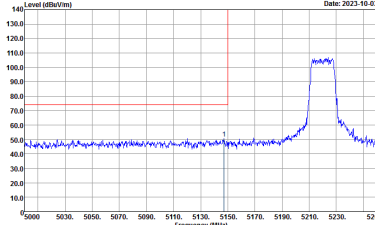
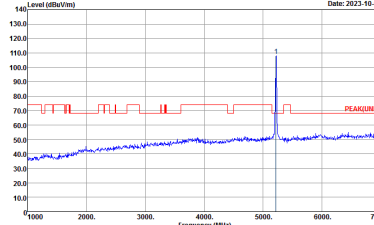
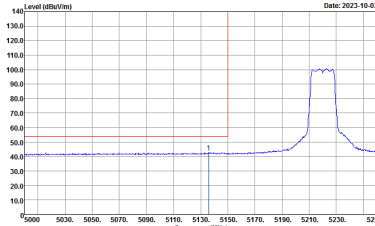
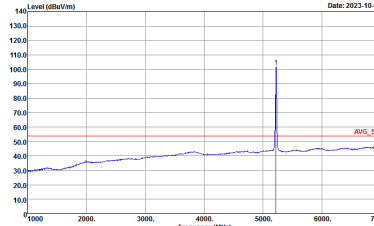

WIFI	Band 1 5150~5250MHz Band Edge @ 3m	
ANT	802.11a CH44 5220MHz - L	
1	Horizontal	Fundamental
Peak	 <p>Site : 03CH07-HY Condition : : PEAK_BE_74 3m HF_ANT_00075962 HORIZONTAL : RBW:1000.000kHz VBW:3000.000kHz SWT:Auto</p>	 <p>Site : 03CH07-HY Condition : : PEAK(FUN1) 3m HF_ANT_00075962 HORIZONTAL : RBW:1000.000kHz VBW:3000.000kHz SWT:Auto</p>
Avg.	 <p>Site : 03CH07-HY Condition : : AVG_BE_54 3m HF_ANT_00075962 HORIZONTAL : RBW:1000.000kHz VBW:3.000kHz SWT:Auto</p>	 <p>Site : 03CH07-HY Condition : : AVG_54 3m HF_ANT_00075962 HORIZONTAL : RBW:1000.000kHz VBW:3.000kHz SWT:Auto</p>

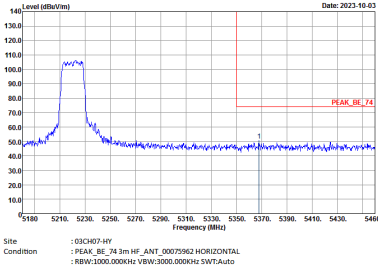
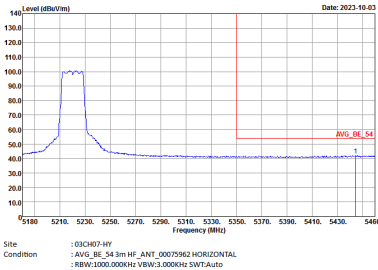

WIFI	Band 1 5150~5250MHz Band Edge @ 3m	
ANT	802.11a CH44 5220MHz - R	
1	Horizontal	Fundamental
Peak		Left blank
Avg.		Left blank

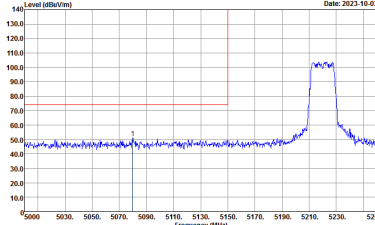
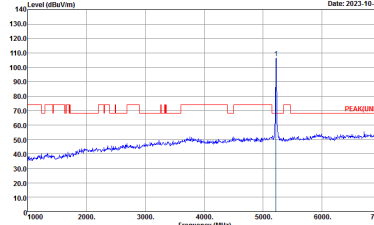
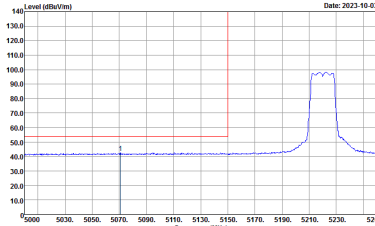
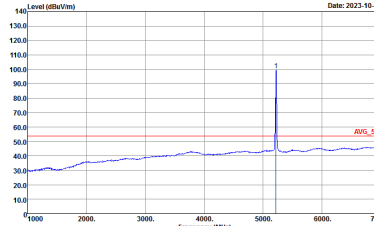

WIFI	Band 1 5150~5250MHz Band Edge @ 3m	
ANT	802.11a CH44 5220MHz - L	
1	Vertical	Fundamental
Peak	 <p>Site : 03CH07-HY Condition : : PEAK_BE_74 3m HF_ANT_00075962 VERTICAL : RBW:1000.000kHz VBW:3000.000kHz SWT:Auto</p>	 <p>Site : 03CH07-HY Condition : : PEAK(LIN)1 3m HF_ANT_00075962 VERTICAL : RBW:1000.000kHz VBW:3000.000kHz SWT:Auto</p>
Avg.	 <p>Site : 03CH07-HY Condition : : AVG_BE_54 3m HF_ANT_00075962 VERTICAL : RBW:1000.000kHz VBW:3.000kHz SWT:Auto</p>	 <p>Site : 03CH07-HY Condition : : AVG_54 3m HF_ANT_00075962 VERTICAL : RBW:1000.000kHz VBW:3.000kHz SWT:Auto</p>

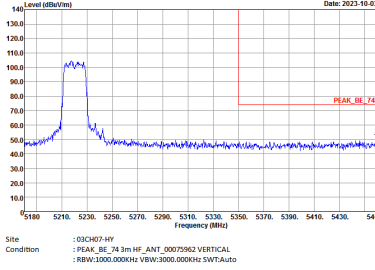
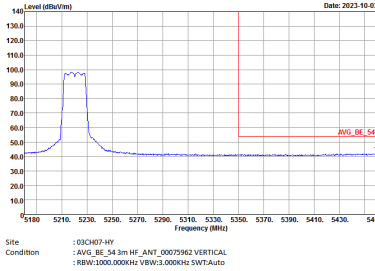

WIFI	Band 1 5150~5250MHz Band Edge @ 3m	
ANT	802.11a CH44 5220MHz - R	
1	Vertical	Fundamental
Peak		Left blank
Avg.		Left blank

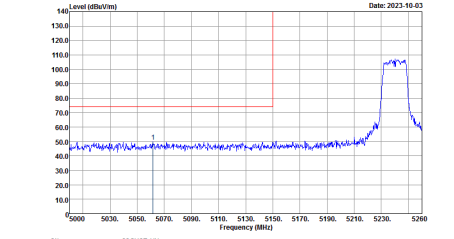
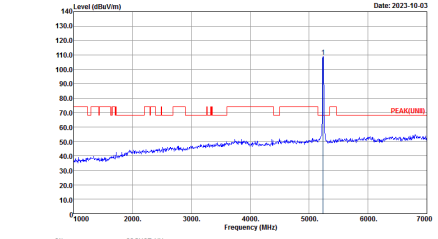
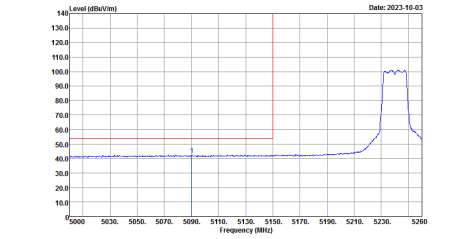
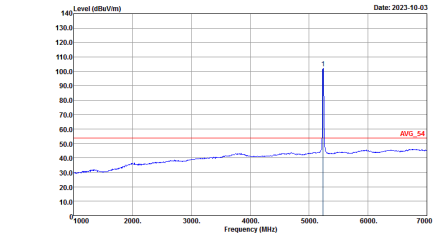

WIFI	Band 1 5150~5250MHz Band Edge @ 3m	
ANT	802.11a CH48 5240MHz - L	
1	Horizontal	Fundamental
Peak	 <p>Site : 03CH07-HY Condition : PEAK_BE_74 3m HF_ANT_00075962 HORIZONTAL : RBW:1000.000kHz VBW:3000.000kHz SWT:Auto</p>	 <p>Site : 03CH07-HY Condition : PEAK(LIN)1 3m HF_ANT_00075962 HORIZONTAL : RBW:1000.000kHz VBW:3000.000kHz SWT:Auto</p>
Avg.	 <p>Site : 03CH07-HY Condition : AVG_BE_54 3m HF_ANT_00075962 HORIZONTAL : RBW:1000.000kHz VBW:3.000kHz SWT:Auto</p>	 <p>Site : 03CH07-HY Condition : AVG_54 3m HF_ANT_00075962 HORIZONTAL : RBW:1000.000kHz VBW:3.000kHz SWT:Auto</p>

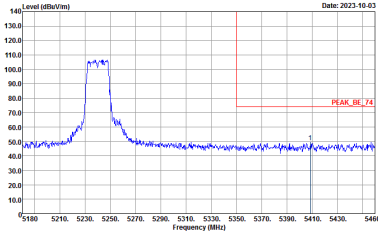
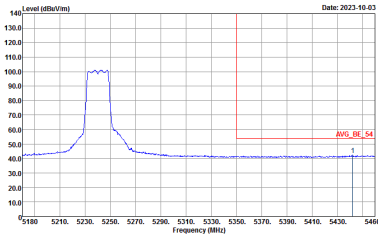

WIFI	Band 1 5150~5250MHz Band Edge @ 3m	
ANT	802.11a CH48 5240MHz - R	
1	Horizontal	Fundamental
Peak	 <p>Site : 03CHK7-HY Condition : : PEAK_BE_74 3m HF ANT_00070962 HORIZONTAL : RBW:1000.000kHz VBW:3000.000kHz SWT:Auto</p>	Left blank
Avg.	 <p>Site : 03CHK7-HY Condition : : AVG_BE_54 3m HF ANT_00070962 HORIZONTAL : RBW:1000.000kHz VBW:3.000kHz SWT:Auto</p>	Left blank



WIFI	Band 1 5150~5250MHz Band Edge @ 3m	
ANT	802.11a CH48 5240MHz - L	
1	Vertical	Fundamental
Peak	<p>Site : 03CH07-HY Condition : PEAK_BE_74 3m HF_ANT_00075962 VERTICAL : RBW:1000.000kHz VBW:3000.000kHz SWT:Auto</p>	<p>Site : 03CH07-HY Condition : PEAK(LIN)1 3m HF_ANT_00075962 VERTICAL : RBW:1000.000kHz VBW:3000.000kHz SWT:Auto</p>
Avg.	<p>Site : 03CH07-HY Condition : AVG_BE_54 3m HF_ANT_00075962 VERTICAL : RBW:1000.000kHz VBW:3.000kHz SWT:Auto</p>	<p>Site : 03CH07-HY Condition : AVG_54 3m HF_ANT_00075962 VERTICAL : RBW:1000.000kHz VBW:3.000kHz SWT:Auto</p>

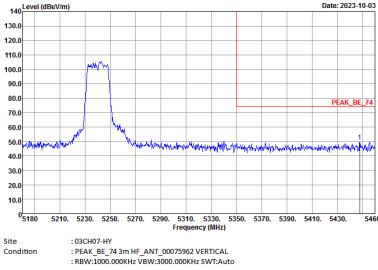
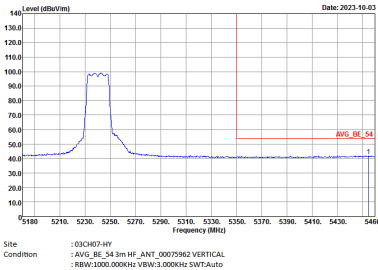

WIFI	Band 1 5150~5250MHz Band Edge @ 3m	
ANT	802.11a CH48 5240MHz - R	
1	Vertical	Fundamental
Peak		Left blank
Avg.		Left blank



Band 1 - 5150~5250MHz
WIFI 802.11a (Harmonic @ 3m)

WIFI	Band 1 5150~5250MHz Harmonic @ 3m	
ANT	802.11a CH36 5180MHz	
1	Horizontal	Vertical
Peak Avg.	<p>Site : 09C807-HY Condition : :PEAK(UWB) 3m HF_ANT_00075962 HORIZONTAL :</p>	<p>Site : 09C807-HY Condition : :PEAK(UWB) 3m HF_ANT_00075962 VERTICAL :</p>

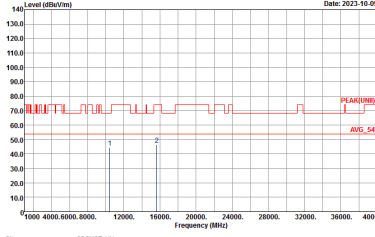
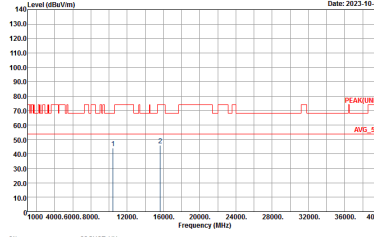

WIFI	Band 1 5150~5250MHz Harmonic @ 3m	
ANT	802.11a CH44 5220MHz	
1	Horizontal	Vertical
Peak Avg.	 <p>Site : 03C2407-477 Condition : : PEAK(AVG) 3m HE_ANT_00075962 HORIZONTAL :</p>	 <p>Site : 03C2407-477 Condition : : PEAK(AVG) 3m HE_ANT_00075962 VERTICAL :</p>



WIFI	Band 1 5150~5250MHz Harmonic @ 3m	
ANT	802.11a CH48 5240MHz	
1	Horizontal	Vertical
Peak Avg.	<p>Site : 03C2407-477 Condition : : PEAK(AVG) 3m HE_ANT_00075962 HORIZONTAL :</p>	<p>Site : 03C2407-477 Condition : : PEAK(AVG) 3m HE_ANT_00075962 VERTICAL :</p>



Band 2 - 5250~5350MHz
WIFI 802.11a (Band Edge @ 3m)

WIFI	Band 2 5250~5350MHz Band Edge @ 3m	
ANT	802.11a CH52 5260MHz - L	
1	Horizontal	Fundamental
Peak	<p>Site : 03CH07-HY Condition : PEAK_BE_74 3m HF_ANT_00075962 HORIZONTAL : RBW:1000.000kHz VBW:3000.000kHz SWT:Auto</p>	<p>Site : 03CH07-HY Condition : PEAK(LNB) 3m HF_ANT_00075962 HORIZONTAL : RBW:1000.000kHz VBW:3000.000kHz SWT:Auto</p>
Avg.	<p>Site : 03CH07-HY Condition : AVG_BE_54 3m HF_ANT_00075962 HORIZONTAL : RBW:1000.000kHz VBW:3.000kHz SWT:Auto</p>	<p>Site : 03CH07-HY Condition : AVG_54 3m HF_ANT_00075962 HORIZONTAL : RBW:1000.000kHz VBW:3.000kHz SWT:Auto</p>



WIFI	Band 2 5250~5350MHz Band Edge @ 3m	
ANT	802.11a CH52 5260MHz - R	
1	Horizontal	Fundamental
Peak		Left blank
Avg.		Left blank

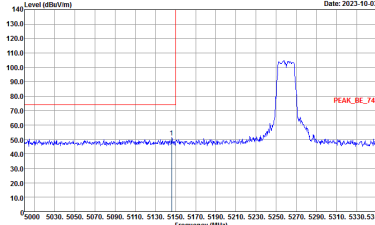
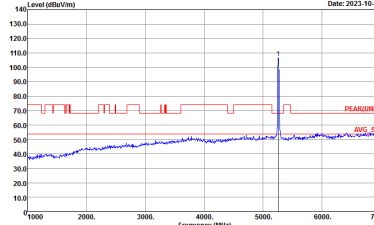
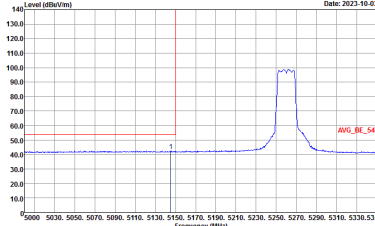
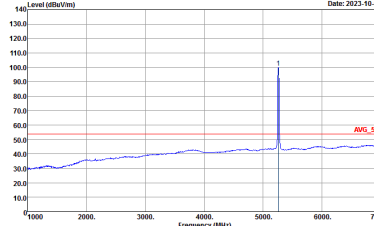

WIFI	Band 2 5250~5350MHz Band Edge @ 3m	
ANT	802.11a CH52 5260MHz - L	
1	Vertical	Fundamental
Peak	 <p>Site : 03CH07-HY Condition : : PEAK_BE_74 3m HF_ANT_00075962 VERTICAL : RBW:1000.000kHz VBW:3000.000kHz SWT:Auto</p>	 <p>Site : 03CH07-HY Condition : : PEAK(LIN)1 3m HF_ANT_00075962 VERTICAL : RBW:1000.000kHz VBW:3000.000kHz SWT:Auto</p>
Avg.	 <p>Site : 03CH07-HY Condition : : AVG_BE_54 3m HF_ANT_00075962 VERTICAL : RBW:1000.000kHz VBW:3.000kHz SWT:Auto</p>	 <p>Site : 03CH07-HY Condition : : AVG_54 3m HF_ANT_00075962 VERTICAL : RBW:1000.000kHz VBW:3.000kHz SWT:Auto</p>

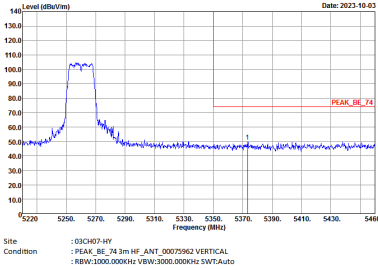
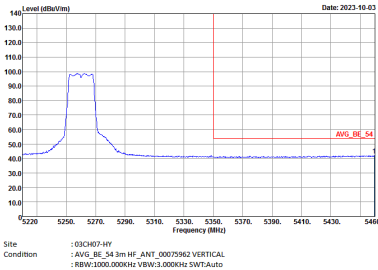

WIFI	Band 2 5250~5350MHz Band Edge @ 3m	
ANT	802.11a CH52 5260MHz - R	
1	Vertical	Fundamental
Peak		Left blank
Avg.		Left blank

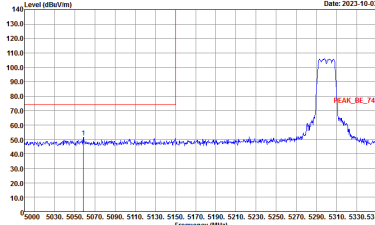
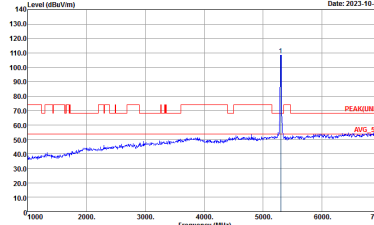
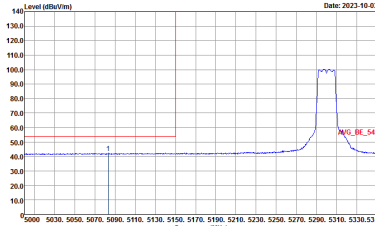
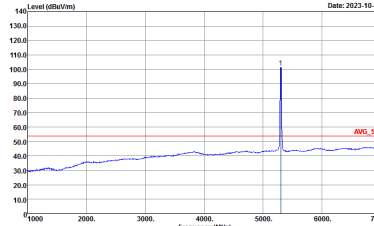

WIFI	Band 2 5250~5350MHz Band Edge @ 3m	
ANT	802.11a CH60 5300MHz - L	
1	Horizontal	Fundamental
Peak	 <p>Site Condition : 03CH07-HY : PEAK_BE_74 3m HF_ANT_00075962 HORIZONTAL : RBW:1000.000kHz VBW:3000.000kHz SWT:Auto</p>	 <p>Site Condition : 03CH07-HY : PEAK_LNB1 3m HF_ANT_00075962 HORIZONTAL : RBW:1000.000kHz VBW:3000.000kHz SWT:Auto</p>
Avg.	 <p>Site Condition : 03CH07-HY : AVG_BE_54 3m HF_ANT_00075962 HORIZONTAL : RBW:1000.000kHz VBW:3.000kHz SWT:Auto</p>	 <p>Site Condition : 03CH07-HY : AVG_54 3m HF_ANT_00075962 HORIZONTAL : RBW:1000.000kHz VBW:3.000kHz SWT:Auto</p>



WIFI	Band 2 5250~5350MHz Band Edge @ 3m	
ANT	802.11a CH60 5300MHz - R	
1	Horizontal	Fundamental
Peak	<p>Site : 03CHK7-HY Condition : PEAK_BE_74 3m HF ANT_00070962 HORIZONTAL : RBW:1000.000kHz VBW:3000.000kHz SWT:Auto</p>	Left blank
Avg.	<p>Site : 03CHK7-HY Condition : AVG_BE_54 3m HF ANT_00070962 HORIZONTAL : RBW:1000.000kHz VBW:3.000kHz SWT:Auto</p>	Left blank



WIFI	Band 2 5250~5350MHz Band Edge @ 3m	
ANT	802.11a CH60 5300MHz - L	
1	Vertical	Fundamental
Peak	<p>Site Condition : 03CH07-HY : PEAK_BE_74 3m HF_ANT_00075962 VERTICAL : RBW:1000.000kHz VBW:3000.000kHz SWT:Auto</p>	<p>Site Condition : 03CH07-HY : PEAK(LIN)1 3m HF_ANT_00075962 VERTICAL : RBW:1000.000kHz VBW:3000.000kHz SWT:Auto</p>
Avg.	<p>Site Condition : 03CH07-HY : AVG_BE_54 3m HF_ANT_00075962 VERTICAL : RBW:1000.000kHz VBW:3.000kHz SWT:Auto</p>	<p>Site Condition : 03CH07-HY : AVG_54 3m HF_ANT_00075962 VERTICAL : RBW:1000.000kHz VBW:3.000kHz SWT:Auto</p>

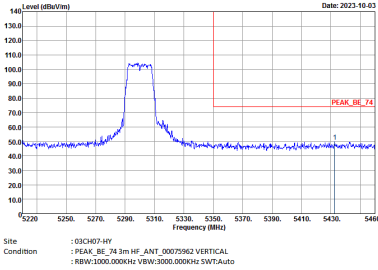
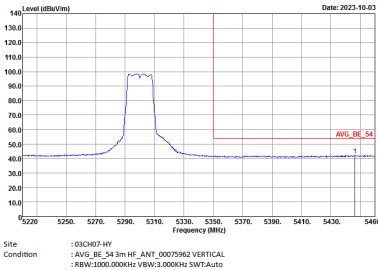

WIFI	Band 2 5250~5350MHz Band Edge @ 3m	
ANT	802.11a CH60 5300MHz - R	
1	Vertical	Fundamental
Peak		Left blank
Avg.		Left blank

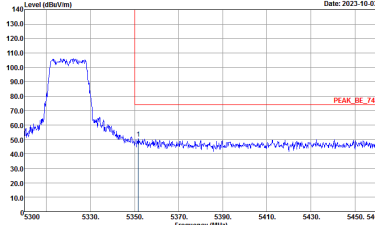
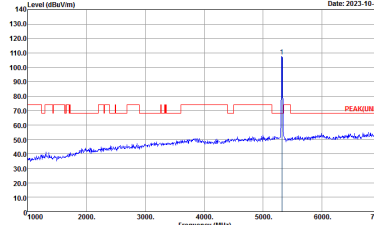
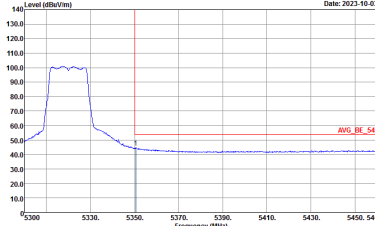
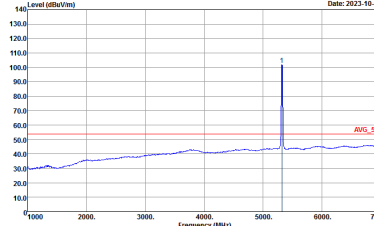

WIFI	Band 2 5250~5350MHz Band Edge @ 3m	
ANT	802.11a CH64 5320MHz	
1	Horizontal	Fundamental
Peak	 <p>Site : 03CH07-HY Condition : : PEAK_BE_74 3m HF_ANT_00075962 HORIZONTAL : RBW:1000.000kHz VBW:3000.000kHz SWT:Auto</p>	 <p>Site : 03CH07-HY Condition : : PEAK(LIN)I 3m HF_ANT_00075962 HORIZONTAL : RBW:1000.000kHz VBW:3000.000kHz SWT:Auto</p>
Avg.	 <p>Site : 03CH07-HY Condition : : AVG_BE_54 3m HF_ANT_00075962 HORIZONTAL : RBW:1000.000kHz VBW:3.000kHz SWT:Auto</p>	 <p>Site : 03CH07-HY Condition : : AVG_54 3m HF_ANT_00075962 HORIZONTAL : RBW:1000.000kHz VBW:3.000kHz SWT:Auto</p>



WIFI	Band 2 5250~5350MHz Band Edge @ 3m	
ANT	802.11a CH64 5320MHz	
1	Vertical	Fundamental
Peak	<p>Site Condition : 03CH07-HY : PEAK_BE_74 3m HF_ANT_00075962 VERTICAL : RBW:1000.000kHz VBW:3000.000kHz SWT:Auto</p>	<p>Site Condition : 03CH07-HY : PEAKFUNB 3m HF_ANT_00075962 VERTICAL : RBW:1000.000kHz VBW:3000.000kHz SWT:Auto</p>
Avg.	<p>Site Condition : 03CH07-HY : AVG_BE_54 3m HF_ANT_00075962 VERTICAL : RBW:1000.000kHz VBW:3.000kHz SWT:Auto</p>	<p>Site Condition : 03CH07-HY : AVG_54 3m HF_ANT_00075962 VERTICAL : RBW:1000.000kHz VBW:3.000kHz SWT:Auto</p>



Band 2 - 5250~5350MHz
WIFI 802.11a (Harmonic @ 3m)

WIFI	Band 2 5250~5350MHz Harmonic @ 3m	
ANT	802.11a CH52 5260MHz	
1	Horizontal	Vertical
Peak Avg.	<p>Site : 09C407-HY Condition : :PEAK(UWB) 3m HF_ANT_00075962 HORIZONTAL :</p>	<p>Site : 09C407-HY Condition : :PEAK(UWB) 3m HF_ANT_00075962 VERTICAL :</p>



WIFI	Band 2 5250~5350MHz Harmonic @ 3m	
ANT	802.11a CH60 5300MHz	
1	Horizontal	Vertical
Peak Avg.	<p>Site : 03C3627-477 Condition : : PEAK(AVG) 3m HE_ANT_00075962 HORIZONTAL :</p>	<p>Site : 03C3627-477 Condition : : PEAK(AVG) 3m HE_ANT_00075962 VERTICAL :</p>



WIFI	Band 2 5250~5350MHz Harmonic @ 3m	
ANT	802.11a CH64 5320MHz	
1	Horizontal	Vertical
Peak Avg.	<p>Site : 032402-HY Condition : PEAK(AVG) 3m HE_ANT_00075962 HORIZONTAL</p>	<p>Site : 032402-HY Condition : PEAK(AVG) 3m HE_ANT_00075962 VERTICAL</p>

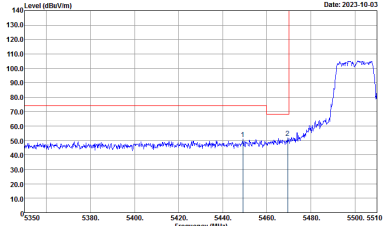
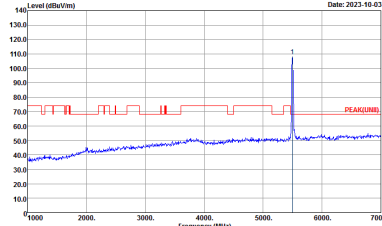
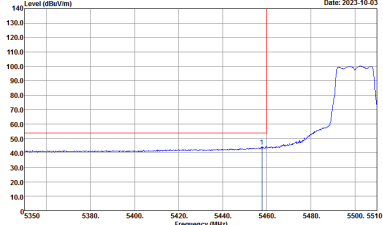
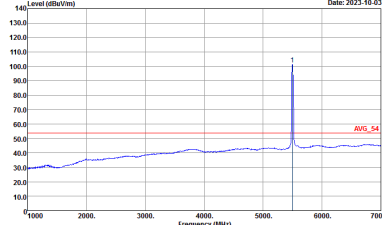

Band 3 - 5470~5725MHz
WIFI 802.11a (Band Edge @ 3m)

WIFI	Band 3 5470~5725MHz Band Edge @ 3m	
ANT	802.11a CH100 5500MHz	
1	Horizontal	Fundamental
Peak	 <p>Site : 03CH07-HY Condition : PEAK_BE(LN11)_B3 3m HF_ANT_00075962 HORIZONTAL : RBW:1000.000kHz; VBW:3000.000kHz; SWT:Auto</p>	 <p>Site : 03CH07-HY Condition : PEAK(LN11)_3m HF_ANT_00075962 HORIZONTAL : RBW:1000.000kHz; VBW:3000.000kHz; SWT:Auto</p>
Avg.	 <p>Site : 03CH07-HY Condition : AVG_BE(LN11)_B3 3m HF_ANT_00075962 HORIZONTAL : RBW:1000.000kHz; VBW:3.000kHz; SWT:Auto</p>	 <p>Site : 03CH07-HY Condition : AVG_34 3m HF_ANT_00075962 HORIZONTAL : RBW:1000.000kHz; VBW:3.000kHz; SWT:Auto</p>

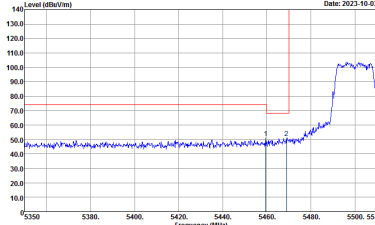
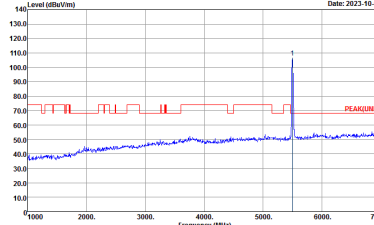
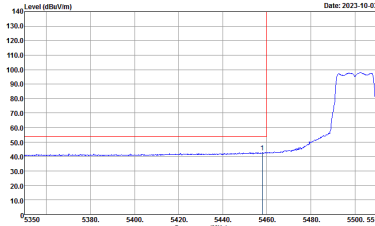
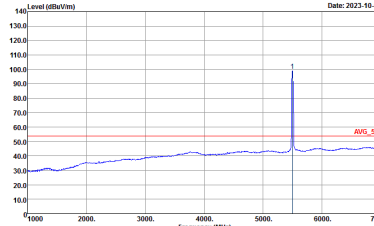

WIFI	Band 3 5470~5725MHz Band Edge @ 3m	
ANT	802.11a CH100 5500MHz	
1	Vertical	Fundamental
Peak	 <p>Site : 03CH07-HY Condition : PEAK_BE(LN11)_B3 3m HF_ANT_00075962 VERTICAL : RBW:1000.000kHz VBW:3000.000kHz SWT:Auto</p>	 <p>Site : 03CH07-HY Condition : PEAK(LN11)_3m HF_ANT_00075962 VERTICAL : RBW:1000.000kHz VBW:3000.000kHz SWT:Auto</p>
Avg.	 <p>Site : 03CH07-HY Condition : AVG_BE(LN11)_B3 3m HF_ANT_00075962 VERTICAL : RBW:1000.000kHz VBW:3.000kHz SWT:Auto</p>	 <p>Site : 03CH07-HY Condition : AVG_S4 3m HF_ANT_00075962 VERTICAL : RBW:1000.000kHz VBW:3.000kHz SWT:Auto</p>