



FCC RADIO TEST REPORT

FCC ID : UZ7FXR9001
Equipment : INDUSTRIAL FIXED RFID READER
Brand Name : ZEBRA
Model Name : FXR9001
Applicant : Zebra Technologies Corporation
1 Zebra Plaza, Holtsville, NY 11742
Manufacturer : Zebra Technologies Corporation
1 Zebra Plaza, Holtsville, NY 11742
Standard : FCC Part 15 Subpart C §15.247

The product was received on Aug. 16, 2023 and testing was performed from Sep. 14, 2023 to Nov. 01, 2023. We, Sporton International Inc. EMC & Wireless Communications Laboratory, would like to declare that the tested sample has been evaluated in accordance with the test procedures and has been in compliance with the applicable technical standards.

The test results in this report apply exclusively to the tested model / sample. Without written approval from Sporton International Inc. EMC & Wireless Communications Laboratory, the test report shall not be reproduced except in full.

Louis Wu

Approved by: Louis Wu

Sporton International Inc. EMC & Wireless Communications Laboratory
No. 52, Huaya 1st Rd., Guishan Dist., Taoyuan City 333, Taiwan (R.O.C.)



Table of Contents

History of this test report.....	3
Summary of Test Result.....	4
1 General Description.....	5
1.1 Product Feature of Equipment Under Test.....	5
1.2 Product Specification of Equipment Under Test.....	8
1.3 Modification of EUT	8
1.4 Testing Location	9
1.5 Applicable Standards.....	9
2 Test Configuration of Equipment Under Test.....	10
2.1 Carrier Frequency Channel	10
2.2 Test Mode.....	11
2.3 Connection Diagram of Test System.....	13
2.4 Support Unit used in test configuration and system	14
2.5 EUT Operation Test Setup	15
2.6 Measurement Results Explanation Example.....	15
3 Test Result.....	16
3.1 Number of Channel Measurement	16
3.2 Hopping Channel Separation Measurement	17
3.3 Dwell Time Measurement.....	18
3.4 20dB and 99% Bandwidth Measurement	19
3.5 Output Power Measurement.....	20
3.6 Conducted Band Edges Measurement.....	21
3.7 Conducted Spurious Emission Measurement	22
3.8 Radiated Band Edges and Spurious Emission Measurement	23
3.9 AC Conducted Emission Measurement.....	27
3.10 Antenna Requirements.....	29
4 List of Measuring Equipment	30
5 Measurement Uncertainty	32
Appendix A. Conducted Test Results	
Appendix B. AC Conducted Emission Test Result	
Appendix C. Radiated Spurious Emission	
Appendix D. Radiated Spurious Emission Plots	
Appendix E. Duty Cycle Plots	
Appendix F. Setup Photographs	



Summary of Test Result

Report Clause	Ref Std. Clause	Test Items	Result (PASS/FAIL)	Remark
3.1	15.247(a)(1)	Number of Channels	Pass	-
3.2	15.247(a)(1)	Hopping Channel Separation	Pass	-
3.3	15.247(a)(1)	Dwell Time of Each Channel	Pass	-
3.4	15.247(a)(1)	20dB Bandwidth	Pass	-
3.4	2.1049	99% Occupied Bandwidth	Reporting only	-
3.5	15.247(b)(1) 15.247(b)(4)	Peak Output Power	Pass	-
3.6	15.247(d)	Conducted Band Edges	Pass	-
3.7	15.247(d)	Conducted Spurious Emission	Pass	-
3.8	15.247(d)	Radiated Band Edges and Radiated Spurious Emission	Pass	7.96 dB under the limit at 30.00 MHz
3.9	15.207	AC Conducted Emission	Pass	25.05 dB under the limit at 0.17 MHz
3.10	15.203	Antenna Requirement	Pass	-

Conformity Assessment Condition:

1. The test results (PASS/FAIL) with all measurement uncertainty excluded are presented against the regulation limits or in accordance with the requirements stipulated by the applicant/manufacturer who shall bear all the risks of non-compliance that may potentially occur if measurement uncertainty is taken into account.
2. The measurement uncertainty please refer to each test result in the section "Measurement Uncertainty".

Disclaimer:

The product specifications of the EUT presented in the test report that may affect the test assessments are declared by the manufacturer who shall take full responsibility for the authenticity.

Reviewed by: Wei Chen
Report Producer: Michelle Chen



1 General Description

1.1 Product Feature of Equipment Under Test

Product Feature	
Equipment	INDUSTRIAL FIXED RFID READER
Brand Name	ZEBRA
Model Name	FXR9001
Sample 1	FXR90011-400000-WR 4+1 Port & Bolt-on: BT, WLAN
Sample 2	FXR90010-800000-WR 8-Port: BT, WLAN
Sample 3	FXR90010-400000-WR 4-Port: BT, WLAN
FCC ID	UZ7FXR9001
EUT supports Radios application	RFID WLAN 11a/b/g/n HT20/HT40 WLAN 11ac VHT20/VHT40/VHT80 WLAN 11ax HE20/HE40/HE80 Bluetooth BR/EDR/LE
HW Version	EV2
SW Version	0.4.11
MFD	01AUG23
EUT Stage	Identical Prototype

Remark: The EUT's information above is declared by manufacturer.

Supported Unit Used in Test Configuration and System				
Cable, 3-way USB Splitter	Brand Name	ZEBRA	Model Name	ADP-USB0010-M12
Cable, USB-C Host, 5ft.	Brand Name	ZEBRA	Model Name	CBL-USBCHST015-M12
Cable, USB-C Host, 15ft.	Brand Name	ZEBRA	Model Name	CBL-USBCHST035-M12
Cable, USB-C Client, 5ft.	Brand Name	ZEBRA	Model Name	CBL-USBCCLT015-M12
Cable, USB-C Client, 15ft.	Brand Name	ZEBRA	Model Name	CBL-USBCCLT035-M12
Cable, USB-A Client, 5ft.	Brand Name	ZEBRA	Model Name	CBL-USBACLT015-M12
Cable, USB-A Client, 15ft.	Brand Name	ZEBRA	Model Name	CBL-USBACLT035-M12
Cable, GPIO	Brand Name	ZEBRA	Model Name	CBL-GP0050-M12M12A
Cable, 12V (Cigarette Lighter) Power Adapter, 3.5 meter	Brand Name	ZEBRA	Model Name	CBL-PWRD035-M12CL
Cable, DC Power Cord (Flying Leads), 3.5m	Brand Name	ZEBRA	Model Name	CBL-PWRD035-M1200
Cable, DC Power Cord (Flying Leads), 10m	Brand Name	ZEBRA	Model Name	CBL-PWRD100-M1200
Cable, Power Supply Output Adapter, 3.5m	Brand Name	ZEBRA	Model Name	CBL-PWRD035-M12M12
Cable, Power Supply Output Adapter, 10m	Brand Name	ZEBRA	Model Name	CBL-PWRD100-M12M12



Supported Unit Used in Test Configuration and System				
Cable, DC-DC Power Supply Input	Brand Name	ZEBRA	Model Name	CBL-PWRD150-M12M00
Cable, AC-DC Power Supply Input (Flying Leads)	Brand Name	ZEBRA	Model Name	CBL-PWRA150-M1200
Cable, AC-DC Power Supply Input (IEC plug)	Brand Name	ZEBRA	Model Name	CBL-PWRA035-M12IEC
CBL: RF, N STR PLUG TO RP-TNC STR PLUG ON LMR-240, 68", IP67 Sealed	Brand Name	ZEBRA	Model Name	CBLRD-3B4000680R
CBL: RF, N STR PLUG TO RP-TNC STR PLUG ON LMR-240, 180", IP67 Sealed	Brand Name	ZEBRA	Model Name	CBLRD-3B4001800R
CBL: RF, N STR PLUG TO RP-TNC STR PLUG ON LMR-240, 240", IP67 Sealed	Brand Name	ZEBRA	Model Name	CBLRD-3B4002400R
CBL: RF, N STR PLUG TO RP-TNC STR PLUG ON LMR-240, 360", IP67 Sealed	Brand Name	ZEBRA	Model Name	CBLRD-3B4003600R
CBL: RF, N STR PLUG TO RP-TNC STR PLUG ON LMR-240, 68", IP67 Sealed	Brand Name	ZEBRA	Model Name	CBLRD-1B4000680R
CBL: RF, N STR PLUG TO RP-TNC STR PLUG ON LMR-240, 180", IP67 Sealed	Brand Name	ZEBRA	Model Name	CBLRD-1B4001800R
CBL: RF, N STR PLUG TO RP-TNC STR PLUG ON LMR-240, 240", IP67 Sealed	Brand Name	ZEBRA	Model Name	CBLRD-1B4002400R
CBL: RF, N STR PLUG TO RP-TNC STR PLUG ON LMR-240, 360", IP67 Sealed	Brand Name	ZEBRA	Model Name	CBLRD-1B4003600R
CHIMERA ETHERNET CABLE 5M	Brand Name	ZEBRA	Model Name	CBL-ENT00500-M1200
CHIMERA ETHERNET CABLE 15M	Brand Name	ZEBRA	Model Name	CBL-ENT01500-M1200
Outdoor AC-DC PSU	Brand Name	ZEBRA	Model Name	PWR-BGA24V90W0WW (Spec PD-007875-01)
Forklift DC-DC PSU	Brand Name	ZEBRA	Model Name	PWR-BGA24V90W1WW (Spec PD-007876-01)
Indoor AC-DC PSU	Brand Name	ZEBRA	Model Name	PWR-BGA24V78W3WW (Spec PD-007877-01)
PoE adaptor	Brand Name	ZEBRA	Model Name	PD-9001GR/AT/AC



Supported Unit Used in Test Configuration and System				
External RFID Antenna	Brand Name	ZEBRA	Model Name	AN480
External RFID Antenna	Brand Name	ZEBRA	Model Name	AN650
External RFID Antenna	Brand Name	ZEBRA	Model Name	SR5502
External RFID Antenna	Brand Name	ZEBRA	Model Name	AN510
External RFID Antenna	Brand Name	ZEBRA	Model Name	AN520
External RFID Antenna	Brand Name	ZEBRA	Model Name	AN610
External RFID Antenna	Brand Name	ZEBRA	Model Name	AN620
External RFID Antenna	Brand Name	ZEBRA	Model Name	AN720
External RFID Antenna	Brand Name	ZEBRA	Model Name	AN440
External RFID Antenna	Brand Name	ZEBRA	Model Name	SP5504
BT/WLAN_ External Antenna	Brand Name	Amphenol	Model Name	ST0228-30-502-A
BT/WLAN_ External Antenna	Brand Name	Amphenol	Model Name	ZB511A-02-001-C
AN650 Antenna cable(5ft/1524mm)	Brand Name	ZEBRA	Model Name	CBLRD-1C4000600R
AN650 Antenna cable(20ft/6096mm)	Brand Name	ZEBRA	Model Name	CBLRD-1C4002400R
AN650 Antenna cable(15ft/4572mm)	Brand Name	ZEBRA	Model Name	CBLRD-1C4001800R
AN650 Antenna cable(30ft/9144mm)	Brand Name	ZEBRA	Model Name	CBLRD-1C4003600R
AN650 Antenna cable(10ft/3048mm)	Brand Name	ZEBRA	Model Name	CBLRD-1C4001200R



1.2 Product Specification of Equipment Under Test

Product Specification is subject to this standard	
Tx/Rx Frequency Range	2402 MHz ~ 2480 MHz
Number of Channels	79
Carrier Frequency of Each Channel	2402+n*1 MHz; n=0~78
Maximum Output Power to Antenna	<Internal Antenna> Bluetooth BR (1Mbps): 10.46 dBm (0.111 W) Bluetooth EDR (2Mbps): 9.63 dBm (0.092 W) Bluetooth EDR (3Mbps): 9.85 dBm (0.097 W)
99% Occupied Bandwidth	<Internal Antenna> Bluetooth BR (1Mbps): 0.855 MHz Bluetooth EDR (2Mbps): 1.165 MHz Bluetooth EDR (3Mbps): 1.157 MHz
Antenna Type / Gain	<Internal Antenna> PIFA Antenna with gain 4.02 dBi <External Antenna 1> Dipole Antenna with gain 2.98 dBi <External Antenna 2> Dipole Antenna with gain 3.59 dBi
Type of Modulation	Bluetooth BR (1Mbps) : GFSK Bluetooth EDR (2Mbps) : $\pi/4$ -DQPSK Bluetooth EDR (3Mbps) : 8-DPSK

Remark: The above EUT's information was declared by manufacturer. Please refer to Disclaimer in report summary.

1.3 Modification of EUT

No modifications made to the EUT during the testing.



1.4 Testing Location

Test Site	Sporton International Inc. EMC & Wireless Communications Laboratory
Test Site Location	No.52, Huaya 1st Rd., Guishan Dist., Taoyuan City 333, Taiwan (R.O.C.) TEL: +886-3-327-3456 FAX: +886-3-328-4978
Test Site No.	Sporton Site No. CO05-HY, 03CH07-HY

Note: The test site complies with ANSI C63.4 2014 requirement.

Test Site	Sporton International Inc. Wensan Laboratory
Test Site Location	No.58, Aly. 75, Ln. 564, Wenhua 3rd, Rd., Guishan Dist., Taoyuan City 333010, Taiwan (R.O.C.) TEL: +886-3-327-0868 FAX: +886-3-327-0855
Test Site No.	Sporton Site No. TH05-HY (TAF Code: 3786)
Remark	The Conducted test item subcontracted to Sporton International Inc. Wensan Laboratory.

FCC designation No.: TW1190 and TW3786

1.5 Applicable Standards

According to the specifications declared by the manufacturer, the EUT must comply with the requirements of the following standards:

- ♦ FCC Part 15 Subpart C §15.247
- ♦ FCC KDB Publication No. 558074 D01 15.247 Meas Guidance v05r02
- ♦ FCC KDB 414788 D01 Radiated Test Site v01r01
- ♦ ANSI C63.10-2013

Remark:

1. All the test items were validated and recorded in accordance with the standards without any modification during the testing.
2. The TAF code is not including all the FCC KDB listed without accreditation.
3. This EUT has also been tested and complied with the requirements of FCC Part 15, Subpart B, recorded in a separate test report.



2 Test Configuration of Equipment Under Test

2.1 Carrier Frequency Channel

Frequency Band	Channel	Freq. (MHz)	Channel	Freq. (MHz)	Channel	Freq. (MHz)
2400-2483.5 MHz	0	2402	27	2429	54	2456
	1	2403	28	2430	55	2457
	2	2404	29	2431	56	2458
	3	2405	30	2432	57	2459
	4	2406	31	2433	58	2460
	5	2407	32	2434	59	2461
	6	2408	33	2435	60	2462
	7	2409	34	2436	61	2463
	8	2410	35	2437	62	2464
	9	2411	36	2438	63	2465
	10	2412	37	2439	64	2466
	11	2413	38	2440	65	2467
	12	2414	39	2441	66	2468
	13	2415	40	2442	67	2469
	14	2416	41	2443	68	2470
	15	2417	42	2444	69	2471
	16	2418	43	2445	70	2472
	17	2419	44	2446	71	2473
	18	2420	45	2447	72	2474
	19	2421	46	2448	73	2475
	20	2422	47	2449	74	2476
	21	2423	48	2450	75	2477
	22	2424	49	2451	76	2478
	23	2425	50	2452	77	2479
	24	2426	51	2453	78	2480
	25	2427	52	2454	-	-
	26	2428	53	2455	-	-



2.2 Test Mode

- a. The EUT has been associated with peripherals and configuration operated in a manner tended to maximize its emission characteristics in a typical application. Frequency range investigated: conduction emission (150 kHz to 30 MHz), radiation emission (9 kHz to the 10th harmonic of the highest fundamental frequency or to 40 GHz, whichever is lower). For radiated measurement, the measured emission level of the EUT was maximized by rotating the EUT on a turntable, adjusting the orientation of the EUT and EUT antenna in three orthogonal axis (X: flat, Y: portrait, Z: landscape) for Internal Antenna, two Antenna Degree, Ant. Horizontal and Ant. Vertical for External Antenna, and adjusting the measurement antenna orientation, following C63.10 exploratory test procedures and only the worst plane, and the worst mode of radiated spurious emissions is Bluetooth 1Mbps mode, and recorded in this report.

- b. AC power line Conducted Emission was tested under maximum output power.



The following summary table is showing all test modes to demonstrate in compliance with the standard.

Summary table of Test Cases			
Test Item	Data Rate / Modulation		
Conducted Test Cases	Bluetooth BR 1Mbps GFSK	Bluetooth EDR 2Mbps $\pi/4$-DQPSK	Bluetooth EDR 3Mbps 8-DPSK
	Mode 1: CH00_2402 MHz	Mode 4: CH00_2402 MHz	Mode 7: CH00_2402 MHz
	Mode 2: CH39_2441 MHz	Mode 5: CH39_2441 MHz	Mode 8: CH39_2441 MHz
	Mode 3: CH78_2480 MHz	Mode 6: CH78_2480 MHz	Mode 9: CH78_2480 MHz
Radiated Test Cases	Bluetooth BR 1Mbps GFSK		
	<Sample 2>		
	<Internal Antenna>		
	Mode 1: CH00_2402 MHz		
	Mode 2: CH39_2441 MHz		
	Mode 3: CH78_2480 MHz		
	<External Antenna>		
Mode 1: CH00_2402 MHz			
Mode 2: CH39_2441 MHz			
Mode 3: CH78_2480 MHz			
AC Conducted Emission	Mode 1 : WLAN (2.4GHz) Link + Bluetooth Link + RFID Link + ADP-USB0010-M12 (3-way USB Splitter) (2) + CBL-GP0050-M12M12A, 5m (GPIO Extension) (7) + CBL-PWRD035-M12M12, 3.5 meter (16) + PWR-BGA24V90W0WW (Outdoor AC-DC PSU) (28) + CBL-PWRA035-M12IEC (22) +CBL-USBCHST015-M12, 1.5m (3) load with USB Flash Drive + CBL-ENT01500-M1200,15M (27) (Data Link with Notebook) + CBL-USBCHST035-M12, 3.5m (23) load with USB Flash Drive + CBL-USBACLT035-M12, 3.5m (24) load with Notebook for Sample 1		
Remark:			
1. For Radiated Test Cases, the worst mode data rate 1Mbps was reported only since the highest RF output power in the preliminary tests. The conducted spurious emissions and conducted band edge measurement for other data rates were not worse than 1Mbps, and no other significantly frequencies found in conducted spurious emission.			
2. Data Link with Notebook means data application transferred mode between EUT and Notebook.			

2.3 Connection Diagram of Test System

<AC Conducted Emission Mode>

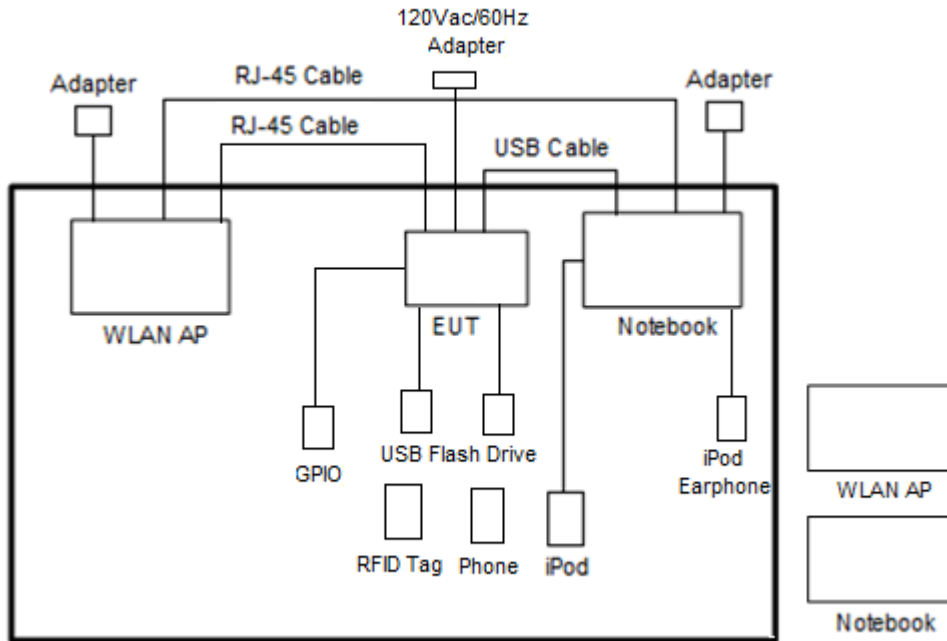

<Bluetooth Tx Mode for Internal Antenna>

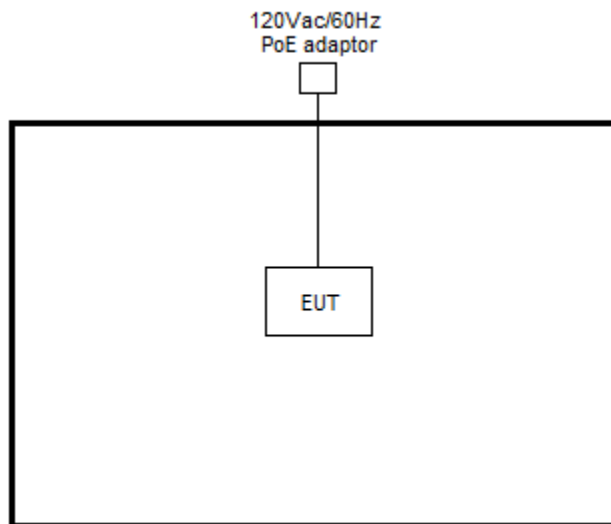

<Bluetooth Tx Mode for External Antenna>

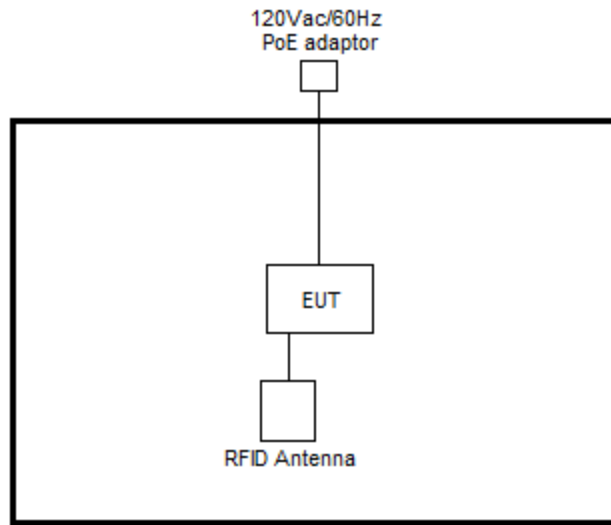

2.4 Support Unit used in test configuration and system

Item	Equipment	Brand Name	Model Name	FCC ID	Data Cable	Power Cord
1.	WLAN AP	ASUS	RT-AC66U	MSQ-RTAC66U	N/A	Unshielded, 1.8 m
2.	Notebook	Dell	Latitude 3420	FCC DoC	N/A	AC I/P: Unshielded, 1.2 m DC O/P: Shielded, 1.8 m
3.	iPod	Apple	A1285	DoC	Shielded, 1.0m	N/A
4.	iPod Earphone	Apple	N/A	Verification	Unshielded, 1.0 m	N/A
5.	Phone	ZEBRA	TC26	N/A	N/A	N/A
6.	USB Flash Drive	SanDisk	E8BOC	N/A	N/A	N/A



2.5 EUT Operation Test Setup

The RF test items, utility “Tera Term Version 4.95” was installed in Notebook which was programmed in order to make the EUT get into the engineering modes to provide channel selection, power level, data rate and the application type and for continuous transmitting signals.

2.6 Measurement Results Explanation Example

For all conducted test items:

The offset level is set in the spectrum analyzer to compensate the RF cable loss and attenuator factor between EUT conducted output port and spectrum analyzer. With the offset compensation, the spectrum analyzer reading level is exactly the EUT RF output level.

Example:

The spectrum analyzer offset is derived from RF cable loss and attenuator factor.

Offset = RF cable loss + attenuator factor.

Following shows an offset computation example with cable loss 4.2 dB and 10 dB attenuator.

$$\begin{aligned} \text{Offset(dB)} &= \text{RF cable loss(dB)} + \text{attenuator factor(dB)}. \\ &= 4.2 + 10 = 14.2 \text{ (dB)} \end{aligned}$$

3 Test Result

3.1 Number of Channel Measurement

3.1.1 Limits of Number of Hopping Frequency

Frequency hopping systems in the 2400-2483.5 MHz band shall use at least 15 channels.

3.1.2 Measuring Instruments

Please refer to the measuring equipment list in this test report.

3.1.3 Test Procedure

1. The testing follows ANSI C63.10-2013 clause 7.8.3.
2. The RF output of EUT is connected to the spectrum analyzer by RF cable and attenuator. The path loss is compensated to the results for each measurement.
3. Set the maximum power setting and enable the EUT to transmit continuously.
4. Enable the EUT hopping function.
5. Use the following spectrum analyzer settings: Span = the frequency band of operation; RBW = 300 kHz; VBW \geq RBW; Sweep = auto; Detector function = peak; Trace = max hold.
6. The number of hopping frequency used is defined as the number of total channel.
7. Record the measurement data derived from spectrum analyzer.

3.1.4 Test Setup

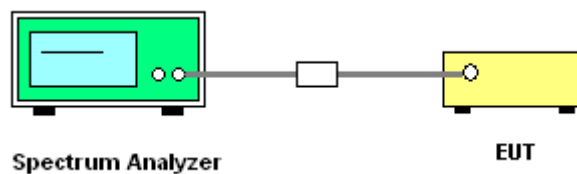

3.1.5 Test Result of Number of Hopping Frequency

Please refer to Appendix A.

3.2 Hopping Channel Separation Measurement

3.2.1 Limit of Hopping Channel Separation

Frequency hopping systems operating in the 2400-2483.5 MHz band may have hopping channel carrier frequencies that are separated by 25 kHz or two-thirds of the 20 dB bandwidth of the hopping channel, whichever is greater.

3.2.2 Measuring Instruments

Please refer to the measuring equipment list in this test report.

3.2.3 Test Procedures

1. The testing follows ANSI C63.10-2013 clause 7.8.2.
2. The RF output of EUT is connected to the spectrum analyzer by RF cable and attenuator. The path loss is compensated to the results for each measurement.
3. Set the maximum power setting and enable the EUT to transmit continuously.
4. Enable the EUT hopping function.
5. Use the following spectrum analyzer settings:
Span = wide enough to capture the peaks of two adjacent channels;
RBW = 300 kHz; VBW \geq RBW; Sweep = auto; Detector function = peak; Trace = max hold.
6. Measure and record the results in the test report.

3.2.4 Test Setup

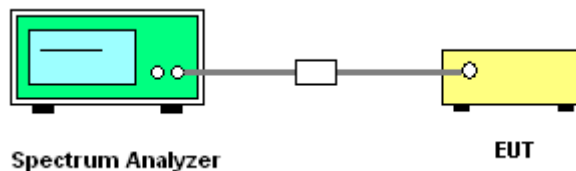

3.2.5 Test Result of Hopping Channel Separation

Please refer to Appendix A.

3.3 Dwell Time Measurement

3.3.1 Limit of Dwell Time

The average time of occupancy on any channel shall not be greater than 0.4 seconds within a period of 0.4 seconds multiplied by the number of hopping channels employed.

3.3.2 Measuring Instruments

Please refer to the measuring equipment list in this test report.

3.3.3 Test Procedures

1. The testing follows ANSI C63.10-2013 clause 7.8.4.
2. The RF output of EUT is connected to the spectrum analyzer by RF cable and attenuator. The path loss is compensated to the results for each measurement.
3. Set the maximum power setting and enable the EUT to transmit continuously.
4. Enable the EUT hopping function.
5. Use the following spectrum analyzer settings: Span = zero span, centered on a hopping channel; RBW = 1 MHz; VBW \geq RBW; Sweep = as necessary to capture the entire dwell time per hopping channel; Detector function = peak; Trace = max hold.
6. Measure and record the results in the test report.

3.3.4 Test Setup

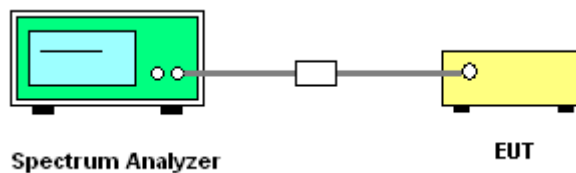

3.3.5 Test Result of Dwell Time

Please refer to Appendix A.

3.4 20dB and 99% Bandwidth Measurement

3.4.1 Limit of 20dB and 99% Bandwidth

Reporting only

3.4.2 Measuring Instruments

Please refer to the measuring equipment list in this test report.

3.4.3 Test Procedures

1. The testing follows ANSI C63.10-2013 clause 6.9.2 and 6.9.3.
2. The RF output of EUT is connected to the spectrum analyzer by RF cable and attenuator. The path loss is compensated to the results for each measurement.
3. Set the maximum power setting and enable the EUT to transmit continuously.
4. Use the following spectrum analyzer settings for 20 dB Bandwidth measurement.
Span = approximately 2 to 5 times the 20 dB bandwidth, centered on a hopping channel;
RBW \geq 1% of the 20 dB bandwidth; VBW \geq RBW; Sweep = auto; Detector function = peak;
Trace = max hold.
5. Use the following spectrum analyzer settings for 99 % Bandwidth measurement.
Span = approximately 1.5 to 5 times the 99% bandwidth, centered on a hopping channel;
RBW \geq 1-5% of the 99% bandwidth; VBW \geq 3 * RBW; Sweep = auto; Detector function = peak;
Trace = max hold.
6. Measure and record the results in the test report.

3.4.4 Test Setup

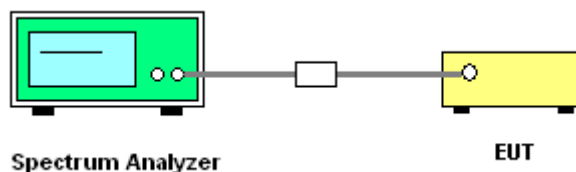

3.4.5 Test Result of 20dB Bandwidth

Please refer to Appendix A.

3.4.6 Test Result of 99% Occupied Bandwidth

Please refer to Appendix A.

3.5 Output Power Measurement

3.5.1 Limit of Output Power

The maximum peak conducted output power of the intentional radiator shall not exceed the following:
For frequency hopping systems operating in the 2400-2483.5 MHz band employing at least 75 non-overlapping hopping channels, and all frequency hopping systems in the 5725-5850 MHz band: 1 watt. For all other frequency hopping systems in the 2400-2483.5 MHz band 0.125 watts.
If directional gain of transmitting antennas is greater than 6 dBi, the power shall be reduced by the same level in dB comparing to gain minus 6 dBi.

3.5.2 Measuring Instruments

Please refer to the measuring equipment list in this test report.

3.5.3 Test Procedures

1. The testing follows ANSI C63.10-2013 clause 7.8.5.
2. The RF output of EUT is connected to the power meter by RF cable and attenuator. The path loss is compensated to the results for each measurement.
3. Set the maximum power setting and enable the EUT to transmit continuously.
4. Measure the conducted output power with cable loss and record the results in the test report.
5. Measure and record the results in the test report.

3.5.4 Test Setup

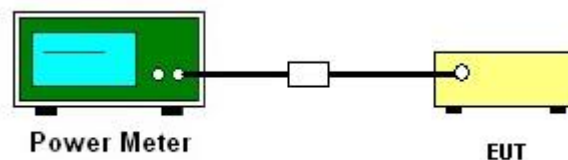

3.5.5 Test Result of Peak Output Power

Please refer to Appendix A.

3.5.6 Test Result of Average Output Power (Reporting Only)

Please refer to Appendix A.

3.6 Conducted Band Edges Measurement

3.6.1 Limit of Band Edges

In any 100 kHz bandwidth outside the intentional radiation frequency band, the radio frequency power shall be at least 20 dB below the highest level of the radiated power. In addition, radiated emissions which fall in the restricted bands must also comply with the radiated emission limits.

3.6.2 Measuring Instruments

Please refer to the measuring equipment list in this test report.

3.6.3 Test Procedures

1. The testing follows ANSI C63.10-2013 clause 7.8.6.
2. Set the maximum power setting and enable the EUT to transmit continuously.
3. Set RBW = 100 kHz, VBW = 300 kHz. Band edge emissions must be at least 20 dB down from the highest emission level within the authorized band as measured with a 100 kHz RBW. The attenuation shall be 30 dB instead of 20 dB when RMS conducted output power procedure is used.
4. Enable hopping function of the EUT and then repeat step 2 and 3.
5. Measure and record the results in the test report.

3.6.4 Test Setup

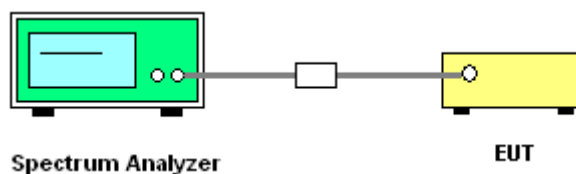

3.6.5 Test Result of Conducted Band Edges

Please refer to Appendix A.

3.6.6 Test Result of Conducted Hopping Mode Band Edges

Please refer to Appendix A.

3.7 Conducted Spurious Emission Measurement

3.7.1 Limit of Spurious Emission Measurement

In any 100 kHz bandwidth outside the intentional radiation frequency band, the radio frequency power shall be at least 20 dB below the highest level of the radiated power. In addition, radiated emissions which fall in the restricted bands must also comply with the radiated emission limits.

3.7.2 Measuring Instruments

Please refer to the measuring equipment list in this test report.

3.7.3 Test Procedure

1. The testing follows ANSI C63.10-2013 clause 7.8.8.
2. The RF output of EUT is connected to the spectrum analyzer by RF cable and attenuator. The path loss is compensated to the results for each measurement.
3. Set the maximum power setting and enable the EUT to transmit continuously.
4. Set RBW = 100 kHz, VBW = 300 kHz, scan up through 10th harmonic. All harmonics / spurious must be at least 20 dB down from the highest emission level within the authorized band as measured with a 100 kHz RBW.
5. Measure and record the results in the test report.
6. The RF fundamental frequency should be excluded against the limit line in the operating frequency band.

3.7.4 Test Setup



3.7.5 Test Result of Conducted Spurious Emission

Please refer to Appendix A.



3.8 Radiated Band Edges and Spurious Emission Measurement

3.8.1 Limit of Radiated Band Edges and Spurious Emission

In any 100 kHz bandwidth outside the intentional radiator frequency band, all harmonics / spurious must be at least 20 dB below the highest emission level within the authorized band. In addition, radiated emissions which fall in the restricted bands must also comply with the limits as below.

Frequency (MHz)	Field Strength (microvolts/meter)	Measurement Distance (meters)
0.009 – 0.490	2400/F(kHz)	300
0.490 – 1.705	24000/F(kHz)	30
1.705 – 30.0	30	30
30 – 88	100	3
88 – 216	150	3
216 - 960	200	3
Above 960	500	3

3.8.2 Measuring Instruments

Please refer to the measuring equipment list in this test report.

**3.8.3 Test Procedures**

1. The EUT is placed on a turntable with 0.8 meter for frequency below 1 GHz and 1.5 meter for frequency above 1 GHz respectively above ground.
2. The EUT is set 3 meters away from the receiving antenna, which is mounted on the top of a variable height antenna tower.
3. For each suspected emission, the EUT is arranged to its worst case and then tune the Antenna tower (from 1 m to 4 m) and turntable (from 0 degree to 360 degrees) to find the maximum reading. A pre-amp and a high pass filter are used for the test in order to get better signal level to comply with the guidelines.
4. Set the maximum power setting and enable the EUT to transmit continuously.
5. Use the following spectrum analyzer settings:
 - (1) Span shall wide enough to fully capture the emission being measured;
 - (2) Set RBW = 100 kHz for $f < 1$ GHz, RBW = 1 MHz for $f > 1$ GHz ; VBW \geq RBW; Sweep = auto; Detector function = peak; Trace = max hold for peak
 - (3) For average measurement: use duty cycle correction factor method per 15.35(c).
Duty cycle = On time/100 milliseconds
On time = $N_1 * L_1 + N_2 * L_2 + \dots + N_{n-1} * L_{n-1} + N_n * L_n$
Where N_1 is number of type 1 pulses, L_1 is length of type 1 pulses, etc.
Average Emission Level = Peak Emission Level + $20 * \log$ (Duty cycle)
6. Corrected Reading: Antenna Factor + Cable Loss + Read Level - Preamp Factor = Level
7. Radiated testing below 1 GHz is performed by adjusting the antenna tower from 1 m to 4 m and by rotating the turn table from 0 degree to 360 degrees to find the peak maximum hold reading. When there is no suspected emission found and the emission level is with at least 6 dB margin against QP limit line, the position is marked as “-“.
8. Radiated testing above 1 GHz is performed by adjusting the antenna tower from 1 m to 4 m and by rotating the turn table from 0 degree to 360 degrees to find the peak maximum hold reading for scanning all frequencies. When there is no suspected emission found and the harmonic emission level is with at least 6 dB margin against average limit line, the position is marked as “-“.

Note: The average levels are calculated from the peak level corrected with duty cycle correction factor (-24.76dB) derived from $20 \log$ (dwell time/100ms). This correction is only for signals that hop with the fundamental signal, such as band-edge and harmonic. Other spurious signals that are independent of the hopping signal would not use this correction.

3.8.4 Test Setup

For radiated test below 30MHz

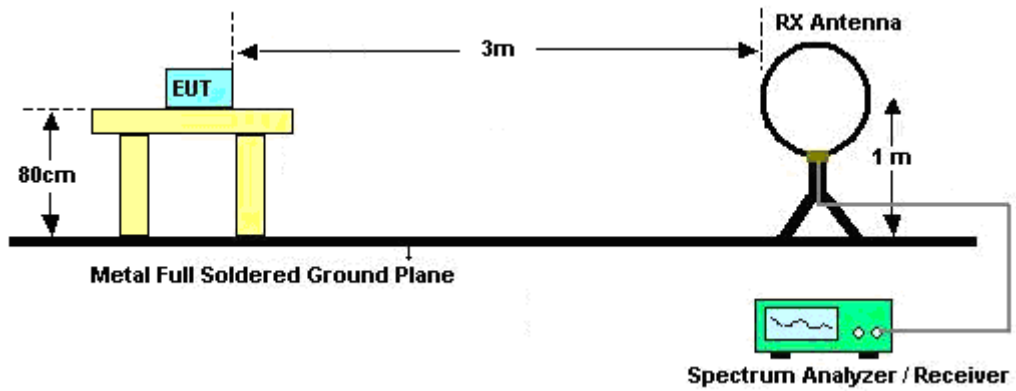

For radiated test from 30MHz to 1GHz

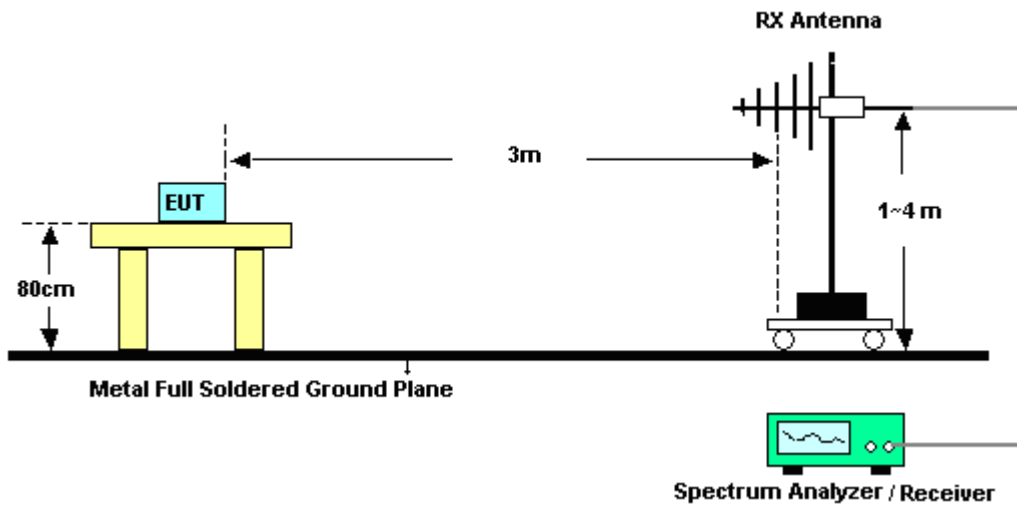

For radiated test from 1GHz to 18GHz

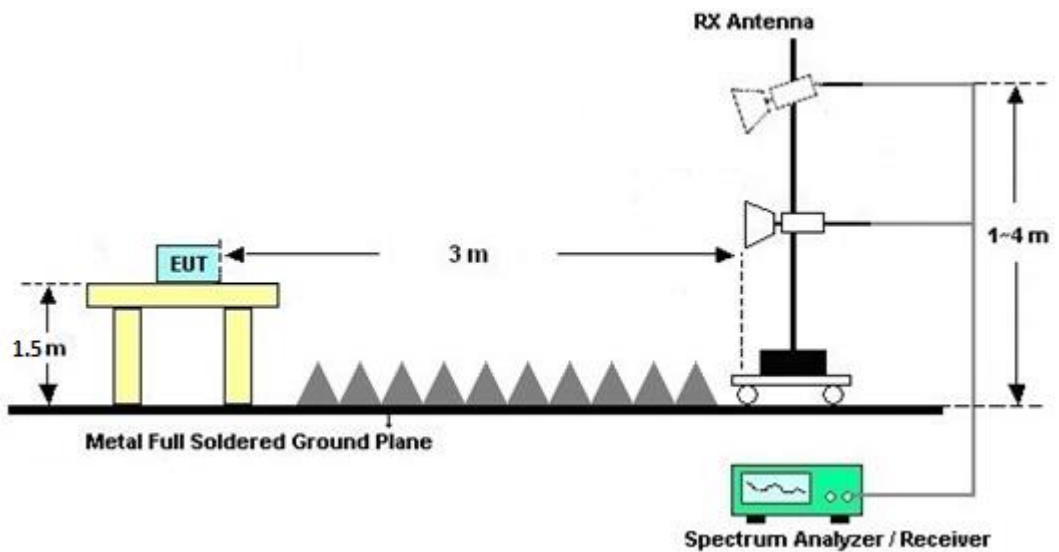

For radiated test above 18GHz

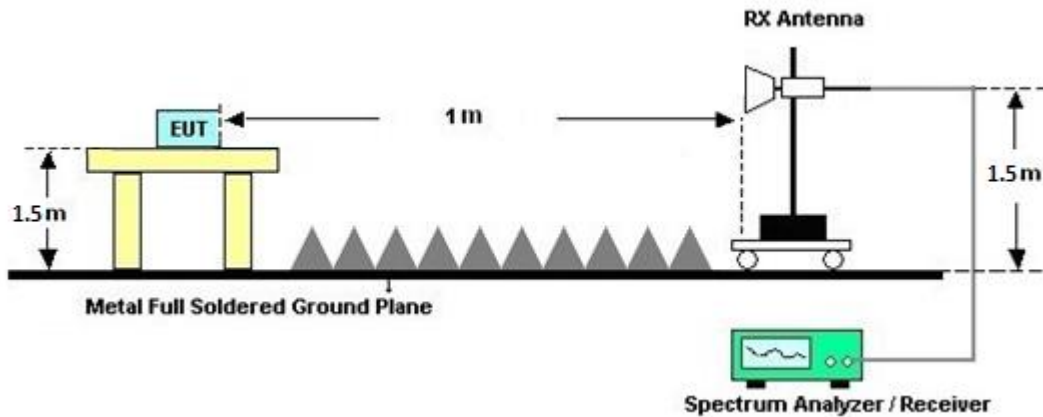

3.8.5 Test Results of Radiated Spurious Emissions (9 kHz ~ 30 MHz)

The low frequency, which starts from 9 kHz to 30 MHz, is pre-scanned and the result which is 20 dB lower than the limit line is not reported.

There is adequate comparison measurement of both open-field test site and alternative test site - semi-Anechoic chamber according to 414788 D01 Radiated Test Site v01r01, and the result comes out very similar.

3.8.6 Test Result of Radiated Spurious at Band Edges

Please refer to Appendix C and D.

3.8.7 Duty Cycle

Please refer to Appendix E.

3.8.8 Test Result of Radiated Spurious Emission (30MHz ~ 10th Harmonic)

Please refer to Appendix C and D.



3.9 AC Conducted Emission Measurement

3.9.1 Limit of AC Conducted Emission

For equipment that is designed to be connected to the public utility (AC) power line, the radio frequency voltage that is conducted back onto the AC power line on any frequency or frequencies within the band 150 kHz to 30 MHz shall not exceed the limits in the following table.

Frequency of emission (MHz)	Conducted limit (dB μ V)	
	Quasi-peak	Average
0.15-0.5	66 to 56*	56 to 46*
0.5-5	56	46
5-30	60	50

*Decreases with the logarithm of the frequency.

3.9.2 Measuring Instruments

Please refer to the measuring equipment list in this test report.

3.9.3 Test Procedures

1. The EUT is placed 0.4 meter away from the conducting wall of the shielding room, and is kept at least 80 centimeters from any other grounded conducting surface.
2. Connect EUT to the power mains through a line impedance stabilization network (LISN).
3. All the support units are connecting to the other LISN.
4. The LISN provides 50 ohm coupling impedance for the measuring instrument.
5. The FCC states that a 50 ohm, 50 microhenry LISN shall be used.
6. Both Line and Neutral shall be tested in order to find out the maximum conducted emission.
7. The frequency range from 150 kHz to 30 MHz is scanned.
8. Set the test-receiver system to Peak Detect Function and specified bandwidth (IF Bandwidth = 9 kHz) with Maximum Hold Mode. Then measurement is also conducted by Average Detector and Quasi-Peak Detector Function respectively.

3.9.4 Test Setup

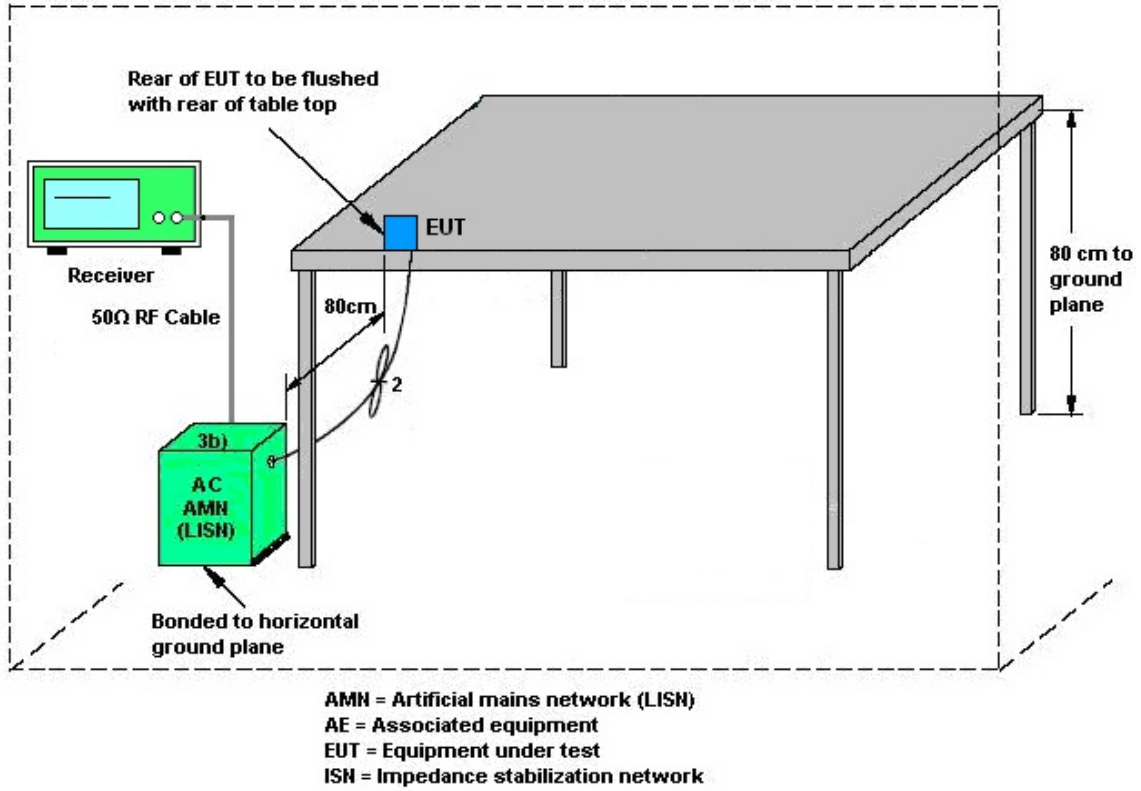

3.9.5 Test Result of AC Conducted Emission

Please refer to Appendix B.



3.10 Antenna Requirements

3.10.1 Standard Applicable

The use of a permanently attached antenna or of an antenna that uses a unique coupling to the intentional radiator shall be considered sufficient to comply with the rule.

3.10.2 Antenna Anti-Replacement Construction

An embedded-in antenna design is used.



4 List of Measuring Equipment

Instrument	Brand Name	Model No.	Serial No.	Characteristics	Calibration Date	Test Date	Due Date	Remark
AC Power Source	ChainTek	APC-1000W	N/A	N/A	N/A	Sep. 14, 2023	N/A	Conduction (CO05-HY)
EMI Test Receiver	Rohde & Schwarz	ESR3	102388	9kHz~3.6GHz	Dec. 01, 2022	Sep. 14, 2023	Nov. 30, 2023	Conduction (CO05-HY)
Hygrometer	Testo	608-H1	34913912	N/A	Nov. 17, 2022	Sep. 14, 2023	Nov. 16, 2023	Conduction (CO05-HY)
LISN	Rohde & Schwarz	ENV216	100080	9kHz~30MHz	Dec. 01, 2022	Sep. 14, 2023	Nov. 30, 2023	Conduction (CO05-HY)
LISN	Rohde & Schwarz	ENV216	100081	9kHz~30MHz	Nov. 17, 2022	Sep. 14, 2023	Nov. 16, 2023	Conduction (CO05-HY)
Software	Rohde & Schwarz	EMC32	N/A	N/A	N/A	Sep. 14, 2023	N/A	Conduction (CO05-HY)
Pulse Limiter	SCHWARZBECK	VTSD 9561-FN	00691	9kHz-200MHz	Jul. 28, 2023	Sep. 14, 2023	Jul. 27, 2024	Conduction (CO05-HY)
LISN Cable	MVE	RG-400	260260	N/A	Dec. 29, 2022	Sep. 14, 2023	Dec. 28, 2023	Conduction (CO05-HY)
Hygrometer	TECEPEL	DTM-303A	TP201996	N/A	Nov. 17, 2022	Sep. 19, 2023~ Oct. 11, 2023	Nov. 16, 2023	Conducted (TH05-HY)
Power Meter	Anritsu	ML2495A	0932001	N/A	Sep. 08, 2023	Sep. 19, 2023~ Oct. 11, 2023	Sep. 07, 2024	Conducted (TH05-HY)
Power Sensor	Anritsu	MA2411B	0846202	300MHz~40GHz	Sep. 08, 2023	Sep. 19, 2023~ Oct. 11, 2023	Sep. 07, 2024	Conducted (TH05-HY)
Power Sensor	DARE	RPR3006W	15100041SNO 10 (NO:248)	10MHz~6GHz	Jan. 05, 2023	Sep. 19, 2023~ Oct. 11, 2023	Jan. 04, 2024	Conducted (TH05-HY)
Signal Analyzer	Rohde & Schwarz	FSV40	101566	10Hz~40GHz	Aug. 23, 2023	Sep. 19, 2023~ Oct. 11, 2023	Aug. 22, 2024	Conducted (TH05-HY)
BT Base Station(Measure)	Rohde & Schwarz	CBT	101136	BT 3.0	Oct. 25, 2022	Sep. 19, 2023~ Oct. 11, 2023	Oct. 24, 2023	Conducted (TH05-HY)
Bilog Antenna	TESEQ	CBL 6111D & 00800N1D01N-06	35419 & 03	30MHz~1GHz	Apr. 23, 2023	Sep. 21, 2023~ Nov. 01, 2023	Apr. 22, 2024	Radiation (03CH07-HY)
Double Ridge Horn Antenna	ESCO	3117	00075962	1GHz ~ 18GHz	Dec. 01, 2022	Sep. 21, 2023~ Nov. 01, 2023	Nov. 30, 2023	Radiation (03CH07-HY)
Loop Antenna	Rohde & Schwarz	HFH2-Z2	100315	9 kHz~30 MHz	Feb. 28, 2023	Sep. 21, 2023~ Nov. 01, 2023	Feb. 27, 2024	Radiation (03CH07-HY)
Preamplifier	MITEQ	AMF-7D-0010 1800-30-10P	1590075	1GHz~18GHz	Apr. 20, 2023	Sep. 21, 2023~ Nov. 01, 2023	Apr. 19, 2024	Radiation (03CH07-HY)
Preamplifier	COM-POWER	PA-103A	161241	10MHz~1GHz	Oct. 03, 2022	Sep. 21, 2023~ Oct. 01, 2023	Oct. 02, 2023	Radiation (03CH07-HY)
Preamplifier	COM-POWER	PA-103A	161241	10MHz~1GHz	Oct. 02, 2023	Oct. 02, 2023 ~ Nov. 01, 2023	Oct. 01, 2024	Radiation (03CH07-HY)
Preamplifier	Agilent	8449B	3008A02362	1GHz~26.5GHz	Mar. 24, 2023	Sep. 21, 2023~ Nov. 01, 2023	Mar. 23, 2024	Radiation (03CH07-HY)
Spectrum Analyzer	Agilent	N9030A	MY52350276	3Hz~44GHz	Mar. 28, 2023	Sep. 21, 2023~ Nov. 01, 2023	Mar. 27, 2024	Radiation (03CH07-HY)
RF Cable	HUBER + SUHNER	SUCOFLEX 104	MY15682/4	30MHz to 18GHz	Feb. 22, 2023	Sep. 21, 2023~ Nov. 01, 2023	Feb. 21, 2024	Radiation (03CH07-HY)
RF Cable	HUBER + SUHNER	SUCOFLEX 104	MY24971/4	9kHz to 18GHz	Feb. 22, 2023	Sep. 21, 2023~ Nov. 01, 2023	Feb. 21, 2024	Radiation (03CH07-HY)
RF Cable	HUBER + SUHNER	SUCOFLEX 104	MY28655/4	9kHz to 18GHz	Feb. 22, 2023	Sep. 21, 2023~ Nov. 01, 2023	Feb. 21, 2024	Radiation (03CH07-HY)
RF Cable	HUBER + SUHNER	SUCOFLEX 126	532078/126E	30MHz~18GHz	Sep. 15, 2023	Sep. 21, 2023~ Nov. 01, 2023	Sep. 14, 2024	Radiation (03CH07-HY)
RF Cable	HUBER + SUHNER	SUCOFLEX 102	MY2858/2	18GHz~40GHz	Feb. 22, 2023	Sep. 21, 2023~ Nov. 01, 2023	Feb. 21, 2024	Radiation (03CH07-HY)
RF Cable	HUBER + SUHNER	SUCOFLEX 102	801606/2	9KHz ~ 40GHz	Apr. 20, 2023	Sep. 21, 2023~ Nov. 01, 2023	Apr. 19, 2024	Radiation (03CH07-HY)



Instrument	Brand Name	Model No.	Serial No.	Characteristics	Calibration Date	Test Date	Due Date	Remark
Controller	EMEC	EM1000	N/A	Control Ant Mast	N/A	Sep. 21, 2023~ Nov. 01, 2023	N/A	Radiation (03CH07-HY)
Controller	MF	MF-7802	N/A	Control Turn table	N/A	Sep. 21, 2023~ Nov. 01, 2023	N/A	Radiation (03CH07-HY)
Antenna Mast	EMEC	AM-BS-4500E	N/A	Boresight mast 1M~4M	N/A	Sep. 21, 2023~ Nov. 01, 2023	N/A	Radiation (03CH07-HY)
Turn Table	ChainTek	Chaintek 3000	N/A	0~360 Degree	N/A	Sep. 21, 2023~ Nov. 01, 2023	N/A	Radiation (03CH07-HY)
Software	Audix	E3	N/A	N/A	N/A	Sep. 21, 2023~ Nov. 01, 2023	N/A	Radiation (03CH07-HY)
USB Data Logger	TECPEL	TR-32	HE17XB2495	N/A	Mar. 14, 2023	Sep. 21, 2023~ Nov. 01, 2023	Mar. 13, 2024	Radiation (03CH07-HY)
Preamplifier	EMEC	EM18G40G	060801	18GHz~40GHz	Jun. 27, 2023	Sep. 21, 2023~ Nov. 01, 2023	Jun. 26, 2024	Radiation (03CH07-HY)
SHF-EHF Horn Antenna	SCHWARZBECK	BBHA 9170	BBHA917025 1	18GHz~40GHz	Nov. 24, 2022	Sep. 21, 2023~ Nov. 01, 2023	Nov. 23, 2023	Radiation (03CH07-HY)



5 Measurement Uncertainty

Uncertainty of Conducted Emission Measurement (150 kHz ~ 30 MHz)

Measuring Uncertainty for a Level of Confidence of 95% ($U = 2Uc(y)$)	3.50 dB
-------------------------------------------------------------------------	---------

Uncertainty of Radiated Emission Measurement (30 MHz ~ 1000 MHz)

Measuring Uncertainty for a Level of Confidence of 95% ($U = 2Uc(y)$)	6.30 dB
-------------------------------------------------------------------------	---------

Uncertainty of Radiated Emission Measurement (1000 MHz ~ 6000 MHz)

Measuring Uncertainty for a Level of Confidence of 95% ($U = 2Uc(y)$)	4.60 dB
-------------------------------------------------------------------------	---------

Uncertainty of Radiated Emission Measurement (6000 MHz ~ 18000 MHz)

Measuring Uncertainty for a Level of Confidence of 95% ($U = 2Uc(y)$)	4.30 dB
-------------------------------------------------------------------------	---------

Uncertainty of Radiated Emission Measurement (18000 MHz ~ 40000 MHz)

Measuring Uncertainty for a Level of Confidence of 95% ($U = 2Uc(y)$)	5.30 dB
-------------------------------------------------------------------------	---------

Appendix A. Test Result of Conducted Test Items

Test Engineer:	Ray Wang	Temperature:	21~25	°C
Test Date:	2023/9/19~2023/10/11	Relative Humidity:	51~54	%

<Internal Antenna>

TEST RESULTS DATA**20dB and 99% Occupied Bandwidth and Hopping Channel Separation**

Mod.	Data Rate	NTX	CH.	Freq. (MHz)	20db BW (MHz)	99% Bandwidth (MHz)	Hopping Channel Separation Measurement (MHz)	Hopping Channel Separation Measurement Limit (MHz)	Pass/Fail
DH	1Mbps	1	0	2402	0.943	0.827	1.337	0.6290	Pass
DH	1Mbps	1	39	2441	0.943	0.855	0.999	0.6290	Pass
DH	1Mbps	1	78	2480	0.943	0.853	0.994	0.6290	Pass
2DH	2Mbps	1	0	2402	1.261	1.157	0.994	0.8406	Pass
2DH	2Mbps	1	39	2441	1.309	1.165	0.990	0.8725	Pass
2DH	2Mbps	1	78	2480	1.304	1.165	1.329	0.8696	Pass
3DH	3Mbps	1	0	2402	1.270	1.155	1.007	0.8464	Pass
3DH	3Mbps	1	39	2441	1.270	1.157	0.994	0.8464	Pass
3DH	3Mbps	1	78	2480	1.270	1.155	1.003	0.8464	Pass

TEST RESULTS DATA**Dwell Time**

Mod.	Hopping Channel Number Rate	Hops Over Occupancy Time (hops)	Package Transfer Time (msec)	Dwell Time (sec)	Limits (sec)	Pass/Fail
DH5	79	106.670	2.90	0.31	0.4	Pass
DH5 (AFH)	20	53.330	2.90	0.15	0.4	Pass

TEST RESULTS DATA**Peak Power Table**

DH	CH.	NTX	Peak Power (dBm)	Power Limit (dBm)	Test Result
DH1	0	1	10.46	30.00	Pass
	39	1	10.30	30.00	Pass
	78	1	10.19	30.00	Pass
2DH1	0	1	9.63	20.97	Pass
	39	1	9.41	20.97	Pass
	78	1	9.33	20.97	Pass
3DH1	0	1	9.85	20.97	Pass
	39	1	9.61	20.97	Pass
	78	1	9.55	20.97	Pass

TEST RESULTS DATA**Average Power Table
(Reporting Only)**

DH	CH.	NTX	Average Power (dBm)	Duty Factor (dB)
DH1	0	1	9.78	5.06
	39	1	9.57	5.06
	78	1	9.49	5.06
2DH1	0	1	7.04	5.17
	39	1	6.87	5.17
	78	1	6.82	5.17
3DH1	0	1	7.05	5.09
	39	1	6.88	5.09
	78	1	6.85	5.09

TEST RESULTS DATA**Number of Hopping Frequency**

Number of Hopping (Channel)	Adaptive Frequency Hopping (Channel)	Limits (Channel)	Pass/Fail
79	20	> 15	Pass



Number of Hopping Frequency

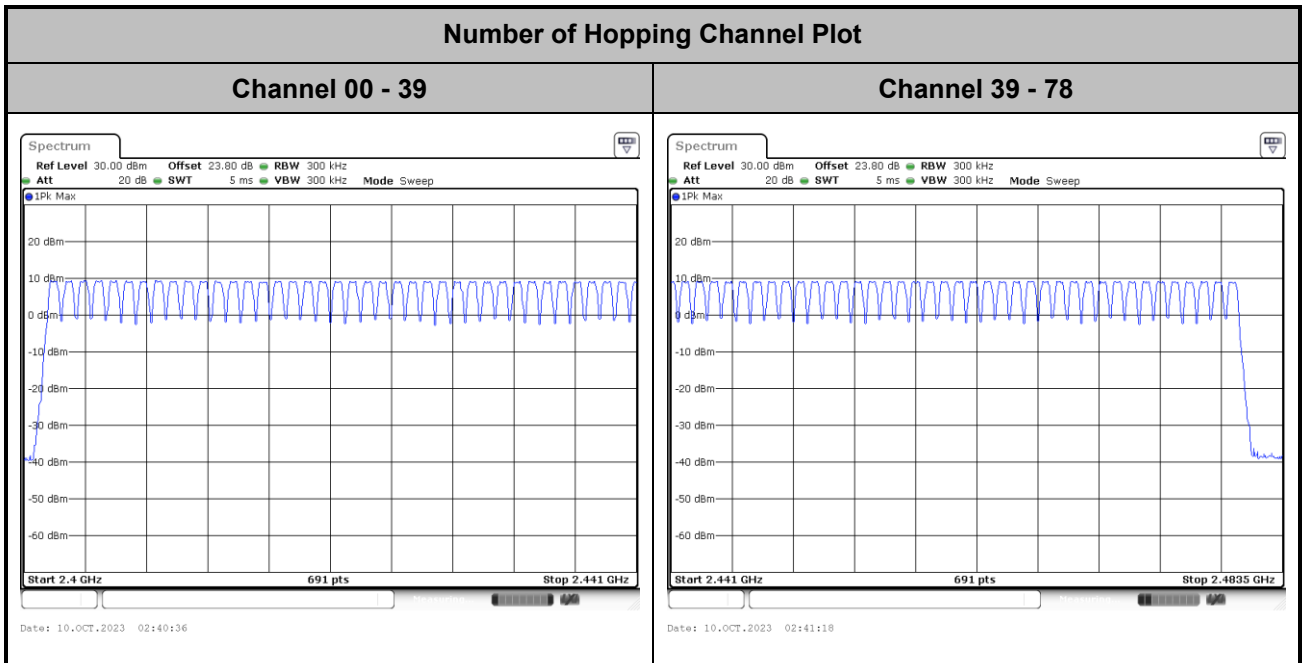



Hopping Channel Separation

<1Mbps>

Channel Separation Plot on Channel 00 - 01

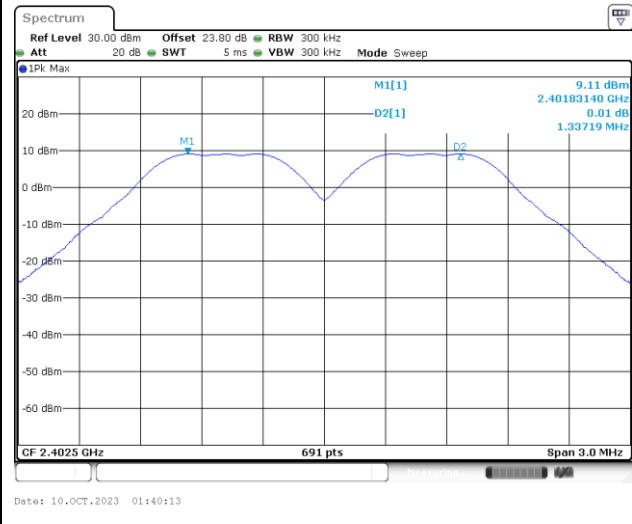

Channel Separation Plot on Channel 39 - 40

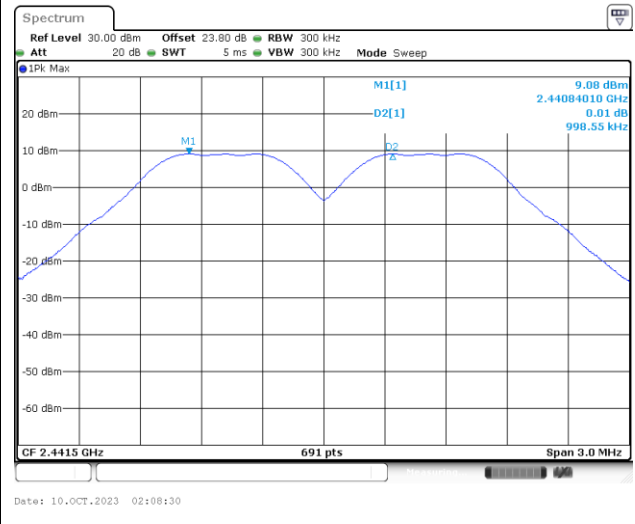

Channel Separation Plot on Channel 77 - 78

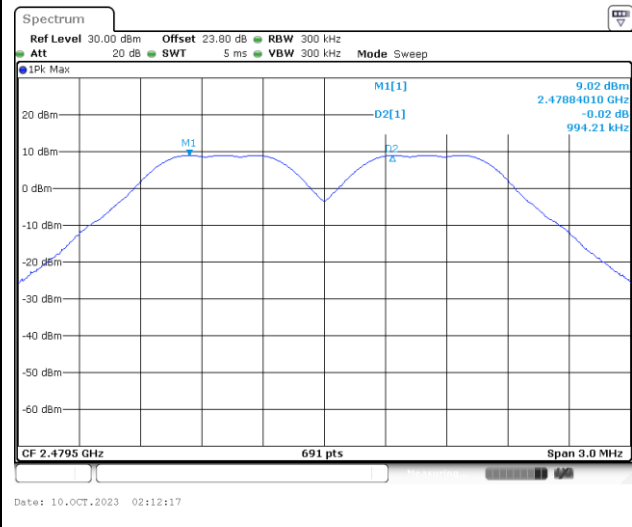



<2Mbps>

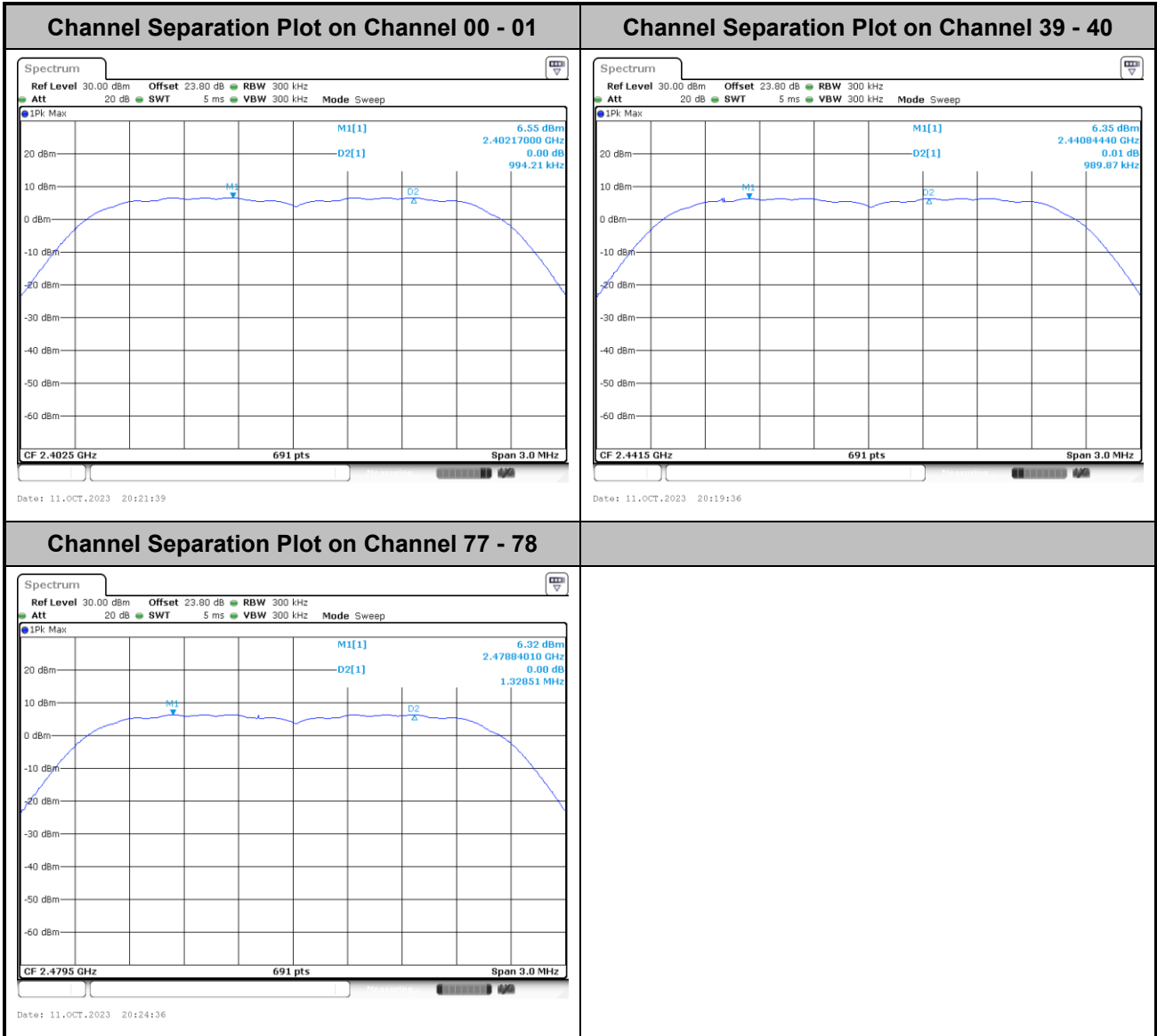



<3Mbps>

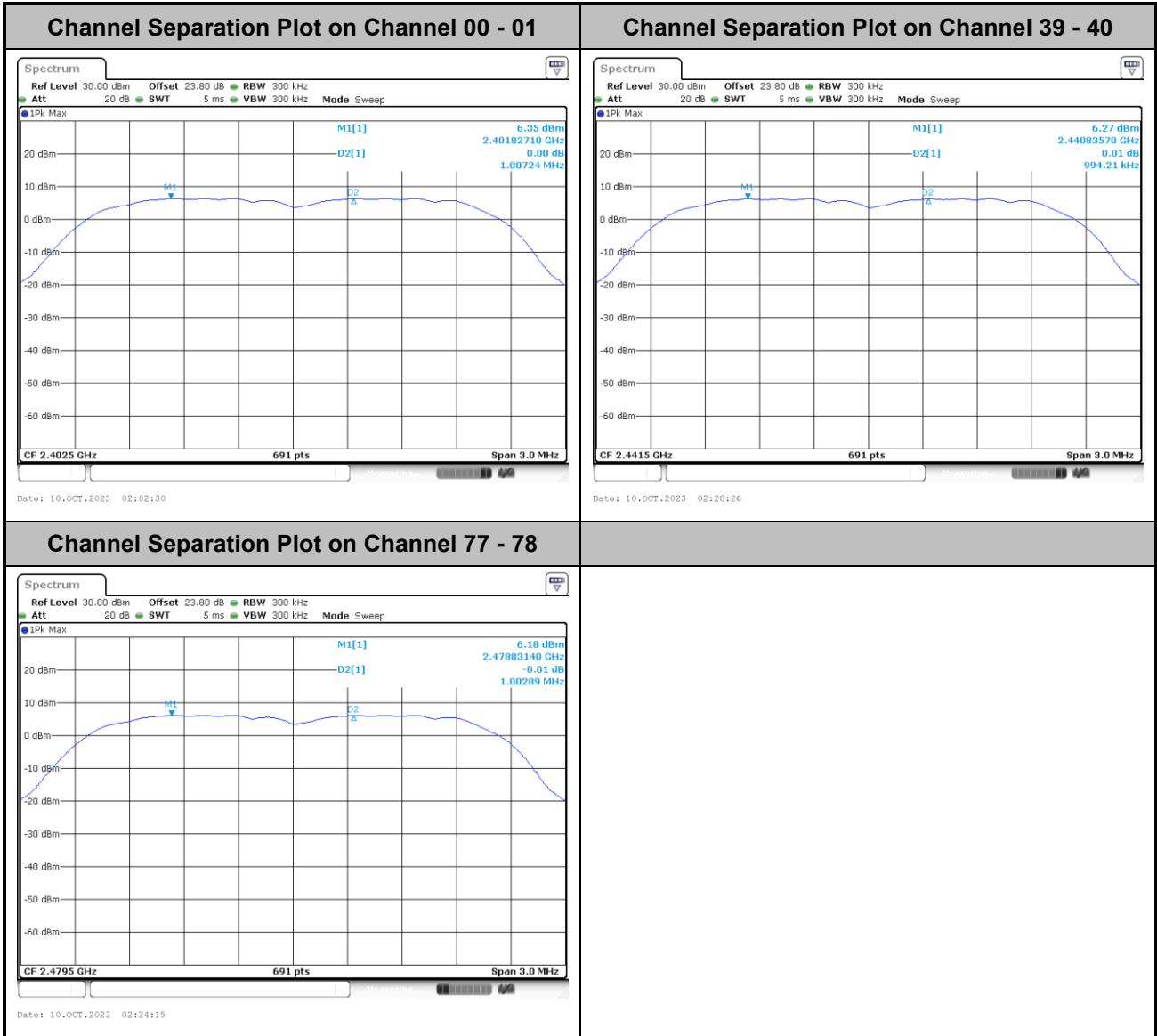



20dB Bandwidth

<1Mbps>

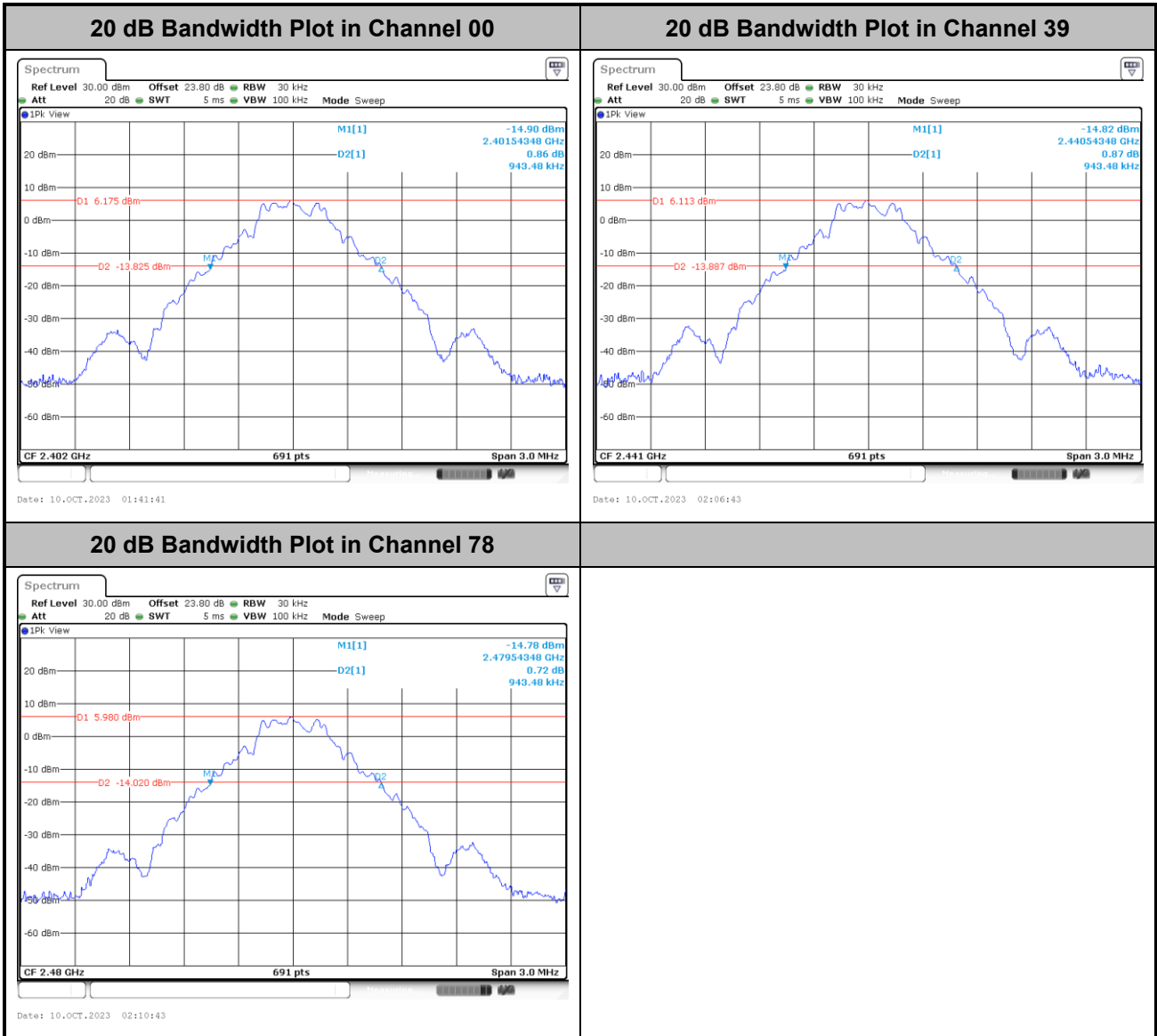



<2Mbps>

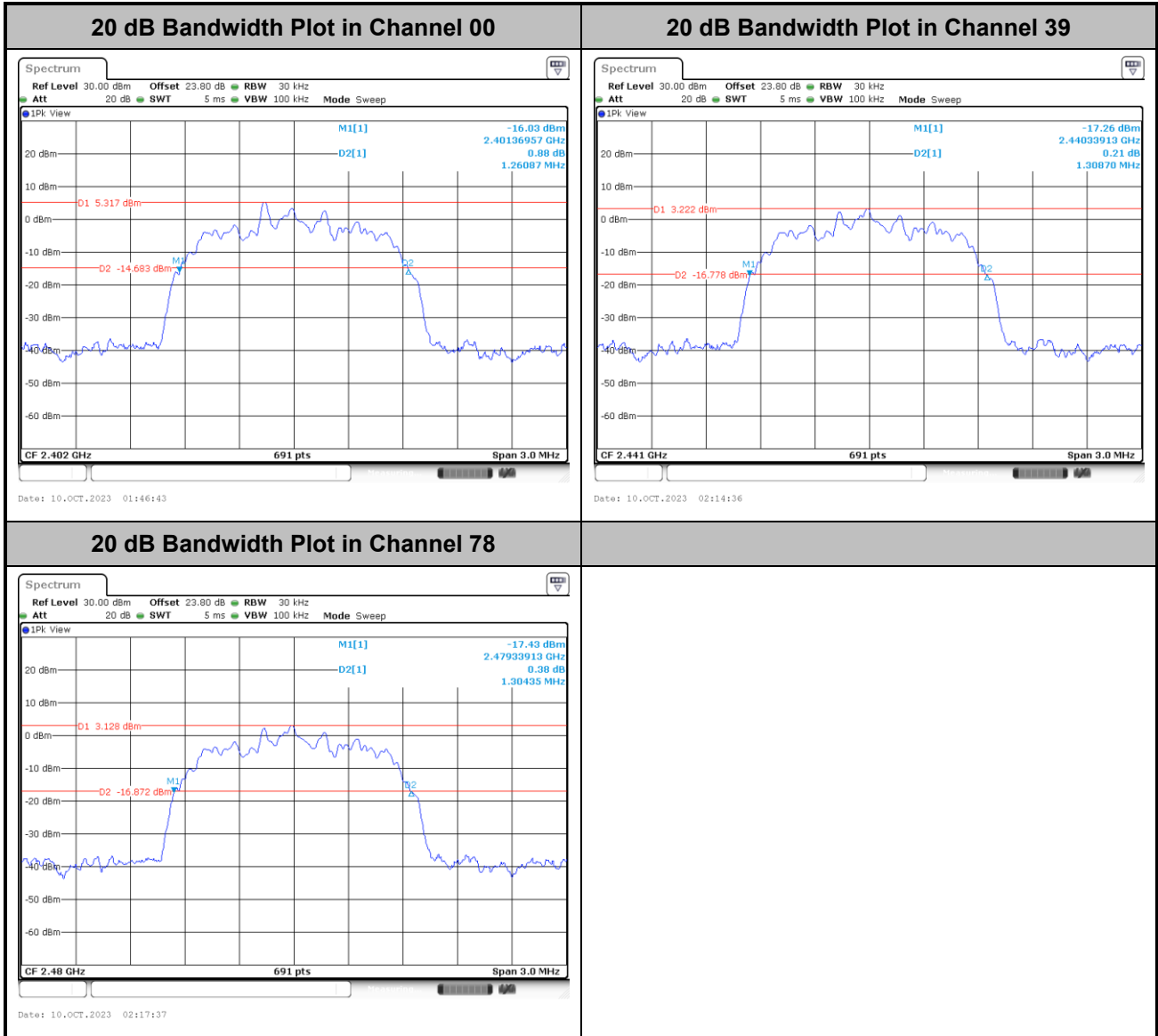



<3Mbps>

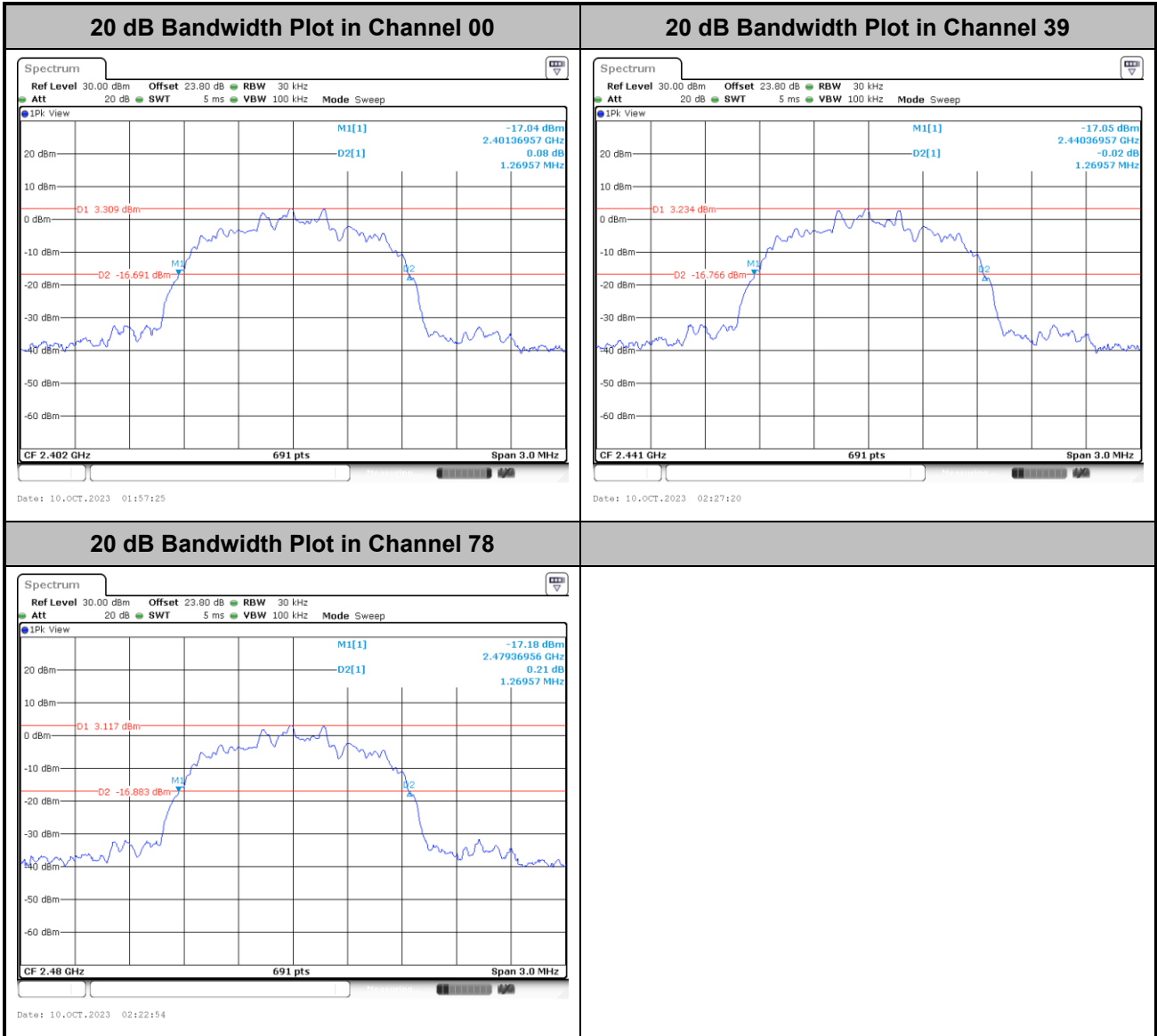



99% Occupied Bandwidth

<1Mbps>

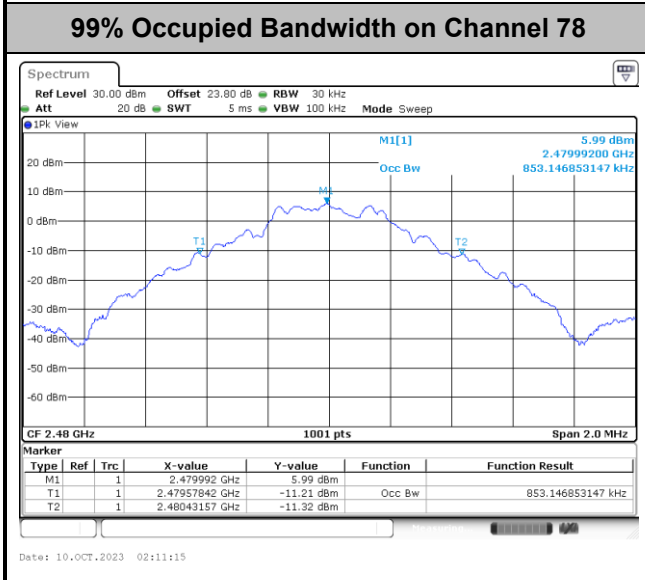
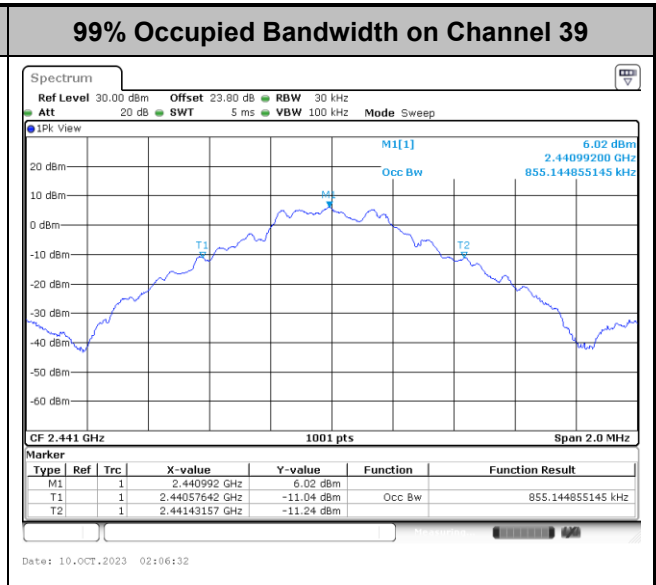
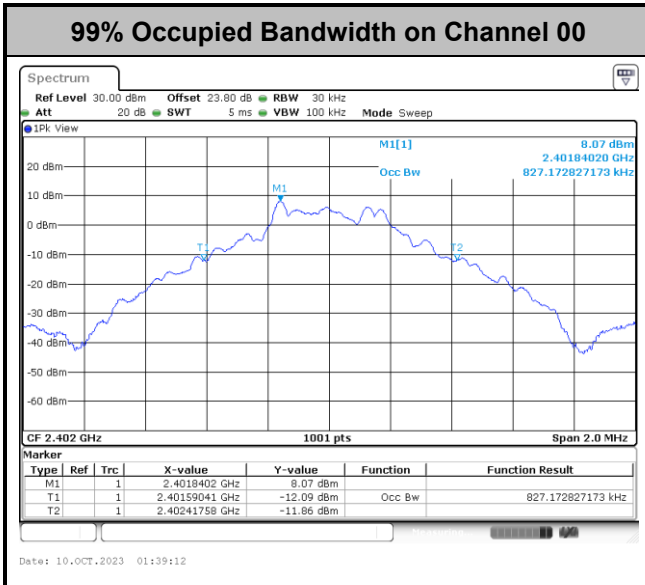



<2Mbps>

99% Occupied Bandwidth on Channel 00

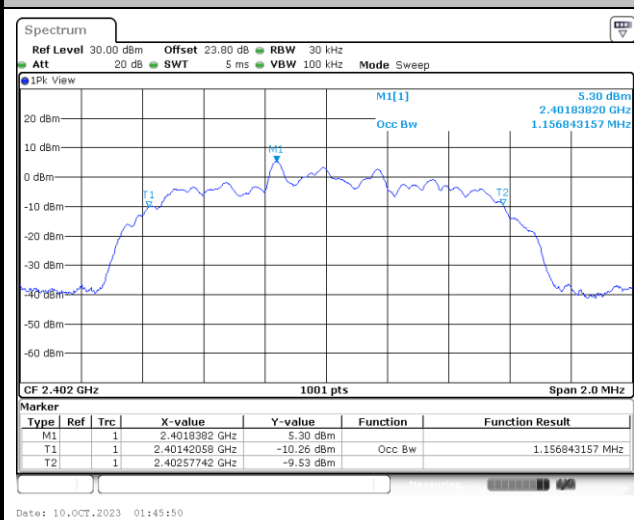

Date: 10.OCT.2023 01:45:50

99% Occupied Bandwidth on Channel 39

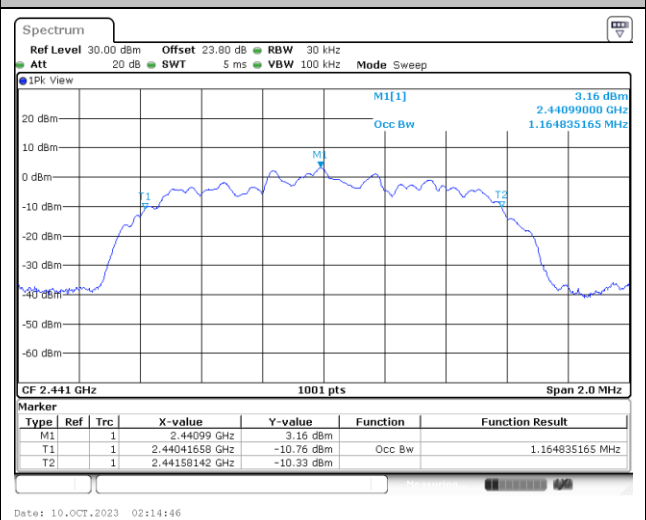

Date: 10.OCT.2023 02:14:46

99% Occupied Bandwidth on Channel 78

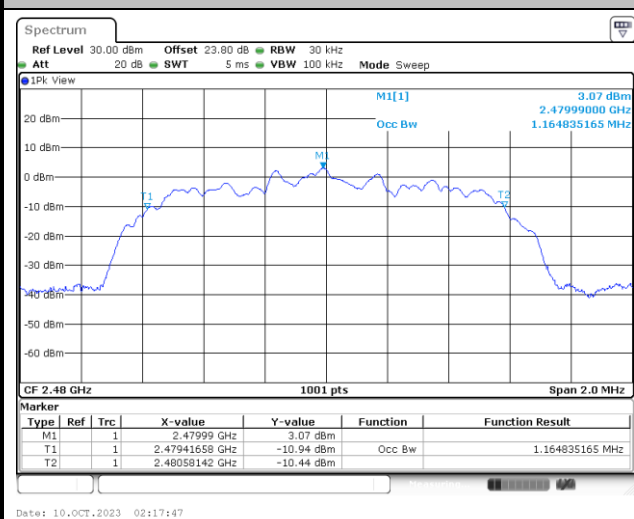

Date: 10.OCT.2023 02:17:47



<3Mbps>

99% Occupied Bandwidth on Channel 00

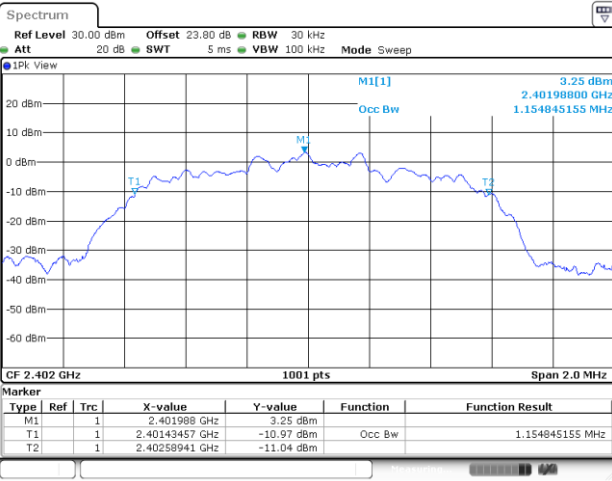

99% Occupied Bandwidth on Channel 39

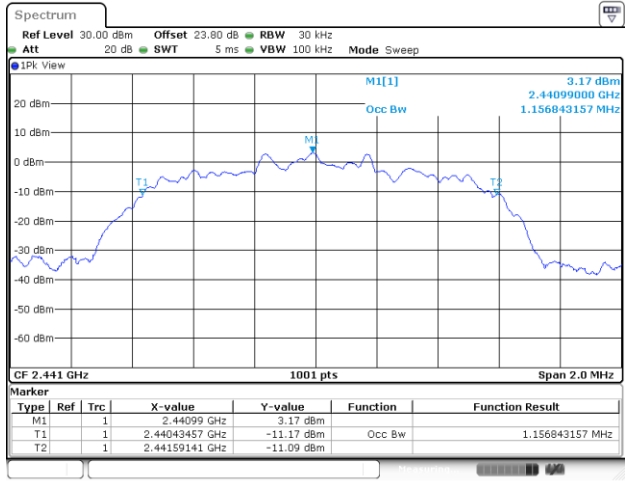

99% Occupied Bandwidth on Channel 78

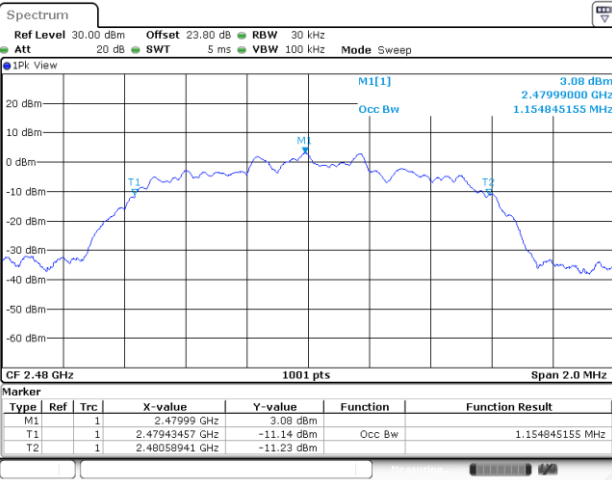



Band Edges

<1Mbps>

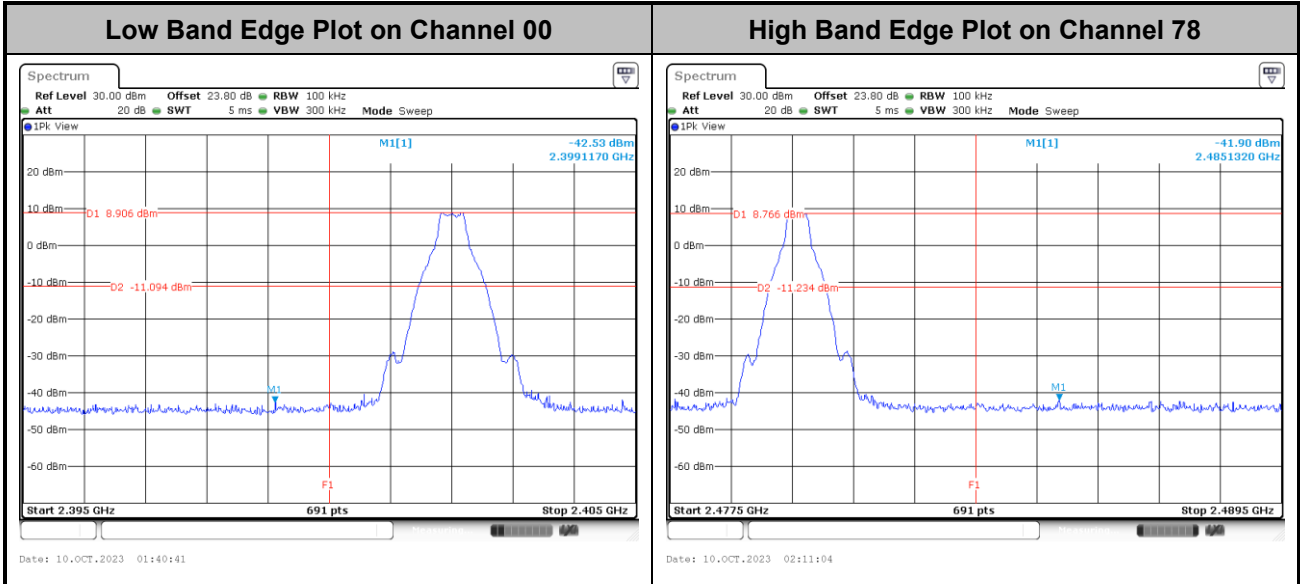

<2Mbps>

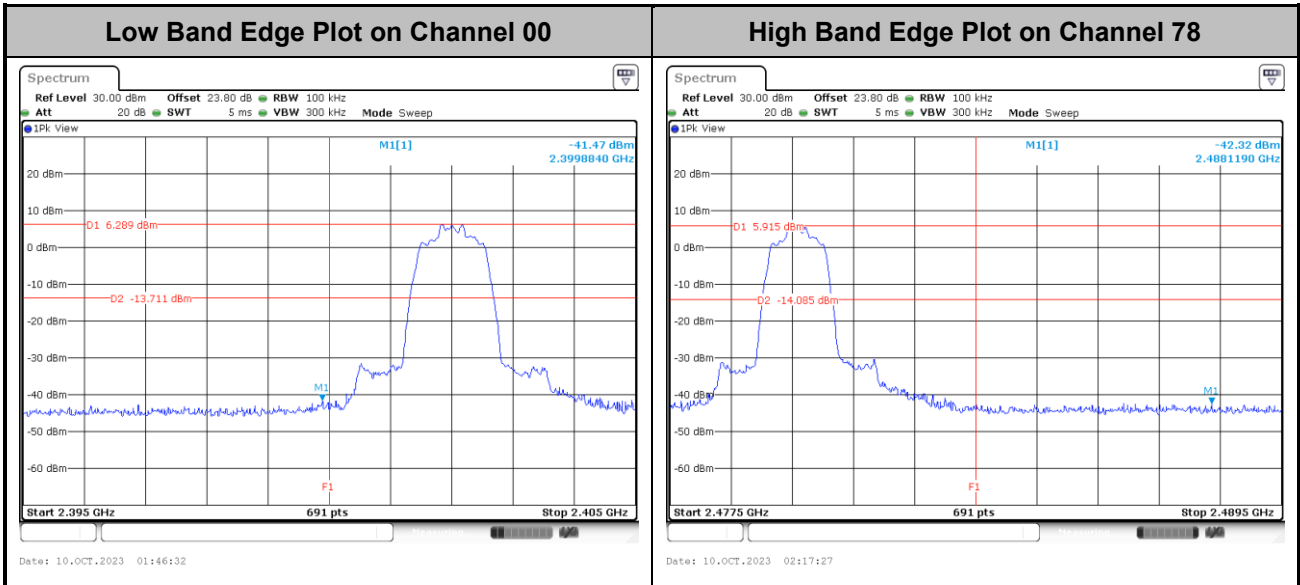



<3Mbps>

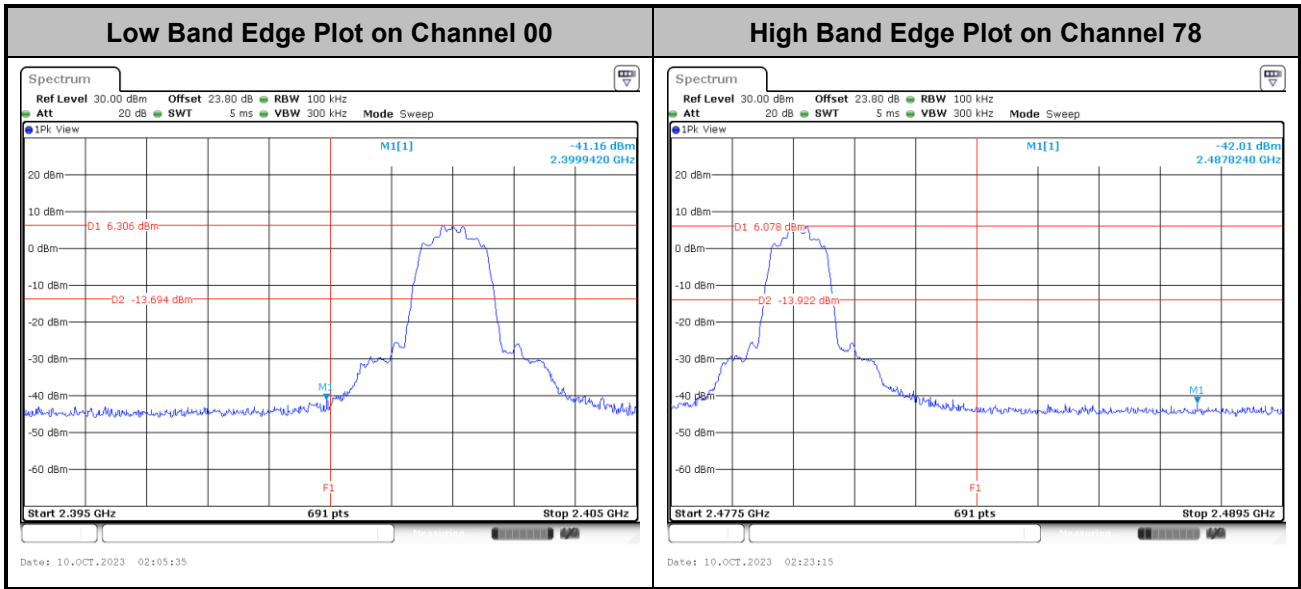



Hopping Mode Band Edges

<1Mbps>

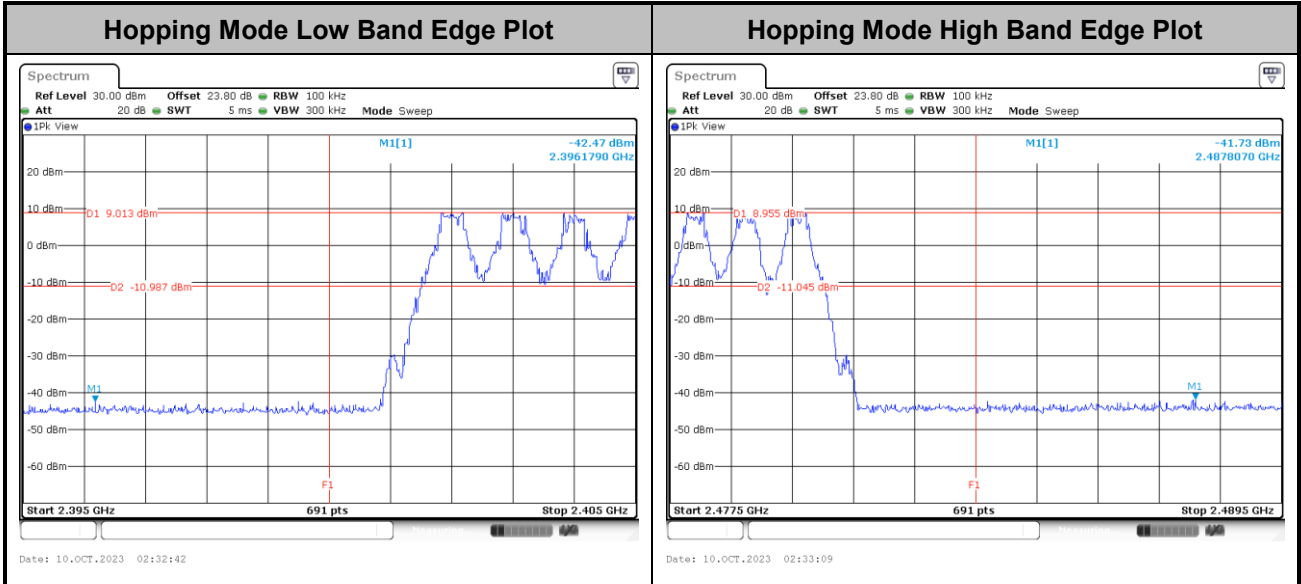

<2Mbps>

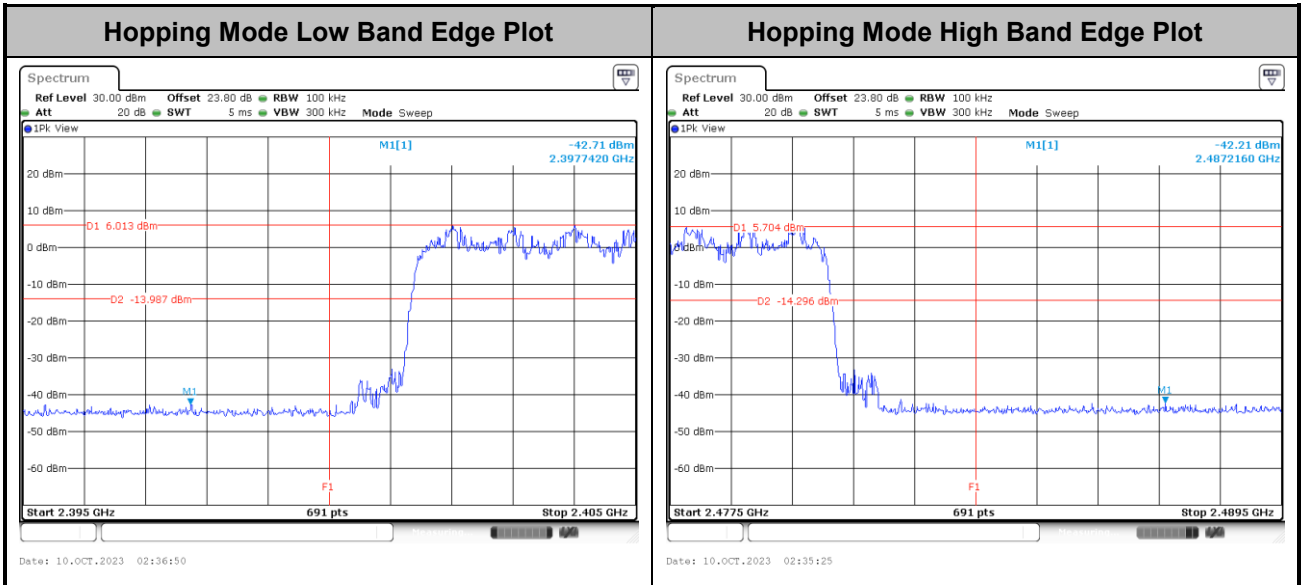



<3Mbps>

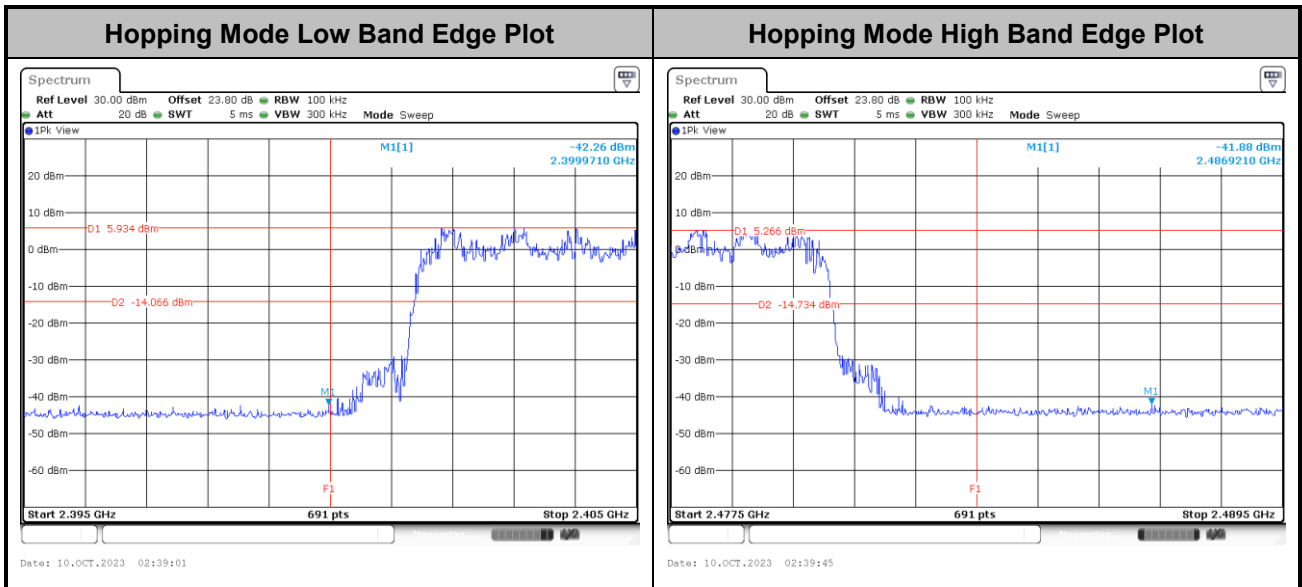



Conducted Spurious Emission

<1Mbps>

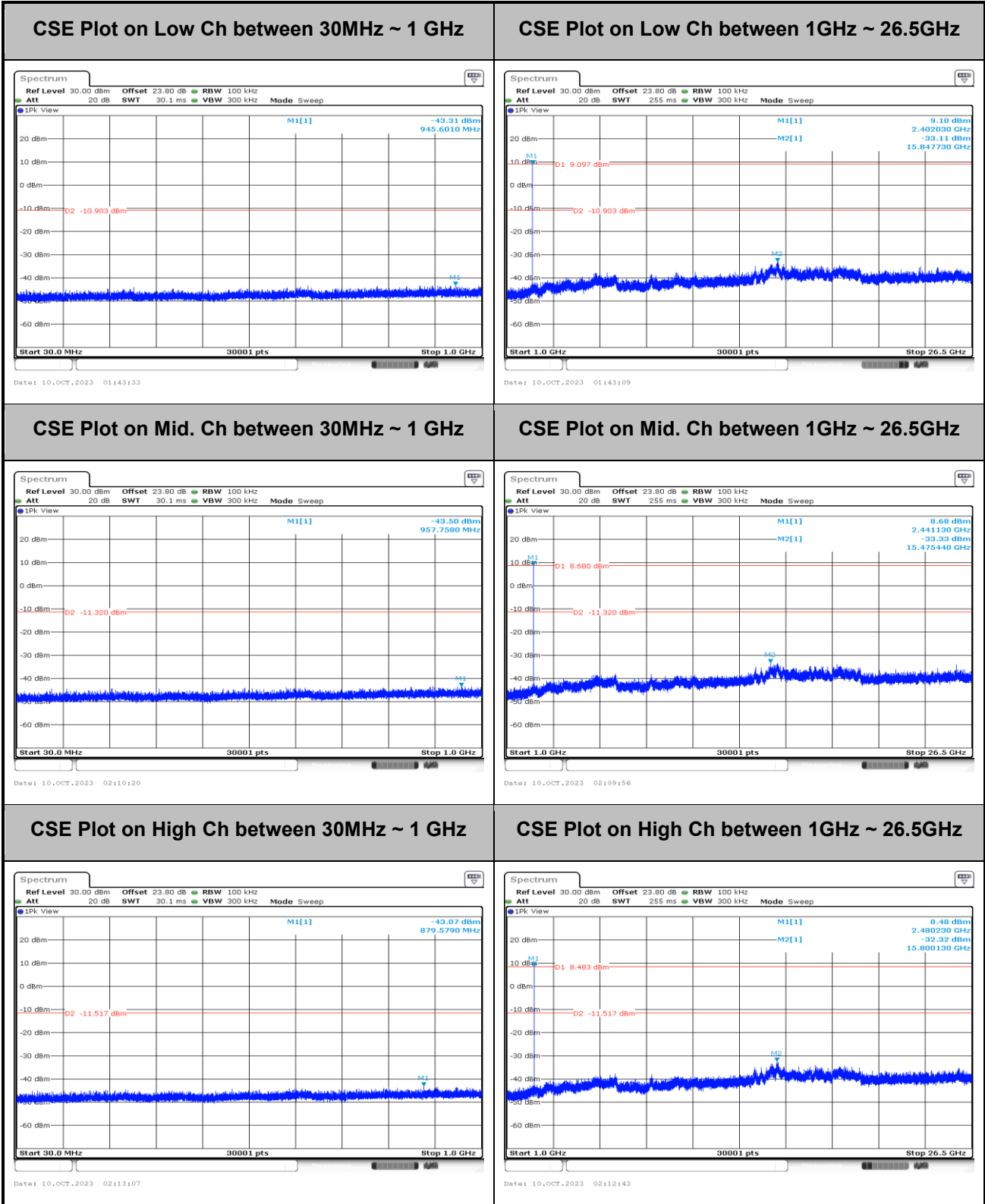



<2Mbps>

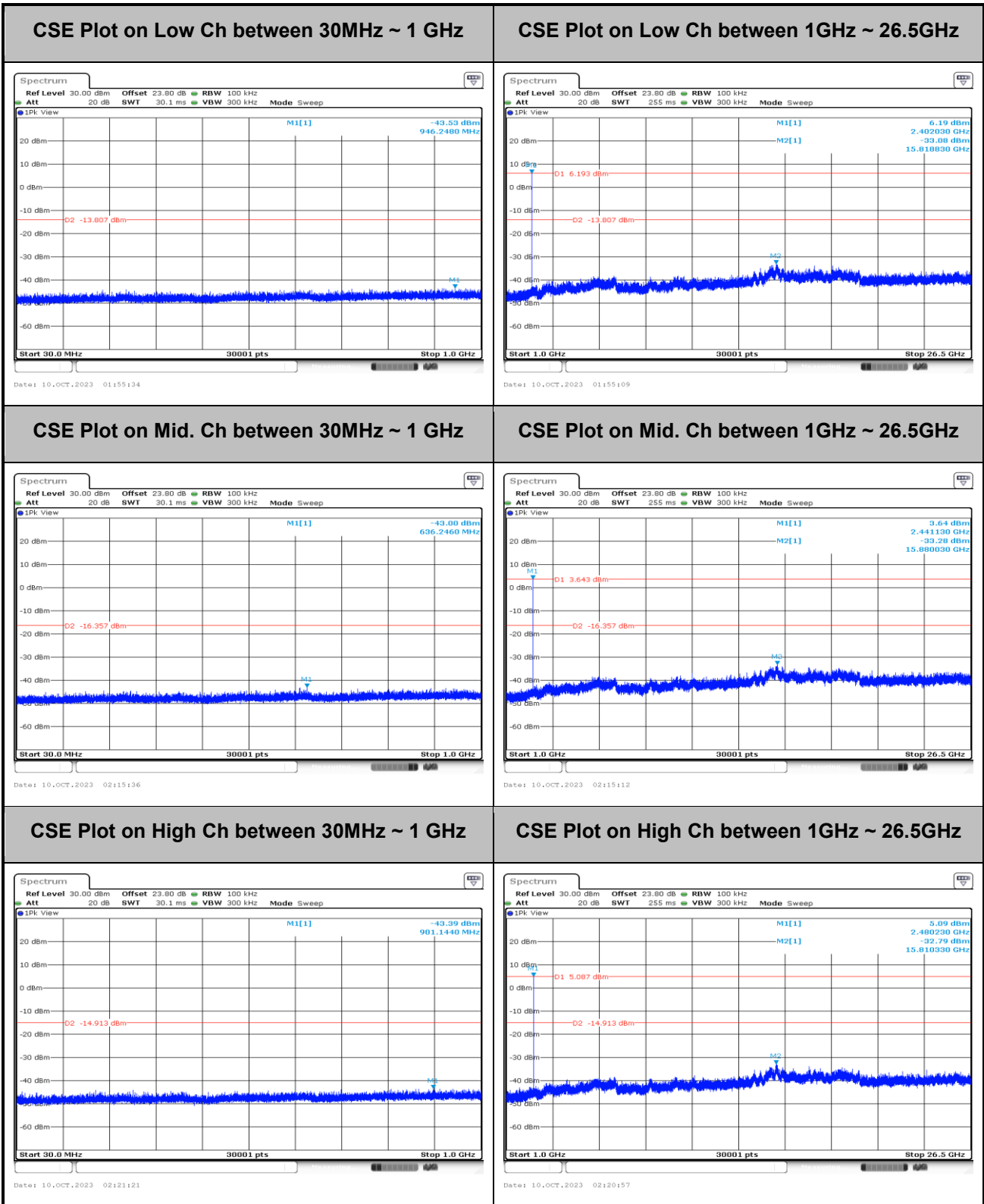



<3Mbps>

CSE Plot on Low Ch between 30MHz ~ 1 GHz

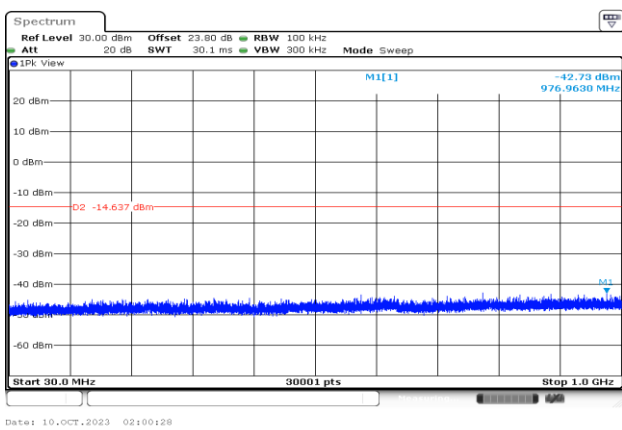

CSE Plot on Low Ch between 1GHz ~ 26.5GHz

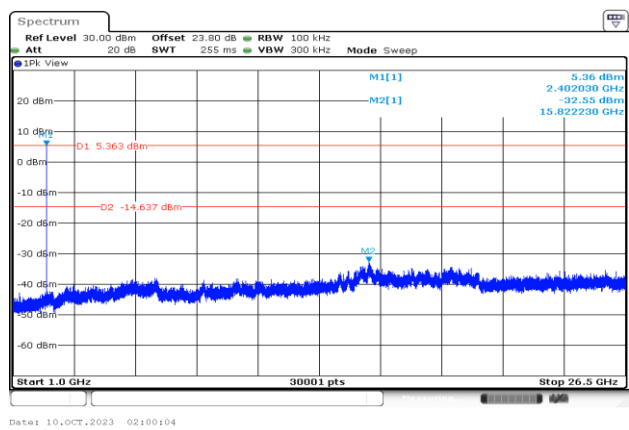

CSE Plot on Mid. Ch between 30MHz ~ 1 GHz

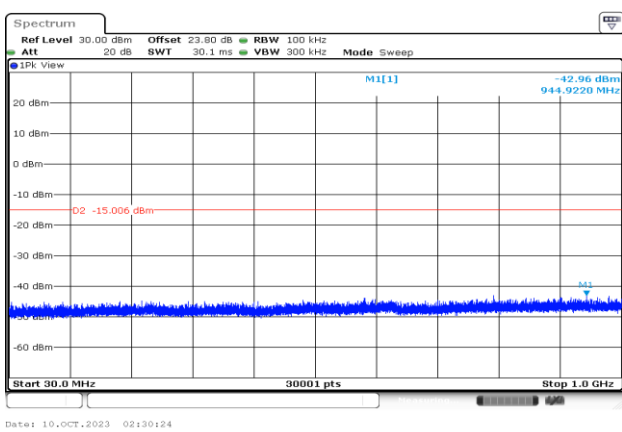

CSE Plot on Mid. Ch between 1GHz ~ 26.5GHz

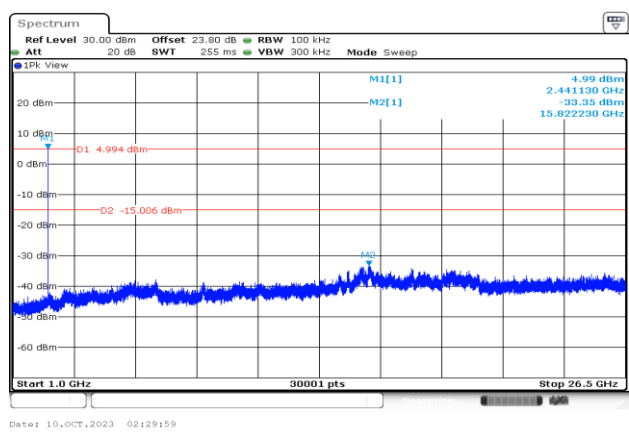

CSE Plot on High Ch between 30MHz ~ 1 GHz

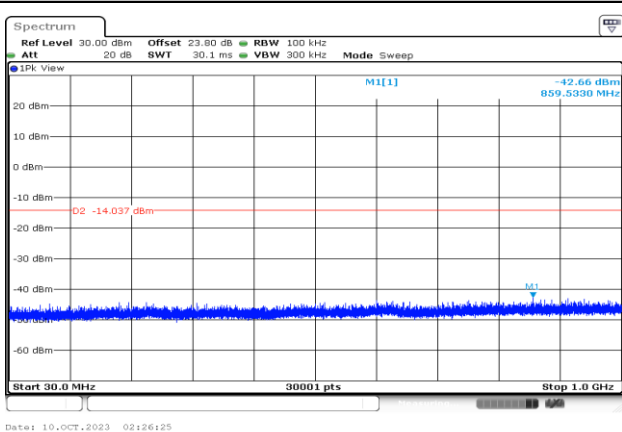

CSE Plot on High Ch between 1GHz ~ 26.5GHz

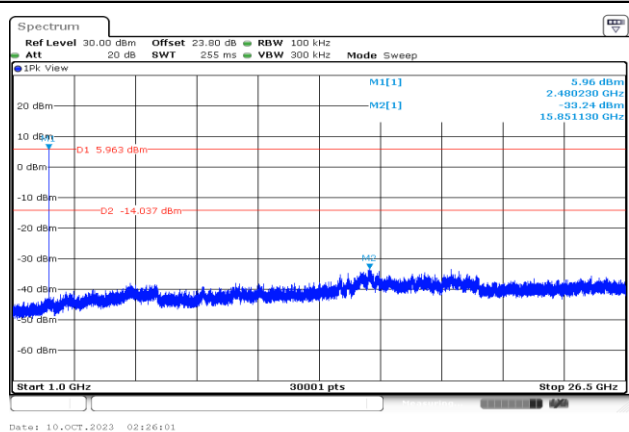



Appendix B. AC Conducted Emission Test Results

Test Engineer :	Calvin Wang	Temperature :	23~26°C
		Relative Humidity :	45~55%

EUT Information

Report NO : 381616
 Test Mode : Mode 1
 Test Voltage : 120Vac/60Hz
 Phase : Line

Full Spectrum

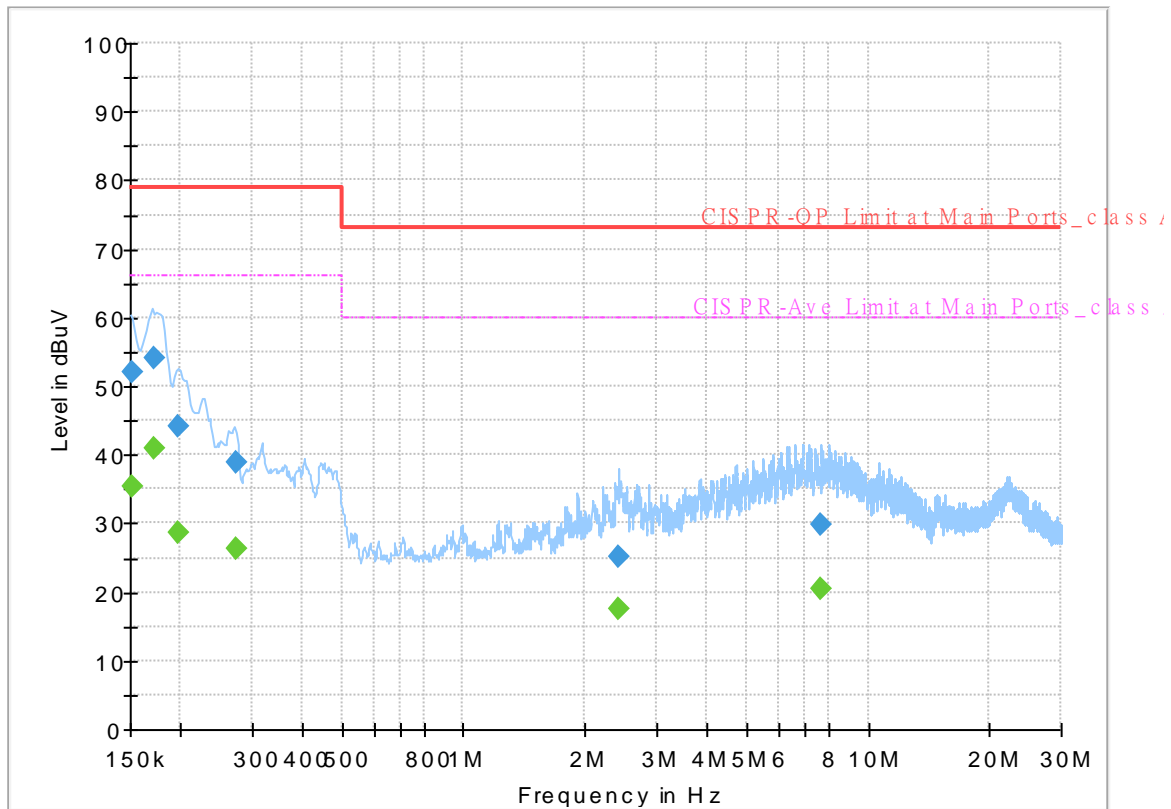

Final_Result

Frequency (MHz)	QuasiPeak (dBuV)	CAverage (dBuV)	Limit (dBuV)	Margin (dB)	Line	Filter	Corr. (dB)
0.152250	---	35.31	66.00	30.69	L1	OFF	19.8
0.152250	52.01	---	79.00	26.99	L1	OFF	19.8
0.172500	---	40.79	66.00	25.21	L1	OFF	19.8
0.172500	53.95	---	79.00	25.05	L1	OFF	19.8
0.197250	---	28.66	66.00	37.34	L1	OFF	19.8
0.197250	44.05	---	79.00	34.95	L1	OFF	19.8
0.273750	---	26.38	66.00	39.62	L1	OFF	19.8
0.273750	38.87	---	79.00	40.13	L1	OFF	19.8
2.413500	---	17.45	60.00	42.55	L1	OFF	19.9
2.413500	25.25	---	73.00	47.75	L1	OFF	19.9
7.669500	---	20.40	60.00	39.60	L1	OFF	19.9
7.669500	29.72	---	73.00	43.28	L1	OFF	19.9

EUT Information

Report NO : 381616
 Test Mode : Mode 1
 Test Voltage : 120Vac/60Hz
 Phase : Neutral

Full Spectrum

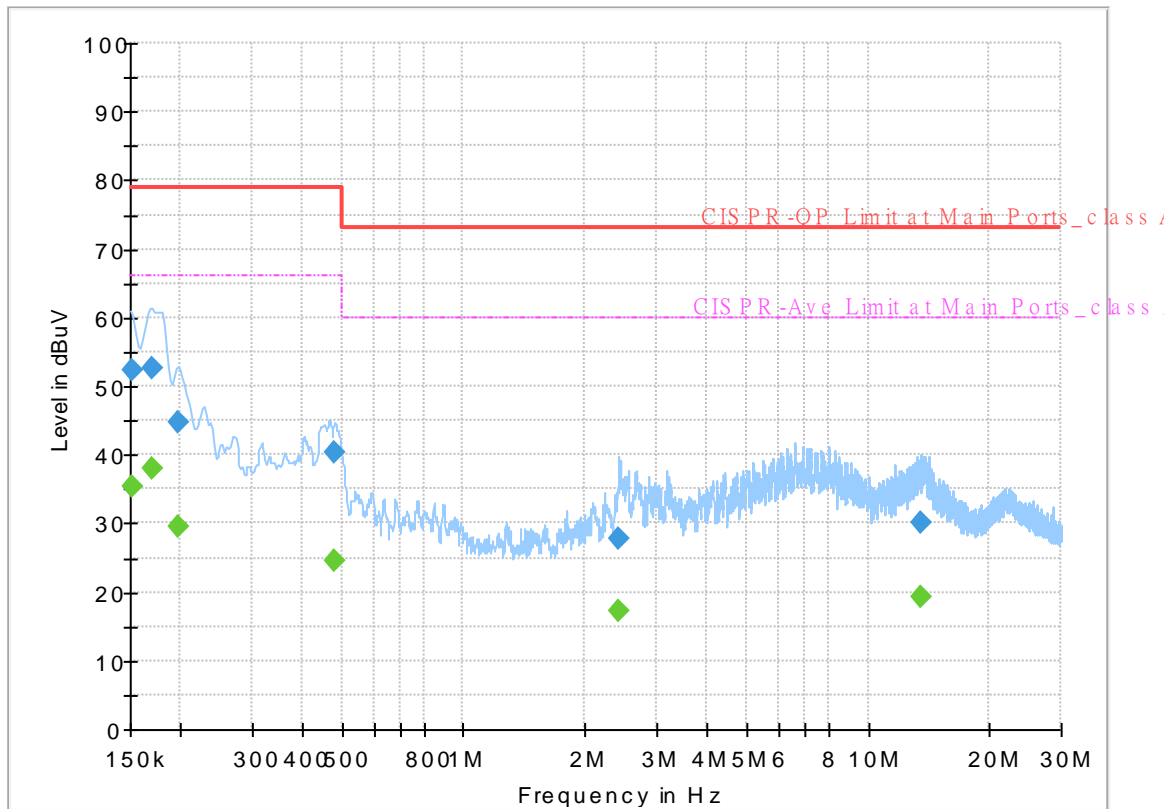

Final_Result

Frequency (MHz)	QuasiPeak (dBuV)	CAverage (dBuV)	Limit (dBuV)	Margin (dB)	Line	Filter	Corr. (dB)
0.152250	---	35.33	66.00	30.67	N	OFF	19.8
0.152250	52.40	---	79.00	26.60	N	OFF	19.8
0.170250	---	37.87	66.00	28.13	N	OFF	19.8
0.170250	52.76	---	79.00	26.24	N	OFF	19.8
0.197250	---	29.56	66.00	36.44	N	OFF	19.8
0.197250	44.67	---	79.00	34.33	N	OFF	19.8
0.478500	---	24.64	66.00	41.36	N	OFF	19.8
0.478500	40.34	---	79.00	38.66	N	OFF	19.8
2.413500	---	17.26	60.00	42.74	N	OFF	19.8
2.413500	27.92	---	73.00	45.08	N	OFF	19.8
13.506000	---	19.26	60.00	40.74	N	OFF	20.0
13.506000	30.12	---	73.00	42.88	N	OFF	20.0



Appendix C. Radiated Spurious Emission

Test Engineer :	Jesse Wang, Stan Hsieh and Ken Wu	Temperature :	23.2~27.6°C
		Relative Humidity :	42.5~74.0%



<Sample 2>

<Internal Antenna>

2.4GHz 2400~2483.5MHz

BT (Band Edge @ 3m)

BT	Note	Frequency (MHz)	Level (dBμV/m)	Margin (dB)	Limit Line (dBμV/m)	Read Level (dBμV)	Antenna Factor (dB/m)	Path Loss (dB)	Preamp Factor (dB)	Ant Pos (cm)	Table Pos (deg)	Peak Avg. (P/A)	Pol. (H/V)	
BT CH00 2402MHz		2346.96	45.43	-28.57	74	39.48	32.08	8.06	34.19	102	298	P	H	
		2346.96	20.67	-33.33	54	-	-	-	-	-	-	A	H	
	*	2402	106.13	-	-	100.03	32.1	8.2	34.2	102	298	P	H	
		2402	81.37	27.37	54	-	-	-	-	-	-	A	H	
													H	
														H
			2339.295	45.24	-28.76	74	39.34	32.04	8.05	34.19	128	15	P	V
			2339.295	20.48	-33.52	54	-	-	-	-	-	-	A	V
	*	2402	104.21	-	-	98.11	32.1	8.2	34.2	128	15	P	V	
		2402	79.45	25.45	54	-	-	-	-	-	-	A	V	
														V
														V
BT CH 39 2441MHz		2332.82	45.21	-28.79	74	39.37	32	8.03	34.19	106	300	P	H	
		2332.82	20.45	-33.55	54	-	-	-	-	-	-	A	H	
	*	2441	106.85	-	-	100.76	32.02	8.28	34.21	106	300	P	H	
	*	2441	82.09	-	-	-	-	-	-	-	-	A	H	
		2489.43	45.09	-28.91	74	38.93	32	8.38	34.22	106	300	P	H	
		2489.43	20.33	-33.67	54	-	-	-	-	-	-	A	H	
		2380.28	45.49	-28.51	74	39.44	32.1	8.15	34.2	126	18	P	V	
		2380.28	20.73	-33.27	54	-	-	-	-	-	-	A	V	
	*	2441	103.95	-	-	97.86	32.02	8.28	34.21	126	18	P	V	
	*	2441	79.19	-	-	-	-	-	-	-	-	A	V	
		2492.72	45.54	-28.46	74	39.37	32	8.39	34.22	126	18	P	V	
		2492.72	20.78	-33.22	54	-	-	-	-	-	-	A	V	



BT CH 78 2480MHz	*	2480	105.49	-	-	99.35	32	8.36	34.22	340	294	P	H
	*	2480	80.73	-	-	-	-	-	-	-	-	A	H
		2487.88	49.83	-24.17	74	43.67	32	8.38	34.22	340	294	P	H
		2487.88	25.07	-28.93	54	-	-	-	-	-	-	A	H
													H
													H
	*	2480	104.04	-	-	97.9	32	8.36	34.22	100	29	P	V
	*	2480	79.28	-	-	-	-	-	-	-	-	A	V
		2483.52	50.56	-23.44	74	44.41	32	8.37	34.22	100	29	P	V
		2483.52	25.8	-28.2	54	-	-	-	-	-	-	A	V
													V
													V
Remark	1. No other spurious found. 2. All results are PASS against Peak and Average limit line.												



2.4GHz 2400~2483.5MHz
BT (Harmonic @ 3m)

BT	Note	Frequency (MHz)	Level (dBμV/m)	Margin (dB)	Limit Line (dBμV/m)	Read Level (dBμV)	Antenna Factor (dB/m)	Path Loss (dB)	Preamp Factor (dB)	Ant Pos (cm)	Table Pos (deg)	Peak Avg. (P/A)	Pol. (H/V)	
BT CH 00 2402MHz		4804	55.36	-18.64	74	67.6	34.02	12.78	59.04	277	302	P	H	
		4804	30.6	-23.4	54	-	-	-	-	-	-	A	H	
													H	
													H	
													H	
													H	
													H	
													H	
													H	
													H	
													H	
													H	
													H	
			4804	52.06	-21.94	74	64.3	34.02	12.78	59.04	100	65	P	V
			4804	27.3	-26.7	54	-	-	-	-	-	-	A	V
														V
														V
														V
														V
														V
													V	
													V	
													V	



Emission below 1GHz

2.4GHz BT (LF)

BT	Note	Frequency	Level	Margin	Limit	Read	Antenna	Path	Preamp	Ant	Table	Peak	Pol.	
		(MHz)	(dBμV/m)	(dB)	(dBμV/m)	(dBμV)	(dB/m)	(dB)	(dB)	(cm)	(deg)	(P/A)	(H/V)	
2.4GHz BT LF		30.54	23.04	-16.96	40	27.94	23.98	1.06	29.94	-	-	P	H	
		47.82	25.79	-14.21	40	39.04	15.33	1.34	29.92	-	-	P	H	
		216.03	31.83	-14.17	46	44.1	15.03	2.53	29.83	-	-	P	H	
		443.5	29.95	-16.05	46	33.2	22.85	3.66	29.76	-	-	P	H	
		796.3	32.9	-13.1	46	29.31	27.89	4.99	29.29	-	-	P	H	
		928.6	34.38	-11.62	46	28.43	29.23	5.47	28.75	-	-	P	H	
														H
														H
														H
														H
														H
														H
			30	32.04	-7.96	40	36.82	24.11	1.05	29.94	-	-	P	V
			48.36	30	-10	40	43.53	15.04	1.35	29.92	-	-	P	V
			220.89	31.88	-14.12	46	43.78	15.38	2.55	29.83	-	-	P	V
			517.7	30.47	-15.53	46	32.58	23.82	3.86	29.79	-	-	P	V
			779.5	33.55	-12.45	46	30.16	27.84	4.91	29.36	-	-	P	V
			858.6	36.35	-9.65	46	31.33	28.97	5.16	29.11	-	-	P	V
														V
														V
													V	
													V	
													V	

Remark

- No other spurious found.
- All results are PASS against limit line.
- The emission position marked as "-" means no suspected emission found and emission level has at least 6dB margin against limit or emission is noise floor only.



<External Antenna>

2.4GHz 2400~2483.5MHz

BT (Band Edge @ 3m)

BT	Note	Frequency	Level	Margin	Limit Line	Read Level	Antenna Factor	Path Loss	Preamp Factor	Ant Pos	Table Pos	Peak Avg.	Pol.	
		(MHz)	(dBμV/m)	(dB)	(dBμV/m)	(dBμV)	(dB/m)	(dB)	(dB)	(cm)	(deg)	(P/A)	(H/V)	
BT CH00 2402MHz		2385.81	45.54	-28.46	74	39.48	32.1	8.16	34.2	135	280	P	H	
		2385.81	20.78	-33.22	54	-	-	-	-	-	-	A	H	
	*	2402	109.76	-	-	103.66	32.1	8.2	34.2	135	280	P	H	
	*	2402	85	-	-	-	-	-	-	-	-	A	H	
													H	
														H
			2311.68	45.83	-28.17	74	40.17	31.87	7.97	34.18	100	202	P	V
			2311.68	21.07	-32.93	54	-	-	-	-	-	-	A	V
	*		2402	101.7	-	-	95.6	32.1	8.2	34.2	100	202	P	V
	*		2402	76.94	-	-	-	-	-	-	-	-	A	V
													V	
													V	
BT CH 39 2441MHz		2355.64	45.55	-28.45	74	39.55	32.1	8.09	34.19	400	292	P	H	
		2355.64	20.79	-33.21	54	-	-	-	-	-	-	A	H	
	*	2441	109.54	-	-	103.45	32.02	8.28	34.21	400	292	P	H	
	*	2441	84.78	-	-	-	-	-	-	-	-	A	H	
			2493.35	44.37	-29.63	74	38.2	32	8.39	34.22	400	292	P	H
			2493.35	19.61	-34.39	54	-	-	-	-	-	-	A	H
			2376.22	45.82	-28.18	74	39.78	32.1	8.14	34.2	100	203	P	V
			2376.22	21.06	-32.94	54	-	-	-	-	-	-	A	V
	*		2441	101.92	-	-	95.83	32.02	8.28	34.21	100	203	P	V
	*		2441	77.16	-	-	-	-	-	-	-	-	A	V
			2497.97	44.87	-29.13	74	38.69	32	8.4	34.22	100	203	P	V
			2497.97	20.11	-33.89	54	-	-	-	-	-	-	A	V



BT CH 78 2480MHz	*	2480	108.94	-	-	102.8	32	8.36	34.22	387	276	P	H
		2480	84.18	30.18	54	-	-	-	-	-	-	A	H
		2483.6	52.67	-21.33	74	46.52	32	8.37	34.22	387	276	P	H
		2483.6	27.91	-26.09	54	-	-	-	-	-	-	A	H
													H
													H
	*	2480	100.48	-	-	94.34	32	8.36	34.22	388	179	P	V
		2480	75.72	21.72	54	-	-	-	-	-	-	A	V
		2488.24	46.17	-27.83	74	40.01	32	8.38	34.22	388	179	P	V
		2488.24	21.41	-32.59	54	-	-	-	-	-	-	A	V
													V
													V
Remark	1. No other spurious found. 2. All results are PASS against Peak and Average limit line.												



2.4GHz 2400~2483.5MHz
BT (Harmonic @ 3m)

BT	Note	Frequency (MHz)	Level (dBμV/m)	Margin (dB)	Limit Line (dBμV/m)	Read Level (dBμV)	Antenna Factor (dB/m)	Path Loss (dB)	Preamp Factor (dB)	Ant Pos (cm)	Table Pos (deg)	Peak Avg. (P/A)	Pol. (H/V)	
BT CH 00 2402MHz		4804	53.06	-20.94	74	65.3	34.02	12.78	59.04	400	289	P	H	
		4804	28.3	-25.7	54	-	-	-	-	-	-	A	H	
													H	
													H	
													H	
													H	
													H	
													H	
													H	
													H	
													H	
													H	
			4804	49.56	-24.44	74	61.8	34.02	12.78	59.04	400	18	P	V
			4804	24.8	-29.2	54	-	-	-	-	-	-	A	V
														V
														V
														V
														V
														V
														V
													V	
													V	



Emission below 1GHz

2.4GHz BT (LF)

BT	Note	Frequency	Level	Margin	Limit	Read	Antenna	Path	Preamp	Ant	Table	Peak	Pol.	
		(MHz)	(dBμV/m)	(dB)	(dBμV/m)	(dBμV)	(dB/m)	(dB)	(dB)	(cm)	(deg)	(P/A)	(H/V)	
2.4GHz BT LF		48.36	28.05	-11.95	40	41.58	15.04	1.35	29.92	-	-	P	H	
		179.58	29.14	-14.36	43.5	41.48	15.07	2.42	29.83	-	-	P	H	
		229.53	32.9	-13.1	46	43.91	16.24	2.57	29.82	-	-	P	H	
		878.9	32.25	-13.75	46	27.06	28.88	5.29	28.98	-	-	P	H	
		932.8	34.16	-11.84	46	28.1	29.32	5.48	28.74	-	-	P	H	
		975.5	34.29	-19.71	54	26.42	30.73	5.58	28.44	-	-	P	H	
														H
														H
														H
														H
														H
														H
														H
			30	31.65	-8.35	40	36.43	24.11	1.05	29.94	-	-	P	V
			48.63	29.59	-10.41	40	43.26	14.9	1.35	29.92	-	-	P	V
			228.72	34.07	-11.93	46	45.17	16.15	2.57	29.82	-	-	P	V
			909.7	34.9	-11.1	46	29.52	28.75	5.44	28.81	-	-	P	V
			959.4	36.87	-9.13	46	29.24	30.68	5.54	28.59	-	-	P	V
			998.6	37.39	-16.61	54	29.72	30.24	5.65	28.22	-	-	P	V
														V
													V	
													V	
													V	
													V	
													V	

Remark

- No other spurious found.
- All results are PASS against limit line.
- The emission position marked as "-" means no suspected emission found and emission level has at least 6dB margin against limit or emission is noise floor only.



Note symbol

*	Fundamental Frequency which can be ignored. However, the level of any unwanted emissions shall not exceed the level of the fundamental frequency.
!	Test result is Margin line.
P/A	Peak or Average
H/V	Horizontal or Vertical



A calculation example for radiated spurious emission is shown as below:

BT	Note	Frequency	Level	Margin	Limit	Read	Antenna	Path	Preamp	Ant	Table	Peak	Pol.
		(MHz)	(dBμV/m)	(dB)	(dBμV/m)	(dBμV)	(dB/m)	(dB)	(dB)	(cm)	(deg)	(P/A)	(H/V)
BT CH 00 2402MHz		2390	55.45	-18.55	74	54.51	32.22	4.58	35.86	103	308	P	H

1. Path Loss(dB) = Cable loss(dB) + Filter loss(dB) + Attenuator loss(dB)
2. Level(dBμV/m) =
Antenna Factor(dB/m) + Path Loss(dB) + Read Level(dBμV) - Preamp Factor(dB)
3. Margin(dB) = Level(dBμV/m) – Limit Line(dBμV/m)

For Peak Limit @ 2390MHz:

1. Level(dBμV/m)
= Antenna Factor(dB/m) + Path Loss(dB) + Read Level(dBμV) - Preamp Factor(dB)
= 32.22(dB/m) + 4.58(dB) + 54.51(dBμV) – 35.86 (dB)
= 55.45 (dBμV/m)
2. Margin(dB)
= Level(dBμV/m) – Limit Line(dBμV/m)
= 55.45(dBμV/m) – 74(dBμV/m)
= -18.55(dB)

Peak measured complies with the limit line, so test result is “PASS”.



Appendix D. Radiated Spurious Emission Plots

Test Engineer :	Jesse Wang, Stan Hsieh and Ken Wu	Temperature :	23.2~27.6°C
		Relative Humidity :	42.5~74.0%

<Sample 2>

<Internal Antenna>

2.4GHz 2400~2483.5MHz

BT (Band Edge @ 3m)

BT	2.4GHz 2400~2483.5MHz Band Edge @ 3m	
	BT CH00 2402MHz	
	Horizontal	Fundamental
Peak	<p>Site : 03CH07-HY Condition : PEAK_BE_74 3m HF_ANT_00075962 HORIZONTAL : RBW:1000.000KHz VBW:3000.000KHz SWT:Auto</p>	<p>Site : 03CH07-HY Condition : PEAK_74 3m HF_ANT_00075962 HORIZONTAL : RBW:1000.000KHz VBW:3000.000KHz SWT:Auto</p>

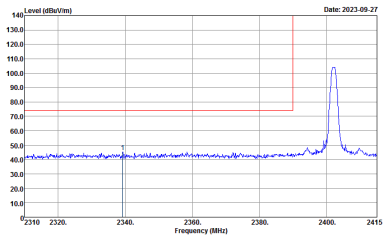
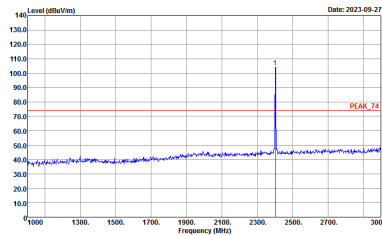

BT	2.4GHz 2400~2483.5MHz Band Edge @ 3m	
BT CH00 2402MHz		
Vertical		Fundamental
Peak	 <p data-bbox="430 683 813 728">Date: 2023-09-27 Site : 09CH07-HY Condition : PEAK_24 3m HF_ANT_00075963 VERTICAL : RBW:1000.000kHz VBW:3000.000kHz SWT:Auto</p>	 <p data-bbox="901 683 1284 728">Date: 2023-09-27 Site : 09CH07-HY Condition : PEAK_24 3m HF_ANT_00075963 VERTICAL : RBW:1000.000kHz VBW:3000.000kHz SWT:Auto</p>



BT	2.4GHz 2400~2483.5MHz Band Edge @ 3m	
BT CH39 2441MHz		
Horizontal		Fundamental
Peak	<p>Date: 2023-09-27</p> <p>Site : 03CH07-HY Condition : PEAK_BE_74 3m HF_ANT_00075962 HORIZONTAL : RBW:1000.000kHz VBW:3000.000kHz SWT:Auto</p>	<p>Date: 2023-09-27</p> <p>Site : 03CH07-HY Condition : PEAK_74 3m HF_ANT_00075962 HORIZONTAL : RBW:1000.000kHz VBW:3000.000kHz SWT:Auto</p>
Peak	<p>Date: 2023-09-27</p> <p>Site : 03CH07-HY Condition : PEAK_BE_74 3m HF_ANT_00075962 HORIZONTAL : RBW:1000.000kHz VBW:3000.000kHz SWT:Auto</p>	Left blank



BT	2.4GHz 2400~2483.5MHz Band Edge @ 3m	
BT CH39 2441MHz		
	Vertical	Fundamental
Peak	<p>Date: 2023-09-27</p> <p>Site : 03CH07-HY Condition : PEAK_BE_74 3m HF_ANT_00075962 VERTICAL : RBW:1000.000kHz VBW:3000.000kHz SWT:Auto</p>	<p>Date: 2023-09-27</p> <p>Site : 03CH07-HY Condition : PEAK_74 3m HF_ANT_00075962 VERTICAL : RBW:1000.000kHz VBW:3000.000kHz SWT:Auto</p>
Peak	<p>Date: 2023-09-27</p> <p>Site : 03CH07-HY Condition : PEAK_BE_74 3m HF_ANT_00075962 VERTICAL : RBW:1000.000kHz VBW:3000.000kHz SWT:Auto</p>	Left blank

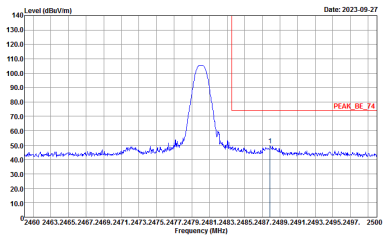
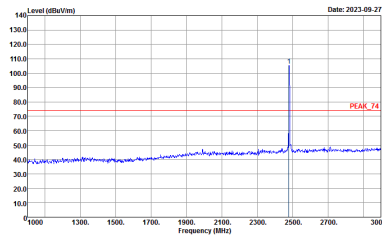

BT	2.4GHz 2400~2483.5MHz Band Edge @ 3m	
BT CH78 2480MHz		
	Horizontal	Fundamental
Peak	 <p>Date: 2023-09-27</p> <p>Site : 09CH07-HY Condition : :PEAK_BE_74 3m HF_ANT_00075962 HORIZONTAL :RBW:1000.000kHz VBW:3000.000kHz SWT:Auto</p>	 <p>Date: 2023-09-27</p> <p>Site : 09CH07-HY Condition : :PEAK_74 3m HF_ANT_00075962 HORIZONTAL :RBW:1000.000kHz VBW:3000.000kHz SWT:Auto</p>

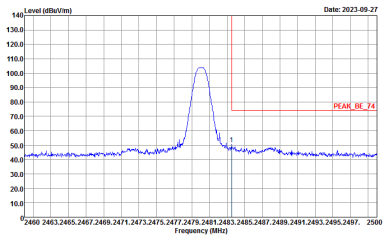
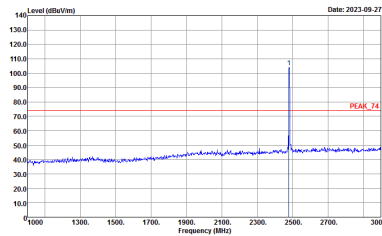

BT	2.4GHz 2400~2483.5MHz Band Edge @ 3m	
BT CH78 2480MHz		
	Vertical	Fundamental
Peak	 <p>Date: 2023-09-27</p> <p>Site : 09CH07-HY Condition : PEAK_BE_74 3m HF_ANT_00075962 VERTICAL : RBW:1000.000kHz VBW:3000.000kHz SWT:Auto</p>	 <p>Date: 2023-09-27</p> <p>Site : 09CH07-HY Condition : PEAK_74 3m HF_ANT_00075962 VERTICAL : RBW:1000.000kHz VBW:3000.000kHz SWT:Auto</p>



2.4GHz 2400~2483.5MHz

BT (Harmonic @ 3m)

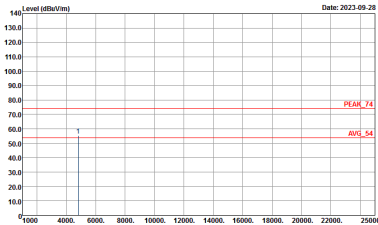
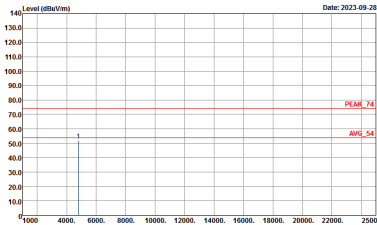
BT	2.4GHz 2400~2483.5MHz Harmonic @ 3m	
	BT CH00 2402MHz	
	Horizontal	Vertical
Peak Avg.	 <p>Site : 03CH07-HY Condition : PEAK_74 3m HF_ANT_00075962 HORIZONTAL</p>	 <p>Site : 03CH07-HY Condition : PEAK_74 3m HF_ANT_00075962 VERTICAL</p>

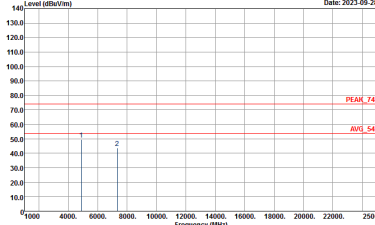
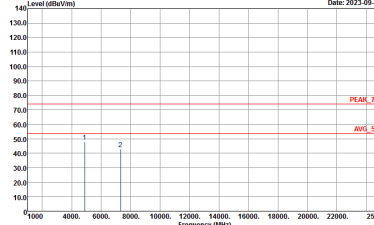

BT	2.4GHz 2400~2483.5MHz Harmonic @ 3m	
BT CH39 2441MHz		
Horizontal		Vertical
Peak Avg.	 <p>Site : 03CH07-HY Condition : PEAK_74 3m HF_ANT_00075962 HORIZONTAL</p>	 <p>Site : 03CH07-HY Condition : PEAK_74 3m HF_ANT_00075962 VERTICAL</p>

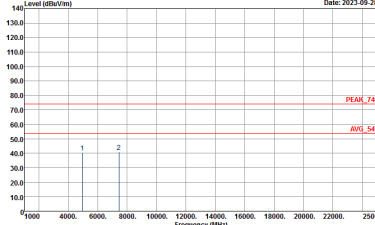
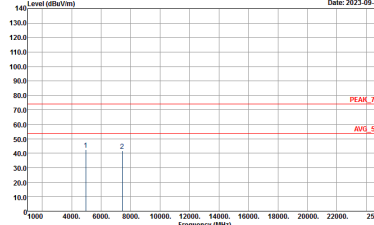

BT	2.4GHz 2400~2483.5MHz Harmonic @ 3m	
	BT CH78 2480MHz	
	Horizontal	Vertical
Peak Avg.	 <p>Date: 2023-09-28</p> <p>Site : 03CH07-HY Condition : PEAK_74 3m HF_ANT_00075962 HORIZONTAL</p>	 <p>Date: 2023-09-28</p> <p>Site : 03CH07-HY Condition : PEAK_74 3m HF_ANT_00075962 VERTICAL</p>



Emission below 1GHz

2.4GHz BT (LF)

BT	2.4GHz 2400~2483.5MHz	
	BT LF	
	Horizontal	Vertical
QP / Peak		



<External Antenna>

2.4GHz 2400~2483.5MHz

BT (Band Edge @ 3m)

BT	2.4GHz 2400~2483.5MHz Band Edge @ 3m	
BT CH00 2402MHz		
	Horizontal	Fundamental
Peak	<p>Site : 03CH07-HH Condition : PEAK_85_74 3m HF_ANT_00075962 HORIZONTAL : RBW:1000.000kHz VBW:3000.000kHz SWTA:Auto</p>	<p>Site : 03CH07-HH Condition : PEAK_74 3m HF_ANT_00075962 HORIZONTAL : RBW:1000.000kHz VBW:3000.000kHz SWTA:Auto</p>

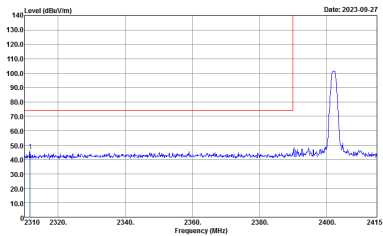
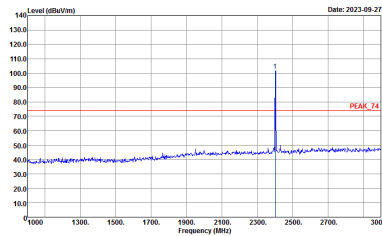

BT	2.4GHz 2400~2483.5MHz Band Edge @ 3m	
	BT CH00 2402MHz	
	Vertical	Fundamental
Peak	 <p data-bbox="430 683 813 728">Date: 2023-09-27 Site : 09CH07-HY Condition : PEAK_BE_74 3m HF_ANT_00075963 VERTICAL : RBW:1000.000kHz VBW:3000.000kHz SWT:Auto</p>	 <p data-bbox="901 683 1284 728">Date: 2023-09-27 Site : 09CH07-HY Condition : PEAK_74 3m HF_ANT_00075963 VERTICAL : RBW:1000.000kHz VBW:3000.000kHz SWT:Auto</p>



BT	2.4GHz 2400~2483.5MHz Band Edge @ 3m	
BT CH39 2441MHz		
Horizontal		Fundamental
Peak	<p>Date: 2023-09-27</p> <p>Site : 03CH07-HY Condition : PEAK_BE_74 3m HF_ANT_00075962 HORIZONTAL : RBW:1000.000kHz VBW:3000.000kHz SWT:Auto</p>	<p>Date: 2023-09-27</p> <p>Site : 03CH07-HY Condition : PEAK_74 3m HF_ANT_00075962 HORIZONTAL : RBW:1000.000kHz VBW:3000.000kHz SWT:Auto</p>
Peak	<p>Date: 2023-09-27</p> <p>Site : 03CH07-HY Condition : PEAK_BE_74 3m HF_ANT_00075962 HORIZONTAL : RBW:1000.000kHz VBW:3000.000kHz SWT:Auto</p>	Left blank

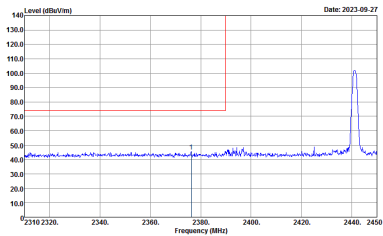
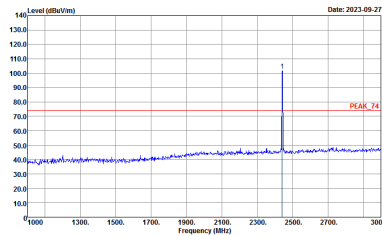
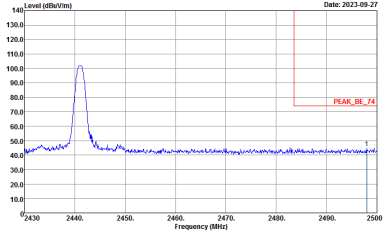

BT	2.4GHz 2400~2483.5MHz Band Edge @ 3m	
BT CH39 2441MHz		
Vertical		Fundamental
Peak	 <p>Date: 2023-09-27</p> <p>Site : 03CH07-HY Condition : PEAK_BE_74 3m HF_ANT_00075962 VERTICAL : RBW:1000.000kHz VBW:3000.000kHz SWTA:Auto</p>	 <p>Date: 2023-09-27</p> <p>Site : 03CH07-HY Condition : PEAK_74 3m HF_ANT_00075962 VERTICAL : RBW:1000.000kHz VBW:3000.000kHz SWTA:Auto</p>
Peak	 <p>Date: 2023-09-27</p> <p>Site : 03CH07-HY Condition : PEAK_BE_74 3m HF_ANT_00075962 VERTICAL : RBW:1000.000kHz VBW:3000.000kHz SWTA:Auto</p>	Left blank

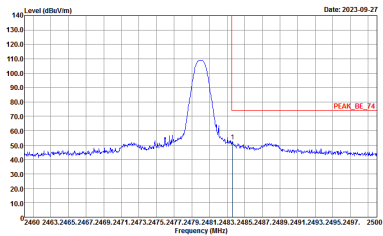
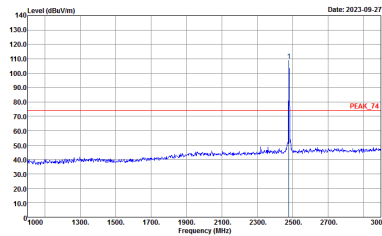

BT	2.4GHz 2400~2483.5MHz Band Edge @ 3m	
BT CH78 2480MHz		
	Horizontal	Fundamental
Peak	 <p>Date: 2023-09-27</p> <p>Site : 09CH07-HY Condition : PEAK_BE_74 3m HF_ANT_00075962 HORIZONTAL : RBW:1000.000kHz VBW:3000.000kHz SWT:Auto</p>	 <p>Date: 2023-09-27</p> <p>Site : 09CH07-HY Condition : PEAK_74 3m HF_ANT_00075962 HORIZONTAL : RBW:1000.000kHz VBW:3000.000kHz SWT:Auto</p>

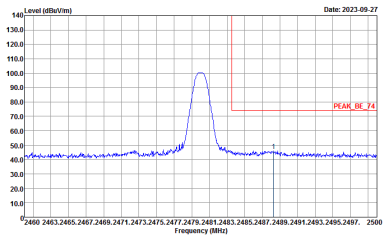
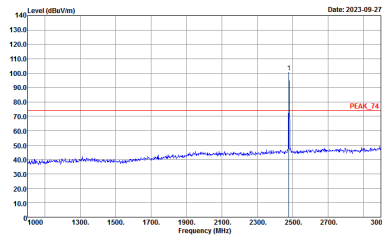

BT	2.4GHz 2400~2483.5MHz Band Edge @ 3m	
BT CH78 2480MHz		
	Vertical	Fundamental
Peak	 <p>Date: 2023-09-27</p> <p>Site : 09CH07-HY Condition : PEAK_BE_74 3m HF_ANT_00075962 VERTICAL : RBW:1000.000kHz VBW:3000.000kHz SWT:Auto</p>	 <p>Date: 2023-09-27</p> <p>Site : 09CH07-HY Condition : PEAK_74 3m HF_ANT_00075962 VERTICAL : RBW:1000.000kHz VBW:3000.000kHz SWT:Auto</p>



2.4GHz 2400~2483.5MHz

BT (Harmonic @ 3m)

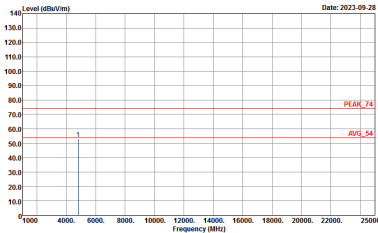
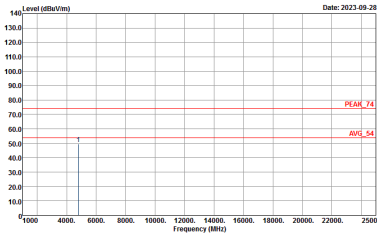
BT	2.4GHz 2400~2483.5MHz Harmonic @ 3m	
	BT CH00 2402MHz	
	Horizontal	Vertical
Peak Avg.	 <p>Site : 03CH07-HY Condition : PEAK_74 3m HF_ANT_00075962 HORIZONTAL</p>	 <p>Site : 03CH07-HY Condition : PEAK_74 3m HF_ANT_00075962 VERTICAL</p>

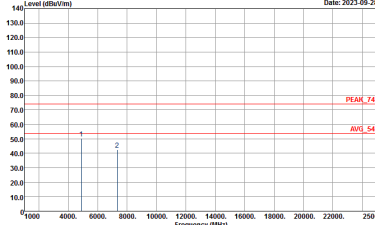
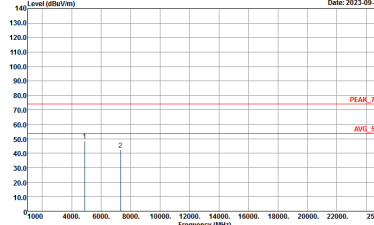

BT	2.4GHz 2400~2483.5MHz Harmonic @ 3m	
	BT CH39 2441MHz	
	Horizontal	Vertical
Peak Avg.	 <p>Site : 03CH07-HY Condition : PEAK_74 3m HF_ANT_00075962 HORIZONTAL</p>	 <p>Site : 03CH07-HY Condition : PEAK_74 3m HF_ANT_00075962 VERTICAL</p>



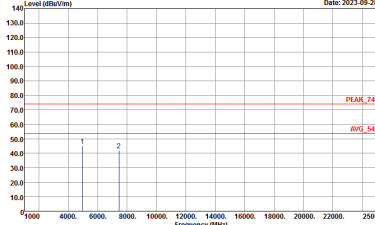
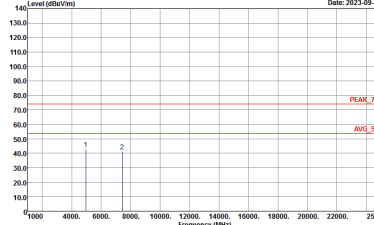

BT	2.4GHz 2400~2483.5MHz Harmonic @ 3m	
	BT CH78 2480MHz	
	Horizontal	Vertical
Peak Avg.	 <p>Site : 03CH07-HY Condition : PEAK_74 3m HF_ANT_00075962 HORIZONTAL</p>	 <p>Site : 03CH07-HY Condition : PEAK_74 3m HF_ANT_00075962 VERTICAL</p>



Emission below 1GHz

2.4GHz BT (LF)

BT	2.4GHz 2400~2483.5MHz	
	BT LF	
	Horizontal	Vertical
QP / Peak	 <p>Site : 03CH07-HY Condition : QP 3m LF-ANT-35415(6)_H HORIZONTAL</p>	 <p>Site : 03CH07-HY Condition : QP 3m LF-ANT-35415(6)_H VERTICAL</p>



Appendix E. Duty Cycle Plots

<Sample 2>

<Internal Antenna>

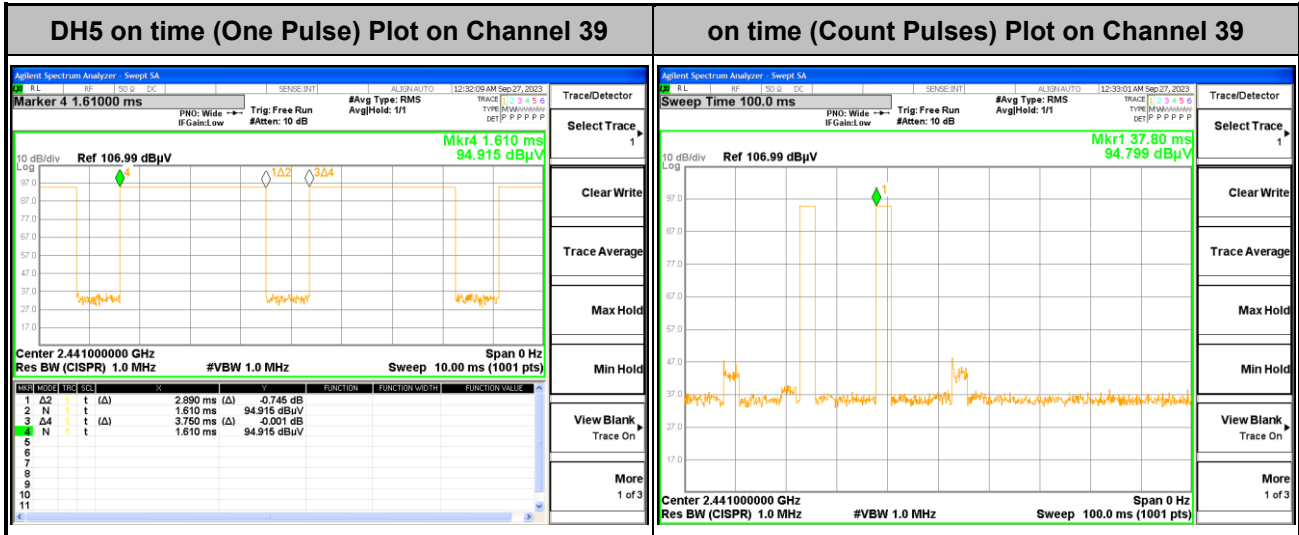

Note:

1. Worst case Duty cycle = on time/100 milliseconds = $2 * 2.89 / 100 = 5.78 \%$
2. Worst case Duty cycle correction factor = $20 * \log(\text{Duty cycle}) = -24.76 \text{ dB}$
3. DH5 has the highest duty cycle worst case and is reported.

Duty Cycle Correction Factor Consideration for AFH mode:

Bluetooth normal hopping rate is 1600Hz and reduced to 800Hz in AFH mode; due to the reduced number of hopping frequencies, with the same packet configuration the dwell time in each channel frequency within 100msec period is longer in AFH mode than normal mode.

In AFH mode, the minimum hopping frequencies are 20, to get the longest dwell time DH5 packet is observed; the on time period to have DH5 packet completing one hopping sequence is

$$2.89 \text{ ms} \times 20 \text{ channels} = 57.8 \text{ ms}$$

There cannot be 2 complete hopping sequences within 100ms period, considering the random hopping behavior, maximum 2 hops can be possibly observed within the period. $[100 \text{ ms} / 57.8 \text{ ms}] = 2 \text{ hops}$

Thus, the maximum possible ON time:

$$2.89 \text{ ms} \times 2 = 5.78 \text{ ms}$$

Worst case Duty Cycle Correction factor, which is derived from the maximum possible ON time,

$$20 \times \log(5.78 \text{ ms}/100 \text{ ms}) = -24.76 \text{ dB}$$



<External Antenna>

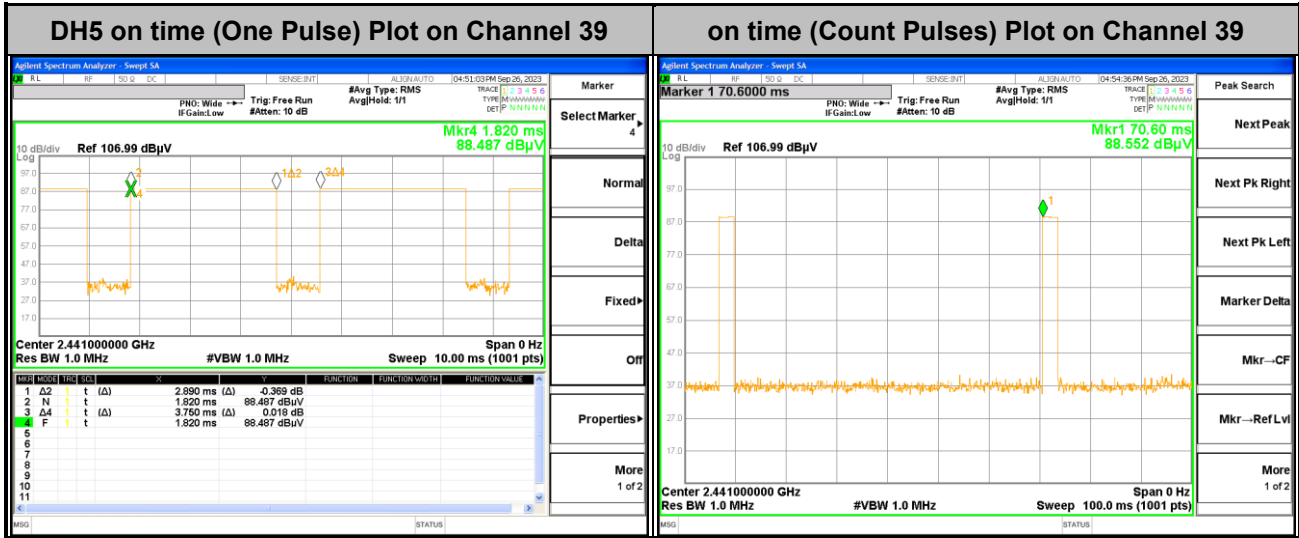

Note:

1. Worst case Duty cycle = on time/100 milliseconds = 2 * 2.89 / 100 = 5.78 %
2. Worst case Duty cycle correction factor = 20*log(Duty cycle) = -24.76 dB
3. DH5 has the highest duty cycle worst case and is reported.

Duty Cycle Correction Factor Consideration for AFH mode:

Bluetooth normal hopping rate is 1600Hz and reduced to 800Hz in AFH mode; due to the reduced number of hopping frequencies, with the same packet configuration the dwell time in each channel frequency within 100msec period is longer in AFH mode than normal mode.

In AFH mode, the minimum hopping frequencies are 20, to get the longest dwell time DH5 packet is observed; the on time period to have DH5 packet completing one hopping sequence is

$$2.89 \text{ ms} \times 20 \text{ channels} = 57.8 \text{ ms}$$

There cannot be 2 complete hopping sequences within 100ms period, considering the random hopping behavior, maximum 2 hops can be possibly observed within the period. [100 ms / 57.8 ms] = 2 hops

Thus, the maximum possible ON time:

$$2.89 \text{ ms} \times 2 = 5.78 \text{ ms}$$

Worst case Duty Cycle Correction factor, which is derived from the maximum possible ON time,

$$20 \times \log(5.78 \text{ ms}/100 \text{ ms}) = -24.76 \text{ dB}$$