



# FCC RF Test Report

**APPLICANT** : Zebra Technologies Corporation  
**EQUIPMENT** : RFID READER  
**BRAND NAME** : Zebra  
**MODEL NAME** : FX9600  
**FCC ID** : UZ7FX9600  
**STANDARD** : FCC Part 15 Subpart C §15.247  
**CLASSIFICATION** : (DSS) Spread Spectrum Transmitter

The product was received on Oct. 03, 2017 and testing was completed on Oct. 23, 2017. We, SPORTON INTERNATIONAL INC., would like to declare that the tested sample has been evaluated in accordance with the test procedures and has been in compliance with the applicable technical standards.

The test results in this report apply exclusively to the tested model / sample. Without written approval of SPORTON INTERNATIONAL INC., the test report shall not be reproduced except in full.

Reviewed by: Joseph Lin / Supervisor

Approved by: Jones Tsai / Manager



## **SPORTON INTERNATIONAL INC.**

**No. 52, Hwa Ya 1<sup>st</sup> Rd., Hwa Ya Technology Park, Kwei-Shan District, Tao Yuan City, Taiwan, R.O.C.**

SPORTON INTERNATIONAL INC.

TEL : 886-3-327-3456

FAX : 886-3-328-4978

FCC ID : UZ7FX9600

Page Number : 1 of 42

Report Issued Date : Nov. 02, 2017

Report Version : Rev. 02

Report Template No.: BU5-FR15CBT Version 2.0



# TABLE OF CONTENTS

**REVISION HISTORY.....3**

**SUMMARY OF TEST RESULT .....4**

**1 GENERAL DESCRIPTION.....5**

1.1 Applicant .....5

1.2 Manufacturer.....5

1.3 Product Feature of Equipment Under Test.....5

1.4 Product Specification of Equipment Under Test.....6

1.5 Modification of EUT .....6

1.6 Testing Location .....6

1.7 Applicable Standards.....7

**2 TEST CONFIGURATION OF EQUIPMENT UNDER TEST.....8**

2.1 Carrier Frequency Channel .....8

2.2 Test Mode.....9

2.3 Connection Diagram of Test System.....10

2.4 EUT Operation Test Setup .....11

2.5 Measurement Results Explanation Example.....12

**3 TEST RESULT .....13**

3.1 Number of Channel Measurement .....13

3.2 Hopping Channel Separation Measurement .....15

3.3 Dwell Time Measurement.....18

3.4 20dB and 99% Bandwidth Measurement .....20

3.5 Output Power Measurement.....25

3.6 Conducted Band Edges Measurement.....28

3.7 Conducted Spurious Emission Measurement .....31

3.8 Radiated Band Edges and Spurious Emission Measurement .....34

3.9 AC Power Line Conducted Emissions Measurement.....38

3.10 Antenna Requirements.....40

**4 LIST OF MEASURING EQUIPMENT.....41**

**5 UNCERTAINTY OF EVALUATION.....42**

**APPENDIX A. AC CONDUCTED EMISSION TEST RESULT**

**APPENDIX B. RADIATED SPURIOUS EMISSION PLOTS**

**APPENDIX C. DUTY CYCLE PLOTS**

**APPENDIX D. SETUP PHOTOGRAPHS**



### REVISION HISTORY

REPORT NO.	VERSION	DESCRIPTION	ISSUED DATE
FR751510	Rev. 01	Initial issue of report	Oct. 31, 2017
FR751510	Rev. 02	1. Add Conducted Emissions Photographs in appendix B 2. Revise description in section 3.10.3	Nov. 02, 2017



### SUMMARY OF TEST RESULT

Report Section	FCC Rule	Description	Limit	Result	Remark
3.1	15.247(a)(1)	Number of Channels	≥ 25Chs	Pass	-
3.2	15.247(a)(1)	Hopping Channel Separation	≥ 20dB BW	Pass	-
3.3	15.247(a)(1)	Dwell Time of Each Channel	≤ 0.4sec in 20sec period	Pass	-
3.4	15.247(a)(1)	20dB Bandwidth	NA	Pass	-
3.4	-	99% Bandwidth	-	Pass	-
3.5	15.247(b)(1)	Output Power	≤ 1 W	Pass	-
3.6	15.247(d)	Conducted Band Edges	≤ 20dBc	Pass	-
3.7	15.247(d)	Conducted Spurious Emission	≤ 20dBc	Pass	-
3.8	15.247(d)	Radiated Band Edges and Radiated Spurious Emission	15.209(a) & 15.247(d)	Pass	Under limit 6.27 dB at 943.300 MHz
3.9	15.207	AC Conducted Emission	15.207(a)	Pass	Under limit 12.20 dB at 16.230MHz
3.10	15.203 & 15.247(b)	Antenna Requirement	N/A	Pass	-



# 1 General Description

## 1.1 Applicant

**Zebra Technologies Corporation**  
1 Zebra Plaza, Holtsville, NY 11742-1300, USA

## 1.2 Manufacturer

**Zebra Technologies Corporation**  
1 Zebra Plaza, Holtsville, NY 11742-1300, USA

## 1.3 Product Feature of Equipment Under Test

Product Feature	
Equipment	RFID READER
Brand Name	Zebra
Model Name	FX9600
Sample 1	EUT with 8 antenna port
Sample 2	EUT with 4 antenna port
FCC ID	UZ7FX9600
EUT supports Radios application	UHF RFID
HW Version	0.0.5.0
SW Version	OS version : 2.2.10.0 Radio Firmware : 2.1.2.0 Radio RF Board : 13.0.0.0
MFD	30SEP17
EUT Stage	Production Unit

**Remark:** The above EUT's information was declared by manufacturer. Please refer to the specifications or user's manual for more detailed description.

Accessories Information		
Adapter	Brand Name	Zebra
	Model Name	PS000088A01
	Part Number	PWR-BGA24V78W0WWW
PoE	Brand Name	Zebra
	Model Name	PD-9001GR/AT/AC
	Part Number	AP-PSBIAS-2P3-ATR
Power Cable	Brand Name	Zebra
	Model Name	N/A
	Part Number	301105-419
Antenna	Brand Name	Zebra
	Model Name	AN480-CL66100WR
	Part Number	N/A
Antenna RF Cable	Brand Name	Zebra
	Model Name	CBLRD-1B40006801
	Part Number	N/A



### 1.4 Product Specification of Equipment Under Test

Standards-related Product Specification	
Tx/Rx Frequency Range	902.75 MHz ~ 927.25 MHz
Number of Channels	50
Maximum Output Power to Antenna	Conducted power from antenna side: 29.94dBm (0.9863 W)
20dB Bandwidth	0.091 MHz
99% Occupied Bandwidth	0.079 MHz
Antenna Type / Gain	External Antenna with gain 6.00 dBi
Type of Modulation	ASK

### 1.5 Modification of EUT

No modifications are made to the EUT during all test items.

### 1.6 Testing Location

Sporton Lab is accredited to ISO 17025 by Taiwan Accreditation Foundation (TAF code : 1190) and the FCC designation No. TW1190 under the FCC 2.948(e) by Mutual Recognition Agreement (MRA) in FCC Test.

Test Site	SPORTON INTERNATIONAL INC.		
Test Site Location	No. 52, Hwa Ya 1 <sup>st</sup> Rd., Hwa Ya Technology Park, Kwei-Shan District, Tao Yuan City, Taiwan, R.O.C. TEL: +886-3-327-3456 FAX: +886-3-328-4978		
Test Site No.	<b>Sporton Site No.</b>		
	TH05-HY	CO05-HY	03CH07-HY

**Note:** The test site complies with ANSI C63.4 2014 requirement.



## 1.7 Applicable Standards

According to the specifications of the manufacturer, the EUT must comply with the requirements of the following standards:

- ♦ FCC Part 15 Subpart C §15.247
- ♦ ANSI C63.10-2013

### **Remark:**

1. All test items were verified and recorded according to the standards and without any deviation during the test.
2. This EUT has also been tested and complied with the requirements of FCC Part 15, Subpart B, recorded in a separate test report.



## 2 Test Configuration of Equipment Under Test

### 2.1 Carrier Frequency Channel

Frequency Band	Channel	Freq. (MHz)	Channel	Freq. (MHz)
902.75-927.25 MHz	0	902.75	27	916.25
	1	903.25	28	916.75
	2	903.75	29	917.25
	3	904.25	30	917.75
	4	904.75	31	918.25
	5	905.25	32	918.75
	6	905.75	33	919.25
	7	906.25	34	919.75
	8	906.75	35	920.25
	9	907.25	36	920.75
	10	907.75	37	921.25
	11	908.25	38	921.75
	12	908.75	39	922.25
	13	909.25	40	922.75
	14	909.75	41	923.25
	15	910.25	42	923.75
	16	910.75	43	924.25
	17	911.25	44	924.75
	18	911.75	45	925.25
	19	912.25	46	925.75
	20	912.75	47	926.25
	21	913.25	48	926.75
	22	913.75	49	927.25
	23	914.25		
	24	914.75		
	25	915.25		
26	915.75			





## 2.2 Test Mode

- a. The EUT has been associated with peripherals and configuration operated in a manner tended to maximize its emission characteristics in a typical application. Frequency range investigated:, conduction emission (150 kHz to 30 MHz), radiation emission (9 kHz to the 10th harmonic of the highest fundamental frequency or to 40 GHz, whichever is lower)
- b. AC power line Conducted Emission was tested under maximum output power.

The following summary table is showing all test modes to demonstrate in compliance with the standard.

Summary table of Test Cases	
<b>Conducted Test Cases</b>	<b>UHF RFID</b> <b>902.75MHz~927.25MHz</b>
	Mode 1: CH00_902.75 MHz Mode 2: CH24_914.75 MHz Mode 3: CH49_927.25 MHz
<b>Radiated Test Cases</b>	<b>UHF RFID</b> <b>902.75MHz~927.25MHz</b>
	Mode 1: CH00_902.75 MHz for Sample 1 Mode 2: CH24_914.75 MHz for Sample 1 Mode 3: CH49_927.25 MHz for Sample 1 Mode 4: CH49_927.25 MHz for Sample 2
<b>AC Conducted Emission</b>	Mode 1: RFID On + RJ-45 Link with Notebook + Antenna*8 + USB (Load) + GPIO (Load) + RS-232 (Load) + Adapter (PWRS-14000-260R – PWR-BGA24V78W0WW) for Sample 1 Mode 2: RFID On + RJ-45 Link with Notebook + Antenna*8 + USB (Load) + GPIO (Load) + RS-232 (Load) + PoE for Sample 1 Mode 3: RFID On + RJ-45 Link with Notebook + Antenna*4 + USB (Load) + GPIO (Load) + RS-232 (Load) + PoE for Sample 2

## 2.3 Connection Diagram of Test System

<Radiated Spurious Emission Mode>

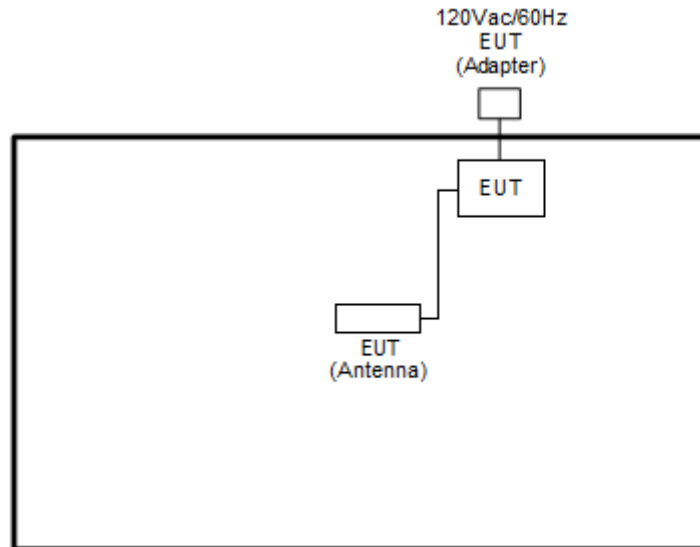

<AC Conducted Emission For Mode 1>

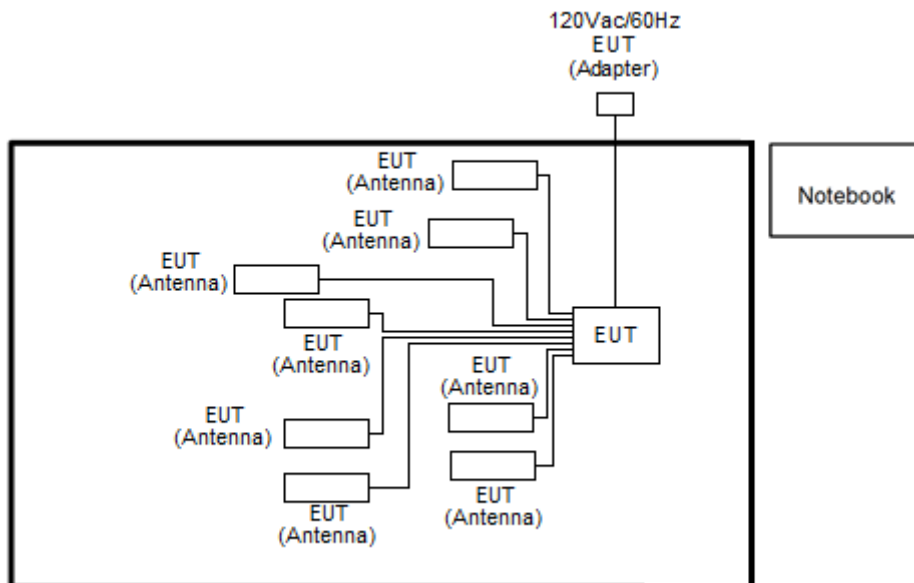

<AC Conducted Emission For Mode 2>

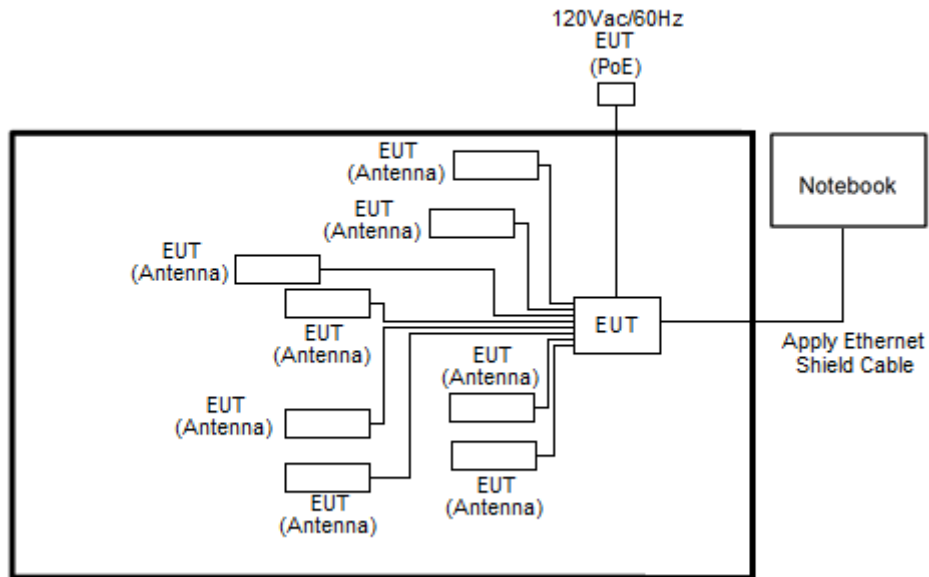

<AC Conducted Emission For Mode 3>

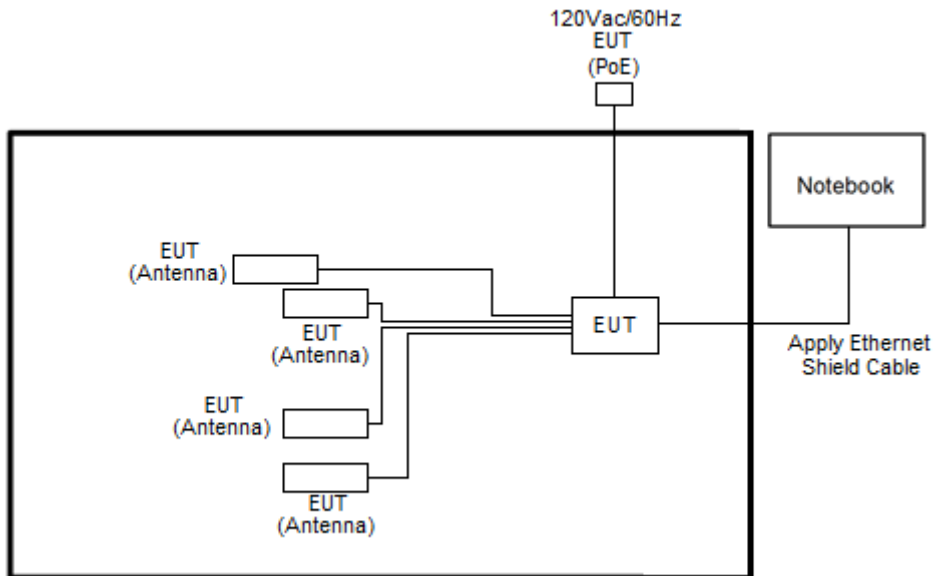

## 2.4 EUT Operation Test Setup

The RF test items, an engineering test program “Putty” was provided and enabled to make EUT transmitting signals.



## 2.5 Measurement Results Explanation Example

**For all conducted test items:**

The offset level is set in the spectrum analyzer to compensate the RF cable loss and attenuator factor between EUT conducted output port and spectrum analyzer. With the offset compensation, the spectrum analyzer reading level is exactly the EUT RF output level.

Example:

The spectrum analyzer offset is derived from RF cable loss and attenuator factor.

*Offset = RF cable loss + attenuator factor.*

Following shows an offset computation example with cable loss 4.2 dB and 10dB attenuator.

$$\begin{aligned} \text{Offset(dB)} &= \text{RF cable loss(dB)} + \text{attenuator factor(dB)}. \\ &= 4.2 + 10 = 14.2 \text{ (dB)} \end{aligned}$$

### 3 Test Result

#### 3.1 Number of Channel Measurement

##### 3.1.1 Limits of Number of Hopping Frequency

Frequency hopping systems in the 902.75-927.25 MHz band shall use at least 25 channels.

##### 3.1.2 Measuring Instruments

The measuring equipment is listed in the section 4 of this test report.

##### 3.1.3 Test Procedure

1. The testing follows ANSI C63.10-2013 clause 7.8.3.
2. The RF output of EUT was connected to the spectrum analyzer by RF cable and attenuator. The path loss was compensated to the results for each measurement.
3. Set to the maximum power setting and enable the EUT transmit continuously.
4. Enable the EUT hopping function.
5. Use the following spectrum analyzer settings: Span = the frequency band of operation; RBW = 300kHz; VBW  $\geq$  RBW; Sweep = auto; Detector function = peak; Trace = max hold.
6. The number of hopping frequency used is defined as the number of total channel.
7. Record the measurement data derived from spectrum analyzer.

##### 3.1.4 Test Setup

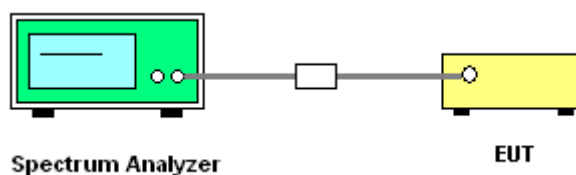



### 3.1.5 Test Result of Number of Hopping Frequency

Number of Hopping (Channel)	Limits (Channel)	Pass/Fail
50	> 25	Pass

Number of Hopping Channel Plot on Channel 00 - 49

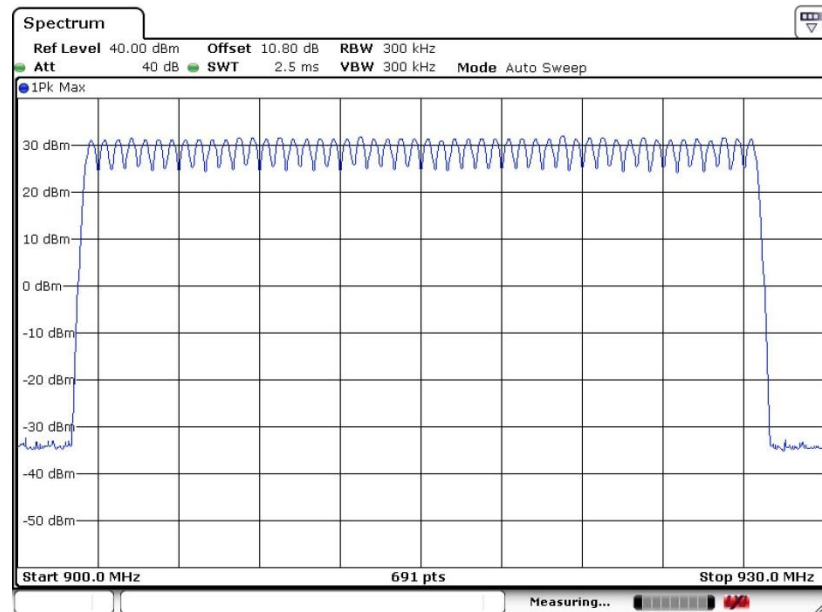

Date: 11.OCT.2017 10:08:37

## 3.2 Hopping Channel Separation Measurement

### 3.2.1 Limit of Hopping Channel Separation

Frequency hopping systems operating in the 902.75-927.25 MHz band may have hopping channel carrier frequencies that are 20 dB bandwidth of the hopping channel, whichever is greater.

### 3.2.2 Measuring Instruments

The measuring equipment is listed in the section 4 of this test report.

### 3.2.3 Test Procedures

1. The testing follows ANSI C63.10-2013 clause 7.8.2.
2. The RF output of EUT was connected to the spectrum analyzer by RF cable and attenuator. The path loss was compensated to the results for each measurement.
3. Set to the maximum power setting and enable the EUT transmit continuously.
4. Enable the EUT hopping function.
5. Use the following spectrum analyzer settings:  
Span = wide enough to capture the peaks of two adjacent channels;  
RBW = 300kHz; VBW  $\geq$  RBW; Sweep = auto; Detector function = peak; Trace = max hold.
6. Measure and record the results in the test report.

### 3.2.4 Test Setup





### 3.2.5 Test Result of Hopping Channel Separation

Mod.	NTX	CH.	Freq. (MHz)	Hopping Channel Separation Measurement (MHz)	Hopping Channel Separation Limit (MHz)	Pass/Fail
UHF RFID	1	0	902.75	0.499	0.0907	Pass
UHF RFID	1	24	914.75	0.501	0.0907	Pass
UHF RFID	1	49	927.25	0.499	0.0907	Pass

Channel Separation Plot on Channel 00 - 01

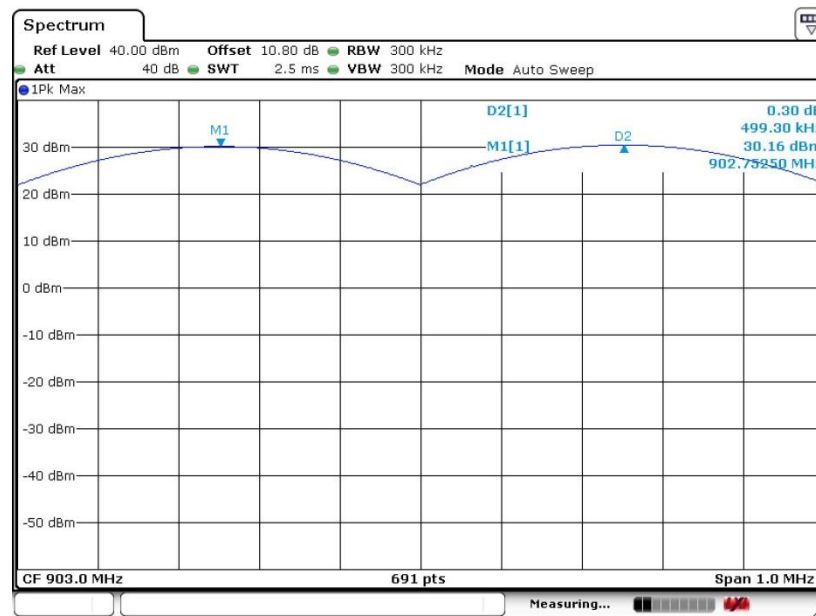

Date: 11.OCT.2017 05:13:35





Channel Separation Plot on Channel 24 - 25

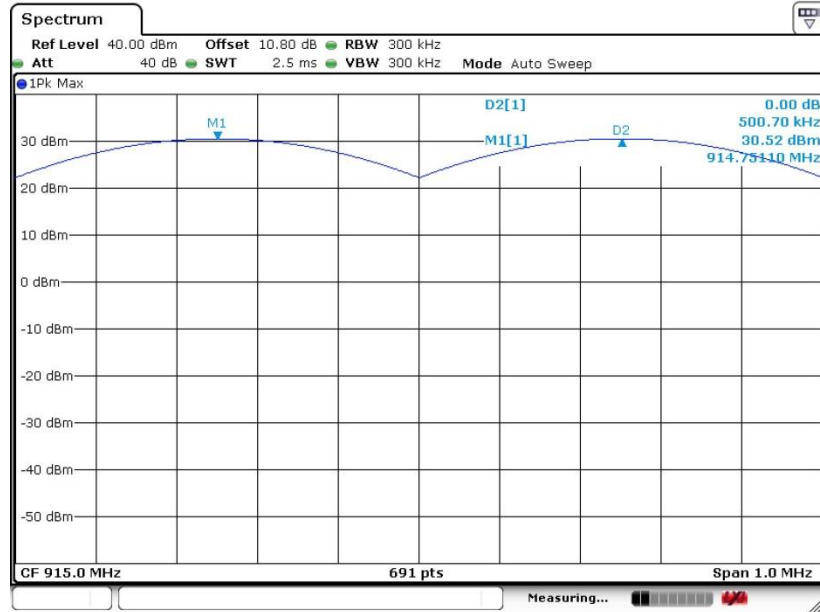

Date: 11.OCT.2017 05:14:50

Channel Separation Plot on Channel 48 - 49

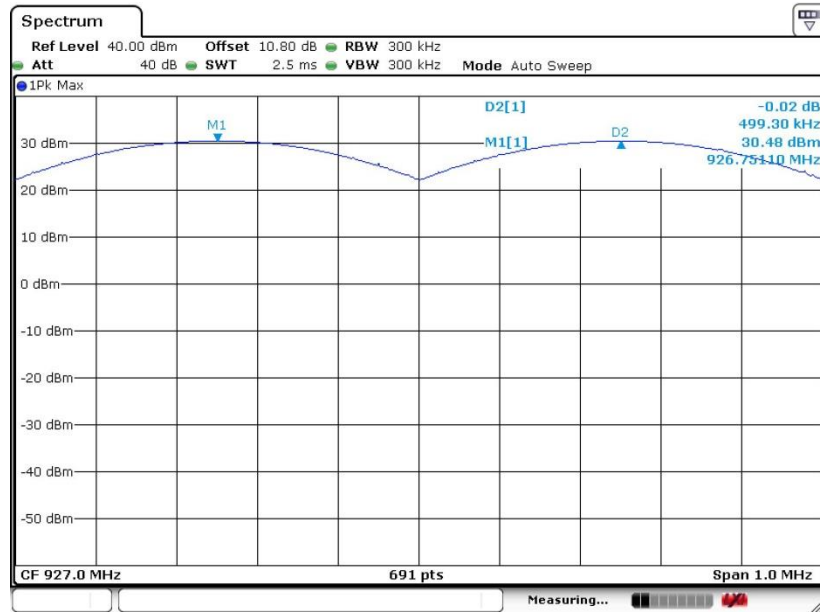

Date: 11.OCT.2017 05:18:29

### 3.3 Dwell Time Measurement

#### 3.3.1 Limit of Dwell Time

The average time of occupancy on any channel shall not be greater than 0.4 seconds within a period of 20 seconds multiplied by the number of hopping channels employed.

#### 3.3.2 Measuring Instruments

The measuring equipment is listed in the section 4 of this test report.

#### 3.3.3 Test Procedures

1. The testing follows ANSI C63.10-2013 clause 7.8.4.
2. The RF output of EUT was connected to the spectrum analyzer by RF cable and attenuator. The path loss was compensated to the results for each measurement.
3. Set to the maximum power setting and enable the EUT transmit continuously.
4. Enable the EUT hopping function.
5. Use the following spectrum analyzer settings: Span = zero span, centered on a hopping channel; RBW = 1 MHz; VBW  $\geq$  RBW; Sweep = as necessary to capture the entire dwell time per hopping channel; Detector function = peak; Trace = max hold.
6. Measure and record the results in the test report.

#### 3.3.4 Test Setup

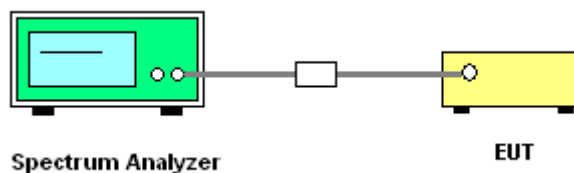

#### 3.3.5 Test Result of Dwell Time

Mod.	Channel Number Rate	Package Transfer Time (msec)	Hops Over Occupancy Time(hops)	Dwell Time (sec)	Limits (sec)	Pass/Fail
Nomal	50	388.41	51.00	0.396	0.4	Pass



Package Transfer Time Plot

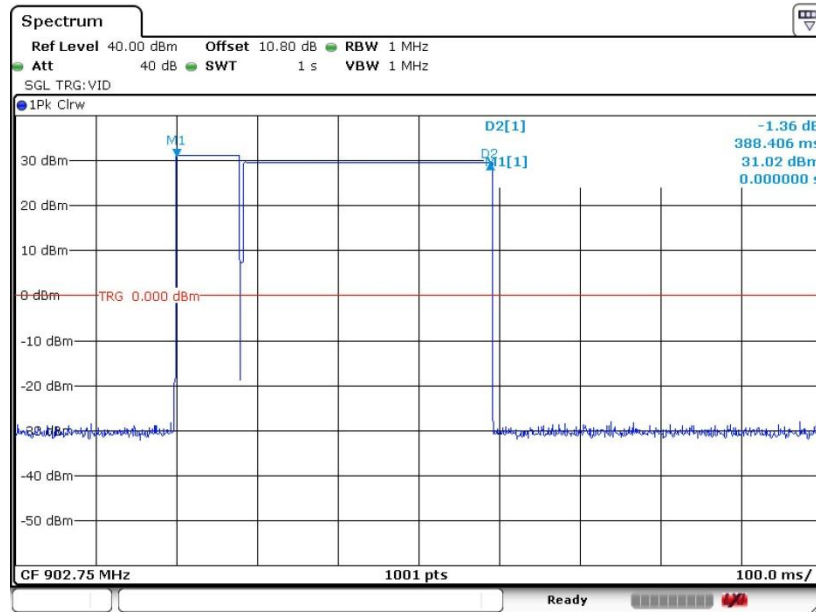

Date: 11.OCT.2017 09:51:52

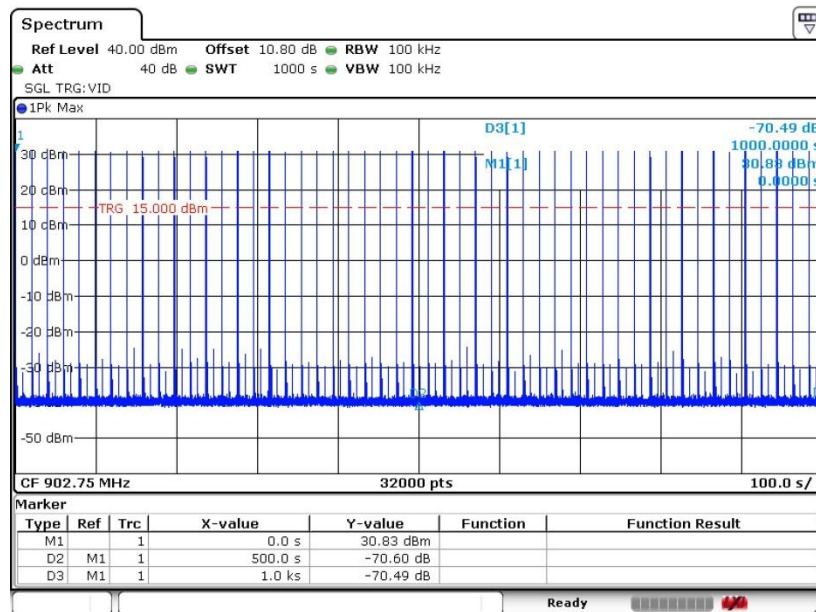

Date: 23.OCT.2017 16:22:42

Remark: Dwell Time(s) = Hops Over Occupancy Time (hops) x Package Transfer Time

### 3.4 20dB and 99% Bandwidth Measurement

#### 3.4.1 Limit of 20dB and 99% Bandwidth

Reporting only

#### 3.4.2 Measuring Instruments

The measuring equipment is listed in the section 4 of this test report.

#### 3.4.3 Test Procedures

1. The testing follows ANSI C63.10-2013 clause 6.9.2 and 6.9.3.
2. The RF output of EUT was connected to the spectrum analyzer by RF cable and attenuator. The path loss was compensated to the results for each measurement.
3. Set to the maximum power setting and enable the EUT transmit continuously.
4. Use the following spectrum analyzer settings for 20dB Bandwidth measurement.  
Span = approximately 2 to 5 times the 20 dB bandwidth, centered on a hopping channel;  
RBW  $\geq$  1% of the 20 dB bandwidth; VBW  $\geq$  RBW; Sweep = auto; Detector function = peak;  
Trace = max hold.
5. Use the following spectrum analyzer settings for 99 % Bandwidth measurement.  
Span = approximately 1.5 to 5 times the 99% bandwidth, centered on a hopping channel;  
RBW  $\geq$  1% of the 99% bandwidth; VBW  $\geq$  RBW; Sweep = auto; Detector function = peak;  
Trace = max hold.
6. Measure and record the results in the test report.

#### 3.4.4 Test Setup

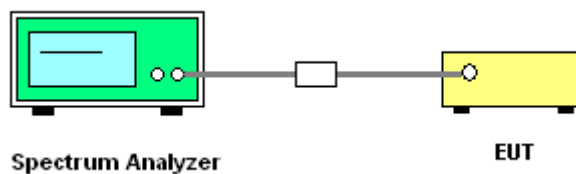



3.4.5 Test Result of 20dB Bandwidth

Mod.	N <sub>TX</sub>	CH.	Freq.(MHz)	20db BW (MHz)	Pass/Fail
UHF RFID	1	0	902.75	0.091	Pass
UHF RFID	1	24	914.75	0.091	Pass
UHF RFID	1	49	927.25	0.091	Pass

20 dB Bandwidth Plot on Channel 00

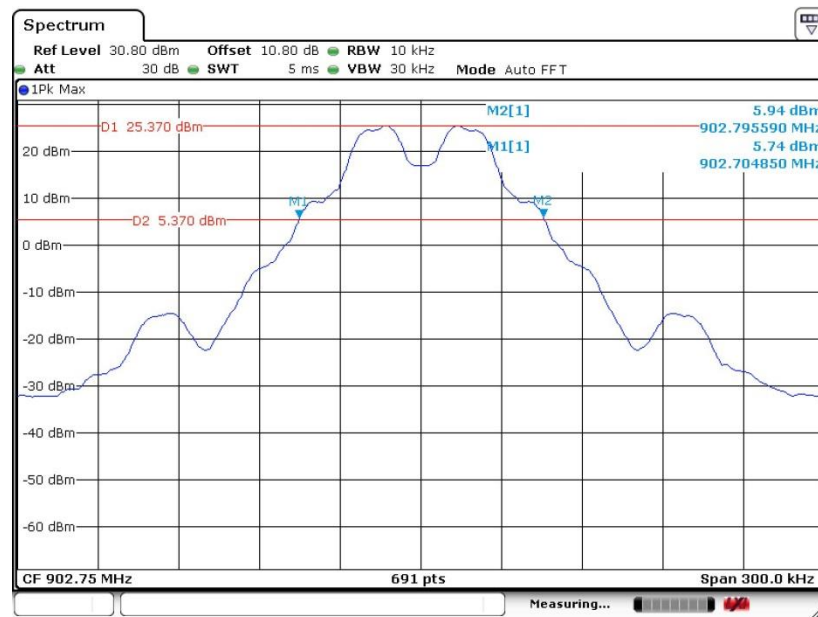



### 20 dB Bandwidth Plot on Channel 24

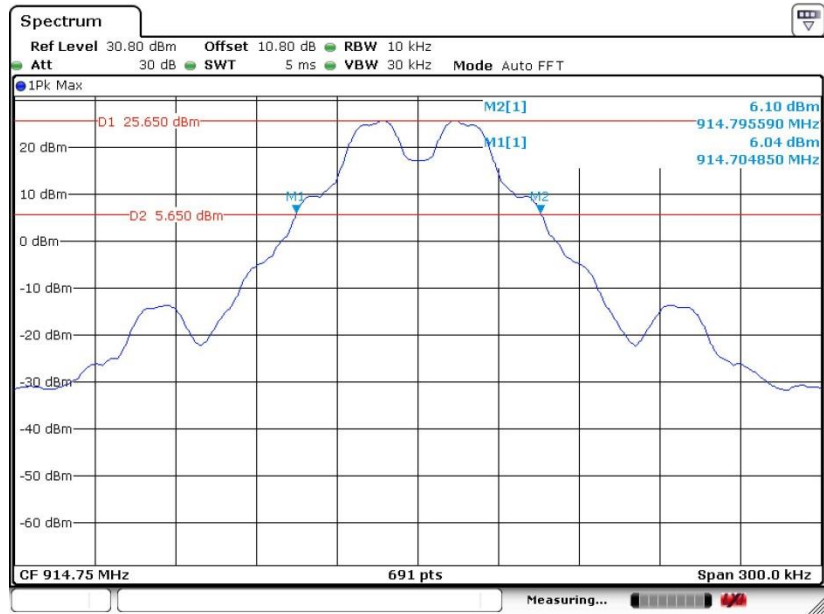

Date: 11.OCT.2017 10:19:40

### 20 dB Bandwidth Plot on Channel 49

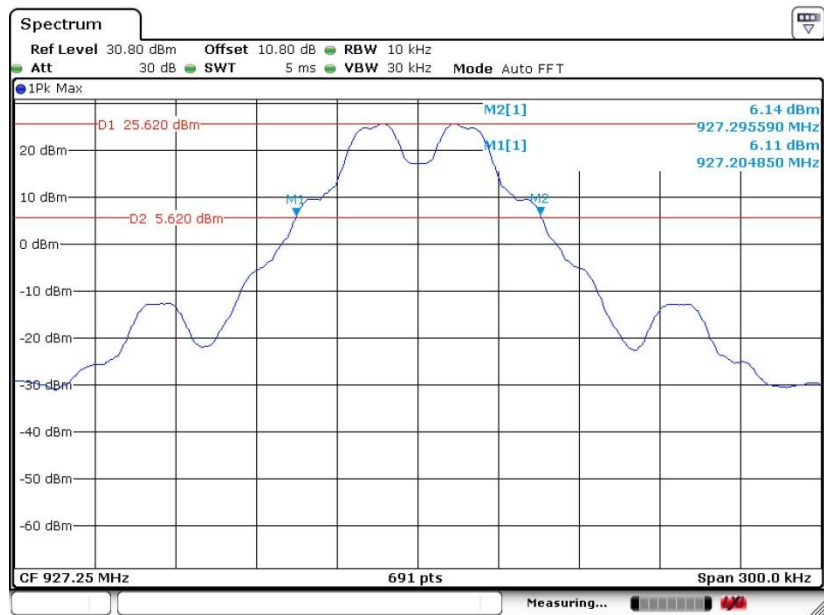

Date: 11.OCT.2017 10:21:08



3.4.6 Test Result of 99% Occupied Bandwidth

Mod.	NTX	CH.	Freq. (MHz)	99% Bandwidth (MHz)	Pass/Fail
UHF RFID	1	0	902.75	0.079	Pass
UHF RFID	1	24	914.75	0.079	Pass
UHF RFID	1	49	927.25	0.079	Pass

99% Occupied Bandwidth Plot on Channel 00

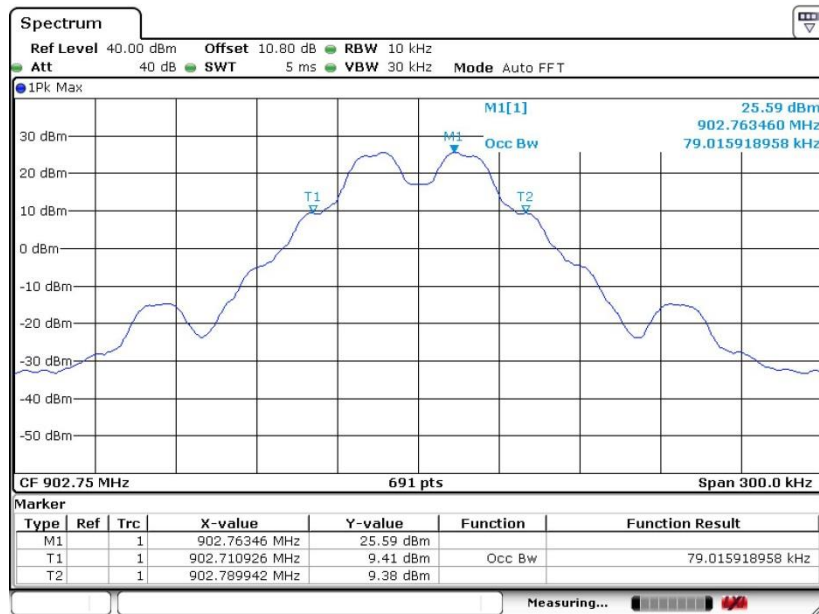

Date: 11.OCT.2017 08:08:30



### 99% Occupied Bandwidth Plot on Channel 24

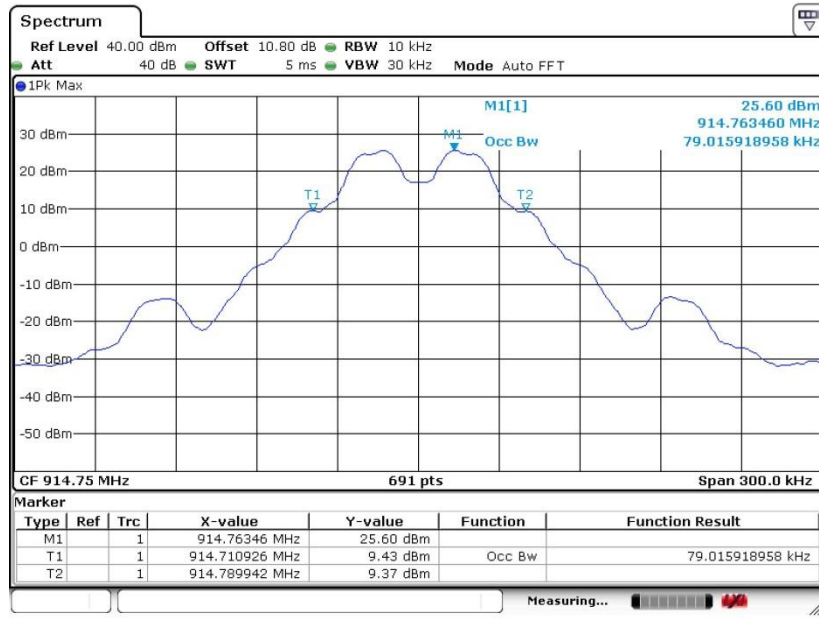

Date: 11.OCT.2017 08:07:46

### 99% Occupied Bandwidth Plot on Channel 49

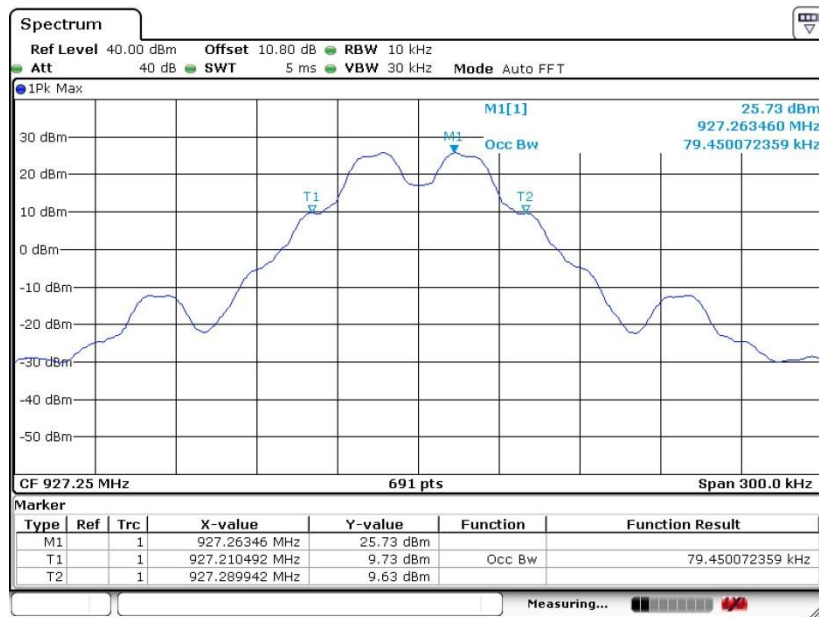

Date: 11.OCT.2017 08:05:26

Note : The occupied channel bandwidth is maintained within the band of operation for all of the modulations.



## 3.5 Output Power Measurement

### 3.5.1 Limit of Output Power

Section 15.247 (a) Operation under the provisions of this Section is limited to frequency hopping and digitally modulated intentional radiators that comply with the following provisions:

(1)(i) For frequency hopping systems operating in the 902-928 MHz band: if the 20 dB bandwidth of the hopping channel is less than 250 kHz, the system shall use at least 50 hopping frequencies and the average time of occupancy on any frequency shall not be greater than 0.4 seconds within a 20 second period; if the 20 dB bandwidth of the hopping channel is 250 kHz or greater, the system shall use at least 25 hopping frequencies and the average time of occupancy on any frequency shall not be greater than 0.4 seconds within a 10 second period. The maximum allowed 20 dB bandwidth of the hopping channel is 500 kHz.

Section 15.247 (b) The maximum peak conducted output power of the intentional radiator shall not exceed the following: (2) For frequency hopping systems operating in the 902-928 MHz band: 1 watt for systems employing at least 50 hopping channels; and, 0.25 watts for systems employing less than 50 hopping channels, but at least 25 hopping channels, as permitted under paragraph (a)(1)(i) of this section.

### 3.5.2 Measuring Instruments

The measuring equipment is listed in the section 4 of this test report.

### 3.5.3 Test Procedures

1. The testing follows ANSI C63.10-2013 clause 7.8.5.
2. The RF output of EUT was connected to the power meter by RF cable and attenuator. The path loss was compensated to the results for each measurement.
3. Set to the maximum power setting and enable the EUT transmit continuously.
4. Measure the conducted output power with cable loss and record the results in the test report.
5. Measure and record the results in the test report.

### 3.5.4 Test Setup

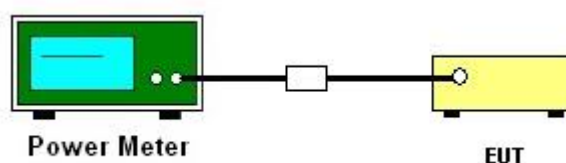



3.5.5 Test Result of Output Power

Port 1			
Frequacy(MHz)	Conducted power from FX9600 side	cable loss	Conducted power from antenna side
902.75 MHz	30.29	0.7	29.59
914.75 MHz	30.36	0.7	29.66
927.25 MHz	30.4	0.7	29.7

Port 2			
Frequacy(MHz)	Conducted power from FX9600 side	cable loss	Conducted power from antenna side
902.75 MHz	30.64	0.7	29.94
914.75 MHz	30.31	0.7	29.61
927.25 MHz	30.44	0.7	29.74

Port 3			
Frequacy(MHz)	Conducted power from FX9600 side	cable loss	Conducted power from antenna side
902.75 MHz	30.29	0.7	29.59
914.75 MHz	30.44	0.7	29.74
927.25 MHz	30.57	0.7	29.87

Port 4			
Frequacy(MHz)	Conducted power from FX9600 side	cable loss	Conducted power from antenna side
902.75 MHz	30.27	0.7	29.57
914.75 MHz	30.36	0.7	29.66
927.25 MHz	30.33	0.7	29.63

Port 5			
Frequacy(MHz)	Conducted power from FX9600 side	cable loss	Conducted power from antenna side
902.75 MHz	30.35	0.7	29.65
914.75 MHz	30.45	0.7	29.75
927.25 MHz	30.39	0.7	29.69



Port 6			
Frequacy(MHz)	Conducted power from FX9600 side	cable loss	Conducted power from antenna side
902.75 MHz	30.36	0.7	29.66
914.75 MHz	30.33	0.7	29.63
927.25 MHz	30.42	0.7	29.72

Port 7			
Frequacy(MHz)	Conducted power from FX9600 side	cable loss	Conducted power from antenna side
902.75 MHz	30.38	0.7	29.68
914.75 MHz	30.49	0.7	29.79
927.25 MHz	30.38	0.7	29.68

Port 8			
Frequacy(MHz)	Conducted power from FX9600 side	cable loss	Conducted power from antenna side
902.75 MHz	30.24	0.7	29.54
914.75 MHz	30.29	0.7	29.59
927.25 MHz	30.35	0.7	29.65

Power Limit (dBm)	30.00	Test Result	Pass
-------------------	-------	-------------	------

## 3.6 Conducted Band Edges Measurement

### 3.6.1 Limit of Band Edges

In any 100 kHz bandwidth outside the intentional radiation frequency band, the radio frequency power shall be at least 20 dB below the highest level of the radiated power. In addition, radiated emissions which fall in the restricted bands must also comply with the radiated emission limits.

### 3.6.2 Measuring Instruments

The measuring equipment is listed in the section 4 of this test report.

### 3.6.3 Test Procedures

1. The testing follows ANSI C63.10-2013 clause 7.8.6.
2. Set to the maximum power setting and enable the EUT transmit continuously.
3. Set RBW = 100kHz, VBW = 300kHz. Band edge emissions must be at least 20 dB down from the highest emission level within the authorized band as measured with a 100kHz RBW. The attenuation shall be 30 dB instead of 20 dB when RMS conducted output power procedure is used.
4. Enable hopping function of the EUT and then repeat step 2. and 3.
5. Measure and record the results in the test report.

### 3.6.4 Test Setup

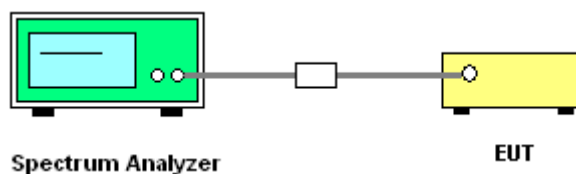



### 3.6.5 Test Result of Conducted Band Edges

Low Band Edge Plot on Channel 00

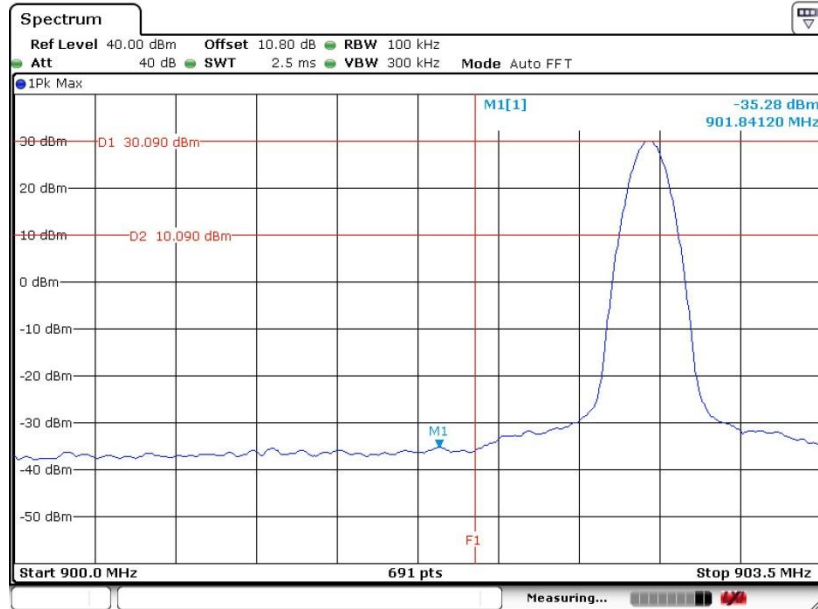

High Band Edge Plot on Channel 49

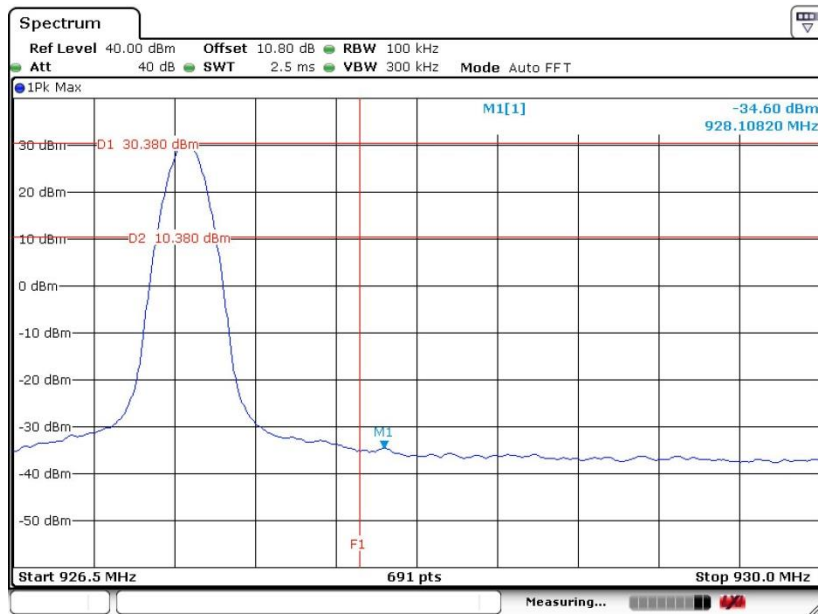



### 3.6.6 Test Result of Conducted Hopping Mode Band Edges

#### Hopping Mode Low Band Edge Plot

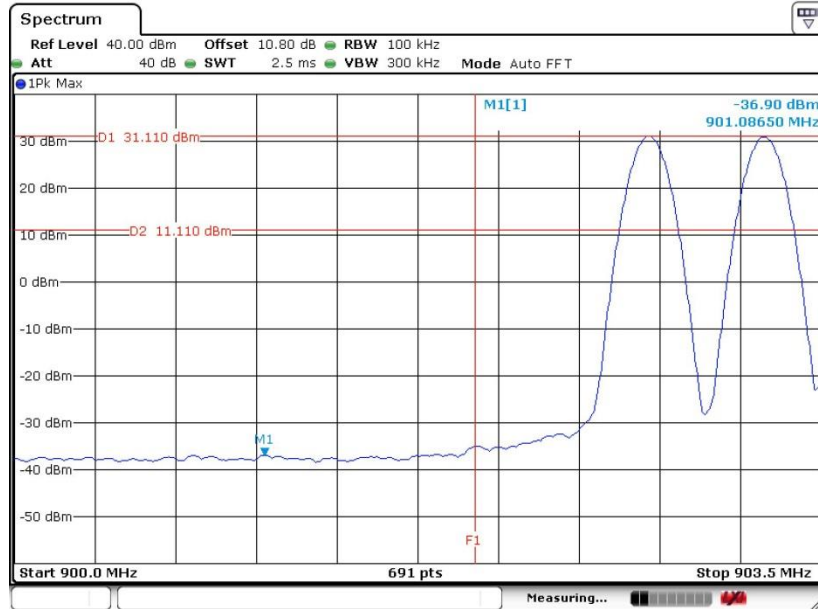

Date: 11.OCT.2017 08:45:13

#### Hopping Mode High Band Edge Plot

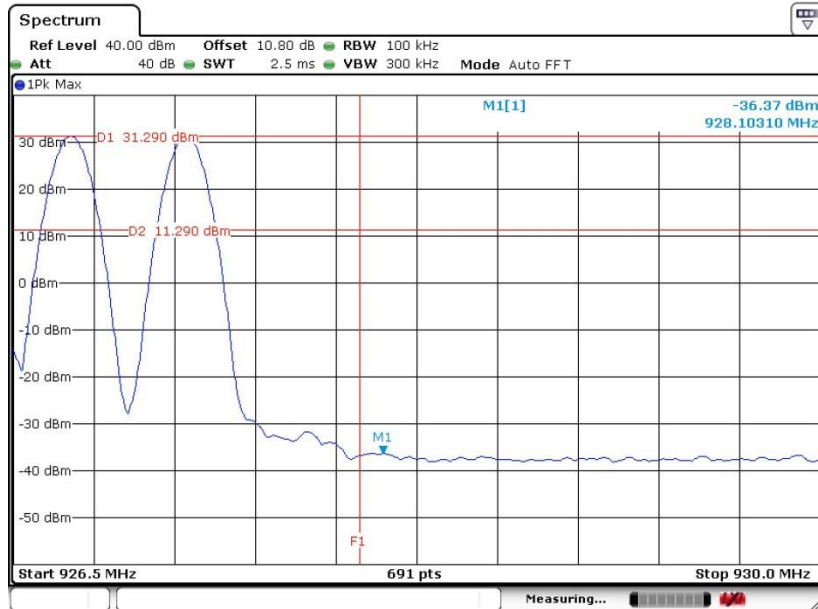

Date: 11.OCT.2017 08:47:28

## 3.7 Conducted Spurious Emission Measurement

### 3.7.1 Limit of Spurious Emission Measurement

In any 100 kHz bandwidth outside the intentional radiation frequency band, the radio frequency power shall be at least 20 dB below the highest level of the radiated power. In addition, radiated emissions which fall in the restricted bands must also comply with the radiated emission limits.

### 3.7.2 Measuring Instruments

The measuring equipment is listed in the section 4 of this test report.

### 3.7.3 Test Procedure

1. The testing follows ANSI C63.10-2013 clause 7.8.8.
2. The RF output of EUT was connected to the spectrum analyzer by RF cable and attenuator. The path loss was compensated to the results for each measurement.
3. Set to the maximum power setting and enable the EUT transmit continuously.
4. Set RBW = 100 kHz, VBW = 300kHz, scan up through 10th harmonic. All harmonics / spurs must be at least 20 dB down from the highest emission level within the authorized band as measured with a 100 kHz RBW.
5. Measure and record the results in the test report.
6. The RF fundamental frequency should be excluded against the limit line in the operating frequency band.

### 3.7.4 Test Setup

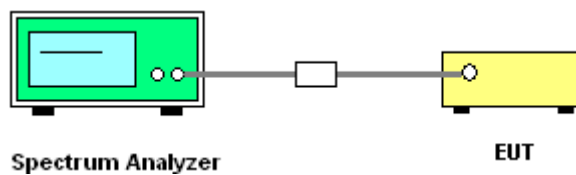



### 3.7.5 Test Result of Conducted Spurious Emission

CSE Plot on Ch 00 between 30MHz ~ 10 GHz

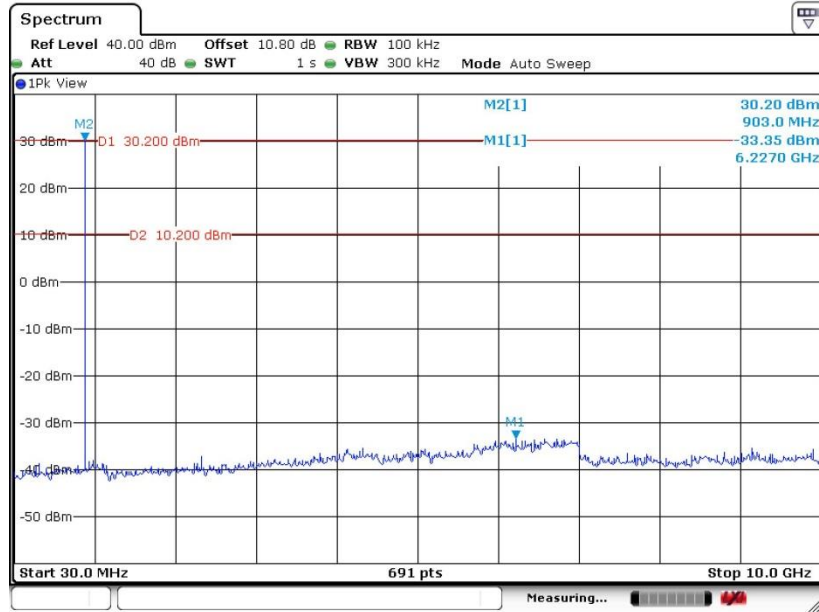

CSE Plot on Ch 24 between 30MHz ~ 10 GHz

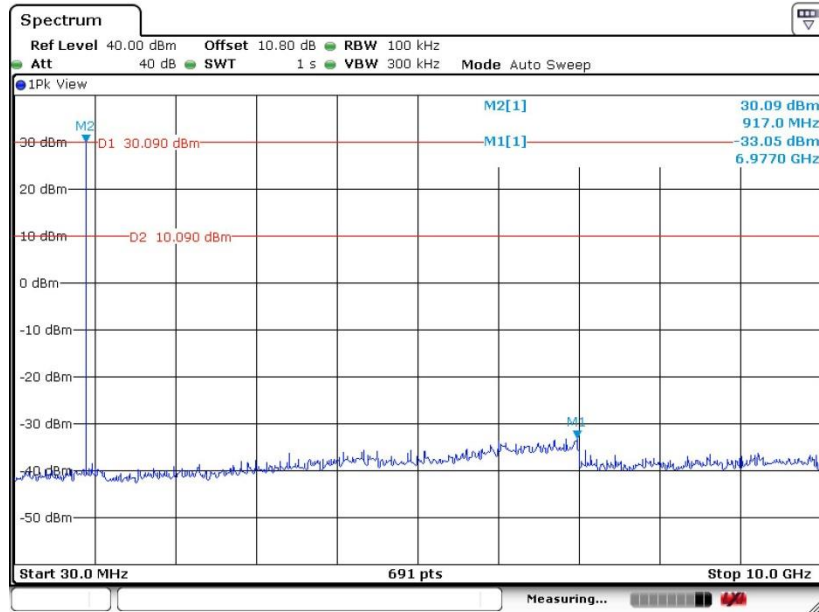





CSE Plot on Ch 49 between 30MHz ~ 10 GHz

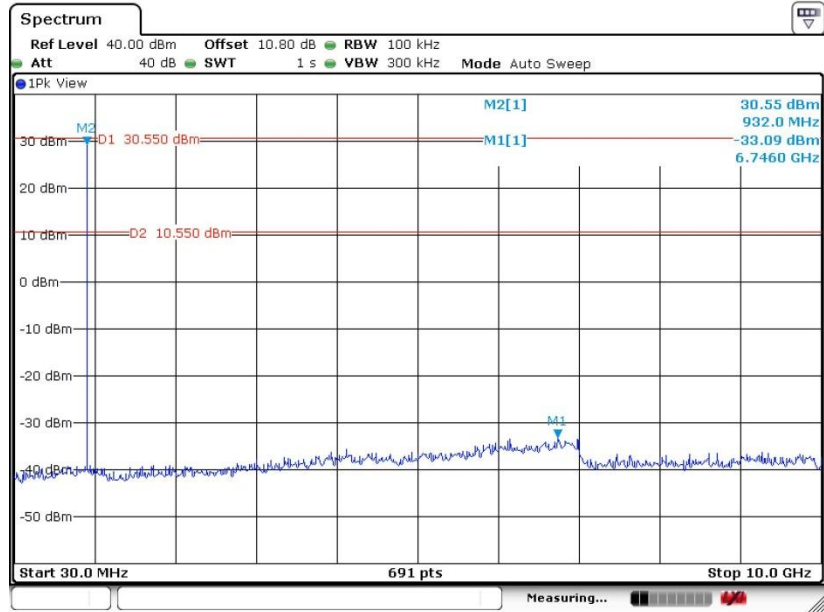

Date: 11.OCT.2017 08:59:38



### 3.8 Radiated Band Edges and Spurious Emission Measurement

#### 3.8.1 Limit of Radiated Band Edges and Spurious Emission

In any 100 kHz bandwidth outside the intentional radiator frequency band, all harmonics/spurious must be at least 20 dB below the highest emission level within the authorized band. In addition, radiated emissions which fall in the restricted bands must also comply with the limits as below.

Frequency (MHz)	Field Strength (microvolts/meter)	Measurement Distance (meters)
0.009 – 0.490	2400/F(kHz)	300
0.490 – 1.705	24000/F(kHz)	30
1.705 – 30.0	30	30
30 – 88	100	3
88 – 216	150	3
216 - 960	200	3
Above 960	500	3

#### 3.8.2 Measuring Instruments

The measuring equipment is listed in the section 4 of this test report.



### 3.8.3 Test Procedures

1. The EUT was placed on a turntable with 0.8 meter for frequency below 1GHz and 1.5 meter for frequency above 1GHz respectively above ground.
2. The EUT was set 3 meters from the interference receiving antenna, which was mounted on the top of a variable height antenna tower.
3. For each suspected emission, the EUT was arranged to its worst case and then tune the Antenna tower (from 1 m to 4 m) and turntable (from 0 degree to 360 degrees) to find the maximum reading. A pre-amp and a high pass filter are used for the test in order to get better signal level to comply with the guidelines.
4. Set to the maximum power setting and enable the EUT transmit continuously.
5. Use the following spectrum analyzer settings:
  - (1) Span shall wide enough to fully capture the emission being measured;
  - (2) Set RBW=100 kHz for  $f < 1$  GHz, RBW=1MHz for  $f > 1$ GHz ; VBW  $\geq$  RBW; Sweep = auto; Detector function = peak; Trace = max hold for peak
  - (3) For average measurement: use duty cycle correction factor method per 15.35(c).  
Duty cycle = On time/100 milliseconds  
On time =  $N_1 * L_1 + N_2 * L_2 + \dots + N_{n-1} * L_{n-1} + N_n * L_n$   
Where  $N_1$  is number of type 1 pulses,  $L_1$  is length of type 1 pulses, etc.  
Average Emission Level = Peak Emission Level +  $20 * \log(\text{Duty cycle})$
6. Corrected Reading: Antenna Factor + Cable Loss + Read Level - Preamp Factor = Level

### 3.8.4 Test Setup

For radiated emissions below 30MHz

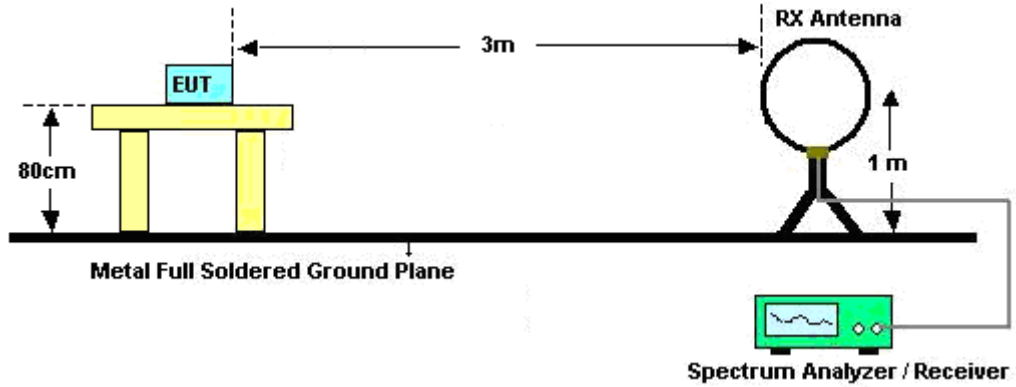

For radiated emissions from 30MHz to 1GHz

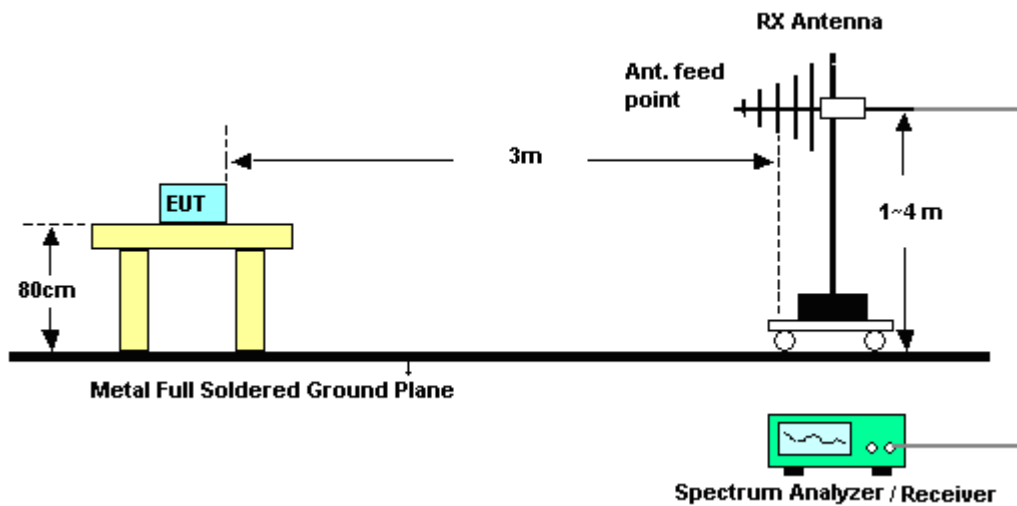

For radiated emissions above 1GHz

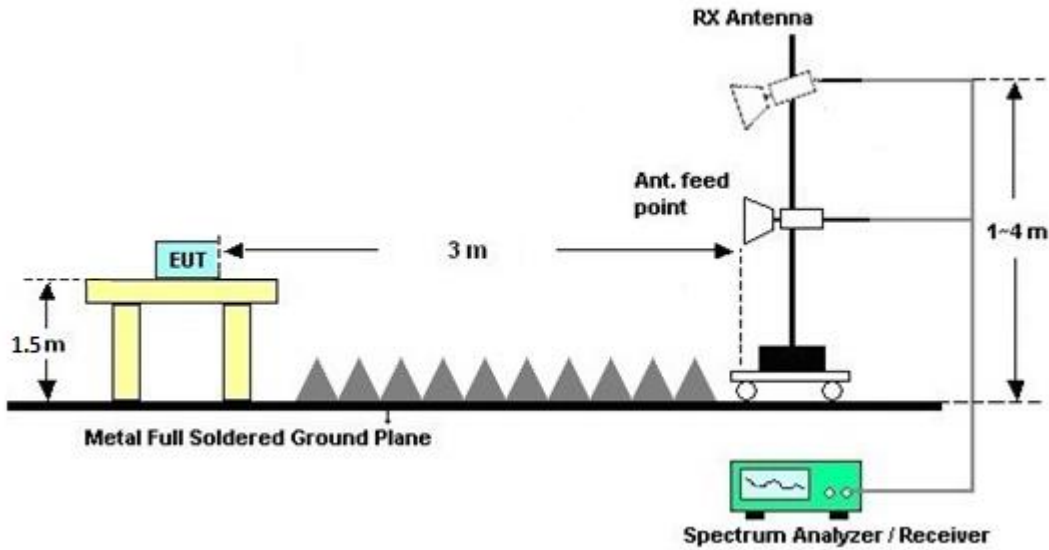

### 3.8.5 Test Results of Radiated Spurious Emissions (9 kHz ~ 30 MHz)

The low frequency, which started from 9 kHz to 30MHz, was pre-scanned and the result which was 20dB lower than the limit line per 15.31(o) was not reported.

### 3.8.6 Test Result of Radiated Spurious at Band Edges

Please refer to Appendix B.

### 3.8.7 Duty Cycle

Please refer to Appendix C.

### 3.8.8 Test Result of Radiated Spurious Emission

Please refer to Appendix B.



### 3.9 AC Power Line Conducted Emissions Measurement

#### 3.9.1 Limit of AC Conducted Emission

For equipment that is designed to be connected to the public utility (AC) power line, the radio frequency voltage that is conducted back onto the AC power line on any frequency or frequencies within the band 150 kHz to 30 MHz shall not exceed the limits in the following table.

Frequency of Emission (MHz)	Conducted Limit (dB $\mu$ V)	
	Quasi-Peak	Average
0.15-0.5	66 to 56*	56 to 46*
0.5-5	56	46
5-30	60	50

\*Decreases with the logarithm of the frequency.

#### 3.9.2 Measuring Instruments

See list of measuring instruments of this test report.

#### 3.9.3 Test Procedures

7. The EUT was placed 0.4 meter from the conducting wall of the shielding room, and it was kept at least 80 centimeters from any other grounded conducting surface.
8. Connect EUT to the power mains through a line impedance stabilization network (LISN).
9. All the support units are connecting to the other LISN.
10. The LISN provides 50 ohm coupling impedance for the measuring instrument.
11. The FCC states that a 50 ohm, 50 microhenry LISN should be used.
12. Both sides of AC line were checked for maximum conducted interference.
13. The frequency range from 150 kHz to 30 MHz was searched.
14. Set the test-receiver system to Peak Detect Function and specified bandwidth (IF Bandwidth = 9kHz) with Maximum Hold Mode. Then measurement is also conducted by Average Detector and Quasi-Peak Detector Function respectively.

### 3.9.4 Test setup

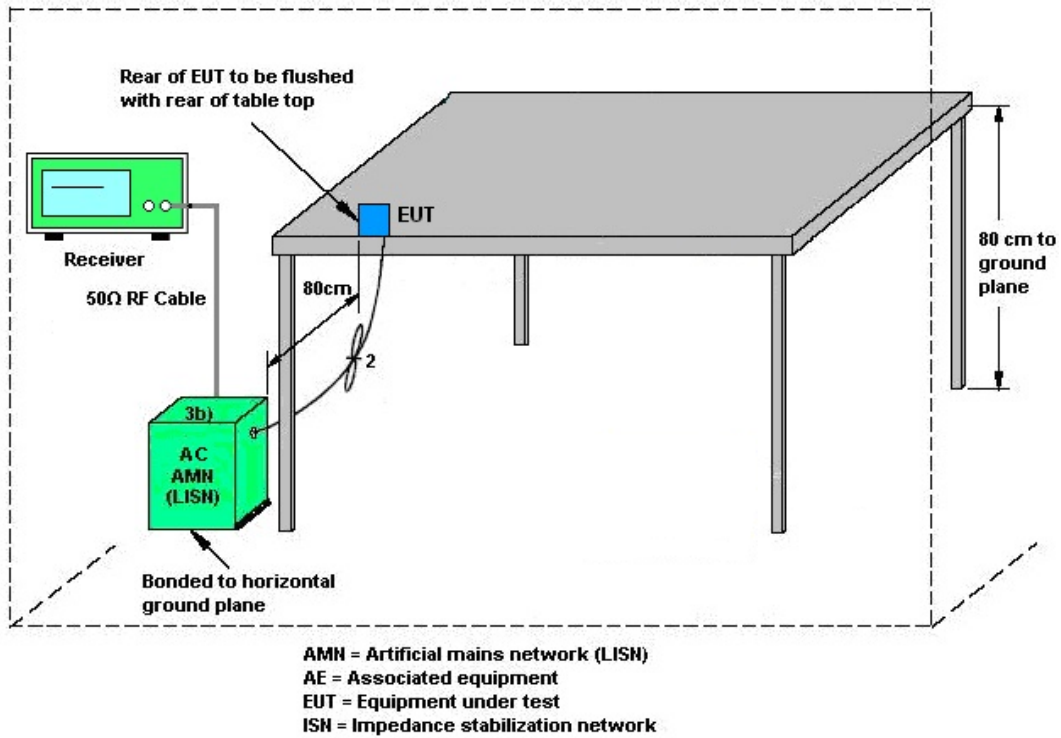

### 3.9.5 Test Result of AC Conducted Emission

Please refer to Appendix A.



## **3.10 Antenna Requirements**

### **3.10.1 Standard Applicable**

If directional gain of transmitting antennas is greater than 6dBi, the power shall be reduced by the same level in dB comparing to gain minus 6dBi. The use of a permanently attached antenna or of an antenna that uses a unique coupling to the intentional radiator shall be considered sufficient to comply with the rule.

### **3.10.2 Antenna Anti-Replacement Construction**

An embedded-in antenna design is used.

### **3.10.3 Antenna Gain**

The antenna peak gain of EUT is 6 dBi. Therefore, it is not necessary to reduce maximum peak output power limit.





## 4 List of Measuring Equipment

Instrument	Manufacturer	Model No.	Serial No.	Characteristics	Calibration Date	Test Date	Due Date	Remark
Power Meter	Anritsu	ML2495A	1218006	N/A	Oct. 06, 2017	Oct. 06, 2017 ~ Oct. 23, 2017	Oct. 05, 2018	Conducted (TH05-HY)
Power Sensor	Anritsu	MA2411B	1207363	300MHz~40GHz	Oct. 06, 2017	Oct. 06, 2017 ~ Oct. 23, 2017	Oct. 05, 2018	Conducted (TH05-HY)
Signal Analyzer	Rohde & Schwarz	FSV40	101408	10Hz~40GHz	Jul. 20, 2017	Oct. 06, 2017 ~ Oct. 23, 2017	Jul. 19, 2018	Conducted (TH05-HY)
AC Power Source	ChainTek	APC-1000W	N/A	N/A	N/A	Oct. 07, 2017 ~ Oct. 18, 2017	N/A	Conduction (CO05-HY)
EMI Test Receiver	Rohde & Schwarz	ESCI 7	100724	9kHz~7GHz	Sep. 20, 2017	Oct. 07, 2017 ~ Oct. 18, 2017	Sep. 19, 2018	Conduction (CO05-HY)
LISN	Rohde & Schwarz	ENV216	100080	9kHz~30MHz	Nov. 29, 2016	Oct. 07, 2017 ~ Oct. 18, 2017	Nov. 28, 2017	Conduction (CO05-HY)
LISN	Rohde & Schwarz	ENV216	100081	9kHz~30MHz	Dec. 06, 2016	Oct. 07, 2017 ~ Oct. 18, 2017	Dec. 05, 2017	Conduction (CO05-HY)
Bilog Antenna	TESEQ	CBL 6111D&00800 N1D01N-06	35419&03	30MHz to 1GHz	Jan. 07, 2017	Oct. 12, 2017	Jan. 06, 2018	Radiation (03CH07-HY)
Double Ridge Horn Antenna	ESCO	3117	00075962	1GHz ~ 18GHz	Aug. 23, 2017	Oct. 12, 2017	Aug. 22, 2018	Radiation (03CH07-HY)
EMI Test Receiver	Agilent	N9038A (MXE)	MY532900 53	20Hz to 26.5GHz	Jan. 12, 2017	Oct. 12, 2017	Jan. 11, 2018	Radiation (03CH07-HY)
Loop Antenna	Rohde & Schwarz	HFH2-Z2	100315	9 kHz~30 MHz	May 15, 2017	Oct. 12, 2017	May 14, 2019	Radiation (03CH07-HY)
Preamplifier	MITEQ	AMF-7D-0010 1800-30-10P	1590075	1GHz ~ 18GHz	Apr. 25, 2017	Oct. 12, 2017	Apr. 24, 2018	Radiation (03CH07-HY)
Preamplifier	COM-POWER	PA-103A	161241	10MHz-1GHz	Mar. 14, 2017	Oct. 12, 2017	Mar. 13, 2018	Radiation (03CH07-HY)
Antenna Mast	Max-Full	MFA520BS	N/A	1m~4m	N/A	Oct. 12, 2017	N/A	Radiation (03CH07-HY)
Turn Table	ChainTek	Chaintek 3000	N/A	0~360 Degree	N/A	Oct. 12, 2017	N/A	Radiation (03CH07-HY)



## 5 Uncertainty of Evaluation

### Uncertainty of Conducted Emission Measurement (150 kHz ~ 30 MHz)

Measuring Uncertainty for a Level of Confidence of 95% ( $U = 2Uc(y)$ )	2.7
---	-----

### Uncertainty of Radiated Emission Measurement (30 MHz ~ 1000 MHz)

Measuring Uncertainty for a Level of Confidence of 95% ( $U = 2Uc(y)$ )	5.7
---	-----

### Uncertainty of Radiated Emission Measurement (1000 MHz ~ 18000 MHz)

Measuring Uncertainty for a Level of Confidence of 95% ( $U = 2Uc(y)$ )	5.5
---	-----

### Uncertainty of Radiated Emission Measurement (18000 MHz ~ 40000 MHz)

Measuring Uncertainty for a Level of Confidence of 95% ( $U = 2Uc(y)$ )	5.2
---	-----



## Appendix A. AC Conducted Emission Test Results

Test Engineer :	Shareef Yu	Temperature :	26~27°C
		Relative Humidity :	58~62%