



**FCC & Industry Canada Certification Test Report**  
**For the**  
**Motorola - Enterprise Mobility Solutions**  
**FX7400**

**FCC ID: UZ7FX7400**  
**IC: 109AN-FX7400**

WLL JOB# 11047-01 Rev.2  
October 29, 2009

Prepared for:

**Motorola - Enterprise Mobility Solutions**  
**Jays Close**  
**Viables Industrial Estate**  
**Basingstoke**  
**Hampshire**  
**RG22 4PD**  
**United Kingdom**

Prepared By:

**Washington Laboratories, Ltd.**  
**7560 Lindbergh Drive**  
**Gaithersburg, Maryland 20879**



Testing Certificate 2675.01

**FCC & Industry Canada Certification Test Report**  
**for the**  
**Motorola - Enterprise Mobility Solutions**  
**FX7400**

**FCC ID: UZ7FX7400**

**IC: 109AN-FX7400**

**October 29, 2009**

WLL JOB# 11047-01 Rev.2

Prepared by:



James Ritter  
EMC Compliance Engineer

Reviewed by:



Steven D. Koster  
EMC Operations Manager

## Abstract

This report has been prepared on behalf of Motorola - Enterprise Mobility Solutions to support the attached Application for Equipment Authorization. The test report and application are submitted for a Frequency Hopping Spread Spectrum Transmitter under Part 15.247 (7/2008) of the FCC Rules and Regulations and Spectrum Management and Telecommunications Policy RSS-210e issue 7 of Industry Canada. This Certification Test Report documents the test configuration and test results for the Motorola - Enterprise Mobility Solutions FX7400.

Testing was performed on an Open Area Test Site (OATS) of Washington Laboratories, Ltd, 7560 Lindbergh Drive, Gaithersburg, MD 20879. Site description and site attenuation data have been placed on file with the FCC's Sampling and Measurements Branch at the FCC laboratory in Columbia, MD. The Industry Canada OATS numbers are 3035A-1 and 3035A-2 for Washington Laboratories, Ltd. Site 1 and Site 2, respectively. Washington Laboratories, Ltd. has been accepted by the FCC and approved by the American Association for Laboratory Accreditation (A2LA) under Certificate 2675.01 as an independent FCC test laboratory.

The Motorola - Enterprise Mobility Solutions FX7400 complies with the limits for a Frequency Hopping Spread Spectrum Transmitter device under FCC Part 15.247 and Industry Canada RSS-210e issue 7.

Revision History	Description of Change	Date
Rev 0	Initial Release	October 17, 2009
Rev 1	Correction of Company Name & address, Addition of Globetek PS Motorola part number, minor typographical corrections	October 19, 2009
Rev 2	Addition of Astec AC/DC Converter Data	October 29, 2009

## Table of Contents

Abstract.....	ii
1 Introduction.....	1
1.1 Compliance Statement .....	1
1.2 Test Scope.....	1
1.3 Contract Information.....	1
1.4 Test Dates .....	1
1.5 Test and Support Personnel .....	1
1.6 Abbreviations.....	2
2 Equipment Under Test .....	3
2.1 EUT Identification & Description .....	3
2.2 Test Configuration .....	4
2.3 Testing Algorithm.....	4
2.4 Modulation Modes (profiles).....	5
2.5 Test Location .....	5
2.6 Measurements .....	5
2.6.1 References.....	5
2.7 Measurement Uncertainty.....	6
3 Test Equipment .....	7
4 Test Summary .....	8
5 Test Results.....	9
5.1 RF Power Output: (§2.1046, §15.247 (b)(2), RSS-210 [A8.4(1)] ) .....	9
5.2 Occupied Bandwidth: (§2.1046, §15.247 (a)(1)(i), RSS-210 [A8.1(c)]) .....	11
5.3 Channel Spacing /Number of Hop Channels (§15.247(a)(1), RSS210[A8.1]).....	14
5.4 Time of Occupancy (§15.247 (a)(i), RSS-210 [A8.1(c)] ) .....	15
5.5 Conducted Spurious Emissions at Antenna Terminals (§2.1051) .....	16
5.5.1 Band-edge Measurements.....	16
5.5.2 Conducted Spurious Plots.....	16
5.6 Radiated Transmitter Spurious Emissions: (§15.205, 15.209, RSS210[A8.5]) .....	41
5.6.1 Test Procedure .....	41
5.7 Receiver Radiated Spurious Emissions: (§15.209, RSS-Gen [7.2.3.2]).....	49
5.7.1 Test Procedure .....	49
5.7.2 Test Summary .....	49
5.8 AC Conducted Emissions (FCC Pt.15.207, RSS-Gen [7.2.2]).....	54
5.8.1 Requirements .....	54
5.8.2 Test Procedure .....	54
5.8.3 Test Data .....	54
Appendix A1 RF Peak Power Plots .....	59
Appendix A2 20dB Power Plots .....	107
Appendix A3 Number of Hoppers and Channel Spacing Plots.....	131
Appendix A4 Time of Occupancy Plots .....	140
Appendix A5 Band-edge Plots .....	164

## List of Tables

Table 1: Device Summary .....	3
Table 2: Modulation Profiles .....	5
Table 3: Expanded Uncertainty List .....	7
Table 4: Test Equipment List.....	7
Table 5: Test Summary Table.....	8
Table 6 RF Power Summary –Highest Power Level .....	9
Table 7: RF Power Output – Complete Table .....	9
Table 8: Occupied Bandwidth Summary (shows widest OBW) .....	12
Table 9: Occupied Bandwidth Results- Complete Results .....	12
Table 10: Number of Hoppers Summary .....	14
Table 11: Channel Spacing Summary.....	14
Table 12: Time of Occupancy Summary table .....	15
Table 13 Band-edge Summary Table (worst case).....	16
Table 14: Spectrum Analyzer Settings .....	41
Table 15: Radiated Spurious Emissions Summary Table.....	41
Table 16: Radiated Emission Test Data, 4-Port unit GlobeTek PS, Low Channel .....	42
Table 17: Radiated Emission Test Data, 4-Port unit POE PS, Center Channel .....	43
Table 18: Radiated Emission Test Data, 4-Port unit GlobeTek PS, High Channel.....	44
Table 19: Radiated Emission Test Data <1GHz 4 Port Unit with Astec PS .....	45
Table 20: Radiated Emission Test Data, 2-Port unit GlobeTek PS, Low Channel .....	46
Table 21: Radiated Emission Test Data, 2-Port unit GlobeTek PS, Center Channel .....	47
Table 22: Radiated Emission Test Data, 2-Port unit GlobeTek PS, High Channel.....	48
Table 23: Receiver Radiated Spurious Emissions Summary Table .....	49
Table 24: Receiver Radiated Emission Test Data, 4-Port unit GlobeTek PS.....	50
Table 25: Receiver Radiated Emission Test Data, 4-Port unit Astec PS.....	51
Table 26: Receiver Radiated Emission Test Data, 4-Port unit POE PS .....	52
Table 27: Receiver Radiated Emission Test Data, 2-Port unit GlobeTek PS.....	53
Table 28: Conducted Emission Test Data, 4-Port unit GlobeTek PS .....	55
Table 29: Conducted Emission Test Data, 4-Port unit Astec PS.....	56
Table 30: Conducted Emission Test Data, 4-Port unit POE PS .....	57
Table 31 Conducted Emission Test Data, 2-Port unit GlobeTek PS .....	58

## List of Figures

Figure 1: System Configuration.....	4
Figure 2: Conducted Spurious Emissions, Low Channel, High Power, 30 - 900MHz .....	17
Figure 3: Conducted Spurious Emissions, Low Channel, High Power, 900-930MHz .....	18
Figure 4: Conducted Spurious Emissions, Low Channel, High Power, 930MHz -5GHz .....	19
Figure 5: Conducted Spurious Emissions, Low Channel, High Power, 5-10GHz .....	20
Figure 6: Conducted Spurious Emissions, Low Channel, Low Power, 30 - 900MHz .....	21
Figure 7: Conducted Spurious Emissions, Low Channel, Low Power, 900 - 930MHz .....	22
Figure 8: Conducted Spurious Emissions, Low Channel, Low Power, 930MHz-5GHz.....	23
Figure 9: Conducted Spurious Emissions, Low Channel, Low Power, 5-10GHz.....	24
Figure 10: Conducted Spurious Emissions, Center Channel, High Power, 30-900MHz .....	25
Figure 11: Conducted Spurious Emissions, Center Channel, High Power, 900-930MHz .....	26
Figure 12: Conducted Spurious Emissions, Center Channel, High Power, 930MHz-5GHz.....	27

Figure 13: Conducted Spurious Emissions, Center Channel, High Power, 5-10GHz.....	28
Figure 14: Conducted Spurious Emissions, Center Channel, Low Power, 30-900MHz.....	29
Figure 15: Conducted Spurious Emissions, Center Channel, Low Power, 900-930MHz.....	30
Figure 16: Conducted Spurious Emissions, Center Channel, Low Power, 930MHz-5GHz .....	31
Figure 17: Conducted Spurious Emissions, Center Channel, Low Power, 5-10GHz .....	32
Figure 18: Conducted Spurious Emissions, High Channel, High Power, 30-900MHz.....	33
Figure 19: Conducted Spurious Emissions, High Channel, High Power, 900-930MHz.....	34
Figure 20: Conducted Spurious Emissions, High Channel, High Power, 930MHz-5GHz .....	35
Figure 21: Conducted Spurious Emissions, High Channel, High Power, 5-10GHz .....	36
Figure 22: Conducted Spurious Emissions, High Channel, Low Power, 30-900MHz .....	37
Figure 23: Conducted Spurious Emissions, High Channel, Low Power, 900-930MHz .....	38
Figure 24: Conducted Spurious Emissions, High Channel, Low Power, 930MHz-5GHz.....	39
Figure 25: Conducted Spurious Emissions, High Channel, low Power, 5-10GHz .....	40
Figure 26: RF Peak Power, Low Channel, High Power, Modulation Profile 0.....	59
Figure 27: RF Peak Power, Low Channel, High Power, Modulation Profile 1.....	60
Figure 28: RF Peak Power, Low Channel, High Power, Modulation Profile 2.....	61
Figure 29: RF Peak Power, Low Channel, High Power, Modulation Profile 3.....	62
Figure 30: RF Peak Power, Low Channel, High Power, Modulation Profile 4.....	63
Figure 31: RF Peak Power, Low Channel, High Power, Modulation Profile 5.....	64
Figure 32: RF Peak Power, Low Channel, High Power, Modulation Profile 6.....	65
Figure 33: RF Peak Power, Low Channel, High Power, Modulation Profile 7.....	66
Figure 34: RF Peak Power, Center Channel, High Power, Modulation Profile 0 .....	67
Figure 35: RF Peak Power, Center Channel, High Power, Modulation Profile 1 .....	68
Figure 36: RF Peak Power, Center Channel, High Power, Modulation Profile 2 .....	69
Figure 37: RF Peak Power, Center Channel, High Power, Modulation Profile 3 .....	70
Figure 38: RF Peak Power, Center Channel, High Power, Modulation Profile 4 .....	71
Figure 39: RF Peak Power, Center Channel, High Power, Modulation Profile 5 .....	72
Figure 40: RF Peak Power, Center Channel, High Power, Modulation Profile 6 .....	73
Figure 41: RF Peak Power, Center Channel, High Power, Modulation Profile 7 .....	74
Figure 42: RF Peak Power, High Channel, High Power, Modulation Profile 0.....	75
Figure 43: RF Peak Power, High Channel, High Power, Modulation Profile 1 .....	76
Figure 44: RF Peak Power, High Channel, High Power, Modulation Profile 2.....	77
Figure 45: RF Peak Power, High Channel, High Power, Modulation Profile 3.....	78
Figure 46: RF Peak Power, High Channel, High Power, Modulation Profile 4.....	79
Figure 47: RF Peak Power, High Channel, High Power, Modulation Profile 5 .....	80
Figure 48: RF Peak Power, High Channel, High Power, Modulation Profile 6.....	81
Figure 49: RF Peak Power, High Channel, High Power, Modulation Profile 7 .....	82
Figure 50: RF Peak Power, Low Channel, Low Power, Modulation Profile 0 .....	83
Figure 51: RF Peak Power, Low Channel, Low Power, Modulation Profile 1 .....	84
Figure 52: RF Peak Power, Low Channel, Low Power, Modulation Profile 2 .....	85
Figure 53: RF Peak Power, Low Channel, Low Power, Modulation Profile 3 .....	86
Figure 54: RF Peak Power, Low Channel, Low Power, Modulation Profile 4 .....	87
Figure 55: RF Peak Power, Low Channel, Low Power, Modulation Profile 5 .....	88
Figure 56: RF Peak Power, Low Channel, Low Power, Modulation Profile 6 .....	89
Figure 57: RF Peak Power, Low Channel, Low Power, Modulation Profile 7 .....	90

---

Figure 58: RF Peak Power, Center Channel, Low Power, Modulation Profile 0.....	91
Figure 59: RF Peak Power, Center Channel, Low Power, Modulation Profile 1.....	92
Figure 60: RF Peak Power, Center Channel, Low Power, Modulation Profile 2.....	93
Figure 61: RF Peak Power, Center Channel, Low Power, Modulation Profile 3.....	94
Figure 62: RF Peak Power, Center Channel, Low Power, Modulation Profile 4.....	95
Figure 63: RF Peak Power, Center Channel, Low Power, Modulation Profile 5.....	96
Figure 64: RF Peak Power, Center Channel, Low Power, Modulation Profile 6.....	97
Figure 65: RF Peak Power, Center Channel, Low Power, Modulation Profile 7.....	98
Figure 66: RF Peak Power, High Channel, Low Power, Modulation Profile 0.....	99
Figure 67: RF Peak Power, High Channel, Low Power, Modulation Profile 1.....	100
Figure 68: RF Peak Power, High Channel, Low Power, Modulation Profile 2.....	101
Figure 69: RF Peak Power, High Channel, Low Power, Modulation Profile 3.....	102
Figure 70: RF Peak Power, High Channel, Low Power, Modulation Profile 4.....	103
Figure 71: RF Peak Power, High Channel, Low Power, Modulation Profile 5.....	104
Figure 72: RF Peak Power, High Channel, Low Power, Modulation Profile 6.....	105
Figure 73: RF Peak Power, High Channel, Low Power, Modulation Profile 7.....	106
Figure 74: Occupied Bandwidth, Low Channel, Modulation Profile 0.....	107
Figure 75: Occupied Bandwidth, Low Channel, Modulation Profile 1.....	108
Figure 76: Occupied Bandwidth, Low Channel, Modulation Profile 2.....	109
Figure 77: Occupied Bandwidth, Low Channel, Modulation Profile 3.....	110
Figure 78: Occupied Bandwidth, Low Channel, Modulation Profile 4.....	111
Figure 79: Occupied Bandwidth, Low Channel, Modulation Profile 5.....	112
Figure 80: Occupied Bandwidth, Low Channel, Modulation Profile 6.....	113
Figure 81: Occupied Bandwidth, Low Channel, Modulation Profile 7.....	114
Figure 82: Occupied Bandwidth, Center Channel, Modulation Profile 0.....	115
Figure 83: Occupied Bandwidth, Center Channel, Modulation Profile 1.....	116
Figure 84: Occupied Bandwidth, Center Channel, Modulation Profile 2.....	117
Figure 85: Occupied Bandwidth, Center Channel, Modulation Profile 3.....	118
Figure 86: Occupied Bandwidth, Center Channel, Modulation Profile 4.....	119
Figure 87: Occupied Bandwidth, Center Channel, Modulation Profile 5.....	120
Figure 88: Occupied Bandwidth, Center Channel, Modulation Profile 6.....	121
Figure 89: Occupied Bandwidth, Center Channel, Modulation Profile 7.....	122
Figure 90: Occupied Bandwidth, High Channel, Modulation Profile 0.....	123
Figure 91: Occupied Bandwidth, High Channel, Modulation Profile 1.....	124
Figure 92: Occupied Bandwidth, High Channel, Modulation Profile 2.....	125
Figure 93: Occupied Bandwidth, High Channel, Modulation Profile 3.....	126
Figure 94: Occupied Bandwidth, High Channel, Modulation Profile 4.....	127
Figure 95: Occupied Bandwidth, High Channel, Modulation Profile 5.....	128
Figure 96: Occupied Bandwidth, High Channel, Modulation Profile 6.....	129
Figure 97: Occupied Bandwidth, High Channel, Modulation Profile 7.....	130
Figure 98: Number of Channels.....	131
Figure 99: Channel Spacing, Modulation Profile 0.....	132
Figure 100: Channel Spacing, Modulation Profile 1.....	133
Figure 101: Channel Spacing, Modulation Profile 2.....	134
Figure 102: Channel Spacing, Modulation Profile 3.....	135

Figure 103: Channel Spacing, Modulation Profile 4 .....	136
Figure 104: Channel Spacing, Modulation Profile 5 .....	137
Figure 105: Channel Spacing, Modulation Profile 6 .....	138
Figure 106: Channel Spacing, Modulation Profile 7 .....	139
Figure 107: Time of Occupancy, Off Time between data Bits, data Profile 0 .....	140
Figure 108: Time of Occupancy, On time per pulse train, data Profile 0.....	141
Figure 109: Time of Occupancy, On Time Per 20 Sec., data Profile 0 .....	142
Figure 110: Time of Occupancy, Off Time between data Bits, data Profile 1 .....	143
Figure 111: Time of Occupancy, On time per pulse train, data Profile 1.....	144
Figure 112: Time of Occupancy, On Time Per 20 Sec., data Profile 1 .....	145
Figure 113: Time of Occupancy, Off Time between data Bits, data Profile 2 .....	146
Figure 114: Time of Occupancy, On time per pulse train, data Profile 2.....	147
Figure 115: Time of Occupancy, On Time Per 20 Sec., data Profile 2 .....	148
Figure 116: Time of Occupancy, Off Time between data Bits, data Profile 3 .....	149
Figure 117: Time of Occupancy, On time per pulse train, data Profile 3.....	150
Figure 118: Time of Occupancy, On Time Per 20 Sec., data Profile 3 .....	151
Figure 119: Time of Occupancy, Off Time between data Bits, data Profile 4 .....	152
Figure 120: Time of Occupancy, On time per pulse train, data Profile 4.....	153
Figure 121: Time of Occupancy, On Time Per 10 Sec., data Profile 4 .....	154
Figure 122: Time of Occupancy, Off Time between data Bits, data Profile 5 .....	155
Figure 123: Time of Occupancy, On time per pulse train, data Profile 5.....	156
Figure 124: Time of Occupancy, On Time Per 20 Sec., data Profile 5 .....	157
Figure 125: Time of Occupancy, Off Time between data Bits, data Profile 6 .....	158
Figure 126: Time of Occupancy, On time per pulse train, data Profile 6.....	159
Figure 127: Time of Occupancy, On Time Per 20 Sec., data Profile 6 .....	160
Figure 128: Time of Occupancy, Off Time between data Bits, data Profile 7 .....	161
Figure 129: Time of Occupancy, On time per pulse train, data Profile 7.....	162
Figure 130: Time of Occupancy, On Time Per 20 Sec., data Profile 7 .....	163
Figure 131: Low Band-edge Non-hopping, High Power, Modulation Profile 0 .....	164
Figure 132: Low Band-edge Non-hopping, High Power, Modulation Profile 1 .....	165
Figure 133: Low Band-edge Non-hopping, High Power, Modulation Profile 2 .....	166
Figure 134: Low Band-edge Non-hopping, High Power, Modulation Profile 3 .....	167
Figure 135: Low Band-edge Non-hopping, High Power, Modulation Profile 4 .....	168
Figure 136: Low Band-edge Non-hopping, High Power, Modulation Profile 5 .....	169
Figure 137: Low Band-edge Non-hopping, High Power, Modulation Profile 6 .....	170
Figure 138: Low Band-edge Non-hopping, High Power, Modulation Profile 7 .....	171
Figure 139: Upper Band-edge Non-hopping, High Power, Modulation Profile 0 .....	172
Figure 140: Upper Band-edge Non-hopping, High Power, Modulation Profile 1 .....	173
Figure 141: Upper Band-edge Non-hopping, High Power, Modulation Profile 2 .....	174
Figure 142: Upper Band-edge Non-hopping, High Power, Modulation Profile 3 .....	175
Figure 143: Upper Band-edge Non-hopping, High Power, Modulation Profile 4 .....	176
Figure 144: Upper Band-edge Non-hopping, High Power, Modulation Profile 5 .....	177
Figure 145: Upper Band-edge Non-hopping, High Power, Modulation Profile 6 .....	178
Figure 146: Upper Band-edge Non-hopping, High Power, Modulation Profile 7 .....	179
Figure 147: Lower Band-edge Hopping, High Power, Modulation Profile 0 .....	180



Figure 148: Lower Band-edge Hopping, High Power, Modulation Profile 1 .....	181
Figure 149: Lower Band-edge Hopping, High Power, Modulation Profile 2 .....	182
Figure 150: Lower Band-edge Hopping, High Power, Modulation Profile 3 .....	183
Figure 151: Lower Band-edge Hopping, High Power, Modulation Profile 4 .....	184
Figure 152: Lower Band-edge Hopping, High Power, Modulation Profile 5 .....	185
Figure 153: Lower Band-edge Hopping, High Power, Modulation Profile 6 .....	186
Figure 154: Lower Band-edge Hopping, High Power, Modulation Profile 7 .....	187
Figure 155: Upper Band-edge Hopping, High Power, Modulation Profile 0.....	188
Figure 156: Upper Band-edge Hopping, High Power, Modulation Profile 1.....	189
Figure 157: Upper Band-edge Hopping, High Power, Modulation Profile 2.....	190
Figure 158: Upper Band-edge Hopping, High Power, Modulation Profile 3.....	191
Figure 159: Upper Band-edge Hopping, High Power, Modulation Profile 4.....	192
Figure 160: Upper Band-edge Hopping, High Power, Modulation Profile 5.....	193
Figure 161: Upper Band-edge Hopping, High Power, Modulation Profile 6.....	194
Figure 162: Upper Band-edge Hopping, High Power, Modulation Profile 7.....	195
Figure 163: Low Band-edge Non-hopping, Low Power, Modulation Profile 0.....	196
Figure 164: Low Band-edge Non-hopping, Low Power, Modulation Profile 1.....	197
Figure 165: Low Band-edge Non-hopping, Low Power, Modulation Profile 2.....	198
Figure 166: Low Band-edge Non-hopping, Low Power, Modulation Profile 3.....	199
Figure 167: Low Band-edge Non-hopping, Low Power, Modulation Profile 4.....	200
Figure 168: Low Band-edge Non-hopping, Low Power, Modulation Profile 5.....	201
Figure 169: Low Band-edge Non-hopping, Low Power, Modulation Profile 6.....	202
Figure 170: Low Band-edge Non-hopping, Low Power, Modulation Profile 7.....	203
Figure 171: High Band-edge Non-hopping, Low Power, Modulation Profile 0.....	204
Figure 172: High Band-edge Non-hopping, Low Power, Modulation Profile 1.....	205
Figure 173: High Band-edge Non-hopping, Low Power, Modulation Profile 2.....	206
Figure 174: High Band-edge Non-hopping, Low Power, Modulation Profile 3.....	207
Figure 175: High Band-edge Non-hopping, Low Power, Modulation Profile 4.....	208
Figure 176: High Band-edge Non-hopping, Low Power, Modulation Profile 5.....	209
Figure 177: High Band-edge Non-hopping, Low Power, Modulation Profile 6.....	210
Figure 178: High Band-edge Non-hopping, Low Power, Modulation Profile 7.....	211
Figure 179: Lower Band-edge Hopping, Low Power, Modulation Profile 0.....	212
Figure 180: Lower Band-edge Hopping, Low Power, Modulation Profile 1.....	213
Figure 181: Lower Band-edge Hopping, Low Power, Modulation Profile 2.....	214
Figure 182: Lower Band-edge Hopping, Low Power, Modulation Profile 3.....	215
Figure 183: Lower Band-edge Hopping, Low Power, Modulation Profile 4.....	216
Figure 184: Lower Band-edge Hopping, Low Power, Modulation Profile 5.....	217
Figure 185: Lower Band-edge Hopping, Low Power, Modulation Profile 6.....	218
Figure 186: Lower Band-edge Hopping, Low Power, Modulation Profile 7.....	219
Figure 187: Upper Band-edge Hopping, Low Power, Modulation Profile 0.....	220
Figure 188: Upper Band-edge Hopping, Low Power, Modulation Profile 1.....	221
Figure 189: Upper Band-edge Hopping, Low Power, Modulation Profile 2.....	222
Figure 190: Upper Band-edge Hopping, Low Power, Modulation Profile 3.....	223
Figure 191: Upper Band-edge Hopping, Low Power, Modulation Profile 4.....	224
Figure 192: Upper Band-edge Hopping, Low Power, Modulation Profile 5.....	225

Figure 193: Upper Band-edge Hopping, Low Power, Modulation Profile 6 ..... 226  
Figure 194: Upper Band-edge Hopping, Low Power, Modulation Profile 7 ..... 227

## 1 Introduction

### 1.1 Compliance Statement

The Motorola - Enterprise Mobility Solutions FX7400 complies with the limits for a Frequency Hopping Spread Spectrum Transmitter device under FCC Part 15.247 (7/2008) and Industry Canada RSS-210e issue 7.

### 1.2 Test Scope

Tests for radiated and conducted (at antenna terminal) emissions were performed. All measurements were performed in accordance Public Notice DA 00-705 "Filing and Measurement Guidelines for Frequency Hopping Spread Spectrum Systems". The measurement equipment conforms to ANSI C63.2 Specifications for Electromagnetic Noise and Field Strength Instrumentation.

### 1.3 Contract Information

Customer:	Motorola - Enterprise Mobility Solutions Jays Close Viabes Industrial Estate Basingstoke Hampshire RG22 4PD United Kingdom
Purchase Order Number:	NP4798797
Quotation Number:	64683D

### 1.4 Test Dates

Testing was performed on the following date(s):	9/2/2009 to 9/29/2009
---	-----------------------

### 1.5 Test and Support Personnel

Washington Laboratories, LTD	James Ritter
Client Representative	Alan Parrish

## 1.6 Abbreviations

<b>A</b>	<b>A</b> mpere
<b>ac</b>	<b>a</b> lternating <b>c</b> urrent
<b>AM</b>	<b>A</b> mplitude <b>M</b> odulation
<b>Amps</b>	<b>A</b> mperes
<b>b/s</b>	<b>b</b> its per <b>s</b> econd
<b>BW</b>	<b>B</b> and <b>W</b> idth
<b>CE</b>	<b>C</b> onducted <b>E</b> mission
<b>cm</b>	<b>c</b> entimeter
<b>CW</b>	<b>C</b> ontinuous <b>W</b> ave
<b>dB</b>	<b>d</b> eci <b>B</b> el
<b>dc</b>	<b>d</b> irect <b>c</b> urrent
<b>EMI</b>	<b>E</b> lectromagnetic <b>I</b> nterference
<b>EUT</b>	<b>E</b> quipment <b>U</b> nder <b>T</b> est
<b>FM</b>	<b>F</b> requency <b>M</b> odulation
<b>G</b>	<b>g</b> iga - prefix for $10^9$ multiplier
<b>Hz</b>	<b>H</b> ertz
<b>IF</b>	<b>I</b> ntermediate <b>F</b> requency
<b>k</b>	<b>k</b> ilo - prefix for $10^3$ multiplier
<b>LISN</b>	<b>L</b> ine <b>I</b> mpedance <b>S</b> tabilization <b>N</b> etwork
<b>M</b>	<b>M</b> ega - prefix for $10^6$ multiplier
<b>m</b>	<b>m</b> eter
<b>μ</b>	<b>m</b> icro - prefix for $10^{-6}$ multiplier
<b>NB</b>	<b>N</b> arrow <b>b</b> and
<b>QP</b>	<b>Q</b> uasi- <b>P</b> eak
<b>RE</b>	<b>R</b> adiated <b>E</b> missions
<b>RF</b>	<b>R</b> adio <b>F</b> requency
<b>rms</b>	<b>r</b> oot- <b>m</b> ean- <b>s</b> quare
<b>SN</b>	<b>S</b> erial <b>N</b> umber
<b>S/A</b>	<b>S</b> pectrum <b>A</b> nalyzer
<b>V</b>	<b>V</b> olt

## 2 Equipment Under Test

### 2.1 EUT Identification & Description

The Motorola - Enterprise Mobility Solutions FX7400 is a fixed RFID Reader in the 902-928 MHz band. The unit comes in 4 antenna port (FX7400-4) and a 2 antenna port version (FX7400-2). These units are identical except for the number of available antenna ports. Each unit has 2 external power supply options as follows.

- a) A GlobeTek external 100-240Vac to +24Vdc power supply adaptor Motorola Part No: 50-14000-159R .
- b) A power over Ethernet (POE) with Symbol power Injector 1 port PN# AP-PSBIAS-1P2-AFR.
- c) An Astec external 100-240Vac to +24Vdc power supply adaptor Motorola Part No 50-14000-260R RevA.

**Table 1: Device Summary**

ITEM	DESCRIPTION
Manufacturer:	Motorola - Enterprise Mobility Solutions
FCC ID:	UZ7FX7400
IC:	109AN-FX7400
Model:	FX7400
Serial Number tested	US-01 (2 port unit), US-02 (4 port unit)
FCC Rule Parts:	§15.247
Industry Canada:	RSS210e issue 7
Frequency Range:	902.75-927.25MHz
Maximum Output Power:	993.12mW (29.97dBm)
Modulation:	DB-ASK, PR-ASK
Occupied Bandwidth:	432.18kHz
Keying:	Automatic
Type of Information:	Data
Number of Channels:	50
Power Output Level	User selectable 15dBm-30dBm
Antenna Connector	Reverse TNC
Antenna Type	6dBiL Plate (STI AN480-CL66100WR)
Interface Cables:	USB, Ethernet, GPIO, Power input, 4 antenna ports (2 for 2 port unit)
Power Source & Voltage:	+24VDC supplied from 1 of 3 configurations listed above
Highest Transmit Spurious emission	138.0 uV/m @ 3m- 1000MHz
Highest Receive Spurious Emission	133.9uV/m @3m -1125.25MHz
Emission Designator	432kG1D

## 2.2 Test Configuration

For Conducted Radio RF testing the 4 port FX7400 unit w/ a Globetek external 100-240Vac to +24Vdc power supply adaptor was used. The antenna ports transmit sequentially with only one port transmitting at a time. In light of this conducted antenna port transmitter testing was performed on antenna port 1 (with ports 2-4 disabled) using the GlobeTek power supply. Radiated Testing was performed on the 4 port unit with 4 antennas. In addition Radiated tests and AC Mains testing were performed with the Astec AC/DC adaptor and the Power over Ethernet power option. Radiated tests and AC Mains testing were also performed with the 2 port version. Conducted testing was conducted at the lowest and highest power levels.

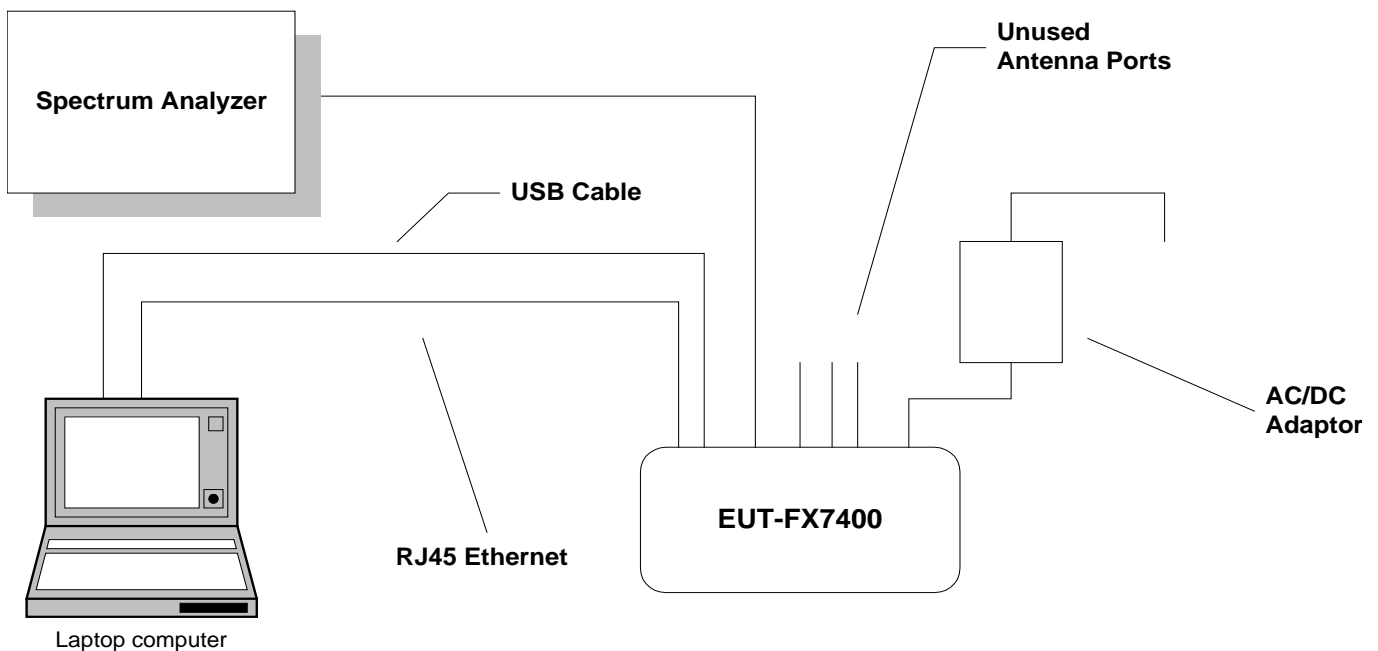

Figure 1: System Configuration

## 2.3 Testing Algorithm

The FX7400 was programmed for testing on stationary channels using customer Telnet commands from a support Laptop (via Ethernet). Hopping functions were tested in a user based WEB application. Both of these applications allowed setting of the transmitter power and data profiles.

Worst case emission levels are provided in the test results data.

## 2.4 Modulation Modes (profiles)

The FX7400 can operate with 8 distinct modulation data profiles as listed in the below table. Throughout this test report these will be referred to by the profile number in the leftmost column of the below table.

**Table 2: Modulation Profiles**

Selec-tor	ID_High	ID_Low	Mod-type	Tari (uS)	X	PW (uS)	Rtcal (uS) (Calc'd)	Trcal (uS) (Calc'd)	DR	M	TRExt	LF (KHz)	Data-rate (kbps)
0	0x0000 0009	0x0004 0001	DSB-ASK	25.00	1.00	12.50	75.00	200.00	8.00	FM0	1	40.00	40
1	0x0000 0009	0x0004 0004	DSB-ASK	12.50	1.00	6.25	37.50	50.00	8.00	M=2	1	160.00	80
2	0x0000 0009	0x0001 0090	PR-ASK	25.00	0.50	12.50	62.50	85.33	21.33	M=4	1	250.00	62.5
3	0x0000 0009	0x0004 0008	PR-ASK	25.00	0.50	12.50	62.50	71.11	21.33	M=4	1	300.00	75

Selec-tor	ID_High	ID_Low	Mod-type	Tari (uS)	X	PW (uS)	Rtcal (uS) (Calc'd)	Trcal (uS) (Calc'd)	DR	M	TRExt	LF (KHz)	Data-rate (kbps)
4	0x0000 0009	0x0004 0013	DSB-ASK	6.25	0.50	3.13	15.63	20.00	8.00	FM0	1	400.00	400
5	0x0000 0009	0x0004 0052	PR-ASK	25.00	0.50	12.50	62.50	85.33	21.33	M=2	1	250.00	125
6	0x0000 0001	0x0000 0001	PR-ASK	25.00	0.50	12.50	62.50	85.33	21.33	M=4	0	250.00	62.5
7	0x0000 0001	0x0000 0002	PR-ASK	25.00	0.50	12.50	62.50	71.11	21.33	M=4	0	300.00	75

## 2.5 Test Location

All measurements herein were performed at Washington Laboratories, Ltd. test center in Gaithersburg, MD. Site description and site attenuation data have been placed on file with the FCC's Sampling and Measurements Branch at the FCC laboratory in Columbia, MD. The Industry Canada OATS numbers are 3035A-1 and 3035A-2 for Washington Laboratories, Ltd. Site 1 and Site 2, respectively. Washington Laboratories, Ltd. has been accepted by the FCC and approved by the American Association for Laboratory Accreditation (A2LA) under Certificate 2675.01 as an independent FCC test laboratory.

## 2.6 Measurements

### 2.6.1 References

FCC Public Notice DA 00-705, Filing and Measurement Guidelines for Frequency Hopping Spread Spectrum Systems

ANSI C63.2 Specifications for Electromagnetic Noise and Field Strength Instrumentation

ANSI C63.4 Methods of Measurement of Radio Noise from Low-Voltage Electrical and Electronic Equipment in the Range of 9 kHz to 40 GHz.

## 2.7 Measurement Uncertainty

All results reported herein relate only to the equipment tested. The basis for uncertainty calculation uses ANSI/NCSL Z540-2-1997 with a type B evaluation of the standard uncertainty. Elements contributing to the standard uncertainty are combined using the method described in Equation 1 to arrive at the total standard uncertainty. The standard uncertainty is multiplied by the coverage factor to determine the expanded uncertainty which is generally accepted for use in commercial, industrial, and regulatory applications and when health and safety are concerned (see Equation 2). A coverage factor was selected to yield a 95% confidence in the uncertainty estimation.

**Equation 1: Standard Uncertainty**

$$u_c = \pm \sqrt{\frac{a^2}{div_a^2} + \frac{b^2}{div_b^2} + \frac{c^2}{div_c^2} + \dots}$$

Where  $u_c$  = standard uncertainty

$a, b, c, \dots$  = individual uncertainty elements

$Div_{a, b, c}$  = the individual uncertainty element divisor based on the probability distribution

Divisor = 1.732 for rectangular distribution

Divisor = 2 for normal distribution

Divisor = 1.414 for trapezoid distribution

**Equation 2: Expanded Uncertainty**

$$U = k u_c$$

Where  $U$  = expanded uncertainty

$k$  = coverage factor

$k \leq 2$  for 95% coverage (ANSI/NCSL Z540-2 Annex G)

$u_c$  = standard uncertainty

The measurement uncertainty complies with the maximum allowed uncertainty from CISPR 16-4-2. Measurement uncertainty is not used to adjust the measurements to determine compliance. The expanded uncertainty values for the various scopes in the WLL accreditation are provided in Table 3 below.



**Table 3: Expanded Uncertainty List**

Scope	Standard(s)	Expanded Uncertainty
Conducted Emissions	CISPR11, CISPR22, CISPR14, FCC Part 15	2.63 dB
Radiated Emissions	CISPR11, CISPR22, CISPR14, FCC Part 15	4.55 dB

### 3 Test Equipment

Table 4 shows a list of the test equipment used for measurements along with the calibration information.

**Table 4: Test Equipment List**

#### Bench Conducted Testing

WLL Asset #	Manufacturer Model/Type	Function	Cal. Due
00618	HP 8563A	Analyzer, Spectrum	4/10/2010

#### Radiated Emissions Testing

WLL Asset #	Manufacturer Model/Type	Function	Cal. Due
626	ARA, DRG-118/A	Antenna, Horn	06/03/2011
66	HP, 8449B	Pre-Amplifier, RF. 1-26.5GHz	07/21/2010
280	ITC, 21C-3A1	Waveguide 3.45-11.0GHz	02/19/2010
337	WLL, 1.2-5GHz	Filter, Band Pass	02/19/2010
69	HP, 85650A	Adapter, QP	06/28/2010
73	HP, 8568B	Analyzer, Spectrum	06/28/2010
71	HP, 85685A	Preselector, RF	06/28/2010
618	HP 8563A	Analyzer, Spectrum	04/10/2010
644	Sunol Science JB1	BiConalog Antenna	12/29/2009

#### Conducted AC Mains testing

WLL Asset #	Manufacturer Model/Type	Function	Cal. Due
125	Solar, 8028-50-TS-24-BNC	LISN	07/17/2010
126	Solar, 8028-50-TS-24-BNC	LISN	07/17/2010
69	HP, 85650A	Adapter, QP	06/28/2010
73	HP, 8568B	Analyzer, Spectrum	06/28/2010
71	HP, 85685A	Preselector, RF	06/28/2010
53	HP, 11947A	Limiter, Transient	03/09/2010

#### 4 Test Summary

The Table Below shows the results of testing for compliance with a Digital Transmission System in accordance with FCC Part 15.247:2007 and RSS210e issue 7. Full results are shown in section 5.

**Table 5: Test Summary Table**

<b>TX Test Summary (Frequency Hopping Spread Spectrum)</b>			
<b>FCC Rule Part</b>	<b>IC Rule Part</b>	<b>Description</b>	<b>Result</b>
15.247 (a)(1)(i)	RSS-210 [A8. 1 (c)]	20dB Bandwidth	Pass
15.247 (b)(2)	RSS-210 [A8.4 (1)]	Transmit Output Power	Pass
15.247 (a)(1)	RSS-210 [A8.1 (b)]	Channel Separation	Pass
15.247 (a)(1)(i)	RSS-210 [A8. 1 (c)]	Number of Channels =50 minimum	Pass
15.247 (a)(1)(i)	RSS-210 [A8. 1 (c)]	Time of Occupancy	
15.247 (d)	RSS-210 [A8. 5]	Occupied BW / Out-of-Band Emissions (Band Edge @ 20dB below)	Pass
15.205 15.209	RSS-210 [A8. 5]	General Field Strength Limits (Restricted Bands & RE Limits)	Pass
15.207	RSS-Gen [7.2.2]	AC Conducted Emissions	Pass
<b>RX/Digital Test Summary (Frequency Hopping Spread Spectrum)</b>			
<b>FCC Rule Part</b>	<b>IC Rule Part</b>	<b>Description</b>	<b>Result</b>
15.207	RSS-Gen [7.2.2]	AC Conducted Emissions	Pass
15.209	RSS-Gen [7.2.3.2]	General Field Strength Limits (Restricted Bands & RE Limits)	Pass

## 5 Test Results

### 5.1 RF Power Output: (§2.1046, §15.247 (b)(2), RSS-210 [A8.4(1)])

To measure the output power the hopping sequence was stopped while the frequency dwelled on a low, high and middle channel. The output from the transmitter was connected to an attenuator and then to the input of the RF Spectrum Analyzer. The analyzer offset was adjusted to compensate for the attenuator and other losses in the system. Readings were taken with a spectrum analyzer in Max Hold using a resolution bandwidth greater than the 20dB bandwidth and a video bandwidth 3 times the RBW.

Power Plots of the results are presented in appendix A1.

**Table 6 RF Power Summary –Highest Power Level**

Level	Limit	Pass/Fail
29.97dBm	30dBm	Pass

**Table 7: RF Power Output – Complete Table**

Frequency	Modulation Profile	Power Setting	Level	Limit	Pass/Fail
Low Channel: 902.75MHz	0	High	29.80dBm	30dBm	Pass
		Low	14.88dBm	30dBm	Pass
Low Channel: 902.75MHz	1	High	29.97dBm	30dBm	Pass
		Low	14.89dBm	30dBm	Pass
Low Channel: 902.75MHz	2	High	29.89dBm	30dBm	Pass
		Low	15.14dBm	30dBm	Pass
Low Channel: 902.75MHz	3	High	29.97dBm	30dBm	Pass
		Low	14.80dBm	30dBm	Pass
Low Channel: 902.75MHz	4	High	29.64dBm	30dBm	Pass
		Low	14.8dBm	30dBm	Pass
Low Channel: 902.75MHz	5	High	29.97dBm	30dBm	Pass
		Low	14.89dBm	30dBm	Pass
Low Channel: 902.75MHz	6	High	29.88dBm	30dBm	Pass
		Low	15.30dBm	30dBm	Pass
Low Channel: 902.75MHz	7	High	29.97dBm	30dBm	Pass
		Low	14.96dBm	30dBm	Pass

Frequency	Modulation Profile	Power Setting	Level	Limit	Pass/Fail
Center Channel: 915.25MHz	0	High	29.80dBm	30dBm	Pass
		Low	15.03dBm	30dBm	Pass
Center Channel: 915.25MHz	1	High	29.97dBm	30dBm	Pass
		Low	14.80dBm	30dBm	Pass
Center Channel: 915.25MHz	2	High	29.89dBm	30dBm	Pass
		Low	15.39dBm	30dBm	Pass
Center Channel: 915.25MHz	3	High	29.97dBm	30dBm	Pass
		Low	14.80dBm	30dBm	Pass
Center Channel: 915.25MHz	4	High	29.64dBm	30dBm	Pass
		Low	14.72dBm	30dBm	Pass
Center Channel: 915.25MHz	5	High	29.97dBm	30dBm	Pass
		Low	14.97dBm	30dBm	Pass
Center Channel: 915.25MHz	6	High	29.80dBm	30dBm	Pass
		Low	15.22dBm	30dBm	Pass
Center Channel: 915.25MHz	7	High	29.89dBm	30dBm	Pass
		Low	14.80dBm	30dBm	Pass

Frequency	Modulation Profile	Power Setting	Level	Limit	Pass/Fail
High channel: 927.25MHz	0	High	29.64dBm	30dBm	Pass
		Low	14.72dBm	30dBm	Pass
High channel: 927.25MHz	1	High	29.64dBm	30dBm	Pass
		Low	14.64dBm	30dBm	Pass
High channel: 927.25MHz	2	High	29.72dBm	30dBm	Pass
		Low	14.80dBm	30dBm	Pass
High channel: 927.25MHz	3	High	29.97dBm	30dBm	Pass
		Low	14.72dBm	30dBm	Pass
High channel: 927.25MHz	4	High	29.80dBm	30dBm	Pass
		Low	14.56dBm	30dBm	Pass
High channel: 927.25MHz	5	High	29.72dBm	30dBm	Pass
		Low	15.06dBm	30dBm	Pass
High channel: 927.25MHz	6	High	29.88dBm	30dBm	Pass
		Low	14.64dBm	30dBm	Pass
High channel: 927.25MHz	7	High	29.64dBm	30dBm	Pass
		Low	14.67dBm	30dBm	Pass

**5.2 Occupied Bandwidth: (§2.1046, §15.247 (a)(1)(i), RSS-210 [A8.1(c)])**

Occupied bandwidth was performed by coupling the output of the EUT to the input of a spectrum analyzer. The spectrum analyzer RBW was set to larger than 1% of the 20dB bandwidth with the VBW set greater than the RBW in a Max Hold mode.

For Frequency Hopping Spread Spectrum Systems, FCC Part 15.247 requires the maximum 20 dB bandwidth not exceed 500kHz. At full modulation, the occupied bandwidth was measured as shown:

The below table provides a summary of the Occupied Bandwidth Results.

20dB Bandwidth Plots of the results are presented in appendix A2.

**Table 8: Occupied Bandwidth Summary (shows widest OBW)**

Modulation Profile	Bandwidth	Limit	Pass/Fail
4	432.18 kHz	500 kHz	Pass

**Table 9: Occupied Bandwidth Results- Complete Results**

Frequency	Modulation Profile	Bandwidth	Limit	Pass/Fail
Low Channel: 902.75MHz	0	82.87 kHz	500 kHz	Pass
	1	184.42 kHz	500 kHz	Pass
	2	81.27 kHz	500 kHz	Pass
	3	82.75 kHz	500 kHz	Pass
	4	431.84 kHz	500 kHz	Pass
	5	82.59 kHz	500 kHz	Pass
	6	81.12 kHz	500 kHz	Pass
	7	82.03 kHz	500 kHz	Pass

Frequency	Modulation Profile	Bandwidth	Limit	Pass/Fail
Center Channel: 915.25MHz	0	82.57 kHz	500 kHz	Pass
	1	184.35 kHz	500 kHz	Pass
	2	81.23 kHz	500 kHz	Pass
	3	81.61 kHz	500 kHz	Pass
	4	431.67 kHz	500 kHz	Pass
	5	81.32 khz	500 kHz	Pass
	6	81.01 kHz	500 kHz	Pass
	7	81.88 kHz	500 kHz	Pass

Frequency	Modulation Profile	Bandwidth	Limit	Pass/Fail
High Channel: 927.25MHz	0	82.57 kHz	500 kHz	Pass
	1	183.67 kHz	500 kHz	Pass
	2	81.34 kHz	500 kHz	Pass
	3	80.73 kHz	500 kHz	Pass
	4	432.18 kHz	500 kHz	Pass
	5	80.91 kHz	500 kHz	Pass
	6	78.93 kHz	500 kHz	Pass
	7	80.74 kHz	500 kHz	Pass

**5.3 Channel Spacing /Number of Hop Channels (§15247(a)(1), RSS210[A8.1])**

Per the FCC requirements, frequency hopping systems shall have hopping channel carrier frequencies separated by a minimum of 25kHz or the 20 dB bandwidth, whichever is greater. In addition, for transmitters in the 902-928MHz frequency range the number of hopping channels shall be stated.

The EUT antenna was removed and the cable was connected directly into a spectrum analyzer through a 20 dB attenuator. An offset was programmed into the spectrum analyzer to compensate for the loss of the external attenuator. The spectrum analyzer resolution bandwidth was set to 300 kHz and the video bandwidth was set to 1MHz for the number of hoppers measurement . The channel spacing of 2 adjacent channels was measured using a spectrum analyzer span setting greater than 1% of the applicable span.

The following tables show the channel spacing and number of hopping channels data. The number of hoppers is the same for all profiles. Plot data is presented in appendix A3 of this report.

**Table 10: Number of Hoppers Summary**

Number of Hoppers	Limit	Pass/Fail
50	50 minimum	Pass

**Table 11: Channel Spacing Summary**

Modulation Profile	Chanel Spacing	Minimum Limit (20dB BW)	Pass/Fail
0	503.3kHz	82.9kHz	Pass
1	506.7kHz	184.4kHz	Pass
2	509.5khz	81.4kHz	Pass
3	503.3kHz	82.8kHz	Pass
4	507.7Khz	432.2kHz	Pass
5	506.7kHz	82.6kHz	Pass
6	506.7kHz	81.2kHz	Pass
7	504.3kHz	82.0kHz	Pass



**5.4 Time of Occupancy (§15.247 (a)(i), RSS-210 [A8.1(c)] )**

For frequency hopping systems operating in the 902-928 MHz band: if the 20 dB bandwidth of the hopping channel is less than 250 kHz, the average time of occupancy on any frequency shall not be greater than 0.4 seconds within a 20 second period; if the 20 dB bandwidth of the hopping channel is 250 kHz or greater, the average time of occupancy on any frequency shall not be greater than 0.4 seconds within a 10 second period.

Modulation profile 4 is the only profile with a 20dB bandwidth greater than 250kHz.

The readings were taken at with the EUT antenna port connected to a spectrum analyzer through a suitable attenuator. The RBW of the analyzer was set to 300kHz (the RBW was reduced from the prescribed 1MHz in order to prevent merging of adjacent channels that are only 500MHz apart). The analyzer was set to zero-span and the on time was measured. As the On time pulse train consisted of various size ON bits with a constant off time between bits the pulse train total ON time was calculated by subtracting the total off time from the pulse train total time. This was then compared to the allowed on time in order to verify compliance.

The below table summarizes the results. Plot data is supplied in appendix A4 of this report.

**Table 12: Time of Occupancy Summary table**

Modulation Profile	Time of Occupancy	Maximum Limit	Pass/Fail
0	350.2ms	0.4 seconds per 20 sec	Pass
1	290.0ms	0.4 seconds per 20 sec	Pass
2	325.3ms	0.4 seconds per 20 sec	Pass
3	315.3ms	0.4 seconds per 20 sec	Pass
4	243.3ms	0.4 seconds per 10 sec	Pass
5	307.0ms	0.4 seconds per 20 sec	Pass
6	307.0ms	0.4 seconds per 20 sec	Pass
7	308.7ms	0.4 seconds per 20 sec	Pass

## 5.5 Conducted Spurious Emissions at Antenna Terminals (§2.1051)

The EUT must comply with requirements for spurious emissions at antenna terminals. Per §15.247(c) all spurious emissions in any 100 kHz bandwidth outside the frequency band in which the spread spectrum device is operating shall be attenuated 20 dB below the highest power level in a 100 kHz bandwidth within the band containing the highest level of the desired power.

The EUT antenna was removed and the cable was connected directly into a spectrum analyzer through a 10 dB attenuator. An offset was programmed into the spectrum analyzer to compensate for the loss of the external attenuator. The spectrum analyzer resolution bandwidth was set to 100 kHz and the video bandwidth was set to 300 kHz. The amplitude of the EUT carrier frequency was measured to determine the emissions limit (20 dB below the carrier frequency amplitude). The emissions outside of the allocated frequency band were then scanned from 30 MHz up to the tenth harmonic of the carrier.

### 5.5.1 Band-edge Measurements

Table 13 provides a summary of the highest levels in relation to the band-edge for stationary and hopping signals both high and low power.

Close-up plots of the conducted band-edge are provided for each modulation profile in high and low power in a hopping and non hopping mode in appendix A4 of this report.

**Table 13 Band-edge Summary Table (worst case)**

Band-edge	Condition	Power-level	Modulation Profile	Relative level of Spur	Minimum Limit	Pass/fail
Lower	902.75MHz	High	3	-62.1dBc	-20dBc	Pass
Upper	927.25MHz	High	4	-47.13dBc	-20dBc	Pass
Lower	902.75MHz	Low	4	-46.4dBc	-20dBc	Pass
Upper	927.25MHz	Low	4	-59.3dBc	-20dBc	Pass
Lower	Hopping	High	7	-36.5dBc	-20dBc	Pass
Upper	Hopping	High	7	-36.2dBc	-20dBc	Pass
Lower	Hopping	Low	1	-34.2dBc	-20dBc	Pass
Upper	Hopping	Low	6	-34.5dBc	-20dBc	Pass

### 5.5.2 Conducted Spurious Plots

The following are plots of the conducted spurious emissions data taken in the high and low power modes at modulation profile 0

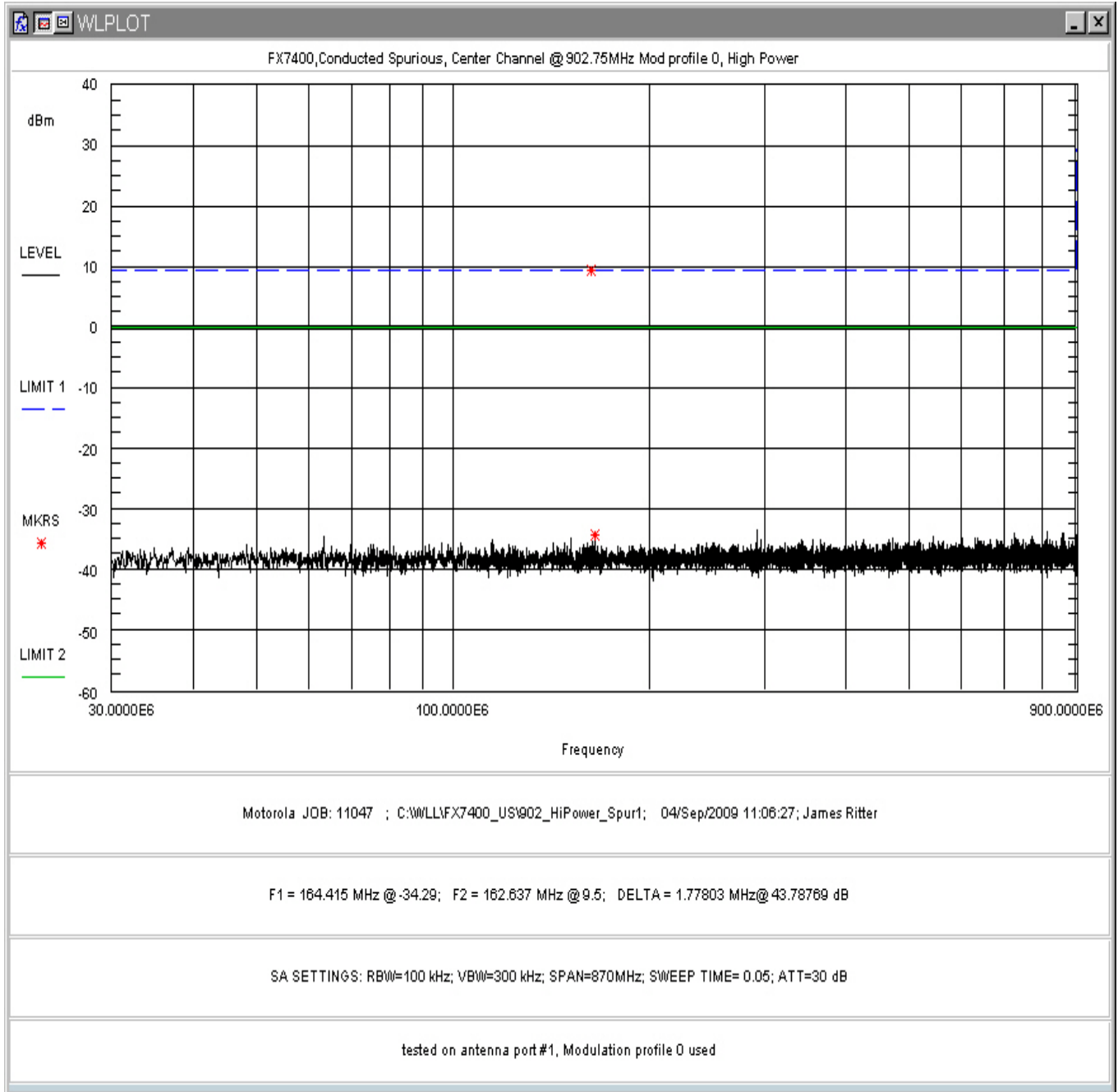
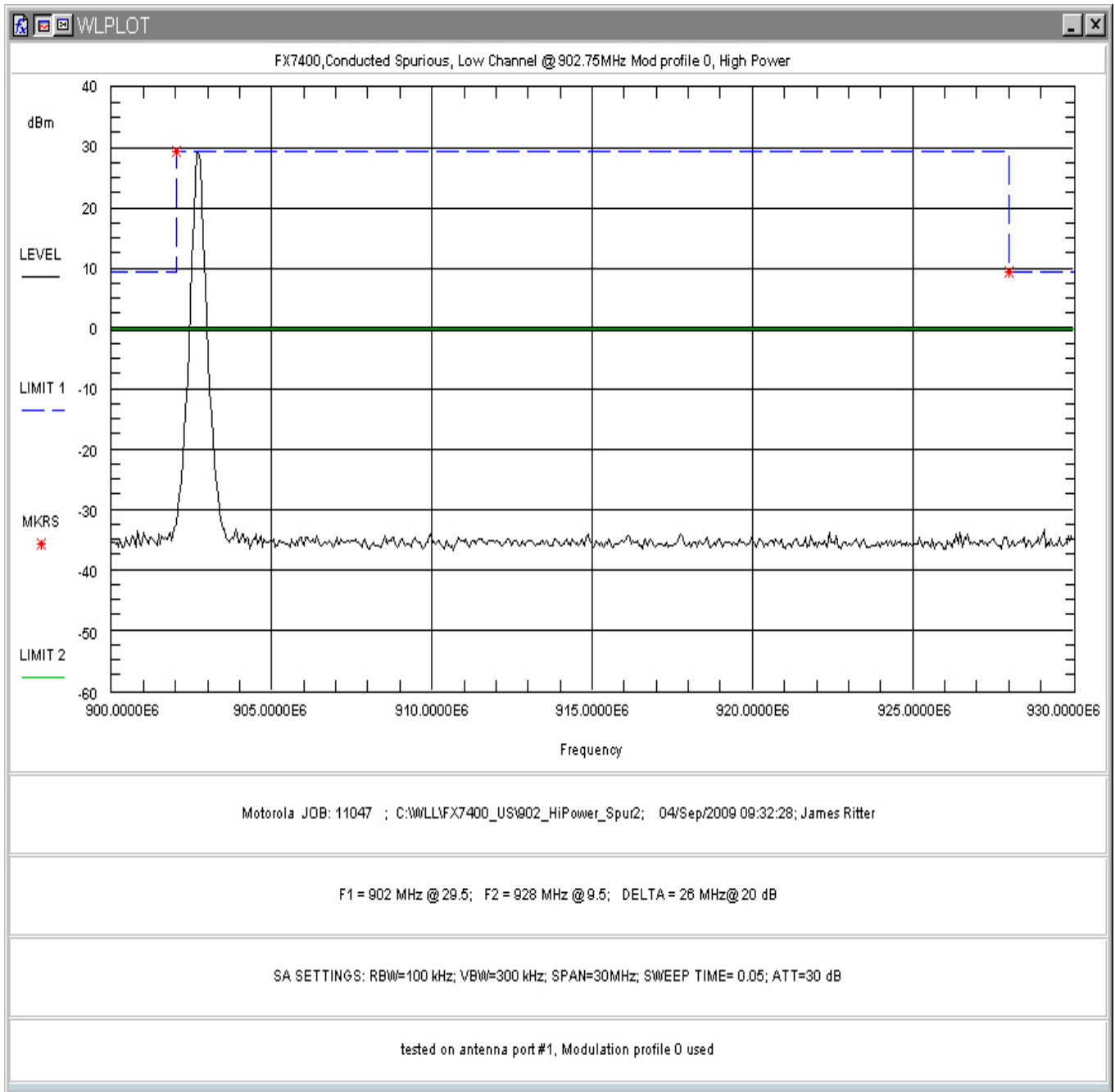

Figure 2: Conducted Spurious Emissions, Low Channel, High Power, 30 - 900MHz



**Figure 3: Conducted Spurious Emissions, Low Channel, High Power, 900-930MHz**

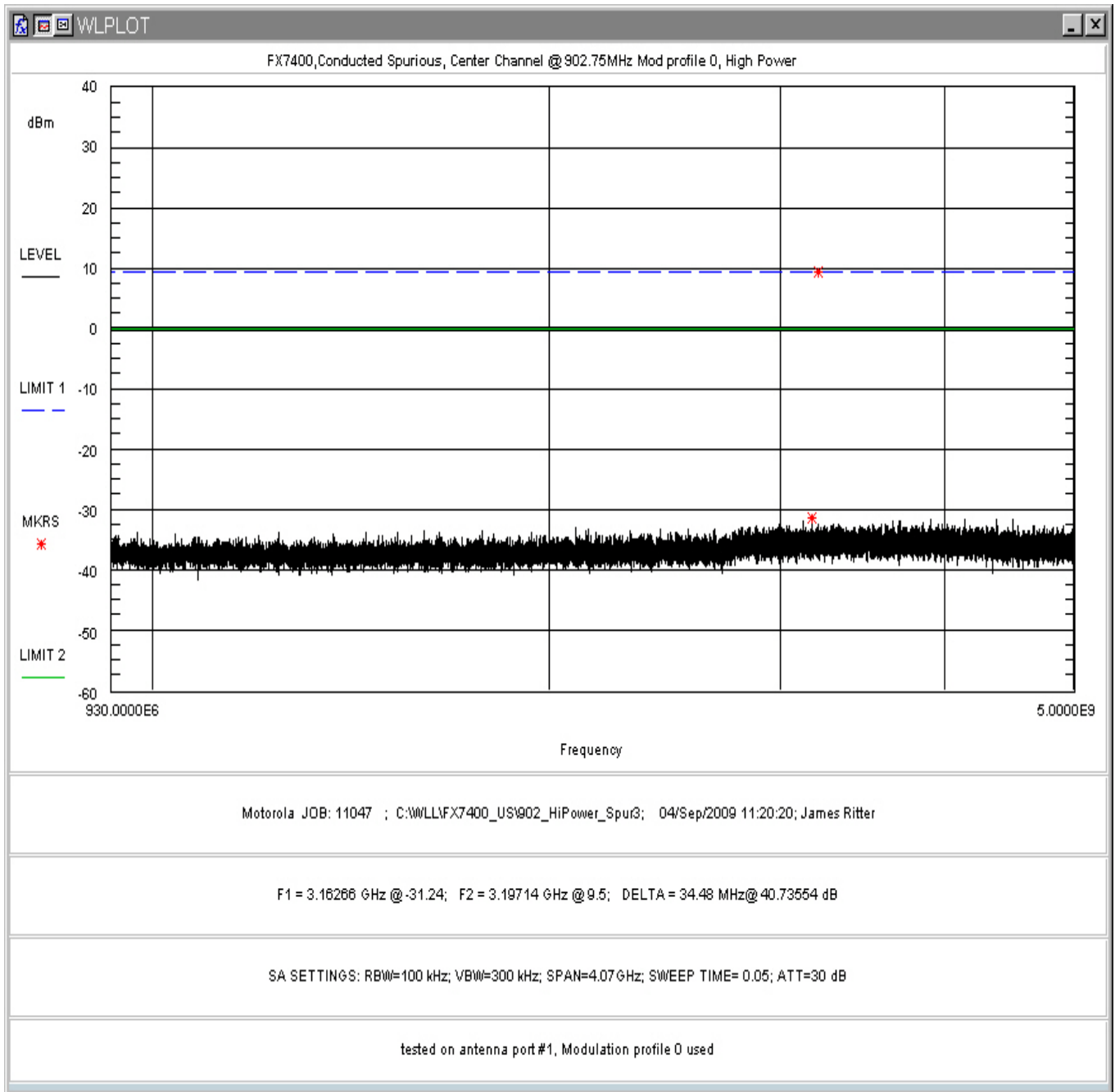
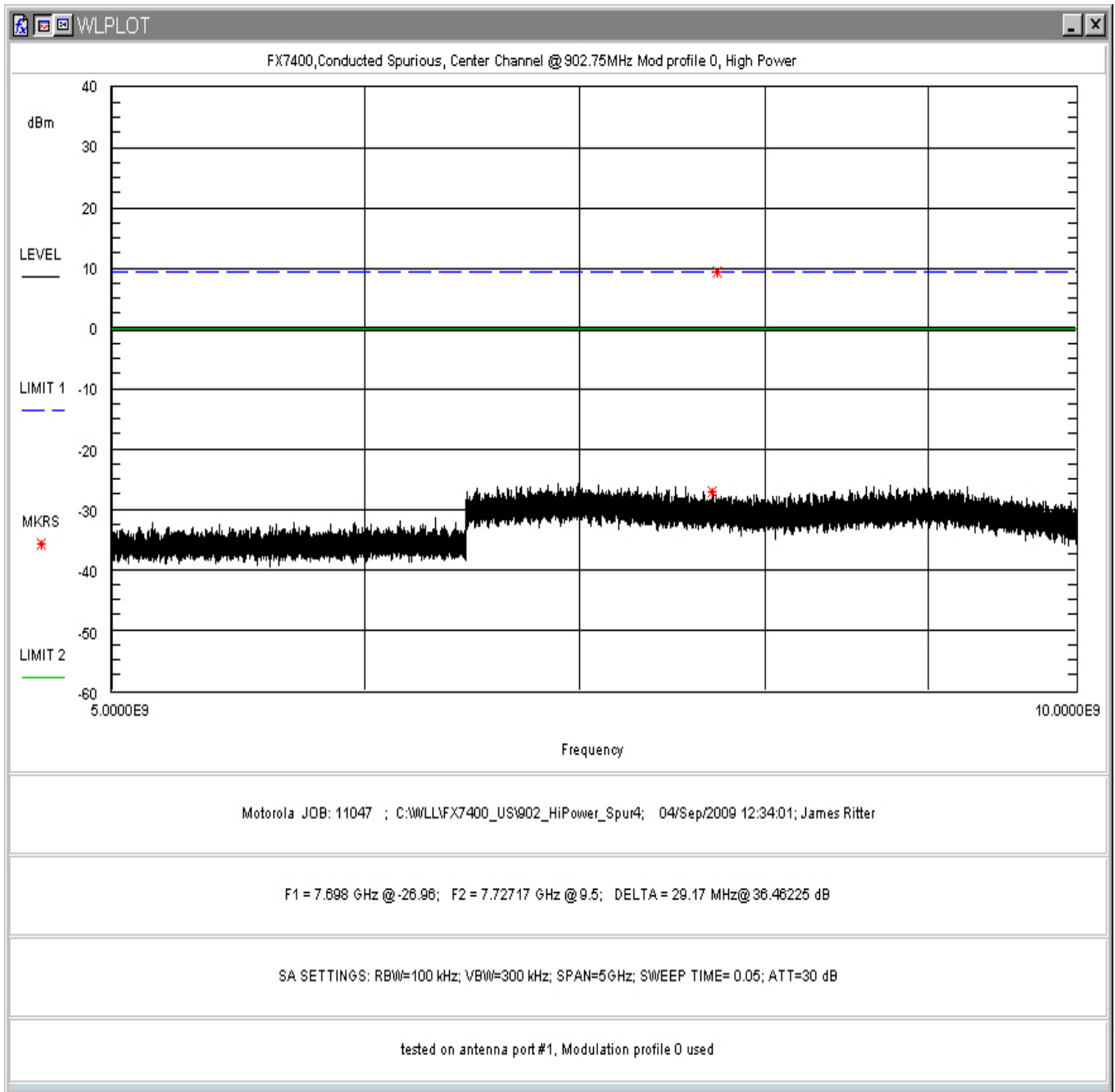

Figure 4: Conducted Spurious Emissions, Low Channel, High Power, 930MHz -5GHz



**Figure 5: Conducted Spurious Emissions, Low Channel, High Power, 5-10GHz**

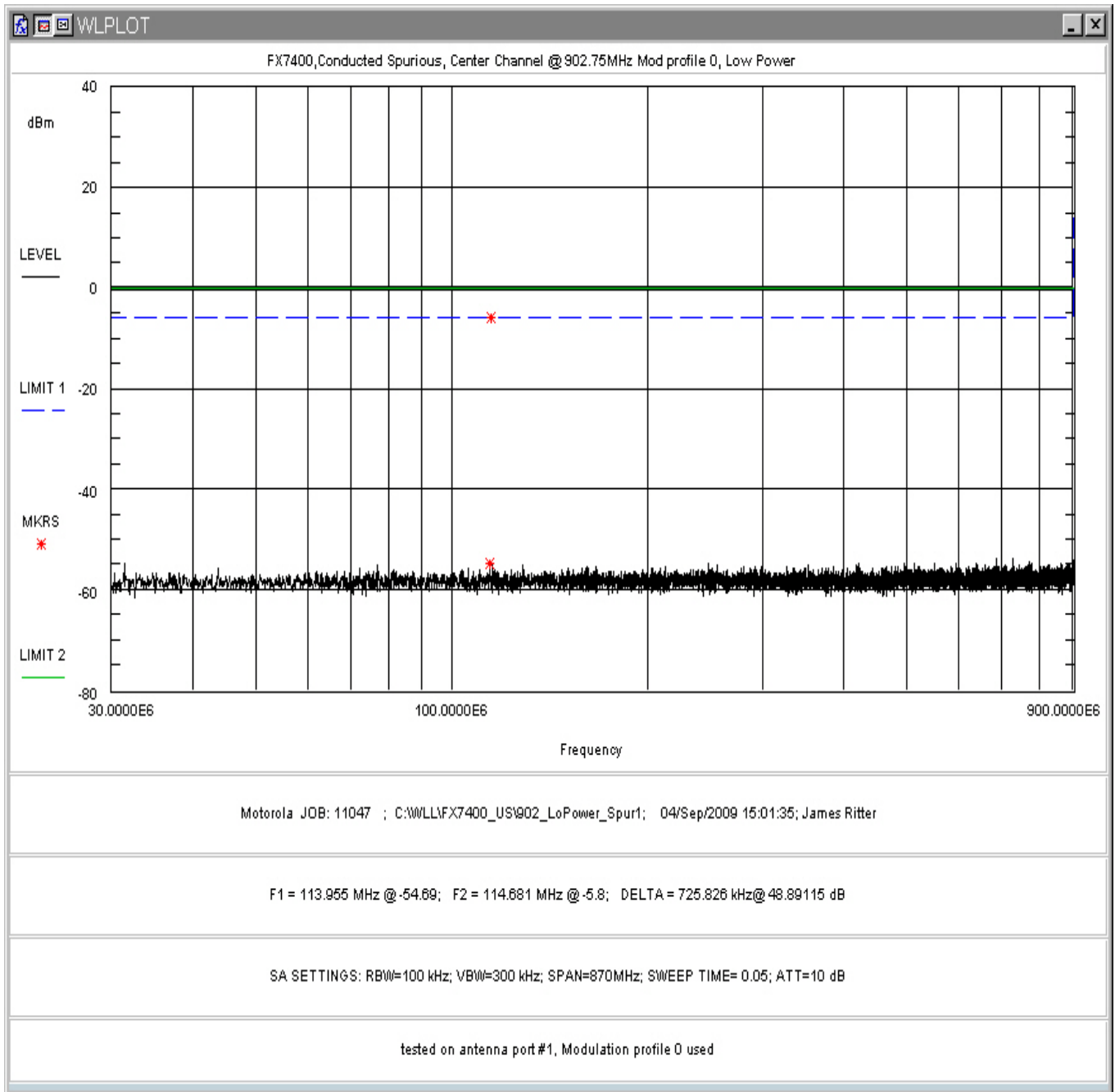

Figure 6: Conducted Spurious Emissions, Low Channel, Low Power, 30 - 900MHz

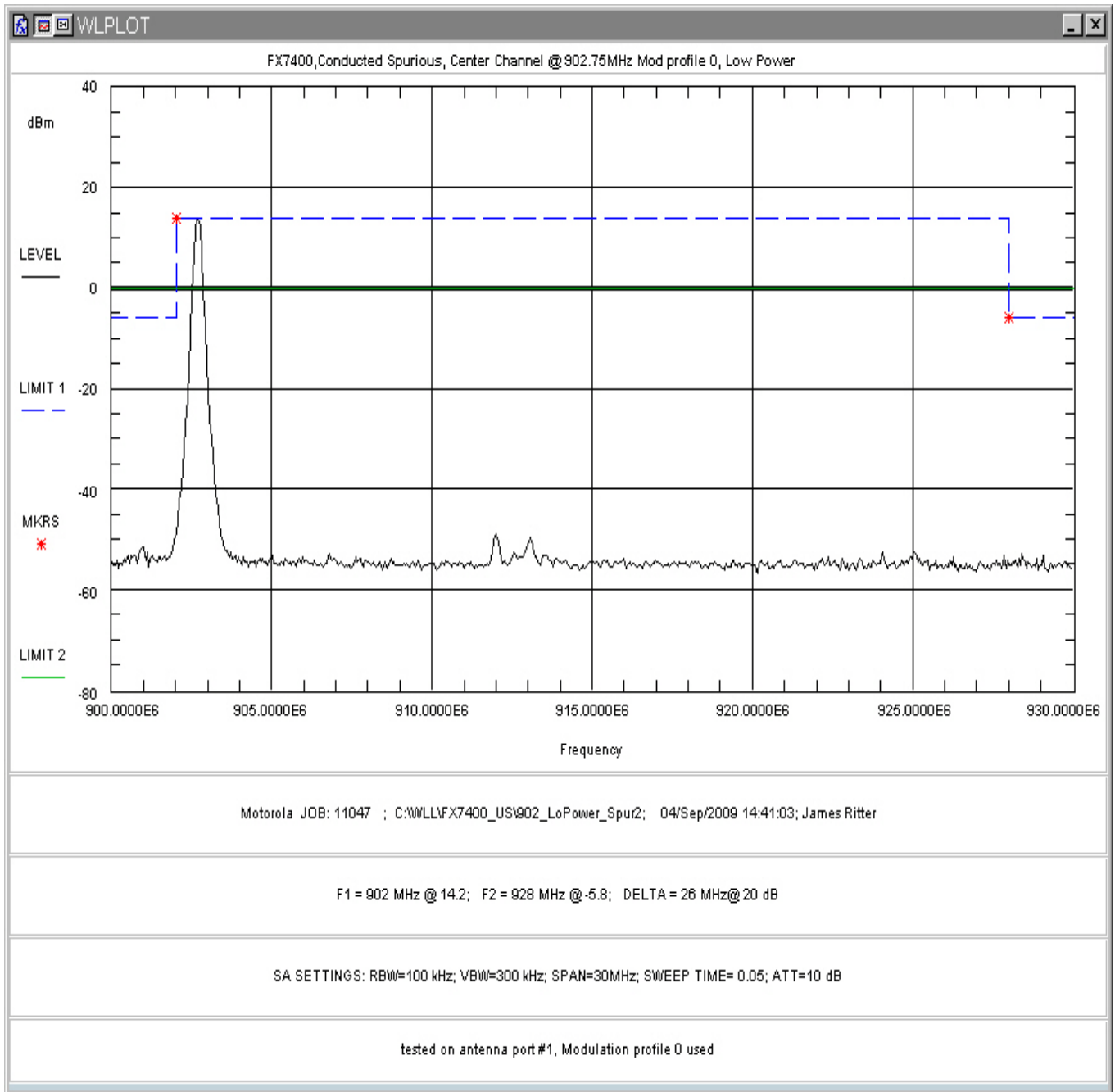
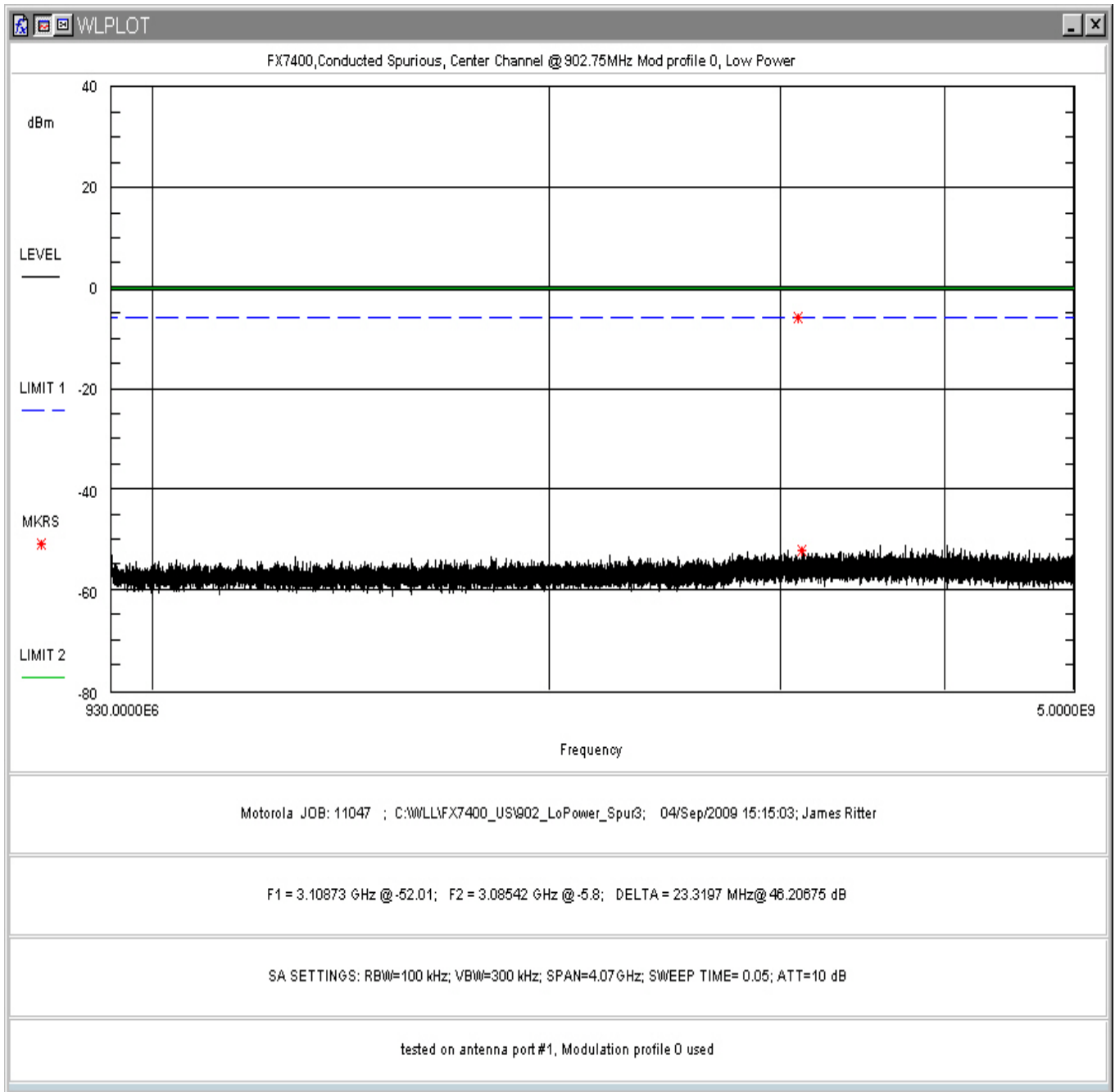
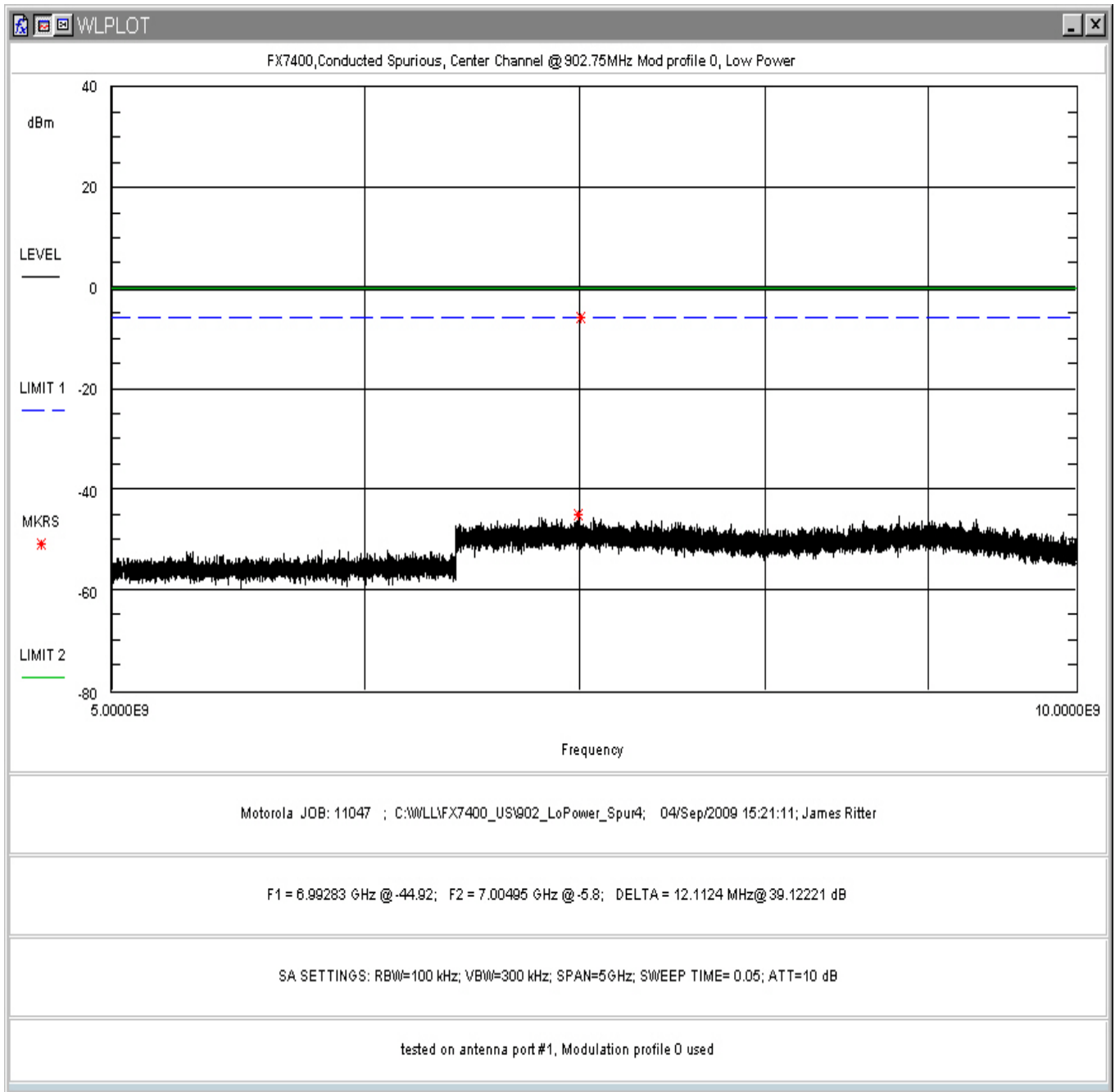

Figure 7: Conducted Spurious Emissions, Low Channel, Low Power, 900 - 930MHz

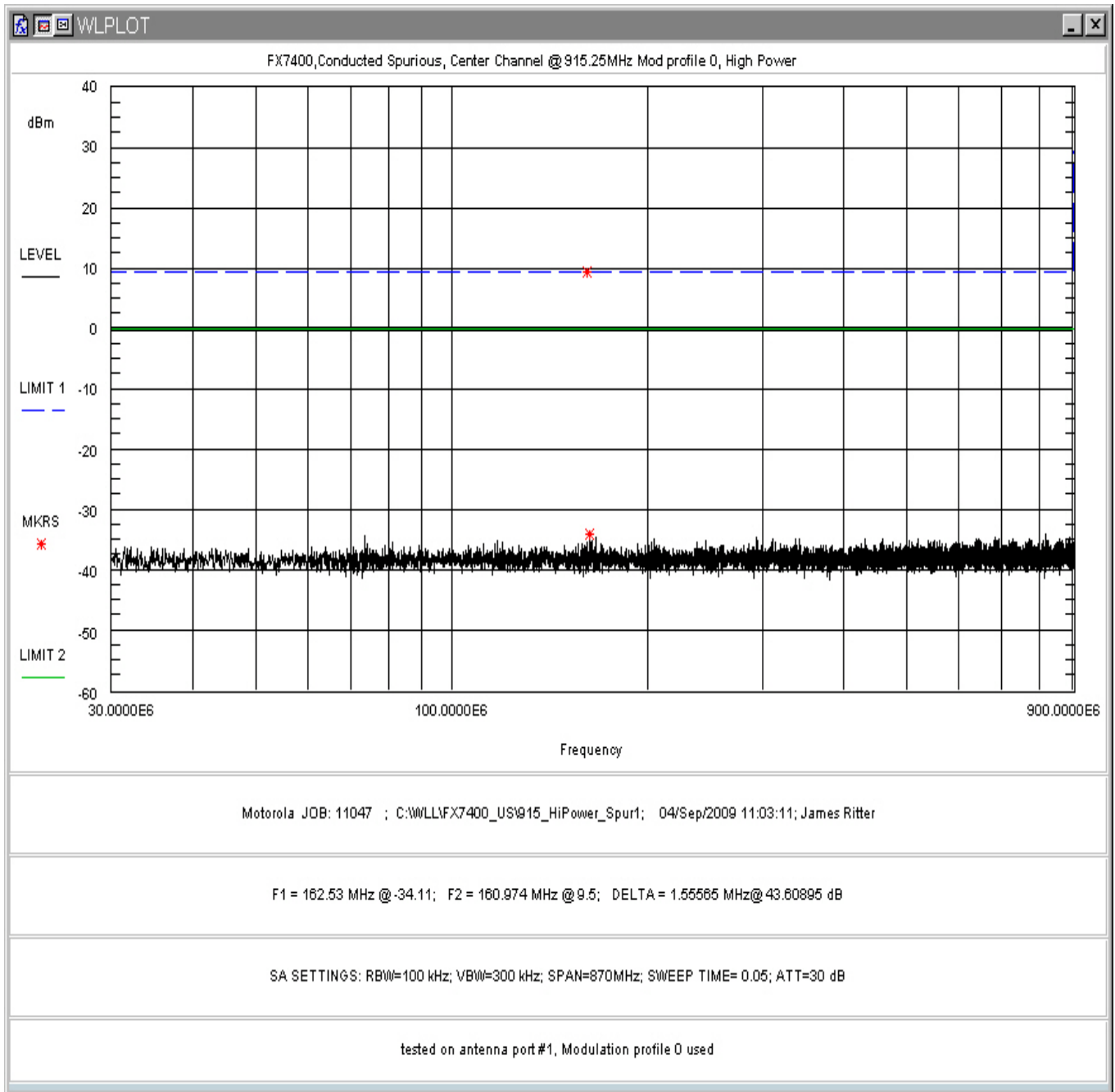



**Figure 8: Conducted Spurious Emissions, Low Channel, Low Power, 930MHz-5GHz**



**Figure 9: Conducted Spurious Emissions, Low Channel, Low Power, 5-10GHz**



**Figure 10: Conducted Spurious Emissions, Center Channel, High Power, 30-900MHz**

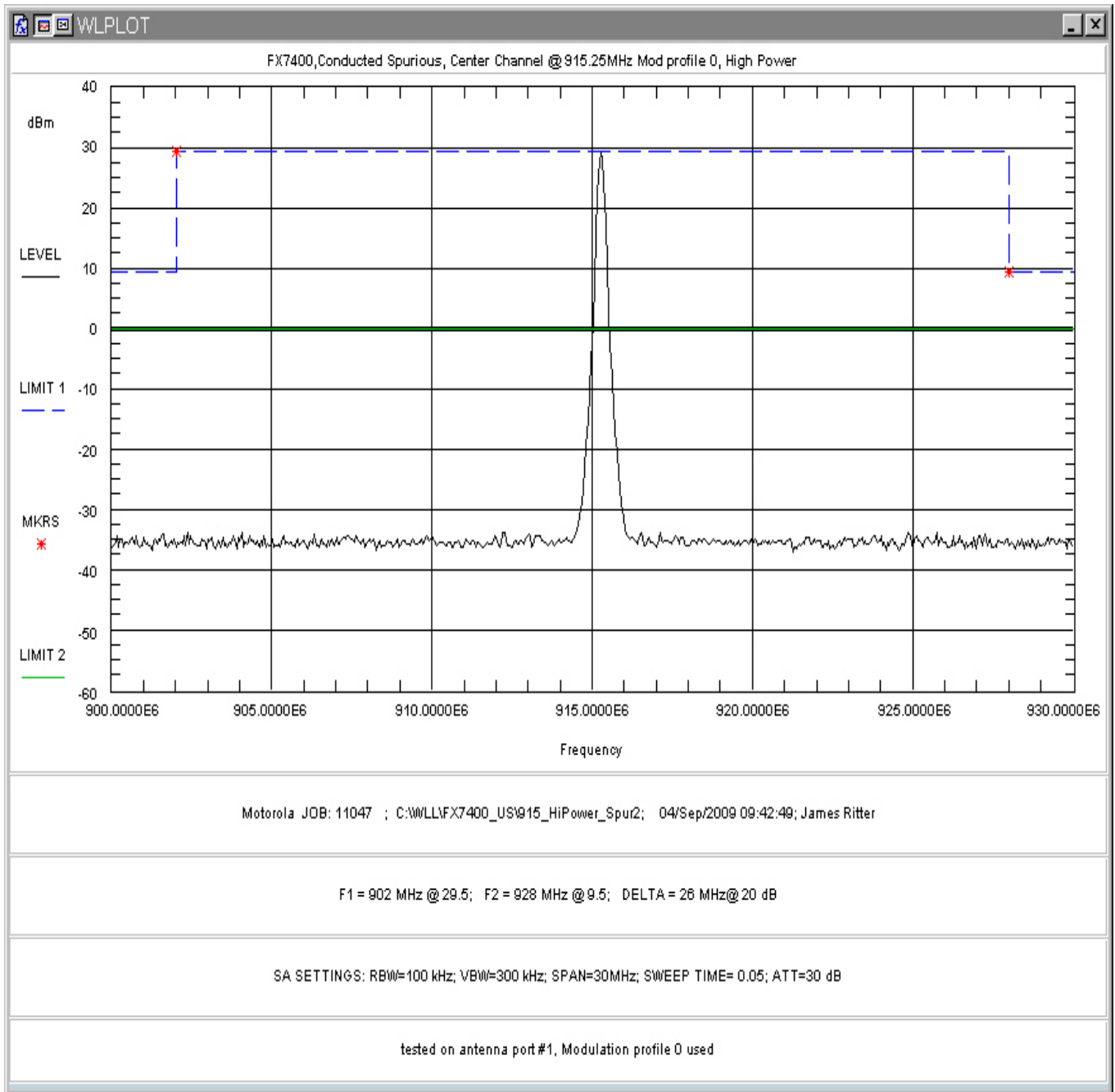

Figure 11: Conducted Spurious Emissions, Center Channel, High Power, 900-930MHz

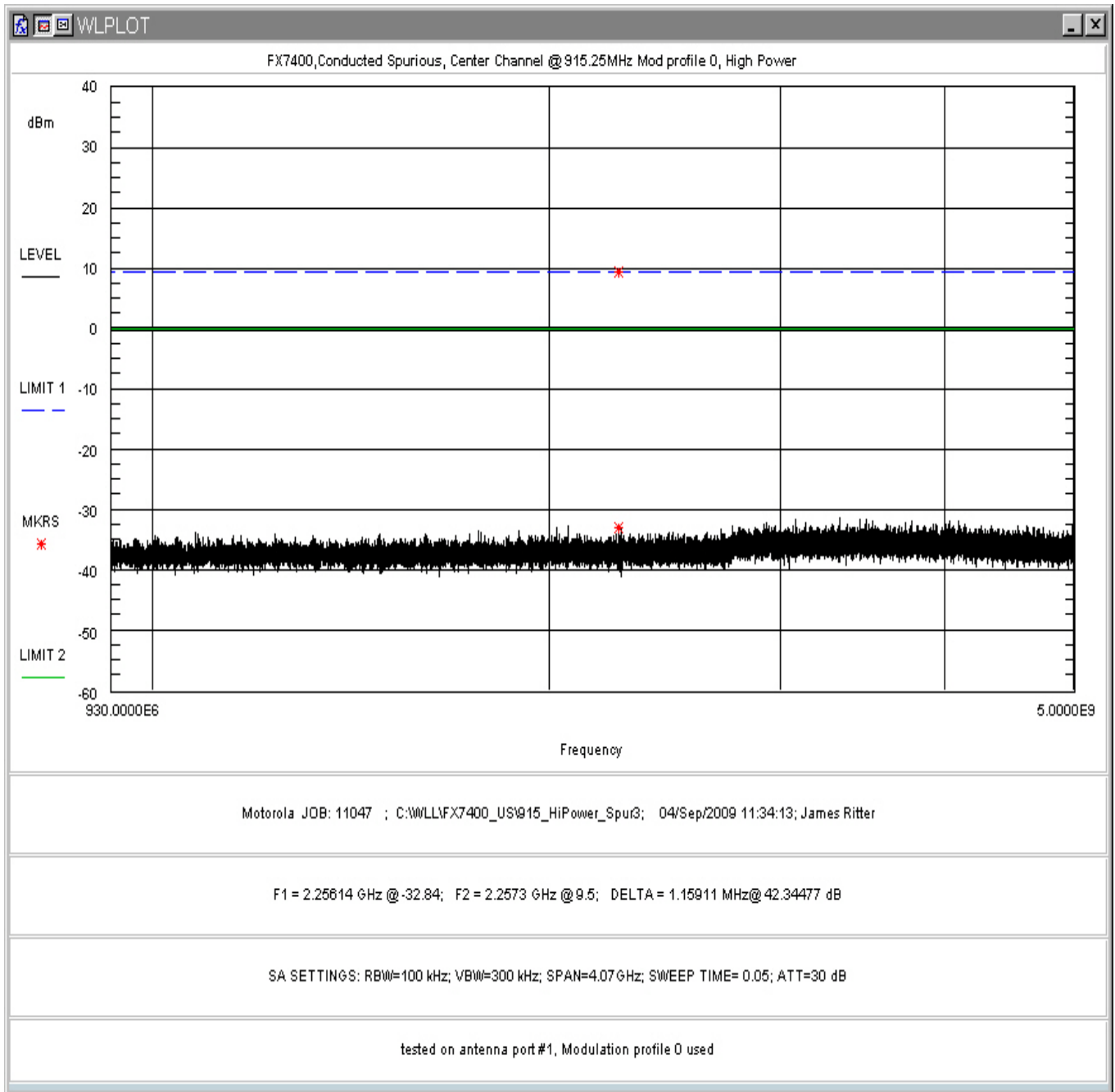

Figure 12: Conducted Spurious Emissions, Center Channel, High Power, 930MHz-5GHz

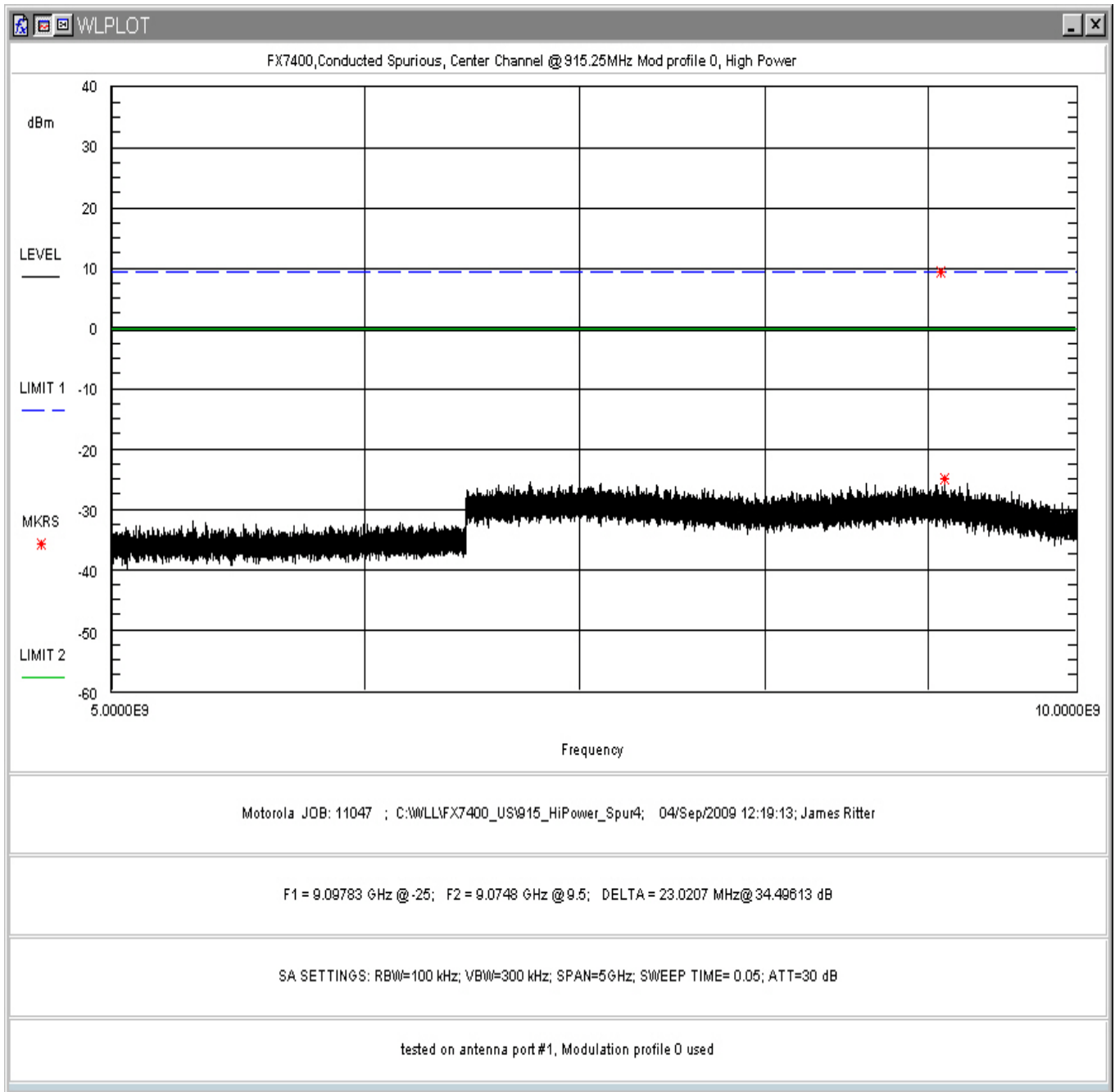

Figure 13: Conducted Spurious Emissions, Center Channel, High Power, 5-10GHz

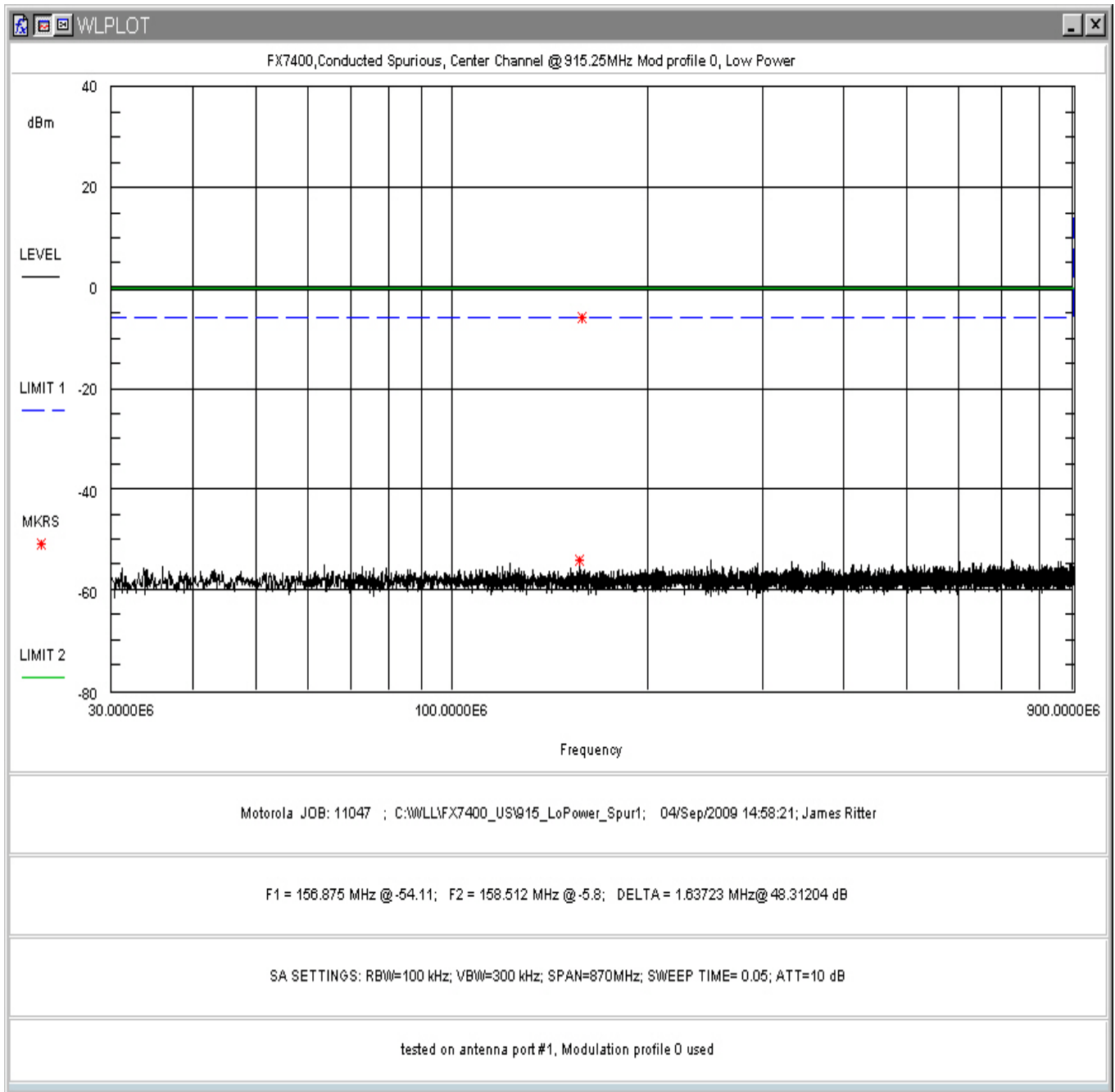

Figure 14: Conducted Spurious Emissions, Center Channel, Low Power, 30-900MHz

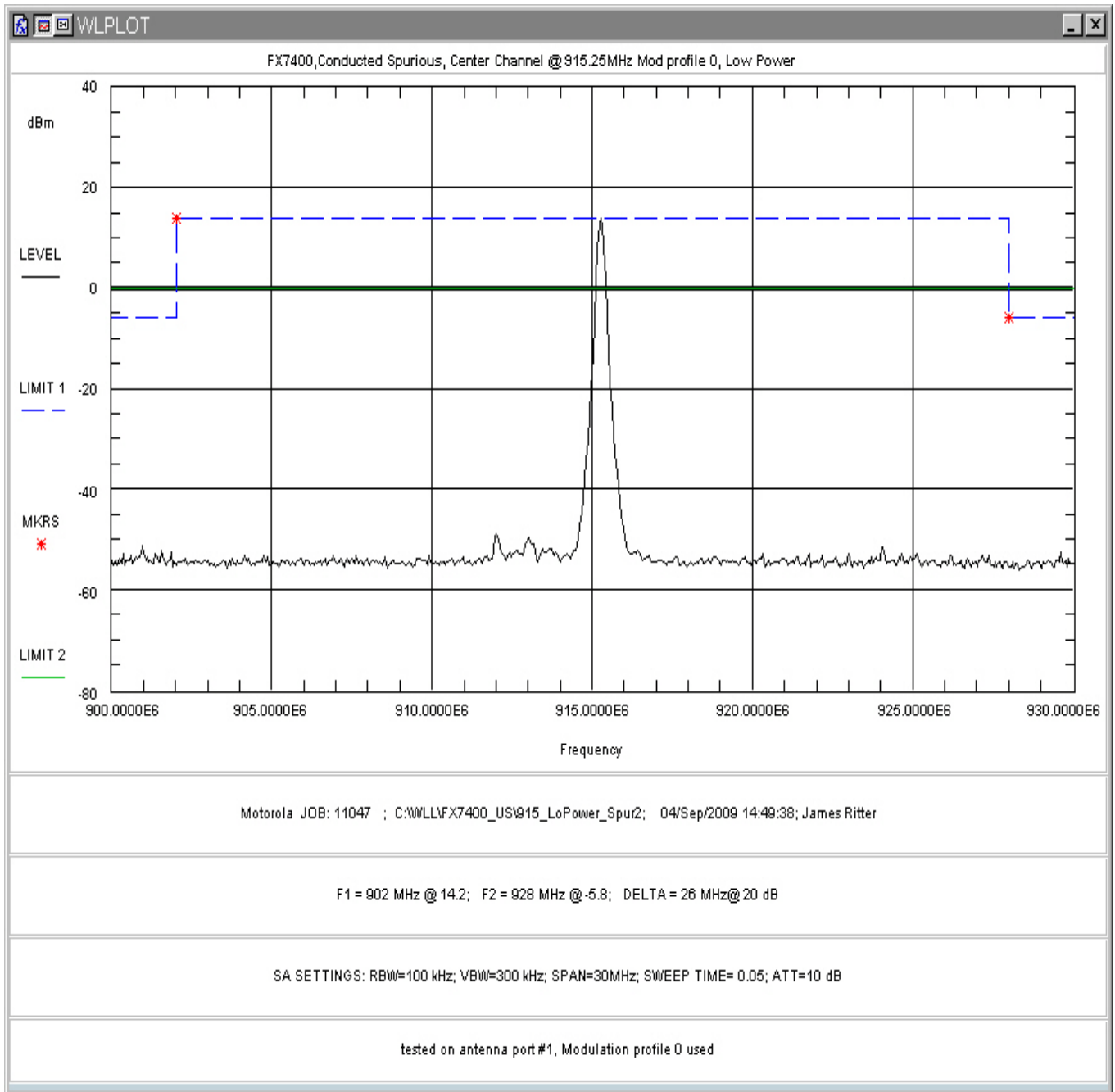

Figure 15: Conducted Spurious Emissions, Center Channel, Low Power, 900-930MHz



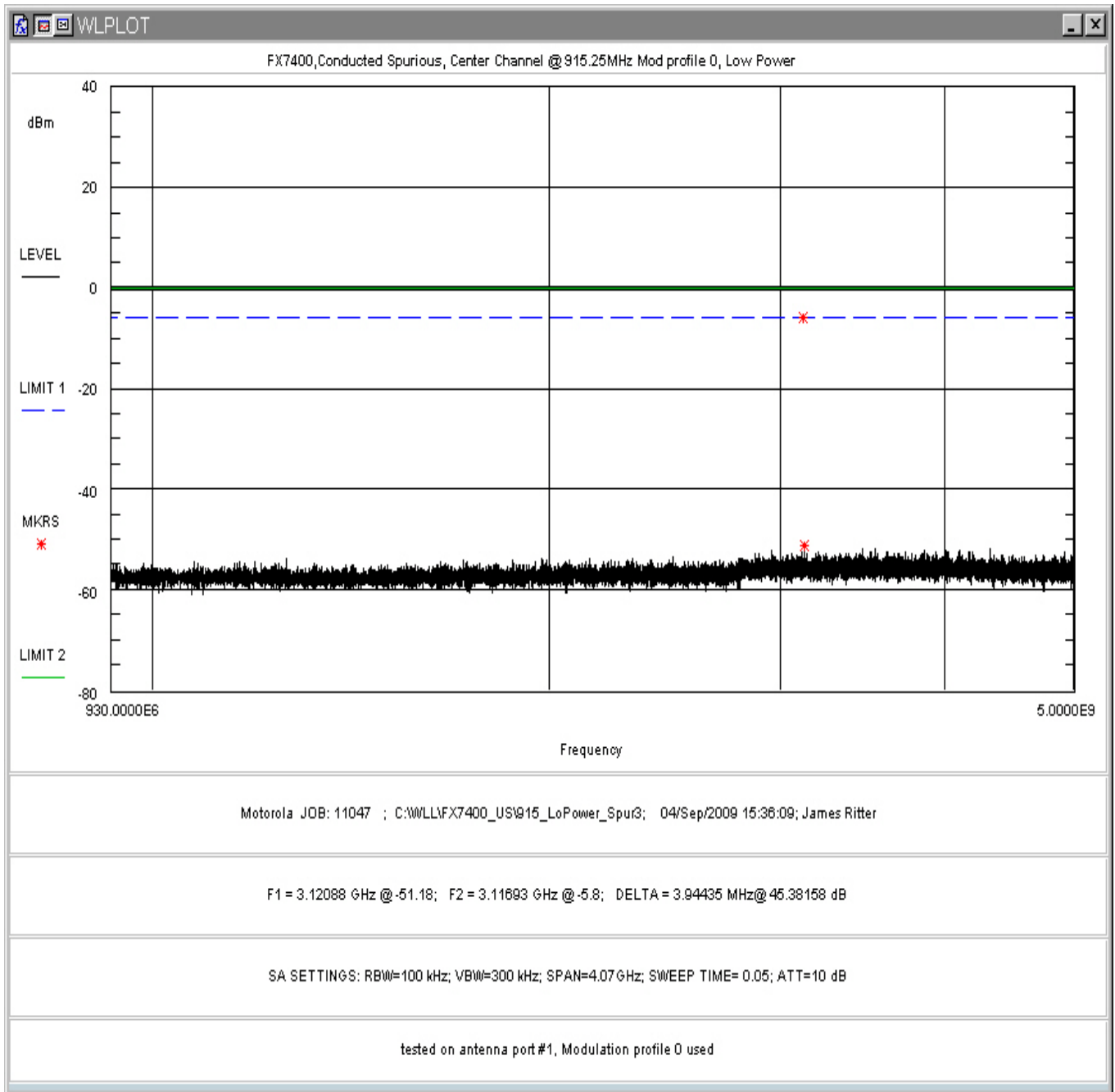

Figure 16: Conducted Spurious Emissions, Center Channel, Low Power, 930MHz-5GHz

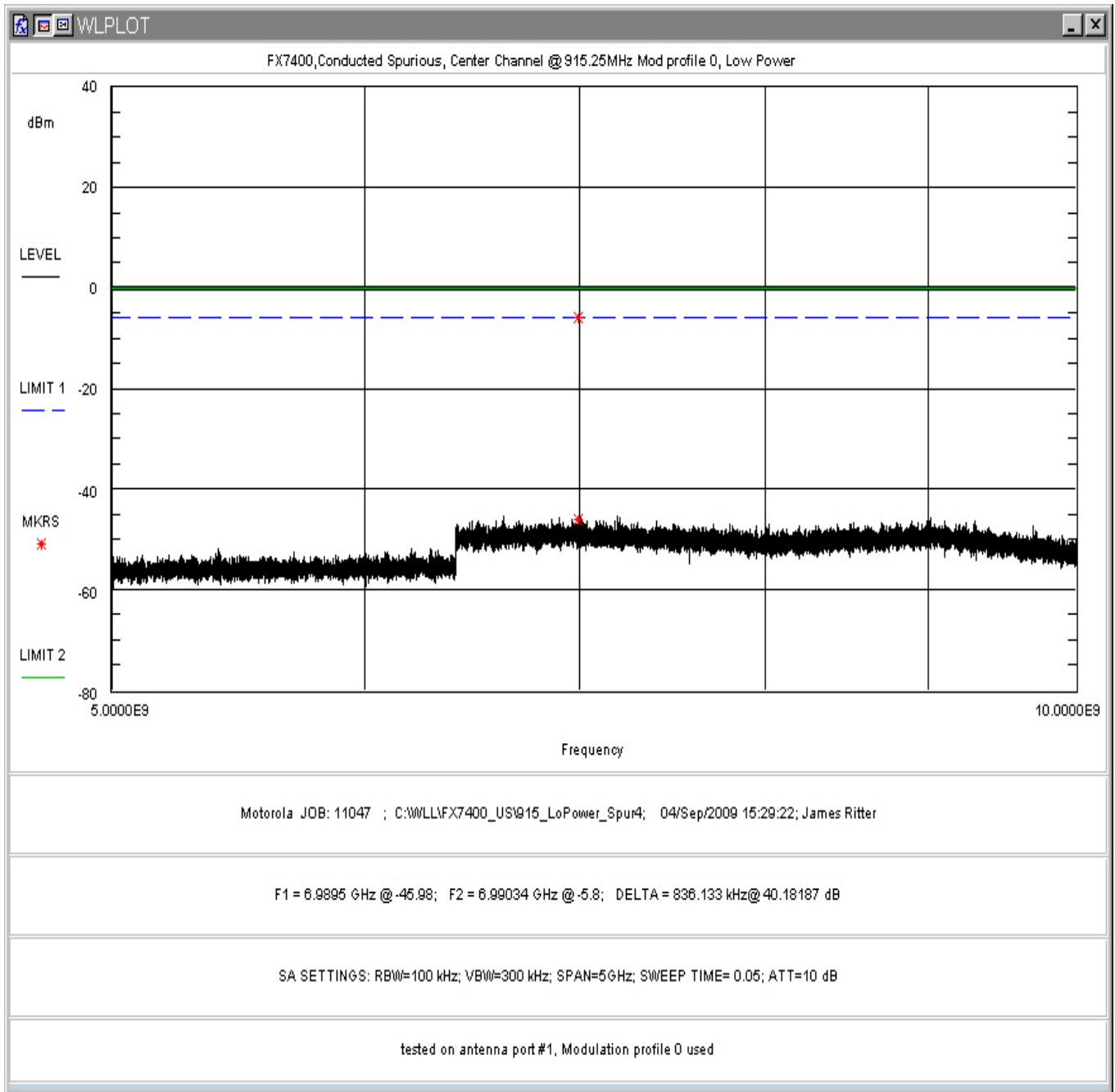
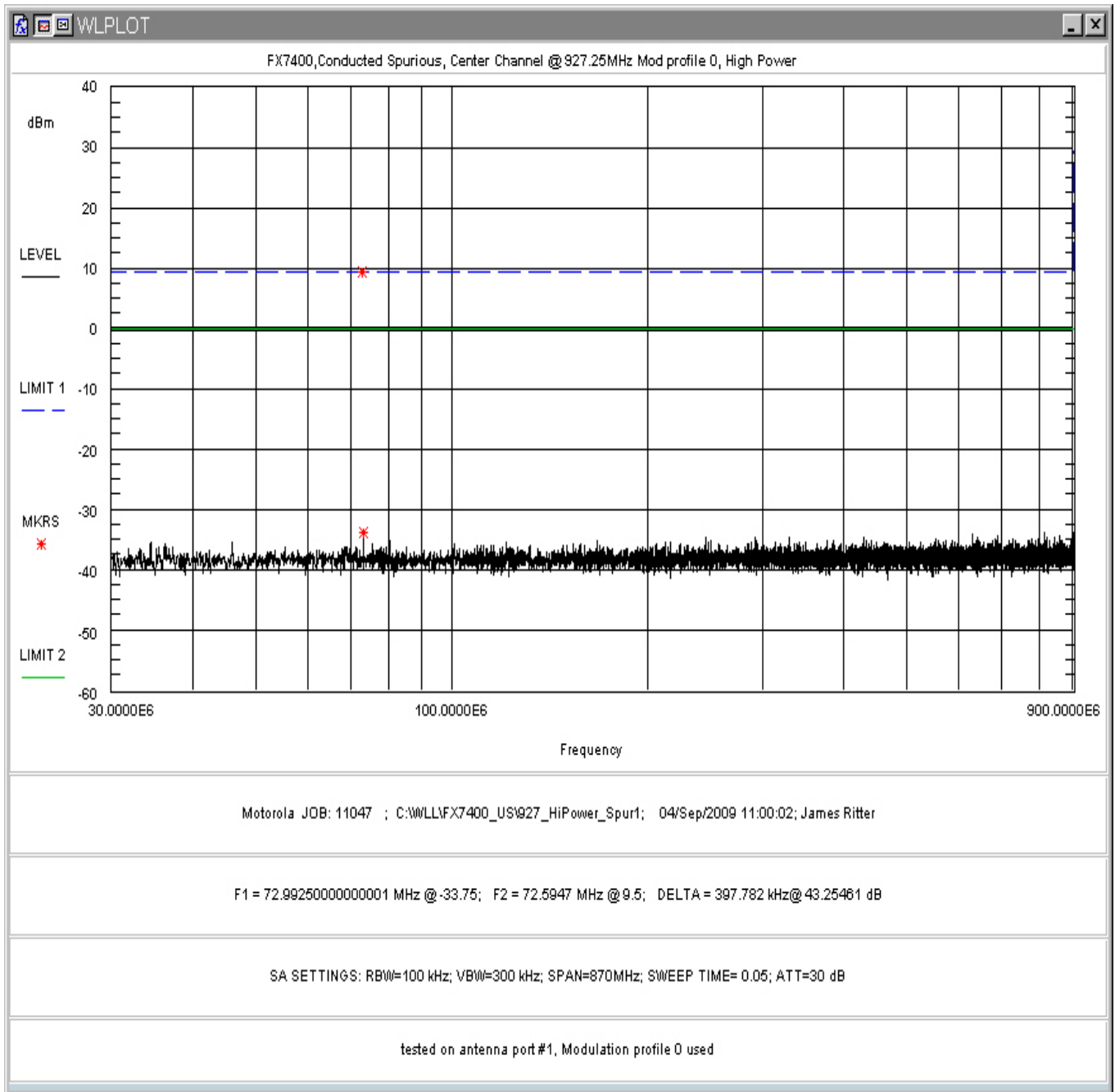
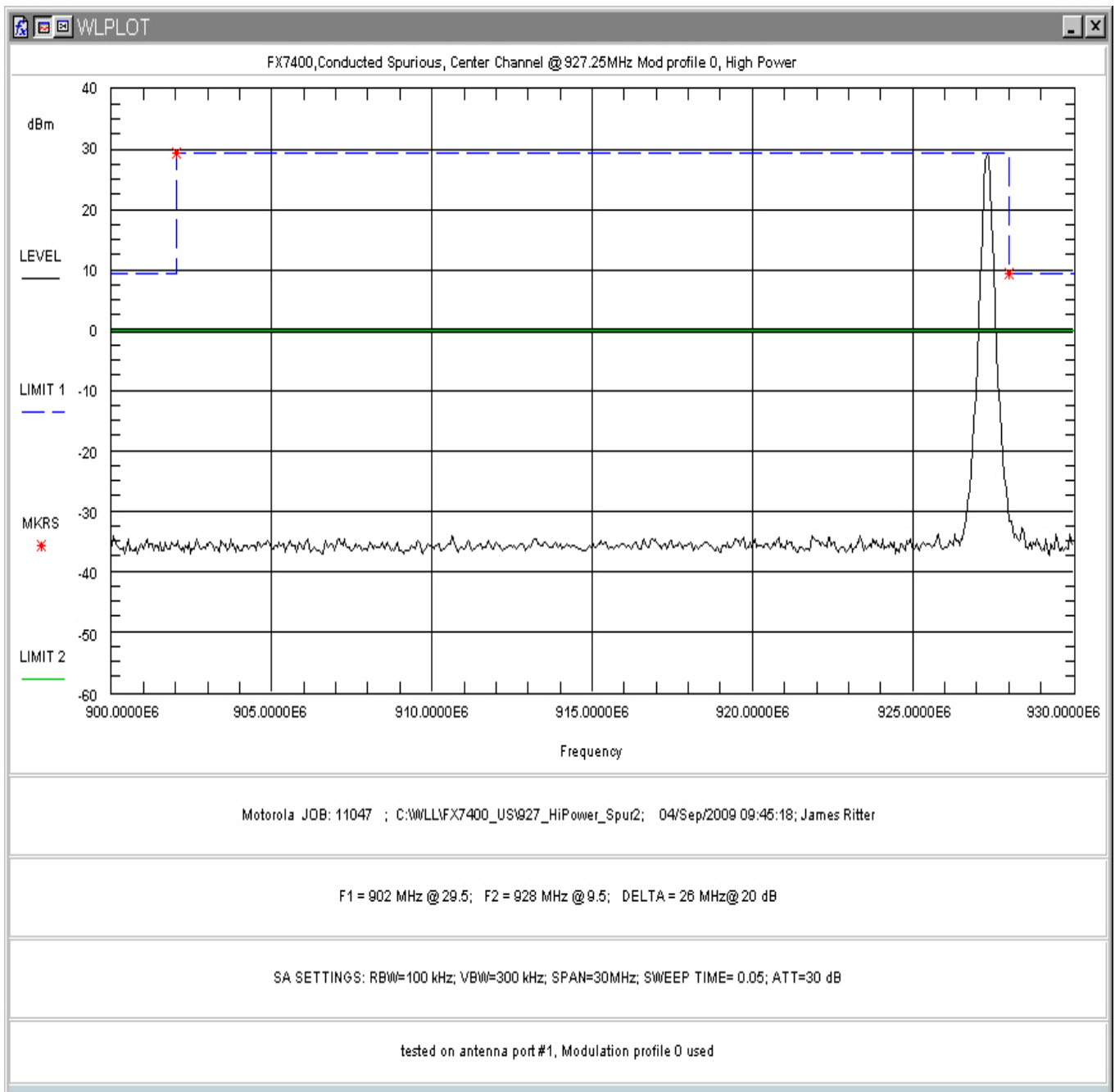

Figure 17: Conducted Spurious Emissions, Center Channel, Low Power, 5-10GHz



**Figure 18: Conducted Spurious Emissions, High Channel, High Power, 30-900MHz**



**Figure 19: Conducted Spurious Emissions, High Channel, High Power, 900-930MHz**

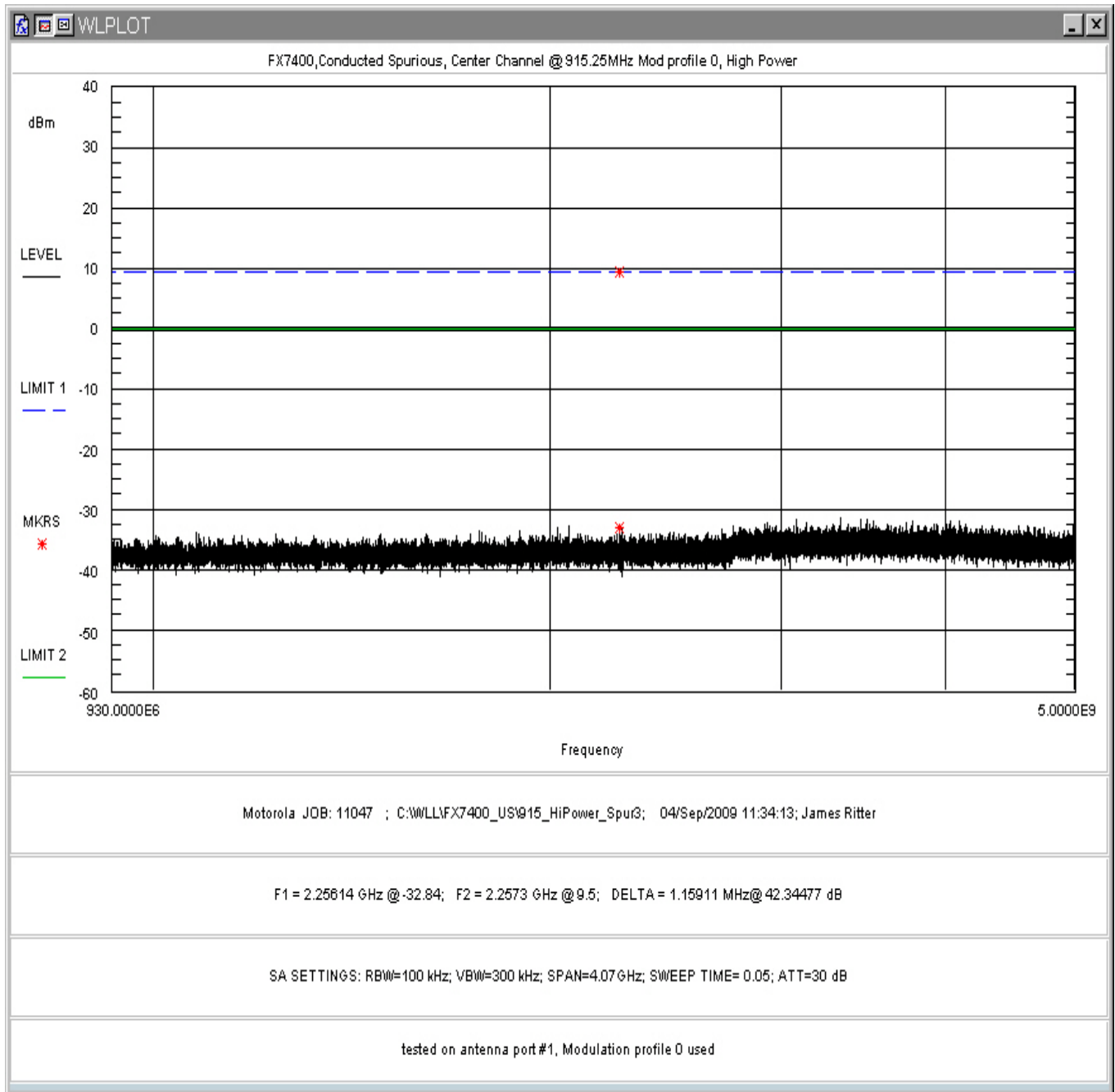

Figure 20: Conducted Spurious Emissions, High Channel, High Power, 930MHz-5GHz

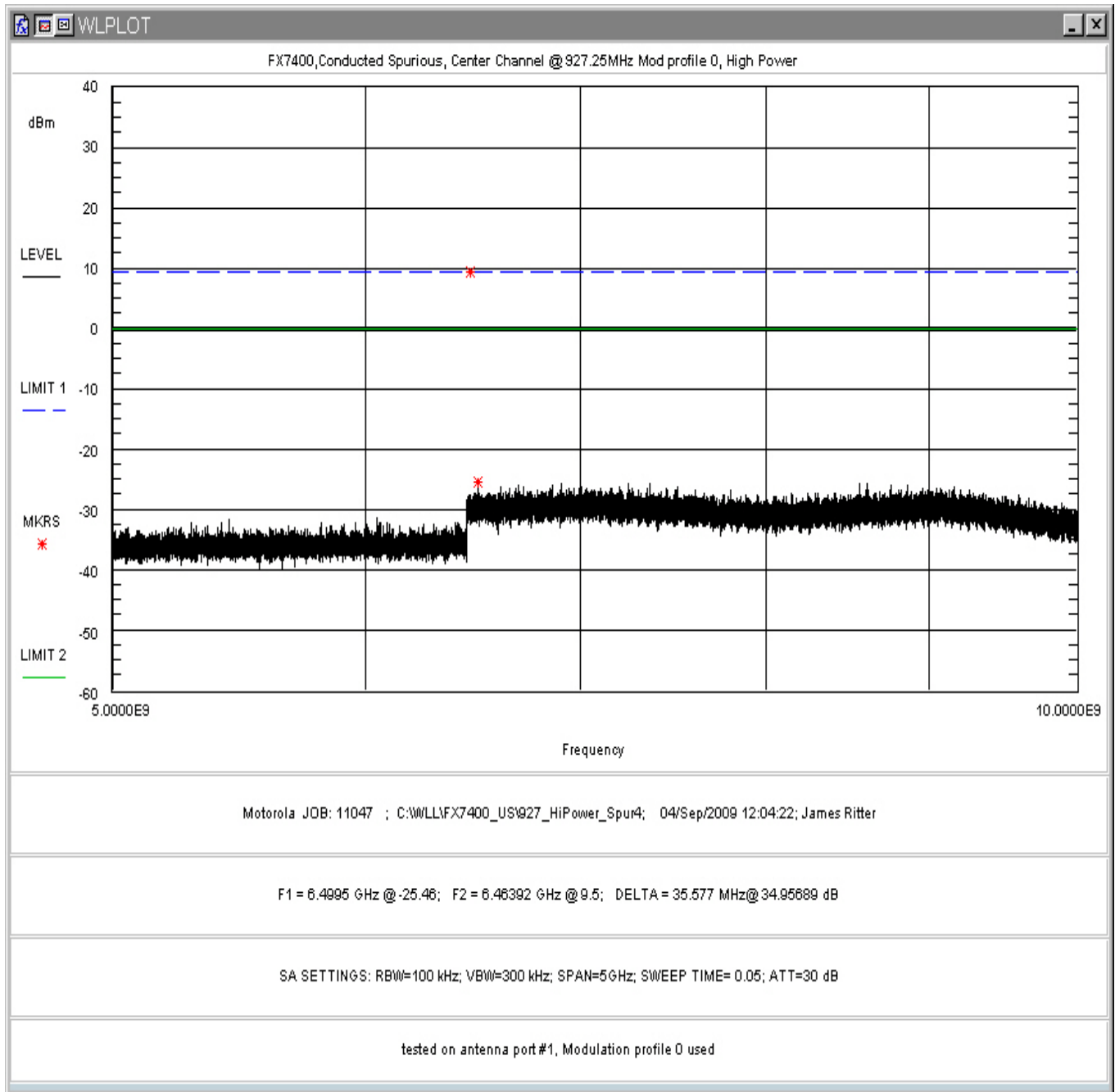

Figure 21: Conducted Spurious Emissions, High Channel, High Power, 5-10GHz

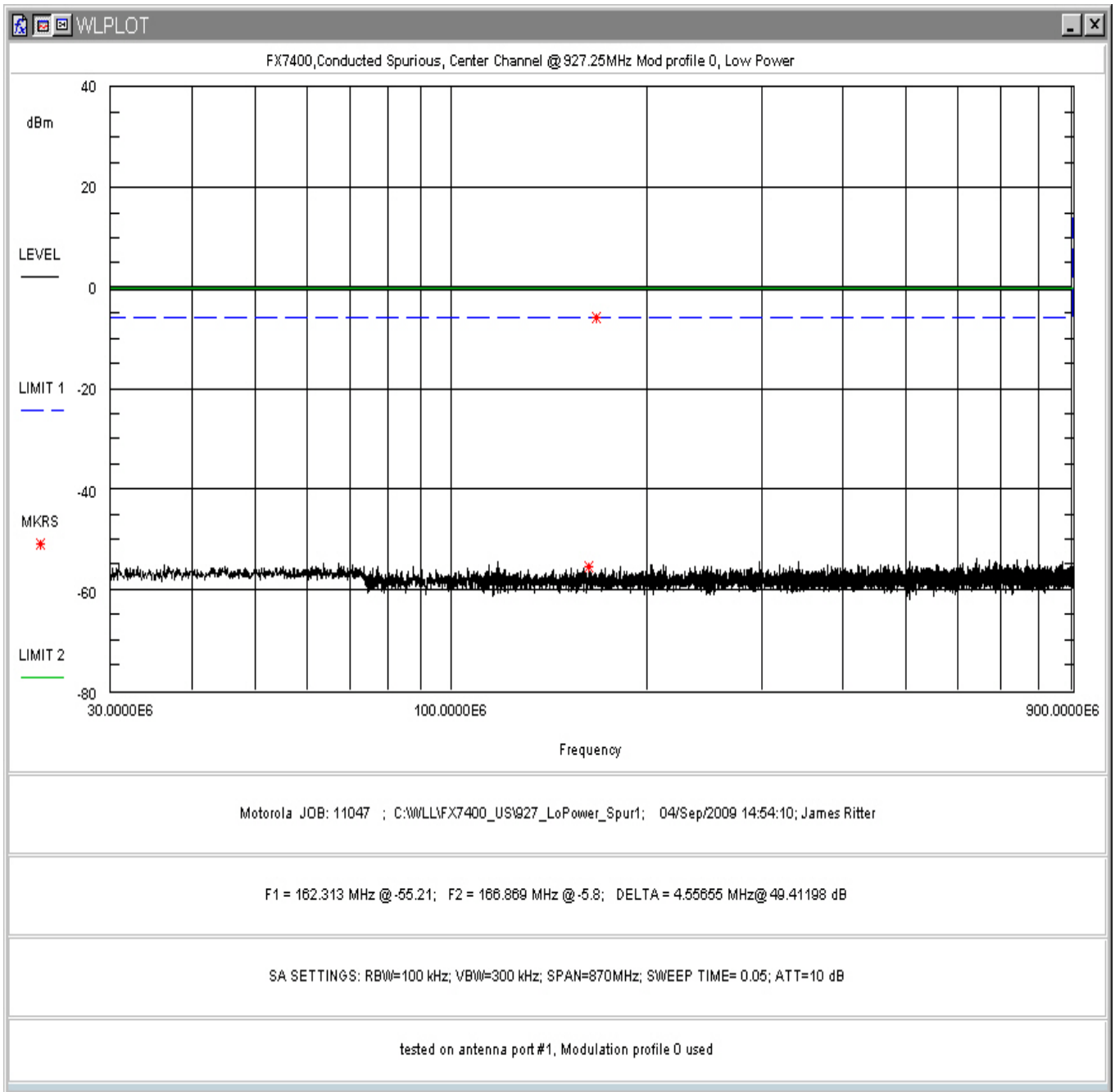
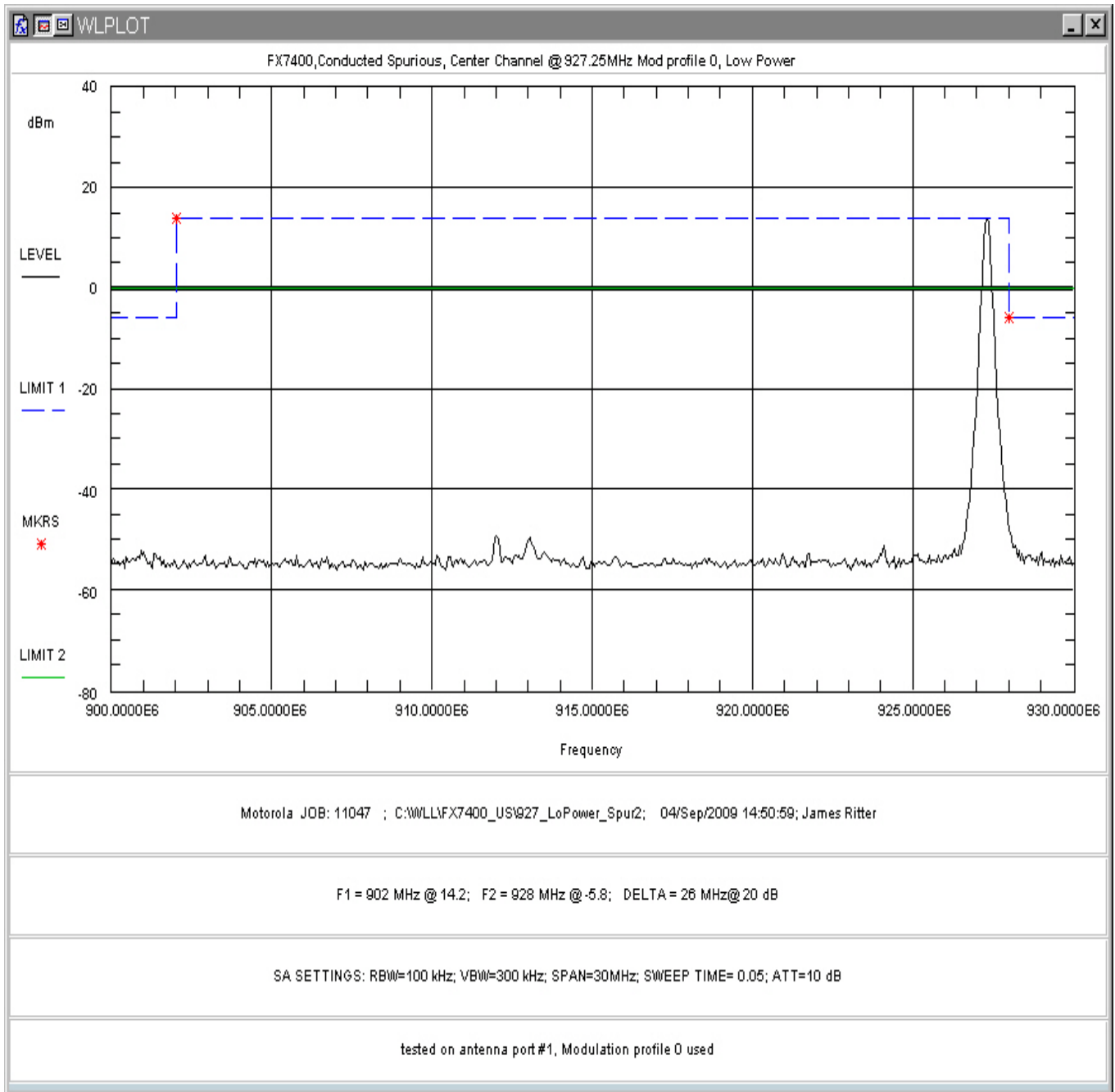

Figure 22: Conducted Spurious Emissions, High Channel, Low Power, 30-900MHz



**Figure 23: Conducted Spurious Emissions, High Channel, Low Power, 900-930MHz**



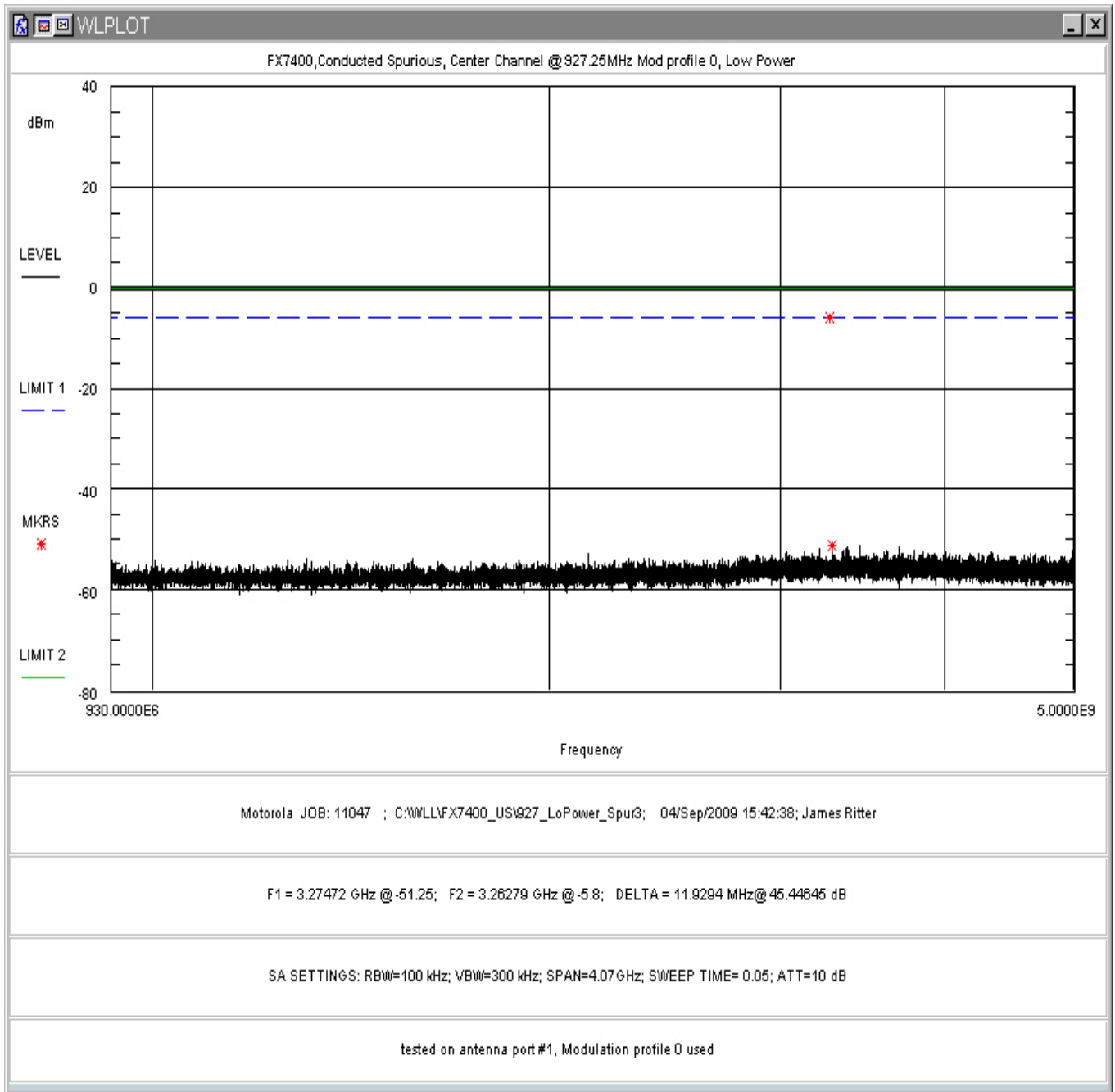
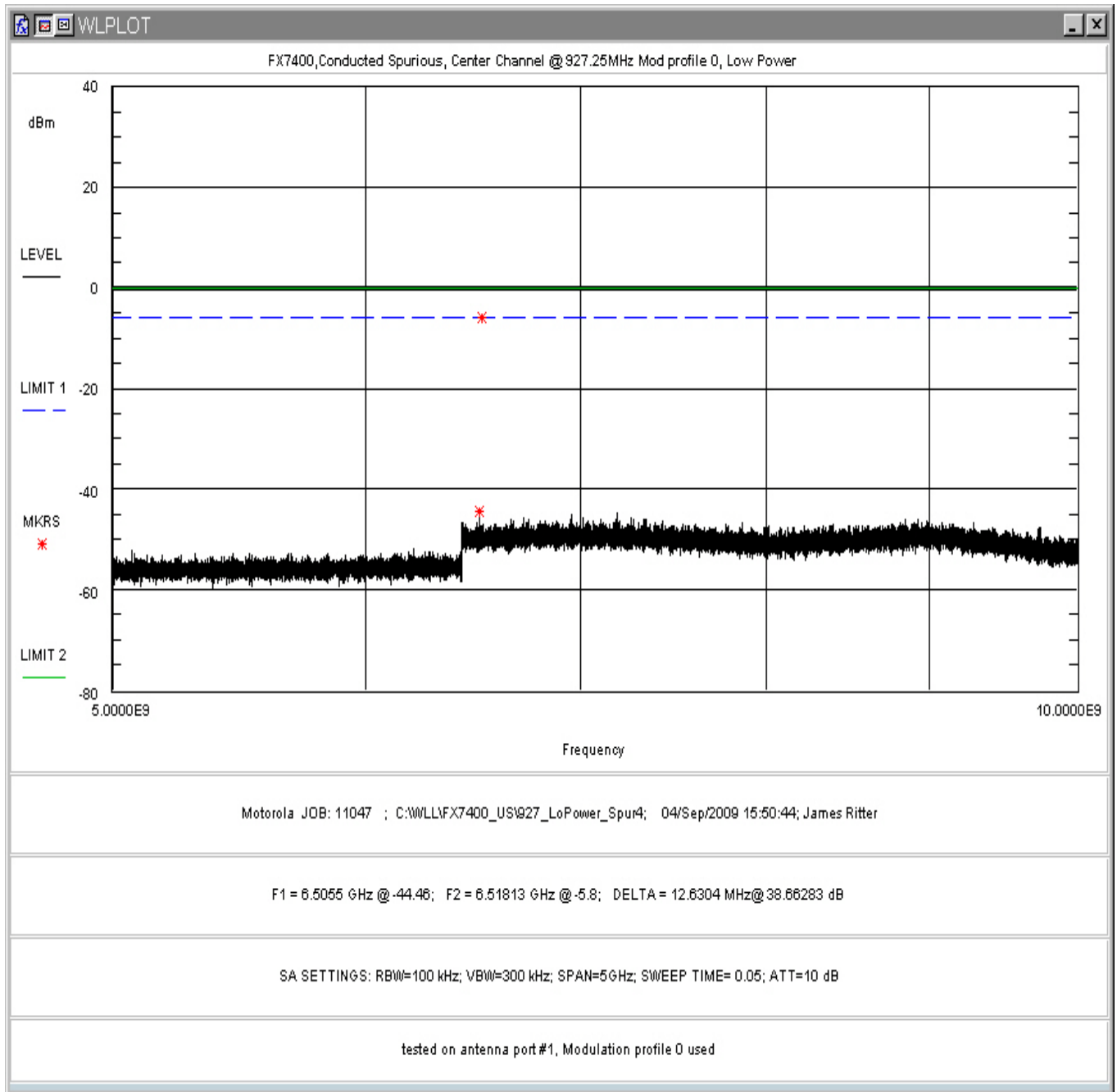

Figure 24: Conducted Spurious Emissions, High Channel, Low Power, 930MHz-5GHz



**Figure 25: Conducted Spurious Emissions, High Channel, low Power, 5-10GHz**

**5.6 Radiated Transmitter Spurious Emissions: (§15.205, 15.209, RSS210[A8.5])**

The EUT must comply with the requirements for radiated spurious emissions that fall within the restricted bands. These emissions must meet the limits specified in §15.209 and §15.35(b) for peak measurements.

**5.6.1 Test Procedure**

The EUT was placed on motorized turntable for radiated testing on a 3-meter open field test site. The emissions from the EUT were measured continuously at every azimuth by rotating the turntable. Receiving antennas were mounted on an antenna mast to determine the height of maximum emissions. The height of the antenna was varied between 1 and 4 meters. The peripherals were placed on the table in accordance with ANSI C63.4-2003. Cables were varied in position to produce maximum emissions. Both the horizontal and vertical field components were measured.

The Unit was tested with the 4 port and 2 Port EUT versions with both the GlobeTek and POE power options. The Astec power supply was tested with the 4 port unit below 1GHz for verification purposes. The emissions were measured using the following resolution bandwidths:

**Table 14: Spectrum Analyzer Settings**

Frequency Range	Resolution Bandwidth	Video Bandwidth
30MHz-1000 MHz	120kHz	>100 kHz
>1000 MHz	1 MHz	10 Hz (Avg.), 1MHz (Peak)

**Table 15: Radiated Spurious Emissions Summary Table**

**4 Port Unit**

Channel	Highest Emission Relative to limit (uV/m)	Frequency of emission (MHZ)	Margin to Limit (dB)
902.75MHz	82.2	1000.00	-15.7
915.25MHz	138.0	1000.00	-11.2
927.25MHz	128.8	2781.75	-11.8

**2 Port Unit**

Channel	Highest Emission Relative to limit (uV/m)	Frequency of emission (MHZ)	Margin to Limit (dB)
902.75MHz	108.4	1000.00	-13.3
915.25MHz	117.0	2745.75	-12.6
927.25MHz	108.4	1000.00	-13.3

**Table 16: Radiated Emission Test Data, 4-Port unit GlobeTek PS, Low Channel**

Transmit @ 902.75MHz

Frequency (MHz)	Polarity H/V	Azimuth (Degree)	Ant. Height (m)	SA Level (dBuV)	Corr Factors (dB)	Corr. Level (uV/m)	Limit (uV/m)	Margin (dB)
Peak								
2708.25	H	0.00	2.36	46.83	-4.3	133.2	5000.0	-31.5
3611.00	H	10.00	2.50	43.33	-3.0	104.4	5000.0	-33.6
4513.75	H	0.00	2.60	42.17	-2.3	98.7	5000.0	-34.1
5416.50	H	0.00	2.50	42.17	0.3	132.2	5000.0	-31.6
8124.75	H	10.00	2.70	43.67	3.0	216.3	5000.0	-27.3
AVG								
2708.25	H	0.00	2.36	35.67	-4.3	36.8	500.0	-22.7
3611.00	H	10.00	2.50	32.20	-3.0	29.0	500.0	-24.7
4513.75	H	0.00	2.60	30.83	-2.3	26.7	500.0	-25.4
5416.50	H	0.00	2.50	31.17	0.3	37.3	500.0	-22.6
8124.75	H	10.00	2.70	33.00	3.0	63.3	500.0	-17.9
Peak								
2708.25	V	0.00	2.00	47.10	-4.3	137.4	5000.0	-31.2
3611.00	V	180.00	2.60	44.83	-3.0	124.1	5000.0	-32.1
4513.75	V	10.00	2.50	41.33	-2.3	89.6	5000.0	-34.9
5416.50	V	0.00	2.50	41.67	0.3	124.8	5000.0	-32.1
8124.75	V	10.00	2.60	43.83	3.0	220.3	5000.0	-27.1
AVG								
2708.25	V	0.00	2.32	36.90	-4.3	42.5	500.0	-21.4
3611.00	V	180.00	2.60	34.60	-3.0	38.2	500.0	-22.3
4513.75	V	10.00	2.50	31.17	-2.3	27.8	500.0	-25.1
5416.50	V	0.00	2.50	31.17	0.3	37.3	500.0	-22.6
8124.75	V	10.00	2.60	33.00	3.0	63.3	500.0	-17.9
Non Harmonics								
108.79	V	10.00	1.25	11.60	12.5	16.0	150.0	-19.5
114.53	V	0.00	1.48	7.60	13.1	10.9	150.0	-22.8
170.89	V	180.00	1.52	3.90	13.3	7.2	150.0	-26.3
249.97	V	270.00	1.85	9.30	13.7	14.1	200.0	-23.0
1000.00	V	90.00	6.70	6.50	29.9	66.1	500.0	-17.6
108.75	H	290.00	3.89	14.20	12.5	21.5	150.0	-16.9
165.82	H	0.00	3.70	10.50	13.6	16.1	150.0	-19.4
272.01	H	0.00	2.09	7.50	16.6	16.0	200.0	-21.9
1000.00	H	180.00	1.50	8.40	29.9	82.2	500.0	-15.7

**Table 17: Radiated Emission Test Data, 4-Port unit POE PS, Center Channel**

Transmit @ 915.25 MHz

Frequency (MHz)	Polarity H/V	Azimuth (Degree)	Ant. Height (m)	SA Level (dBuV)	Corr Factors (dB)	Corr. Level (uV/m)	Limit (uV/m)	Margin (dB)
Peak								
2745.75	H	0.00	2.42	56.17	-4.3	392.0	5000.0	-22.1
3661.00	H	350.00	2.60	44.50	-2.9	119.7	5000.0	-32.4
4576.25	H	10.00	2.55	43.00	-2.0	112.0	5000.0	-33.0
7322.00	H	180.00	2.80	44.00	3.3	232.3	5000.0	-26.7
8237.25	H	350.00	2.65	46.17	3.3	295.8	5000.0	-24.6
9152.50	H	0.00	2.50	43.17	4.8	250.8	5000.0	-26.0
AVG								
2745.75	H	0.00	2.42	42.50	-4.3	81.2	500.0	-15.8
3661.00	H	350.00	2.60	32.17	-2.9	28.9	500.0	-24.8
4576.25	H	10.00	2.55	30.83	-2.0	27.6	500.0	-25.2
7322.00	H	180.00	2.80	33.33	3.3	68.0	500.0	-17.3
8237.25	H	350.00	2.65	33.67	3.3	70.2	500.0	-17.1
9152.50	H	0.00	2.50	34.00	4.8	87.3	500.0	-15.2
Peak								
2745.75	V	15.00	2.51	52.00	-4.3	242.5	5000.0	-26.3
3661.00	V	0.00	2.60	44.80	-2.9	123.9	5000.0	-32.1
4576.25	V	10.00	2.40	42.17	-2.0	101.8	5000.0	-33.8
7322.00	V	190.00	2.50	42.33	3.3	191.7	5000.0	-28.3
8237.25	V	200.00	2.40	46.50	3.3	307.3	5000.0	-24.2
9152.50	V	180.00	2.50	46.80	4.8	381.0	5000.0	-22.4
AVG								
2745.75	V	15.00	2.51	41.33	-4.3	71.0	500.0	-17.0
3661.00	V	0.00	2.60	32.83	-2.9	31.2	500.0	-24.1
4576.25	V	10.00	2.40	31.33	-2.0	29.2	500.0	-24.7
7322.00	V	190.00	2.50	31.33	3.3	54.0	500.0	-19.3
8237.25	V	200.00	2.40	33.50	3.3	68.8	500.0	-17.2
9152.50	V	180.00	2.50	34.10	4.8	88.3	500.0	-15.1
Non Harmonics								
114.18	V	180.00	1.30	15.90	13.1	28.1	150.0	-14.5
162.96	V	180.00	1.31	7.70	13.6	11.7	150.0	-22.2
168.80	V	190.00	1.29	10.20	13.4	15.2	150.0	-19.9
244.08	V	180.00	1.58	9.80	13.5	14.7	200.0	-22.7
272.05	V	0.00	1.70	7.80	16.6	16.6	200.0	-21.6
1000.00	V	200.00	1.30	8.50	29.9	83.2	500.0	-15.6
111.62	H	270.00	3.70	13.60	12.8	20.9	150.0	-17.1
168.79	H	0.00	3.12	14.90	13.4	26.1	150.0	-15.2
272.01	H	190.00	1.74	8.90	16.6	18.8	200.0	-20.5
1000.00	H	180.00	1.80	12.90	29.9	138.0	500.0	-11.2

**Table 18: Radiated Emission Test Data, 4-Port unit GlobeTek PS, High Channel**

Transmit @ 927.25MHz

Frequency (MHz)	Polarity H/V	Azimuth (Degree)	Ant. Height (m)	SA Level (dBuV)	Corr Factors (dB)	Corr. Level (uV/m)	Limit (uV/m)	Margin (dB)
Peak								
2781.75	H	0.00	2.30	57.33	-4.3	449.8	5000.0	-20.9
3709.00	H	45.00	2.39	45.00	-2.9	127.0	5000.0	-31.9
4636.25	H	90.00	2.50	42.85	-1.8	113.4	5000.0	-32.9
7418.00	H	0.00	2.40	42.33	3.4	192.7	5000.0	-28.3
8345.25	H	10.00	2.80	47.50	3.5	353.2	5000.0	-23.0
AVG								
2781.75	H	0.00	2.30	46.50	-4.3	128.8	500.0	-11.8
3709.00	H	45.00	2.39	32.10	-2.9	28.8	500.0	-24.8
4636.25	H	90.00	2.50	31.20	-1.8	29.7	500.0	-24.5
7418.00	H	0.00	2.40	33.00	3.4	65.8	500.0	-17.6
8345.25	H	10.00	2.80	33.50	3.5	70.5	500.0	-17.0
Peak								
2781.75	V	0.00	2.32	56.17	-4.3	393.6	5000.0	-22.1
3709.00	V	0.00	2.20	44.20	-2.9	115.8	5000.0	-32.7
4636.25	V	180.00	2.50	42.67	-1.8	111.1	5000.0	-33.1
7418.00	V	45.00	2.60	44.00	3.4	233.6	5000.0	-26.6
8345.25	V	10.00	2.63	46.50	3.5	314.8	5000.0	-24.0
AVG								
2781.75	V	0.00	2.32	41.67	-4.3	74.1	500.0	-16.6
3709.00	V	0.00	2.20	32.60	-2.9	30.5	500.0	-24.3
4636.25	V	180.00	2.50	31.33	-1.8	30.1	500.0	-24.4
7418.00	V	45.00	2.60	33.00	3.4	65.8	500.0	-17.6
8345.25	V	10.00	2.63	33.50	3.5	70.5	500.0	-17.0
Non Harmonics								
108.75	V	0.00	1.00	8.10	12.5	10.7	150.0	-23.0
114.50	V	180.00	1.20	13.20	13.1	20.7	150.0	-17.2
171.82	V	180.00	1.00	13.40	13.2	21.5	150.0	-16.9
249.97	V	270.00	1.70	11.90	13.7	19.1	200.0	-20.4
1000.00	V	225.00	1.40	7.00	29.9	70.0	500.0	-17.1
108.75	H	0.00	2.00	7.10	12.5	9.5	150.0	-24.0
114.52	H	315.00	2.20	9.80	13.1	14.0	150.0	-20.6
171.81	H	90.00	2.10	12.10	13.2	18.5	150.0	-18.2
249.98	H	135.00	1.70	12.50	13.7	20.4	200.0	-19.8
1000.00	H	180.00	2.20	8.90	-11.2	0.8	500.0	-56.3

**Table 19: Radiated Emission Test Data <1GHz 4 Port Unit with Astec PS**

Frequency (MHz)	Polarity H/V	Azimuth (Degree)	Ant. Height (m)	SA Level (dBuV)	Corr Factors (dB)	Corr. Level (uV/m)	Limit (uV/m)	Margin (dB)
110.82	V	90.00	1.20	10.20	13.5	15.3	150.0	-19.8
114.61	V	90.00	1.17	10.50	14.2	17.2	150.0	-18.8
252.74	V	10.00	1.80	9.30	13.1	13.1	200.0	-23.7
1000.00	V	0.00	0.00	7.40	26.9	51.9	500.0	-19.7
1125.25	V	270.00	2.70	46.50	-10.7	61.9	500.0	-18.1
112.24	H	45.00	3.84	8.90	13.8	13.6	150.0	-20.9
252.05	H	270.00	3.20	5.70	13.1	8.7	200.0	-27.3
272.01	H	0.00	0.00	0.00	14.4	5.3	200.0	-31.6
1000.00	H	0.00	0.00	6.80	26.9	48.4	500.0	-20.3
1125.25	H	190.00	2.65	52.90	-10.7	129.3	500.0	-11.7

**Table 20: Radiated Emission Test Data, 2-Port unit GlobeTek PS, Low Channel**

Transmit @ 902.75MHz

Frequency (MHz)	Polarity H/V	Azimuth (Degree)	Ant. Height (m)	SA Level (dBuV)	Corr Factors (dB)	Corr. Level (uV/m)	Limit (uV/m)	Margin (dB)
Peak								
2708.25	H	0.00	205.00	47.00	-4.3	135.8	5000.0	-31.3
3611.00	H	10.00	2.35	44.50	-3.0	119.5	5000.0	-32.4
4513.75	H	90.00	2.50	43.50	-2.3	115.0	5000.0	-32.8
5416.50	H	45.00	2.70	44.17	0.3	166.4	5000.0	-29.6
8124.75	H	10.00	2.50	45.00	3.0	252.1	5000.0	-25.9
AVG								
2708.25	H	0.00	205.00	39.20	-4.3	55.3	500.0	-19.1
3611.00	H	10.00	2.35	32.80	-3.0	31.1	500.0	-24.1
4513.75	H	90.00	2.50	31.20	-2.3	27.9	500.0	-25.1
5416.50	H	45.00	2.70	31.00	0.3	36.5	500.0	-22.7
8124.75	H	10.00	2.50	32.83	3.0	62.1	500.0	-18.1
Peak								
2708.25	V	10.00	2.00	48.10	0.0	254.1	5000.0	-25.9
3611.00	V	270.00	2.28	45.60	-3.0	135.6	5000.0	-31.3
4513.75	V	270.00	2.50	44.17	-2.3	124.2	5000.0	-32.1
5416.50	V	10.00	2.50	44.00	0.3	163.2	5000.0	-29.7
8124.75	V	50.00	2.60	45.50	3.0	267.0	5000.0	-25.4
AVG								
2708.25	V	10.00	2.32	36.67	-4.3	41.3	500.0	-21.7
3611.00	V	270.00	2.28	31.50	-3.0	26.7	500.0	-25.4
4513.75	V	270.00	2.50	31.60	-2.3	29.2	500.0	-24.7
5416.50	V	10.00	2.50	30.83	0.3	35.8	500.0	-22.9
8124.75	V	50.00	2.60	32.83	3.0	62.1	500.0	-18.1
Non Harmonics								
123.55	V	90.00	1.50	9.70	14.7	16.7	150.0	-19.1
124.99	V	180.00	1.20	14.00	15.0	28.3	150.0	-14.5
272.03	V	90.00	2.00	6.40	16.6	14.1	200.0	-23.0
1000.00	V	90.00	2.00	6.70	29.9	67.6	500.0	-17.4
124.99	H	190.00	3.54	11.90	15.0	22.2	150.0	-16.6
1000.00	H	180.00	180.00	10.80	29.9	108.4	500.0	-13.3



**Table 21: Radiated Emission Test Data, 2-Port unit GlobeTek PS, Center Channel**

Transmit @ 915.25MHz

Frequency (MHz)	Polarity H/V	Azimuth (Degree)	Ant. Height (m)	SA Level (dBuV)	Corr Factors (dB)	Corr. Level (uV/m)	Limit (uV/m)	Margin (dB)
<b>Peak</b>								
2745.75	H	0.00	2.29	58.83	-4.3	532.4	5000.0	-19.5
3661.00	H	45.00	2.53	45.67	-2.9	136.9	5000.0	-31.3
4576.25	H	0.00	2.50	42.80	-2.0	109.5	5000.0	-33.2
7322.00	H	180.00	2.60	43.00	3.3	207.0	5000.0	-27.7
8237.25	H	0.00	2.60	46.50	3.3	307.3	5000.0	-24.2
9152.50	H	10.00	2.40	43.80	4.8	269.7	5000.0	-25.4
<b>AVG</b>								
2745.75	H	0.00	2.29	45.67	-4.3	117.0	500.0	-12.6
3661.00	H	45.00	2.53	32.33	-2.9	29.5	500.0	-24.6
4576.25	H	0.00	2.50	30.60	-2.0	26.9	500.0	-25.4
7322.00	H	180.00	3.60	32.00	3.3	58.4	500.0	-18.7
8237.25	H	0.00	2.60	34.00	3.3	72.9	500.0	-16.7
9152.50	H	10.00	2.40	34.20	4.8	89.3	500.0	-15.0
<b>Peak</b>								
2745.75	V	10.00	2.54	56.83	-4.3	422.9	5000.0	-21.5
3661.00	V	90.00	2.51	45.17	-2.9	129.3	5000.0	-31.8
4576.25	V	0.00	2.60	43.10	-2.0	113.3	5000.0	-32.9
7322.00	V	270.00	2.53	43.20	3.3	211.9	5000.0	-27.5
8237.25	V	190.00	2.61	45.80	3.3	283.5	5000.0	-24.9
9152.50	V	0.00	2.62	45.80	4.8	339.5	5000.0	-23.4
<b>AVG</b>								
2745.75	V	10.00	2.54	44.50	-4.3	102.3	500.0	-13.8
3661.00	V	90.00	2.51	32.33	-2.9	29.5	500.0	-24.6
4576.25	V	0.00	2.60	33.00	-2.0	35.4	500.0	-23.0
7322.00	V	270.00	2.53	32.80	3.3	64.0	500.0	-17.9
8237.25	V	190.00	2.61	33.20	3.3	66.5	500.0	-17.5
9152.50	V	0.00	2.62	33.60	4.8	83.3	500.0	-15.6
<b>Non Harmonics</b>								
123.55	V	90.00	1.50	9.70	14.7	16.7	150.0	-19.1
124.99	V	180.00	1.20	14.00	15.0	28.3	150.0	-14.5
272.03	V	90.00	2.00	6.40	16.6	14.1	200.0	-23.0
1000.00	V	90.00	2.00	6.70	29.9	67.6	500.0	-17.4
124.99	H	190.00	3.54	11.90	15.0	22.2	150.0	-16.6
1000.00	H	180.00	180.00	10.80	29.9	108.4	500.0	-13.3

**Table 22: Radiated Emission Test Data, 2-Port unit GlobeTek PS, High Channel**

Transmit @ 927.25MHz

Frequency (MHz)	Polarity H/V	Azimuth (Degree)	Ant. Height (m)	SA Level (dBuV)	Corr Factors (dB)	Corr. Level (uV/m)	Limit (uV/m)	Margin (dB)
<b>Peak</b>								
2781.75	H	0.00	2.32	53.50	-4.3	289.4	5000.0	-24.7
3709.00	H	10.00	2.50	45.00	-2.9	127.0	5000.0	-31.9
4636.25	H	45.00	2.63	42.85	-1.8	113.4	5000.0	-32.9
7418.00	H	45.00	2.58	42.33	3.4	192.7	5000.0	-28.3
8345.25	H	0.00	2.60	47.50	3.5	353.2	5000.0	-23.0
<b>AVG</b>								
2781.75	H	0.00	2.32	42.67	-4.3	83.2	500.0	-15.6
3709.00	H	10.00	2.50	32.10	-2.9	28.8	500.0	-24.8
4636.25	H	45.00	2.63	31.20	-1.8	29.7	500.0	-24.5
7418.00	H	45.00	2.58	33.00	3.4	65.8	500.0	-17.6
8345.25	H	0.00	2.60	33.50	3.5	70.5	500.0	-17.0
<b>Peak</b>								
2781.75	V	0.00	2.52	53.17	-4.3	278.6	5000.0	-25.1
3709.00	V	10.00	2.50	44.20	-2.9	115.8	5000.0	-32.7
4636.25	V	20.00	2.80	42.67	-1.8	111.1	5000.0	-33.1
7418.00	V	0.00	2.62	44.00	3.4	233.6	5000.0	-26.6
8345.25	V	180.00	2.63	46.50	3.5	314.8	5000.0	-24.0
<b>AVG</b>								
2781.75	V	0.00	2.52	42.17	-4.3	78.5	500.0	-16.1
3709.00	V	10.00	2.50	32.60	-2.9	30.5	500.0	-24.3
4636.25	V	20.00	2.80	31.33	-1.8	30.1	500.0	-24.4
7418.00	V	0.00	2.62	33.00	3.4	65.8	500.0	-17.6
8345.25	V	180.00	2.63	33.50	3.5	70.5	500.0	-17.0
<b>Non Harmonics</b>								
123.55	V	90.00	1.50	9.70	14.7	16.7	150.0	-19.1
124.99	V	180.00	1.20	14.00	15.0	28.3	150.0	-14.5
272.03	V	90.00	2.00	6.40	16.6	14.1	200.0	-23.0
1000.00	V	90.00	2.00	6.70	29.9	67.6	500.0	-17.4
124.99	H	190.00	3.54	11.90	15.0	22.2	150.0	-16.6
1000.00	H	180.00	180.00	10.80	29.9	108.4	500.0	-13.3

**5.7 Receiver Radiated Spurious Emissions: (§15.209, RSS-Gen [7.2.3.2])**

The EUT must comply with the requirements for radiated spurious emissions from the receiver. These emissions must meet the limits specified in §15.209 and RSS-Gen.

**5.7.1 Test Procedure**

The EUT was placed on motorized turntable for radiated testing on a 3-meter open field test site. The emissions from the EUT were measured continuously at every azimuth by rotating the turntable. Receiving antennas were mounted on an antenna mast to determine the height of maximum emissions. The height of the antenna was varied between 1 and 4 meters. The emissions were measured using the following resolution bandwidths:

The Unit was tested with the 4 port and 2 Port EUT versions with the GlobeTek Power supply. The POE and Astec PS power options were verified on the 4 Port Unit.

Frequency Range	Resolution Bandwidth	Video Bandwidth
30MHz-1000 MHz	120kHz	> 100 kHz
>1000 MHz	1 MHz	10 Hz (Avg.)

**5.7.2 Test Summary**

The EUT complied with the requirements for receiver radiated emissions FCC 15.209 IC RSS-Gen. Receiver Radiated Spurious Test Data

**Table 23: Receiver Radiated Spurious Emissions Summary Table**

Configuration	Highest Emission Relative to limit (uV/m)	Frequency of emission (MHZ)	Margin to Limit (dB)
4 Port unit w. GlobeTek PS	34.8	81.48	-9.2
4 Port unit w. Astec PS	54.2	39.53	-5.3
4 Port unit w. POE PS	69.1	47.01	-3.2
2 Port unit w. GlobeTek PS	41.4	81.66	-7.7

**Table 24: Receiver Radiated Emission Test Data, 4-Port unit GlobeTek PS**

Frequency (MHz)	Polarity H/V	Azimuth (Degree)	Ant. Height (m)	SA Level (dBuV)	Corr Factors (dB)	Corr. Level (uV/m)	Limit (uV/m)	Margin (dB)
33.47	V	90.00	1.00	6.70	20.0	21.6	100.0	-13.3
39.53	V	100.00	1.00	7.70	15.0	13.7	100.0	-17.3
49.58	V	90.00	1.00	12.60	9.3	12.4	100.0	-18.1
57.18	V	270.00	1.00	17.30	7.4	17.2	100.0	-15.3
81.48	V	0.00	1.00	18.60	9.8	26.4	100.0	-11.6
108.75	V	0.00	1.00	8.10	12.5	10.7	150.0	-23.0
114.50	V	180.00	1.20	13.20	13.1	20.7	150.0	-17.2
143.15	V	225.00	1.20	12.50	14.0	21.2	150.0	-17.0
171.82	V	180.00	1.00	13.40	13.2	21.5	150.0	-16.9
207.50	V	0.00	1.00	12.60	13.6	20.3	150.0	-17.4
249.97	V	270.00	1.70	11.90	13.7	19.1	200.0	-20.4
300.37	V	225.00	1.70	10.30	16.3	21.4	200.0	-19.4
499.50	V	180.00	1.65	11.70	20.7	41.7	200.0	-13.6
750.00	V	180.00	1.70	4.80	26.0	34.6	200.0	-15.2
1000.00	V	225.00	1.40	7.00	29.9	70.0	500.0	-17.1
1125.25	V	270.00	2.70	46.50	-10.7	61.9	500.0	-18.1
33.43	H	45.00	3.72	4.50	20.0	16.8	100.0	-15.5
39.53	H	225.00	3.37	9.20	15.0	16.3	100.0	-15.8
49.82	H	270.00	2.80	19.50	9.2	27.3	100.0	-11.3
57.18	H	270.00	3.24	20.60	7.4	25.1	100.0	-12.0
81.48	H	225.00	2.50	21.00	9.8	34.8	100.0	-9.2
108.75	H	0.00	2.00	7.10	12.5	9.5	150.0	-24.0
114.52	H	315.00	2.20	9.80	13.1	14.0	150.0	-20.6
143.15	H	315.00	2.20	17.20	14.0	36.4	150.0	-12.3
171.81	H	90.00	2.10	12.10	13.2	18.5	150.0	-18.2
207.50	H	135.00	1.70	20.50	13.6	50.5	150.0	-9.5
249.98	H	135.00	1.70	12.50	13.7	20.4	200.0	-19.8
300.34	H	135.00	1.90	7.20	16.3	15.0	200.0	-22.5
499.50	H	180.00	2.00	13.20	20.7	49.5	200.0	-12.1
750.00	H	180.00	2.00	6.10	26.0	40.2	200.0	-13.9
1000.00	H	180.00	2.20	8.90	-11.2	0.8	500.0	-56.3
1071.86	H	90.00	2.61	41.00	-10.9	32.1	500.0	-23.9
1125.25	H	190.00	2.65	52.90	-10.7	129.3	500.0	-11.7