



FCC RADIO TEST REPORT

FCC ID : UZ7ET65AW
Equipment : Rugged 2 in 1 Android Tablet
Brand Name : Zebra
Model Name : ET65AW
Applicant : Zebra Technologies Corporation
1 Zebra Plaza, Holtsville, NY 11742
Manufacturer : Zebra Technologies Corporation
1 Zebra Plaza, Holtsville, NY 11742
Standard : FCC 47 CFR Part 2, 90(R)

The product was received on Jul. 12, 2023 and testing was performed from Jul. 21, 2023 to Sep. 14, 2023. We, Sporton International Inc. EMC & Wireless Communications Laboratory, would like to declare that the tested sample has been evaluated in accordance with the test procedures given in ANSI / TIA-603-E and has been in compliance with the applicable technical standards.

The test results in this report apply exclusively to the tested model / sample. Without written approval from Sporton International Inc. EMC & Wireless Communications Laboratory, the test report shall not be reproduced except in full.

Approved by: Louis Wu

Sporton International Inc. EMC & Wireless Communications Laboratory

No. 52, Huaya 1st Rd., Guishan Dist., Taoyuan City 333, Taiwan (R.O.C.)



Table of Contents

History of this test report	3
Summary of Test Result	4
1 General Description	5
1.1 Product Feature of Equipment Under Test.....	5
1.2 Product Specification of Equipment Under Test.....	6
1.3 Modification of EUT	6
1.4 Testing Site.....	6
1.5 Applied Standards	7
2 Test Configuration of Equipment Under Test	8
2.1 Test Mode	8
2.2 Connection Diagram of Test System.....	9
2.3 Support Unit used in test configuration and system	9
2.4 Measurement Results Explanation Example.....	9
2.5 Frequency List of Low/Middle/High Channels	10
3 Conducted Test Items	11
3.1 Measuring Instruments	11
3.2 Conducted Output Power Measurement and ERP.....	12
3.3 Peak-to-Average Ratio	13
3.4 Occupied Bandwidth.....	14
3.5 Conducted Band Edge	15
3.6 Emission Mask.....	16
3.7 Conducted Spurious Emission	17
3.8 Frequency Stability	18
4 Radiated Test Items	19
4.1 Measuring Instruments	19
4.2 Radiated Spurious Emission	21
5 List of Measuring Equipment	22
6 Measurement Uncertainty	23
Appendix A. Test Results of Conducted Test	
Appendix B. Test Results of Radiated Test	
Appendix C. Test Setup Photographs	



History of this test report

Report No.	Version	Description	Issue Date
FG371211D	01	Initial issue of report	Sep. 19, 2023



Summary of Test Result

Report Clause	Ref Std. Clause	Test Items	Result (PASS/FAIL)	Remark
3.2	§2.1046	Conducted Output Power	Reporting only	-
	§90.542 (a)(7)	Effective Radiated Power	Pass	-
3.3	-	Peak-to-Average Ratio	Reporting only	-
3.4	§2.1049	Occupied Bandwidth	Reporting only	-
3.5	§2.1053 §90.543 (e)(2)	Conducted Band Edge Measurement	Pass	-
3.6	§2.1051 §90.210 (n)	Emission Mask	Pass	-
3.7	§2.1053 §90.543 (e)(3)	Conducted Spurious Emission	Pass	-
3.8	§2.1055 §90.539 (e)	Frequency Stability Temperature & Voltage	Pass	-
4.2	§2.1053 §90.543 (e)(3) §90.543 (f)	Radiated Spurious Emission	Pass	19.43 dB under the limit at 1587.00 MHz

Conformity Assessment Condition:

1. The test results (PASS/FAIL) with all measurement uncertainty excluded are presented against the regulation limits or in accordance with the requirements stipulated by the applicant/manufacturer who shall bear all the risks of non-compliance that may potentially occur if measurement uncertainty is taken into account.
2. The measurement uncertainty please refer to each test result in the section "Measurement Uncertainty".

Disclaimer:

The product specifications of the EUT presented in the test report that may affect the test assessments are declared by the manufacturer who shall take full responsibility for the authenticity.

Reviewed by: Keven Cheng

Report Producer: Michelle Chen



1 General Description

1.1 Product Feature of Equipment Under Test

Product Feature	
Equipment	Rugged 2 in 1 Android Tablet
Brand Name	Zebra
Model Name	ET65AW
FCC ID	UZ7ET65AW
EUT supports Radios application	WCDMA/HSPA/LTE/5G NR/NFC/GNSS WLAN 11a/b/g/n HT20/HT40 WLAN 11ac VHT20/VHT40/VHT80/VHT160 WLAN 11ax HE20/HE40/HE80/HE160 Bluetooth BR/EDR/LE
HW Version	DV2
SW Version	A13
MFD	21JUN23
DUT Stage	Identical Prototype

Remark: The above EUT's information was declared by manufacturer.

Specification of Accessories				
Adapter	Brand Name	Zebra	Part Number	PWR-BGA15V45W-UC2-WW
Battery 1	Brand Name	Zebra	Part Number	BT-000471-0020
Battery 2	Brand Name	Zebra	Part Number	BT-000471-0820

Supported Unit Used in Test Configuration and System				
USB TYPE C to 3.5mm audio connector	Brand Name	Zebra	Part Number	ADP-USBC-35MM1-01
3.5mm Earphone	Brand Name	Zebra	Part Number	HDST-35MM-PTVP-01
USB TYPE C Earphone	Brand Name	Zebra	Part Number	HPST-USBC-PTT1-01
Headset Jumper	Brand Name	Zebra	Part Number	CBL-TC51-HDST35-01



1.2 Product Specification of Equipment Under Test

Product Specification is subject to this standard	
Tx Frequency	790.5 ~ 795.5 MHz
Rx Frequency	760.5 ~ 765.5 MHz
Bandwidth	5MHz / 10MHz
Maximum Output Power to Antenna	23.58 dBm
Antenna Type	PIFA Antenna
Antenna Gain	-0.14 dBi
Type of Modulation	QPSK / 16QAM / 64QAM / 256QAM

Remark: The EUT's information above is declared by manufacturer. Please refer to Disclaimer in report summary.

1.3 Modification of EUT

No modifications made to the EUT during the testing.

1.4 Testing Site

Test Site	Sporton International Inc. EMC & Wireless Communications Laboratory
Test Site Location	No.52, Huaya 1st Rd., Guishan Dist., Taoyuan City 333, Taiwan (R.O.C.) TEL: +886-3-327-3456 FAX: +886-3-328-4978
Test Site No.	Sporton Site No. TH03-HY
Test Engineer	Cotty Hsu
Temperature (°C)	22.3~22.6
Relative Humidity (%)	52~54

Test Site	Sporton International Inc. Wensan Laboratory
Test Site Location	No.58, Aly. 75, Ln. 564, Wenhua 3rd, Rd., Guishan Dist., Taoyuan City 333010, Taiwan (R.O.C.) TEL: +886-3-327-0868 FAX: +886-3-327-0855
Test Site No.	Sporton Site No. 03CH12-HY (TAF Code: 3786)
Test Engineer	Jesse Fan, Tim Lee and Wilson Wu
Temperature (°C)	20~25
Relative Humidity (%)	50~60
Remark	The Radiated Spurious Emission test item subcontracted to Sporton International Inc. Wensan Laboratory.

Note: The test site complies with ANSI C63.4 2014 requirement.

FCC Designation No.: TW1190 and TW3786



1.5 Applied Standards

According to the specifications declared by the manufacturer, the EUT must comply with the requirements of the following standards:

- ♦ ANSI C63.26-2015
- ♦ FCC 47 CFR Part 2, Part 90(R)
- ♦ ANSI / TIA-603-E
- ♦ FCC KDB 971168 D01 Power Meas. License Digital Systems v03r01
- ♦ FCC KDB 412172 D01 Determining ERP and EIRP v01r01
- ♦ FCC KDB 414788 D01 Radiated Test Site v01r01

Remark:

1. All the test items were validated and recorded in accordance with the standards without any modification during the testing.
2. This EUT has also been tested and complied with the requirements of FCC Part 15, Subpart B, recorded in a separate test report.
3. The TAF code is not including all the FCC KDB listed without accreditation.



2 Test Configuration of Equipment Under Test

2.1 Test Mode

Antenna port conducted and radiated test items listed below are performed according to KDB 971168 D01 Power Meas. License Digital Systems v03r01 with maximum output power.

For radiated measurement, the measured emission level of the EUT was maximized by rotating the EUT on a turntable, adjusting the orientation of the EUT and EUT antenna in three orthogonal axis (X: flat, Y: portrait, Z: landscape), and adjusting the measurement antenna orientation, following C63.26 exploratory test procedures and only the worst case emissions were reported in this report..

Conducted Test Cases	Band	Bandwidth (MHz)						Modulation				RB #			Test Channel		
		1.4	3	5	10	15	20	QPSK	16QAM	64QAM	256QAM	1	Half	Full	L	M	H
Max. Output Power	14	-	-	v	v	-	-	v	v	v	v	v	v	v	v	v	v
Peak-to-Average Ratio	14	-	-	v	v	-	-	v	v	v	v			v		v	
26dB and 99% Bandwidth	14	-	-	v	v	-	-	v	v	v	v			v		v	
Conducted Band Edge	14	-	-	v	v	-	-	v	v	v	v	v		v	v		v
Emission Mask	14	-	-	v	v	-	-	v	v	v	v	v		v	v	v	v
Conducted Spurious Emission	14	-	-	v	v	-	-	v				v			v	v	v
Frequency Stability	14	-	-		v	-	-	v						v		v	
E.R.P	14	-	-	v	v	-	-	v	v	v	v	Max. Power					
Radiated Spurious Emission	14	Worst Case												v	v	v	
Remark	<ol style="list-style-type: none"> The mark "v " means that this configuration is chosen for testing The mark "-" means that this bandwidth is not supported. The device is investigated from 30MHz to 10 times of fundamental signal for radiated spurious emission test under different RB size/offset and modulations in exploratory test. Subsequently, only the worst case emissions are reported. All the radiated test cases were performed with Battery 1. One representative bandwidth is selected to perform PAR and frequency stability. 																

2.2 Connection Diagram of Test System

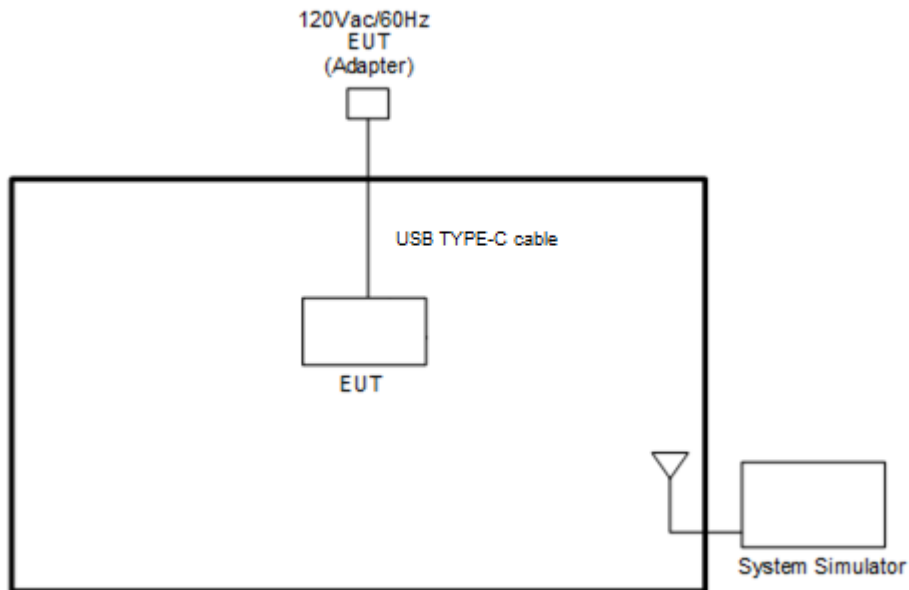

2.3 Support Unit used in test configuration and system

Item	Equipment	Brand Name	Model No.	FCC ID	Data Cable	Power Cord
1.	System Simulator	Anritsu	MT8821C	N/A	N/A	Unshielded, 1.8 m

2.4 Measurement Results Explanation Example

For all conducted test items:

The offset level is set in the spectrum analyzer to compensate the RF cable loss and attenuator factor between EUT conducted output port and spectrum analyzer. With the offset compensation, the spectrum analyzer reading level is exactly the EUT RF output level.

The spectrum analyzer offset is derived from RF cable loss and attenuator factor.

Offset = RF cable loss + attenuator factor.

Following shows an offset computation example with cable loss 4.5 dB and 10dB attenuator.

Example :

$$\begin{aligned} \text{Offset(dB)} &= \text{RF cable loss(dB)} + \text{attenuator factor(dB)}. \\ &= 4.5 + 10 = 14.5 \text{ (dB)} \end{aligned}$$



2.5 Frequency List of Low/Middle/High Channels

LTE Band 14 Channel and Frequency List				
BW [MHz]	Channel/Frequency(MHz)	Lowest	Middle	Highest
10	Channel	-	23330	-
	Frequency	-	793	-
5	Channel	23305	23330	23355
	Frequency	790.5	793	795.5

3 Conducted Test Items

3.1 Measuring Instruments

See list of measuring instruments of this test report.

3.1.1 Test Setup

3.1.2 Conducted Output Power

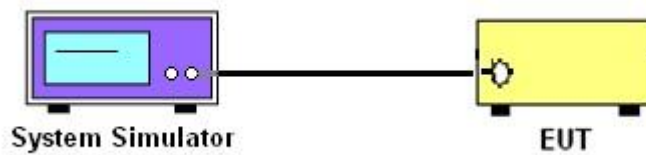

3.1.3 Peak-to-Average Ratio, Occupied Bandwidth, Conducted Band-Edge, Emission Mask, and Conducted Spurious Emission

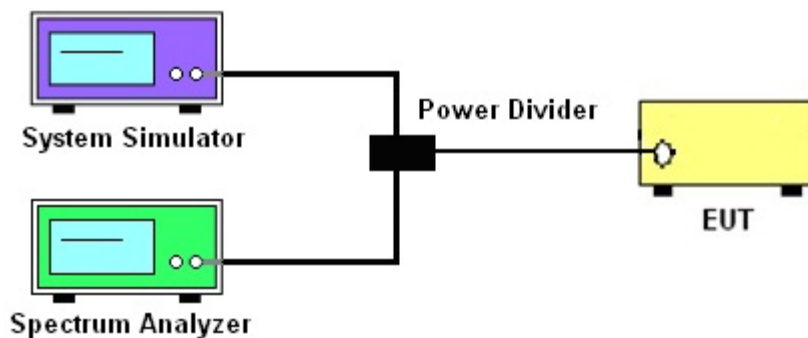

3.1.4 Frequency Stability

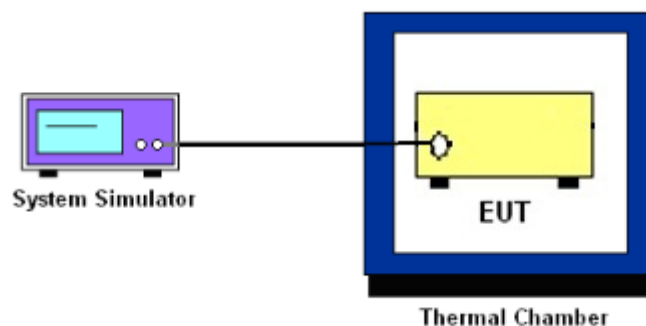

3.1.5 Test Result of Conducted Test

Please refer to Appendix A.



3.2 Conducted Output Power Measurement and ERP

3.2.1 Description of the Conducted Output Power Measurement and ERP Measurement

A base station simulator was used to establish communication with the EUT. Its parameters were set to transmit the maximum power on the EUT. The measured power in the radio frequency on the transmitter output terminals shall be reported.

The ERP of mobile transmitters must not exceed 3 Watts for LTE Band 14.

According to KDB 412172 D01 Power Approach,

$EIRP = P_T + G_T - L_C$, $ERP = EIRP - 2.15$, where

P_T = transmitter output power in dBm

G_T = gain of the transmitting antenna in dBi

L_C = signal attenuation in the connecting cable between the transmitter and antenna in dB

3.2.2 Test Procedures

1. The transmitter output port was connected to base station.
2. Set EUT at maximum power through base station.
3. Select lowest, middle, and highest channels for each band and different modulation.
4. Measure and record the power level from the system simulator.



3.3 Peak-to-Average Ratio

3.3.1 Description of the PAR Measurement

Power Complementary Cumulative Distribution Function (CCDF) curves provide a means for characterizing the power peaks of a digitally modulated signal on a statistical basis. A CCDF curve depicts the probability of the peak signal amplitude exceeding the average power level. Most contemporary measurement instrumentation include the capability to produce CCDF curves for an input signal provided that the instrument's resolution bandwidth can be set wide enough to accommodate the entire input signal bandwidth. In measuring transmissions in this band using an average power technique, the peak-to-average ratio (PAR) of the transmission may not exceed 13 dB.

3.3.2 Test Procedures

The testing follows ANSI C63.26-2015 Section 5.2.6

1. The EUT was connected to spectrum and system simulator via a power divider.
2. Set the CCDF (Complementary Cumulative Distribution Function) option in spectrum analyzer.
3. The highest RF powers were measured and recorded the maximum PAPR level associated with a probability of 0.1 %.
4. Record the deviation as Peak to Average Ratio.



3.4 Occupied Bandwidth

3.4.1 Description of Occupied Bandwidth Measurement

The occupied bandwidth is the width of a frequency band such that, below the lower and above the upper frequency limits, the mean powers emitted are each equal to a specified percentage 0.5% of the total mean transmitted power.

The 26 dB emission bandwidth is defined as the frequency range between two points, one above and one below the carrier frequency, at which the spectral density of the emission is attenuated 26 dB below the maximum in-band spectral density of the modulated signal. Spectral density (power per unit bandwidth) is to be measured with a detector of resolution bandwidth equal to approximately 1.0% of the emission bandwidth.

3.4.2 Test Procedures

The testing follows ANSI C63.26-2015 Section 5.4.3 (26dB) and Section 5.4.4 (99OB)

1. The EUT was connected to spectrum analyzer and system simulator via a power divider.
2. The spectrum analyzer center frequency is set to the nominal EUT channel center frequency. The span range for the spectrum analyzer shall be between two and five times the anticipated OBW.
3. The nominal resolution bandwidth (RBW) shall be in the range of 1 to 5 % of the anticipated OBW, and the VBW shall be at least 3 times the RBW.
4. Set the detection mode to peak, and the trace mode to max hold.
5. Determine the reference value: Set the EUT to transmit a modulated signal. Allow the trace to stabilize. Set the spectrum analyzer marker to the highest level of the displayed trace.
(this is the reference value)
6. Determine the “-26 dB down amplitude” as equal to (Reference Value – X).
7. Place two markers, one at the lowest and the other at the highest frequency of the envelope of the spectral display such that each marker is at or slightly below the “-X dB down amplitude” determined in step 6. If a marker is below this “-X dB down amplitude” value it shall be placed as close as possible to this value. The OBW is the positive frequency difference between the two markers.
8. Use the 99 % power bandwidth function of the spectrum analyzer and report the measured bandwidth.



3.5 Conducted Band Edge

3.5.1 Description of Conducted Band Edge Measurement

90.543(e)

- (1) On all frequencies between 769-775 MHz and 799-805 MHz, by a factor not less than $76 + 10 \log (P)$ dB in a 6.25 kHz band segment, for base and fixed stations.
- (2) On all frequencies between 769-775 MHz and 799-805 MHz, by a factor not less than $65 + 10 \log (P)$ dB in a 6.25 kHz band segment, for mobile and portable stations.
- (3) On any frequency between 775-788 MHz, above 805 MHz, and below 758 MHz, by at least $43 + 10 \log (P)$ dB.

3.5.2 Test Procedures

The testing follows FCC KDB 971168 D01 v03r01 Section 6.1.

1. The EUT was connected to spectrum analyzer and system simulator via a power divider.
2. The band edges of low and high channels for the highest RF powers were measured.
3. Set RBW $\geq 1\%$ EBW in the 100kHz band immediately outside and adjacent to the band edge.
4. Beyond the 100kHz band from the band edge, RBW=100kHz was used.
5. Set spectrum analyzer with RMS detector.
6. The RF fundamental frequency should be excluded against the limit line in the operating frequency band.
7. Checked that all the results comply with the emission limit line.

The limit line is derived from $43 + 10\log(P)$ dB below the transmitter power P(Watts)



3.6 Emission Mask

3.6.1 Description of Emissions Mask Measurement

Transmitters designed must meet the emission mask comply with the emission mask provisions of FCC Part 90.210(n).

3.6.2 Test Procedures

The testing follows FCC KDB 971168 D01 v03r01 Section 6.0.

1. The EUT was connected to spectrum analyzer and system simulator via a power divider.
2. The power of the modulated signal was measured on a spectrum analyzer using an RMS and 10 second sweep time in order to maximize the level.
3. The RF fundamental frequency should be excluded against the limit line in the operating frequency band.



3.7 Conducted Spurious Emission

3.7.1 Description of Conducted Spurious Emission Measurement

The power of any emission outside of the authorized operating frequency ranges must be lower than the transmitter power (P) by a factor of at least $43 + 10 \log (P)$ dB.

It is measured by means of a calibrated spectrum analyzer and scanned from 30MHz up to a frequency including its 10th harmonic.

3.7.2 Test Procedures

The testing follows FCC KDB 971168 D01 v03r01 Section 6.1.

1. The EUT was connected to spectrum analyzer and base station via power divider.
2. The RF output of EUT was connected to the spectrum analyzer by RF cable and attenuator. The path loss was compensated to the results for each measurement.
3. The middle channel for the highest RF power within the transmitting frequency was measured.
4. The conducted spurious emission for the whole frequency range was taken.
5. Make the measurement with the spectrum analyzer's RBW = 1MHz, VBW = 3MHz.
6. Set spectrum analyzer with RMS detector.
7. Taking the record of maximum spurious emission.
8. The RF fundamental frequency should be excluded against the limit line in the operating frequency band.
9. The limit line is derived from $43 + 10\log(P)$ dB below the transmitter power P(Watts)



3.8 Frequency Stability

3.8.1 Description of Frequency Stability Measurement

The frequency stability shall be sufficient to ensure that the fundamental emission stays within the authorized frequency block.

3.8.2 Test Procedures for Temperature Variation

The testing follows FCC KDB 971168 D01 v03r01 Section 9.0.

1. The EUT was set up in the thermal chamber and connected with the base station.
2. With power OFF, the temperature was decreased to -30°C and the EUT was stabilized before testing. Power was applied and the maximum change in frequency was recorded within one minute.
3. With power OFF, the temperature was raised in 10°C step up to 50°C. The EUT was stabilized at each step for at least half an hour. Power was applied and the maximum frequency change was recorded within one minute.

3.8.3 Test Procedures for Voltage Variation

The testing follows FCC KDB 971168 D01 v03r01 Section 9.0.

1. The EUT was placed in a temperature chamber at 20±5° C and connected with the base station.
2. The power supply voltage to the EUT was varied from 85% to 115% of the nominal value measured at the input to the EUT.
3. The variation in frequency was measured for the worst case.

4 Radiated Test Items

4.1 Measuring Instruments

See list of measuring instruments of this test report.

4.1.1 Test Setup

For radiated test below 30MHz

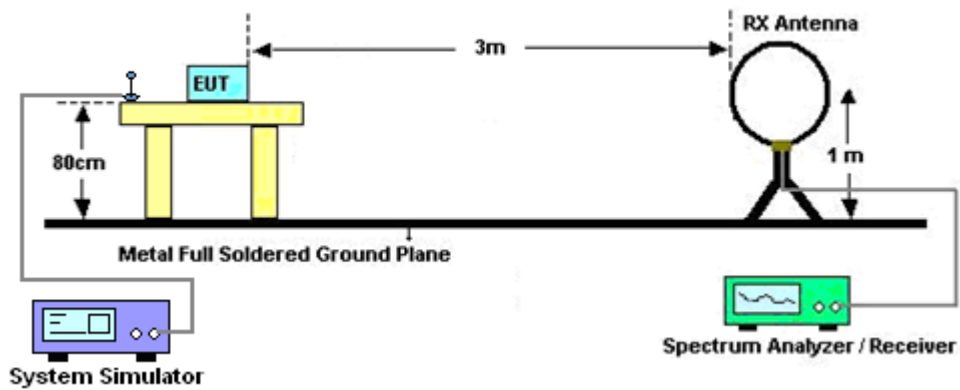

For radiated test from 30MHz to 1GHz

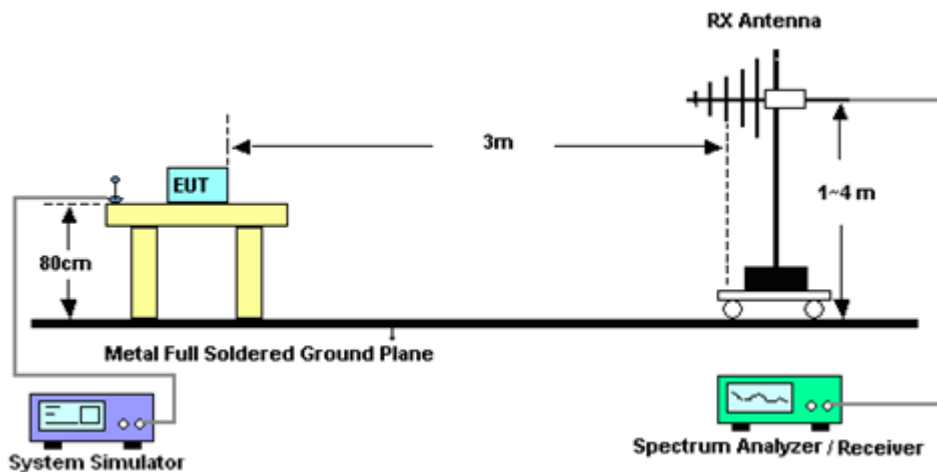

For radiated test above 1GHz

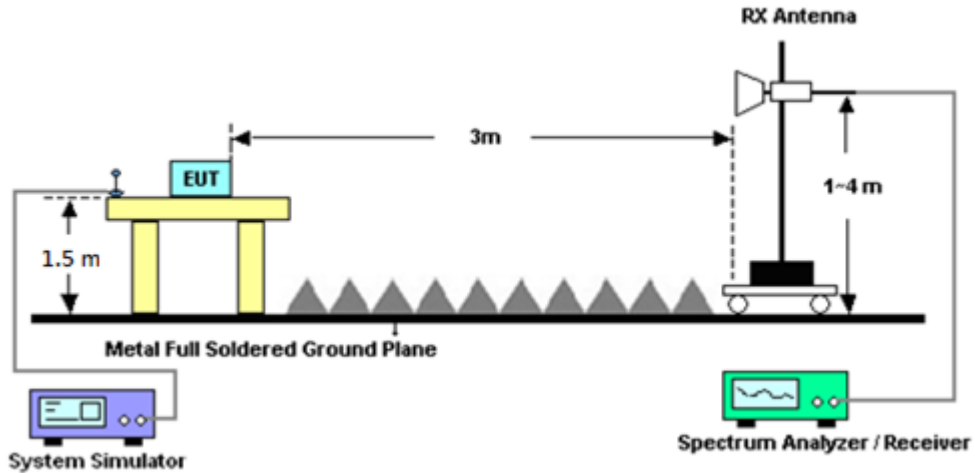

4.1.2 Test Result of Radiated Test

Please refer to Appendix B.

Note:

The low frequency, which started from 9 kHz to 30MHz, was pre-scanned and the result which was 20dB lower than the limit line was not reported.

There is adequate comparison measurement of both open-field test site and alternative test site - semi-Anechoic chamber according to 414788 D01 Radiated Test Site v01r01, and the result came out very similar.



4.2 Radiated Spurious Emission

4.2.1 Description of Radiated Spurious Emission

The radiated spurious emission was measured by substitution method according to ANSI / TIA-603-E. The power of any emission outside of the authorized operating frequency ranges must be attenuated below the transmitter power (P) by a factor of at least $43 + 10 \log (P)$ dB.

For operations in the 758-775 MHz and 788-805 MHz bands, all emissions including harmonics in the band 1559–1610 MHz shall be limited to -70 dBW/MHz equivalent isotropically radiated power (EIRP) for wideband signals, and -80 dBW EIRP for discrete emissions of less than 700 Hz bandwidth. For the purpose of equipment authorization, a transmitter shall be tested with an antenna that is representative of the type that will be used with the equipment in normal operation.

The spectrum is scanned from 30 MHz up to a frequency including its 10th harmonic.

4.2.2 Test Procedures

The testing follows FCC KDB 971168 D01 v03r01 Section 7 and ANSI / TIA-603-E Section 2.2.12.

1. The EUT was placed on a turntable with 0.8 meter for frequency below 1GHz and 1.5 meter for frequency above 1GHz respectively above ground.
2. The EUT was set 3 meters from the receiving antenna, which was mounted on the antenna tower.
3. The table was rotated 360 degrees to determine the position of the highest spurious emission.
4. The height of the receiving antenna is varied between one meter and four meters to search the maximum spurious emission for both horizontal and vertical polarizations.
5. Make the measurement with the spectrum analyzer's RBW = 1MHz, VBW = 3MHz, Sweep = 500ms, Taking the record of maximum spurious emission.
6. A horn antenna was substituted in place of the EUT and was driven by a signal generator.
7. Tune the output power of signal generator to the same emission level with EUT maximum spurious emission.
8. Taking the record of output power at antenna port.
9. Repeat step 7 to step 8 for another polarization.
10. The RF fundamental frequency should be excluded against the limit line in the operating frequency band.
11. The limit line is derived from $43 + 10\log(P)$ dB below the transmitter power P(Watts)



5 List of Measuring Equipment

Instrument	Brand Name	Model No.	Serial No.	Characteristics	Calibration Date	Test Date	Due Date	Remark
Radio Communication Analyzer	Anritsu	MT8821C	6262025353	LTE FDD/TDD LTE-2CC DLCA/ULCA	Oct. 13, 2022	Jul. 21, 2023~ Sep. 14, 2023	Oct. 12, 2023	Conducted (TH03-HY)
Thermal Chamber	ESPEC	SH-641	92013720	-40°C ~90°C	Sep. 07, 2022	Jul. 21, 2023~ Sep. 01, 2023	Sep. 06, 2023	Conducted (TH03-HY)
Thermal Chamber	ESPEC	SH-641	92013720	-40°C ~90°C	Sep. 04, 2023	Sep. 14, 2023	Sep. 03, 2024	Conducted (TH03-HY)
DC Power Supply	GW Instek	GPP-2323	GES906037	0V~64V : 0A~6A	Dec. 29, 2022	Jul. 21, 2023~ Sep. 14, 2023	Dec. 28, 2023	Conducted (TH03-HY)
Coupler	Warison	20dB 25W SMA Directional Coupler	#B	1-18GHz	Jan. 06, 2023	Jul. 21, 2023~ Sep. 14, 2023	Jan. 05, 2024	Conducted (TH03-HY)
Spectrum Analyzer	Rohde & Schwarz	FSV40	101908	10Hz~40GHz	Sep. 27, 2022	Jul. 21, 2023~ Sep. 14, 2023	Sep. 26, 2023	Conducted (TH03-HY)
Loop Antenna	Rohde & Schwarz	HFH2-Z2	100488	9 kHz~30 MHz	Sep. 20, 2022	Jul. 22, 2023~ Aug. 10, 2023	Sep. 19, 2023	Radiation (03CH12-HY)
Bilog Antenna	TESEQ	CBL 6111D & 00800N1D01N -06	37059 & 01	30MHz~1GHz	Nov. 10, 2022	Jul. 22, 2023~ Aug. 10, 2023	Nov. 09, 2023	Radiation (03CH12-HY)
Horn Antenna	SCHWARZBECK	BBHA 9120 D	9120D-1328	1GHz~18GHz	Dec. 15, 2022	Jul. 22, 2023~ Aug. 10, 2023	Dec. 14, 2023	Radiation (03CH12-HY)
Horn Antenna	SCHWARZBECK	BBHA 9120 D	9120D-02294	1GHz~18GHz	Jun. 30, 2023	Jul. 22, 2023~ Aug. 10, 2023	Jun. 29, 2024	Radiation (03CH12-HY)
Preamplifier	COM-POWER	PA-103A	161241	10MHz~1GHz	Oct. 03, 2022	Jul. 22, 2023~ Aug. 10, 2023	Oct. 02, 2023	Radiation (03CH12-HY)
Preamplifier	Agilent	8449B	3008A02375	1GHz~26.5GHz	May 23, 2023	Jul. 22, 2023~ Aug. 10, 2023	May 22, 2024	Radiation (03CH12-HY)
Preamplifier	E-INSTRUMENT TECH LTD.	ERA-100M-18 G-56-01-A70	EC1900249	1GHz-18GHz	Dec. 21, 2022	Jul. 22, 2023~ Aug. 10, 2023	Dec. 20, 2023	Radiation (03CH12-HY)
Spectrum Analyzer	Agilent	N9010A	MY53470118	10Hz~44GHz	Jan. 10, 2023	Jul. 22, 2023~ Aug. 10, 2023	Jan. 09, 2024	Radiation (03CH12-HY)
Filter	Wainwright	WHKX12-1080 -1200-15000-6 OSS	SN1	1.2GHz High Pass Filter	Mar. 14, 2023	Jul. 22, 2023~ Aug. 10, 2023	Mar. 13, 2024	Radiation (03CH12-HY)
Filter	Wainwright	WHKX12-2700 -3000-18000-6 OST	SN2	3GHz High Pass Filter	Mar. 14, 2023	Jul. 22, 2023~ Aug. 10, 2023	Mar. 13, 2024	Radiation (03CH12-HY)
Filter	Wainwright	WHKX8-5872. 5-6750-18000- 40ST	SN2	6.75GHz High Pass Filter	Mar. 14, 2023	Jul. 22, 2023~ Aug. 10, 2023	Mar. 13, 2024	Radiation (03CH12-HY)
RF Cable	HUBER + SUHNER	SUCOFLEX 102	803951/2	9kHz~30MHz	Mar. 07, 2023	Jul. 22, 2023~ Aug. 10, 2023	Mar. 06, 2024	Radiation (03CH12-HY)
RF Cable	HUBER + SUHNER	SUCOFLEX 126E	0058/126E	30MHz~18GHz	Dec. 20, 2022	Jul. 22, 2023~ Aug. 10, 2023	Dec. 19, 2023	Radiation (03CH12-HY)
RF Cable	HUBER + SUHNER	SUCOFLEX 102	505134/2	30MHz~40GHz	Dec. 20, 2022	Jul. 22, 2023~ Aug. 10, 2023	Dec. 19, 2023	Radiation (03CH12-HY)
RF Cable	HUBER + SUHNER	SUCOFLEX 102	803953/2	30MHz~40GHz	Dec. 20, 2022	Jul. 22, 2023~ Aug. 10, 2023	Dec. 19, 2023	Radiation (03CH12-HY)
Antenna Mast	EMEC	AM-BS-4500-B	N/A	1m~4m	N/A	Jul. 22, 2023~ Aug. 10, 2023	N/A	Radiation (03CH12-HY)
Turn Table	EMEC	TT2000	N/A	0~360 Degree	N/A	Jul. 22, 2023~ Aug. 10, 2023	N/A	Radiation (03CH12-HY)
Software	Audix	E3 6.2009-8-24	RK-000989	N/A	N/A	Jul. 22, 2023~ Aug. 10, 2023	N/A	Radiation (03CH12-HY)
Signal Generator	Rohde & Schwarz	SMF100A	101107	100kHz~40GHz	Jan. 11, 2023	Jul. 22, 2023~ Aug. 10, 2023	Jan. 10, 2024	Radiation (03CH12-HY)



6 Measurement Uncertainty

Uncertainty of Radiated Emission Measurement (30 MHz ~ 1000 MHz)

Measuring Uncertainty for a Level of Confidence of 95% ($U = 2Uc(y)$)	3.07 dB
---	---------

Uncertainty of Radiated Emission Measurement (1 GHz ~ 18 GHz)

Measuring Uncertainty for a Level of Confidence of 95% ($U = 2Uc(y)$)	3.63 dB
---	---------



Appendix A. Test Results of Conducted Test

Conducted Output Power(Average power & ERP)

LTE Band 14 Maximum Average Power [dBm] (GT - LC = -0.14 dB)								
BW [MHz]	RB Size	RB Offset	Mod	Lowest	Middle	Highest	ERP (dBm)	ERP (W)
10	1	0	QPSK		23.58		21.29	0.1346
10	1	25			23.34			
10	1	49			23.21			
10	25	0			22.45			
10	25	12			22.41			
10	25	25			22.26			
10	50	0			22.36			
10	1	0	16-QAM		22.92		20.63	0.1156
10	1	25			22.79			
10	1	49			22.76			
10	25	0			21.33			
10	25	12			21.43			
10	25	25			21.31			
10	50	0			21.45			
10	1	0	64-QAM		21.72		19.43	0.0877
10	1	25			21.46			
10	1	49			21.31			
10	25	0			20.39			
10	25	12			20.51			
10	25	25			20.38			
10	50	0			20.29			
10	1	0	256-QAM		18.42		16.62	0.0459
10	1	25			18.35			
10	1	49			18.91			
10	25	0			18.47			
10	25	12			18.85			
10	25	25			18.69			
10	50	0			18.35			
Limit	ERP < 3W			Result			Pass	



LTE Band 14 Maximum Average Power [dBm] (GT - LC = -0.14 dB)								
BW [MHz]	RB Size	RB Offset	Mod	Lowest	Middle	Highest	ERP (dBm)	ERP (W)
5	1	0	QPSK	23.51	23.55	23.52	21.26	0.1337
5	1	12		23.33	23.34	23.34		
5	1	24		23.12	23.11	23.16		
5	12	0		22.45	22.37	22.36		
5	12	7		22.41	22.40	22.32		
5	12	13		22.24	22.19	22.25		
5	25	0		22.35	22.35	22.35		
5	1	0	16-QAM	22.86	22.92	22.90	20.63	0.1156
5	1	12		22.71	22.76	22.74		
5	1	24		22.72	22.68	22.74		
5	12	0		21.25	21.27	21.32		
5	12	7		21.38	21.41	21.35		
5	12	13		21.30	21.30	21.22		
5	25	0		21.43	21.44	21.39		
5	1	0	64-QAM	21.66	21.63	21.66	19.37	0.0865
5	1	12		21.39	21.44	21.40		
5	1	24		21.28	21.30	21.29		
5	12	0		20.33	20.30	20.29		
5	12	7		20.44	20.51	20.44		
5	12	13		20.31	20.35	20.38		
5	25	0		20.19	20.19	20.28		
5	1	0	256-QAM	18.36	18.32	18.40	16.62	0.0459
5	1	12		18.34	18.30	18.33		
5	1	24		18.84	18.85	18.91		
5	12	0		18.44	18.43	18.43		
5	12	7		18.80	18.78	18.77		
5	12	13		18.66	18.62	18.62		
5	25	0		18.33	18.31	18.25		
Limit	ERP < 3W			Result			Pass	



LTE Band 14

Peak-to-Average Ratio

Mode	LTE Band 14 / 5MHz				
Mod.	QPSK	16QAM	64QAM	256QAM	Limit: 13dB
RB Size	Full RB	Full RB	Full RB	Full RB	Result
Middle CH	5.01	5.97	6.49	6.58	PASS
Mode	LTE Band 14 / 10MHz				
Mod.	QPSK	16QAM	64QAM	256QAM	Limit: 13dB
RB Size	Full RB	Full RB	Full RB	Full RB	Result
Middle CH	4.96	5.88	6.58	6.46	PASS

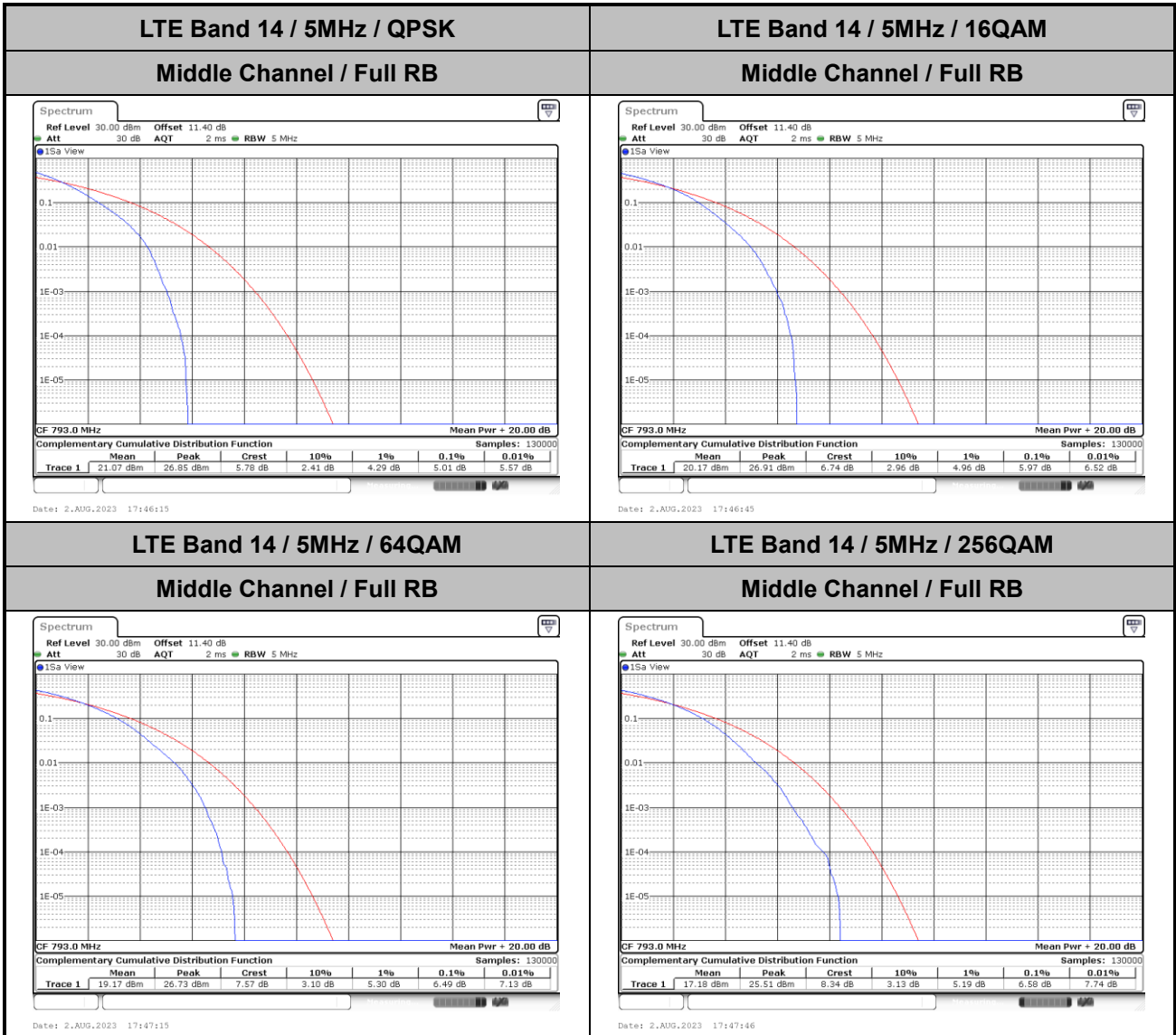

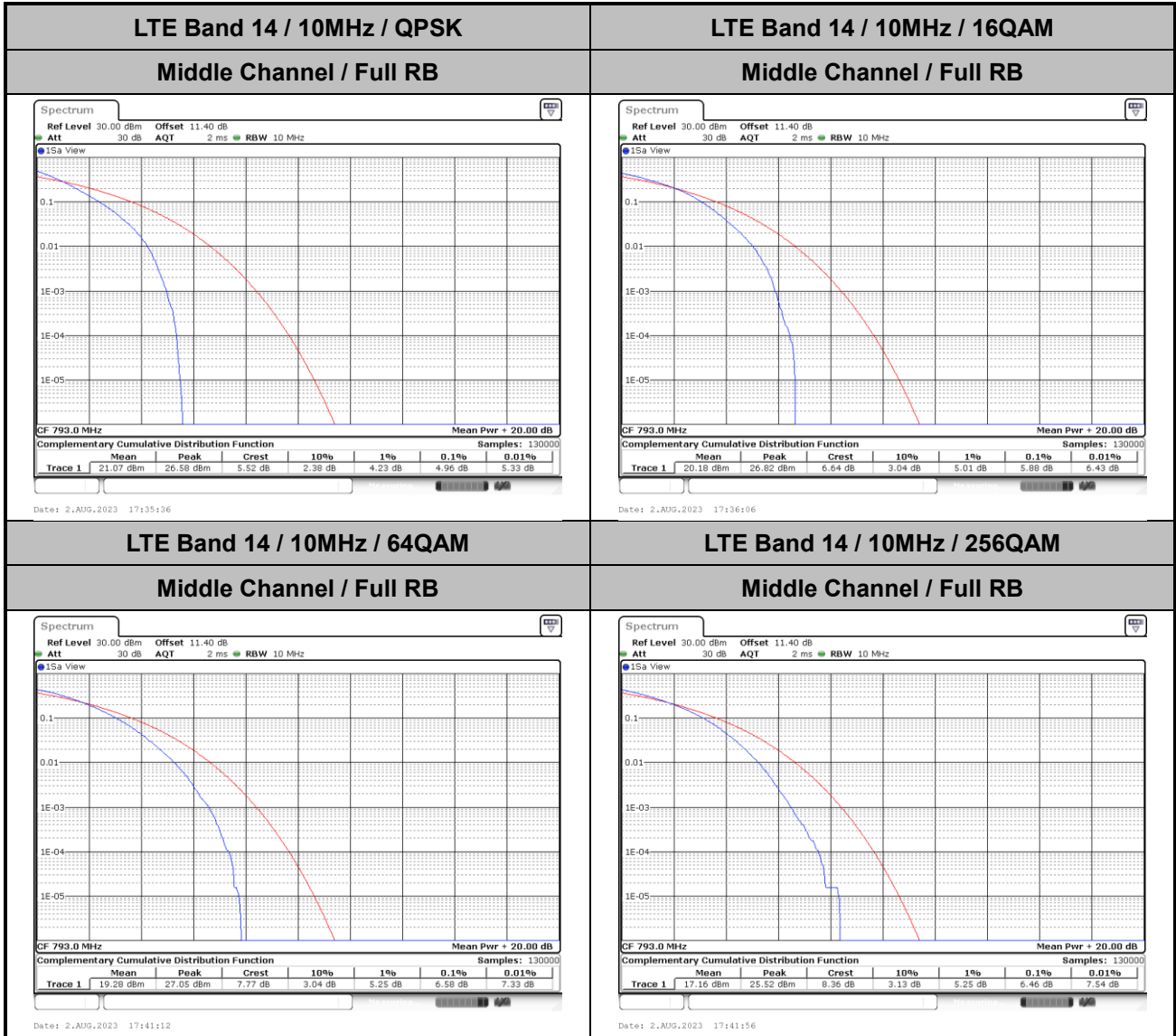



26dB Bandwidth

Mode	LTE Band 14 : 26dB BW(MHz)											
BW	1.4MHz		3MHz		5MHz		10MHz		15MHz		20MHz	
Mod.	QPSK	16QAM	QPSK	16QAM	QPSK	16QAM	QPSK	16QAM	QPSK	16QAM	QPSK	16QAM
Middle CH	-	-	-	-	4.90	4.88	9.73	9.93	-	-	-	-
Mode	LTE Band 14 : 26dB BW(MHz)											
BW	1.4MHz		3MHz		5MHz		10MHz		15MHz		20MHz	
Mod.	64QAM	256QAM	64QAM	256QAM	64QAM	256QAM	64QAM	256QAM	64QAM	256QAM	64QAM	256QAM
Middle CH	-	-	-	-	4.91	4.90	9.67	9.87	-	-	-	-

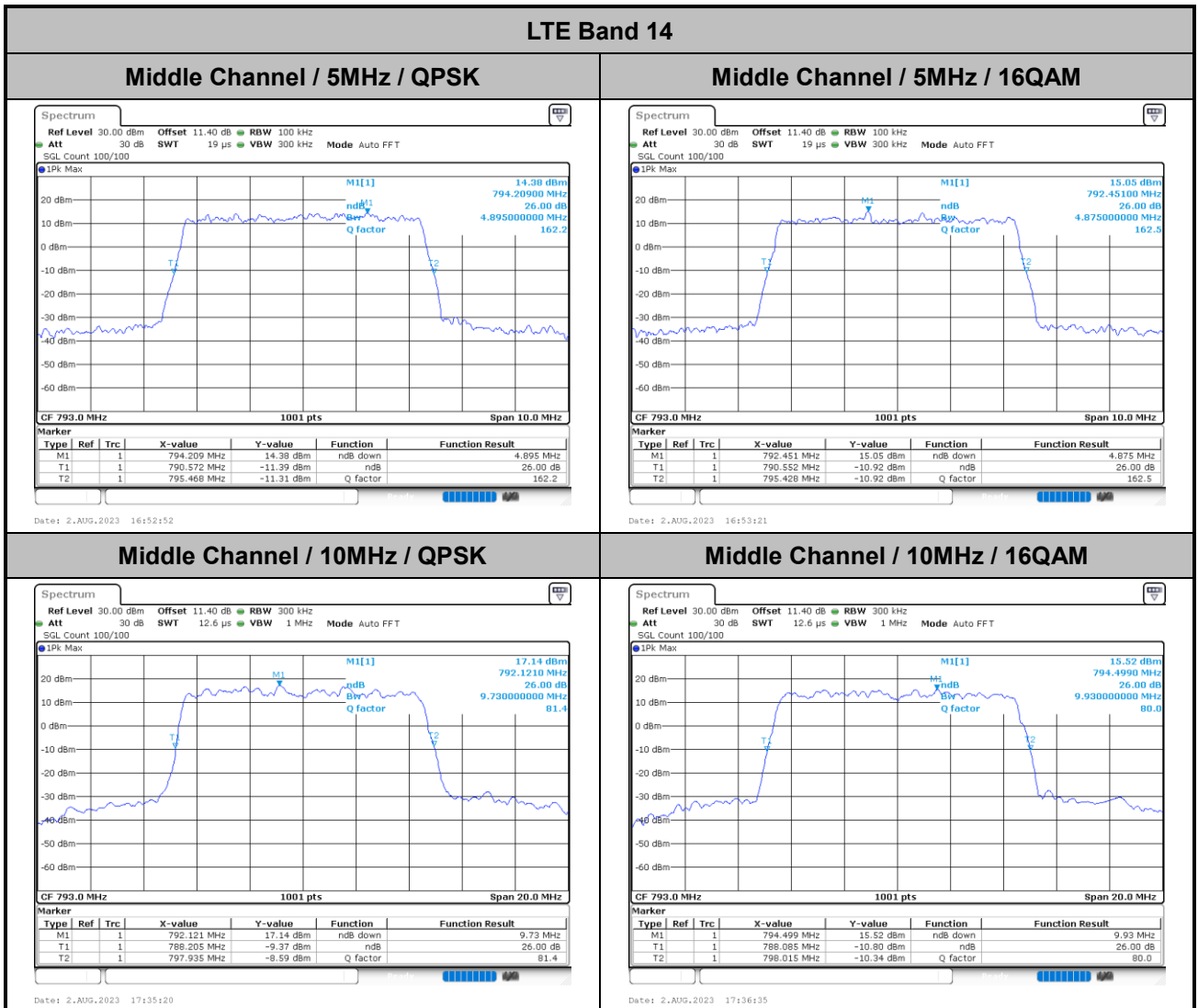



LTE Band 14

Middle Channel / 5MHz / 64QAM

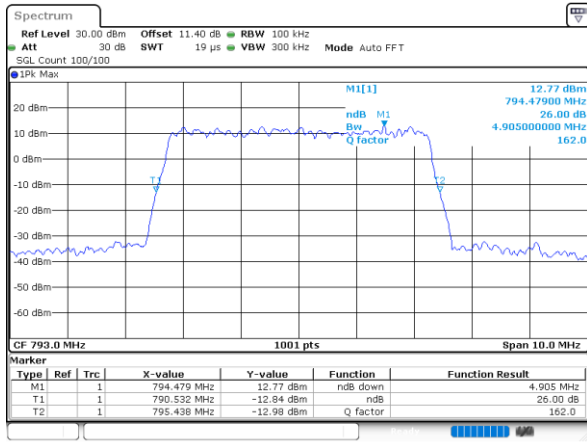

Date: 2.AUG.2023 16:54:18

Middle Channel / 10MHz / 64QAM

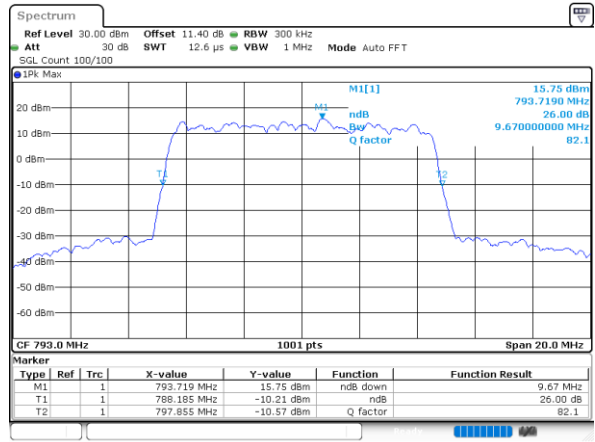

Date: 2.AUG.2023 17:41:26



LTE Band 14

Middle Channel / 5MHz / 256QAM

Middle Channel / 10MHz / 256QAM

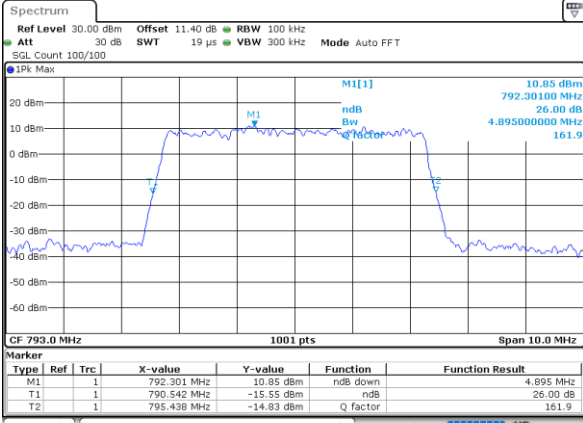

Date: 2.AUG.2023 16:15:447

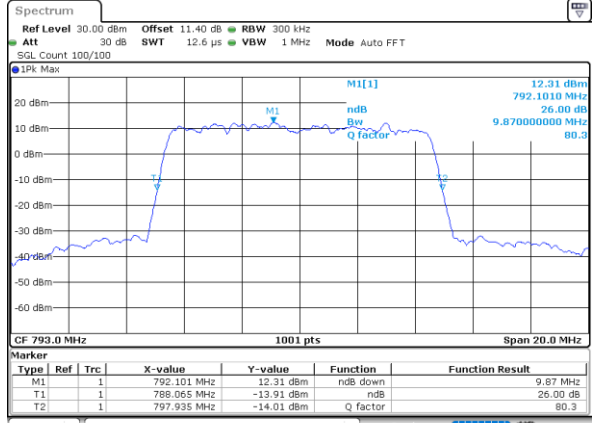

Date: 2.AUG.2023 17:42:25



Occupied Bandwidth

Mode	LTE Band 14 : 99%OBW(MHz)											
BW	1.4MHz		3MHz		5MHz		10MHz		15MHz		20MHz	
Mod.	QPSK	16QAM	QPSK	16QAM	QPSK	16QAM	QPSK	16QAM	QPSK	16QAM	QPSK	16QAM
Middle CH	-	-	-	-	4.47	4.50	8.97	8.97	-	-	-	-
Mode	LTE Band 14 : 99%OBW(MHz)											
BW	1.4MHz		3MHz		5MHz		10MHz		15MHz		20MHz	
Mod.	64QAM	256QAM	64QAM	256QAM	64QAM	256QAM	64QAM	256QAM	64QAM	256QAM	64QAM	256QAM
Middle CH	-	-	-	-	4.51	4.48	8.97	8.95	-	-	-	-

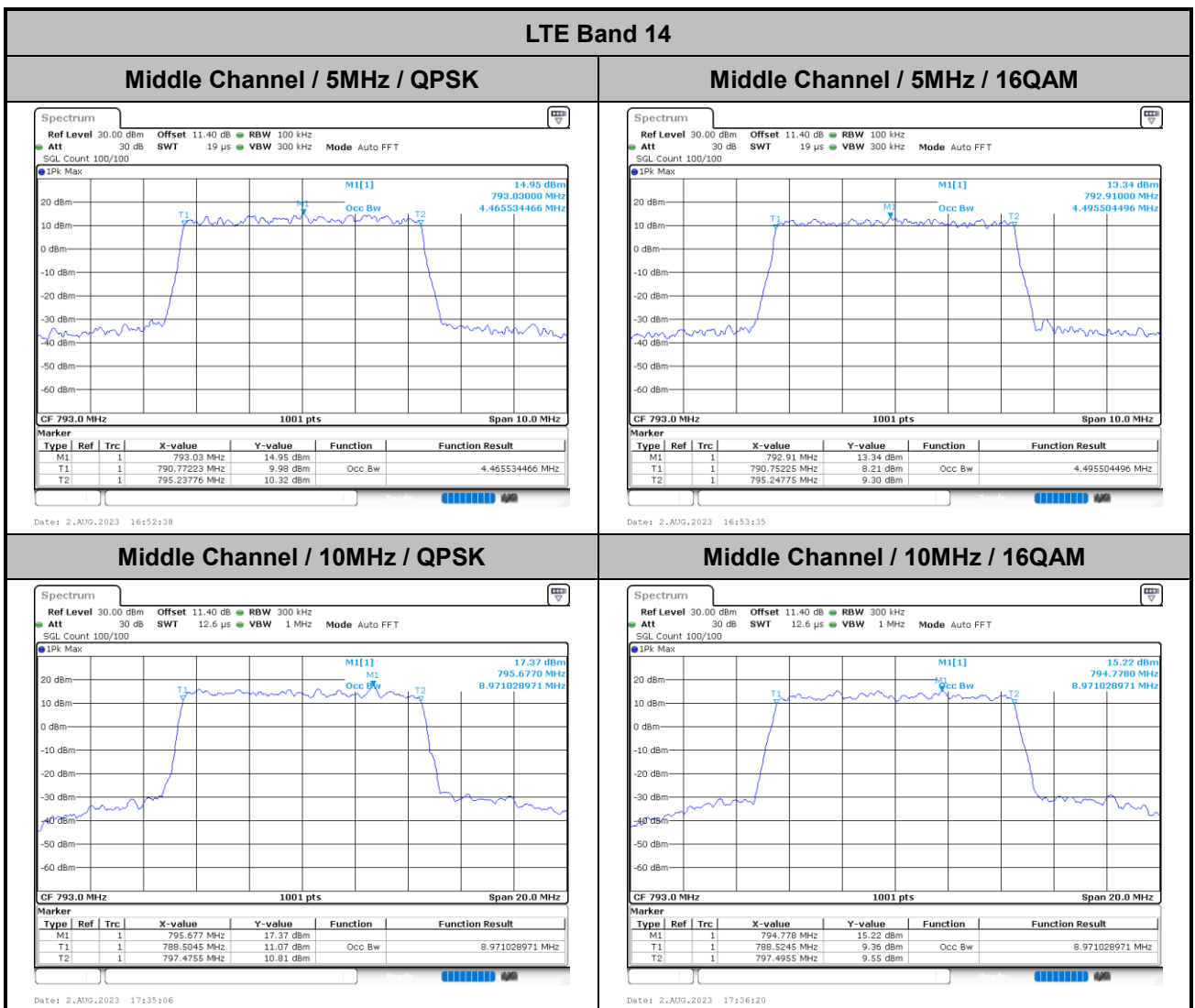



LTE Band 14

Middle Channel / 5MHz / 64QAM

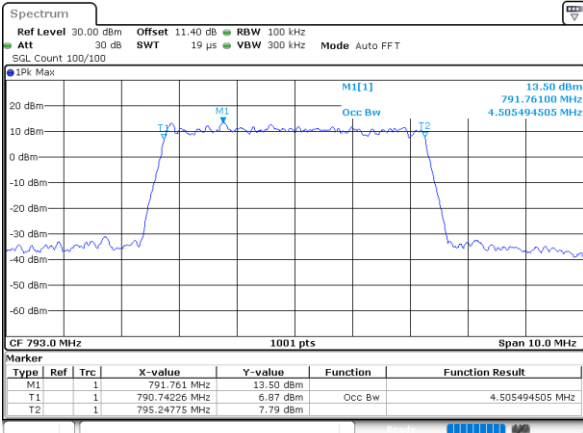

Date: 2.AUG.2023 16:54:04

Middle Channel / 10MHz / 64QAM

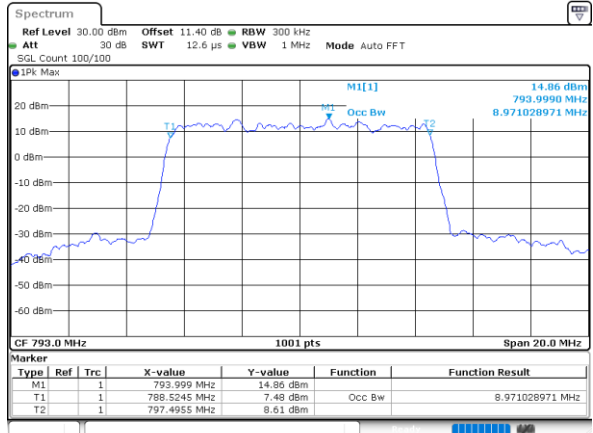

Date: 2.AUG.2023 17:40:57

LTE Band 14

Middle Channel / 5MHz / 256QAM

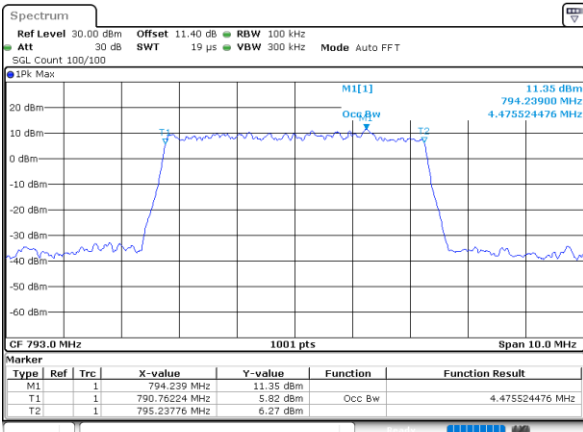

Date: 2.AUG.2023 16:55:02

Middle Channel / 10MHz / 256QAM

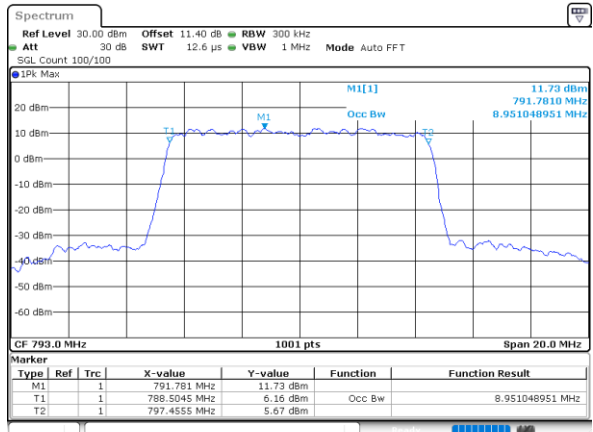

Date: 2.AUG.2023 17:42:11



Conducted Band Edge

LTE Band 14 / 5MHz / QPSK

Lowest Band Edge / 1 RB

Highest Band Edge / 1 RB

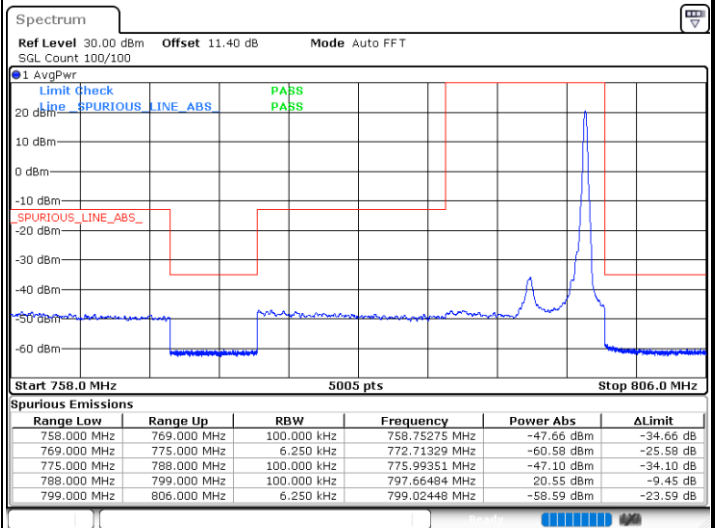
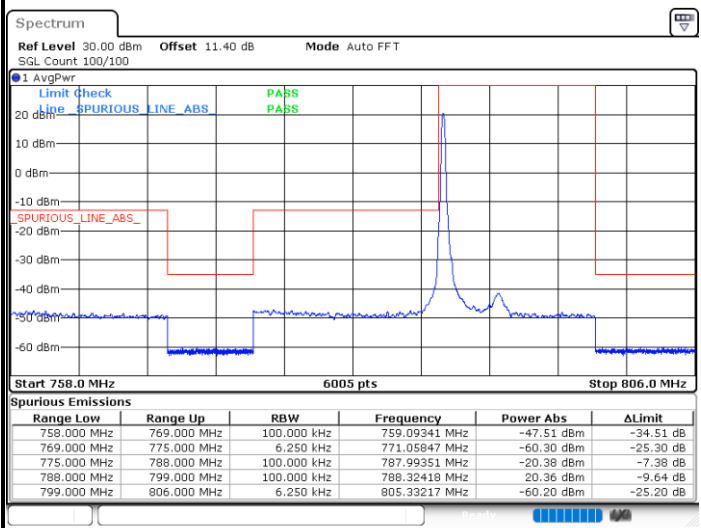

Date: 2.AUG.2023 16:30:20

Date: 2.AUG.2023 17:10:19

Lowest Band Edge / Full RB

Highest Band Edge / Full RB

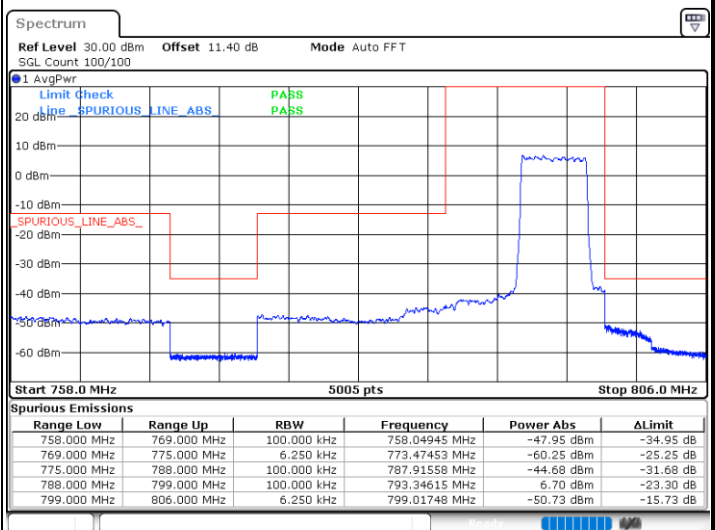
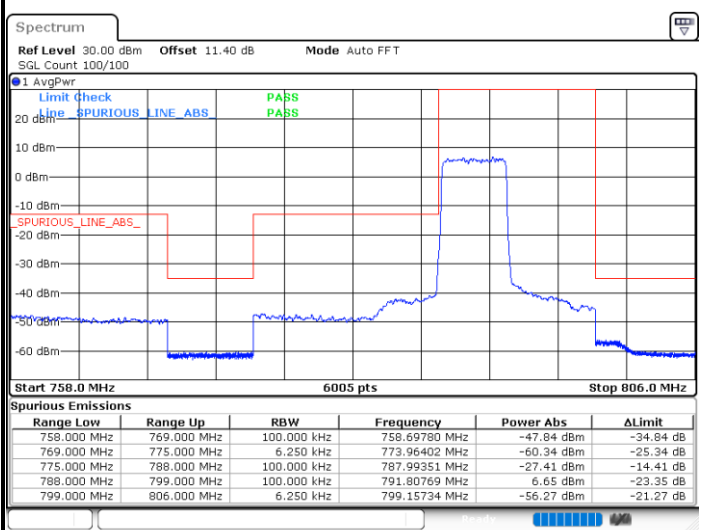

Date: 2.AUG.2023 16:28:50

Date: 2.AUG.2023 17:11:49



LTE Band 14 / 5MHz / 16QAM

Lowest Band Edge / 1 RB

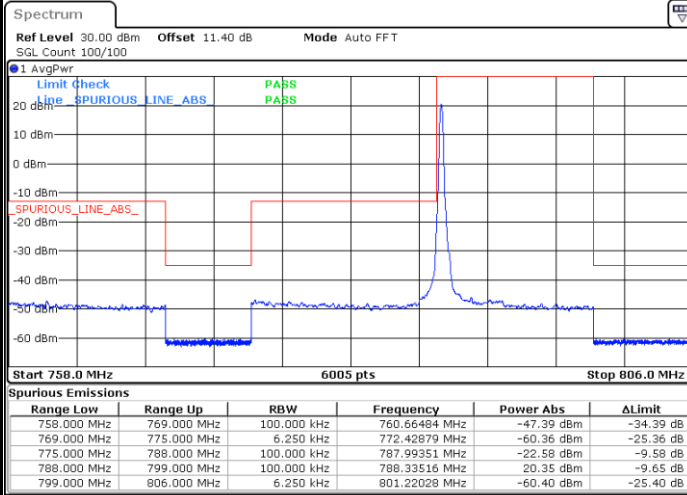

Date: 2.AUG.2023 16:32:52

Highest Band Edge / 1 RB

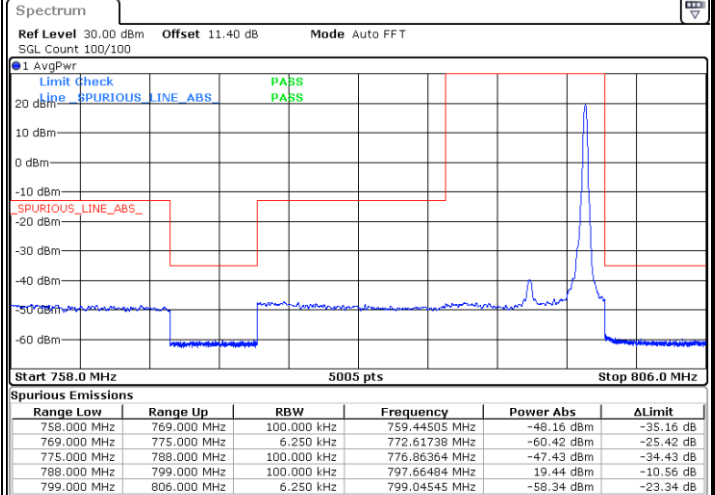

Date: 2.AUG.2023 17:14:48

Lowest Band Edge / Full RB

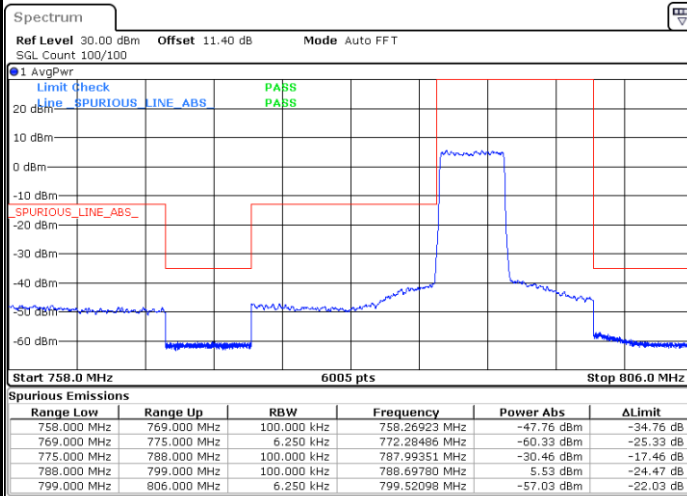

Date: 2.AUG.2023 16:34:22

Highest Band Edge / Full RB

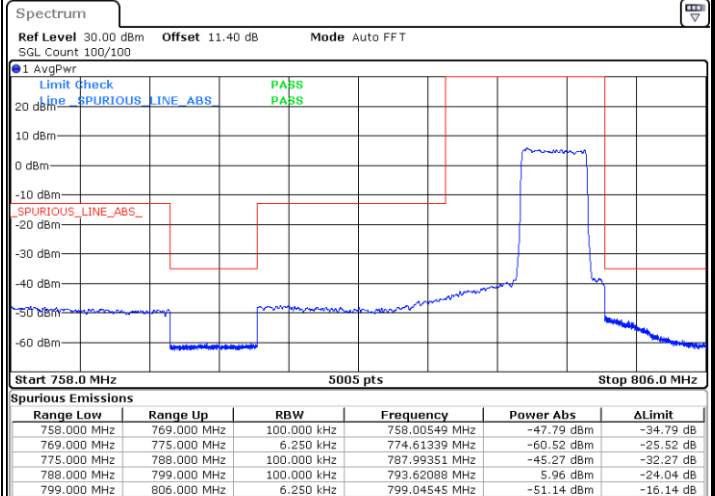

Date: 2.AUG.2023 17:13:18



LTE Band 14 / 5MHz / 64QAM

Lowest Band Edge / 1 RB

Highest Band Edge / 1 RB

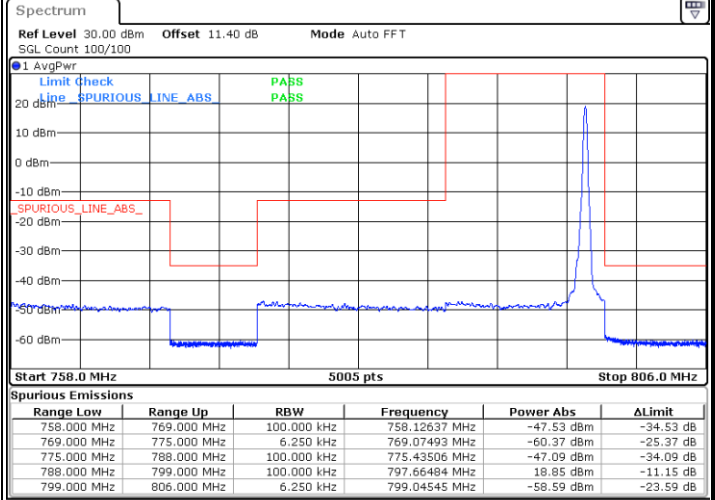
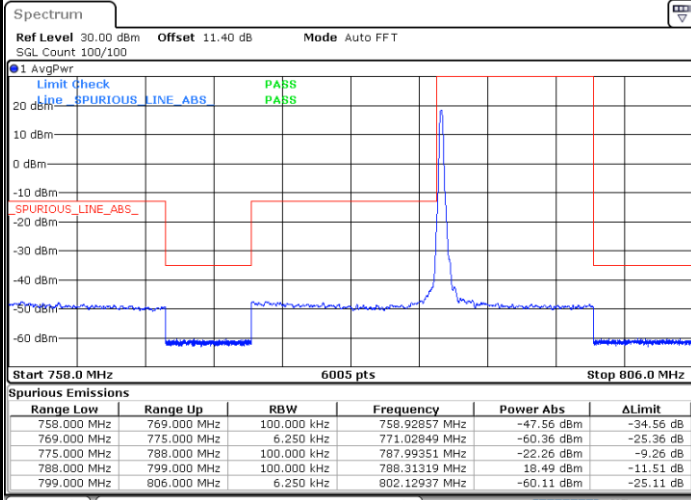

Date: 2.AUG.2023 16:37:22

Date: 2.AUG.2023 17:16:18

Lowest Band Edge / Full RB

Highest Band Edge / Full RB

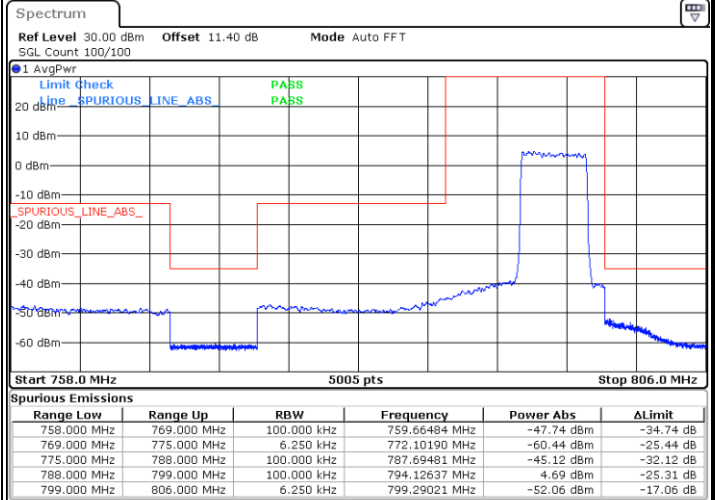
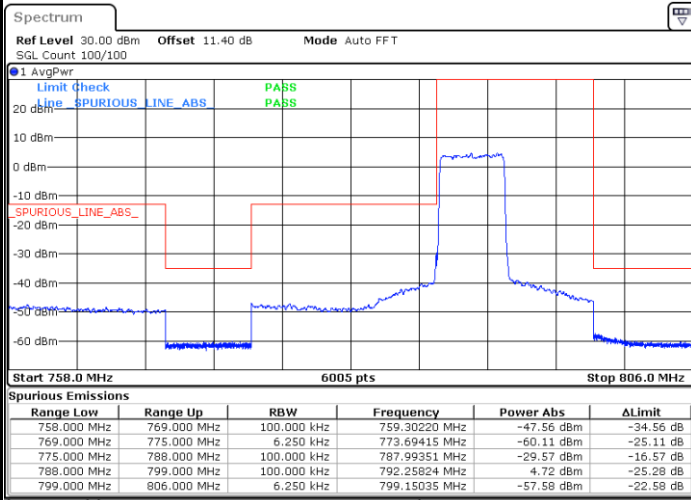

Date: 2.AUG.2023 16:35:52

Date: 2.AUG.2023 17:17:47



LTE Band 14 / 5MHz / 256QAM

Lowest Band Edge / 1 RB

Highest Band Edge / 1 RB

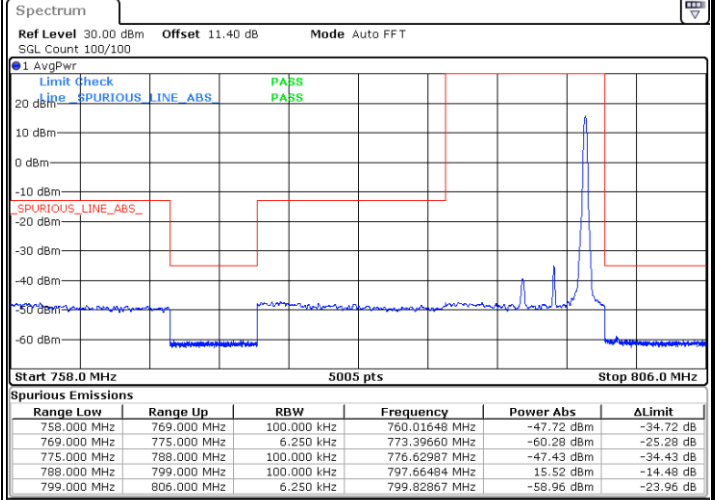
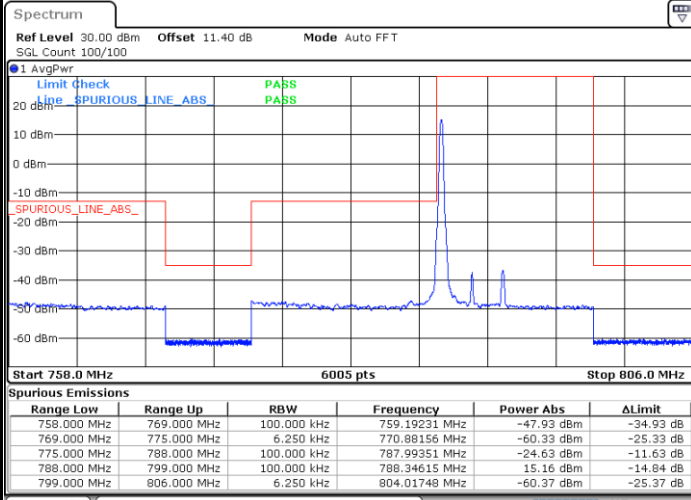

Date: 2.AUG.2023 16:38:51

Date: 2.AUG.2023 17:20:50

Lowest Band Edge / Full RB

Highest Band Edge / Full RB

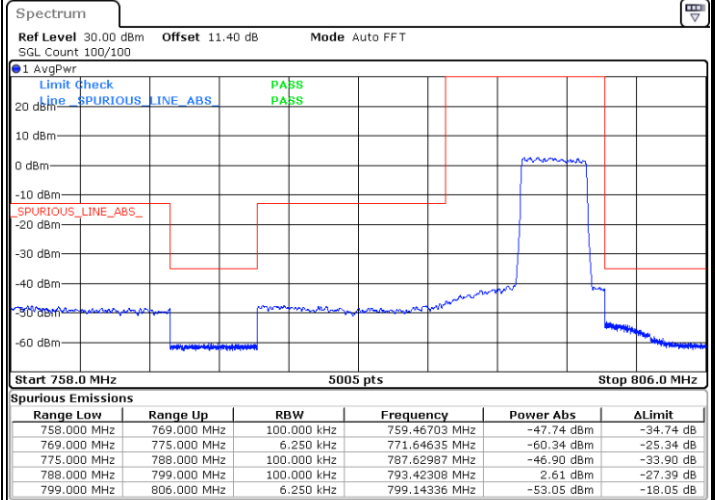
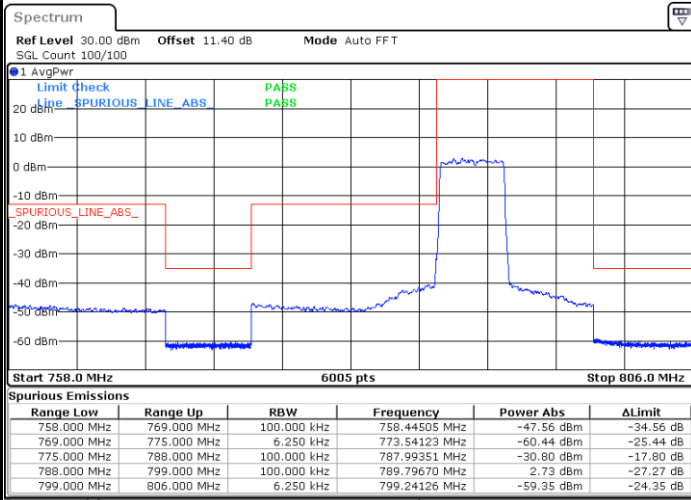

Date: 2.AUG.2023 16:40:24

Date: 2.AUG.2023 17:19:17

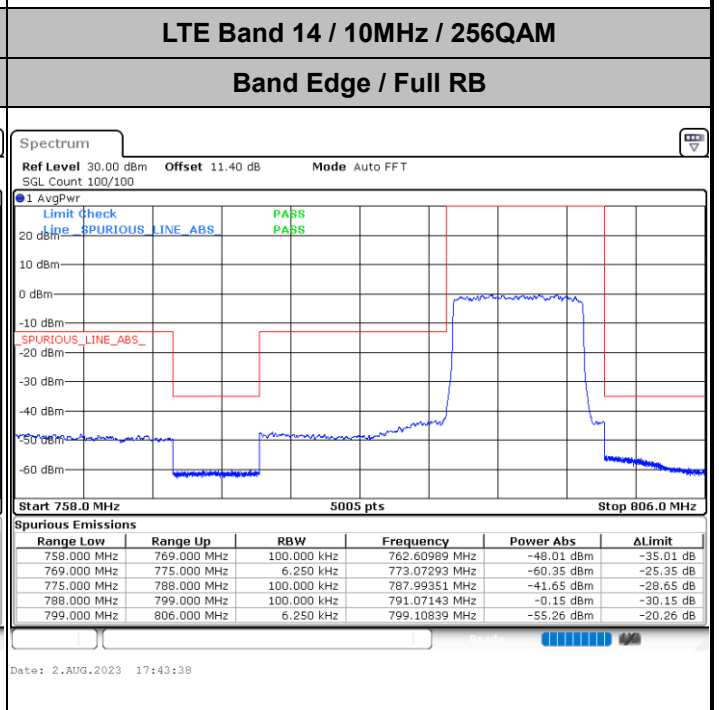
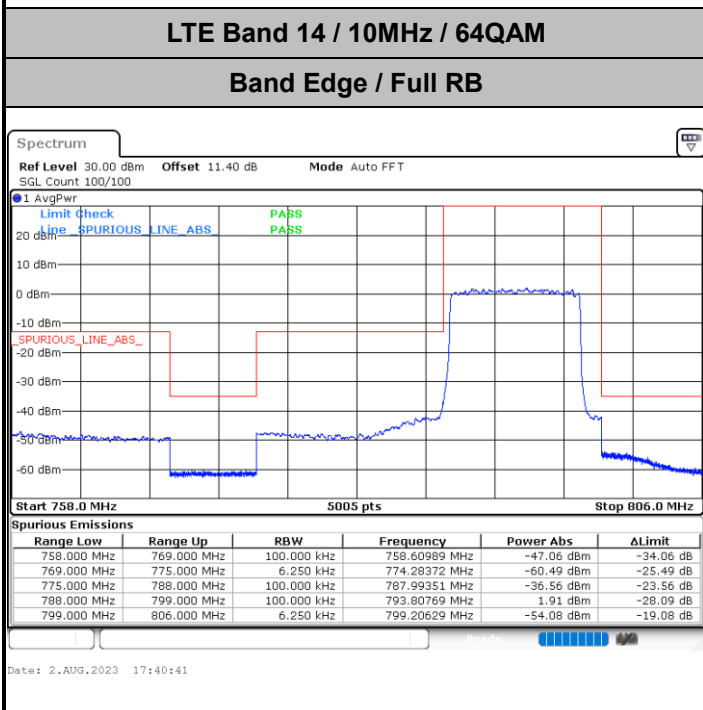
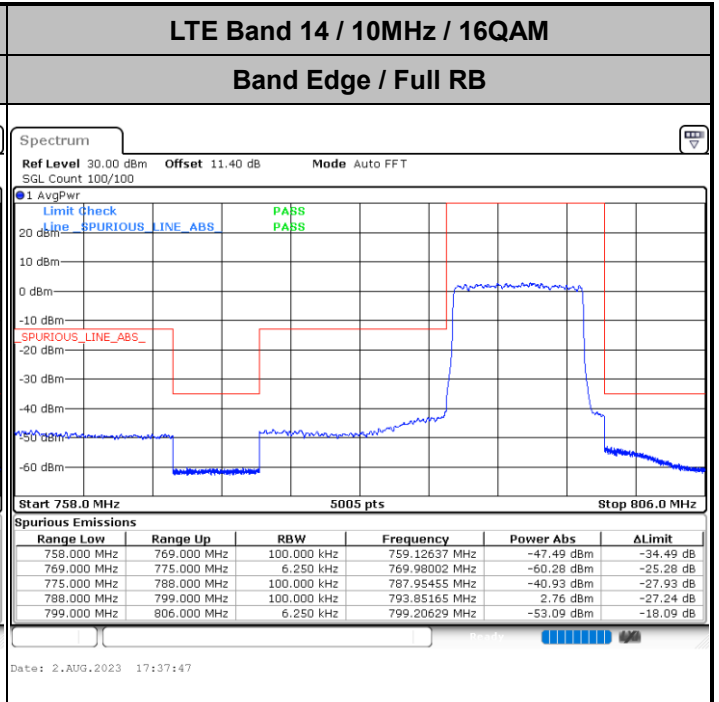
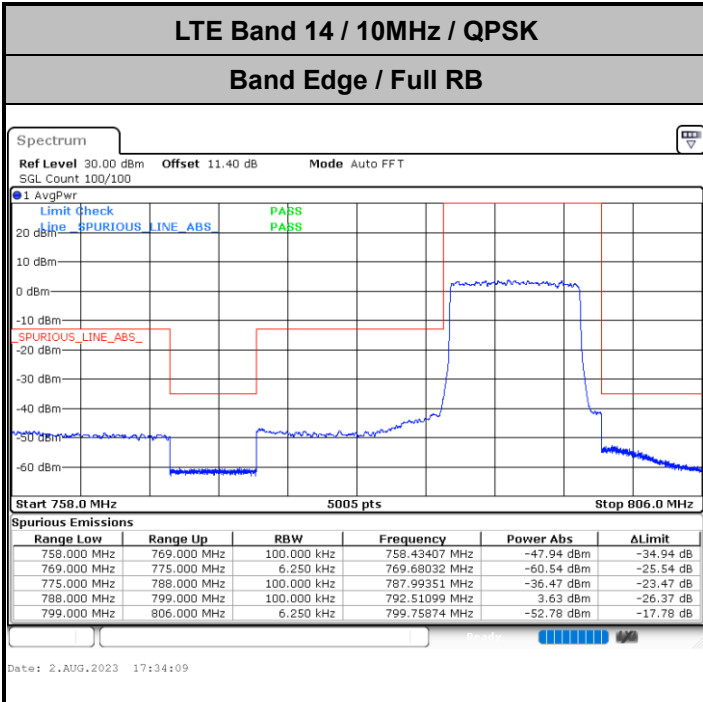



Conducted Spurious Emission

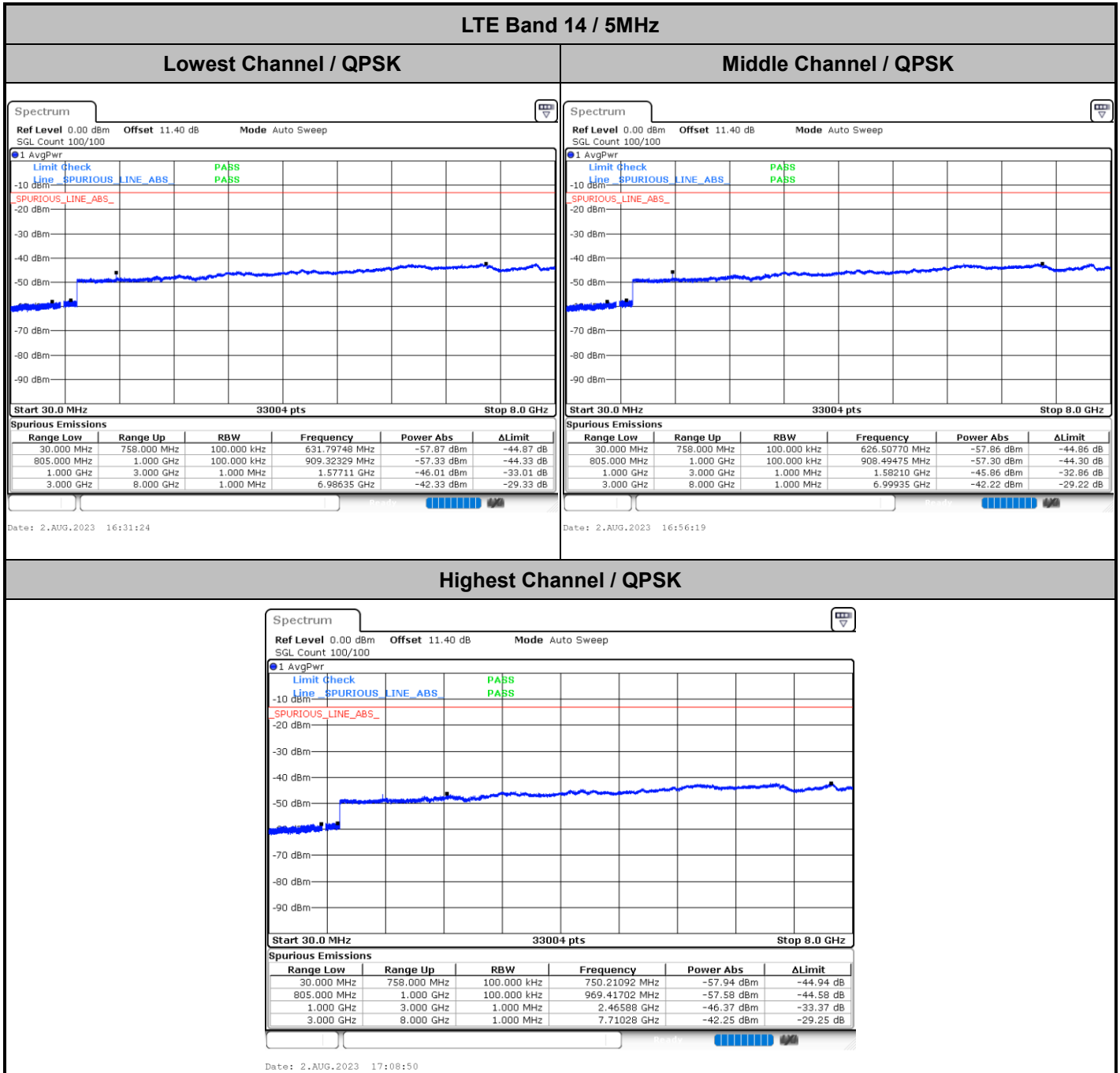



LTE Band 14 / 10MHz

Middle Channel / QPSK

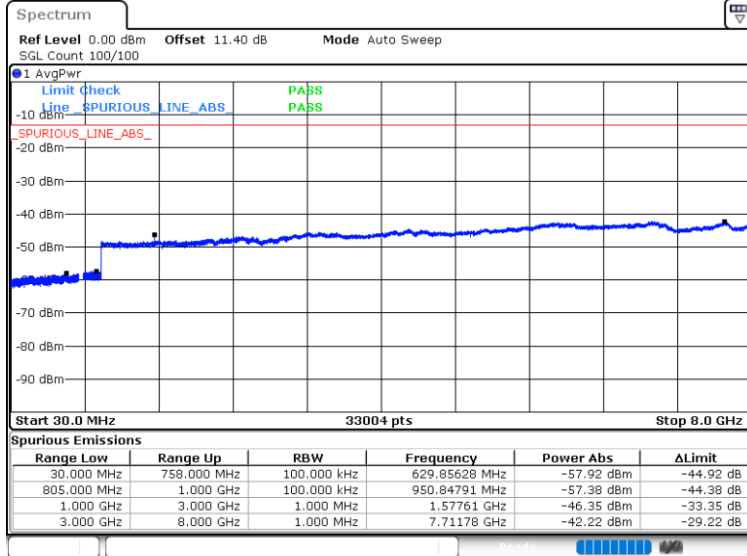

Date: 2.AUG.2023 17:45:39



Mask

LTE Band 14 / 5MHz / QPSK

Lowest Channel / 1RB

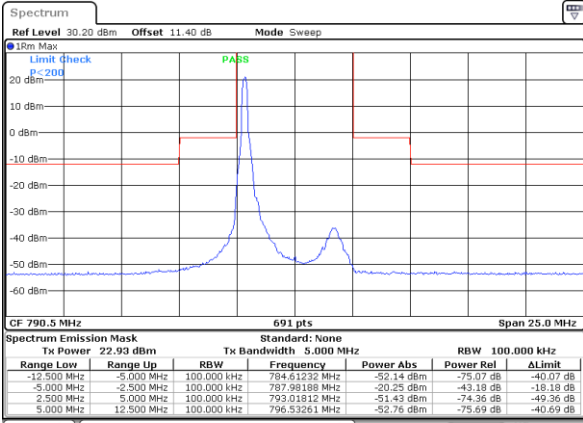

Date: 2.AUG.2023 16:41:26

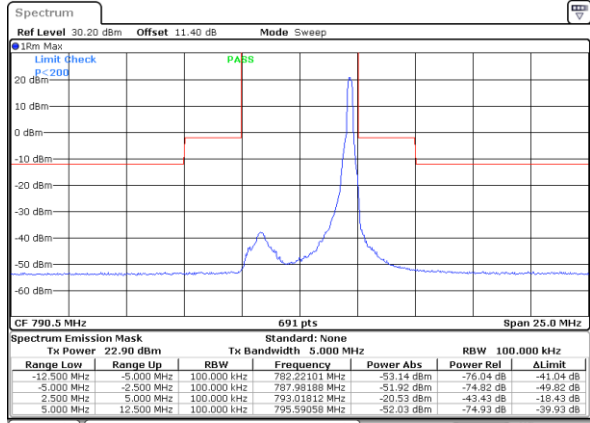

Date: 2.AUG.2023 16:42:23

Lowest Channel / Full RB

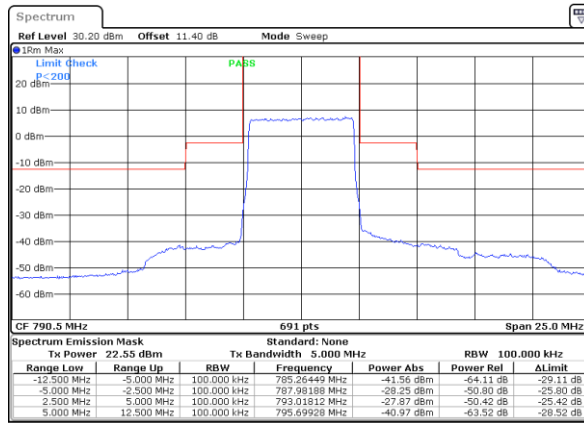

Date: 2.AUG.2023 16:43:21



LTE Band 14 / 5MHz / 16QAM

Lowest Channel / 1RB

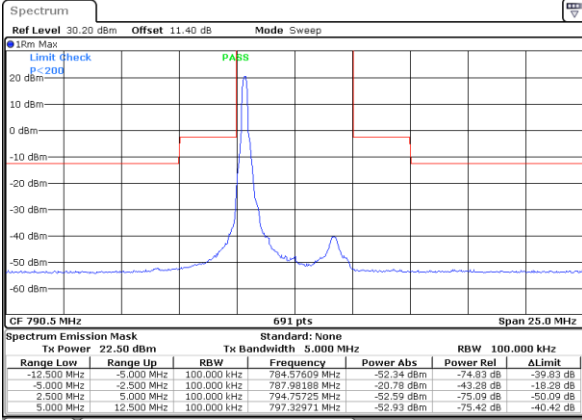

Date: 2.AUG.2023 16:44:16

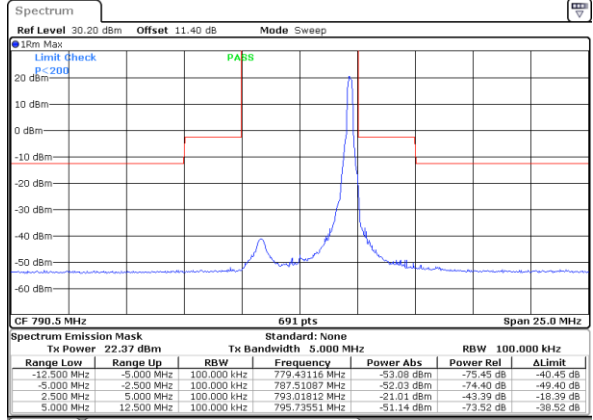

Date: 2.AUG.2023 16:45:18

Lowest Channel / Full RB

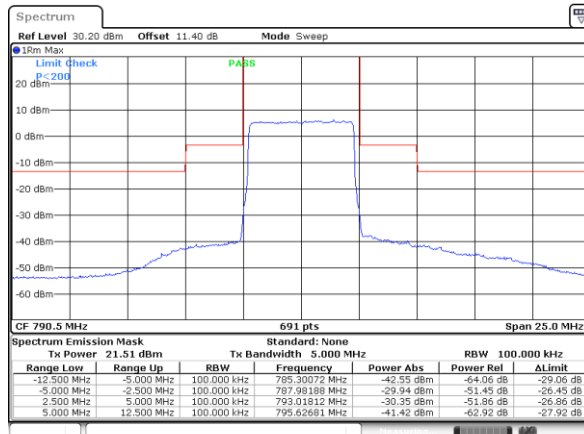

Date: 2.AUG.2023 16:44:20



LTE Band 14 / 5MHz / 64QAM

Lowest Channel / 1RB

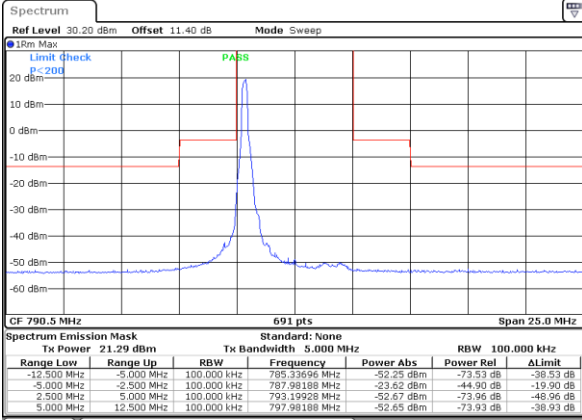

Date: 2.AUG.2023 16:47:14

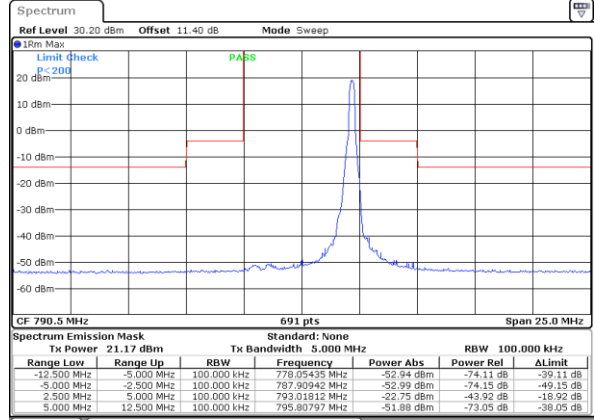

Date: 2.AUG.2023 16:48:11

Lowest Channel / Full RB

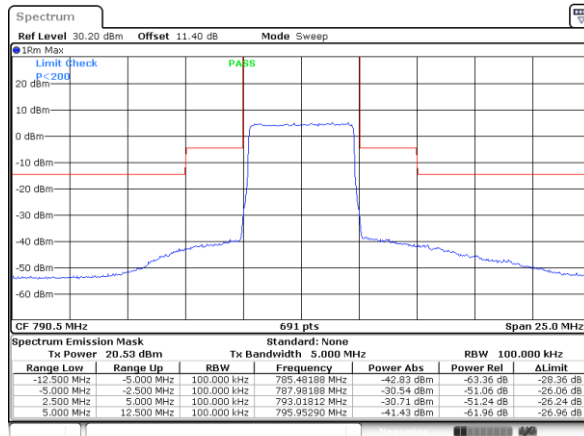

Date: 2.AUG.2023 16:49:09



LTE Band 14 / 5MHz / 256QAM

Lowest Channel / 1RB

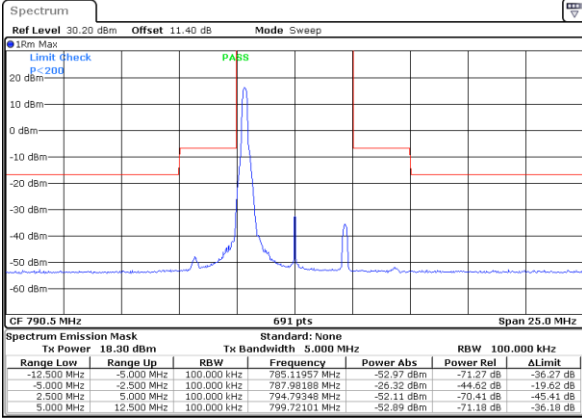

Date: 2.AUG.2023 16:52:09

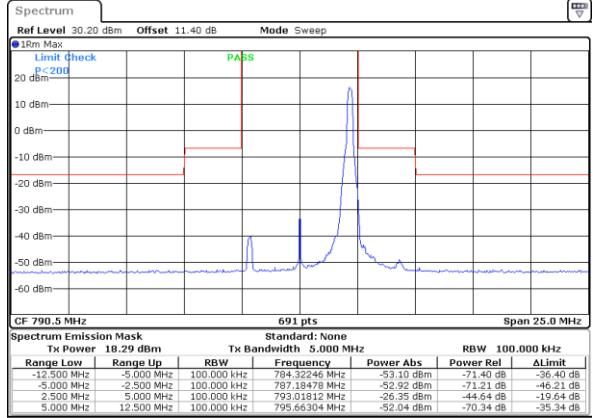

Date: 2.AUG.2023 16:51:08

Lowest Channel / Full RB

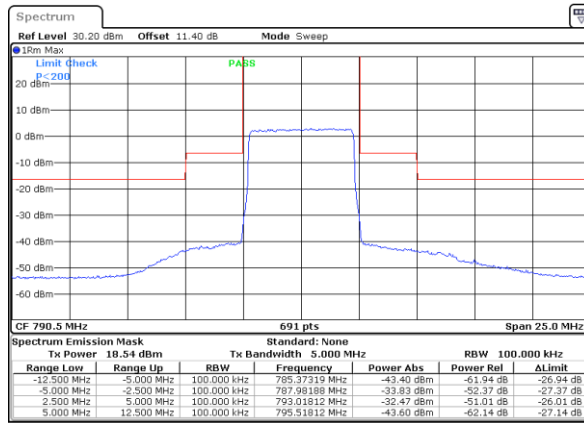

Date: 2.AUG.2023 16:50:07



LTE Band 14 / 5MHz / QPSK

Middle Channel / 1RB

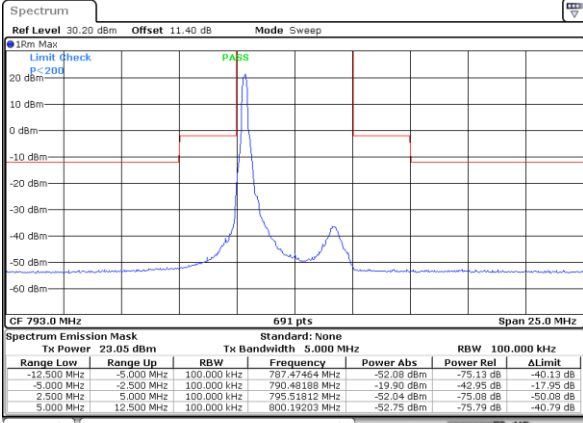

Date: 2.AUG.2023 16:57:01

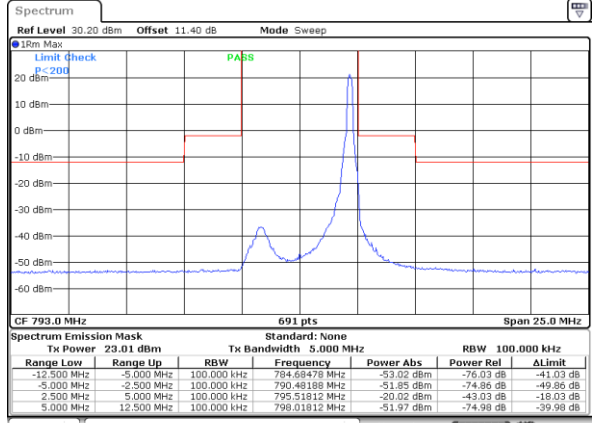

Date: 2.AUG.2023 16:57:59

Middle Channel / Full RB

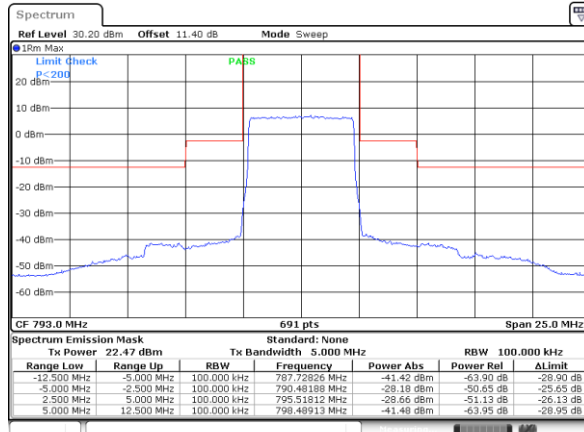

Date: 2.AUG.2023 16:58:06



LTE Band 14 / 5MHz / 16QAM

Middle Channel / 1RB

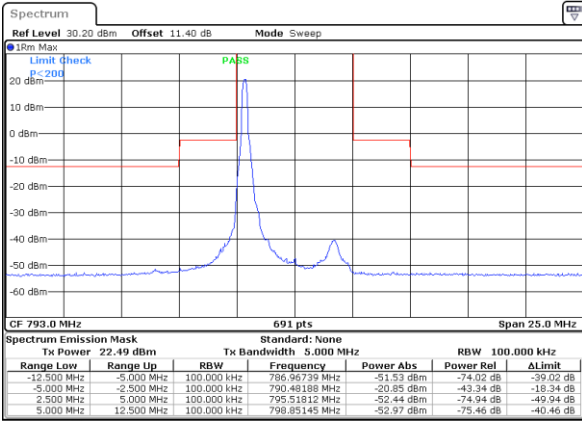

Date: 2.AUG.2023 17:01:48

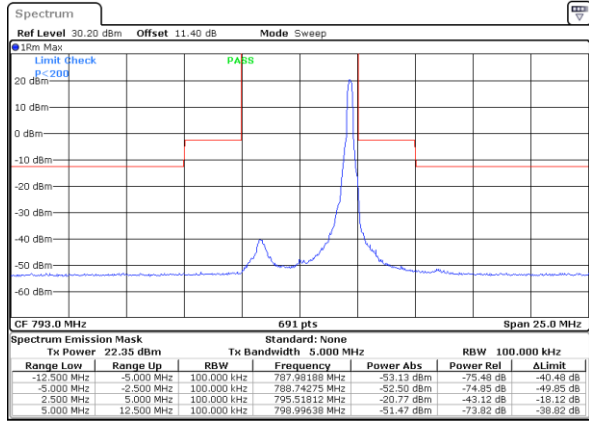

Date: 2.AUG.2023 17:00:51

Middle Channel / Full RB

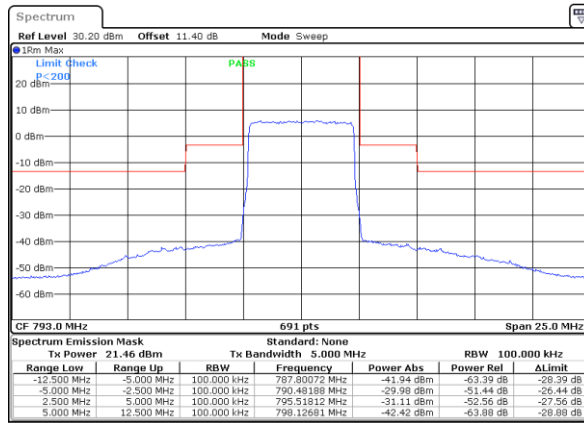

Date: 2.AUG.2023 16:59:03



LTE Band 14 / 5MHz / 64QAM

Middle Channel / 1RB

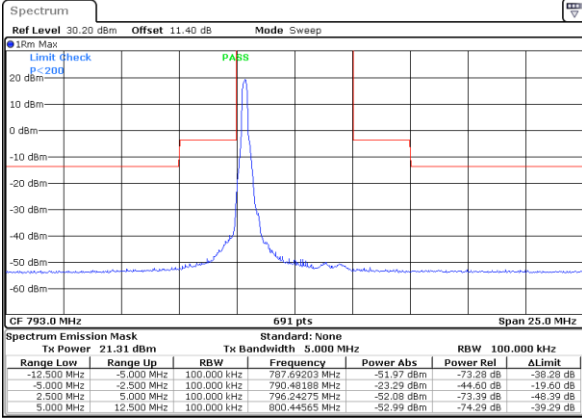

Date: 2.AUG.2023 17:02:45

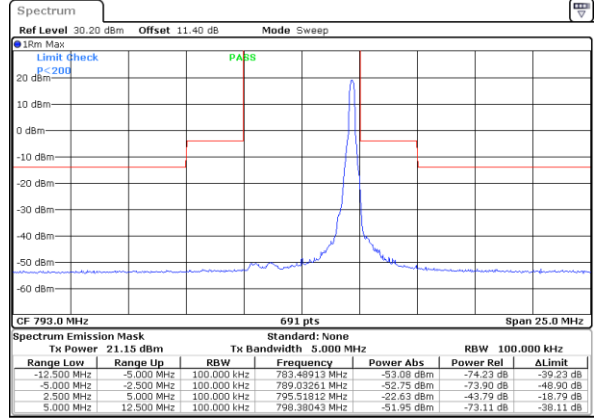

Date: 2.AUG.2023 17:03:42

Middle Channel / Full RB

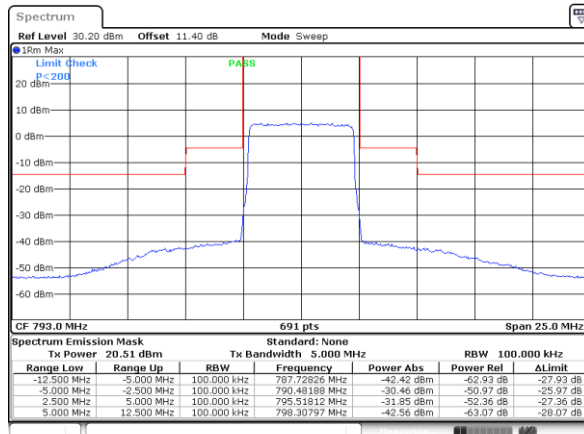

Date: 2.AUG.2023 17:04:40



LTE Band 14 / 5MHz / 256QAM

Middle Channel / 1RB

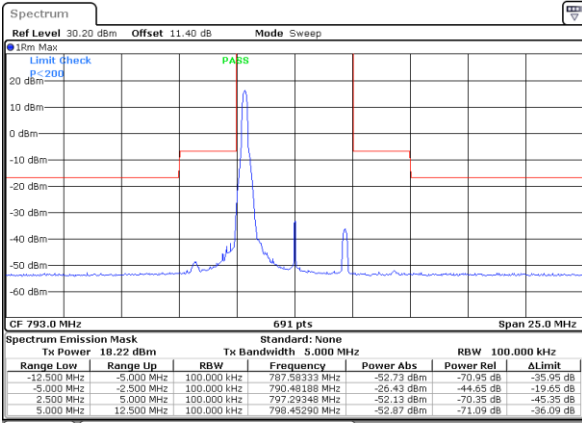

Date: 2.AUG.2023 17:07:32

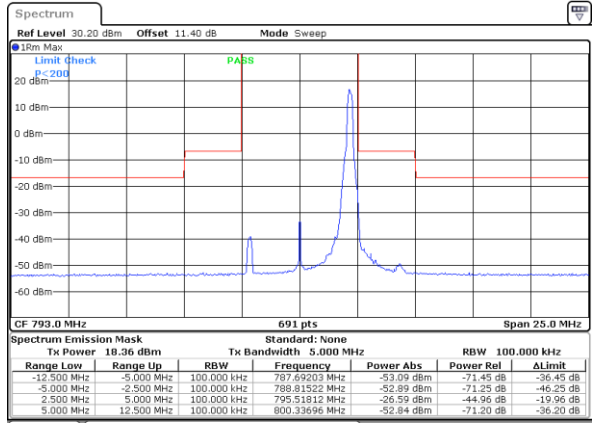

Date: 2.AUG.2023 17:06:35

Middle Channel / Full RB

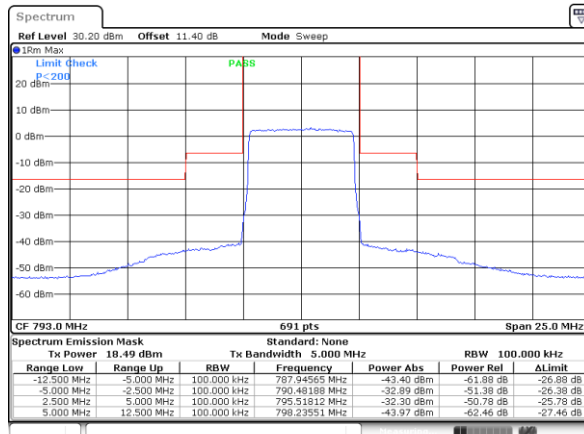

Date: 2.AUG.2023 17:05:37



LTE Band 14 / 5MHz / QPSK

Highest Channel / 1RB

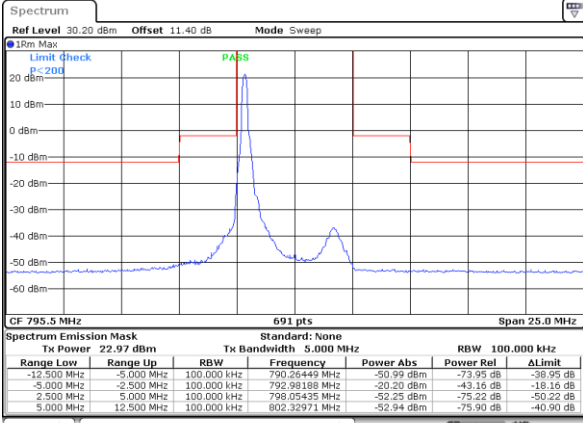

Date: 2.AUG.2023 17:21:51

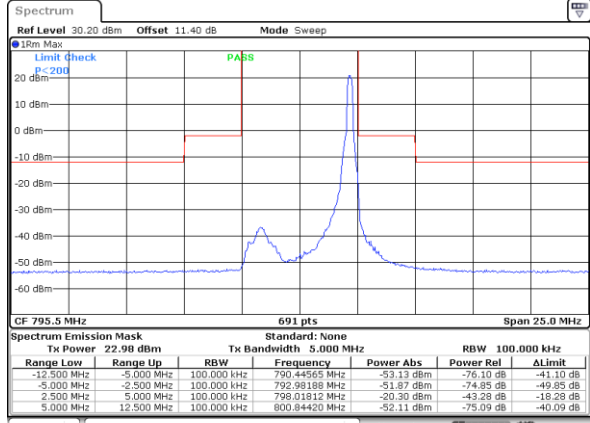

Date: 2.AUG.2023 17:22:49

Highest Channel / Full RB

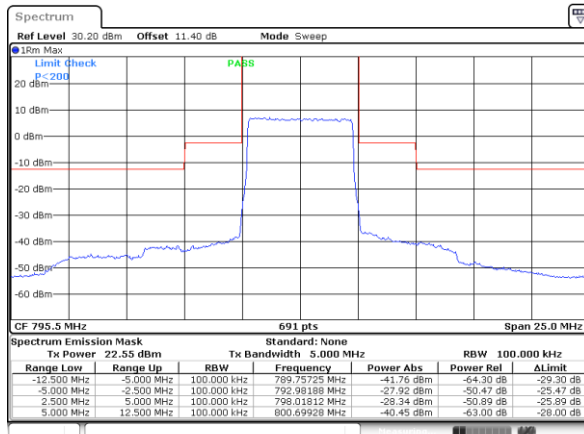

Date: 2.AUG.2023 17:23:47



LTE Band 14 / 5MHz / 16QAM

Highest Channel / 1RB

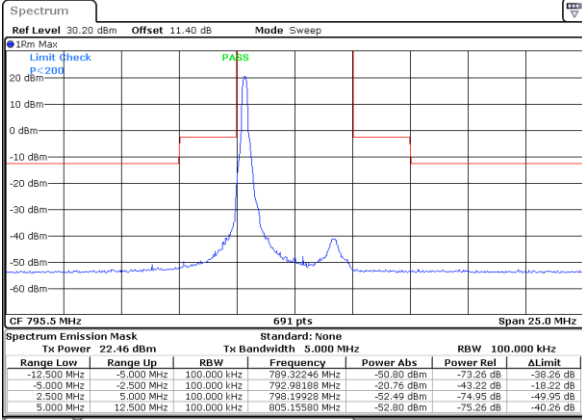

Date: 2.AUG.2023 17:12:41

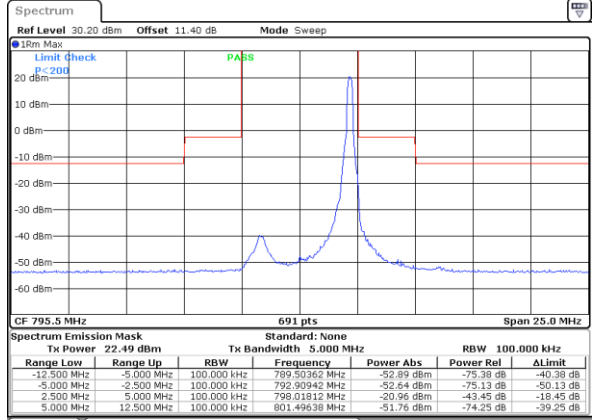

Date: 2.AUG.2023 17:25:43

Highest Channel / Full RB

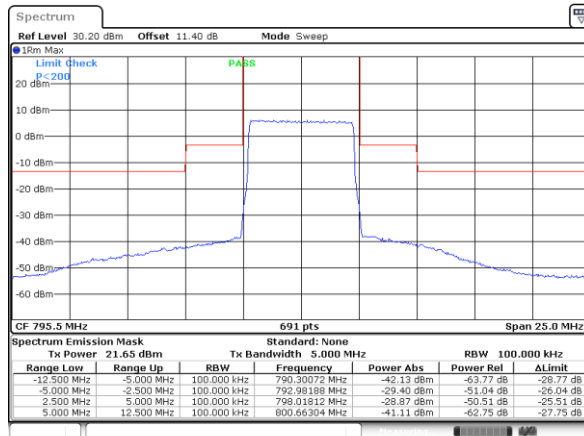

Date: 2.AUG.2023 17:24:45



LTE Band 14 / 5MHz / 64QAM

Highest Channel / 1RB

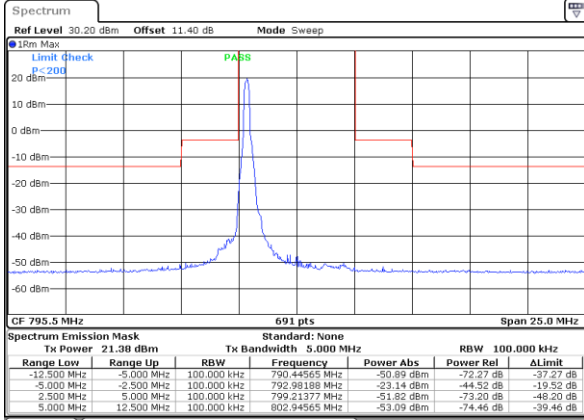

Date: 2.AUG.2023 17:27:139

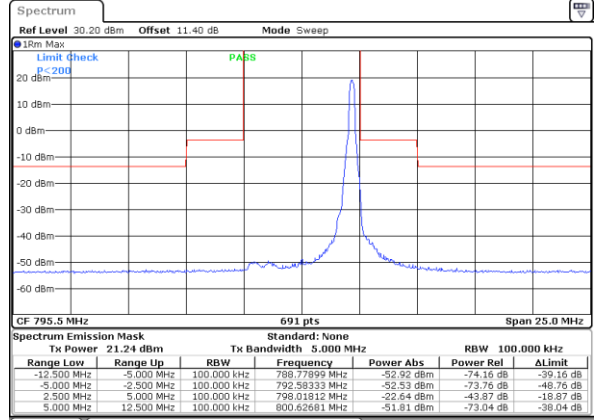

Date: 2.AUG.2023 17:28:37

Highest Channel / Full RB

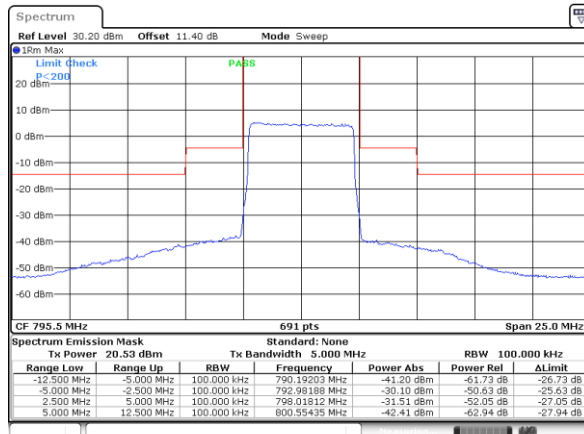

Date: 2.AUG.2023 17:29:05



LTE Band 14 / 5MHz / 256QAM

Highest Channel / 1RB

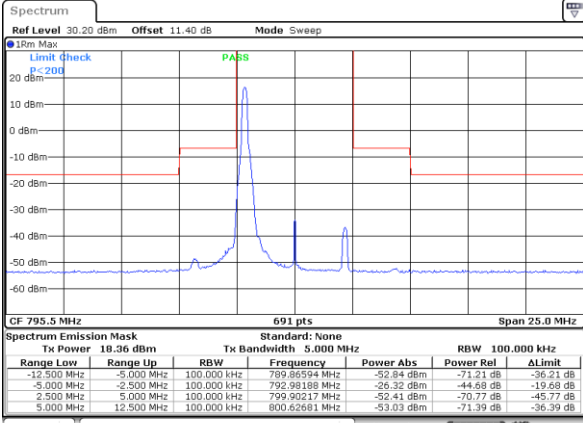

Date: 2.AUG.2023 17:32:35

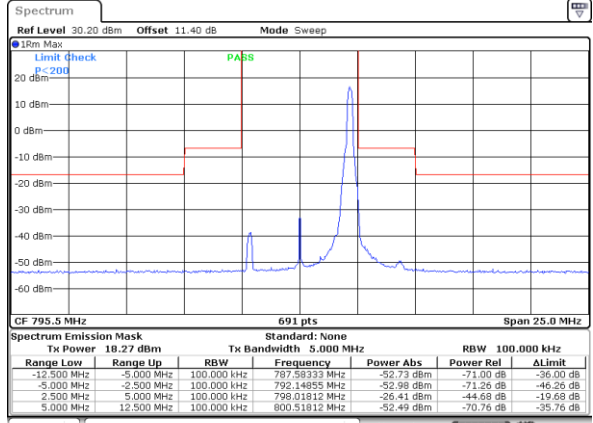

Date: 2.AUG.2023 17:31:34

Highest Channel / Full RB

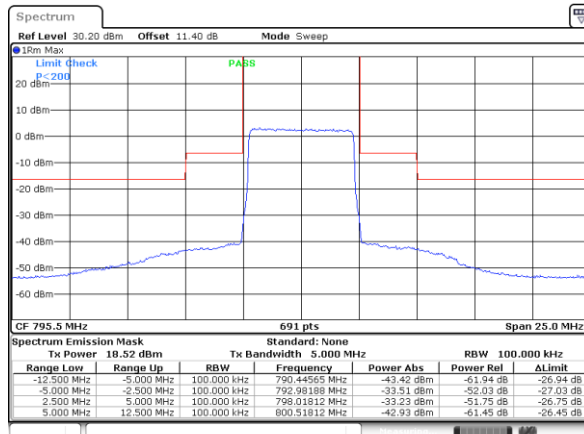

Date: 2.AUG.2023 17:30:03

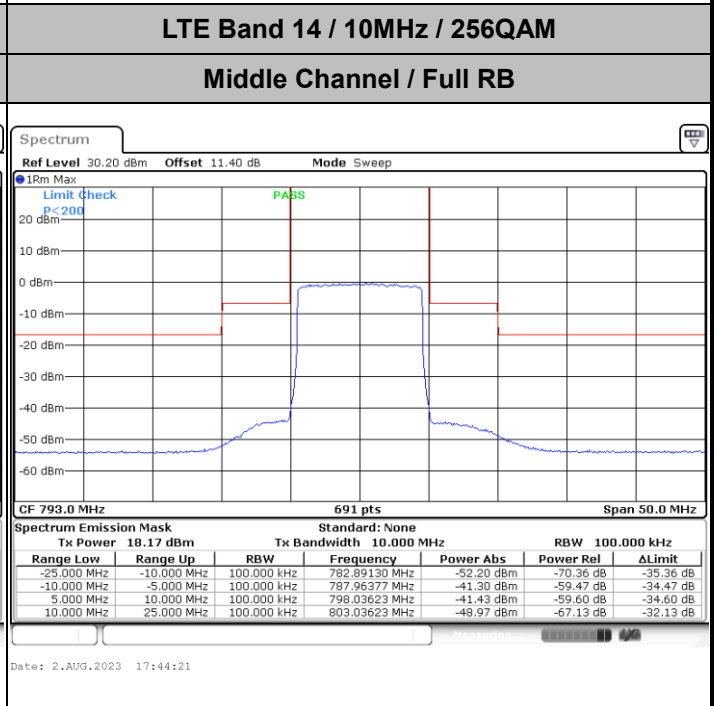
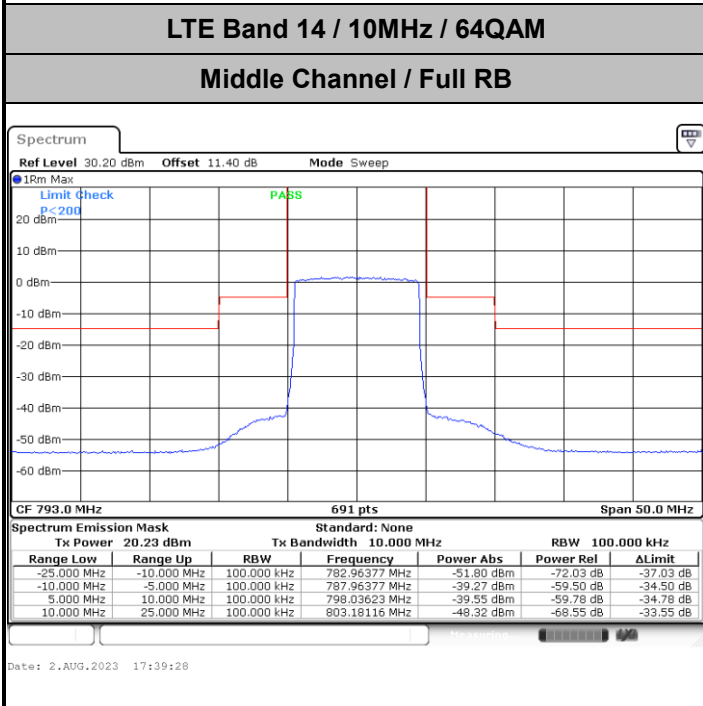
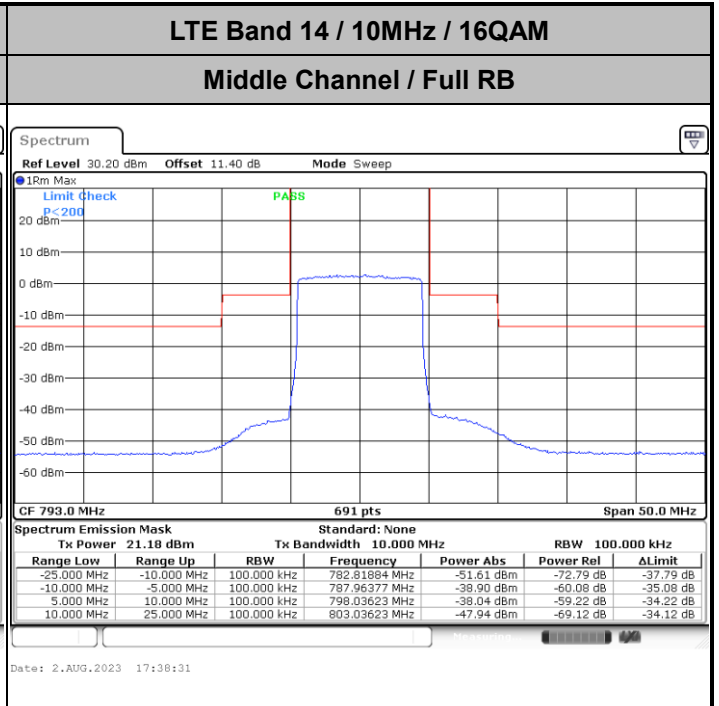
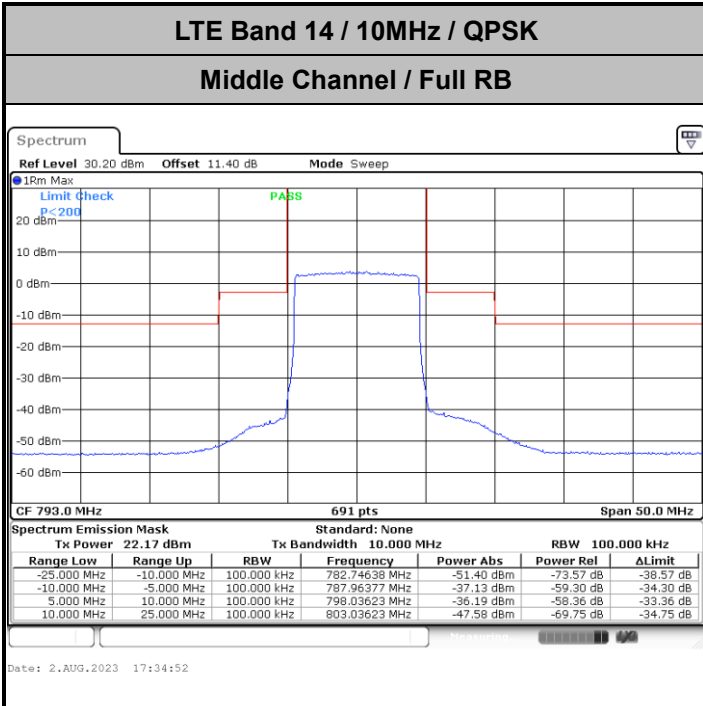



Frequency Stability

Test Conditions		LTE Band 14 (QPSK) / Middle Channel	Limit
Temperature (°C)	Voltage (Volt)	BW 10MHz	Note 2.
		Deviation (ppm)	Result
50	Normal Voltage	0.0000	PASS
40	Normal Voltage	0.0021	
30	Normal Voltage	0.0023	
20(Ref.)	Normal Voltage	0.0000	
10	Normal Voltage	0.0000	
0	Normal Voltage	0.0102	
-10	Normal Voltage	0.0211	
-20	Normal Voltage	0.0034	
-30	Normal Voltage	0.0052	
20	Maximum Voltage	0.0146	
20	Normal Voltage	0.0000	
20	Battery End Point	0.0090	

Note:

1. Normal Voltage = 4.05 V. ; Battery End Point (BEP) = 3.85 V. ; Maximum Voltage = 4.35 V.
2. The frequency fundamental emissions stay within the authorized frequency block.



Appendix B. Test Results of Radiated Test

<Ant. 1>

LTE Band 14

LTE Band 14 / 5MHz / QPSK									
Channel	Frequency (MHz)	ERP (dBm)	Limit (dBm)	Margin (dB)	SPA Reading (dBm)	S.G. Power (dBm)	TX Cable loss (dB)	TX Antenna Gain (dBi)	Polarization (H/V)
Lowest	1577	-62.11	-42.15	-19.96	-70.66	-68.17	0.59	8.81	H
	2365	-59.42	-13	-46.42	-70.71	-66.84	0.70	10.28	H
	3153	-56.03	-13	-43.03	-71.01	-63.39	0.82	10.33	H
									H
									H
									H
									H
	1577	-61.80	-42	-19.65	-70.47	-67.86	0.59	8.81	V
	2365	-59.24	-13	-46.24	-70.55	-66.66	0.70	10.28	V
	3153	-56.24	-13	-43.24	-71.08	-63.60	0.82	10.33	V
									V
									V
									V
									V



Middle	1582	-62.25	-42.15	-20.10	-70.80	-68.33	0.59	8.83	H
	2372	-59.22	-13	-46.22	-70.54	-66.67	0.70	10.30	H
	3163	-55.31	-13	-42.31	-70.31	-62.68	0.83	10.34	H
									H
									H
									H
									H
	1582	-62.11	-42.15	-19.96	-70.75	-68.19	0.59	8.83	V
	2372	-58.86	-13	-45.86	-70.20	-66.31	0.70	10.30	V
	3163	-55.41	-13	-42.41	-70.28	-62.78	0.83	10.34	V
									V
									V
									V
									V
Highest	1587	-62.14	-42.15	-19.99	-70.68	-68.24	0.60	8.85	H
	2380	-59.00	-13	-46.00	-70.33	-66.47	0.71	10.33	H
	3173	-55.22	-13	-42.22	-70.23	-62.60	0.83	10.36	H
									H
									H
									H
									H
	1587	-61.58	-42.15	-19.43	-70.20	-67.68	0.60	8.85	V
	2380	-58.97	-13	-45.97	-70.32	-66.44	0.71	10.33	V
	3173	-55.62	-13	-42.62	-70.53	-63.00	0.83	10.36	V
									V
									V
									V
									V

Remark: Spurious emissions within 30-1000MHz were found more than 20dB below limit line.



LTE Band 14 / 10MHz / QPSK									
Channel	Frequency (MHz)	ERP (dBm)	Limit (dBm)	Margin (dB)	SPA Reading (dBm)	S.G. Power (dBm)	TX Cable loss (dB)	TX Antenna Gain (dBi)	Polarization (H/V)
Middle	1577	-61.89	-42.15	-19.74	-70.44	-67.95	0.59	8.81	H
	2366	-59.26	-13	-46.26	-70.55	-66.69	0.70	10.28	H
	3154	-55.32	-13	-42.32	-70.30	-62.68	0.82	10.33	H
									H
									H
									H
									H
	1577	-61.73	-42.15	-19.58	-70.40	-67.79	0.59	8.81	V
	2366	-59.12	-13	-46.12	-70.44	-66.55	0.70	10.28	V
	3154	-55.89	-13	-42.89	-70.73	-63.25	0.82	10.33	V
									V
									V
									V
									V

Remark: Spurious emissions within 30-1000MHz were found more than 20dB below limit line.