



# FCC RADIO TEST REPORT

**FCC ID** : UZ7ET65AW  
**Equipment** : Rugged 2 in 1 Android Tablet  
**Brand Name** : Zebra  
**Model Name** : ET65AW  
**Applicant** : Zebra Technologies Corporation  
1 Zebra Plaza, Holtsville, NY 11742  
**Manufacturer** : Zebra Technologies Corporation  
1 Zebra Plaza, Holtsville, NY 11742  
**Standard** : FCC 47 CFR Part 2, Part 27(D)

The product was received on Jul. 12, 2023 and testing was performed from Jul. 21, 2023 to Sep. 14, 2023. We, Sporton International Inc. EMC & Wireless Communications Laboratory, would like to declare that the tested sample has been evaluated in accordance with the test procedures given in ANSI / TIA-603-E and has been in compliance with the applicable technical standards.

The test results in this report apply exclusively to the tested model / sample. Without written approval from Sporton International Inc. EMC & Wireless Communications Laboratory, the test report shall not be reproduced except in full.

*Louis Wu*

Approved by: Louis Wu

**Sporton International Inc. EMC & Wireless Communications Laboratory**

No. 52, Huaya 1st Rd., Guishan Dist., Taoyuan City 333, Taiwan (R.O.C.)



## Table of Contents

<b>History of this test report</b> .....	<b>3</b>
<b>Summary of Test Result</b> .....	<b>4</b>
<b>1 General Description</b> .....	<b>5</b>
1.1 Product Feature of Equipment Under Test.....	5
1.2 Modification of EUT .....	6
1.3 Testing Site.....	6
1.4 Applied Standards .....	7
<b>2 Test Configuration of Equipment Under Test</b> .....	<b>8</b>
2.1 Test Mode.....	8
2.2 Connection Diagram of Test System.....	9
2.3 Support Unit used in test configuration and system .....	9
2.4 Measurement Results Explanation Example.....	9
2.5 Frequency List of Low/Middle/High Channels .....	10
<b>3 Conducted Test Items</b> .....	<b>11</b>
3.1 Measuring Instruments .....	11
3.2 Conducted Output Power Measurement .....	12
3.3 Peak-to-Average Ratio .....	13
3.4 Effective Isotropic Radiated Power.....	14
3.5 Occupied Bandwidth.....	15
3.6 Conducted Band Edge .....	16
3.7 Conducted Spurious Emission .....	17
3.8 Frequency Stability .....	18
<b>4 Radiated Test Items</b> .....	<b>19</b>
4.1 Measuring Instruments .....	19
4.2 Radiated Spurious Emission Measurement .....	21
<b>5 List of Measuring Equipment</b> .....	<b>22</b>
<b>6 Measurement Uncertainty</b> .....	<b>24</b>
<b>Appendix A. Test Results of Conducted Test</b>	
<b>Appendix B. Test Results of Radiated Test</b>	
<b>Appendix C. Test Setup Photographs</b>	



### History of this test report

Report No.	Version	Description	Issue Date
FG371211H	01	Initial issue of report	Sep. 19, 2023



### Summary of Test Result

Report Clause	Ref Std. Clause	Test Items	Result (PASS/FAIL)	Remark
3.2	§2.1046	Conducted Output Power	Reporting only	-
3.3	-	Peak-to-Average Ratio	Reporting only	-
3.4	§27.50 (a)(3)	Effective Isotropic Radiated Power	Pass	-
3.5	§2.1049	Occupied Bandwidth	Reporting only	-
3.6	§2.1051 §27.53 (a)(4)	Conducted Band Edge Measurement	Pass	-
3.7	§2.1051 §27.53 (a)(4)	Conducted Spurious Emission	Pass	-
3.8	§2.1055 §27.54	Frequency Stability Temperature & Voltage	Pass	-
4.2	§2.1053 §27.53 (a)(4)	Radiated Spurious Emission	Pass	6.39 dB under the limit at 6924.00 MHz

**Conformity Assessment Condition:**

1. The test results (PASS/FAIL) with all measurement uncertainty excluded are presented against the regulation limits or in accordance with the requirements stipulated by the applicant/manufacturer who shall bear all the risks of non-compliance that may potentially occur if measurement uncertainty is taken into account.
2. The measurement uncertainty please refer to each test result in the section "Measurement Uncertainty".

**Disclaimer:**

The product specifications of the EUT presented in the test report that may affect the test assessments are declared by the manufacturer who shall take full responsibility for the authenticity.

**Reviewed by: Keven Cheng**

**Report Producer: Lucy Wu**



# 1 General Description

## 1.1 Product Feature of Equipment Under Test

Product Feature	
Equipment	Rugged 2 in 1 Android Tablet
Brand Name	Zebra
Model Name	ET65AW
FCC ID	UZ7ET65AW
EUT supports Radios application	WCDMA/HSPA/LTE/5G NR/NFC/GNSS WLAN 11a/b/g/n HT20/HT40 WLAN 11ac VHT20/VHT40/VHT80/VHT160 WLAN 11ax HE20/HE40/HE80/HE160 Bluetooth BR/EDR/LE
HW Version	DV2
SW Version	A13
MFD	21JUN23
EUT Stage	Identical Prototype

Remark: The EUT's information above is declared by manufacturer.

Specification of Accessories				
Adapter	Brand Name	Zebra	Part Number	PWR-BGA15V45W-UC2-WW
Battery 1	Brand Name	Zebra	Part Number	BT-000471-0020
Battery 2	Brand Name	Zebra	Part Number	BT-000471-0820

Supported Unit Used in Test Configuration and System				
USB TYPE C to 3.5mm audio connector	Brand Name	Zebra	Part Number	ADP-USBC-35MM1-01
3.5mm Earphone	Brand Name	Zebra	Part Number	HDST-35MM-PTVP-01
USB TYPE C Earphone	Brand Name	Zebra	Part Number	HPST-USBC-PTT1-01
Headset Jumper	Brand Name	Zebra	Part Number	CBL-TC51-HDST35-01

## 1.2 Product Specification of Equipment Under Test

Product Specification is subject to this standard	
Tx Frequency	LTE Band 30: 2307.5 MHz ~ 2312.5 MHz
Rx Frequency	LTE Band 30: 2352.5 MHz ~ 2357.5 MHz
Bandwidth	5MHz / 10MHz
Maximum Output Power to Antenna	22.19 dBm
Antenna Type	<Ant. 3>: PIFA Antenna
Antenna Gain	0.77 dBi
Type of Modulation	QPSK / 16QAM / 64QAM / 256QAM

Remark: The above EUT's information was declared by manufacturer. Please refer to Disclaimer in report summary.



### 1.3 Modification of EUT

No modifications made to the EUT during the testing.

### 1.4 Testing Site

<b>Test Site</b>	Sporton International Inc. EMC & Wireless Communications Laboratory
<b>Test Site Location</b>	No.52, Huaya 1st Rd., Guishan Dist., Taoyuan City 333, Taiwan (R.O.C.) TEL: +886-3-327-3456 FAX: +886-3-328-4978
<b>Test Site No.</b>	<b>Sporton Site No.</b>
	TH03-HY
<b>Test Engineer</b>	Cotty Hsu
<b>Temperature (°C)</b>	22.3~22.6
<b>Relative Humidity (%)</b>	52~54

<b>Test Site</b>	Sporton International Inc. Wensan Laboratory.
<b>Test Site Location</b>	No.58, Aly. 75, Ln. 564, Wenhua 3rd, Rd., Guishan Dist., Taoyuan City 333010, Taiwan (R.O.C.) TEL: +886-3-327-0868 FAX: +886-3-327-0855
<b>Test Site No.</b>	<b>Sporton Site No.</b>
	03CH12-HY (TAF Code: 3786)
<b>Test Engineer</b>	Jesse Fan, Tim Lee and Wilson Wu
<b>Temperature (°C)</b>	20~25
<b>Relative Humidity (%)</b>	50~60
<b>Remark</b>	The Radiated Spurious Emission test item subcontracted to Sporton International Inc. Wensan Laboratory.

**Note:** The test site complies with ANSI C63.4 2014 requirement.

FCC Designation No.: TW1190 and TW3786



## **1.5 Applied Standards**

According to the specifications declared by the manufacturer, the EUT must comply with the requirements of the following standards:

- ♦ ANSI C63.26-2015
- ♦ FCC 47 CFR Part 2, Part 27(D)
- ♦ ANSI / TIA-603-E
- ♦ FCC KDB 971168 Power Meas License Digital Systems D01 v03r01
- ♦ FCC KDB 412172 D01 Determining ERP and EIRP v01r01
- ♦ FCC KDB 414788 D01 Radiated Test Site v01r01

**Remark:**

1. All the test items were validated and recorded in accordance with the standards without any modification during the testing.
2. This EUT has also been tested and complied with the requirements of FCC Part 15, Subpart B, recorded in a separate test report.
3. The TAF code is not including all the FCC KDB listed without accreditation.



## 2 Test Configuration of Equipment Under Test

### 2.1 Test Mode

Antenna port conducted and radiated test items listed below are performed according to KDB 971168 D01 Power Meas. License Digital Systems v03r01 with maximum output power.

For radiated measurement, the measured emission level of the EUT was maximized by rotating the EUT on a turntable, adjusting the orientation of the EUT and EUT antenna in three orthogonal axis (X: flat, Y: portrait, Z: landscape), and adjusting the measurement antenna orientation, following C63.26 exploratory test procedures and only the worst case emissions were reported in this report.

Test Items	Band	Bandwidth (MHz)						Modulation				RB #			Test Channel		
		1.4	3	5	10	15	20	QPSK	16QAM	64QAM	256QAM	1	Half	Full	L	M	H
Max. Output Power	30	-	-	v	v	-	-	v	v	v	v	v	v	v	v	v	v
Peak-to-Average Ratio	30	-	-		v	-	-	v	v	v	v			v		v	
E.I.R.P	30	-	-	v	v	-	-	v	v	v	v	Max. Power					
26dB and 99% Bandwidth	30	-	-	v	v	-	-	v	v	v	v			v		v	
Conducted Band Edge	30	-	-	v	v	-	-	v	v	v	v	v		v	v		v
Conducted Spurious Emission	30	-	-	v	v	-	-	v				v			v	v	v
Frequency Stability	30	-	-		v	-	-	v						v		v	
Radiated Spurious Emission	30	Worst Case													v	v	v
Remark	<ol style="list-style-type: none"> <li>The mark "v " means that this configuration is chosen for testing</li> <li>The mark "- " means that this bandwidth is not supported.</li> <li>The device is investigated from 30MHz to 10 times of fundamental signal for radiated spurious emission test under different RB size/offset and modulations in exploratory test. Subsequently, only the worst case emissions are reported.</li> <li>All the radiated test cases were performed with Battery 1.</li> <li>One representative bandwidth is selected to perform PAR and frequency stability.</li> </ol>																



## 2.2 Connection Diagram of Test System

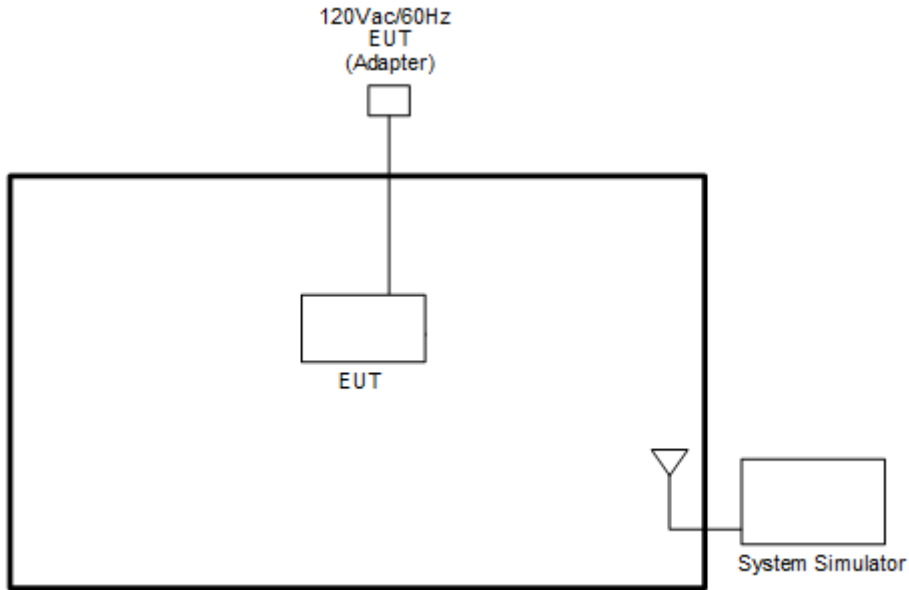

## 2.3 Support Unit used in test configuration and system

Item	Equipment	Brand Name	Model No.	FCC ID	Data Cable	Power Cord
1.	System Simulator	Anritsu	MT8821C	N/A	N/A	Unshielded, 1.8 m

## 2.4 Measurement Results Explanation Example

### For all conducted test items:

The offset level is set in the spectrum analyzer to compensate the RF cable loss and attenuator factor between EUT conducted output port and spectrum analyzer. With the offset compensation, the spectrum analyzer reading level is exactly the EUT RF output level.

The spectrum analyzer offset is derived from RF cable loss and attenuator factor.

*Offset = RF cable loss + attenuator factor.*

Following shows an offset computation example with cable loss 4.2 dB and 10dB attenuator.

Example :

*Offset(dB) = RF cable loss(dB) + attenuator factor(dB).*

$$= 4.2 + 10 = 14.2 \text{ (dB)}$$



## 2.5 Frequency List of Low/Middle/High Channels

LTE Band 30 Channel and Frequency List				
BW [MHz]	Channel/Frequency(MHz)	Lowest	Middle	Highest
10	Channel	-	27710	-
	Frequency	-	2310	-
5	Channel	27685	27710	27735
	Frequency	2307.5	2310	2312.5

### 3 Conducted Test Items

#### 3.1 Measuring Instruments

See list of measuring instruments of this test report.

##### 3.1.1 Test Setup

##### 3.1.2 Conducted Output Power

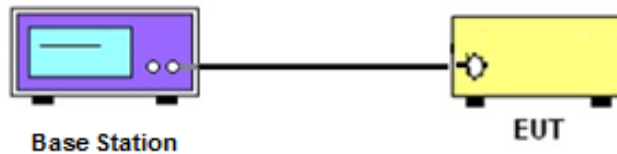

##### 3.1.3 Peak-to-Average Ratio, Occupied Bandwidth, 26dB Bandwidth ,Band-Edge and Conducted Spurious Emission

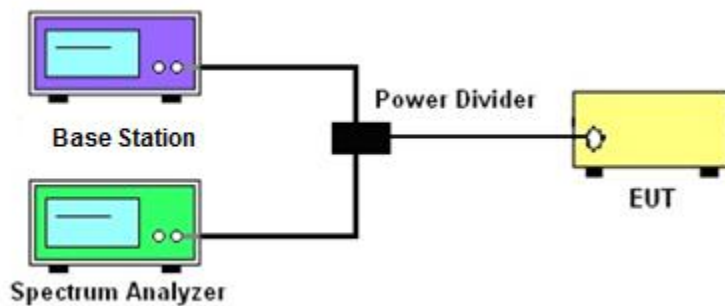

##### 3.1.4 Frequency Stability

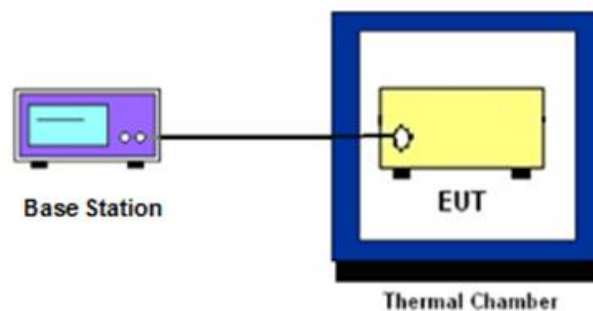

##### 3.1.5 Test Result of Conducted Test

Please refer to Appendix A.



## **3.2 Conducted Output Power Measurement**

### **3.2.1 Description of the Conducted Output Power Measurement**

A base station simulator was used to establish communication with the EUT. Its parameters were set to transmit the maximum power on the EUT. The measured power in the radio frequency on the transmitter output terminals shall be reported.

### **3.2.2 Test Procedures**

1. The transmitter output port was connected to the system simulator.
2. Set EUT at maximum power through the system simulator.
3. Select lowest, middle, and highest channels for each band and different modulation.
4. Measure and record the power level from the system simulator.



### **3.3 Peak-to-Average Ratio**

#### **3.3.1 Description of the PAR Measurement**

Power Complementary Cumulative Distribution Function (CCDF) curves provide a means for characterizing the power peaks of a digitally modulated signal on a statistical basis. A CCDF curve depicts the probability of the peak signal amplitude exceeding the average power level. Most contemporary measurement instrumentation include the capability to produce CCDF curves for an input signal provided that the instrument's resolution bandwidth can be set wide enough to accommodate the entire input signal bandwidth. In measuring transmissions in this band using an average power technique, the peak-to-average ratio (PAR) of the transmission may not exceed 13 dB.

#### **3.3.2 Test Procedures**

The testing follows ANSI C63.26-2015 Section 5.2.6

1. The EUT was connected to spectrum and system simulator via a power divider.
2. Set the CCDF (Complementary Cumulative Distribution Function) option in spectrum analyzer.
3. The highest RF powers were measured and recorded the maximum PAPR level associated with a probability of 0.1 %.
4. Record the deviation as Peak to Average Ratio.



### 3.4 Effective Isotropic Radiated Power

#### 3.4.1 Description of Effective Isotropic Radiated Power

For mobile and portable stations transmitting in the 2305-2315 MHz band or the 2350-2360 MHz band, the average EIRP must not exceed 50 milliwatts within any 1 megahertz of authorized bandwidth, *except that* for mobile and portable stations compliant with 3GPP LTE standards or another advanced mobile broadband protocol that avoids concentrating energy at the edge of the operating band the average EIRP must not exceed 250 milliwatts within any 5 megahertz of authorized bandwidth but may exceed 50 milliwatts within any 1 megahertz of authorized bandwidth. For mobile and portable stations using time division duplexing (TDD) technology, the duty cycle must not exceed 38 percent in the 2305-2315 MHz and 2350-2360 MHz bands. Mobile and portable stations using FDD technology are restricted to transmitting in the 2305-2315 MHz band. Power averaging shall not include intervals in which the transmitter is off.

**Remark:** EIRP use worst case measure the total power to cover per 5MHz Power.

According to KDB 412172 D01 Power Approach,

$EIRP = P_T + G_T - L_C$ ,  $ERP = EIRP - 2.15$ , where

$P_T$  = transmitter output power in dBm

$G_T$  = gain of the transmitting antenna in dBi

$L_C$  = signal attenuation in the connecting cable between the transmitter and antenna in dB

#### 3.4.2 Test Procedures

The testing follows ANSI C63.26-2015 Section 5.2.4.5

1. Determine the EIRP by adding the effective antenna gain to the adjusted power level.



## 3.5 Occupied Bandwidth

### 3.5.1 Description of Occupied Bandwidth Measurement

The occupied bandwidth is the width of a frequency band such that, below the lower and above the upper frequency limits, the mean powers emitted are each equal to a specified percentage 0.5% of the total mean transmitted power.

The 26 dB emission bandwidth is defined as the frequency range between two points, one above and one below the carrier frequency, at which the spectral density of the emission is attenuated 26 dB below the maximum in-band spectral density of the modulated signal. Spectral density (power per unit bandwidth) is to be measured with a detector of resolution bandwidth equal to approximately 1.0% of the emission bandwidth.

### 3.5.2 Test Procedures

The testing follows ANSI C63.26-2015 Section 5.4.3 (26dB) and Section 5.4.4 (99OB)

1. The EUT was connected to spectrum analyzer and system simulator via a power divider.
2. The spectrum analyzer center frequency is set to the nominal EUT channel center frequency. The span range for the spectrum analyzer shall be between two and five times the anticipated OBW.
3. The nominal resolution bandwidth (RBW) shall be in the range of 1 to 5 % of the anticipated OBW, and the VBW shall be at least 3 times the RBW.
4. Set the detection mode to peak, and the trace mode to max hold.
5. Determine the reference value: Set the EUT to transmit a modulated signal. Allow the trace to stabilize. Set the spectrum analyzer marker to the highest level of the displayed trace.  
(this is the reference value)
6. Determine the “-26 dB down amplitude” as equal to (Reference Value – X).
7. Place two markers, one at the lowest and the other at the highest frequency of the envelope of the spectral display such that each marker is at or slightly below the “-X dB down amplitude” determined in step 6. If a marker is below this “-X dB down amplitude” value it shall be placed as close as possible to this value. The OBW is the positive frequency difference between the two markers.
8. Use the 99 % power bandwidth function of the spectrum analyzer and report the measured bandwidth.



## 3.6 Conducted Band Edge

### 3.6.1 Description of Conducted Band Edge Measurement

27.53 (a)(4)

For mobile and portable stations operating in the 2305-2315 MHz and 2350-2360 MHz bands:

- (i) By a factor of not less than:  $43 + 10 \log (P)$  dB on all frequencies between 2305 and 2320 MHz and on all frequencies between 2345 and 2360 MHz that are outside the licensed band(s) of operation, not less than  $55 + 10 \log (P)$  dB on all frequencies between 2320 and 2324 MHz and on all frequencies between 2341 and 2345 MHz, not less than  $61 + 10 \log (P)$  dB on all frequencies between 2324 and 2328 MHz and on all frequencies between 2337 and 2341 MHz, and not less than  $67 + 10 \log (P)$  dB on all frequencies between 2328 and 2337 MHz.
- (ii) By a factor of not less than  $43 + 10 \log (P)$  dB on all frequencies between 2300 and 2305 MHz,  $55 + 10 \log (P)$  dB on all frequencies between 2296 and 2300 MHz,  $61 + 10 \log (P)$  dB on all frequencies between 2292 and 2296 MHz,  $67 + 10 \log (P)$  dB on all frequencies between 2288 and 2292 MHz, and  $70 + 10 \log (P)$  dB below 2288 MHz.
- (iii) By a factor of not less than  $43 + 10 \log (P)$  dB on all frequencies between 2360 and 2365 MHz, and not less than  $70 + 10 \log (P)$  dB above 2365 MHz.

### 3.6.2 Test Procedures

The testing follows FCC KDB 971168 D01 v03r01 Section 6.1.

1. The EUT was connected to spectrum analyzer and system simulator via a power divider.
2. The band edges of low and high channels for the highest RF powers were measured.
3. Set RBW  $\geq$  1% EBW in the 1MHz band immediately outside and adjacent to the band edge.
4. Beyond the 1 MHz band from the band edge, RBW=1MHz was used.
5. Set spectrum analyzer with RMS detector.
6. The RF fundamental frequency should be excluded against the limit line in the operating frequency band.
7. Checked that all the results comply with the emission limit line.

The limit line is derived from  $43 + 10\log(P)$ dB below the transmitter power P(Watts)





## 3.7 Conducted Spurious Emission

### 3.7.1 Description of Conducted Spurious Emission Measurement

The power of any emission outside of the authorized operating frequency ranges must be lower than the transmitter power (P) by a factor of at least  $70 + 10 \log (P)$  dB.

It is measured by means of a calibrated spectrum analyzer and scanned from 9 kHz up to a frequency including its 10<sup>th</sup> harmonic.

### 3.7.2 Test Procedures

The testing follows FCC KDB 971168 D01 v03r01 Section 6.1.

1. The EUT was connected to spectrum analyzer and system simulator via a power divider.
2. The RF output of EUT was connected to the spectrum analyzer by RF cable and attenuator. The path loss was compensated to the results for each measurement.
3. The middle channel for the highest RF power within the transmitting frequency was measured.
4. The conducted spurious emission for the whole frequency range was taken.
5. Make the measurement with the spectrum analyzer's RBW = 1MHz, VBW = 3MHz.
6. Set spectrum analyzer with RMS detector.
7. Taking the record of maximum spurious emission.
8. The RF fundamental frequency should be excluded against the limit line in the operating frequency band.

The limit line is derived from  $70 + 10\log(P)$ dB below the transmitter power P(Watts)  
=  $P(W) - [70 + 10\log(P)]$  (dB)  
=  $[30 + 10\log(P)]$  (dBm) -  $[70 + 10\log(P)]$  (dB)  
= -40dBm.



## **3.8 Frequency Stability**

### **3.8.1 Description of Frequency Stability Measurement**

The frequency stability shall be sufficient to ensure that the fundamental emission stays within the authorized frequency block.

### **3.8.2 Test Procedures for Temperature Variation**

The testing follows FCC KDB 971168 D01 v03r01 Section 9.0.

1. The EUT was set up in the thermal chamber and connected with the system simulator.
2. With power OFF, the temperature was decreased to -30°C and the EUT was stabilized before testing. Power was applied and the maximum change in frequency was recorded within one minute.
3. With power OFF, the temperature was raised in 10°C step up to 50°C. The EUT was stabilized at each step for at least half an hour. Power was applied and the maximum frequency change was recorded within one minute.

### **3.8.3 Test Procedures for Voltage Variation**

The testing follows FCC KDB 971168 D01 v03r01 Section 9.0.

1. The EUT was placed in a temperature chamber at 20±5° C and connected with the system simulator.
2. The power supply voltage to the EUT was varied from 85% to 115% of the nominal value measured at the input to the EUT.
3. The variation in frequency was measured for the worst case.

## 4 Radiated Test Items

### 4.1 Measuring Instruments

See list of measuring instruments of this test report.

#### 4.1.1 Test Setup

For radiated test below 30MHz

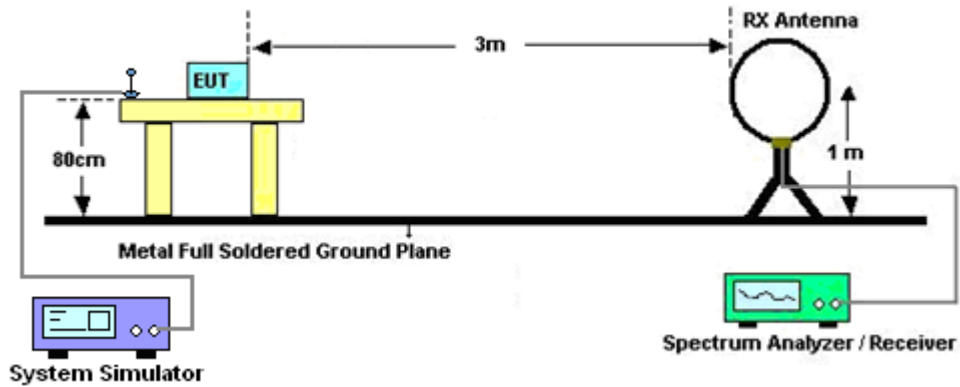

For radiated test from 30MHz to 1GHz

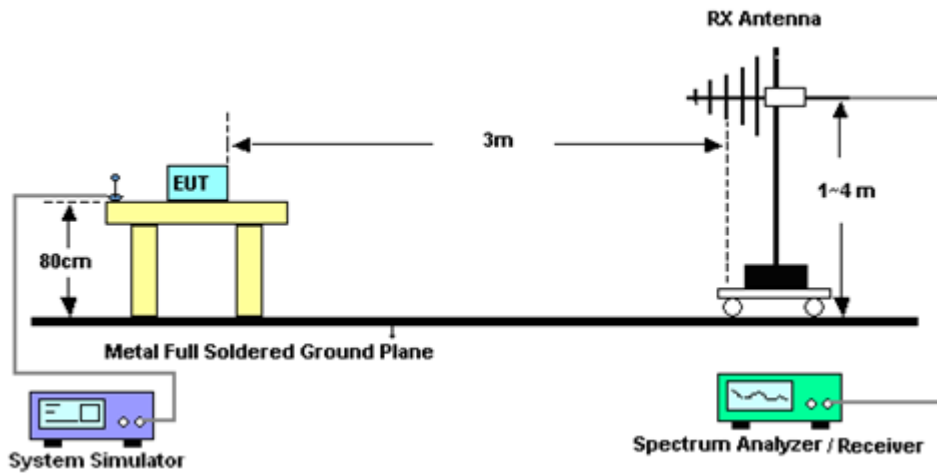

For radiated test from 1GHz to 18GHz

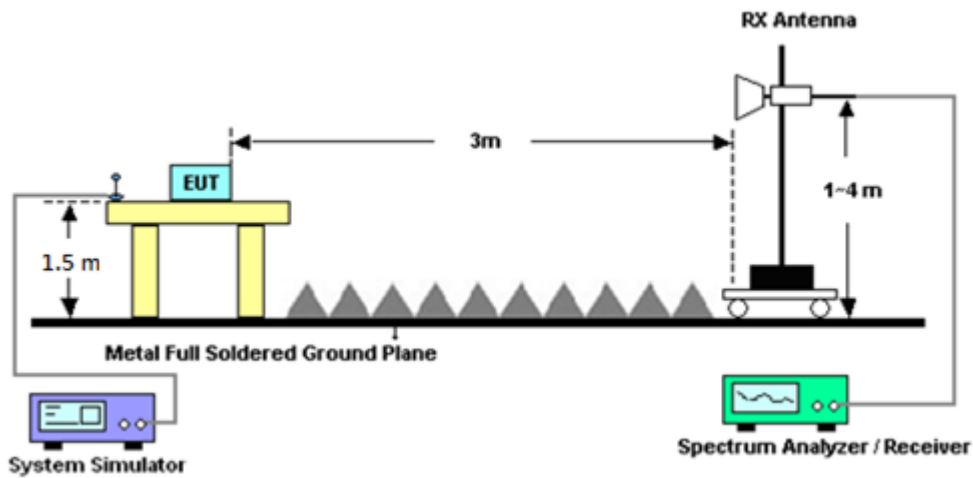

For radiated test above 18GHz

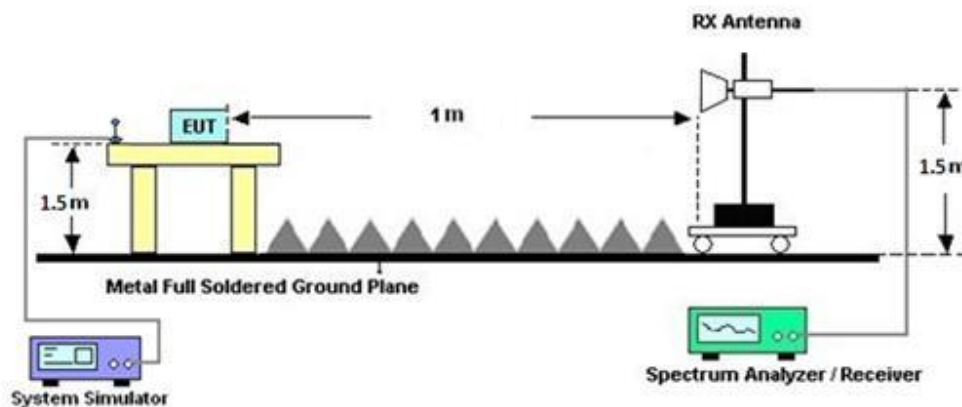

### 4.1.2 Test Result of Radiated Test

Please refer to Appendix B.

**Note:**

The low frequency, which started from 9 kHz to 30MHz, was pre-scanned and the result which was 20dB lower than the limit line was not reported.

There is adequate comparison measurement of both open-field test site and alternative test site - semi-Anechoic chamber according to 414788 D01 Radiated Test Site v01r01, and the result came out very similar.



## 4.2 Radiated Spurious Emission Measurement

### 4.2.1 Description of Radiated Spurious Emission Measurement

The radiated spurious emission was measured by substitution method according to ANSI / TIA-603-E. The power of any emission outside of the authorized operating frequency ranges must be attenuated below the transmitter power (P) by a factor of at least  $70 + 10 \log (P)$  dB. The spectrum is scanned from 30 MHz up to a frequency including its 10th harmonic.

### 4.2.2 Test Procedures

The testing follows FCC KDB 971168 D01 v03r01 Section 7 and ANSI / TIA-603-E Section 2.2.12.

1. The EUT was placed on a turntable with 0.8 meter height for frequency below 1GHz and 1.5 meter height for frequency above 1GHz respectively above ground.
2. The EUT was set 3 meters from the receiving antenna mounted on the antenna tower.
3. The table was rotated 360 degrees to determine the position of the highest spurious emission.
4. The height of the receiving antenna is varied between 1m to 4m to search the maximum spurious emission for both horizontal and vertical polarizations.
5. During the measurement, the system simulator parameters were set to force the EUT transmitting at maximum output power.
6. Make the measurement with the spectrum analyzer's RBW = 1MHz, VBW = 3MHz, taking the record of maximum spurious emission.
7. A horn antenna was substituted in place of the EUT and was driven by a signal generator.
8. Tune the output power of signal generator to the same emission level with EUT maximum spurious emission.  
$$\text{EIRP (dBm)} = \text{S.G. Power} - \text{Tx Cable Loss} + \text{Tx Antenna Gain}$$
$$\text{ERP (dBm)} = \text{EIRP} - 2.15$$
9. The RF fundamental frequency should be excluded against the limit line in the operating frequency band.  
The limit line is derived from  $70 + 10\log(P)$ dB below the transmitter power P(Watts)  
$$= P(\text{W}) - [70 + 10\log(P)] (\text{dB})$$
$$= [30 + 10\log(P)] (\text{dBm}) - [70 + 10\log(P)] (\text{dB})$$
$$= -40\text{dBm}.$$



## 5 List of Measuring Equipment

Instrument	Brand Name	Model No.	Serial No.	Characteristics	Calibration Date	Test Date	Due Date	Remark
Loop Antenna	Rohde & Schwarz	HFH2-Z2	100488	9 kHz~30 MHz	Sep. 20, 2022	Jul. 22, 2023~ Aug. 10, 2023	Sep. 19, 2023	Radiation (03CH12-HY)
Bilog Antenna	TESEQ	CBL 6111D & 00800N1D01N -06	37059 & 01	30MHz~1GHz	Nov. 10, 2022	Jul. 22, 2023~ Aug. 10, 2023	Nov. 09, 2023	Radiation (03CH12-HY)
Horn Antenna	SCHWARZBE CK	BBHA 9120 D	9120D-1328	1GHz~18GHz	Dec. 15, 2022	Jul. 22, 2023~ Aug. 10, 2023	Dec. 14, 2023	Radiation (03CH12-HY)
Horn Antenna	SCHWARZBE CK	BBHA 9120 D	9120D-02294	1GHz~18GHz	Jun. 30, 2023	Jul. 22, 2023~ Aug. 10, 2023	Jun. 29, 2024	Radiation (03CH12-HY)
SHF-EHF Horn Antenna	SCHWARZBE CK	BBHA9170	00993	18GHz~40GHz	Nov. 24, 2022	Jul. 22, 2023~ Aug. 10, 2023	Nov. 23, 2023	Radiation (03CH12-HY)
SHF-EHF Horn Antenna	SCHWARZBE CK	BBHA9170	00994	18GHz~40GHz	Nov. 04, 2022	Jul. 22, 2023~ Aug. 10, 2023	Nov. 03, 2023	Radiation (03CH12-HY)
Preamplifier	COM-POWER	PA-103A	161241	10MHz~1GHz	Oct. 03, 2022	Jul. 22, 2023~ Aug. 10, 2023	Oct. 02, 2023	Radiation (03CH12-HY)
Preamplifier	Agilent	8449B	3008A02375	1GHz~26.5GHz	May 23, 2023	Jul. 22, 2023~ Aug. 10, 2023	May 22, 2024	Radiation (03CH12-HY)
Preamplifier	E-INSTRUME NT TECH LTD.	ERA-100M-18 G-56-01-A70	EC1900249	1GHz-18GHz	Dec. 21, 2022	Jul. 22, 2023~ Aug. 10, 2023	Dec. 20, 2023	Radiation (03CH12-HY)
Preamplifier	EMEC	EM18G40G	060715	18GHz~40GHz	Dec. 07, 2022	Jul. 22, 2023~ Aug. 10, 2023	Dec. 06, 2023	Radiation (03CH12-HY)
Spectrum Analyzer	Agilent	N9010A	MY53470118	10Hz~44GHz	Jan. 10, 2023	Jul. 22, 2023~ Aug. 10, 2023	Jan. 09, 2024	Radiation (03CH12-HY)
Filter	Wainwright	WHKX12-1080 -1200-15000-6 0SS	SN1	1.2GHz High Pass Filter	Mar. 14, 2023	Jul. 22, 2023~ Aug. 10, 2023	Mar. 13, 2024	Radiation (03CH12-HY)
Filter	Wainwright	WHKX12-2700 -3000-18000-6 0ST	SN2	3GHz High Pass Filter	Mar. 14, 2023	Jul. 22, 2023~ Aug. 10, 2023	Mar. 13, 2024	Radiation (03CH12-HY)
Filter	Wainwright	WHKX8-5872. 5-6750-18000- 40ST	SN2	6.75GHz High Pass Filter	Mar. 14, 2023	Jul. 22, 2023~ Aug. 10, 2023	Mar. 13, 2024	Radiation (03CH12-HY)
RF Cable	HUBER + SUHNER	SUCOFLEX 102	803951/2	9kHz~30MHz	Mar. 07, 2023	Jul. 22, 2023~ Aug. 10, 2023	Mar. 06, 2024	Radiation (03CH12-HY)
RF Cable	HUBER + SUHNER	SUCOFLEX 126E	0058/126E	30MHz~18GHz	Dec. 20, 2022	Jul. 22, 2023~ Aug. 10, 2023	Dec. 19, 2023	Radiation (03CH12-HY)
RF Cable	HUBER + SUHNER	SUCOFLEX 102	505134/2	30MHz~40GHz	Dec. 20, 2022	Jul. 22, 2023~ Aug. 10, 2023	Dec. 19, 2023	Radiation (03CH12-HY)
RF Cable	HUBER + SUHNER	SUCOFLEX 102	803953/2	30MHz~40GHz	Dec. 20, 2022	Jul. 22, 2023~ Aug. 10, 2023	Dec. 19, 2023	Radiation (03CH12-HY)
Antenna Mast	EMEC	AM-BS-4500-B	N/A	1m~4m	N/A	Jul. 22, 2023~ Aug. 10, 2023	N/A	Radiation (03CH12-HY)
Turn Table	EMEC	TT2000	N/A	0~360 Degree	N/A	Jul. 22, 2023~ Aug. 10, 2023	N/A	Radiation (03CH12-HY)
Software	Audix	E3 6.2009-8-24	RK-000989	N/A	N/A	Jul. 22, 2023~ Aug. 10, 2023	N/A	Radiation (03CH12-HY)
Signal Generator	Rohde & Schwarz	SMF100A	101107	100kHz~40GHz	Jan. 11, 2023	Jul. 22, 2023~ Aug. 10, 2023	Jan. 10, 2024	Radiation (03CH12-HY)



Instrument	Brand Name	Model No.	Serial No.	Characteristics	Calibration Date	Test Date	Due Date	Remark
Radio Communication Analyzer	Anritsu	MT8821C	6262025353	LTE FDD/TDD LTE-2CC DLCA/ULCA	Oct. 13, 2022	Jul. 21, 2023~ Sep. 14, 2023	Oct. 12, 2023	Conducted (TH03-HY)
Thermal Chamber	ESPEC	SH-641	92013720	-40°C ~90°C	Sep. 07, 2022	Jul. 21, 2023~ Sep. 01, 2023	Sep. 06, 2023	Conducted (TH03-HY)
Thermal Chamber	ESPEC	SH-641	92013720	-40°C ~90°C	Sep. 04, 2023	Sep. 14, 2023	Sep. 03, 2024	Conducted (TH03-HY)
DC Power Supply	GW Instek	GPP-2323	GES906037	0V~64V ; 0A~6A	Dec. 29, 2022	Jul. 21, 2023~ Sep. 14, 2023	Dec. 28, 2023	Conducted (TH03-HY)
Coupler	Warison	20dB 25W SMA Directional Coupler	#B	1-18GHz	Jan. 06, 2023	Jul. 21, 2023~ Sep. 14, 2023	Jan. 05, 2024	Conducted (TH03-HY)
Spectrum Analyzer	Rohde & Schwarz	FSV40	101908	10Hz~40GHz	Sep. 27, 2022	Jul. 21, 2023~ Sep. 14, 2023	Sep. 26, 2023	Conducted (TH03-HY)



## 6 Measurement Uncertainty

### Uncertainty of Radiated Emission Measurement (30 MHz ~ 1000 MHz)

Measuring Uncertainty for a Level of Confidence of 95% ( $U = 2Uc(y)$ )	3.07 dB
---	---------

### Uncertainty of Radiated Emission Measurement (1 GHz ~ 18 GHz)

Measuring Uncertainty for a Level of Confidence of 95% ( $U = 2Uc(y)$ )	3.63 dB
---	---------

### Uncertainty of Radiated Emission Measurement (18 GHz ~ 40 GHz)

Measuring Uncertainty for a Level of Confidence of 95% ( $U = 2Uc(y)$ )	4.14 dB
---	---------





## Appendix A. Test Results of Conducted Test

### Conducted Output Power(Average power & EIRP)

LTE Band 30 Maximum Average Power [dBm] (GT - LC = 0.77 dB)								
BW [MHz]	RB Size	RB Offset	Mod	Lowest	Middle	Highest	EIRP (dBm)	EIRP (W)
10	1	0	QPSK		22.19		22.96	0.1977
10	1	25			22.12			
10	1	49			22.14			
10	25	0			21.30			
10	25	12			21.29			
10	25	25			21.18			
10	50	0			21.24			
10	1	0	16-QAM		21.79		22.67	0.1849
10	1	25			21.81			
10	1	49			21.90			
10	25	0			20.38			
10	25	12			20.31			
10	25	25			20.10			
10	50	0			20.29			
10	1	0	64-QAM		20.53		21.30	0.1349
10	1	25			20.48			
10	1	49			20.43			
10	25	0			19.39			
10	25	12			19.40			
10	25	25			19.28			
10	50	0			19.35			
10	1	0	256-QAM		17.65		18.51	0.0710
10	1	25			17.54			
10	1	49			17.48			
10	25	0			17.61			
10	25	12			17.54			
10	25	25			17.54			
10	50	0			17.74			
Limit	EIRP < 250mW/5MHz			Result			Pass	

Total EIRP power is less than partial EIRP limit 250 mW/5MHz.



LTE Band 30 Maximum Average Power [dBm] (GT - LC = 0.77 dB)								
BW [MHz]	RB Size	RB Offset	Mod	Lowest	Middle	Highest	EIRP (dBm)	EIRP (W)
5	1	0	QPSK	22.13	22.18	22.13	22.95	0.1972
5	1	12		22.05	22.02	22.02		
5	1	24		22.10	22.07	22.13		
5	12	0		21.30	21.30	21.24		
5	12	7		21.21	21.22	21.25		
5	12	13		21.10	21.13	21.14		
5	25	0		21.21	21.15	21.16		
5	1	0	16-QAM	21.76	21.69	21.72	22.63	0.1832
5	1	12		21.80	21.81	21.79		
5	1	24		21.80	21.83	21.86		
5	12	0		20.30	20.36	20.28		
5	12	7		20.30	20.27	20.31		
5	12	13		20.02	20.03	20.01		
5	25	0		20.23	20.24	20.28		
5	1	0	64-QAM	20.45	20.44	20.48	21.25	0.1334
5	1	12		20.46	20.45	20.42		
5	1	24		20.41	20.43	20.41		
5	12	0		19.34	19.38	19.34		
5	12	7		19.33	19.35	19.40		
5	12	13		19.24	19.19	19.24		
5	25	0		19.28	19.27	19.30		
5	1	0	256-QAM	17.64	17.63	17.60	18.51	0.0710
5	1	12		17.48	17.54	17.45		
5	1	24		17.45	17.46	17.41		
5	12	0		17.55	17.58	17.57		
5	12	7		17.50	17.50	17.44		
5	12	13		17.44	17.48	17.47		
5	25	0		17.74	17.67	17.65		
Limit	EIRP < 250mW/5MHz			Result			Pass	

Total EIRP power is less than partial EIRP limit 250 mW/5MHz.



# LTE Band 30

## Peak-to-Average Ratio

Mode	LTE Band 30 / 10MHz				
Mod.	QPSK	16QAM	64QAM	256QAM	Limit: 13dB
RB Size	Full RB	Full RB	Full RB	Full RB	Result
Middle CH	4.99	5.80	6.49	6.52	PASS

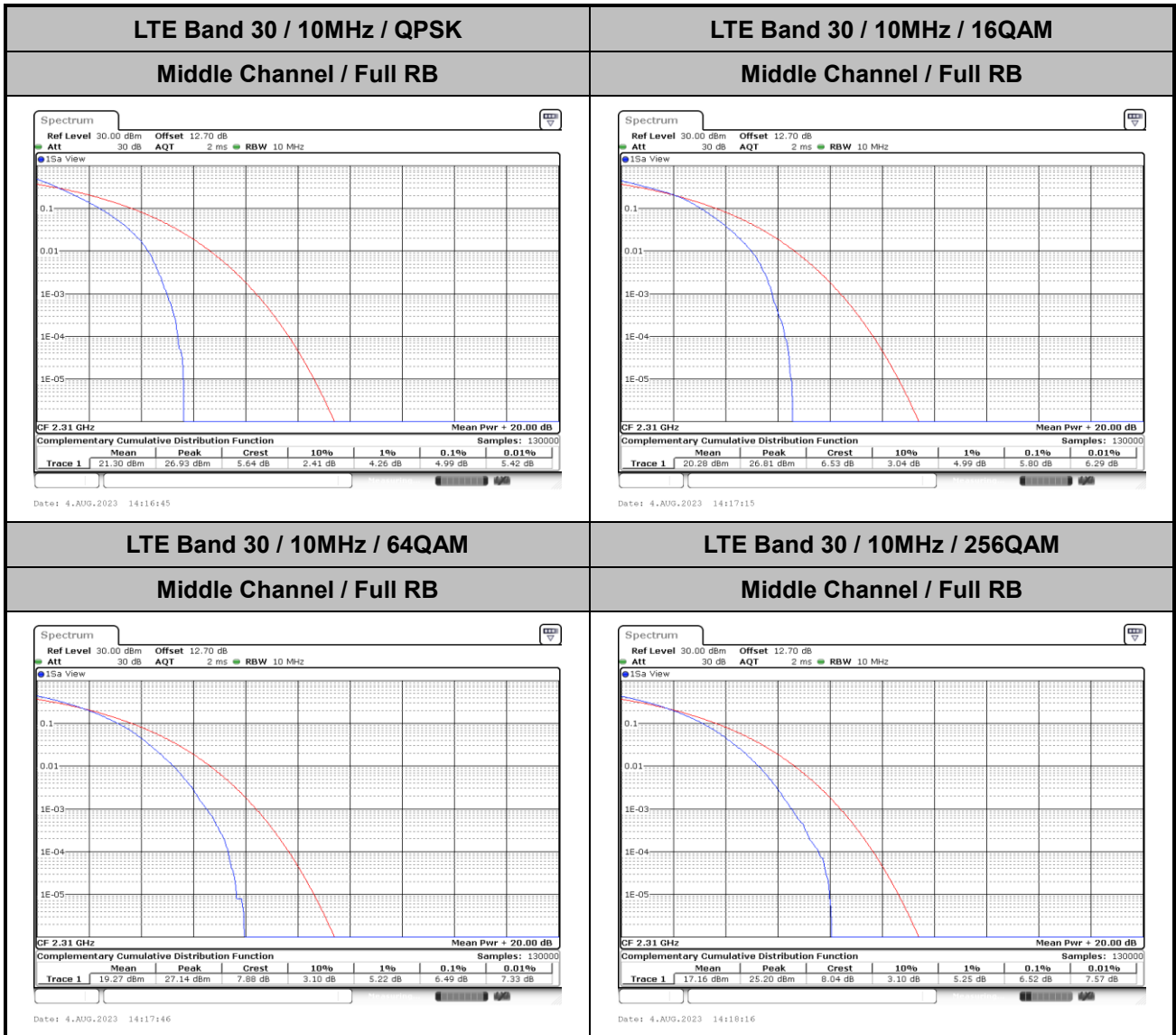



## 26dB Bandwidth

Mode	LTE Band 30 : 26dB BW(MHz)											
BW	1.4MHz		3MHz		5MHz		10MHz		15MHz		20MHz	
Mod.	QPSK	16QAM	QPSK	16QAM	QPSK	16QAM	QPSK	16QAM	QPSK	16QAM	QPSK	16QAM
Middle CH	-	-	-	-	4.88	4.83	9.87	9.81	-	-	-	-
Mode	LTE Band 30 : 26dB BW(MHz)											
BW	1.4MHz		3MHz		5MHz		10MHz		15MHz		20MHz	
Mod.	64QAM	256QAM	64QAM	256QAM	64QAM	256QAM	64QAM	256QAM	64QAM	256QAM	64QAM	256QAM
Middle CH	-	-	-	-	4.95	4.89	9.79	9.85	-	-	-	-

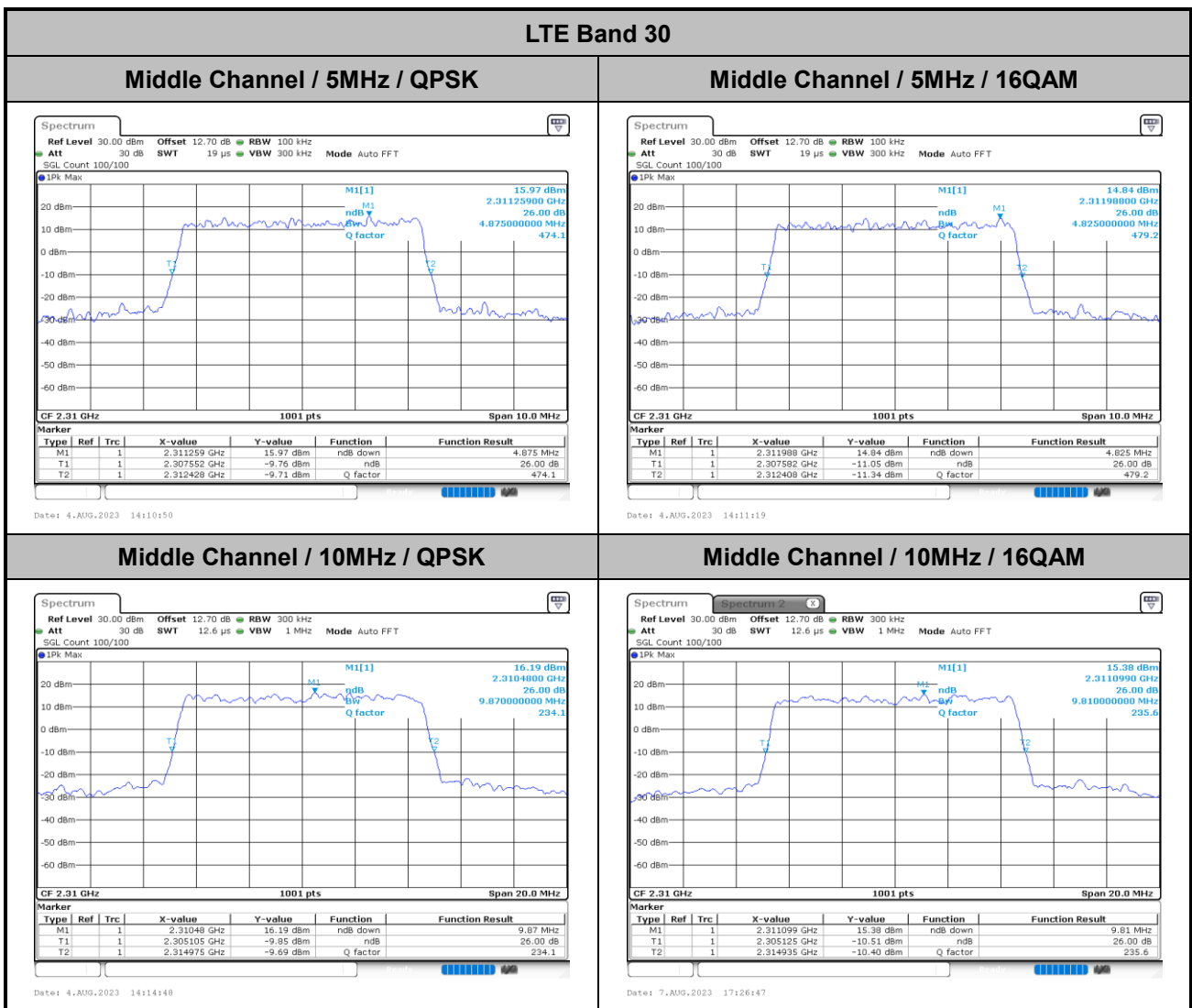



LTE Band 30

Middle Channel / 5MHz / 64QAM

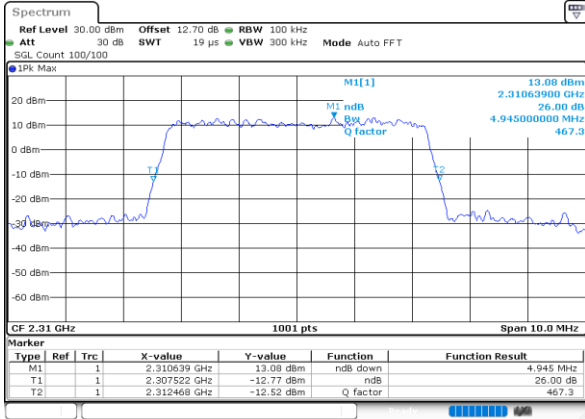

Date: 4.AUG.2023 14:11:48

Middle Channel / 10MHz / 64QAM

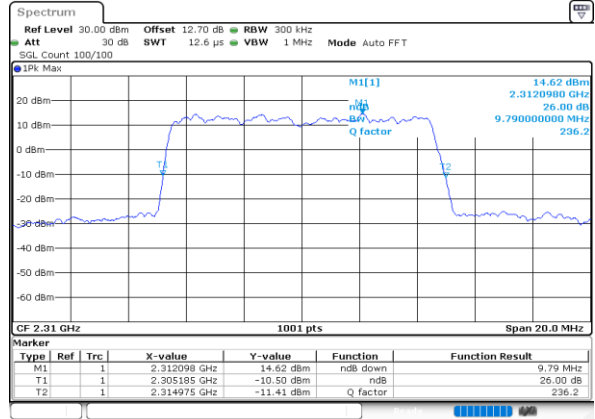

Date: 4.AUG.2023 14:15:46

Middle Channel / 5MHz / 256QAM

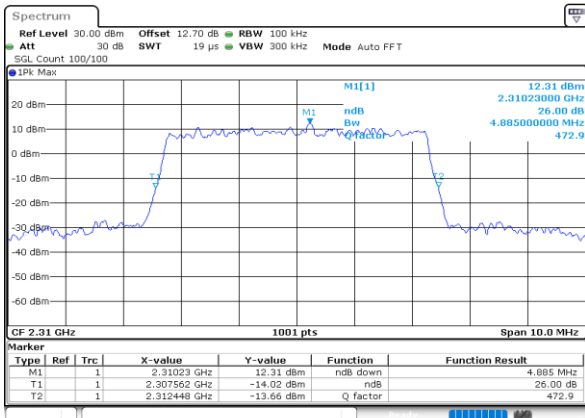

Date: 4.AUG.2023 14:11:217

Middle Channel / 10MHz / 256QAM

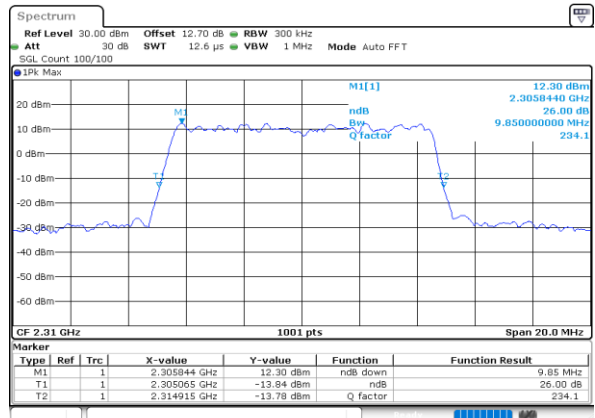

Date: 4.AUG.2023 14:16:15



# Occupied Bandwidth

Mode	LTE Band 30 : 99%OBW(MHz)											
BW	1.4MHz		3MHz		5MHz		10MHz		15MHz		20MHz	
Mod.	QPSK	16QAM	QPSK	16QAM	QPSK	16QAM	QPSK	16QAM	QPSK	16QAM	QPSK	16QAM
Middle CH	-	-	-	-	4.89	4.51	9.05	9.07	-	-	-	-
Mode	LTE Band 30 : 99%OBW(MHz)											
BW	1.4MHz		3MHz		5MHz		10MHz		15MHz		20MHz	
Mod.	64QAM	256QAM	64QAM	256QAM	64QAM	256QAM	64QAM	256QAM	64QAM	256QAM	64QAM	256QAM
Middle CH	-	-	-	-	4.49	4.48	9.03	9.07	-	-	-	-

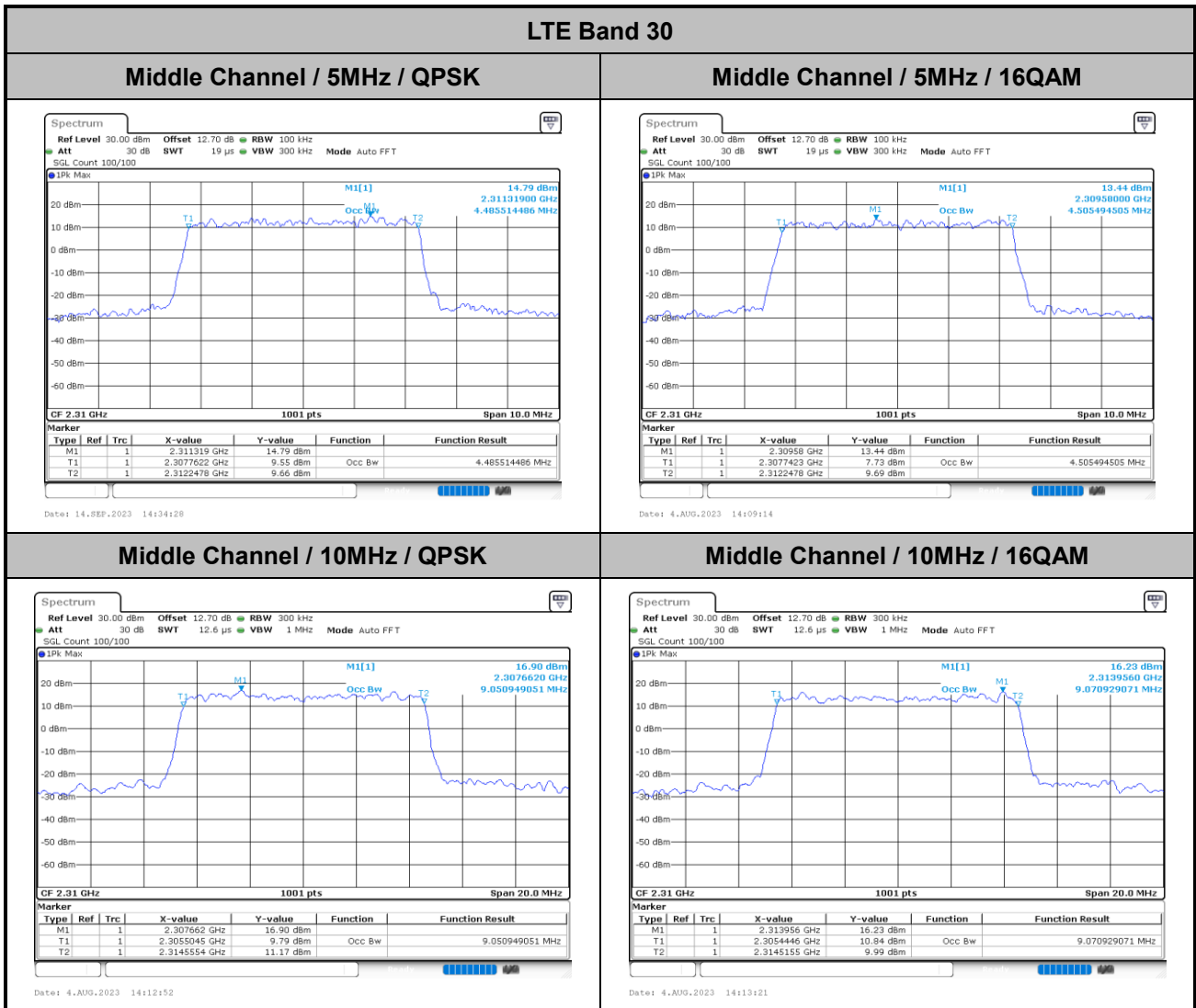



LTE Band 30

Middle Channel / 5MHz / 64QAM

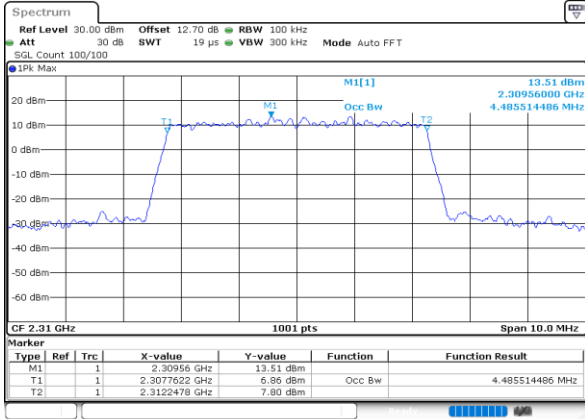

Date: 4.AUG.2023 14:09:52

Middle Channel / 10MHz / 64QAM

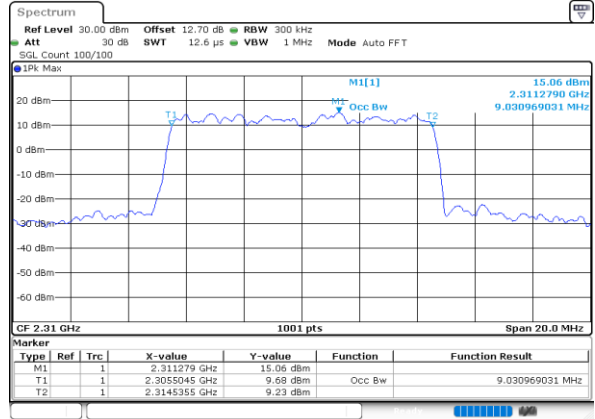

Date: 4.AUG.2023 14:13:50

Middle Channel / 5MHz / 256QAM

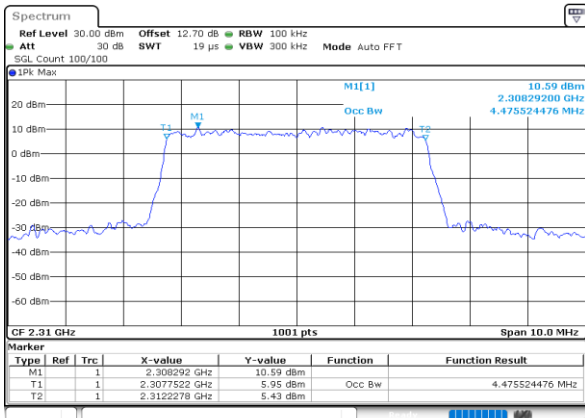

Date: 4.AUG.2023 14:10:21

Middle Channel / 10MHz / 256QAM

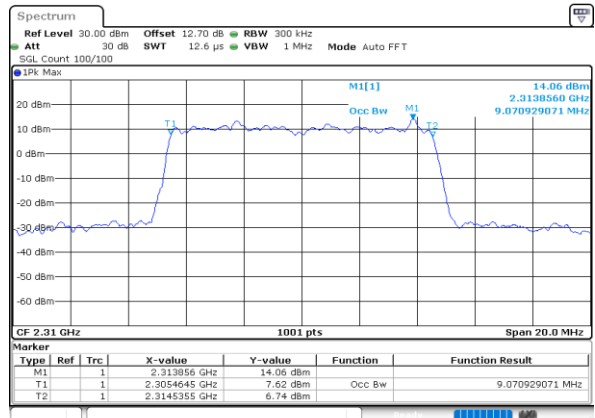

Date: 4.AUG.2023 14:14:19



# Conducted Band Edge

## LTE Band 30 / 5MHz / QPSK

### Lowest Band Edge / 1 RB

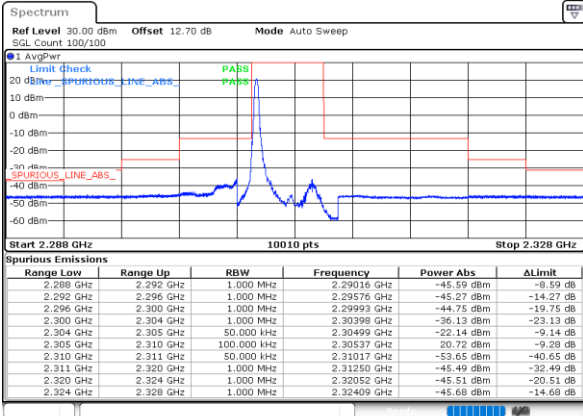

Date: 4.AUG.2023 13:35:10

### Highest Band Edge / 1 RB

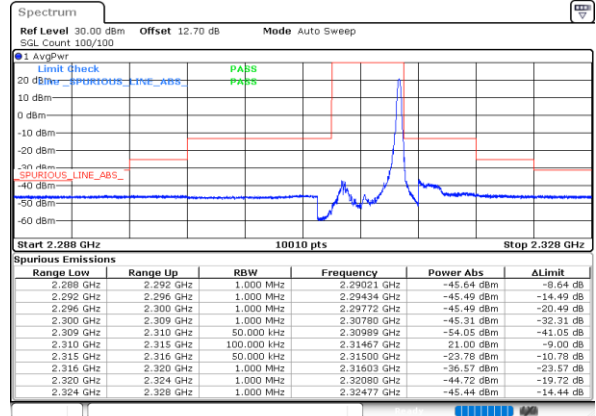

Date: 4.AUG.2023 13:47:16

### Lowest Band Edge / 1 RB / Lower zoom in

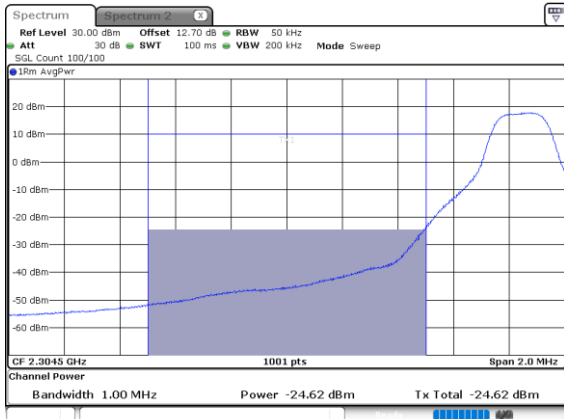

Date: 7.AUG.2023 17:19:27

### Highest Band Edge / 1 RB / Lower zoom in

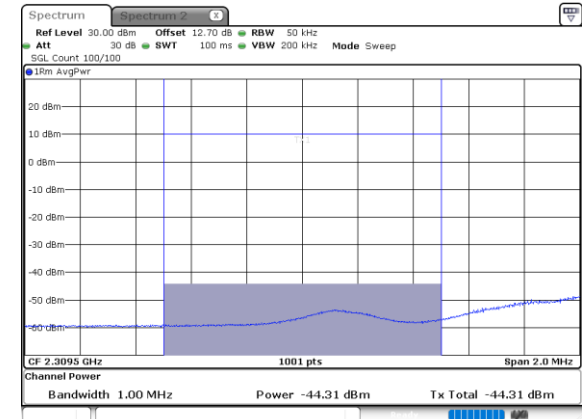

Date: 7.AUG.2023 16:28:28

### Lowest Band Edge / 1 RB / Upper zoom in

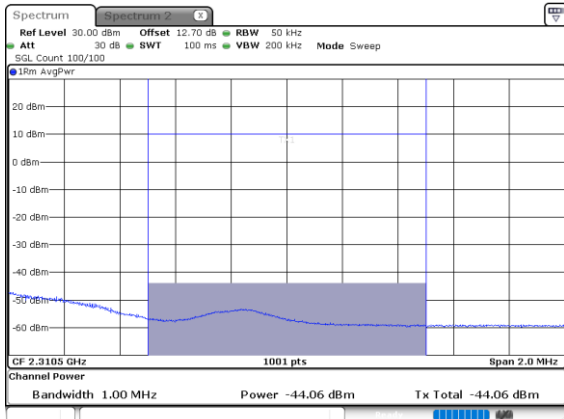

Date: 7.AUG.2023 17:20:07

### Highest Band Edge / 1 RB / Upper zoom in

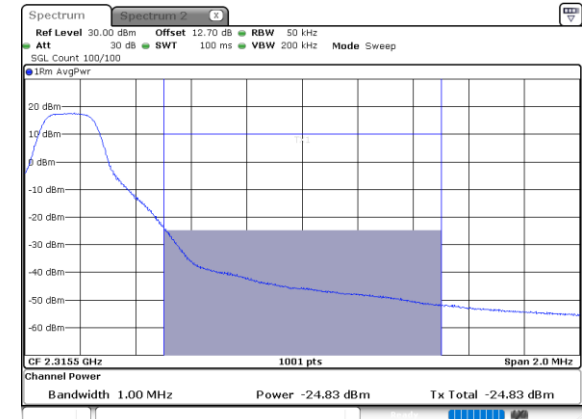

Date: 7.AUG.2023 16:48:20





LTE Band 30 / 5MHz / QPSK

Lowest Band Edge / Full RB

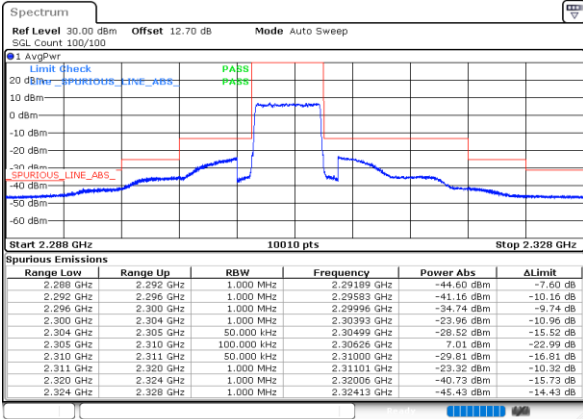

Highest Band Edge / Full RB

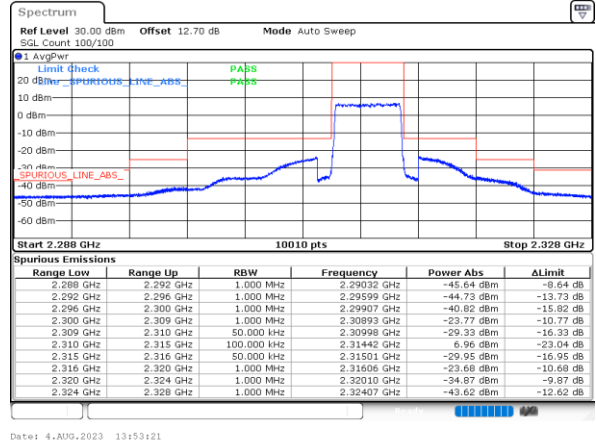

Lowest Band Edge / Full RB / Lower zoom in

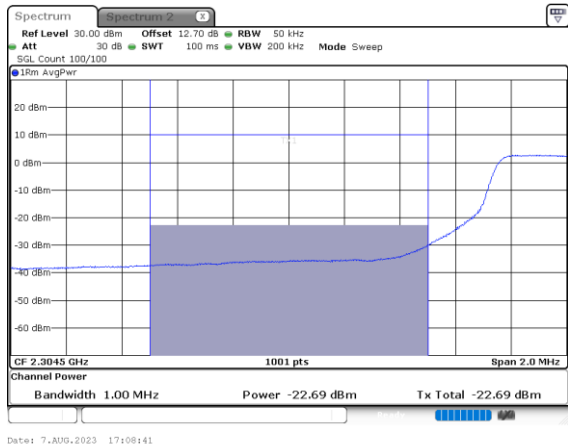

Highest Band Edge / Full RB / Lower zoom in

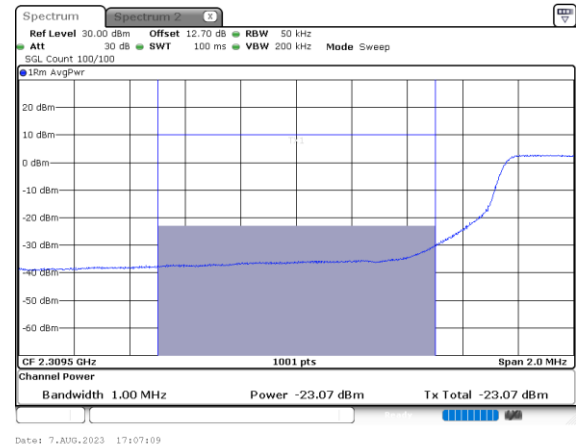

Lowest Band Edge / Full RB / Upper zoom in

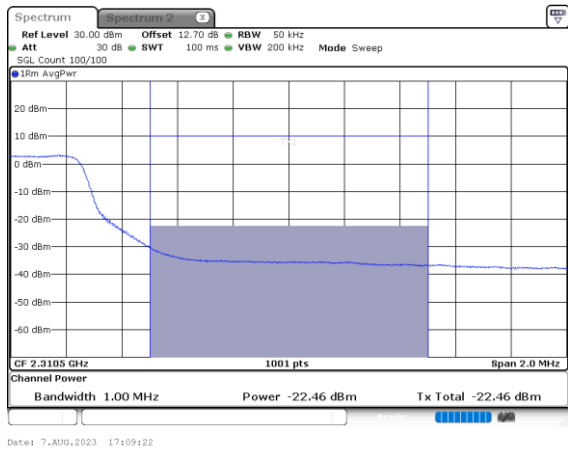

Highest Band Edge / Full RB / Upper zoom in

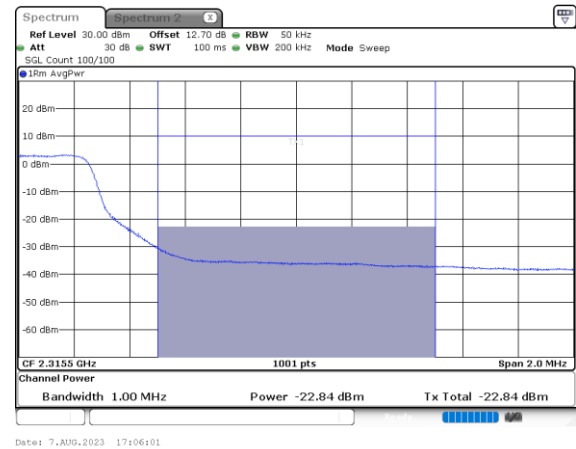



LTE Band 30 / 5MHz / 16QAM

Lowest Band Edge / 1 RB

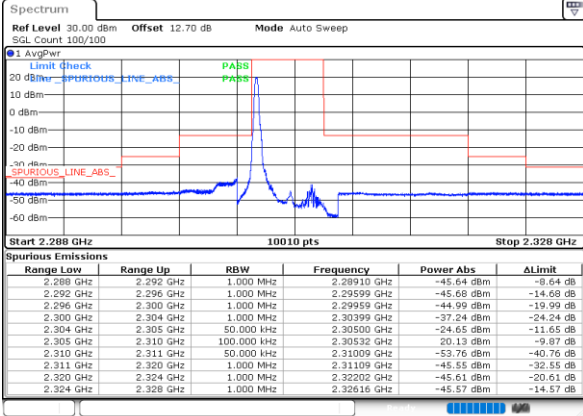

Highest Band Edge / 1 RB

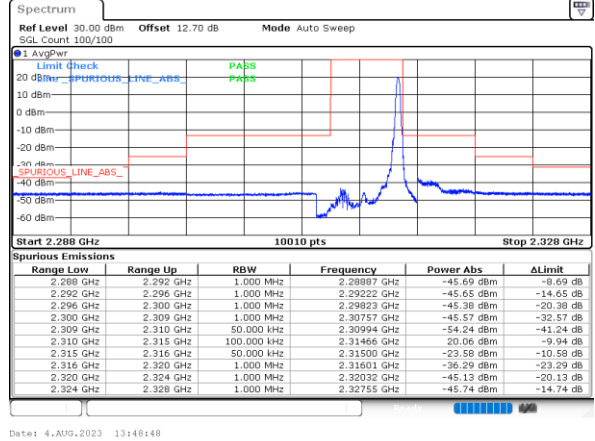

Lowest Band Edge / 1 RB / Lower zoom in

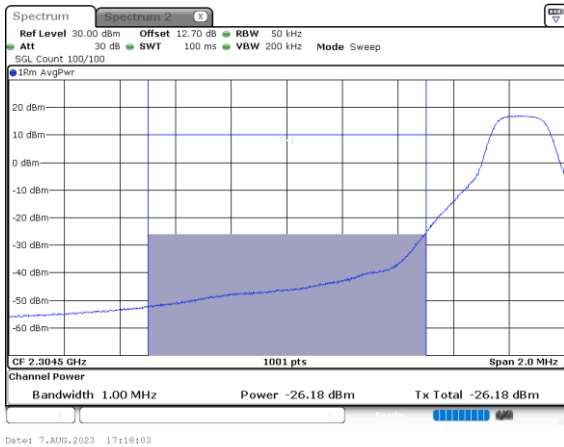

Highest Band Edge / 1 RB / Lower zoom in

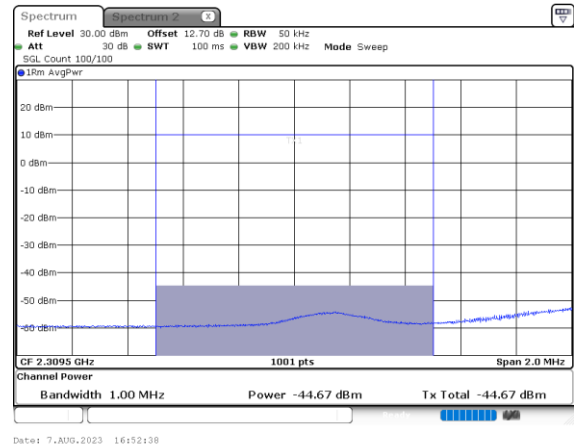

Lowest Band Edge / 1 RB / Upper zoom in

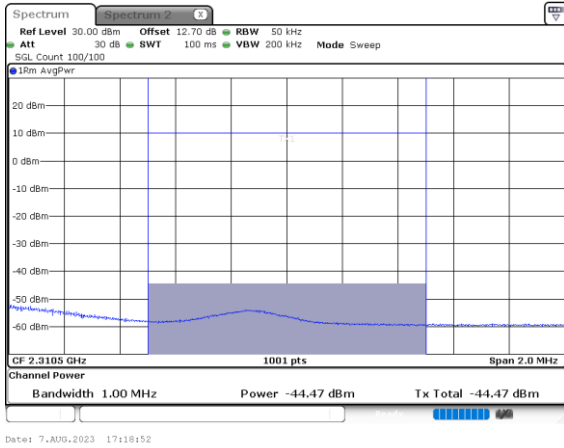

Highest Band Edge / 1 RB / Upper zoom in

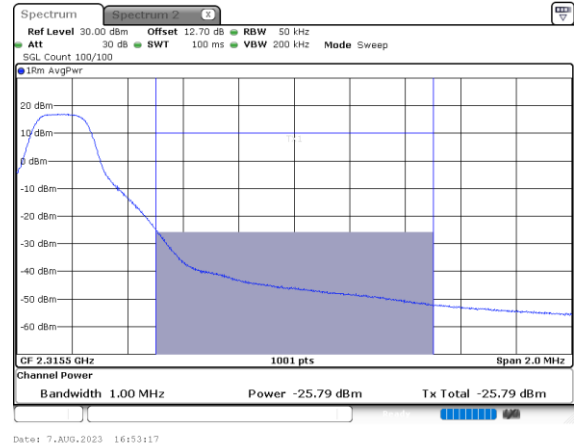



LTE Band 30 / 5MHz / 16QAM

Lowest Band Edge / Full RB

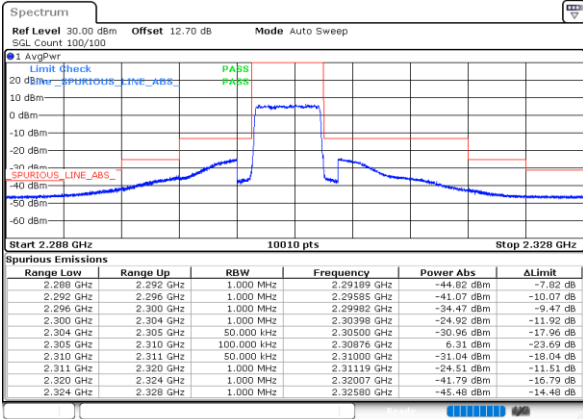

Highest Band Edge / Full RB

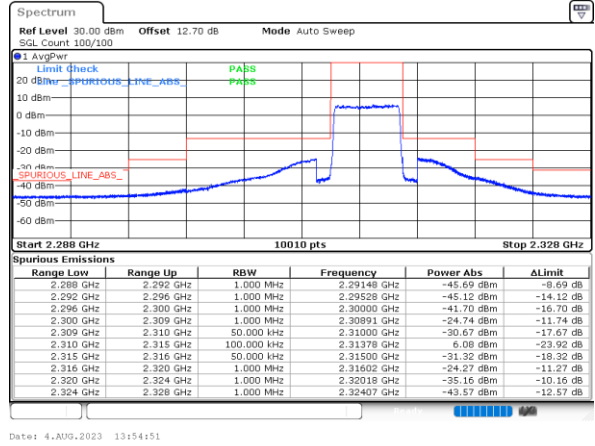

Lowest Band Edge / Full RB / Lower zoom in

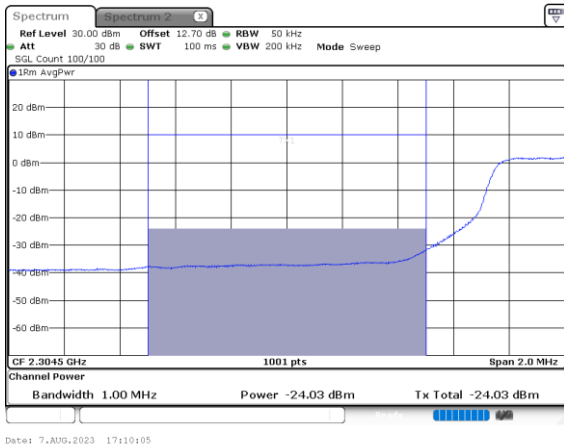

Highest Band Edge / Full RB / Lower zoom in

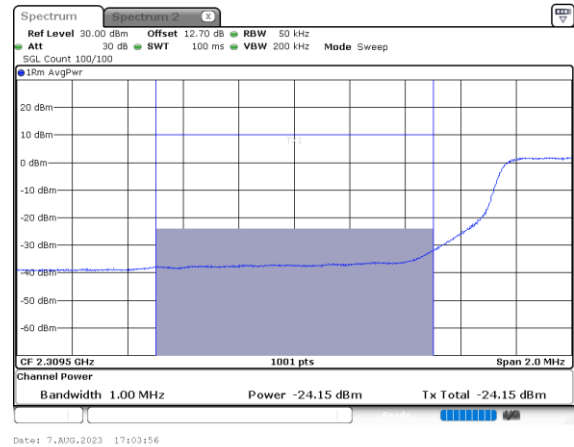

Lowest Band Edge / Full RB / Upper zoom in

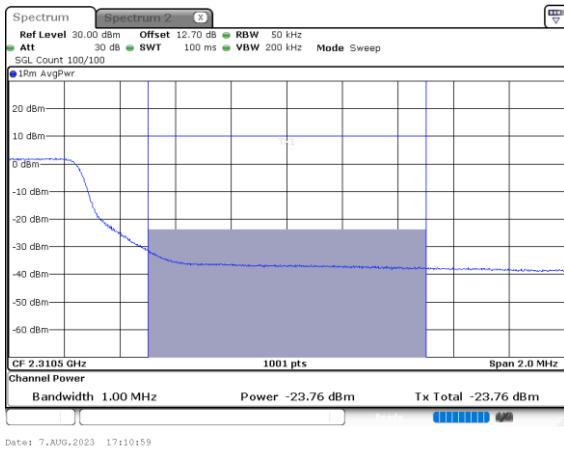

Highest Band Edge / Full RB / Upper zoom in

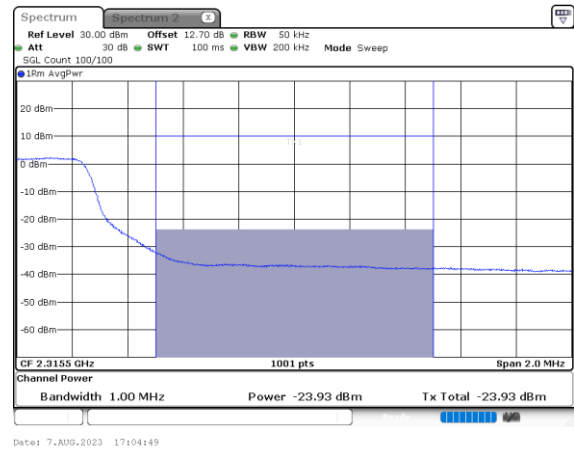



LTE Band 30 / 5MHz / 64QAM

Lowest Band Edge / 1 RB

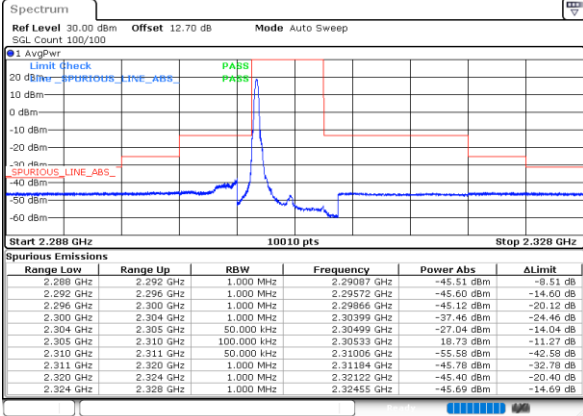

Highest Band Edge / 1 RB

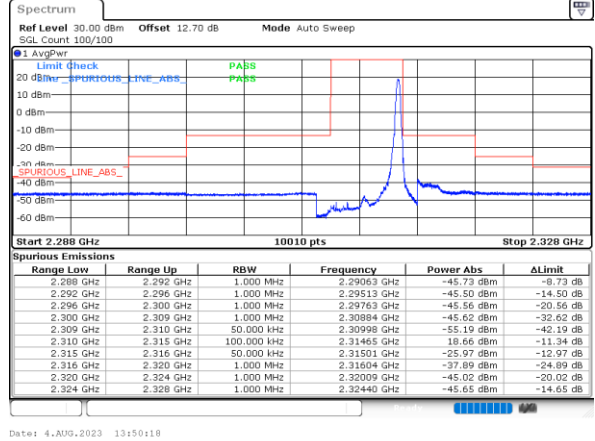

Lowest Band Edge / 1 RB / Lower zoom in

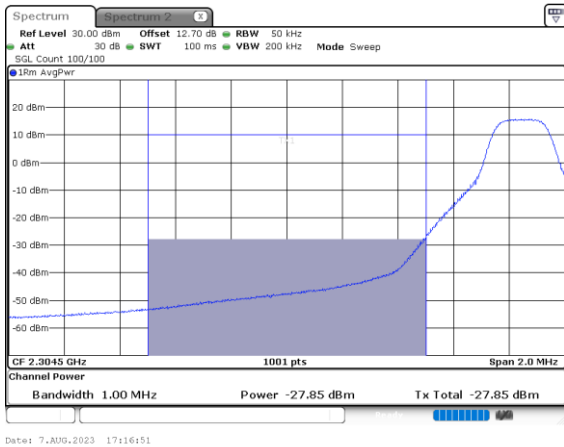

Highest Band Edge / 1 RB / Lower zoom in

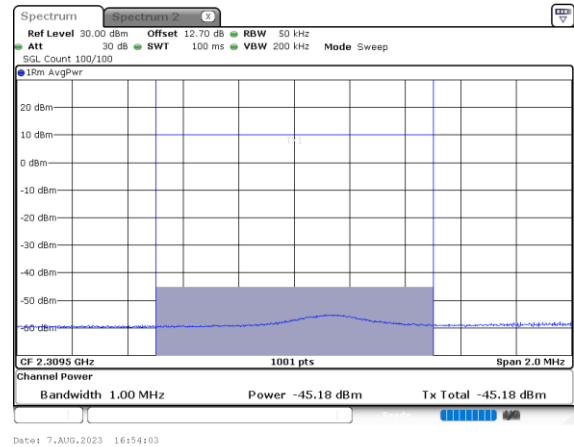

Lowest Band Edge / 1 RB / Upper zoom in

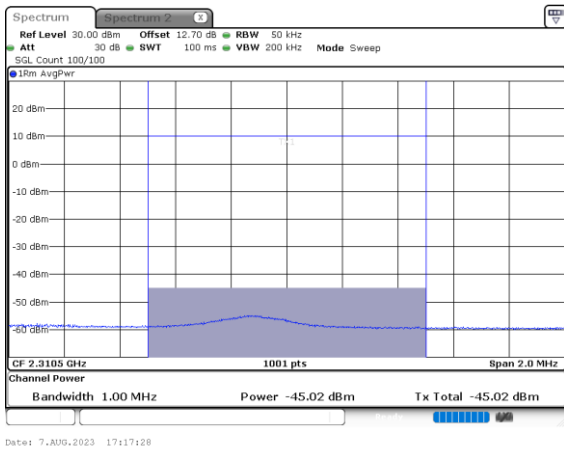

Highest Band Edge / 1 RB / Upper zoom in

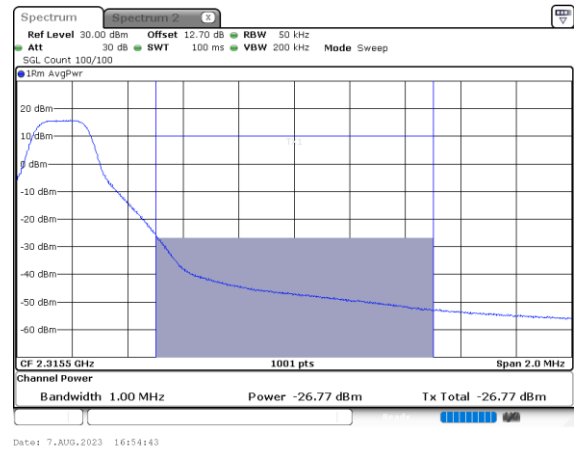



LTE Band 30 / 5MHz / 64QAM

Lowest Band Edge / Full RB

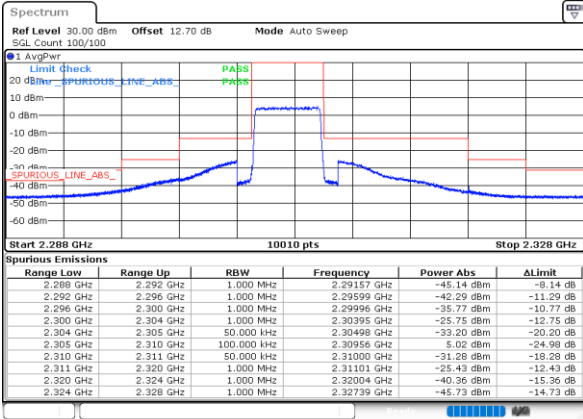

Highest Band Edge / Full RB

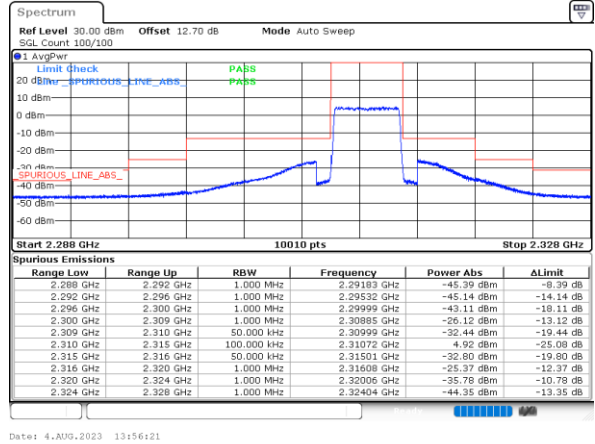

Lowest Band Edge / Full RB / Lower zoom in

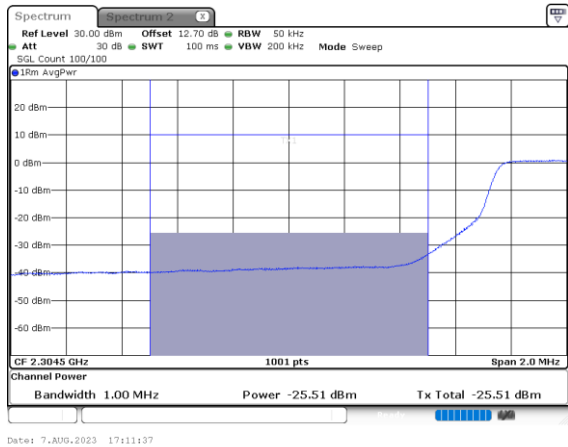

Highest Band Edge / Full RB / Lower zoom in

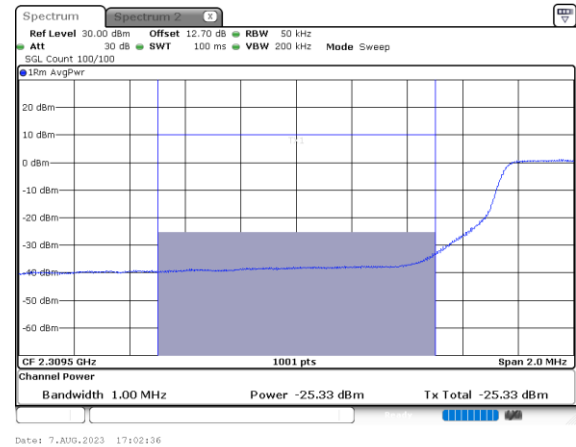

Lowest Band Edge / Full RB / Upper zoom in

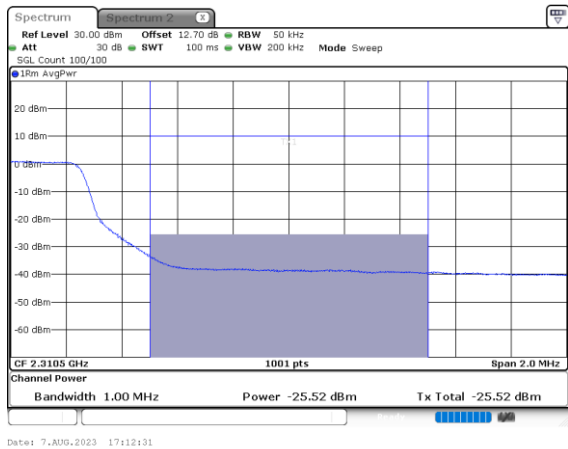

Highest Band Edge / Full RB / Upper zoom in

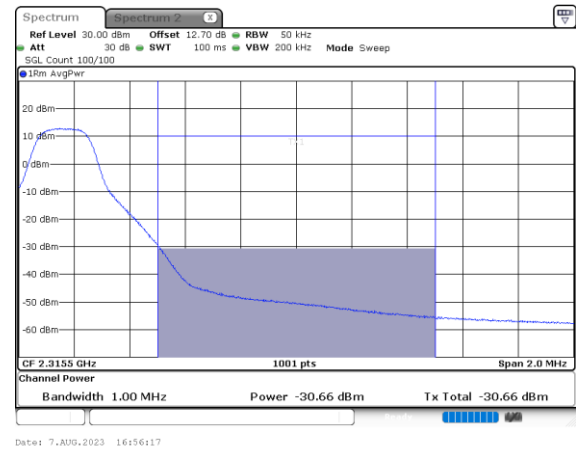



LTE Band 30 / 5MHz / 256QAM

Lowest Band Edge / 1 RB

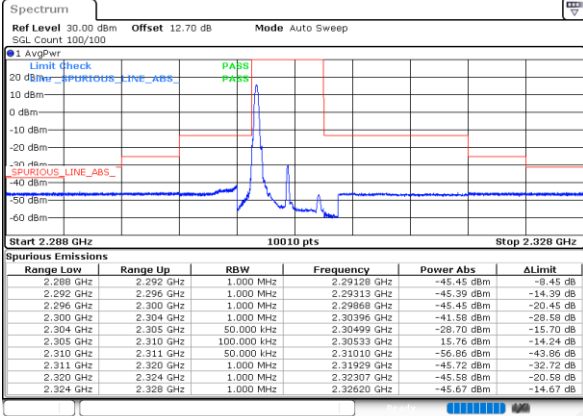

Highest Band Edge / 1 RB

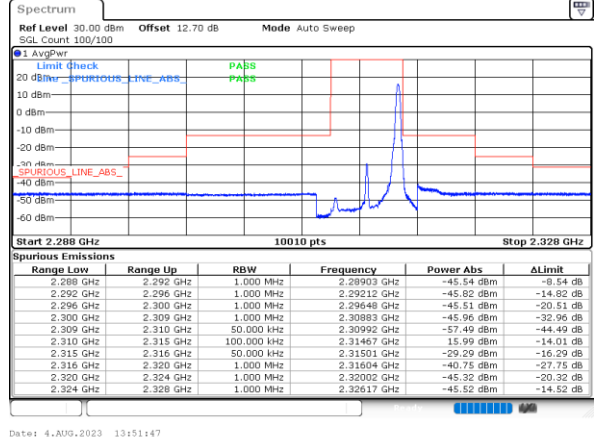

Lowest Band Edge / 1 RB / Lower zoom in

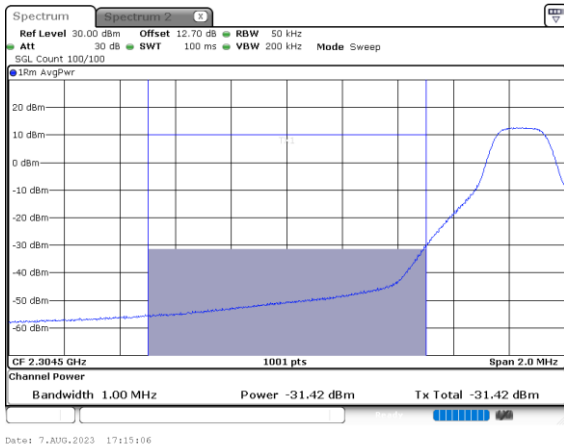

Highest Band Edge / 1 RB / Lower zoom in

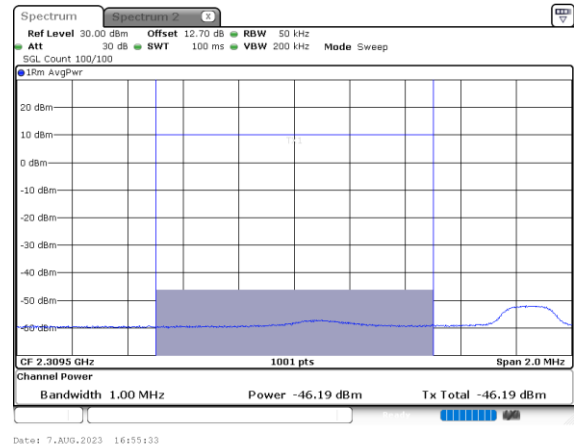

Lowest Band Edge / 1 RB / Upper zoom in

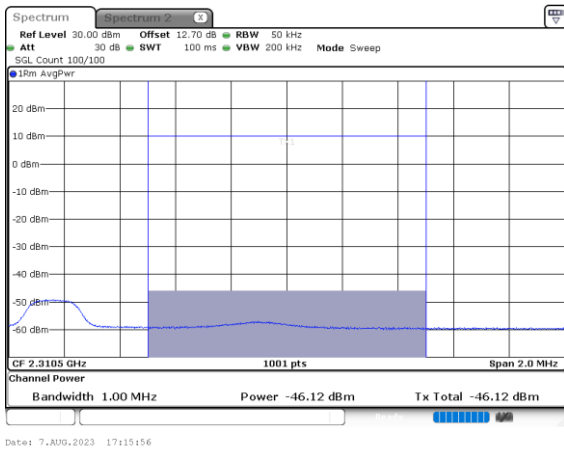

Highest Band Edge / 1 RB / Upper zoom in

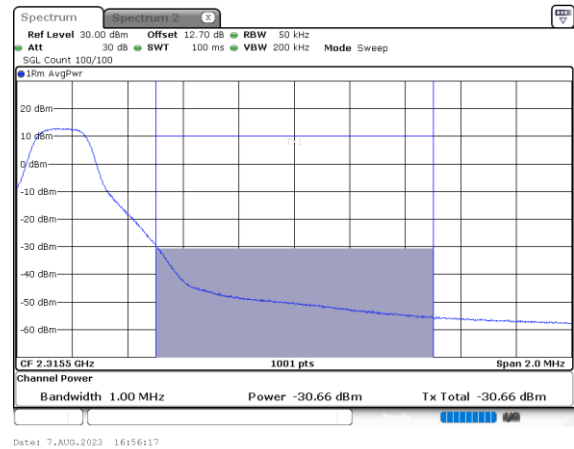



LTE Band 30 / 5MHz / 256QAM

Lowest Band Edge / Full RB

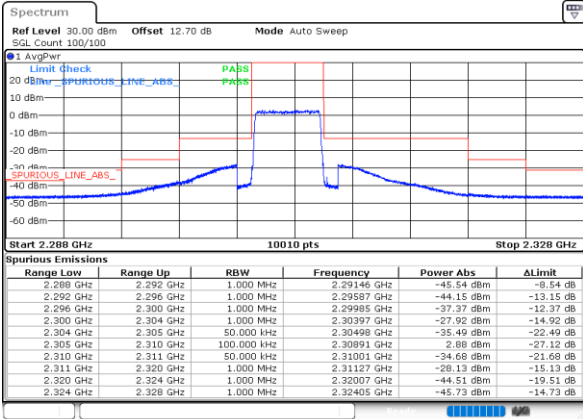

Highest Band Edge / Full RB

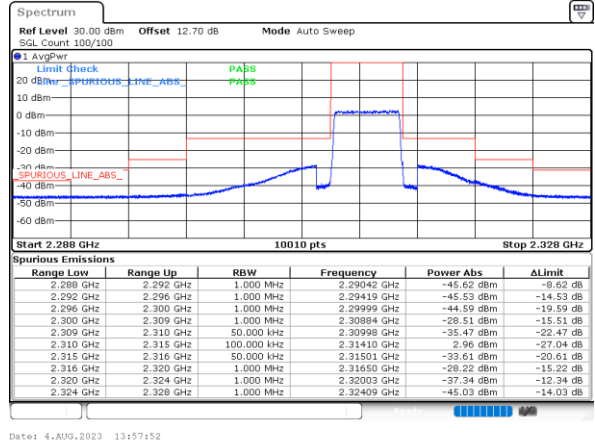

Lowest Band Edge / Full RB / Lower zoom in

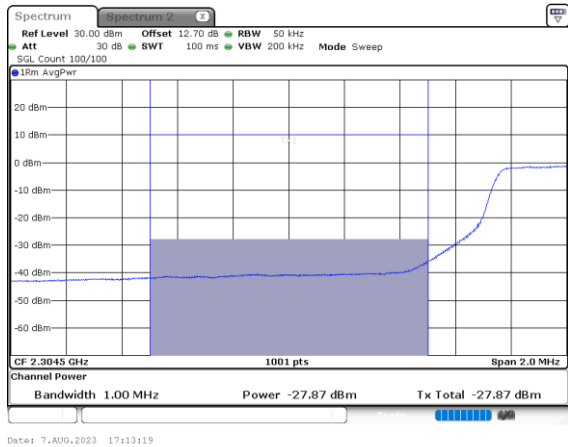

Highest Band Edge / Full RB / Lower zoom in

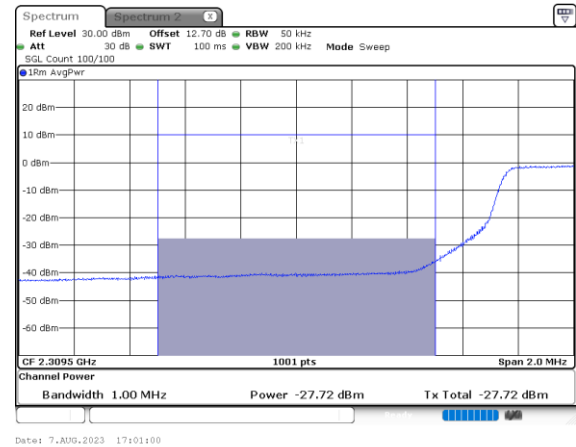

Lowest Band Edge / Full RB / Upper zoom in

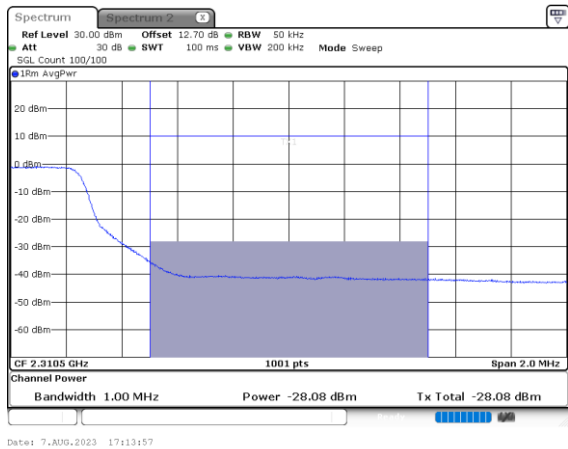

Highest Band Edge / Full RB / Upper zoom in

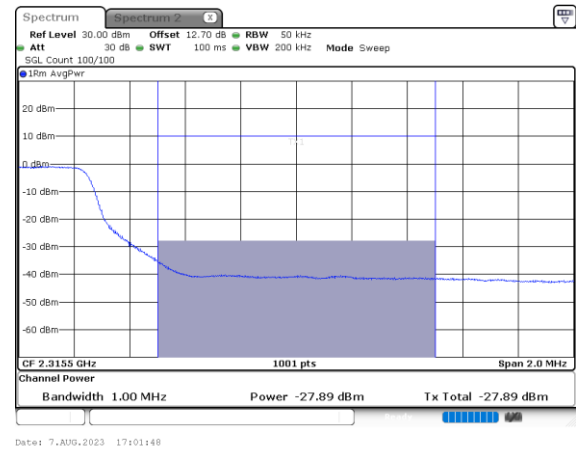



LTE Band 30 / 10MHz / QPSK

Middle Band Edge / Full RB

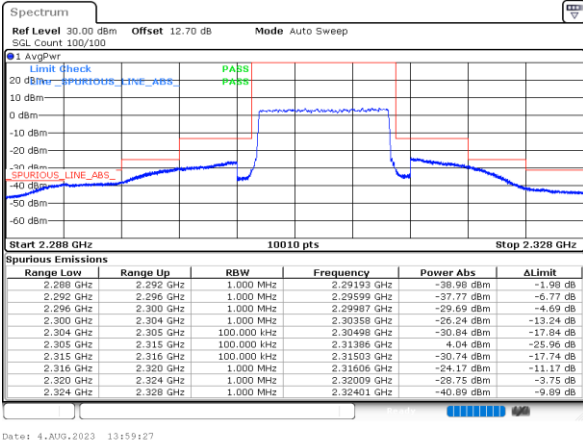

Date: 4.AUG.2023 13:59:27

Middle Band Edge / Full RB / Lower zoom in

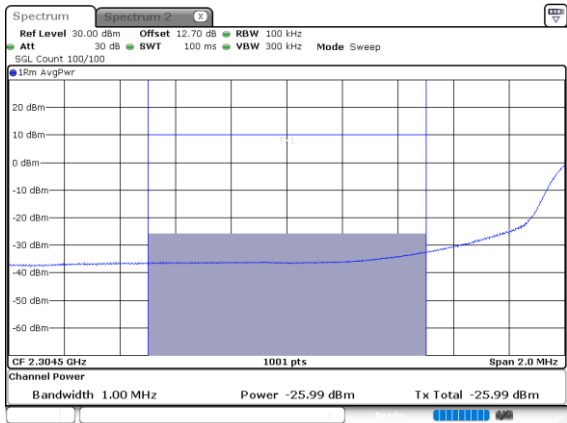

Date: 7.AUG.2023 17:29:39

Middle Band Edge / Full RB / Upper zoom in

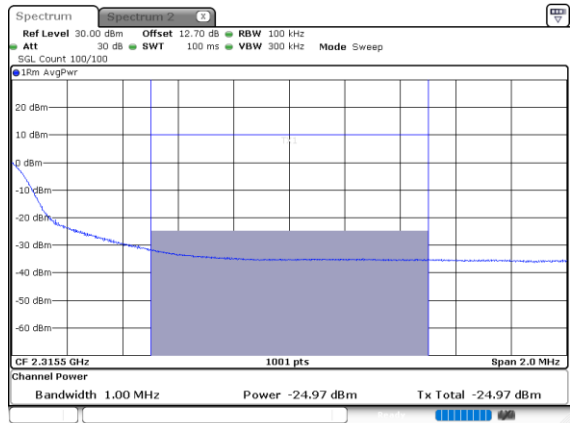

Date: 7.AUG.2023 17:30:21





LTE Band 30 / 10MHz / 16QAM

Middle Band Edge / Full RB

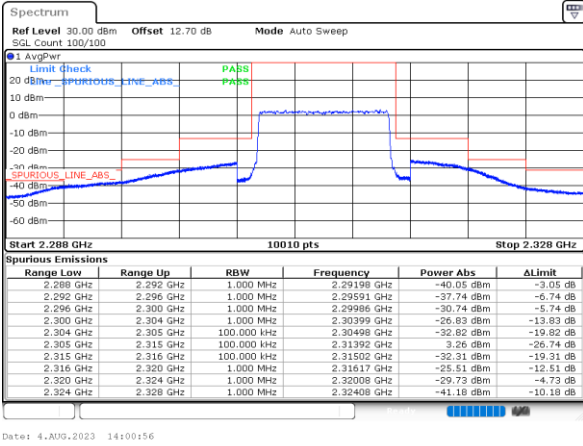

Middle Band Edge / Full RB / Lower zoom in

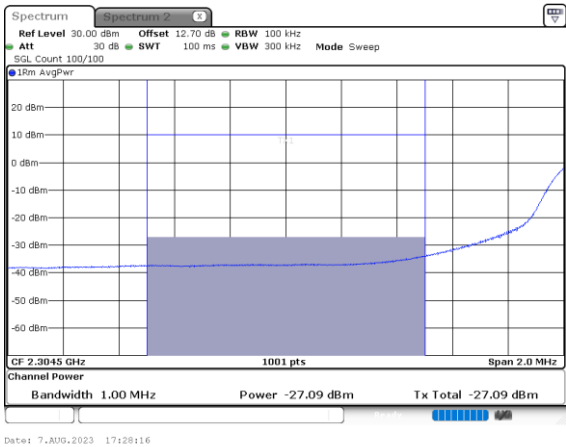

Middle Band Edge / Full RB / Upper zoom in

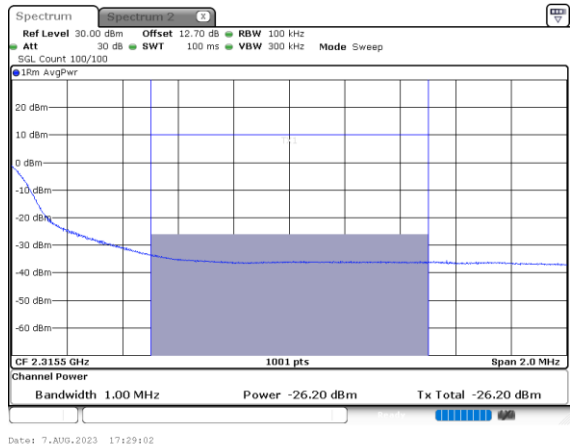



LTE Band 30 / 10MHz / 64QAM

Middle Band Edge / Full RB

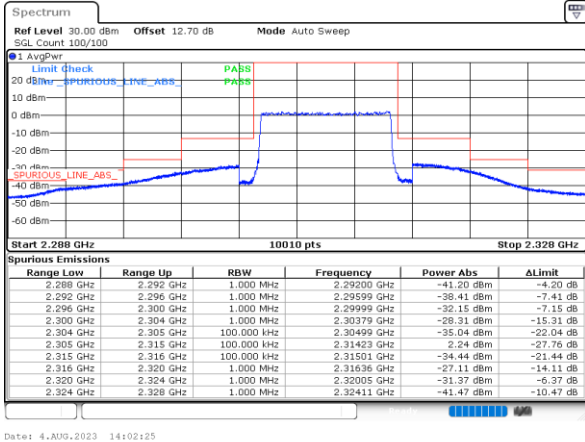

Date: 4.AUG.2023 14:02:25

Middle Band Edge / Full RB / Lower zoom in

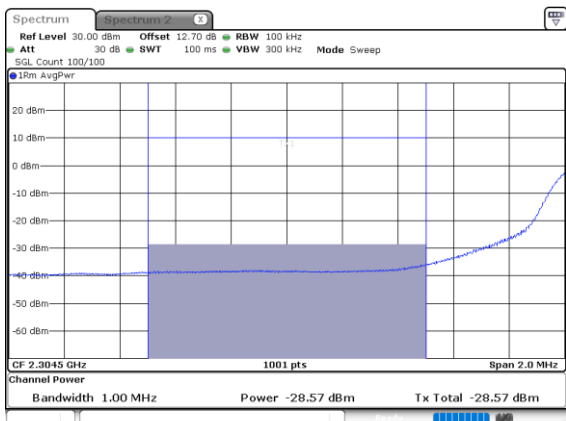

Date: 7.AUG.2023 17:31:01

Middle Band Edge / Full RB / Upper zoom in

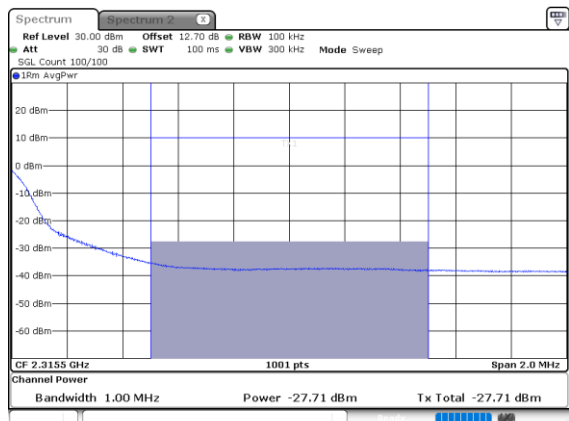

Date: 7.AUG.2023 17:32:08



LTE Band 30 / 10MHz / 256QAM

Middle Band Edge / Full RB

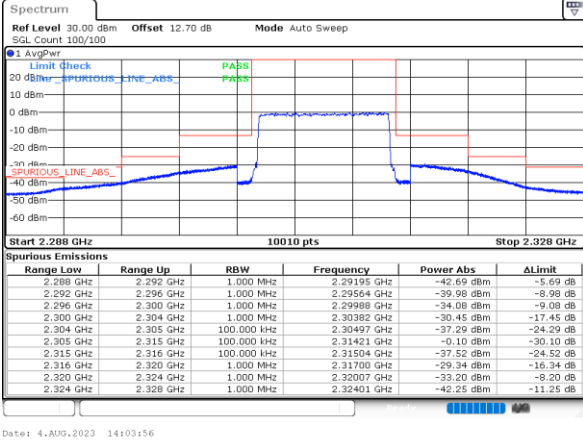

Date: 4.AUG.2023 14:03:56

Middle Band Edge / Full RB / Lower zoom in

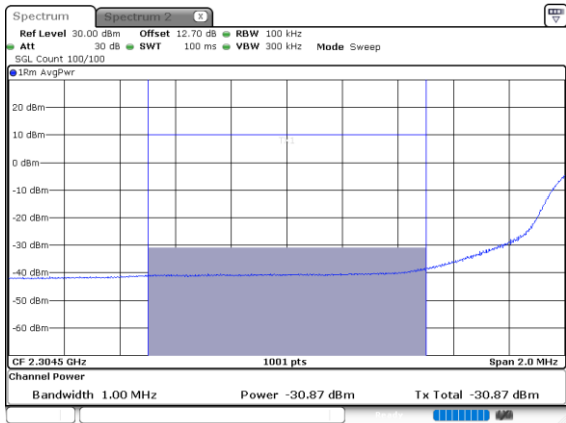

Date: 7.AUG.2023 17:33:02

Middle Band Edge / Full RB / Upper zoom in

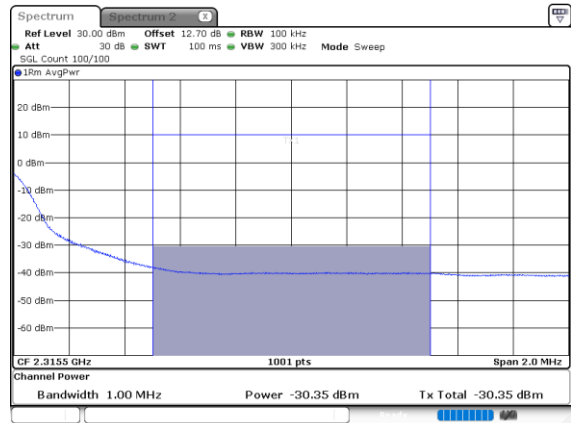

Date: 7.AUG.2023 17:33:55



# Conducted Spurious Emission

## LTE Band 30 / 5MHz

### Lowest Channel / QPSK

### Middle Channel / QPSK

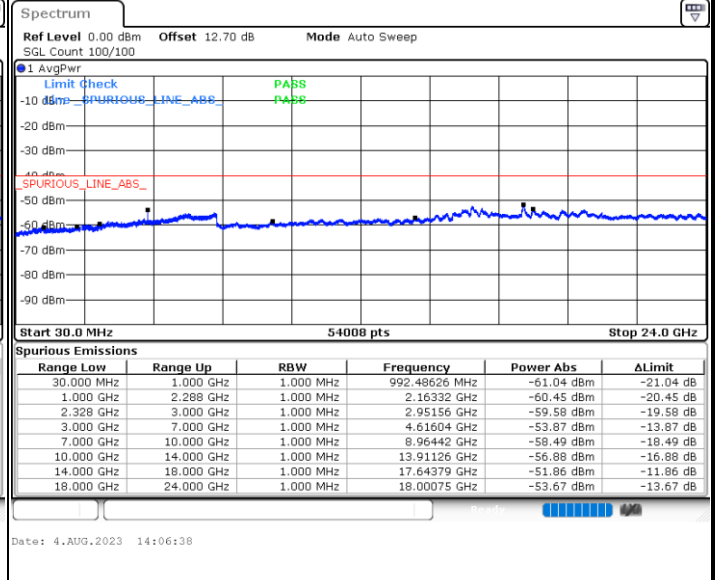
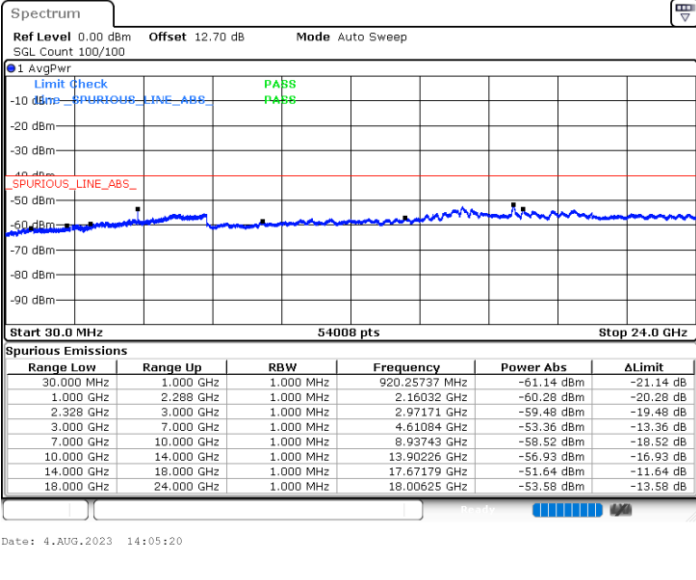

### Highest Channel / QPSK

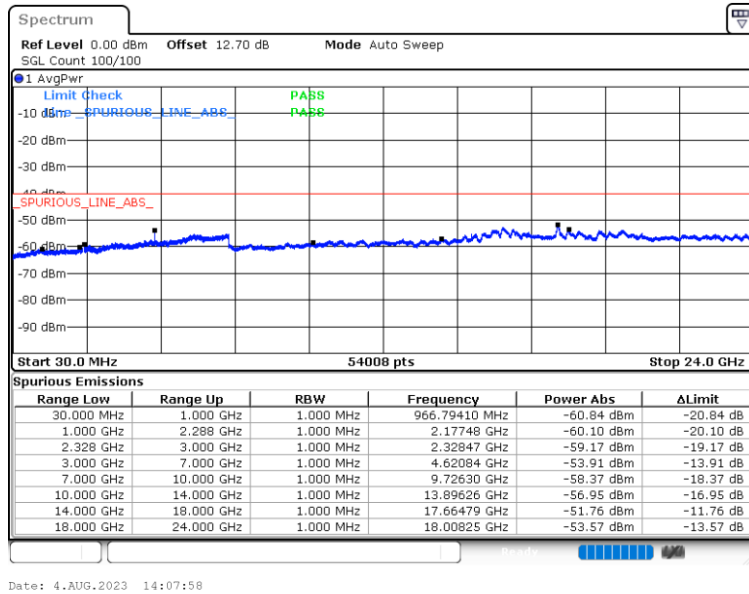



LTE Band 30 / 10MHz

Middle Channel / QPSK

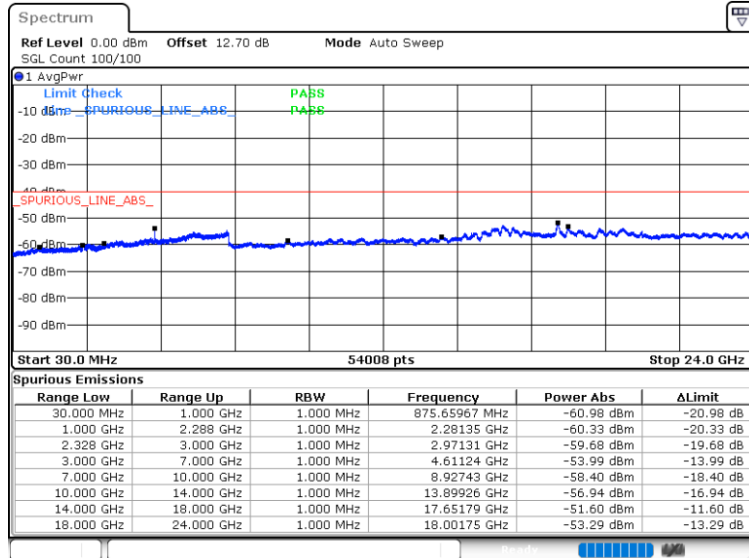

Date: 4.AUG.2023 14:19:33



### Frequency Stability

Test Conditions		LTE Band 30 (QPSK) / Middle Channel	Limit
Temperature (°C)	Voltage (Volt)	BW 10MHz	Note 2.
		Deviation (ppm)	Result
50	Normal Voltage	0.0008	PASS
40	Normal Voltage	0.0019	
30	Normal Voltage	0.0019	
20(Ref.)	Normal Voltage	0.0000	
10	Normal Voltage	0.0008	
0	Normal Voltage	0.0022	
-10	Normal Voltage	0.0022	
-20	Normal Voltage	0.0031	
-30	Normal Voltage	0.0042	
20	Maximum Voltage	0.0031	
20	Normal Voltage	0.0000	
20	Battery End Point	0.0030	

**Note:**

- 1. Normal Voltage = 4.05 V. ; Battery End Point (BEP) = 3.85 V. ; Maximum Voltage = 4.35 V.
- 2. The frequency fundamental emissions stay within the authorized frequency block.



## Appendix B. Test Results of Radiated Test

<Ant. 3>

### LTE Band 30

LTE Band 30 / 5MHz / QPSK									
Channel	Frequency ( MHz )	EIRP ( dBm )	Limit ( dBm )	Margin ( dB )	SPA Reading (dBm)	S.G. Power ( dBm )	TX Cable loss ( dB )	TX Antenna Gain (dBi)	Polarization (H/V)
Lowest	4611	-60.70	-40	-20.70	-45.8	-71.40	0.98	11.68	H
	6916	-50.35	-40	-10.35	-43.44	-60.04	1.29	10.97	H
	9221	-61.24	-40	-21.24	-55.79	-70.98	1.47	11.21	H
									H
									H
									H
	4611	-57.02	-40	-17.02	-43.06	-67.72	0.98	11.68	V
	6916	-47.14	-40	-7.14	-41.66	-56.83	1.29	10.97	V
	9221	-61.81	-40	-21.81	-55.58	-71.55	1.47	11.21	V
									V
									V
									V
Middle	4616	-59.22	-40	-19.22	-44.37	-69.91	0.98	11.68	H
	6924	-50.96	-40	-10.96	-44.05	-60.66	1.29	10.99	H
	9231	-61.71	-40	-21.71	-56.29	-71.45	1.47	11.22	H
									H
									H
									H
	4616	-56.14	-40	-16.14	-42.23	-66.83	0.98	11.68	V
	6924	-46.39	-40	-6.39	-40.91	-56.09	1.29	10.99	V
	9231	-62.84	-40	-22.84	-56.64	-72.58	1.47	11.22	V
									V
									V
									V



Highest	4621	-60.35	-40	-20.35	-45.54	-71.04	0.98	11.67	H
	6931	-49.40	-40	-9.40	-42.48	-59.11	1.29	11.00	H
	9241	-61.26	-40	-21.26	-55.89	-71.01	1.47	11.22	H
									H
									H
									H
	4621	-57.90	-40	-17.90	-44.03	-68.59	0.98	11.67	V
	6931	-46.44	-40	-6.44	-40.95	-56.15	1.29	11.00	V
	9241	-62.02	-40	-22.02	-55.86	-71.77	1.47	11.22	V
									V
									V
									V

Remark: Spurious emissions within 30-1000MHz were found more than 20dB below limit line.





LTE Band 30 / 10MHz / QPSK									
Channel	Frequency ( MHz )	EIRP ( dBm )	Limit ( dBm )	Margin ( dB )	SPA Reading (dBm)	S.G. Power ( dBm )	TX Cable loss ( dB )	TX Antenna Gain (dBi)	Polarization (H/V)
Middle	4611	-59.49	-40	-19.49	-44.59	-70.19	0.98	11.68	H
	6916	-54.66	-40	-14.66	-47.75	-64.35	1.29	10.97	H
	9222	-62.08	-40	-22.08	-56.63	-71.82	1.47	11.21	H
									H
									H
									H
	4611	-57.58	-40	-17.58	-43.63	-68.28	0.98	11.68	V
	6916	-46.64	-40	-6.64	-41.16	-56.33	1.29	10.97	V
	9222	-61.99	-40	-21.99	-55.76	-71.73	1.47	11.21	V
									V
									V
									V

**Remark:** Spurious emissions within 30-1000MHz were found more than 20dB below limit line.