



FCC RADIO TEST REPORT

FCC ID : UZ7ET65AW
Equipment : Rugged 2 in 1 Android Tablet
Brand Name : Zebra
Model Name : ET65AW
Applicant : Zebra Technologies Corporation
1 Zebra Plaza, Holtsville, NY 11742
Manufacturer : Zebra Technologies Corporation
1 Zebra Plaza, Holtsville, NY 11742
Standard : FCC 47 CFR Part 2, and 90(S)

The product was received on Jul. 12, 2023 and testing was performed from Jul. 22, 2023 to Sep. 08, 2023. We, Sporton International Inc. EMC & Wireless Communications Laboratory, would like to declare that the tested sample has been evaluated in accordance with the test procedures given in ANSI / TIA-603-E and has been in compliance with the applicable technical standards.

The test results in this report apply exclusively to the tested model / sample. Without written approval from Sporton International Inc. EMC & Wireless Communications Laboratory, the test report shall not be reproduced except in full.

Louis Wu

Approved by: Louis Wu

Sporton International Inc. EMC & Wireless Communications Laboratory
No. 52, Huaya 1st Rd., Guishan Dist., Taoyuan City 333, Taiwan (R.O.C.)



Table of Contents

History of this test report.....	3
Summary of Test Result.....	4
1 General Description	5
1.1 Feature of Equipment Under Test.....	5
1.2 Product Specification of Equipment Under Test	6
1.3 Modification of EUT	6
1.4 Testing Site.....	6
1.5 Applied Standards	7
2 Test Configuration of Equipment Under Test	8
2.1 Test Mode.....	8
2.2 Connection Diagram of Test System	9
2.3 Support Unit used in test configuration and system.....	9
2.4 Measurement Results Explanation Example	9
2.5 Frequency List of Low/Middle/High Channels.....	10
3 Conducted Test Items.....	11
3.1 Measuring Instruments.....	11
3.2 Conducted Output Power Measurement and ERP Measurement	12
3.3 Peak-to-Average Ratio	13
3.4 99% Occupied Bandwidth and 26dB Bandwidth Measurement.....	14
3.5 Emissions Mask Measurement	15
3.6 Emissions Mask – Out Of Band Emissions Measurement.....	16
3.7 Frequency Stability Measurement.....	17
3.8 Field Strength of Spurious Radiation Measurement	18
4 List of Measuring Equipment.....	21
5 Measurement Uncertainty	22
Appendix A. Test Results of Conducted Test	
Appendix B. Test Results of Radiated Test	
Appendix C. Test Setup Photographs	



Summary of Test Result

Report Clause	Ref Std. Clause	Test Items	Result (PASS/FAIL)	Remark
3.2	§2.1046 §90.635	Conducted Output Power and Effective Radiated Power	Pass	-
3.3	-	Peak-to-Average Ratio	Reporting only	-
3.4	§2.1049 §90.209	Occupied Bandwidth and 26dB Bandwidth	Reporting only	-
3.5	§2.1051 §90.691	Emission masks – In-band emissions	Pass	-
3.6	§2.1051 §90.691	Emission masks – Out of band emissions	Pass	-
3.7	§2.1055 §90.213	Frequency Stability for Temperature & Voltage	Pass	-
3.8	§2.1053 §90.691	Field Strength of Spurious Radiation	Pass	42.16 dB under the limit at 3258.00 MHz

Conformity Assessment Condition:

1. The test results (PASS/FAIL) with all measurement uncertainty excluded are presented against the regulation limits or in accordance with the requirements stipulated by the applicant/manufacturer who shall bear all the risks of non-compliance that may potentially occur if measurement uncertainty is taken into account.
2. The measurement uncertainty please refer to each test result in the section "Measurement Uncertainty".

Disclaimer:

The product specifications of the EUT presented in the test report that may affect the test assessments are declared by the manufacturer who shall take full responsibility for the authenticity.

Reviewed by: Keven Cheng

Report Producer: Michelle Chen



1 General Description

1.1 Feature of Equipment Under Test

Product Feature	
Equipment	Rugged 2 in 1 Android Tablet
Brand Name	Zebra
Model Name	ET65AW
FCC ID	UZ7ET65AW
EUT supports Radios application	WCDMA/HSPA/LTE/5G NR/NFC/GNSS WLAN 11a/b/g/n HT20/HT40 WLAN 11ac VHT20/VHT40/VHT80/VHT160 WLAN 11ax HE20/HE40/HE80/HE160 Bluetooth BR/EDR/LE
HW Version	DV2
SW Version	A13
MFD	21JUN23
DUT Stage	Identical Prototype

Remark: The above EUT's information was declared by manufacturer.

Specification of Accessories				
Adapter	Brand Name	Zebra	Part Number	PWR-BGA15V45W-UC2-WW
Battery 1	Brand Name	Zebra	Part Number	BT-000471-0020
Battery 2	Brand Name	Zebra	Part Number	BT-000471-0820

Supported Unit Used in Test Configuration and System				
USB TYPE C to 3.5mm audio connector	Brand Name	Zebra	Part Number	ADP-USBC-35MM1-01
3.5mm Earphone	Brand Name	Zebra	Part Number	HDST-35MM-PTVP-01
USB TYPE C Earphone	Brand Name	Zebra	Part Number	HPST-USBC-PTT1-01
Headset Jumper	Brand Name	Zebra	Part Number	CBL-TC51-HDST35-01

1.2 Product Specification of Equipment Under Test

Product Specification is subject to this standard	
Tx Frequency	816.5 ~ 821.5 MHz
Rx Frequency	861.5 ~ 866.5 MHz
Bandwidth	5MHz / 10MHz / 15MHz / 20MHz
Maximum Output Power to Antenna	24.09 dBm 24.14 dBm for Straddle Channel
Antenna Type	PIFA Antenna
Antenna Gain	Ant. 1: -0.60 dBi
Type of Modulation	PI/2 BPSK / QPSK / 16QAM / 64QAM / 256QAM

Remark: The above EUT's information was declared by manufacturer. Please refer to Disclaimer in report summary.

1.3 Modification of EUT

No modifications made to the EUT during the testing.

1.4 Testing Site

Test Site	Sporton International Inc. EMC & Wireless Communications Laboratory
Test Site Location	No.52, Huaya 1st Rd., Guishan Dist., Taoyuan City 333, Taiwan (R.O.C.) TEL: +886-3-327-3456 FAX: +886-3-328-4978
Test Site No.	Sporton Site No. TH03-HY
Test Engineer	Hank Chen and Luffy Lin
Temperature (°C)	23.5~24.1
Relative Humidity (%)	48~52

Test Site	Sporton International Inc. Wensan Laboratory
Test Site Location	No.58, Aly. 75, Ln. 564, Wenhua 3rd, Rd., Guishan Dist., Taoyuan City 333010, Taiwan (R.O.C.) TEL: +886-3-327-0868 FAX: +886-3-327-0855
Test Site No.	Sporton Site No. 03CH12-HY (TAF Code: 3786)
Test Engineer	Jesse Fan, Tim Lee and Wilson Wu
Temperature (°C)	20~25
Relative Humidity (%)	50~60
Remark	The Radiated Spurious Emission test item subcontracted to Sporton International Inc. Wensan Laboratory.

Note: The test site complies with ANSI C63.4 2014 requirement.
FCC Designation No.: TW1190 and TW3786



1.5 Applied Standards

According to the specifications declared by the manufacturer, the EUT must comply with the requirements of the following standards:

- ♦ FCC 47 CFR Part 2, 90
- ♦ ANSI / TIA-603-E
- ♦ ANSI C63.26-2015
- ♦ FCC KDB 971168 D01 Power Meas. License Digital Systems v03r01
- ♦ FCC KDB 412172 D01 Determining ERP and EIRP v01r01
- ♦ FCC KDB 414788 D01 Radiated Test Site v01r01
- ♦ Interim Guidance for Equipment Authorization of Devices with Channel Bandwidths Combined Across Two Contiguous Service Rule Allocations OET/Lab/EACB, June 6, 2013

Remark:

1. All the test items were validated and recorded in accordance with the standards without any modification during the testing.
2. This EUT has also been tested and complied with the requirements of FCC Part 15, Subpart B, recorded in a separate test report.
3. The TAF code is not including all the FCC KDB listed without accreditation.



2 Test Configuration of Equipment Under Test

2.1 Test Mode

During all testing, EUT is in link mode with base station emulator at maximum power level.

For radiated measurement, the measured emission level of the EUT was maximized by rotating the EUT on a turntable, adjusting the orientation of the EUT and EUT antenna in three orthogonal axis (X: flat, Y: portrait, Z: landscape), and adjusting the measurement antenna orientation, following C63.26 exploratory test procedures and only the worst case emissions were reported in this report.

Frequency range investigated for radiated emission is 30 MHz to 9000 MHz.

Conducted Test Cases	Band	Bandwidth (MHz)				Modulation					RB #			Test Channel		
		5	10	15	20	PI/2 BPSK	QPSK	16QAM	64QAM	256QAM	1	Half	Full	L	M	H
Max. Output Power	n26	v	v	v	v	v	v	v	v	v	v	v	v	v	v	v
Peak-to-Average Ratio	n26		v		v	v	v	v	v	v			v		v	
26dB and 99% Bandwidth	n26	v	v	v	v	v	v	v	v	v			v		v	
Emission masks In-band emissions	n26	v	v			v	v	v	v	v	v		v	v	v	v
Emission masks – Out of band emissions	n26	v					v				v			v	v	v
Frequency Stability	n26		v		v	v							v		v	
E.R.P.	n26	v	v	v	v	v	v	v	v	v	Max. Power					
Radiated Spurious Emission	n26	Worst Case											v	v	v	
Remark	<ol style="list-style-type: none"> The mark "v " means that this configuration is chosen for testing The mark "- " means that this bandwidth is not supported. 5G NR n26 transmit frequency for part22 rule is 824MHz-849MHz, for part90 rule is 814MHz-824MHz. ERP over 15MHz bandwidth complies the ERP limit line of part22 rule, therefore ERP of the partial frequency spectrum which falls within part 22 also complies. For radiated measurement, pre-scanned in two modes, DFT-s OFDM and CP OFDM. The worst cases (DFT-s OFDM) were recorded in this report. All the radiated test cases were performed with Battery 1. One representative bandwidth is selected to perform PAR and frequency stability. 															

2.2 Connection Diagram of Test System

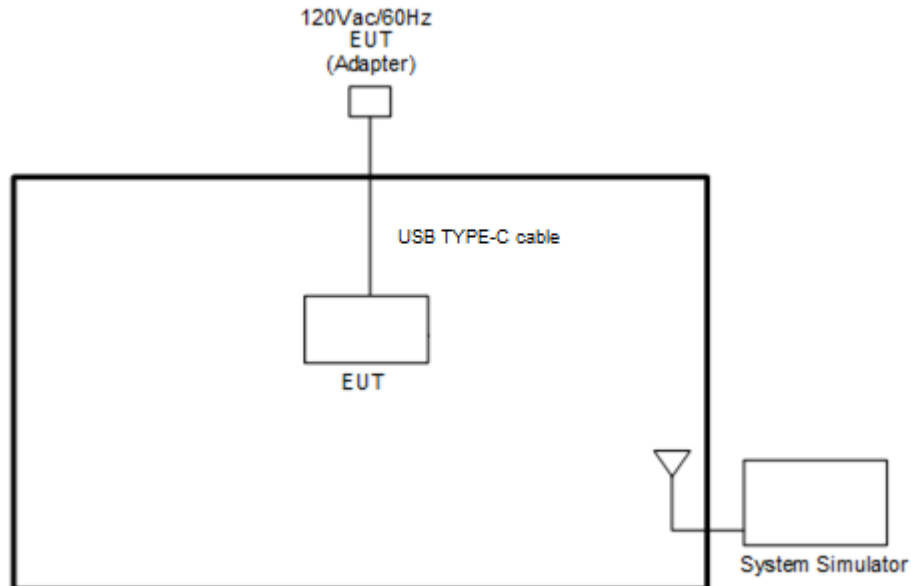

2.3 Support Unit used in test configuration and system

Item	Equipment	Brand Name	Model No.	FCC ID	Data Cable	Power Cord
1.	System Simulator	Anritsu	MT8000A	N/A	N/A	Unshielded, 1.8 m

2.4 Measurement Results Explanation Example

For all conducted test items:

The offset level is set in the spectrum analyzer to compensate the RF cable loss and attenuator factor between RF conducted output port and spectrum analyzer. With the offset compensation, the spectrum analyzer reading level will be exactly the RF output level.

The spectrum analyzer offset is derived from RF cable loss and attenuator factor.

Offset = RF cable loss + attenuator factor.

The following shows an offset computation example with RF cable loss 4.2 dB and a 10dB attenuator.

Example :

$$\begin{aligned} \text{Offset(dB)} &= \text{RF cable loss(dB)} + \text{attenuator factor(dB)}. \\ &= 4.2 + 10 = 14.2 \text{ (dB)} \end{aligned}$$



2.5 Frequency List of Low/Middle/High Channels

5G NR n26 Channel and Frequency List				
BW [MHz]	Channel/Frequency(MHz)	Lowest	Middle	Highest
10	Channel	-	163800	-
	Frequency	-	819	-
5	Channel	163300	163800	164300
	Frequency	816.5	819	821.5

5G NR n26 Channel and Frequency List				
BW [MHz]	Channel/Frequency(MHz)	-	cross-rule channels	-
20	Channel	-	164800	-
	Frequency	-	824	-
15	Channel	-	164800	-
	Frequency	-	824	-
10	Channel	-	164800	-
	Frequency	-	824	-
5	Channel	-	164800	-
	Frequency	-	824	-

3 Conducted Test Items

3.1 Measuring Instruments

See list of measuring instruments of this test report.

3.1.1 Test Setup

3.1.2 Conducted Output Power

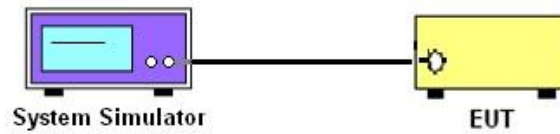

3.1.3 Peak-to-Average Ratio, Occupied Bandwidth, Conducted Band-Edge, Emission Mask, Emissions Mask – Out Of Band Emissions, and Conducted Spurious Emission

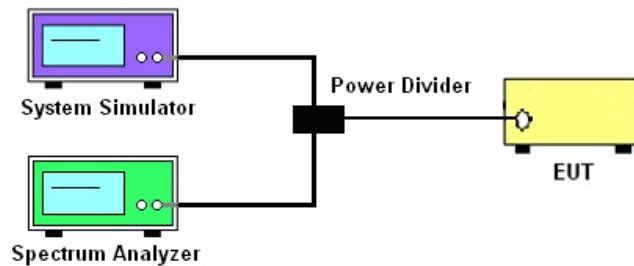

3.1.4 Frequency Stability

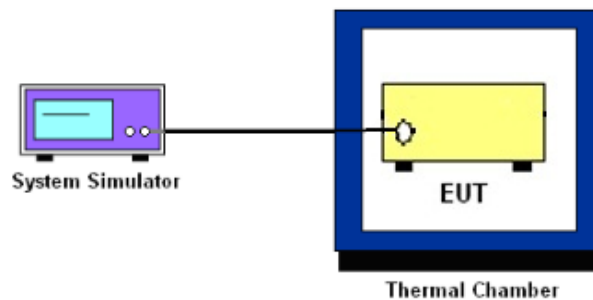

3.1.5 Test Result of Conducted Test

Please refer to Appendix A.



3.2 Conducted Output Power Measurement and ERP Measurement

3.2.1 Description of the Conducted Output Power Measurement and ERP Measurement

A system simulator was used to establish communication with the EUT. Its parameters were set to enforce EUT transmitting at the maximum power. The measured power in the radio frequency on the transmitter output terminals shall be reported.

The output power of mobile transmitters must not exceed 100 Watts for 5G NR n26.

According to KDB 412172 D01 Power Approach,

$EIRP = P_T + G_T - L_C$, where

P_T = transmitter output power in dBm

G_T = gain of the transmitting antenna in dBi

L_C = signal attenuation in the connecting cable between the transmitter and antenna in dB

3.2.2 Test Procedures

1. The transmitter output port was connected to the system simulator.
2. Set EUT at maximum power through system simulator.
3. Select lowest, middle, and highest channels for each band and different modulation.
4. Measure and record the power level from the system simulator.



3.3 Peak-to-Average Ratio

3.3.1 Description of the PAR Measurement

Reporting only

3.3.2 Test Procedures

1. The EUT was connected to spectrum and system simulator via a power divider.
2. Set the CCDF (Complementary Cumulative Distribution Function) option in spectrum analyzer.
3. The highest RF powers were measured and recorded the maximum PAPR level associated with a probability of 0.1 %.
4. Record the deviation as Peak to Average Ratio.



3.4 99% Occupied Bandwidth and 26dB Bandwidth Measurement

3.4.1 Description of (Occupied) Bandwidth Limitations Measurement

The 99% occupied bandwidth is the width of a frequency band such that, below the lower and above the upper frequency limits, the mean powers emitted are each equal to a specified percentage 0.5% of the total mean transmitted power.

The emission bandwidth is defined as the width of the signal between two points, located at the 2 sides of the carrier frequency, outside of which all emissions are attenuated at least 26 dB below the transmitter power.

3.4.2 Test Procedures

1. The EUT was connected to spectrum analyzer and system simulator via a power divider.
2. The 26dB and 99% occupied bandwidth (BW) of the middle channel for the highest RF power with full RB sizes were measured.



3.5 Emissions Mask Measurement

3.5.1 Description of Emissions Mask Measurement

Equipment used in this licensed to EA or non-EA systems shall comply with the emission mask provisions of FCC Part 90.691.(a)

(a) Out-of-band emission requirement shall apply only to the "outer" channels included in an EA license and to spectrum adjacent to interior channels used by incumbent licensees. The emission limits are as follows:

(1) For any frequency removed from the EA licensee's frequency block by up to and including 37.5 kHz, the power of any emission shall be attenuated below the transmitter power (P) in watts by at least $116 \text{ Log}_{10}(f/6.1)$ decibels or $50 + 10 \text{ Log}_{10}(P)$ decibels or 80 decibels, whichever is the lesser attenuation, where f is the frequency removed from the center of the outer channel in the block in kilohertz and where f is greater than 12.5 kHz.

(2) For any frequency removed from the EA licensee's frequency block greater than 37.5 kHz, the power of any emission shall be attenuated below the transmitter power (P) in watts by at least $43 + 10 \text{ Log}_{10}(P)$ decibels or 80 decibels, whichever is the lesser attenuation, where f is the frequency removed from the center of the outer channel in the block in kilohertz and where f is greater than 37.5 kHz.

3.5.2 Test Procedures

1. The EUT was connected to spectrum analyzer and base station via power divider.
2. The emissions mask of low and high channels for the highest RF powers were measured.
3. Set RBW and VBW 3 times of RBW to make the measurement with the spectrum analyzer's, and according to KDB 971168 D02 Misc Rev Approve License Devices v02r01 standards, set RBW = 300 Hz to make offsets less than 37.5 kHz from a channel edge , RBW = 100 kHz to make offsets greater than 37.5 kHz, that is allowed.
4. The test results were shown below plots with a correction offset factor including cable loss, insertion loss of power divider.



3.6 Emissions Mask – Out Of Band Emissions Measurement

3.6.1 Description of Conducted Emissions Out of band emissions measurement

The power of any emission FCC Part 90.691 (a)(2) on any frequency removed from the assigned frequency by out of the authorized bandwidth at least $43 + 10 \log (P)$ dB. It is measured by means of a calibrated spectrum analyzer and scanned from 30 MHz up to a frequency including its 10th harmonic.

3.6.2 Test Procedures

1. The EUT was connected to spectrum analyzer and system simulator via a power divider.
2. The RF output of EUT was connected to the spectrum analyzer by RF cable and attenuator. The path loss was compensated to the results for each measurement.
3. The middle channel for the highest RF power within the transmitting frequency was measured.
4. The conducted spurious emission for the whole frequency range was taken.
5. For testing below 1GHz, make the measurement with the spectrum analyzer's RBW = 100 kHz, VBW = 3MHz, taking the record of maximum spurious emission.
6. For testing above 1GHz, make the measurement with the spectrum analyzer's RBW = 1MHz, VBW = 3MHz, taking the record of maximum spurious emission.
7. The RF fundamental frequency should be excluded against the limit line in the operating frequency band.
8. The limit line is derived from $43 + 10\log(P)$ dB below the transmitter power P(Watts)



3.7 Frequency Stability Measurement

3.7.1 Description of Frequency Stability Measurement

The frequency stability shall be sufficient to ensure that the fundamental emission stays within the authorized frequency block.

3.7.2 Measuring Instruments

The measuring equipment is listed in the section 4 of this test report.

3.7.3 Test Procedures for Temperature Variation

1. The EUT was set up in the thermal chamber and connected with the base station.
2. With power OFF, the temperature was decreased to -30°C and the EUT was stabilized for three hours. Power was applied and the maximum change in frequency was recorded within one minute.
3. With power OFF, the temperature was raised in 10°C step up to 50°C. The EUT was stabilized at each step for at least half an hour. Power was applied and the maximum frequency change was recorded within one minute.

3.7.4 Test Procedures for Voltage Variation

1. The EUT was placed in a temperature chamber at 20±5° C and connected with the base station.
2. The power supply voltage to the EUT was varied from BEP to 115% of the nominal value measured at the input to the EUT.
3. The variation in frequency was measured for the worst case.



3.8 Field Strength of Spurious Radiation Measurement

3.8.1 Description of Field Strength of Spurious Radiated Measurement

The radiated spurious emission was measured by substitution method according to ANSI / TIA-603-E. The power of any emission FCC Part 90.691 on any frequency removed from the assigned frequency by more than 250 percent of the authorized bandwidth at least $43 + 10 \log (P)$ dB. The spectrum is scanned from 30 MHz up to a frequency including its 10th harmonic.

The power of any emission outside of the authorized operating frequency ranges must be attenuated below the transmitter power (P) by a factor of at least $43+10\log_{10}(P[\text{Watts}])$ dB. The spectrum is scanned from 30 MHz up to a frequency including its 10th harmonic.

3.8.2 Test Procedures

1. The EUT was placed on a turntable with 0.8 meter for frequency below 1GHz and 1.5 meter for frequency above 1GHz respectively above ground.
2. The EUT was set 3 meters from the receiving antenna, which was mounted on the antenna tower.
3. The table was rotated 360 degrees to determine the position of the highest spurious emission.
4. The height of the receiving antenna is varied between one meter and four meters to search the maximum spurious emission for both horizontal and vertical polarizations.
5. For testing below 1GHz, make the measurement with the spectrum analyzer's RBW = 100 kHz, VBW = 3MHz, Sweep = 500ms, Taking the record of maximum spurious emission.
6. For testing above 1GHz, make the measurement with the spectrum analyzer's RBW = 1MHz, VBW = 3MHz, Sweep = 500ms, Taking the record of maximum spurious emission.
7. Measure the burst average result by setting trace = max hold or trace = average with duty cycle factor when margin is not enough.
8. A horn antenna was substituted in place of the EUT and was driven by a signal generator.
9. Tune the output power of signal generator to the same emission level with EUT maximum spurious emission.
10. Taking the record of output power at antenna port.
11. Repeat step 7 to step 8 for another polarization.
12. $\text{EIRP (dBm)} = \text{S.G. Power} - \text{Tx Cable Loss} + \text{Tx Antenna Gain}$
13. $\text{ERP (dBm)} = \text{EIRP} - 2.15$
14. The RF fundamental frequency should be excluded against the limit line in the operating frequency band.
15. The limit line is derived from $43 + 10\log(P)$ dB below the transmitter power P(Watts)

3.8.3 Test Setup

For radiated test below 30MHz

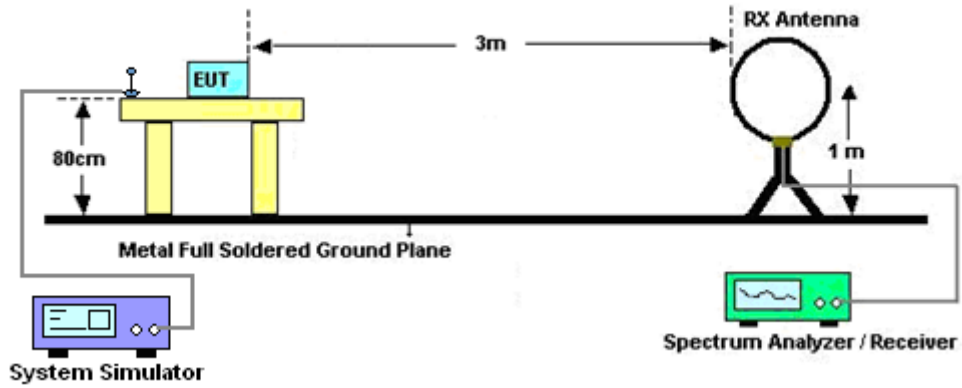

For radiated test from 30MHz to 1GHz

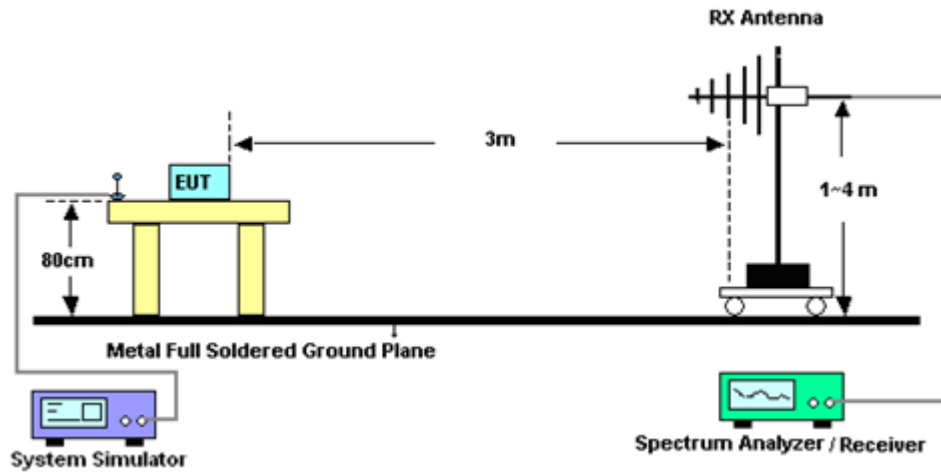

For radiated test above 1GHz

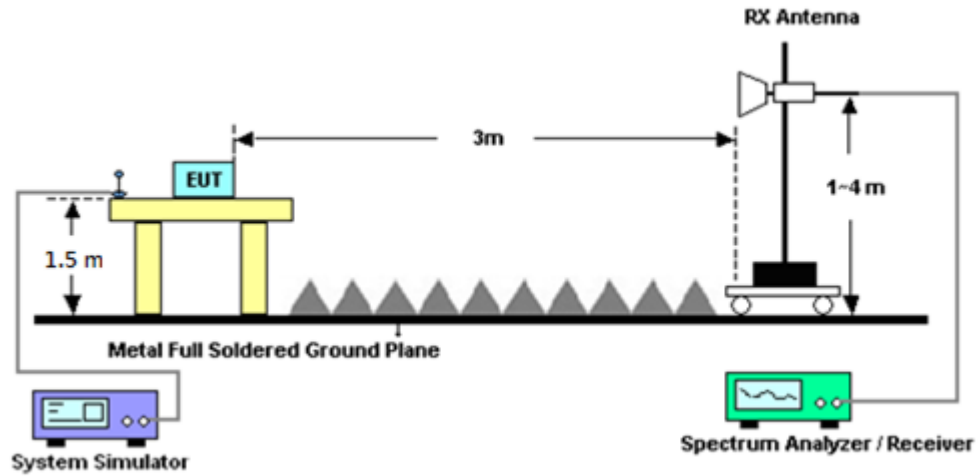

3.8.4 Test Result of Field Strength of Spurious Radiated

Please refer to Appendix B.

Note:

The low frequency, which started from 9 kHz to 30MHz, was pre-scanned and the result which was 20dB lower than the limit line was not reported.

There is adequate comparison measurement of both open-field test site and alternative test site - semi-Anechoic chamber according to 414788 D01 Radiated Test Site v01r01, and the result came out very similar.



4 List of Measuring Equipment

Instrument	Brand Name	Model No.	Serial No.	Characteristics	Calibration Date	Test Date	Due Date	Remark
Hygrometer	Testo	608-H1	34893241	N/A	Mar. 28, 2023	Jul. 28, 2023~ Sep. 08, 2023	Mar. 27, 2024	Conducted (TH03-HY)
Radio Communication Test Station	Anritsu	MT8000A	6272337370	N/A	Oct. 28, 2022	Jul. 28, 2023~ Sep. 08, 2023	Oct. 27, 2023	Conducted (TH03-HY)
Base Station(Measure)	Anritsu	MT8821C	6262116725	LTE FDD/TDD LTE-3CC DLCA/2CC ULCA	Oct. 13, 2022	Jul. 28, 2023~ Sep. 08, 2023	Oct. 12, 2023	Conducted (TH03-HY)
Loop Antenna	Rohde & Schwarz	HFH2-Z2	100488	9 kHz~30 MHz	Sep. 20, 2022	Jul. 22, 2023~ Aug. 10, 2023	Sep. 19, 2023	Radiation (03CH12-HY)
Bilog Antenna	TESEQ	CBL 6111D & 00800N1D01N-06	37059 & 01	30MHz~1GHz	Nov. 10, 2022	Jul. 22, 2023~ Aug. 10, 2023	Nov. 09, 2023	Radiation (03CH12-HY)
Horn Antenna	SCHWARZBECK	BBHA 9120 D	9120D-1328	1GHz~18GHz	Dec. 15, 2022	Jul. 22, 2023~ Aug. 10, 2023	Dec. 14, 2023	Radiation (03CH12-HY)
Horn Antenna	SCHWARZBECK	BBHA 9120 D	9120D-0229 4	1GHz~18GHz	Jun. 30, 2023	Jul. 22, 2023~ Aug. 10, 2023	Jun. 29, 2024	Radiation (03CH12-HY)
Preamplifier	COM-POWER	PA-103A	161241	10MHz~1GHz	Oct. 03, 2022	Jul. 22, 2023~ Aug. 10, 2023	Oct. 02, 2023	Radiation (03CH12-HY)
Preamplifier	Agilent	8449B	3008A02375	1GHz~26.5GHz	May 23, 2023	Jul. 22, 2023~ Aug. 10, 2023	May 22, 2024	Radiation (03CH12-HY)
Preamplifier	E-INSTRUMENT TECH LTD.	ERA-100M-18G-56- 01-A70	EC1900249	1GHz-18GHz	Dec. 21, 2022	Jul. 22, 2023~ Aug. 10, 2023	Dec. 20, 2023	Radiation (03CH12-HY)
Spectrum Analyzer	Agilent	N9010A	MY53470118	10Hz~44GHz	Jan. 10, 2023	Jul. 22, 2023~ Aug. 10, 2023	Jan. 09, 2024	Radiation (03CH12-HY)
Filter	Wainwright	WHKX12-1080-120 0-15000-60SS	SN1	1.2GHz High Pass Filter	Mar. 14, 2023	Jul. 22, 2023~ Aug. 10, 2023	Mar. 13, 2024	Radiation (03CH12-HY)
Filter	Wainwright	WHKX12-2700-300 0-18000-60ST	SN2	3GHz High Pass Filter	Mar. 14, 2023	Jul. 22, 2023~ Aug. 10, 2023	Mar. 13, 2024	Radiation (03CH12-HY)
Filter	Wainwright	WHKX8-5872.5-675 0-18000-40ST	SN2	6.75GHz High Pass Filter	Mar. 14, 2023	Jul. 22, 2023~ Aug. 10, 2023	Mar. 13, 2024	Radiation (03CH12-HY)
RF Cable	HUBER + SUHNER	SUCOFLEX 102	803951/2	9kHz~30MHz	Mar. 07, 2023	Jul. 22, 2023~ Aug. 10, 2023	Mar. 06, 2024	Radiation (03CH12-HY)
RF Cable	HUBER + SUHNER	SUCOFLEX 126E	0058/126E	30MHz~18GHz	Dec. 20, 2022	Jul. 22, 2023~ Aug. 10, 2023	Dec. 19, 2023	Radiation (03CH12-HY)
RF Cable	HUBER + SUHNER	SUCOFLEX 102	505134/2	30MHz~40GHz	Dec. 20, 2022	Jul. 22, 2023~ Aug. 10, 2023	Dec. 19, 2023	Radiation (03CH12-HY)
RF Cable	HUBER + SUHNER	SUCOFLEX 102	803953/2	30MHz~40GHz	Dec. 20, 2022	Jul. 22, 2023~ Aug. 10, 2023	Dec. 19, 2023	Radiation (03CH12-HY)
Antenna Mast	EMEC	AM-BS-4500-B	N/A	1m~4m	N/A	Jul. 22, 2023~ Aug. 10, 2023	N/A	Radiation (03CH12-HY)
Turn Table	EMEC	TT2000	N/A	0~360 Degree	N/A	Jul. 22, 2023~ Aug. 10, 2023	N/A	Radiation (03CH12-HY)
Software	Audix	E3 6.2009-8-24	RK-000989	N/A	N/A	Jul. 22, 2023~ Aug. 10, 2023	N/A	Radiation (03CH12-HY)
Signal Generator	Rohde & Schwarz	SMF100A	101107	100kHz~40GHz	Jan. 11, 2023	Jul. 22, 2023~ Aug. 10, 2023	Jan. 10, 2024	Radiation (03CH12-HY)



5 Measurement Uncertainty

Uncertainty of Radiated Emission Measurement (30 MHz ~ 1000 MHz)

Measuring Uncertainty for a Level of Confidence of 95% ($U = 2Uc(y)$)	3.07 dB
---	---------

Uncertainty of Radiated Emission Measurement (1 GHz ~ 18 GHz)

Measuring Uncertainty for a Level of Confidence of 95% ($U = 2Uc(y)$)	3.63 dB
---	---------



Appendix A. Test Results of Conducted Test

Conducted Output Power(Average power) and ERP

Part90s NR n26 Maximum Average Power [dBm] (GT - LC = -0.6 dB)								
BW [MHz]	RB Size	RB Offset	Mod	Lowest	Middle	Highest	ERP (dBm)	ERP
5	1	1	PI/2 BPSK	23.96	24.03	23.98	21.34	0.1361
5	1	23		24.02	23.92	23.97		
5	12	6		24.04	24.01	24.04		
5	1	0		23.56	23.55	23.44		
5	1	24		23.49	23.57	23.51		
5	25	0		23.52	23.53	23.54		
5	1	1	QPSK	24.09	24.05	23.96		
5	1	23		24.01	23.99	24.03		
5	12	6		23.95	23.98	24.08		
5	1	0		22.94	22.98	22.99		
5	1	24		23.01	23.08	23.00		
5	25	0		23.05	23.00	23.07		
5	1	1	16-QAM	22.90	23.03	22.96	20.28	0.1067
5	1	1	64-QAM	21.59	21.63	21.57		
5	1	1	256-QAM	19.07	19.04	18.95		
Limit	ERP < 100W			Result			Pass	

Part90s NR n26 Maximum Average Power [dBm] (GT - LC = -0.6 dB)								
BW [MHz]	RB Size	RB Offset	Mod	Lowest	Middle	Highest	ERP (dBm)	ERP
10	1	1	PI/2 BPSK	-	24.04	-	21.32	0.1355
10	1	50		-	23.95	-		
10	25	12		-	24.03	-		
10	1	0		-	23.57	-		
10	1	51		-	23.52	-		
10	50	0		-	23.52	-		
10	1	1	QPSK	-	24.07	-		
10	1	50		-	24.01	-		
10	25	12		-	24.04	-		
10	1	0		-	23.02	-		
10	1	51		-	23.07	-		
10	50	0		-	23.06	-		
10	1	1	16-QAM	-	22.92	-	20.17	0.1040
10	1	1	64-QAM	-	21.67	-		
10	1	1	256-QAM	-	19.04	-		
Limit	ERP < 100W			Result			Pass	



NR n26 Straddle Channel Maximum Average Power [dBm] (GT - LC = -0.6 dB)								
BW [MHz]	RB Size	RB Offset	Mod	Lowest	Middle	Highest	ERP (dBm)	ERP
5	1	1	PI/2 BPSK	-	23.99	-	21.37	0.1371
5	1	23		-	24.08	-		
5	12	6		-	24.12	-		
5	1	0		-	23.50	-		
5	1	24		-	23.54	-		
5	25	0		-	23.59	-		
5	1	1	QPSK	-	24.03	-		
5	1	23		-	24.05	-		
5	12	6		-	24.10	-		
5	1	0		-	23.07	-		
5	1	24		-	23.04	-		
5	25	0		-	23.11	-		
5	1	1	16-QAM	-	23.02	-	20.27	0.1064
5	1	1	64-QAM	-	21.67	-		
5	1	1	256-QAM	-	18.94	-		
Limit	Reporting only			Result			N/A	

NR n26 Straddle Channel Maximum Average Power [dBm] (GT - LC = -0.6 dB)								
BW [MHz]	RB Size	RB Offset	Mod	Lowest	Middle	Highest	ERP (dBm)	ERP
10	1	1	PI/2 BPSK	-	23.97	-	21.33	0.1358
10	1	50		-	24.08	-		
10	25	12		-	24.01	-		
10	1	0		-	23.52	-		
10	1	51		-	23.62	-		
10	50	0		-	23.54	-		
10	1	1	QPSK	-	24.00	-		
10	1	50		-	24.02	-		
10	25	12		-	23.97	-		
10	1	0		-	22.94	-		
10	1	51		-	23.18	-		
10	50	0		-	23.01	-		
10	1	1	16-QAM	-	22.92	-	20.17	0.1040
10	1	1	64-QAM	-	21.60	-		
10	1	1	256-QAM	-	19.09	-		
Limit	Reporting only			Result			N/A	



NR n26 Straddle Channel Maximum Average Power [dBm] (GT - LC = -0.6 dB)										
BW [MHz]	RB Size	RB Offset	Mod	Lowest	Middle	Highest	ERP (dBm)	ERP		
15	1	1	PI/2 BPSK	-	23.95	-	21.39	0.1377		
15	1	77		-	24.02	-				
15	36	18		-	23.97	-				
15	1	0		-	23.45	-				
15	1	78		-	23.57	-				
15	75	0		-	23.53	-				
15	1	1	QPSK	-	23.90	-			20.14	0.1033
15	1	77		-	24.14	-				
15	36	18		-	24.01	-				
15	1	0		-	23.02	-				
15	1	78		-	23.17	-				
15	75	0		-	23.01	-				
15	1	1	16-QAM	-	22.89	-	20.14	0.1033		
15	1	1	64-QAM	-	21.54	-				
15	1	1	256-QAM	-	19.03	-				
Limit	Reporting only			Result			N/A			

NR n26 Straddle Channel Maximum Average Power [dBm] (GT - LC = -0.6 dB)										
BW [MHz]	RB Size	RB Offset	Mod	Lowest	Middle	Highest	ERP (dBm)	ERP		
20	1	1	PI/2 BPSK	-	23.98	-	21.37	0.1371		
20	1	104		-	24.12	-				
20	50	25		-	23.95	-				
20	1	0		-	23.46	-				
20	1	105		-	23.59	-				
20	100	0		-	23.64	-				
20	1	1	QPSK	-	23.90	-			20.10	0.1023
20	1	104		-	24.07	-				
20	50	25		-	23.96	-				
20	1	0		-	22.87	-				
20	1	105		-	23.05	-				
20	100	0		-	23.06	-				
20	1	1	16-QAM	-	22.85	-	20.10	0.1023		
20	1	1	64-QAM	-	21.54	-				
20	1	1	256-QAM	-	18.86	-				
Limit	Reporting only			Result			N/A			



FR1 n26

Peak-to-Average Ratio

Mode	FR1 n26 / 10MHz / DFT-S OFDM				
Mod.	PI/2 BPSK	QPSK	16QAM	64QAM	Limit: 13dB
RB Size	Full RB	Full RB	Full RB	Full RB	Result
Middle CH	4.34	5.72	6.58	6.52	PASS
Mode	FR1 n26 / 10MHz / DFT-S OFDM				
Mod.	256QAM				Limit: 13dB
RB Size	Full RB				Result
Middle CH	6.64				PASS



FR1 n26 / 10MHz / DFT-S OFDM / Middle Channel / Full RB

PI/2 BPSK

QPSK

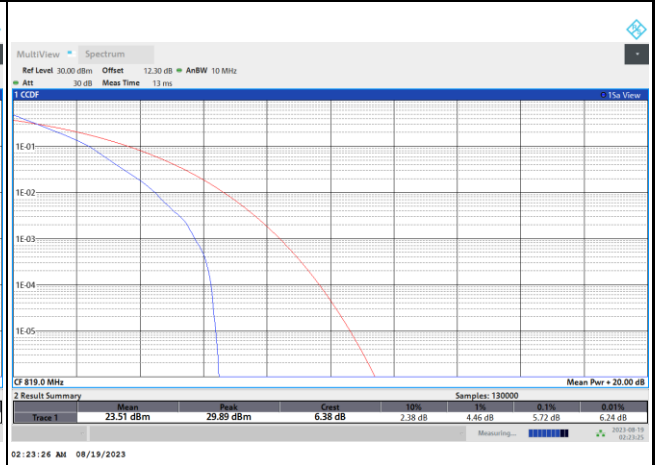
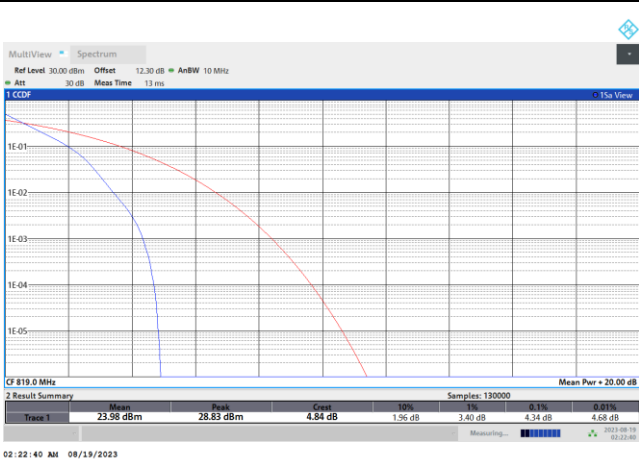

16QAM

64QAM

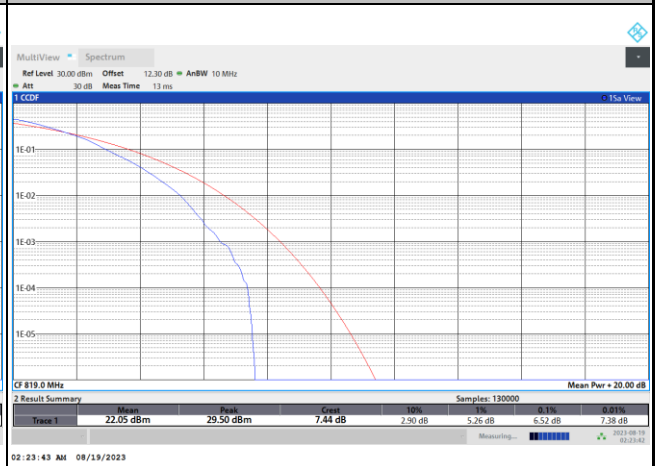
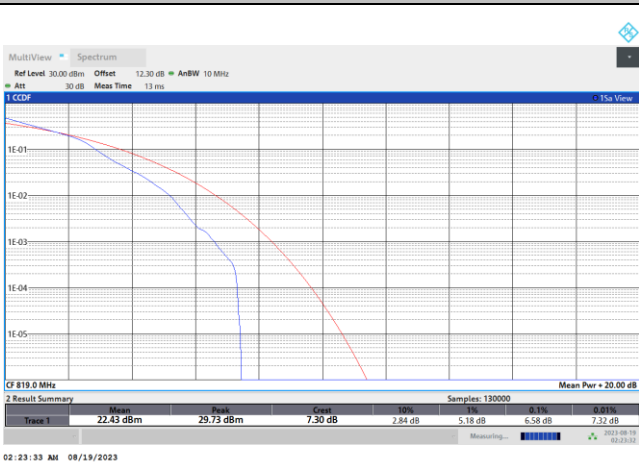

256QAM

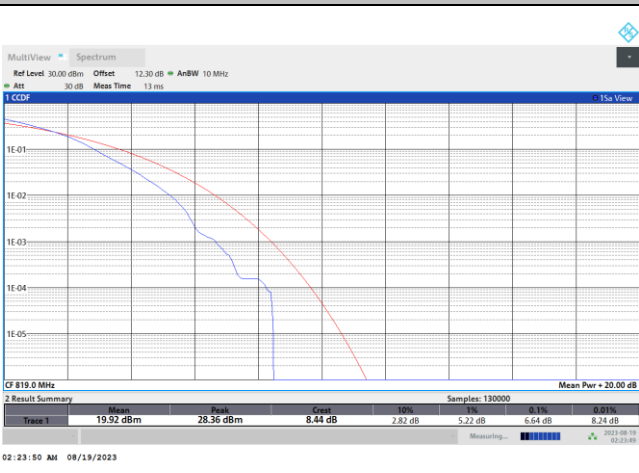



26dB Bandwidth

Mode	FR1 n26 : 26dB BW(MHz) / DFT-S OFDM							
BW	5MHz		10MHz					
Mod.	PI/2 BPSK		PI/2 BPSK					
Middle CH	4.95		9.41					

Mode	FR1 n26 : 26dB BW(MHz) / CP OFDM							
BW	5MHz		10MHz					
Mod.	QPSK	16QAM	QPSK	16QAM				
Middle CH	5.01	4.95	9.75	9.79				
Mod.	64QAM	256QAM	64QAM	256QAM				
Middle CH	4.89	5.01	9.93	9.91				



FR1 n26 / 5MHz / DFT-S OFDM / Middle Channel / Full RB

PI/2 BPSK

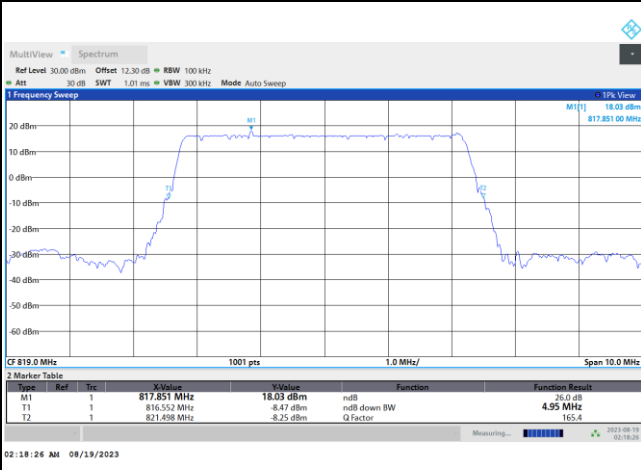

FR1 n26 / 5MHz / CP OFDM / Middle Channel / Full RB

QPSK

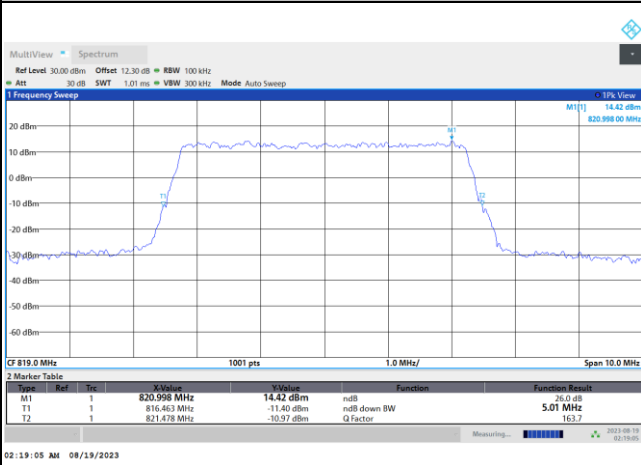

16QAM

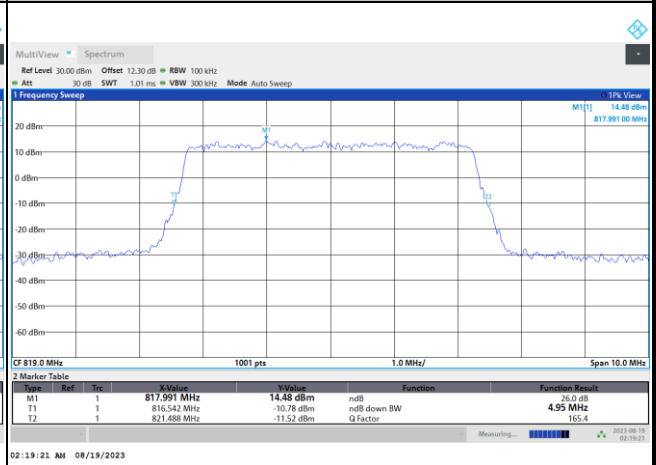

64QAM

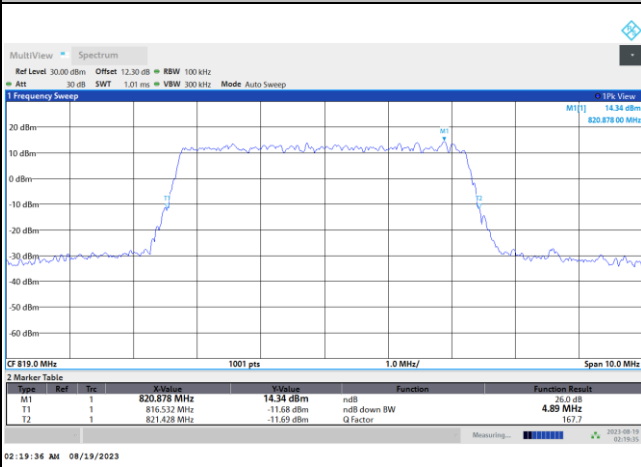

256QAM

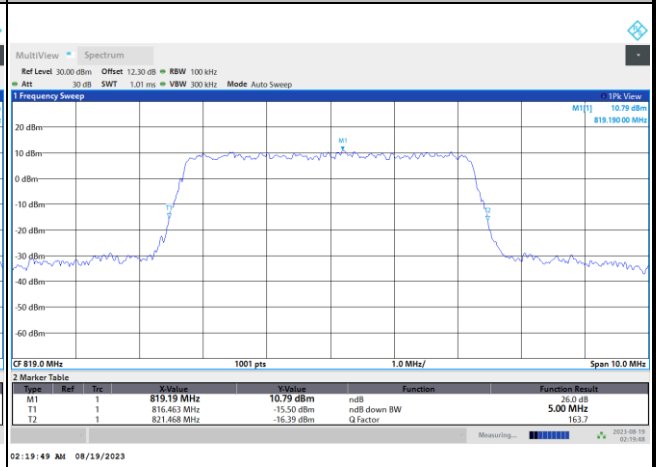



FR1 n26 / 10MHz / DFT-S OFDM / Middle Channel / Full RB

PI/2 BPSK

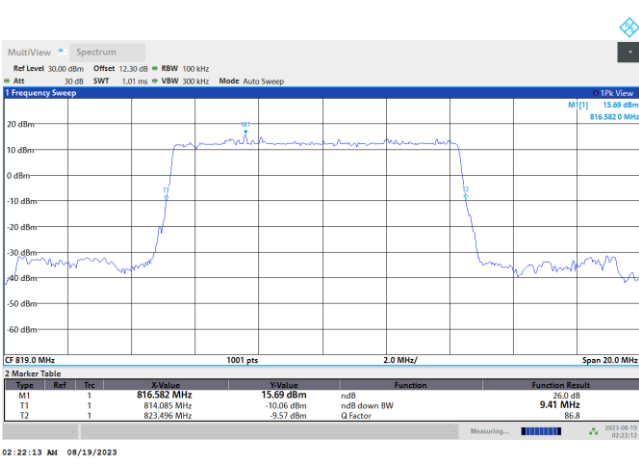

FR1 n26 / 10MHz / CP OFDM / Middle Channel / Full RB

QPSK

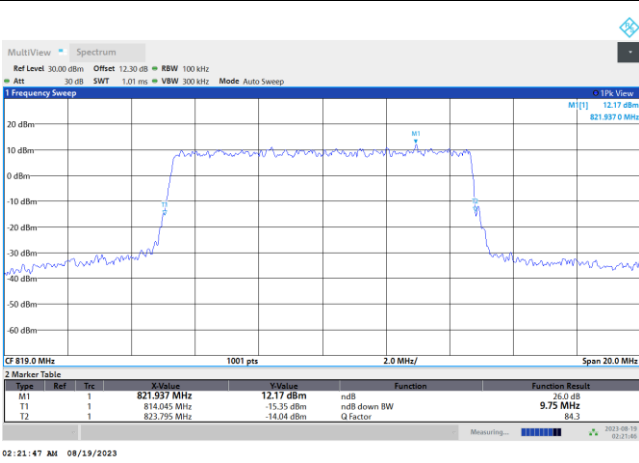

16QAM

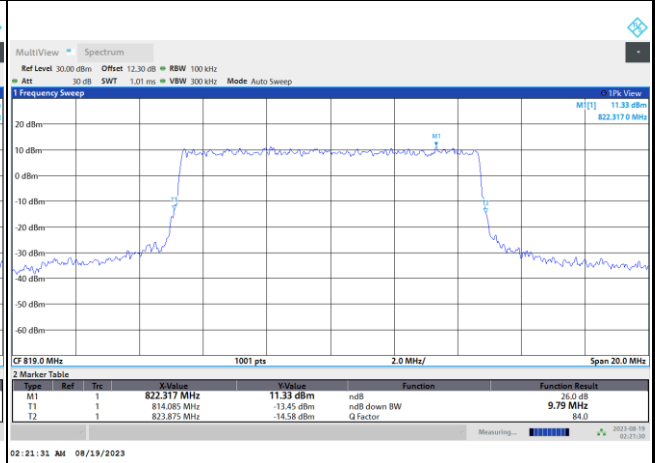

64QAM

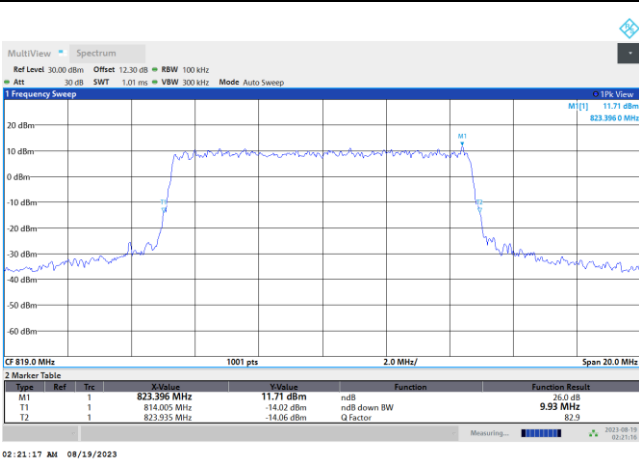

256QAM

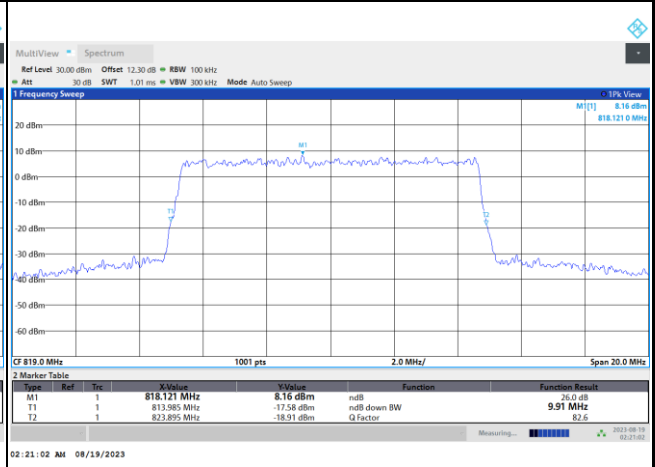



Occupied Bandwidth

Mode	FR1 n26 : 99%OBW(MHz) / DFT-S OFDM							
BW	5MHz		10MHz					
Mod.	PI/2 BPSK		PI/2 BPSK					
Middle CH	4.48		8.88					

Mode	FR1 n26 : 99%OBW (MHz) / CP OFDM							
BW	5MHz		10MHz					
Mod.	QPSK	16QAM	QPSK	16QAM				
Middle CH	4.49	4.48	9.28	9.28				
Mod.	64QAM	256QAM	64QAM	256QAM				
Middle CH	4.48	4.48	9.26	9.28				



FR1 n26 / 5MHz / DFT-S OFDM / Middle Channel / Full RB

PI/2 BPSK

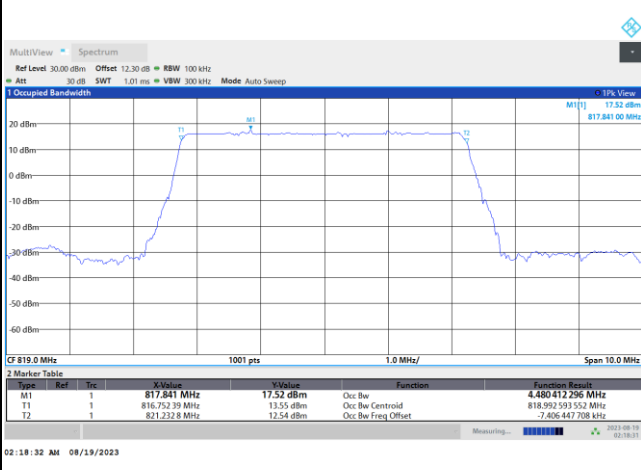

FR1 n26 / 5MHz / CP OFDM / Middle Channel / Full RB

QPSK

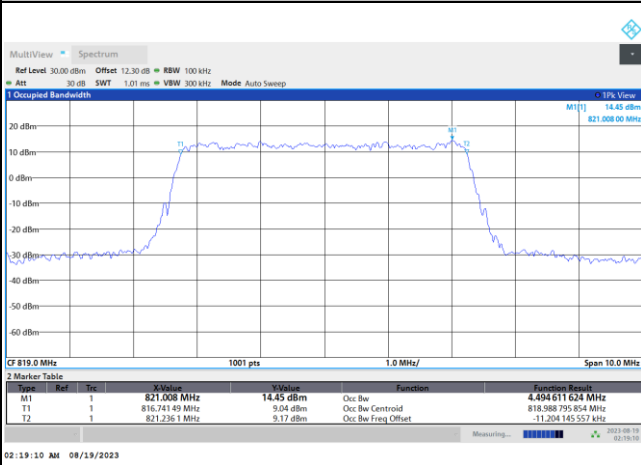

16QAM

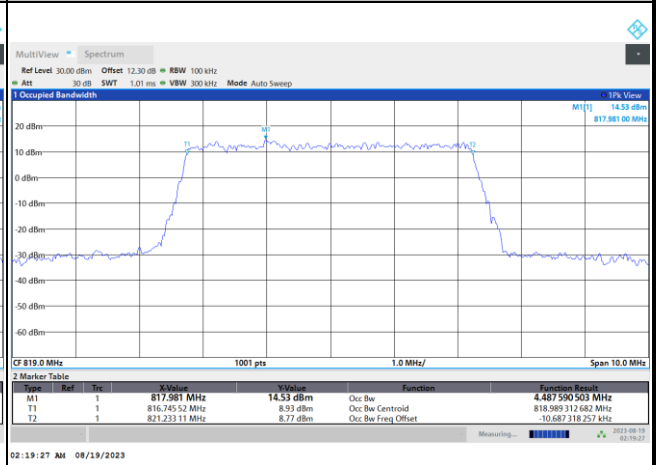

64QAM

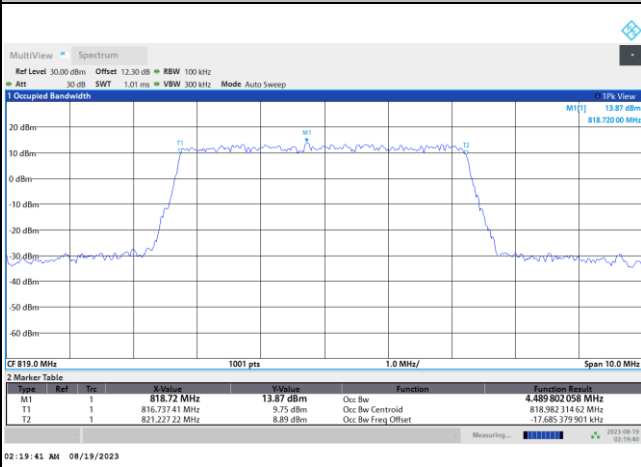

256QAM

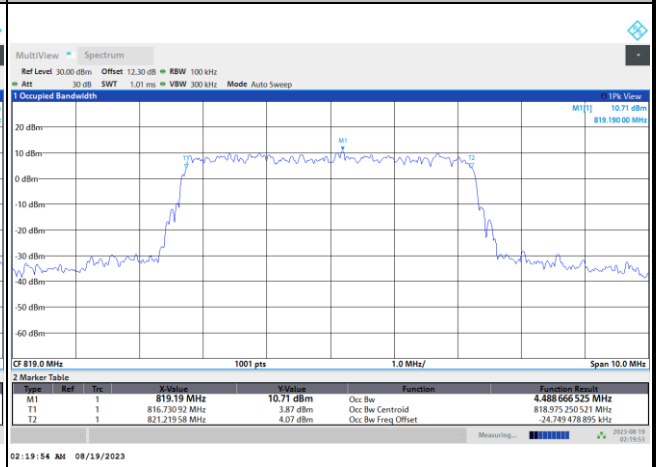



FR1 n26 / 10MHz / DFT-S OFDM / Middle Channel / Full RB

PI/2 BPSK

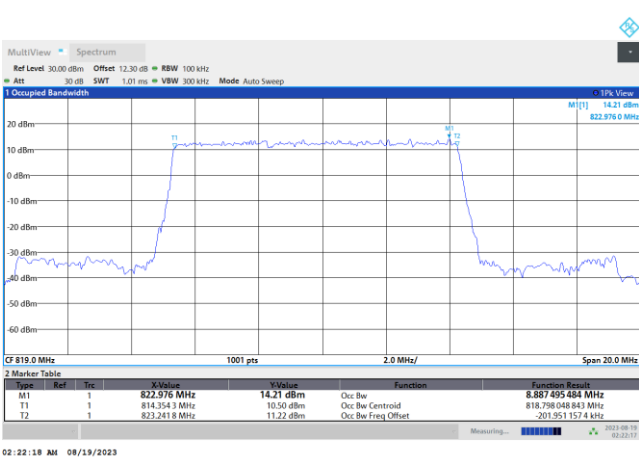

FR1 n26 / 10MHz / CP OFDM / Middle Channel / Full RB

QPSK

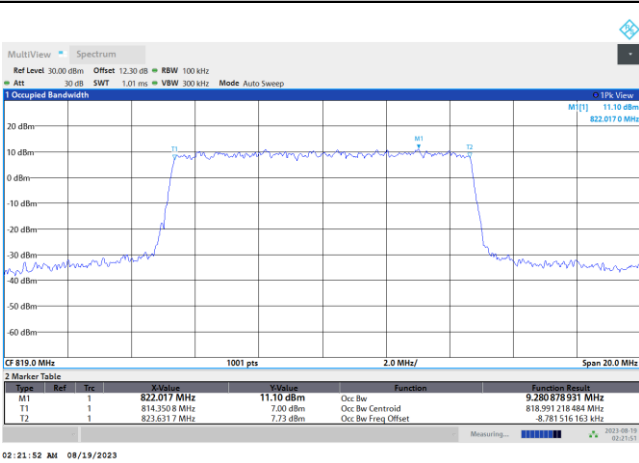

16QAM

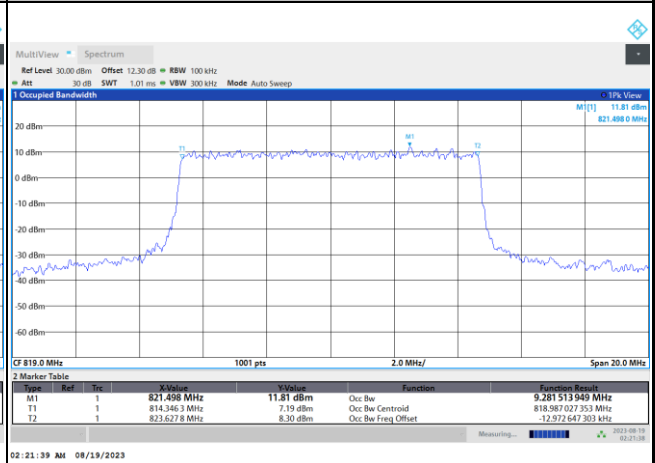

64QAM

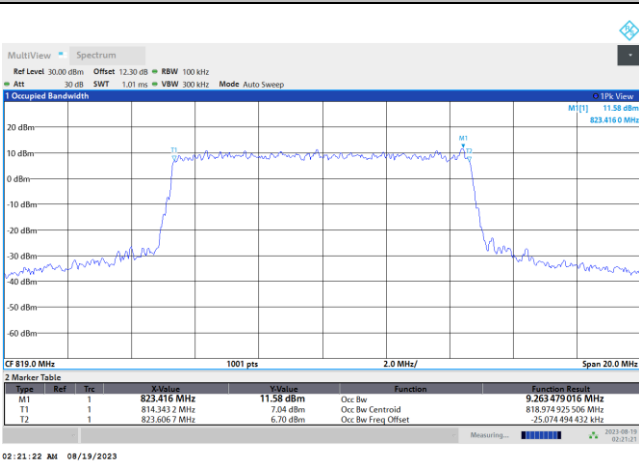

256QAM

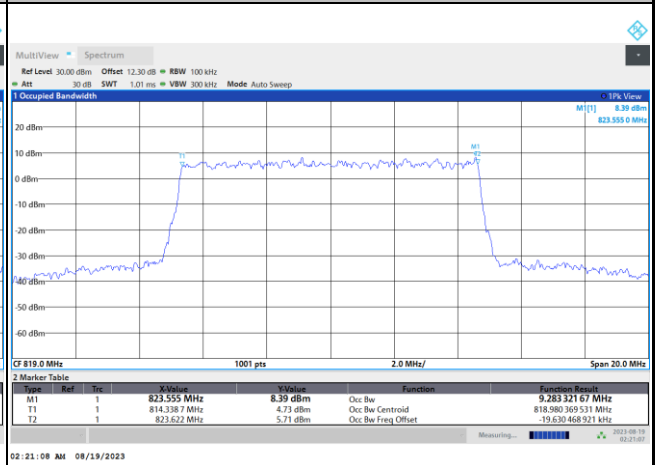



Emission masks – In-band emissions

FR1 n26 / 5MHz / DFT-S OFDM / PI/2 BPSK

Lowest MASK / 1RB0

Highest MASK / 1RBmax

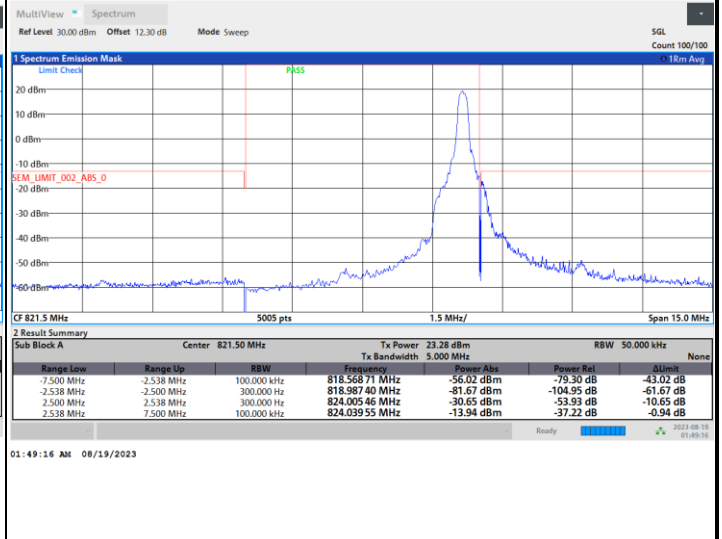
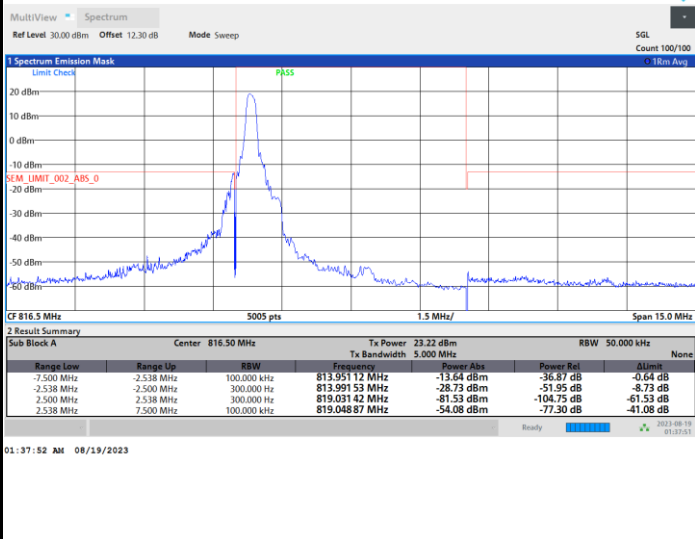

Lowest MASK / Full RB

Highest MASK / Full RB

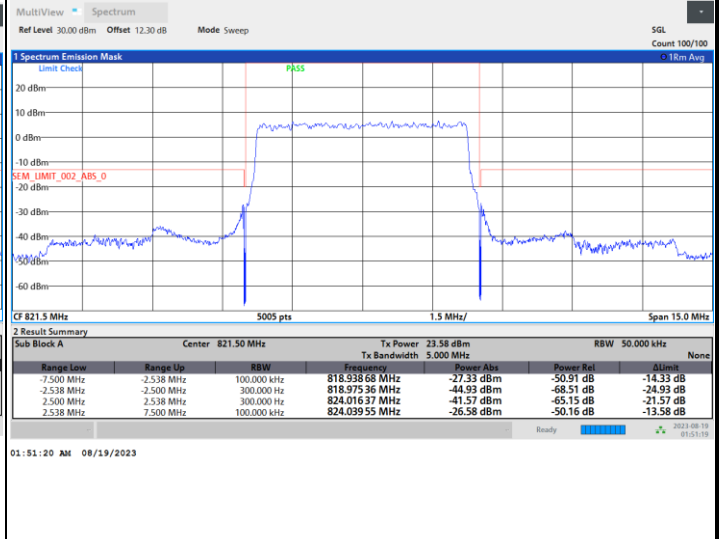
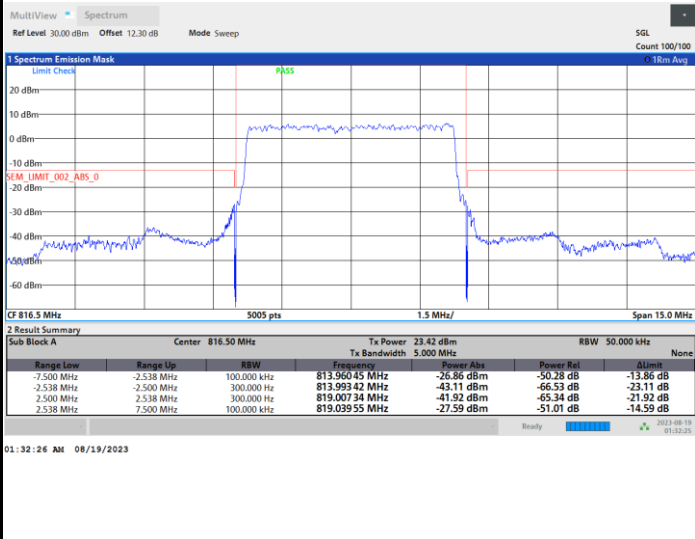



FR1 n26 / 5MHz / DFT-S OFDM / QPSK

Lowest MASK / 1RB0

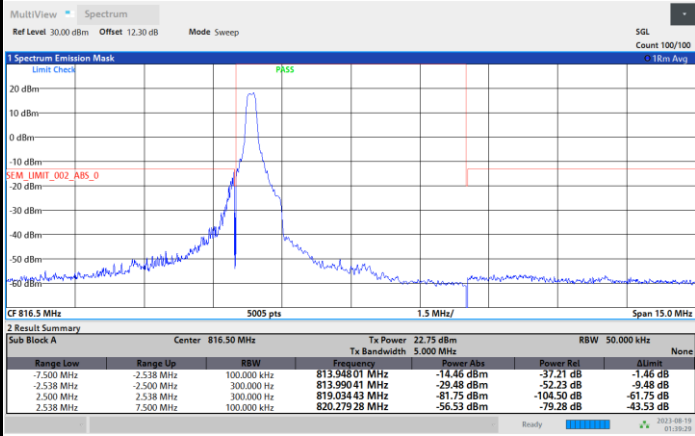

Highest MASK / 1RBmax

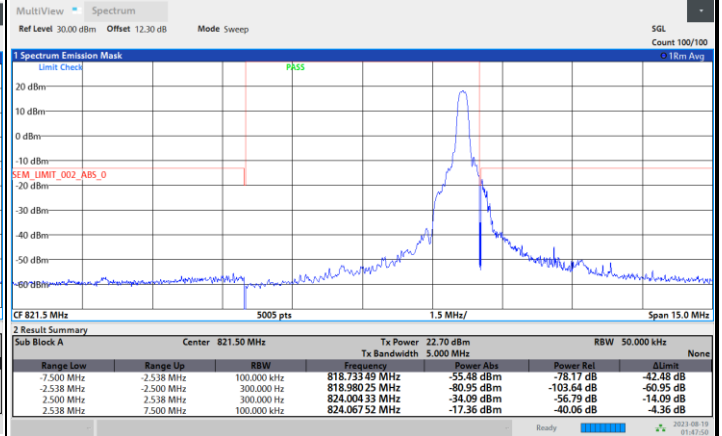

Lowest MASK / Full RB

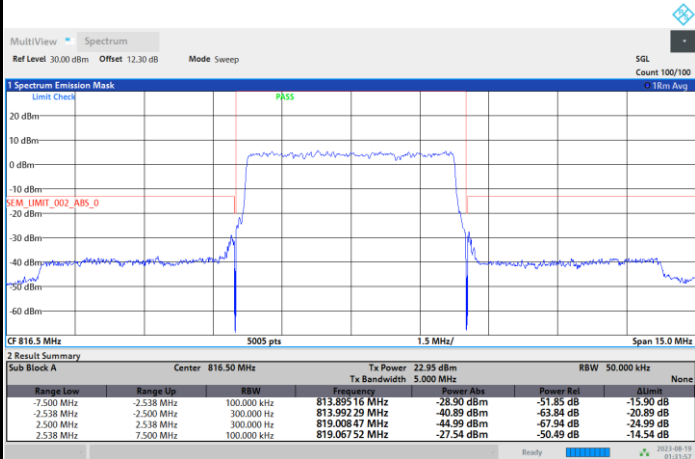

Highest MASK / Full RB

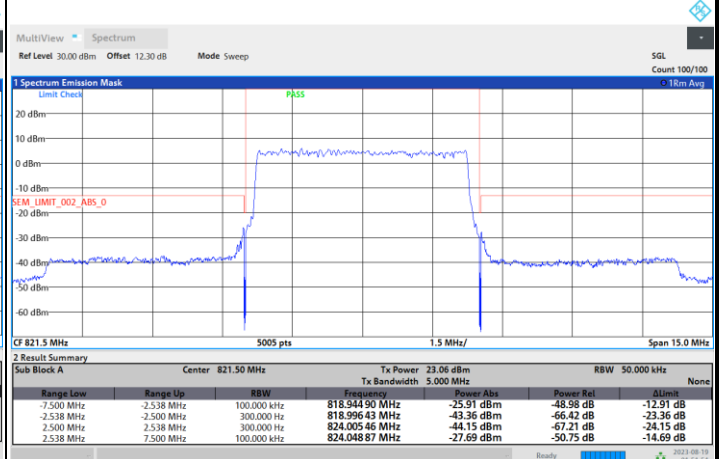



FR1 n26 / 5MHz / DFT-S OFDM / 16QAM

Lowest MASK / 1RB0

Highest MASK / 1RBmax

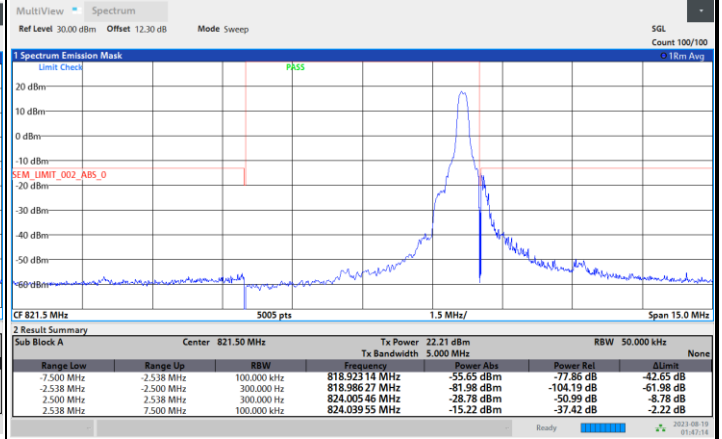
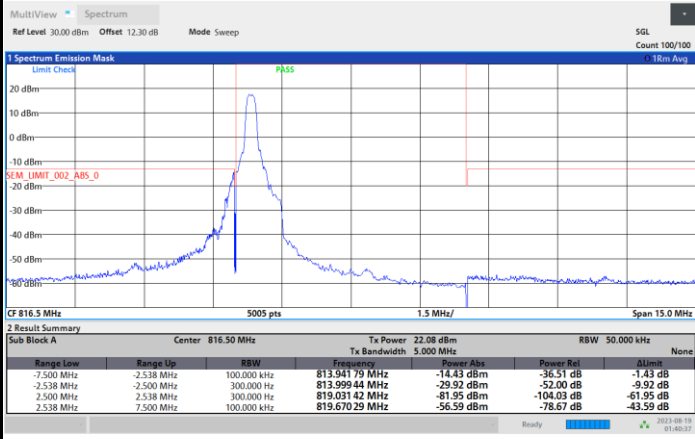

Lowest MASK / Full RB

Highest MASK / Full RB

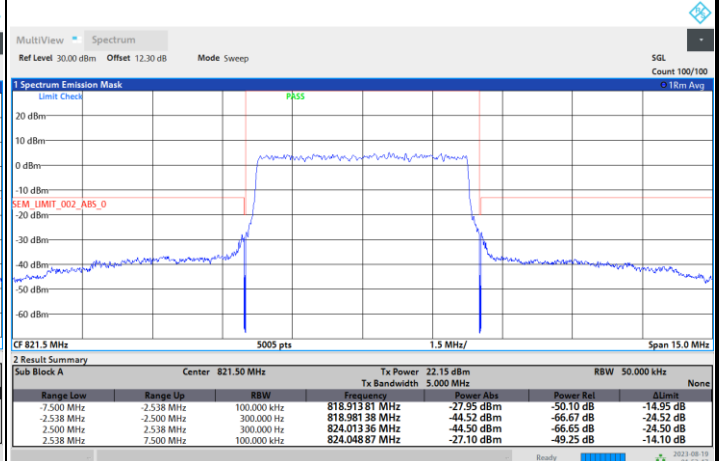
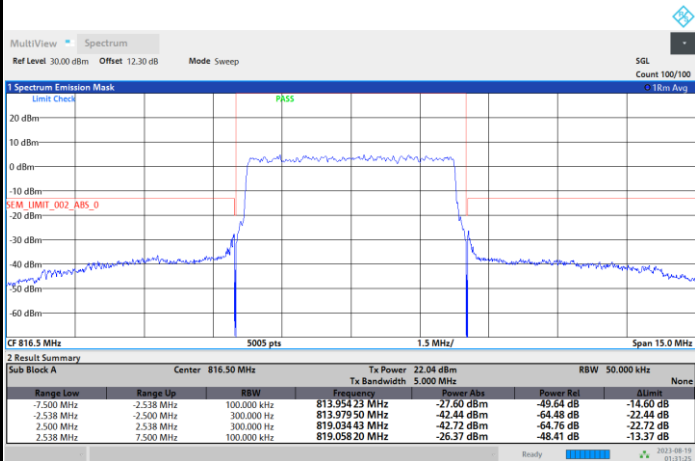



FR1 n26 / 5MHz / DFT-S OFDM / 64QAM

Lowest MASK / 1RB0

Highest MASK / 1RBmax

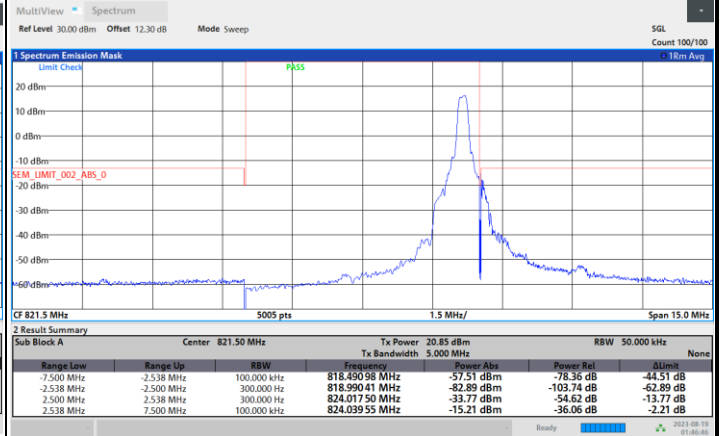
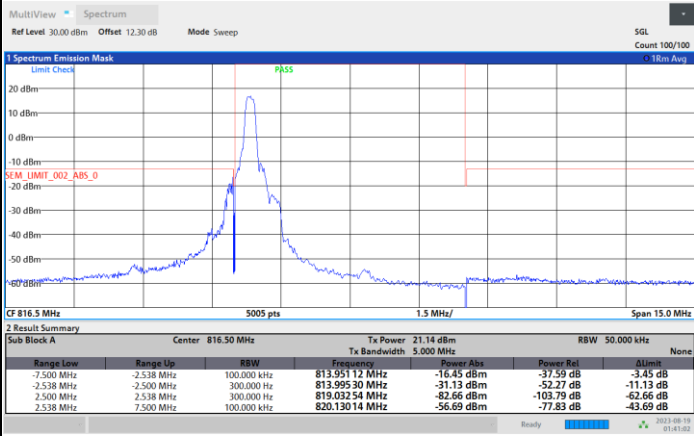

Lowest MASK / Full RB

Highest MASK / Full RB

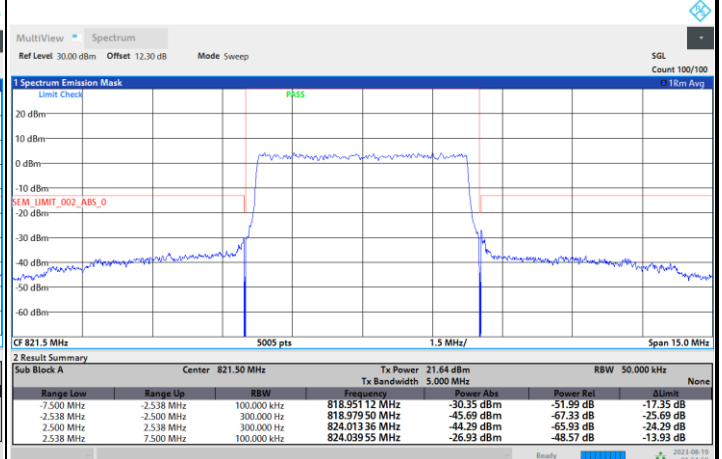
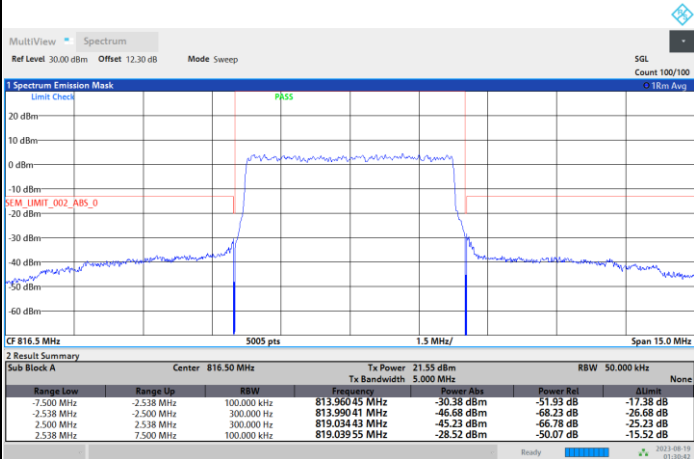



FR1 n26 / 5MHz / DFT-S OFDM / 256QAM

Lowest MASK / 1RB0

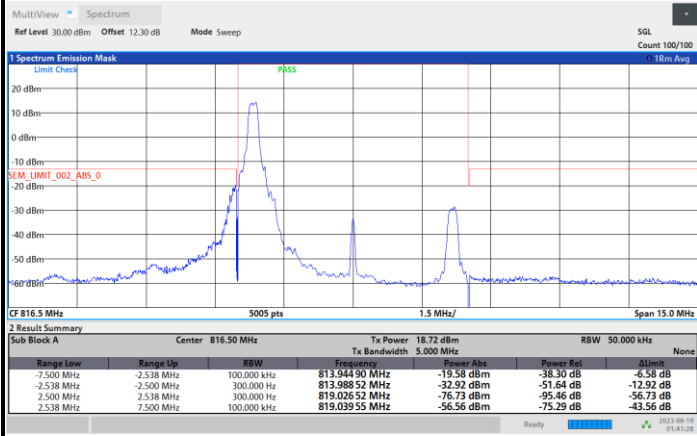

Highest MASK / 1RBmax

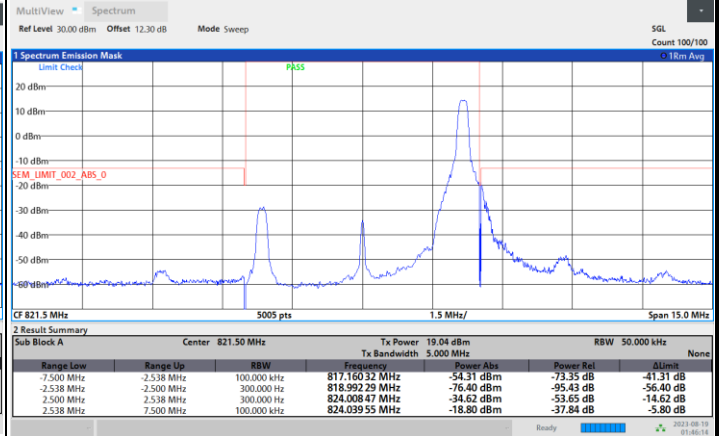

Lowest MASK / Full RB

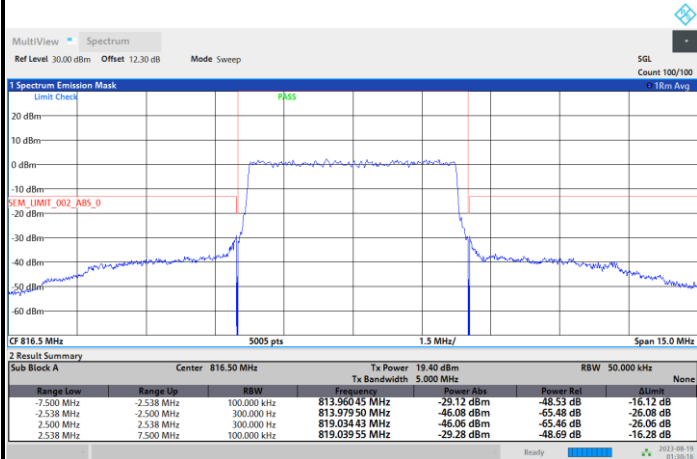

Highest MASK / Full RB

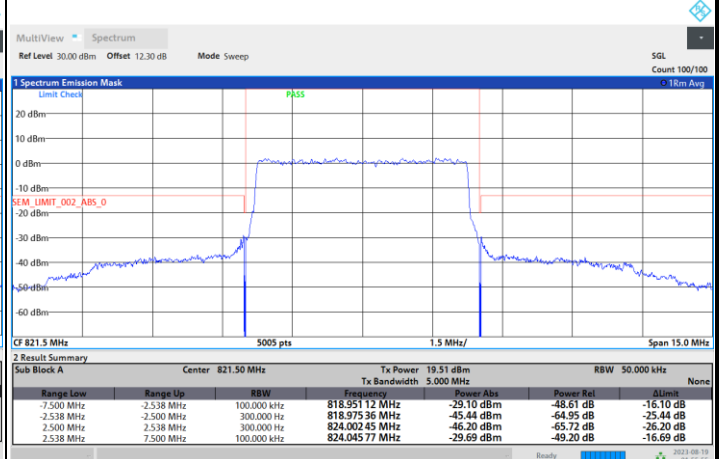



FR1 n26 / 5MHz / CP OFDM / QPSK / Full RB

Lowest MASK

Highest MASK

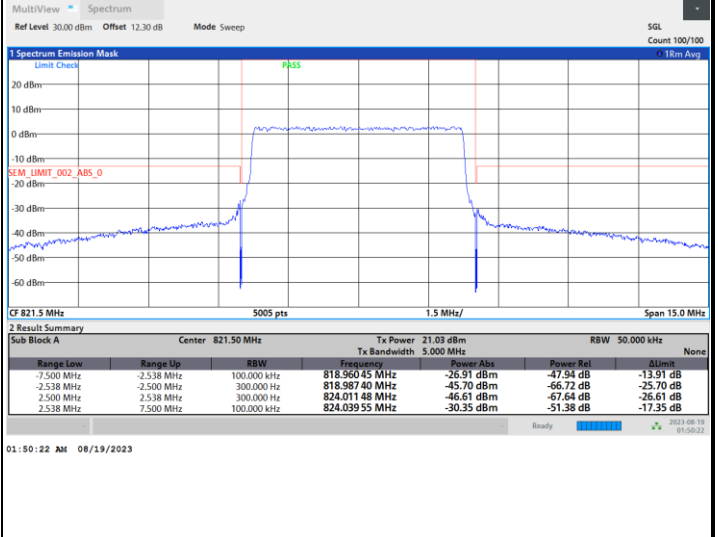
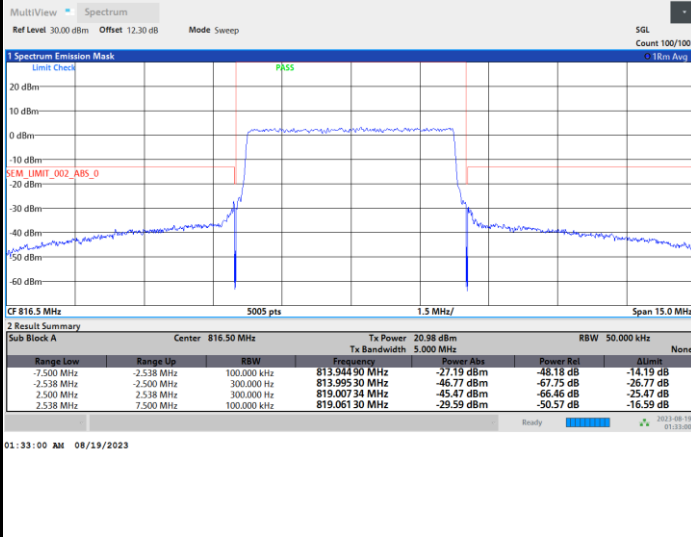



FR1 n26 / 10MHz / DFT-s-OFDM / PI/2 BPSK

Middle MASK / Full RB

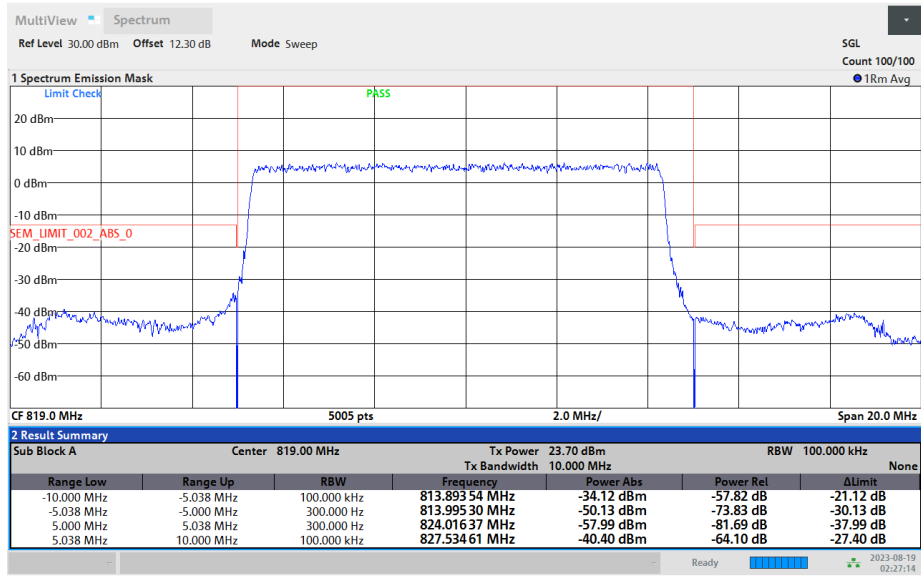

02:27:15 AM 08/19/2023

FR1 n26 / 10MHz / DFT-s-OFDM / QPSK

Lowest MASK / Full RB

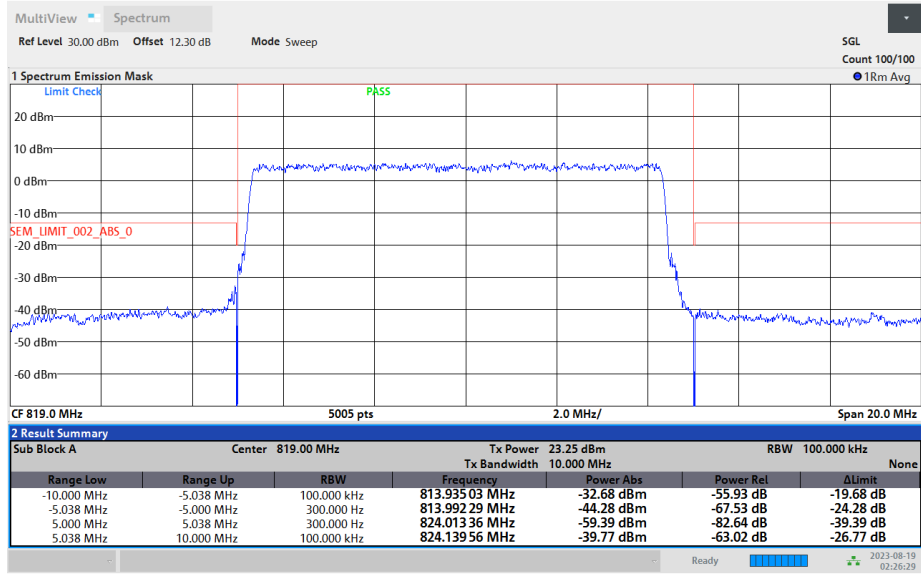

02:26:29 AM 08/19/2023



FR1 n26 / 10MHz / DFT-s-OFDM / 16QAM

Middle MASK / Full RB

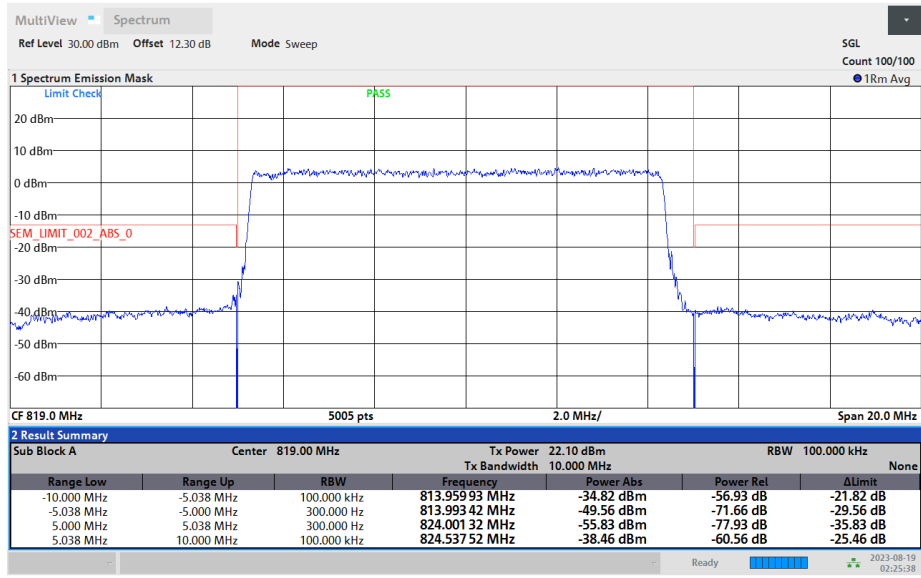

02:25:39 AM 08/19/2023

FR1 n26 / 10MHz / DFT-s-OFDM / 64QAM

Middle MASK / Full RB

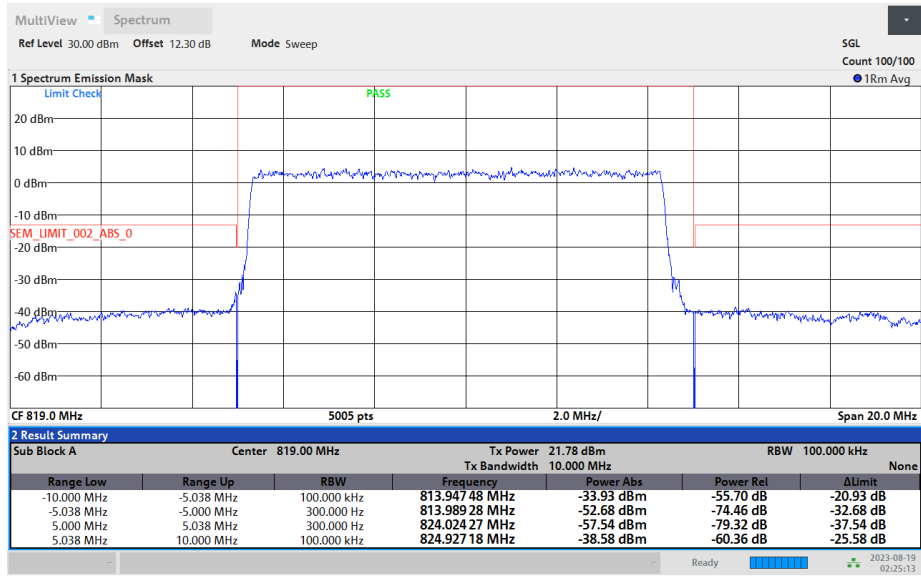

02:25:14 AM 08/19/2023



FR1 n26 / 10MHz / DFT-s-OFDM / 256QAM

Middle MASK / Full RB

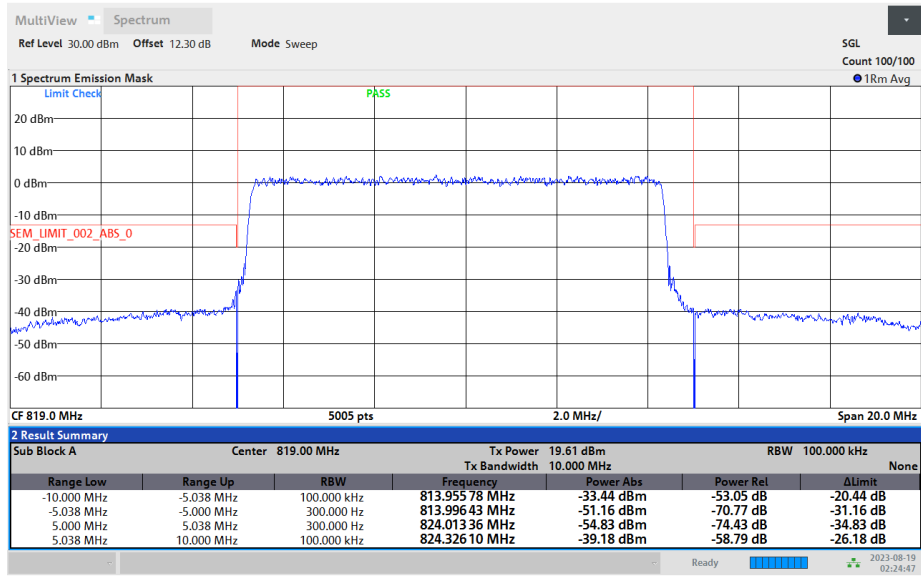

02:24:48 AM 08/19/2023

FR1 n26 / 10MHz / CP OFDM / QPSK / Full RB

Middle MASK

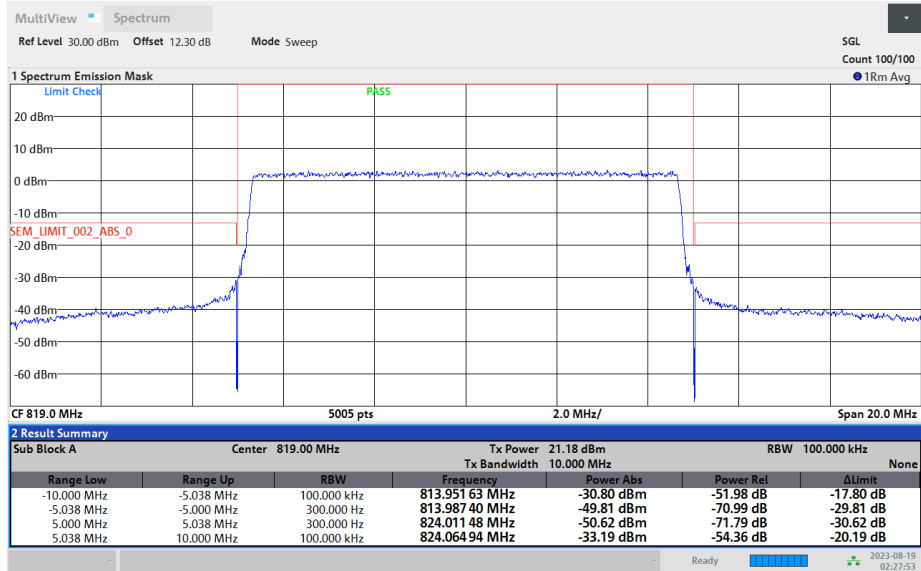

02:27:53 AM 08/19/2023



Emission masks – Out of band emissions

FR1 n26 / 5MHz / DFT-S OFDM / QPSK / 1RB1

Lowest Channel

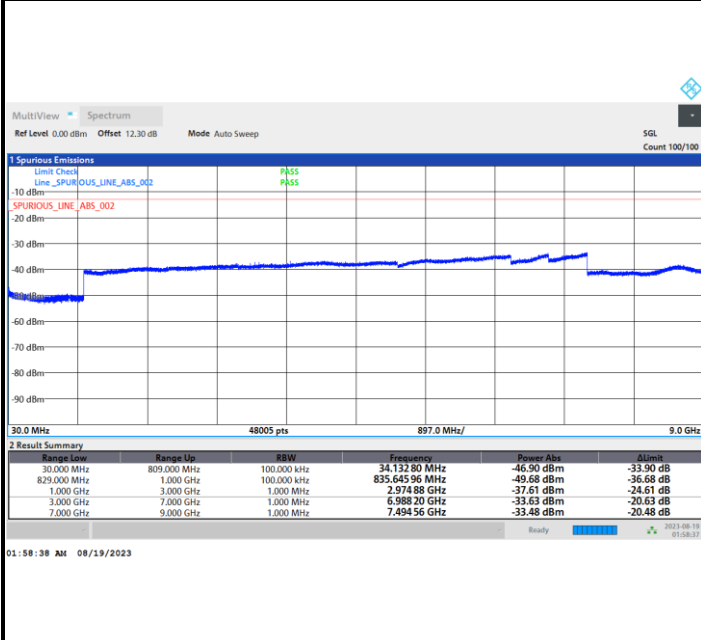

Middle Channel

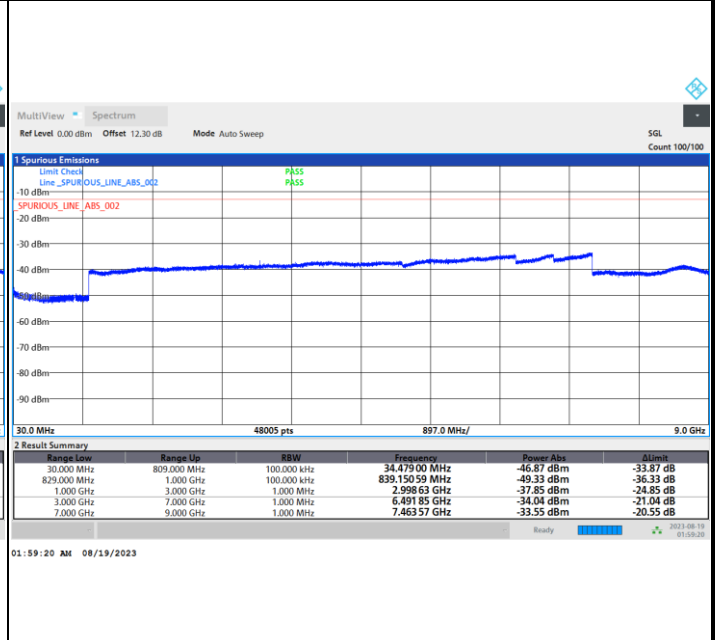

Highest Channel

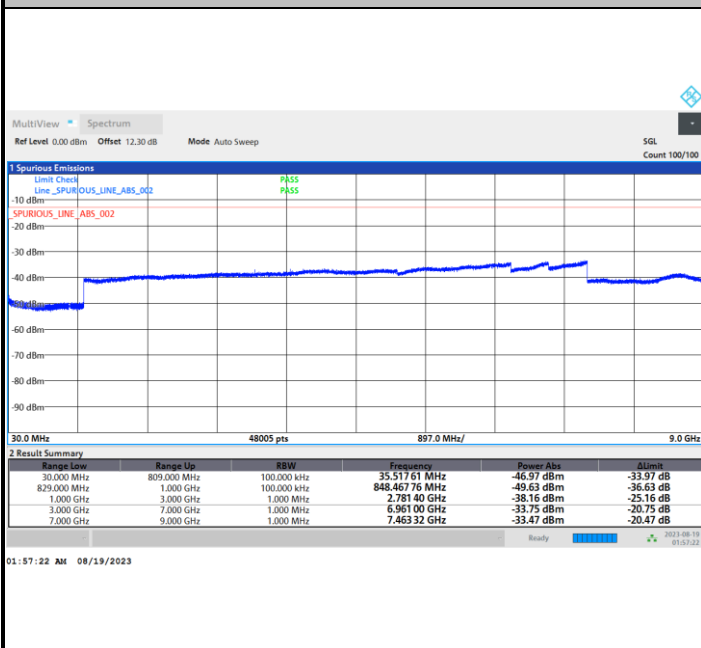



Frequency Stability

Test Conditions		FR1 n26 (BPSK) / Middle Channel	Limit
Temperature (°C)	Voltage (Volt)	BW 10MHz	2.5 ppm
		Deviation (ppm)	Result
50	Normal Voltage	0.0017	PASS
40	Normal Voltage	0.0141	
30	Normal Voltage	0.0162	
20(Ref.)	Normal Voltage	0.0000	
10	Normal Voltage	0.0097	
0	Normal Voltage	0.0100	
-10	Normal Voltage	0.0001	
-20	Normal Voltage	0.0031	
-30	Normal Voltage	0.0088	
20	Maximum Voltage	0.0006	
20	Normal Voltage	0.0127	
20	Battery End Point	0.0086	

Note: Normal Voltage = 4.05 V. ; Battery End Point (BEP) = 3.85 V. ; Maximum Voltage = 4.35 V.



FR1 n26 Straddle Channel

Peak-to-Average Ratio

Mode	FR1 n26 / 20MHz / DFT-S OFDM				
Mod.	PI/2 BPSK	QPSK	16QAM	64QAM	Limit: 13dB
RB Size	Full RB	Full RB	Full RB	Full RB	Result
824 MHz	4.18	5.66	6.46	6.64	PASS
Mode	FR1 n26 / 20MHz / DFT-S OFDM				
Mod.	256QAM				Limit: 13dB
RB Size	Full RB				Result
824 MHz	6.58				PASS



FR1 n26 / 20MHz / DFT-S OFDM / 824 MHz/ Full RB

PI/2 BPSK

QPSK

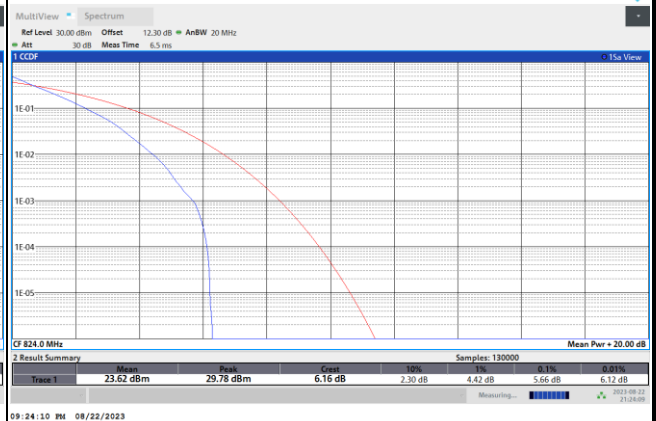
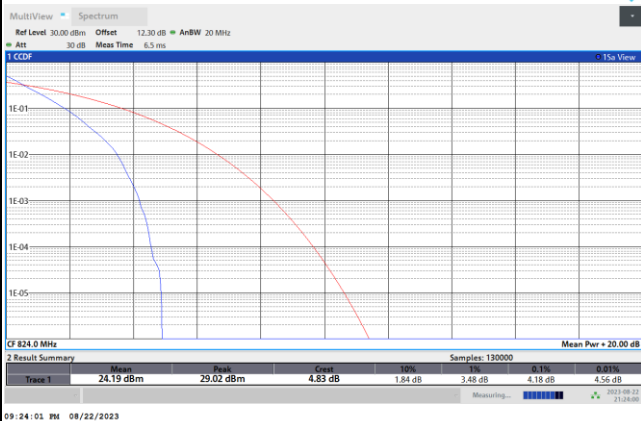

16QAM

64QAM

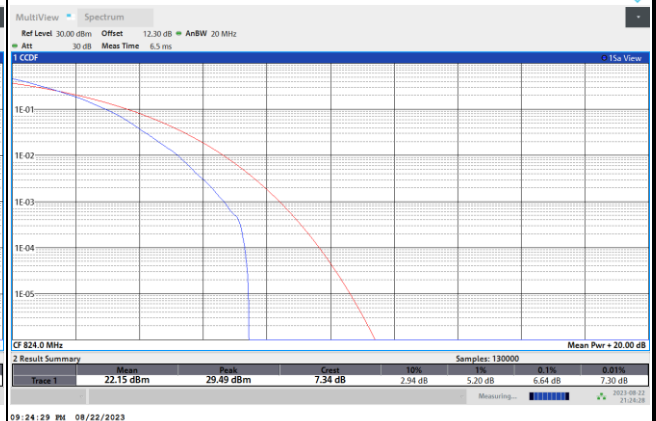
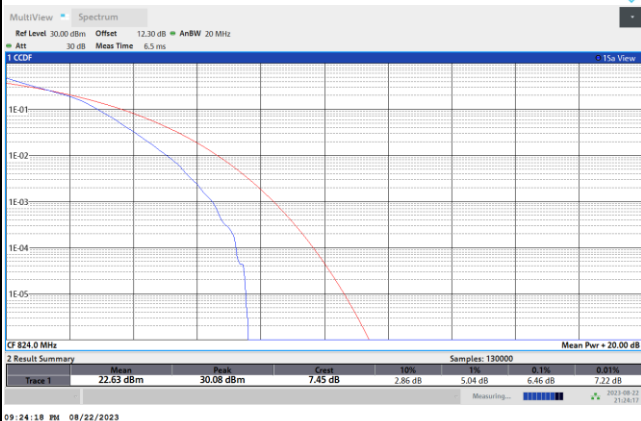

256QAM

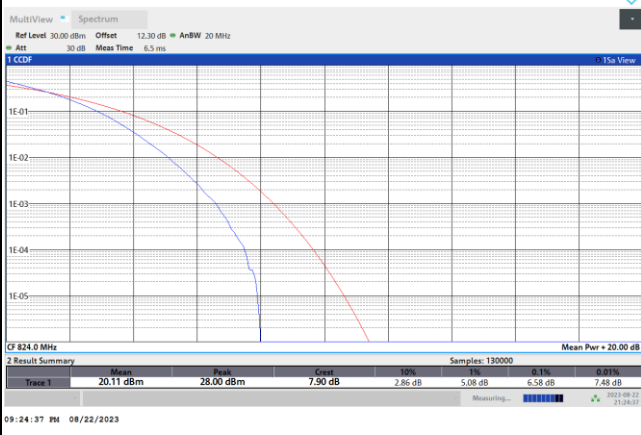



26dB Bandwidth

Mode	FR1 n26 : 26dB BW(MHz) / DFT-S OFDM							
BW	5MHz		10MHz		15MHz		20MHz	
Mod.	PI/2 BPSK		PI/2 BPSK		PI/2 BPSK		PI/2 BPSK	
Middle CH	4.92		9.47		14.30		18.78	
BW	25MHz		30MHz					
Mod.	PI/2 BPSK		PI/2 BPSK					
Middle CH	-		-					

Mode	FR1 n26 : 26dB BW(MHz) / CP OFDM							
BW	5MHz		10MHz		15MHz		20MHz	
Mod.	QPSK	16QAM	QPSK	16QAM	QPSK	16QAM	QPSK	16QAM
Middle CH	5.00	4.97	9.87	9.83	15.05	14.99	19.98	19.90
Mod.	64QAM	256QAM	64QAM	256QAM	64QAM	256QAM	64QAM	256QAM
Middle CH	4.95	5.00	9.89	9.93	15.11	15.02	19.86	19.94
BW	25MHz		30MHz					
Mod.	QPSK	16QAM	QPSK	16QAM				
Middle CH	-	-	-	-				
Mod.	64QAM	256QAM	64QAM	256QAM				
Middle CH	-	-	-	-				



FR1 n26 / 5MHz / DFT-S OFDM /824 MHz/ Full RB

PI/2 BPSK

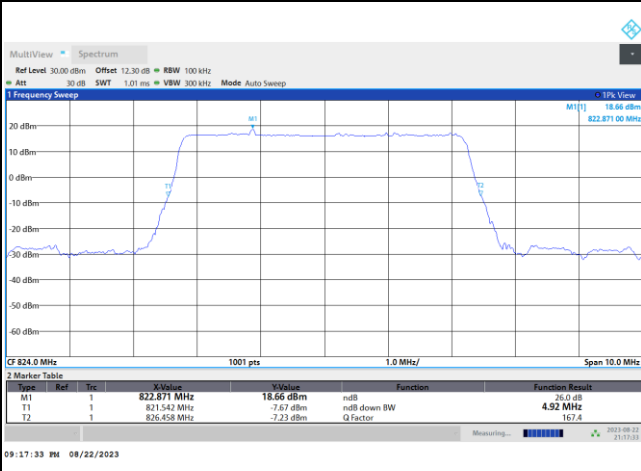

FR1 n26 / 5MHz / CP OFDM /824 MHz/ Full RB

QPSK

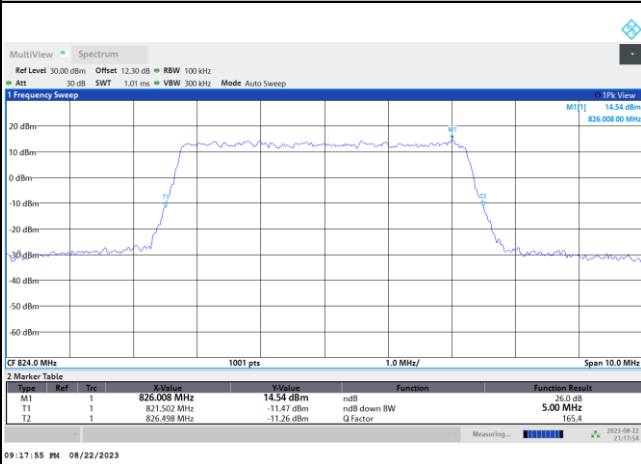

16QAM

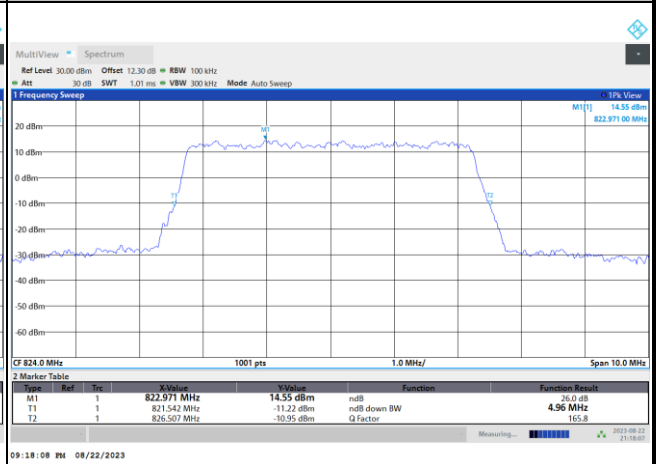

64QAM

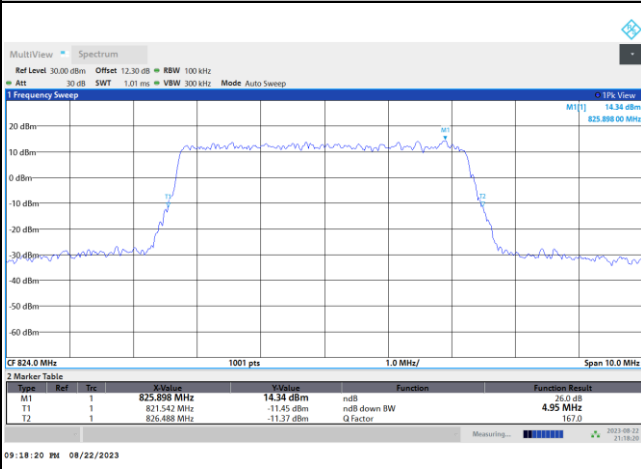

256QAM

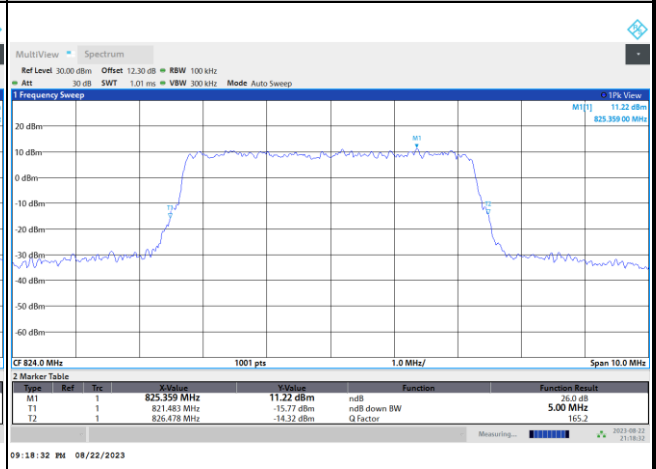



FR1 n26 / 10MHz / DFT-S OFDM /824 MHz/ Full RB

PI/2 BPSK

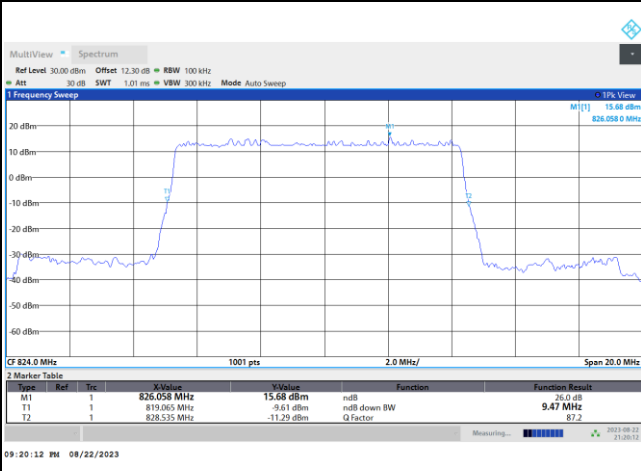

FR1 n26 / 10MHz / CP OFDM /824 MHz/ Full RB

QPSK

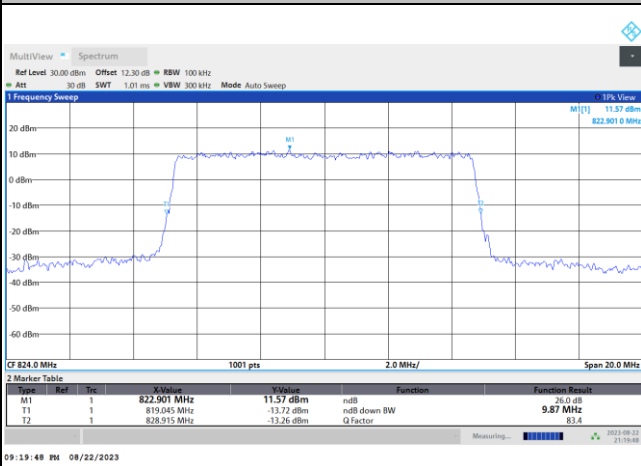

16QAM

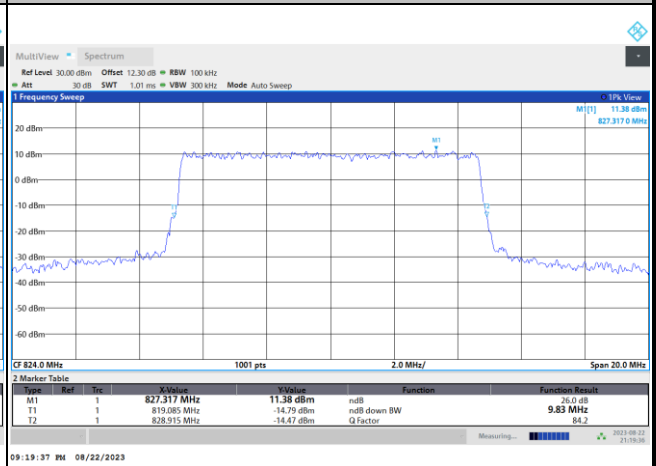

64QAM

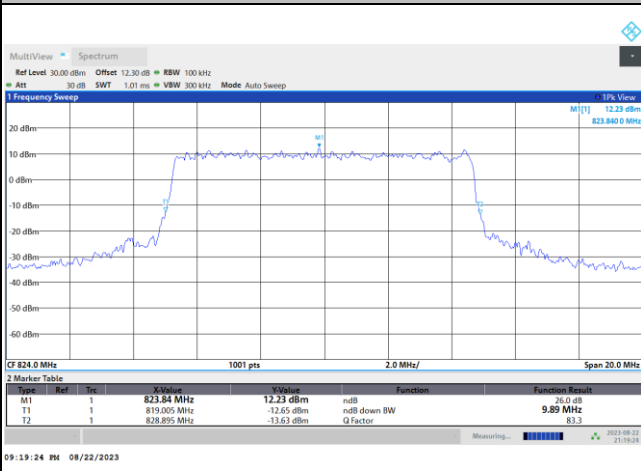

256QAM

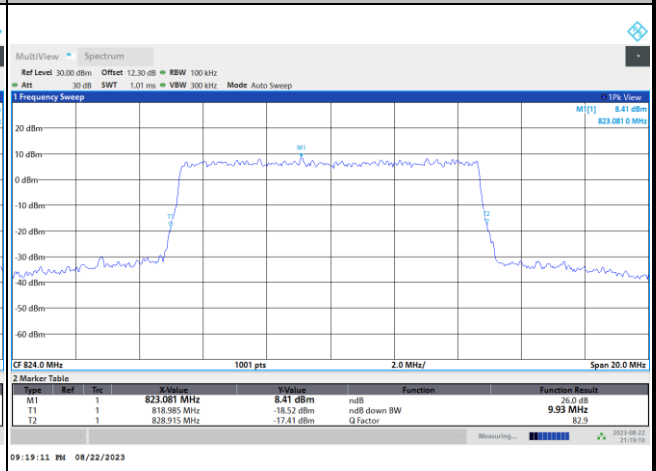



FR1 n26 / 15MHz / DFT-S OFDM /824 MHz/ Full RB

PI/2 BPSK

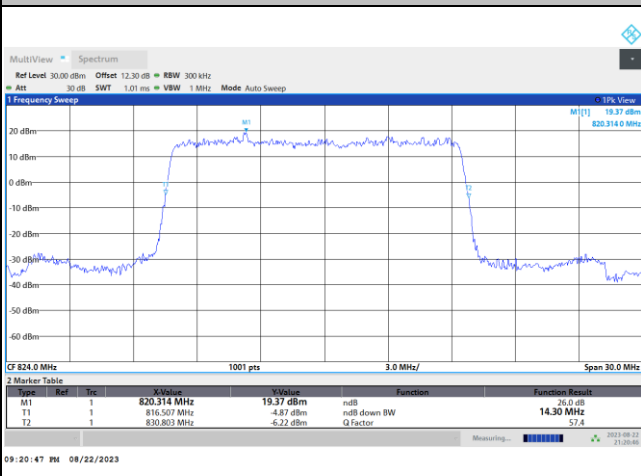

FR1 n26 / 15MHz / CP OFDM /824 MHz/ Full RB

QPSK

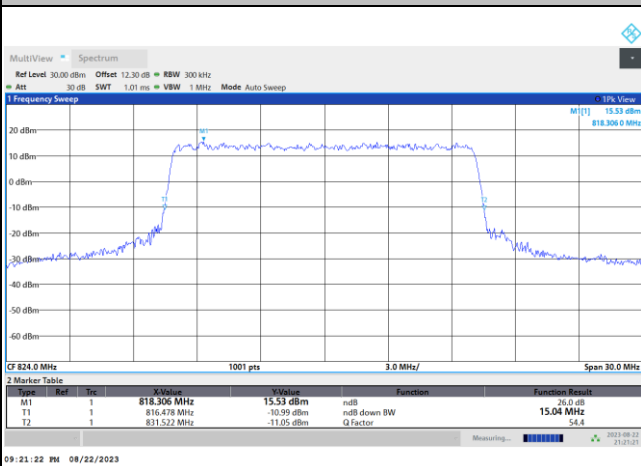

16QAM

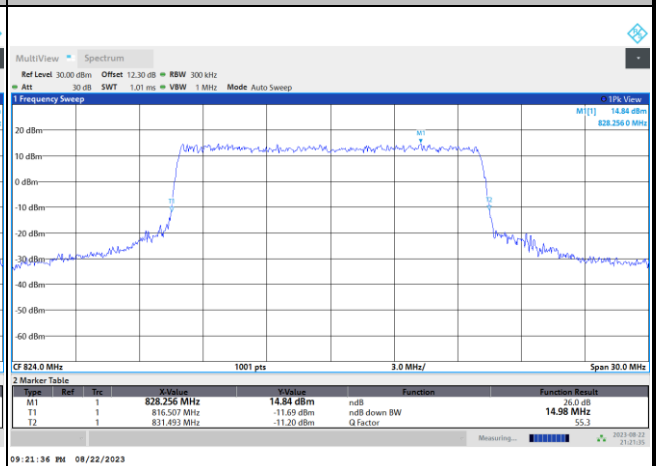

64QAM

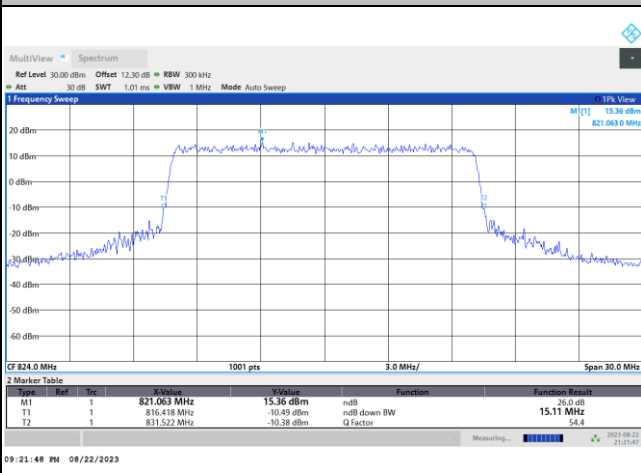

256QAM

