



# FCC RADIO TEST REPORT

**FCC ID** : UZ7ET56DE  
**Equipment** : Tablet  
**Brand Name** : ZEBRA  
**Model Name** : ET56DE  
**Applicant** : Zebra Technologies Corporation  
1 Zebra Plaza, Holtsville, NY 11742  
**Manufacturer** : Zebra Technologies Corporation  
1 Zebra Plaza, Holtsville, NY 11742  
**Standard** : FCC Part 15 Subpart C §15.247

The product was received on Jan. 16, 2019 and testing was started from Jun. 23, 2019 and completed on Jul. 27, 2019. We, SPORTON INTERNATIONAL INC., EMC & Wireless Communications Laboratory, would like to declare that the tested sample has been evaluated in accordance with the test procedures and has been in compliance with the applicable technical standards.

The report must not be used by the client to claim product certification, approval, or endorsement by TAF or any agency of government.

The test results in this report apply exclusively to the tested model / sample. Without written approval of SPORTON INTERNATIONAL INC. EMC & Wireless Communications Laboratory, the test report shall not be reproduced except in full.

Approved by: Louis Wu

**SPORTON INTERNATIONAL INC. EMC & Wireless Communications Laboratory**  
No. 52, Huaya 1st Rd., Guishan Dist., Taoyuan City, Taiwan (R.O.C.)



## Table of Contents

History of this test report.....	3
Summary of Test Result.....	4
<b>1 General Description .....</b>	<b>5</b>
1.1 Product Feature of Equipment Under Test.....	5
1.2 Product Specification of Equipment Under Test.....	6
1.3 Modification of EUT .....	7
1.4 Testing Location .....	8
1.5 Applicable Standards.....	8
<b>2 Test Configuration of Equipment Under Test .....</b>	<b>9</b>
2.1 Carrier Frequency and Channel .....	9
2.2 Test Mode.....	10
2.3 Connection Diagram of Test System.....	16
2.4 Support Unit used in test configuration and system .....	17
2.5 EUT Operation Test Setup .....	17
2.6 Measurement Results Explanation Example.....	18
<b>3 Test Result .....</b>	<b>19</b>
3.1 6dB and 99% Bandwidth Measurement .....	19
3.2 Output Power Measurement.....	23
3.3 Power Spectral Density Measurement .....	27
3.4 Conducted Band Edges and Spurious Emission Measurement .....	31
3.5 Radiated Band Edges and Spurious Emission Measurement .....	92
3.6 AC Conducted Emission Measurement.....	97
3.7 Antenna Requirements.....	99
<b>4 List of Measuring Equipment.....</b>	<b>101</b>
<b>5 Uncertainty of Evaluation .....</b>	<b>103</b>
<b>Appendix A. AC Conducted Emission Test Result</b>	
<b>Appendix B. Radiated Spurious Emission</b>	
<b>Appendix C. Radiated Spurious Emission Plots</b>	
<b>Appendix D. Duty Cycle Plots</b>	
<b>Appendix E. Setup Photographs</b>	





### Summary of Test Result

Report Clause	Ref Std. Clause	Test Items	Result (PASS/FAIL)	Remark
3.1	15.247(a)(2)	6dB Bandwidth	Pass	-
3.1	2.1049	99% Occupied Bandwidth	Reporting only	-
3.2	15.247(b)	Power Output Measurement	Pass	-
3.3	15.247(e)	Power Spectral Density	Pass	-
3.4	15.247(d)	Conducted Band Edges	Pass	-
		Conducted Spurious Emission	Pass	-
3.5	15.247(d)	Radiated Band Edges and Radiated Spurious Emission	Pass	Under limit 1.12 dB at 2483.550 MHz
3.6	15.207	AC Conducted Emission	Pass	Under limit 7.38 dB at 13.560 MHz
3.7	15.203 & 15.247(b)	Antenna Requirement	Pass	-

<b>Declaration of Conformity:</b>
The test results with all measurement uncertainty excluded are presented in accordance with the regulation limits or requirements declared by manufacturers.
<b>Comments and Explanations:</b>
The declared of product specification for EUT presented in the report are provided by the manufacturer, and the manufacturer takes all the responsibilities for the accuracy of product specification.

Reviewed by: Wii Chang

Report Producer: Jessie Ho



# 1 General Description

## 1.1 Product Feature of Equipment Under Test

Product Feature	
Equipment	Tablet
Brand Name	ZEBRA
Model Name	ET56DE
FCC ID	UZ7ET56DE
EUT supports Radios application	WCDMA/HSPA/LTE/NFC/GNSS WLAN 11a/b/g/n HT20/HT40 WLAN 11ac VHT20/VHT40/VHT80 Bluetooth BR/EDR/LE
HW Version	DV2
SW Version	Android version 8.1.0
FW Version	01-20-03-00-OG-U00-PRD
FW Version for TXBF	01-19-08-00-0G-U00-PLT
MFD	19Jun01
EUT Stage	Identical Prototype

Remark: The above EUT's information was declared by manufacturer.

Specification of Accessories				
Spare Standard Battery 24.13Wh	Brand Name	Zebra	Model Name	BT-000393

Supported Unit Used in Test Configuration and System				
Cradle (Dock) for EMC	Brand Name	Zebra	Part Number	CRD-ET5X-1SCG1
Cradle (Dock) for RSE	Brand Name	Zebra	Part Number	CHG-ET5X-CBL1-01
Adapter	Brand Name	Zebra	Part Number	PWRBGA12V50W0WW
DC Cable	Brand Name	Zebra	Part Number	CBL-DC-388A1-01



## 1.2 Product Specification of Equipment Under Test

Standards-related Product Specification	
<b>Tx/Rx Channel Frequency Range</b>	2412 MHz ~ 2462 MHz
<b>Maximum (Average) Output Power to antenna &lt;CDD Mode&gt;</b>	<p><b>&lt;Ant. 1&gt;</b>            802.11b : 21.40 dBm (0.1380 W)            802.11g : 19.10 dBm (0.0813 W)            802.11n HT20 : 18.90 dBm (0.0776 W)            802.11n HT40 : 17.70 dBm (0.0589 W)            802.11ac VHT20 : 17.90 dBm(0.0617 W)            802.11ac VHT40 : 17.30 dBm(0.0537 W)</p> <p><b>&lt;Ant. 2&gt;</b>            802.11b : 21.30 dBm (0.1349 W)            802.11g : 19.20 dBm (0.0832 W)            802.11n HT20 : 18.90 dBm (0.0776 W)            802.11n HT40 : 17.80 dBm (0.0603 W)            802.11ac VHT20 : 17.90 dBm(0.0617 W)            802.11ac VHT40 : 16.90 dBm(0.0490 W)</p> <p><b>&lt;MIMO Ant. 1 + 2&gt;</b>            802.11b : 24.41 dBm (0.2761 W)            802.11g : 22.21 dBm (0.1663 W)            802.11n HT20 : 21.66 dBm (0.1466 W)            802.11n HT40 : 20.66 dBm (0.1164 W)            802.11ac VHT20 : 20.61 dBm(0.1151 W)            802.11ac VHT40 : 20.21 dBm(0.1050 W)</p>
<b>Maximum (Average) Output Power to antenna &lt;TXBF Mode&gt;</b>	<p><b>&lt;MIMO Ant. 1 + 2&gt;</b>            802.11ac VHT20 : 21.71 dBm(0.1483 W)            802.11ac VHT40 : 19.87 dBm(0.0971 W)</p>
<b>99% Occupied Bandwidth &lt;CDD Mode&gt;</b>	<p><b>&lt;Ant. 1&gt;</b>            802.11b : 13.25MHz            802.11g : 16.75MHz            802.11ac VHT20 : 17.95MHz            802.11ac VHT40 : 36.60MHz</p> <p><b>&lt;Ant. 2&gt;</b>            802.11b : 13.10MHz            802.11g : 16.90MHz            802.11ac VHT20 : 17.95MHz            802.11ac VHT40 : 36.60MHz</p> <p><b>&lt;MIMO Ant. 1&gt;</b>            802.11b : 13.40MHz            802.11g : 16.85MHz            802.11ac VHT20 : 17.95MHz            802.11ac VHT40 : 36.70MHz</p> <p><b>&lt;MIMO Ant. 2&gt;</b>            802.11b : 13.70MHz            802.11g : 16.80MHz            802.11ac VHT20 : 17.95MHz            802.11ac VHT40 : 36.60MHz</p>



Standards-related Product Specification			
<b>99% Occupied Bandwidth &lt;TXBF Mode&gt;</b>	<b>&lt;MIMO Ant. 1&gt;</b> 802.11ac VHT20 : 17.88MHz 802.11ac VHT40 : 37.16MHz		
	<b>&lt;MIMO Ant. 2&gt;</b> 802.11ac VHT20 : 17.98MHz 802.11ac VHT40 : 37.26MHz		
<b>Antenna Type / Gain</b>	<Ant. 1> Chip Antenna with gain 1.24 dBi <Ant. 2> Chip Antenna with gain 2.46 dBi		
<b>Type of Modulation</b>	802.11b : DSSS (DBPSK / DQPSK / CCK) 802.11g/n : OFDM (BPSK / QPSK / 16QAM / 64QAM) 802.11ac: OFDM (BPSK / QPSK / 16QAM / 64QAM / 256QAM)		
<b>Antenna Function Description</b>		Ant. 1	Ant. 2
	802.11 b/g/n/ac	V	V
	802.11 b/g/n/ac MIMO	V	V
	802.11 ac TXBF	V	V

Note: MIMO Ant. 1+2 is a calculated result from sum of the power MIMO Ant. 1 and MIMO Ant. 2.

### 1.3 Modification of EUT

No modifications are made to the EUT during all test items.



### 1.4 Testing Location

<b>Test Site</b>	SPORTON INTERNATIONAL INC. EMC & Wireless Communications Laboratory	
<b>Test Site Location</b>	No.52, Huaya 1st Rd., Guishan Dist., Taoyuan City, Taiwan (R.O.C.) TEL: +886-3-327-3456 FAX: +886-3-328-4978	
<b>Test Site No.</b>	<b>Sporton Site No.</b>	
	TH05-HY	CO05-HY

**Note:** The test site complies with ANSI C63.4 2014 requirement.

<b>Test Site</b>	SPORTON INTERNATIONAL INC. EMC & Wireless Communications Laboratory	
<b>Test Site Location</b>	No.58, Aly. 75, Ln. 564, Wenhua 3rd, Rd., Guishan Dist., Taoyuan City, Taiwan (R.O.C.) TEL: +886-3-327-0868 FAX: +886-3-327-0855	
<b>Test Site No.</b>	<b>Sporton Site No.</b>	
	03CH13-HY	

**Note:** The test site complies with ANSI C63.4 2014 requirement.

FCC designation No.: TW1190 and TW0007

### 1.5 Applicable Standards

According to the specifications of the manufacturer, the EUT must comply with the requirements of the following standards:

- ♦ FCC Part 15 Subpart C §15.247
- ♦ FCC KDB Publication No. 558074 D01 DTS Meas. Guidance v05r02
- ♦ FCC KDB 414788 D01 Radiated Test Site v01r01.
- ♦ FCC KDB 662911 D01 Multiple Transmitter Output v02r01.
- ♦ ANSI C63.10-2013

**Remark:**

1. All test items were verified and recorded according to the standards and without any deviation during the test.
2. This EUT has also been tested and complied with the requirements of FCC Part 15, Subpart B, recorded in a separate test report.





## 2 Test Configuration of Equipment Under Test

- a. The EUT has been associated with peripherals and configuration operated in a manner tended to maximize its emission characteristics in a typical application. Frequency range investigated: conduction emission (150 kHz to 30 MHz), radiation emission (9 kHz to the 10th harmonic of the highest fundamental frequency or to 40 GHz, whichever is lower). For radiated measurement, pre-scanned in three orthogonal panels, X, Y, Z. The worst cases (X plane) were recorded in this report.
  
- b. AC power line Conducted Emission was tested under maximum output power.

### 2.1 Carrier Frequency and Channel

Frequency Band	Channel	Freq. (MHz)	Channel	Freq. (MHz)
2400-2483.5 MHz	1	2412	7	2442
	2	2417	8	2447
	3	2422	9	2452
	4	2427	10	2457
	5	2432	11	2462
	6	2437		



## 2.2 Test Mode

Final test modes are considering the modulation and worse data rates as below table.

### Single Mode

Modulation	Data Rate
802.11b	1 Mbps
802.11g	6 Mbps
802.11n HT20	MCS0
802.11n HT40	MCS0
802.11ac VHT20 (Covered by HT20)	MCS0
802.11ac VHT40 (Covered by HT40)	MCS0

### MIMO Mode

Modulation	Data Rate
802.11b	1 Mbps
802.11g	6 Mbps
802.11n HT20	MCS0
802.11n HT40	MCS0
802.11ac VHT20 (Covered by HT20)	MCS0
802.11ac VHT40 (Covered by HT40)	MCS0

### TXBF Mode

Modulation	Data Rate
802.11ac VHT20	MCS0
802.11ac VHT40	MCS0

Test Cases	
<b>AC Conducted Emission</b>	Mode 1 :LTE Band 66 Idle + WLAN (2.4GHz) Link + Bluetooth Link + USB Cable (Type C) + SD Card (Data Link) + USB File Transfer with Notebook (Notebook to SD Card) + NFC On + Front Camera + AC Adaptor (PWRBGA12V50W0WW) with DC Cable (CBL-DC-388A1-01)Dock (CRD-ET5X-1SCG1) (Charging with EUT)



<CDD Mode>

<Ant. 1>

802.11b RF Avg Output Power (dBm)						
Power vs. Channel			Power vs Data Rate			
Channel	Frequency (MHz)	Data Rate (bps)	Channel	Data Rate (bps)		
		1M		2M	5.5M	11M
Duty Cycle (%)		100.00		98.30	95.80	93.00
CH 01	2412	21.30	CH 11	21.30	21.00	21.00
CH 06	2437	21.20				
CH 11	2462	21.40				

802.11g RF Avg Output Power (dBm)										
Power vs. Channel			Power vs Data Rate							
Channel	Frequency (MHz)	Data Rate (bps)	Channel	Data Rate (bps)						
		6M		9Mbps	12Mbps	18Mbps	24Mbps	36Mbps	48Mbps	54Mbps
Duty Cycle (%)		94.57		93.00	91.00	87.50	84.20	78.70	73.90	71.90
CH 01	2412	16.80	CH 06	19.00	19.00	19.00	18.80	19.00	19.00	19.00
CH 06	2437	19.10								
CH 11	2462	18.30								

802.11n HT20 RF Avg Output Power (dBm)										
Power vs. Channel			Power vs Data Rate							
Channel	Frequency (MHz)	MCS Index	Channel	MCS Index						
		MCS 0		MCS 1	MCS 2	MCS 3	MCS 4	MCS 5	MCS 6	MCS 7
Duty Cycle (%)		94.76		90.30	86.80	83.50	78.00	73.20	71.50	69.70
CH 01	2412	15.60	CH 06	18.80	18.80	18.80	18.60	18.50	18.60	18.60
CH 06	2437	18.90								
CH 11	2462	17.00								

802.11n HT40 RF Avg Output Power (dBm)										
Power vs. Channel			Power vs Data Rate							
Channel	Frequency (MHz)	MCS Index	Channel	MCS Index						
		MCS 0		MCS 1	MCS 2	MCS 3	MCS 4	MCS 5	MCS 6	MCS 7
Duty Cycle (%)		90.80		83.00	77.30	72.70	65.40	60.70	58.80	56.70
CH 03	2422	14.90	CH 06	17.30	17.30	17.30	17.30	17.30	17.30	17.30
CH 06	2437	17.70								
CH 09	2452	14.20								



802.11ac VHT20 RF Avg Output Power (dBm)											
Power vs. Channel			Power vs Data Rate								
Channel	Frequency (MHz)	MCS Index	Channel	MCS Index							
		MCS 0		MCS 1	MCS 2	MCS 3	MCS 4	MCS 5	MCS 6	MCS 7	MCS 8
Duty Cycle (%)		94.85		90.20	86.80	83.60	78.00	73.70	71.50	70.00	67.00
CH 01	2412	15.60	CH 06	17.80	17.80	17.80	17.50	17.60	17.60	17.60	17.60
CH 06	2437	17.90									
CH 11	2462	16.90									

802.11ac VHT40 RF Avg Output Power (dBm)												
Power vs. Channel			Power vs Data Rate									
Channel	Frequency (MHz)	MCS Index	Channel	MCS Index								
		MCS 0		MCS 1	MCS 2	MCS 3	MCS 4	MCS 5	MCS 6	MCS 7	MCS 8	MCS 9
Duty Cycle (%)		90.94		83.20	77.20	72.90	66.00	61.20	59.50	57.40	54.10	53.10
CH 03	2422	14.80	CH 06	17.20	17.20	17.20	17.20	17.20	17.20	17.20	17.20	17.20
CH 06	2437	17.30										
CH 09	2452	14.10										

<Ant. 2>

802.11b RF Avg Output Power (dBm)						
Power vs. Channel			Power vs Data Rate			
Channel	Frequency (MHz)	Data Rate (bps)	Channel	Data Rate (bps)		
		1M		2M	5.5M	11M
Duty Cycle (%)		100.00		98.30	95.80	93.00
CH 01	2412	21.30	CH 01	20.90	20.90	20.90
CH 06	2437	21.10				
CH 11	2462	21.10				

802.11g RF Avg Output Power (dBm)										
Power vs. Channel			Power vs Data Rate							
Channel	Frequency (MHz)	Data Rate (bps)	Channel	Data Rate (bps)						
		6M		9Mbps	12Mbps	18Mbps	24Mbps	36Mbps	48Mbps	54Mbps
Duty Cycle (%)		94.77		92.90	90.80	87.30	84.00	78.40	73.30	71.30
CH 01	2412	16.80	CH 06	19.10	19.10	18.90	18.80	18.90	19.00	19.00
CH 06	2437	19.20								
CH 11	2462	18.20								



802.11n HT20 RF Avg Output Power (dBm)										
Power vs. Channel			Power vs Data Rate							
Channel	Frequency (MHz)	MCS Index	Channel	MCS Index						
		MCS 0		MCS 1	MCS 2	MCS 3	MCS 4	MCS 5	MCS 6	MCS 7
Duty Cycle (%)		94.83		90.30	86.70	83.40	77.80	73.10	71.20	69.50
CH 01	2412	15.60	CH 06	18.80	18.80	18.80	18.50	18.50	18.50	18.50
CH 06	2437	18.90								
CH 11	2462	16.90								

802.11n HT40 RF Avg Output Power (dBm)										
Power vs. Channel			Power vs Data Rate							
Channel	Frequency (MHz)	MCS Index	Channel	MCS Index						
		MCS 0		MCS 1	MCS 2	MCS 3	MCS 4	MCS 5	MCS 6	MCS 7
Duty Cycle (%)		90.37		82.70	77.10	72.70	65.50	60.50	58.60	56.30
CH 03	2422	15.30	CH 06	17.40	17.40	17.40	17.40	17.40	17.40	17.40
CH 06	2437	17.80								
CH 09	2452	14.00								

802.11ac VHT20 RF Avg Output Power (dBm)											
Power vs. Channel			Power vs Data Rate								
Channel	Frequency (MHz)	MCS Index	Channel	MCS Index							
		MCS 0		MCS 1	MCS 2	MCS 3	MCS 4	MCS 5	MCS 6	MCS 7	MCS 8
Duty Cycle (%)		94.48		90.30	86.70	83.40	77.70	73.40	71.60	69.90	66.70
CH 01	2412	15.60	CH 06	17.80	17.80	17.80	17.70	17.70	17.80	17.60	17.70
CH 06	2437	17.90									
CH 11	2462	16.80									

802.11ac VHT40 RF Avg Output Power (dBm)												
Power vs. Channel			Power vs Data Rate									
Channel	Frequency (MHz)	MCS Index	Channel	MCS Index								
		MCS 0		MCS 1	MCS 2	MCS 3	MCS 4	MCS 5	MCS 6	MCS 7	MCS 8	MCS 9
Duty Cycle (%)		90.58		83.00	77.40	72.80	65.70	61.00	59.40	57.30	54.00	53.10
CH 03	2422	15.20	CH 06	16.80	16.80	16.80	16.80	16.80	16.80	16.80	16.80	16.80
CH 06	2437	16.90										
CH 09	2452	14.10										



MIMO <Ant. 1+2>

802.11b RF Avg Output Power (dBm)						
Power vs. Channel			Power vs Data Rate			
Channel	Frequency (MHz)	Data Rate (bps)	Channel	Data Rate (bps)		
		1M		2M	5.5M	11M
CH 01	2412	24.41	CH 01	24.36	23.96	23.96
CH 06	2437	24.16				
CH 11	2462	24.36				

802.11g RF Avg Output Power (dBm)										
Power vs. Channel			Power vs Data Rate							
Channel	Frequency (MHz)	Data Rate (bps)	Channel	Data Rate (bps)						
		6M		9Mbps	12Mbps	18Mbps	24Mbps	36Mbps	48Mbps	54Mbps
CH 01	2412	19.41	CH 06	22.11	22.16	22.01	21.86	22.01	22.06	22.11
CH 06	2437	22.21								
CH 11	2462	20.06								

802.11n HT20 RF Avg Output Power (dBm)										
Power vs. Channel			Power vs Data Rate							
Channel	Frequency (MHz)	MCS Index	Channel	MCS Index						
		MCS0		MCS1	MCS2	MCS3	MCS4	MCS5	MCS6	MCS7
CH 01	2412	17.21	CH 06	21.46	21.41	21.41	21.61	21.61	21.61	21.61
CH 06	2437	21.66								
CH 11	2462	18.01								

802.11n HT40 RF Output Power (dBm)										
Power vs. Channel			Power vs Data Rate							
Channel	Frequency (MHz)	MCS Index	Channel	MCS Index						
		MCS0		MCS1	MCS2	MCS3	MCS4	MCS5	MCS6	MCS7
CH 03	2422	16.61	CH 06	20.61	20.61	20.61	20.61	20.61	20.61	20.56
CH 06	2437	20.66								
CH 09	2452	17.56								



802.11ac VHT20 RF Avg Output Power (dBm)											
Power vs. Channel			Power vs Data Rate								
Channel	Frequency (MHz)	MCS Index	Channel	MCS Index							
		MCS 0		MCS 1	MCS 2	MCS 3	MCS 4	MCS 5	MCS 6	MCS 7	MCS 8
CH 01	2412	17.11	CH 06	20.46	20.46	20.46	20.16	20.26	20.26	20.21	20.21
CH 06	2437	20.61									
CH 11	2462	17.91									

802.11ac VHT40 RF Avg Output Power (dBm)												
Power vs. Channel			Power vs Data Rate									
Channel	Frequency (MHz)	MCS Index	Channel	MCS Index								
		MCS 0		MCS 1	MCS 2	MCS 3	MCS 4	MCS 5	MCS 6	MCS 7	MCS 8	MCS 9
CH 03	2422	16.51	CH 06	20.11	20.16	20.16	20.16	20.16	20.16	20.06	20.16	20.16
CH 06	2437	20.21										
CH 09	2452	17.46										

<TXBF Mode>

MIMO <Ant. 1+2>

802.11ac VHT20 RF Avg Output Power (dBm)												
Power vs. Channel			Power vs Data Rate									
Channel	Frequency (MHz)	MCS Index	Channel	MCS Index								
		MCS 0		MCS 1	MCS 2	MCS 3	MCS 4	MCS 5	MCS 6	MCS 7	MCS 8	
CH 01	2412	19.86	CH 06	21.56	21.56	21.56	21.56	21.56	21.56	21.51	21.51	21.47
CH 06	2437	21.71										
CH 11	2462	19.81										

802.11ac VHT40 RF Avg Output Power (dBm)												
Power vs. Channel			Power vs Data Rate									
Channel	Frequency (MHz)	MCS Index	Channel	MCS Index								
		MCS 0		MCS 1	MCS 2	MCS 3	MCS 4	MCS 5	MCS 6	MCS 7	MCS 8	MCS 9
CH 03	2422	16.86	CH 06	19.81	19.81	19.82	19.87	19.82	19.77	19.72	19.82	19.81
CH 06	2437	19.87										
CH 09	2452	17.27										

### 2.3 Connection Diagram of Test System

<WLAN Tx>

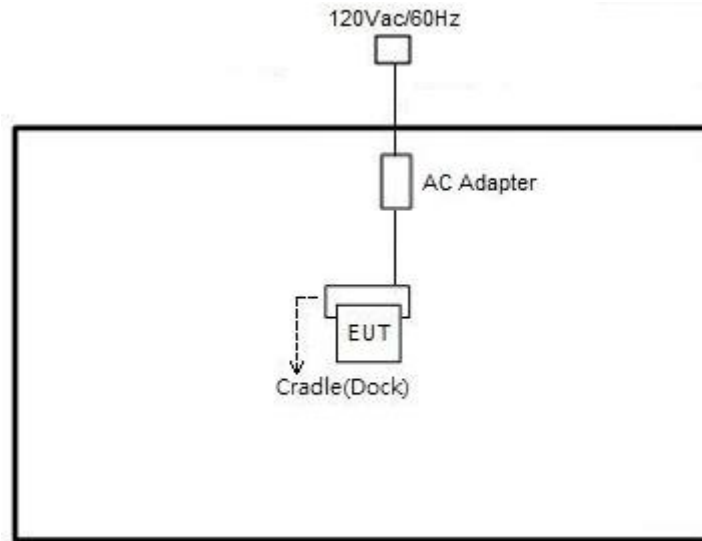

<AC Conducted Emission Mode>

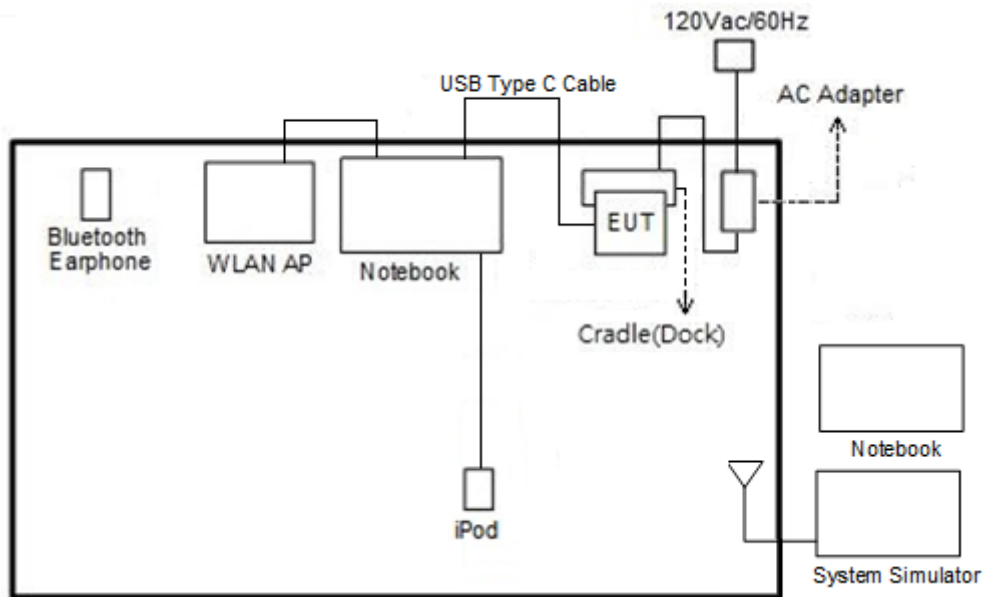





## 2.4 Support Unit used in test configuration and system

Item	Equipment	Trade Name	Model Name	FCC ID	Data Cable	Power Cord
1.	System Simulator	Anritsu	MT8820C	N/A	N/A	Unshielded, 1.8 m
2.	System Simulator	R&S	CBT32	N/A	N/A	N/A
3.	GPS Station	Pendulum	GSG-54	N/A	N/A	Unshielded, 1.8 m
4.	Bluetooth Earphone	Sony Ericsson	MW600	PY7DDA-2029	N/A	N/A
5.	WLAN AP	ASUS	RT-AC1750	MSQ-RTAC66U	N/A	Unshielded,1.8m
6.	iPod	Apple	A1285	FCC DoC	Shielded, 1.0 m	N/A
7.	Notebook	DELL	Latitude E3340	FCC DoC/ Contains FCC ID: PD97260NGU	N/A	AC I/P: Unshielded, 1.2 m DC O/P: Shielded, 1.8 m
8.	Notebook	DELL	Latitude E6320	FCC DoC/ Contains FCC ID: QDS-BRCM1054	N/A	AC I/P: Unshielded, 1.2 m DC O/P: Shielded, 1.8 m
9.	NoteBook-26	Lenovo	E335	N/A	N/A	N/A
10.	SD Card	SanDisk	MicroSD HC	FCC DoC	N/A	N/A

## 2.5 EUT Operation Test Setup

The RF test items, utility "QRCT V3.0.271.0" was installed in Notebook which was programmed in order to make the EUT get into the engineering modes to provide channel selection, power level, data rate and the application type and for continuous transmitting signals.

For TXBF mode, the modulation modes and data rates manipulated by the command lines in the engineering program made the EUT link to another EUT by power under the normal operation. The "adb" software tool was used to enable the EUT to transmit signals continuously.



## 2.6 Measurement Results Explanation Example

For all conducted test items:

The offset level is set in the spectrum analyzer to compensate the RF cable loss and attenuator factor between EUT conducted output port and spectrum analyzer. With the offset compensation, the spectrum analyzer reading level is exactly the EUT RF output level.

Example:

The spectrum analyzer offset is derived from RF cable loss and attenuator factor.

*Offset = RF cable loss + attenuator factor.*

Following shows an offset computation example with cable loss 4.2 dB and 10dB attenuator.

$$\begin{aligned} \text{Offset(dB)} &= \text{RF cable loss(dB)} + \text{attenuator factor(dB)}. \\ &= 4.2 + 10 = 14.2 \text{ (dB)} \end{aligned}$$

### 3 Test Result

#### 3.1 6dB and 99% Bandwidth Measurement

##### 3.1.1 Limit of 6dB and 99% Bandwidth

The minimum 6 dB bandwidth shall be at least 500 kHz.

##### 3.1.2 Measuring Instruments

See list of measuring equipment of this test report.

##### 3.1.3 Test Procedures

1. The testing follows the ANSI C63.10 Section 6.9.3 (OBW) and 11.8.1 (6dB BW).
2. The RF output of EUT was connected to the spectrum analyzer by RF cable and attenuator. The path loss was compensated to the results for each measurement.
3. Set to the maximum power setting and enable the EUT transmit continuously.
4. Make the measurement with the spectrum analyzer's resolution bandwidth (RBW) = 100 kHz. Set the Video bandwidth (VBW) = 300 kHz. In order to make an accurate measurement. The 6 dB bandwidth must be greater than 500 kHz.
5. For 99% Bandwidth Measurement, the spectrum analyzer's resolution bandwidth (RBW) is set 1-5% of the emission bandwidth and set the Video bandwidth (VBW)  $\geq 3 * RBW$ .
6. Measure and record the results in the test report.

##### 3.1.4 Test Setup





3.1.5 Test Result of 6dB and 99% Occupied Bandwidth

Test Engineer :	Jimmy Chang	Temperature :	24~26°C
		Relative Humidity :	52~55%

<CDD Mode>

2.4GHz Band										
Mod.	Data Rate	N <sub>TX</sub>	CH.	Freq. (MHz)	99% Occupied BW (MHz)		6dB BW (MHz)		6dB BW Limit (MHz)	Pass/Fail
					Ant 1	Ant 2	Ant 1	Ant 2		
11b	1Mbps	1	1	2412	13.25	12.95	8.02	7.51	0.50	Pass
11b	1Mbps	1	6	2437	13.10	12.90	8.04	8.04	0.50	Pass
11b	1Mbps	1	11	2462	13.15	13.10	8.05	8.02	0.50	Pass
11g	6Mbps	1	1	2412	16.70	16.75	15.32	15.68	0.50	Pass
11g	6Mbps	1	6	2437	16.75	16.80	15.55	15.64	0.50	Pass
11g	6Mbps	1	11	2462	16.75	16.90	15.66	16.04	0.50	Pass
HT20	MCS0	1	1	2412	17.95	17.95	15.92	16.08	0.50	Pass
HT20	MCS0	1	6	2437	17.95	17.95	15.97	15.96	0.50	Pass
HT20	MCS0	1	11	2462	17.90	17.95	15.32	16.54	0.50	Pass
HT40	MCS0	1	3	2422	36.50	36.50	35.36	35.09	0.50	Pass
HT40	MCS0	1	6	2437	36.50	36.50	35.08	35.69	0.50	Pass
HT40	MCS0	1	9	2452	36.60	36.60	35.10	34.96	0.50	Pass
11b	1Mbps	2	1	2412	13.40	13.45	8.02	7.02	0.50	Pass
11b	1Mbps	2	6	2437	13.15	12.90	8.04	8.02	0.50	Pass
11b	1Mbps	2	11	2462	13.20	13.70	7.03	8.02	0.50	Pass
11g	6Mbps	2	1	2412	16.80	16.70	15.76	15.44	0.50	Pass
11g	6Mbps	2	6	2437	16.85	16.80	15.30	16.04	0.50	Pass
11g	6Mbps	2	11	2462	16.70	16.80	15.12	16.04	0.50	Pass
HT20	MCS0	2	1	2412	17.85	17.95	15.92	16.09	0.50	Pass
HT20	MCS0	2	6	2437	17.95	17.95	15.96	16.16	0.50	Pass
HT20	MCS0	2	11	2462	17.80	17.95	16.54	17.12	0.50	Pass
HT40	MCS0	2	3	2422	36.40	36.40	35.04	33.84	0.50	Pass
HT40	MCS0	2	6	2437	36.50	36.50	35.40	35.68	0.50	Pass
HT40	MCS0	2	9	2452	36.70	36.60	36.00	35.08	0.50	Pass

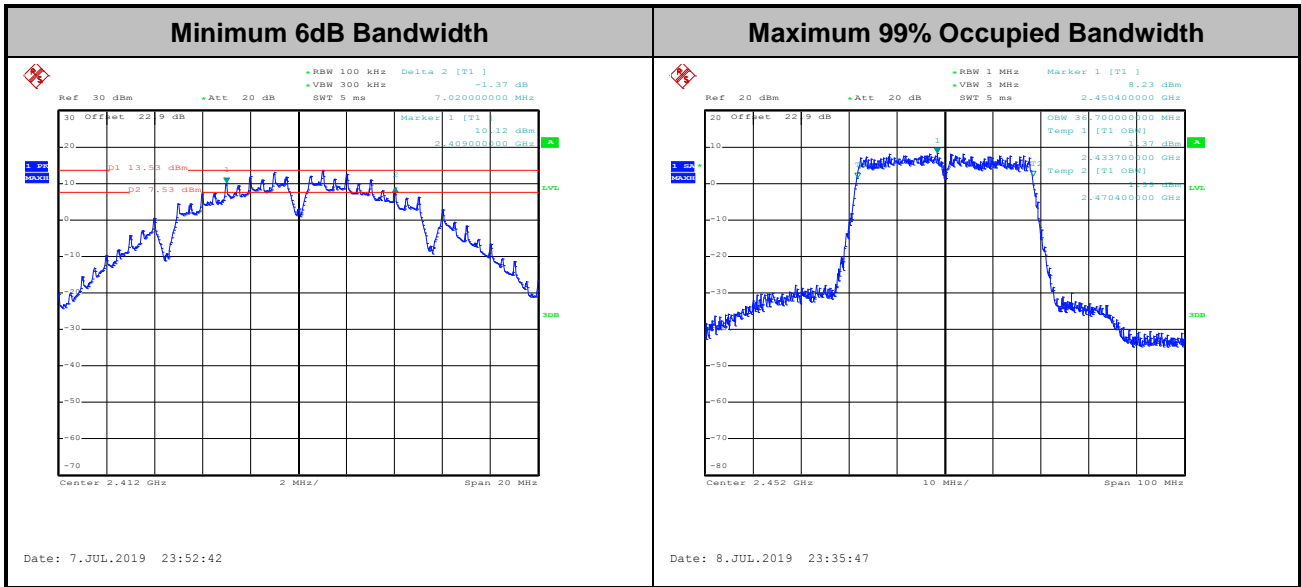

Note: The occupied channel bandwidth is maintained within the band of operation for all of the modulations.



Test Engineer :	Jimmy Chang	Temperature :	24~26°C
		Relative Humidity :	52~55%

<TXBF Modes>

2.4GHz Band										
Mod.	Data Rate	NTX	CH.	Freq. (MHz)	99% Occupied BW (MHz)		6dB BW (MHz)		6dB BW Limit (MHz)	Pass/Fail
					Ant 1	Ant 2	Ant 1	Ant 2		
VHT20	MCS0	2	1	2412	17.88	17.93	17.62	17.68	0.50	Pass
VHT20	MCS0	2	6	2437	17.88	17.93	17.60	17.64	0.50	Pass
VHT20	MCS0	2	11	2462	17.88	17.98	17.68	17.66	0.50	Pass
VHT40	MCS0	2	3	2422	37.06	37.26	35.68	37.08	0.50	Pass
VHT40	MCS0	2	6	2437	37.16	37.16	35.92	36.64	0.50	Pass
VHT40	MCS0	2	9	2452	37.06	37.06	36.28	36.64	0.50	Pass

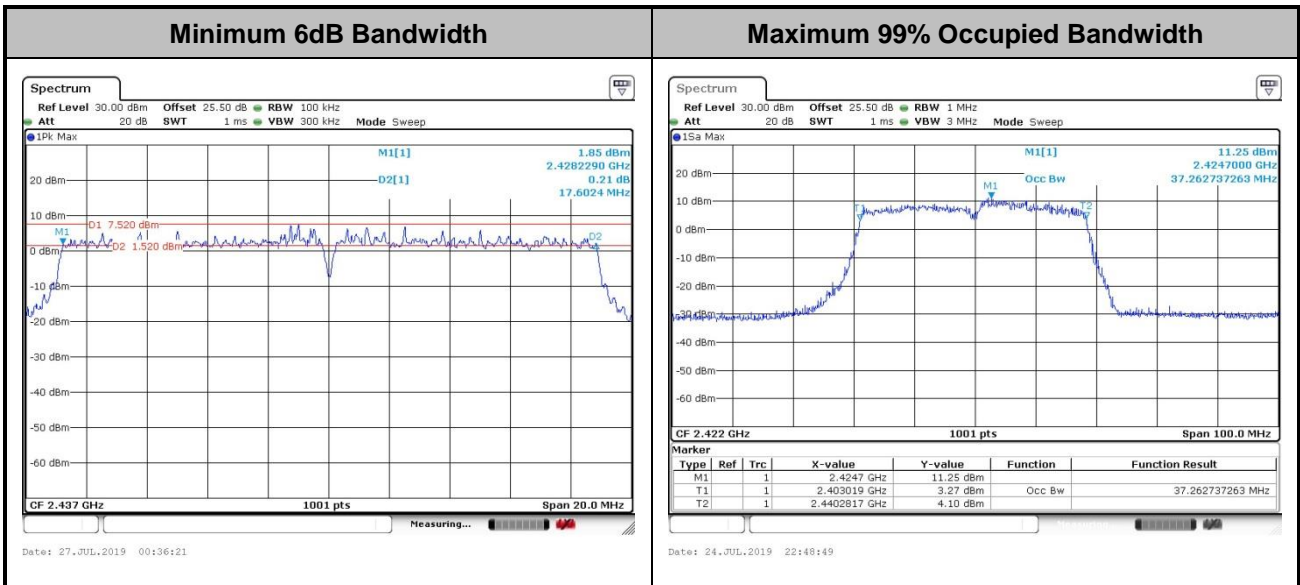

Note: The occupied channel bandwidth is maintained within the band of operation for all of the modulations.

## 3.2 Output Power Measurement

### 3.2.1 Limit of Output Power

For systems using digital modulation in the 2400-2483.5MHz, the limit for output power is 30dBm. If transmitting antenna with directional gain greater than 6dBi is used, the output power from the intentional radiator shall be reduced below the above stated value by the amount in dB that the directional gain of the antenna exceeds 6 dBi. In case of point-to-point operation, the limit has to be reduced by 1dB for every 3dB that the directional gain of the antenna exceeds 6dBi.

### 3.2.2 Measuring Instruments

See list of measuring equipment of this test report.

### 3.2.3 Test Procedures

1. For Average Power, the testing follows ANSI C63.10 Section 11.9.2.3.2 Method AVGPM-G
2. The RF output of EUT was connected to the power meter by RF cable and attenuator. The path loss was compensated to the results for each measurement.
3. Set to the maximum power setting and enable the EUT transmit continuously.
4. Measure the conducted output power and record the results in the test report.
5. For MIMO mode, calculation method follows FCC KDB 662911 D01 Multiple Transmitter Output v02r01.

### 3.2.4 Test Setup

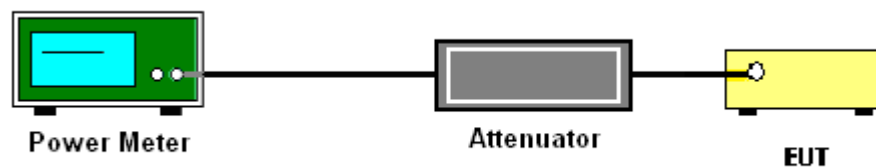



3.2.5 Test Result of Average Output Power

Test Engineer :	Jimmy Chang	Temperature :	24~26°C
		Relative Humidity :	52~55%

<CDD Mode>

2.4GHz Band																		
Mod.	Data Rate	NTX	CH.	Freq. (MHz)	Average Conducted Power (dBm)			Conducted Power Limit (dBm)		DG (dBi)		EIRP Power (dBm)		EIRP Power Limit (dBm)		Pass /Fail	Setting	
					Ant 1	Ant 2	SUM	Ant 1	Ant 2	Ant 1	Ant 2	Ant 1	Ant 2	Ant 1	Ant 2		Ant 1	Ant 2
11b	1Mbps	1	1	2412	21.30	21.30	30.00	30.00	1.24	2.46	22.54	23.76	36.00	36.00	Pass	20.50	20.50	
11b	1Mbps	1	6	2437	21.20	21.10	30.00	30.00	1.24	2.46	22.44	23.56	36.00	36.00	Pass	20.50	20.50	
11b	1Mbps	1	11	2462	21.40	21.10	30.00	30.00	1.24	2.46	22.64	23.56	36.00	36.00	Pass	21.00	20.50	
11g	6Mbps	1	1	2412	16.80	16.80	30.00	30.00	1.24	2.46	18.04	19.26	36.00	36.00	Pass	16.50	16.50	
11g	6Mbps	1	6	2437	19.10	19.20	30.00	30.00	1.24	2.46	20.34	21.66	36.00	36.00	Pass	19.00	19.00	
11g	6Mbps	1	11	2462	18.30	18.20	30.00	30.00	1.24	2.46	19.54	20.66	36.00	36.00	Pass	18.00	18.00	
HT20	MCS0	1	1	2412	15.60	15.60	30.00	30.00	1.24	2.46	16.84	18.06	36.00	36.00	Pass	15.50	15.50	
HT20	MCS0	1	6	2437	18.90	18.90	30.00	30.00	1.24	2.46	20.14	21.36	36.00	36.00	Pass	19.00	19.00	
HT20	MCS0	1	11	2462	17.00	16.90	30.00	30.00	1.24	2.46	18.24	19.36	36.00	36.00	Pass	17.00	17.00	
HT40	MCS0	1	3	2422	14.90	15.30	30.00	30.00	1.24	2.46	16.14	17.76	36.00	36.00	Pass	14.00	14.00	
HT40	MCS0	1	6	2437	17.70	17.80	30.00	30.00	1.24	2.46	18.94	20.26	36.00	36.00	Pass	17.00	17.50	
HT40	MCS0	1	9	2452	14.20	14.00	30.00	30.00	1.24	2.46	15.44	16.46	36.00	36.00	Pass	13.50	13.50	
VHT20	MCS0	1	1	2412	15.60	15.60	30.00	30.00	1.24	2.46	16.84	18.06	36.00	36.00	Pass	15.50	15.50	
VHT20	MCS0	1	6	2437	17.90	17.90	30.00	30.00	1.24	2.46	19.14	20.36	36.00	36.00	Pass	18.00	18.00	
VHT20	MCS0	1	11	2462	16.90	16.80	30.00	30.00	1.24	2.46	18.14	19.26	36.00	36.00	Pass	17.00	17.00	
VHT40	MCS0	1	3	2422	14.80	15.20	30.00	30.00	1.24	2.46	16.04	17.66	36.00	36.00	Pass	14.00	14.00	
VHT40	MCS0	1	6	2437	17.30	16.90	30.00	30.00	1.24	2.46	18.54	19.36	36.00	36.00	Pass	16.50	16.50	
VHT40	MCS0	1	9	2452	14.10	14.10	30.00	30.00	1.24	2.46	15.34	16.56	36.00	36.00	Pass	13.50	13.50	





2.4GHz Band																		
Mod.	Data Rate	NTX	CH.	Freq. (MHz)	Average Conducted Power (dBm)			Conducted Power Limit (dBm)		DG (dBi)		EIRP Power (dBm)		EIRP Power Limit (dBm)		Pass /Fail	Setting	
					Ant 1	Ant 2	SUM	Ant 1	Ant 2	Ant 1	Ant 2	Ant 1	Ant 2	Ant 1	Ant 2		Ant 1	Ant 2
11b	1Mbps	2	1	2412	21.40	21.40	24.41	30.00	2.46	26.87	36.00	Pass	20.50					
11b	1Mbps	2	6	2437	21.10	21.20	24.16	30.00	2.46	26.62	36.00	Pass	20.50					
11b	1Mbps	2	11	2462	21.40	21.30	24.36	30.00	2.46	26.82	36.00	Pass	21.00					
11g	6Mbps	2	1	2412	16.40	16.40	19.41	30.00	2.46	21.87	36.00	Pass	16.00					
11g	6Mbps	2	6	2437	19.10	19.30	22.21	30.00	2.46	24.67	36.00	Pass	19.00					
11g	6Mbps	2	11	2462	17.10	17.00	20.06	30.00	2.46	22.52	36.00	Pass	17.00					
HT20	MCS0	2	1	2412	14.10	14.30	17.21	30.00	2.46	19.67	36.00	Pass	14.00					
HT20	MCS0	2	6	2437	18.70	18.60	21.66	30.00	2.46	24.12	36.00	Pass	18.50					
HT20	MCS0	2	11	2462	15.00	15.00	18.01	30.00	2.46	20.47	36.00	Pass	15.00					
HT40	MCS0	2	3	2422	13.40	13.80	16.61	30.00	2.46	19.07	36.00	Pass	12.50					
HT40	MCS0	2	6	2437	17.80	17.60	20.66	30.00	2.46	23.12	36.00	Pass	17.00					
HT40	MCS0	2	9	2452	14.60	14.50	17.56	30.00	2.46	20.02	36.00	Pass	14.00					
VHT20	MCS0	2	1	2412	14.00	14.20	17.11	30.00	2.46	19.57	36.00	Pass	14.00					
VHT20	MCS0	2	6	2437	17.60	17.60	20.61	30.00	2.46	23.07	36.00	Pass	17.50					
VHT20	MCS0	2	11	2462	14.90	14.90	17.91	30.00	2.46	20.37	36.00	Pass	15.00					
VHT40	MCS0	2	3	2422	13.30	13.70	16.51	30.00	2.46	18.97	36.00	Pass	12.50					
VHT40	MCS0	2	6	2437	17.30	17.10	20.21	30.00	2.46	22.67	36.00	Pass	16.50					
VHT40	MCS0	2	9	2452	14.50	14.40	17.46	30.00	2.46	19.92	36.00	Pass	14.00					

Note: Measured power (dBm) has offset with cable loss.



<b>Test Engineer :</b>	Jimmy Chang	<b>Temperature :</b>	24~26°C
		<b>Relative Humidity :</b>	52~55%

**<TXBF Mode>**

2.4GHz Band																		
Mod.	Data Rate	NTX	CH.	Freq. (MHz)	Average Conducted Power (dBm)			Conducted Power Limit (dBm)		DG (dBi)		EIRP Power (dBm)		EIRP Power Limit (dBm)		Pass /Fail	Setting	
					Ant 1	Ant 2	SUM	Ant 1	Ant 2	Ant 1	Ant 2	Ant 1	Ant 2	Ant 1	Ant 2		Ant 1	Ant 2
VHT20	MCS0	2	1	2412	17.00	16.70	19.86	30.00	4.88	24.74	36.00	Pass	16.50					
VHT20	MCS0	2	6	2437	18.80	18.60	21.71	30.00	4.88	26.59	36.00	Pass	18.50					
VHT20	MCS0	2	11	2462	16.90	16.70	19.81	30.00	4.88	24.69	36.00	Pass	16.50					
VHT40	MCS0	2	3	2422	13.90	13.80	16.86	30.00	4.88	21.74	36.00	Pass	13.50					
VHT40	MCS0	2	6	2437	17.10	16.60	19.87	30.00	4.88	24.75	36.00	Pass	16.50					
VHT40	MCS0	2	9	2452	14.50	14.00	17.27	30.00	4.88	22.15	36.00	Pass	14.00					

Note: Measured power (dBm) has offset with cable loss.

### 3.3 Power Spectral Density Measurement

#### 3.3.1 Limit of Power Spectral Density

The peak power spectral density shall not be greater than 8dBm in any 3kHz band at any time interval of continuous transmission.

#### 3.3.2 Measuring Instruments

See list of measuring equipment of this test report.

#### 3.3.3 Test Procedures

1. The testing follows the ANSI C63.10 Section 11.10.2 Method PKPSD.
2. The RF output of EUT was connected to the spectrum analyzer by RF cable and attenuator. The path loss was compensated to the results for each measurement.
3. Set to the maximum power setting and enable the EUT transmit continuously.
4. Make the measurement with the spectrum analyzer's resolution bandwidth (RBW) = 3 kHz. Video bandwidth VBW = 10 kHz In order to make an accurate measurement, set the span to 1.5 times DTS Channel Bandwidth. (6dB BW)
5. Detector = peak, Sweep time = auto couple, Trace mode = max hold, Allow trace to fully stabilize. Use the peak marker function to determine the maximum power level.
6. Measure and record the results in the test report.
7. For MIMO mode, calculation method follows FCC KDB 662911 D01 Multiple Transmitter Output v02r01.

If measurements performed using method (2) plus  $10 \log(N)$  exceeds the emission limit, the test should choose method (1) before declaring that the device fails the emission limit.

Method (1): Measure and sum the spectra across the outputs.

The total final Power Spectral Density is from a device with 2 transmitter outputs. The spectrum measurements of the individual outputs are all performed with the same span and number of points, the spectrum value in the first spectral bin of output 1 is summed with that in the first spectral bin of output 2 to obtain the value for the first frequency bin of the summed spectrum.

Method (2): Measure and add  $10 \log(N)$  dB, where N is the number of outputs. (N=2)

#### 3.3.4 Test Setup

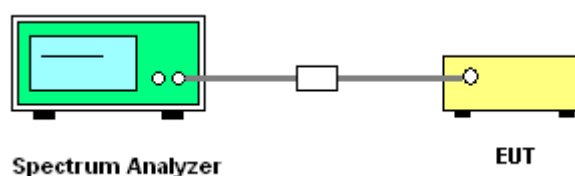



3.3.5 Test Result of Power Spectral Density

Test Engineer :	Jimmy Chang	Temperature :	24~26°C
		Relative Humidity :	52~55%

<CDD Mode>

2.4GHz Band												
Mod.	Data Rate	NTX	CH.	Freq. (MHz)	Peak PSD (dBm/3kHz)			DG (dBi)		Peak PSD Limit (dBm/3kHz)		Pass/Fail
					Ant 1	Ant 2	Worse + 3.01	Ant 1	Ant 2	Ant 1	Ant 2	
11b	1Mbps	1	1	2412	-4.95	-3.55	-	1.24	2.46	8.00	8.00	Pass
11b	1Mbps	1	6	2437	-4.08	-4.67	-	1.24	2.46	8.00	8.00	Pass
11b	1Mbps	1	11	2462	-4.47	-4.39	-	1.24	2.46	8.00	8.00	Pass
11g	6Mbps	1	1	2412	-10.68	-11.88	-	1.24	2.46	8.00	8.00	Pass
11g	6Mbps	1	6	2437	-8.59	-7.85	-	1.24	2.46	8.00	8.00	Pass
11g	6Mbps	1	11	2462	-8.70	-10.16	-	1.24	2.46	8.00	8.00	Pass
HT20	MCS0	1	1	2412	-11.56	-11.57	-	1.24	2.46	8.00	8.00	Pass
HT20	MCS0	1	6	2437	-9.03	-7.85	-	1.24	2.46	8.00	8.00	Pass
HT20	MCS0	1	11	2462	-9.99	-10.48	-	1.24	2.46	8.00	8.00	Pass
HT40	MCS0	1	3	2422	-14.95	-13.78	-	1.24	2.46	8.00	8.00	Pass
HT40	MCS0	1	6	2437	-12.15	-11.37	-	1.24	2.46	8.00	8.00	Pass
HT40	MCS0	1	9	2452	-13.96	-16.37	-	1.24	2.46	8.00	8.00	Pass
11b	1Mbps	2	1	2412	-4.32	-3.72	-0.71	4.88		8.00		Pass
11b	1Mbps	2	6	2437	-4.84	-3.79	-0.78	4.88		8.00		Pass
11b	1Mbps	2	11	2462	-4.29	-4.24	-1.23	4.88		8.00		Pass
11g	6Mbps	2	1	2412	-11.50	-11.87	-8.49	4.88		8.00		Pass
11g	6Mbps	2	6	2437	-8.93	-9.20	-5.92	4.88		8.00		Pass
11g	6Mbps	2	11	2462	-11.24	-11.21	-8.20	4.88		8.00		Pass
HT20	MCS0	2	1	2412	-13.58	-13.44	-10.43	4.88		8.00		Pass
HT20	MCS0	2	6	2437	-8.83	-9.03	-5.82	4.88		8.00		Pass
HT20	MCS0	2	11	2462	-11.71	-12.81	-8.70	4.88		8.00		Pass
HT40	MCS0	2	3	2422	-17.18	-16.28	-13.27	4.88		8.00		Pass
HT40	MCS0	2	6	2437	-11.29	-12.95	-8.28	4.88		8.00		Pass
HT40	MCS0	2	9	2452	-15.71	-15.08	-12.07	4.88		8.00		Pass

Measured power density (dBm) has offset with cable loss.

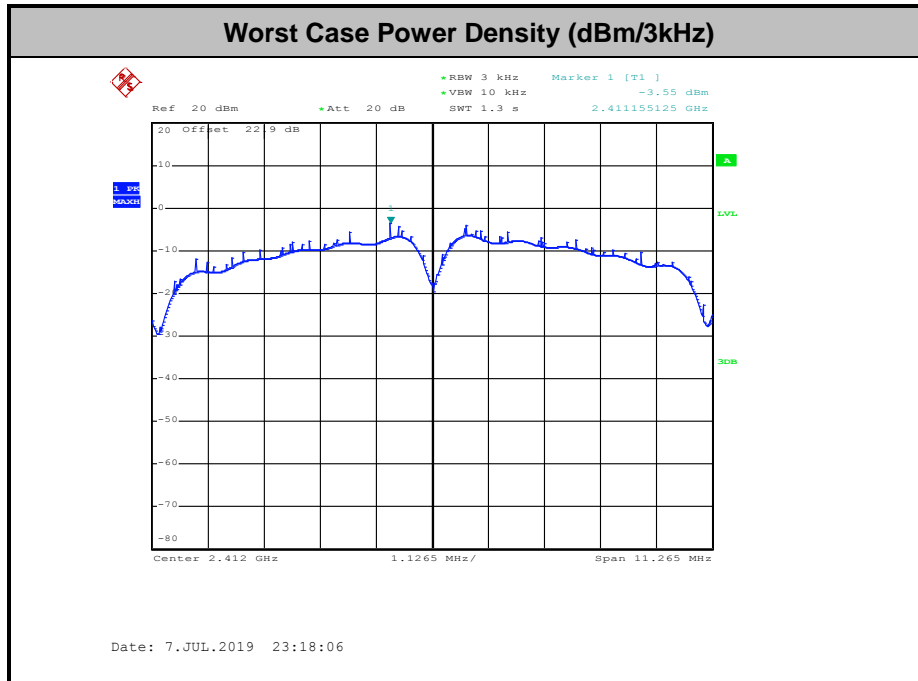



Test Engineer :	Jimmy Chang	Temperature :	24~26°C
		Relative Humidity :	52~55%

<TXBF Modes>

2.4GHz Band												
Mod.	Data Rate	NTX	CH.	Freq. (MHz)	Peak PSD (dBm/3kHz)			DG (dBi)		Peak PSD Limit (dBm/3kHz)		Pass/Fail
					Ant 1	Ant 2	Worse + 3.01	Ant 1	Ant 2	Ant 1	Ant 2	
VHT20	MCS0	2	1	2412	-8.89	-8.65	-5.64	4.88		8.00		Pass
VHT20	MCS0	2	6	2437	-7.45	-7.21	-4.20	4.88		8.00		Pass
VHT20	MCS0	2	11	2462	-8.71	-8.68	-5.67	4.88		8.00		Pass
VHT40	MCS0	2	3	2422	-11.42	-11.14	-8.13	4.88		8.00		Pass
VHT40	MCS0	2	6	2437	-12.02	-12.37	-9.01	4.88		8.00		Pass
VHT40	MCS0	2	9	2452	-11.79	-11.39	-8.38	4.88		8.00		Pass

Measured power density (dBm) has offset with cable loss.

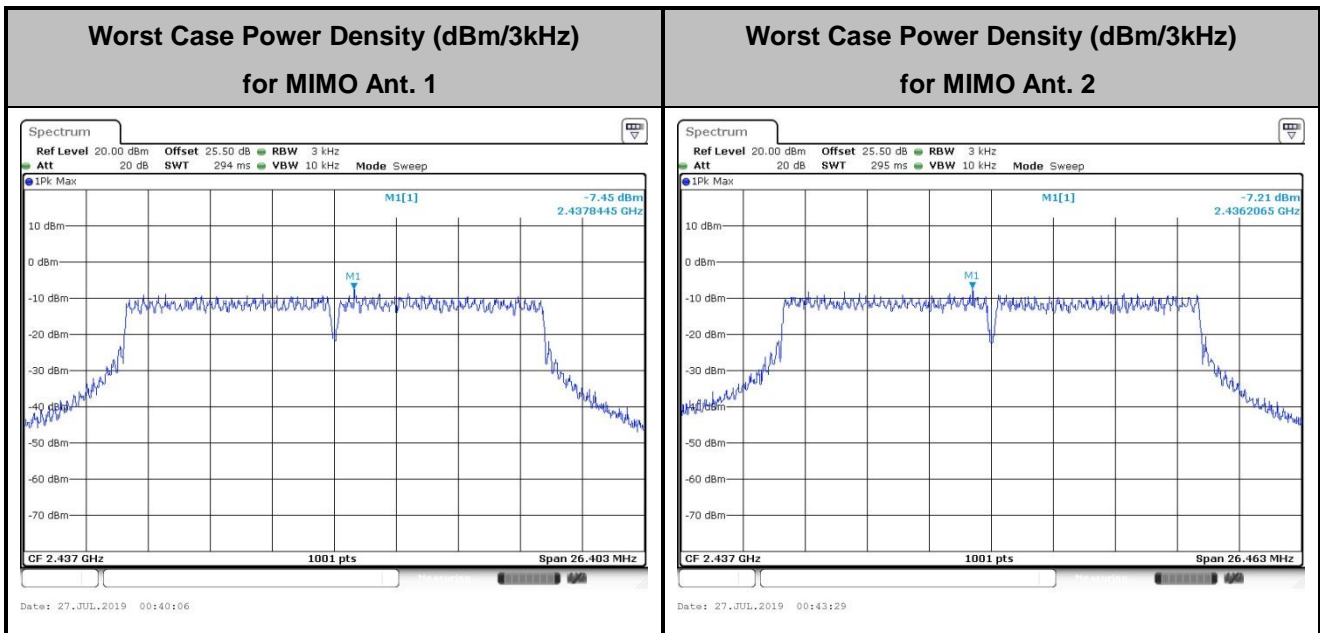

## 3.4 Conducted Band Edges and Spurious Emission Measurement

### 3.4.1 Limit of Conducted Band Edges and Spurious Emission Measurement

In any 100 kHz bandwidth outside of the authorized frequency band, the emissions which fall in the non-restricted bands shall be attenuated at least 20 dB / 30dB relative to the maximum PSD level in 100 kHz by RF conducted measurement.

### 3.4.2 Measuring Instruments

See list of measuring equipment of this test report.

### 3.4.3 Test Procedures

1. The testing follows the ANSI C63.10 Section 11.11.3 Emission level measurement
2. The RF output of EUT was connected to the spectrum analyzer by RF cable and attenuator. The path loss was compensated to the results for each measurement.
3. Set to the maximum power setting and enable the EUT transmit continuously.
4. Set RBW = 100 kHz, VBW=300 kHz, Peak Detector. Unwanted Emissions measured in any 100 kHz bandwidth outside of the authorized frequency band shall be attenuated by at least 20 dB relative to the maximum in-band peak PSD level in 100 kHz when maximum peak conducted output power procedure is used. If the transmitter complies with the conducted power limits based on the use of RMS averaging over a time interval, the attenuation required under this paragraph shall be 30 dB instead of 20 dB per 15.247(d).
5. Measure and record the results in the test report.
6. The RF fundamental frequency should be excluded against the limit line in the operating frequency band.

### 3.4.4 Test Setup

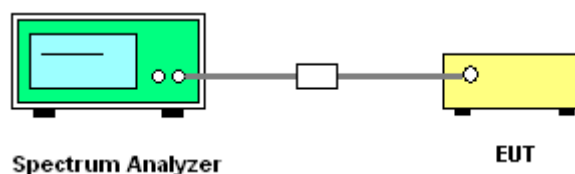



3.4.5 Test Result of Conducted Band Edges and Spurious Emission

Test Engineer :	Jimmy Chang	Temperature :	24~26°C
		Relative Humidity :	52~55%

Number of TX = 1, Ant. 1 (Measured)

Test Mode :	802.11b	Test Channel :	01
-------------	---------	----------------	----

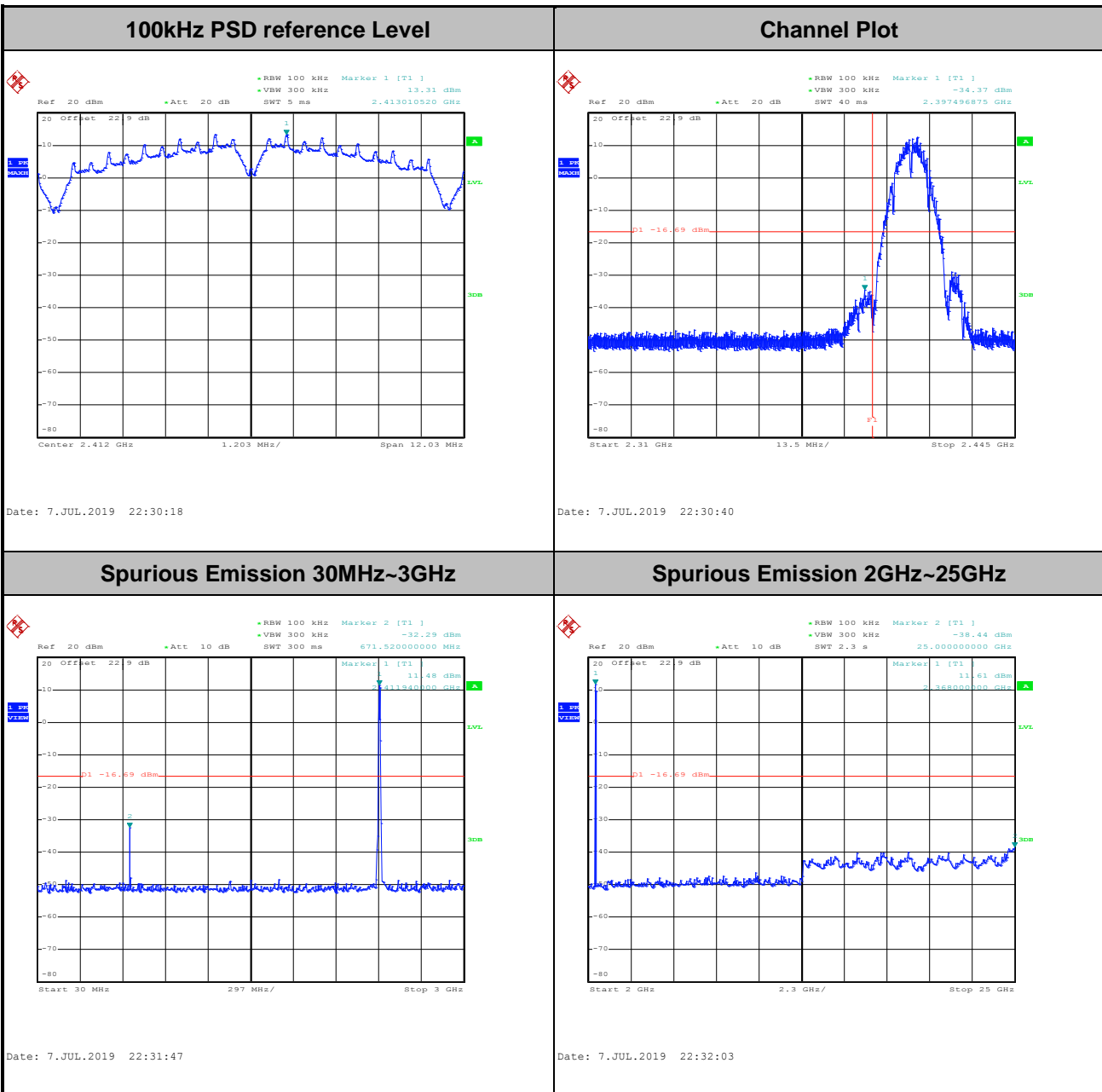





Test Mode :	802.11b	Test Channel :	06
-------------	---------	----------------	----

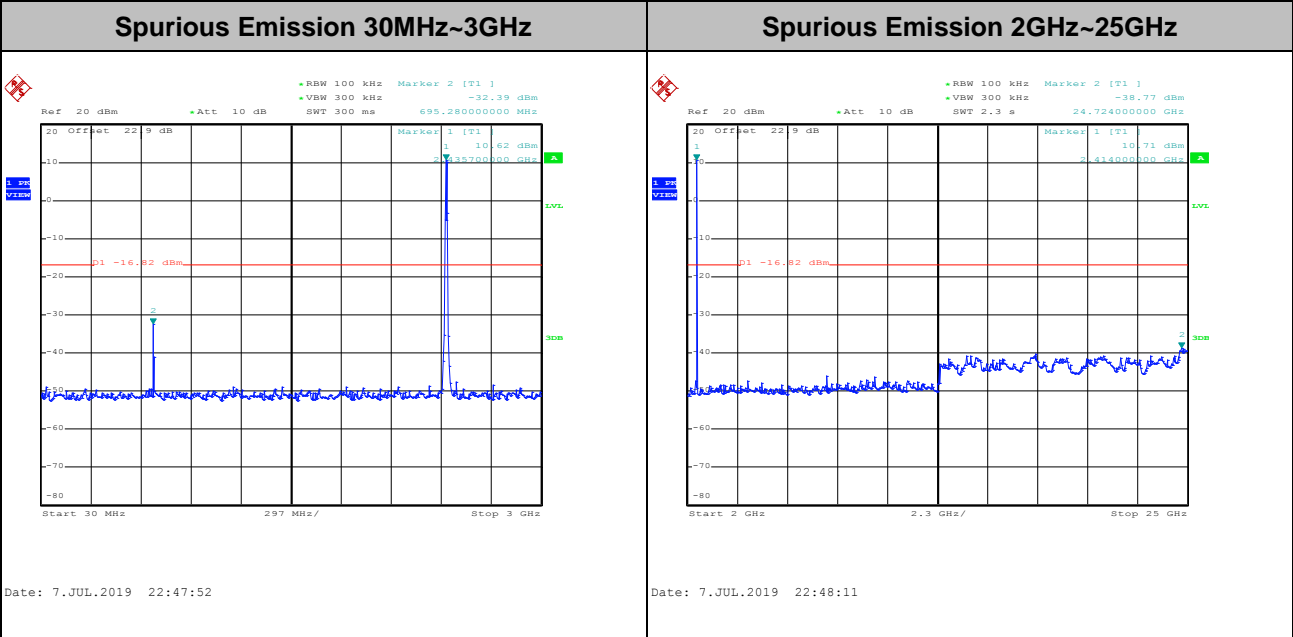
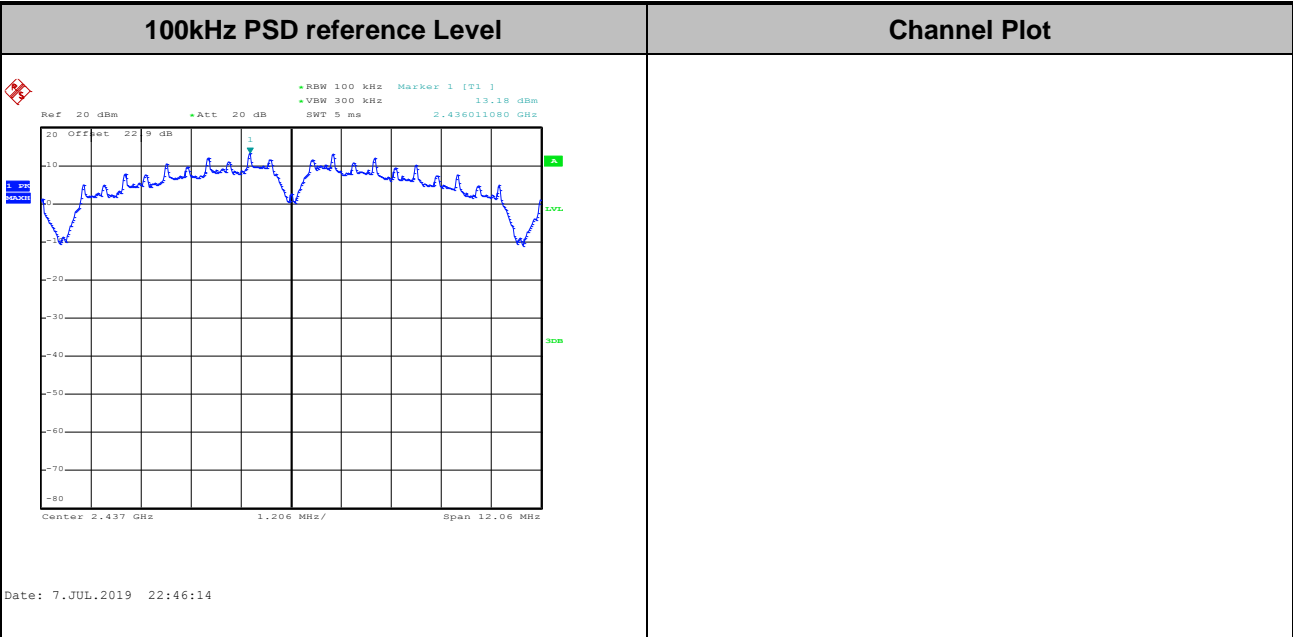



Test Mode :	802.11b	Test Channel :	11
-------------	---------	----------------	----

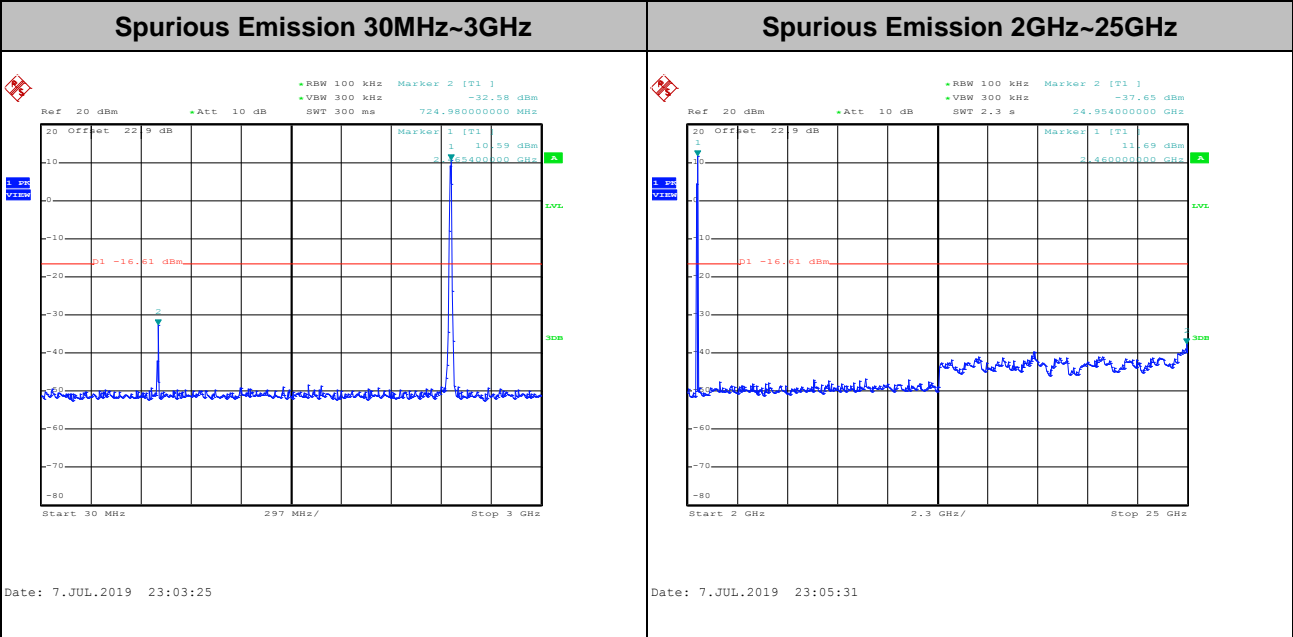
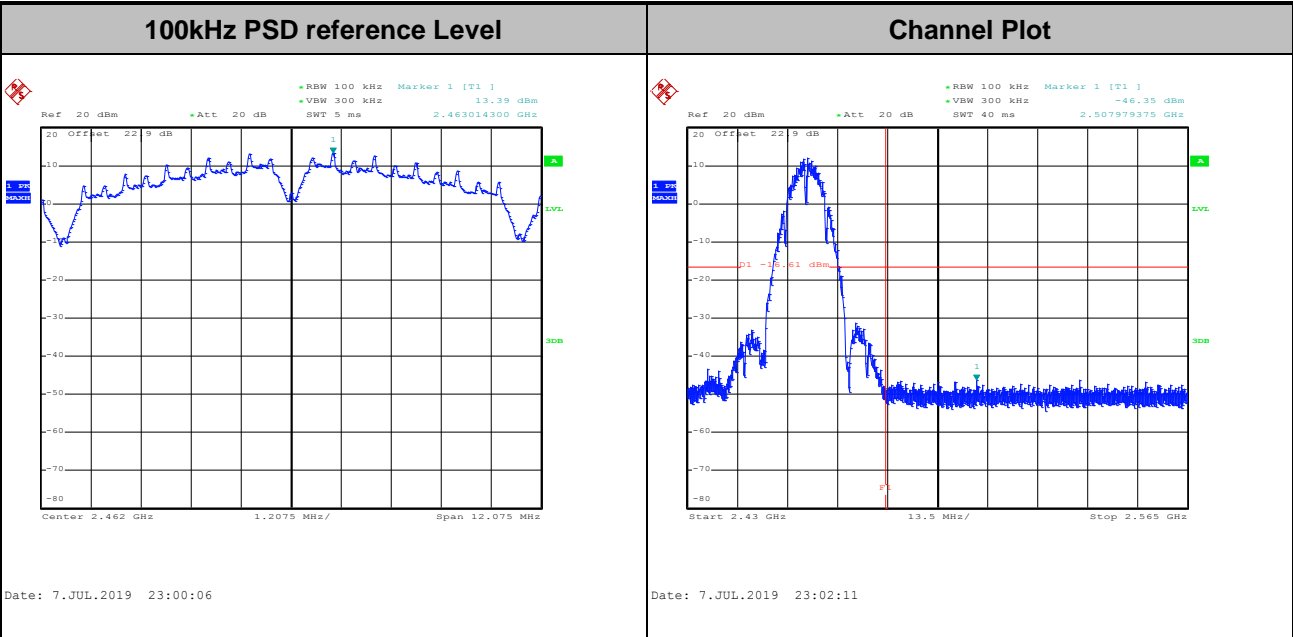



Test Mode :	802.11g	Test Channel :	01
-------------	---------	----------------	----

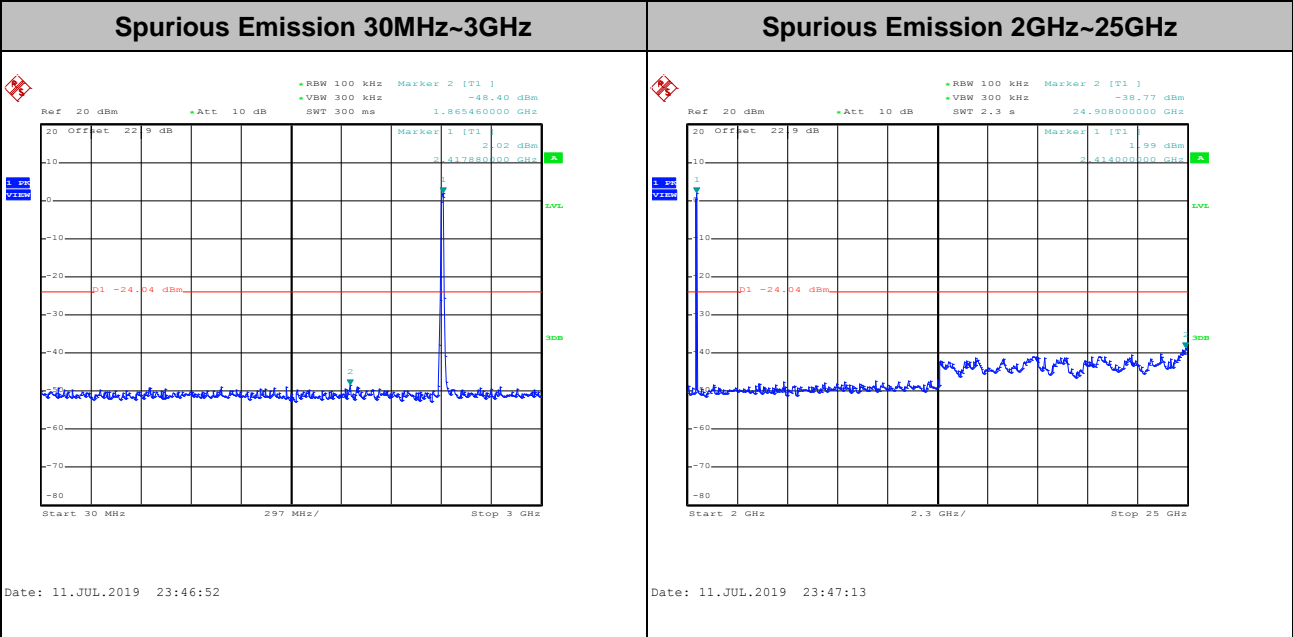
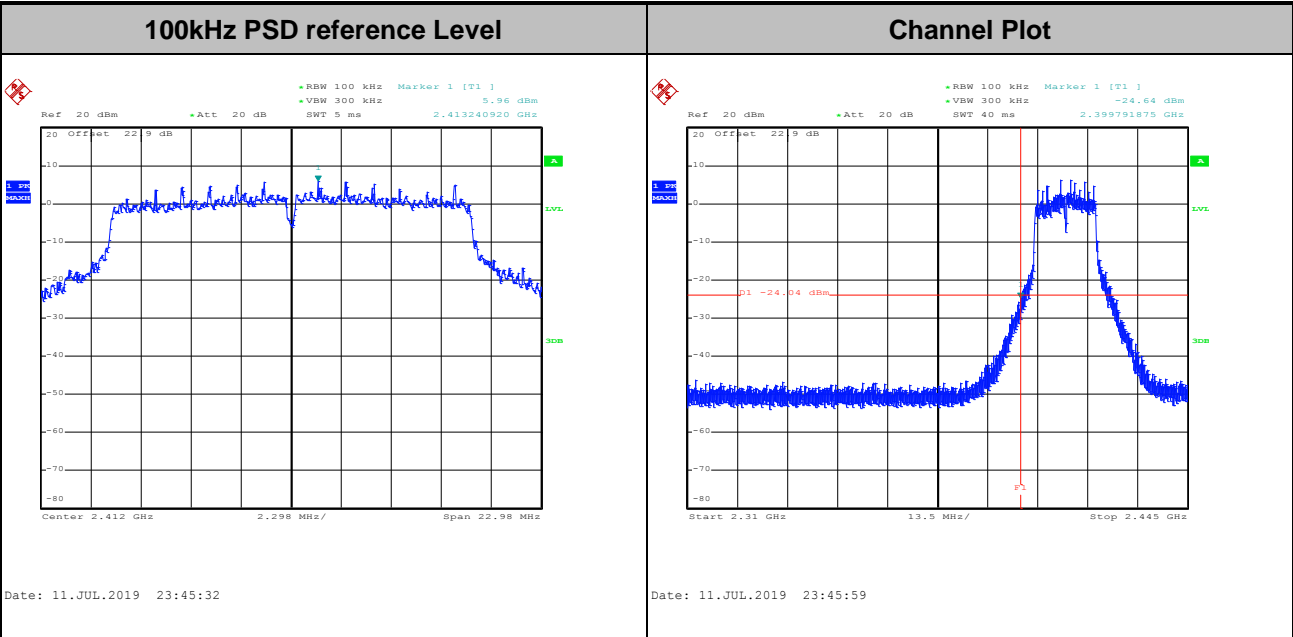



Test Mode :	802.11g	Test Channel :	06
-------------	---------	----------------	----

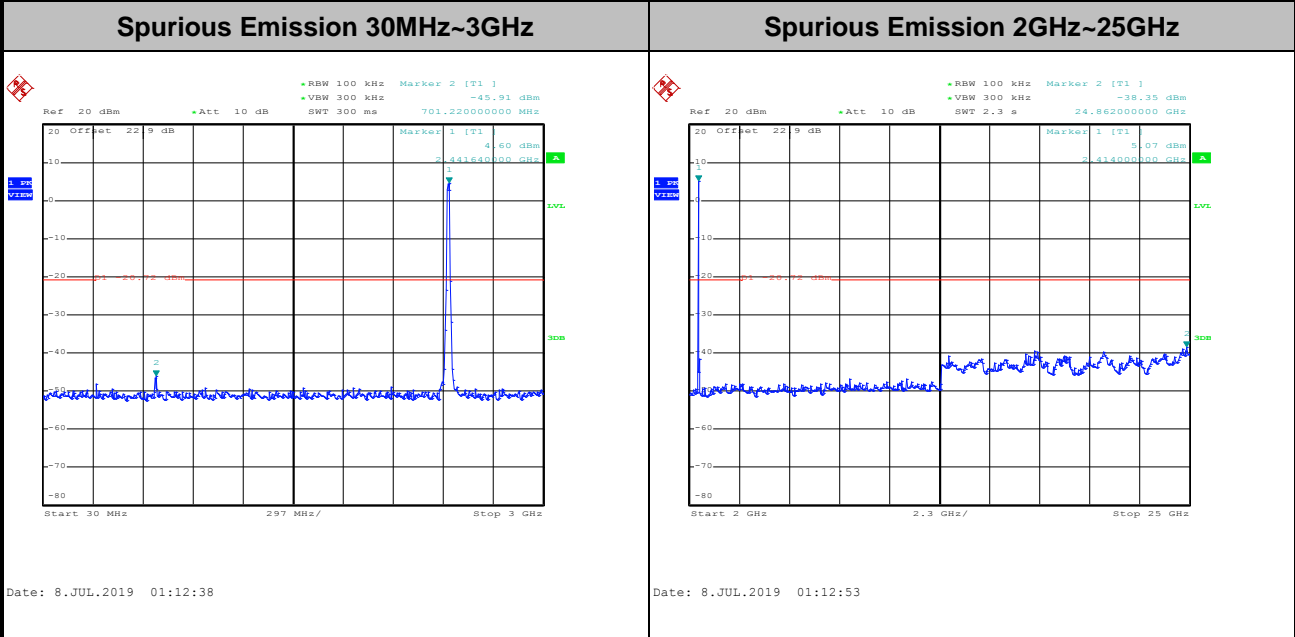
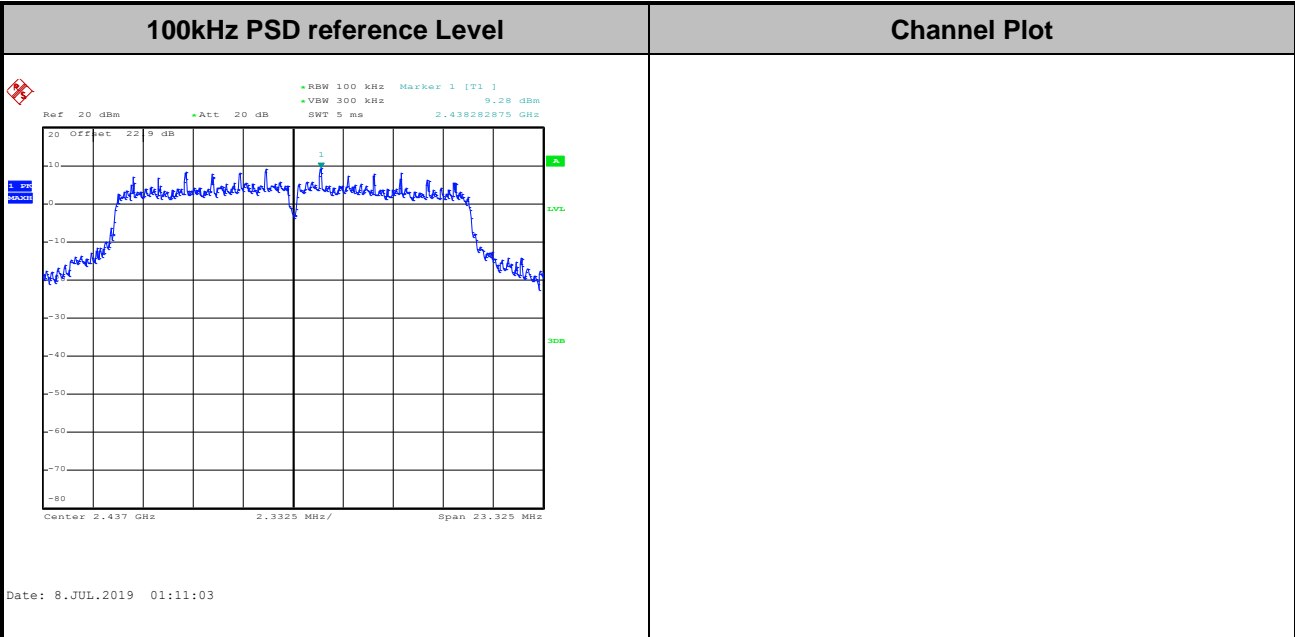



Test Mode :	802.11g	Test Channel :	11
-------------	---------	----------------	----

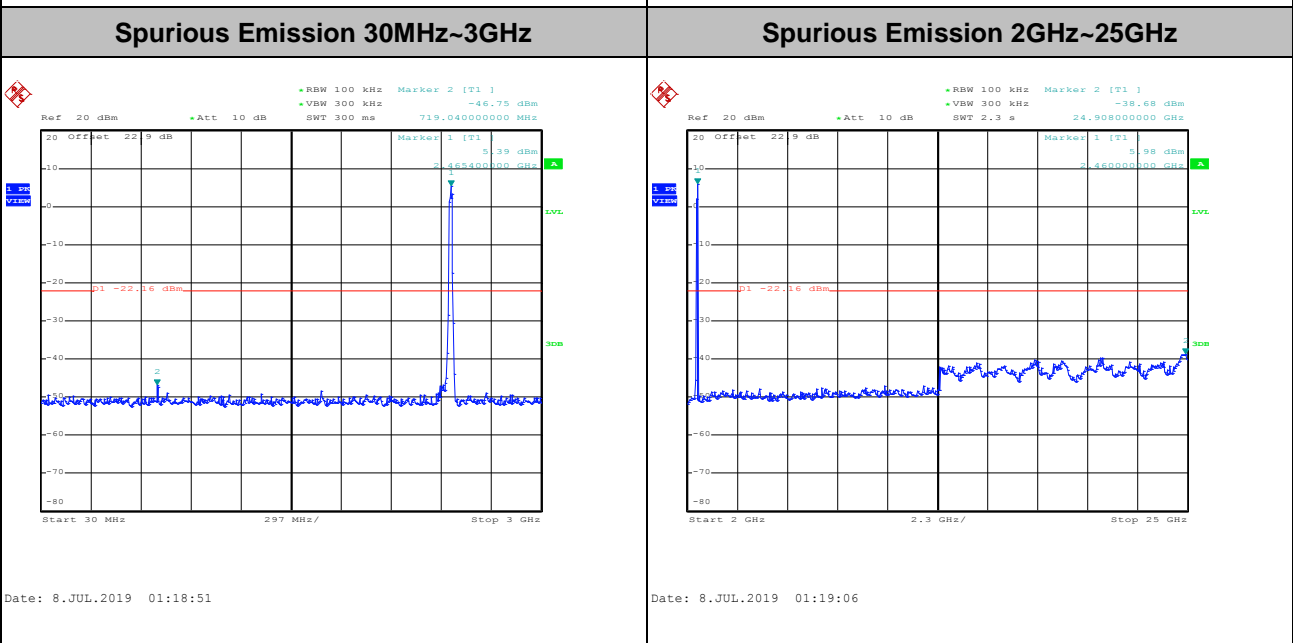
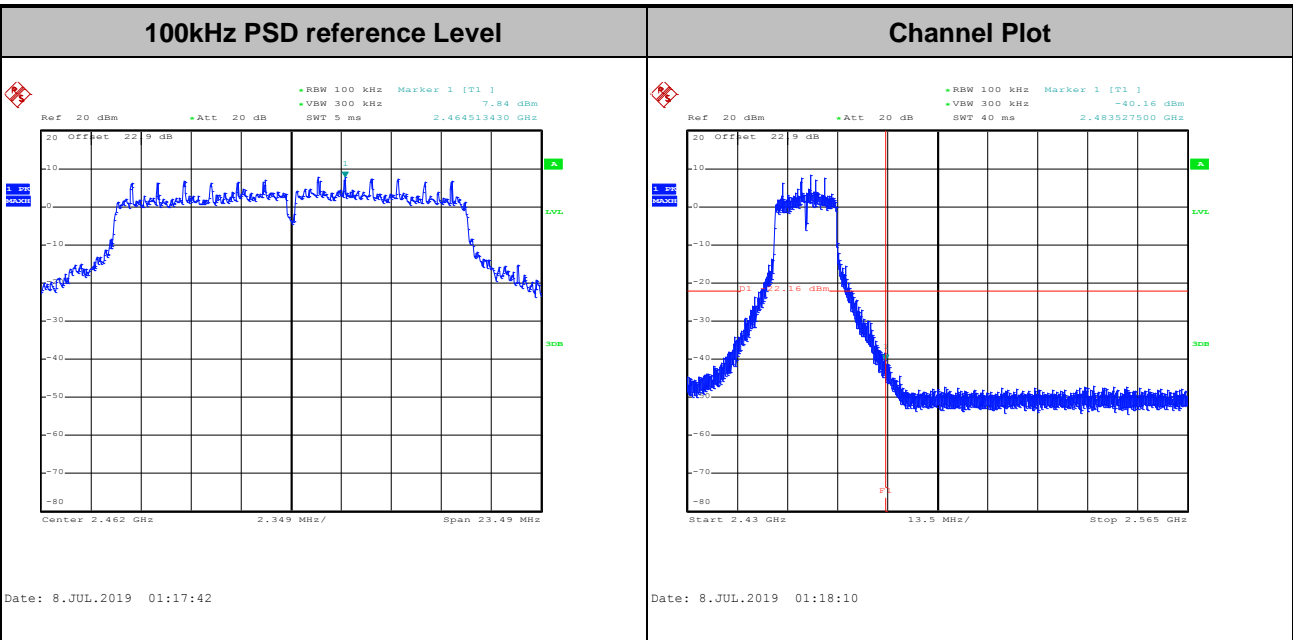



Test Mode : 802.11n HT20 Test Channel : 01

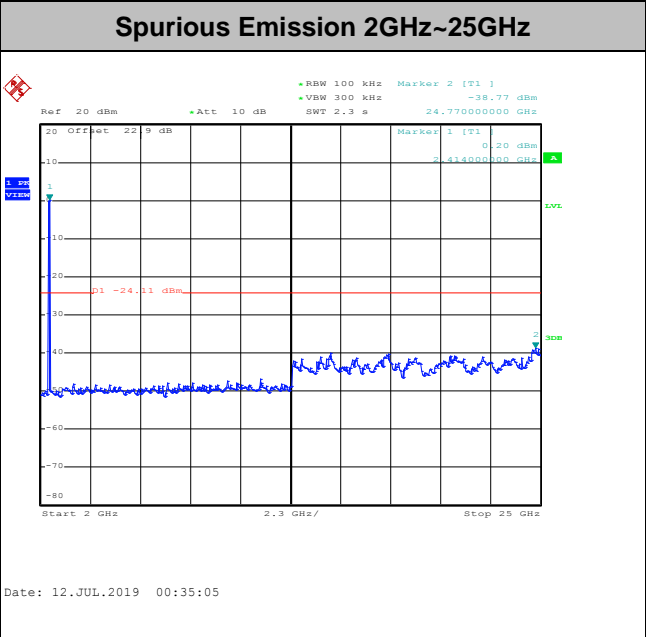
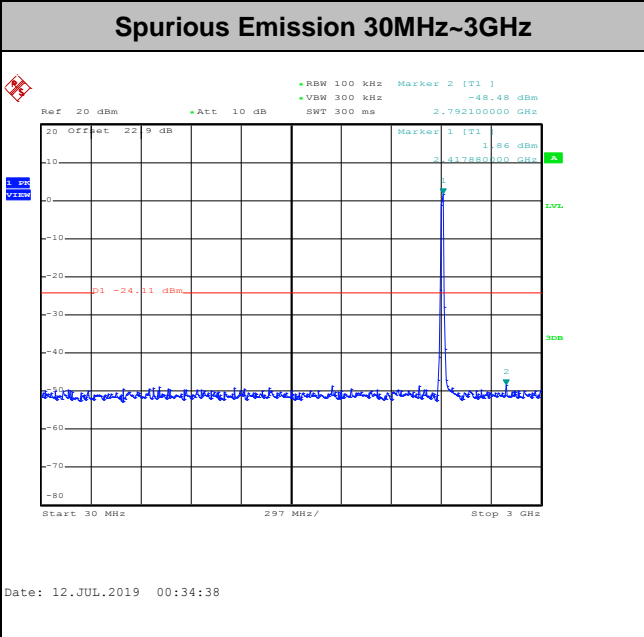
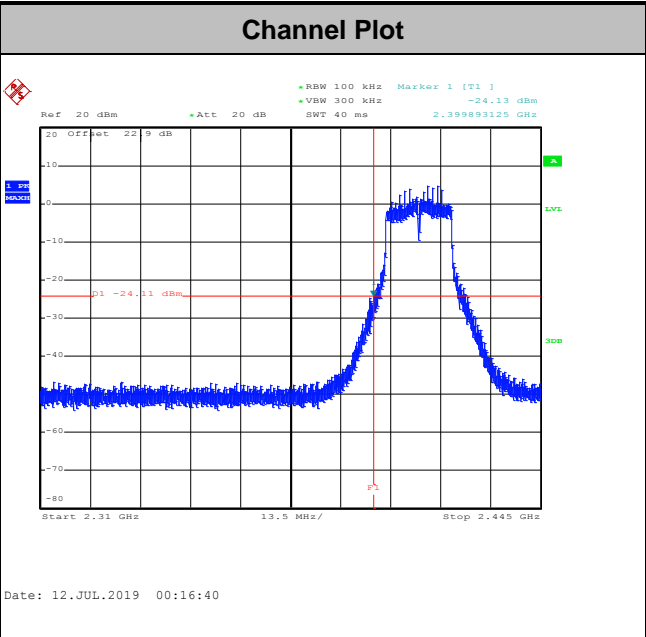
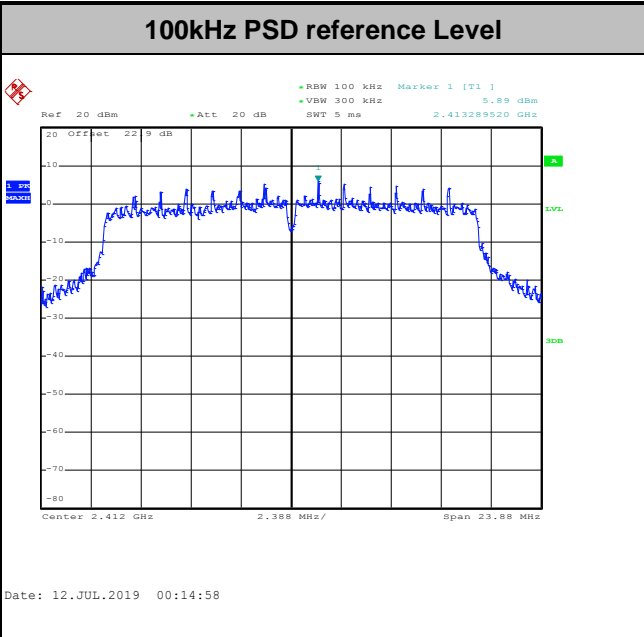



Test Mode :	802.11n HT20	Test Channel :	06
-------------	--------------	----------------	----

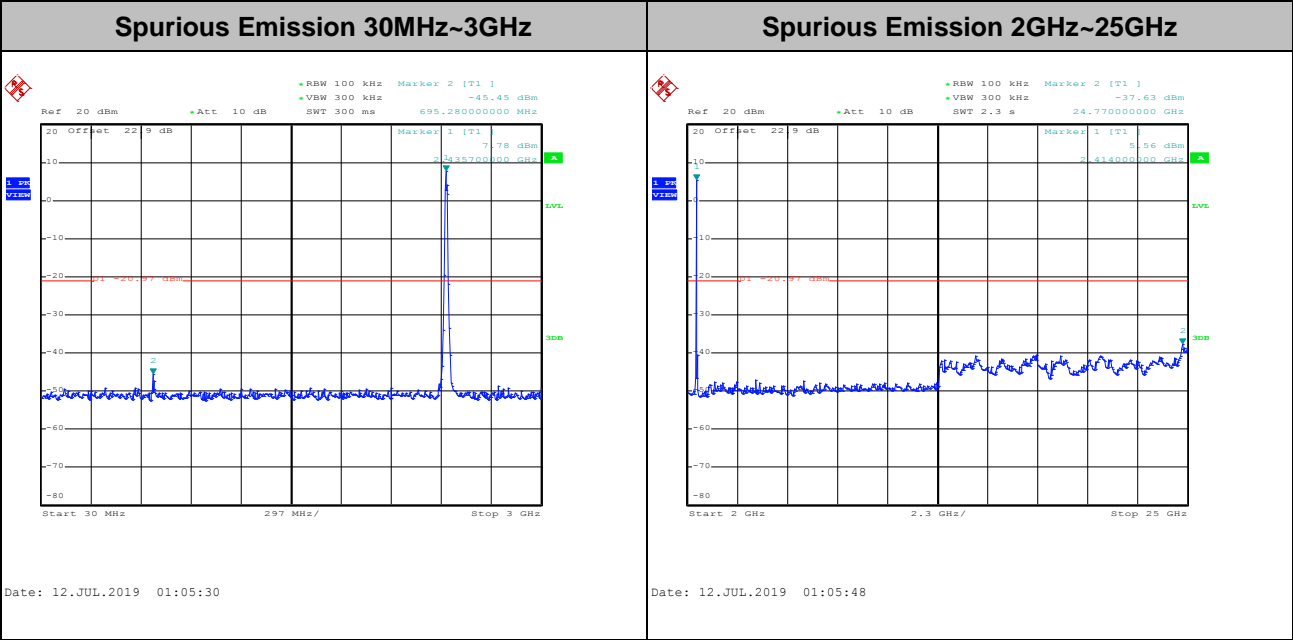
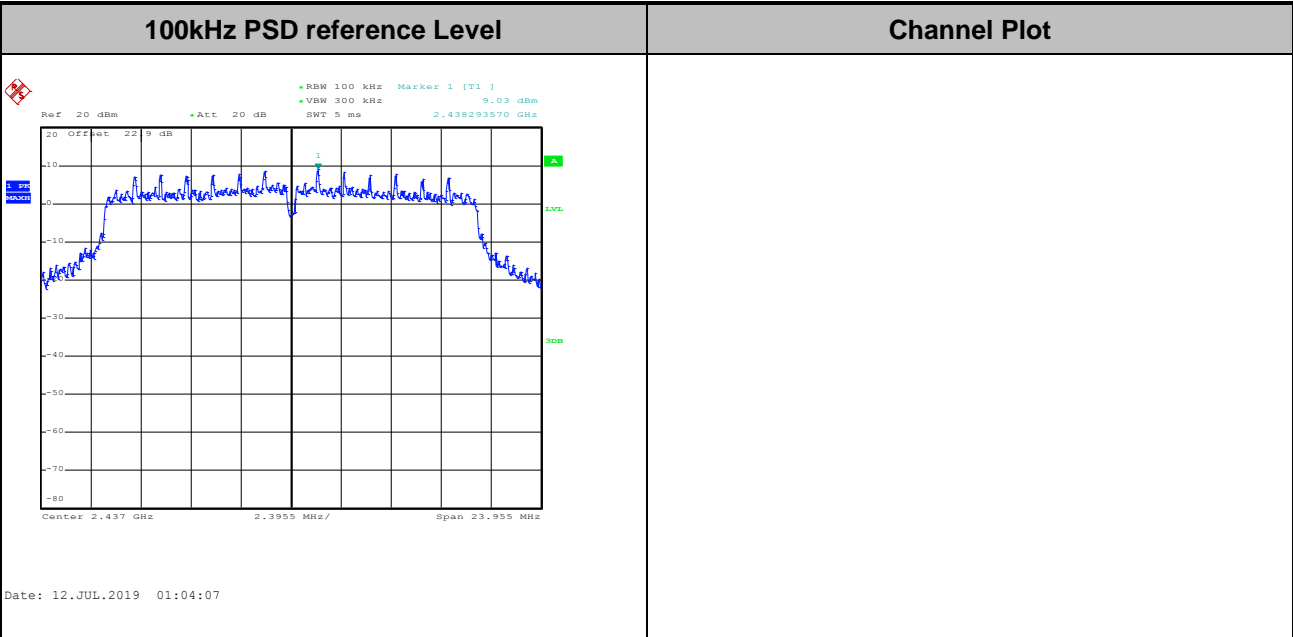



Test Mode :	802.11n HT20	Test Channel :	11
-------------	--------------	----------------	----

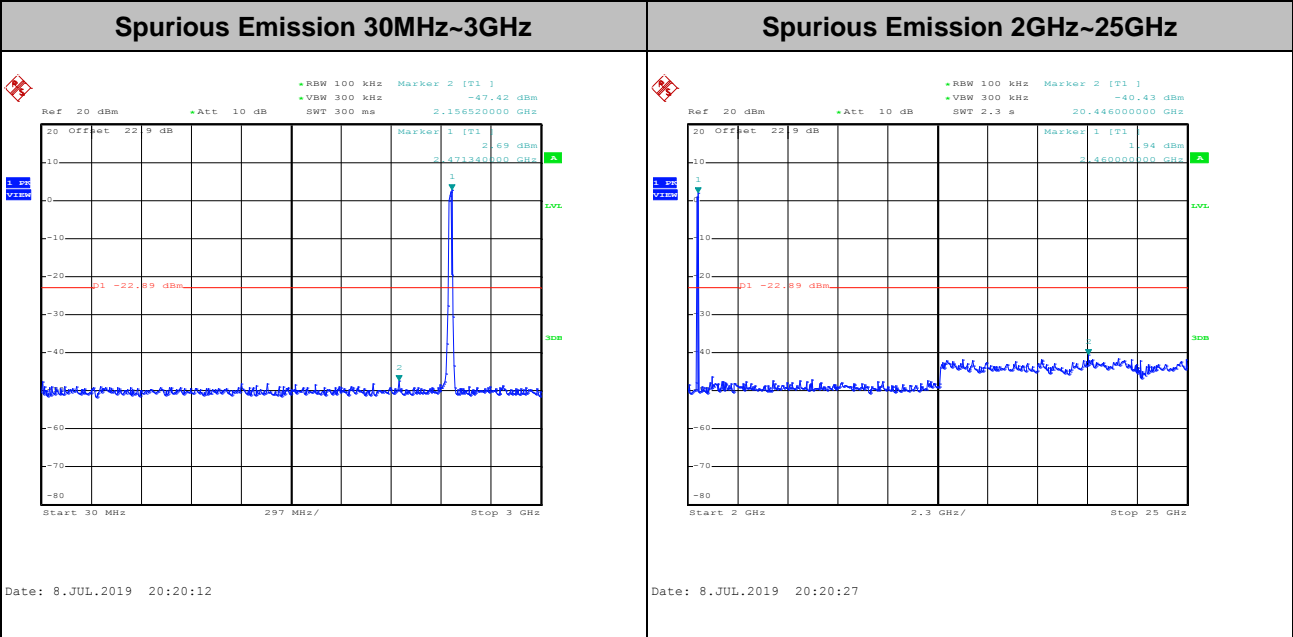
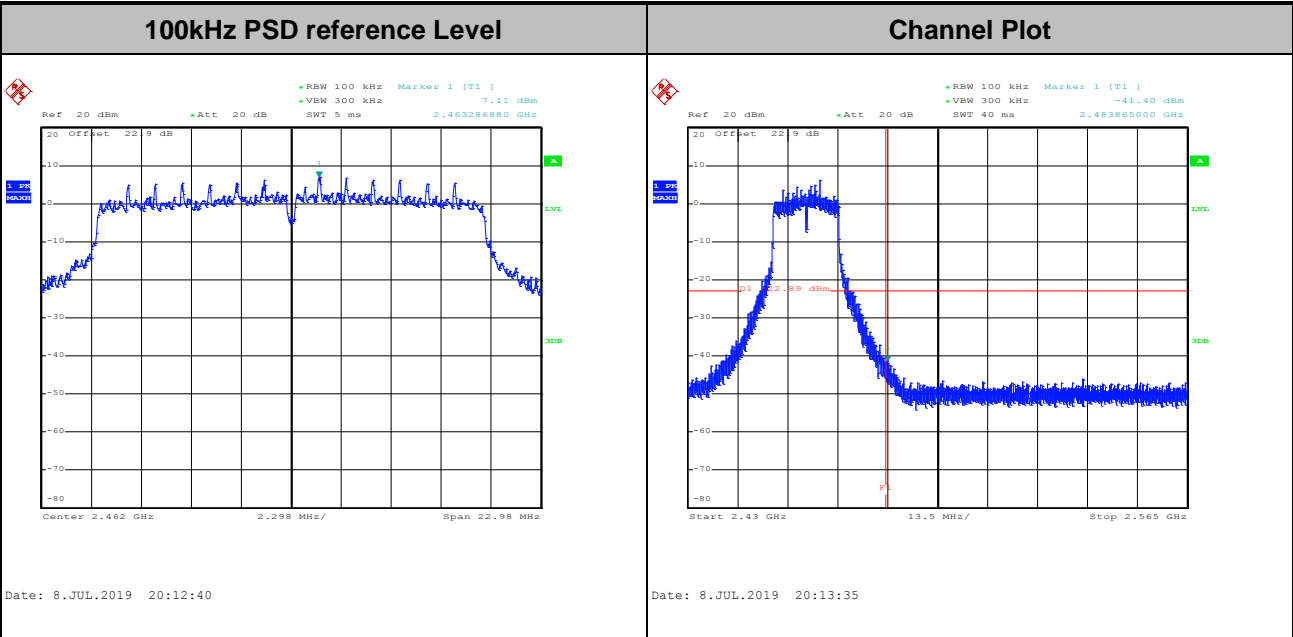





Test Mode : 802.11n HT40      Test Channel : 03

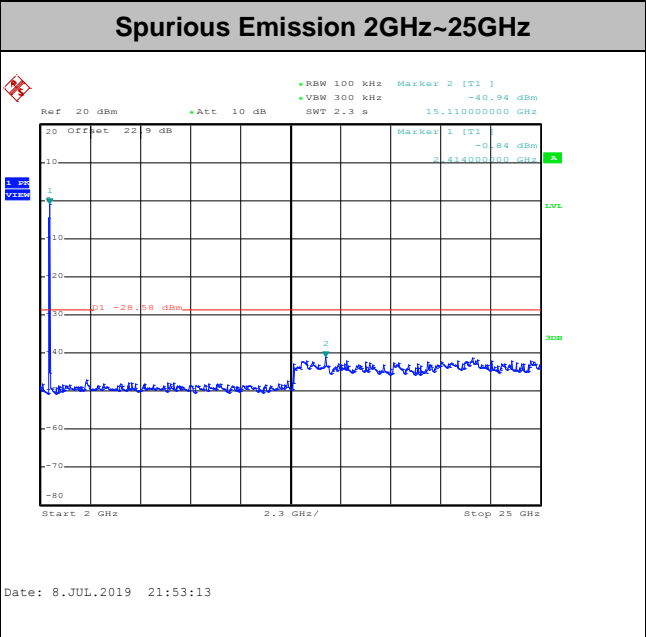
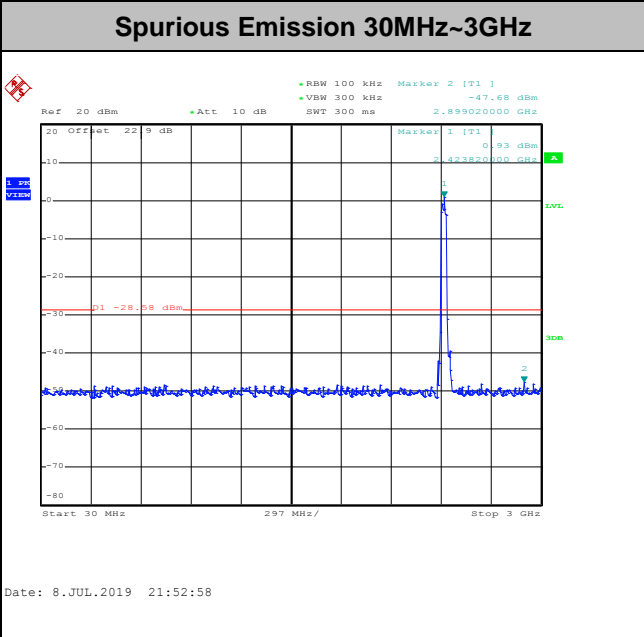
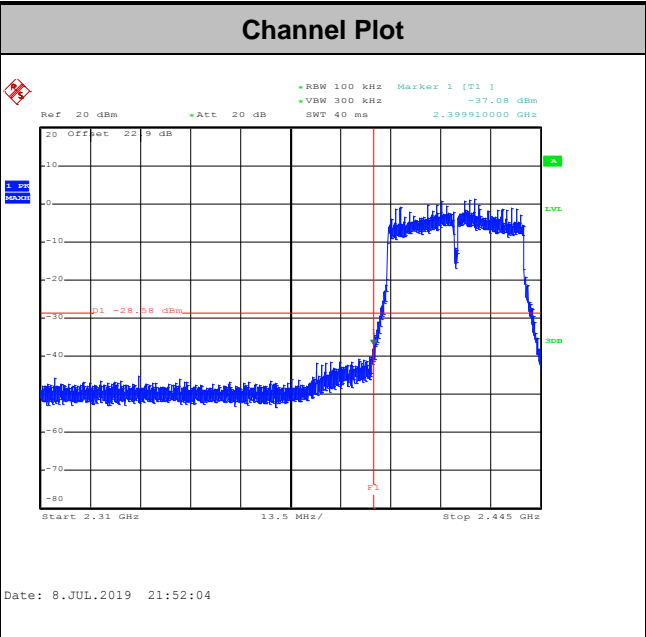
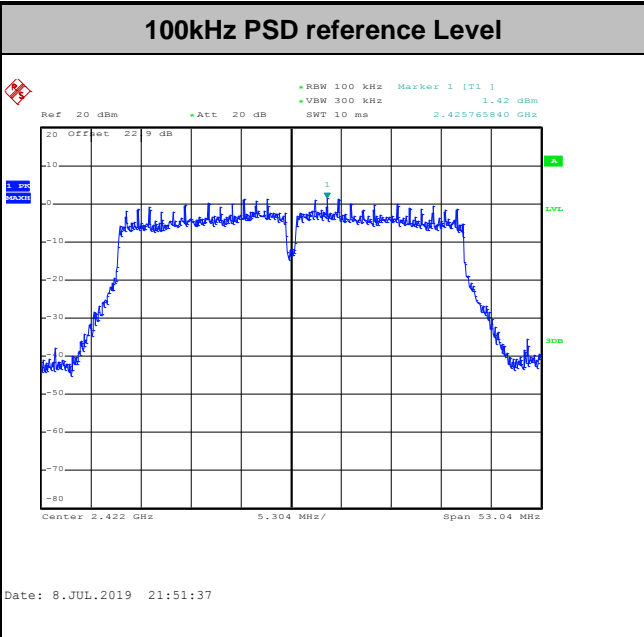



Test Mode :	802.11n HT40	Test Channel :	06
-------------	--------------	----------------	----

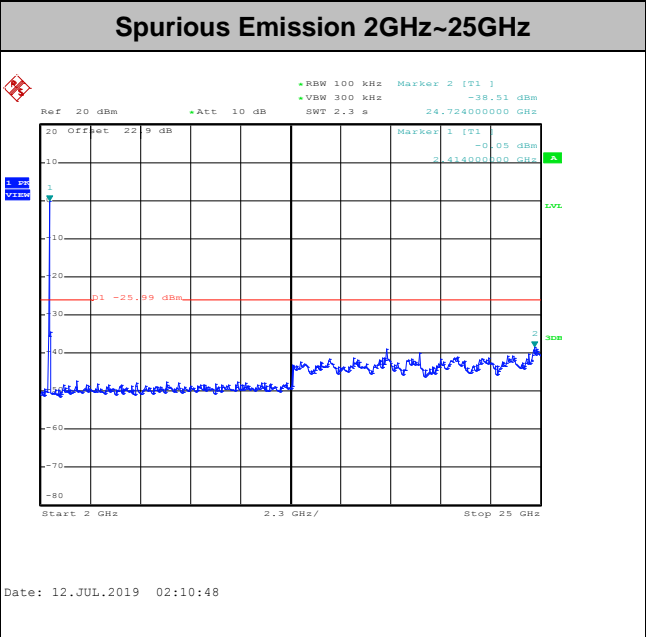
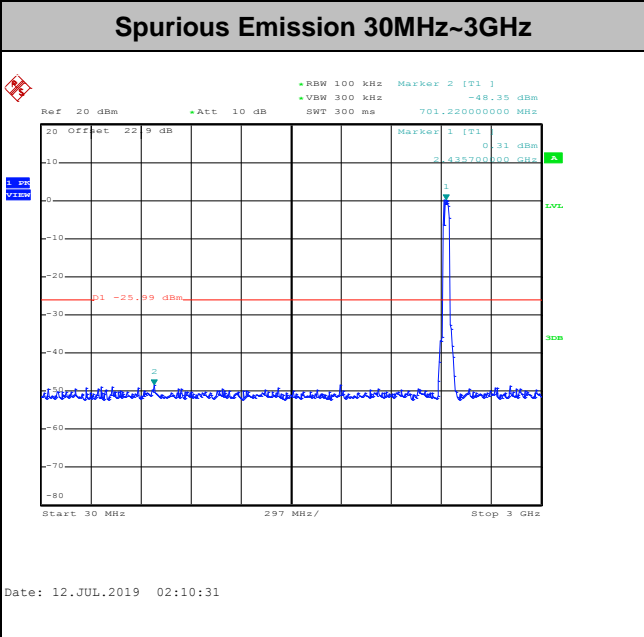
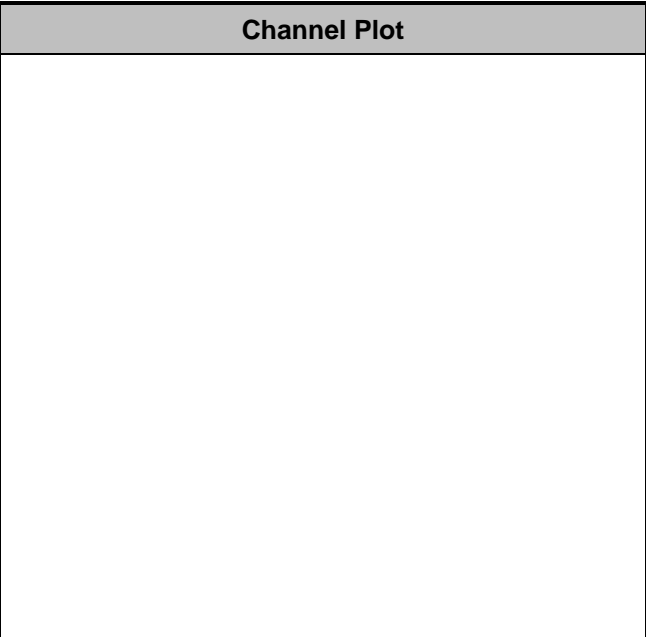
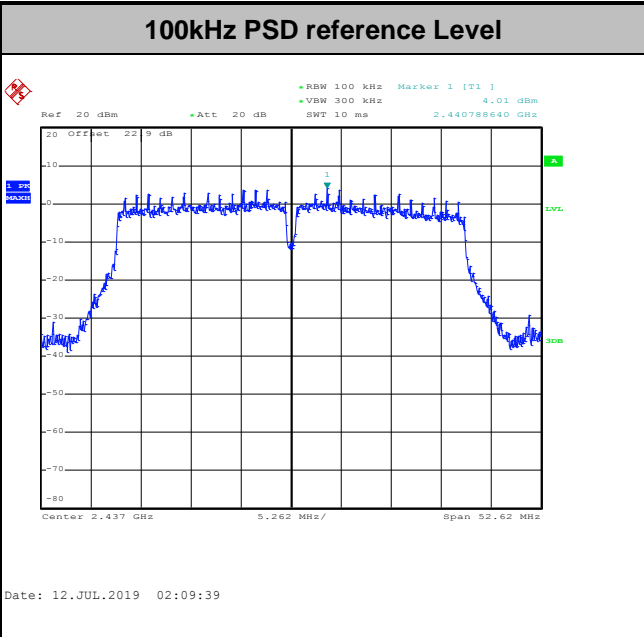



Test Mode :	802.11n HT40	Test Channel :	09
-------------	--------------	----------------	----

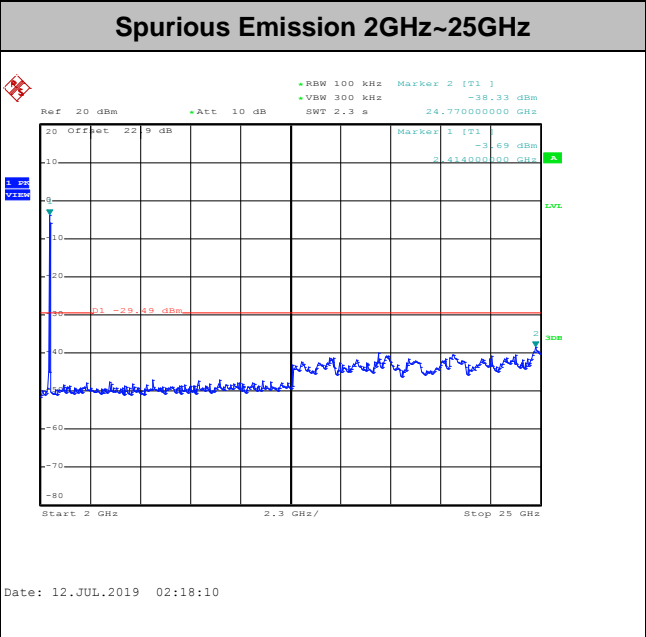
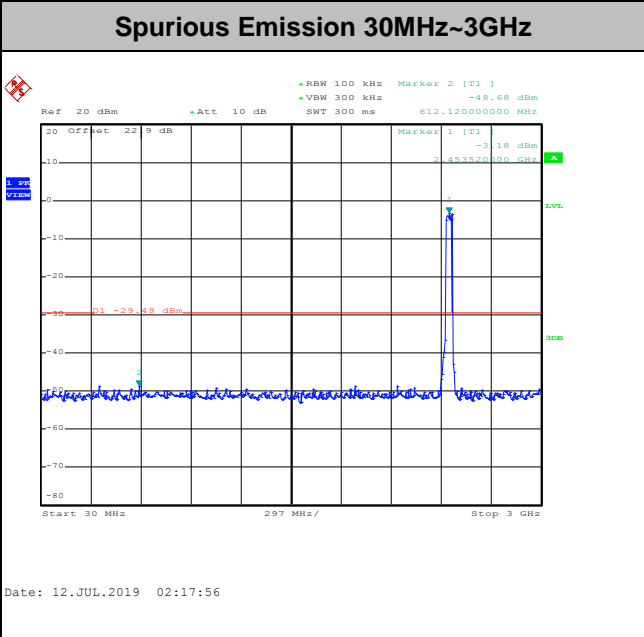
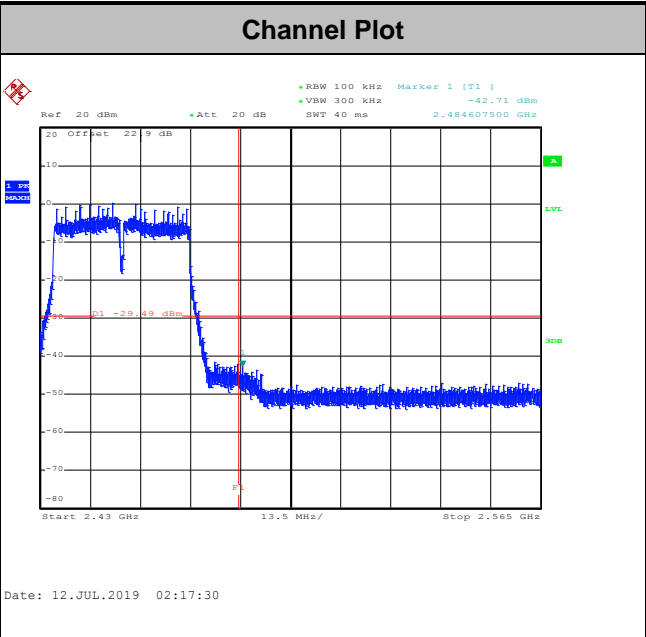
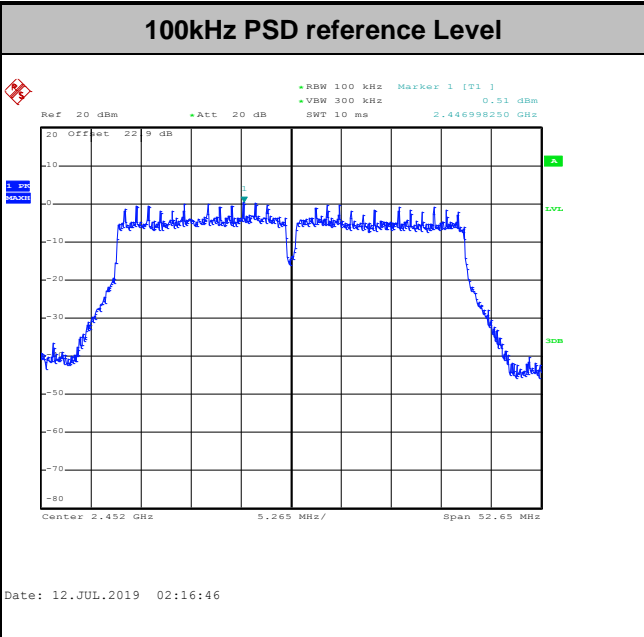



Number of TX = 1, Ant. 2 (Measured)

Test Mode :	802.11b	Test Channel :	01
-------------	---------	----------------	----

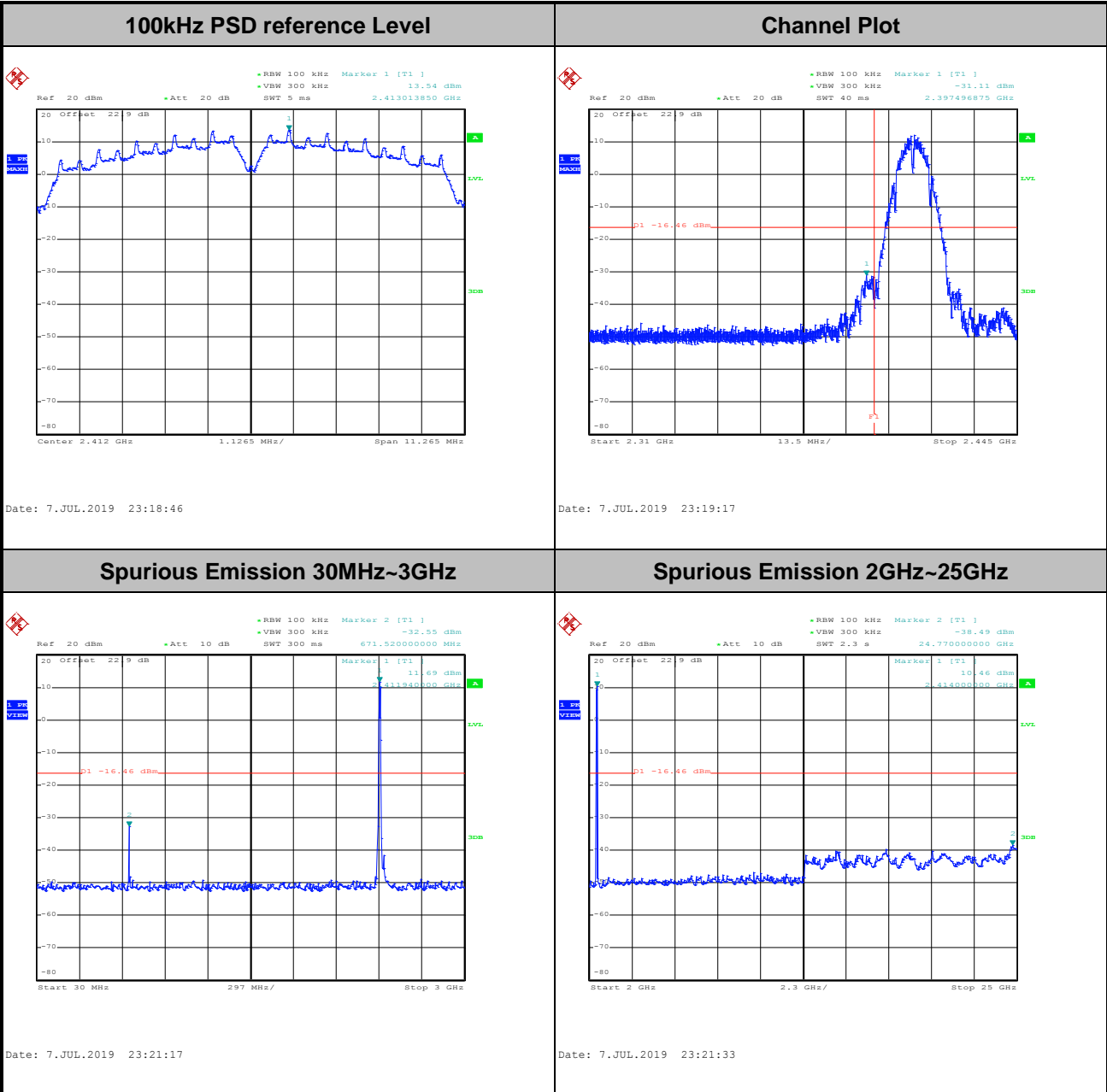



Test Mode :	802.11b	Test Channel :	06
-------------	---------	----------------	----

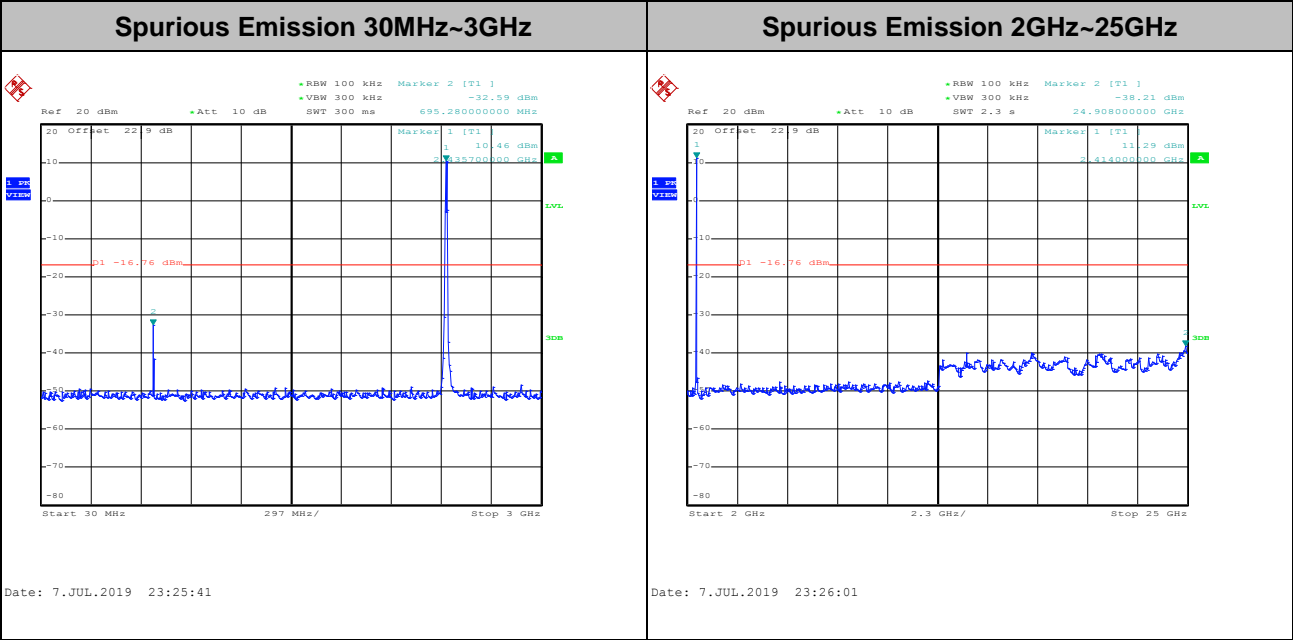
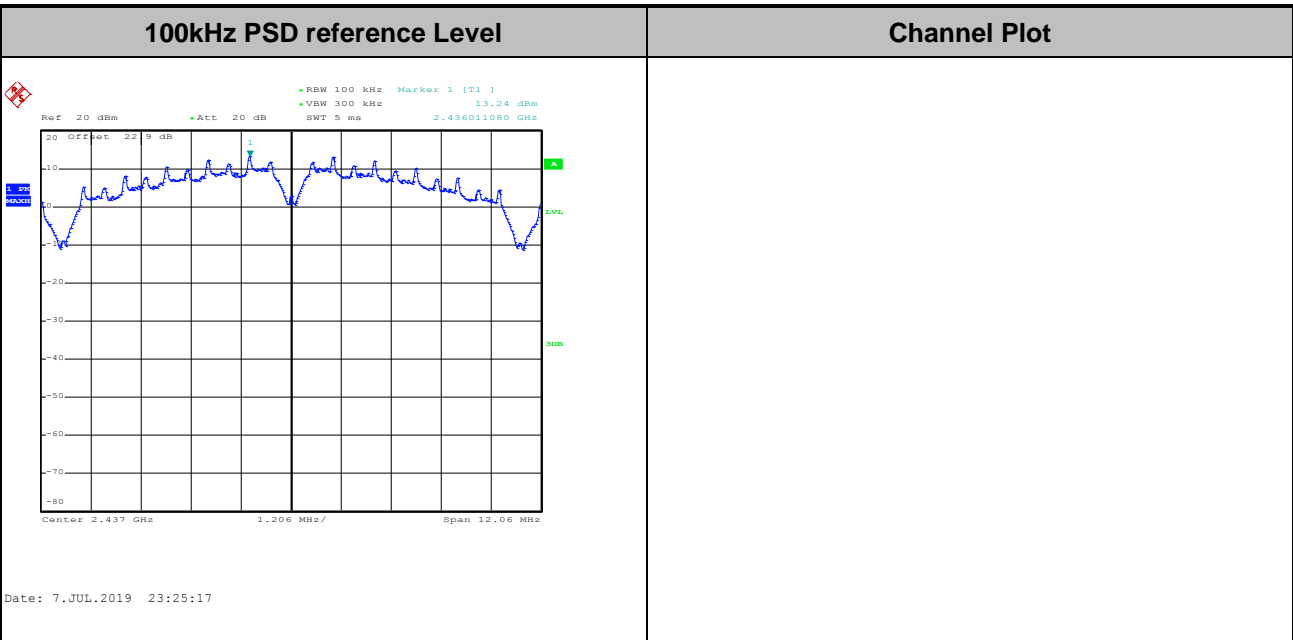



Test Mode :	802.11b	Test Channel :	11
-------------	---------	----------------	----

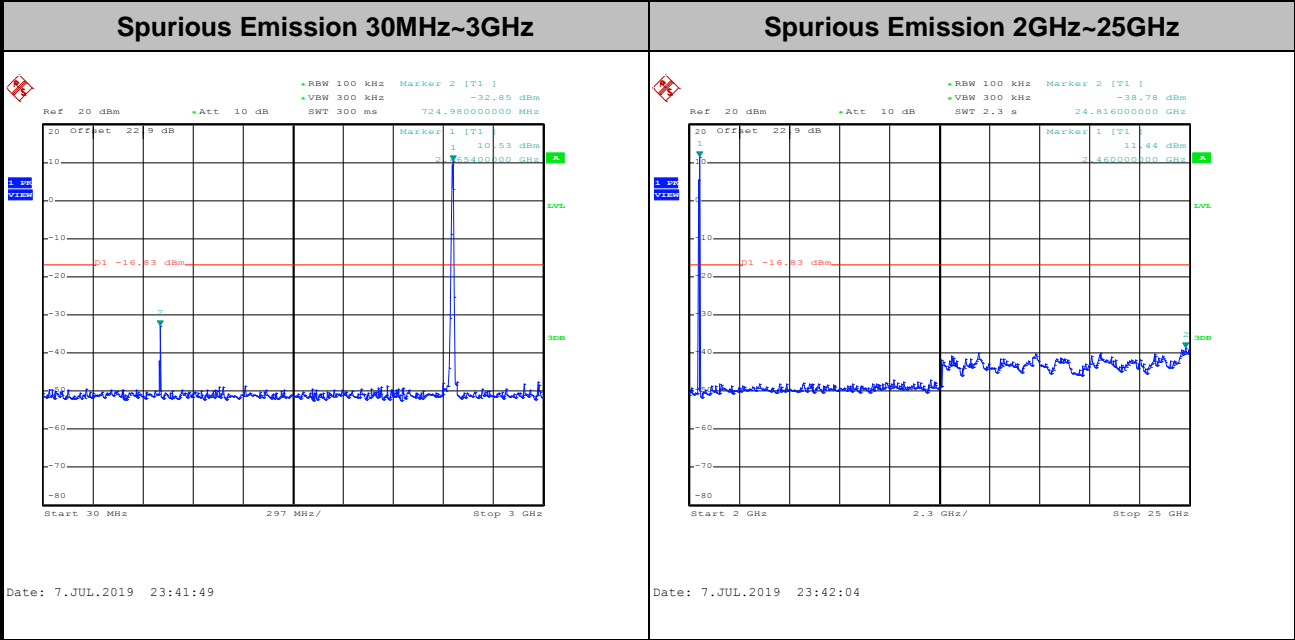
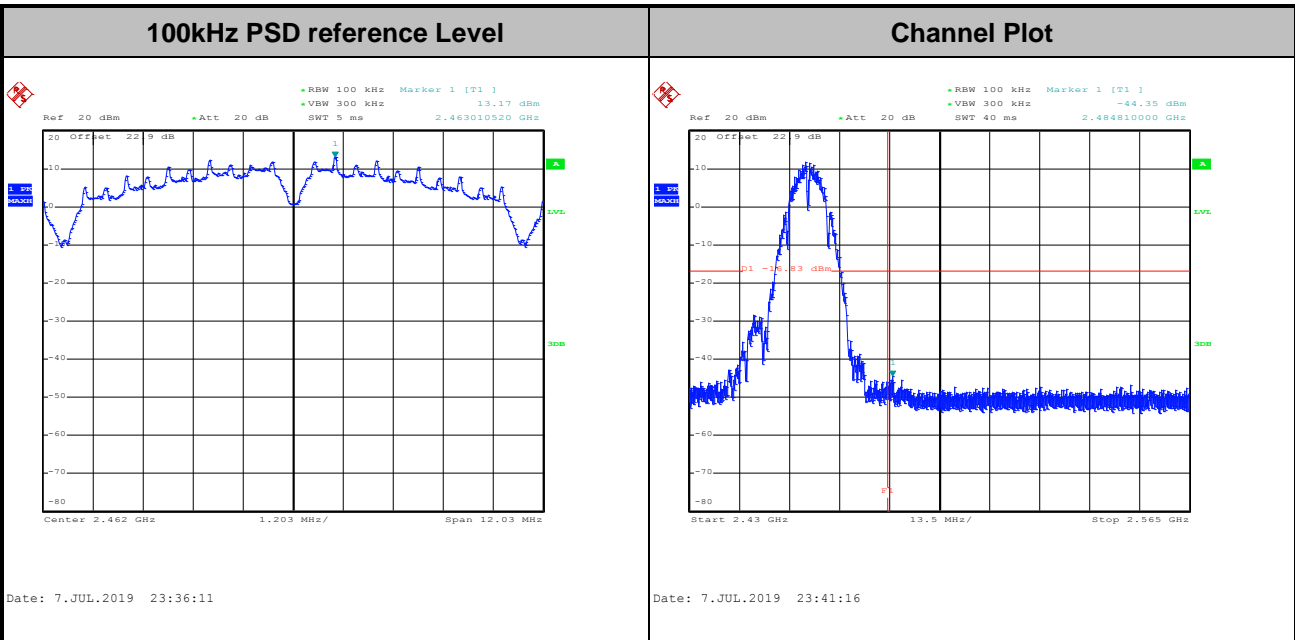



Test Mode :	802.11g	Test Channel :	01
-------------	---------	----------------	----

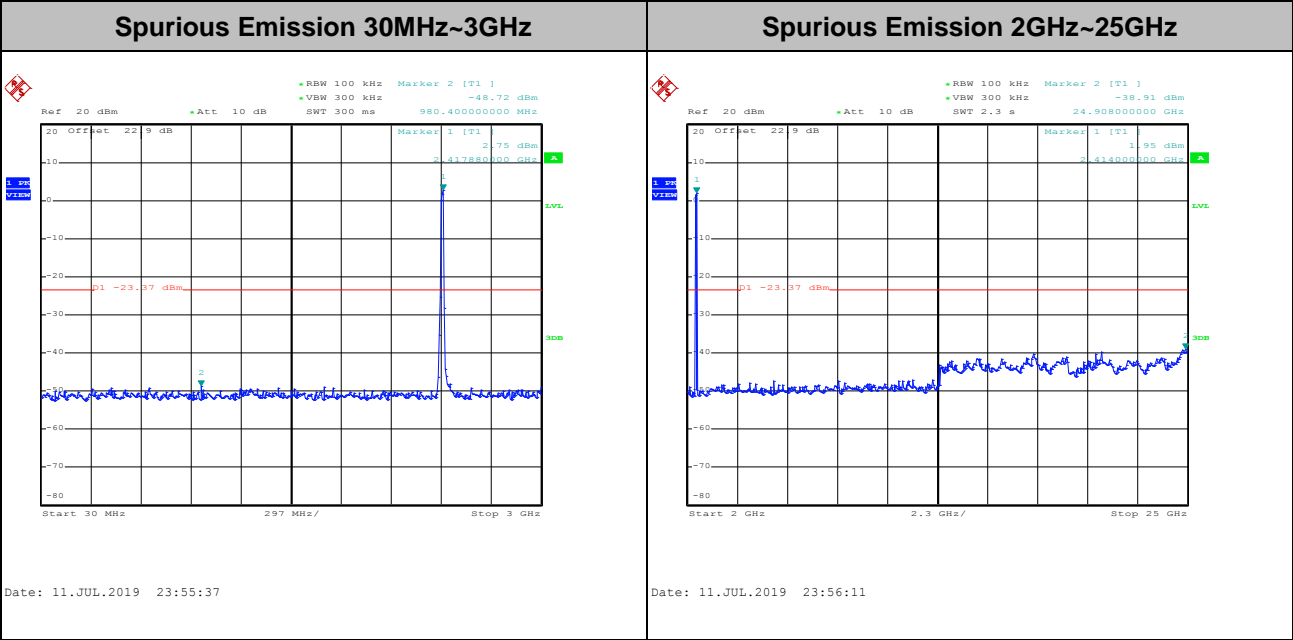
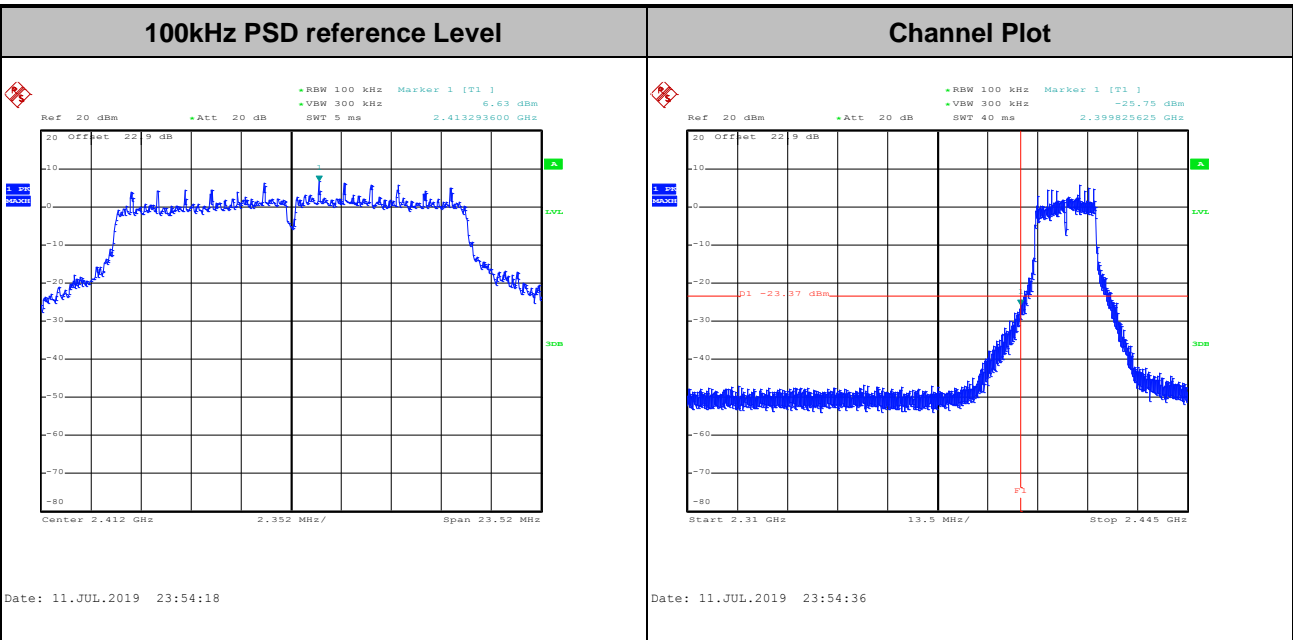



Test Mode :	802.11g	Test Channel :	06
-------------	---------	----------------	----

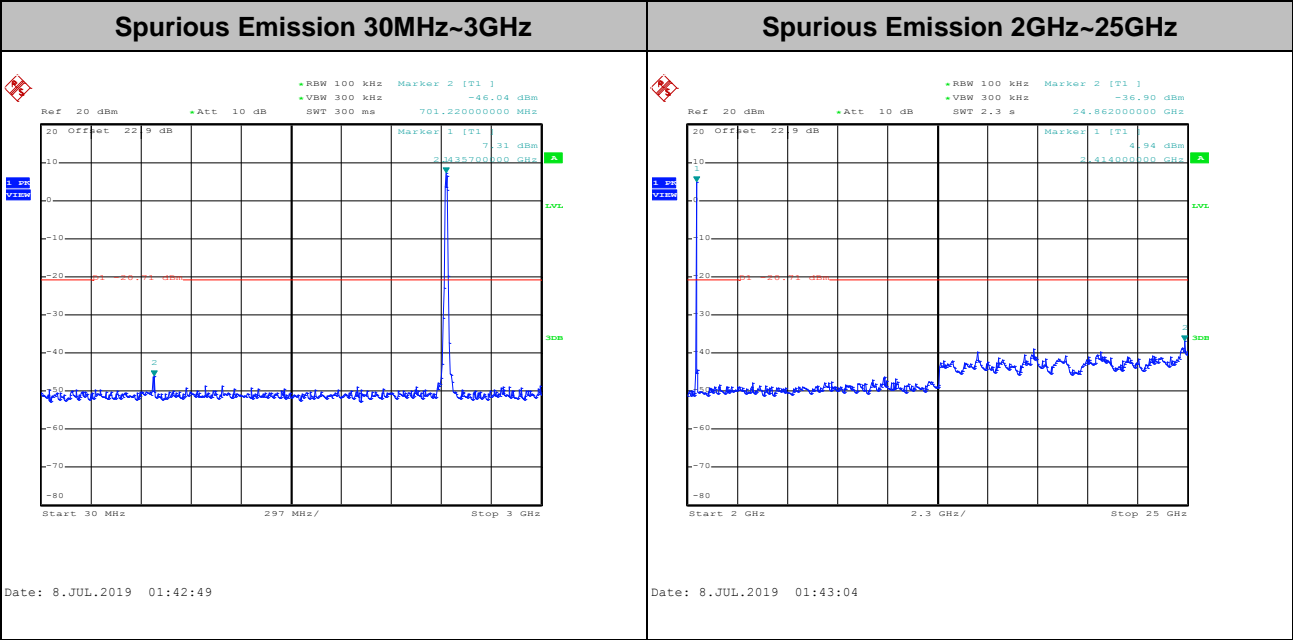
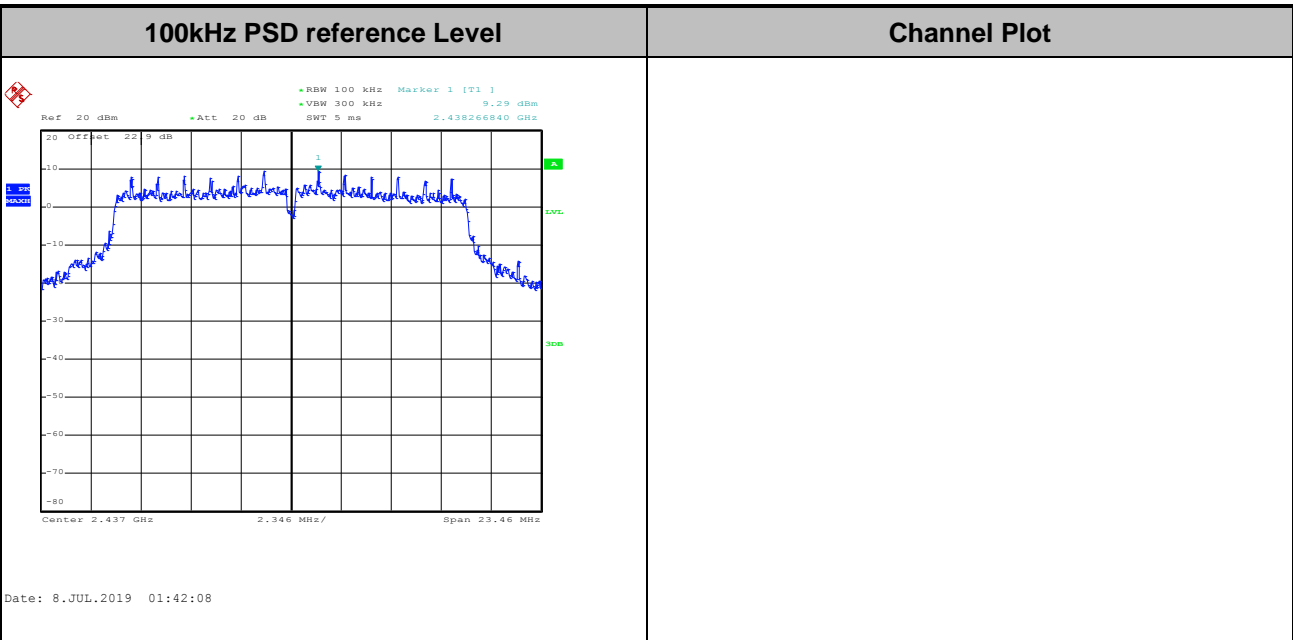





Test Mode :	802.11g	Test Channel :	11
-------------	---------	----------------	----

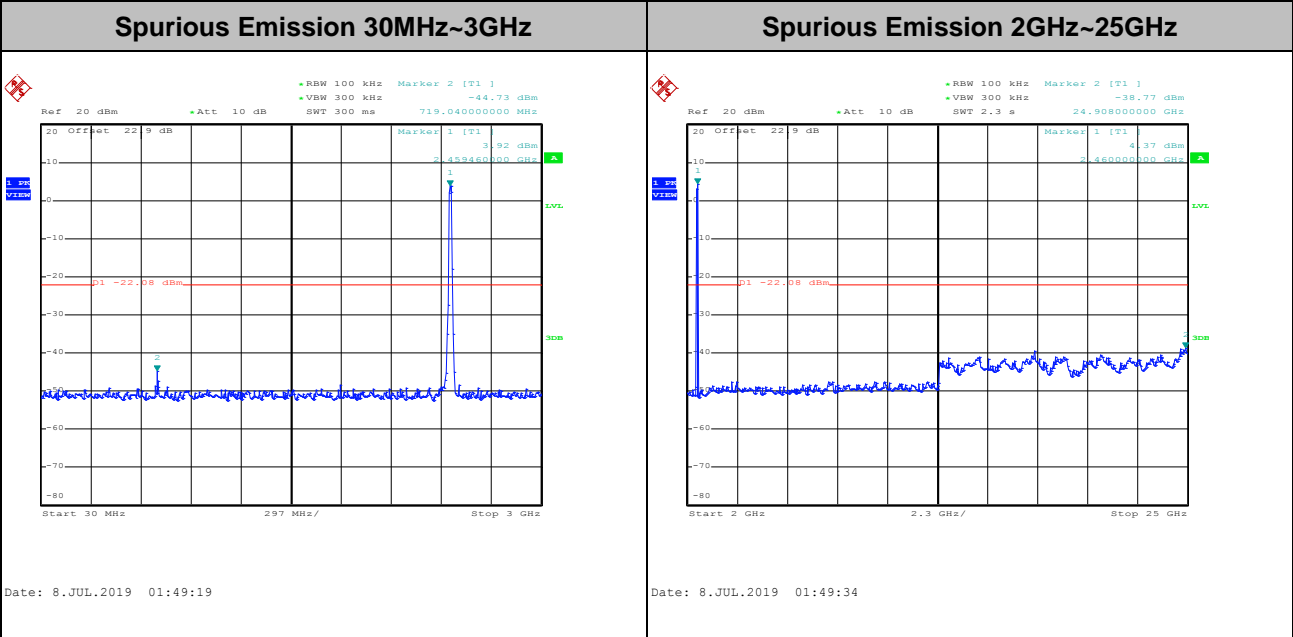
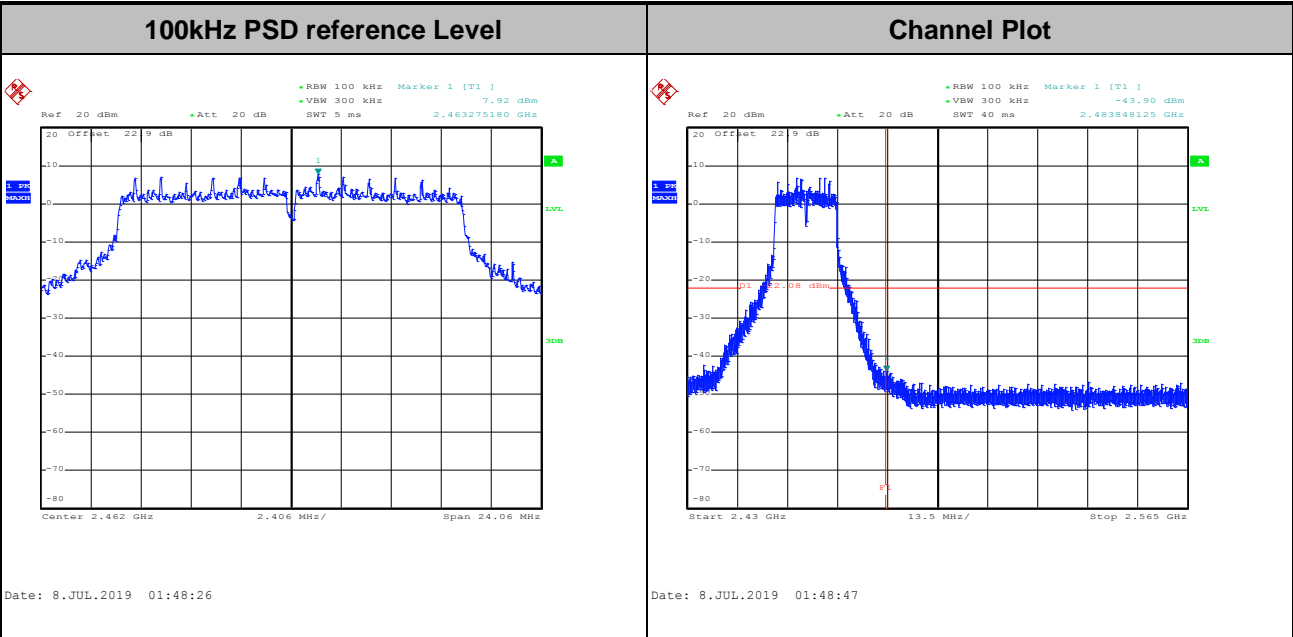



Test Mode :	802.11n HT20	Test Channel :	01
-------------	--------------	----------------	----

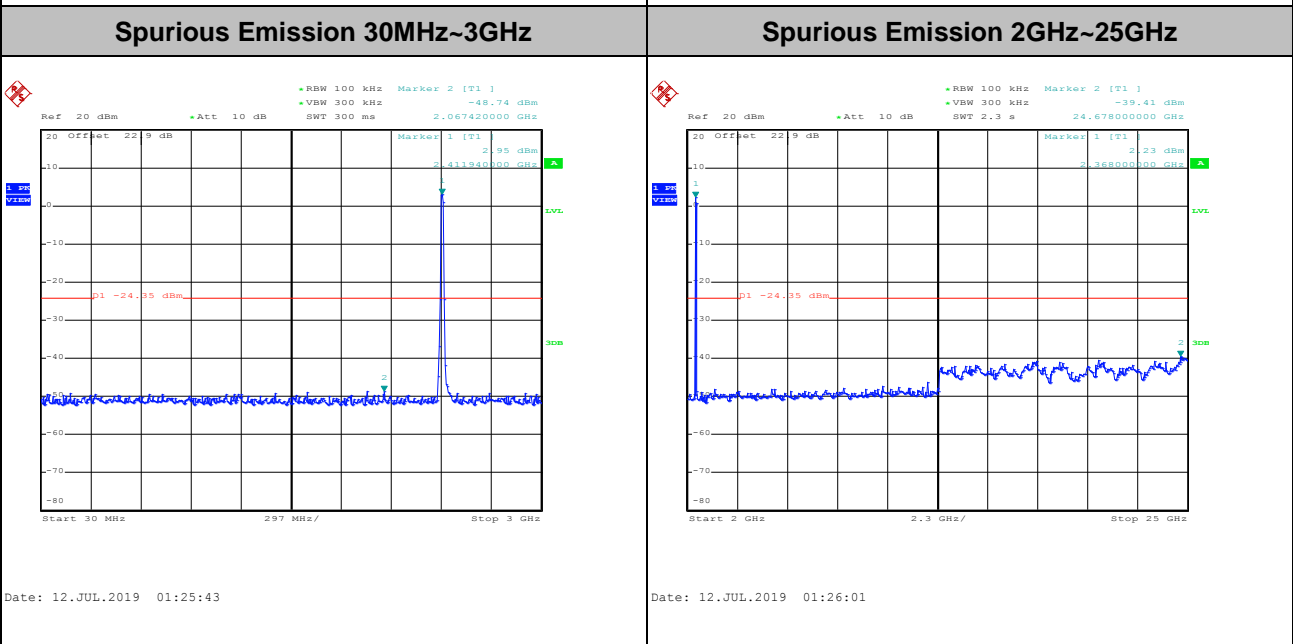
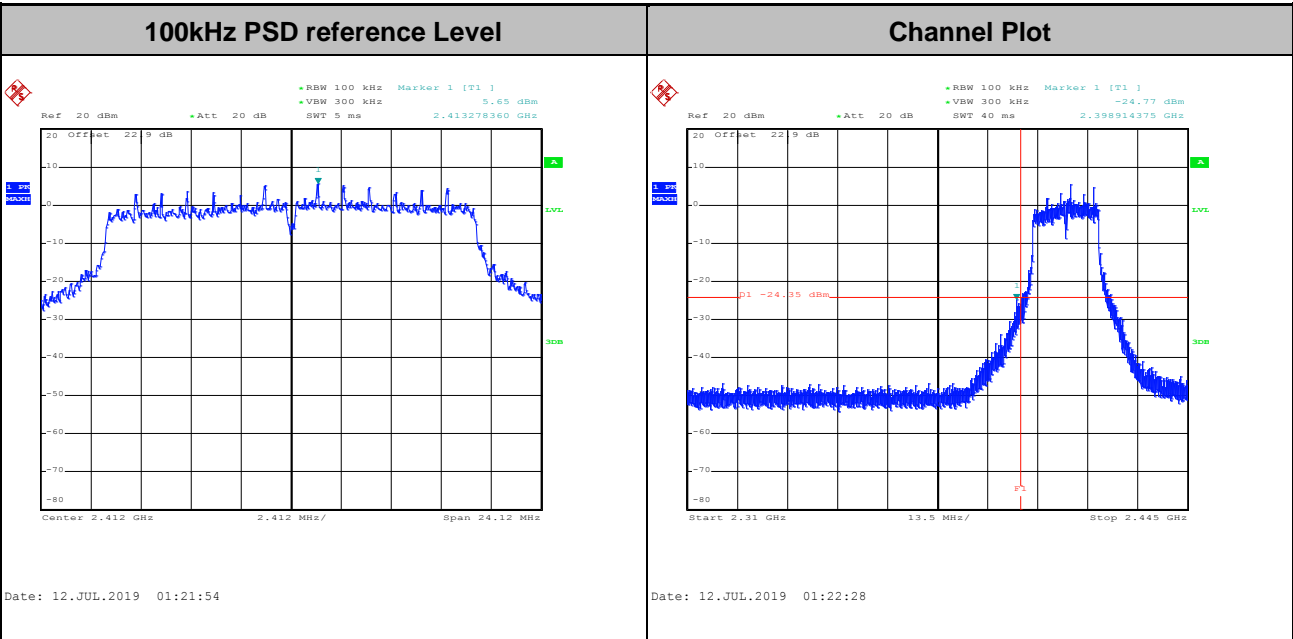



Test Mode :	802.11n HT20	Test Channel :	06
-------------	--------------	----------------	----

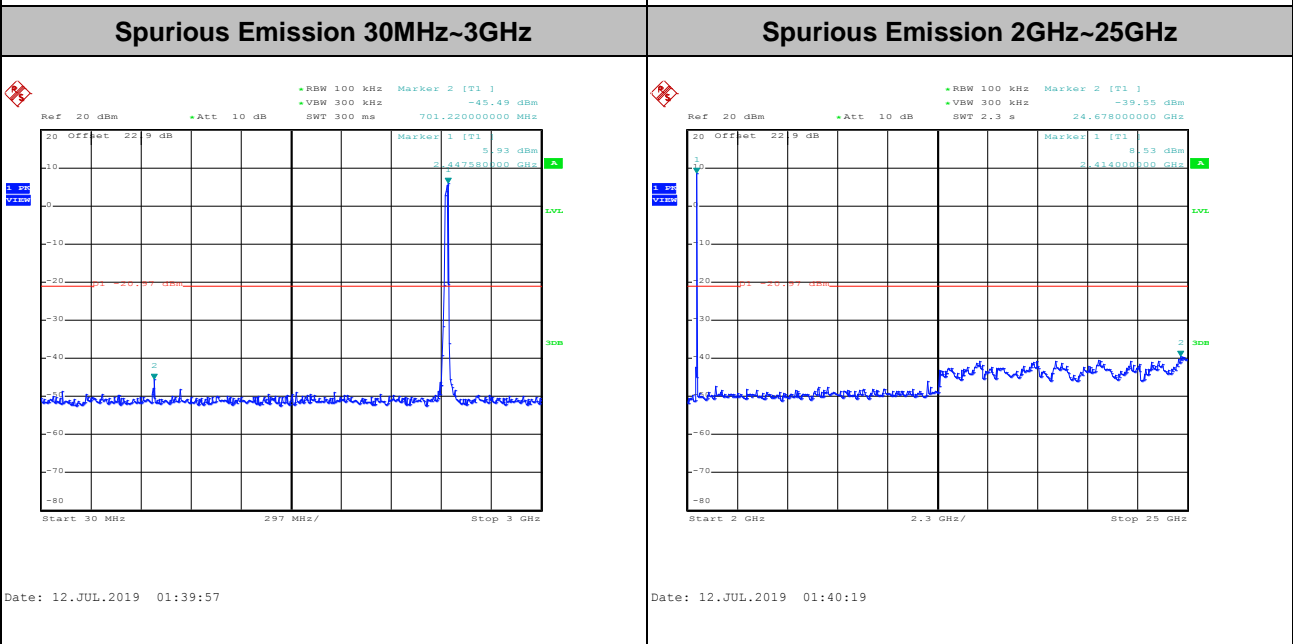
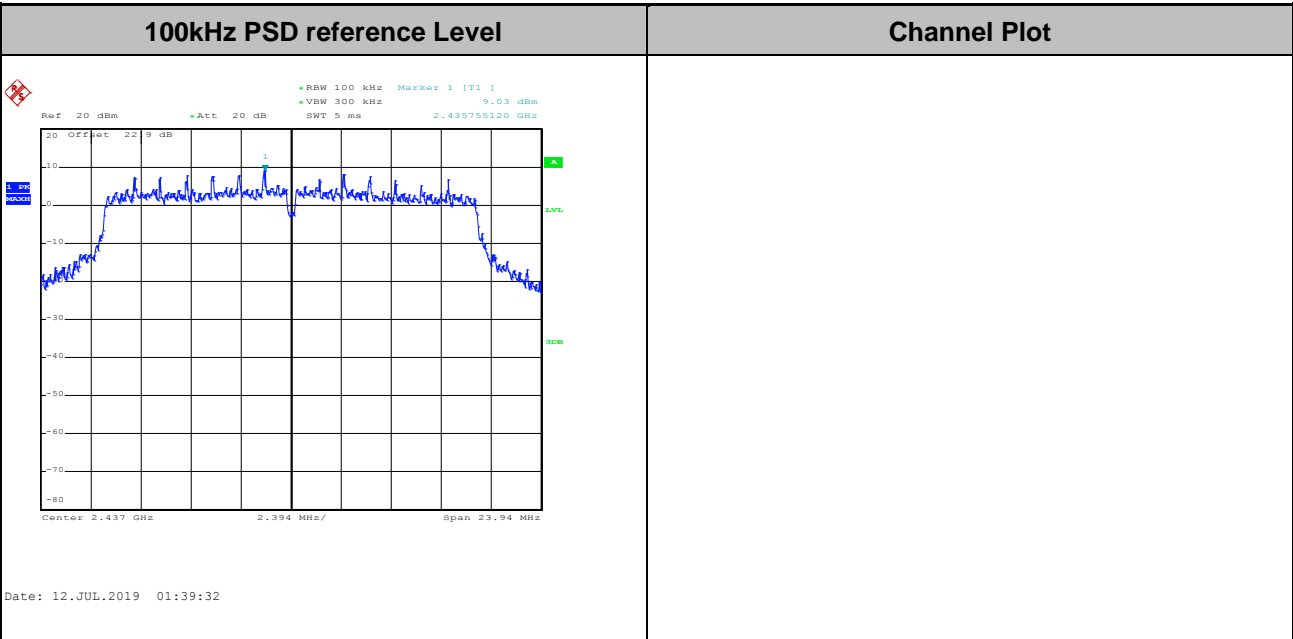



Test Mode :	802.11n HT20	Test Channel :	11
-------------	--------------	----------------	----

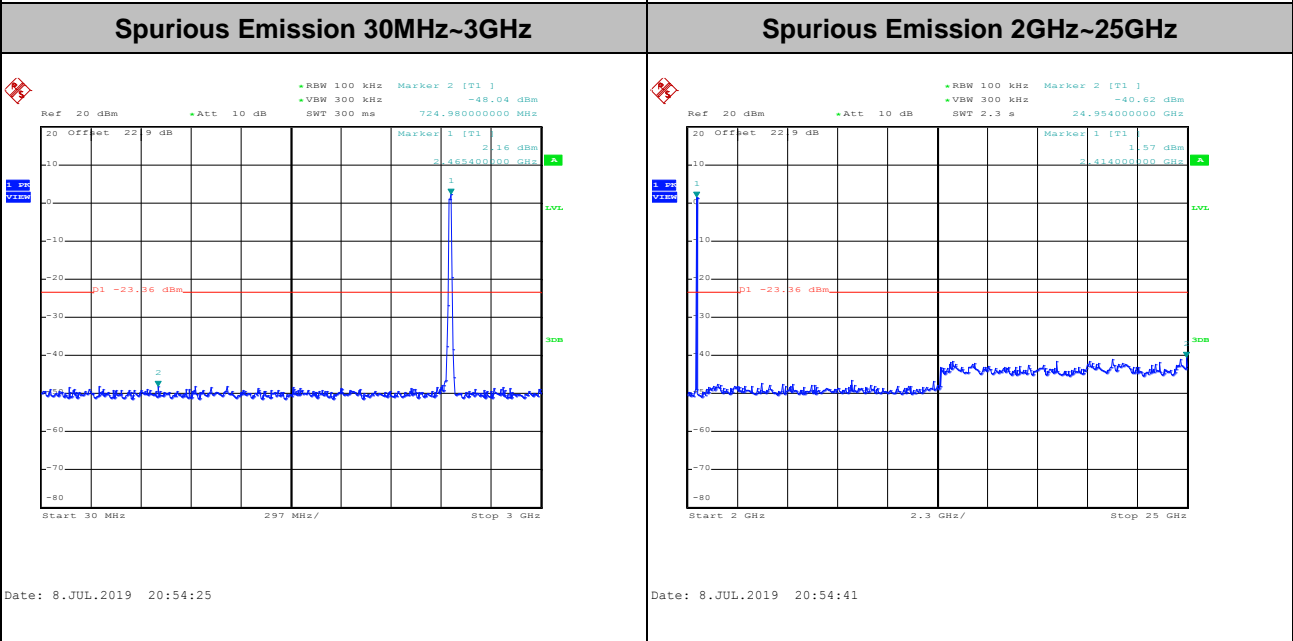
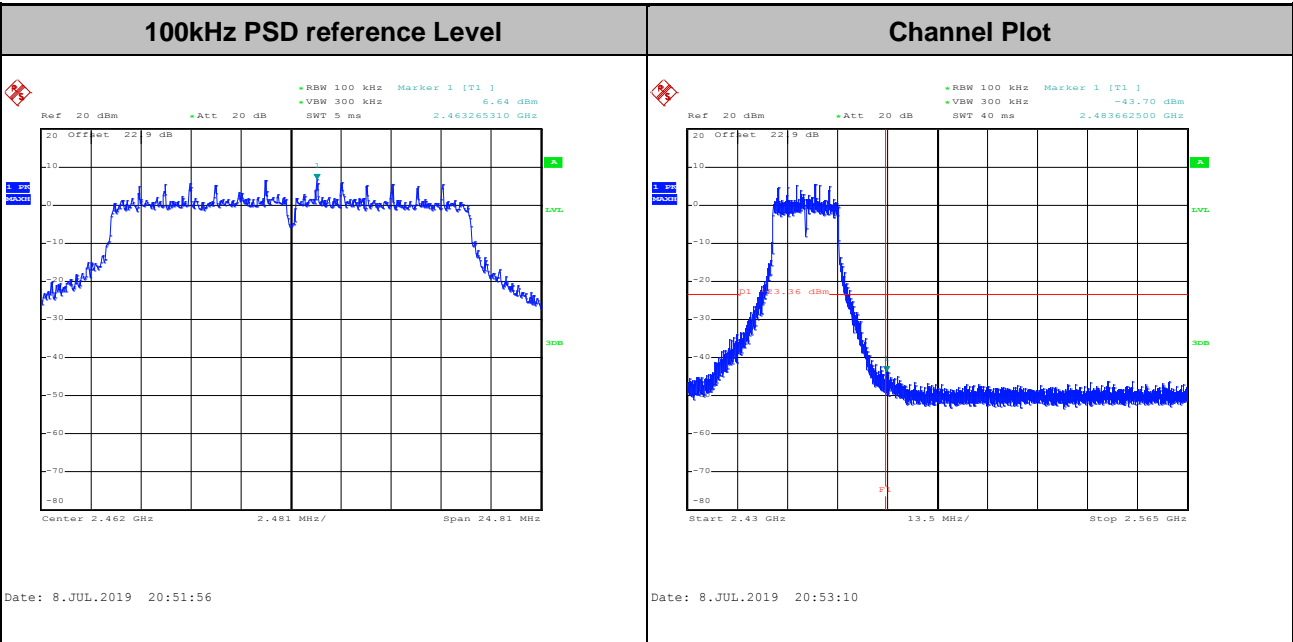



Test Mode :	802.11n HT40	Test Channel :	03
-------------	--------------	----------------	----

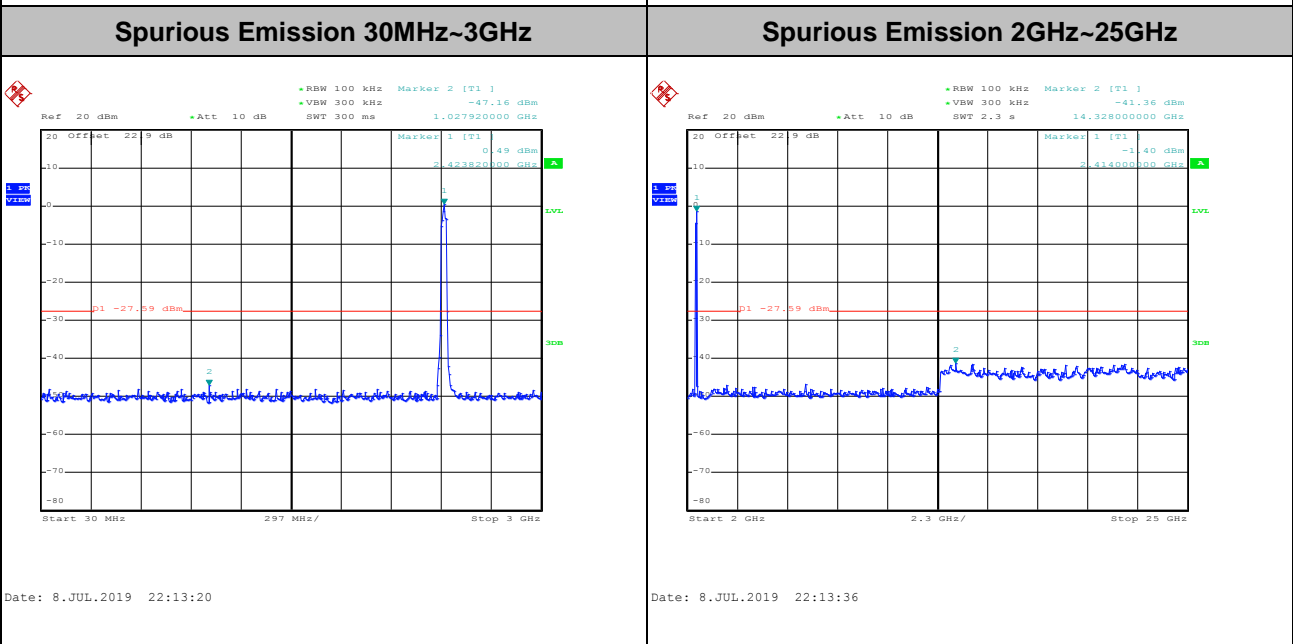
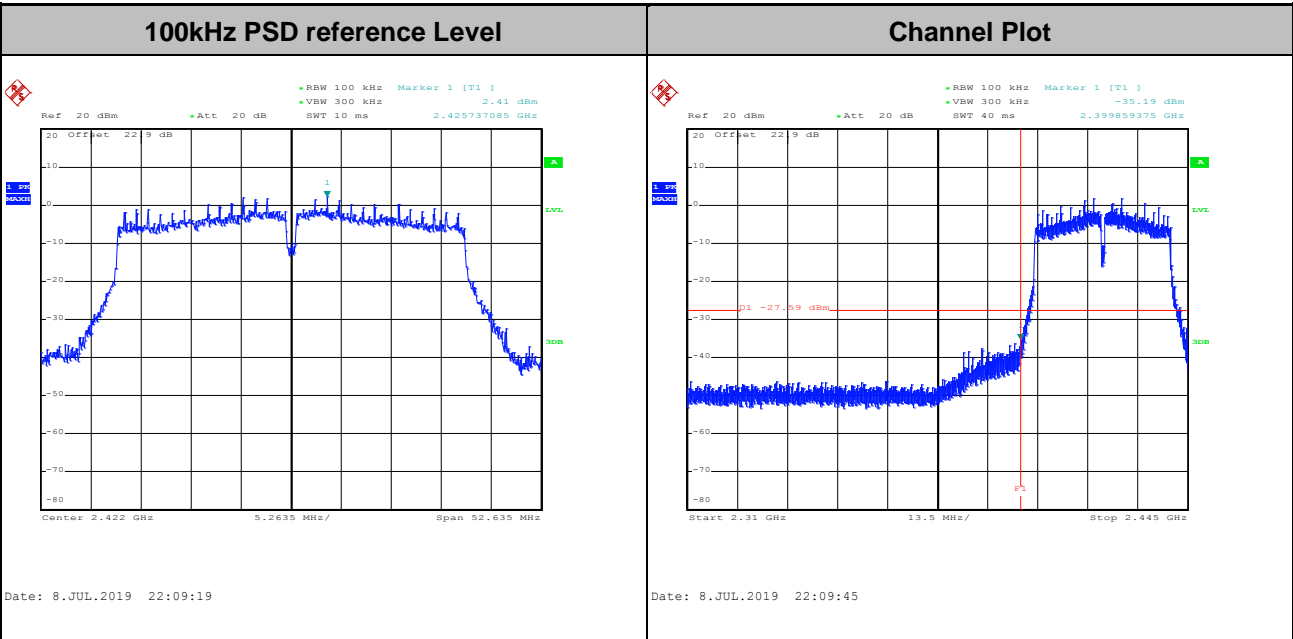



Test Mode :	802.11n HT40	Test Channel :	06
-------------	--------------	----------------	----

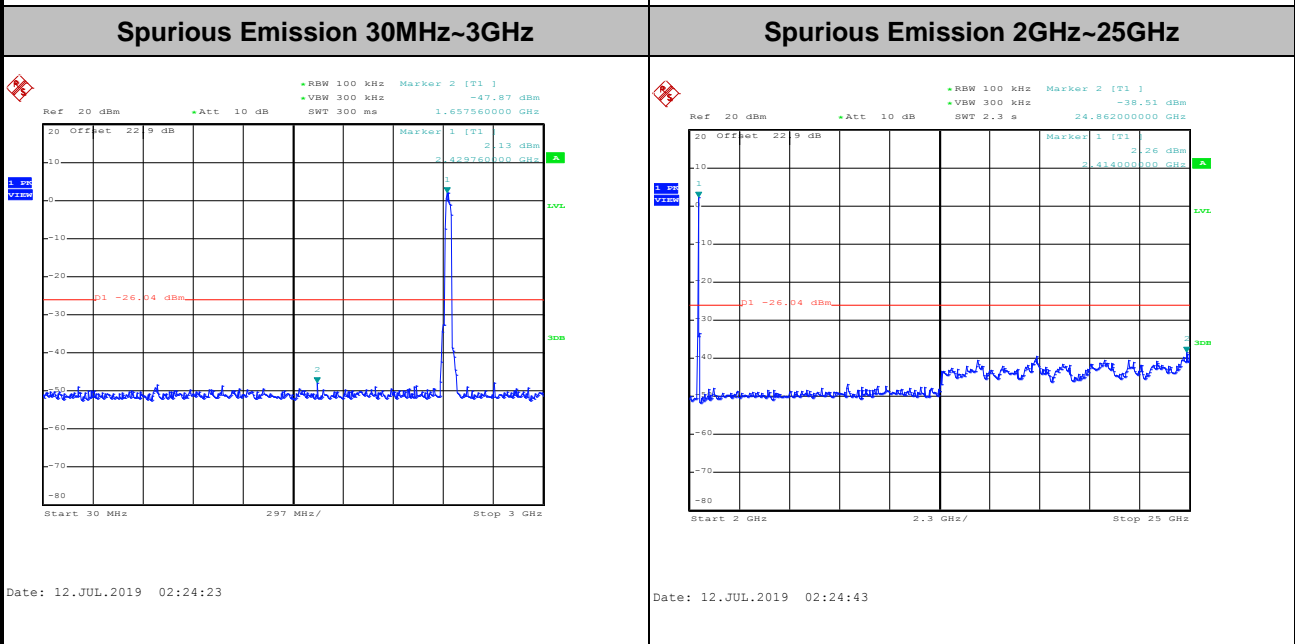
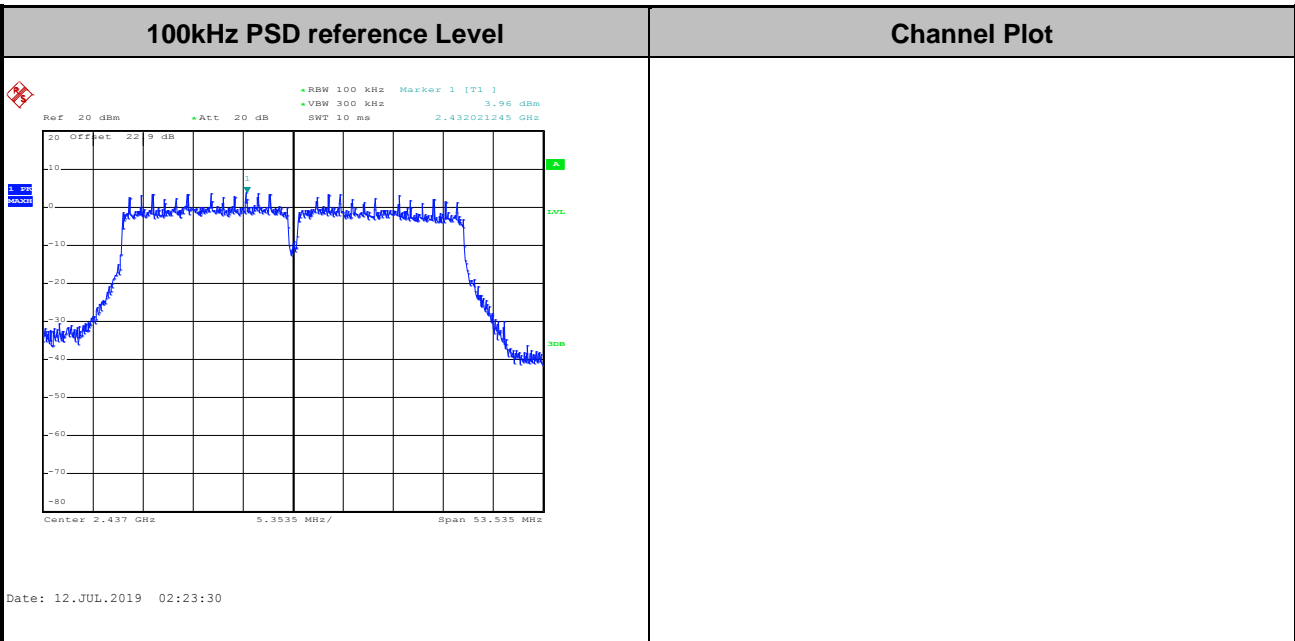



Test Mode :	802.11n HT40	Test Channel :	09
-------------	--------------	----------------	----

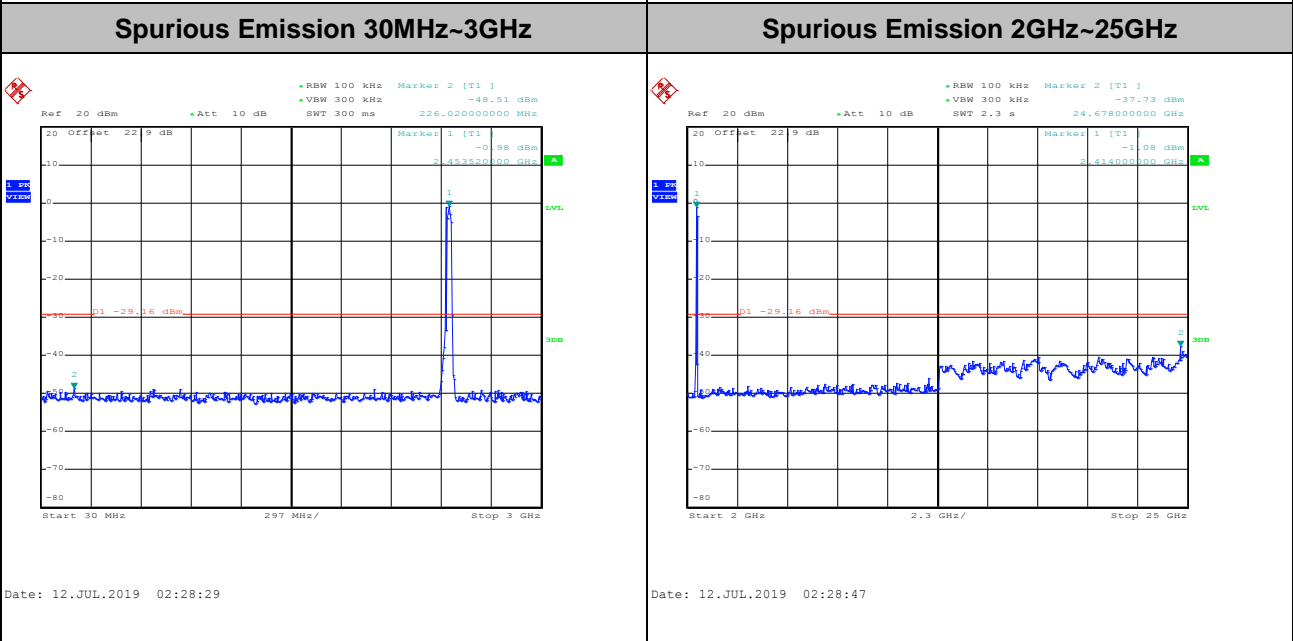
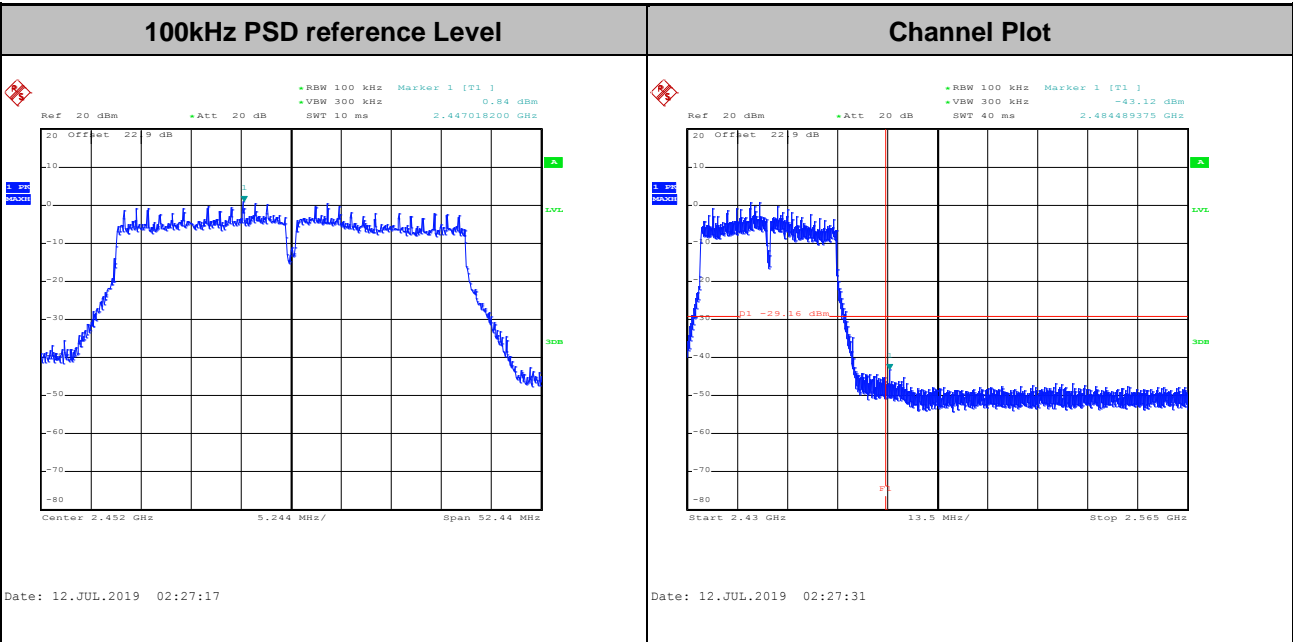



<CDD Modes>

Number of TX = 2, Ant. 1 (Measured)

Test Mode :	802.11b	Test Channel :	01
-------------	---------	----------------	----

<b>100kHz PSD reference Level</b>	<b>Channel Plot</b>
-----------------------------------	---------------------

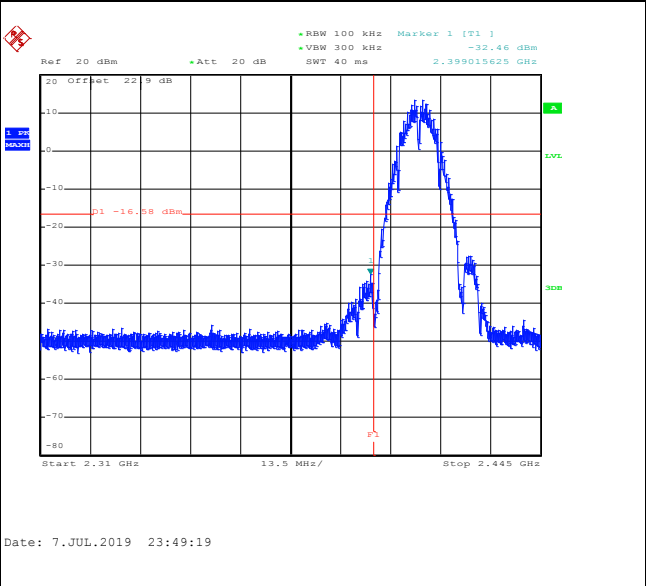
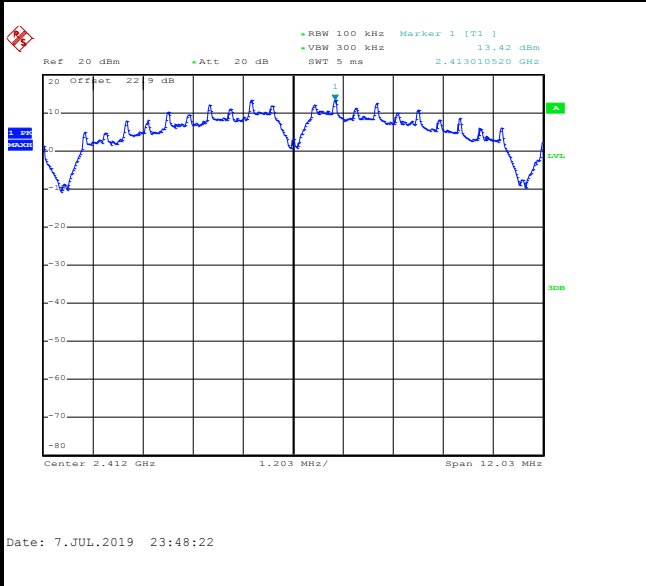

<b>Spurious Emission 30MHz~3GHz</b>	<b>Spurious Emission 2GHz~25GHz</b>
-------------------------------------	-------------------------------------

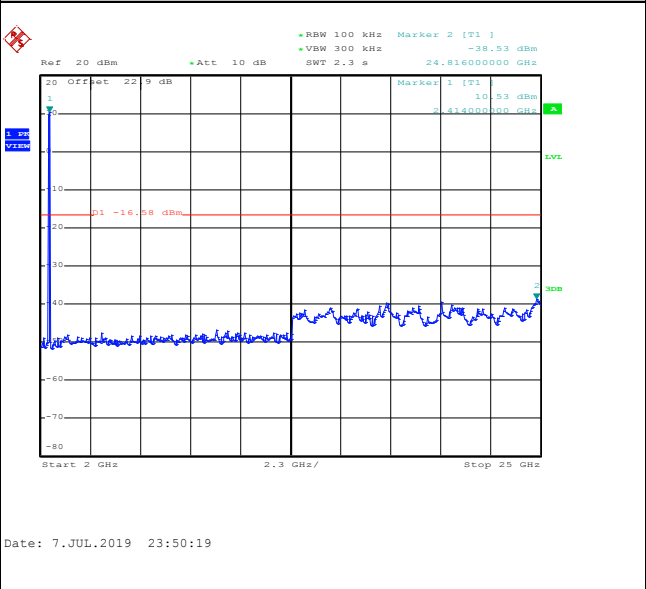
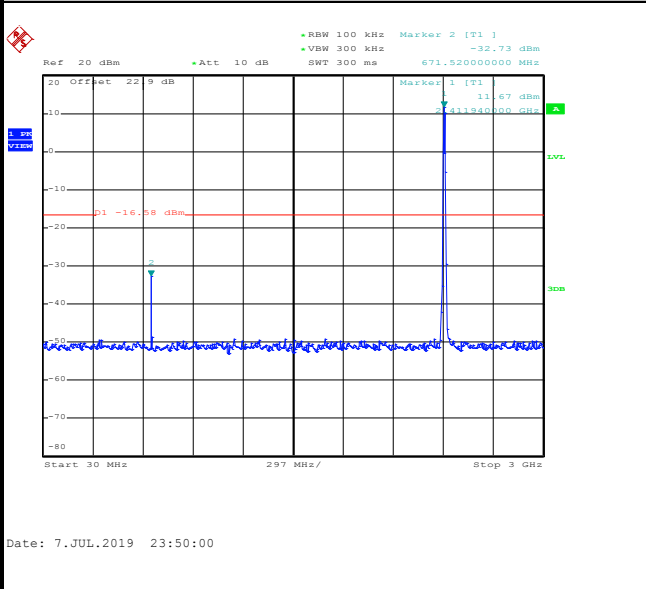





Test Mode :	802.11b	Test Channel :	06
-------------	---------	----------------	----

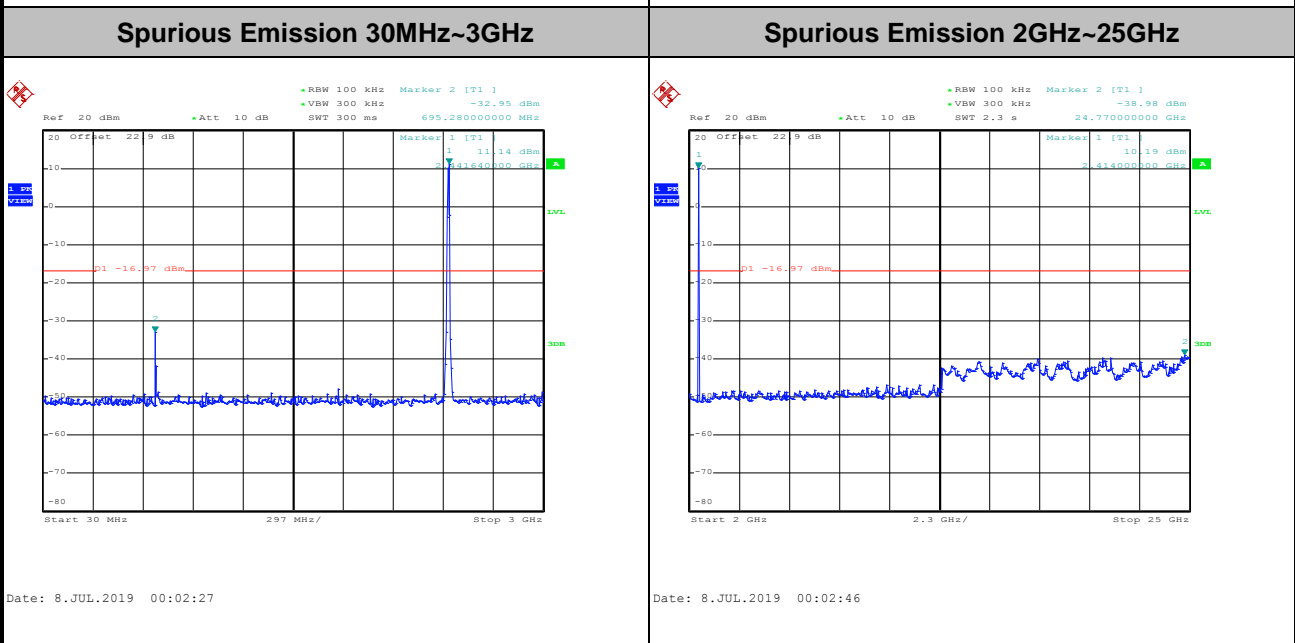
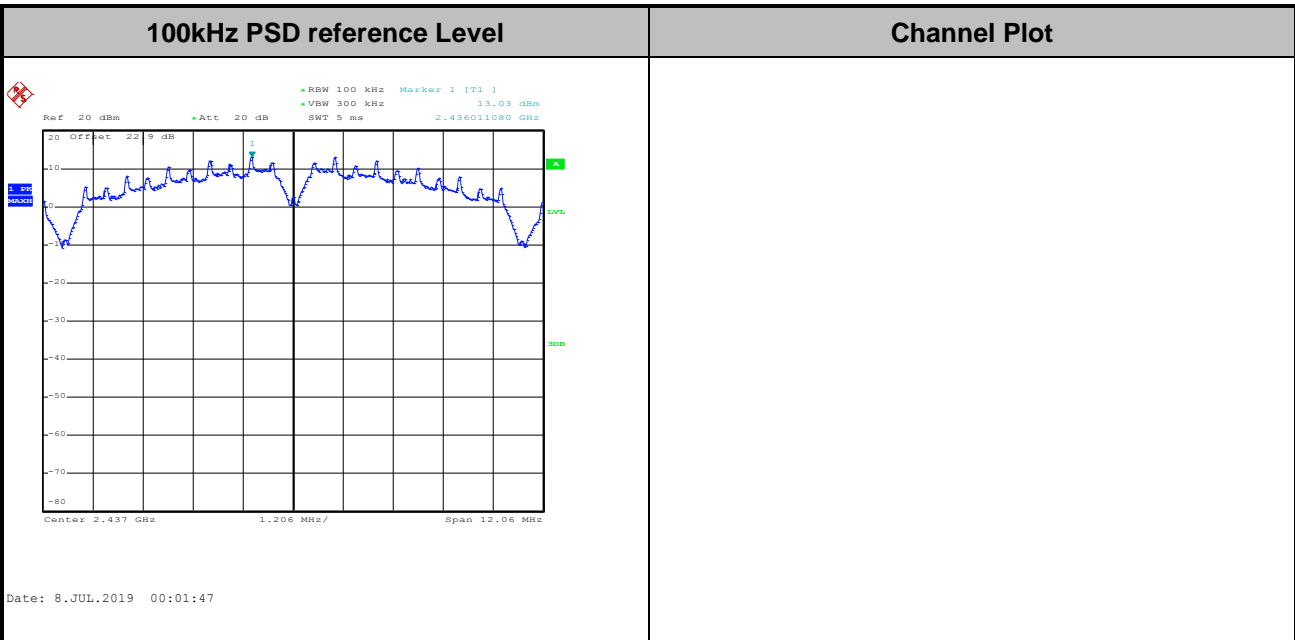



Test Mode :	802.11b	Test Channel :	11
-------------	---------	----------------	----

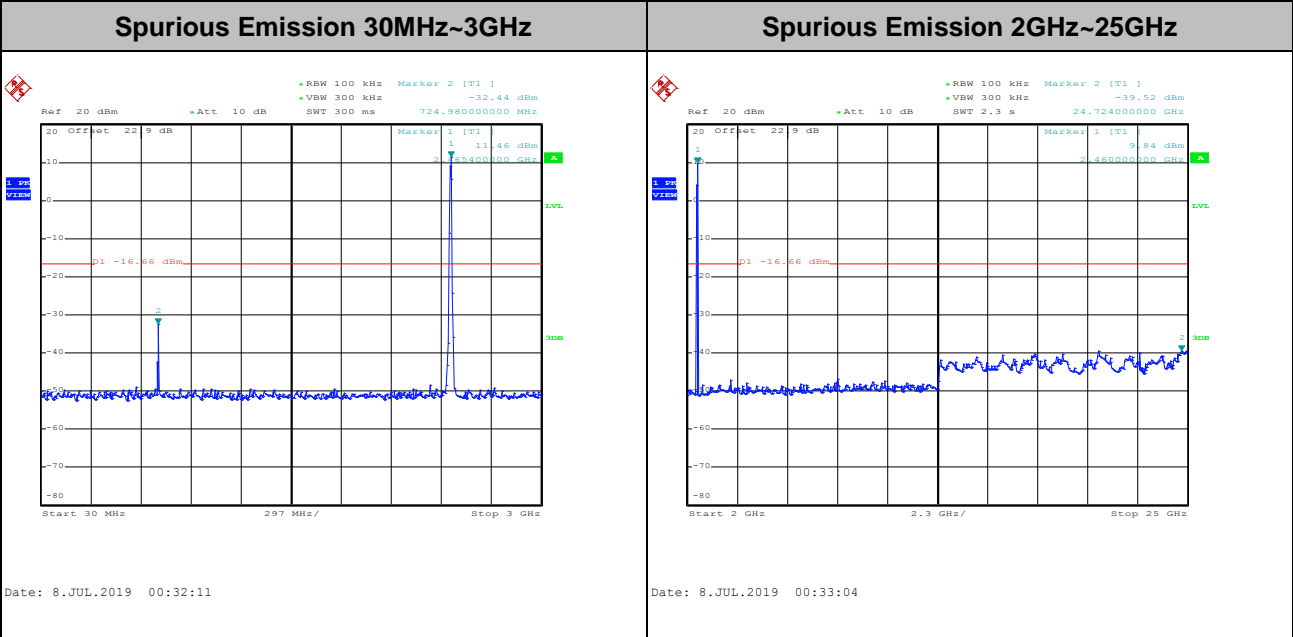
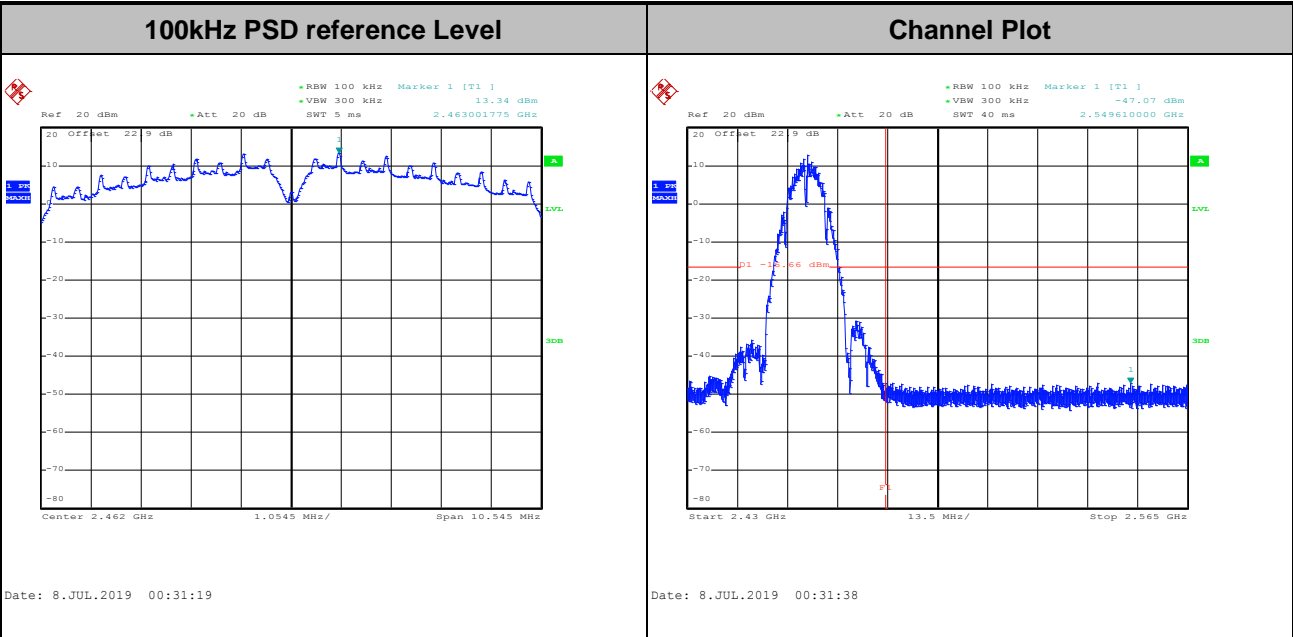



Test Mode : 802.11g Test Channel : 01

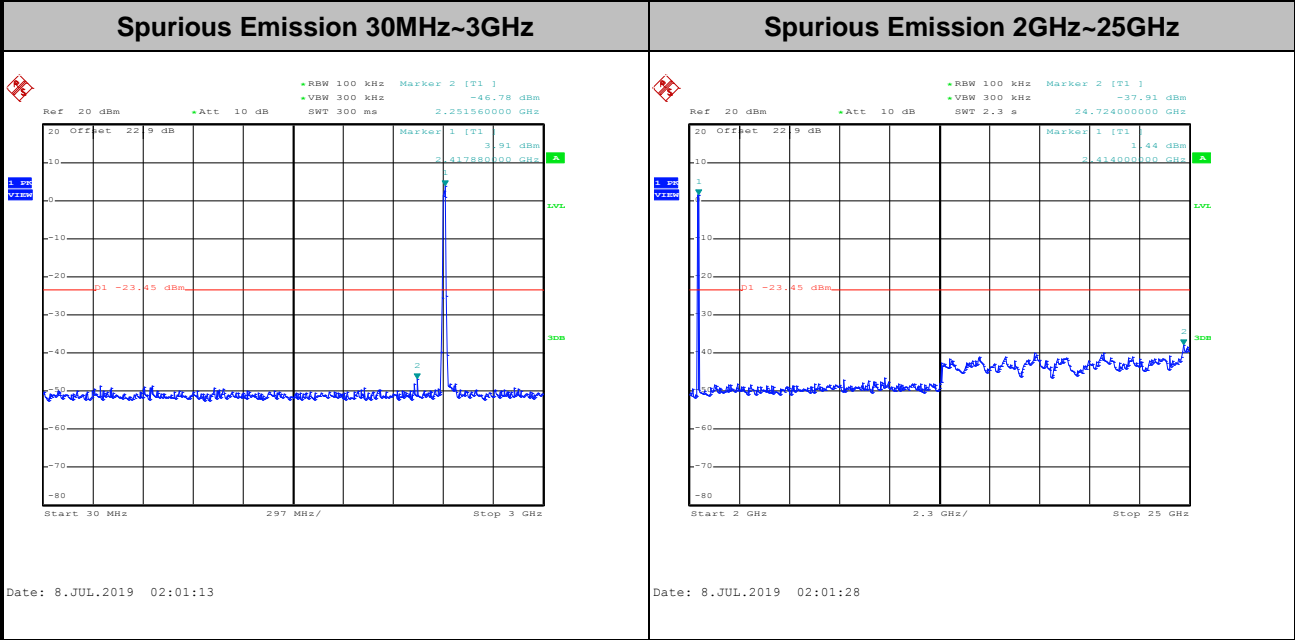
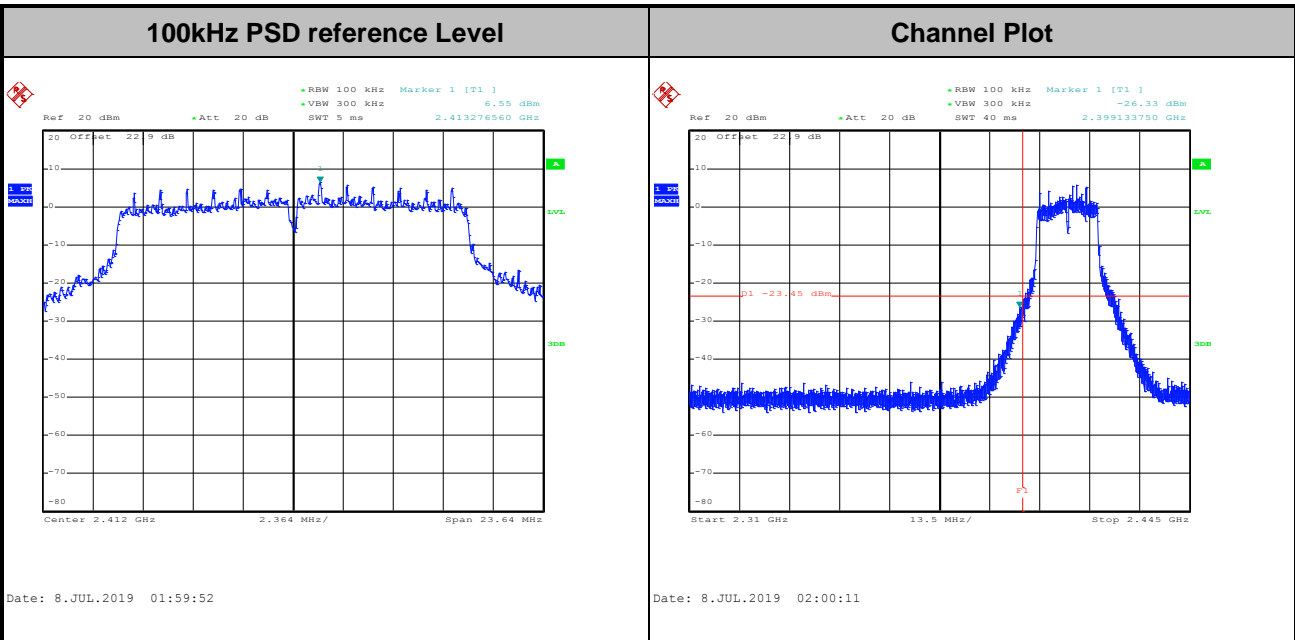



Test Mode :	802.11g	Test Channel :	06
-------------	---------	----------------	----

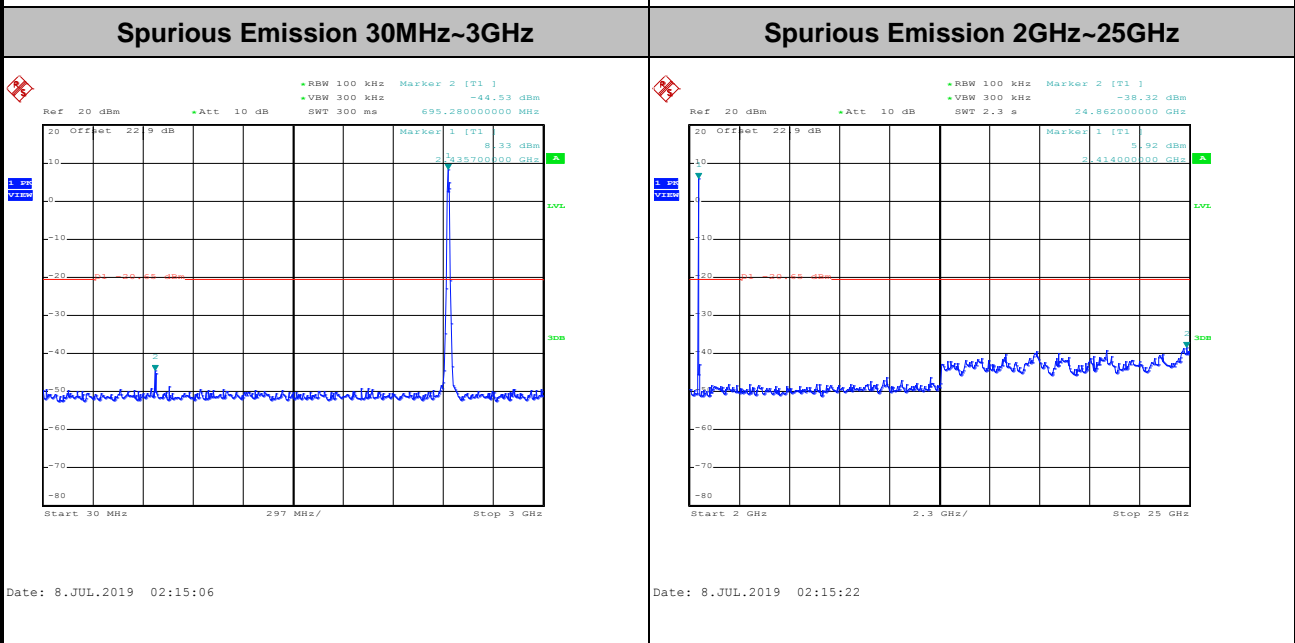
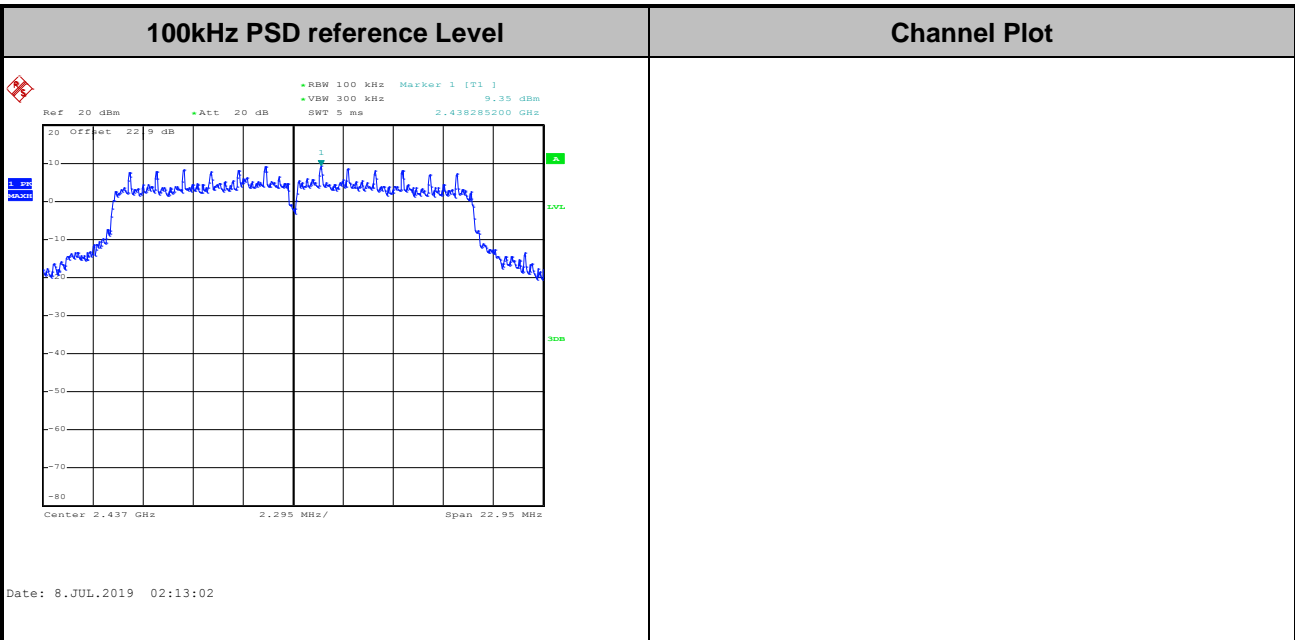



Test Mode :	802.11g	Test Channel :	11
-------------	---------	----------------	----

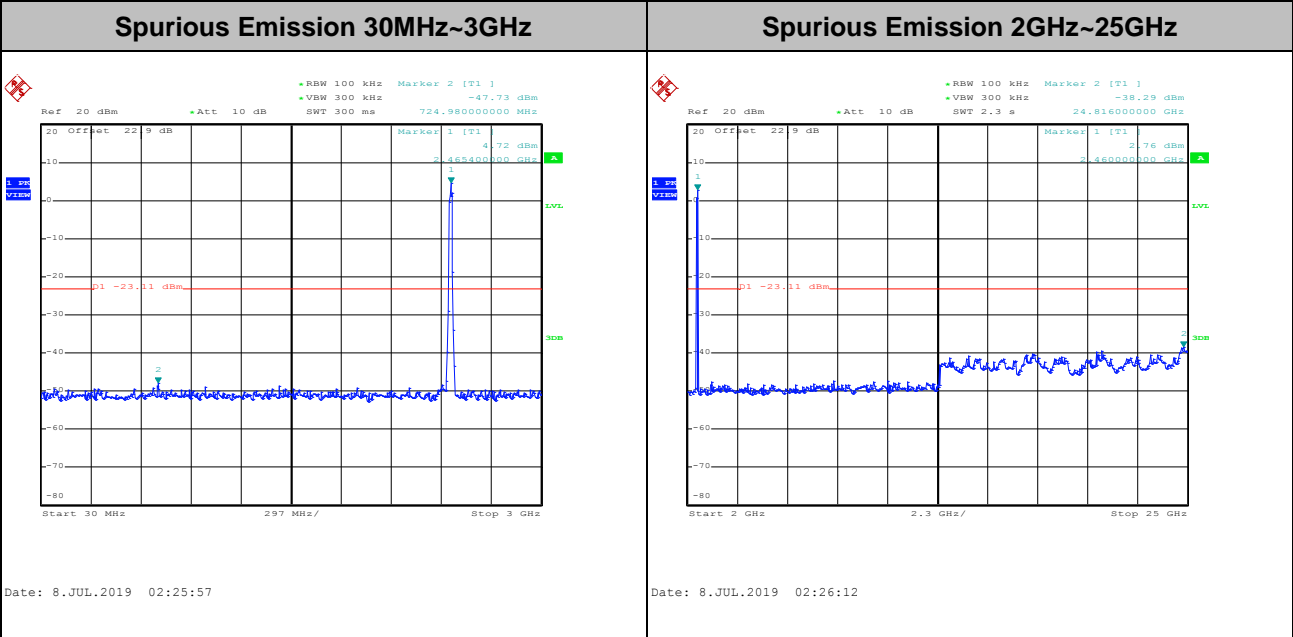
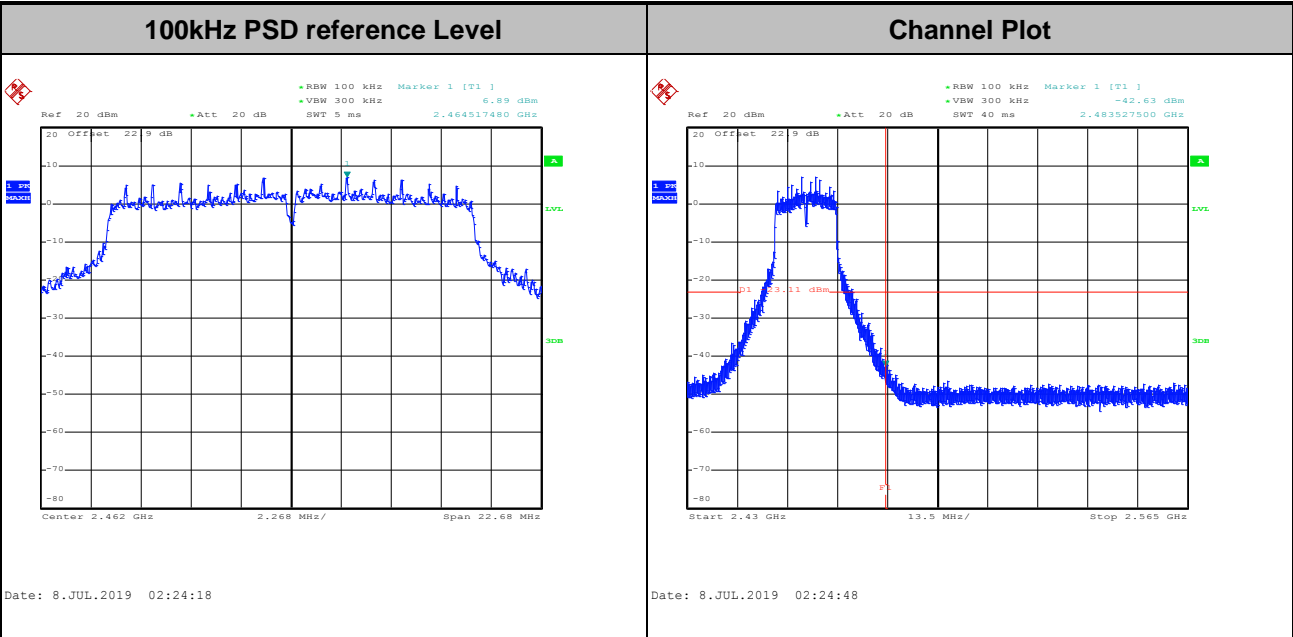



Test Mode : 802.11n HT20 Test Channel : 01

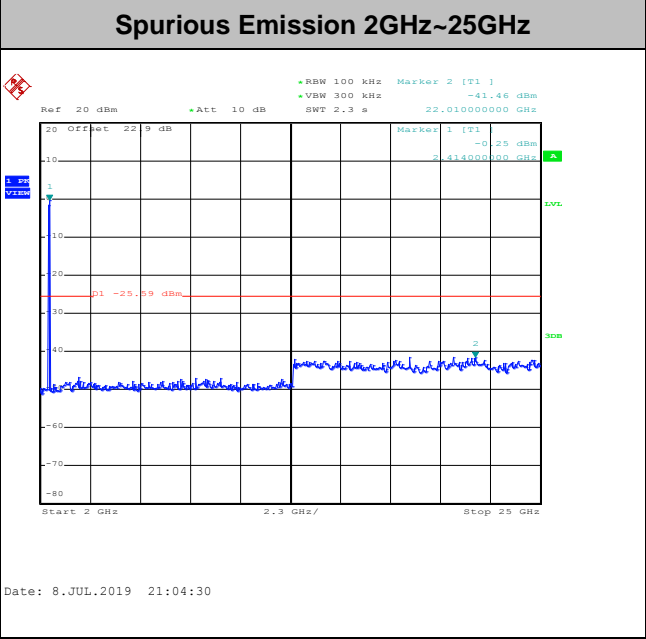
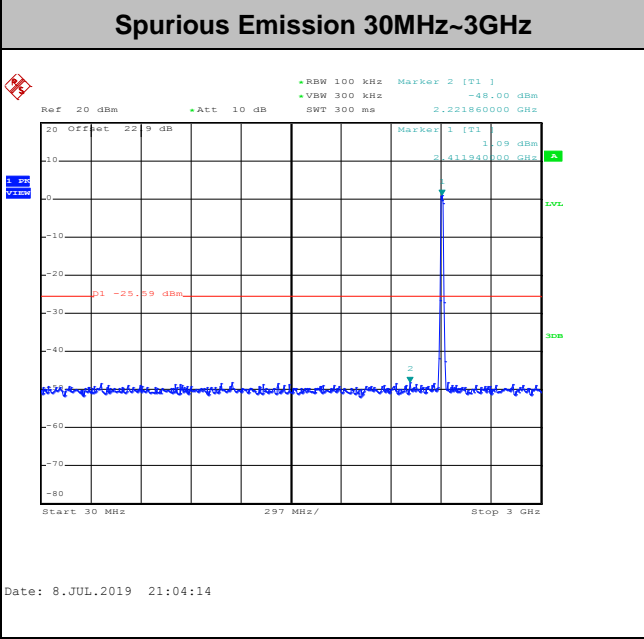
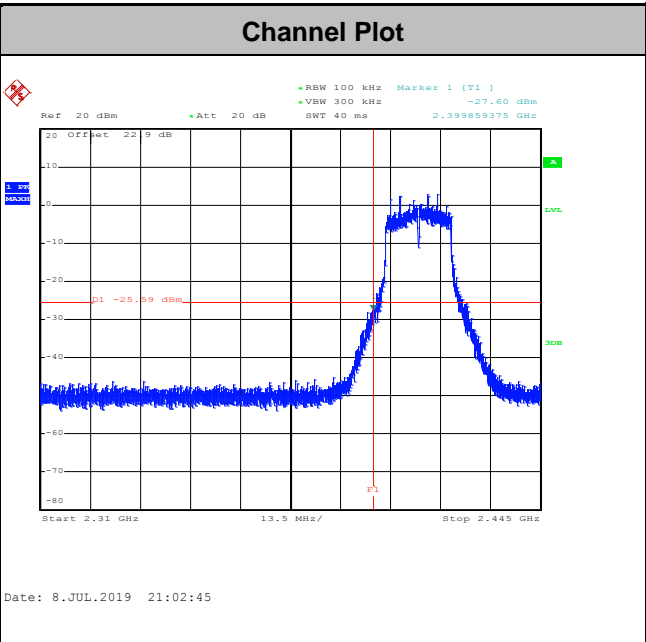
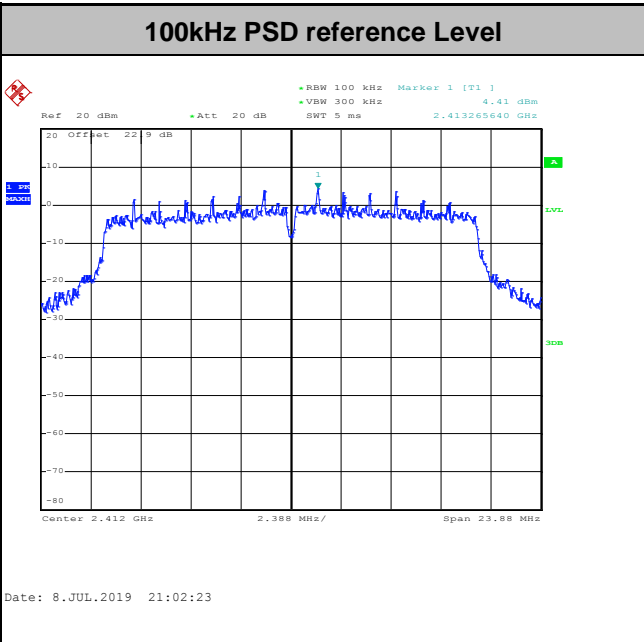



Test Mode :	802.11n HT20	Test Channel :	06
-------------	--------------	----------------	----

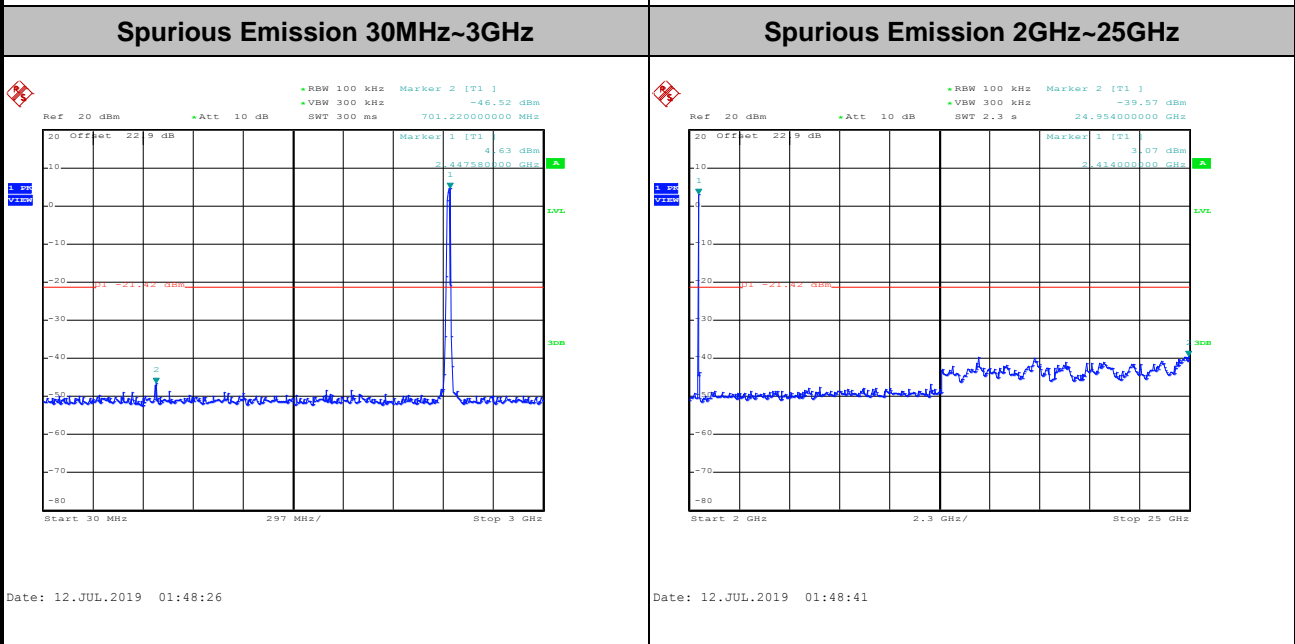
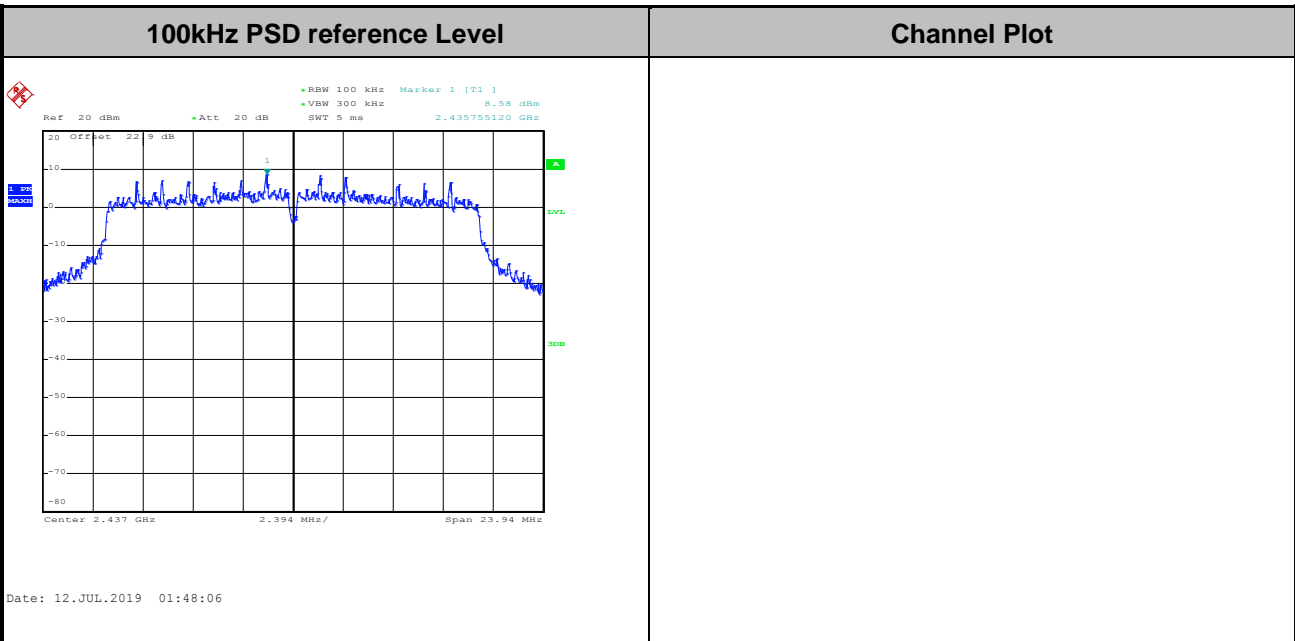



Test Mode :	802.11n HT20	Test Channel :	11
-------------	--------------	----------------	----

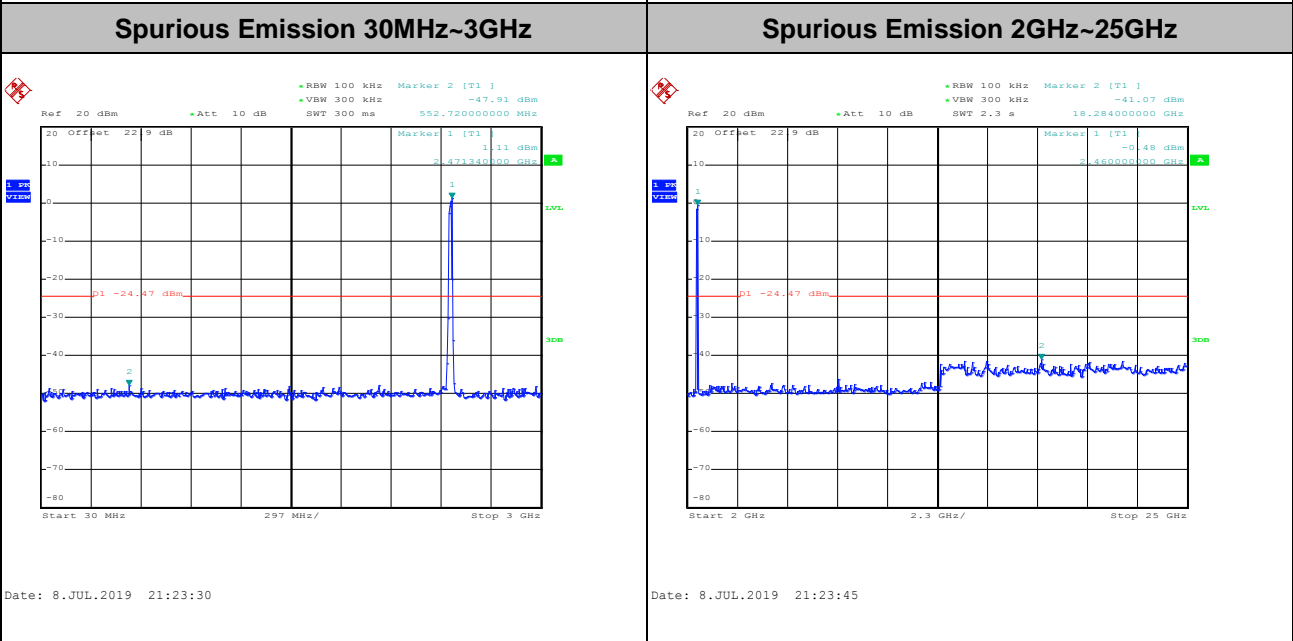
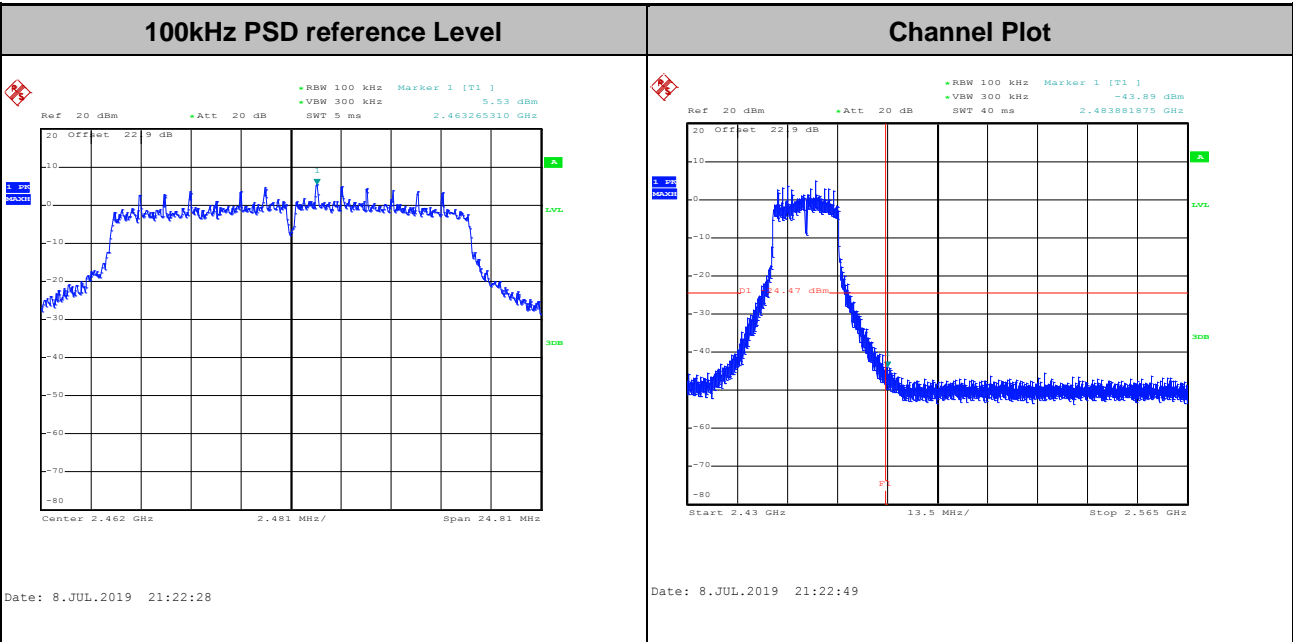





Test Mode :	802.11n HT40	Test Channel :	03
-------------	--------------	----------------	----

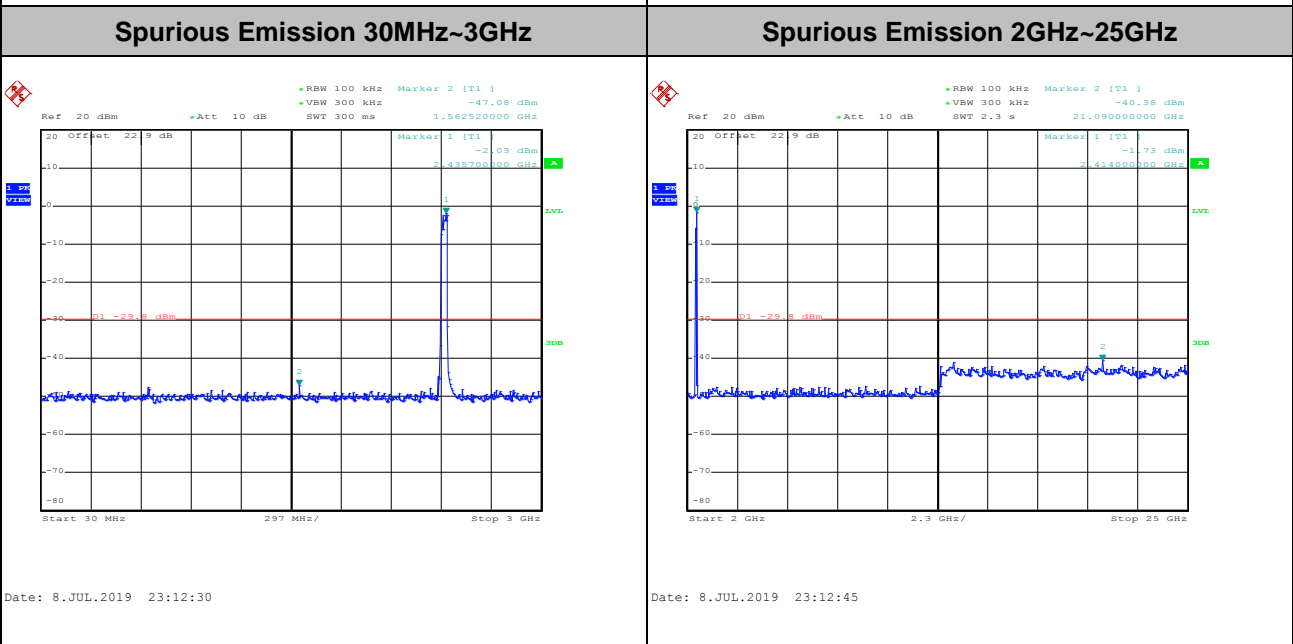
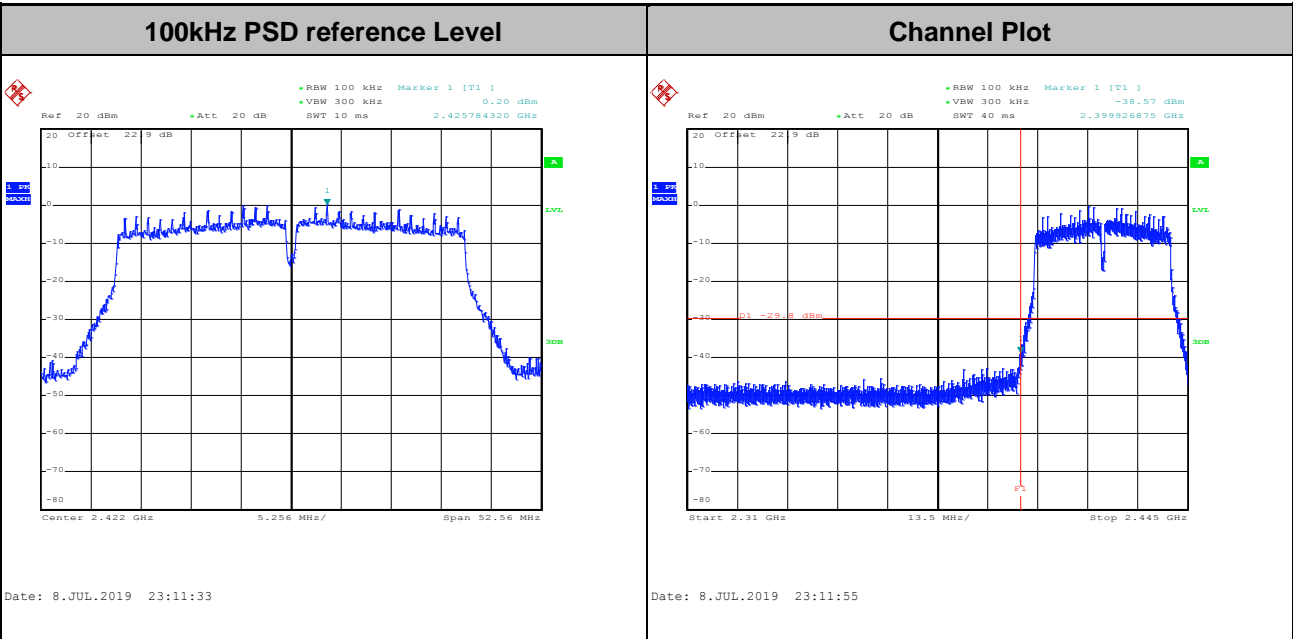



Test Mode :	802.11n HT40	Test Channel :	06
-------------	--------------	----------------	----

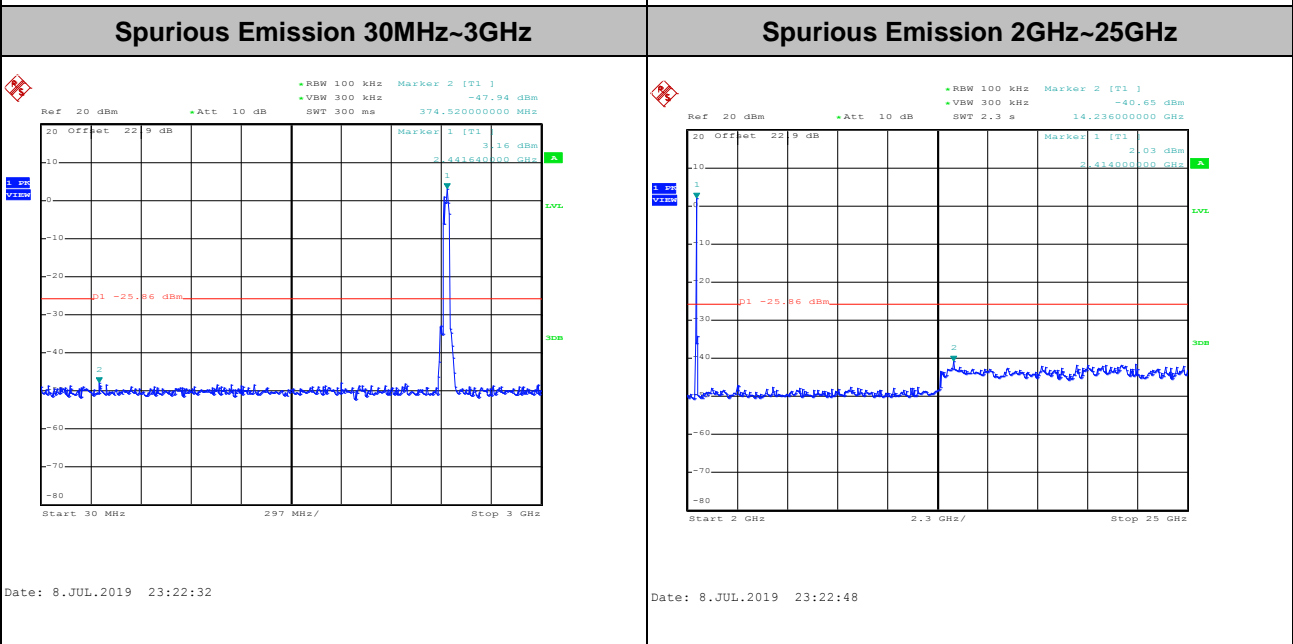
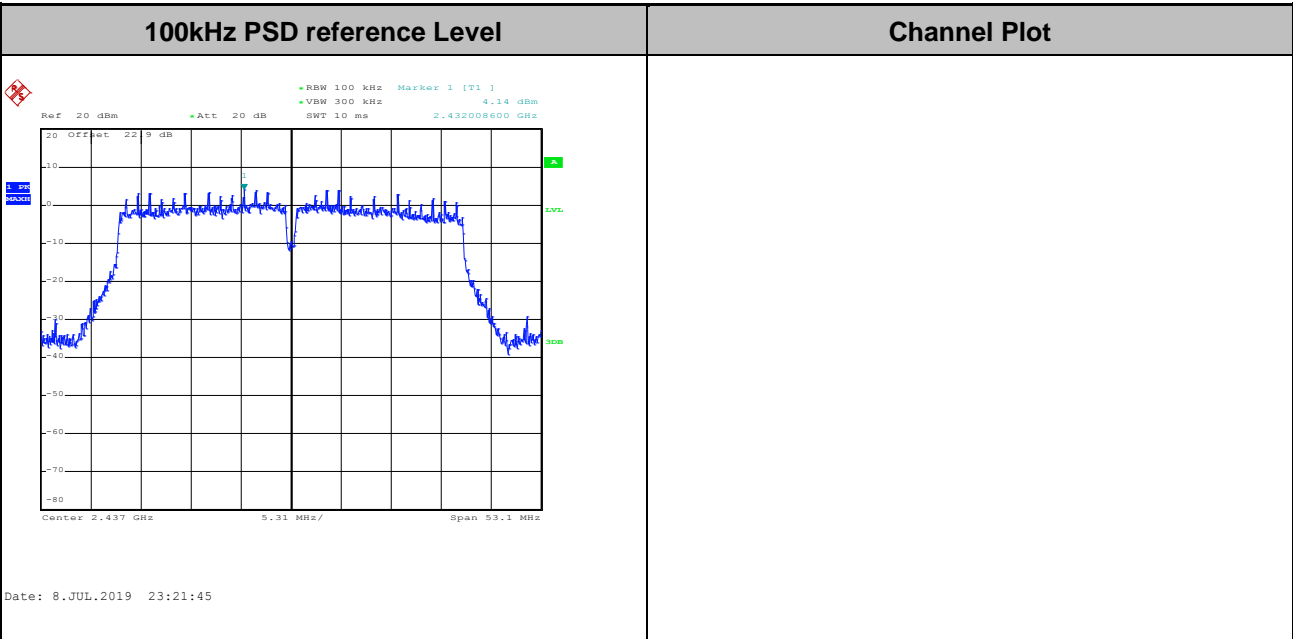



Test Mode :	802.11n HT40	Test Channel :	09
-------------	--------------	----------------	----

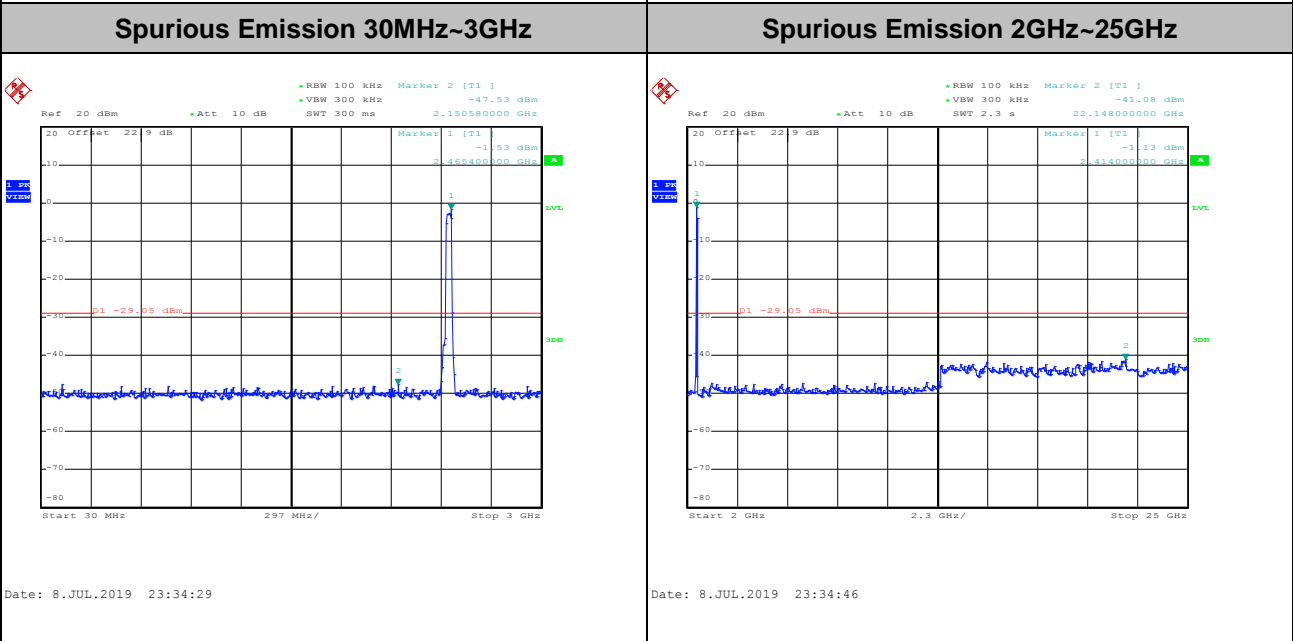
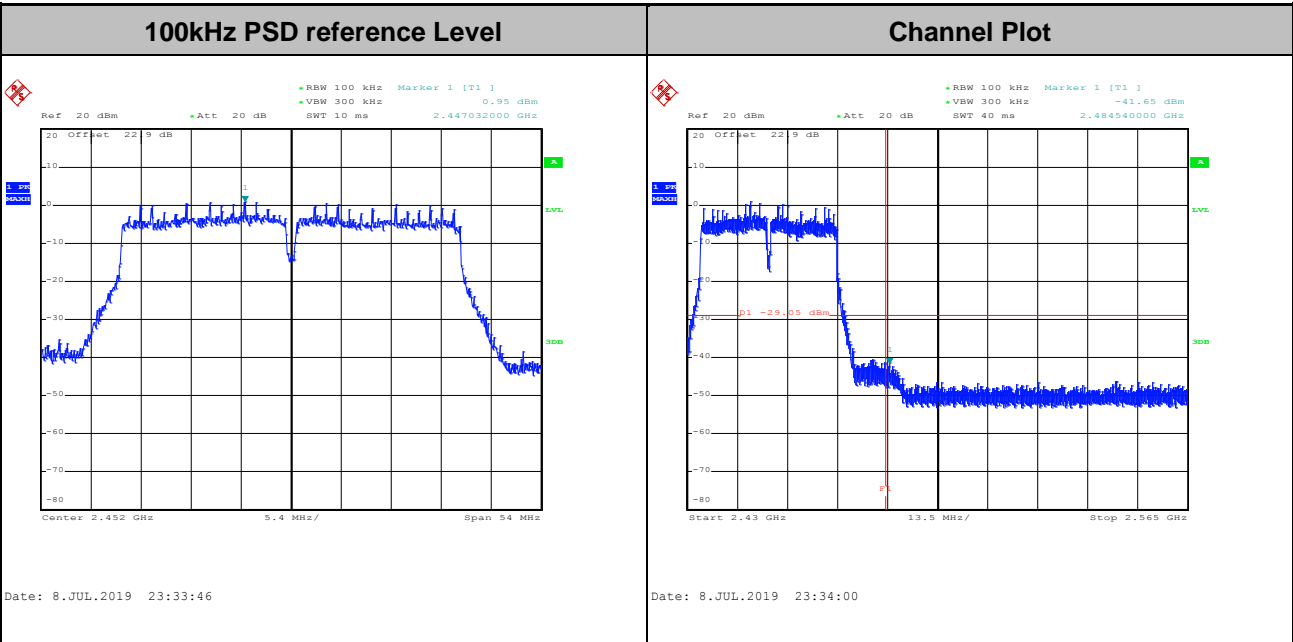



Number of TX = 2, Ant. 2 (Measured)

Test Mode :	802.11b	Test Channel :	01
-------------	---------	----------------	----

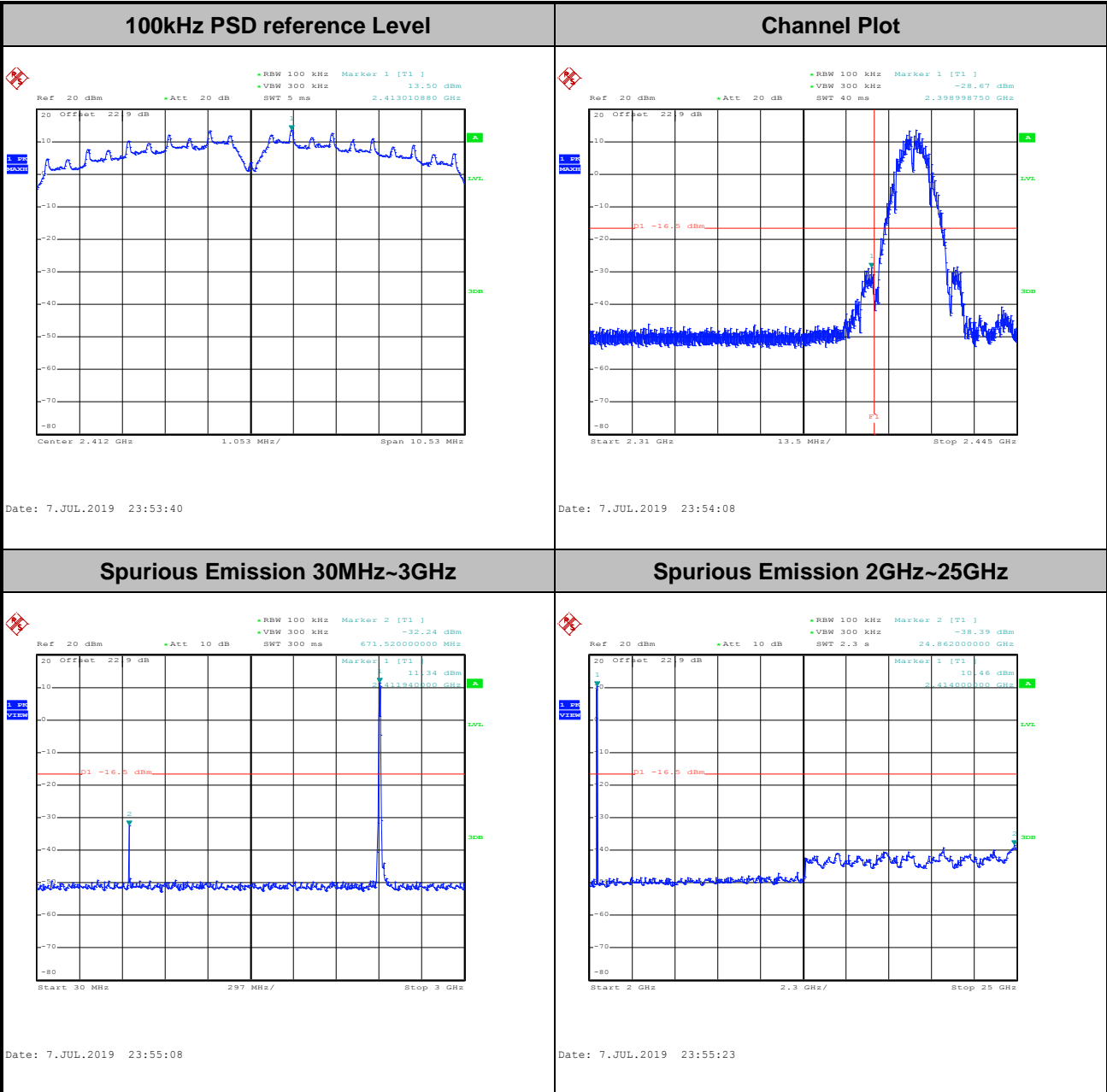



Test Mode :	802.11b	Test Channel :	06
-------------	---------	----------------	----

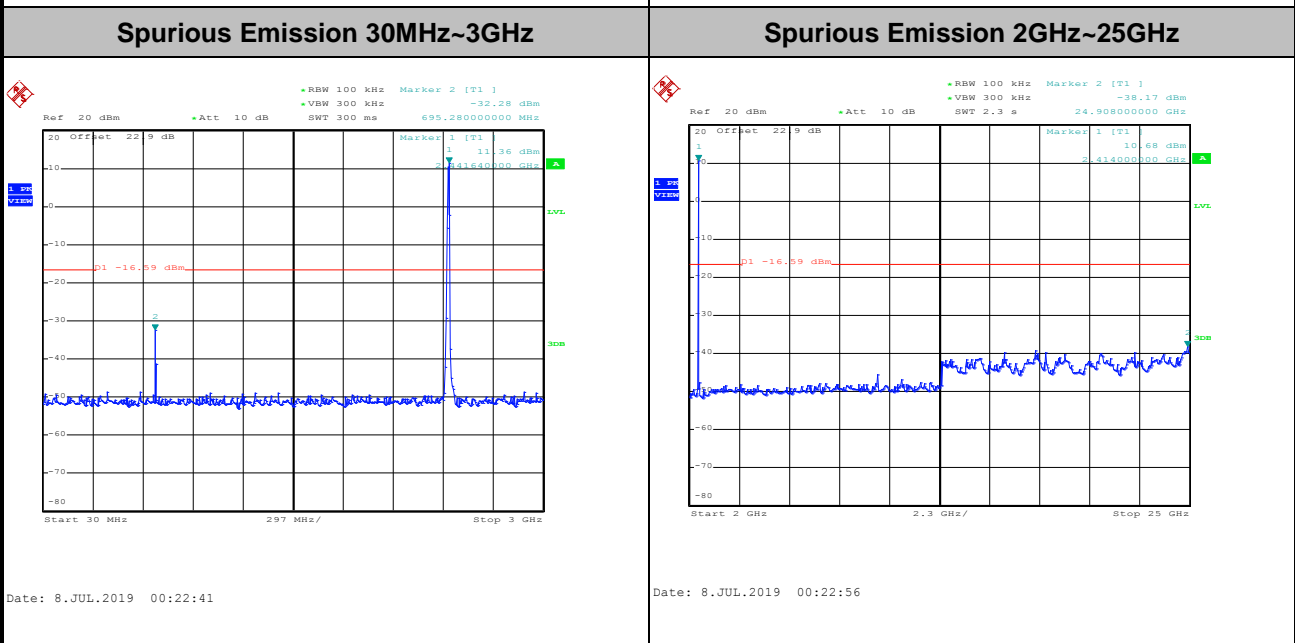
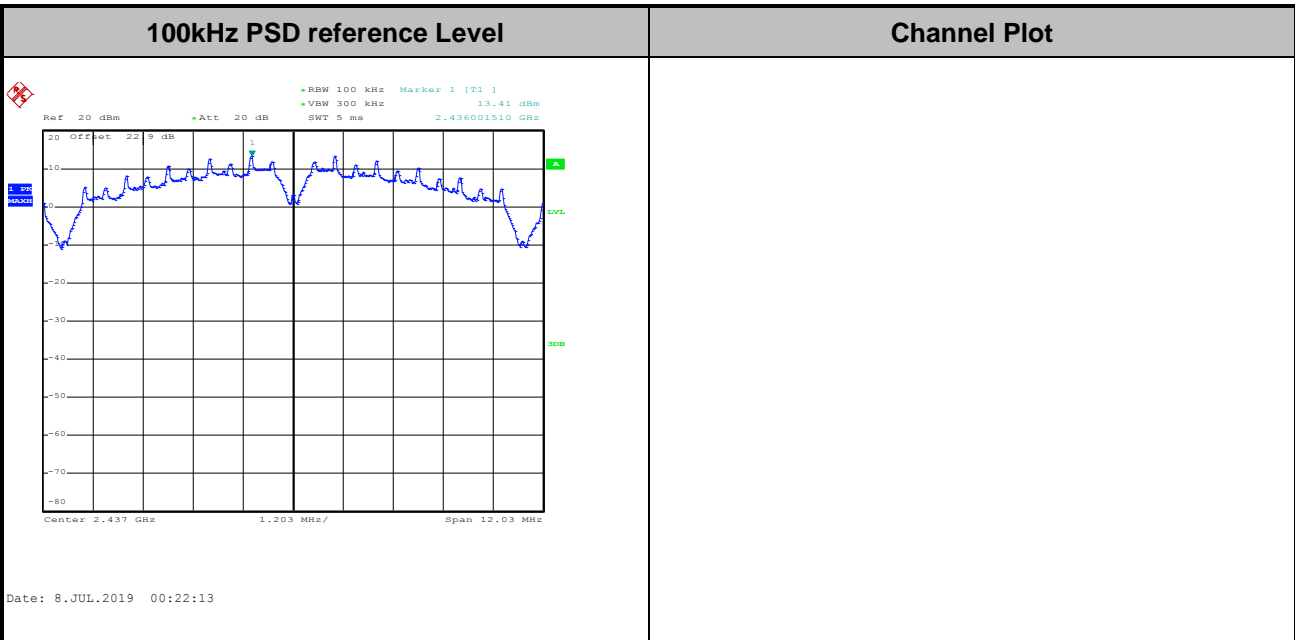



Test Mode :	802.11b	Test Channel :	11
-------------	---------	----------------	----

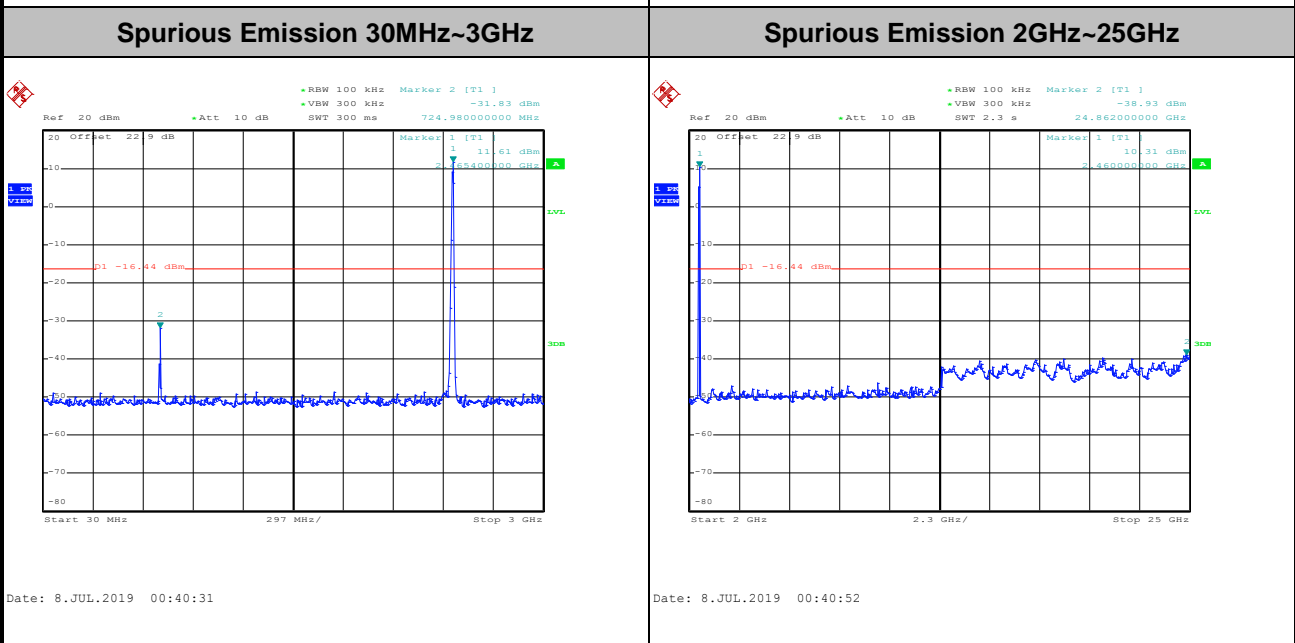
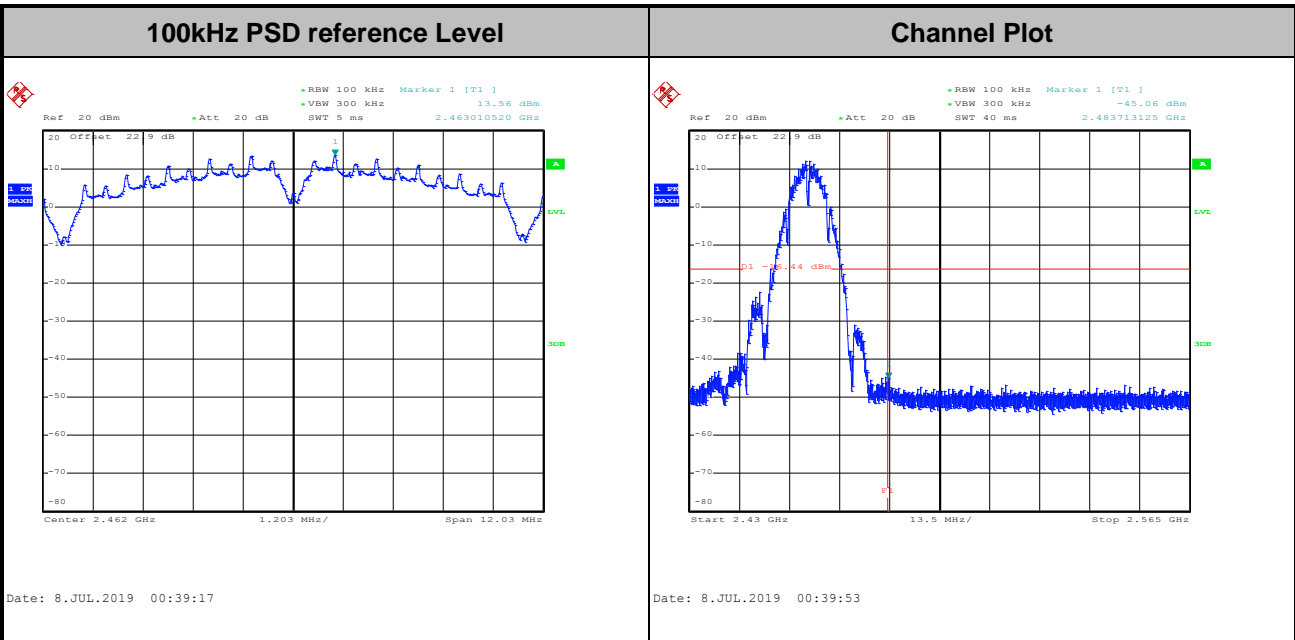



Test Mode : 802.11g Test Channel : 01

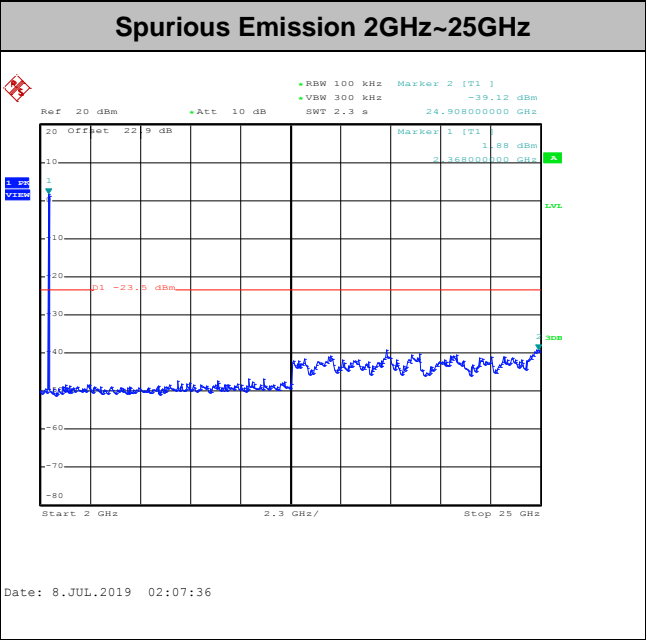
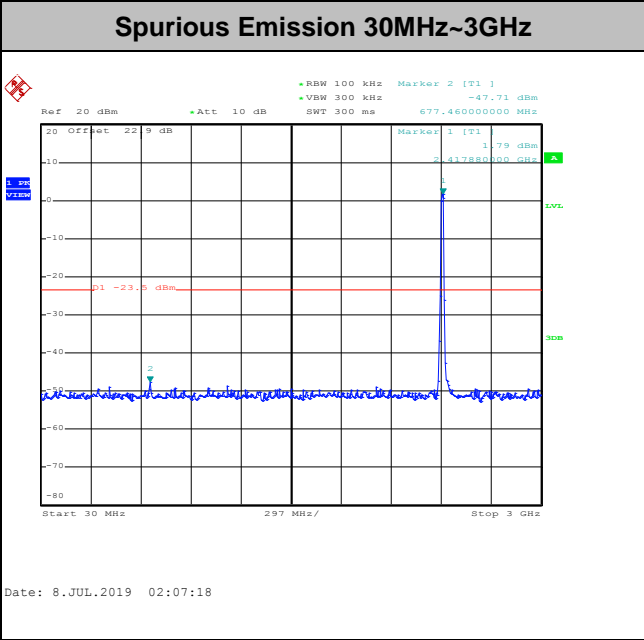
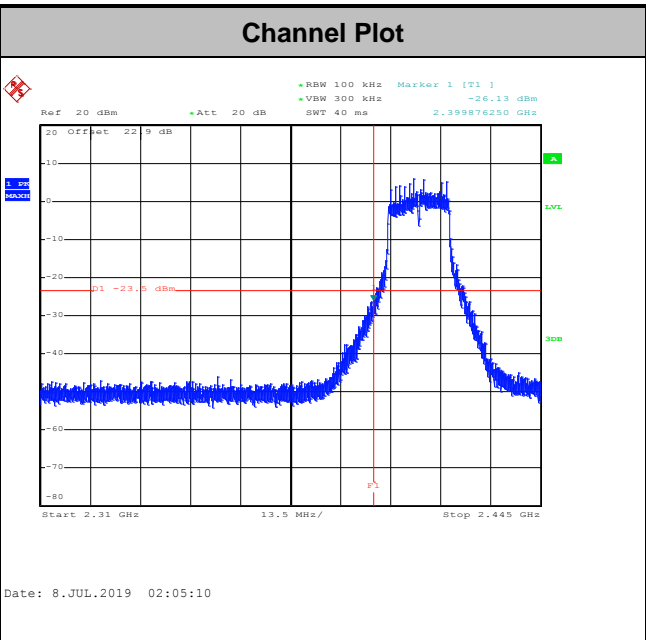
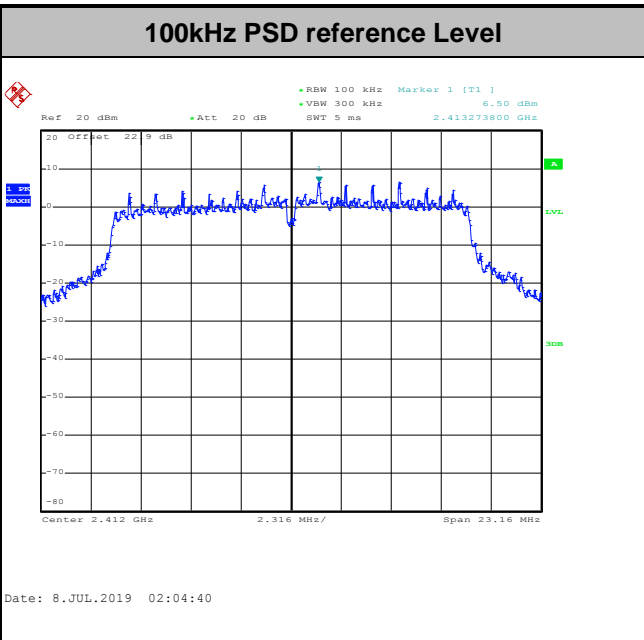



Test Mode :	802.11g	Test Channel :	06
-------------	---------	----------------	----

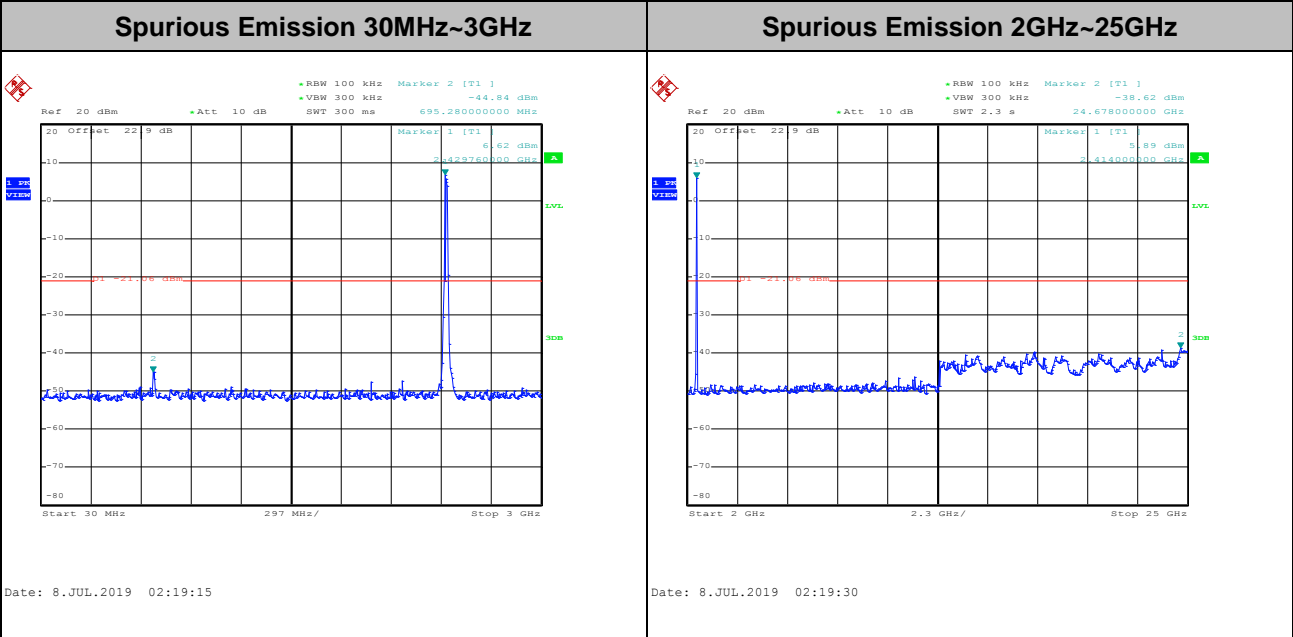
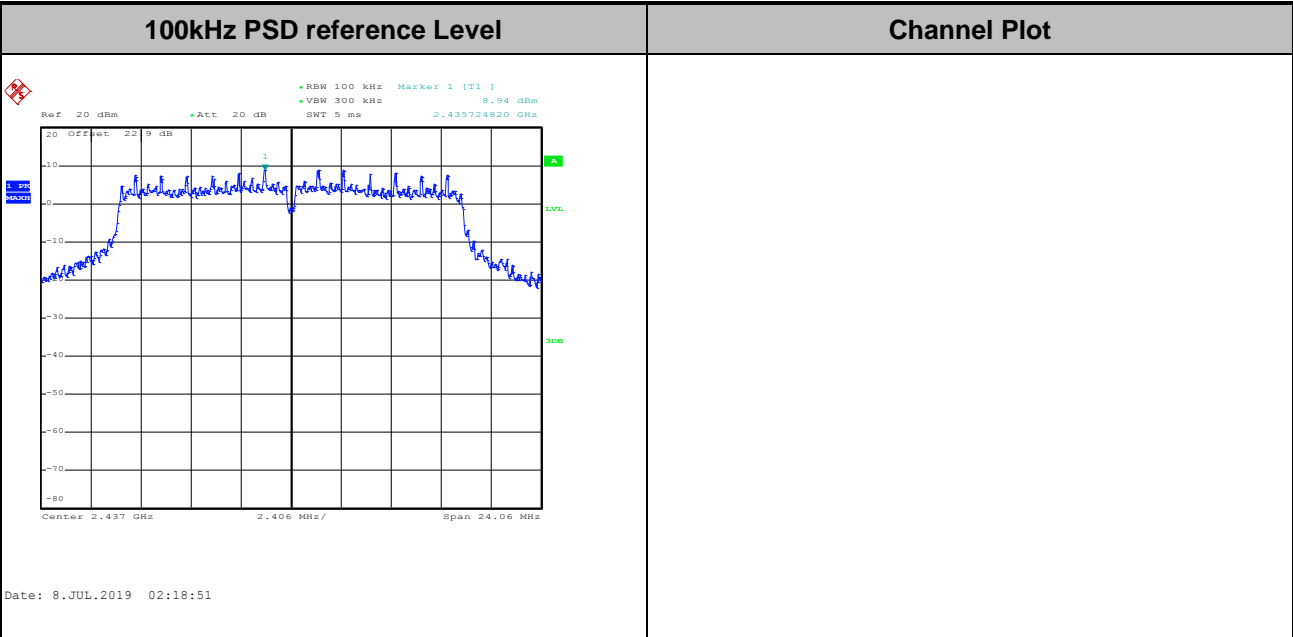





Test Mode :	802.11g	Test Channel :	11
-------------	---------	----------------	----

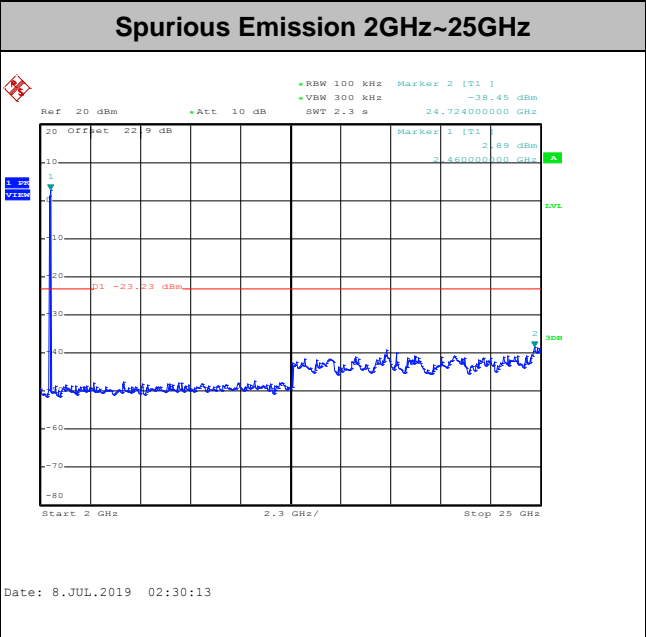
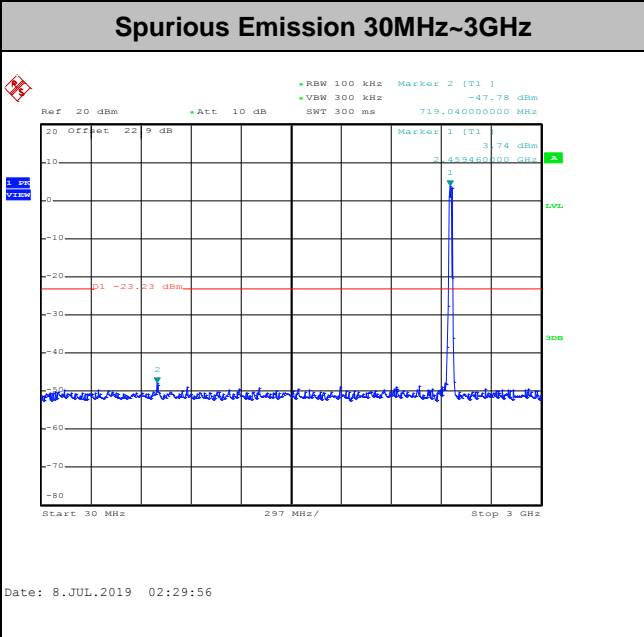
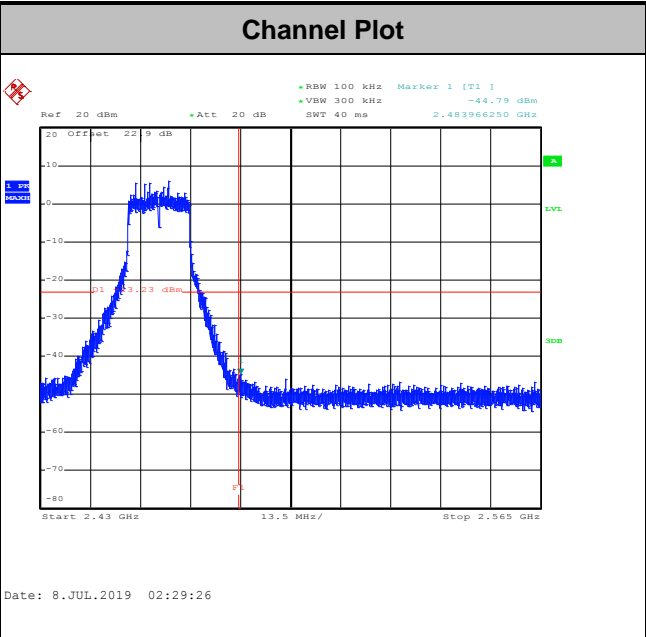
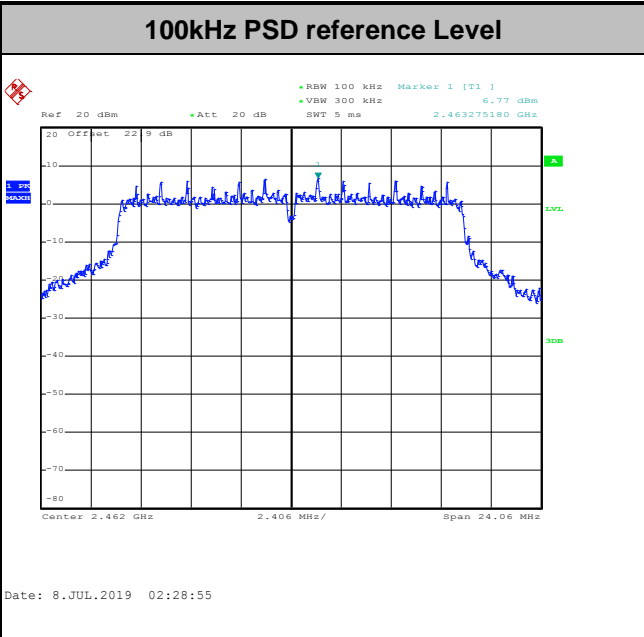



Test Mode :	802.11n HT20	Test Channel :	01
-------------	--------------	----------------	----

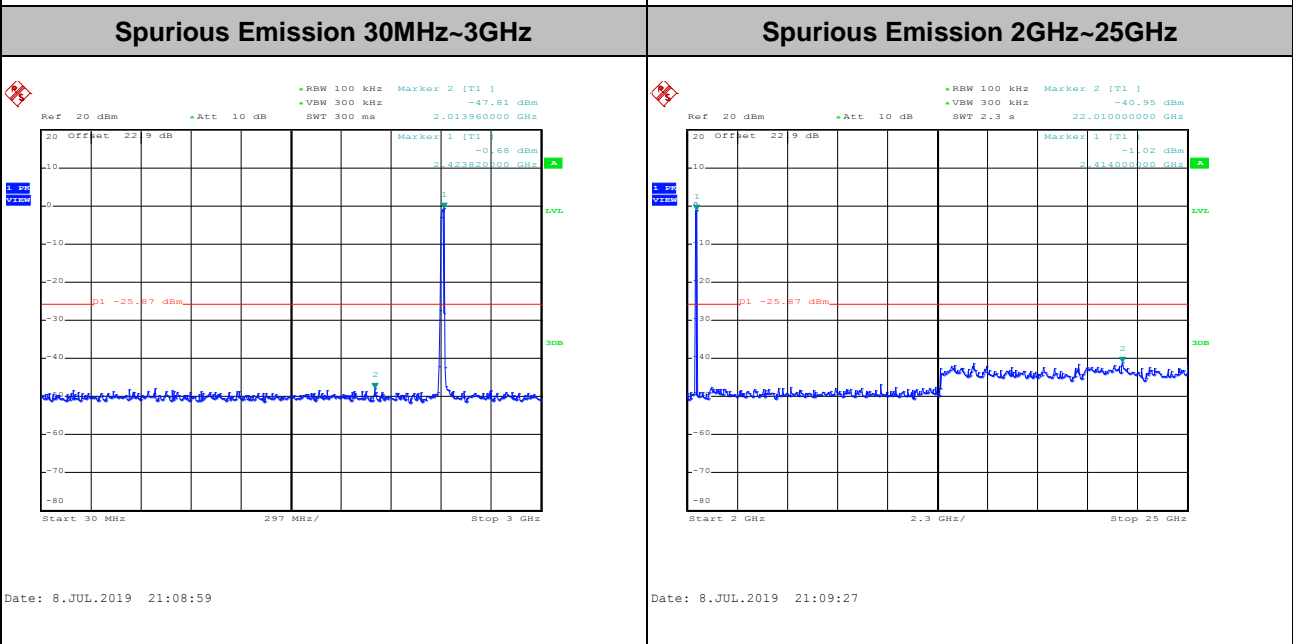
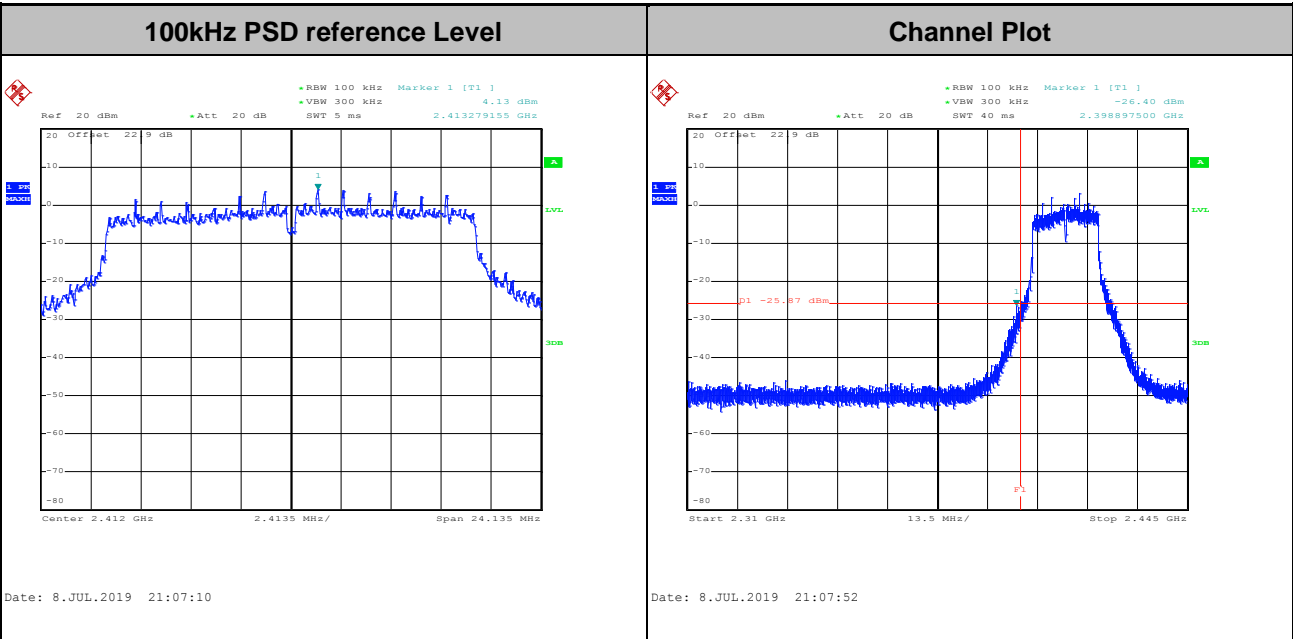



Test Mode :	802.11n HT20	Test Channel :	06
-------------	--------------	----------------	----

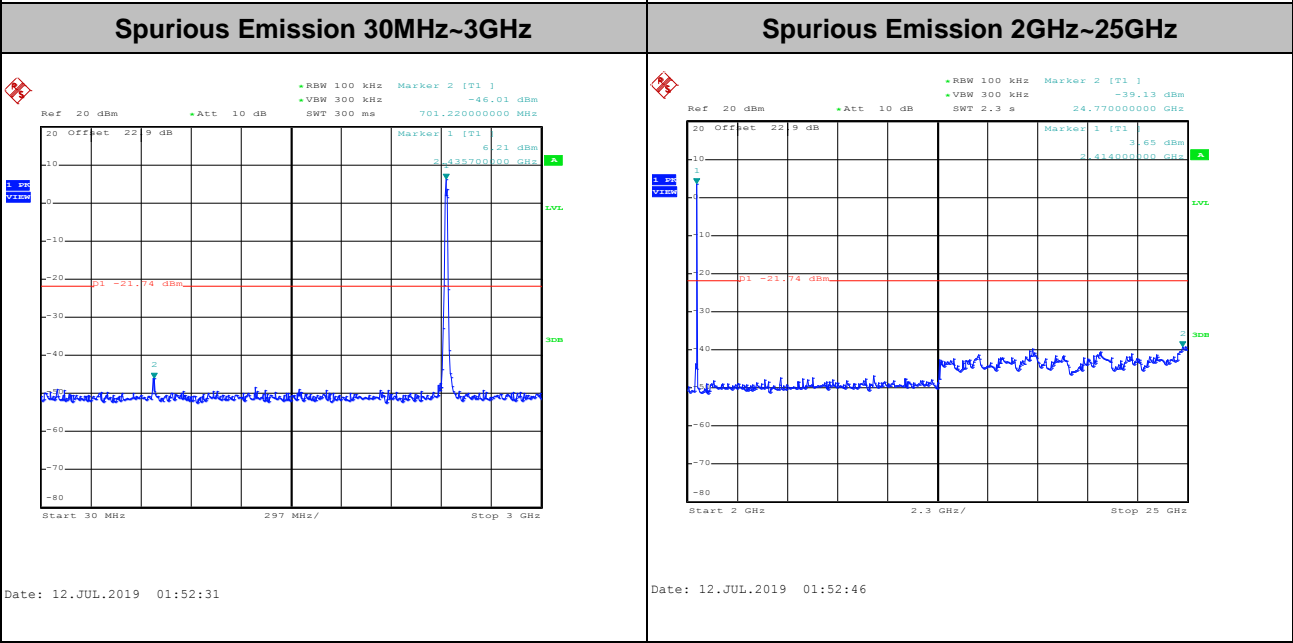
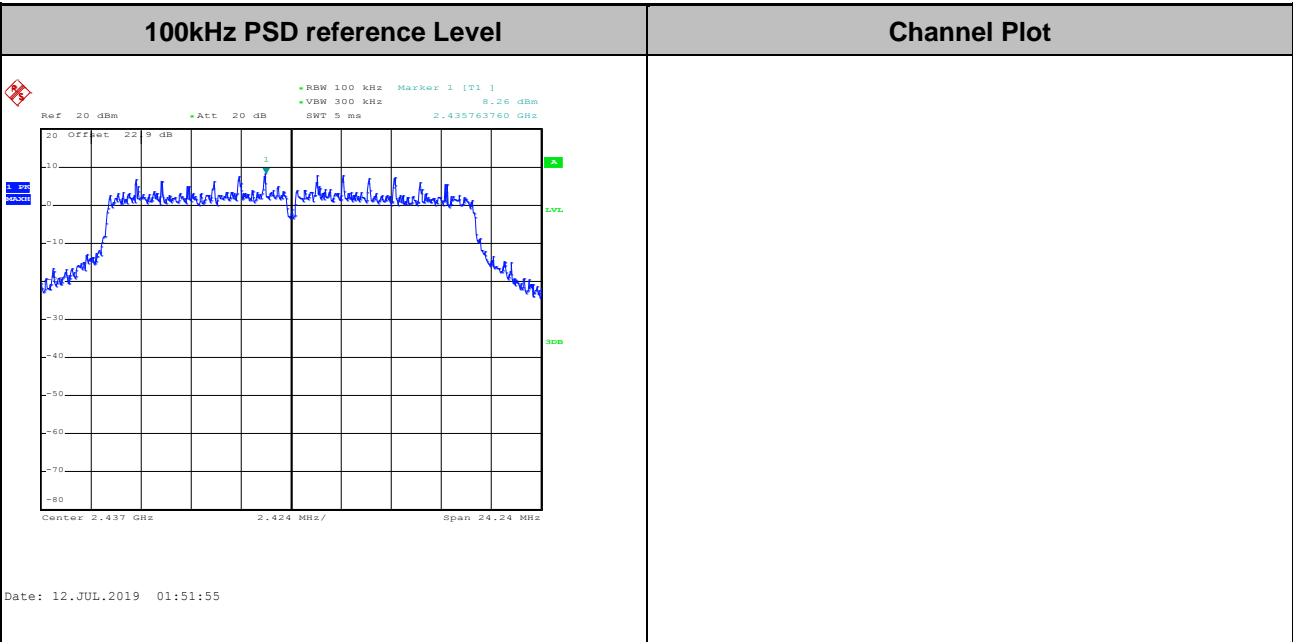



Test Mode :	802.11n HT20	Test Channel :	11
-------------	--------------	----------------	----

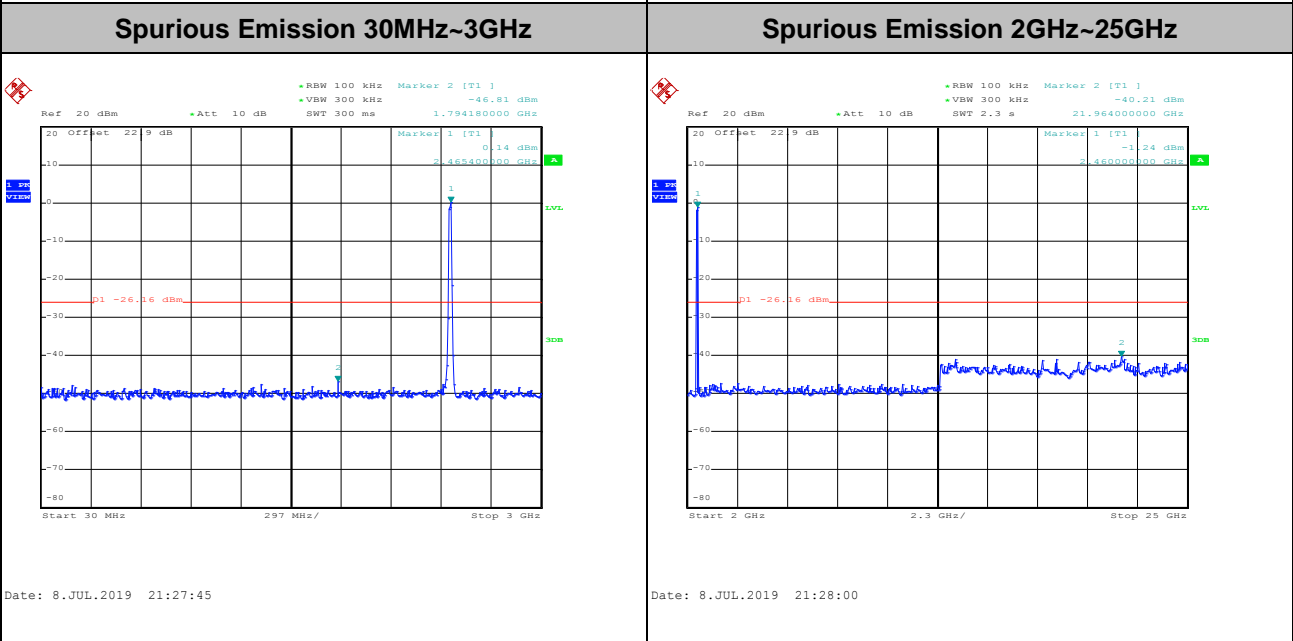
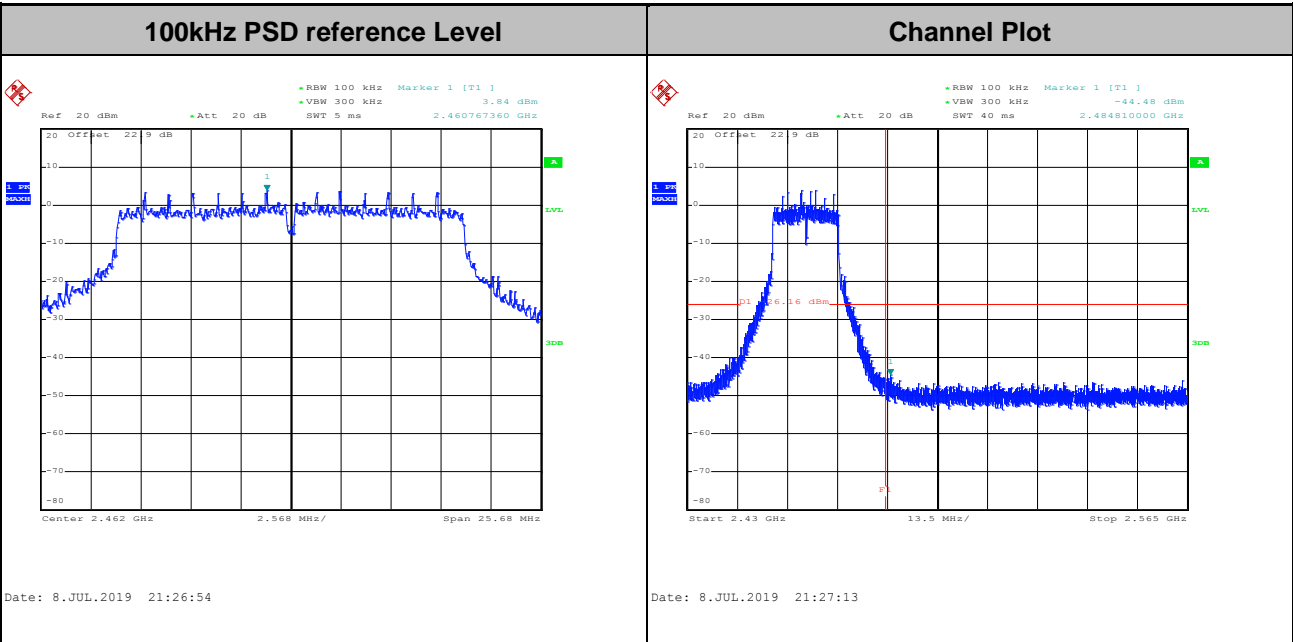



Test Mode :	802.11n HT40	Test Channel :	03
-------------	--------------	----------------	----

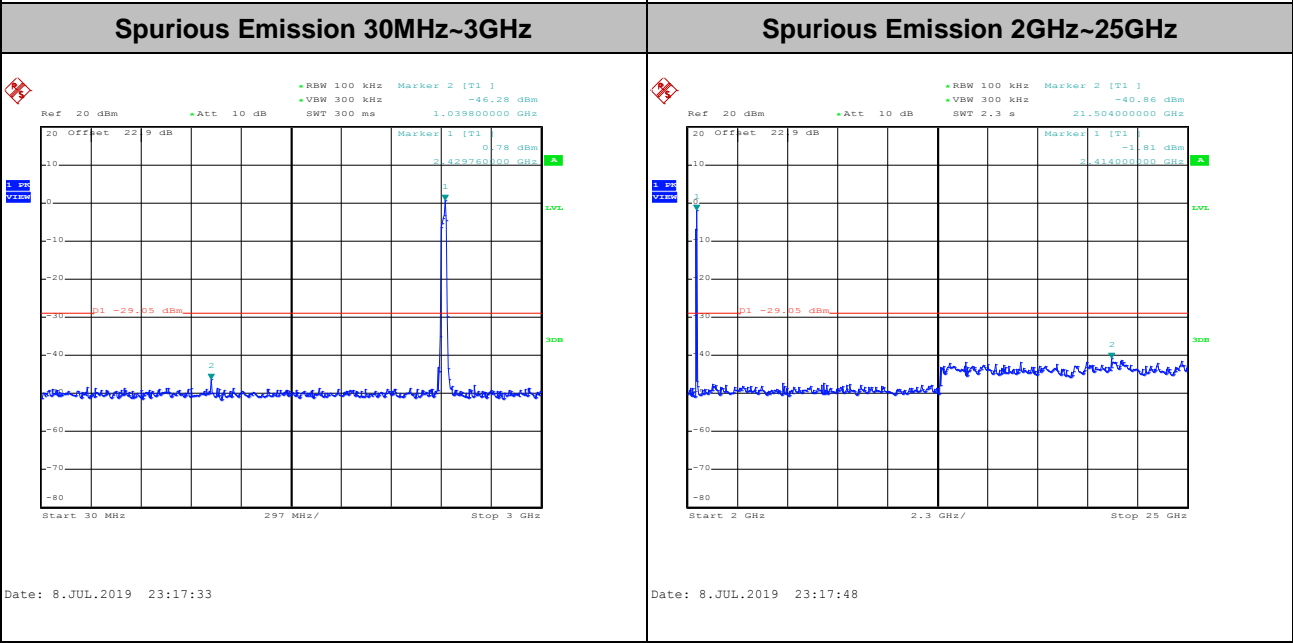
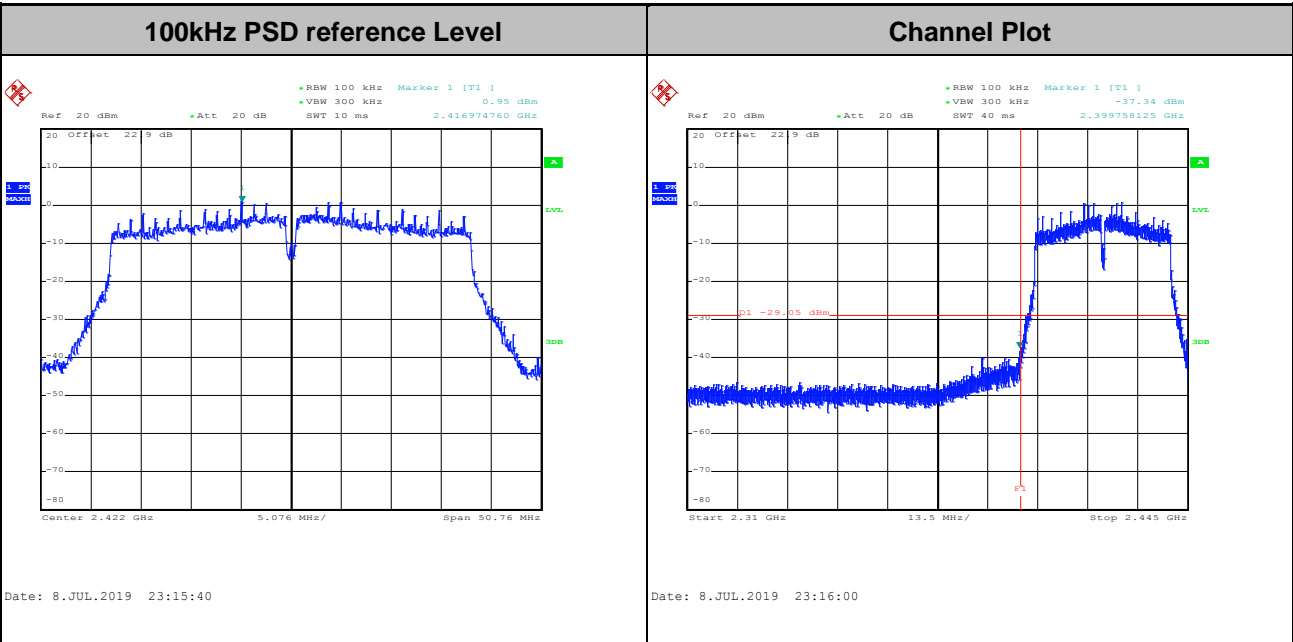



Test Mode :	802.11n HT40	Test Channel :	06
-------------	--------------	----------------	----

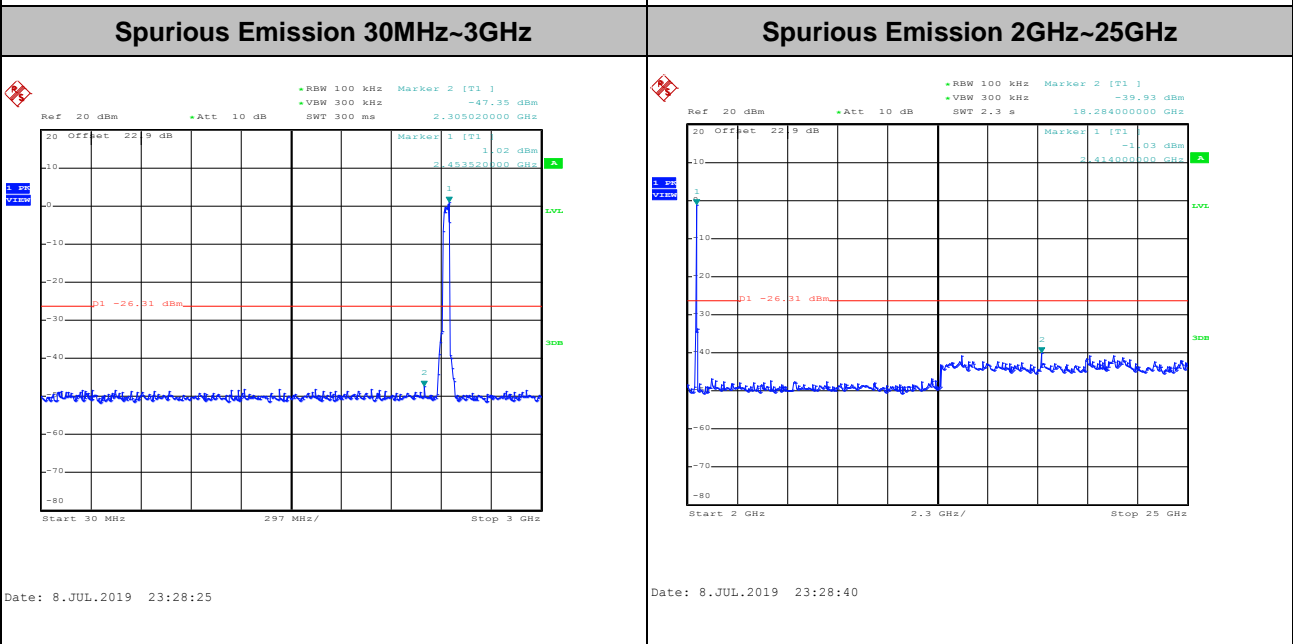
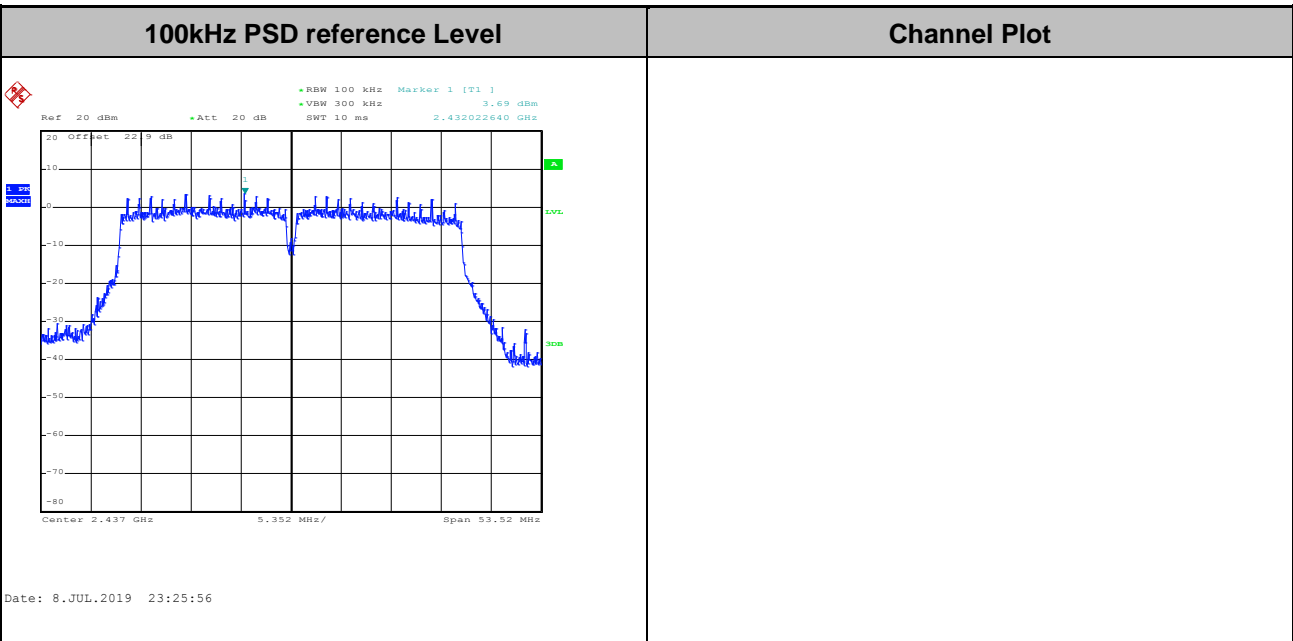



Test Mode :	802.11n HT40	Test Channel :	09
-------------	--------------	----------------	----

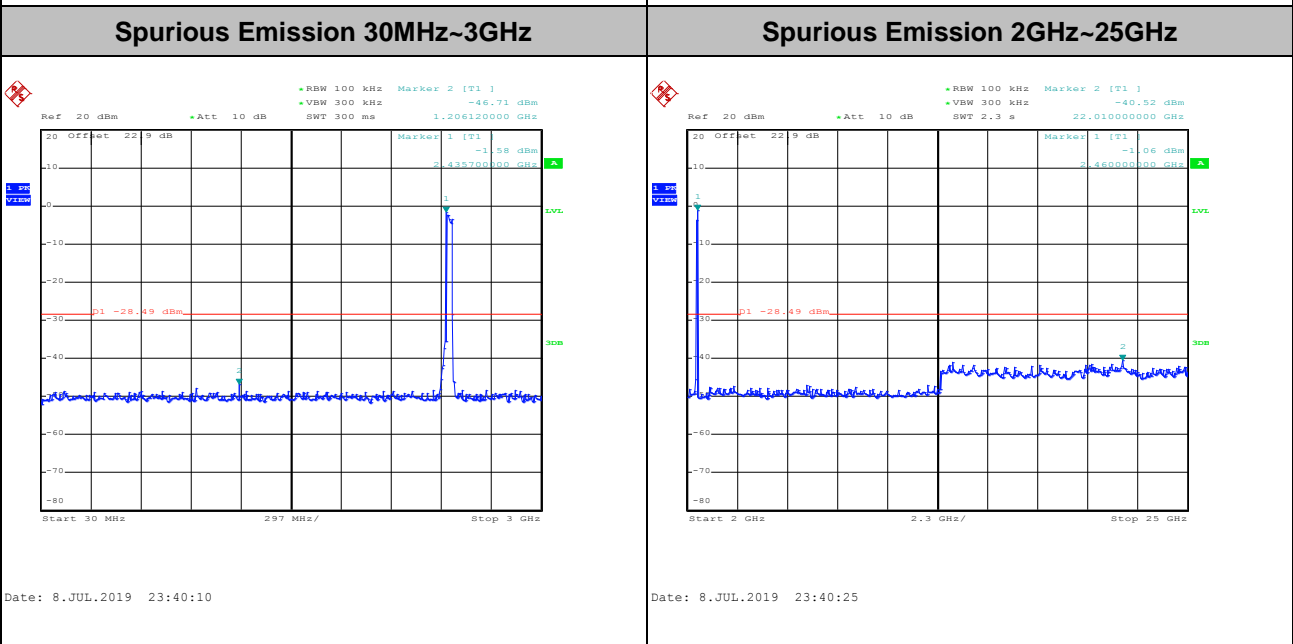
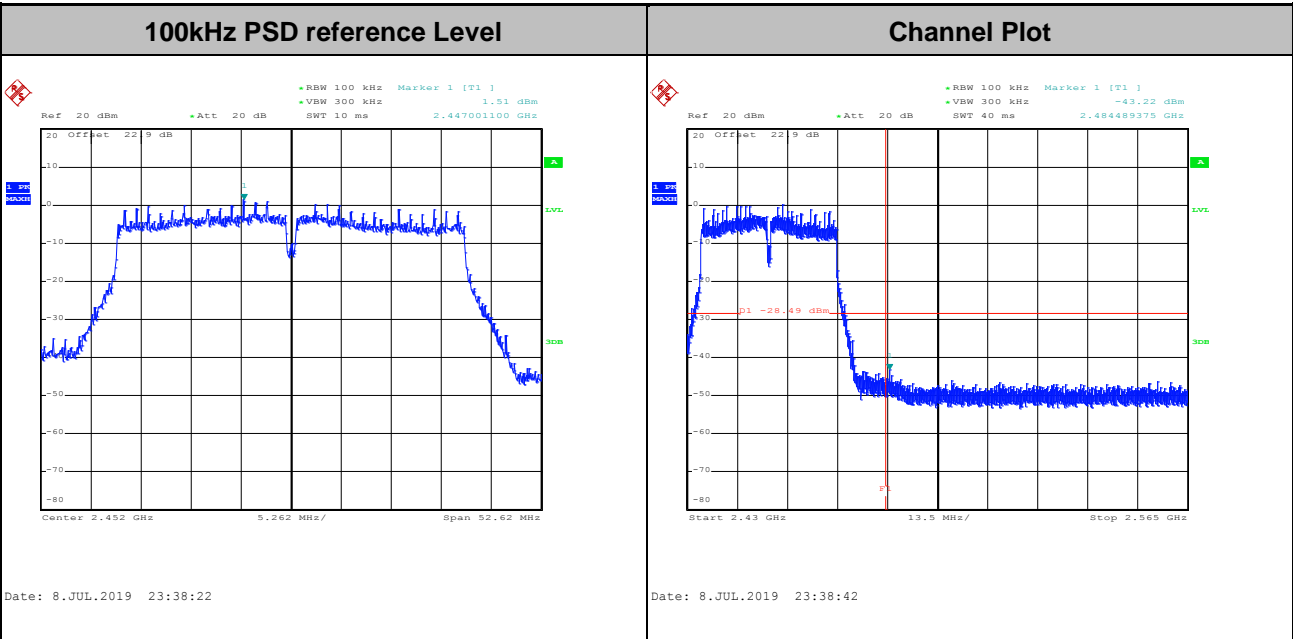



<TXBF Modes>

Number of TX = 2, Ant. 1 (Measured)

Test Mode :	802.11ac VHT20	Test Channel :	01
-------------	----------------	----------------	----

<b>100kHz PSD reference Level</b>	<b>Channel Plot</b>
-----------------------------------	---------------------

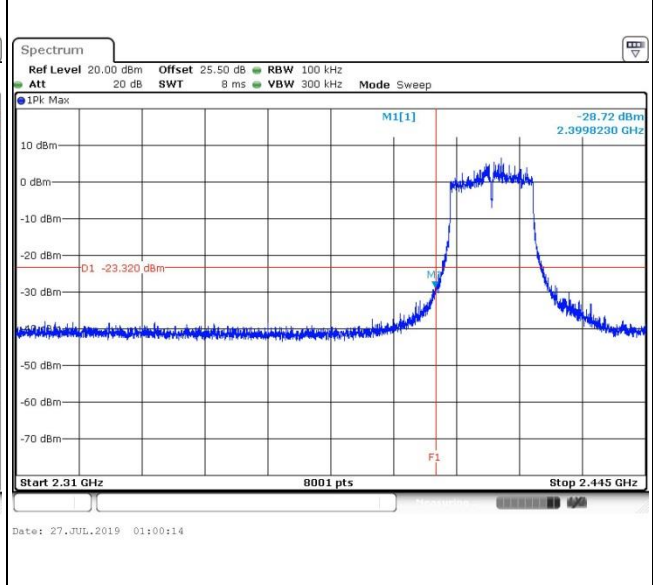
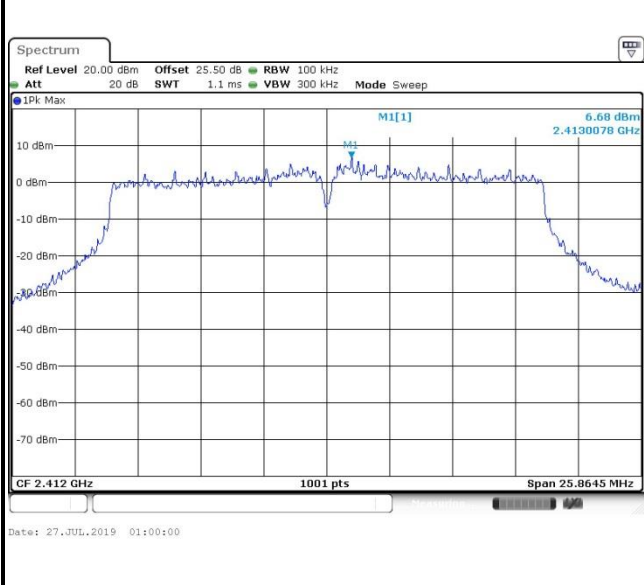

**Spurious Emission 30MHz~3GHz**

**Spurious Emission 2GHz~25GHz**

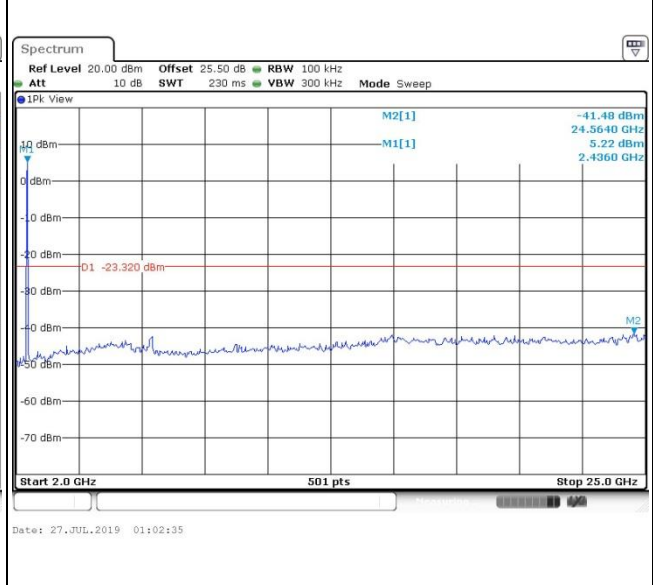
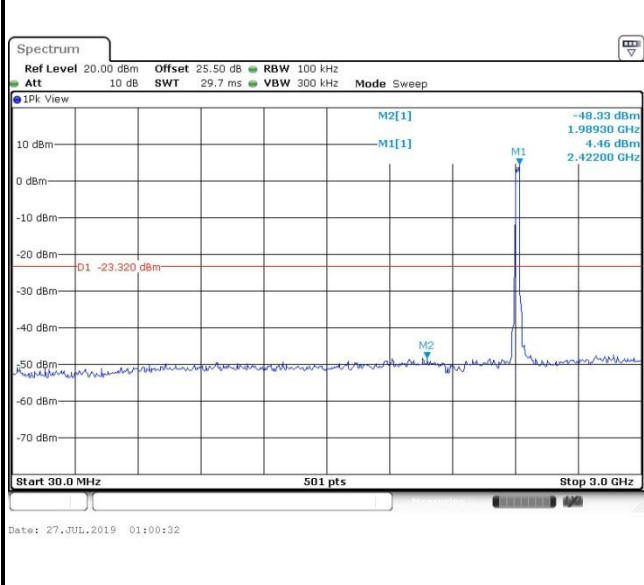





Test Mode :	802.11ac VHT20	Test Channel :	06
-------------	----------------	----------------	----

<b>100kHz PSD reference Level</b>	<b>Channel Plot</b>
-----------------------------------	---------------------

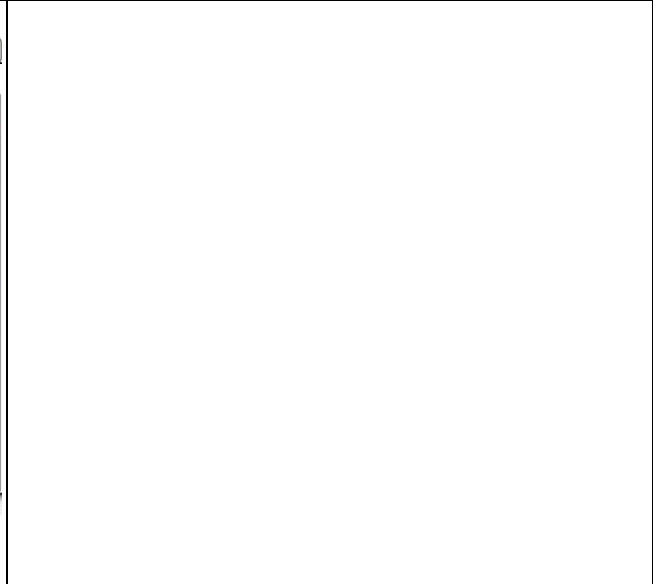
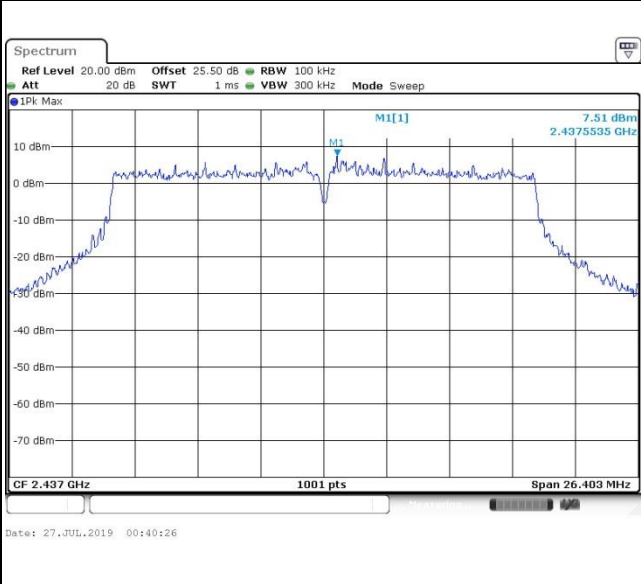

<b>Spurious Emission 30MHz~3GHz</b>	<b>Spurious Emission 2GHz~25GHz</b>
-------------------------------------	-------------------------------------

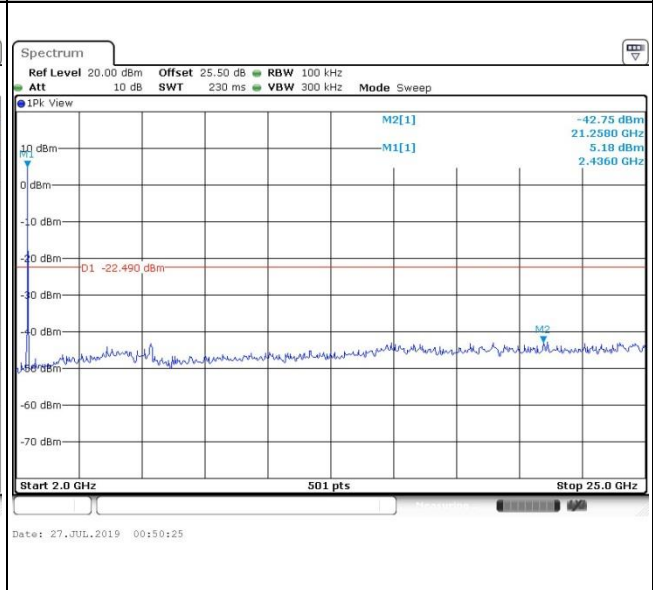
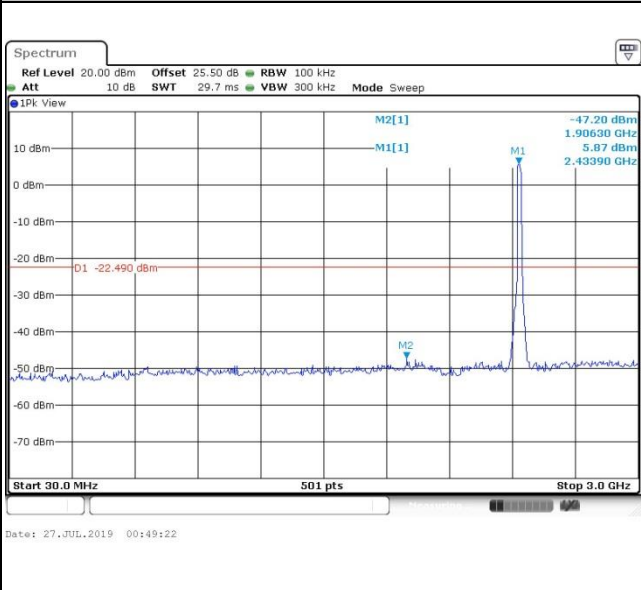



Test Mode : 802.11ac VHT20      Test Channel : 11

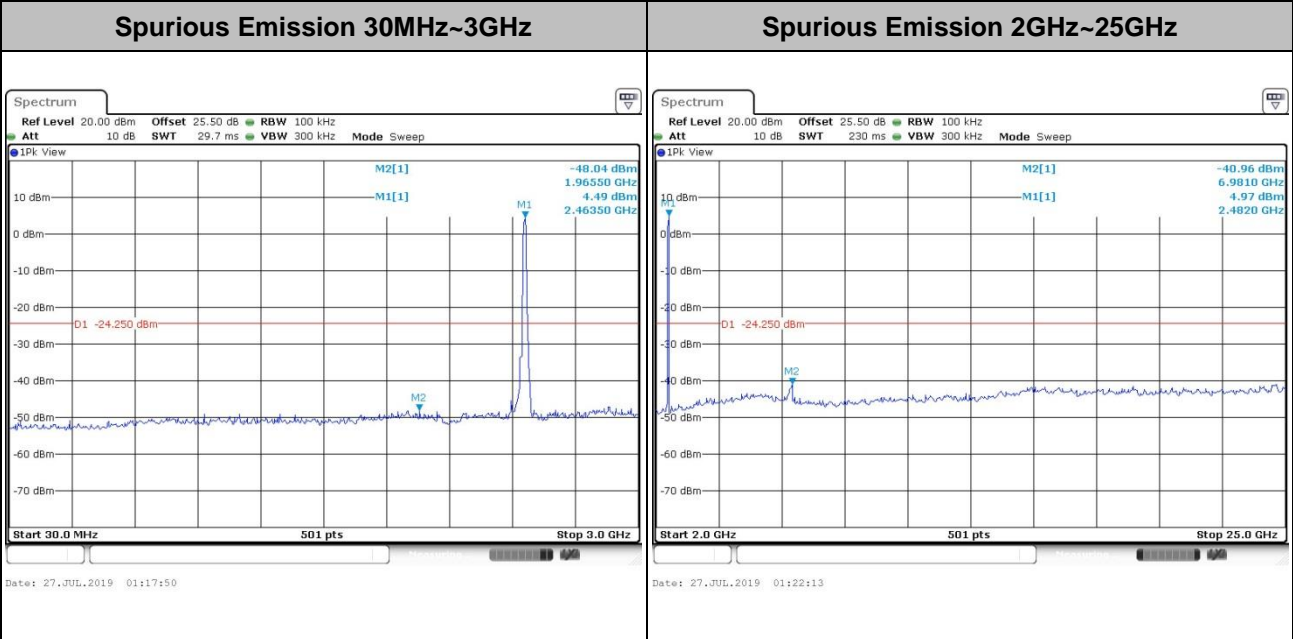
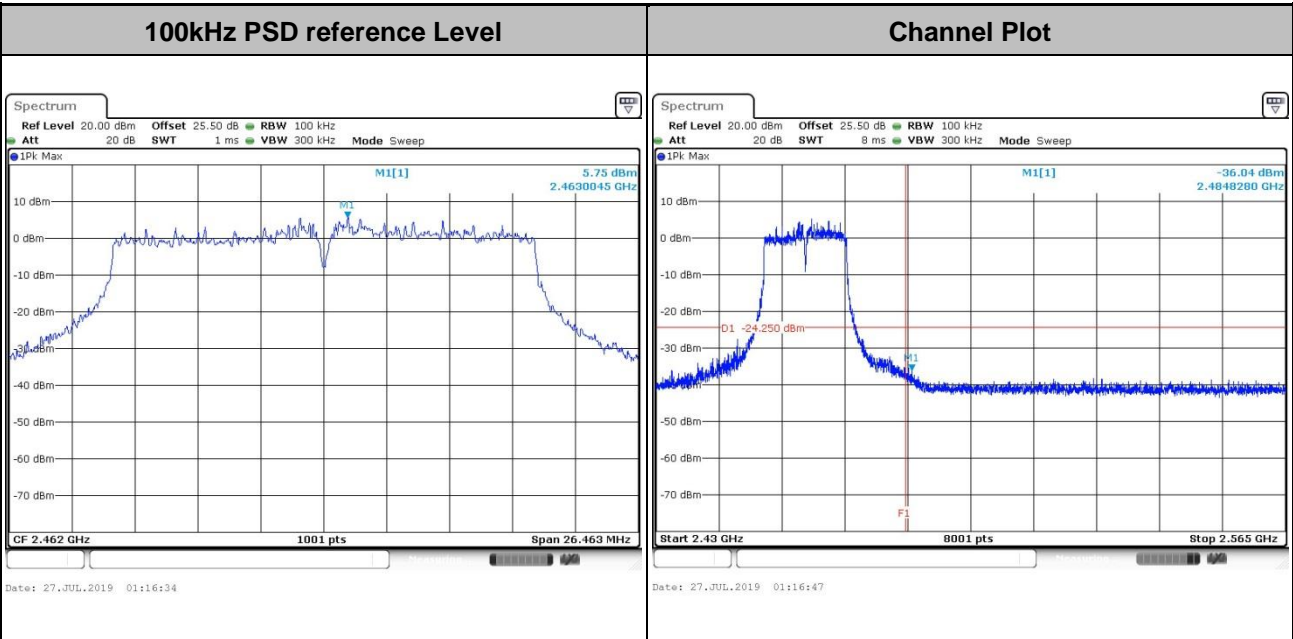



Test Mode : 802.11ac VHT40      Test Channel : 03

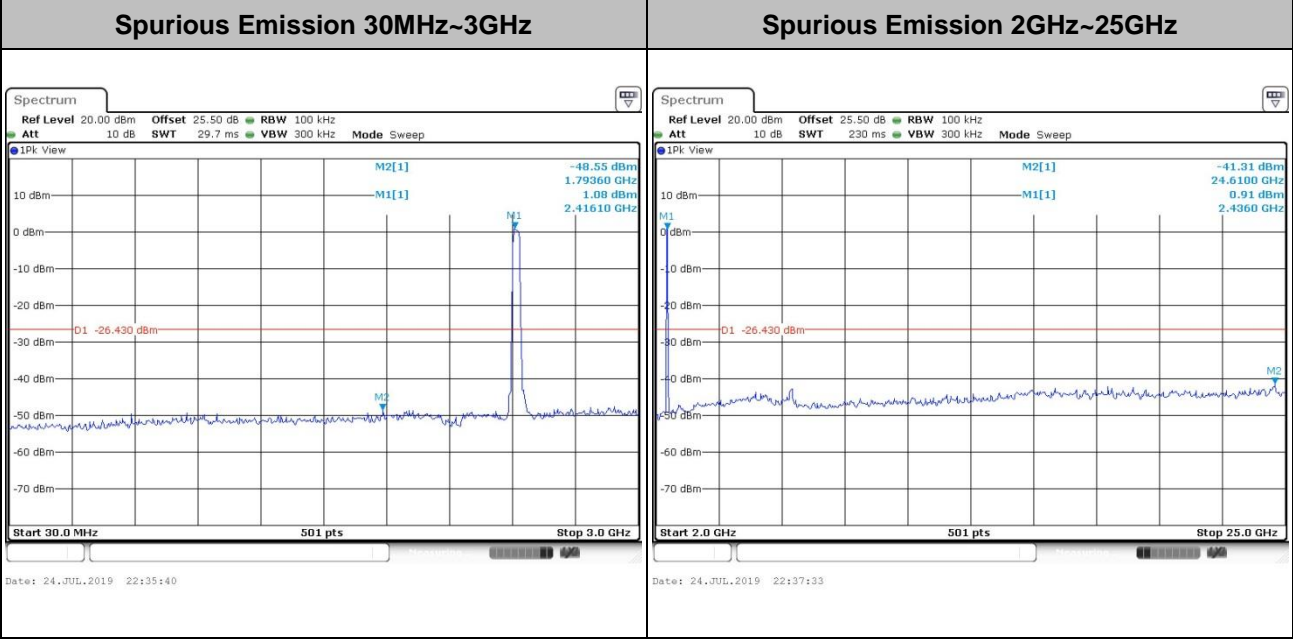
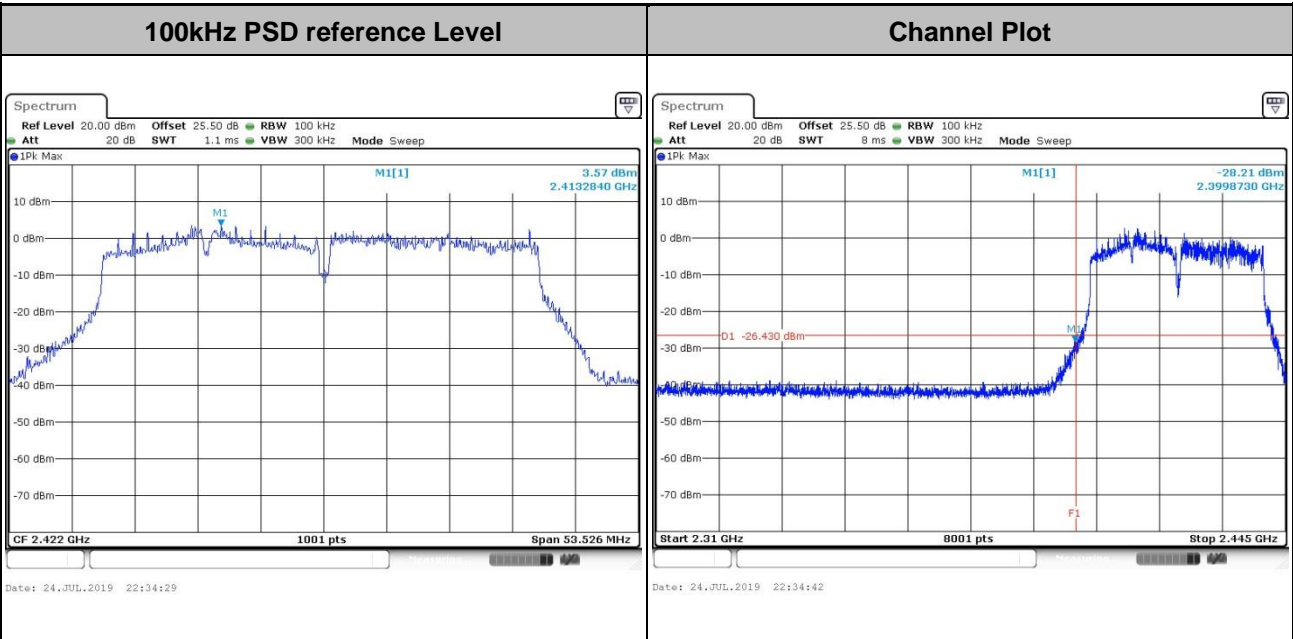



Test Mode :	802.11ac VHT40	Test Channel :	06
-------------	----------------	----------------	----

<b>100kHz PSD reference Level</b>	<b>Channel Plot</b>
-----------------------------------	---------------------

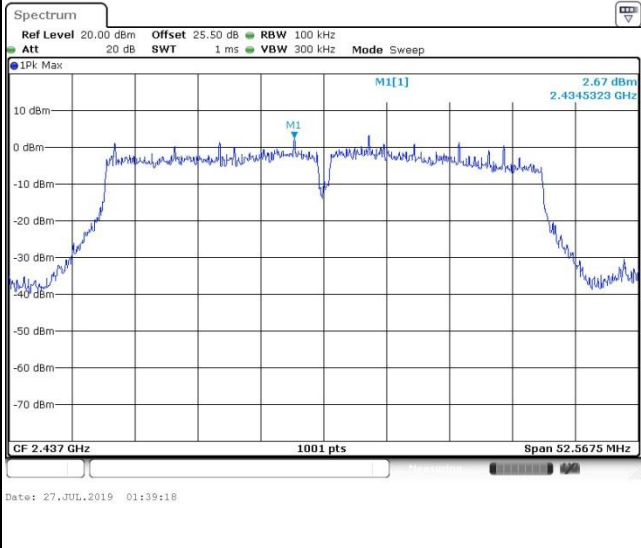

<b>Spurious Emission 30MHz~3GHz</b>	<b>Spurious Emission 2GHz~25GHz</b>
-------------------------------------	-------------------------------------

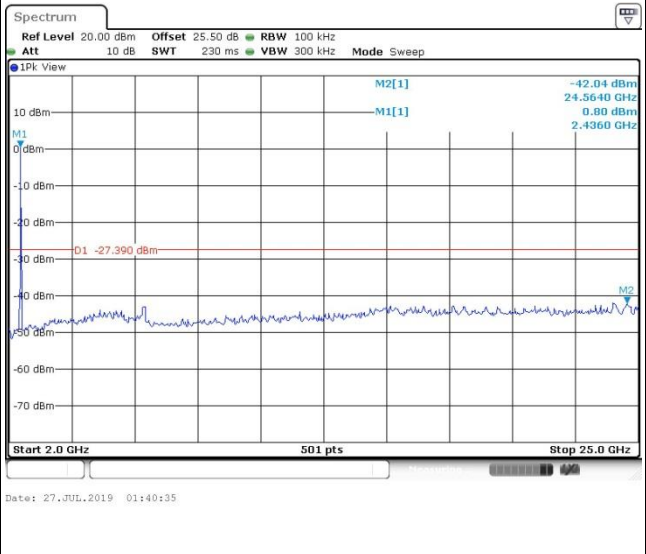
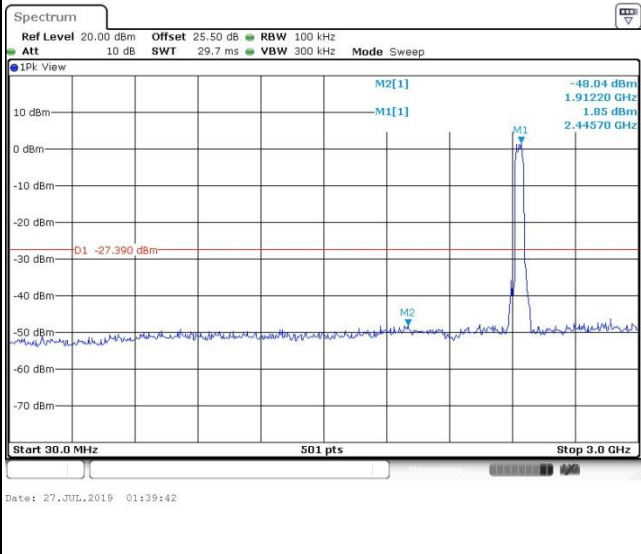



Test Mode : 802.11ac VHT40      Test Channel : 09

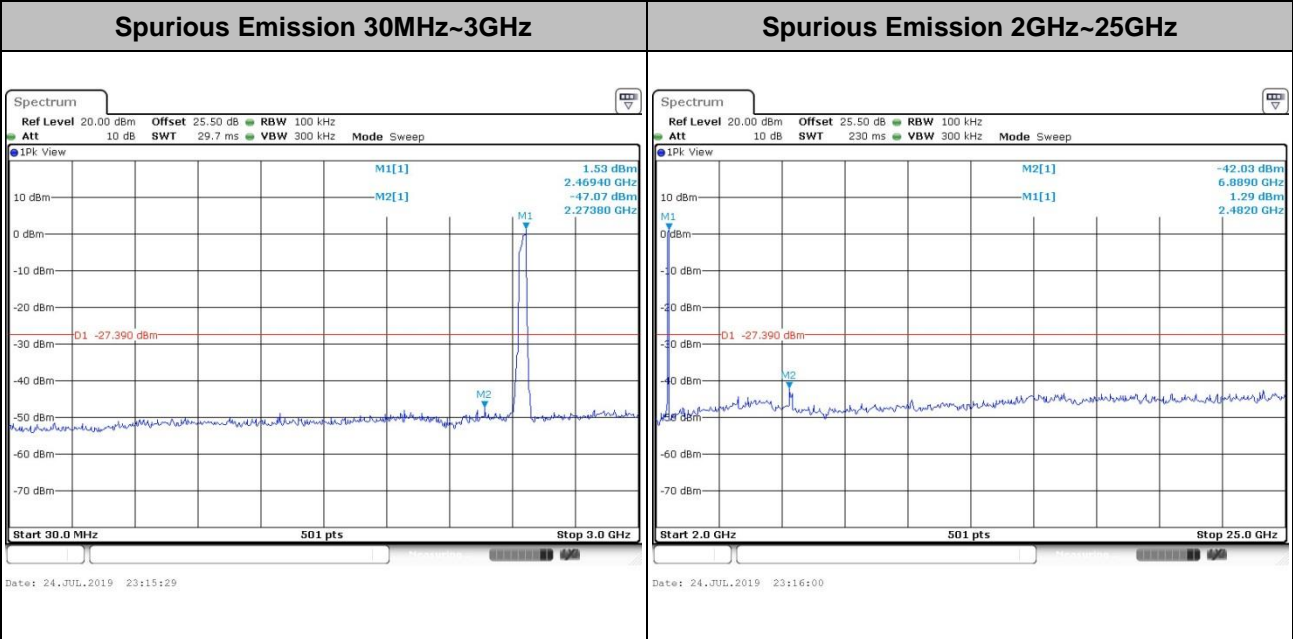
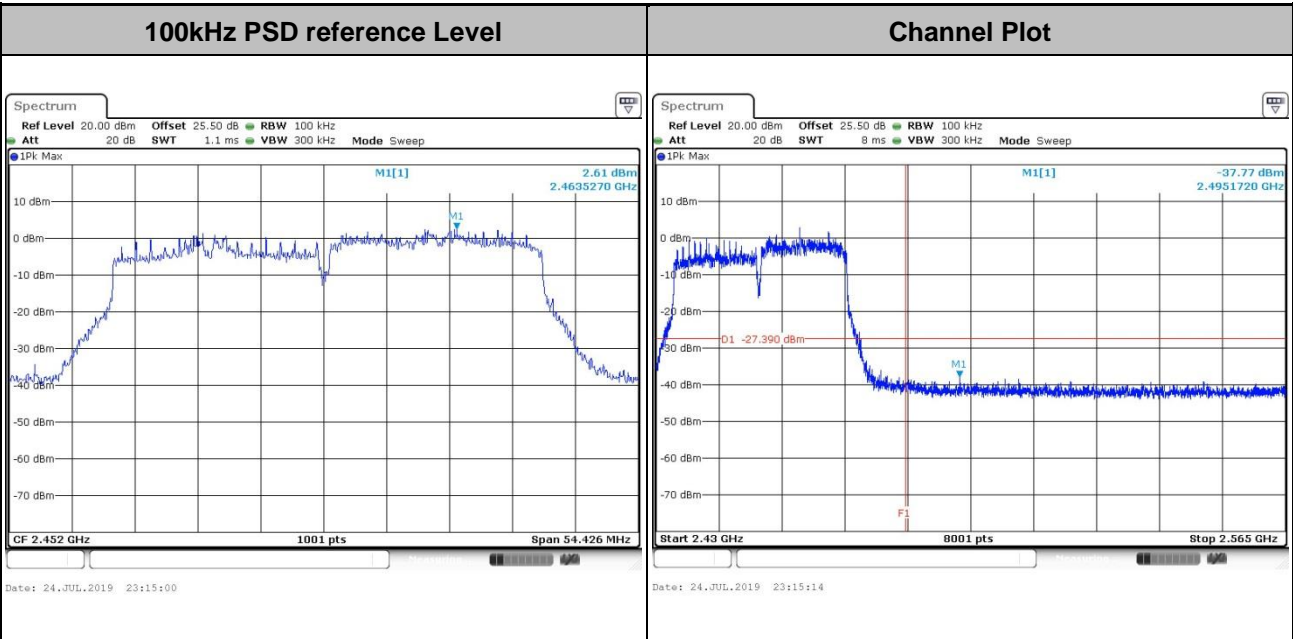



Number of TX = 2, Ant. 2 (Measured)

Test Mode :	802.11ac VHT20	Test Channel :	01
-------------	----------------	----------------	----

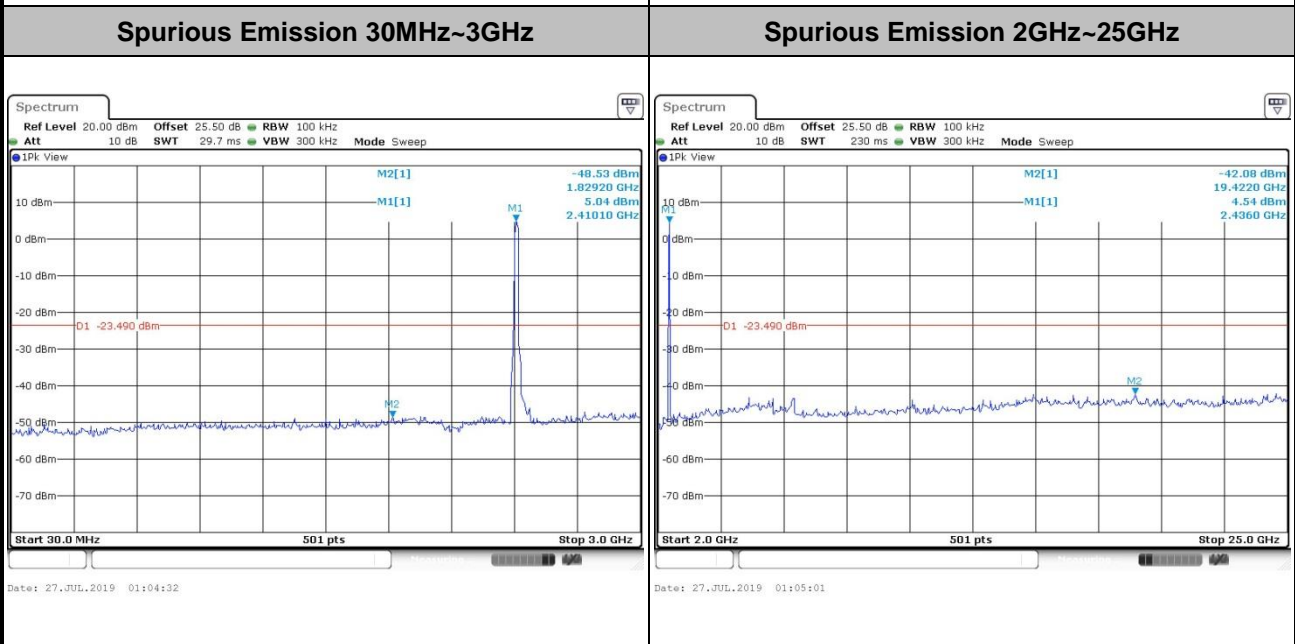
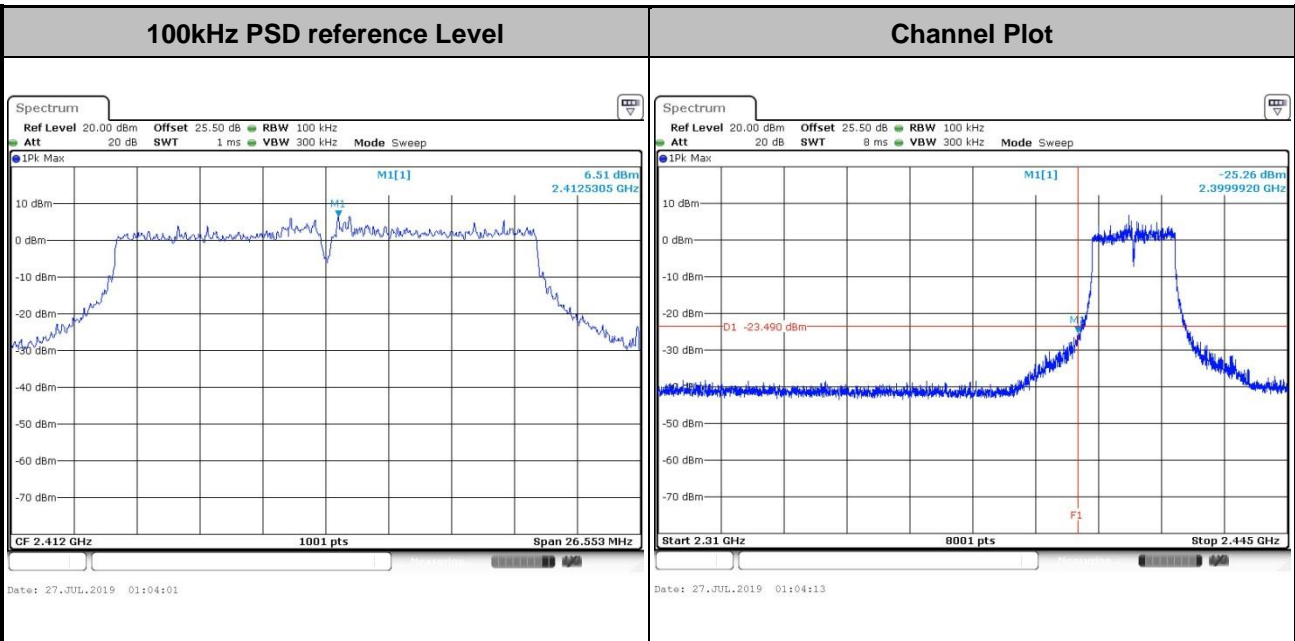



Test Mode :	802.11ac VHT20	Test Channel :	06
-------------	----------------	----------------	----

<b>100kHz PSD reference Level</b>	<b>Channel Plot</b>
-----------------------------------	---------------------

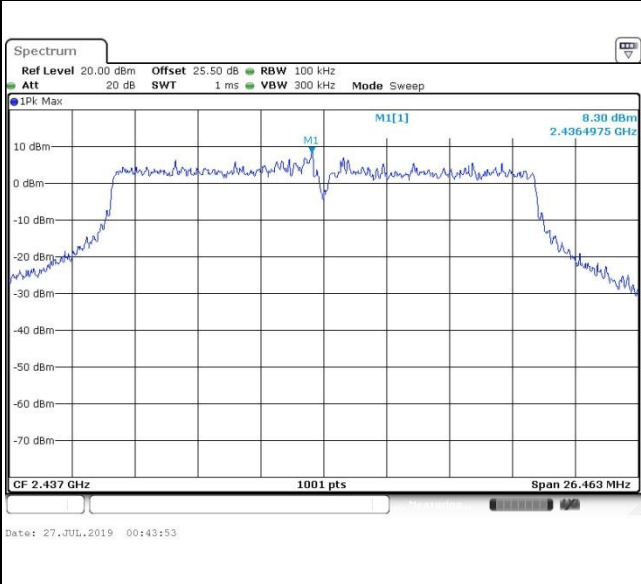

<b>Spurious Emission 30MHz~3GHz</b>	<b>Spurious Emission 2GHz~25GHz</b>
-------------------------------------	-------------------------------------

