



# FCC CO-LOCATION RADIO TEST REPORT

FCC ID : UZ7ET56DE  
Equipment : Tablet  
Brand Name : ZEBRA  
Model Name : ET56DE  
Applicant : Zebra Technologies Corporation  
1 Zebra Plaza, Holtsville, NY 11742  
Manufacturer : Zebra Technologies Corporation  
1 Zebra Plaza, Holtsville, NY 11742  
Standard : FCC Part 15 Subpart E §15.407

The product was received on Jan. 16, 2019 and testing was started from Jun. 29, 2019 and completed on Jul. 15, 2019. We, SPORTON INTERNATIONAL INC. EMC & Wireless Communications Laboratory, would like to declare that the tested sample has been evaluated in accordance with the test procedures and has been in compliance with the applicable technical standards.

The report must not be used by the client to claim product certification, approval, or endorsement by TAF or any agency of government.

The test results in this report apply exclusively to the tested model / sample. Without written approval of SPORTON INTERNATIONAL INC. EMC & Wireless Communications Laboratory, the test report shall not be reproduced except in full.

Reviewed by: Louis Wu

**SPORTON INTERNATIONAL INC. EMC & Wireless Communications Laboratory**  
No. 52, Huaya 1st Rd., Guishan Dist., Taoyuan City, Taiwan (R.O.C.)



## Table of Contents

History of this test report..... 3

Summary of Test Result..... 4

**1 General Description ..... 5**

    1.1 Product Feature of Equipment Under Test..... 5

    1.2 Product Specification of Equipment Under Test..... 6

    1.3 Modification of EUT ..... 6

    1.4 Testing Location ..... 6

    1.5 Applicable Standards..... 7

**2 Test Configuration of Equipment Under Test ..... 8**

    2.1 Carrier Frequency and Channel ..... 8

    2.2 Test Mode..... 8

    2.3 Connection Diagram of Test System..... 8

    2.4 EUT Operation Test Setup ..... 8

**3 Test Result ..... 9**

    3.1 Unwanted Emissions Measurement..... 9

    3.2 Antenna Requirements..... 13

**4 List of Measuring Equipment..... 14**

**5 Uncertainty of Evaluation ..... 15**

**Appendix A. Radiated Spurious Emission**

**Appendix B. Radiated Spurious Emission Plots**

**Appendix C. Duty Cycle Plots**

**Appendix D. Setup Photographs**





### Summary of Test Result

Report Clause	Ref Std. Clause	Test Items	Result (PASS/FAIL)	Remark
3.1	15.407(b)	Unwanted Emissions	Pass	Under limit 2.66 dB at 5470.000 MHz
3.2	15.203 15.407(a)	Antenna Requirement	Pass	-

**Declaration of Conformity:**

The test results with all measurement uncertainty excluded are presented in accordance with the regulation limits or requirements declared by manufacturers.

**Comments and Explanations:**

The declared of product specification for EUT presented in the report are provided by the manufacturer, and the manufacturer takes all the responsibilities for the accuracy of product specification.

**Reviewed by: Wii Chang**

**Report Producer: Aileen Huang**



# 1 General Description

## 1.1 Product Feature of Equipment Under Test

Product Feature	
Equipment	Tablet
Brand Name	ZEBRA
Model Name	ET56DE
FCC ID	UZ7ET56DE
EUT supports Radios application	WCDMA/HSPA/LTE/NFC/GNSS WLAN 11a/b/g/n HT20/HT40 WLAN 11ac VHT20/VHT40/VHT80 Bluetooth BR/EDR/LE
HW Version	DV2
SW Version	Android version 8.1.0
FW Version	01-20-03-00-OG-U00-PRD
MFD	19Jun01
EUT Stage	Identical Prototype

Remark: The above EUT's information was declared by manufacturer.

Specification of Accessories				
Spare Standard Battery 24.13Wh	Brand Name	Zebra	Model Name	BT-000393

Supported Unit Used in Test Configuration and System				
Cradle (Dock) for EMC	Brand Name	Zebra	Part Number	CRD-ET5X-1SCG1
Cradle (Dock) for RSE	Brand Name	Zebra	Part Number	CHG-ET5X-CBL1-01
Adapter	Brand Name	Zebra	Part Number	PWRBGA12V50W0WW
DC Cable	Brand Name	Zebra	Part Number	CBL-DC-388A1-01



### 1.2 Product Specification of Equipment Under Test

Standards-related Product Specification	
<b>Tx/Rx Frequency Range</b>	WLAN 802.11n: 2412 MHz ~ 2462 MHz WLAN 802.11ac: 5180 MHz ~ 5240 MHz; 5260 MHz ~ 5320 MHz; 5500 MHz ~ 5720 MHz; 5745 MHz ~ 5825 MHz
<b>Antenna Type / Gain</b>	<2412 MHz ~ 2462 MHz> Ant. 0 : Chip Antenna with gain 1.24 dBi Ant. 1 : Chip Antenna with gain 2.46 dBi <5150 MHz ~ 5250 MHz> Ant. 0 : Chip Antenna with gain 3.50 dBi Ant. 1 : Chip Antenna with gain 3.30 dBi <5250 MHz ~ 5350 MHz> Ant. 0 : Chip Antenna with gain 3.87 dBi Ant. 1 : Chip Antenna with gain 3.43 dBi <5470 MHz ~ 5725 MHz> Ant. 0 : Chip Antenna with gain 3.92 dBi Ant. 1 : Chip Antenna with gain 3.83 dBi <5725 MHz ~ 5850 MHz> Ant. 0 : Chip Antenna with gain 3.82 dBi Ant. 1 : Chip Antenna with gain 3.76 dBi
<b>Type of Modulation</b>	802.11n: OFDM (BPSK / QPSK / 16QAM / 64QAM) 802.11ac : OFDM (BPSK / QPSK / 16QAM / 64QAM / 256QAM)

### 1.3 Modification of EUT

No modifications are made to the EUT during all test items.

### 1.4 Testing Location

<b>Test Site</b>	SPORTON INTERNATIONAL INC. EMC & Wireless Communications Laboratory
<b>Test Site Location</b>	No.58, Aly. 75, Ln. 564, Wenhua 3rd, Rd., Guishan Dist., Taoyuan City, Taiwan (R.O.C.) TEL: +886-3-327-0868 FAX: +886-3-327-0855
<b>Test Site No.</b>	<b>Sporton Site No.</b> 03CH13-HY

**Note:** The test site complies with ANSI C63.4 2014 requirement.

FCC Designation No. TW0007



## **1.5 Applicable Standards**

According to the specifications of the manufacturer, the EUT must comply with the requirements of the following standards:

- ♦ FCC Part 15 Subpart E
- ♦ FCC KDB 789033 D02 General UNII Test Procedures New Rules v02r01.
- ♦ FCC KDB 414788 D01 Radiated Test Site v01r01.
- ♦ FCC KDB Publication No. 558074 D01 DTS Meas. Guidance v05r01
- ♦ ANSI C63.10-2013

**Remark:**

1. All test items were verified and recorded according to the standards and without any deviation during the test.
2. This EUT has also been tested and complied with the requirements of FCC Part 15, Subpart B, recorded in a separate test report.

## 2 Test Configuration of Equipment Under Test

The EUT has been associated with peripherals and configuration operated in a manner tended to maximize its emission characteristics in a typical application. Frequency range investigated: radiation emission (9 kHz to the 10th harmonic of the highest fundamental frequency or to 40 GHz, whichever is lower). For radiated measurement, pre-scanned in three orthogonal panels, X, Y, Z. The worst cases (X plane for WLAN2.4GHz + WLAN5GHz) were recorded in this report.

### 2.1 Carrier Frequency and Channel

2400-2483.5 MHz 802.11n HT40		5150-5250 MHz 802.11ac VTH40	
Channel	Freq. (MHz)	Channel	Freq. (MHz)
06	2437	102	5510

### 2.2 Test Mode

Final test modes are considering the modulation and worse data rates as below table.

<Co-Location>

Modulation	Data Rate
802.11n HT40 for Ant. 1 + 802.11ac VTH40 for Ant. 2	MCS0 + MCS0

### 2.3 Connection Diagram of Test System

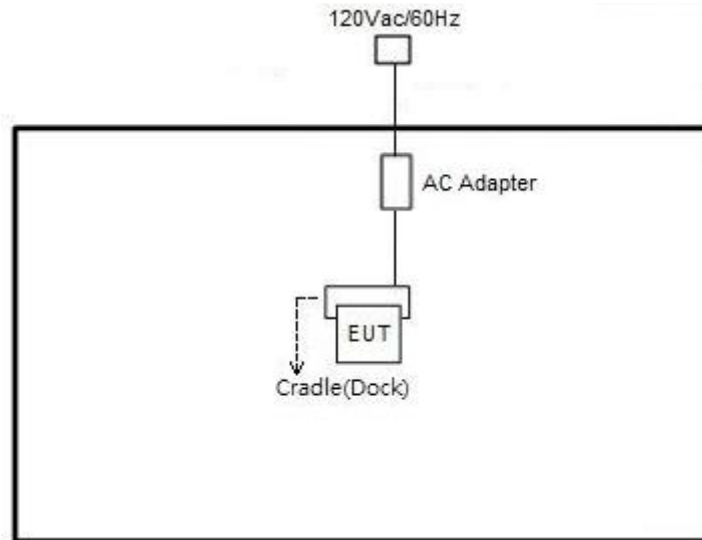

### 2.4 EUT Operation Test Setup

The RF test items, utility “QRCT\_qud.win.1.1\_installer\_10044.7” was installed in Notebook which was programmed in order to make the EUT get into the engineering modes to provide channel selection, power level, data rate and the application type and for continuous transmitting signals.





### 3 Test Result

#### 3.1 Unwanted Emissions Measurement

This section is to measure unwanted emissions through radiated measurement for band edge spurious emissions and out of band emissions measurement.

##### 3.1.1 Limit of Unwanted Emissions

(1) Unwanted spurious emissions fallen in restricted bands shall comply with the general field strength limits as below table,

Frequency (MHz)	Field Strength (microvolts/meter)	Measurement Distance (meters)
0.009 – 0.490	2400/F(kHz)	300
0.490 – 1.705	24000/F(kHz)	30
1.705 – 30.0	30	30
30 – 88	100	3
88 – 216	150	3
216 - 960	200	3
Above 960	500	3

**Note:** The following formula is used to convert the EIRP to field strength.

$$E = \frac{1000000\sqrt{30P}}{3} \mu\text{V/m, where P is the eirp (Watts)}$$

EIRP (dBm)	Field Strength at 3m (dBμV/m)
- 27	68.3

(2) KDB789033 D02 v02r01 G)2)c)

- (i) Section 15.407(b)(1) to (b)(3) specify the unwanted emission limits for the U-NII-1 and U-NII-2 bands. As specified, emissions above 1000 MHz that are outside of the restricted bands are subject to a peak emission limit of -27 dBm/MHz.<sup>3</sup>
- (ii) Section 15.407(b)(4) specifies the unwanted emission limit for the U-NII-3 band. A band emissions mask is specified in Section 15.407(b)(4)(i). The emission limits are in terms of a Peak detector. An alternative to the band emissions mask is specified in Section 15.407(b)(4)(ii). The alternative limits are based on the highest antenna gain specified in the filing. There are also marketing and importation restrictions for the devices using the alternative limit.<sup>4</sup>

**Note 3:** An out-of-band emission that complies with both the average and peak limits of Section 15.209 is not required to satisfy the -27 dBm/MHz peak emission limit.

**Note 4:** Only devices with antenna gains of 10 dBi or less may be approved using the emission limits specified in Section 15.247(d) till March 2, 2018; all other devices operating in this band must use the mask specified in Section 15.407(b)(4)(i).



### 3.1.2 Measuring Instruments

See list of measuring equipment of this test report.

### 3.1.3 Test Procedures

1. The testing follows FCC KDB 789033 D02 General UNII Test Procedures New Rules v02r01. Section G) Unwanted emissions measurement.
  - (1) Procedure for Unwanted Emissions Measurements Below 1000MHz
    - RBW = 120 kHz
    - VBW = 300 kHz
    - Detector = Peak
    - Trace mode = max hold
  - (2) Procedure for Peak Unwanted Emissions Measurements Above 1000 MHz
    - RBW = 1 MHz
    - VBW  $\geq$  3 MHz
    - Detector = Peak
    - Sweep time = auto
    - Trace mode = max hold
  - (3) Procedures for Average Unwanted Emissions Measurements Above 1000MHz
    - RBW = 1 MHz
    - VBW = 10 Hz, when duty cycle is no less than 98 percent.
    - VBW  $\geq$  1/T, when duty cycle is less than 98 percent where T is the minimum transmission duration over which the transmitter is on and is transmitting at its maximum power control level for the tested mode of operation.
2. The EUT was placed on a turntable with 0.8 meter for frequency below 1GHz and 1.5 meter for frequency above 1GHz respectively above ground.
3. The EUT was set 3 meters from the interference receiving antenna which was mounted on the top of a variable height antenna tower.
4. The antenna is a broadband antenna and its height is adjusted between one meter and four meters above ground to find the maximum value of the field strength for both horizontal polarization and vertical polarization of the antenna.
5. For each suspected emission, the EUT was arranged to its worst case and then adjust the antenna tower (from 1 m to 4 m) and turntable (from 0 degree to 360 degrees) to find the maximum reading.

6. For testing below 1GHz, if the emission level of the EUT in peak mode was 3 dB lower than the limit specified, then peak values of EUT will be reported, otherwise, the emissions will be repeated one by one using the CISPR quasi-peak method and reported.
7. For testing above 1GHz, the emission level of the EUT in peak mode was 20dB lower than average limit (that means the emission level in average mode also complies with the limit in average mode), then peak values of EUT will be reported, otherwise, the emissions will be measured in average mode again and reported.

### 3.1.4 Test Setup

For radiated emissions below 30MHz

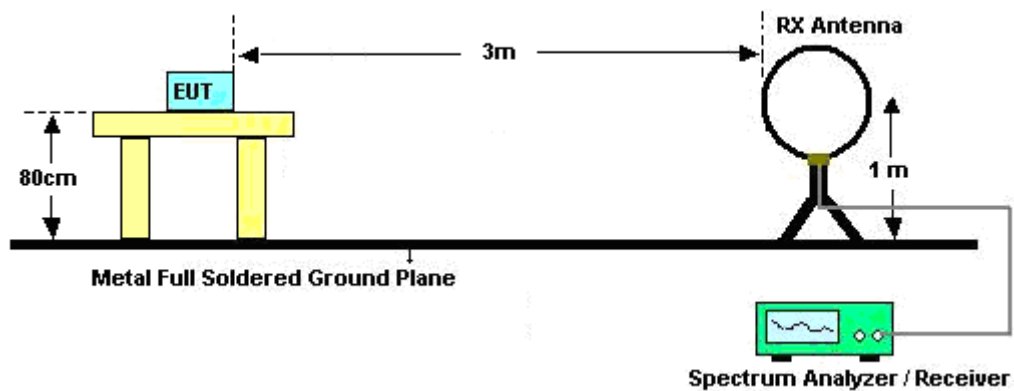

For radiated emissions from 30MHz to 1GHz

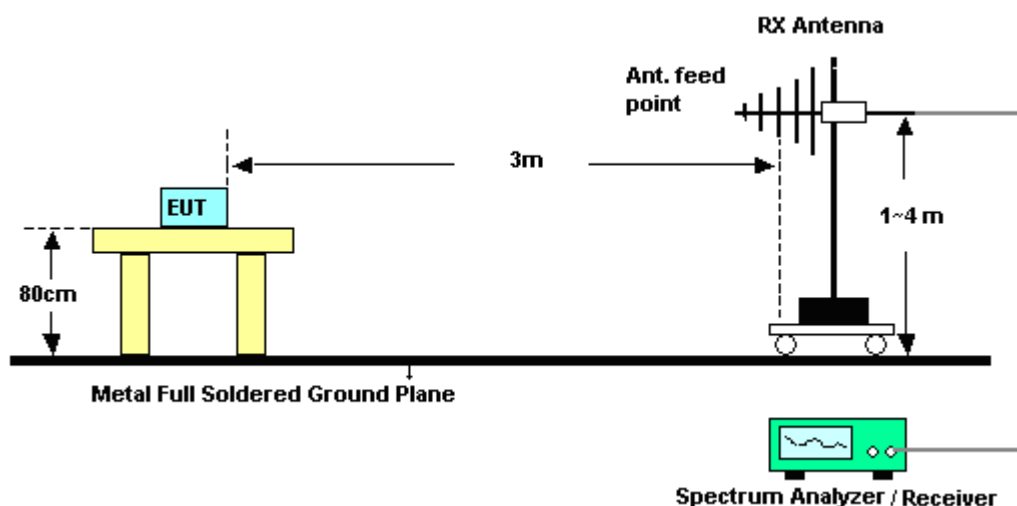

For radiated emissions above 1GHz

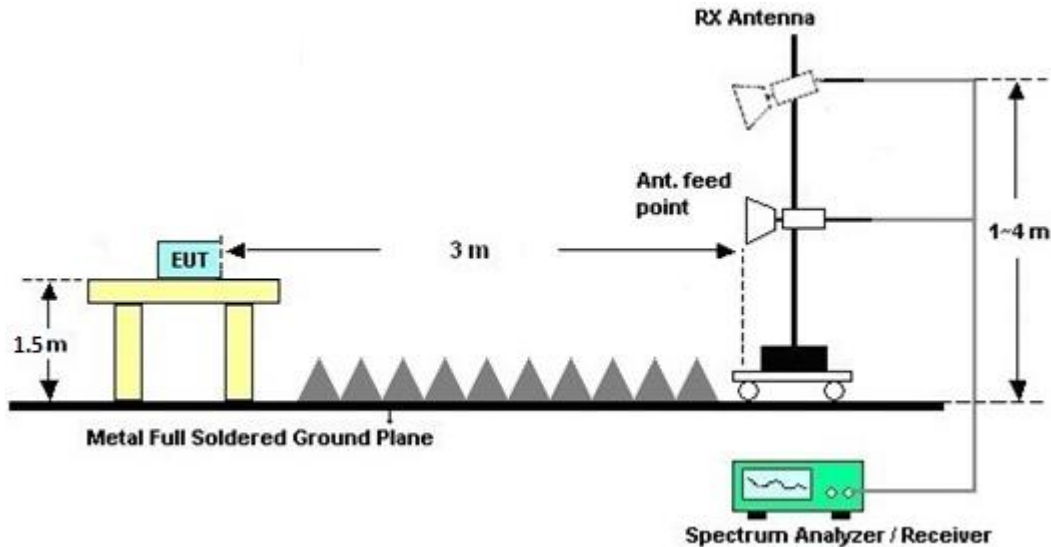

### 3.1.5 Test Results of Radiated Spurious Emissions (9 kHz ~ 30 MHz)

The low frequency, which started from 9 kHz to 30MHz, was pre-scanned and the result which was 20dB lower than the limit line was not reported.

There is a comparison data of both open-field test site and alternative test site - semi-Anechoic chamber according to 414788 D01 Radiated Test Site v01r01, and the result came out very similar.

### 3.1.6 Test Result of Radiated Spurious at Band Edges

Please refer to Appendix A and B.

### 3.1.7 Duty Cycle

Please refer to Appendix C.

### 3.1.8 Test Result of Radiated Spurious Emissions (30MHz ~ 10th Harmonic)

Please refer to Appendix A and B.



## **3.2 Antenna Requirements**

### **3.2.1 Standard Applicable**

If transmitting antenna directional gain is greater than 6 dBi, both the peak transmit power and the peak power spectral density shall be reduced by the amount in dB that the directional gain of the antenna exceeds 6 dBi.

### **3.2.2 Antenna Anti-Replacement Construction**

An embedded-in antenna design is used.

### **3.2.3 Antenna Gain**

The antenna peak gain of EUT is less than 6 dBi. Therefore, it is not necessary to reduce maximum peak output power limit.



## 4 List of Measuring Equipment

Instrument	Manufacturer	Model No.	Serial No.	Characteristics	Calibration Date	Test Date	Due Date	Remark
Loop Antenna	Rohde & Schwarz	HFH2-Z2	100488	9 kHz~30 MHz	Jan. 07, 2019	Jun. 29, 2019 ~Jul. 15, 2019	Jan. 06, 2020	Radiation (03CH13-HY)
Horn Antenna	SCHWARZBECK	BBHA 9120 D	9120D-1212	1GHz ~ 18GHz	May 14, 2019	Jun. 29, 2019 ~Jul. 15, 2019	May 13, 2020	Radiation (03CH13-HY)
Bilog Antenna	TESEQ	CBL 6111D&00800 N1D01N-06	37059&01	30MHz~1GHz	Oct. 13, 2018	Jun. 29, 2019 ~Jul. 15, 2019	Oct. 12, 2019	Radiation (03CH13-HY)
SHF-EHF Horn Antenna	SCHWARZBECK	BBHA 9170	BBHA9170584	18GHz- 40GHz	Dec. 05, 2018	Jun. 29, 2019 ~Jul. 15, 2019	Dec. 04, 2019	Radiation (03CH13-HY)
Preamplifier	Keysight	83017A	MY53270080	1GHz~26.5GHz	Nov. 14, 2018	Jun. 29, 2019 ~Jul. 15, 2019	Nov. 13, 2020	Radiation (03CH13-HY)
Preamplifier	MITEQ	AMF-7D-0010 1800-30-10P	1590074	1GHz~18GHz	May 20, 2019	Jun. 29, 2019 ~Jul. 15, 2019	May 19, 2020	Radiation (03CH13-HY)
Amplifier	Sonoma-Instrument	310 N	187282	9KHz~1GHz	Dec. 18, 2018	Jun. 29, 2019 ~Jul. 15, 2019	Dec. 17, 2019	Radiation (03CH13-HY)
Preamplifier	EMEC	EM18G40G	060715	18GHz~40GHz	Dec. 06, 2018	Jun. 29, 2019 ~Jul. 15, 2019	Dec. 05, 2019	Radiation (03CH13-HY)
RF Cable	HUBER + SUHNER	SUCOFLEX 126E	0030/126E	30M-18G	Feb. 13, 2019	Jun. 29, 2019 ~Jul. 15, 2019	Feb. 12, 2020	Radiation (03CH13-HY)
RF Cable	HUBER + SUHNER	SUCOFLEX 104	804793/4	30M-18G	Feb. 13, 2019	Jun. 29, 2019 ~Jul. 15, 2019	Feb. 12, 2020	Radiation (03CH13-HY)
RF Cable	HUBER + SUHNER	SUCOFLEX 104	MY24961/4	30M-18G	Feb. 13, 2019	Jun. 29, 2019 ~Jul. 15, 2019	Feb. 12, 2020	Radiation (03CH13-HY)
RF Cable	HUBER + SUHNER	SUCOFLEX 102	MY2859/2	30M~40GHz	Mar. 13, 2019	Jun. 29, 2019 ~Jul. 15, 2019	Mar. 12, 2020	Radiation (03CH13-HY)
RF Cable	HUBER + SUHNER	SUCOFLEX 102	MY4274/2	30M~40GHz	Mar. 13, 2019	Jun. 29, 2019 ~Jul. 15, 2019	Mar. 12, 2020	Radiation (03CH13-HY)
Spectrum Analyzer	Keysight	N9010A	MY55370526	10Hz~44GHz	Mar. 19, 2019	Jun. 29, 2019 ~Jul. 15, 2019	Mar. 18, 2020	Radiation (03CH13-HY)
Antenna Mast	EMEC	AM-BS-4500- B	N/A	1m~4m	N/A	Jun. 29, 2019 ~Jul. 15, 2019	N/A	Radiation (03CH13-HY)
Turn Table	EMEC	TT2000	N/A	0~360 Degree	N/A	Jun. 29, 2019 ~Jul. 15, 2019	N/A	Radiation (03CH13-HY)
Software	AUDIX	E3 6.2009-8-24c	RK-001124	N/A	N/A	Jun.29, 2019 ~ Jul.15, 2019	N/A	Radiation (03CH13-HY)
EMI Test Receiver	Keysight	N9038A(MXE)	MY54130085	20Hz ~ 8.4GHz	Nov. 01, 2018	Jun. 29, 2019 ~Jul. 15, 2019	Oct. 31, 2019	Radiation (03CH13-HY)
Filter	Woken	WHKX8-5272. 5-6750-18000- 40ST	SN5	6.75G Highpass	Mar. 13, 2019	Jun. 29, 2019 ~Jul. 15, 2019	Mar. 12, 2020	Radiation (03CH13-HY)
Filter	Wainwright	WLKS1200-8S S	SN3	1.2G Low Pass	Nov. 02, 2018	Jun. 29, 2019 ~Jul. 15, 2019	Nov. 01, 2019	Radiation (03CH13-HY)
Filter	Wainwright	WHKX12-280 5-3000-18000- 40ST	SN1	3G High Pass	Nov. 14, 2018	Jun. 29, 2019 ~Jul. 15, 2019	Nov. 13, 2019	Radiation (03CH13-HY)



## 5 Uncertainty of Evaluation

### Uncertainty of Radiated Emission Measurement (30 MHz ~ 1000 MHz)

Measuring Uncertainty for a Level of Confidence of 95% ( $U = 2Uc(y)$ )	4.9
---	-----

### Uncertainty of Radiated Emission Measurement (1000 MHz ~ 18000 MHz)

Measuring Uncertainty for a Level of Confidence of 95% ( $U = 2Uc(y)$ )	5.4
---	-----

### Uncertainty of Radiated Emission Measurement (18000 MHz ~ 40000 MHz)

Measuring Uncertainty for a Level of Confidence of 95% ( $U = 2Uc(y)$ )	4.3
---	-----



## Appendix A. Radiated Spurious Emission

Test Engineer :	Ryan Lin, JC Liang, and Wilson Wu	Temperature :	21.5~23.5 °C
		Relative Humidity :	46.5~49.5 %

### 2.4GHz 2400~2483.5MHz (Band Edge @ 3m)

WIFI Ant. 0 Simultaneously	Note	Frequency ( MHz )	Level ( dBμV/m )	Over Limit ( dB )	Limit Line ( dBμV/m )	Read Level ( dBμV )	Antenna Factor ( dB/m )	Path Loss ( dB )	Preamp Factor ( dB )	Ant Pos ( cm )	Table Pos ( deg )	Peak Avg. ( P/A )	Pol. ( H/V )
Ant 0_ 11g(n40)_Tx_ Ch06 + Ant 1_ 11ac(40)_Tx_ Ch102		2389.8	56.11	-17.89	74	44.15	27.62	13.92	29.58	129	311	P	H
		2389.8	46.07	-7.93	54	34.11	27.62	13.92	29.58	129	311	A	H
	*	2437	107.92	-	-	96.01	27.53	13.96	29.58	129	311	P	H
	*	2437	99.86	-	-	87.95	27.53	13.96	29.58	129	311	A	H
		2483.52	59.29	-14.71	74	47.36	27.5	14	29.57	129	311	P	H
		2483.52	49.84	-4.16	54	37.91	27.5	14	29.57	129	311	A	H
		2388.68	53.41	-20.59	74	41.45	27.62	13.92	29.58	395	0	P	V
		2389.94	44.5	-9.5	54	32.54	27.62	13.92	29.58	395	0	A	V
	*	2437	107.15	-	-	95.24	27.53	13.96	29.58	395	0	P	V
	*	2437	98.99	-	-	87.08	27.53	13.96	29.58	395	0	A	V
		2483.76	55.65	-18.35	74	43.72	27.5	14	29.57	395	0	P	V
		2483.52	46.58	-7.42	54	34.65	27.5	14	29.57	395	0	A	V
Remark	1. No other spurious found. 2. All results are PASS against Peak and Average limit line.												





5GHz Band 3 5470~5725MHz (Band Edge @ 3m)

WIFI	Note	Frequency	Level	Over	Limit	Read	Antenna	Path	Preamp	Ant	Table	Peak	Pol.
Ant.0		( MHz )	( dBμV/m )	Limit	Line	Level	Factor	Loss	Factor	Pos	Pos	Avg.	(H/V)
Simultaneously				( dB )	( dBμV/m )	( dBμV )	( dB/m )	( dB )	( dB )	( cm )	( deg )	( P/A )	
<b>Ant 0_</b> <b>11g(n40)_Tx_</b> <b>Ch06</b> <b>+</b> <b>Ant 1_</b> <b>11ac(40)_Tx_</b> <b>Ch102</b>		5459.92	57.68	-16.32	74	49.22	31.82	6.18	29.54	106	296	P	H
		5470	65.54	-2.66	68.2	57.05	31.84	6.19	29.54	106	296	A	H
		5459.92	50.42	-3.58	54	41.96	31.82	6.18	29.54	106	296	P	H
	*	5510	109.82	-	-	101.24	31.9	6.23	29.55	106	296	A	H
	*	5510	101.3	-	-	92.72	31.9	6.23	29.55	106	296	P	H
		5733.185	49.9	-18.3	68.2	41.01	32.07	6.37	29.55	106	296	A	H
		5459.68	53.54	-20.46	74	45.08	31.82	6.18	29.54	347	164	P	V
		5470	63.09	-5.11	68.2	54.6	31.84	6.19	29.54	347	164	A	V
		5459.92	47.59	-6.41	54	39.13	31.82	6.18	29.54	347	164	P	V
	*	5510	107.01	-	-	98.43	31.9	6.23	29.55	347	164	A	V
	*	5510	98.49	-	-	89.91	31.9	6.23	29.55	347	164	P	V
		5743.895	49.51	-18.69	68.2	40.59	32.09	6.38	29.55	347	164	A	V
	<b>Remark</b>	1. No other spurious found. 2. All results are PASS against Peak and Average limit line.											



**2.4GHz + 5GHz (Harmonic @ 3m)**

WIFI Ant. Simultaneously	Note	Frequency ( MHz )	Level ( dBμV/m )	Over Limit ( dB )	Limit Line ( dBμV/m )	Read Level ( dBμV )	Antenna Factor ( dB/m )	Path Loss ( dB )	Preamp Factor ( dB )	Ant Pos ( cm )	Table Pos ( deg )	Peak Avg. ( P/A )	Pol. ( H/V )	
Ant 0_11g(n40)_Tx_Ch06 + Ant 1_11ac(40)_Tx_Ch102		4874	47.96	-26.04	74	40.38	31.25	5.74	29.41	100	0	P	H	
		7311	43.62	-30.38	74	55.54	36.7	7.79	57.27	100	0	P	H	
		11400	46.45	-27.55	74	52.47	39.9	9.9	56.34	100	0	P	H	
		17100	47.56	-20.64	68.2	50.86	40.2	12.15	56.3	100	0	P	H	
													H	
													H	
			4874	48.12	-25.88	74	40.54	31.25	5.74	29.41	100	0	P	V
			7311	43.41	-30.59	74	55.33	36.7	7.79	57.27	100	0	P	V
			11400	47.51	-26.49	74	53.53	39.9	9.9	56.34	100	0	P	V
			17100	48.47	-19.73	68.2	51.77	40.2	12.15	56.3	100	0	P	V
														V
														V
<b>Remark</b>	2. No other spurious found. 2. All results are PASS against Peak and Average limit line.													





**Note symbol**

*	<b>Fundamental Frequency</b> which can be ignored. However, the level of any unwanted emissions shall not exceed the level of the fundamental frequency.
!	Test result is <b>over limit</b> line.
P/A	<b>Peak</b> or <b>Average</b>
H/V	<b>Horizontal</b> or <b>Vertical</b>



A calculation example for radiated spurious emission is shown as below:

WIFI	Note	Frequency	Level	Over	Limit	Read	Antenna	Path	Preamp	Ant	Table	Peak	Pol.
Ant.				Limit	Line	Level	Factor	Loss	Factor	Pos	Pos	Avg.	
1		( MHz )	( dBµV/m )	( dB )	( dBµV/m )	( dBµV )	( dB/m )	( dB )	( dB )	( cm )	( deg )	( P/A )	( H/V )
802.11b		2390	55.45	-18.55	74	54.51	32.22	4.58	35.86	103	308	P	H
CH 01													
2412MHz		2390	43.54	-10.46	54	42.6	32.22	4.58	35.86	103	308	A	H

1. Path Loss(dB) = Cable loss(dB) + Filter loss(dB) + Attenuator loss(dB)
2. Level(dBµV/m) =  
Antenna Factor(dB/m) + Path Loss(dB) + Read Level(dBµV) - Preamp Factor(dB)
3. Over Limit(dB) = Level(dBµV/m) – Limit Line(dBµV/m)

**For Peak Limit @ 2390MHz:**

1. Level(dBµV/m)  
= Antenna Factor(dB/m) + Path Loss(dB) + Read Level(dBµV) - Preamp Factor(dB)  
= 32.22(dB/m) + 4.58(dB) + 54.51(dBµV) – 35.86 (dB)  
= 55.45 (dBµV/m)
2. Over Limit(dB)  
= Level(dBµV/m) – Limit Line(dBµV/m)  
= 55.45(dBµV/m) – 74(dBµV/m)  
= -18.55(dB)

**For Average Limit @ 2390MHz:**

1. Level(dBµV/m)  
= Antenna Factor(dB/m) + Path Loss(dB) + Read Level(dBµV) - Preamp Factor(dB)  
= 32.22(dB/m) + 4.58(dB) + 42.6(dBµV) – 35.86 (dB)  
= 43.54 (dBµV/m)
2. Over Limit(dB)  
= Level(dBµV/m) – Limit Line(dBµV/m)  
= 43.54(dBµV/m) – 54(dBµV/m)  
= -10.46(dB)

**Both peak and average measured complies with the limit line, so test result is “PASS”.**



## Appendix B. Radiated Spurious Emission Plots

Test Engineer :	Ryan Lin, JC Liang, and Wilson Wu	Temperature :	21.5~23.5 °C
		Relative Humidity :	46.5~49.5 %

Note symbol

-L	Low channel location
-R	High channel location

### 2.4GHz 2400~2483.5MHz (Band Edge @ 3m)

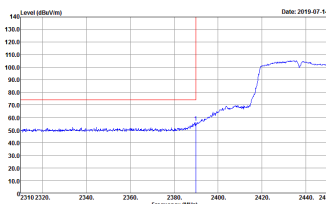
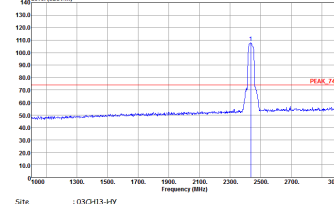
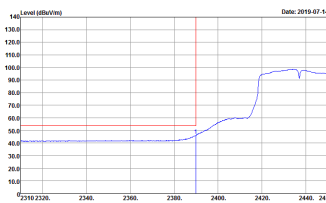
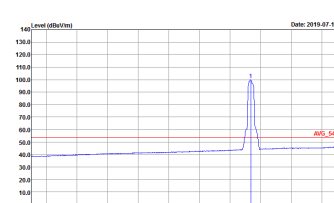
ANT 0	Ant 0_11g(n40)_Tx_Ch06+Ant 1_11ac(40)_Tx_Ch102	
Simultaneously	Horizontal	Fundamental
<b>Peak</b>	 <p>Site : 03CH3-HY            Condition : PEAK_9C_74 3m HORN_91200_1212 HORIZONTAL            Detector : Peak            Project : 911635            Mode : 52            Power : 17.5</p>	 <p>Site : 03CH3-HY            Condition : PEAK_74 3m HORN_91200_1212 HORIZONTAL            Detector : Peak            Project : 911635            Mode : 52            Power : 17.5</p>
<b>Avg.</b>	 <p>Site : 03CH3-HY            Condition : AVG_BE_54 3m HORN_91200_1212 HORIZONTAL            Detector : Peak            Project : 911635            Mode : 52            Power : 17.5</p>	 <p>Site : 03CH3-HY            Condition : AVG_54 3m HORN_91200_1212 HORIZONTAL            Detector : Peak            Project : 911635            Mode : 52            Power : 17.5</p>



ANT 0	Ant 0_11g(n40)_Tx_Ch06+Ant 1_11ac(40)_Tx_Ch102	
Simultaneously	Vertical	Fundamental
Peak	 <p>Site : 03CH3-HY            Condition : PEAK_BE_74 3m HORN_91200_1212 VERTICAL            Detector : Peak            Project : 911635            Mode : 52            Power : 17.5</p>	 <p>Site : 03CH3-HY            Condition : PEAK_74 3m HORN_91200_1212 VERTICAL            Detector : Peak            Project : 911635            Mode : 52            Power : 17.5</p>
Avg.	 <p>Site : 03CH3-HY            Condition : AVG_BE_54 3m HORN_91200_1212 VERTICAL            Detector : Peak            Project : 911635            Mode : 52            Power : 17.5</p>	 <p>Site : 03CH3-HY            Condition : AVG_54 3m HORN_91200_1212 VERTICAL            Detector : Peak            Project : 911635            Mode : 52            Power : 17.5</p>

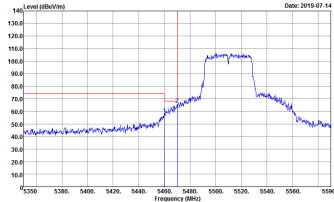
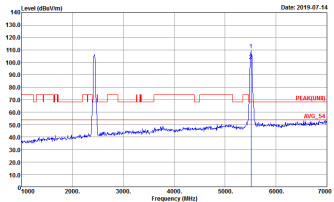

5GHz Band 3 5470~5725MHz (Band Edge @ 3m)

ANT 1	Ant 0_11g(n40)_Tx_Ch06+Ant 1_11ac(40)_Tx_Ch102	
Simultaneously	Horizontal	Fundamental
<p>Peak</p>	 <p>Site : 03CH3-HY            Condition : PEAK_BETWEEN_33_3m_HORN_91200_1212_HORIZONTAL            RBW:3000.000kHz VBW:3000.000kHz SWT:Auto            Detector : Peak            Project : 911635            Mode : 52            Power : 17.5</p>	 <p>Site : 03CH3-HY            Condition : PEAK(FUND) 3m_HORN_91200_1212_HORIZONTAL            RBW:1000.000kHz VBW:3000.000kHz SWT:Auto            Detector : Peak            Project : 911635            Mode : 52            Power : 17.5</p>



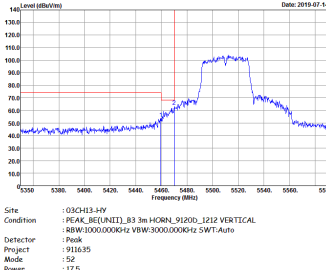
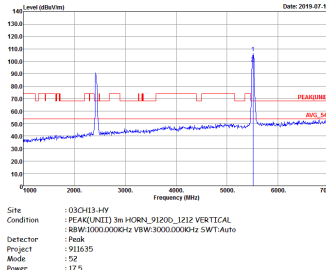

ANT 1	Ant 0_11g(n40)_Tx_Ch06+Ant 1_11ac(40)_Tx_Ch102	
Simultaneously	Vertical	Fundamental
<p style="text-align: center;"><b>Peak</b></p>	 <p>Site : 03CH13-HY Condition : PEAK_BE[UNITE]_B3 3m HORN_91200_1212 VERTICAL Detector : Peak Project : 911635 Mode : 52 Power : 17.5</p>	 <p>Site : 03CH13-HY Condition : PEAK[UNITE] 3m HORN_91200_1212 VERTICAL Detector : Peak Project : 911635 Mode : 52 Power : 17.5</p>

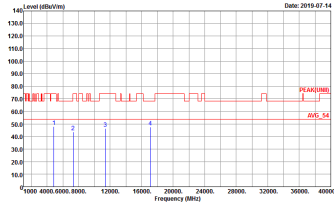
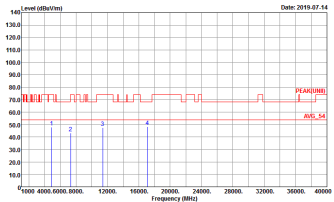

2.4GHz + 5GHz Band 3 (Harmonic @ 3m)

ANT	Ant 0_11g(n40)_Tx_Ch06+Ant 1_11ac(40)_Tx_Ch102	
Simultaneously	Horizontal	Vertical
<p>Peak</p> <p>Avg.</p>	 <p>Site : 03CH13-HY Condition : PEAK(LINE1) 3m HORN_91200_1212 HORIZONTAL Detector : Peak Project : 911635 Mode : S2</p>	 <p>Site : 03CH13-HY Condition : PEAK(LINE1) 3m HORN_91200_1212 VERTICAL Detector : Peak Project : 911635 Mode : S2</p>



Emission below 1GHz  
2.4GHz + 5GHz Band 3 (LF @ 3m)

ANT	Ant 0_11g(n40)_Tx_Ch06+Ant 1_11ac(40)_Tx_Ch102	
Simultaneously	Horizontal	Vertical
<p style="text-align: center;"><b>Peak</b> <b>Avg.</b></p>		



### Appendix C. Duty Cycle Plots

Antenna	Band	Duty Cycle (%)	T(us)	1/T(kHz)	VBW Setting	Duty Factor (dB)
1	2.4GHz 802.11n HT40	90.80	948.00	1.05	3kHz	0.42
2	5GHz 802.11ac VHT40	94.48	1540.00	0.65	1kHz	0.25

<Ant. 0>

802.11n HT40

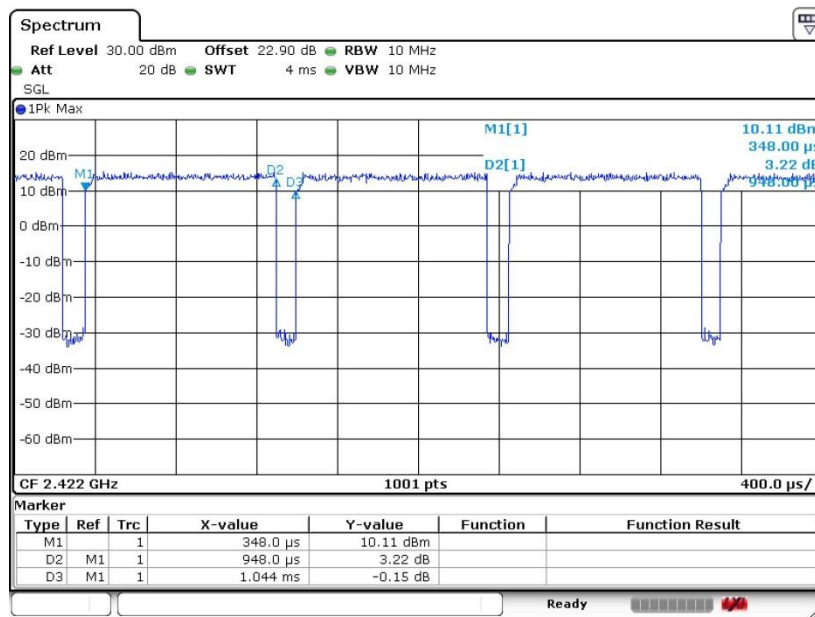

Date: 4.JUL.2019 03:31:14



<Ant. 1>

802.11ac VHT40

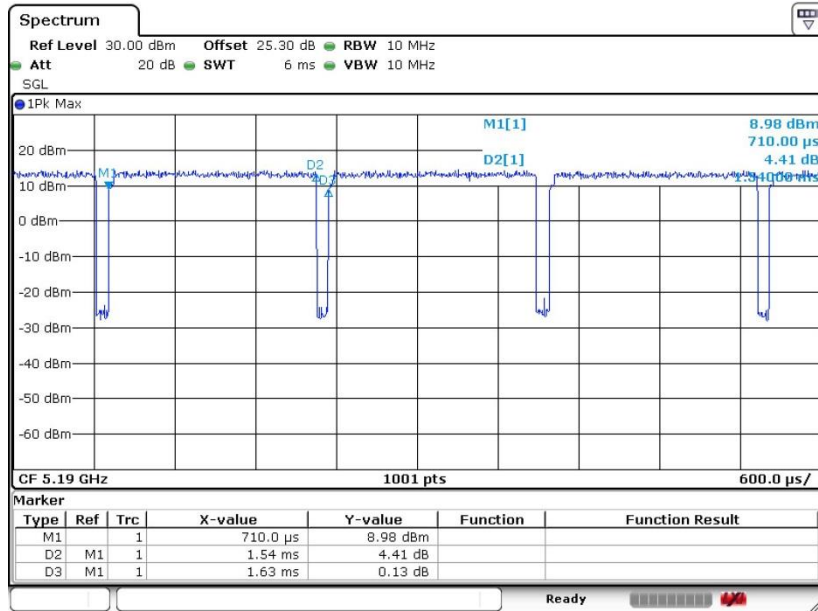

Date: 4.JUL.2019 06:51:53