



FCC RADIO TEST REPORT

FCC ID : UZ7ET56DE
Equipment : Tablet
Brand Name : ZEBRA
Model name : ET56DE
Applicant : Zebra Technologies Corporation
1 Zebra Plaza, Holtsville, NY 11742
Manufacturer : Zebra Technologies Corporation
1 Zebra Plaza, Holtsville, NY 11742
Standard : FCC Part 15 Subpart E §15.407

The product was received on Jan. 16, 2019 and testing was started from Jun. 23, 2019 and completed on Jul. 31, 2019. We, SPORTON INTERNATIONAL INC., EMC & Wireless Communications Laboratory, would like to declare that the tested sample has been evaluated in accordance with the test procedures and has been in compliance with the applicable technical standards.

The report must not be used by the client to claim product certification, approval, or endorsement by TAF or any agency of government.

The test results in this report apply exclusively to the tested model / sample. Without written approval of SPORTON INTERNATIONAL INC. EMC & Wireless Communications Laboratory, the test report shall not be reproduced except in full.

Louis Wu

Approved by: Louis Wu

SPORTON INTERNATIONAL INC. EMC & Wireless Communications Laboratory

No. 52, Huaya 1st Rd., Guishan Dist., Taoyuan City, Taiwan (R.O.C.)



Table of Contents

History of this test report.....	3
Summary of Test Result.....	4
1 General Description	5
1.1 Product Feature of Equipment Under Test.....	5
1.2 Product Specification of Equipment Under Test.....	6
1.3 Modification of EUT	7
1.4 Testing Location	8
1.5 Applicable Standards.....	8
2 Test Configuration of Equipment Under Test	9
2.1 Carrier Frequency and Channel	9
2.2 Test Mode.....	9
2.3 Connection Diagram of Test System.....	15
2.4 Support Unit used in test configuration and system	16
2.5 EUT Operation Test Setup	16
2.6 Measurement Results Explanation Example.....	17
3 Test Result	18
3.1 6dB and 26dB and 99% Occupied Bandwidth Measurement	18
3.2 Maximum Conducted Output Power Measurement	24
3.3 Power Spectral Density Measurement	27
3.4 Unwanted Emissions Measurement.....	33
3.5 AC Conducted Emission Measurement.....	39
3.6 Automatically Discontinue Transmission	41
3.7 Antenna Requirements.....	42
4 List of Measuring Equipment.....	44
5 Uncertainty of Evaluation.....	46
Appendix A. AC Conducted Emission Test Result	
Appendix B. Radiated Spurious Emission	
Appendix C. Radiated Spurious Emission Plots	
Appendix D. Duty Cycle Plots	
Appendix E. Setup Photographs	



History of this test report

Report No.	Version	Description	Issued Date
FR911635F	01	Initial issue of report	Aug. 08, 2019



Summary of Test Result

Report Clause	Ref Std. Clause	Test Items	Result (PASS/FAIL)	Remark
3.1	15.403 (i)	6dB & 26dB Bandwidth	Pass	-
3.1	2.1049	99% Occupied Bandwidth	Reporting only	-
3.2	15.407 (a)	Maximum Conducted Output Power	Pass	-
3.3	15.407 (a)	Power Spectral Density	Pass	-
3.4	15.407(b)	Unwanted Emissions	Pass	Under limit 6.76 dB at 34.850 MHz
3.5	15.207	AC Conducted Emission	Pass	Under limit 7.16 dB at 13.560 MHz
3.6	15.407 (c)	Automatically Discontinue Transmission	Pass	-
3.7	15.203 & 15.407 (a)	Antenna Requirement	Pass	-

Declaration of Conformity:

The test results with all measurement uncertainty excluded are presented in accordance with the regulation limits or requirements declared by manufacturers.

Comments and Explanations:

The declared of product specification for EUT presented in the report are provided by the manufacturer, and the manufacturer takes all the responsibilities for the accuracy of product specification.

Reviewed by: Wii Chang**Report Producer: Jessie Ho**



1 General Description

1.1 Product Feature of Equipment Under Test

Product Feature	
Equipment	Tablet
Brand Name	ZEBRA
Model Name	ET56DE
FCC ID	UZ7ET56DE
EUT supports Radios application	WCDMA/HSPA/LTE/NFC/GNSS WLAN 11a/b/g/n HT20/HT40 WLAN 11ac VHT20/VHT40/VHT80 Bluetooth BR/EDR/LE
HW Version	DV2
SW Version	Android version 8.1.0
FW Version	01-20-03-00-OG-U00-PRD
FW Version for TXBF	01-19-08-00-0G-U00-PLT
MFD	19Jun01
EUT Stage	Identical Prototype

Remark: The above EUT's information was declared by manufacturer.

Specification of Accessories				
Spare Standard Battery 24.13Wh	Brand Name	Zebra	Model Name	BT-000393

Supported Unit Used in Test Configuration and System				
Cradle (Dock) for EMC	Brand Name	Zebra	Part Number	CRD-ET5X-1SCG1
Cradle (Dock) for RSE	Brand Name	Zebra	Part Number	CHG-ET5X-CBL1-01
Adapter	Brand Name	Zebra	Part Number	PWRBGA12V50W0WW
DC Cable	Brand Name	Zebra	Part Number	CBL-DC-388A1-01



1.2 Product Specification of Equipment Under Test

Standards-related Product Specification	
Tx/Rx Channel Frequency Range	5745 MHz ~ 5825 MHz
Maximum Output Power <CDD Modes>	<p><Ant. 1> 802.11a : 19.80 dBm / 0.0955 W 802.11n HT20 : 19.80 dBm / 0.0955 W 802.11n HT40 : 18.80 dBm / 0.0759 W 802.11ac VHT20: 19.90 dBm / 0.0977 W 802.11ac VHT40: 18.90 dBm / 0.0776 W 802.11ac VHT80: 19.10 dBm / 0.0813 W</p> <p><Ant. 2> 802.11a : 19.90 dBm / 0.0977 W 802.11n HT20 : 19.80 dBm / 0.0955 W 802.11n HT40 : 18.70 dBm / 0.0741 W 802.11ac VHT20: 19.90 dBm / 0.0977 W 802.11ac VHT40: 18.80 dBm / 0.0759 W 802.11ac VHT80: 19.10 dBm / 0.0813 W</p> <p>MIMO <Ant. 1 + 2> 802.11a : 22.86 dBm / 0.1932 W 802.11n HT20 : 22.81 dBm / 0.1910 W 802.11n HT40 : 21.81 dBm / 0.1517 W 802.11ac VHT20: 22.91 dBm / 0.1954 W 802.11ac VHT40: 21.91 dBm / 0.1552 W 802.11ac VHT80: 22.21 dBm / 0.1663 W</p>
Maximum Output Power <TXBF Modes>	<p>MIMO <Ant. 1 + 2> 802.11ac VHT20: 22.41 dBm / 0.1742 W 802.11ac VHT40: 21.23 dBm / 0.1327 W 802.11ac VHT80: 21.98 dBm / 0.1578 W</p>
99% Occupied Bandwidth <CDD Modes>	<p><Ant. 1> 802.11a : 16.90 MHz 802.11ac VHT20 : 18.05 MHz 802.11ac VHT40 : 36.60 MHz 802.11ac VHT80 : 77.04 MHz</p> <p><Ant. 2> 802.11a : 16.80 MHz 802.11ac VHT20 : 17.95 MHz 802.11ac VHT40 : 36.60 MHz 802.11ac VHT80 : 76.80 MHz</p> <p>MIMO <Ant. 1> 802.11a : 17.00 MHz 802.11ac VHT20 : 18.15 MHz 802.11ac VHT40 : 36.70 MHz 802.11ac VHT80 : 76.92 MHz</p> <p>MIMO <Ant. 2> 802.11a : 16.75 MHz 802.11ac VHT20 : 17.90 MHz 802.11ac VHT40 : 36.50 MHz 802.11ac VHT80 : 76.68 MHz</p>



Standards-related Product Specification													
99% Occupied Bandwidth <TXBF Modes>	MIMO <Ant. 1> 802.11ac VHT20 : 19.63 MHz 802.11ac VHT40 : 38.06 MHz 802.11ac VHT80 : 79.72 MHz MIMO <Ant. 2> 802.11ac VHT20 : 18.23 MHz 802.11ac VHT40 : 37.86 MHz 802.11ac VHT80 : 78.76 MHz												
Type of Modulation	802.11a/n : OFDM (BPSK / QPSK / 16QAM / 64QAM) 802.11ac : OFDM (BPSK / QPSK / 16QAM / 64QAM / 256QAM)												
Antenna Type / Gain	<Ant. 1> : Chip Antenna with gain 3.82 dBi <Ant. 2> : Chip Antenna with gain 3.76 dBi												
Antenna Function Description	<table border="1"> <thead> <tr> <th></th> <th>Ant. 1</th> <th>Ant. 2</th> </tr> </thead> <tbody> <tr> <td>802.11 a/n/ac</td> <td>V</td> <td>V</td> </tr> <tr> <td>802.11 n/ac MIMO</td> <td>V</td> <td>V</td> </tr> <tr> <td>802.11ac TXBF</td> <td>V</td> <td>V</td> </tr> </tbody> </table>		Ant. 1	Ant. 2	802.11 a/n/ac	V	V	802.11 n/ac MIMO	V	V	802.11ac TXBF	V	V
	Ant. 1	Ant. 2											
802.11 a/n/ac	V	V											
802.11 n/ac MIMO	V	V											
802.11ac TXBF	V	V											

Note: MIMO Ant. 1+2 is a calculated result from sum of the power MIMO Ant. 1 and MIMO Ant. 2.

1.3 Modification of EUT

No modifications are made to the EUT during all test items.



1.4 Testing Location

Test Site	SPORTON INTERNATIONAL INC. EMC & Wireless Communications Laboratory	
Test Site Location	No.52, Huaya 1st Rd., Guishan Dist., Taoyuan City, Taiwan (R.O.C.) TEL: +886-3-327-3456 FAX: +886-3-328-4978	
Test Site No.	Sporton Site No.	
	TH05-HY	CO05-HY

Note: The test site complies with ANSI C63.4 2014 requirement.

Test Site	SPORTON INTERNATIONAL INC. EMC & Wireless Communications Laboratory	
Test Site Location	No.58, Aly. 75, Ln. 564, Wenhua 3rd, Rd., Guishan Dist., Taoyuan City, Taiwan (R.O.C.) TEL: +886-3-327-0868 FAX: +886-3-327-0855	
Test Site No.	Sporton Site No.	
	03CH13-HY	

Note: The test site complies with ANSI C63.4 2014 requirement.

FCC designation No.: TW1190 and TW0007

1.5 Applicable Standards

According to the specifications of the manufacturer, the EUT must comply with the requirements of the following standards:

- ♦ FCC Part 15 Subpart E
- ♦ FCC KDB 789033 D02 General UNII Test Procedures New Rules v02r01.
- ♦ FCC KDB 414788 D01 Radiated Test Site v01r01.
- ♦ FCC KDB 662911 D01 Multiple Transmitter Output v02r01.
- ♦ ANSI C63.10-2013

Remark:

1. All test items were verified and recorded according to the standards and without any deviation during the test.
2. This EUT has also been tested and complied with the requirements of FCC Part 15, Subpart B, recorded in a separate test report.



2 Test Configuration of Equipment Under Test

- a. The EUT has been associated with peripherals and configuration operated in a manner tended to maximize its emission characteristics in a typical application. Frequency range investigated: conduction emission (150 kHz to 30 MHz), radiation emission (9 kHz to the 10th harmonic of the highest fundamental frequency or to 40 GHz, whichever is lower). For radiated measurement, pre-scanned in three orthogonal panels, X, Y, Z. The worst cases (X plane) were recorded in this report.
- b. AC power line Conducted Emission was tested under maximum output power.

2.1 Carrier Frequency and Channel

Frequency Band	Channel	Freq. (MHz)	Channel	Freq. (MHz)
5725-5850 MHz Band 4 (U-NII-3)	149	5745	157	5785
	151*	5755	159*	5795
	153	5765	161	5805
	155#	5775	165	5825

Note:

1. The above Frequency and Channel in "*" were 802.11n HT40 and 802.11ac VHT40.
2. The above Frequency and Channel in "#n" were 802.11ac VHT80.

2.2 Test Mode

Final test modes are considering the modulation and worse data rates as below table.

Single Mode

Modulation	Data Rate
802.11a	6 Mbps
802.11n HT20 (Covered by VHT20)	MCS0
802.11n HT40 (Covered by VHT40)	MCS0
802.11ac VHT20	MCS0
802.11ac VHT40	MCS0
802.11ac VHT80	MCS0



MIMO Mode

Modulation	Data Rate
802.11a	6 Mbps
802.11n HT20 (Covered by VHT20)	MCS0
802.11n HT40 (Covered by VHT40)	MCS0
802.11ac VHT20	MCS0
802.11ac VHT40	MCS0
802.11ac VHT80	MCS0

TXBF Mode

Modulation	Data Rate
802.11ac VHT20	MCS0
802.11ac VHT40	MCS0
802.11ac VHT80	MCS0

Test Cases	
AC Conducted Emission	Mode 1 : LTE Band 66 Idle + WLAN (5GHz) Link + Bluetooth Link + USB Cable (Type C) + SD Card (Data Link) + USB File Transfer with Notebook (Notebook to SD Card) + NFC On + Front Camera + AC Adaptor (PWRBGA12V50W0WW) with DC Cable (CBL-DC-388A1-01) + Dock (CRD-ET5X-1SCG1) (Charging with EUT)

<CDD Mode>

Ch. #		Band IV : 5725-5850 MHz			
		802.11a	802.11ac VHT20	802.11ac VHT40	802.11ac VHT80
L	Low	149	149	151	-
M	Middle	157	157	-	155
H	High	165	165	159	-

<TXBF Mode>

Ch. #		Band IV : 5725-5850 MHz		
		802.11ac VHT20	802.11ac VHT40	802.11ac VHT80
L	Low	149	151	-
M	Middle	157	-	155
H	High	165	159	-



<CDD Mode>

<Ant. 1>

802.11a RF Output Power (dBm)										
Power vs. Channel			Power vs Data Rate							
Channel	Frequency (MHz)	Data Rate (bps)	channel	Data Rate (bps)						
		6M		9M	12M	18M	24M	36M	48M	54M
Duty Cycle (%)		95.37		93.40	91.40	88.20	85.00	79.90	75.20	72.90
CH 149	5745	19.60	CH 165	19.70	19.70	19.40	19.70	19.40	19.40	19.40
CH 157	5785	19.70								
CH 165	5825	19.80								

802.11n HT20 RF Output Power (dBm)										
Power vs. Channel			Power vs Data Rate							
Channel	Frequency (MHz)	MCS Index	channel	MCS Index						
		MCS0		MCS1	MCS2	MCS3	MCS4	MCS5	MCS6	MCS7
Duty Cycle (%)		94.96		91.10	87.70	84.70	79.50	75.00	73.10	71.60
CH 149	5745	19.70	CH 157	19.40	19.60	19.60	19.40	19.40	19.40	19.40
CH 157	5785	19.80								
CH 165	5825	19.60								

802.11n HT40 RF Output Power (dBm)										
Power vs. Channel			Power vs Data Rate							
Channel	Frequency (MHz)	MCS Index	channel	MCS Index						
		MCS0		MCS1	MCS2	MCS3	MCS4	MCS5	MCS6	MCS7
Duty Cycle (%)		93.77		89.30	85.30	81.60	76.00	71.20	69.30	67.50
CH 151	5755	18.60	CH 159	18.70	18.70	18.70	18.70	18.70	18.70	18.70
CH 159	5795	18.80								

802.11ac VHT20 RF Output Power (dBm)											
Power vs. Channel			Power vs Data Rate								
Channel	Frequency (MHz)	MCS Index	channel	MCS Index							
		MCS0		MCS1	MCS2	MCS3	MCS4	MCS5	MCS6	MCS7	MCS8
Duty Cycle (%)		95.17		91.00	87.70	84.70	79.40	75.40	73.50	71.50	68.50
CH 149	5745	19.80	CH 157	19.50	19.70	19.70	19.50	19.50	19.50	19.50	
CH 157	5785	19.90									
CH 165	5825	19.70									

802.11ac VHT40 RF Output Power (dBm)												
Power vs. Channel			Power vs Data Rate									
Channel	Frequency (MHz)	MCS Index	channel	MCS Index								
		MCS0		MCS1	MCS2	MCS3	MCS4	MCS5	MCS6	MCS7	MCS8	MCS9
Duty Cycle (%)		94.49		89.40	85.40	81.80	76.20	71.50	69.70	67.80	65.00	63.30
CH 151	5755	18.70	CH 159	18.80	18.80	18.80	18.80	18.80	18.80	18.80	18.80	18.80
CH 159	5795	18.90										



802.11ac VHT80 RF Output Power (dBm)												
Power vs. Channel			Power vs Data Rate									
Channel	Frequency (MHz)	MCS Index	channel	MCS Index								
		MCS0		MCS1	MCS2	MCS3	MCS4	MCS5	MCS6	MCS7	MCS8	MCS9
Duty Cycle (%)		88.13		80.60	18.80	18.80	18.80	18.80	18.80	18.80	18.80	18.80
CH155	5775	19.10	CH155	18.70	18.70	18.70	19.00	19.00	19.00	19.00	19.00	19.00

<Ant. 2>

802.11a RF Output Power (dBm)										
Power vs. Channel			Power vs Data Rate							
Channel	Frequency (MHz)	Data Rate (bps)	channel	Data Rate (bps)						
		6M		9M	12M	18M	24M	36M	48M	54M
Duty Cycle (%)		95.76		93.20	91.20	88.10	84.70	79.80	74.90	72.80
CH 149	5745	19.90	CH 149	19.50	19.50	19.80	19.60	19.70	19.80	19.80
CH 157	5785	19.60		19.50	19.50	19.80	19.60	19.70	19.80	19.80
CH 165	5825	19.80		19.50	19.50	19.80	19.60	19.70	19.80	19.80

802.11n HT20 RF Output Power (dBm)										
Power vs. Channel			Power vs Data Rate							
Channel	Frequency (MHz)	MCS Index	channel	MCS Index						
		MCS0		MCS1	MCS2	MCS3	MCS4	MCS5	MCS6	MCS7
Duty Cycle (%)		94.65		91.10	87.70	84.40	79.30	74.90	73.00	71.60
CH 149	5745	19.80	CH 149	19.70	19.60	19.60	19.70	19.70	19.70	19.70
CH 157	5785	19.70		19.70	19.60	19.60	19.70	19.70	19.70	19.70
CH 165	5825	19.60		19.70	19.60	19.60	19.70	19.70	19.70	19.70

802.11n HT40 RF Output Power (dBm)										
Power vs. Channel			Power vs Data Rate							
Channel	Frequency (MHz)	MCS Index	channel	MCS Index						
		MCS0		MCS1	MCS2	MCS3	MCS4	MCS5	MCS6	MCS7
Duty Cycle (%)		93.80		89.30	85.00	81.60	75.60	71.00	69.20	67.40
CH 151	5755	18.60	CH 159	18.60	18.60	18.60	18.60	18.60	18.60	18.50
CH 159	5795	18.70		18.60	18.60	18.60	18.60	18.60	18.60	18.50

802.11ac VHT20 RF Output Power (dBm)											
Power vs. Channel			Power vs Data Rate								
Channel	Frequency (MHz)	MCS Index	channel	MCS Index							
		MCS0		MCS1	MCS2	MCS3	MCS4	MCS5	MCS6	MCS7	MCS8
Duty Cycle (%)		95.09		91.00	87.60	84.10	79.10	75.20	73.20	71.40	68.50
CH 149	5745	19.90	CH 149	19.80	19.70	19.70	19.80	19.80	19.80	19.80	19.80
CH 157	5785	19.80		19.80	19.70	19.70	19.80	19.80	19.80	19.80	
CH 165	5825	19.70		19.80	19.70	19.70	19.80	19.80	19.80	19.80	



802.11ac VHT40 RF Output Power (dBm)												
Power vs. Channel			Power vs Data Rate									
Channel	Frequency (MHz)	MCS Index	channel	MCS Index								
		MCS0		MCS1	MCS2	MCS3	MCS4	MCS5	MCS6	MCS7	MCS8	MCS9
Duty Cycle (%)		94.48		89.40	85.40	81.80	76.10	71.50	69.70	67.90	65.00	63.20
CH 151	5755	18.70	CH 159	18.70	18.70	18.70	18.70	18.70	18.70	18.60	18.70	18.60
CH 159	5795	18.80										

802.11ac VHT80 RF Output Power (dBm)												
Power vs. Channel			Power vs Data Rate									
Channel	Frequency (MHz)	MCS Index	channel	MCS Index								
		MCS0		MCS1	MCS2	MCS3	MCS4	MCS5	MCS6	MCS7	MCS8	MCS9
Duty Cycle (%)		87.81		80.60	74.70	70.20	63.20	58.90	57.30	55.50	52.70	51.80
CH155	5775	19.10	CH155	18.70	18.70	18.70	19.00	19.00	19.00	19.00	19.00	19.00

MIMO <Ant. 1 + 2>

802.11a RF Output Power (dBm)										
Power vs. Channel			Power vs Data Rate							
Channel	Frequency (MHz)	Data Rate (bps)	channel	Data Rate (bps)						
		6M		9M	12M	18M	24M	36M	48M	54M
Duty Cycle (%)										
CH 149	5745	22.66	CH 157	22.46	22.41	22.66	22.46	22.66	22.66	22.66
CH 157	5785	22.86								
CH 165	5825	22.81								

802.11n HT20 RF Output Power (dBm)										
Power vs. Channel			Power vs Data Rate							
Channel	Frequency (MHz)	MCS Index	channel	MCS Index						
		MCS0		MCS1	MCS2	MCS3	MCS4	MCS5	MCS6	MCS7
Duty Cycle (%)										
CH 149	5745	22.81	CH 149	22.41	22.71	22.71	22.41	22.41	22.41	22.41
CH 157	5785	22.66								
CH 165	5825	22.61								

802.11n HT40 RF Output Power (dBm)										
Power vs. Channel			Power vs Data Rate							
Channel	Frequency (MHz)	MCS Index	channel	MCS Index						
		MCS0		MCS1	MCS2	MCS3	MCS4	MCS5	MCS6	MCS7
Duty Cycle (%)										
CH 151	5755	21.66	CH 159	21.56	21.46	21.46	21.41	21.46	21.46	21.41
CH 159	5795	21.81								



802.11ac VHT20 RF Output Power (dBm)											
Power vs. Channel			Power vs Data Rate								
Channel	Frequency (MHz)	MCS Index	channel	MCS Index							
		MCS0		MCS1	MCS2	MCS3	MCS4	MCS5	MCS6	MCS7	MCS8
Duty Cycle (%)											
CH 149	5745	22.91									
CH 157	5785	22.76	CH 149	22.51	22.81	22.81	22.51	22.51	22.51	22.51	22.51
CH 165	5825	22.71									

802.11ac VHT40 RF Output Power (dBm)												
Power vs. Channel			Power vs Data Rate									
Channel	Frequency (MHz)	MCS Index	channel	MCS Index								
		MCS0		MCS1	MCS2	MCS3	MCS4	MCS5	MCS6	MCS7	MCS8	MCS9
Duty Cycle (%)												
CH 151	5755	21.76										
CH 159	5795	21.91	CH 159	21.66	21.56	21.56	21.51	21.56	21.56	21.51	21.51	21.51

802.11ac VHT80 RF Output Power (dBm)												
Power vs. Channel			Power vs Data Rate									
Channel	Frequency (MHz)	MCS Index	channel	MCS Index								
		MCS0		MCS1	MCS2	MCS3	MCS4	MCS5	MCS6	MCS7	MCS8	MCS9
Duty Cycle (%)												
CH155	5775	22.21	CH155	21.81	21.81	21.81	22.16	22.16	22.16	22.16	22.16	22.16

<TXBF Mode>

MIMO <Ant. 1 + 2>

802.11ac VHT20 RF Output Power (dBm)											
Power vs. Channel			Power vs Data Rate								
Channel	Frequency (MHz)	MCS Index	channel	MCS Index							
		MCS0		MCS1	MCS2	MCS3	MCS4	MCS5	MCS6	MCS7	MCS8
Duty Cycle (%)											
CH 149	5745	22.36									
CH 157	5785	22.41	CH 157	22.26	22.21	22.26	22.21	22.21	22.26	22.21	22.16
CH 165	5825	22.36									

802.11ac VHT40 RF Output Power (dBm)												
Power vs. Channel			Power vs Data Rate									
Channel	Frequency (MHz)	MCS Index	channel	MCS Index								
		MCS0		MCS1	MCS2	MCS3	MCS4	MCS5	MCS6	MCS7	MCS8	MCS9
Duty Cycle (%)												
CH 151	5755	21.23										
CH 159	5795	21.21	CH 151	21.13	21.14	21.14	21.14	21.13	21.13	21.08	21.08	21.13

802.11ac VHT80 RF Output Power (dBm)												
Power vs. Channel			Power vs Data Rate									
Channel	Frequency (MHz)	MCS Index	channel	MCS Index								
		MCS0		MCS1	MCS2	MCS3	MCS4	MCS5	MCS6	MCS7	MCS8	MCS9
Duty Cycle (%)												
CH155	5775	21.98	CH155	21.93	21.94	21.94	21.93	21.90	21.88	21.88	21.87	21.93

2.3 Connection Diagram of Test System

<WLAN Tx>

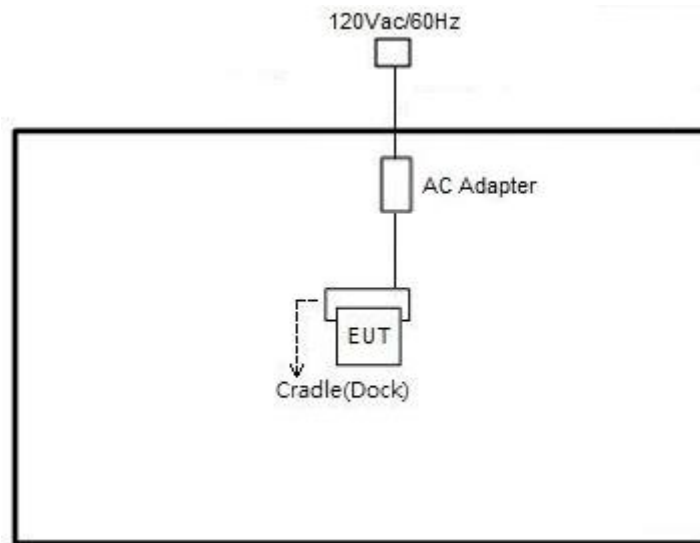

<AC Conducted Emission Mode>

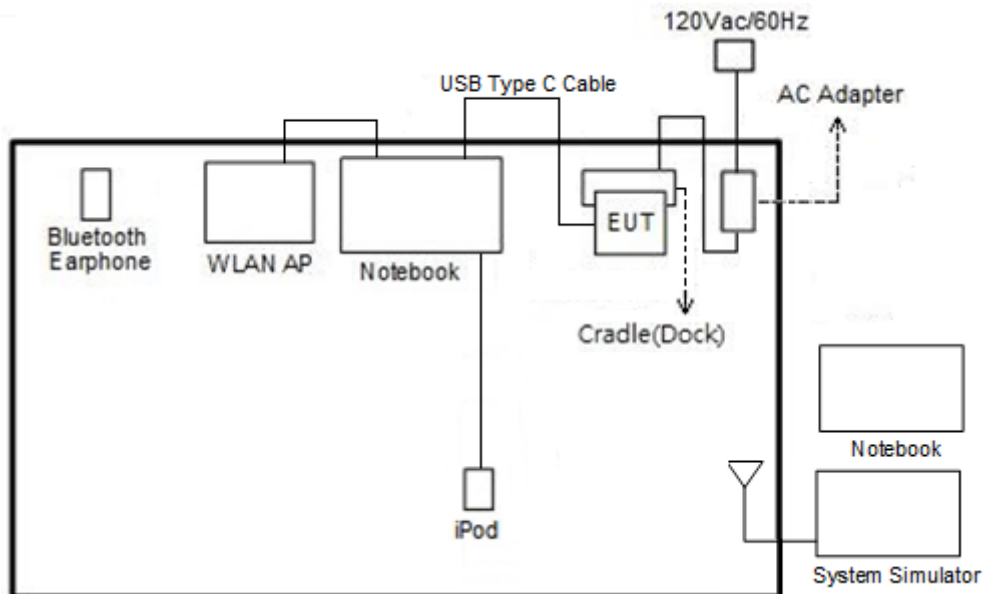



2.4 Support Unit used in test configuration and system

Item	Equipment	Trade Name	Model Name	FCC ID	Data Cable	Power Cord
1.	System Simulator	Anritsu	MT8820C	N/A	N/A	Unshielded, 1.8 m
2.	GPS Station	Pendulum	GSG-54	N/A	N/A	Unshielded, 1.8 m
3.	Bluetooth Earphone	Sony Ericsson	MW600	PY7DDA-2029	N/A	N/A
4.	WLAN AP	ASUS	RT-AC1750	MSQ-RTAC66U	N/A	Unshielded,1.8m
5.	iPod	Apple	A1285	FCC DoC	Shielded, 1.0 m	N/A
6.	Notebook	DELL	Latitude E3340	FCC DoC/ Contains FCC ID: PD97260NGU	N/A	AC I/P: Unshielded, 1.2 m DC O/P: Shielded, 1.8 m
7.	Notebook	DELL	Latitude E6320	FCC DoC/ Contains FCC ID: QDS-BRCM1054	N/A	AC I/P: Unshielded, 1.2 m DC O/P: Shielded, 1.8 m
8.	NoteBook-26	Lenovo	E335	N/A	N/A	N/A
9.	SD Card	SanDisk	MicroSD HC	FCC DoC	N/A	N/A

2.5 EUT Operation Test Setup

The RF test items, utility “QRCT V3.0.271.0” was installed in Notebook which was programmed in order to make the EUT get into the engineering modes to provide channel selection, power level, data rate and the application type and for continuous transmitting signals.

For TXBF mode, the modulation modes and data rates manipulated by the command lines in the engineering program made the EUT link to another EUT by power under the normal operation. The “adb” software tool was used to enable the EUT to transmit signals continuously.



2.6 Measurement Results Explanation Example

For all conducted test items:

The offset level is set in the spectrum analyzer to compensate the RF cable loss and attenuator factor between EUT conducted output port and spectrum analyzer. With the offset compensation, the spectrum analyzer reading level is exactly the EUT RF output level.

Example :

The spectrum analyzer offset is derived from RF cable loss and attenuator factor.

Offset = RF cable loss + attenuator factor.

Following shows an offset computation example with cable loss 4.2 dB and 10dB attenuator.

$$\begin{aligned} \text{Offset(dB)} &= \text{RF cable loss(dB)} + \text{attenuator factor(dB)}. \\ &= 4.2 + 10 = 14.2 \text{ (dB)} \end{aligned}$$

3 Test Result

3.1 6dB and 26dB and 99% Occupied Bandwidth Measurement

3.1.1 Description of 6dB and 26dB and 99% Occupied Bandwidth

The minimum 6 dB bandwidth shall be at least 500 kHz.

26dB and 99% Occupied bandwidth are reporting only.

3.1.2 Measuring Instruments

See list of measuring equipment of this test report.

3.1.3 Test Procedures

1. The testing follows FCC KDB 789033 D02 General UNII Test Procedures New Rules v02r01. Section C) Emission bandwidth for the band 5.725-5.85GHz
2. Set RBW = 100kHz.
3. Set the VBW $\geq 3 \times$ RBW.
4. Detector = Peak.
5. Trace mode = max hold
6. Measure the maximum width of the emission that is 6 dB down from the peak of the emission.
7. Measure and record the results in the test report.

3.1.4 Test Setup

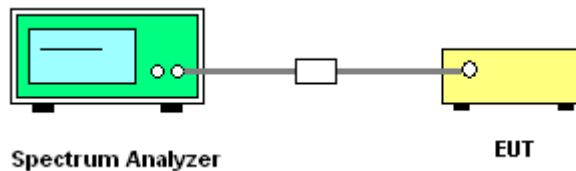



3.1.5 Test Result of 6dB and 26dB and 99% Occupied Bandwidth

<CDD Mode>

Test Engineer :	Jimmy Chang	Temperature :	24~26°C
		Relative Humidity :	52~55%

Band IV												
Mod.	Data Rate	NTX	CH.	Freq. (MHz)	99% Bandwidth (MHz)		26dB Bandwidth (MHz)		6 dB Bandwidth (MHz)		6 dB Bandwidth Min. Limit (MHz)	Pass/Fail
					Ant 1	Ant 2	Ant 1	Ant 2	Ant 1	Ant 2		
11a	6Mbps	1	149	5745	16.80	16.80	25.60	25.25	15.30	15.50	0.5	Pass
11a	6Mbps	1	157	5785	16.85	16.80	26.20	25.20	15.05	15.30	0.5	Pass
11a	6Mbps	1	165	5825	16.90	16.80	26.15	25.27	15.05	15.35	0.5	Pass
VHT20	MCS0	1	149	5745	18.05	17.95	28.10	26.60	15.60	16.80	0.5	Pass
VHT20	MCS0	1	157	5785	18.05	17.95	28.80	26.70	16.55	15.35	0.5	Pass
VHT20	MCS0	1	165	5825	18.05	17.90	27.95	27.35	16.80	15.25	0.5	Pass
VHT40	MCS0	1	151	5755	36.60	36.60	41.94	41.76	35.70	35.64	0.5	Pass
VHT40	MCS0	1	159	5795	36.60	36.60	41.76	41.81	35.64	35.72	0.5	Pass
VHT80	MCS0	1	155	5775	77.04	76.80	98.06	93.44	75.79	75.20	0.5	Pass
11a	6Mbps	2	149	5745	16.85	16.70	25.40	25.00	15.05	15.05	0.5	Pass
11a	6Mbps	2	157	5785	16.90	16.75	27.45	26.10	15.70	16.01	0.5	Pass
11a	6Mbps	2	165	5825	17.00	16.70	27.95	25.55	15.30	15.85	0.5	Pass
VHT20	MCS0	2	149	5745	18.15	17.85	28.30	27.65	16.50	15.10	0.5	Pass
VHT20	MCS0	2	157	5785	18.00	17.90	28.25	26.65	16.75	15.10	0.5	Pass
VHT20	MCS0	2	165	5825	18.10	17.85	29.05	26.40	15.00	15.40	0.5	Pass
VHT40	MCS0	2	151	5755	36.60	36.50	41.76	41.88	35.10	35.09	0.5	Pass
VHT40	MCS0	2	159	5795	36.70	36.50	41.76	41.94	35.73	35.91	0.5	Pass
VHT80	MCS0	2	155	5775	76.92	76.68	98.45	83.18	75.00	75.20	0.5	Pass

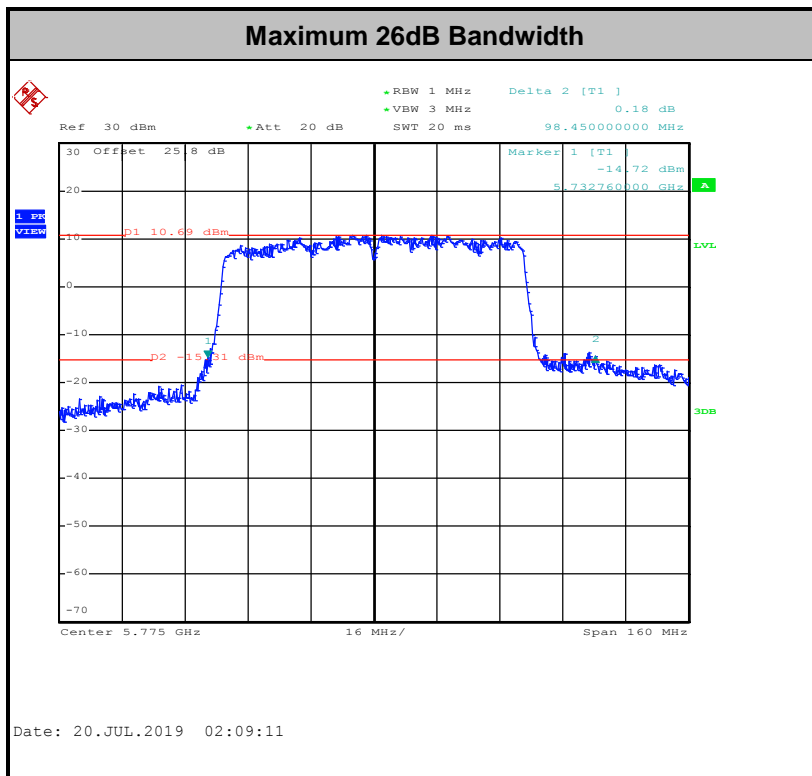
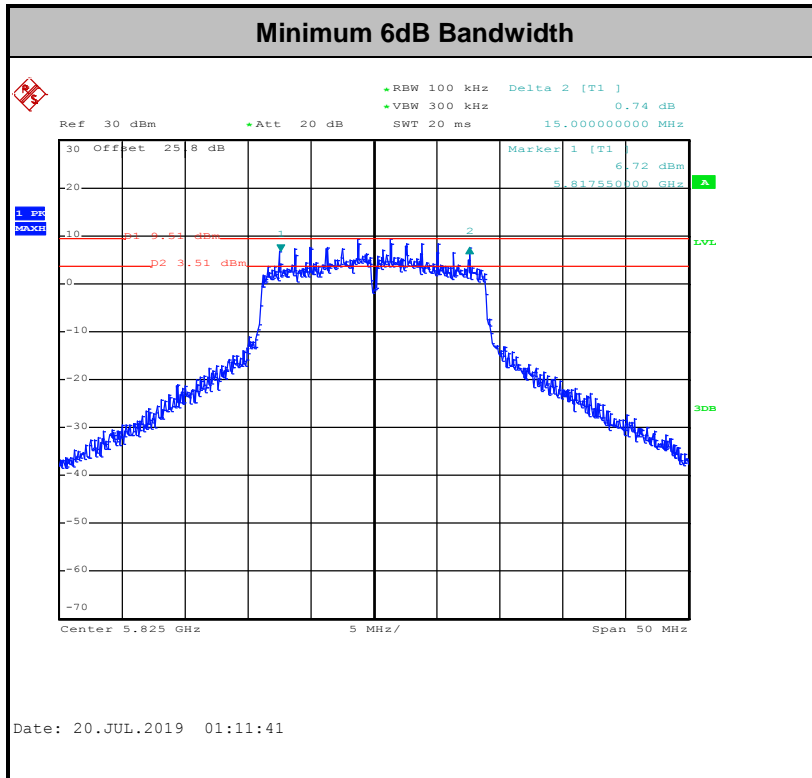

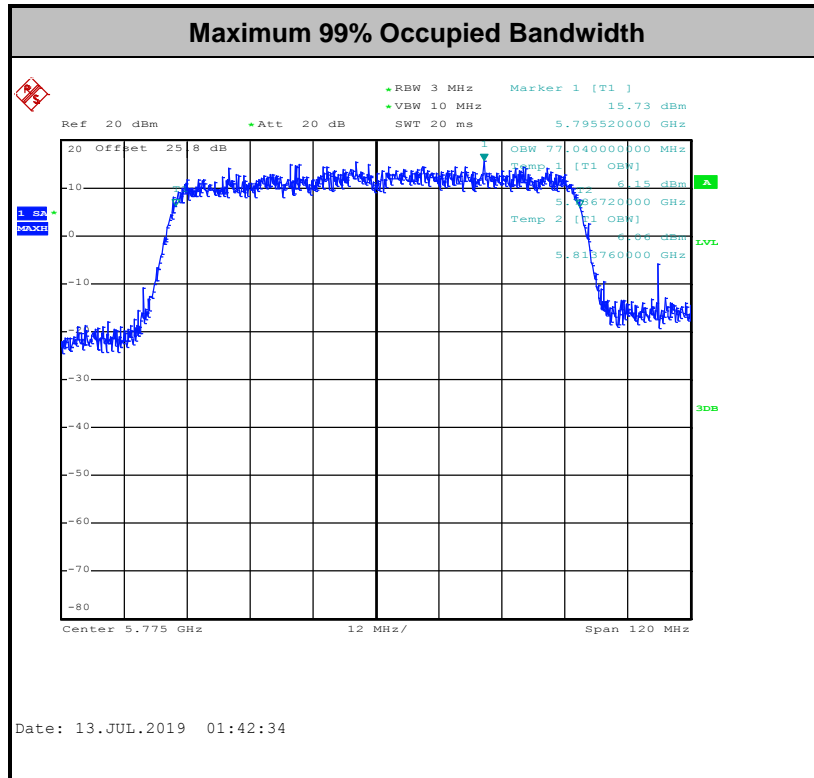

Note: The occupied channel bandwidth is maintained within the band of operation for all of the modulations.



<TXBF Modes>

Test Engineer :	Jimmy Chang	Temperature :	24~26°C
		Relative Humidity :	52~55%

Band IV												
Mod.	Data Rate	NTX	CH.	Freq. (MHz)	99% Bandwidth (MHz)		26dB Bandwidth (MHz)		6 dB Bandwidth (MHz)		6 dB Bandwidth Min. Limit (MHz)	Pass/Fail
					Ant 1	Ant 2	Ant 1	Ant 2	Ant 1	Ant 2		
VHT20	MCS0	2	149	5745	18.13	17.98	36.91	29.92	17.73	17.73	0.5	Pass
VHT20	MCS0	2	157	5785	18.48	18.18	40.66	38.56	17.68	17.68	0.5	Pass
VHT20	MCS0	2	165	5825	19.63	18.23	43.86	40.36	17.73	17.73	0.5	Pass
VHT40	MCS0	2	151	5755	37.76	37.36	45.49	50.53	35.78	36.41	0.5	Pass
VHT40	MCS0	2	159	5795	38.06	37.86	73.46	59.70	36.41	36.41	0.5	Pass
VHT80	MCS0	2	155	5775	79.72	78.76	154.17	118.92	76.24	76.24	0.5	Pass

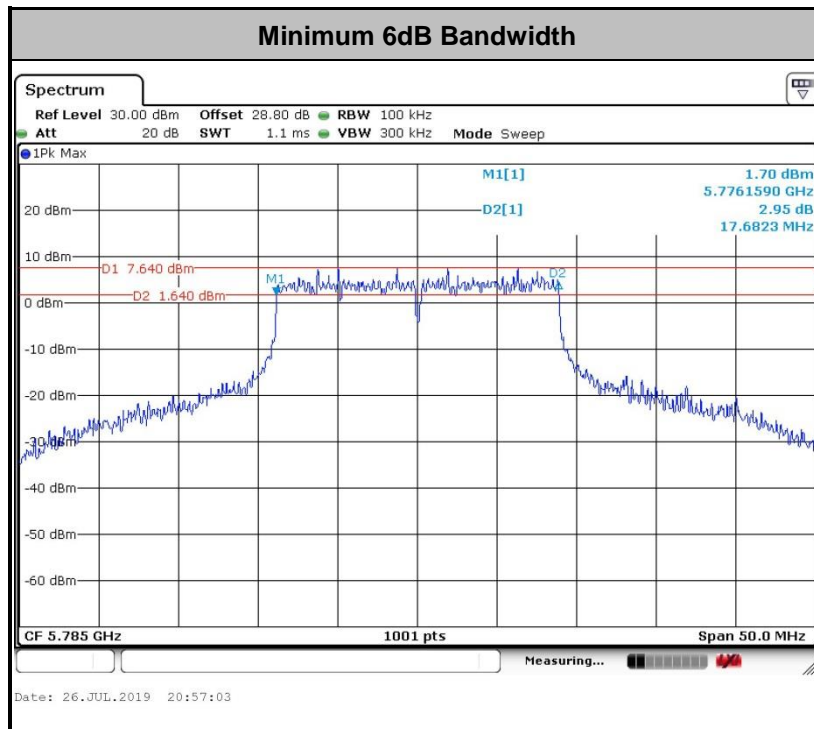

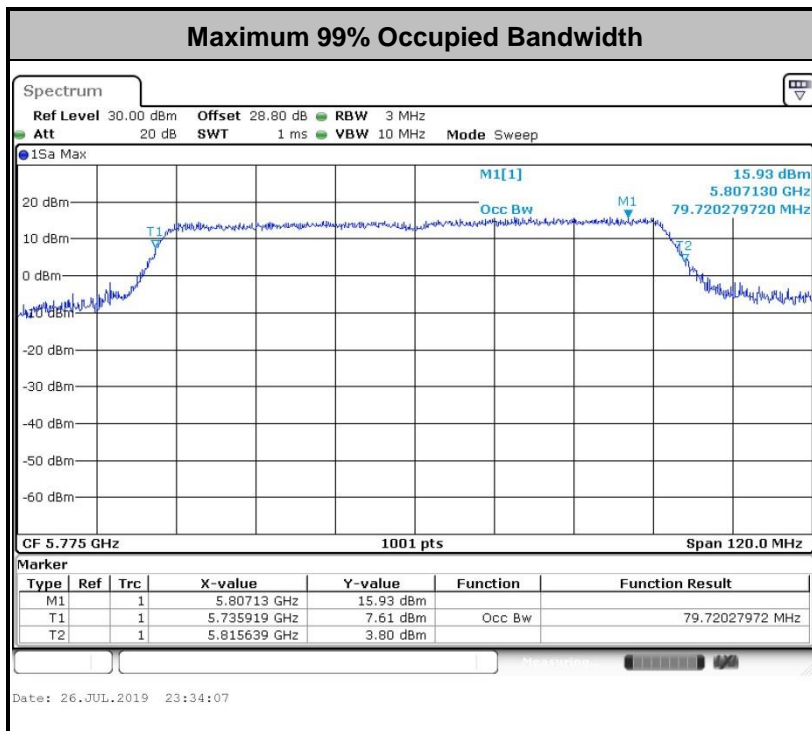
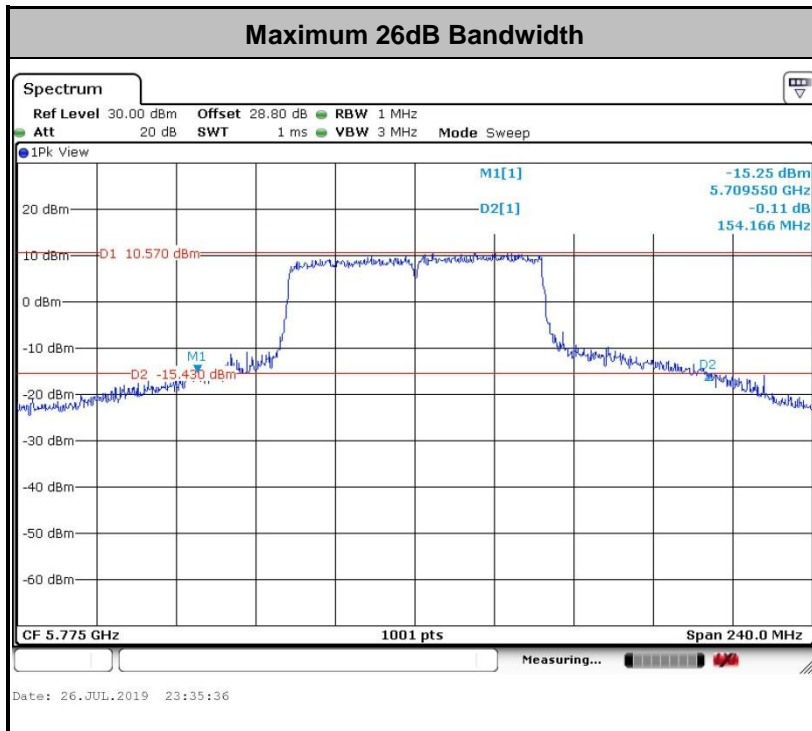

Note: The occupied channel bandwidth is maintained within the band of operation for all of the modulations.

3.2 Maximum Conducted Output Power Measurement

3.2.1 Limit of Maximum Conducted Output Power

For the band 5.725–5.85 GHz, the maximum conducted output power over the frequency band of operation shall not exceed 1 W.

If transmitting antennas of directional gain greater than 6 dBi are used, the peak output power shall be reduced by the amount in dB that the directional gain of the antenna exceeds 6 dBi.

3.2.2 Measuring Instruments

See list of measuring equipment of this test report.

3.2.3 Test Procedures

The testing follows Method PM-G of FCC KDB 789033 D02 General UNII Test Procedures New Rules v02r01 for TXBF modes.

Method PM-G (Measurement using a gated RF average power meter):

1. Measurement is performed using a wideband RF power meter.
2. The EUT is configured to transmit at its maximum power control level.
3. Measure the average power of the transmitter
4. Since the measurement is made only during the ON time of the transmitter, no duty cycle correction factor is required.

3.2.4 Test Setup

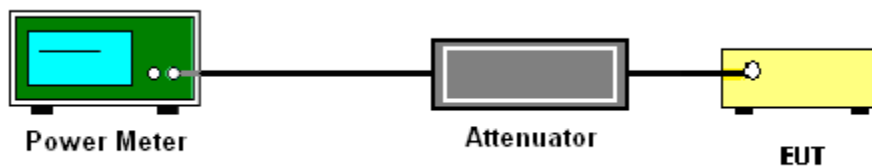



3.2.5 Test Result of Maximum Conducted Output Power

Test Engineer :	Jimmy Chang	Temperature :	24~26°C
		Relative Humidity :	52~55%

<CDD Mode>

Band IV														
Mod.	Data Rate	NTX	CH.	Freq. (MHz)	Average Conducted Power (dBm)			FCC Conducted Power Limit (dBm)		DG (dBi)		Pass /Fail	Setting	
					Ant 1	Ant 2	SUM	Ant 1	Ant 2	Ant 1	Ant 2		Ant 1	Ant 2
11a	6Mbps	1	149	5745	19.60	19.90		30.00	30.00	3.82	3.76	Pass	19.5	20
11a	6Mbps	1	157	5785	19.70	19.60		30.00	30.00	3.82	3.76	Pass	19.5	19.5
11a	6Mbps	1	165	5825	19.80	19.80		30.00	30.00	3.82	3.76	Pass	19.5	20
HT20	MCS0	1	149	5745	19.70	19.80		30.00	30.00	3.82	3.76	Pass	20	20
HT20	MCS0	1	157	5785	19.80	19.70		30.00	30.00	3.82	3.76	Pass	20	20
HT20	MCS0	1	165	5825	19.60	19.60		30.00	30.00	3.82	3.76	Pass	19.5	20
HT40	MCS0	1	151	5755	18.60	18.60		30.00	30.00	3.82	3.76	Pass	18	18
HT40	MCS0	1	159	5795	18.80	18.70		30.00	30.00	3.82	3.76	Pass	18	18
VHT20	MCS0	1	149	5745	19.80	19.90		30.00	30.00	3.82	3.76	Pass	20	20
VHT20	MCS0	1	157	5785	19.90	19.80		30.00	30.00	3.82	3.76	Pass	20	20
VHT20	MCS0	1	165	5825	19.70	19.70		30.00	30.00	3.82	3.76	Pass	19.5	20
VHT40	MCS0	1	151	5755	18.70	18.70		30.00	30.00	3.82	3.76	Pass	18	18
VHT40	MCS0	1	159	5795	18.90	18.80		30.00	30.00	3.82	3.76	Pass	18	18
VHT80	MCS0	1	155	5775	19.10	19.10		30.00	30.00	3.82	3.76	Pass	18.5	18.5
11a	6Mbps	2	149	5745	19.60	19.70	22.66	30.00		3.82		Pass	19.5	
11a	6Mbps	2	157	5785	19.80	19.90	22.86	30.00		3.82		Pass	19.5	
11a	6Mbps	2	165	5825	19.80	19.80	22.81	30.00		3.82		Pass	19.5	
HT20	MCS0	2	149	5745	19.80	19.80	22.81	30.00		3.82		Pass	20	
HT20	MCS0	2	157	5785	19.70	19.60	22.66	30.00		3.82		Pass	19.5	
HT20	MCS0	2	165	5825	19.60	19.60	22.61	30.00		3.82		Pass	19.5	
HT40	MCS0	2	151	5755	18.70	18.60	21.66	30.00		3.82		Pass	18	
HT40	MCS0	2	159	5795	18.80	18.80	21.81	30.00		3.82		Pass	18	
VHT20	MCS0	2	149	5745	19.90	19.90	22.91	30.00		3.82		Pass	20	
VHT20	MCS0	2	157	5785	19.80	19.70	22.76	30.00		3.82		Pass	19.5	
VHT20	MCS0	2	165	5825	19.70	19.70	22.71	30.00		3.82		Pass	19.5	
VHT40	MCS0	2	151	5755	18.80	18.70	21.76	30.00		3.82		Pass	18	
VHT40	MCS0	2	159	5795	18.90	18.90	21.91	30.00		3.82		Pass	18	
VHT80	MCS0	2	155	5775	19.30	19.10	22.21	30.00		3.82		Pass	18.5	



<TXBF Mode>

Test Engineer :	Jimmy Chang	Temperature :	24~26°C
		Relative Humidity :	52~55%

Band IV														
Mod.	Data Rate	NTX	CH.	Freq. (MHz)	Average Conducted Power (dBm)			FCC Conducted Power Limit (dBm)		DG (dBi)		Pass /Fail	Setting	
					Ant 1	Ant 2	SUM	Ant 1	Ant 2	Ant 1	Ant 2		Ant 1	Ant 2
VHT20	MCS0	2	149	5745	19.50	19.20	22.36	29.20		6.80		Pass	19	
VHT20	MCS0	2	157	5785	19.50	19.30	22.41	29.20		6.80		Pass	19	
VHT20	MCS0	2	165	5825	19.40	19.30	22.36	29.20		6.80		Pass	19	
VHT40	MCS0	2	151	5755	18.60	17.80	21.23	29.20		6.80		Pass	17.5	
VHT40	MCS0	2	159	5795	18.40	18.00	21.21	29.20		6.80		Pass	17.5	
VHT80	MCS0	2	155	5775	19.40	18.50	21.98	29.20		6.80		Pass	18.5	



3.3 Power Spectral Density Measurement

3.3.1 Limit of Power Spectral Density

For the band 5.725–5.85 GHz, the maximum power spectral density shall not exceed 30 dBm in any 500-kHz band.

If transmitting antennas of directional gain greater than 6 dBi are used, the peak output power shall be reduced by the amount in dB that the directional gain of the antenna exceeds 6 dBi.

3.3.2 Measuring Instruments

See list of measuring equipment of this test report.

3.3.3 Test Procedures

The testing follows FCC KDB 789033 D02 General UNII Test Procedures New Rules v02r01. Section F) Maximum power spectral density.

Method SA-3

(power averaging (rms) detection with max hold):

- Set span to encompass the entire emission bandwidth (EBW) of the signal.
 - Set RBW = 300 kHz.
 - Set VBW \geq 1 MHz.
 - Number of points in sweep \geq 2 Span / RBW.
 - Sweep time \leq (number of points in sweep) \times T, when duty cycle is less than 98 percent where T is the minimum transmission duration over which the transmitter is on and is transmitting at its maximum power control level for the tested mode of operation.
 - Detector = power averaging (rms).
 - Trace mode = max hold.
 - Allow max hold to run for at least 60 seconds, or longer as needed to allow the trace to stabilize.
1. The RF output of EUT was connected to the spectrum analyzer by a low loss cable.
 2. Each plot has already offset with cable loss, and attenuator loss. Measure the PPSD and record it.

3. For MIMO mode, calculation method follows FCC KDB 662911 D01 Multiple Transmitter Output v02r01.

Method (c): Measure and add $10 \log(N_{ANT})$ dB.

With this technique, spectrum measurements are performed at each output of the device, but rather than summing the spectra or the spectral peaks across the outputs, the quantity $10 \log(N_{ANT})$ dB is added to each spectrum value before comparing to the emission limit. The addition of $10 \log(N_{ANT})$ dB serves to apportion the emission limit among the N_{ANT} outputs so that each output is permitted to contribute no more than $1/N_{ANT}^{th}$ of the PSD limit.

3.3.4 Test Setup

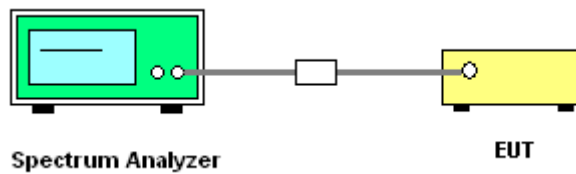



3.3.5 Test Result of Power Spectral Density

<CDD Mode>

Test Engineer :	Jimmy Chang	Temperature :	24~26°C
		Relative Humidity :	52~55%

Band IV																
Mod.	Data Rate	NTX	CH.	Freq. (MHz)	Duty Factor (dB)		10log (500kHz /RBW) Factor (dB)		Average Power Density (dBm/500kHz)			Average PSD Limit (dBm/500kHz)		DG (dBi)		Pass /Fail
					Ant 1	Ant 2	Ant 1	Ant 2	Ant 1	Ant 2	SUM	Ant 1	Ant 2	Ant 1	Ant 2	
11a	6Mbps	1	149	5745	0.21	0.19	2.22	2.22	9.35	9.51		30.00	30.00	3.82	3.76	Pass
11a	6Mbps	1	157	5785	0.21	0.19	2.22	2.22	9.38	9.86		30.00	30.00	3.82	3.76	Pass
11a	6Mbps	1	165	5825	0.21	0.19	2.22	2.22	9.57	10.03		30.00	30.00	3.82	3.76	Pass
VHT20	MCS0	1	149	5745	0.21	0.19	2.22	2.22	9.95	9.95		30.00	30.00	3.82	3.76	Pass
VHT20	MCS0	1	157	5785	0.21	0.19	2.22	2.22	10.00	10.11		30.00	30.00	3.82	3.76	Pass
VHT20	MCS0	1	165	5825	0.21	0.19	2.22	2.22	10.03	10.02		30.00	30.00	3.82	3.76	Pass
VHT40	MCS0	1	151	5755	0.21	0.19	2.22	2.22	4.36	4.35		30.00	30.00	3.82	3.76	Pass
VHT40	MCS0	1	159	5795	0.21	0.19	2.22	2.22	4.81	4.76		30.00	30.00	3.82	3.76	Pass
VHT80	MCS0	1	155	5775	0.21	0.19	2.22	2.22	4.04	3.75		30.00	30.00	3.82	3.76	Pass
11a	6Mbps	2	149	5745	0.19	0.19	2.22		9.63	9.48	12.83	29.20		6.80		Pass
11a	6Mbps	2	157	5785	0.19	0.19	2.22		10.11	9.34	13.31	29.20		6.80		Pass
11a	6Mbps	2	165	5825	0.19	0.19	2.22		10.19	9.41	13.39	29.20		6.80		Pass
VHT20	MCS0	2	149	5745	0.22	0.20	2.22		10.17	10.29	13.50	29.20		6.80		Pass
VHT20	MCS0	2	157	5785	0.22	0.20	2.22		10.14	10.33	13.54	29.20		6.80		Pass
VHT20	MCS0	2	165	5825	0.22	0.20	2.22		9.97	10.26	13.47	29.20		6.80		Pass
VHT40	MCS0	2	151	5755	0.24	0.27	2.22		4.56	5.10	8.38	29.20		6.80		Pass
VHT40	MCS0	2	159	5795	0.24	0.27	2.22		5.11	5.36	8.64	29.20		6.80		Pass
VHT80	MCS0	2	155	5775	0.49	0.55	2.22		4.60	4.67	8.23	29.20		6.80		Pass

Note: PSD Sum = Max PSD (Ant. 1, Ant. 2) + 10 log (n)



Worst Case Power Density (dBm/MHz) for MIMO Ant. 1

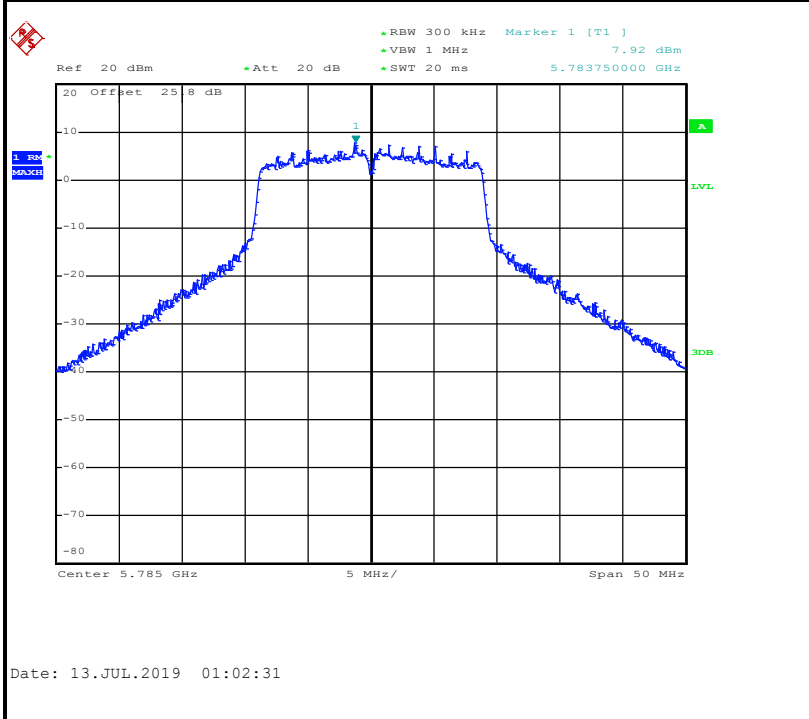

Worst Case Power Density (dBm/MHz) for MIMO Ant. 2

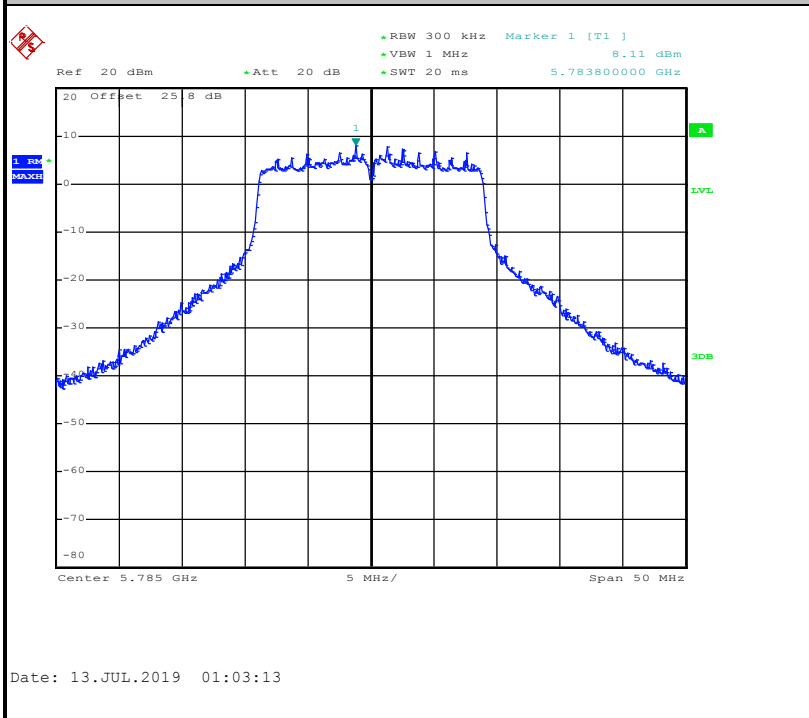



<TXBF Modes>

Test Engineer :	Jimmy Chang	Temperature :	24~26°C
		Relative Humidity :	52~55%

Band IV																
Mod.	Data Rate	NTX	CH.	Freq. (MHz)	Duty Factor (dB)		10log (500kHz /RBW) Factor (dB)		Average Power Density (dBm/500kHz)			Average PSD Limit (dBm/500kHz)		DG (dBi)		Pass /Fail
					Ant 1	Ant 2	Ant 1	Ant 2	Ant 1	Ant 2	SUM	Ant 1	Ant 2	Ant 1	Ant 2	
VHT20	MCS0	2	149	5745	0.00	0.00	2.22	9.31	8.53	12.32	29.20	6.80	6.80	6.80	Pass	
VHT20	MCS0	2	157	5785	0.00	0.00	2.22	9.47	7.56	12.48	29.20	6.80	6.80	6.80	Pass	
VHT20	MCS0	2	165	5825	0.00	0.00	2.22	9.32	8.44	12.33	29.20	6.80	6.80	6.80	Pass	
VHT40	MCS0	2	151	5755	0.00	0.00	2.22	5.00	3.39	8.01	29.20	6.80	6.80	6.80	Pass	
VHT40	MCS0	2	159	5795	0.00	0.00	2.22	4.65	3.53	7.66	29.20	6.80	6.80	6.80	Pass	
VHT80	MCS0	2	155	5775	0.00	0.00	2.22	3.77	1.83	6.78	29.20	6.80	6.80	6.80	Pass	

Note: PSD Sum = Max PSD (Ant. 1, Ant. 2) + 10 log (n)

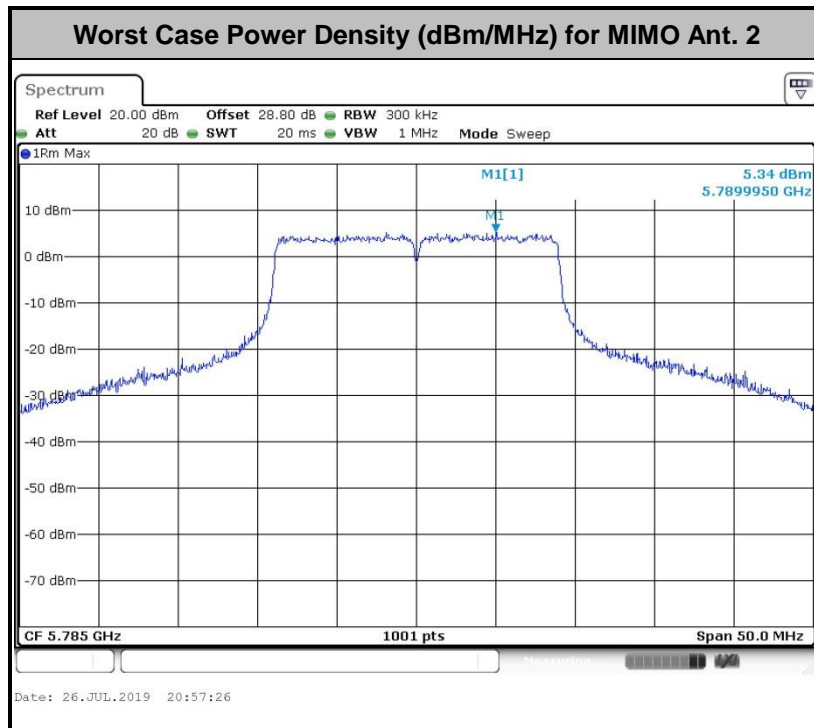
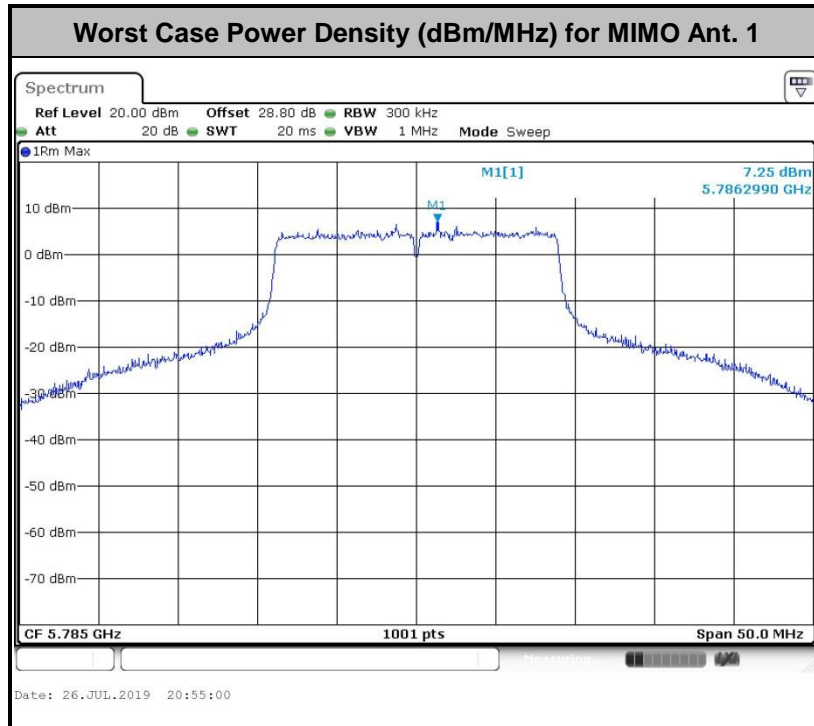



3.4 Unwanted Emissions Measurement

This section is to measure unwanted emissions through radiated measurement for band edge spurious emissions and out of band emissions measurement.

3.4.1 Limit of Unwanted Emissions

(1) For transmitters operating in the 5.725-5.85 GHz band:

15.407(b)(4)(i) All emissions shall be limited to a level of -27 dBm/MHz at 75 MHz or more above or below the band edge increasing linearly to 10 dBm/MHz at 25 MHz above or below the band edge, and from 25 MHz above or below the band edge increasing linearly to a level of 15.6 dBm/MHz at 5 MHz above or below the band edge, and from 5 MHz above or below the band edge increasing linearly to a level of 27 dBm/MHz at the band edge.

(2) Unwanted spurious emissions fallen in restricted bands shall comply with the general field strength limits as below table,

Frequency (MHz)	Field Strength (microvolts/meter)	Measurement Distance (meters)
0.009 – 0.490	2400/F(kHz)	300
0.490 – 1.705	24000/F(kHz)	30
1.705 – 30.0	30	30
30 – 88	100	3
88 – 216	150	3
216 - 960	200	3
Above 960	500	3

Note: The following formula is used to convert the EIRP to field strength.

$$E = \frac{1000000\sqrt{30P}}{3} \text{ } \mu\text{V/m, where P is the eirp (Watts)}$$



EIRP (dBm)	Field Strength at 3m (dBµV/m)
- 27	68.3

(3) KDB789033 D02 v02r01 G)2)c)

- (i) Section 15.407(b)(1) to (b)(3) specify the unwanted emission limits for the U-NII-1 and U-NII-2 bands. As specified, emissions above 1000 MHz that are outside of the restricted bands are subject to a peak emission limit of -27 dBm/MHz.³
- (ii) Section 15.407(b)(4) specifies the unwanted emission limit for the U-NII-3 band. A band emissions mask is specified in Section 15.407(b)(4)(i). The emission limits are in terms of a Peak detector. An alternative to the band emissions mask is specified in Section 15.407(b)(4)(ii). The alternative limits are based on the highest antenna gain specified in the filing. There are also marketing and importation restrictions for the devices using the alternative limit.⁴

Note 3: An out-of-band emission that complies with both the average and peak limits of Section 15.209 is not required to satisfy the -27 dBm/MHz peak emission limit.

Note 4: Only devices with antenna gains of 10 dBi or less may be approved using the emission limits specified in Section 15.247(d) till March 2, 2018; all other devices operating in this band must use the mask specified in Section 15.407(b)(4)(i).

3.4.2 Measuring Instruments

See list of measuring equipment of this test report.

3.4.3 Test Procedures

1. The testing follows FCC KDB 789033 D02 General UNII Test Procedures New Rules v02r01. Section G) Unwanted emissions measurement.
 - (1) Procedure for Unwanted Emissions Measurements Below 1000MHz
 - RBW = 120 kHz
 - VBW = 300 kHz
 - Detector = Peak
 - Trace mode = max hold
 - (2) Procedure for Peak Unwanted Emissions Measurements Above 1000 MHz
 - RBW = 1 MHz
 - VBW ≥ 3 MHz
 - Detector = Peak
 - Sweep time = auto
 - Trace mode = max hold

(3) Procedures for Average Unwanted Emissions Measurements Above 1000MHz

- RBW = 1 MHz
 - VBW = 10 Hz, when duty cycle is no less than 98 percent.
 - $VBW \geq 1/T$, when duty cycle is less than 98 percent where T is the minimum transmission duration over which the transmitter is on and is transmitting at its maximum power control level for the tested mode of operation.
2. The EUT was placed on a turntable with 0.8 meter for frequency below 1GHz and 1.5 meter for frequency above 1GHz respectively above ground.
 3. The EUT was set 3 meters from the interference receiving antenna which was mounted on the top of a variable height antenna tower.
 4. The antenna is a broadband antenna and its height is adjusted between one meter and four meters above ground to find the maximum value of the field strength for both horizontal polarization and vertical polarization of the antenna.
 5. For each suspected emission, the EUT was arranged to its worst case and then adjust the antenna tower (from 1 m to 4 m) and turntable (from 0 degree to 360 degrees) to find the maximum reading.
 6. For testing below 1GHz, if the emission level of the EUT in peak mode was 3 dB lower than the limit specified, then peak values of EUT will be reported, otherwise, the emissions will be repeated one by one using the CISPR quasi-peak method and reported.
 7. For testing above 1GHz, the emission level of the EUT in peak mode was 20dB lower than average limit (that means the emission level in average mode also complies with the limit in average mode), then peak values of EUT will be reported, otherwise, the emissions will be measured in average mode again and reported.

3.4.4 Test Setup

For radiated emissions below 30MHz

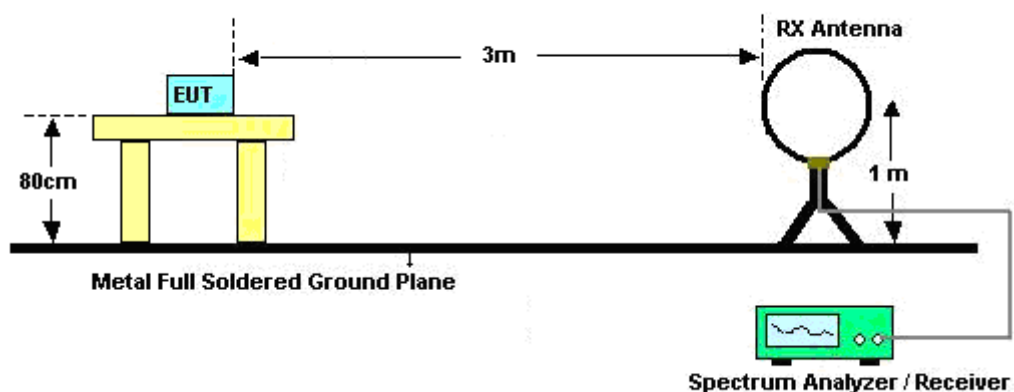

For radiated emissions from 30MHz to 1GHz

<CDD Mode>

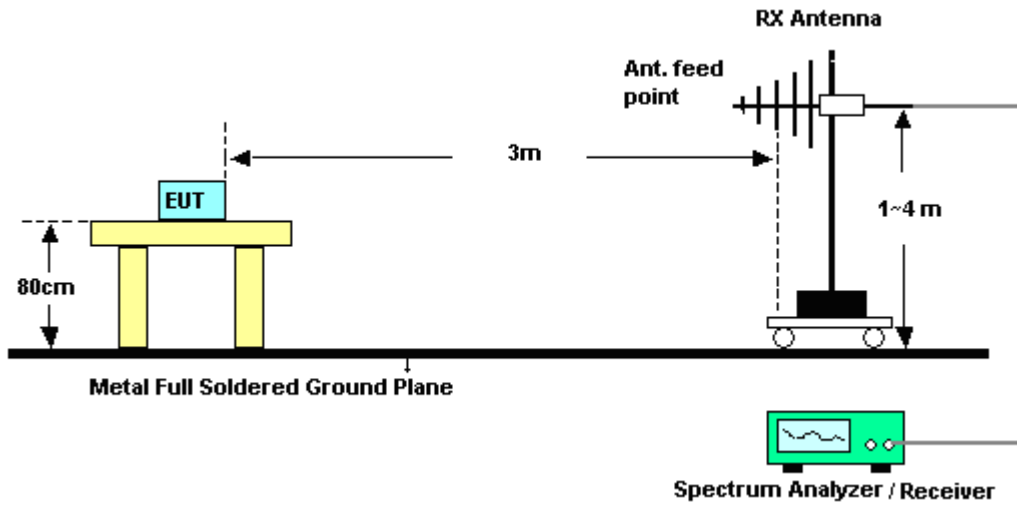

<TXBF Modes>

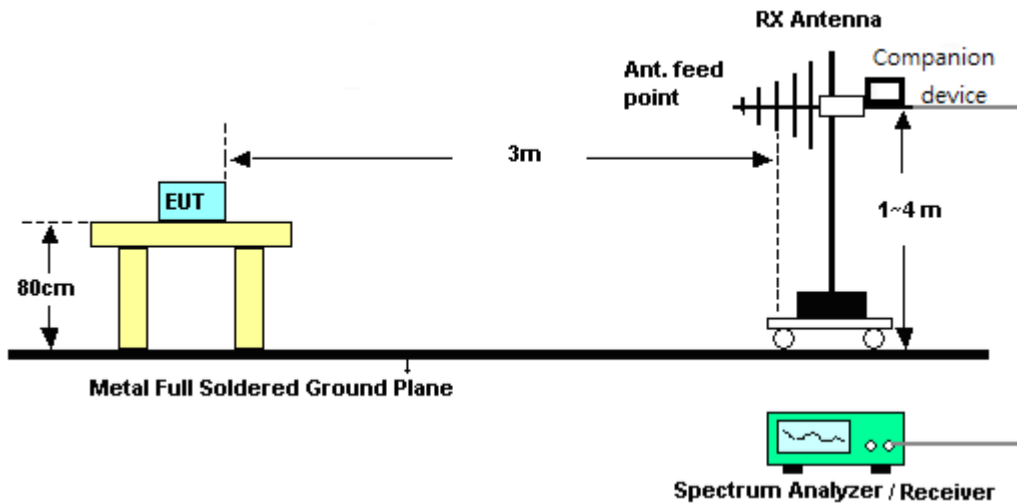

For radiated emissions above 1GHz

<CDD Mode>

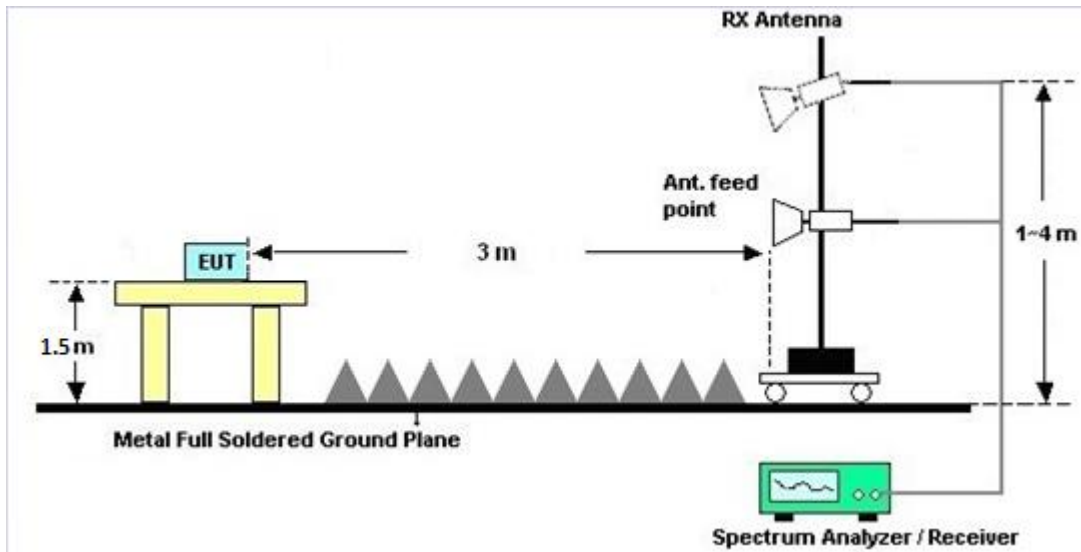

<TXBF Modes>

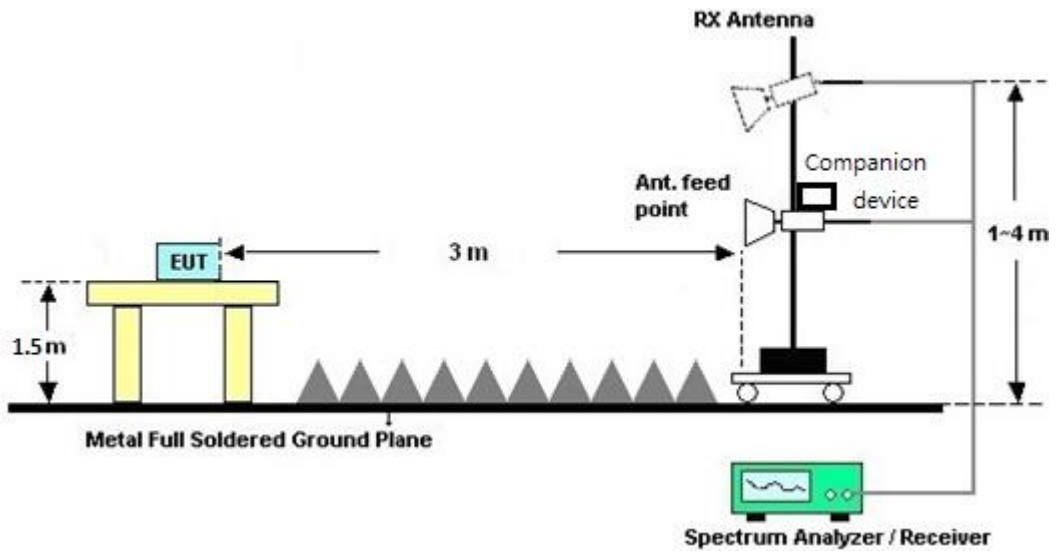



3.4.5 Test Results of Radiated Emissions (9 kHz ~ 30 MHz)

The low frequency, which started from 9 kHz to 30MHz, was pre-scanned and the result which was 20dB lower than the limit line was not reported.

There is a comparison data of both open-field test site and alternative test site - semi-Anechoic chamber according to 414788 D01 Radiated Test Site v01r01, and the result came out very similar.

3.4.6 Test Result of Radiated Band Edges

Please refer to Appendix B and C.

3.4.7 Duty Cycle

Please refer to Appendix D.

3.4.8 Test Result of Unwanted Radiated Emission (30MHz ~ 10th Harmonic)

Please refer to Appendix B and C.



3.5 AC Conducted Emission Measurement

3.5.1 Limit of AC Conducted Emission

For equipment that is designed to be connected to the public utility (AC) power line, the radio frequency voltage that is conducted back onto the AC power line on any frequency or frequencies within the band 150 kHz to 30 MHz shall not exceed the limits in the following table.

Frequency of emission (MHz)	Conducted limit (dB μ V)	
	Quasi-peak	Average
0.15-0.5	66 to 56*	56 to 46*
0.5-5	56	46
5-30	60	50

*Decreases with the logarithm of the frequency.

3.5.2 Measuring Instruments

See list of measuring equipment of this test report.

3.5.3 Test Procedures

1. The EUT was placed 0.4 meter from the conducting wall of the shielding room was kept at least 80 centimeters from any other grounded conducting surface.
2. Connect EUT to the power mains through a line impedance stabilization network (LISN).
3. All the support units are connecting to the other LISN.
4. The LISN provides 50 ohm coupling impedance for the measuring instrument.
5. The FCC states that a 50 ohm, 50 microhenry LISN should be used.
6. Both sides of AC line were checked for maximum conducted interference.
7. The frequency range from 150 kHz to 30 MHz was searched.
8. Set the test-receiver system to Peak Detect Function and specified bandwidth with Maximum Hold Mode.

3.5.4 Test Setup

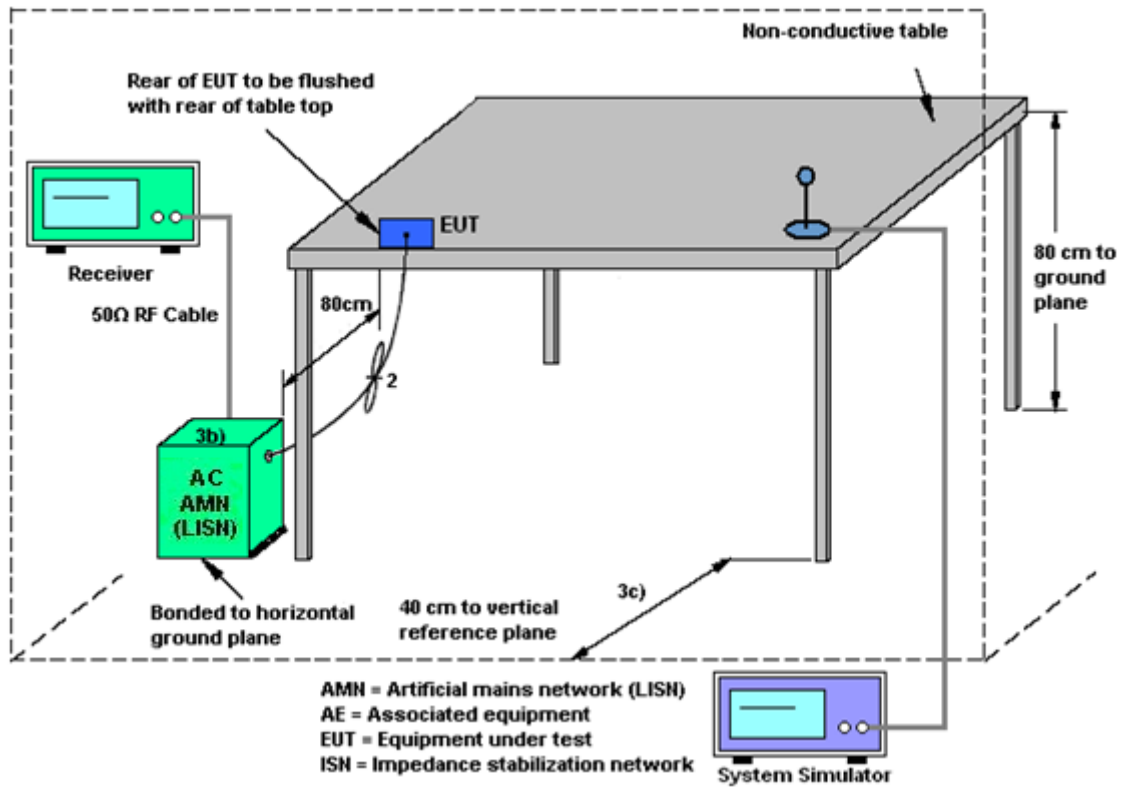

3.5.5 Test Result of AC Conducted Emission

Please refer to Appendix A.



3.6 Automatically Discontinue Transmission

3.6.1 Limit of Automatically Discontinue Transmission

The device shall automatically discontinue transmission in case of either absence of information to transmit or operational failure. These provisions are not intended to preclude the transmission of control or signaling information or the use of repetitive codes used by certain digital technologies to complete frame or burst intervals. Applicants shall include in their application for equipment authorization to describe how this requirement is met.

3.6.2 Measuring Instruments

See list of measuring equipment of this test report.

3.6.3 Test Result of Automatically Discontinue Transmission

While the EUT is not transmitting any information, the EUT can automatically discontinue transmission and become standby mode for power saving. The EUT can detect the controlling signal of ACK message transmitting from remote device and verify whether it shall resend or discontinue transmission.



3.7 Antenna Requirements

3.7.1 Standard Applicable

If transmitting antenna directional gain is greater than 6 dBi, both the peak transmit power and the peak power spectral density shall be reduced by the amount in dB that the directional gain of the antenna exceeds 6 dBi.

3.7.2 Antenna Anti-Replacement Construction

An embedded-in antenna design is used.

3.7.3 Antenna Gain

<CDD Modes >

FCC KDB 662911 D01 Multiple Transmitter Output v02r01

For CDD transmissions, directional gain is calculated as

Directional gain = GANT + Array Gain, where Array Gain is as follows.

For power spectral density (PSD) measurements on all devices,

Array Gain = 10 log(NANT/NSS=1) dB.

For power measurements on IEEE 802.11 devices,

Array Gain = 0 dB (i.e., no array gain) for NANT ≤ 4.

Directional gain may be calculated by using the formulas applicable to equal gain antennas with GANT set equal to the gain of the antenna having the highest gain;

The EUT supports CDD mode.

For power, the directional gain GANT is set equal to the antenna having the highest gain, i.e., F)2)f)i).

For PSD, the directional gain calculation is following F)2)f)ii) of KDB 662911 D01 v02r01.

The power and PSD limit should be modified if the directional gain of EUT is over 6 dBi,

The directional gain "DG" is calculated as following table.

<CDD Modes>						
			DG	DG	Power	PSD
	Ant. 1	Ant. 2	for	for	Limit	Limit
	(dBi)	(dBi)	Power	PSD	Reduction	Reduction
			(dBi)	(dBi)	(dB)	(dB)
Band IV	3.82	3.76	3.82	6.80	0.00	0.80

Power Limit Reduction = DG(Power) – 6dBi, (min = 0)

PSD Limit Reduction = DG(PSD) – 6dBi, (min = 0)

TXBF modes

FCC KDB 662911 D01 Multiple Transmitter Output v02r01

For CDD transmissions, directional gain is calculated as

$$DirectionalGain = 10 \cdot \log \left[\frac{\sum_{j=1}^{N_{SS}} \left\{ \sum_{k=1}^{N_{ANT}} g_{j,k} \right\}^2}{N_{ANT}} \right]$$

where

Each antenna is driven by no more than one spatial stream;

N_{SS} = the number of independent spatial streams of data;

N_{ANT} = the total number of antennas

$g_{j,k} = 10^{G_k / 20}$ if the k th antenna is being fed by spatial stream j , or zero if it is not;
 G_k is the gain in dBi of the k th antenna.

The EUT supports beamforming for 802.11ac modes.

The directional gain calculation is following F)2)e)ii) of KDB 662911 D01 v02r01.

The power and PSD limit should be modified if the directional gain of EUT is over 6 dBi,

The directional gain “DG” is calculated as following table.

			DG	DG	Power	PSD
			for	for	Limit	Limit
	Ant 1	Ant 2	Power	PSD	Reduction	Reduction
	(dBi)	(dBi)	(dBi)	(dBi)	(dB)	(dB)
Band IV	3.82	3.76	6.80	6.80	0.80	0.80

Power Limit Reduction = DG(Power) – 6dBi, (min = 0)

PSD Limit Reduction = DG(PSD) – 6dBi, (min = 0)



4 List of Measuring Equipment

Instrument	Manufacturer	Model No.	Serial No.	Characteristics	Calibration Date	Test Date	Due Date	Remark
AC Power Source	ChainTek	APC-1000W	N/A	N/A	N/A	Jun. 23, 2019	N/A	Conduction (CO05-HY)
EMI Test Receiver	Rohde & Schwarz	ESR3	102388	9kHz~3.6GHz	Nov. 12, 2018	Jun. 23, 2019	Nov. 11, 2019	Conduction (CO05-HY)
LISN	Rohde & Schwarz	ENV216	100080	9kHz~30MHz	Nov. 14, 2018	Jun. 23, 2019	Nov. 13, 2019	Conduction (CO05-HY)
LISN	Rohde & Schwarz	ENV216	100081	9kHz~30MHz	Nov. 09, 2018	Jun. 23, 2019	Nov. 08, 2019	Conduction (CO05-HY)
Software	Rohde & Schwarz	EMC32 V10.30	N/A	N/A	N/A	Jun. 23, 2019	N/A	Conduction (CO05-HY)
LF Cable	HUBER + SUHNER	RG-214/U	LF01	N/A	Dec. 31, 2018	Jun. 23, 2019	Dec. 30, 2019	Conduction (CO05-HY)
Pulse Limiter	Rohde & Schwarz	ESH3-Z2	100851	N/A	Dec. 31, 2018	Jun. 23, 2019	Dec. 30, 2019	Conduction (CO05-HY)
Power Sensor	DARE	RPR3006W	13I00030S NO32	9kHz~6GHz	Dec. 03, 2018	Jun. 23, 2019~ Jul. 31, 2019	Dec. 02, 2019	Conducted (TH05-HY)
Spectrum Analyzer	Rohde & Schwarz	FSV 30	100895	9kHz~30GHz	Apr. 20, 2018	Jun. 23, 2019~ Jul. 31, 2019	Apr. 19, 2019	Conducted (TH05-HY)
Switch Box & RF Cable	Burgeon	ETF-058	EC120838 2	N/A	Mar. 27, 2019	Jun. 23, 2019~ Jul. 31, 2019	Mar. 26, 2020	Conducted (TH05-HY)
Power Sensor	DARE	RPR3006W	16I00054S NO10	10MHz~6GHz	Dec. 19, 2018	Jun. 23, 2019~ Jul. 31, 2019	Dec. 18, 2019	Conducted (TH05-HY)
Spectrum Analyzer	Rohde & Schwarz	FSP40	100057	9kHz-40GHz	Nov. 21, 2018	Jun. 23, 2019~ Jul. 31, 2019	Nov. 20, 2019	Conducted (TH05-HY)
Switch Box & RF Cable	EM	EMSW18	SW107090 3	N/A	Dec. 19, 2018	Jun. 23, 2019~ Jul. 31, 2019	Dec. 18, 2019	Conducted (TH05-HY)
Loop Antenna	Rohde & Schwarz	HFH2-Z2	100488	9 kHz~30 MHz	Jan. 07, 2019	Jun. 29, 2019~ Jul. 15, 2019	Jan. 06, 2020	Radiation (03CH13-HY)
Horn Antenna	SCHWARZBECK	BBHA 9120 D	9120D-121 2	1GHz ~ 18GHz	May 14, 2019	Jun. 29, 2019~ Jul. 15, 2019	May 13, 2020	Radiation (03CH13-HY)
Bilog Antenna	TESEQ	CBL 6111D&00800 N1D01N-06	37059&01	30MHz~1GHz	Oct. 13, 2018	Jun. 29, 2019~ Jul. 15, 2019	Oct. 12, 2019	Radiation (03CH13-HY)
SHF-EHF Horn Antenna	SCHWARZBECK	BBHA 9170	BBHA9170 584	18GHz- 40GHz	Dec. 05, 2018	Jun. 29, 2019~ Jul. 15, 2019	Dec. 04, 2019	Radiation (03CH13-HY)
Preamplifier	Keysight	83017A	MY532700 80	1GHz~26.5GHz	Nov. 14, 2018	Jun. 29, 2019~ Jul. 15, 2019	Nov. 13, 2020	Radiation (03CH13-HY)
Preamplifier	MITEQ	AMF-7D-0010 1800-30-10P	1590074	1GHz~18GHz	May 20, 2019	Jun. 29, 2019~ Jul. 15, 2019	May 19, 2020	Radiation (03CH13-HY)
Amplifier	Sonoma-Instrument	310 N	187282	9KHz~1GHz	Dec. 18, 2018	Jun. 29, 2019~ Jul. 15, 2019	Dec. 17, 2019	Radiation (03CH13-HY)
Preamplifier	EMEC	EM18G40G	060715	18GHz~40GHz	Dec. 06, 2018	Jun. 29, 2019~ Jul. 15, 2019	Dec. 05, 2019	Radiation (03CH13-HY)



Instrument	Manufacturer	Model No.	Serial No.	Characteristics	Calibration Date	Test Date	Due Date	Remark
RF Cable	HUBER + SUHNER	SUCOFLEX 126E	0030/126E	30M-18G	Feb. 13, 2019	Jun. 29, 2019~ Jul. 15, 2019	Feb. 12, 2020	Radiation (03CH13-HY)
RF Cable	HUBER + SUHNER	SUCOFLEX 104	804793/4	30M-18G	Feb. 13, 2019	Jun. 29, 2019~ Jul. 15, 2019	Feb. 12, 2020	Radiation (03CH13-HY)
RF Cable	HUBER + SUHNER	SUCOFLEX 104	MY24961/4	30M-18G	Feb. 13, 2019	Jun. 29, 2019~ Jul. 15, 2019	Feb. 12, 2020	Radiation (03CH13-HY)
RF Cable	HUBER + SUHNER	SUCOFLEX 102	MY2859/2	30M~40GHz	Mar. 13, 2019	Jun. 29, 2019~ Jul. 15, 2019	Mar. 12, 2020	Radiation (03CH13-HY)
RF Cable	HUBER + SUHNER	SUCOFLEX 102	MY4274/2	30M~40GHz	Mar. 13, 2019	Jun. 29, 2019~ Jul. 15, 2019	Mar. 12, 2020	Radiation (03CH13-HY)
Spectrum Analyzer	Keysight	N9010A	MY55370526	10Hz~44GHz	Mar. 19, 2019	Jun. 29, 2019~ Jul. 15, 2019	Mar. 18, 2020	Radiation (03CH13-HY)
Antenna Mast	EMEC	AM-BS-4500-B	N/A	1m~4m	N/A	Jun. 29, 2019~ Jul. 15, 2019	N/A	Radiation (03CH13-HY)
Turn Table	EMEC	TT2000	N/A	0~360 Degree	N/A	Jun. 29, 2019~ Jul. 15, 2019	N/A	Radiation (03CH13-HY)
Software	AUDIX	E3 6.2009-8-24c	RK-001124	N/A	N/A	Jun. 29, 2019~ Jul. 15, 2019	N/A	Radiation (03CH13-HY)
EMI Test Receiver	Keysight	N9038A(MXE)	MY54130085	20Hz ~ 8.4GHz	Nov. 01, 2018	Jun. 29, 2019~ Jul. 15, 2019	Oct. 31, 2019	Radiation (03CH13-HY)
Filter	Woken	WHKX8-5272.5-6750-18000-40ST	SN5	6.75G Highpass	Mar. 13, 2019	Jun. 29, 2019~ Jul. 15, 2019	Mar. 12, 2020	Radiation (03CH13-HY)
Filter	Wainwright	WLKS1200-8SS	SN3	1.2G Low Pass	Nov. 02, 2018	Jun. 29, 2019~ Jul. 15, 2019	Nov. 01, 2019	Radiation (03CH13-HY)
Filter	Wainwright	WHKX12-2805-3000-18000-40ST	SN1	3G High Pass	Nov. 14, 2018	Jun. 29, 2019~ Jul. 15, 2019	Nov. 13, 2019	Radiation (03CH13-HY)



5 Uncertainty of Evaluation

Uncertainty of Conducted Emission Measurement (150kHz ~ 30MHz)

Measuring Uncertainty for a Level of Confidence of 95% ($U = 2Uc(y)$)	2.20
---	------

Uncertainty of Radiated Emission Measurement (30 MHz ~ 1000 MHz)

Measuring Uncertainty for a Level of Confidence of 95% ($U = 2Uc(y)$)	4.90
---	------

Uncertainty of Radiated Emission Measurement (1000 MHz ~ 18000 MHz)

Measuring Uncertainty for a Level of Confidence of 95% ($U = 2Uc(y)$)	5.40
---	------

Uncertainty of Radiated Emission Measurement (18000 MHz ~ 40000 MHz)

Measuring Uncertainty for a Level of Confidence of 95% ($U = 2Uc(y)$)	4.30
---	------



Appendix A. AC Conducted Emission Test Results

Test Engineer :	Jimmy Chang	Temperature :	24~26°C
		Relative Humidity :	52~55%
Test Voltage :	120Vac / 60Hz	Phase :	Line

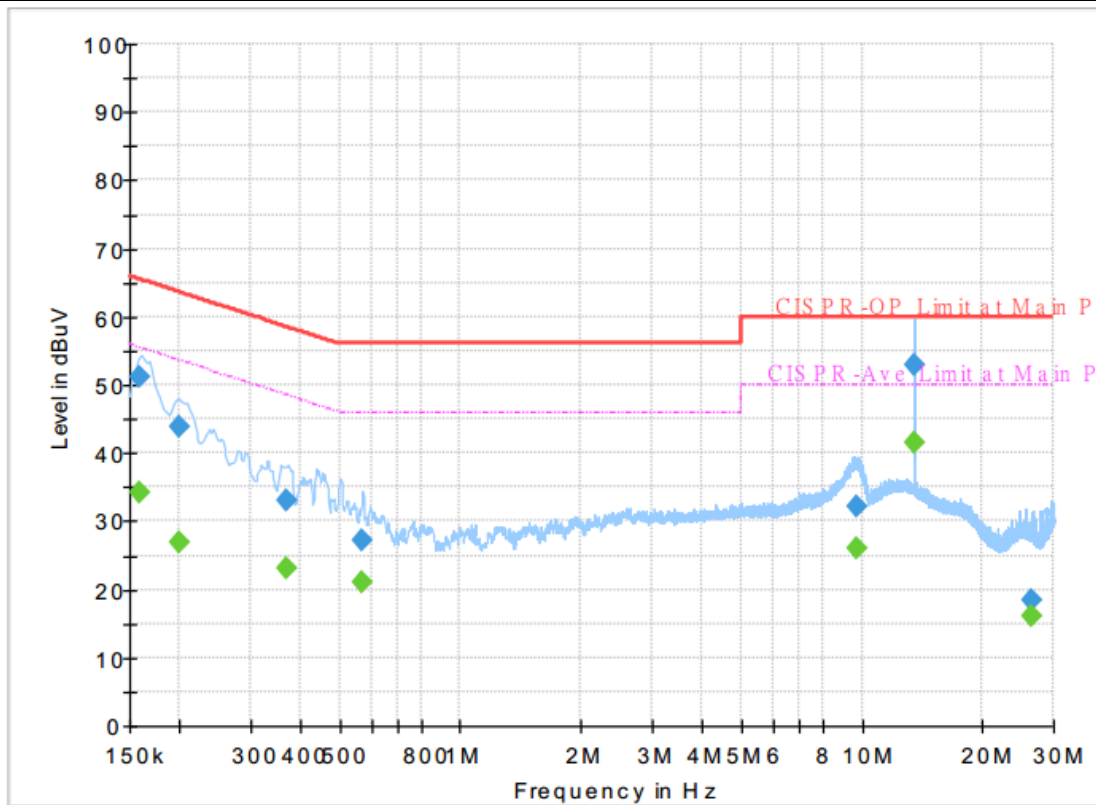

Final Result

Frequency (MHz)	QuasiPeak (dBuV)	CAverage (dBuV)	Limit (dBuV)	Margin (dB)	Line	Filter	Corr. (dB)
0.159000	---	34.27	55.52	21.25	L1	OFF	19.4
0.159000	51.17	---	65.52	14.35	L1	OFF	19.4
0.199500	---	26.82	53.63	26.81	L1	OFF	19.4
0.199500	43.72	---	63.63	19.91	L1	OFF	19.4
0.370500	---	23.19	48.49	25.30	L1	OFF	19.4
0.370500	32.99	---	58.49	25.50	L1	OFF	19.4
0.570750	---	21.04	46.00	24.96	L1	OFF	19.4
0.570750	27.30	---	56.00	28.70	L1	OFF	19.4
9.764250	---	26.15	50.00	23.85	L1	OFF	19.6
9.764250	32.06	---	60.00	27.94	L1	OFF	19.6
13.560000	---	41.60	50.00	8.40	L1	OFF	19.6
13.560000	52.84	---	60.00	7.16	L1	OFF	19.6
26.598750	---	16.12	50.00	33.88	L1	OFF	19.7
26.598750	18.53	---	60.00	41.47	L1	OFF	19.7



Test Engineer :	Jimmy Chang	Temperature :	24~26°C
		Relative Humidity :	52~55%
Test Voltage :	120Vac / 60Hz	Phase :	Neutral

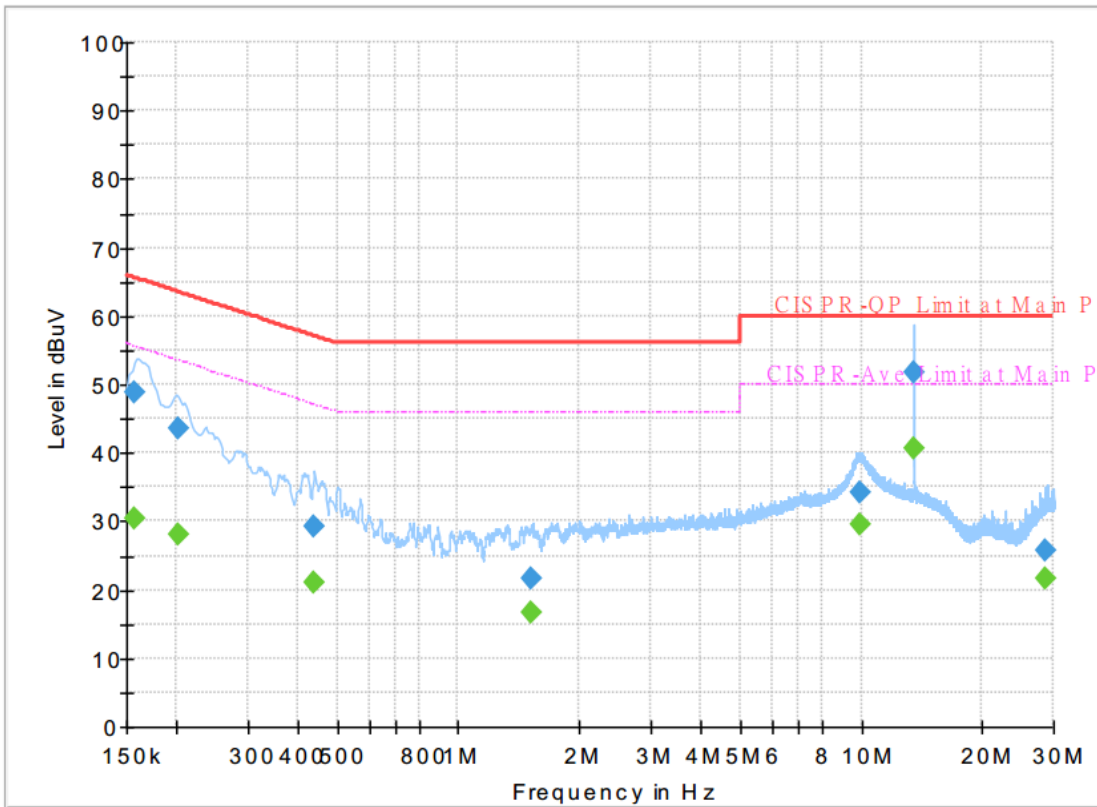

Final Result

Frequency (MHz)	QuasiPeak (dBuV)	CAverage (dBuV)	Limit (dBuV)	Margin (dB)	Line	Filter	Corr. (dB)
0.156750	---	30.46	55.63	25.17	N	OFF	19.4
0.156750	48.91	---	65.63	16.72	N	OFF	19.4
0.201750	---	28.06	53.54	25.48	N	OFF	19.4
0.201750	43.48	---	63.54	20.06	N	OFF	19.4
0.438000	---	20.97	47.10	26.13	N	OFF	19.5
0.438000	29.17	---	57.10	27.93	N	OFF	19.5
1.515750	---	16.71	46.00	29.29	N	OFF	19.5
1.515750	21.52	---	56.00	34.48	N	OFF	19.5
9.917250	---	29.42	50.00	20.58	N	OFF	19.7
9.917250	34.07	---	60.00	25.93	N	OFF	19.7
13.560000	---	40.65	50.00	9.35	N	OFF	19.7
13.560000	51.84	---	60.00	8.16	N	OFF	19.7
28.545000	---	21.63	50.00	28.37	N	OFF	20.0
28.545000	25.72	---	60.00	34.28	N	OFF	20.0



Appendix B. Radiated Spurious Emission

Test Engineer :	Ryan Lin, JC Liang, Wilson Wu	Temperature :	21.5~23.5°C
		Relative Humidity :	46.5~49.5%

<CDD Mode>

Band 4 - 5725~5850MHz

WIFI 802.11a (Band Edge @ 3m)

WIFI Ant.	Note	Frequency (MHz)	Level (dBμV/m)	Over Limit (dB)	Limit Line (dBμV/m)	Read Level (dBμV)	Antenna Factor (dB/m)	Path Loss (dB)	Preamp Factor (dB)	Ant Pos (cm)	Table Pos (deg)	Peak Avg. (P/A)	Pol. (H/V)	
802.11a CH 149 5745MHz		5639.8	50.31	-17.89	68.2	41.62	31.9	6.34	29.55	102	248	P	H	
		5687	51.95	-43.66	95.61	43.18	31.97	6.35	29.55	102	248	P	H	
		5719	59.27	-51.25	110.52	50.41	32.04	6.37	29.55	102	248	P	H	
		5724	70.01	-49.91	119.92	61.14	32.05	6.37	29.55	102	248	P	H	
	*	5745	112.25	-	-	103.33	32.09	6.38	29.55	102	248	P	H	
	*	5745	104.87	-	-	95.95	32.09	6.38	29.55	102	248	A	H	
														H
														H
			5613.2	48.25	-19.95	68.2	39.57	31.9	6.33	29.55	292	351	P	V
			5699.8	49.01	-56.04	105.05	40.2	32	6.36	29.55	292	351	P	V
			5716.6	54.78	-55.07	109.85	45.93	32.03	6.37	29.55	292	351	P	V
			5725	65.06	-57.14	122.2	56.19	32.05	6.37	29.55	292	351	P	V
	*		5745	108.52	-	-	99.6	32.09	6.38	29.55	292	351	P	V
	*		5745	101.25	-	-	92.33	32.09	6.38	29.55	292	351	A	V
														V
													V	



WIFI Ant. 1	Note	Frequency (MHz)	Level (dBμV/m)	Over Limit (dB)	Limit Line (dBμV/m)	Read Level (dBμV)	Antenna Factor (dB/m)	Path Loss (dB)	Preamp Factor (dB)	Ant Pos (cm)	Table Pos (deg)	Peak Avg. (P/A)	Pol. (H/V)
		5639.2	49.4	-18.8	68.2	40.71	31.9	6.34	29.55	100	244	P	H
		5665.4	50	-29.63	79.63	41.27	31.93	6.35	29.55	100	244	P	H
		5711	50.43	-57.85	108.28	41.6	32.02	6.36	29.55	100	244	P	H
		5724	49.75	-70.17	119.92	40.88	32.05	6.37	29.55	100	244	P	H
	*	5785	112.78	-	-	103.71	32.24	6.39	29.56	100	244	P	H
	*	5785	105.59	-	-	96.52	32.24	6.39	29.56	100	244	A	H
		5853.6	52.35	-61.64	113.99	43.06	32.41	6.44	29.56	100	244	P	H
		5857.6	51.97	-58.1	110.07	42.66	32.42	6.45	29.56	100	244	P	H
		5919.2	51	-21.48	72.48	41.52	32.54	6.5	29.56	100	244	P	H
		5934.2	50.69	-17.51	68.2	41.17	32.57	6.51	29.56	100	244	P	H
													H
													H
802.11a													
CH 157													
5785MHz		5605.4	49.45	-18.75	68.2	40.78	31.9	6.32	29.55	302	346	P	V
		5690.2	49.66	-48.31	97.97	40.87	31.98	6.36	29.55	302	346	P	V
		5716.6	48.1	-61.75	109.85	39.25	32.03	6.37	29.55	302	346	P	V
		5724.4	49.02	-71.81	120.83	40.15	32.05	6.37	29.55	302	346	P	V
	*	5785	109.28	-	-	100.21	32.24	6.39	29.56	302	346	P	V
	*	5785	101.79	-	-	92.72	32.24	6.39	29.56	302	346	A	V
		5854	49.56	-63.52	113.08	40.27	32.41	6.44	29.56	302	346	P	V
		5860.8	50.82	-58.35	109.17	41.51	32.42	6.45	29.56	302	346	P	V
		5896.8	50.84	-38.19	89.03	41.43	32.49	6.48	29.56	302	346	P	V
		5928	50.18	-18.02	68.2	40.68	32.56	6.5	29.56	302	346	P	V
													V
													V



WIFI Ant. 1	Note	Frequency (MHz)	Level (dBμV/m)	Over Limit (dB)	Limit Line (dBμV/m)	Read Level (dBμV)	Antenna Factor (dB/m)	Path Loss (dB)	Preamp Factor (dB)	Ant Pos (cm)	Table Pos (deg)	Peak Avg. (P/A)	Pol. (H/V)	
802.11a CH 165 5825MHz	*	5825	112.48	-	-	103.27	32.35	6.42	29.56	101	241	P	H	
	*	5825	105.12	-	-	95.91	32.35	6.42	29.56	101	241	A	H	
		5850.6	66.39	-54.44	120.83	57.11	32.4	6.44	29.56	101	241	P	H	
		5855.4	59.98	-50.71	110.69	50.69	32.41	6.44	29.56	101	241	P	H	
		5891.6	53.6	-39.28	92.88	44.21	32.48	6.47	29.56	101	241	P	H	
		5932.2	51.43	-16.77	68.2	41.92	32.56	6.51	29.56	101	241	P	H	
														H
														H
	*	5825	109.61	-	-	100.4	32.35	6.42	29.56	284	353	P	V	
	*	5825	102.43	-	-	93.22	32.35	6.42	29.56	284	353	A	V	
		5850	60.77	-61.43	122.2	51.49	32.4	6.44	29.56	284	353	P	V	
		5855	57.85	-52.95	110.8	48.56	32.41	6.44	29.56	284	353	P	V	
		5876.6	51	-53.01	104.01	41.65	32.45	6.46	29.56	284	353	P	V	
		5949	50.42	-17.78	68.2	40.86	32.6	6.52	29.56	284	353	P	V	
														V
														V
													V	
Remark	1. No other spurious found. 2. All results are PASS against Peak and Average limit line.													



Band 4 5725~5850MHz
WIFI 802.11a (Harmonic @ 3m)

WIFI Ant. 1	Note	Frequency (MHz)	Level (dBμV/m)	Over Limit (dB)	Limit Line (dBμV/m)	Read Level (dBμV)	Antenna Factor (dB/m)	Path Loss (dB)	Preamp Factor (dB)	Ant Pos (cm)	Table Pos (deg)	Peak Avg. (P/A)	Pol. (H/V)
802.11a CH 149 5745MHz		11490	47.33	-26.67	74	53.09	40.08	10.46	56.3	100	0	P	H
		17235	48.32	-19.88	68.2	51.84	40.1	12.95	56.57	100	0	P	H
													H
													H
		11490	46.67	-27.33	74	52.43	40.08	10.46	56.3	100	0	P	V
		17235	47.83	-20.37	68.2	51.35	40.1	12.95	56.57	100	0	P	V
													V
													V
802.11a CH 157 5785MHz		11570	46.38	-27.62	74	52.15	40.03	10.5	56.3	100	0	P	H
		17355	48.29	-19.91	68.2	51.33	40.69	13.08	56.81	100	0	P	H
													H
													H
		11570	46.44	-27.56	74	52.21	40.03	10.5	56.3	100	0	P	V
		17355	48.27	-19.93	68.2	51.31	40.69	13.08	56.81	100	0	P	V
													V
													V
802.11a CH 165 5825MHz		11650	46.98	-27.02	74	53.04	39.7	10.54	56.3	100	0	P	H
		17475	49.3	-18.9	68.2	51.69	41.45	13.21	57.05	100	0	P	H
													H
													H
		11650	47.62	-26.38	74	53.68	39.7	10.54	56.3	100	0	P	V
		17475	50.1	-18.1	68.2	52.49	41.45	13.21	57.05	100	0	P	V
													V
													V
Remark	1. No other spurious found. 2. All results are PASS against Peak and Average limit line.												



Band 4 5725~5850MHz
WIFI 802.11ac VHT20 (Band Edge @ 3m)

WIFI Ant. 1	Note	Frequency (MHz)	Level (dBμV/m)	Over Limit (dB)	Limit Line (dBμV/m)	Read Level (dBμV)	Antenna Factor (dB/m)	Path Loss (dB)	Preamp Factor (dB)	Ant Pos (cm)	Table Pos (deg)	Peak Avg. (P/A)	Pol. (H/V)	
802.11ac VHT20 CH 149 5745MHz		5609.2	50.69	-17.51	68.2	42.02	31.9	6.32	29.55	103	246	P	H	
		5689.6	53.41	-44.12	97.53	44.62	31.98	6.36	29.55	103	246	P	H	
		5720	63.8	-47	110.8	54.94	32.04	6.37	29.55	103	246	P	H	
		5724.4	75.22	-45.61	120.83	66.35	32.05	6.37	29.55	103	246	P	H	
	*	5745	113.23	-	-	104.31	32.09	6.38	29.55	103	246	P	H	
	*	5745	105.77	-	-	96.85	32.09	6.38	29.55	103	246	A	H	
														H
														H
			5635.8	48.41	-19.79	68.2	39.73	31.9	6.33	29.55	339	348	P	V
			5698.6	51.02	-53.15	104.17	42.21	32	6.36	29.55	339	348	P	V
			5720	56.86	-53.94	110.8	48	32.04	6.37	29.55	339	348	P	V
			5724.4	66.63	-54.2	120.83	57.76	32.05	6.37	29.55	339	348	P	V
	*		5745	109.44	-	-	100.52	32.09	6.38	29.55	339	348	P	V
	*		5745	101.56	-	-	92.64	32.09	6.38	29.55	339	348	A	V
														V
														V



WIFI Ant. 1	Note	Frequency (MHz)	Level (dBμV/m)	Over Limit (dB)	Limit Line (dBμV/m)	Read Level (dBμV)	Antenna Factor (dB/m)	Path Loss (dB)	Preamp Factor (dB)	Ant Pos (cm)	Table Pos (deg)	Peak Avg. (P/A)	Pol. (H/V)
		5627	50.86	-17.34	68.2	42.18	31.9	6.33	29.55	100	241	P	H
		5692	51.41	-47.89	99.3	42.62	31.98	6.36	29.55	100	241	P	H
		5715	50.29	-59.11	109.4	41.44	32.03	6.37	29.55	100	241	P	H
		5724.8	50.19	-71.55	121.74	41.32	32.05	6.37	29.55	100	241	P	H
	*	5785	113.2	-	-	104.13	32.24	6.39	29.56	100	241	P	H
	*	5785	105.78	-	-	96.71	32.24	6.39	29.56	100	241	A	H
		5852.2	53.48	-63.7	117.18	44.2	32.4	6.44	29.56	100	241	P	H
		5863	52	-56.56	108.56	42.68	32.43	6.45	29.56	100	241	P	H
		5893.6	52.81	-38.59	91.4	43.41	32.49	6.47	29.56	100	241	P	H
		5929	51.38	-16.82	68.2	41.88	32.56	6.5	29.56	100	241	P	H
802.11ac													H
VHT20													H
CH 157		5612.6	49.35	-18.85	68.2	40.67	31.9	6.33	29.55	303	350	P	V
5785MHz		5661.4	49.54	-27.12	76.66	40.83	31.92	6.34	29.55	303	350	P	V
		5717.6	50.05	-60.08	110.13	41.19	32.04	6.37	29.55	303	350	P	V
		5723.8	48.95	-70.51	119.46	40.08	32.05	6.37	29.55	303	350	P	V
	*	5785	109.68	-	-	100.61	32.24	6.39	29.56	303	350	P	V
	*	5785	101.98	-	-	92.91	32.24	6.39	29.56	303	350	A	V
		5852.6	49.99	-66.28	116.27	40.7	32.41	6.44	29.56	303	350	P	V
		5865.2	50.32	-57.62	107.94	41	32.43	6.45	29.56	303	350	P	V
		5911.4	50.52	-27.71	78.23	41.07	32.52	6.49	29.56	303	350	P	V
		5937.6	49.44	-18.76	68.2	39.91	32.58	6.51	29.56	303	350	P	V
													V
													V



WIFI Ant. 1	Note	Frequency (MHz)	Level (dBμV/m)	Over Limit (dB)	Limit Line (dBμV/m)	Read Level (dBμV)	Antenna Factor (dB/m)	Path Loss (dB)	Preamp Factor (dB)	Ant Pos (cm)	Table Pos (deg)	Peak Avg. (P/A)	Pol. (H/V)	
802.11ac VHT20 CH 165 5825MHz	*	5825	112.8	-	-	103.59	32.35	6.42	29.56	100	240	P	H	
	*	5825	105.06	-	-	95.85	32.35	6.42	29.56	100	240	A	H	
		5850	70.58	-51.62	122.2	61.3	32.4	6.44	29.56	100	240	P	H	
		5855.2	59.81	-50.93	110.74	50.52	32.41	6.44	29.56	100	240	P	H	
		5877.2	54.94	-48.63	103.57	45.59	32.45	6.46	29.56	100	240	P	H	
		5940.2	50.85	-17.35	68.2	41.32	32.58	6.51	29.56	100	240	P	H	
														H
														H
	*	5825	109.33	-	-	100.12	32.35	6.42	29.56	285	353	P	V	
	*	5825	101.78	-	-	92.57	32.35	6.42	29.56	285	353	A	V	
		5850	66.5	-55.7	122.2	57.22	32.4	6.44	29.56	285	353	P	V	
		5855	55.27	-55.53	110.8	45.98	32.41	6.44	29.56	285	353	P	V	
		5875.8	52.08	-52.53	104.61	42.73	32.45	6.46	29.56	285	353	P	V	
		5941.4	50.2	-18	68.2	40.67	32.58	6.51	29.56	285	353	P	V	
														V
													V	
Remark	1. No other spurious found. 2. All results are PASS against Peak and Average limit line.													



Band 4 5725~5850MHz
WIFI 802.11ac VHT20 (Harmonic @ 3m)

WIFI Ant. 1	Note	Frequency (MHz)	Level (dBµV/m)	Over Limit (dB)	Limit Line (dBµV/m)	Read Level (dBµV)	Antenna Factor (dB/m)	Path Loss (dB)	Preamp Factor (dB)	Ant Pos (cm)	Table Pos (deg)	Peak Avg. (P/A)	Pol. (H/V)
802.11ac VHT20 CH 149 5745MHz		11490	47.08	-26.92	74	52.84	40.08	10.46	56.3	100	0	P	H
		17235	48.32	-19.88	68.2	51.84	40.1	12.95	56.57	100	0	P	H
													H
													H
		11490	46.45	-27.55	74	52.21	40.08	10.46	56.3	100	0	P	V
		17235	47.65	-20.55	68.2	51.17	40.1	12.95	56.57	100	0	P	V
													V
802.11ac VHT20 CH 157 5785MHz		11570	46.6	-27.4	74	52.37	40.03	10.5	56.3	100	0	P	H
		17355	49.31	-18.89	68.2	52.35	40.69	13.08	56.81	100	0	P	H
													H
													H
		11570	46.23	-27.77	74	52	40.03	10.5	56.3	100	0	P	V
		17355	48.05	-20.15	68.2	51.09	40.69	13.08	56.81	100	0	P	V
													V
802.11ac VHT20 CH 165 5825MHz		11650	46.21	-27.79	74	52.27	39.7	10.54	56.3	100	0	P	H
		17475	49.67	-18.53	68.2	52.06	41.45	13.21	57.05	100	0	P	H
													H
													H
		11650	46.29	-27.71	74	52.35	39.7	10.54	56.3	100	0	P	V
		17475	49.27	-18.93	68.2	51.66	41.45	13.21	57.05	100	0	P	V
													V
Remark	1. No other spurious found.												
	2. All results are PASS against Peak and Average limit line.												



Band 4 5725~5850MHz
WIFI 802.11ac VHT40 (Band Edge @ 3m)

WIFI Ant. 1	Note	Frequency (MHz)	Level (dBμV/m)	Over Limit (dB)	Limit Line (dBμV/m)	Read Level (dBμV)	Antenna Factor (dB/m)	Path Loss (dB)	Preamp Factor (dB)	Ant Pos (cm)	Table Pos (deg)	Peak Avg. (P/A)	Pol. (H/V)
		5634.8	52.54	-15.66	68.2	43.86	31.9	6.33	29.55	100	247	P	H
		5699.6	58.01	-46.9	104.91	49.2	32	6.36	29.55	100	247	P	H
		5719.2	74.42	-36.16	110.58	65.56	32.04	6.37	29.55	100	247	P	H
		5722.8	76.13	-41.05	117.18	67.26	32.05	6.37	29.55	100	247	P	H
	*	5755	110.8	-	-	101.86	32.12	6.38	29.56	100	247	P	H
	*	5755	102.76	-	-	93.82	32.12	6.38	29.56	100	247	A	H
		5851.6	52.09	-66.46	118.55	42.81	32.4	6.44	29.56	100	247	P	H
		5857.4	52.95	-57.18	110.13	43.65	32.41	6.45	29.56	100	247	P	H
		5880.2	51.55	-49.79	101.34	42.19	32.46	6.46	29.56	100	247	P	H
		5944.4	50.83	-17.37	68.2	41.28	32.59	6.52	29.56	100	247	P	H
802.11ac													H
VHT40													H
CH 151		5633.4	49.56	-18.64	68.2	40.88	31.9	6.33	29.55	323	347	P	V
5755MHz		5697.6	53.4	-50.03	103.43	44.59	32	6.36	29.55	323	347	P	V
		5719.4	70.98	-39.65	110.63	62.12	32.04	6.37	29.55	323	347	P	V
		5725	71.94	-50.26	122.2	63.07	32.05	6.37	29.55	323	347	P	V
	*	5755	106.31	-	-	97.37	32.12	6.38	29.56	323	347	P	V
	*	5755	98.21	-	-	89.27	32.12	6.38	29.56	323	347	A	V
		5851.4	48.83	-70.18	119.01	39.55	32.4	6.44	29.56	323	347	P	V
		5855.4	50.29	-60.4	110.69	41	32.41	6.44	29.56	323	347	P	V
		5898.6	50.23	-37.47	87.7	40.81	32.5	6.48	29.56	323	347	P	V
		5931.8	49.65	-18.55	68.2	40.14	32.56	6.51	29.56	323	347	P	V
													V
													V



WIFI Ant. 1	Note	Frequency (MHz)	Level (dBμV/m)	Over Limit (dB)	Limit Line (dBμV/m)	Read Level (dBμV)	Antenna Factor (dB/m)	Path Loss (dB)	Preamp Factor (dB)	Ant Pos (cm)	Table Pos (deg)	Peak Avg. (P/A)	Pol. (H/V)
		5611.8	48.95	-19.25	68.2	40.28	31.9	6.32	29.55	101	233	P	H
		5684.6	50.13	-43.71	93.84	41.36	31.97	6.35	29.55	101	233	P	H
		5712.8	53.38	-55.41	108.79	44.53	32.03	6.37	29.55	101	233	P	H
		5724.4	55.64	-65.19	120.83	46.77	32.05	6.37	29.55	101	233	P	H
	*	5795	110.47	-	-	101.35	32.28	6.4	29.56	101	233	P	H
	*	5795	102.81	-	-	93.69	32.28	6.4	29.56	101	233	A	H
		5850.6	65.46	-55.37	120.83	56.18	32.4	6.44	29.56	101	233	P	H
		5857.2	63.19	-46.99	110.18	53.89	32.41	6.45	29.56	101	233	P	H
		5878.4	55.32	-47.35	102.67	45.96	32.46	6.46	29.56	101	233	P	H
		5936.4	52.08	-16.12	68.2	42.56	32.57	6.51	29.56	101	233	P	H
802.11ac													H
VHT40													H
CH 159		5623.4	49.6	-18.6	68.2	40.92	31.9	6.33	29.55	301	351	P	V
5795MHz		5683.8	49.7	-43.55	93.25	40.93	31.97	6.35	29.55	301	351	P	V
		5711	49.72	-58.56	108.28	40.89	32.02	6.36	29.55	301	351	P	V
		5724.8	51.34	-70.4	121.74	42.47	32.05	6.37	29.55	301	351	P	V
	*	5795	107.5	-	-	98.38	32.28	6.4	29.56	301	351	P	V
	*	5795	99.46	-	-	90.34	32.28	6.4	29.56	301	351	A	V
		5852.4	59.68	-57.05	116.73	50.4	32.4	6.44	29.56	301	351	P	V
		5857.2	56.56	-53.62	110.18	47.26	32.41	6.45	29.56	301	351	P	V
		5915.2	56.29	-19.14	75.43	46.83	32.53	6.49	29.56	301	351	P	V
		5944	50.03	-18.17	68.2	40.48	32.59	6.52	29.56	301	351	P	V
													V
													V
Remark	1. No other spurious found. 2. All results are PASS against Peak and Average limit line.												



Band 4 5725~5850MHz
WIFI 802.11ac VHT40 (Harmonic @ 3m)

WIFI Ant. 1	Note	Frequency (MHz)	Level (dBμV/m)	Over Limit (dB)	Limit Line (dBμV/m)	Read Level (dBμV)	Antenna Factor (dB/m)	Path Loss (dB)	Preamp Factor (dB)	Ant Pos (cm)	Table Pos (deg)	Peak Avg. (P/A)	Pol. (H/V)	
802.11ac VHT40 CH 151 5755MHz		11510	46.4	-27.6	74	52.14	40.09	10.47	56.3	100	0	P	H	
		17265	47.81	-20.39	68.2	51.27	40.19	12.98	56.63	100	0	P	H	
													H	
													H	
			11510	46.75	-27.25	74	52.49	40.09	10.47	56.3	100	0	P	V
			17265	48.04	-20.16	68.2	51.5	40.19	12.98	56.63	100	0	P	V
														V
802.11ac VHT40 CH 159 5795MHz		11590	47.16	-26.84	74	52.94	40.01	10.51	56.3	100	0	P	H	
		17385	49.13	-19.07	68.2	51.99	40.9	13.11	56.87	100	0	P	H	
													H	
													H	
			11590	46.2	-27.8	74	51.98	40.01	10.51	56.3	100	0	P	V
			17385	49.05	-19.15	68.2	51.91	40.9	13.11	56.87	100	0	P	V
														V
Remark	1. No other spurious found.													
	2. All results are PASS against Peak and Average limit line.													



Band 4 5725~5850MHz
WIFI 802.11ac VHT80 (Band Edge @ 3m)

WIFI Ant. 1	Note	Frequency (MHz)	Level (dBμV/m)	Over Limit (dB)	Limit Line (dBμV/m)	Read Level (dBμV)	Antenna Factor (dB/m)	Path Loss (dB)	Preamp Factor (dB)	Ant Pos (cm)	Table Pos (deg)	Peak Avg. (P/A)	Pol. (H/V)
		5647	55.45	-12.75	68.2	46.76	31.9	6.34	29.55	100	235	P	H
		5695	73.73	-27.78	101.51	64.93	31.99	6.36	29.55	100	235	P	H
		5717.8	77.14	-33.04	110.18	68.28	32.04	6.37	29.55	100	235	P	H
		5720.6	77.01	-35.16	112.17	68.15	32.04	6.37	29.55	100	235	P	H
	*	5775	107.68	-	-	98.65	32.2	6.39	29.56	100	235	P	H
	*	5775	100.35	-	-	91.32	32.2	6.39	29.56	100	235	A	H
		5851.4	81.08	-37.93	119.01	71.8	32.4	6.44	29.56	100	235	P	H
		5855.2	78.29	-32.45	110.74	69	32.41	6.44	29.56	100	235	P	H
		5876.4	72.92	-31.24	104.16	63.57	32.45	6.46	29.56	100	235	P	H
		5929.4	56.17	-12.03	68.2	46.67	32.56	6.5	29.56	100	235	P	H
802.11ac													H
VHT80													H
CH 155		5644.6	51.3	-16.9	68.2	42.61	31.9	6.34	29.55	317	349	P	V
5775MHz		5694.8	68.42	-32.95	101.37	59.62	31.99	6.36	29.55	317	349	P	V
		5718.8	70.78	-39.68	110.46	61.92	32.04	6.37	29.55	317	349	P	V
		5720.6	71.67	-40.5	112.17	62.81	32.04	6.37	29.55	317	349	P	V
	*	5775	104.05	-	-	95.02	32.2	6.39	29.56	317	349	P	V
	*	5775	97	-	-	87.97	32.2	6.39	29.56	317	349	A	V
		5853.8	74.93	-38.61	113.54	65.64	32.41	6.44	29.56	317	349	P	V
		5855.2	71.91	-38.83	110.74	62.62	32.41	6.44	29.56	317	349	P	V
		5879.8	66.17	-35.46	101.63	56.81	32.46	6.46	29.56	317	349	P	V
		5925.2	53.53	-14.67	68.2	44.04	32.55	6.5	29.56	317	349	P	V
													V
													V
Remark	1. No other spurious found. 2. All results are PASS against Peak and Average limit line.												



**Band 4 5725~5850MHz
WIFI 802.11ac VHT80 (Harmonic @ 3m)**

WIFI Ant. 1	Note	Frequency (MHz)	Level (dBμV/m)	Over Limit (dB)	Limit Line (dBμV/m)	Read Level (dBμV)	Antenna Factor (dB/m)	Path Loss (dB)	Preamp Factor (dB)	Ant Pos (cm)	Table Pos (deg)	Peak Avg. (P/A)	Pol. (H/V)	
802.11ac VHT80 CH 155 5775MHz		11550	46.57	-27.43	74	52.33	40.05	10.49	56.3	100	0	P	H	
		17325	47.92	-20.28	68.2	51.16	40.47	13.04	56.75	100	0	P	H	
													H	
													H	
			11550	46.19	-27.81	74	51.95	40.05	10.49	56.3	100	0	P	V
			17325	48.15	-20.05	68.2	51.39	40.47	13.04	56.75	100	0	P	V
														V
														V
Remark	1. No other spurious found. 2. All results are PASS against Peak and Average limit line.													



Emission below 1GHz

5GHz WIFI 802.11ac VHT80 (LF @ 3m)

WIFI	Note	Frequency	Level	Over	Limit	Read	Antenna	Path	Preamp	Ant	Table	Peak	Pol.	
Ant.				Limit	Line	Level	Factor	Loss	Factor	Pos	Pos	Avg.		
1		(MHz)	(dBμV/m)	(dB)	(dBμV/m)	(dBμV)	(dB/m)	(dB)	(dB)	(cm)	(deg)	(P/A)	(H/V)	
5GHz 802.11ac VHT80 LF		30	22.77	-17.23	40	29.9	24.7	0.45	32.29	-	-	P	H	
		61.04	23.17	-16.83	40	43.25	11.59	0.58	32.27	-	-	P	H	
		135.73	24.76	-18.74	43.5	38.7	17.23	0.93	32.18	-	-	P	H	
		305.48	28.81	-17.19	46	40.58	18.91	1.38	32.15	-	-	P	H	
		839.95	31.41	-14.59	46	31.93	28.6	2.42	31.7	-	-	P	H	
		950.53	33.26	-12.74	46	31.07	30.51	2.45	30.98	100	0	P	H	
													H	
													H	
													H	
													H	
													H	
													H	
													H	
													H	
													H	
			34.85	33.24	-6.76	40	42.67	22.39	0.45	32.29	100	0	P	V
			60.07	30.81	-9.19	40	50.88	11.6	0.58	32.27	-	-	P	V
			93.05	24.37	-19.13	43.5	40.92	14.9	0.72	32.22	-	-	P	V
		120.21	24.36	-19.14	43.5	38.51	17.1	0.88	32.2	-	-	P	V	
		159.98	25.67	-17.83	43.5	40.66	16.1	0.98	32.17	-	-	P	V	
		954.41	33.08	-12.92	46	30.77	30.59	2.46	30.95	-	-	P	V	
													V	
													V	
													V	
													V	
													V	
													V	
Remark	1. No other spurious found. 2. All results are PASS against limit line.													



Band 4 - 5725~5850MHz
WIFI 802.11a (Band Edge @ 3m)

WIFI	Note	Frequency	Level	Over	Limit	Read	Antenna	Path	Preamp	Ant	Table	Peak	Pol.	
Ant.				Limit	Line	Level	Factor	Loss	Factor	Pos	Pos	Avg.		
2		(MHz)	(dBμV/m)	(dB)	(dBμV/m)	(dBμV)	(dB/m)	(dB)	(dB)	(cm)	(deg)	(P/A)	(H/V)	
802.11a CH 149 5745MHz		5641.4	50.13	-18.07	68.2	41.44	31.9	6.34	29.55	100	294	P	H	
		5698.6	54.19	-49.98	104.17	45.38	32	6.36	29.55	100	294	P	H	
		5720	62.64	-48.16	110.8	53.78	32.04	6.37	29.55	100	294	P	H	
		5724.8	75.22	-46.52	121.74	66.35	32.05	6.37	29.55	100	294	P	H	
	*	5745	113.12	-	-	104.2	32.09	6.38	29.55	100	294	P	H	
	*	5745	105.7	-	-	96.78	32.09	6.38	29.55	100	294	A	H	
														H
														H
			5649	49.97	-18.23	68.2	41.28	31.9	6.34	29.55	355	164	P	V
			5689.2	51.7	-45.54	97.24	42.91	31.98	6.36	29.55	355	164	P	V
			5719.6	55.84	-54.85	110.69	46.98	32.04	6.37	29.55	355	164	P	V
			5724.4	69.43	-51.4	120.83	60.56	32.05	6.37	29.55	355	164	P	V
	*		5745	110.32	-	-	101.4	32.09	6.38	29.55	355	164	P	V
	*		5745	102.76	-	-	93.84	32.09	6.38	29.55	355	164	A	V
														V
													V	



WIFI Ant. 2	Note	Frequency (MHz)	Level (dBµV/m)	Over Limit (dB)	Limit Line (dBµV/m)	Read Level (dBµV)	Antenna Factor (dB/m)	Path Loss (dB)	Preamp Factor (dB)	Ant Pos (cm)	Table Pos (deg)	Peak Avg. (P/A)	Pol. (H/V)
		5639.2	50.05	-18.15	68.2	41.36	31.9	6.34	29.55	100	291	P	H
		5691	49.88	-48.68	98.56	41.09	31.98	6.36	29.55	100	291	P	H
		5708	53.34	-54.1	107.44	44.51	32.02	6.36	29.55	100	291	P	H
		5723	52.43	-65.21	117.64	43.56	32.05	6.37	29.55	100	291	P	H
	*	5785	112.49	-	-	103.42	32.24	6.39	29.56	100	291	P	H
	*	5785	104.99	-	-	95.92	32.24	6.39	29.56	100	291	A	H
		5854.8	52.46	-58.8	111.26	43.17	32.41	6.44	29.56	100	291	P	H
		5861.2	52.85	-56.21	109.06	43.54	32.42	6.45	29.56	100	291	P	H
		5884.8	51.97	-45.95	97.92	42.59	32.47	6.47	29.56	100	291	P	H
		5928.2	51.31	-16.89	68.2	41.81	32.56	6.5	29.56	100	291	P	H
													H
													H
802.11a													
CH 157													
5785MHz		5614.8	49.16	-19.04	68.2	40.48	31.9	6.33	29.55	355	156	P	V
		5697.4	50.95	-52.33	103.28	42.15	31.99	6.36	29.55	355	156	P	V
		5717	50.88	-59.08	109.96	42.03	32.03	6.37	29.55	355	156	P	V
		5720.6	50.8	-61.37	112.17	41.94	32.04	6.37	29.55	355	156	P	V
	*	5785	110.08	-	-	101.01	32.24	6.39	29.56	355	156	P	V
	*	5785	102.49	-	-	93.42	32.24	6.39	29.56	355	156	A	V
		5852.2	50.37	-66.81	117.18	41.09	32.4	6.44	29.56	355	156	P	V
		5857	50.99	-59.25	110.24	41.69	32.41	6.45	29.56	355	156	P	V
		5875.2	50.97	-54.08	105.05	41.62	32.45	6.46	29.56	355	156	P	V
		5934.8	49.22	-18.98	68.2	39.7	32.57	6.51	29.56	355	156	P	V
													V
													V



WIFI Ant. 2	Note	Frequency (MHz)	Level (dBμV/m)	Over Limit (dB)	Limit Line (dBμV/m)	Read Level (dBμV)	Antenna Factor (dB/m)	Path Loss (dB)	Preamp Factor (dB)	Ant Pos (cm)	Table Pos (deg)	Peak Avg. (P/A)	Pol. (H/V)	
802.11a CH 165 5825MHz	*	5825	111.8	-	-	102.59	32.35	6.42	29.56	100	291	P	H	
	*	5825	104.82	-	-	95.61	32.35	6.42	29.56	100	291	A	H	
		5850	58.37	-63.83	122.2	49.09	32.4	6.44	29.56	100	291	P	H	
		5857.4	54.9	-55.23	110.13	45.6	32.41	6.45	29.56	100	291	P	H	
		5875.2	53.51	-51.54	105.05	44.16	32.45	6.46	29.56	100	291	P	H	
		5928.8	50.56	-17.64	68.2	41.06	32.56	6.5	29.56	100	291	P	H	
														H
														H
	*	5825	109.74	-	-	100.53	32.35	6.42	29.56	332	156	P	V	
	*	5825	102.12	-	-	92.91	32.35	6.42	29.56	332	156	A	V	
		5850.2	55.04	-66.7	121.74	45.76	32.4	6.44	29.56	332	156	P	V	
		5857.6	52.79	-57.28	110.07	43.48	32.42	6.45	29.56	332	156	P	V	
		5878.6	51.75	-50.78	102.53	42.39	32.46	6.46	29.56	332	156	P	V	
		5941.4	49.97	-18.23	68.2	40.44	32.58	6.51	29.56	332	156	P	V	
														V
														V
													V	
Remark	1. No other spurious found. 2. All results are PASS against Peak and Average limit line.													



Band 4 5725~5850MHz
WIFI 802.11a (Harmonic @ 3m)

WIFI Ant. 2	Note	Frequency (MHz)	Level (dBµV/m)	Over Limit (dB)	Limit Line (dBµV/m)	Read Level (dBµV)	Antenna Factor (dB/m)	Path Loss (dB)	Preamp Factor (dB)	Ant Pos (cm)	Table Pos (deg)	Peak Avg. (P/A)	Pol. (H/V)	
802.11a CH 149 5745MHz		11490	47.2	-26.8	74	52.96	40.08	10.46	56.3	100	0	P	H	
		17235	47.87	-20.33	68.2	51.39	40.1	12.95	56.57	100	0	P	H	
													H	
													H	
			11490	46.7	-27.3	74	52.46	40.08	10.46	56.3	100	0	P	V
			17235	47.95	-20.25	68.2	51.47	40.1	12.95	56.57	100	0	P	V
														V
														V
802.11a CH 157 5785MHz		11570	46.15	-27.85	74	51.92	40.03	10.5	56.3	100	0	P	H	
		17355	48.89	-19.31	68.2	51.93	40.69	13.08	56.81	100	0	P	H	
													H	
													H	
			11570	46.67	-27.33	74	52.44	40.03	10.5	56.3	100	0	P	V
			17355	48.71	-19.49	68.2	51.75	40.69	13.08	56.81	100	0	P	V
														V
														V
802.11a CH 165 5825MHz		11650	46.99	-27.01	74	53.05	39.7	10.54	56.3	100	0	P	H	
		17475	49.35	-18.85	68.2	51.74	41.45	13.21	57.05	100	0	P	H	
													H	
													H	
			11650	46.98	-27.02	74	53.04	39.7	10.54	56.3	100	0	P	V
			17475	49.8	-18.4	68.2	52.19	41.45	13.21	57.05	100	0	P	V
														V
														V
Remark	1. No other spurious found. 2. All results are PASS against Peak and Average limit line.													



Band 4 5725~5850MHz
WIFI 802.11ac VHT20 (Band Edge @ 3m)

WIFI Ant. 2	Note	Frequency (MHz)	Level (dBμV/m)	Over Limit (dB)	Limit Line (dBμV/m)	Read Level (dBμV)	Antenna Factor (dB/m)	Path Loss (dB)	Preamp Factor (dB)	Ant Pos (cm)	Table Pos (deg)	Peak Avg. (P/A)	Pol. (H/V)	
802.11ac VHT20 CH 149 5745MHz		5648.8	50.43	-17.77	68.2	41.74	31.9	6.34	29.55	100	294	P	H	
		5698	53.4	-50.33	103.73	44.59	32	6.36	29.55	100	294	P	H	
		5719.6	64.37	-46.32	110.69	55.51	32.04	6.37	29.55	100	294	P	H	
		5724.6	76.34	-44.95	121.29	67.47	32.05	6.37	29.55	100	294	P	H	
	*	5745	112.43	-	-	103.51	32.09	6.38	29.55	100	294	P	H	
	*	5745	105.12	-	-	96.2	32.09	6.38	29.55	100	294	A	H	
														H
														H
			5646.4	50.11	-18.09	68.2	41.42	31.9	6.34	29.55	356	162	P	V
			5690.6	51.5	-46.77	98.27	42.71	31.98	6.36	29.55	356	162	P	V
			5719.6	61.1	-49.59	110.69	52.24	32.04	6.37	29.55	356	162	P	V
			5724.6	72.75	-48.54	121.29	63.88	32.05	6.37	29.55	356	162	P	V
	*		5745	109.34	-	-	100.42	32.09	6.38	29.55	356	162	P	V
	*		5745	102.12	-	-	93.2	32.09	6.38	29.55	356	162	A	V
													V	
													V	



WIFI Ant. 2	Note	Frequency (MHz)	Level (dBμV/m)	Over Limit (dB)	Limit Line (dBμV/m)	Read Level (dBμV)	Antenna Factor (dB/m)	Path Loss (dB)	Preamp Factor (dB)	Ant Pos (cm)	Table Pos (deg)	Peak Avg. (P/A)	Pol. (H/V)
		5643	50.19	-18.01	68.2	41.5	31.9	6.34	29.55	114	290	P	H
		5699.4	50.8	-53.96	104.76	41.99	32	6.36	29.55	114	290	P	H
		5708.2	52.33	-55.17	107.5	43.5	32.02	6.36	29.55	114	290	P	H
		5722.4	52.23	-64.04	116.27	43.37	32.04	6.37	29.55	114	290	P	H
	*	5785	112.19	-	-	103.12	32.24	6.39	29.56	114	290	P	H
	*	5785	104.97	-	-	95.9	32.24	6.39	29.56	114	290	A	H
		5854	53.37	-59.71	113.08	44.08	32.41	6.44	29.56	114	290	P	H
		5859.4	52.81	-56.76	109.57	43.5	32.42	6.45	29.56	114	290	P	H
		5886	50.31	-46.72	97.03	40.93	32.47	6.47	29.56	114	290	P	H
		5947.2	50.74	-17.46	68.2	41.19	32.59	6.52	29.56	114	290	P	H
802.11ac													H
VHT20													H
CH 157		5610	48.98	-19.22	68.2	40.31	31.9	6.32	29.55	357	154	P	V
5785MHz		5698.2	49.34	-54.53	103.87	40.53	32	6.36	29.55	357	154	P	V
		5712.4	50.43	-58.24	108.67	41.6	32.02	6.36	29.55	357	154	P	V
		5720.6	49.86	-62.31	112.17	41	32.04	6.37	29.55	357	154	P	V
	*	5785	109.65	-	-	100.58	32.24	6.39	29.56	357	154	P	V
	*	5785	102.3	-	-	93.23	32.24	6.39	29.56	357	154	A	V
		5852.8	52.13	-63.69	115.82	42.84	32.41	6.44	29.56	357	154	P	V
		5869.4	50.43	-56.34	106.77	41.09	32.44	6.46	29.56	357	154	P	V
		5878	50.19	-52.78	102.97	40.83	32.46	6.46	29.56	357	154	P	V
		5930.6	49.78	-18.42	68.2	40.28	32.56	6.5	29.56	357	154	P	V
													V
													V



WIFI Ant. 2	Note	Frequency (MHz)	Level (dBμV/m)	Over Limit (dB)	Limit Line (dBμV/m)	Read Level (dBμV)	Antenna Factor (dB/m)	Path Loss (dB)	Preamp Factor (dB)	Ant Pos (cm)	Table Pos (deg)	Peak Avg. (P/A)	Pol. (H/V)	
802.11ac VHT20 CH 165 5825MHz	*	5825	111.82	-	-	102.61	32.35	6.42	29.56	100	292	P	H	
	*	5825	104.29	-	-	95.08	32.35	6.42	29.56	100	292	A	H	
		5850.2	63.53	-58.21	121.74	54.25	32.4	6.44	29.56	100	292	P	H	
		5857.2	54.66	-55.52	110.18	45.36	32.41	6.45	29.56	100	292	P	H	
		5892.4	53.22	-39.07	92.29	43.83	32.48	6.47	29.56	100	292	P	H	
		5941.4	50.56	-17.64	68.2	41.03	32.58	6.51	29.56	100	292	P	H	
														H
														H
	*	5825	109.34	-	-	100.13	32.35	6.42	29.56	328	157	P	V	
	*	5825	101.87	-	-	92.66	32.35	6.42	29.56	328	157	A	V	
		5850	61.95	-60.25	122.2	52.67	32.4	6.44	29.56	328	157	P	V	
		5859	53.4	-56.28	109.68	44.09	32.42	6.45	29.56	328	157	P	V	
		5879	52.57	-49.66	102.23	43.21	32.46	6.46	29.56	328	157	P	V	
		5942.4	49.66	-18.54	68.2	40.13	32.58	6.51	29.56	328	157	P	V	
														V
														V
Remark	1. No other spurious found. 2. All results are PASS against Peak and Average limit line.													



Band 4 5725~5850MHz
WIFI 802.11ac VHT20 (Harmonic @ 3m)

WIFI Ant. 2	Note	Frequency (MHz)	Level (dBμV/m)	Over Limit (dB)	Limit Line (dBμV/m)	Read Level (dBμV)	Antenna Factor (dB/m)	Path Loss (dB)	Preamp Factor (dB)	Ant Pos (cm)	Table Pos (deg)	Peak Avg. (P/A)	Pol. (H/V)	
802.11ac VHT20 CH 149 5745MHz		11490	46.29	-27.71	74	52.05	40.08	10.46	56.3	100	0	P	H	
		17235	47.7	-20.5	68.2	51.22	40.1	12.95	56.57	100	0	P	H	
													H	
													H	
			11490	47.4	-26.6	74	53.16	40.08	10.46	56.3	100	0	P	V
			17235	48.26	-19.94	68.2	51.78	40.1	12.95	56.57	100	0	P	V
														V
802.11ac VHT20 CH 157 5785MHz		11570	46.51	-27.49	74	52.28	40.03	10.5	56.3	100	0	P	H	
		17355	49.46	-18.74	68.2	52.5	40.69	13.08	56.81	100	0	P	H	
													H	
													H	
			11570	47.1	-26.9	74	52.87	40.03	10.5	56.3	100	0	P	V
			17355	48.44	-19.76	68.2	51.48	40.69	13.08	56.81	100	0	P	V
														V
802.11ac VHT20 CH 165 5825MHz		11650	46.42	-27.58	74	52.48	39.7	10.54	56.3	100	0	P	H	
		17475	49.8	-18.4	68.2	52.19	41.45	13.21	57.05	100	0	P	H	
													H	
													H	
			11650	47.58	-26.42	74	53.64	39.7	10.54	56.3	100	0	P	V
			17475	49.48	-18.72	68.2	51.87	41.45	13.21	57.05	100	0	P	V
														V
Remark	1. No other spurious found.													
	2. All results are PASS against Peak and Average limit line.													



Band 4 5725~5850MHz
WIFI 802.11ac VHT40 (Band Edge @ 3m)

WIFI Ant. 2	Note	Frequency (MHz)	Level (dBμV/m)	Over Limit (dB)	Limit Line (dBμV/m)	Read Level (dBμV)	Antenna Factor (dB/m)	Path Loss (dB)	Preamp Factor (dB)	Ant Pos (cm)	Table Pos (deg)	Peak Avg. (P/A)	Pol. (H/V)	
		5628.4	51.72	-16.48	68.2	43.04	31.9	6.33	29.55	100	294	P	H	
		5698	56.51	-47.22	103.73	47.7	32	6.36	29.55	100	294	P	H	
		5717.6	74.68	-35.45	110.13	65.82	32.04	6.37	29.55	100	294	P	H	
		5723.8	75.09	-44.37	119.46	66.22	32.05	6.37	29.55	100	294	P	H	
	*	5755	110.5	-	-	101.56	32.12	6.38	29.56	100	294	P	H	
	*	5755	101.86	-	-	92.92	32.12	6.38	29.56	100	294	A	H	
		5850	51.98	-70.22	122.2	42.7	32.4	6.44	29.56	100	294	P	H	
		5859.8	52.21	-57.24	109.45	42.9	32.42	6.45	29.56	100	294	P	H	
		5882.8	50.71	-48.7	99.41	41.33	32.47	6.47	29.56	100	294	P	H	
		5931.8	51.71	-16.49	68.2	42.2	32.56	6.51	29.56	100	294	P	H	
802.11ac VHT40 CH 151 5755MHz													H	
													H	
			5650	49.31	-18.89	68.2	40.62	31.9	6.34	29.55	306	163	P	V
			5699	53.79	-50.67	104.46	44.98	32	6.36	29.55	306	163	P	V
			5719.4	71.69	-38.94	110.63	62.83	32.04	6.37	29.55	306	163	P	V
			5724	73.17	-46.75	119.92	64.3	32.05	6.37	29.55	306	163	P	V
		*	5755	104.61	-	-	95.67	32.12	6.38	29.56	306	163	P	V
		*	5755	99.06	-	-	90.12	32.12	6.38	29.56	306	163	A	V
			5851	50.17	-69.75	119.92	40.89	32.4	6.44	29.56	306	163	P	V
			5859.8	50.63	-58.82	109.45	41.32	32.42	6.45	29.56	306	163	P	V
			5894.6	49.95	-40.71	90.66	40.54	32.49	6.48	29.56	306	163	P	V
			5934.4	49.69	-18.51	68.2	40.17	32.57	6.51	29.56	306	163	P	V
														V
														V



WIFI Ant. 2	Note	Frequency (MHz)	Level (dBµV/m)	Over Limit (dB)	Limit Line (dBµV/m)	Read Level (dBµV)	Antenna Factor (dB/m)	Path Loss (dB)	Preamp Factor (dB)	Ant Pos (cm)	Table Pos (deg)	Peak Avg. (P/A)	Pol. (H/V)
		5641.2	49.86	-18.34	68.2	41.17	31.9	6.34	29.55	107	291	P	H
		5691	52.08	-46.48	98.56	43.29	31.98	6.36	29.55	107	291	P	H
		5712.8	53.36	-55.43	108.79	44.51	32.03	6.37	29.55	107	291	P	H
		5721.8	54.1	-60.8	114.9	45.24	32.04	6.37	29.55	107	291	P	H
	*	5795	109.7	-	-	100.58	32.28	6.4	29.56	107	291	P	H
	*	5795	101.63	-	-	92.51	32.28	6.4	29.56	107	291	A	H
		5851.6	56.56	-61.99	118.55	47.28	32.4	6.44	29.56	107	291	P	H
		5855	55.01	-55.79	110.8	45.72	32.41	6.44	29.56	107	291	P	H
		5875.6	52.54	-52.21	104.75	43.19	32.45	6.46	29.56	107	291	P	H
		5926	50.07	-18.13	68.2	40.58	32.55	6.5	29.56	107	291	P	H
802.11ac													H
VHT40													H
CH 159		5634.6	49.46	-18.74	68.2	40.78	31.9	6.33	29.55	314	164	P	V
5795MHz		5663.2	50.08	-27.92	78	41.35	31.93	6.35	29.55	314	164	P	V
		5719.8	51.76	-58.98	110.74	42.9	32.04	6.37	29.55	314	164	P	V
		5722.6	52.32	-64.41	116.73	43.45	32.05	6.37	29.55	314	164	P	V
	*	5795	107.43	-	-	98.31	32.28	6.4	29.56	314	164	P	V
	*	5795	99.37	-	-	90.25	32.28	6.4	29.56	314	164	A	V
		5854.2	54.61	-58.01	112.62	45.32	32.41	6.44	29.56	314	164	P	V
		5860.8	52.69	-56.48	109.17	43.38	32.42	6.45	29.56	314	164	P	V
		5878	52.09	-50.88	102.97	42.73	32.46	6.46	29.56	314	164	P	V
		5928.4	49.71	-18.49	68.2	40.21	32.56	6.5	29.56	314	164	P	V
													V
													V
Remark	1. No other spurious found. 2. All results are PASS against Peak and Average limit line.												



Band 4 5725~5850MHz
WIFI 802.11ac VHT40 (Harmonic @ 3m)

WIFI Ant. 2	Note	Frequency (MHz)	Level (dBμV/m)	Over Limit (dB)	Limit Line (dBμV/m)	Read Level (dBμV)	Antenna Factor (dB/m)	Path Loss (dB)	Preamp Factor (dB)	Ant Pos (cm)	Table Pos (deg)	Peak Avg. (P/A)	Pol. (H/V)	
802.11ac VHT40 CH 151 5755MHz		11510	47.21	-26.79	74	52.95	40.09	10.47	56.3	100	0	P	H	
		17265	47.84	-20.36	68.2	51.3	40.19	12.98	56.63	100	0	P	H	
													H	
													H	
			11510	47.44	-26.56	74	53.18	40.09	10.47	56.3	100	0	P	V
			17265	47.67	-20.53	68.2	51.13	40.19	12.98	56.63	100	0	P	V
														V
														V
802.11ac VHT40 CH 159 5795MHz		11590	46.98	-27.02	74	52.76	40.01	10.51	56.3	100	0	P	H	
		17385	48.62	-19.58	68.2	51.48	40.9	13.11	56.87	100	0	P	H	
													H	
													H	
			11590	46.11	-27.89	74	51.89	40.01	10.51	56.3	100	0	P	V
			17385	49.95	-18.25	68.2	52.81	40.9	13.11	56.87	100	0	P	V
														V
														V
Remark	1. No other spurious found. 2. All results are PASS against Peak and Average limit line.													



Band 4 5725~5850MHz
WIFI 802.11ac VHT80 (Band Edge @ 3m)

WIFI Ant. 2	Note	Frequency (MHz)	Level (dBμV/m)	Over Limit (dB)	Limit Line (dBμV/m)	Read Level (dBμV)	Antenna Factor (dB/m)	Path Loss (dB)	Preamp Factor (dB)	Ant Pos (cm)	Table Pos (deg)	Peak Avg. (P/A)	Pol. (H/V)
		5646	53.98	-14.22	68.2	45.29	31.9	6.34	29.55	100	289	P	H
		5695	72.78	-28.73	101.51	63.98	31.99	6.36	29.55	100	289	P	H
		5719	75.1	-35.42	110.52	66.24	32.04	6.37	29.55	100	289	P	H
		5723	75.47	-42.17	117.64	66.6	32.05	6.37	29.55	100	289	P	H
	*	5775	107.99	-	-	98.96	32.2	6.39	29.56	100	289	P	H
	*	5775	99	-	-	89.97	32.2	6.39	29.56	100	289	A	H
		5853.6	72.88	-41.11	113.99	63.59	32.41	6.44	29.56	100	289	P	H
		5861	71.71	-37.41	109.12	62.4	32.42	6.45	29.56	100	289	P	H
		5875	64.44	-40.76	105.2	55.09	32.45	6.46	29.56	100	289	P	H
		5927	51.15	-17.05	68.2	41.66	32.55	6.5	29.56	100	289	P	H
802.11ac													H
VHT80													H
CH 155		5649.8	51.31	-16.89	68.2	42.62	31.9	6.34	29.55	334	160	P	V
5775MHz		5698.6	69.48	-34.69	104.17	60.67	32	6.36	29.55	334	160	P	V
		5718.4	72.45	-37.9	110.35	63.59	32.04	6.37	29.55	334	160	P	V
		5724	72.68	-47.24	119.92	63.81	32.05	6.37	29.55	334	160	P	V
	*	5775	104.81	-	-	95.78	32.2	6.39	29.56	334	160	P	V
	*	5775	96.85	-	-	87.82	32.2	6.39	29.56	334	160	A	V
		5854	69.36	-43.72	113.08	60.07	32.41	6.44	29.56	334	160	P	V
		5858.2	67.11	-42.79	109.9	57.8	32.42	6.45	29.56	334	160	P	V
		5875	62.95	-42.25	105.2	53.6	32.45	6.46	29.56	334	160	P	V
		5933.6	50.53	-17.67	68.2	41.01	32.57	6.51	29.56	334	160	P	V
													V
													V
Remark	1. No other spurious found. 2. All results are PASS against Peak and Average limit line.												



**Band 4 5725~5850MHz
WIFI 802.11ac VHT80 (Harmonic @ 3m)**

WIFI Ant. 2	Note	Frequency (MHz)	Level (dBμV/m)	Over Limit (dB)	Limit Line (dBμV/m)	Read Level (dBμV)	Antenna Factor (dB/m)	Path Loss (dB)	Preamp Factor (dB)	Ant Pos (cm)	Table Pos (deg)	Peak Avg. (P/A)	Pol. (H/V)	
802.11ac VHT80 CH 155 5775MHz		11550	47.58	-26.42	74	53.34	40.05	10.49	56.3	100	0	P	H	
		17325	47.8	-20.4	68.2	51.04	40.47	13.04	56.75	100	0	P	H	
													H	
													H	
			11550	45.77	-28.23	74	51.53	40.05	10.49	56.3	100	0	P	V
			17325	48.13	-20.07	68.2	51.37	40.47	13.04	56.75	100	0	P	V
														V
														V
Remark	1. No other spurious found. 2. All results are PASS against Peak and Average limit line.													



Emission below 1GHz

5GHz WIFI 802.11ac VHT80 (LF @ 3m)

WIFI	Note	Frequency	Level	Over	Limit	Read	Antenna	Path	Preamp	Ant	Table	Peak	Pol.	
Ant.				Limit	Line	Level	Factor	Loss	Factor	Pos	Pos	Avg.		
2		(MHz)	(dBμV/m)	(dB)	(dBμV/m)	(dBμV)	(dB/m)	(dB)	(dB)	(cm)	(deg)	(P/A)	(H/V)	
5GHz 802.11ac VHT80 LF		33.88	22.98	-17.02	40	31.88	22.92	0.45	32.29	-	-	P	H	
		136.7	24.19	-19.31	43.5	38.16	17.2	0.93	32.18	-	-	P	H	
		159.98	23.67	-19.83	43.5	38.66	16.1	0.98	32.17	-	-	P	H	
		293.84	28.45	-17.55	46	40.38	18.78	1.35	32.15	-	-	P	H	
		774.96	30.75	-15.25	46	32.52	27.8	2.23	31.94	-	-	P	H	
		955.38	33.76	-12.24	46	31.42	30.61	2.46	30.94	100	0	P	H	
														H
														H
														H
														H
														H
														H
														H
														H
														H
			33.88	33.22	-6.78	40	42.12	22.92	0.45	32.29	100	0	P	V
			60.07	32.18	-7.82	40	52.25	11.6	0.58	32.27	-	-	P	V
			103.72	24.6	-18.9	43.5	39.98	15.97	0.8	32.21	-	-	P	V
		159.98	24.94	-18.56	43.5	39.93	16.1	0.98	32.17	-	-	P	V	
		578.05	27.76	-18.24	46	32.51	25.4	1.97	32.22	-	-	P	V	
		957.32	33.15	-12.85	46	30.74	30.65	2.46	30.92	-	-	P	V	
													V	
													V	
													V	
													V	
													V	
													V	
Remark	1. No other spurious found. 2. All results are PASS against limit line.													



Band 4 - 5725~5850MHz
WIFI 802.11a (Band Edge @ 3m)

WIFI	Note	Frequency	Level	Over	Limit	Read	Antenna	Path	Preamp	Ant	Table	Peak	Pol.	
Ant.				Limit	Line	Level	Factor	Loss	Factor	Pos	Pos	Avg.		
1+2		(MHz)	(dBμV/m)	(dB)	(dBμV/m)	(dBμV)	(dB/m)	(dB)	(dB)	(cm)	(deg)	(P/A)	(H/V)	
802.11a CH 149 5745MHz		5647.2	50.65	-17.55	68.2	41.96	31.9	6.34	29.55	108	233	P	H	
		5699.4	52.95	-51.81	104.76	44.14	32	6.36	29.55	108	233	P	H	
		5719.6	62.21	-48.48	110.69	53.35	32.04	6.37	29.55	108	233	P	H	
		5725	77.05	-45.15	122.2	68.18	32.05	6.37	29.55	108	233	P	H	
	*	5745	116.67	-	-	107.75	32.09	6.38	29.55	108	233	P	H	
	*	5745	109.57	-	-	100.65	32.09	6.38	29.55	108	233	A	H	
														H
														H
			5646.6	49.65	-18.55	68.2	40.96	31.9	6.34	29.55	343	161	P	V
			5684.4	50.43	-43.26	93.69	41.66	31.97	6.35	29.55	343	161	P	V
			5718	57.25	-52.99	110.24	48.39	32.04	6.37	29.55	343	161	P	V
			5723.2	67.11	-50.99	118.1	58.24	32.05	6.37	29.55	343	161	P	V
	*		5745	112.02	-	-	103.1	32.09	6.38	29.55	343	161	P	V
	*		5745	105.29	-	-	96.37	32.09	6.38	29.55	343	161	A	V
														V
														V



WIFI Ant. 1+2	Note	Frequency (MHz)	Level (dBµV/m)	Over Limit (dB)	Limit Line (dBµV/m)	Read Level (dBµV)	Antenna Factor (dB/m)	Path Loss (dB)	Preamp Factor (dB)	Ant Pos (cm)	Table Pos (deg)	Peak Avg. (P/A)	Pol. (H/V)	
802.11a CH 157 5785MHz		5616.2	49.92	-18.28	68.2	41.24	31.9	6.33	29.55	100	232	P	H	
		5698.4	50.8	-53.22	104.02	41.99	32	6.36	29.55	100	232	P	H	
		5709.4	52.08	-55.75	107.83	43.25	32.02	6.36	29.55	100	232	P	H	
		5724.8	51.93	-69.81	121.74	43.06	32.05	6.37	29.55	100	232	P	H	
	*	5785	116.87	-	-	107.8	32.24	6.39	29.56	100	232	P	H	
	*	5785	109.64	-	-	100.57	32.24	6.39	29.56	100	232	A	H	
		5854.4	51.88	-60.29	112.17	42.59	32.41	6.44	29.56	100	232	P	H	
		5858	53.38	-56.58	109.96	44.07	32.42	6.45	29.56	100	232	P	H	
		5880.4	51.87	-49.32	101.19	42.51	32.46	6.46	29.56	100	232	P	H	
		5926.8	49.79	-18.41	68.2	40.3	32.55	6.5	29.56	100	232	P	H	
														H
														H
			5611.6	48.36	-19.84	68.2	39.69	31.9	6.32	29.55	357	160	P	V
			5685.2	49.46	-44.82	94.28	40.69	31.97	6.35	29.55	357	160	P	V
			5707	50.72	-56.44	107.16	41.9	32.01	6.36	29.55	357	160	P	V
			5721.8	49.94	-64.96	114.9	41.08	32.04	6.37	29.55	357	160	P	V
	*		5785	112.06	-	-	102.99	32.24	6.39	29.56	357	160	P	V
	*		5785	105.09	-	-	96.02	32.24	6.39	29.56	357	160	A	V
			5854.4	49.73	-62.44	112.17	40.44	32.41	6.44	29.56	357	160	P	V
			5869	50.37	-56.51	106.88	41.03	32.44	6.46	29.56	357	160	P	V
		5887.4	50.49	-45.5	95.99	41.11	32.47	6.47	29.56	357	160	P	V	
		5925.4	48.63	-19.57	68.2	39.14	32.55	6.5	29.56	357	160	P	V	
													V	
													V	



WiFi Ant. 1+2	Note	Frequency (MHz)	Level (dBμV/m)	Over Limit (dB)	Limit Line (dBμV/m)	Read Level (dBμV)	Antenna Factor (dB/m)	Path Loss (dB)	Preamp Factor (dB)	Ant Pos (cm)	Table Pos (deg)	Peak Avg. (P/A)	Pol. (H/V)	
802.11a CH 165 5825MHz	*	5825	116.41	-	-	107.2	32.35	6.42	29.56	100	233	P	H	
	*	5825	109.16	-	-	99.95	32.35	6.42	29.56	100	233	A	H	
		5850	68.4	-53.8	122.2	59.12	32.4	6.44	29.56	100	233	P	H	
		5855.2	62.01	-48.73	110.74	52.72	32.41	6.44	29.56	100	233	P	H	
		5877.2	53.45	-50.12	103.57	44.1	32.45	6.46	29.56	100	233	P	H	
		5929.8	50.65	-17.55	68.2	41.15	32.56	6.5	29.56	100	233	P	H	
														H
														H
	*	5825	112.71	-	-	103.5	32.35	6.42	29.56	330	173	P	V	
	*	5825	105.43	-	-	96.22	32.35	6.42	29.56	330	173	A	V	
		5852	61.54	-56.1	117.64	52.26	32.4	6.44	29.56	330	173	P	V	
		5857.2	54.26	-55.92	110.18	44.96	32.41	6.45	29.56	330	173	P	V	
		5882.2	51.57	-48.28	99.85	42.2	32.46	6.47	29.56	330	173	P	V	
		5927.8	49.77	-18.43	68.2	40.27	32.56	6.5	29.56	330	173	P	V	
														V
														V
													V	
Remark	1. No other spurious found. 2. All results are PASS against Peak and Average limit line.													



Band 4 5725~5850MHz
WIFI 802.11a (Harmonic @ 3m)

WIFI Ant. 1+2	Note	Frequency (MHz)	Level (dBμV/m)	Over Limit (dB)	Limit Line (dBμV/m)	Read Level (dBμV)	Antenna Factor (dB/m)	Path Loss (dB)	Preamp Factor (dB)	Ant Pos (cm)	Table Pos (deg)	Peak Avg. (P/A)	Pol. (H/V)	
802.11a CH 149 5745MHz		11490	46.95	-27.05	74	52.71	40.08	10.46	56.3	100	0	P	H	
		17235	47.81	-20.39	68.2	51.33	40.1	12.95	56.57	100	0	P	H	
													H	
													H	
			11490	47.25	-26.75	74	53.01	40.08	10.46	56.3	100	0	P	V
			17235	47.6	-20.6	68.2	51.12	40.1	12.95	56.57	100	0	P	V
														V
														V
802.11a CH 157 5785MHz		11570	46.57	-27.43	74	52.34	40.03	10.5	56.3	100	0	P	H	
		17355	48.03	-20.17	68.2	51.07	40.69	13.08	56.81	100	0	P	H	
													H	
													H	
			11570	47.11	-26.89	74	52.88	40.03	10.5	56.3	100	0	P	V
			17355	48.2	-20	68.2	51.24	40.69	13.08	56.81	100	0	P	V
														V
														V
802.11a CH 165 5825MHz		11650	47.35	-26.65	74	53.41	39.7	10.54	56.3	100	0	P	H	
		17475	49.75	-18.45	68.2	52.14	41.45	13.21	57.05	100	0	P	H	
													H	
													H	
			11650	46.99	-27.01	74	53.05	39.7	10.54	56.3	100	0	P	V
			17475	50.13	-18.07	68.2	52.52	41.45	13.21	57.05	100	0	P	V
														V
														V
Remark	1. No other spurious found. 2. All results are PASS against Peak and Average limit line.													



Band 4 5725~5850MHz
WIFI 802.11ac VHT20 (Band Edge @ 3m)

WIFI Ant. 1+2	Note	Frequency (MHz)	Level (dBμV/m)	Over Limit (dB)	Limit Line (dBμV/m)	Read Level (dBμV)	Antenna Factor (dB/m)	Path Loss (dB)	Preamp Factor (dB)	Ant Pos (cm)	Table Pos (deg)	Peak Avg. (P/A)	Pol. (H/V)	
802.11ac VHT20 CH 149 5745MHz		5609	49.31	-18.89	68.2	40.64	31.9	6.32	29.55	106	231	P	H	
		5699.2	54.29	-50.32	104.61	45.48	32	6.36	29.55	106	231	P	H	
		5720	66.33	-44.47	110.8	57.47	32.04	6.37	29.55	106	231	P	H	
		5724.6	79.91	-41.38	121.29	71.04	32.05	6.37	29.55	106	231	P	H	
	*	5745	116.9	-	-	107.98	32.09	6.38	29.55	106	231	P	H	
	*	5745	109.68	-	-	100.76	32.09	6.38	29.55	106	231	A	H	
														H
														H
			5604.4	49.32	-18.88	68.2	40.65	31.9	6.32	29.55	392	140	P	V
			5695.6	51.34	-50.62	101.96	42.54	31.99	6.36	29.55	392	140	P	V
			5719.8	62.43	-48.31	110.74	53.57	32.04	6.37	29.55	392	140	P	V
			5725	73.87	-48.33	122.2	65	32.05	6.37	29.55	392	140	P	V
	*		5745	113.19	-	-	104.27	32.09	6.38	29.55	392	140	P	V
	*		5745	105.96	-	-	97.04	32.09	6.38	29.55	392	140	A	V
													V	
													V	



WIFI Ant. 1+2	Note	Frequency (MHz)	Level (dBµV/m)	Over Limit (dB)	Limit Line (dBµV/m)	Read Level (dBµV)	Antenna Factor (dB/m)	Path Loss (dB)	Preamp Factor (dB)	Ant Pos (cm)	Table Pos (deg)	Peak Avg. (P/A)	Pol. (H/V)
		5617	48.78	-19.42	68.2	40.1	31.9	6.33	29.55	102	231	P	H
		5677.2	49.78	-38.59	88.37	41.03	31.95	6.35	29.55	102	231	P	H
		5713	52.1	-56.74	108.84	43.25	32.03	6.37	29.55	102	231	P	H
		5724.2	52.48	-67.9	120.38	43.61	32.05	6.37	29.55	102	231	P	H
	*	5785	116.66	-	-	107.59	32.24	6.39	29.56	102	231	P	H
	*	5785	109.3	-	-	100.23	32.24	6.39	29.56	102	231	A	H
		5853	52.61	-62.75	115.36	43.32	32.41	6.44	29.56	102	231	P	H
		5856	52.63	-57.89	110.52	43.34	32.41	6.44	29.56	102	231	P	H
		5877.4	51.44	-51.98	103.42	42.09	32.45	6.46	29.56	102	231	P	H
		5927.6	51.18	-17.02	68.2	41.68	32.56	6.5	29.56	102	231	P	H
802.11ac													H
VHT20													H
CH 157		5630	48.84	-19.36	68.2	40.16	31.9	6.33	29.55	300	346	P	V
5785MHz		5662.6	49.04	-28.51	77.55	40.31	31.93	6.35	29.55	300	346	P	V
		5708.6	48.6	-59.01	107.61	39.77	32.02	6.36	29.55	300	346	P	V
		5721.8	47.94	-66.96	114.9	39.08	32.04	6.37	29.55	300	346	P	V
	*	5785	112.35	-	-	103.28	32.24	6.39	29.56	300	346	P	V
	*	5785	105.12	-	-	96.05	32.24	6.39	29.56	300	346	A	V
		5855	49.8	-61	110.8	40.51	32.41	6.44	29.56	300	346	P	V
		5864	50.96	-57.32	108.28	41.64	32.43	6.45	29.56	300	346	P	V
		5881	50.39	-50.35	100.74	41.03	32.46	6.46	29.56	300	346	P	V
		5950	49.32	-18.88	68.2	39.76	32.6	6.52	29.56	300	346	P	V
													V
													V



WIFI Ant. 1+2	Note	Frequency (MHz)	Level (dBμV/m)	Over Limit (dB)	Limit Line (dBμV/m)	Read Level (dBμV)	Antenna Factor (dB/m)	Path Loss (dB)	Preamp Factor (dB)	Ant Pos (cm)	Table Pos (deg)	Peak Avg. (P/A)	Pol. (H/V)	
802.11ac VHT20 CH 165 5825MHz	*	5825	116.69	-	-	107.48	32.35	6.42	29.56	101	229	P	H	
	*	5825	109.13	-	-	99.92	32.35	6.42	29.56	101	229	A	H	
		5850.2	69.91	-51.83	121.74	60.63	32.4	6.44	29.56	101	229	P	H	
		5859.2	59.88	-49.74	109.62	50.57	32.42	6.45	29.56	101	229	P	H	
		5904.2	54.07	-29.48	83.55	44.64	32.51	6.48	29.56	101	229	P	H	
		5942.8	50.97	-17.23	68.2	41.43	32.59	6.51	29.56	101	229	P	H	
														H
														H
	*	5825	112.56	-	-	103.35	32.35	6.42	29.56	331	352	P	V	
	*	5825	105.18	-	-	95.97	32.35	6.42	29.56	331	352	A	V	
		5850	69.43	-52.77	122.2	60.15	32.4	6.44	29.56	331	352	P	V	
		5856.6	57.13	-53.22	110.35	47.83	32.41	6.45	29.56	331	352	P	V	
		5882.8	51.42	-47.99	99.41	42.04	32.47	6.47	29.56	331	352	P	V	
		5928.8	49.43	-18.77	68.2	39.93	32.56	6.5	29.56	331	352	P	V	
														V
													V	
Remark	1. No other spurious found. 2. All results are PASS against Peak and Average limit line.													



Band 4 5725~5850MHz
WIFI 802.11ac VHT20 (Harmonic @ 3m)

WIFI Ant. 1+2	Note	Frequency (MHz)	Level (dBμV/m)	Over Limit (dB)	Limit Line (dBμV/m)	Read Level (dBμV)	Antenna Factor (dB/m)	Path Loss (dB)	Preamp Factor (dB)	Ant Pos (cm)	Table Pos (deg)	Peak Avg. (P/A)	Pol. (H/V)	
802.11ac VHT20 CH 149 5745MHz		11490	46.72	-27.28	74	52.48	40.08	10.46	56.3	100	0	P	H	
		17235	47.75	-20.45	68.2	51.27	40.1	12.95	56.57	100	0	P	H	
													H	
													H	
			11490	47.51	-26.49	74	53.27	40.08	10.46	56.3	100	0	P	V
			17235	48.15	-20.05	68.2	51.67	40.1	12.95	56.57	100	0	P	V
														V
802.11ac VHT20 CH 157 5785MHz		11570	46.42	-27.58	74	52.19	40.03	10.5	56.3	100	0	P	H	
		17355	48.57	-19.63	68.2	51.61	40.69	13.08	56.81	100	0	P	H	
													H	
													H	
			11570	46.32	-27.68	74	52.09	40.03	10.5	56.3	100	0	P	V
			17355	49.13	-19.07	68.2	52.17	40.69	13.08	56.81	100	0	P	V
														V
802.11ac VHT20 CH 165 5825MHz		11650	47.44	-26.56	74	53.5	39.7	10.54	56.3	100	0	P	H	
		17475	49.75	-18.45	68.2	52.14	41.45	13.21	57.05	100	0	P	H	
													H	
													H	
			11650	47.94	-26.06	74	54	39.7	10.54	56.3	100	0	P	V
			17475	49.54	-18.66	68.2	51.93	41.45	13.21	57.05	100	0	P	V
														V
Remark	1. No other spurious found.													
	2. All results are PASS against Peak and Average limit line.													



Band 4 5725~5850MHz
WIFI 802.11ac VHT40 (Band Edge @ 3m)

WIFI Ant. 1+2	Note	Frequency (MHz)	Level (dBμV/m)	Over Limit (dB)	Limit Line (dBμV/m)	Read Level (dBμV)	Antenna Factor (dB/m)	Path Loss (dB)	Preamp Factor (dB)	Ant Pos (cm)	Table Pos (deg)	Peak Avg. (P/A)	Pol. (H/V)	
		5634.6	50.32	-17.88	68.2	41.64	31.9	6.33	29.55	111	233	P	H	
		5693.6	60.44	-40.04	100.48	51.64	31.99	6.36	29.55	111	233	P	H	
		5715.2	75.55	-33.91	109.46	66.7	32.03	6.37	29.55	111	233	P	H	
		5724.2	76.45	-43.93	120.38	67.58	32.05	6.37	29.55	111	233	P	H	
	*	5755	114.12	-	-	105.18	32.12	6.38	29.56	111	233	P	H	
	*	5755	106.62	-	-	97.68	32.12	6.38	29.56	111	233	A	H	
		5851.2	53.65	-65.81	119.46	44.37	32.4	6.44	29.56	111	233	P	H	
		5855	52.69	-58.11	110.8	43.4	32.41	6.44	29.56	111	233	P	H	
		5887.2	51.4	-44.74	96.14	42.02	32.47	6.47	29.56	111	233	P	H	
		5940.8	50.89	-17.31	68.2	41.36	32.58	6.51	29.56	111	233	P	H	
802.11ac VHT40 CH 151 5755MHz													H	
													H	
			5638.8	49.83	-18.37	68.2	41.14	31.9	6.34	29.55	356	167	P	V
			5699.8	54.91	-50.14	105.05	46.1	32	6.36	29.55	356	167	P	V
			5719.8	72.03	-38.71	110.74	63.17	32.04	6.37	29.55	356	167	P	V
			5724.8	76.53	-45.21	121.74	67.66	32.05	6.37	29.55	356	167	P	V
		*	5755	110.41	-	-	101.47	32.12	6.38	29.56	356	167	P	V
		*	5755	102.5	-	-	93.56	32.12	6.38	29.56	356	167	A	V
			5850.4	49.26	-72.03	121.29	39.98	32.4	6.44	29.56	356	167	P	V
			5861.2	50.82	-58.24	109.06	41.51	32.42	6.45	29.56	356	167	P	V
			5897.6	49.66	-38.78	88.44	40.24	32.5	6.48	29.56	356	167	P	V
			5929	49.27	-18.93	68.2	39.77	32.56	6.5	29.56	356	167	P	V
														V
														V



WIFI Ant. 1+2	Note	Frequency (MHz)	Level (dBµV/m)	Over Limit (dB)	Limit Line (dBµV/m)	Read Level (dBµV)	Antenna Factor (dB/m)	Path Loss (dB)	Preamp Factor (dB)	Ant Pos (cm)	Table Pos (deg)	Peak Avg. (P/A)	Pol. (H/V)
		5605.6	49.58	-18.62	68.2	40.91	31.9	6.32	29.55	103	231	P	H
		5693.4	51.2	-49.13	100.33	42.4	31.99	6.36	29.55	103	231	P	H
		5712.8	57.98	-50.81	108.79	49.13	32.03	6.37	29.55	103	231	P	H
		5725	55.12	-67.08	122.2	46.25	32.05	6.37	29.55	103	231	P	H
	*	5795	114.75	-	-	105.63	32.28	6.4	29.56	103	231	P	H
	*	5795	107.35	-	-	98.23	32.28	6.4	29.56	103	231	A	H
		5853.4	67.91	-46.54	114.45	58.62	32.41	6.44	29.56	103	231	P	H
		5857.2	64.93	-45.25	110.18	55.63	32.41	6.45	29.56	103	231	P	H
		5875.6	59.35	-45.4	104.75	50	32.45	6.46	29.56	103	231	P	H
		5929.6	51.72	-16.48	68.2	42.22	32.56	6.5	29.56	103	231	P	H
802.11ac													H
VHT40													H
CH 159		5636.2	48.89	-19.31	68.2	40.21	31.9	6.33	29.55	369	171	P	V
5795MHz		5699.8	50.52	-54.53	105.05	41.71	32	6.36	29.55	369	171	P	V
		5719	51.52	-59	110.52	42.66	32.04	6.37	29.55	369	171	P	V
		5722.4	53.63	-62.64	116.27	44.77	32.04	6.37	29.55	369	171	P	V
	*	5795	111.22	-	-	102.1	32.28	6.4	29.56	369	171	P	V
	*	5795	102.95	-	-	93.83	32.28	6.4	29.56	369	171	A	V
		5851	58.51	-61.41	119.92	49.23	32.4	6.44	29.56	369	171	P	V
		5857.8	58.9	-51.11	110.01	49.59	32.42	6.45	29.56	369	171	P	V
		5879.4	53.3	-48.63	101.93	43.94	32.46	6.46	29.56	369	171	P	V
		5932.6	51.25	-16.95	68.2	41.73	32.57	6.51	29.56	369	171	P	V
													V
													V
Remark	1. No other spurious found. 2. All results are PASS against Peak and Average limit line.												



**Band 4 5725~5850MHz
WIFI 802.11ac VHT40 (Harmonic @ 3m)**

WIFI Ant. 1+2	Note	Frequency (MHz)	Level (dBμV/m)	Over Limit (dB)	Limit Line (dBμV/m)	Read Level (dBμV)	Antenna Factor (dB/m)	Path Loss (dB)	Preamp Factor (dB)	Ant Pos (cm)	Table Pos (deg)	Peak Avg. (P/A)	Pol. (H/V)	
802.11ac VHT40 CH 151 5755MHz		11510	46.97	-27.03	74	52.71	40.09	10.47	56.3	100	0	P	H	
		17265	47.4	-20.8	68.2	50.86	40.19	12.98	56.63	100	0	P	H	
													H	
													H	
			11510	46.66	-27.34	74	52.4	40.09	10.47	56.3	100	0	P	V
			17265	47.51	-20.69	68.2	50.97	40.19	12.98	56.63	100	0	P	V
														V
														V
802.11ac VHT40 CH 159 5795MHz		11590	46.75	-27.25	74	52.53	40.01	10.51	56.3	100	0	P	H	
		17385	49.01	-19.19	68.2	51.87	40.9	13.11	56.87	100	0	P	H	
													H	
													H	
			11590	47.25	-26.75	74	53.03	40.01	10.51	56.3	100	0	P	V
			17385	49.61	-18.59	68.2	52.47	40.9	13.11	56.87	100	0	P	V
														V
														V
Remark	1. No other spurious found. 2. All results are PASS against Peak and Average limit line.													



Band 4 5725~5850MHz
WIFI 802.11ac VHT80 (Band Edge @ 3m)

WIFI Ant. 1+2	Note	Frequency (MHz)	Level (dBμV/m)	Over Limit (dB)	Limit Line (dBμV/m)	Read Level (dBμV)	Antenna Factor (dB/m)	Path Loss (dB)	Preamp Factor (dB)	Ant Pos (cm)	Table Pos (deg)	Peak Avg. (P/A)	Pol. (H/V)	
802.11ac VHT80 CH 155 5775MHz		5648.6	55.63	-12.57	68.2	46.94	31.9	6.34	29.55	100	235	P	H	
		5695	72.9	-28.61	101.51	64.1	31.99	6.36	29.55	100	235	P	H	
		5718.8	78.44	-32.02	110.46	69.58	32.04	6.37	29.55	100	235	P	H	
		5724.2	77.77	-42.61	120.38	68.9	32.05	6.37	29.55	100	235	P	H	
	*	5775	110.95	-	-	101.92	32.2	6.39	29.56	100	235	P	H	
	*	5775	103.24	-	-	94.21	32.2	6.39	29.56	100	235	A	H	
		5850	80.4	-41.8	122.2	71.12	32.4	6.44	29.56	100	235	P	H	
		5870.8	77.85	-28.52	106.37	68.51	32.44	6.46	29.56	100	235	P	H	
		5875	72.3	-32.9	105.2	62.95	32.45	6.46	29.56	100	235	P	H	
		5930.2	54.16	-14.04	68.2	44.66	32.56	6.5	29.56	100	235	P	H	
														H
														H
			5641.4	52.01	-16.19	68.2	43.32	31.9	6.34	29.55	337	175	P	V
			5698.6	68.73	-35.44	104.17	59.92	32	6.36	29.55	337	175	P	V
			5719.4	73.59	-37.04	110.63	64.73	32.04	6.37	29.55	337	175	P	V
			5721	74.16	-38.92	113.08	65.3	32.04	6.37	29.55	337	175	P	V
	*		5775	108.29	-	-	99.26	32.2	6.39	29.56	337	175	P	V
	*		5775	100.51	-	-	91.48	32.2	6.39	29.56	337	175	A	V
			5850	71.79	-50.41	122.2	62.51	32.4	6.44	29.56	337	175	P	V
			5864.2	74.14	-34.08	108.22	64.82	32.43	6.45	29.56	337	175	P	V
		5879	67.88	-34.35	102.23	58.52	32.46	6.46	29.56	337	175	P	V	
		5925.2	52.97	-15.23	68.2	43.48	32.55	6.5	29.56	337	175	P	V	
													V	
													V	
Remark	1. No other spurious found. 2. All results are PASS against Peak and Average limit line.													



**Band 4 5725~5850MHz
WIFI 802.11ac VHT80 (Harmonic @ 3m)**

WIFI Ant. 1+2	Note	Frequency (MHz)	Level (dBμV/m)	Over Limit (dB)	Limit Line (dBμV/m)	Read Level (dBμV)	Antenna Factor (dB/m)	Path Loss (dB)	Preamp Factor (dB)	Ant Pos (cm)	Table Pos (deg)	Peak Avg. (P/A)	Pol. (H/V)	
802.11ac VHT80 CH 155 5775MHz		11550	46.76	-27.24	74	52.52	40.05	10.49	56.3	100	0	P	H	
		17325	48.82	-19.38	68.2	52.06	40.47	13.04	56.75	100	0	P	H	
													H	
													H	
			11550	46.06	-27.94	74	51.82	40.05	10.49	56.3	100	0	P	V
			17325	48.01	-20.19	68.2	51.25	40.47	13.04	56.75	100	0	P	V
														V
														V
Remark	1. No other spurious found. 2. All results are PASS against Peak and Average limit line.													



Emission below 1GHz

5GHz WIFI 802.11ac VHT80 (LF @ 3m)

WIFI	Note	Frequency	Level	Over	Limit	Read	Antenna	Path	Preamp	Ant	Table	Peak	Pol.	
Ant.				Limit	Line	Level	Factor	Loss	Factor	Pos	Pos	Avg.		
1+2		(MHz)	(dBμV/m)	(dB)	(dBμV/m)	(dBμV)	(dB/m)	(dB)	(dB)	(cm)	(deg)	(P/A)	(H/V)	
5GHz 802.11ac VHT80 LF		30.97	22.45	-17.55	40	29.97	24.31	0.45	32.29	-	-	P	H	
		133.79	25.01	-18.49	43.5	38.92	17.28	0.92	32.19	-	-	P	H	
		159.98	22.44	-21.06	43.5	37.43	16.1	0.98	32.17	-	-	P	H	
		297.72	30.27	-15.73	46	42.12	18.85	1.36	32.15	-	-	P	H	
		917.55	32.13	-13.87	46	31.62	29.15	2.44	31.26	-	-	P	H	
		957.32	33.98	-12.02	46	31.57	30.65	2.46	30.92	100	0	P	H	
														H
														H
														H
														H
														H
														H
														H
														H
														H
			34.85	33.03	-6.97	40	42.46	22.39	0.45	32.29	100	0	P	V
			61.04	30.46	-9.54	40	50.54	11.59	0.58	32.27	-	-	P	V
			120.21	24.54	-18.96	43.5	38.69	17.1	0.88	32.2	-	-	P	V
		159.98	24.36	-19.14	43.5	39.35	16.1	0.98	32.17	-	-	P	V	
		925.31	33.49	-12.51	46	32.73	29.31	2.45	31.19	-	-	P	V	
		952.47	33.83	-12.17	46	31.58	30.55	2.45	30.96	-	-	P	V	
													V	
													V	
													V	
													V	
													V	
													V	
Remark	1. No other spurious found. 2. All results are PASS against limit line.													



<TXBF Mode>

Band 4 - 5725~5850MHz

WIFI 802.11ac VHT20 (Band Edge @ 3m)

WIFI	Note	Frequency	Level	Over	Limit	Read	Antenna	Path	Preamp	Ant	Table	Peak	Pol.	
Ant.				Limit	Line	Level	Factor	Loss	Factor	Pos	Pos	Avg.		
1+2		(MHz)	(dBµV/m)	(dB)	(dBµV/m)	(dBµV)	(dB/m)	(dB)	(dB)	(cm)	(deg)	(P/A)	(H/V)	
802.11ac VHT20 CH 149 5745MHz		5649	50.05	-18.15	68.2	41.36	31.9	6.34	29.55	101	300	P	H	
		5699	54.31	-50.15	104.46	45.5	32	6.36	29.55	101	300	P	H	
		5719.6	63.59	-47.1	110.69	54.73	32.04	6.37	29.55	101	300	P	H	
		5724.8	74.12	-47.62	121.74	65.25	32.05	6.37	29.55	101	300	P	H	
	*	5745	117.03	-	-	108.11	32.09	6.38	29.55	101	300	P	H	
	*	5745	108.23	-	-	99.31	32.09	6.38	29.55	101	300	A	H	
														H
														H
			5648.6	50.43	-17.77	68.2	41.74	31.9	6.34	29.55	317	163	P	V
			5696.2	52.77	-49.63	102.4	43.97	31.99	6.36	29.55	317	163	P	V
			5719.8	62.04	-48.7	110.74	53.18	32.04	6.37	29.55	317	163	P	V
			5724.4	71.64	-49.19	120.83	62.77	32.05	6.37	29.55	317	163	P	V
		*	5745	113.03	-	-	104.11	32.09	6.38	29.55	317	163	P	V
		*	5745	102.24	-	-	93.32	32.09	6.38	29.55	317	163	A	V
													V	
													V	



WIFI Ant. 1+2	Note	Frequency (MHz)	Level (dBµV/m)	Over Limit (dB)	Limit Line (dBµV/m)	Read Level (dBµV)	Antenna Factor (dB/m)	Path Loss (dB)	Preamp Factor (dB)	Ant Pos (cm)	Table Pos (deg)	Peak Avg. (P/A)	Pol. (H/V)
		5624	50.13	-18.07	68.2	41.45	31.9	6.33	29.55	253	296	P	H
		5695.4	51.44	-50.37	101.81	42.64	31.99	6.36	29.55	253	296	P	H
		5718.2	53.14	-57.16	110.3	44.28	32.04	6.37	29.55	253	296	P	H
		5725	54.86	-67.34	122.2	45.99	32.05	6.37	29.55	253	296	P	H
	*	5785	116.32	-	-	107.25	32.24	6.39	29.56	253	296	P	H
	*	5785	105.64	-	-	96.57	32.24	6.39	29.56	253	296	A	H
		5853	53.33	-62.03	115.36	44.04	32.41	6.44	29.56	253	296	P	H
		5861.6	53.78	-55.17	108.95	44.47	32.42	6.45	29.56	253	296	P	H
		5891	51.42	-41.91	93.33	42.03	32.48	6.47	29.56	253	296	P	H
		5946.2	49.94	-18.26	68.2	40.39	32.59	6.52	29.56	253	296	P	H
802.11ac													H
VHT20													H
CH 157		5617.4	49.44	-18.76	68.2	40.76	31.9	6.33	29.55	330	146	P	H
5785MHz		5679.8	49.91	-40.38	90.29	41.15	31.96	6.35	29.55	330	146	P	H
		5715.2	50.72	-58.74	109.46	41.87	32.03	6.37	29.55	330	146	P	H
		5720.4	50.49	-61.22	111.71	41.63	32.04	6.37	29.55	330	146	P	V
	*	5785	112.92	-	-	103.85	32.24	6.39	29.56	330	146	P	V
	*	5785	101.63	-	-	92.56	32.24	6.39	29.56	330	146	A	V
		5854	52.22	-60.86	113.08	42.93	32.41	6.44	29.56	330	146	P	V
		5861.6	51.09	-57.86	108.95	41.78	32.42	6.45	29.56	330	146	P	V
		5886.8	50.91	-45.53	96.44	41.53	32.47	6.47	29.56	330	146	P	V
		5946.2	49.64	-18.56	68.2	40.09	32.59	6.52	29.56	330	146	P	V
													V
													V



WIFI Ant. 1+2	Note	Frequency (MHz)	Level (dBµV/m)	Over Limit (dB)	Limit Line (dBµV/m)	Read Level (dBµV)	Antenna Factor (dB/m)	Path Loss (dB)	Preamp Factor (dB)	Ant Pos (cm)	Table Pos (deg)	Peak Avg. (P/A)	Pol. (H/V)	
802.11ac VHT20 CH 165 5825MHz	*	5825	114.65	-	-	105.44	32.35	6.42	29.56	260	227	P	H	
	*	5825	103.94	-	-	94.73	32.35	6.42	29.56	260	227	A	H	
		5850	64.29	-57.91	122.2	55.01	32.4	6.44	29.56	260	227	P	H	
		5858.4	58.29	-51.56	109.85	48.98	32.42	6.45	29.56	260	227	P	H	
		5881.4	61.38	-39.07	100.45	52.01	32.46	6.47	29.56	260	227	P	H	
		5925.2	55.85	-12.35	68.2	46.36	32.55	6.5	29.56	260	227	P	H	
														H
														H
														H
														H
	*	5825	111.22	-	-	102.01	32.35	6.42	29.56	337	183	P	V	
	*	5825	102.94	-	-	93.73	32.35	6.42	29.56	337	183	A	V	
		5850.4	58.1	-63.19	121.29	48.82	32.4	6.44	29.56	337	183	P	V	
		5869.4	58.34	-48.43	106.77	49	32.44	6.46	29.56	337	183	P	V	
		5890.8	53.49	-39.98	93.47	44.1	32.48	6.47	29.56	337	183	P	V	
		5930.2	49.92	-18.28	68.2	40.42	32.56	6.5	29.56	337	183	P	V	
														V
														V
														V
														V
													V	
													V	



Band 4 5725~5850MHz
WIFI 802.11ac VHT20 (Harmonic @ 3m)

WIFI Ant. 1+2	Note	Frequency (MHz)	Level (dBμV/m)	Over Limit (dB)	Limit Line (dBμV/m)	Read Level (dBμV)	Antenna Factor (dB/m)	Path Loss (dB)	Preamp Factor (dB)	Ant Pos (cm)	Table Pos (deg)	Peak Avg. (P/A)	Pol. (H/V)	
802.11ac VHT20 CH 149 5745MHz		11490	46.04	-27.96	74	51.96	39.92	10.46	56.3	100	0	P	H	
		17235	48.17	-20.03	68.2	50.95	40.84	12.95	56.57	100	0	P	H	
													H	
													H	
			11490	45.94	-28.06	74	51.86	39.92	10.46	56.3	100	0	P	V
			17235	48.07	-20.13	68.2	50.85	40.84	12.95	56.57	100	0	P	V
														V
802.11ac VHT20 CH 157 5785MHz		11570	45.39	-28.61	74	51.16	40.03	10.5	56.3	100	0	P	H	
		17355	48.53	-19.67	68.2	51.57	40.69	13.08	56.81	100	0	P	H	
													H	
													H	
			11570	45.78	-28.22	74	51.55	40.03	10.5	56.3	100	0	P	V
			17355	47.93	-20.27	68.2	50.97	40.69	13.08	56.81	100	0	P	V
														V
802.11ac VHT20 CH 165 5825MHz		11650	46.43	-27.57	74	52.57	39.62	10.54	56.3	100	0	P	H	
		17475	49.77	-18.43	68.2	51.93	41.68	13.21	57.05	100	0	P	H	
													H	
													H	
			11650	47.44	-26.56	74	53.58	39.62	10.54	56.3	100	0	P	V
			17475	49.57	-18.63	68.2	51.73	41.68	13.21	57.05	100	0	P	V
														V
Remark	1. No other spurious found.													
	2. All results are PASS against Peak and Average limit line.													



Band 4 5725~5850MHz
WIFI 802.11ac VHT40 (Band Edge @ 3m)

WIFI Ant. 1+2	Note	Frequency (MHz)	Level (dBμV/m)	Over Limit (dB)	Limit Line (dBμV/m)	Read Level (dBμV)	Antenna Factor (dB/m)	Path Loss (dB)	Preamp Factor (dB)	Ant Pos (cm)	Table Pos (deg)	Peak Avg. (P/A)	Pol. (H/V)
		5633.6	51.06	-17.14	68.2	42.38	31.9	6.33	29.55	261	298	P	H
		5699.2	57.58	-47.03	104.61	48.77	32	6.36	29.55	261	298	P	H
		5720	78	-32.8	110.8	69.14	32.04	6.37	29.55	261	298	P	H
		5724.2	81.08	-39.3	120.38	72.21	32.05	6.37	29.55	261	298	P	H
	*	5755	113.08	-	-	104.14	32.12	6.38	29.56	261	298	P	H
	*	5755	104.83	-	-	95.89	32.12	6.38	29.56	261	298	A	H
		5853.6	51.87	-62.12	113.99	42.58	32.41	6.44	29.56	261	298	P	H
		5861.6	52.67	-56.28	108.95	43.36	32.42	6.45	29.56	261	298	P	H
		5891.8	50.94	-41.79	92.73	41.55	32.48	6.47	29.56	261	298	P	H
		5933	50.33	-17.87	68.2	40.81	32.57	6.51	29.56	261	298	P	H
802.11ac													H
VHT40													H
CH 151		5647.8	50.99	-17.21	68.2	42.3	31.9	6.34	29.55	319	163	P	V
5755MHz		5699.4	56.06	-48.7	104.76	47.25	32	6.36	29.55	319	163	P	V
		5717.8	73.81	-36.37	110.18	64.95	32.04	6.37	29.55	319	163	P	V
		5724.6	76.37	-44.92	121.29	67.5	32.05	6.37	29.55	319	163	P	V
	*	5755	110.38	-	-	101.44	32.12	6.38	29.56	319	163	P	V
	*	5755	101.46	-	-	92.52	32.12	6.38	29.56	319	163	P	V
		5850.8	51	-69.38	120.38	41.72	32.4	6.44	29.56	319	163	P	V
		5860	52.46	-56.94	109.4	43.15	32.42	6.45	29.56	319	163	P	V
		5875.2	51.1	-53.95	105.05	41.75	32.45	6.46	29.56	319	163	P	V
		5926.4	49.54	-18.66	68.2	40.05	32.55	6.5	29.56	319	163	P	V
													V
													V



WIFI Ant. 1+2	Note	Frequency (MHz)	Level (dBμV/m)	Over Limit (dB)	Limit Line (dBμV/m)	Read Level (dBμV)	Antenna Factor (dB/m)	Path Loss (dB)	Preamp Factor (dB)	Ant Pos (cm)	Table Pos (deg)	Peak Avg. (P/A)	Pol. (H/V)
		5621.2	49.47	-18.73	68.2	40.79	31.9	6.33	29.55	259	297	P	H
		5699.8	52.9	-52.15	105.05	44.09	32	6.36	29.55	259	297	P	H
		5720	57.08	-53.72	110.8	48.22	32.04	6.37	29.55	259	297	P	H
		5721.8	57.13	-57.77	114.9	48.27	32.04	6.37	29.55	259	297	P	H
	*	5795	111.63	-	-	102.51	32.28	6.4	29.56	259	297	P	H
	*	5795	102.76	-	-	93.64	32.28	6.4	29.56	259	297	A	H
		5850.4	64.01	-57.28	121.29	54.73	32.4	6.44	29.56	259	297	P	H
		5855	65.11	-45.69	110.8	55.82	32.41	6.44	29.56	259	297	P	H
		5876.2	57.24	-47.07	104.31	47.89	32.45	6.46	29.56	259	297	P	H
		5926.8	50.76	-17.44	68.2	41.27	32.55	6.5	29.56	259	297	P	H
802.11ac													H
VHT40													H
CH 159		5611	49.27	-18.93	68.2	40.6	31.9	6.32	29.55	318	167	P	V
5795MHz		5698	50.95	-52.78	103.73	42.14	32	6.36	29.55	318	167	P	V
		5713.8	54.25	-54.82	109.07	45.4	32.03	6.37	29.55	318	167	P	V
		5722.6	52.95	-63.78	116.73	44.08	32.05	6.37	29.55	318	167	P	V
	*	5795	108.61	-	-	99.49	32.28	6.4	29.56	318	167	P	V
	*	5795	99.83	-	-	90.71	32.28	6.4	29.56	318	167	A	V
		5851.8	63.97	-54.12	118.09	54.69	32.4	6.44	29.56	318	167	P	V
		5856.8	64.98	-45.32	110.3	55.68	32.41	6.45	29.56	318	167	P	V
		5877	55.6	-48.11	103.71	46.25	32.45	6.46	29.56	318	167	P	V
		5934.4	51.13	-17.07	68.2	41.61	32.57	6.51	29.56	318	167	P	V
													V
													V
Remark	1. No other spurious found. 2. All results are PASS against Peak and Average limit line.												



**Band 4 5725~5850MHz
WIFI 802.11ac VHT40 (Harmonic @ 3m)**

WIFI Ant. 1+2	Note	Frequency (MHz)	Level (dBμV/m)	Over Limit (dB)	Limit Line (dBμV/m)	Read Level (dBμV)	Antenna Factor (dB/m)	Path Loss (dB)	Preamp Factor (dB)	Ant Pos (cm)	Table Pos (deg)	Peak Avg. (P/A)	Pol. (H/V)
802.11ac VHT40 CH 151 5755MHz		11510	45.99	-28.01	74	51.73	40.09	10.47	56.3	100	0	P	H
		17265	47.29	-20.91	68.2	50.75	40.19	12.98	56.63	100	0	P	H
													H
													H
		11510	48.1	-25.9	74	53.84	40.09	10.47	56.3	100	0	P	V
		17265	47.45	-20.75	68.2	50.91	40.19	12.98	56.63	100	0	P	V
													V
													V
802.11ac VHT40 CH 159 5795MHz		11590	46.46	-27.54	74	52.24	40.01	10.51	56.3	100	0	P	H
		17385	49.45	-18.75	68.2	52.31	40.9	13.11	56.87	100	0	P	H
													H
													H
		11590	46.47	-27.53	74	52.25	40.01	10.51	56.3	100	0	P	V
		17385	49.01	-19.19	68.2	51.87	40.9	13.11	56.87	100	0	P	V
													V
													V
Remark	1. No other spurious found. 2. All results are PASS against Peak and Average limit line.												



Band 4 5725~5850MHz
WIFI 802.11ac VHT80 (Band Edge @ 3m)

WIFI Ant. 1+2	Note	Frequency (MHz)	Level (dBμV/m)	Over Limit (dB)	Limit Line (dBμV/m)	Read Level (dBμV)	Antenna Factor (dB/m)	Path Loss (dB)	Preamp Factor (dB)	Ant Pos (cm)	Table Pos (deg)	Peak Avg. (P/A)	Pol. (H/V)	
		5640.8	54.31	-13.89	68.2	45.62	31.9	6.34	29.55	100	296	P	H	
		5697	73.98	-29.01	102.99	65.18	31.99	6.36	29.55	100	296	P	H	
		5714.2	77.38	-31.8	109.18	68.53	32.03	6.37	29.55	100	296	P	H	
		5723.2	78.85	-39.25	118.1	69.98	32.05	6.37	29.55	100	296	P	H	
	*	5775	109.8	-	-	100.77	32.2	6.39	29.56	100	296	P	H	
	*	5775	100.97	-	-	91.94	32.2	6.39	29.56	100	296	A	H	
		5850	75.58	-46.62	122.2	66.3	32.4	6.44	29.56	100	296	P	H	
		5856	72.87	-37.65	110.52	63.58	32.41	6.44	29.56	100	296	P	H	
		5876.4	65.85	-38.31	104.16	56.5	32.45	6.46	29.56	100	296	P	H	
		5933.4	51.27	-16.93	68.2	41.75	32.57	6.51	29.56	100	296	P	H	
802.11ac VHT80 CH 155 5775MHz													H	
													H	
			5647.8	52.6	-15.6	68.2	43.91	31.9	6.34	29.55	351	165	P	V
			5696.6	70.32	-32.37	102.69	61.52	31.99	6.36	29.55	351	165	P	V
			5715.8	72.46	-37.17	109.63	63.61	32.03	6.37	29.55	351	165	P	V
			5724.4	72.93	-47.9	120.83	64.06	32.05	6.37	29.55	351	165	P	V
		*	5775	107.11	-	-	98.08	32.2	6.39	29.56	351	165	P	V
		*	5775	97.77	-	-	88.74	32.2	6.39	29.56	351	165	A	V
			5850	70.08	-52.12	122.2	60.8	32.4	6.44	29.56	351	165	P	V
			5855.4	70.54	-40.15	110.69	61.25	32.41	6.44	29.56	351	165	P	V
			5875	62.2	-43	105.2	52.85	32.45	6.46	29.56	351	165	P	V
			5931.4	51.64	-16.56	68.2	42.13	32.56	6.51	29.56	351	165	P	V
														V
														V
	Remark	1. No other spurious found. 2. All results are PASS against Peak and Average limit line.												



Band 4 5725~5850MHz

WIFI 802.11ac VHT80 (Harmonic @ 3m)

WIFI Ant. 1+2	Note	Frequency (MHz)	Level (dBμV/m)	Over Limit (dB)	Limit Line (dBμV/m)	Read Level (dBμV)	Antenna Factor (dB/m)	Path Loss (dB)	Preamp Factor (dB)	Ant Pos (cm)	Table Pos (deg)	Peak Avg. (P/A)	Pol. (H/V)	
802.11ac VHT80 CH 155 5775MHz		11550	45.63	-28.37	74	51.39	40.05	10.49	56.3	100	0	P	H	
		17325	47.81	-20.39	68.2	51.05	40.47	13.04	56.75	100	0	P	H	
													H	
													H	
			11550	46.08	-27.92	74	51.84	40.05	10.49	56.3	100	0	P	V
			17325	48.54	-19.66	68.2	51.78	40.47	13.04	56.75	100	0	P	V
														V
Remark	1. No other spurious found. 2. All results are PASS against Peak and Average limit line.													



Note symbol

*	Fundamental Frequency which can be ignored. However, the level of any unwanted emissions shall not exceed the level of the fundamental frequency.
!	Test result is over limit line.
P/A	Peak or Average
H/V	Horizontal or Vertical



A calculation example for radiated spurious emission is shown as below:

WIFI	Note	Frequency	Level	Over	Limit	Read	Antenna	Path	Preamp	Ant	Table	Peak	Pol.
Ant.				Limit	Line	Level	Factor	Loss	Factor	Pos	Pos	Avg.	
1		(MHz)	(dBμV/m)	(dB)	(dBμV/m)	(dBμV)	(dB/m)	(dB)	(dB)	(cm)	(deg)	(P/A)	(H/V)
802.11b		2390	55.45	-18.55	74	54.51	32.22	4.58	35.86	103	308	P	H
CH 01													
2412MHz		2390	43.54	-10.46	54	42.6	32.22	4.58	35.86	103	308	A	H

1. Path Loss(dB) = Cable loss(dB) + Filter loss(dB) + Attenuator loss(dB)
2. Level(dBμV/m) = Antenna Factor(dB/m) + Path Loss(dB) + Read Level(dBμV) - Preamp Factor(dB)
3. Over Limit(dB) = Level(dBμV/m) – Limit Line(dBμV/m)

For Peak Limit @ 2390MHz:

1. Level(dBμV/m)
= Antenna Factor(dB/m) + Path Loss(dB) + Read Level(dBμV) - Preamp Factor(dB)
= 32.22(dB/m) + 4.58(dB) + 54.51(dBμV) – 35.86 (dB)
= 55.45 (dBμV/m)
2. Over Limit(dB)
= Level(dBμV/m) – Limit Line(dBμV/m)
= 55.45(dBμV/m) – 74(dBμV/m)
= -18.55(dB)

For Average Limit @ 2390MHz:

1. Level(dBμV/m)
= Antenna Factor(dB/m) + Path Loss(dB) + Read Level(dBμV) - Preamp Factor(dB)
= 32.22(dB/m) + 4.58(dB) + 42.6(dBμV) – 35.86 (dB)
= 43.54 (dBμV/m)
2. Over Limit(dB) = Level(dBμV/m) – Limit Line(dBμV/m)
= 43.54(dBμV/m) – 54(dBμV/m)
= -10.46(dB)

Both peak and average measured complies with the limit line, so test result is “PASS”.



Appendix C. Radiated Spurious Emission Plots

Test Engineer :	Ryan Lin, JC Liang, Wilson Wu	Temperature :	21.5~23.5°C
		Relative Humidity :	46.5~49.5%

<CDD Mode>

Band 4 - 5725~5850MHz WIFI 802.11a (Band Edge @ 3m)

WIFI	Band 4 5725~5850MHz Band Edge @ 3m	
ANT	802.11a CH149 5745MHz	
1	Horizontal	Fundamental
Peak	<p>Site : 09CH13-HY Condition : PEAK_SE(94)_16-24 3m HORN_91200_1212 HORIZONTAL RBW:1000.000kHz VBW:3000.000kHz SWT:Auto Detector : Peak Project : 911635 Mode : 34 Power : 19.5</p>	<p>Site : 09CH13-HY Condition : PEAK(LINE) 3m HORN_91200_1212 HORIZONTAL RBW:1000.000kHz VBW:3000.000kHz SWT:Auto Detector : Peak Project : 911635 Mode : 34 Power : 19.5</p>



WIFI	Band 4 5725-5850MHz Band Edge @ 3m	
ANT	802.11a CH149 5745MHz	
1	Vertical	Fundamental
Peak	<p>Date: 2019-07-08 PEAK_BE(4)_16-24</p> <p>Site : 03CH12-HY Condition : PEAK_BE(84)_16-24 3m HORN_91200_1212 VERTICAL RBW:1000.000KHz VBW:3000.000KHz SWT:Auto Detector : Peak Project : 911635 Mode : 34 Power : 19.5</p>	<p>Date: 2019-07-08 PEAK_UB</p> <p>Site : 03CH12-HY Condition : PEAK(UNII) 3m HORN_91200_1212 VERTICAL RBW:1000.000KHz VBW:3000.000KHz SWT:Auto Detector : Peak Project : 911635 Mode : 34 Power : 19.5</p>



WIFI	Band 4 5725~5850MHz Band Edge @ 3m	
ANT	802.11a CH157 5785MHz	
1	Horizontal	Fundamental
Peak	<p>Site : 03CH13-HY Condition : PEAK_BE(B4)_16-24 3m HORN_91200_1212 HORIZONTAL Detector : Peak Project : 911635 Mode : 35 Power : 19.5</p>	<p>Site : 03CH13-HY Condition : PEAK(UNII) 3m HORN_91200_1212 HORIZONTAL Detector : Peak Project : 911635 Mode : 35 Power : 19.5</p>
Peak	<p>Site : 03CH13-HY Condition : PEAK_BE(B4)_16-24 3m HORN_91200_1212 HORIZONTAL Detector : Peak Project : 911635 Mode : 35 Power : 19.5</p>	Left blank



WIFI	Band 4 5725~5850MHz Band Edge @ 3m	
ANT	802.11a CH157 5785MHz	
1	Vertical	Fundamental
Peak	<p>Site : 03CH13-HY Condition : PEAK_BE(B4)_16-24 3m HORN_91200_1212 VERTICAL RBW:1000.000KHz VBW:3000.000KHz SWT:Auto Detector : Peak Project : 911635 Mode : 35 Power : 19.5</p>	<p>Site : 03CH13-HY Condition : PEAK(UNII) 3m HORN_91200_1212 VERTICAL RBW:1000.000KHz VBW:3000.000KHz SWT:Auto Detector : Peak Project : 911635 Mode : 35 Power : 19.5</p>
Peak	<p>Site : 03CH13-HY Condition : PEAK_BE(B4)_16-24 3m HORN_91200_1212 VERTICAL RBW:1000.000KHz VBW:3000.000KHz SWT:Auto Detector : Peak Project : 911635 Mode : 35 Power : 19.5</p>	Left blank



WIFI	Band 4 5725~5850MHz Band Edge @ 3m	
ANT	802.11a CH165 5825MHz	
1	Horizontal	Fundamental
Peak	<p>Site : 03CH12-HY Condition : PEAK_BE(B4)_16-24 3m HORN_91200_1212 HORIZONTAL Detector : Peak Project : 911635 Mode : 36 Power : 19.5</p>	<p>Site : 03CH12-HY Condition : PEAK(UNII) 3m HORN_91200_1212 HORIZONTAL Detector : Peak Project : 911635 Mode : 36 Power : 19.5</p>



WIFI	Band 4 5725~5850MHz Band Edge @ 3m	
ANT	802.11a CH165 5825MHz	
1	Vertical	Fundamental
Peak	<p> Site : 03CH12-HY Condition : PEAK_BE(B4)_16-24 3m HORN_91200_1212 VERTICAL Detector : Peak Project : 911635 Mode : 36 Power : 19.5 </p>	<p> Site : 03CH12-HY Condition : PEAK(UNII) 3m HORN_91200_1212 VERTICAL Detector : Peak Project : 911635 Mode : 36 Power : 19.5 </p>



Band 4 5725~5850MHz
WIFI 802.11ac VHT20 (Band Edge @ 3m)

WIFI	Band 4 5725~5850MHz Band Edge @ 3m	
ANT	802.11ac VHT20 CH149 5745MHz	
1	Horizontal	Fundamental
Peak	<p>Site : 03CH13-HY Condition : PEAK_BE(B4)_16-24 3m HORN_91200_1212 HORIZONTAL RBW:1000.000kHz VBW:3000.000kHz SWT:Auto Detector : Peak Project : 911635 Mode : 37 Power : 20</p>	<p>Site : 03CH13-HY Condition : PEAK(FUNB) 3m HORN_91200_1212 HORIZONTAL RBW:1000.000kHz VBW:3000.000kHz SWT:Auto Detector : Peak Project : 911635 Mode : 37 Power : 20</p>



WIFI	Band 4 5725~5850MHz Band Edge @ 3m	
ANT	802.11ac VHT20 CH149 5745MHz	
1	Vertical	Fundamental
<p>Peak</p> <p>Avg.</p>	<p>Date: 2019-07-08 PEAK: 85.045, 115.21</p> <p>Site : 03CH12-HY Condition : PEAK_8E(84)_16-24 3m HORN_91200_1212 VERTICAL RBW:1000.000KHz VBW:3000.000KHz SWT:Auto Detector : Peak Project : 911635 Mode : 37 Power : 20</p>	<p>Date: 2019-07-08 PEAK: 85.045, 115.21</p> <p>Site : 03CH12-HY Condition : PEAK(UNII) 3m HORN_91200_1212 VERTICAL RBW:1000.000KHz VBW:3000.000KHz SWT:Auto Detector : Peak Project : 911635 Mode : 37 Power : 20</p>



WIFI	Band 4 5725~5850MHz Band Edge @ 3m	
ANT	802.11ac VHT20 CH157 5785MHz	
1	Horizontal	Fundamental
Peak	<p>Site : 03CH13-HY Condition : PEAK_BE(B4)_16-24 3m HORN_91200_1212 HORIZONTAL Detector : Peak Project : 911635 Mode : 38 Power : 20</p>	<p>Site : 03CH13-HY Condition : PEAK(UNII) 3m HORN_91200_1212 HORIZONTAL Detector : Peak Project : 911635 Mode : 38 Power : 20</p>
Peak	<p>Site : 03CH13-HY Condition : PEAK_BE(B4)_16-24 3m HORN_91200_1212 HORIZONTAL Detector : Peak Project : 911635 Mode : 38 Power : 20</p>	Left blank



WIFI	Band 4 5725~5850MHz Band Edge @ 3m	
ANT	802.11ac VHT20 CH157 5785MHz	
1	Vertical	Fundamental
Peak	<p> Site : 03CH13-HY Condition : PEAK_BE(B4)_16-24 3m HORN_91200_1212 VERTICAL Detector : Peak Project : 911635 Mode : 38 Power : 20 </p>	<p> Site : 03CH13-HY Condition : PEAK(UNII) 3m HORN_91200_1212 VERTICAL Detector : Peak Project : 911635 Mode : 38 Power : 20 </p>
Peak	<p> Site : 03CH13-HY Condition : PEAK_BE(B4)_16-24 3m HORN_91200_1212 VERTICAL Detector : Peak Project : 911635 Mode : 38 Power : 20 </p>	Left blank

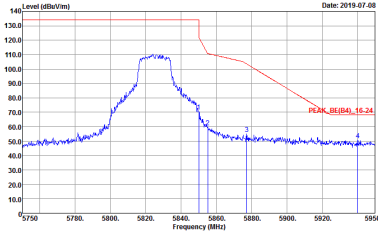
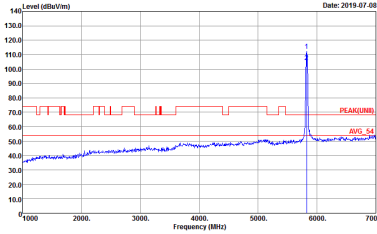

WIFI	Band 4 5725~5850MHz Band Edge @ 3m	
ANT	802.11ac VHT20 CH165 5825MHz	
1	Horizontal	Fundamental
<p>Peak</p>	 <p>Date: 2019-07-08</p> <p>Site : 03CH12-HY Condition : PEAK_BE(B4)_16-24 3m HORN_91200_1212 HORIZONTAL Detector : Peak Project : 911635 Mode : 39 Power : 19.5</p>	 <p>Date: 2019-07-08</p> <p>Site : 03CH12-HY Condition : PEAK(UNII) 3m HORN_91200_1212 HORIZONTAL Detector : Peak Project : 911635 Mode : 39 Power : 19.5</p>

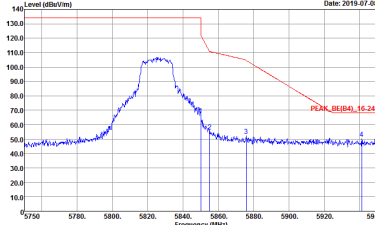
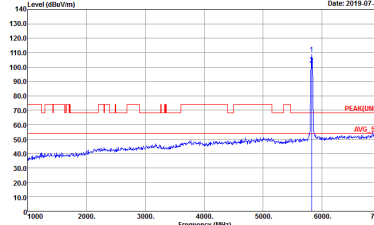

WIFI	Band 4 5725~5850MHz Band Edge @ 3m	
ANT	802.11ac VHT20 CH165 5825MHz	
1	Vertical	Fundamental
<p>Peak</p> <p>Avg.</p>	 <p>Site : 03CH12-HY Condition : PEAK_BE(B4)_16-24 3m HORN_91200_1212 VERTICAL Detector : Peak Project : 911635 Mode : 39 Power : 19.5</p>	 <p>Site : 03CH12-HY Condition : PEAK(UNII) 3m HORN_91200_1212 VERTICAL Detector : Peak Project : 911635 Mode : 39 Power : 19.5</p>



Band 4 5725~5850MHz
WIFI 802.11ac VHT40 (Band Edge @ 3m)

WIFI	Band 4 5725~5850MHz Band Edge @ 3m	
ANT	802.11ac VHT40 CH151 5755MHz	
1	Horizontal	Fundamental
Peak	<p>Site : 03CH13-HY Condition : PEAK_BE(B4)_16-24 3m HORN_91200_1212 HORIZONTAL Detector : Peak Project : 911635 Mode : 40 Power : 19</p>	<p>Site : 03CH13-HY Condition : PEAK(UNI) 3m HORN_91200_1212 HORIZONTAL Detector : Peak Project : 911635 Mode : 40 Power : 19</p>
Peak	<p>Site : 03CH13-HY Condition : PEAK_BE(B4)_16-24 3m HORN_91200_1212 HORIZONTAL Detector : Peak Project : 911635 Mode : 40 Power : 19</p>	Left blank



WIFI	Band 4 5725~5850MHz Band Edge @ 3m	
ANT	802.11ac VHT40 CH151 5755MHz	
1	Vertical	Fundamental
Peak	<p>Site : 03CH13-HY Condition : PEAK_BE(B4)_16-24 3m HORN_91200_1212 VERTICAL Detector : Peak Project : 911635 Mode : 40 Power : 19</p>	<p>Site : 03CH13-HY Condition : PEAK(UNII) 3m HORN_91200_1212 VERTICAL Detector : Peak Project : 911635 Mode : 40 Power : 19</p>
Peak	<p>Site : 03CH13-HY Condition : PEAK_BE(B4)_16-24 3m HORN_91200_1212 VERTICAL Detector : Peak Project : 911635 Mode : 40 Power : 19</p>	Left blank



WIFI	Band 4 5725~5850MHz Band Edge @ 3m	
ANT	802.11ac VHT40 CH159 5795MHz	
1	Horizontal	Fundamental
Peak	<p>Site : 03CH13-HY Condition : PEAK_BE(B4)_16-24 3m HORN_91200_1212 HORIZONTAL Detector : Peak Project : 911635 Mode : 41 Power : 19</p>	<p>Site : 03CH13-HY Condition : PEAK(UNII) 3m HORN_91200_1212 HORIZONTAL Detector : Peak Project : 911635 Mode : 41 Power : 19</p>
Peak	<p>Site : 03CH13-HY Condition : PEAK_BE(B4)_16-24 3m HORN_91200_1212 HORIZONTAL Detector : Peak Project : 911635 Mode : 41 Power : 19</p>	Left blank



WIFI	Band 4 5725~5850MHz Band Edge @ 3m	
ANT	802.11ac VHT40 CH159 5795MHz	
1	Vertical	Fundamental
Peak	<p>Site : 03CH13-HY Condition : PEAK_BE(84)_16-24 3m HORN_91200_1212 VERTICAL Detector : Peak Project : 911635 Mode : 41 Power : 19</p>	<p>Site : 03CH13-HY Condition : PEAK(UNII) 3m HORN_91200_1212 VERTICAL Detector : Peak Project : 911635 Mode : 41 Power : 19</p>
Peak	<p>Site : 03CH13-HY Condition : PEAK_BE(84)_16-24 3m HORN_91200_1212 VERTICAL Detector : Peak Project : 911635 Mode : 41 Power : 19</p>	Left blank

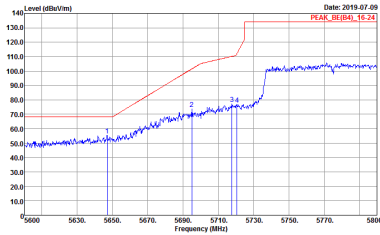
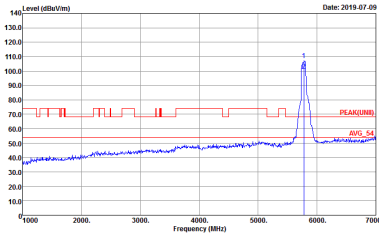
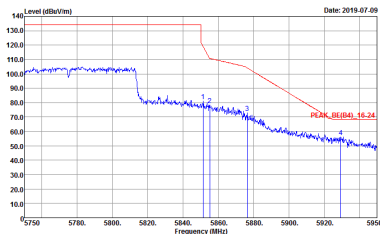

Band 4 5725~5850MHz
WIFI 802.11ac VHT80 (Band Edge @ 3m)

WIFI	Band 4 5725~5850MHz Band Edge @ 3m	
ANT	802.11ac VHT80 CH155 5775MHz	
1	Horizontal	Fundamental
Peak	 <p>Date: 2019-07-09 PEAK_BE(84)_16-24</p> <p>Site : 03CH13-HY Condition : PEAK_BE(84)_16-24 3m HORN_91200_1212 HORIZONTAL RBW:1000.000KHz VBW:3000.000KHz SWT:Auto Detector : Peak Project : 911635 Mode : 42 Power : 19.5</p>	 <p>Date: 2019-07-09 PEAK(UNIT) AVG_54</p> <p>Site : 03CH13-HY Condition : PEAK(UNIT) 3m HORN_91200_1212 HORIZONTAL RBW:1000.000KHz VBW:3000.000KHz SWT:Auto Detector : Peak Project : 911635 Mode : 42 Power : 19.5</p>
Peak	 <p>Date: 2019-07-09 PEAK_BE(84)_16-24</p> <p>Site : 03CH13-HY Condition : PEAK_BE(84)_16-24 3m HORN_91200_1212 HORIZONTAL RBW:1000.000KHz VBW:3000.000KHz SWT:Auto Detector : Peak Project : 911635 Mode : 42 Power : 19.5</p>	Left blank



WIFI	Band 4 5725~5850MHz Band Edge @ 3m	
ANT	802.11ac VHT80 CH155 5775MHz	
1	Vertical	Fundamental
Peak	<p> Site : 03CH13-HY Condition : PEAK_BE(B4)_16-24 3m HORN_91200_1212 VERTICAL Detector : Peak Project : 911635 Mode : 42 Power : 19.5 </p>	<p> Site : 03CH13-HY Condition : PEAK(UNII) 3m HORN_91200_1212 VERTICAL Detector : Peak Project : 911635 Mode : 42 Power : 19.5 </p>
Peak	<p> Site : 03CH13-HY Condition : PEAK_BE(B4)_16-24 3m HORN_91200_1212 VERTICAL Detector : Peak Project : 911635 Mode : 42 Power : 19.5 </p>	Left blank



Band 4 - 5725~5850MHz
WIFI 802.11a (Harmonic @ 3m)

WIFI	Band 4 5725~5850MHz Harmonic @ 3m	
ANT	802.11a CH149 5745MHz	
1	Horizontal	Vertical
Peak Avg.	<p>Site : 03CH13-1F Condition : PEAK(UNII) 3m HORN_91200_1212 HORIZONTAL Detector : Peak Project : 911635 Mode : 34 Power : 19.5</p>	<p>Site : 03CH13-1F Condition : PEAK(UNII) 3m HORN_91200_1212 VERTICAL Detector : Peak Project : 911635 Mode : 34 Power : 19.5</p>

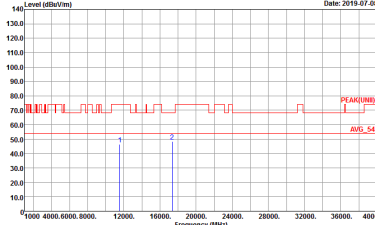
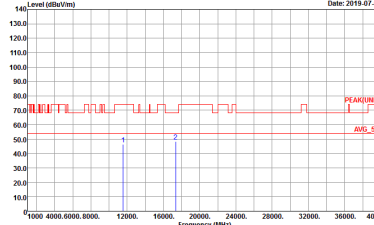

WIFI	Band 4 5725~5850MHz Harmonic @ 3m	
ANT	802.11a CH157 5785MHz	
1	Horizontal	Vertical
<p>Peak Avg.</p>	 <p>Date: 2019-07-08</p> <p>Site : 03CH12-HY Condition : PEAK(UNII) 3m HORN_91200_1212 HORIZONTAL Detector : Peak Project : 911635 Mode : 35 Power : 19.5</p>	 <p>Date: 2019-07-08</p> <p>Site : 03CH12-HY Condition : PEAK(UNII) 3m HORN_91200_1212 VERTICAL Detector : Peak Project : 911635 Mode : 35 Power : 19.5</p>

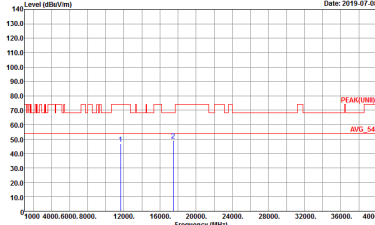
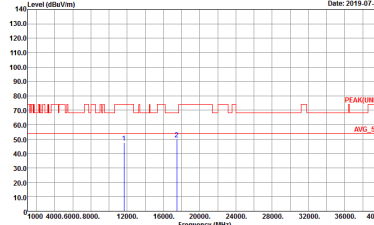

WIFI	Band 4 5725~5850MHz Harmonic @ 3m	
ANT	802.11a CH165 5825MHz	
1	Horizontal	Vertical
<p>Peak Avg.</p>	 <p>Site : 03CH12-HY Condition : PEAK(UNII) 3m HORN_91200_1212 HORIZONTAL Detector : Peak Project : 911635 Mode : 36 Power : 19.5</p>	 <p>Site : 03CH12-HY Condition : PEAK(UNII) 3m HORN_91200_1212 VERTICAL Detector : Peak Project : 911635 Mode : 36 Power : 19.5</p>



**Band 4 5725~5850MHz
WIFI 802.11ac VHT20 (Harmonic @ 3m)**

WIFI	Band 4 5725~5850MHz Harmonic @ 3m	
ANT	802.11ac VHT20 CH149 5745MHz	
1	Horizontal	Vertical
Peak Avg.	<p>Site : 03CH13-HY Condition : PEAK(UNII) 3m HORN_91200_1212 HORIZONTAL Detector : Peak Project : 911635 Mode : 37 Power : 20</p>	<p>Site : 03CH13-HY Condition : PEAK(UNII) 3m HORN_91200_1212 VERTICAL Detector : Peak Project : 911635 Mode : 37 Power : 20</p>



WIFI	Band 4 5725~5850MHz Harmonic @ 3m	
ANT	802.11ac VHT20 CH157 5785MHz	
1	Horizontal	Vertical
Peak Avg.	<p>Site : 03CH12-HY Condition : PEAK(UNII) 3m HORN_91200_1212 HORIZONTAL Detector : Peak Project : 911635 Mode : 38 Power : 20</p>	<p>Site : 03CH12-HY Condition : PEAK(UNII) 3m HORN_91200_1212 VERTICAL Detector : Peak Project : 911635 Mode : 38 Power : 20</p>

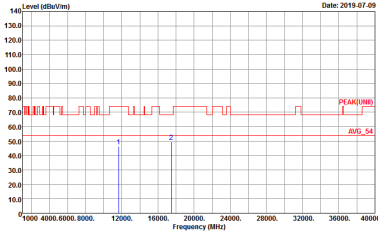
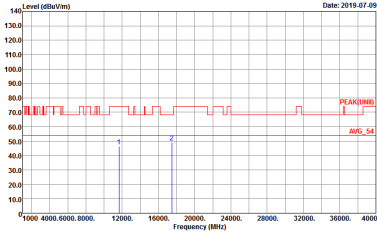

WIFI	Band 4 5725~5850MHz Harmonic @ 3m	
ANT	802.11ac VHT20 CH165 5825MHz	
1	Horizontal	Vertical
Peak Avg.	 <p>Site : 03CH12-HY Condition : PEAK(UNII) 3m HORN_91200_1212 HORIZONTAL Detector : Peak Project : 911635 Mode : 39 Power : 19.5</p>	 <p>Site : 03CH12-HY Condition : PEAK(UNII) 3m HORN_91200_1212 VERTICAL Detector : Peak Project : 911635 Mode : 39 Power : 19.5</p>



**Band 4 5725~5850MHz
WIFI 802.11ac VHT40 (Harmonic @ 3m)**

WIFI	Band 4 5725~5850MHz Harmonic @ 3m	
ANT	802.11ac VHT40 CH151 5755MHz	
1	Horizontal	Vertical
Peak Avg.	<p>Site : 03CH13-HY Condition : PEAK(LINE) 3m HORN_91200_1212 HORIZONTAL Detector : Peak Project : 911635 Mode : 40 Power : 19</p>	<p>Site : 03CH13-HY Condition : PEAK(LINE) 3m HORN_91200_1212 VERTICAL Detector : Peak Project : 911635 Mode : 40 Power : 19</p>



WIFI	Band 4 5725~5850MHz Harmonic @ 3m	
ANT	802.11ac VHT40 CH159 5795MHz	
1	Horizontal	Vertical
Peak Avg.	<p>Site : 03CH12-HY Condition : PEAK(UNII) 3m HORN_91200_1212 HORIZONTAL Detector : Peak Project : 911635 Mode : 41 Power : 19</p>	<p>Site : 03CH12-HY Condition : PEAK(UNII) 3m HORN_91200_1212 VERTICAL Detector : Peak Project : 911635 Mode : 41 Power : 19</p>



Band 4 5725~5850MHz
WIFI 802.11ac VHT80 (Harmonic @ 3m)

WIFI	Band 4 5725~5850MHz Harmonic @ 3m	
ANT	802.11ac VHT80 CH155 5775MHz	
1	Horizontal	Vertical
Peak Avg.	<p>Site : 03CH13-HY Condition : PEAK(UNII) 3m HORN_91200_1212 HORIZONTAL Detector : Peak Project : 911635 Mode : 42 Power : 19.5</p>	<p>Site : 03CH13-HY Condition : PEAK(UNII) 3m HORN_91200_1212 VERTICAL Detector : Peak Project : 911635 Mode : 42 Power : 19.5</p>



Emission below 1GHz
5GHz WIFI 802.11ac VHT80 (LF)

WIFI	5GHz 5725-5850MHz	
ANT	802.11ac VHT80 LF	
1	Horizontal	Vertical
QP / Peak	<p>Site : 03CH13-HY Condition : QP 3m B1LOG_40103 HORIZONTAL Detector : Peak Project : 911635 Mode : 156</p>	<p>Site : 03CH13-HY Condition : QP 3m B1LOG_40103 VERTICAL Detector : Peak Project : 911635 Mode : 156</p>



Band 4 - 5725~5850MHz
WIFI 802.11a (Band Edge @ 3m)

WIFI	Band 4 5725~5850MHz Band Edge @ 3m	
ANT	802.11a CH149 5745MHz	
2	Horizontal	Fundamental
Peak	<p> Site : 03CH13-HY Condition : PEAK_BE(B4)_16-24 3m HORN_91200_1212 HORIZONTAL Detector : Peak Project : 911635 Mode : 76 Power : 20 </p>	<p> Site : 03CH13-HY Condition : PEAK(UNII) 3m HORN_91200_1212 HORIZONTAL Detector : Peak Project : 911635 Mode : 76 Power : 20 </p>

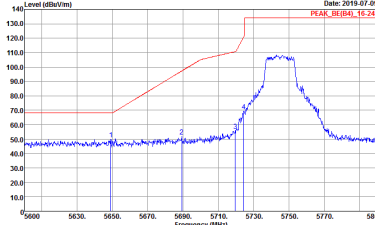
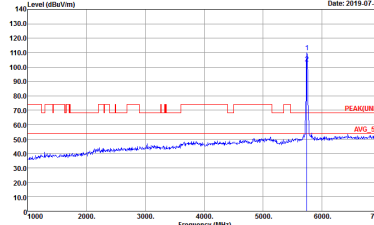

WIFI	Band 4 5725~5850MHz Band Edge @ 3m	
ANT	802.11a CH149 5745MHz	
2	Vertical	Fundamental
<p>Peak</p>	 <p>Date: 2019-07-09 PEAK_BE(49)_16-24</p> <p>Site : 03CH12-HY Condition : PEAK_BE(84)_16-24 3m HORN_91200_1212 VERTICAL RBW:1000.000KHz VBW:3000.000KHz SWT:Auto Detector : Peak Project : 911635 Mode : 76 Power : 20</p>	 <p>Date: 2019-07-09 PEAK_FUND</p> <p>Site : 03CH12-HY Condition : PEAK(FUND)_3m HORN_91200_1212 VERTICAL RBW:1000.000KHz VBW:3000.000KHz SWT:Auto Detector : Peak Project : 911635 Mode : 76 Power : 20</p>



WIFI	Band 4 5725~5850MHz Band Edge @ 3m	
ANT	802.11a CH157 5785MHz	
2	Horizontal	Fundamental
Peak	<p>Site : 03CH13-HY Condition : PEAK_BE(B4)_16-24 3m HORN_91200_1212 HORIZONTAL Detector : Peak Project : 911635 Mode : 77 Power : 19.5</p>	<p>Site : 03CH13-HY Condition : PEAK(UNII) 3m HORN_91200_1212 HORIZONTAL Detector : Peak Project : 911635 Mode : 77 Power : 19.5</p>
Peak	<p>Site : 03CH13-HY Condition : PEAK_BE(B4)_16-24 3m HORN_91200_1212 HORIZONTAL Detector : Peak Project : 911635 Mode : 77 Power : 19.5</p>	Left blank



WIFI	Band 4 5725~5850MHz Band Edge @ 3m	
ANT	802.11a CH157 5785MHz	
2	Vertical	Fundamental
Peak	<p>Site : 03CH13-HY Condition : PEAK_BE(B4)_16-24 3m HORN_91200_1212 VERTICAL Detector : Peak Project : 911635 Mode : 77 Power : 19.5</p>	<p>Site : 03CH13-HY Condition : PEAK(UNII) 3m HORN_91200_1212 VERTICAL Detector : Peak Project : 911635 Mode : 77 Power : 19.5</p>
Peak	<p>Site : 03CH13-HY Condition : PEAK_BE(B4)_16-24 3m HORN_91200_1212 VERTICAL Detector : Peak Project : 911635 Mode : 77 Power : 19.5</p>	Left blank

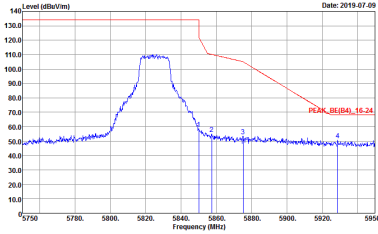
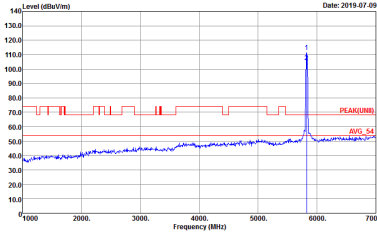

WIFI	Band 4 5725~5850MHz Band Edge @ 3m	
ANT	802.11a CH165 5825MHz	
2	Horizontal	Fundamental
Peak	 <p>Date: 2019-07-09</p> <p>PEAK_BE(B4)_16.24</p> <p>Site : 03CH12-HY Condition : PEAK_BE(B4)_16-24 3m HORN_91200_1212 HORIZONTAL Detector : Peak Project : 911635 Mode : 78 Power : 20</p>	 <p>Date: 2019-07-09</p> <p>PEAK(FUNB)</p> <p>Site : 03CH12-HY Condition : PEAK(FUNB)_16-24 3m HORN_91200_1212 HORIZONTAL Detector : Peak Project : 911635 Mode : 78 Power : 20</p>



WIFI	Band 4 5725~5850MHz Band Edge @ 3m	
ANT	802.11a CH165 5825MHz	
2	Vertical	Fundamental
Peak	<p>Site : 03CH12-HY Condition : PEAK_BE(B4)_16-24 3m HORN_91200_1212 VERTICAL Detector : Peak Project : 911635 Mode : 78 Power : 20</p>	<p>Site : 03CH12-HY Condition : PEAK(FUNII) 3m HORN_91200_1212 VERTICAL Detector : Peak Project : 911635 Mode : 78 Power : 20</p>

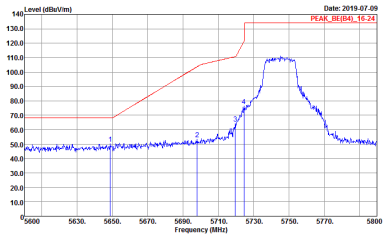
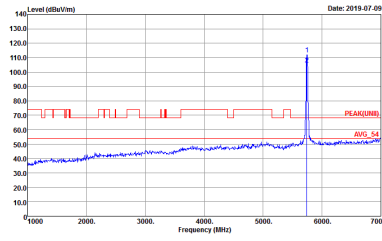

Band 4 5725~5850MHz
WIFI 802.11ac VHT20 (Band Edge @ 3m)

WIFI	Band 4 5725~5850MHz Band Edge @ 3m	
ANT	802.11ac VHT20 CH149 5745MHz	
2	Horizontal	Fundamental
Peak	 <p>Site : 03CH13-HY Condition : PEAK_B(84)_16-24 3m HORN_91200_1212 HORIZONTAL RBW:1000.000kHz VBW:3000.000kHz SWT:Auto Detector : Peak Project : 911635 Mode : 79 Power : 20</p>	 <p>Site : 03CH13-HY Condition : PEAK(UNIT) 3m HORN_91200_1212 HORIZONTAL RBW:1000.000kHz VBW:3000.000kHz SWT:Auto Detector : Peak Project : 911635 Mode : 79 Power : 20</p>

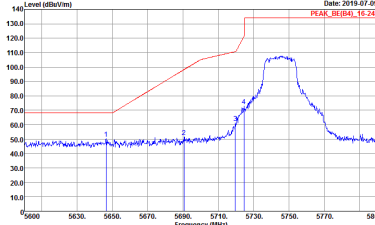
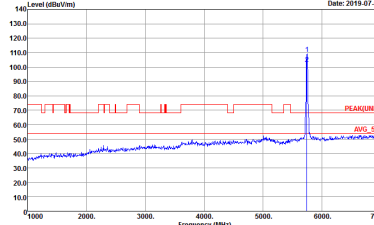

WIFI	Band 4 5725~5850MHz Band Edge @ 3m	
ANT	802.11ac VHT20 CH149 5745MHz	
2	Vertical	Fundamental
<p>Peak Avg.</p>	 <p>Site : 03CH12-HY Condition : PEAK_BE(84)_16-24 3m HORN_91200_1212 VERTICAL Detector : Peak Project : 911635 Mode : 79 Power : 20</p>	 <p>Site : 03CH12-HY Condition : PEAK(UNII) 3m HORN_91200_1212 VERTICAL Detector : Peak Project : 911635 Mode : 79 Power : 20</p>



WIFI	Band 4 5725~5850MHz Band Edge @ 3m	
ANT	802.11ac VHT20 CH157 5785MHz	
2	Horizontal	Fundamental
Peak	<p>Site : 03CH13-HY Condition : PEAK_BE(B4)_16-24 3m HORN_91200_1212 HORIZONTAL Detector : Peak Project : 911635 Mode : 80 Power : 20</p>	<p>Site : 03CH13-HY Condition : PEAK(UNII) 3m HORN_91200_1212 HORIZONTAL Detector : Peak Project : 911635 Mode : 80 Power : 20</p>
Peak	<p>Site : 03CH13-HY Condition : PEAK_BE(B4)_16-24 3m HORN_91200_1212 HORIZONTAL Detector : Peak Project : 911635 Mode : 80 Power : 20</p>	Left blank



WIFI	Band 4 5725~5850MHz Band Edge @ 3m	
ANT	802.11ac VHT20 CH157 5785MHz	
2	Vertical	Fundamental
Peak	<p>Site : 03CH13-HY Condition : PEAK_BE(B4)_16-24 3m HORN_91200_1212 VERTICAL Detector : Peak Project : 911635 Mode : 80 Power : 20</p>	<p>Site : 03CH13-HY Condition : PEAK(UNII) 3m HORN_91200_1212 VERTICAL Detector : Peak Project : 911635 Mode : 80 Power : 20</p>
Peak	<p>Site : 03CH13-HY Condition : PEAK_BE(B4)_16-24 3m HORN_91200_1212 VERTICAL Detector : Peak Project : 911635 Mode : 80 Power : 20</p>	Left blank



WIFI	Band 4 5725~5850MHz Band Edge @ 3m	
ANT	802.11ac VHT20 CH165 5825MHz	
2	Horizontal	Fundamental
Peak	<p>Site : 03CH12-HY Condition : PEAK_BE(B4)_16-24 3m HORN_91200_1212 HORIZONTAL Detector : Peak Project : 911635 Mode : 81 Power : 20</p>	<p>Site : 03CH12-HY Condition : PEAK(UNII) 3m HORN_91200_1212 HORIZONTAL Detector : Peak Project : 911635 Mode : 81 Power : 20</p>

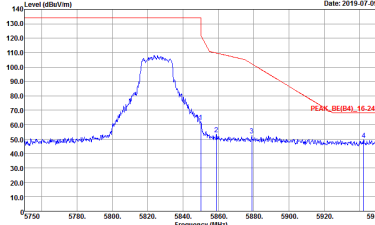
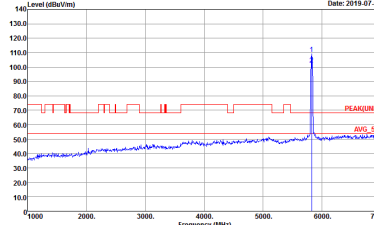

WIFI	Band 4 5725~5850MHz Band Edge @ 3m	
ANT	802.11ac VHT20 CH165 5825MHz	
2	Vertical	Fundamental
<p>Peak Avg.</p>	 <p>Site : 03CH12-HY Condition : PEAK_BE(B4)_16-24 3m HORN_91200_1212 VERTICAL Detector : Peak Project : 911635 Mode : 81 Power : 20</p>	 <p>Site : 03CH12-HY Condition : PEAK(UNII) 3m HORN_91200_1212 VERTICAL Detector : Peak Project : 911635 Mode : 81 Power : 20</p>



Band 4 5725~5850MHz
WIFI 802.11ac VHT40 (Band Edge @ 3m)

WIFI	Band 4 5725~5850MHz Band Edge @ 3m	
ANT	802.11ac VHT40 CH151 5755MHz	
2	Horizontal	Fundamental
Peak	<p>Site : 03CH13-HY Condition : PEAK_BE(84)_16-24 3m HORN_91200_1212 HORIZONTAL Detector : Peak Project : 911635 Mode : 82 Power : 19</p>	<p>Site : 03CH13-HY Condition : PEAK(UNIT) 3m HORN_91200_1212 HORIZONTAL Detector : Peak Project : 911635 Mode : 82 Power : 19</p>
Peak	<p>Site : 03CH13-HY Condition : PEAK_BE(84)_16-24 3m HORN_91200_1212 HORIZONTAL Detector : Peak Project : 911635 Mode : 82 Power : 19</p>	Left blank



WIFI	Band 4 5725~5850MHz Band Edge @ 3m	
ANT	802.11ac VHT40 CH151 5755MHz	
2	Vertical	Fundamental
<p>Peak</p>	<p>Site : 03CH13-HY Condition : PEAK_BE(B4)_16-24 3m HORN_91200_1212 VERTICAL Detector : Peak Project : 911635 Mode : 82 Power : 19</p>	<p>Site : 03CH13-HY Condition : PEAK(UNII) 3m HORN_91200_1212 VERTICAL Detector : Peak Project : 911635 Mode : 82 Power : 19</p>
<p>Peak</p>	<p>Site : 03CH13-HY Condition : PEAK_BE(B4)_16-24 3m HORN_91200_1212 VERTICAL Detector : Peak Project : 911635 Mode : 82 Power : 19</p>	<p>Left blank</p>



WIFI	Band 4 5725~5850MHz Band Edge @ 3m	
ANT	802.11ac VHT40 CH159 5795MHz	
2	Horizontal	Fundamental
Peak	<p>Site : 03CH13-HY Condition : PEAK_BE(B4)_16-24 3m HORN_91200_1212 HORIZONTAL Detector : Peak Project : 911635 Mode : 83 Power : 19</p>	<p>Site : 03CH13-HY Condition : PEAK(UNII) 3m HORN_91200_1212 HORIZONTAL Detector : Peak Project : 911635 Mode : 83 Power : 19</p>
Peak	<p>Site : 03CH13-HY Condition : PEAK_BE(B4)_16-24 3m HORN_91200_1212 HORIZONTAL Detector : Peak Project : 911635 Mode : 83 Power : 19</p>	Left blank



WIFI	Band 4 5725~5850MHz Band Edge @ 3m	
ANT	802.11ac VHT40 CH159 5795MHz	
2	Vertical	Fundamental
Peak	<p>Site : 03CH13-HY Condition : PEAK_BE(B4)_16-24 3m HORN_91200_1212 VERTICAL Detector : Peak Project : 911635 Mode : 83 Power : 19</p>	<p>Site : 03CH13-HY Condition : PEAK(UNII) 3m HORN_91200_1212 VERTICAL Detector : Peak Project : 911635 Mode : 83 Power : 19</p>
Peak	<p>Site : 03CH13-HY Condition : PEAK_BE(B4)_16-24 3m HORN_91200_1212 VERTICAL Detector : Peak Project : 911635 Mode : 83 Power : 19</p>	Left blank

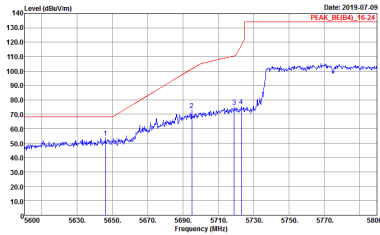
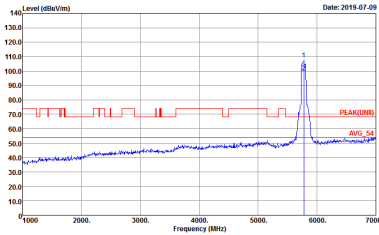
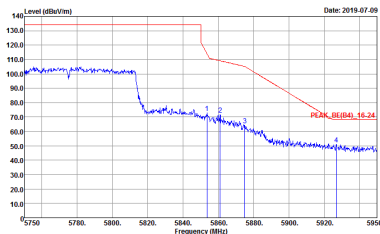

Band 4 5725~5850MHz
WIFI 802.11ac VHT80 (Band Edge @ 3m)

WIFI	Band 4 5725~5850MHz Band Edge @ 3m	
ANT	802.11ac VHT80 CH155 5775MHz	
2	Horizontal	Fundamental
<p align="center">Peak</p>	 <p>Site : 03CH13-HY Condition : PEAK_BE(84)_16-24 3m HORN_91200_1212 HORIZONTAL Detector : Peak Project : 911635 Mode : 83 Power : 19</p>	 <p>Site : 03CH13-HY Condition : PEAK(UNIT) 3m HORN_91200_1212 HORIZONTAL Detector : Peak Project : 911635 Mode : 83 Power : 19</p>
<p align="center">Peak</p>	 <p>Site : 03CH13-HY Condition : PEAK_BE(84)_16-24 3m HORN_91200_1212 HORIZONTAL Detector : Peak Project : 911635 Mode : 83 Power : 19</p>	<p align="center">Left blank</p>



WIFI	Band 4 5725~5850MHz Band Edge @ 3m	
ANT	802.11ac VHT80 CH155 5775MHz	
2	Vertical	Fundamental
Peak	<p> Site : 03CH13-HY Condition : PEAK_BE(B4)_16-24 3m HORN_91200_1212 VERTICAL Detector : Peak Project : 911635 Mode : 83 Power : 19 </p>	<p> Site : 03CH13-HY Condition : PEAK(UNII) 3m HORN_91200_1212 VERTICAL Detector : Peak Project : 911635 Mode : 83 Power : 19 </p>
Peak	<p> Site : 03CH13-HY Condition : PEAK_BE(B4)_16-24 3m HORN_91200_1212 VERTICAL Detector : Peak Project : 911635 Mode : 83 Power : 19 </p>	Left blank



Band 4 - 5725~5850MHz
WIFI 802.11a (Harmonic @ 3m)

WIFI	Band 4 5725~5850MHz Harmonic @ 3m	
ANT	802.11a CH149 5745MHz	
2	Horizontal	Vertical
Peak Avg.	<p>Site : 03CH13-HY Condition : PEAK(UNII) 3m HORN_91200_1212 HORIZONTAL Detector : Peak Project : 911635 Mode : 76 Power : 20</p>	<p>Site : 03CH13-HY Condition : PEAK(UNII) 3m HORN_91200_1212 VERTICAL Detector : Peak Project : 911635 Mode : 76 Power : 20</p>



WIFI	Band 4 5725~5850MHz Harmonic @ 3m	
ANT	802.11a CH157 5785MHz	
2	Horizontal	Vertical
Peak Avg.	<p>Site : 03CH12-HV Condition : PEAK(UNII) 3m HORN_91200_1212 HORIZONTAL Detector : Peak Project : 911635 Mode : 77 Power : 19.5</p>	<p>Site : 03CH12-HV Condition : PEAK(UNII) 3m HORN_91200_1212 VERTICAL Detector : Peak Project : 911635 Mode : 77 Power : 19.5</p>

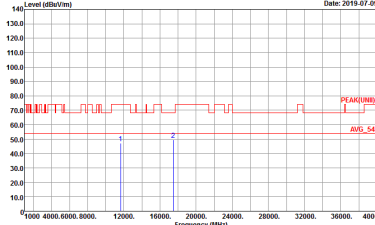
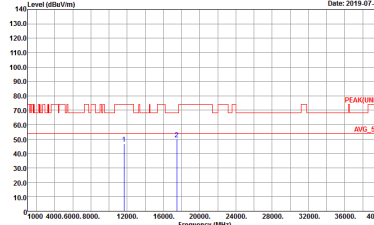

WIFI	Band 4 5725~5850MHz Harmonic @ 3m	
ANT	802.11a CH165 5825MHz	
2	Horizontal	Vertical
<p>Peak Avg.</p>	 <p>Date: 2019-07-09</p> <p>Site : 03CH12-HY Condition : PEAK(UNII) 3m HORN_91200_1212 HORIZONTAL Detector : Peak Project : 911635 Mode : 7B Power : 20</p>	 <p>Date: 2019-07-09</p> <p>Site : 03CH12-HY Condition : PEAK(UNII) 3m HORN_91200_1212 VERTICAL Detector : Peak Project : 911635 Mode : 7B Power : 20</p>



Band 4 5725~5850MHz
WIFI 802.11ac VHT20 (Harmonic @ 3m)

Table with 3 columns: WIFI, ANT, and measurement results for Horizontal and Vertical orientations. Includes peak and average level graphs and technical details like Site, Condition, Detector, Project, Mode, and Power.



WIFI	Band 4 5725~5850MHz Harmonic @ 3m	
ANT	802.11ac VHT20 CH157 5785MHz	
2	Horizontal	Vertical
Peak Avg.	<p>Site : 03CH12-HV Condition : PEAK(UNII) 3m HORN_91200_1212 HORIZONTAL Detector : Peak Project : 911635 Mode : 80 Power : 20</p>	<p>Site : 03CH12-HV Condition : PEAK(UNII) 3m HORN_91200_1212 VERTICAL Detector : Peak Project : 911635 Mode : 80 Power : 20</p>



WIFI	Band 4 5725~5850MHz Harmonic @ 3m	
ANT	802.11ac VHT20 CH165 5825MHz	
2	Horizontal	Vertical
Peak Avg.	<p>Site : 03CH12-HY Condition : PEAK(UNII) 3m HORN_91200_1212 HORIZONTAL Detector : Peak Project : 911635 Mode : 81 Power : 20</p>	<p>Site : 03CH12-HY Condition : PEAK(UNII) 3m HORN_91200_1212 VERTICAL Detector : Peak Project : 911635 Mode : 81 Power : 20</p>



**Band 4 5725~5850MHz
WIFI 802.11ac VHT40 (Harmonic @ 3m)**

WIFI	Band 4 5725~5850MHz Harmonic @ 3m	
ANT	802.11ac VHT40 CH151 5755MHz	
2	Horizontal	Vertical
Peak Avg.	<p>Site : 03CH13-HY Condition : PEAK(UNII) 3m HORN_91200_1212 HORIZONTAL Detector : Peak Project : 911635 Mode : 82 Power : 19</p>	<p>Site : 03CH13-HY Condition : PEAK(UNII) 3m HORN_91200_1212 VERTICAL Detector : Peak Project : 911635 Mode : 82 Power : 19</p>



WIFI	Band 4 5725~5850MHz Harmonic @ 3m	
ANT	802.11ac VHT40 CH159 5795MHz	
2	Horizontal	Vertical
Peak Avg.	<p>Site : 03CH12-HV Condition : PEAK(UNII) 3m HORN_91200_1212 HORIZONTAL Detector : Peak Project : 911635 Mode : 83 Power : 19</p>	<p>Site : 03CH12-HV Condition : PEAK(UNII) 3m HORN_91200_1212 VERTICAL Detector : Peak Project : 911635 Mode : 83 Power : 19</p>



Band 4 5725~5850MHz
WIFI 802.11ac VHT80 (Harmonic @ 3m)

Table with 2 columns: WIFI (Band 4 5725~5850MHz Harmonic @ 3m), ANT (802.11ac VHT80 CH155 5775MHz). Row 2: 2, Horizontal, Vertical. Each plot shows Level (dBu/m) vs Frequency (MHz) with Peak and Avg markers.

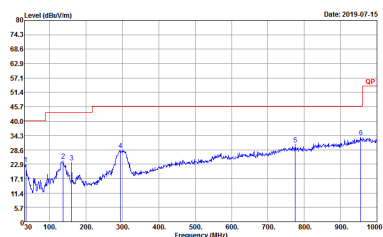
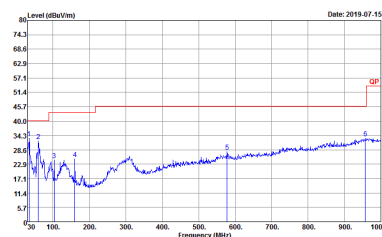

Emission below 1GHz
5GHz WIFI 802.11ac VHT80 (LF)

WIFI	5GHz 5725-5850MHz	
ANT	802.11ac VHT80 LF	
2	Horizontal	Vertical
QP / Peak	 <p>Site : 03CH13-HY Condition : QP 3m B1LOG_40103 HORIZONTAL Detector : Peak Project : 911635 Mode : 157</p>	 <p>Site : 03CH13-HY Condition : QP 3m B1LOG_40103 VERTICAL Detector : Peak Project : 911635 Mode : 157</p>



Band 4 - 5725~5850MHz
WIFI 802.11a (Band Edge @ 3m)

WIFI	Band 4 5725~5850MHz Band Edge @ 3m	
ANT	802.11a CH149 5745MHz	
1+2	Horizontal	Fundamental
Peak	<p> Site : 03CH13-HY Condition : PEAK_BE(B4)_16-24 3m HORN_91200_1212 HORIZONTAL Detector : Peak Project : 911635 Mode : 147 Power : 19.5 </p>	<p> Site : 03CH13-HY Condition : PEAK(LINII) 3m HORN_91200_1212 HORIZONTAL Detector : Peak Project : 911635 Mode : 147 Power : 19.5 </p>

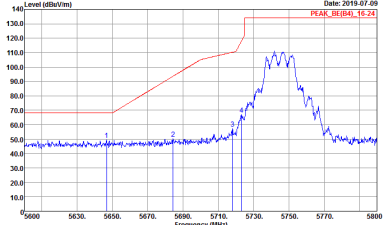
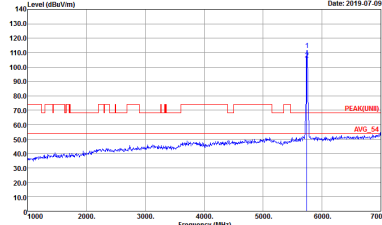

WIFI	Band 4 5725~5850MHz Band Edge @ 3m	
ANT	802.11a CH149 5745MHz	
1+2	Vertical	Fundamental
Peak	 <p>Date: 2019-07-09 PEAK_BE(49)_15(2)</p> <p>Site : 03CH12-4V Condition : PEAK_BE(84)_16-24 3m HORN_91200_1212 VERTICAL Detector : Peak Project : 911635 Mode : 147 Power : 19.5</p>	 <p>Date: 2019-07-09 PEAK(UNB)</p> <p>Site : 03CH12-4V Condition : PEAK(UNII) 3m HORN_91200_1212 VERTICAL Detector : Peak Project : 911635 Mode : 147 Power : 19.5</p>



WIFI	Band 4 5725~5850MHz Band Edge @ 3m	
ANT	802.11a CH157 5785MHz	
1+2	Horizontal	Fundamental
Peak	<p>Site : 03CH13-HY Condition : PEAK_BE(B4)_16-24 3m HORN_91200_1212 HORIZONTAL Detector : Peak Project : 911635 Mode : 148 Power : 19.5</p>	<p>Site : 03CH13-HY Condition : PEAK(UNII) 3m HORN_91200_1212 HORIZONTAL Detector : Peak Project : 911635 Mode : 148 Power : 19.5</p>
Peak	<p>Site : 03CH13-HY Condition : PEAK_BE(B4)_16-24 3m HORN_91200_1212 HORIZONTAL Detector : Peak Project : 911635 Mode : 148 Power : 19.5</p>	Left blank



WIFI	Band 4 5725~5850MHz Band Edge @ 3m	
ANT	802.11a CH157 5785MHz	
1+2	Vertical	Fundamental
Peak	<p>Site : 03CH13-HY Condition : PEAK_BE(B4)_16-24 3m HORN_91200_1212 VERTICAL Detector : Peak Project : 911635 Mode : 148 Power : 19.5</p>	<p>Site : 03CH13-HY Condition : PEAK(UNII) 3m HORN_91200_1212 VERTICAL Detector : Peak Project : 911635 Mode : 148 Power : 19.5</p>
Peak	<p>Site : 03CH13-HY Condition : PEAK_BE(B4)_16-24 3m HORN_91200_1212 VERTICAL Detector : Peak Project : 911635 Mode : 148 Power : 19.5</p>	Left blank

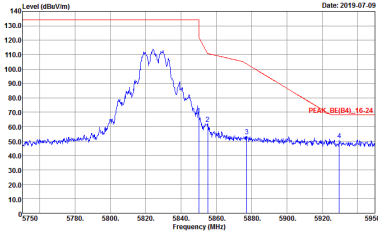
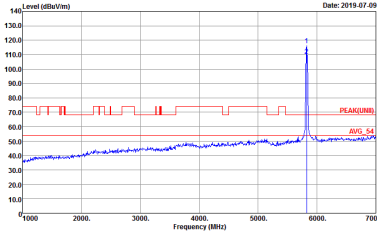

WIFI	Band 4 5725~5850MHz Band Edge @ 3m	
ANT	802.11a CH165 5825MHz	
1+2	Horizontal	Fundamental
Peak	 <p> Site : 03CH12-HY Condition : PEAK_BE(B4)_16-24 3m HORN_91200_1212 HORIZONTAL Detector : Peak Project : 911635 Mode : 149 Power : 19.5 </p>	 <p> Site : 03CH12-HY Condition : PEAK(UNII) 3m HORN_91200_1212 HORIZONTAL Detector : Peak Project : 911635 Mode : 149 Power : 19.5 </p>

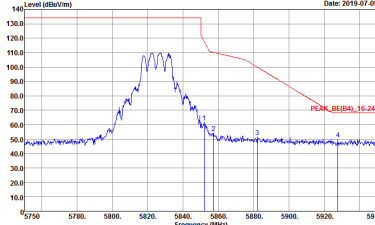
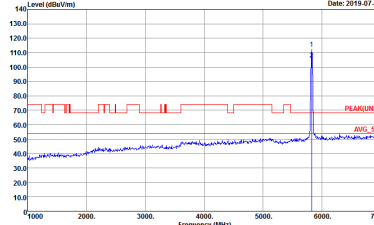

WIFI	Band 4 5725~5850MHz Band Edge @ 3m	
ANT	802.11a CH165 5825MHz	
1+2	Vertical	Fundamental
Peak	 <p> Site : 03CH12-1HY Condition : PEAK_BE(B4)_16-24 3m HORN_91200_1212 VERTICAL Detector : Peak Project : 911635 Mode : 149 Power : 19.5 </p>	 <p> Site : 03CH12-1HY Condition : PEAK(UNII) 3m HORN_91200_1212 VERTICAL Detector : Peak Project : 911635 Mode : 149 Power : 19.5 </p>



Band 4 5725~5850MHz
WIFI 802.11ac VHT20 (Band Edge @ 3m)

Table with 2 columns: WIFI (Band 4 5725~5850MHz Band Edge @ 3m), ANT (802.11ac VHT20 CH149 5745MHz). It contains two spectral plots: 'Horizontal' and 'Fundamental'. The 'Horizontal' plot shows a peak at 5745 MHz with a level of 124.2 dBm. The 'Fundamental' plot shows a peak at 5745 MHz with a level of 124.2 dBm. Both plots include site and condition details.



WIFI	Band 4 5725~5850MHz Band Edge @ 3m	
ANT	802.11ac VHT20 CH149 5745MHz	
1+2	Vertical	Fundamental
<p>Peak</p> <p>Avg.</p>	<p>Date: 2019-07-09 PEAK: 85.045, 75.221</p> <p>Site : 03CH12-HY Condition : PEAK_8E(84)_16-24 3m HORN_91200_1212 VERTICAL RBW:1000.000KHz VBW:3000.000KHz SWT:Auto Detector : Peak Project : 911635 Mode : 150 Power : 20</p>	<p>Date: 2019-07-09 PEAK: 85.045, 75.221</p> <p>Site : 03CH12-HY Condition : PEAK(UNII) 3m HORN_91200_1212 VERTICAL RBW:1000.000KHz VBW:3000.000KHz SWT:Auto Detector : Peak Project : 911635 Mode : 150 Power : 20</p>



WIFI	Band 4 5725~5850MHz Band Edge @ 3m	
ANT	802.11ac VHT20 CH157 5785MHz	
1+2	Horizontal	Fundamental
Peak	<p> Date: 2019-07-09 PEAK_BE(84)_15-21 </p> <p> Site : 03CH13-HY Condition : PEAK_BE(84)_16-24 3m HORN_91200_1212 HORIZONTAL Detector : Peak Project : 911635 Mode : 151 Power : 19.5 </p>	<p> Date: 2019-07-09 PEAK(84)_15-21 </p> <p> Site : 03CH13-HY Condition : PEAK(UNII) 3m HORN_91200_1212 HORIZONTAL Detector : Peak Project : 911635 Mode : 151 Power : 19.5 </p>
Peak	<p> Date: 2019-07-09 PEAK_BE(84)_15-24 </p> <p> Site : 03CH13-HY Condition : PEAK_BE(84)_16-24 3m HORN_91200_1212 HORIZONTAL Detector : Peak Project : 911635 Mode : 151 Power : 19.5 </p>	Left blank



WIFI	Band 4 5725~5850MHz Band Edge @ 3m	
ANT	802.11ac VHT20 CH157 5785MHz	
1+2	Vertical	Fundamental
Peak	<p>Site : 03CH13-HY Condition : PEAK_BE(B4)_16-24 3m HORN_91200_1212 VERTICAL Detector : Peak Project : 911635 Mode : 151 Power : 19.5</p>	<p>Site : 03CH13-HY Condition : PEAK(UNII) 3m HORN_91200_1212 VERTICAL Detector : Peak Project : 911635 Mode : 151 Power : 19.5</p>
Peak	<p>Site : 03CH13-HY Condition : PEAK_BE(B4)_16-24 3m HORN_91200_1212 VERTICAL Detector : Peak Project : 911635 Mode : 151 Power : 19.5</p>	Left blank

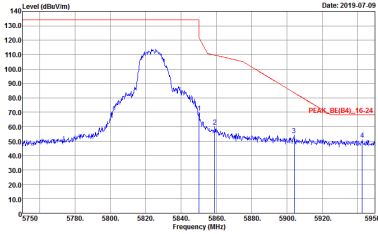
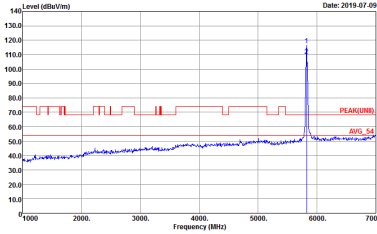

WIFI	Band 4 5725~5850MHz Band Edge @ 3m	
ANT	802.11ac VHT20 CH165 5825MHz	
1+2	Horizontal	Fundamental
Peak	 <p>Site : 03CH12-HY Condition : PEAK_BE(B4)_16-24 3m HORN_91200_1212 HORIZONTAL Detector : Peak Project : 911635 Mode : 152 Power : 19.5</p>	 <p>Site : 03CH12-HY Condition : PEAK(UNII) 3m HORN_91200_1212 HORIZONTAL Detector : Peak Project : 911635 Mode : 152 Power : 19.5</p>

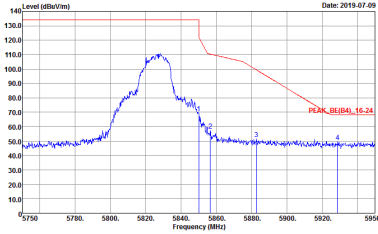
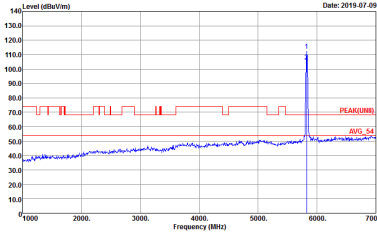

WIFI	Band 4 5725~5850MHz Band Edge @ 3m	
ANT	802.11ac VHT20 CH165 5825MHz	
1+2	Vertical	Fundamental
<p>Peak</p> <p>Avg.</p>	 <p>Site : 03CH12-HY Condition : PEAK_BE(B4)_16-24 3m HORN_91200_1212 VERTICAL Detector : Peak Project : 911635 Mode : 152 Power : 19.5</p>	 <p>Site : 03CH12-HY Condition : PEAK(UNII) 3m HORN_91200_1212 VERTICAL Detector : Peak Project : 911635 Mode : 152 Power : 19.5</p>



Band 4 5725~5850MHz
WIFI 802.11ac VHT40 (Band Edge @ 3m)

WIFI	Band 4 5725~5850MHz Band Edge @ 3m	
ANT	802.11ac VHT40 CH151 5755MHz	
1+2	Horizontal	Fundamental
Peak	<p>Site : 03CH13-HY Condition : PEAK_BE(B4)_16-24 3m HORN_91200_1212 HORIZONTAL RBW:1000.000KHz VBW:3000.000KHz SWT:Auto Detector : Peak Project : 911635 Mode : 153 Power : 19</p>	<p>Site : 03CH13-HY Condition : PEAK(UNIT) 3m HORN_91200_1212 HORIZONTAL RBW:1000.000KHz VBW:3000.000KHz SWT:Auto Detector : Peak Project : 911635 Mode : 153 Power : 19</p>
Peak	<p>Site : 03CH13-HY Condition : PEAK_BE(B4)_16-24 3m HORN_91200_1212 HORIZONTAL RBW:1000.000KHz VBW:3000.000KHz SWT:Auto Detector : Peak Project : 911635 Mode : 153 Power : 19</p>	Left blank



WIFI	Band 4 5725~5850MHz Band Edge @ 3m	
ANT	802.11ac VHT40 CH151 5755MHz	
1+2	Vertical	Fundamental
Peak	<p>Site : 03CH13-HY Condition : PEAK_BE(B4)_16-24 3m HORN_91200_1212 VERTICAL Detector : Peak Project : 911635 Mode : 153 Power : 19</p>	<p>Site : 03CH13-HY Condition : PEAK(UNII) 3m HORN_91200_1212 VERTICAL Detector : Peak Project : 911635 Mode : 153 Power : 19</p>
Peak	<p>Site : 03CH13-HY Condition : PEAK_BE(B4)_16-24 3m HORN_91200_1212 VERTICAL Detector : Peak Project : 911635 Mode : 153 Power : 19</p>	Left blank



WIFI	Band 4 5725~5850MHz Band Edge @ 3m	
ANT	802.11ac VHT40 CH159 5795MHz	
1+2	Horizontal	Fundamental
Peak	<p>Site : 03CH13-HY Condition : PEAK_BE(B4)_16-24 3m HORN_91200_1212 HORIZONTAL Detector : Peak Project : 911635 Mode : 154 Power : 19</p>	<p>Site : 03CH13-HY Condition : PEAK(UNII) 3m HORN_91200_1212 HORIZONTAL Detector : Peak Project : 911635 Mode : 154 Power : 19</p>
Peak	<p>Site : 03CH13-HY Condition : PEAK_BE(B4)_16-24 3m HORN_91200_1212 HORIZONTAL Detector : Peak Project : 911635 Mode : 154 Power : 19</p>	Left blank



WIFI	Band 4 5725~5850MHz Band Edge @ 3m	
ANT	802.11ac VHT40 CH159 5795MHz	
1+2	Vertical	Fundamental
Peak	<p>Site : 03CH13-HY Condition : PEAK_BE(B4)_16-24 3m HORN_91200_1212 VERTICAL Detector : Peak Project : 911635 Mode : 154 Power : 19</p>	<p>Site : 03CH13-HY Condition : PEAK(UNII) 3m HORN_91200_1212 VERTICAL Detector : Peak Project : 911635 Mode : 154 Power : 19</p>
Peak	<p>Site : 03CH13-HY Condition : PEAK_BE(B4)_16-24 3m HORN_91200_1212 VERTICAL Detector : Peak Project : 911635 Mode : 154 Power : 19</p>	Left blank

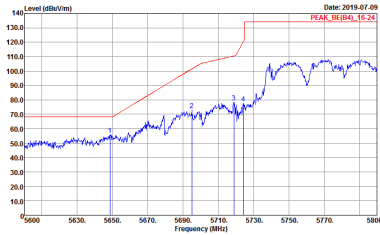
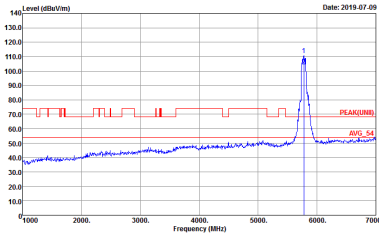
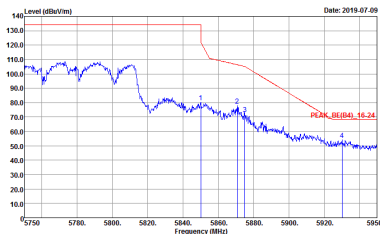

Band 4 5725~5850MHz
WIFI 802.11ac VHT80 (Band Edge @ 3m)

WIFI	Band 4 5725~5850MHz Band Edge @ 3m	
ANT	802.11ac VHT80 CH155 5775MHz	
1+2	Horizontal	Fundamental
<p align="center">Peak</p>	 <p>Site : 03CH13-HY Condition : PEAK_BE(84)_16-24 3m HORN_91200_1212 HORIZONTAL Detector : Peak Project : 911635 Mode : 155 Power : 19</p>	 <p>Site : 03CH13-HY Condition : PEAK(UNIT) 3m HORN_91200_1212 HORIZONTAL Detector : Peak Project : 911635 Mode : 155 Power : 19</p>
<p align="center">Peak</p>	 <p>Site : 03CH13-HY Condition : PEAK_BE(84)_16-24 3m HORN_91200_1212 HORIZONTAL Detector : Peak Project : 911635 Mode : 155 Power : 19</p>	<p align="center">Left blank</p>



WIFI	Band 4 5725~5850MHz Band Edge @ 3m	
ANT	802.11ac VHT80 CH155 5775MHz	
1+2	Vertical	Fundamental
Peak	<p>Site : 03CH13-HY Condition : PEAK_BE(B4)_16-24 3m HORN_91200_1212 VERTICAL Detector : Peak Project : 911635 Mode : 155 Power : 19</p>	<p>Site : 03CH13-HY Condition : PEAK(UNII) 3m HORN_91200_1212 VERTICAL Detector : Peak Project : 911635 Mode : 155 Power : 19</p>
Peak	<p>Site : 03CH13-HY Condition : PEAK_BE(B4)_16-24 3m HORN_91200_1212 VERTICAL Detector : Peak Project : 911635 Mode : 155 Power : 19</p>	Left blank



Band 4 - 5725~5850MHz
WIFI 802.11a (Harmonic @ 3m)

WIFI	Band 4 5725~5850MHz Harmonic @ 3m	
ANT	802.11a CH149 5745MHz	
1+2	Horizontal	Vertical
Peak Avg.	<p>Site : 03CH13-1F Condition : PEAK(UNII) 3m HORN_91200_1212 HORIZONTAL Detector : Peak Project : 911635 Mode : 147 Power : 19.5</p>	<p>Site : 03CH13-1F Condition : PEAK(UNII) 3m HORN_91200_1212 VERTICAL Detector : Peak Project : 911635 Mode : 147 Power : 19.5</p>



WIFI	Band 4 5725~5850MHz Harmonic @ 3m	
ANT	802.11a CH157 5785MHz	
1+2	Horizontal	Vertical
Peak Avg.	<p>Site : 03CH12-HY Condition : PEAK(UNII) 3m HORN_91200_1212 HORIZONTAL Detector : Peak Project : 911635 Mode : 148 Power : 19.5</p>	<p>Site : 03CH12-HY Condition : PEAK(UNII) 3m HORN_91200_1212 VERTICAL Detector : Peak Project : 911635 Mode : 148 Power : 19.5</p>



WIFI	Band 4 5725~5850MHz Harmonic @ 3m	
ANT	802.11a CH165 5825MHz	
1+2	Horizontal	Vertical
Peak Avg.	<p>Site : 03CH12-HV Condition : PEAK(UNII) 3m HORN_91200_1212 HORIZONTAL Detector : Peak Project : 911635 Mode : 149 Power : 19.5</p>	<p>Site : 03CH12-HV Condition : PEAK(UNII) 3m HORN_91200_1212 VERTICAL Detector : Peak Project : 911635 Mode : 149 Power : 19.5</p>



**Band 4 5725~5850MHz
WIFI 802.11ac VHT20 (Harmonic @ 3m)**

WIFI	Band 4 5725~5850MHz Harmonic @ 3m	
ANT	802.11ac VHT20 CH149 5745MHz	
1+2	Horizontal	Vertical
Peak Avg.	<p>Site : 03CH13-HY Condition : PEAK(UNII) 3m HORN_91200_1212 HORIZONTAL Detector : Peak Project : 911635 Mode : 150 Power : 20</p>	<p>Site : 03CH13-HY Condition : PEAK(UNII) 3m HORN_91200_1212 VERTICAL Detector : Peak Project : 911635 Mode : 150 Power : 20</p>



WIFI	Band 4 5725~5850MHz Harmonic @ 3m	
ANT	802.11ac VHT20 CH157 5785MHz	
1+2	Horizontal	Vertical
Peak Avg.	<p>Site : 03CH12-HY Condition : PEAK(UNII) 3m HORN_91200_1212 HORIZONTAL Detector : Peak Project : 911635 Mode : 151 Power : 19.5</p>	<p>Site : 03CH12-HY Condition : PEAK(UNII) 3m HORN_91200_1212 VERTICAL Detector : Peak Project : 911635 Mode : 151 Power : 19.5</p>