



# FCC RADIO TEST REPORT

FCC ID : UZ7ET56DE  
Equipment : Tablet  
Brand Name : ZEBRA  
Model Name : ET56DE  
Applicant : Zebra Technologies Corporation  
1 Zebra Plaza, Holtsville, NY 11742  
Manufacturer : Zebra Technologies Corporation  
1 Zebra Plaza, Holtsville, NY 11742  
Standard : 47 CFR Part 2, 22(H), 24(E), 27(L)

The product was received on Jan. 16, 2019 and testing was started from Jun. 22, 2019 and completed on Jul. 09, 2019. We, SPORTON INTERNATIONAL INC. EMC & Wireless Communications Laboratory, would like to declare that the tested sample has been evaluated in accordance with the test procedures given in ANSI / TIA-603-E and has been in compliance with the applicable technical standards.

The report must not be used by the client to claim product certification, approval, or endorsement by TAF or any agency of government.

The test results in this report apply exclusively to the tested model / sample. Without written approval of SPORTON INTERNATIONAL INC. EMC & Wireless Communications Laboratory, the test report shall not be reproduced except in full.

Approved by: Louis Wu

**SPORTON INTERNATIONAL INC. EMC & Wireless Communications Laboratory**  
No. 52, Huaya 1st Rd., Guishan Dist., Taoyuan City, Taiwan (R.O.C.)



# Table of Contents

**History of this test report..... 3**

**Summary of Test Result..... 4**

**1 General Description ..... 5**

    1.1 Product Feature of Equipment Under Test ..... 5

    1.2 Product Specification of Equipment Under Test ..... 6

    1.3 Modification of EUT ..... 6

    1.4 Maximum ERP/EIRP Power, Frequency Tolerance, and Emission Designator ..... 6

    1.5 Testing Location ..... 7

    1.6 Applicable Standards ..... 8

**2 Test Configuration of Equipment Under Test ..... 9**

    2.1 Test Mode..... 9

    2.2 Connection Diagram of Test System ..... 9

    2.3 Support Unit used in test configuration ..... 9

    2.4 Measurement Results Explanation Example ..... 10

    2.5 Frequency List of Low/Middle/High Channels ..... 10

**3 Conducted Test Result ..... 11**

    3.1 Measuring Instruments..... 11

    3.2 Conducted Output Power and ERP/EIRP ..... 12

    3.3 Peak-to-Average Ratio ..... 13

    3.4 99% Occupied Bandwidth and 26dB Bandwidth Measurement..... 14

    3.5 Conducted Band Edge ..... 15

    3.6 Conducted Spurious Emission ..... 16

    3.7 Frequency Stability ..... 17

**4 Radiated Test Items ..... 18**

    4.1 Measuring Instruments..... 18

    4.2 Test Setup ..... 18

    4.3 Test Result of Radiated Test..... 18

    4.4 Field Strength of Spurious Radiation Measurement ..... 19

**5 List of Measuring Equipment..... 20**

**6 Uncertainty of Evaluation ..... 22**

**Appendix A. Test Results of Conducted Test**

**Appendix B. Test Results of ERP/EIRP and Radiated Test**

**Appendix C. Test Setup Photographs**



### History of this test report

Report No.	Version	Description	Issued Date
FG911635A	01	Initial issue of report	Aug. 01, 2019



### Summary of Test Result

Report Clause	Ref Std. Clause	Test Items	Result (PASS/FAIL)	Remark
3.2	§2.1046	Conducted Output Power	Pass	-
	§22.913 (a)(2)	Effective Radiated Power		
	§24.232 (c)	Equivalent Isotropic Radiated Power		
	§27.50 (d)(4)	Equivalent Isotropic Radiated Power		
3.3	§24.232 (d)	Peak-to-Average Ratio	Pass	-
3.4	§2.1049 §22.917 (b) §24.238 (b) §27.53 (g)	Occupied Bandwidth	Pass	-
3.5	§2.1051 §22.917 (a) §24.238 (a) §27.53 (g)	Band Edge Measurement	Pass	-
3.6	§2.1051 §22.917 (a) §24.238 (a) §27.53 (g)	Conducted Emission	Pass	-
3.7	§2.1055 §22.355	Frequency Stability Temperature & Voltage	Pass	-
	§2.1055 §24.235 §27.54			-
4.4	§2.1053 §22.917 (a) §24.238 (a) §27.53 (h)	Field Strength of Spurious Radiation	Pass	Under limit 32.28 dB at 7410.000 MHz

**Declaration of Conformity:**

The test results with all measurement uncertainty excluded are presented in accordance with the regulation limits or requirements declared by manufacturers.

**Comments and Explanations:**

The declared of product specification for EUT presented in the report are provided by the manufacturer, and the manufacturer takes all the responsibilities for the accuracy of product specification.

**Reviewed by: Wii Chang**

**Report Producer: Yimin Ho**



# 1 General Description

## 1.1 Product Feature of Equipment Under Test

Product Feature	
Equipment	Tablet
Brand Name	ZEBRA
Model Name	ET56DE
FCC ID	UZ7ET56DE
EUT supports Radios application	WCDMA/HSPA/LTE/NFC/GNSS WLAN 11a/b/g/n HT20/HT40 WLAN 11ac VHT20/VHT40/VHT80 Bluetooth BR/EDR/LE
HW Version	DV2
SW Version	Android version 8.1.0
FW Version	01-20-03-00-OG-U00-PRD
MFD	19Jun01
EUT Stage	Identical Prototype

Remark: The above EUT's information was declared by manufacturer.

Specification of Accessories				
Spare Standard Battery 24.13Wh	Brand Name	Zebra	Model Name	BT-000393

Supported Unit Used in Test Configuration and System				
Cradle (Dock) for EMC	Brand Name	Zebra	Part Number	CRD-ET5X-1SCG1
Cradle (Dock) for RSE	Brand Name	Zebra	Part Number	CHG-ET5X-CBL1-01
Adapter	Brand Name	Zebra	Part Number	PWRBGA12V50W0WW
DC Cable	Brand Name	Zebra	Part Number	CBL-DC-388A1-01



### 1.2 Product Specification of Equipment Under Test

Standards-related Product Specification	
<b>Tx Frequency</b>	<b>WCDMA:</b> Band V: 826.4 MHz ~ 846.6 MHz Band II: 1852.4 MHz ~ 1907.6 MHz Band IV: 1712.4 MHz ~ 1752.6 MHz
<b>Rx Frequency</b>	<b>WCDMA:</b> Band V: 871.4 MHz ~ 891.6 MHz Band II: 1932.4 MHz ~ 1987.6 MHz Band IV: 2112.4 MHz ~ 2152.6 MHz
<b>Maximum Output Power to Antenna</b>	<b>WCDMA:</b> Band V: 24.55 dBm Band II: 24.04 dBm Band IV: 21.19 dBm
<b>Antenna Type</b>	PCB Antenna
<b>Antenna Gain</b>	Cellular Band: 0.31 dBi PCS Band: 1.64 dBi AWS Band: 2.32 dBi
<b>Type of Modulation</b>	WCDMA: BPSK (Uplink) HSDPA: 64QAM (Downlink) HSUPA: QPSK (Uplink)

### 1.3 Modification of EUT

No modifications are made to the EUT during all test items.

### 1.4 Maximum ERP/EIRP Power, Frequency Tolerance, and Emission Designator

FCC Rule	Frequency Range (MHz)	System	Type of Modulation	Maximum ERP/EIRP (W)	Frequency Tolerance (ppm)	Emission Designator
Part 22	826.4 ~846.6	WCDMA Band V RMC 12.2Kbps	BPSK	0.1866	0.0060 ppm	4M14F9W
Part 24	1852.4 ~ 1907.6	WCDMA Band II RMC 12.2Kbps	BPSK	0.3698	0.0112 ppm	4M13F9W
Part 27	1712.4 ~ 1752.6	WCDMA Band IV RMC 12.2Kbps	BPSK	0.2244	0.0046 ppm	4M15F9W



### 1.5 Testing Location

<b>Test Site</b>	SPORTON INTERNATIONAL INC. EMC & Wireless Communications Laboratory
<b>Test Site Location</b>	No.52, Huaya 1st Rd., Guishan Dist., Taoyuan City, Taiwan (R.O.C.) TEL: +886-3-327-3456 FAX: +886-3-328-4978
<b>Test Site No.</b>	<b>Sporton Site No.</b> TH03-HY
<b>Test Engineer</b>	Benjamin Lin
<b>Temperature</b>	21~24°C
<b>Relative Humidity</b>	51~55%

**Note:** The test site complies with ANSI C63.4 2014 requirement.

<b>Test Site</b>	SPORTON INTERNATIONAL INC. EMC & Wireless Communications Laboratory
<b>Test Site Location</b>	No.58, Aly. 75, Ln. 564, Wenhua 3rd, Rd., Guishan Dist., Taoyuan City, Taiwan (R.O.C.) TEL: +886-3-327-0868 FAX: +886-3-327-0855
<b>Test Site No.</b>	<b>Sporton Site No.</b> 03CH12-HY
<b>Test Engineer</b>	Jack Cheng, Lance Chiang, Chuan Chu
<b>Temperature</b>	19.3~26°C
<b>Relative Humidity</b>	57.1~73.1%

**Note:** The test site complies with ANSI C63.4 2014 requirement.

FCC Designation No.: TW1190 and TW0007



## **1.6 Applicable Standards**

According to the specifications of the manufacturer, the EUT must comply with the requirements of the following standards:

- ♦ ANSI C63.26-2015
- ♦ ANSI / TIA-603-E
- ♦ 47 CFR Part 2, 22(H), 24(E), 27(L)
- ♦ FCC KDB 971168 D01 Power Meas. License Digital Systems v03r01
- ♦ FCC KDB 412172 D01 Determining ERP and EIRP v01r01

**Remark:**

1. All test items were verified and recorded according to the standards and without any deviation during the test.
2. This EUT has also been tested and complied with the requirements of FCC Part 15, Subpart B, recorded in a separate test report.



## 2 Test Configuration of Equipment Under Test

### 2.1 Test Mode

Antenna port conducted and radiated test items were performed according to KDB 971168 D01 Power Meas. License Digital Systems v03r01 with maximum output power.

For radiated measurement, pre-scanned in three orthogonal panels, X, Y, Z. The worst cases (Y plane) were recorded in this report.

Radiated emissions were investigated as following frequency range:

1. 30 MHz to 9000 MHz for WCDMA Band V.
2. 30 MHz to 18000 MHz for WCDMA Band IV.
3. 30 MHz to 19100 MHz for WCDMA Band II.

All modes and data rates and positions were investigated.

Test modes are chosen to be reported as the worst case configuration below:

Test Modes		
Band	Radiated TCs	Conducted TCs
WCDMA Band V	■ RMC 12.2Kbps Link	■ RMC 12.2Kbps Link
WCDMA Band II	■ RMC 12.2Kbps Link	■ RMC 12.2Kbps Link
WCDMA Band IV	■ RMC 12.2Kbps Link	■ RMC 12.2Kbps Link

### 2.2 Connection Diagram of Test System

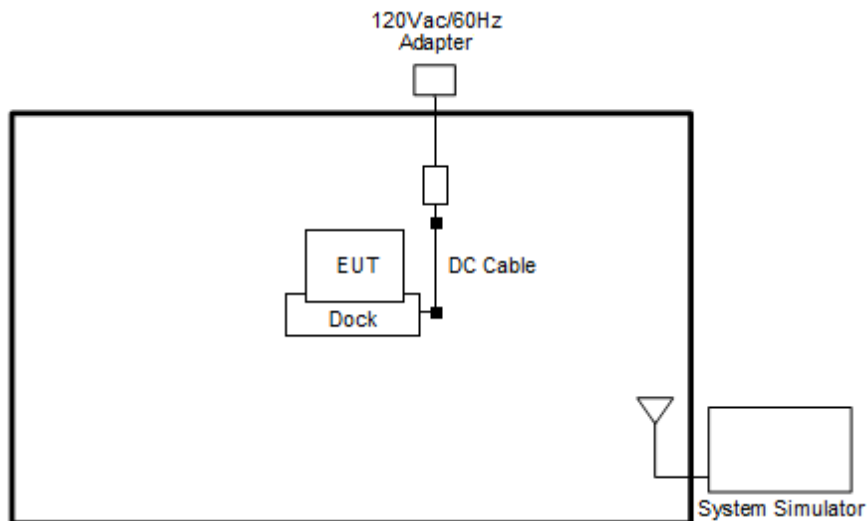

### 2.3 Support Unit used in test configuration

Item	Equipment	Trade Name	Model No.	FCC ID	Data Cable	Power Cord
1.	System Simulator	R&S	CMU 200	N/A	N/A	Unshielded, 1.8 m



### 2.4 Measurement Results Explanation Example

For all conducted test items:

The offset level is set in the spectrum analyzer to compensate the RF cable loss and attenuator factor between RF conducted output port and spectrum analyzer. With the offset compensation, the spectrum analyzer reading level will be exactly the RF output level.

The spectrum analyzer offset is derived from RF cable loss and attenuator factor.

$$\text{Offset} = \text{RF cable loss} + \text{attenuator factor}.$$

The following shows an offset computation example with RF cable loss 4.2 dB and a 10dB attenuator.

Example:

$$\begin{aligned} \text{Offset(dB)} &= \text{RF cable loss(dB)} + \text{attenuator factor(dB)}. \\ &= 4.2 + 10 = 14.2 \text{ (dB)} \end{aligned}$$

### 2.5 Frequency List of Low/Middle/High Channels

Frequency List				
Band	Channel/Frequency(MHz)	Lowest	Middle	Highest
WCDMA Band V	Channel	4132	4182	4233
	Frequency	826.4	836.4	846.6
WCDMA Band II	Channel	9262	9400	9538
	Frequency	1852.4	1880.0	1907.6
WCDMA Band IV	Channel	1312	1413	1513
	Frequency	1712.4	1732.6	1752.6

### 3 Conducted Test Result

#### 3.1 Measuring Instruments

See list of measuring instruments of this test report.

##### 3.1.1 Test Setup

##### 3.1.2 Conducted Output Power

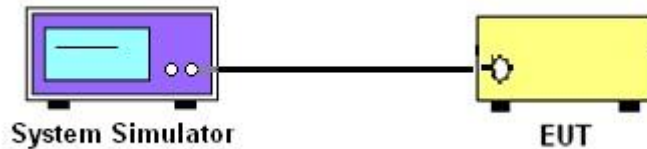

##### 3.1.3 Peak-to-Average Ratio, Occupied Bandwidth, Conducted Band-Edge and Conducted Spurious Emission

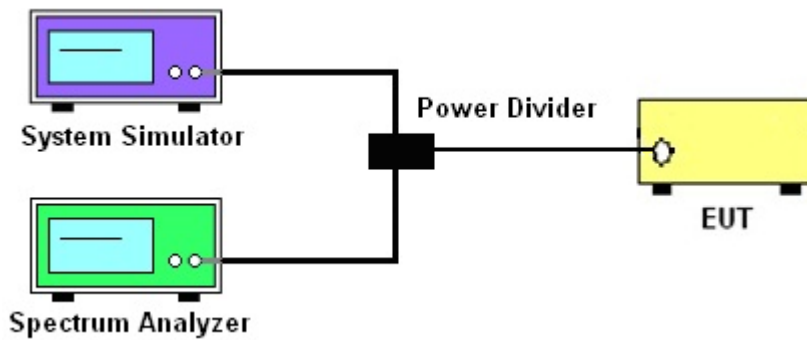

##### 3.1.4 Frequency Stability

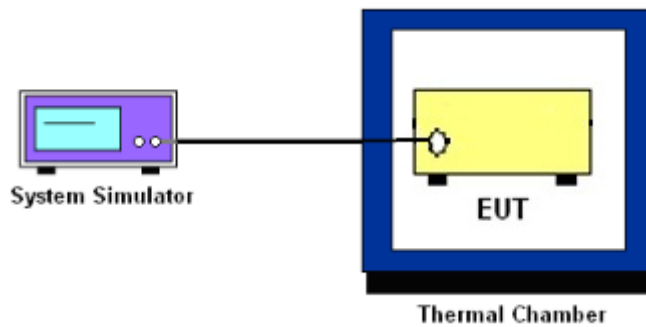

##### 3.1.5 Test Result of Conducted Test

Please refer to Appendix A.



## 3.2 Conducted Output Power and ERP/EIRP

### 3.2.1 Description of the Conducted Output Power and ERP/EIRP

A system simulator was used to establish communication with the EUT. Its parameters were set to enforce EUT transmitting at the maximum power. The measured power in the radio frequency on the transmitter output terminals shall be reported.

The ERP of mobile transmitters must not exceed 7 Watts for WCDMA Band V.

The EIRP of mobile transmitters must not exceed 2 Watts for WCDMA Band II.

The EIRP of mobile transmitters must not exceed 1 Watts for WCDMA Band IV.

According to KDB 412172 D01 Power Approach,

$EIRP = P_T + G_T - L_C$ ,  $ERP = EIRP - 2.15$ , where

$P_T$  = transmitter output power in dBm

$G_T$  = gain of the transmitting antenna in dBi

$L_C$  = signal attenuation in the connecting cable between the transmitter and antenna in dB

### 3.2.2 Test Procedures

1. The transmitter output port was connected to the system simulator.
2. Set EUT at maximum power through system simulator.
3. Select lowest, middle, and highest channels for each band and different modulation.
4. Measure the maximum burst average power for GSM and maximum average power for other modulation signal.



### **3.3 Peak-to-Average Ratio**

#### **3.3.1 Description of the PAR Measurement**

The peak-to-average ratio (PAR) of the transmission may not exceed 13 dB.

#### **3.3.2 Test Procedures**

The testing follows ANSI C63.26-2015 Section 5.2.6

1. The EUT was connected to spectrum analyzer and system simulator via a power divider.
2. Set EUT to transmit at maximum output power.
3. When the duty cycle is less than 98%, then signal gating will be implemented on the spectrum analyzer by triggering from the system simulator.
4. Set the CCDF (Complementary Cumulative Distribution Function) option of the spectrum analyzer.
5. Record the maximum PAPR level associated with a probability of 0.1%.



### **3.4 99% Occupied Bandwidth and 26dB Bandwidth Measurement**

#### **3.4.1 Description of 99% Occupied Bandwidth and 26dB Bandwidth Measurement**

The occupied bandwidth is the width of a frequency band such that, below the lower and above the upper frequency limits, the mean powers emitted are each equal to a specified percentage 0.5% of the total mean transmitted power.

The 26 dB emission bandwidth is defined as the frequency range between two points, one above and one below the carrier frequency, at which the spectral density of the emission is attenuated 26 dB below the maximum in-band spectral density of the modulated signal. Spectral density (power per unit bandwidth) is to be measured with a detector of resolution bandwidth equal to approximately 1.0% of the emission bandwidth.

#### **3.4.2 Test Procedures**

The testing follows ANSI C63.26-2015 Section 5.4.3 (26dB) and Section 5.4.4 (99OB)

1. The EUT was connected to spectrum analyzer and system simulator via a power divider.
2. The spectrum analyzer center frequency is set to the nominal EUT channel center frequency. The span range for the spectrum analyzer shall be between two and five times the anticipated OBW.
3. The nominal resolution bandwidth (RBW) shall be in the range of 1 to 5 % of the anticipated OBW, and the VBW shall be at least 3 times the RBW.
4. Set the detection mode to peak, and the trace mode to max hold.
5. Determine the reference value: Set the EUT to transmit a modulated signal. Allow the trace to stabilize. Set the spectrum analyzer marker to the highest level of the displayed trace.  
(this is the reference value)
6. Determine the “-26 dB down amplitude” as equal to (Reference Value – X).
7. Place two markers, one at the lowest and the other at the highest frequency of the envelope of the spectral display such that each marker is at or slightly below the “-X dB down amplitude” determined in step 6. If a marker is below this “-X dB down amplitude” value it shall be placed as close as possible to this value. The OBW is the positive frequency difference between the two markers.
8. Use the 99 % power bandwidth function of the spectrum analyzer and report the measured bandwidth.



## **3.5 Conducted Band Edge**

### **3.5.1 Description of Conducted Band Edge Measurement**

The power of any emission outside of the authorized operating frequency ranges must be lower than the transmitter power (P) by a factor of at least  $43 + 10 \log (P)$  dB.

### **3.5.2 Test Procedures**

The testing follows FCC KDB 971168 D01 v03r01 Section 6.1.

1. The EUT was connected to the spectrum analyzer and system simulator via a power divider.
2. The RF output of EUT was connected to the spectrum analyzer by an RF cable and attenuator. The path loss was compensated to the results for each measurement.
3. The band edges of low and high channels for the highest RF powers were measured.
4. The RF fundamental frequency should be excluded against the limit line in the operating frequency band.
5. The limit line is derived from  $43 + 10\log(P)$  dB below the transmitter power P(Watts)



### 3.6 Conducted Spurious Emission

#### 3.6.1 Description of Conducted Spurious Emission Measurement

The power of any emission outside of the authorized operating frequency ranges must be lower than the transmitter power (P) by a factor of at least  $43 + 10 \log (P)$  dB.

It is measured by means of a calibrated spectrum analyzer and scanned from 30 MHz up to a frequency including its 10<sup>th</sup> harmonic.

#### 3.6.2 Test Procedures

The testing follows FCC KDB 971168 D01 v03r01 Section 6.1.

1. The EUT was connected to the spectrum analyzer and system simulator via a power divider.
2. The RF output of EUT was connected to the spectrum analyzer by an RF cable and attenuator.  
The path loss was compensated to the results for each measurement.
3. The middle channel for the highest RF power within the transmitting frequency was measured.
4. The conducted spurious emission for the whole frequency range was taken.
5. The RF fundamental frequency should be excluded against the limit line in the operating frequency band.
6. The limit line is derived from  $43 + 10\log(P)$  dB below the transmitter power P(Watts)





### **3.7 Frequency Stability**

#### **3.7.1 Description of Frequency Stability Measurement**

22.355

The frequency stability shall be measured by variation of ambient temperature and variation of primary supply voltage to ensure that the fundamental emission stays within the authorized frequency block. The frequency stability of the transmitter shall be maintained within  $\pm 0.00025\%$  ( $\pm 2.5\text{ppm}$ ) of the center frequency.

24.235 & 27.54

The frequency stability shall be sufficient to ensure that the fundamental emission stays within the authorized frequency block.

#### **3.7.2 Test Procedures for Temperature Variation**

The testing follows FCC KDB 971168 D01 v03r01 Section 9.0.

1. The EUT was set up in the thermal chamber and connected with the system simulator.
2. With power OFF, the temperature was decreased to  $-30^{\circ}\text{C}$  and the EUT was stabilized before testing. Power was applied and the maximum change in frequency was recorded within one minute.
3. With power OFF, the temperature was raised in  $10^{\circ}\text{C}$  steps up to  $50^{\circ}\text{C}$ . The EUT was stabilized at each step for at least half an hour. Power was applied and the maximum frequency change was recorded within one minute.

#### **3.7.3 Test Procedures for Voltage Variation**

The testing follows FCC KDB 971168 D01 v03r01 Section 9.0.

1. The EUT was placed in a temperature chamber at  $20\pm 5^{\circ}\text{C}$  and connected with the system simulator.
2. The power supply voltage to the EUT was varied from 85% to 115% of the nominal value measured at the input to the EUT.
3. The variation in frequency was measured for the worst case.

## 4 Radiated Test Items

### 4.1 Measuring Instruments

See list of measuring instruments of this test report.

### 4.2 Test Setup

For radiated test from 30MHz to 1GHz

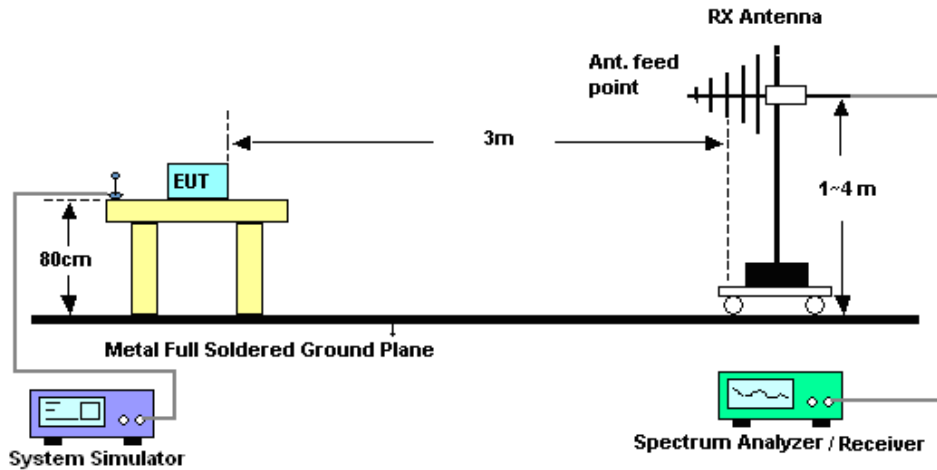

For radiated test above 1GHz

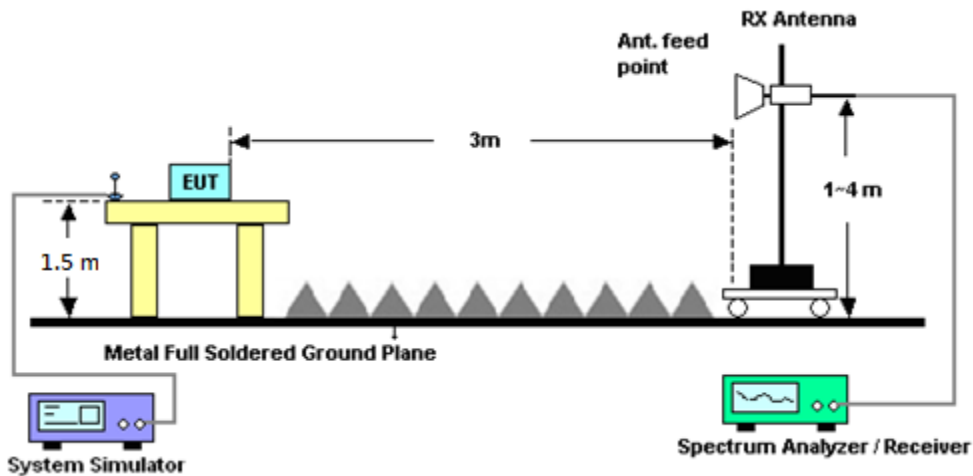

### 4.3 Test Result of Radiated Test

Please refer to Appendix B.



## 4.4 Field Strength of Spurious Radiation Measurement

### 4.4.1 Description of Field Strength of Spurious Radiated Measurement

The power of any emission outside of the authorized operating frequency ranges must be attenuated below the transmitter power (P) by a factor of at least  $43 + 10 \log (P)$  dB. The spectrum is scanned from 30 MHz up to a frequency including its 10th harmonic.

### 4.4.2 Test Procedures

The testing follows FCC KDB 971168 D01 v03r01 Section 7 and ANSI / TIA-603-E Section 2.2.12.

1. The EUT was placed on a rotatable wooden table 0.8 meters for frequency below 1GHz and 1.5 meter for frequency above 1GHz above the ground.
2. The EUT was set 3 meters from the receiving antenna, which was mounted on the antenna tower.
3. The table was rotated 360 degrees to determine the position of the highest spurious emission.
4. The height of the receiving antenna is varied between one meter and four meters to search for the maximum spurious emission for both horizontal and vertical polarizations.
5. Make the measurement with the spectrum analyzer's RBW = 1MHz, VBW = 3MHz, taking record of maximum spurious emission.
6. A horn antenna was substituted in place of the EUT and was driven by a signal generator.
7. Tune the output power of signal generator to the same emission level with EUT maximum spurious emission.
8. Taking the record of output power at antenna port.
9. Repeat step 7 to step 8 for another polarization.
10.  $EIRP (dBm) = S.G. Power - Tx Cable Loss + Tx Antenna Gain$
11.  $ERP (dBm) = EIRP - 2.15$
12. The RF fundamental frequency should be excluded against the limit line in the operating frequency band.
13. The limit line is derived from  $43 + 10\log(P)$  dB below the transmitter power P(Watts)



## 5 List of Measuring Equipment

Instrument	Manufacturer	Model No.	Serial No.	Characteristics	Calibration Date	Test Date	Due Date	Remark
Spectrum Analyzer	Rohde & Schwarz	FSP30	101329	9kHz~30GHz	Jun. 29, 2018	Jun. 22, 2019	Jun. 28, 2019	Conducted (TH03-HY)
Temperature Chamber	ESPEC	SU-641	92013721	-30℃ ~70℃	Nov. 28, 2018	Jun. 22, 2019	Nov. 27, 2019	Conducted (TH03-HY)
Programmable Power Supply	GW Instek	PSS-2005	EL890001	Voltage:0~20V; Current:0~5A	Oct. 08, 2018	Jun. 22, 2019	Oct. 07, 2019	Conducted (TH03-HY)
Base Station (Measure)	Rohde & Schwarz	CMU200	117995	GSM / GPRS / WCDMA / CDMA	Aug. 10, 2018	Jun. 22, 2019	Aug. 09, 2019	Conducted (TH03-HY)
Loop Antenna	Rohde & Schwarz	HFH2-Z2	100488	9 kHz~30 MHz	Jan. 07, 2019	Jul. 05, 2019~ Jul. 09, 2019	Jan. 06, 2020	Radiation (03CH12-HY)
Bilog Antenna	TESEQ	CBL 6111D&00802 N1D01N-06	47020&06	30MHz to 1GHz	Oct. 13, 2018	Jul. 05, 2019~ Jul. 09, 2019	Oct. 12, 2019	Radiation (03CH12-HY)
Horn Antenna	SCHWARZBECK	BBHA 9120D	9120D-121 2	1GHz ~ 18GHz	Oct. 19, 2018	Jul. 05, 2019~ Jul. 09, 2019	Oct. 18, 2019	Radiation (03CH12-HY)
Horn Antenna	SCHWARZBECK	BBHA 9120D	9120D-132 6	1GHz ~ 18GHz	Oct. 30, 2018	Jul. 05, 2019~ Jul. 09, 2019	Oct. 29, 2019	Radiation (03CH12-HY)
SHF-EHF Horn Antenna	SCHWARZBECK	BBHA 9170	BBHA9170 584	18GHz ~ 40GHz	Dec. 05, 2018	Jul. 05, 2019~ Jul. 09, 2019	Dec. 04, 2019	Radiation (03CH12-HY)
Preamplifier	COM-POWER	PA-103	161075	10MHz~1GHz	Mar. 25, 2019	Jul. 05, 2019~ Jul. 09, 2019	Mar. 24, 2020	Radiation (03CH12-HY)
Preamplifier	Agilent	8449B	3008A023 75	1GHz~26.5Ghz	May 28, 2018	Jul. 05, 2019~ Jul. 09, 2019	May 26, 2020	Radiation (03CH12-HY)
Preamplifier	Jet-Power	JPA0118-55-3 03	171000180 0055007	1GHz~18GHz	Apr. 01, 2019	Jul. 05, 2019~ Jul. 09, 2019	Mar. 31, 2020	Radiation (03CH12-HY)
Preamplifier	EMEC	EM18G40G	060715	18GHz ~ 40GHz	Dec. 06, 2018	Jul. 05, 2019~ Jul. 09, 2019	Dec. 05, 2019	Radiation (03CH12-HY)
EMI Test Receiver	Rohde & Schwarz	ESU26	100390	20Hz~26.5GHz	Dec. 26, 2018	Jul. 05, 2019~ Jul. 09, 2019	Dec. 25, 2019	Radiation (03CH12-HY)
Spectrum Analyzer	Keysight	N9010A	MY542004 86	10Hz~44GHz	Dec. 19, 2018	Jul. 05, 2019~ Jul. 09, 2019	Dec. 18, 2019	Radiation (03CH12-HY)
Signal Generator	Rohde & Schwarz	SMB100A	175727	100kHz~40GHz	Dec. 23, 2018	Jul. 05, 2019~ Jul. 09, 2019	Dec. 23, 2019	Radiation (03CH12-HY)
Base Station	Anritsu	MT8821C	620143281 6	GSM / GPRS / WCDMA / LTE FDD/TDD with 44) /LTE-3CC DLCA,2CC ULCA	May 05, 2019	Jul. 05, 2019~ Jul. 09, 2019	May 04, 2020	Radiation (03CH12-HY)
Filter	Wainwright	WLK4-1000-1 530-6000-40S S	SN11	1 GHz Lowpass	Sep. 16, 2018	Jul. 05, 2019~ Jul. 09, 2019	Sep. 15, 2019	Radiation (03CH12-HY)
Filter	Wainwright	WHKX12-108 0-1200-1500- 60SS	SN2	1.2G High Pass	Sep. 16, 2018	Jul. 05, 2019~ Jul. 09, 2019	Sep. 15, 2019	Radiation (03CH12-HY)
Filter	Wainwright	WHKX12-270 0-3000-18000 -60ST	SN2	3GHz High Pass	Mar. 20, 2019	Jul. 05, 2019~ Jul. 09, 2019	Mar. 19, 2020	Radiation (03CH12-HY)



Instrument	Manufacturer	Model No.	Serial No.	Characteristics	Calibration Date	Test Date	Due Date	Remark
Notch Filter	EWT	EWT-14-0041	D1	DCS 1800	Nov. 01, 2018	Jul. 05, 2019~ Jul. 09, 2019	Oct. 31, 2019	Radiation (03CH12-HY)
Notch Filter	Wainwright	WRCT698/79 8-10/40 8SSK	SN1	AWS Band	Nov. 01, 2018	Jul. 05, 2019~ Jul. 09, 2019	Oct. 31, 2019	Radiation (03CH12-HY)
Notch Filter	Wainwright	WRCG824/84 9-40/8SS	SN35	CDMA 850	Nov. 07, 2018	Jul. 05, 2019~ Jul. 09, 2019	Nov. 06, 2019	Radiation (03CH12-HY)
RF Cable	HUBER + SUHNER	SUCOFLEX 126E	0058/126E	30M-18G	Mar. 13, 2019	Jul. 05, 2019~ Jul. 09, 2019	Mar. 12, 2020	Radiation (03CH12-HY)
RF Cable	HUBER + SUHNER	SUCOFLEX 102	505134/2	30M~40GHz	Oct. 16, 2018	Jul. 05, 2019~ Jul. 09, 2019	Oct. 15, 2019	Radiation (03CH12-HY)
RF Cable	HUBER + SUHNER	SUCOFLEX 102	800740/2	30M~40GHz	Oct. 16, 2018	Jul. 05, 2019~ Jul. 09, 2019	Oct. 15, 2019	Radiation (03CH12-HY)
Antenna Mast	EMEC	AM-BS-4500- B	N/A	1m~4m	N/A	Jul. 05, 2019~ Jul. 09, 2019	N/A	Radiation (03CH12-HY)
Turn Table	EMEC	TT2000	N/A	0~360 Degree	N/A	Jul. 05, 2019~ Jul. 09, 2019	N/A	Radiation (03CH12-HY)
Software	Audix	E3 6.2009-8-24	RK-00098 9	N/A	N/A	Jul. 05, 2019~ Jul. 09, 2019	N/A	Radiation (03CH12-HY)



## 6 Uncertainty of Evaluation

### Uncertainty of Radiated Emission Measurement (30 MHz ~ 1000 MHz)

Measuring Uncertainty for a Level of Confidence of 95% ( $U = 2Uc(y)$ )	3.36
---	------

### Uncertainty of Radiated Emission Measurement (1 GHz ~ 18 GHz)

Measuring Uncertainty for a Level of Confidence of 95% ( $U = 2Uc(y)$ )	3.70
---	------

### Uncertainty of Radiated Emission Measurement (18 GHz ~ 40 GHz)

Measuring Uncertainty for a Level of Confidence of 95% ( $U = 2Uc(y)$ )	3.98
---	------



## Appendix A. Test Results of Conducted Test

### Conducted Output Power(Average power)

Conducted Power (*Unit: dBm)						
Band	WCDMA Band V			WCDMA Band II		
Channel	4132	4182	4233	9262	9400	9538
Frequency	826.4	836.4	846.6	1852.4	1880	1907.6
RMC 12.2K	24.50	24.48	24.55	23.97	24.04	24.00
HSDPA Subtest-1	23.42	23.41	23.47	23.19	23.29	23.36
HSDPA Subtest-2	23.47	23.43	23.52	23.22	23.36	23.38
HSDPA Subtest-3	22.97	22.89	23.03	22.69	22.82	22.92
HSDPA Subtest-4	22.96	22.90	23.05	22.70	22.86	22.83
HSUPA Subtest-1	23.44	23.41	23.48	23.13	23.29	23.30
HSUPA Subtest-2	21.46	21.40	21.49	21.12	21.20	21.28
HSUPA Subtest-3	22.41	22.40	22.43	22.15	22.33	22.32
HSUPA Subtest-4	21.43	21.39	21.42	21.15	21.29	21.30
HSUPA Subtest-5	23.50	23.40	23.40	23.20	23.30	23.30

Conducted Power (*Unit: dBm)			
Band	WCDMA Band IV		
Channel	1312	1413	1513
Frequency	1712.4	1732.6	1752.6
RMC 12.2K	21.13	21.19	21.12
HSDPA Subtest-1	20.30	20.34	20.28
HSDPA Subtest-2	20.32	20.35	20.24
HSDPA Subtest-3	19.78	19.86	19.78
HSDPA Subtest-4	19.76	19.81	19.86
HSUPA Subtest-1	20.23	20.33	20.24
HSUPA Subtest-2	18.26	18.32	18.23
HSUPA Subtest-3	19.25	19.27	19.26
HSUPA Subtest-4	18.30	18.29	18.23
HSUPA Subtest-5	20.30	20.30	20.30



## A2. WCDMA

### Peak-to-Average Ratio

Mode	WCDMA Band V	WCDMA Band II	WCDMA Band IV	Limit: 13dB
Mod.	RMC 12.2Kbps	RMC 12.2Kbps	RMC 12.2Kbps	Result
Lowest CH	3.08	3.24	2.88	<b>PASS</b>
Middle CH	3.24	3.20	3.00	
Highest CH	3.28	2.92	3.00	



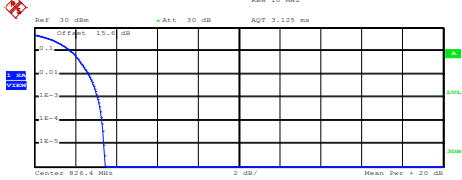
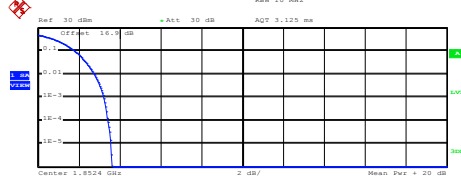
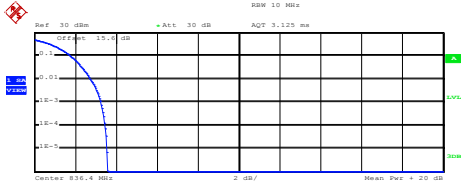
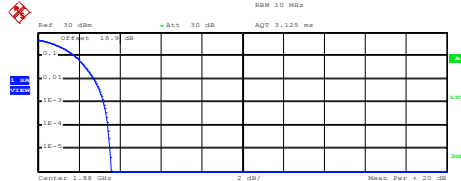
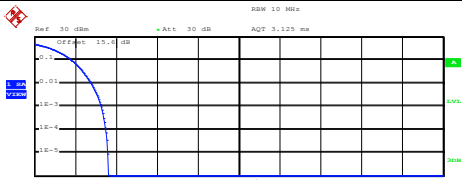
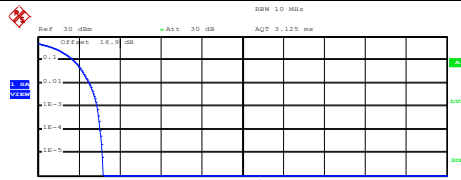

WCDMA Band V (RMC 12.2Kbps)	WCDMA Band II (RMC 12.2Kbps)																
<p style="text-align: center;"><b>Lowest Channel</b></p>  <p>Center 826.4 MHz      2 dB/      Mean Dev + 20 dB</p> <p>Complementary Cumulative Distribution Function (100000 samples) Trace 1 Mean 23.13 dBm Peak 26.58 dBm Crest 3.46 dB</p> <table border="1"> <tr><td>10 %</td><td>1.76 dB</td></tr> <tr><td>1 %</td><td>2.64 dB</td></tr> <tr><td>.1 %</td><td>3.08 dB</td></tr> <tr><td>.01 %</td><td>3.32 dB</td></tr> </table> <p>Date: 22.JUN.2019 17:31:53</p>	10 %	1.76 dB	1 %	2.64 dB	.1 %	3.08 dB	.01 %	3.32 dB	<p style="text-align: center;"><b>Lowest Channel</b></p>  <p>Center 1.8524 GHz      2 dB/      Mean Dev + 20 dB</p> <p>Complementary Cumulative Distribution Function (100000 samples) Trace 1 Mean 22.41 dBm Peak 26.02 dBm Crest 3.61 dB</p> <table border="1"> <tr><td>10 %</td><td>1.80 dB</td></tr> <tr><td>1 %</td><td>2.76 dB</td></tr> <tr><td>.1 %</td><td>3.24 dB</td></tr> <tr><td>.01 %</td><td>3.44 dB</td></tr> </table> <p>Date: 22.JUN.2019 16:56:16</p>	10 %	1.80 dB	1 %	2.76 dB	.1 %	3.24 dB	.01 %	3.44 dB
10 %	1.76 dB																
1 %	2.64 dB																
.1 %	3.08 dB																
.01 %	3.32 dB																
10 %	1.80 dB																
1 %	2.76 dB																
.1 %	3.24 dB																
.01 %	3.44 dB																
<p style="text-align: center;"><b>Middle Channel</b></p>  <p>Center 830.4 MHz      2 dB/      Mean Dev + 20 dB</p> <p>Complementary Cumulative Distribution Function (100000 samples) Trace 1 Mean 22.10 dBm Peak 25.67 dBm Crest 3.56 dB</p> <table border="1"> <tr><td>10 %</td><td>1.76 dB</td></tr> <tr><td>1 %</td><td>2.76 dB</td></tr> <tr><td>.1 %</td><td>3.24 dB</td></tr> <tr><td>.01 %</td><td>3.48 dB</td></tr> </table> <p>Date: 22.JUN.2019 17:32:10</p>	10 %	1.76 dB	1 %	2.76 dB	.1 %	3.24 dB	.01 %	3.48 dB	<p style="text-align: center;"><b>Middle Channel</b></p>  <p>Center 1.88 GHz      2 dB/      Mean Dev + 20 dB</p> <p>Complementary Cumulative Distribution Function (100000 samples) Trace 1 Mean 22.79 dBm Peak 26.37 dBm Crest 3.58 dB</p> <table border="1"> <tr><td>10 %</td><td>1.80 dB</td></tr> <tr><td>1 %</td><td>2.76 dB</td></tr> <tr><td>.1 %</td><td>3.20 dB</td></tr> <tr><td>.01 %</td><td>3.44 dB</td></tr> </table> <p>Date: 22.JUN.2019 16:56:29</p>	10 %	1.80 dB	1 %	2.76 dB	.1 %	3.20 dB	.01 %	3.44 dB
10 %	1.76 dB																
1 %	2.76 dB																
.1 %	3.24 dB																
.01 %	3.48 dB																
10 %	1.80 dB																
1 %	2.76 dB																
.1 %	3.20 dB																
.01 %	3.44 dB																
<p style="text-align: center;"><b>Highest Channel</b></p>  <p>Center 846.6 MHz      2 dB/      Mean Dev + 20 dB</p> <p>Complementary Cumulative Distribution Function (100000 samples) Trace 1 Mean 22.13 dBm Peak 25.74 dBm Crest 3.61 dB</p> <table border="1"> <tr><td>10 %</td><td>1.84 dB</td></tr> <tr><td>1 %</td><td>2.76 dB</td></tr> <tr><td>.1 %</td><td>3.28 dB</td></tr> <tr><td>.01 %</td><td>3.48 dB</td></tr> </table> <p>Date: 22.JUN.2019 17:32:21</p>	10 %	1.84 dB	1 %	2.76 dB	.1 %	3.28 dB	.01 %	3.48 dB	<p style="text-align: center;"><b>Highest Channel</b></p>  <p>Center 1.9076 GHz      2 dB/      Mean Dev + 20 dB</p> <p>Complementary Cumulative Distribution Function (100000 samples) Trace 1 Mean 22.85 dBm Peak 26.02 dBm Crest 3.17 dB</p> <table border="1"> <tr><td>10 %</td><td>1.72 dB</td></tr> <tr><td>1 %</td><td>2.52 dB</td></tr> <tr><td>.1 %</td><td>2.92 dB</td></tr> <tr><td>.01 %</td><td>3.04 dB</td></tr> </table> <p>Date: 22.JUN.2019 16:56:46</p>	10 %	1.72 dB	1 %	2.52 dB	.1 %	2.92 dB	.01 %	3.04 dB
10 %	1.84 dB																
1 %	2.76 dB																
.1 %	3.28 dB																
.01 %	3.48 dB																
10 %	1.72 dB																
1 %	2.52 dB																
.1 %	2.92 dB																
.01 %	3.04 dB																



### WCDMA Band IV (RMC 12.2Kbps)

#### Lowest Channel

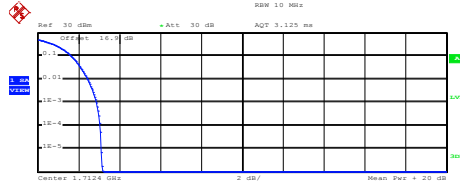

Complementary Cumulative Distribution Function (100000 samples)

Trace 1  
Mean 22.85 dBm  
Peak 26.02 dBm  
Crest 3.17 dB

10 % 1.64 dB  
1 % 2.44 dB  
.1 % 2.88 dB  
.01 % 3.04 dB

Date: 22.JUN.2019 17:13:49

#### Middle Channel

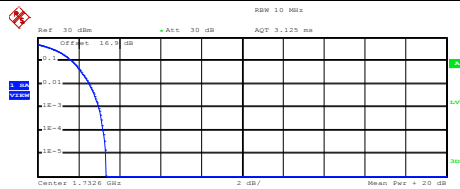

Complementary Cumulative Distribution Function (100000 samples)

Trace 1  
Mean 22.40 dBm  
Peak 25.74 dBm  
Crest 3.34 dB

10 % 1.68 dB  
1 % 2.52 dB  
.1 % 3.00 dB  
.01 % 3.20 dB

Date: 22.JUN.2019 17:14:03

#### Highest Channel

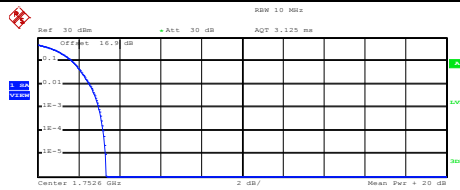

Complementary Cumulative Distribution Function (100000 samples)

Trace 1  
Mean 22.88 dBm  
Peak 26.23 dBm  
Crest 3.35 dB

10 % 1.68 dB  
1 % 2.52 dB  
.1 % 3.00 dB  
.01 % 3.20 dB

Date: 22.JUN.2019 17:14:15



**26dB Bandwidth**

Mode	WCDMA Band V	WCDMA Band II	WCDMA Band IV
Mod.	RMC 12.2Kbps	RMC 12.2Kbps	RMC 12.2Kbps
Lowest CH	4.73	4.71	4.72
Middle CH	4.71	4.70	4.71
Highest CH	4.71	4.71	4.71



WCDMA Band V (RMC 12.2Kbps)

WCDMA Band II (RMC 12.2Kbps)

Lowest Channel

Lowest Channel

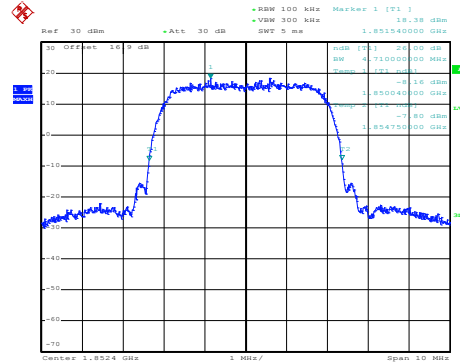
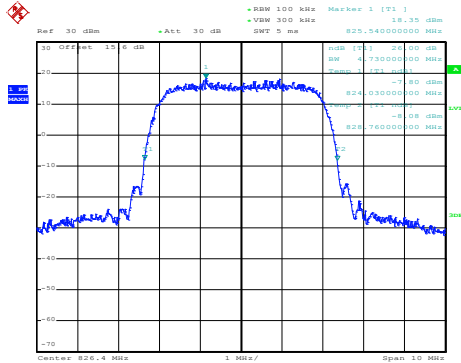

Date: 22.JUN.2019 17:20:45

Date: 22.JUN.2019 16:43:46

Middle Channel

Middle Channel

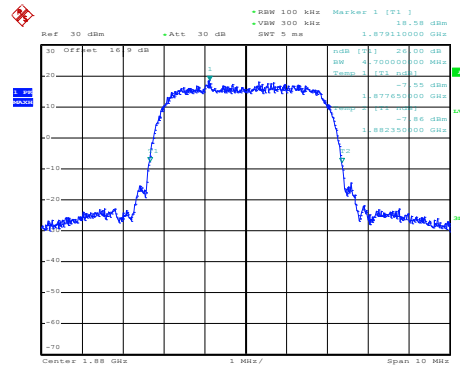
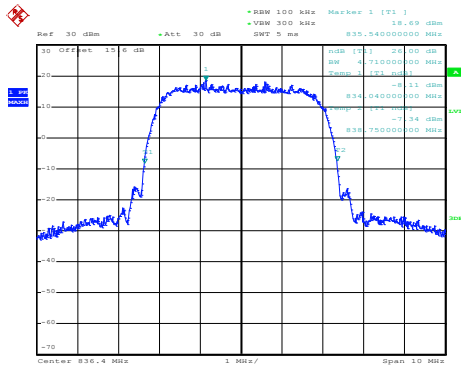

Date: 22.JUN.2019 17:21:19

Date: 22.JUN.2019 16:44:31

Highest Channel

Highest Channel

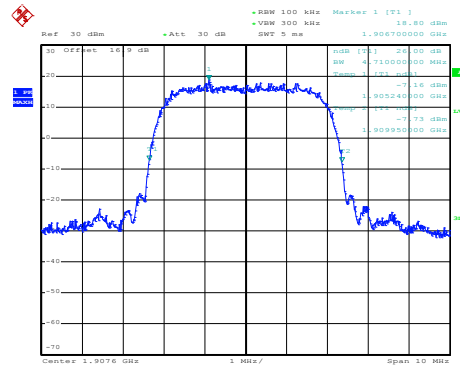
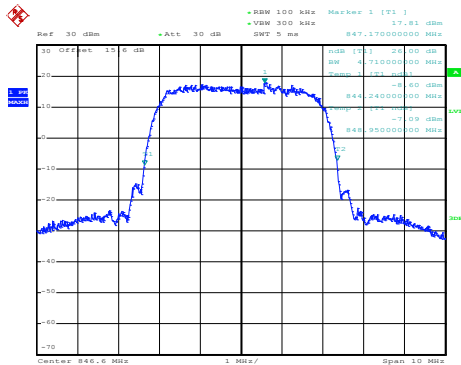

Date: 22.JUN.2019 17:21:54

Date: 22.JUN.2019 16:45:07



### WCDMA Band IV (RMC 12.2Kbps)

#### Lowest Channel

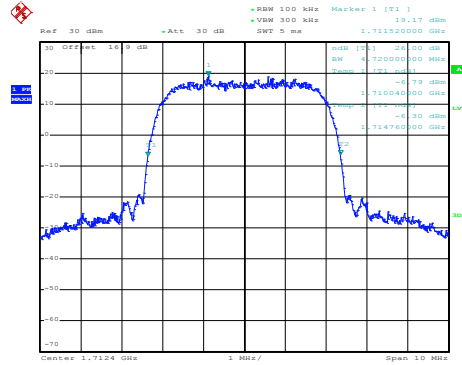

Date: 22.JUN.2019 17:00:12

#### Middle Channel

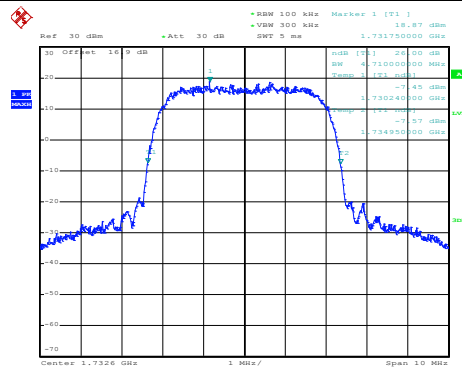

Date: 22.JUN.2019 17:01:01

#### Highest Channel

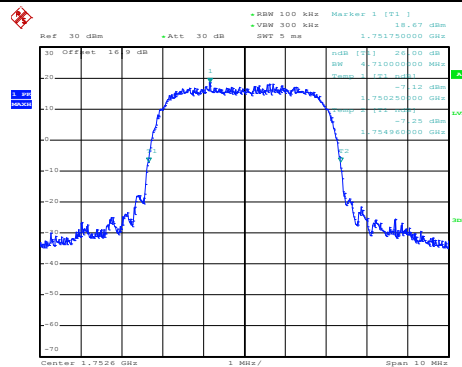

Date: 22.JUN.2019 17:01:37



### Occupied Bandwidth

Mode	WCDMA Band V	WCDMA Band II	WCDMA Band IV
Mod.	RMC 12.2Kbps	RMC 12.2Kbps	RMC 12.2Kbps
Lowest CH	4.14	4.13	4.14
Middle CH	4.14	4.13	4.14
Highest CH	4.14	4.13	4.15



WCDMA Band V (RMC 12.2Kbps)

WCDMA Band II (RMC 12.2Kbps)

Lowest Channel

Lowest Channel

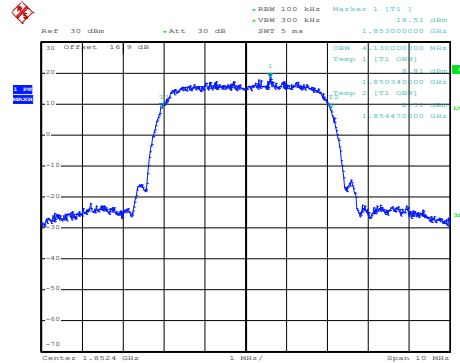
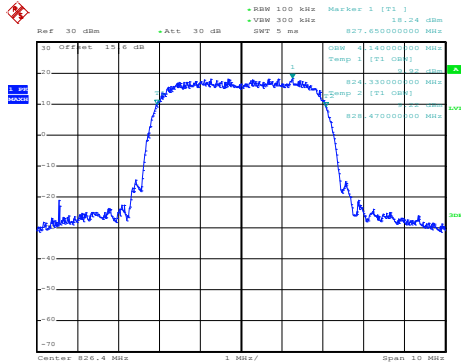

Date: 22.JUN.2019 17:18:56

Date: 22.JUN.2019 16:45:46

Middle Channel

Middle Channel

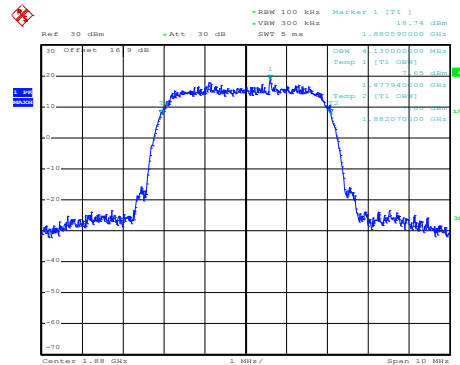
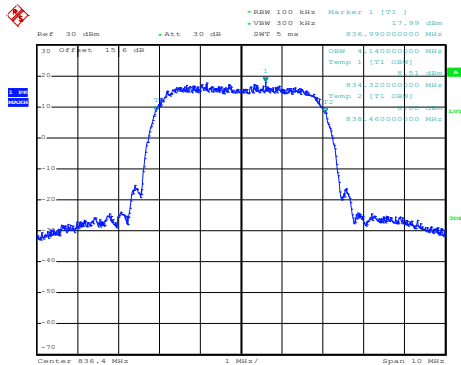

Date: 22.JUN.2019 17:19:31

Date: 22.JUN.2019 16:46:21

Highest Channel

Highest Channel

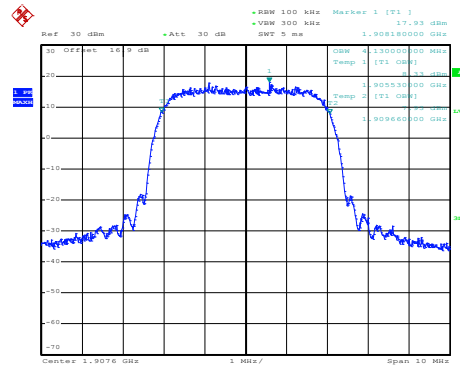
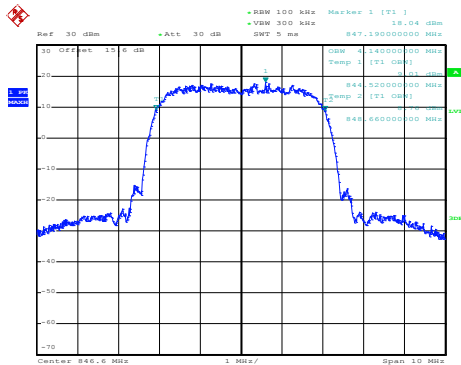

Date: 22.JUN.2019 17:20:07

Date: 22.JUN.2019 16:46:56



### WCDMA Band IV (RMC 12.2Kbps)

#### Lowest Channel

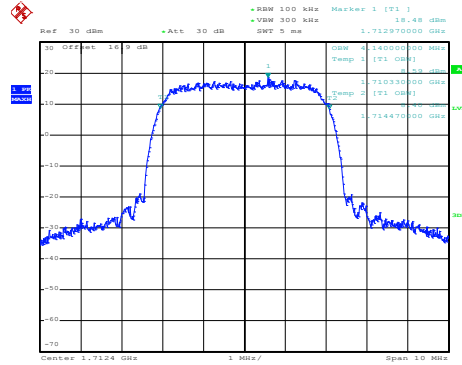

Date: 22.JUN.2019 17:02:15

#### Middle Channel

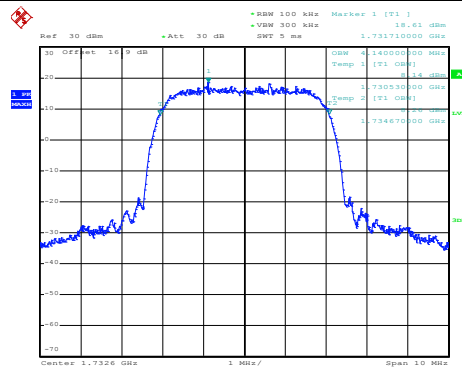

Date: 22.JUN.2019 17:02:49

#### Highest Channel

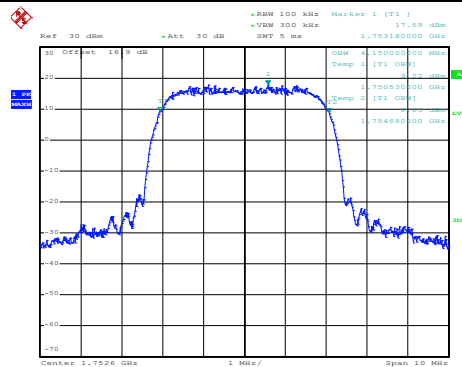

Date: 22.JUN.2019 17:03:40





# Conducted Band Edge

## WCDMA Band V (RMC 12.2Kbps)

### Lowest Band Edge

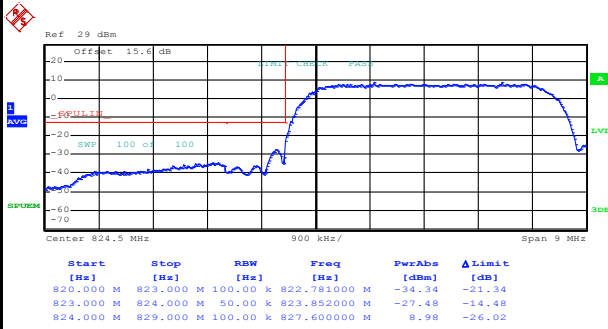

Date: 22.JUN.2019 17:24:49

### Highest Band Edge

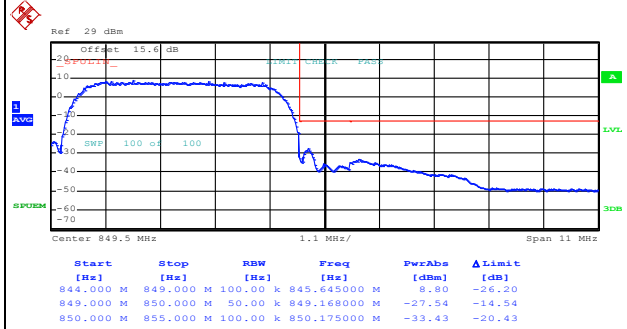

Date: 22.JUN.2019 17:27:55



WCDMA Band II (RMC 12.2Kbps)

Lowest Band Edge

Highest Band Edge

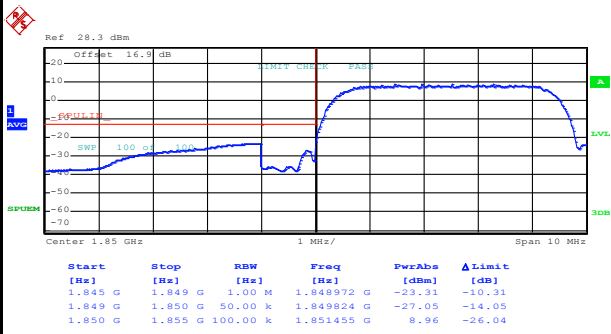

Date: 22.JUN.2019 16:49:49

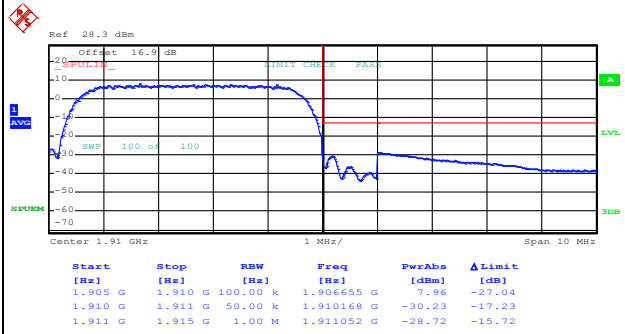

Date: 22.JUN.2019 16:52:44



WCDMA Band IV (RMC 12.2Kbps)

Lowest Band Edge

Highest Band Edge

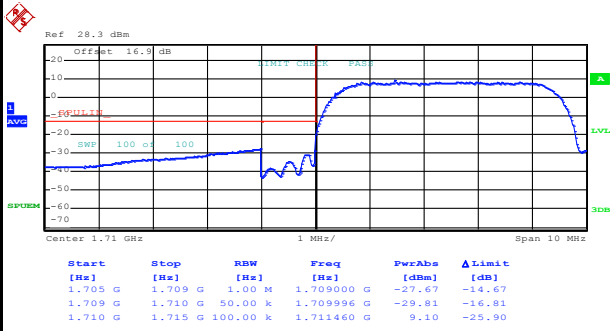

Date: 22.JUN.2019 17:07:14

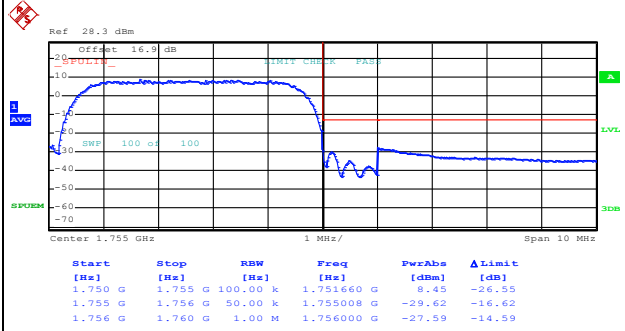

Date: 22.JUN.2019 17:10:02

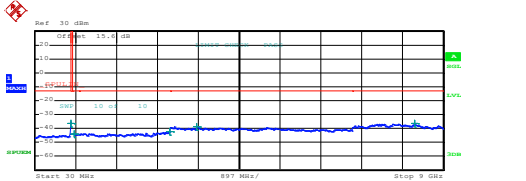
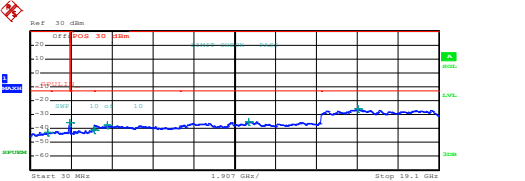
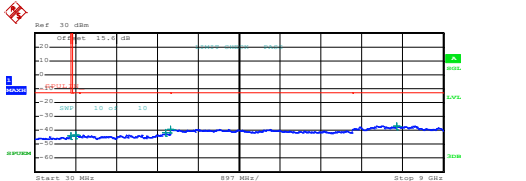
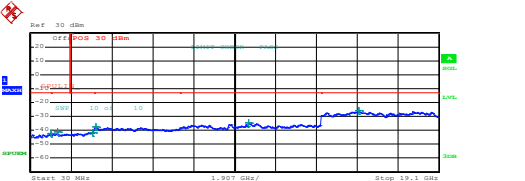
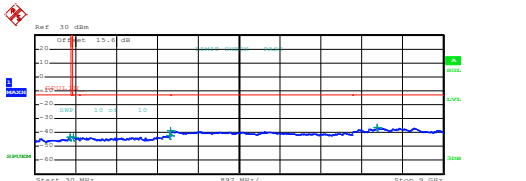
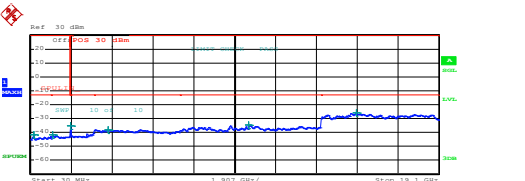

# Conducted Spurious Emission

WCDMA Band V (RMC 12.2Kbps)	WCDMA Band II (RMC 12.2Kbps)																																																																														
Lowest Channel	Lowest Channel																																																																														
 <table border="1" data-bbox="239 660 702 739"> <thead> <tr> <th>Start [Hz]</th> <th>Stop [Hz]</th> <th>RBW [Hz]</th> <th>Freq [Hz]</th> <th>PerAbs [dBm]</th> <th>ΔLimit [dB]</th> </tr> </thead> <tbody> <tr> <td>30,000 M</td> <td>820,000 M</td> <td>1,000 M</td> <td>819,407500 M</td> <td>-30.23</td> <td>-31.23</td> </tr> <tr> <td>835,000 M</td> <td>1,000 G</td> <td>1,000 G</td> <td>882,803750 M</td> <td>-43.83</td> <td>-30.83</td> </tr> <tr> <td>1,000 G</td> <td>3,000 G</td> <td>1,000 M</td> <td>2,999000 G</td> <td>-42.23</td> <td>-29.23</td> </tr> <tr> <td>3,000 G</td> <td>7,000 G</td> <td>1,000 M</td> <td>3,590000 G</td> <td>-38.85</td> <td>-25.85</td> </tr> <tr> <td>7,000 G</td> <td>9,000 G</td> <td>1,000 M</td> <td>8,375500 G</td> <td>-36.54</td> <td>-23.54</td> </tr> </tbody> </table> <p>Date: 22.JUN.2019 17:29:47</p>	Start [Hz]	Stop [Hz]	RBW [Hz]	Freq [Hz]	PerAbs [dBm]	ΔLimit [dB]	30,000 M	820,000 M	1,000 M	819,407500 M	-30.23	-31.23	835,000 M	1,000 G	1,000 G	882,803750 M	-43.83	-30.83	1,000 G	3,000 G	1,000 M	2,999000 G	-42.23	-29.23	3,000 G	7,000 G	1,000 M	3,590000 G	-38.85	-25.85	7,000 G	9,000 G	1,000 M	8,375500 G	-36.54	-23.54	 <table border="1" data-bbox="893 660 1356 739"> <thead> <tr> <th>Start [Hz]</th> <th>Stop [Hz]</th> <th>RBW [Hz]</th> <th>Freq [Hz]</th> <th>PerAbs [dBm]</th> <th>ΔLimit [dB]</th> </tr> </thead> <tbody> <tr> <td>30,000 M</td> <td>1,000 G</td> <td>1,000 M</td> <td>812,547500 M</td> <td>-45.99</td> <td>-29.99</td> </tr> <tr> <td>1,000 G</td> <td>3,000 G</td> <td>1,000 M</td> <td>1,843000 G</td> <td>-36.03</td> <td>-23.03</td> </tr> <tr> <td>3,000 G</td> <td>7,000 G</td> <td>1,000 M</td> <td>2,993300 G</td> <td>-40.78</td> <td>-27.78</td> </tr> <tr> <td>7,000 G</td> <td>13,600 G</td> <td>1,000 M</td> <td>10,219975 G</td> <td>-34.98</td> <td>-21.98</td> </tr> <tr> <td>13,600 G</td> <td>19,100 G</td> <td>1,000 M</td> <td>15,322675 G</td> <td>-26.08</td> <td>-13.08</td> </tr> </tbody> </table> <p>Date: 22.JUN.2019 16:54:12</p>	Start [Hz]	Stop [Hz]	RBW [Hz]	Freq [Hz]	PerAbs [dBm]	ΔLimit [dB]	30,000 M	1,000 G	1,000 M	812,547500 M	-45.99	-29.99	1,000 G	3,000 G	1,000 M	1,843000 G	-36.03	-23.03	3,000 G	7,000 G	1,000 M	2,993300 G	-40.78	-27.78	7,000 G	13,600 G	1,000 M	10,219975 G	-34.98	-21.98	13,600 G	19,100 G	1,000 M	15,322675 G	-26.08	-13.08						
Start [Hz]	Stop [Hz]	RBW [Hz]	Freq [Hz]	PerAbs [dBm]	ΔLimit [dB]																																																																										
30,000 M	820,000 M	1,000 M	819,407500 M	-30.23	-31.23																																																																										
835,000 M	1,000 G	1,000 G	882,803750 M	-43.83	-30.83																																																																										
1,000 G	3,000 G	1,000 M	2,999000 G	-42.23	-29.23																																																																										
3,000 G	7,000 G	1,000 M	3,590000 G	-38.85	-25.85																																																																										
7,000 G	9,000 G	1,000 M	8,375500 G	-36.54	-23.54																																																																										
Start [Hz]	Stop [Hz]	RBW [Hz]	Freq [Hz]	PerAbs [dBm]	ΔLimit [dB]																																																																										
30,000 M	1,000 G	1,000 M	812,547500 M	-45.99	-29.99																																																																										
1,000 G	3,000 G	1,000 M	1,843000 G	-36.03	-23.03																																																																										
3,000 G	7,000 G	1,000 M	2,993300 G	-40.78	-27.78																																																																										
7,000 G	13,600 G	1,000 M	10,219975 G	-34.98	-21.98																																																																										
13,600 G	19,100 G	1,000 M	15,322675 G	-26.08	-13.08																																																																										
Middle Channel	Middle Channel																																																																														
 <table border="1" data-bbox="239 1178 702 1256"> <thead> <tr> <th>Start [Hz]</th> <th>Stop [Hz]</th> <th>RBW [Hz]</th> <th>Freq [Hz]</th> <th>PerAbs [dBm]</th> <th>ΔLimit [dB]</th> </tr> </thead> <tbody> <tr> <td>30,000 M</td> <td>820,000 M</td> <td>1,000 M</td> <td>818,025000 M</td> <td>-44.23</td> <td>-31.23</td> </tr> <tr> <td>835,000 M</td> <td>1,000 G</td> <td>1,000 M</td> <td>918,256254 M</td> <td>-42.28</td> <td>-30.28</td> </tr> <tr> <td>1,000 G</td> <td>3,000 G</td> <td>1,000 M</td> <td>2,897000 G</td> <td>-41.89</td> <td>-28.89</td> </tr> <tr> <td>3,000 G</td> <td>7,000 G</td> <td>1,000 M</td> <td>3,017000 G</td> <td>-39.22</td> <td>-26.22</td> </tr> <tr> <td>7,000 G</td> <td>9,000 G</td> <td>1,000 M</td> <td>7,968000 G</td> <td>-36.76</td> <td>-23.76</td> </tr> </tbody> </table> <p>Date: 22.JUN.2019 17:30:43</p>	Start [Hz]	Stop [Hz]	RBW [Hz]	Freq [Hz]	PerAbs [dBm]	ΔLimit [dB]	30,000 M	820,000 M	1,000 M	818,025000 M	-44.23	-31.23	835,000 M	1,000 G	1,000 M	918,256254 M	-42.28	-30.28	1,000 G	3,000 G	1,000 M	2,897000 G	-41.89	-28.89	3,000 G	7,000 G	1,000 M	3,017000 G	-39.22	-26.22	7,000 G	9,000 G	1,000 M	7,968000 G	-36.76	-23.76	 <table border="1" data-bbox="893 1178 1356 1256"> <thead> <tr> <th>Start [Hz]</th> <th>Stop [Hz]</th> <th>RBW [Hz]</th> <th>Freq [Hz]</th> <th>PerAbs [dBm]</th> <th>ΔLimit [dB]</th> </tr> </thead> <tbody> <tr> <td>30,000 M</td> <td>1,000 G</td> <td>1,000 M</td> <td>980,153000 M</td> <td>-42.58</td> <td>-29.58</td> </tr> <tr> <td>1,000 G</td> <td>3,000 G</td> <td>1,000 M</td> <td>3,300500 G</td> <td>-40.97</td> <td>-27.97</td> </tr> <tr> <td>3,000 G</td> <td>7,000 G</td> <td>1,000 M</td> <td>2,933273 G</td> <td>-41.37</td> <td>-28.37</td> </tr> <tr> <td>7,000 G</td> <td>13,600 G</td> <td>1,000 M</td> <td>3,098000 G</td> <td>-37.34</td> <td>-24.34</td> </tr> <tr> <td>13,600 G</td> <td>19,100 G</td> <td>1,000 M</td> <td>15,319150 G</td> <td>-34.87</td> <td>-21.87</td> </tr> <tr> <td>19,100 G</td> <td>19,100 G</td> <td>1,000 M</td> <td>15,355875 G</td> <td>-25.81</td> <td>-12.81</td> </tr> </tbody> </table> <p>Date: 22.JUN.2019 16:55:05</p>	Start [Hz]	Stop [Hz]	RBW [Hz]	Freq [Hz]	PerAbs [dBm]	ΔLimit [dB]	30,000 M	1,000 G	1,000 M	980,153000 M	-42.58	-29.58	1,000 G	3,000 G	1,000 M	3,300500 G	-40.97	-27.97	3,000 G	7,000 G	1,000 M	2,933273 G	-41.37	-28.37	7,000 G	13,600 G	1,000 M	3,098000 G	-37.34	-24.34	13,600 G	19,100 G	1,000 M	15,319150 G	-34.87	-21.87	19,100 G	19,100 G	1,000 M	15,355875 G	-25.81	-12.81
Start [Hz]	Stop [Hz]	RBW [Hz]	Freq [Hz]	PerAbs [dBm]	ΔLimit [dB]																																																																										
30,000 M	820,000 M	1,000 M	818,025000 M	-44.23	-31.23																																																																										
835,000 M	1,000 G	1,000 M	918,256254 M	-42.28	-30.28																																																																										
1,000 G	3,000 G	1,000 M	2,897000 G	-41.89	-28.89																																																																										
3,000 G	7,000 G	1,000 M	3,017000 G	-39.22	-26.22																																																																										
7,000 G	9,000 G	1,000 M	7,968000 G	-36.76	-23.76																																																																										
Start [Hz]	Stop [Hz]	RBW [Hz]	Freq [Hz]	PerAbs [dBm]	ΔLimit [dB]																																																																										
30,000 M	1,000 G	1,000 M	980,153000 M	-42.58	-29.58																																																																										
1,000 G	3,000 G	1,000 M	3,300500 G	-40.97	-27.97																																																																										
3,000 G	7,000 G	1,000 M	2,933273 G	-41.37	-28.37																																																																										
7,000 G	13,600 G	1,000 M	3,098000 G	-37.34	-24.34																																																																										
13,600 G	19,100 G	1,000 M	15,319150 G	-34.87	-21.87																																																																										
19,100 G	19,100 G	1,000 M	15,355875 G	-25.81	-12.81																																																																										
Highest Channel	Highest Channel																																																																														
 <table border="1" data-bbox="239 1695 702 1774"> <thead> <tr> <th>Start [Hz]</th> <th>Stop [Hz]</th> <th>RBW [Hz]</th> <th>Freq [Hz]</th> <th>PerAbs [dBm]</th> <th>ΔLimit [dB]</th> </tr> </thead> <tbody> <tr> <td>30,000 M</td> <td>820,000 M</td> <td>1,000 M</td> <td>802,225000 M</td> <td>-43.68</td> <td>-30.68</td> </tr> <tr> <td>835,000 M</td> <td>1,000 G</td> <td>1,000 M</td> <td>868,521251 M</td> <td>-43.37</td> <td>-30.37</td> </tr> <tr> <td>1,000 G</td> <td>3,000 G</td> <td>1,000 M</td> <td>2,904500 G</td> <td>-42.31</td> <td>-29.31</td> </tr> <tr> <td>3,000 G</td> <td>7,000 G</td> <td>1,000 M</td> <td>3,010000 G</td> <td>-38.64</td> <td>-25.64</td> </tr> <tr> <td>7,000 G</td> <td>9,000 G</td> <td>1,000 M</td> <td>7,948000 G</td> <td>-36.47</td> <td>-23.47</td> </tr> </tbody> </table> <p>Date: 22.JUN.2019 17:31:35</p>	Start [Hz]	Stop [Hz]	RBW [Hz]	Freq [Hz]	PerAbs [dBm]	ΔLimit [dB]	30,000 M	820,000 M	1,000 M	802,225000 M	-43.68	-30.68	835,000 M	1,000 G	1,000 M	868,521251 M	-43.37	-30.37	1,000 G	3,000 G	1,000 M	2,904500 G	-42.31	-29.31	3,000 G	7,000 G	1,000 M	3,010000 G	-38.64	-25.64	7,000 G	9,000 G	1,000 M	7,948000 G	-36.47	-23.47	 <table border="1" data-bbox="893 1695 1356 1774"> <thead> <tr> <th>Start [Hz]</th> <th>Stop [Hz]</th> <th>RBW [Hz]</th> <th>Freq [Hz]</th> <th>PerAbs [dBm]</th> <th>ΔLimit [dB]</th> </tr> </thead> <tbody> <tr> <td>30,000 M</td> <td>1,000 G</td> <td>1,000 M</td> <td>169,922500 M</td> <td>-41.67</td> <td>-28.67</td> </tr> <tr> <td>1,000 G</td> <td>3,000 G</td> <td>1,000 M</td> <td>1,058300 G</td> <td>-41.73</td> <td>-28.73</td> </tr> <tr> <td>3,000 G</td> <td>7,000 G</td> <td>1,000 M</td> <td>1,933542 G</td> <td>-35.81</td> <td>-22.81</td> </tr> <tr> <td>7,000 G</td> <td>13,600 G</td> <td>1,000 M</td> <td>3,645000 G</td> <td>-37.86</td> <td>-24.86</td> </tr> <tr> <td>13,600 G</td> <td>19,100 G</td> <td>1,000 M</td> <td>10,210900 G</td> <td>-34.88</td> <td>-21.88</td> </tr> <tr> <td>19,100 G</td> <td>19,100 G</td> <td>1,000 M</td> <td>15,246500 G</td> <td>-25.81</td> <td>-12.81</td> </tr> </tbody> </table> <p>Date: 22.JUN.2019 16:55:57</p>	Start [Hz]	Stop [Hz]	RBW [Hz]	Freq [Hz]	PerAbs [dBm]	ΔLimit [dB]	30,000 M	1,000 G	1,000 M	169,922500 M	-41.67	-28.67	1,000 G	3,000 G	1,000 M	1,058300 G	-41.73	-28.73	3,000 G	7,000 G	1,000 M	1,933542 G	-35.81	-22.81	7,000 G	13,600 G	1,000 M	3,645000 G	-37.86	-24.86	13,600 G	19,100 G	1,000 M	10,210900 G	-34.88	-21.88	19,100 G	19,100 G	1,000 M	15,246500 G	-25.81	-12.81
Start [Hz]	Stop [Hz]	RBW [Hz]	Freq [Hz]	PerAbs [dBm]	ΔLimit [dB]																																																																										
30,000 M	820,000 M	1,000 M	802,225000 M	-43.68	-30.68																																																																										
835,000 M	1,000 G	1,000 M	868,521251 M	-43.37	-30.37																																																																										
1,000 G	3,000 G	1,000 M	2,904500 G	-42.31	-29.31																																																																										
3,000 G	7,000 G	1,000 M	3,010000 G	-38.64	-25.64																																																																										
7,000 G	9,000 G	1,000 M	7,948000 G	-36.47	-23.47																																																																										
Start [Hz]	Stop [Hz]	RBW [Hz]	Freq [Hz]	PerAbs [dBm]	ΔLimit [dB]																																																																										
30,000 M	1,000 G	1,000 M	169,922500 M	-41.67	-28.67																																																																										
1,000 G	3,000 G	1,000 M	1,058300 G	-41.73	-28.73																																																																										
3,000 G	7,000 G	1,000 M	1,933542 G	-35.81	-22.81																																																																										
7,000 G	13,600 G	1,000 M	3,645000 G	-37.86	-24.86																																																																										
13,600 G	19,100 G	1,000 M	10,210900 G	-34.88	-21.88																																																																										
19,100 G	19,100 G	1,000 M	15,246500 G	-25.81	-12.81																																																																										



WCDMA Band IV (RMC 12.2Kbps)

Lowest Channel

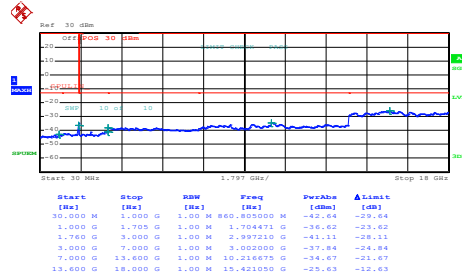

Date: 22.JUN.2019 17:10:57

Middle Channel

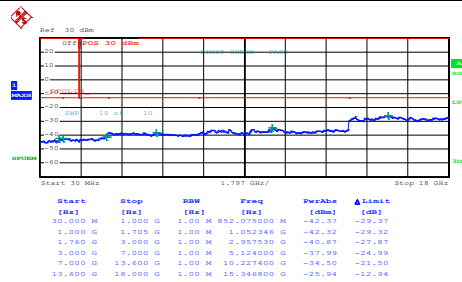

Date: 22.JUN.2019 17:11:47

Highest Channel

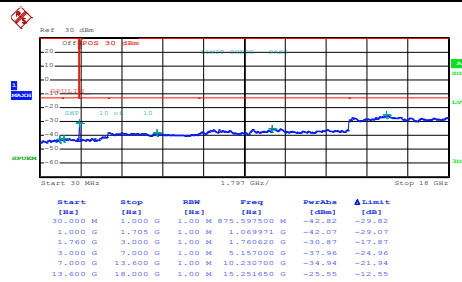

Date: 22.JUN.2019 17:12:46



Frequency Stability

Test Conditions	Middle Channel	WCDMA Band V (RMC 12.2Kbps)	Limit 2.5ppm
Temperature (°C)	Voltage (Volt)	Deviation (ppm)	Result
50	Normal Voltage	0.0012	PASS
40	Normal Voltage	0.0000	
30	Normal Voltage	0.0012	
20(Ref.)	Normal Voltage	0.0000	
10	Normal Voltage	0.0024	
0	Normal Voltage	0.0000	
-10	Normal Voltage	0.0000	
-20	Normal Voltage	0.0012	
-30	Normal Voltage	0.0024	
20	Maximum Voltage	0.0012	
20	Normal Voltage	0.0000	
20	Battery End Point	0.0060	
Test Conditions	Middle Channel	WCDMA Band IV (RMC 12.2Kbps)	
Temperature (°C)	Voltage (Volt)	Deviation (ppm)	Result
50	Normal Voltage	0.0006	PASS
40	Normal Voltage	0.0006	
30	Normal Voltage	0.0000	
20(Ref.)	Normal Voltage	0.0000	
10	Normal Voltage	0.0000	
0	Normal Voltage	0.0006	
-10	Normal Voltage	0.0006	
-20	Normal Voltage	0.0000	
-30	Normal Voltage	0.0006	
20	Maximum Voltage	0.0017	
20	Normal Voltage	0.0000	
20	Battery End Point	0.0046	



Test Conditions	Middle Channel	WCDMA Band II (RMC 12.2Kbps)	Limit Note 2.
Temperature (°C)	Voltage (Volt)	Deviation (ppm)	Result
50	Normal Voltage	0.0005	PASS
40	Normal Voltage	0.0005	
30	Normal Voltage	0.0011	
20(Ref.)	Normal Voltage	0.0000	
10	Normal Voltage	0.0011	
0	Normal Voltage	0.0011	
-10	Normal Voltage	0.0000	
-20	Normal Voltage	0.0000	
-30	Normal Voltage	0.0011	
20	Maximum Voltage	0.0005	
20	Normal Voltage	0.0000	
20	Battery End Point	0.0112	

**Note:**

- 1. Normal Voltage = 3.8V. ; Battery End Point (BEP) = 3.5 V. ; Maximum Voltage =4.4 V
- 2. The frequency fundamental emissions stay within the authorized frequency block.



## Appendix B. Test Results of ERP/EIRP and Radiated Test

### ERP/EIRP

Channel	Mode	Conducted		ERP	
		Power (dBm)	Power (Watts)	ERP(dBm)	ERP(W)
Lowest	WCDMA Band V	24.50	0.2818	22.66	0.1845
Middle	RMC 12.2Kbps	24.48	0.2805	22.64	0.1837
Highest	(GT - LC = 0.31 dB)	24.55	0.2851	22.71	0.1866
Limit	ERP < 7W	Result		PASS	

Channel	Mode	Conducted		EIRP	
		Power (dBm)	Power (Watts)	EIRP(dBm)	EIRP(W)
Lowest	WCDMA Band II	23.97	0.2495	25.61	0.3639
Middle	RMC 12.2Kbps	24.04	0.2535	25.68	0.3698
Highest	(GT - LC = 1.64 dB)	24.00	0.2512	25.64	0.3664
Limit	EIRP < 2W	Result		PASS	

Channel	Mode	Conducted		EIRP	
		Power (dBm)	Power (Watts)	EIRP(dBm)	EIRP(W)
Lowest	WCDMA Band IV	21.13	0.1297	23.45	0.2213
Middle	RMC 12.2Kbps	21.19	0.1315	23.51	0.2244
Highest	(GT - LC = 2.32 dB)	21.12	0.1294	23.44	0.2208
Limit	EIRP < 1W	Result		PASS	





**Radiated Spurious Emission**

**WCDMA 850**

WCDMA 850									
Channel	Frequency ( MHz )	ERP ( dBm )	Limit ( dBm )	Over Limit ( dB )	SPA Reading (dBm)	S.G. Power ( dBm )	TX Cable loss ( dB )	TX Antenna Gain (dBi)	Polarization (H/V)
Lowest	1656	-54.91	-13	-41.91	-65.04	-60.53	0.92	8.69	H
	2480	-56.12	-13	-43.12	-70.43	-63.50	1.15	10.67	H
	3304	-53.13	-13	-40.13	-68.75	-61.68	1.32	12.03	H
									H
									H
									H
	1656	-58.62	-13	-45.62	-68.15	-64.24	0.92	8.69	V
	2480	-55.52	-13	-42.52	-70.01	-62.90	1.15	10.67	V
	3304	-55.23	-13	-42.23	-71.32	-63.78	1.32	12.03	V
									V
Middle	1672	-56.82	-13	-43.82	-67	-62.50	0.93	8.75	H
	2509	-56.44	-13	-43.44	-70.73	-63.85	1.15	10.71	H
	3344	-54.95	-13	-41.95	-70.49	-63.59	1.33	12.13	H
									H
									H
									H
	1672	-59.30	-13	-46.30	-68.82	-64.98	0.93	8.75	V
	2509	-55.76	-13	-42.76	-70.23	-63.17	1.15	10.71	V
	3344	-54.99	-13	-41.99	-70.98	-63.63	1.33	12.13	V
									V
Highest	1688	-56.08	-13	-43.08	-66.29	-61.81	0.93	8.81	H
	2536	-56.46	-13	-43.46	-70.74	-63.89	1.16	10.74	H
	3384	-54.50	-13	-41.50	-69.95	-63.23	1.34	12.22	H
									H
									H
									H
	1688	-58.91	-13	-45.91	-68.46	-64.64	0.93	8.81	V
	2536	-55.11	-13	-42.11	-69.52	-62.54	1.16	10.74	V
	3384	-55.30	-13	-42.30	-71.19	-64.03	1.34	12.22	V
									V

Remark: Spurious emissions within 30-1000MHz were found more than 20dB below limit line.



**WCDMA 1700**

WCDMA 1700									
Channel	Frequency ( MHz )	EIRP ( dBm )	Limit ( dBm )	Over Limit ( dB )	SPA Reading (dBm)	S.G. Power ( dBm )	TX Cable loss ( dB )	TX Antenna Gain (dBi)	Polarization (H/V)
Lowest	3424	-51.21	-13	-38.21	-67.55	-62.18	1.35	12.32	H
	5137	-50.01	-13	-37.01	-71.71	-61.16	1.65	12.79	H
	6852	-47.01	-13	-34.01	-72.46	-57.38	1.74	12.11	H
									H
									H
									H
	3424	-53.99	-13	-40.99	-70.74	-64.96	1.35	12.32	V
	5137	-50.72	-13	-37.72	-72.17	-61.87	1.65	12.79	V
	6852	-47.11	-13	-34.11	-72.15	-57.48	1.74	12.11	V
									V
									V
Middle	3468	-52.69	-13	-39.69	-69.35	-63.76	1.35	12.42	H
	5197	-50.58	-13	-37.58	-72.31	-61.79	1.66	12.88	H
	6930	-46.43	-13	-33.43	-72.32	-56.70	1.73	12.00	H
									H
									H
									H
	3468	-54.07	-13	-41.07	-71.11	-65.14	1.35	12.42	V
	5197	-50.44	-13	-37.44	-72.01	-61.65	1.66	12.88	V
	6930	-46.60	-13	-33.60	-72.03	-56.87	1.73	12.00	V
									V
									V
Highest	3504	-51.05	-13	-38.05	-68	-62.19	1.36	12.50	H
	5256	-50.21	-13	-37.21	-72.12	-61.49	1.68	12.96	H
	7010	-45.66	-13	-32.66	-71.95	-55.82	1.73	11.88	H
									H
									H
									H
	3504	-53.24	-13	-40.24	-70.55	-64.38	1.36	12.50	V
	5256	-50.59	-13	-37.59	-72.27	-61.87	1.68	12.96	V
	7010	-45.88	-13	-32.88	-71.69	-56.04	1.73	11.88	V
									V
									V

Remark: Spurious emissions within 30-1000MHz were found more than 20dB below limit line.



**WCDMA 1900**

WCDMA 1900									
Channel	Frequency ( MHz )	EIRP ( dBm )	Limit ( dBm )	Over Limit ( dB )	SPA Reading (dBm)	S.G. Power ( dBm )	TX Cable loss ( dB )	TX Antenna Gain (dBi)	Polarization (H/V)
Lowest	3702	-51.55	-13	-38.55	-69.65	-62.76	1.41	12.62	H
	5557	-49.19	-13	-36.19	-72.19	-60.75	1.74	13.30	H
	7410	-45.28	-13	-32.28	-72.1	-54.58	1.94	11.24	H
									H
									H
									H
	3702	-50.26	-13	-37.26	-68.5	-61.47	1.41	12.62	V
	5557	-49.88	-13	-36.88	-72.4	-61.44	1.74	13.30	V
	7410	-45.69	-13	-32.69	-72.37	-54.99	1.94	11.24	V
									V
									V
Middle	3762	-51.48	-13	-38.48	-69.77	-62.71	1.43	12.66	H
	5640	-49.30	-13	-36.30	-72.33	-60.87	1.73	13.30	H
	7520	-45.59	-13	-32.59	-71.95	-54.70	1.99	11.10	H
									H
									H
									H
	3762	-52.43	-13	-39.43	-70.92	-63.66	1.43	12.66	V
	5640	-49.63	-13	-36.63	-72.26	-61.20	1.73	13.30	V
	7520	-45.51	-13	-32.51	-71.83	-54.62	1.99	11.10	V
									V
									V
Highest	3816	-52.24	-13	-39.24	-70.77	-63.49	1.44	12.69	H
	5724	-48.44	-13	-35.44	-71.9	-60.01	1.73	13.30	H
	7630	-46.22	-13	-33.22	-72.28	-55.34	2.01	11.13	H
									H
									H
									H
	3816	-52.23	-13	-39.23	-71	-63.48	1.44	12.69	V
	5724	-49.38	-13	-36.38	-72.2	-60.95	1.73	13.30	V
	7630	-45.76	-13	-32.76	-71.73	-54.88	2.01	11.13	V
									V
									V

Remark: Spurious emissions within 30-1000MHz were found more than 20dB below limit line.