



EM7355/EM7655 Modem

Test Report

FOR

CDMA and EVDO

Rev. 2.1

FCC and IC Certifications

IC: 2417C-EM7355
FCC ID: N7NEM7355

© 2010 Sierra Wireless, Inc.

This document contains information which is proprietary and confidential to Sierra Wireless, Inc. Disclosure to persons other than the officers, employees, agents, or subcontractors of the Company or licensee of this document without the prior written permission of Sierra Wireless, Inc. is strictly prohibited.

SIERRA WIRELESS, INC.

FCC Part 22/24/90, RSS-132/133	EM7355	Feb. 05, 2013	Page 2 of 35
--------------------------------	--------	---------------	--------------

Table of Contents

1	Introduction and Purpose	4
1.1	Revision history.....	4
2	Test Summary	4
3	Description of Equipment under Test.....	4
3.1	BC10 Frequency Support.....	5
3.2	Differences between EM7355 and EM7655	5
4	Compliance Test Equipment List	5
5	Test Setup Block Diagrams	6
5.1	Test Setup 1	6
5.2	Test Setup 2.....	7
6	RF Power Output	7
6.1	Test Procedure	7
6.1.1	CDMA/EVDO Max Power setup	7
6.1.2	Test Results CDMA/EVDO Output Power	8
7	Occupied Bandwidth.....	8
7.1	Test Procedure	8
7.2	Test Results	8
7.2.1	CDMA Summary Results	8
7.2.2	CDMA Test Plots.....	9
7.2.3	1x EvDO Test Plots	11
8	Out of Band Emissions at Antenna Terminals	13
8.1	Test Procedure	13
8.2	Test Results	13
8.2.1	CDMA Test Plots.....	14
8.2.2	EVDO Rel. A Test Plots	17
9	Block Edge Compliance	20
9.1	Test Procedure	20
9.2	Test Results	21
9.2.1	CDMA Test Plots.....	22
9.2.2	1x EvDO Test Plots	28
10	Frequency Stability versus Temperature.....	30
10.1	Summary of Results.....	31
10.2	Test Procedure	31
10.3	Test Results	31
10.3.1	CDMA Frequency Error over Temperature	31
11	Frequency Stability versus Voltage.....	31
11.1	Summary of Results.....	31
11.2	Test Procedure	32
11.3	Test Results	32
11.3.1	CDMA Frequency Error over Voltage	32
12	Peak to Average Ratio	32
12.1	Summary of Results.....	32

© 2010 Sierra Wireless, Inc.

The contents of this page are subject to the confidentiality information on page one.

SIERRA WIRELESS, INC.

FCC Part 22/24/90, RSS-132/133	EM7355	Feb. 05, 2013	Page 3 of 35
--------------------------------	--------	---------------	--------------

12.2 *Test Procedure* 32
12.3 *Test Results* 32
 12.3.1 Test Plots..... 33

SIERRA WIRELESS, INC.

FCC Part 22/24/90, RSS-132/133	EM7355	Feb. 05, 2013	Page 4 of 35
--------------------------------	--------	---------------	--------------

1 Introduction and Purpose

This document provides test data for the EM7355 modem output power intended for FCC and Industry Canada certifications.

1.1 Revision history

Rev	Date	Author	Summary of changes	ECO #
1.0	Aug.15, 2012	Markus Myers	First Release	
2.0	Feb. 05, 2013	Markus Myers	Updated channel frequency information, BC10 power and BC10 band edge plots.	
2.1	Feb 8, 2013	Markus Myers	Updated limit lines on emission plots	

2 Test Summary

FCC Rule	IC Standards	DESCRIPTION OF TEST	RESULT	PAGE
2.1046	RSS-132, 4.4 RSS-133, 6.4	RF Power Output	Complies	5
2.202, 22.917, 24.238, 90.691	RSS-Gen, 4.6	Occupied Bandwidth	Complies	16
2.1051, 22.917, 24.238, 90.210	RSS-132, 4.5 RSS-133, 6.5	Out of Band Emissions at Antenna Terminals	Complies	45
2.1051, 22.917, 24.238, 90.691	RSS-Gen, 4.6	Block Edge Compliance	Complies	106
2.1055, 22.355, 24.235, 90.213	RSS-132, 4.3 RSS-133, 6.3	Frequency Stability versus Temperature	Complies	122
2.1055, 22.355, 24.235, 90.213	RSS-132, 4.3 RSS-133, 6.3	Frequency Stability versus Voltage	Complies	124
24.232		Peak to Average Ratio	Complies	126

3 Description of Equipment under Test

The EM7355/EM7655 modem, referred to as “EUT” hereafter, is a multi-band wireless modem operating on the GSM/GPRS/EDGE/UMTS/LTE/CDMA networks. The table below shows the supported North American bands for the device.

Technology	Band	UL Freq. (MHz)	DL Freq. (MHz)	Max Power
LTE	B2	1850 – 1910	1930 – 1990	23 dBm (+/- 1 dB)
	B4	1710 – 1755	2110 – 2155	23 dBm (+/- 1 dB)
	B5	824 – 849	869 – 894	23 dBm (+/- 1 dB)
	B13	777 – 787	746 – 756	23 dBm (+/- 1 dB)
	B17	704 – 716	734 – 746	23 dBm (+/- 1 dB)

© 2010 Sierra Wireless, Inc.

The contents of this page are subject to the confidentiality information on page one.

SIERRA WIRELESS, INC.

	B25	1850 – 1915	1930 – 1995	23 dBm (+/- 1 dB)
WCDMA / HSDPA/ HSUPA / HSPA+	B2	1850 – 1910	1930 – 1990	23 dBm (+/- 1 dB)
	B4	1710 – 1755	2110 – 2155	23 dBm (+/- 1 dB)
	B5	824 – 849	869 – 894	23 dBm (+/- 1 dB)
	BC0	824 – 849	869 – 894	24 dBm (+/- 1 dB)
CDMA / EVDO	BC1	1850 – 1910	1930 – 1990	24 dBm (+/- 1 dB)
	BC10*	817.0 – 824.0	862.0 – 869	24 dBm (+/- 1 dB)
	G850	824 – 849	869 – 894	32.5 dBm (+/-1dB)
GSM	G1900	1850 – 1910	1930 – 1990	29.5 dBm (+/-1dB)
	G850	824 – 849	869 – 894	27 dBm (+/-1dB)
EDGE	G1900	1850 – 1910	1930 – 1990	26 dBm (+/-1dB)

* Only BC10 subclass 2 and 3 frequencies are supported by hardware and firmware.

3.1 BC10 Frequency Support

The device supports BC10 subclass 2 and 3 frequencies only as defined in 3GPP2 C.S0057-D.

3GPP2 C.S0057-D v1.0

Table 4.1.11-1. Band Class 10 Block Frequency Correspondence

System Designator	Band Subclass	Transmit Frequency Band (MHz)	
		Access Terminal	Access Network
A	0	806.000–811.000	851.000–856.000
B	1	811.000–816.000	856.000–861.000
C	2	816.000–821.000	861.000–866.000
D	3	821.000–824.000	866.000–869.000
E	4	896.000–901.000	935.000–940.000

The Sprint Requirements (Sprint Customer Equipment Band Class 10 Requirements V1.3.0) limit the useable channels from 457 – 670 (817.90 MHz – 823.1 MHz inclusive).

3.2 Differences between EM7355 and EM7655

The EM7355 and EM7655 differ only in pcb length and host interface connector. Both products utilize the same pcb RF layout, components and firmware. Please refer to document “7x55 Comparison.pdf”.

4 Compliance Test Equipment List

EQUIPMENT	MANUFACTURER	MODEL NO.	SERIAL NO.	CAL. DUE DATE
-----------	--------------	-----------	------------	---------------

© 2010 Sierra Wireless, Inc.

The contents of this page are subject to the confidentiality information on page one.

SIERRA WIRELESS, INC.

Control Computer	TC	Generic PC	100488	N/A
Wireless Test Set	Rohde & Schwarz	CMU200	110521	October 27, 2013
Wireless Test Set	Rohde & Schwarz	CMW500	101060	June 6, 2014
Spectrum Analyzer	Rohde & Schwarz	FSP	100060	October 27, 2013
DC Power Supply	HP	6632A	3530A	N/A
Interface Board	Shop built	ATEMux	N/A	N/A
Directional Coupler	Pasternack	PE2209-10	N/A	N/A

5 Test Setup Block Diagrams

5.1 Test Setup 1

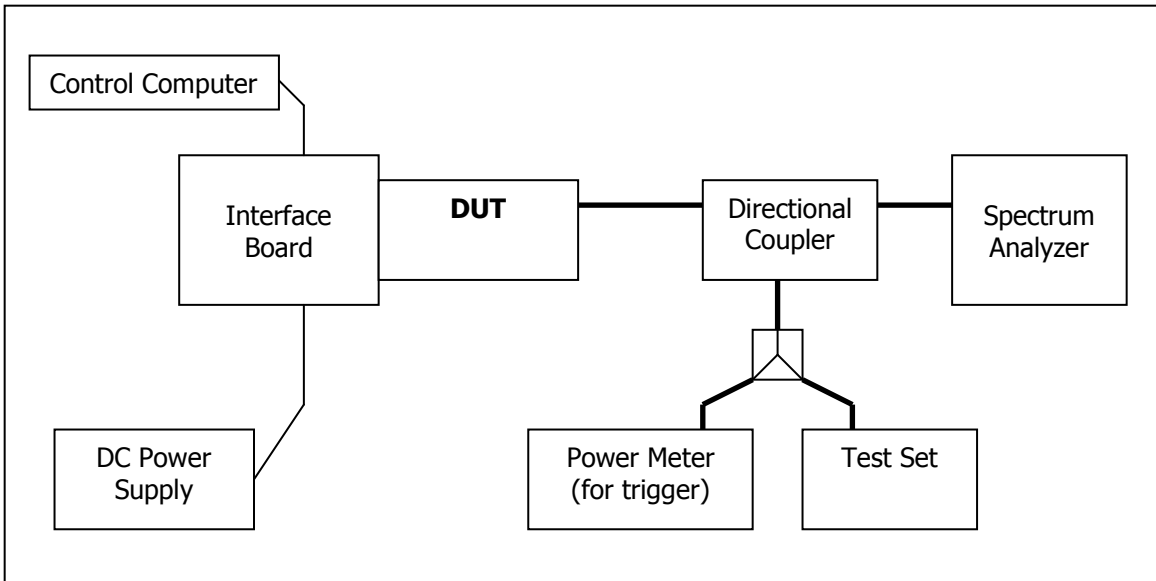

5.2 Test Setup 2

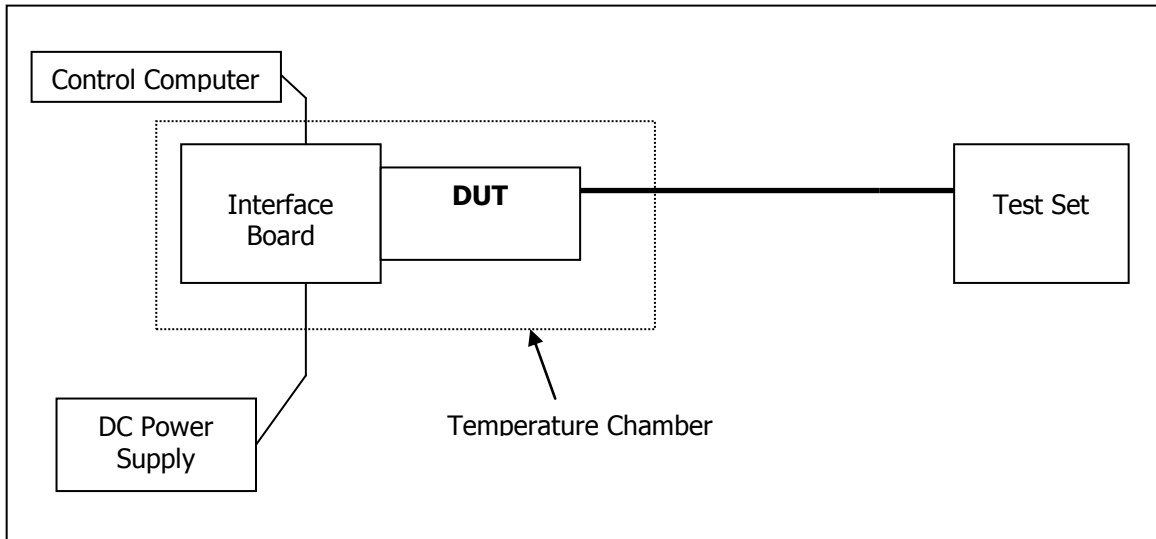

6 RF Power Output

FCC 2.1046

6.1 Test Procedure

The transmitter output was connected to a Rohde & Schwarz CMW500 Test Set and configured to operate at maximum power in a call. The power was measured using the CDMA Tx measurement of the CMW500. Refer to Test Setup 1.

6.1.1 CDMA/EVDO Max Power setup

For CDMA Loopback Call per 3GPP2 CS00114.4.5 Maximum Output Power

- Configure Fundamental Channel Test Mode 1 with 9600 bps data rate.
- Set the Service option to SO2, the radio configuration to RC1, set forward channel power to -85 dBm and connect call.
- Set the reverse power control bits to "All up" and measure the power at the EM7355 module antenna connector.
- Repeat above process for SO9 and SO55 service options and RC1 and RC3 radio configuration.

For EVDO Loopback Call per 3GPP2 CS0033 4.3.4 Maximum Output Power

- For Subtype 0 or 1 Physical Layer, configure the Test Application RTAP (R0) so that the Reverse Data Channel rate corresponds to 153.6 kbps.
- Set Ior to -85 dBm/1.23 MHz and connect call.
- Set the reverse power control bits to "All up" and measure the power at the EM7355 module antenna connector.

SIERRA WIRELESS, INC.

- Repeat above process for Test Application RETAP (RA) service option.

6.1.2 Test Results CDMA/EVDO Output Power

Band	Channel	Frequency (MHz)	CDMA						1x EvDO	
			SO2		SO9		SO55		Rel. 0	Rel. A
			RC1	RC3	RC1	RC3	RC1	RC3	RTAP	RETAP
BC0	1013	824.7	24.31	24.27	24.29	24.31	24.12	24.37	24.07	24.16
	384	836.52	24.21	24.24	24.21	24.23	24.1	24.25	24.12	24.15
	777	848.31	23.95	24.02	24.08	24.04	23.94	24.03	24.06	24.06
BC1	25	1851.25	24.23	24.28	24.36	24.34	24.31	24.35	24.28	24.13
	600	1880	24.32	24.29	24.36	24.36	24.34	24.31	24.26	24.17
	1175	1908.75	24.29	24.33	24.31	24.33	24.29	24.3	24.13	24.12
BC10*	476	817.9	24.21	24.07	24.16	24.11	24.05	24.05	24.07	24.06
	560	820	23.95	24.0	24.0	23.98	23.94	23.97	23.99	23.97
	684	823.1	23.9	24.02	23.92	24.0	23.99	24.02	24.03	23.99

*Note: Only BC10 Sub-Band 2 and 3 are supported by hardware and firmware

7 Occupied Bandwidth

FCC 2.1049

7.1 Test Procedure

The transmitter output was connected to a spectrum analyzer through a calibrated coaxial cable and a directional coupler. The occupied bandwidth (defined as the 99% Power Bandwidth) was measured with the spectrum analyzer at low, middle, and high frequencies in each band. The -26dB bandwidth was also measured and recorded. Refer to Test Setup 1.

7.2 Test Results

The measurements were performed with the

7.2.1 CDMA Summary Results

Band	Channel	Frequency	Configuration	99% OBW (MHz)	-26 dB OBW (MHz)	Plot No.	
BC0	384	836.52	SO2	RC1	1.284	1.437	7.2.2.1
				RC3	1.274	1.437	7.2.2.2
			1x EvDo	Rel. A	1.289	1.442	7.2.3.1
BC1	600	1880	SO2	RC1	1.274	1.446	7.2.2.3
				RC3	1.279	1.437	7.2.2.4
			1x EvDo	Rel. A	1.279	1.437	7.2.3.2

© 2010 Sierra Wireless, Inc.

The contents of this page are subject to the confidentiality information on page one.

SIERRA WIRELESS, INC.

BC10*	560	820.0	SO2	RC1	1.274	1.437	7.2.2.5
				RC3	1.279	1.442	7.2.2.6
			1x EvDo	Rel. A	1.274	1.456	7.2.3.3

7.2.2 CDMA Test Plots

7.2.2.1 CDMA Occupied Bandwidth, SO2, RC1, BC0 Mid channel, 836.52 MHz, 99% BW

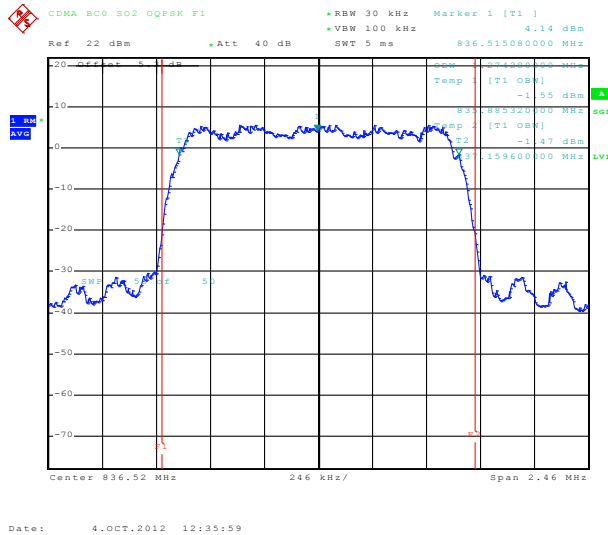

7.2.2.2 CDMA Occupied Bandwidth, SO2, RC3, BC0 Mid channel, 836.52 MHz, 99% BW

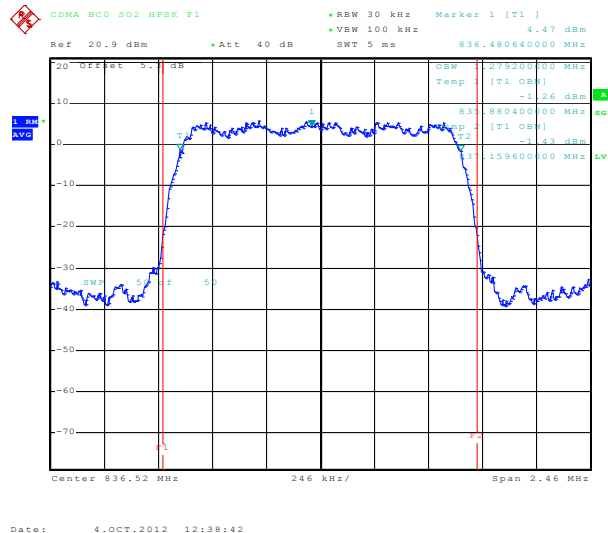

© 2010 Sierra Wireless, Inc.

The contents of this page are subject to the confidentiality information on page one.

SIERRA WIRELESS, INC.

7.2.2.3 CDMA Occupied Bandwidth, SO2, RC1, BC1 Mid channel, 1880.0 MHz, 99% BW

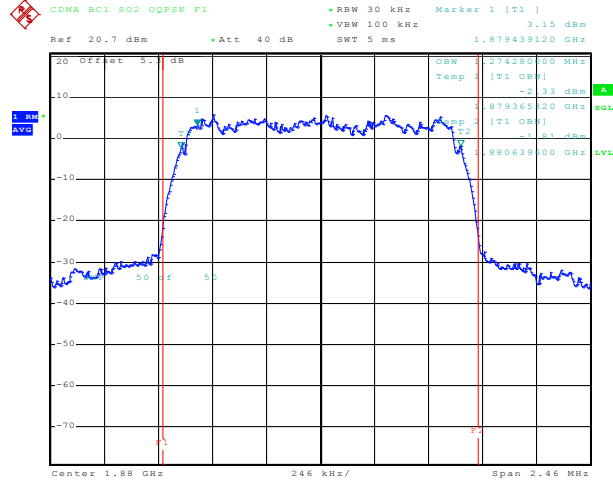

Date: 4.OCT.2012 13:58:32

7.2.2.4 CDMA Occupied Bandwidth, SO2, RC3, BC1 Mid channel, 1880.0 MHz, 99% BW

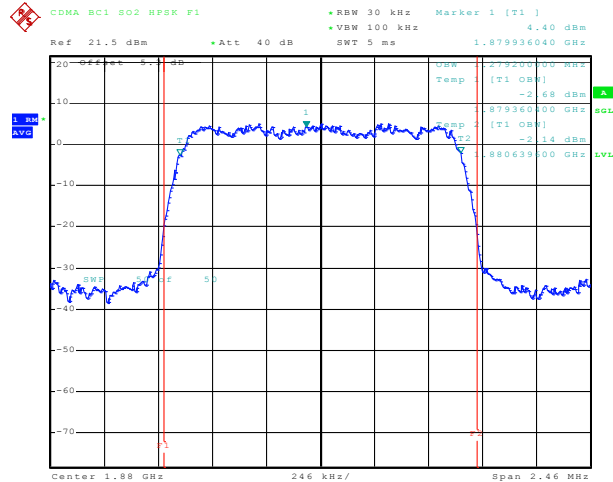

Date: 4.OCT.2012 14:01:14

SIERRA WIRELESS, INC.

7.2.2.5 CDMA Occupied Bandwidth, SO2, RC1, BC10 Mid channel, 820.0 MHz, 99% BW

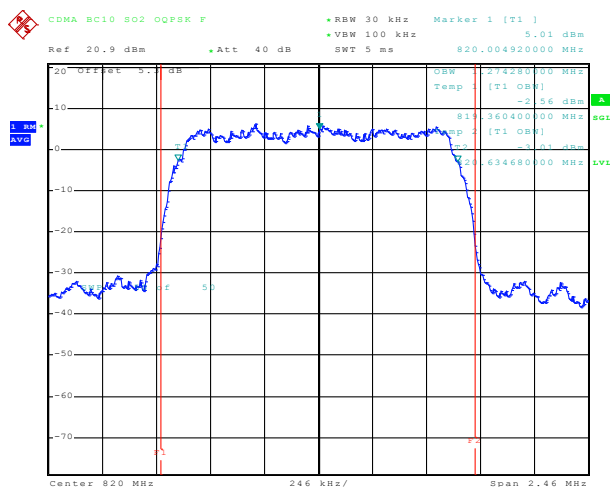

Date: 4.OCT.2012 11:22:58

7.2.2.6 CDMA Occupied Bandwidth, SO2, RC3, BC10 Mid channel, 820.0 MHz, 99% BW

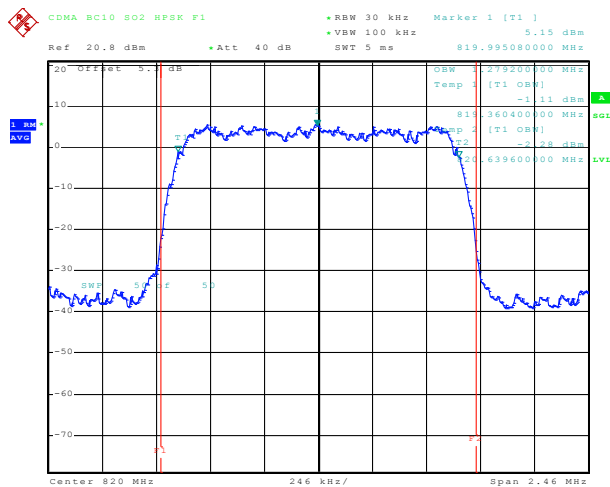

Date: 4.OCT.2012 11:25:46

7.2.3 1x EvDO Test Plots

SIERRA WIRELESS, INC.

7.2.3.1 1x EvDO Occupied Bandwidth, Rel. A, BC0 Mid channel, 836.52 MHz, 99% BW

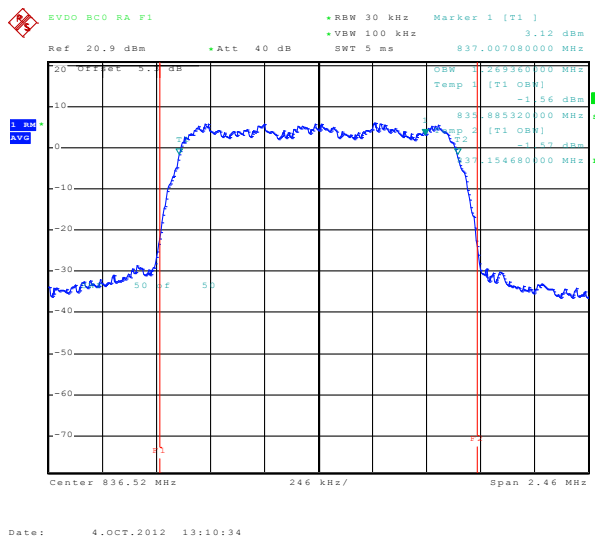

7.2.3.2 1x EvDO Occupied Bandwidth, Rel. A, BC1 Mid channel, 1880.0 MHz, 99% BW

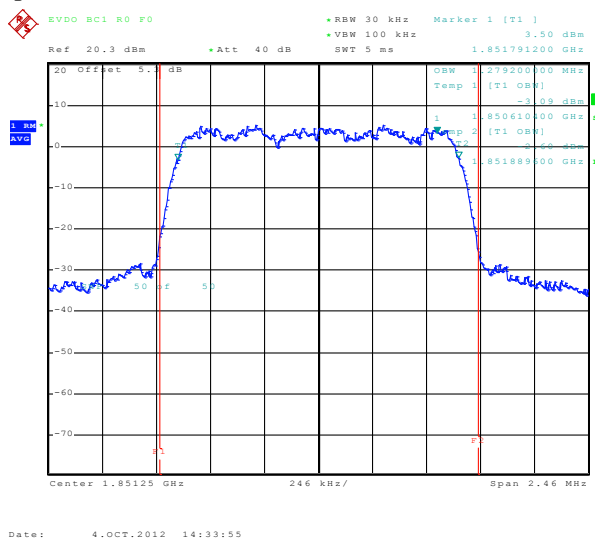

7.2.3.3 1x EvDO Occupied Bandwidth, Rel. A, BC10 Mid channel, 820.0 MHz, 99% BW

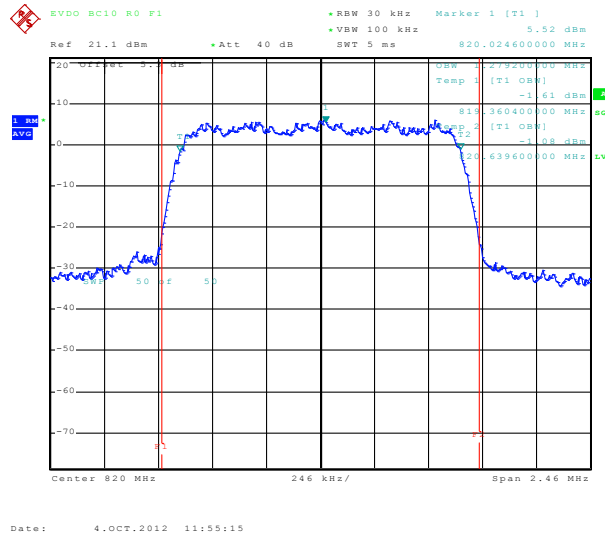

8 Out of Band Emissions at Antenna Terminals

FCC 2.1051, 22.917, 24.238, 90.691(a)

Out of Band Emissions:

The mean power of emissions must be attenuated below the mean power of the unmodulated carrier (P) on any frequency outside the frequency band by at least $(43 + 10 \log P)$ dB. The out of band emission limit translates to a worst case absolute limit of -13dBm in this case.

8.1 Test Procedure

The RF output of the transmitter was connected to a spectrum analyzer through a calibrated coaxial cable. Sufficient scans were taken to show the out-of-band emissions, if any, up to 10th harmonic. The EUT was scanned for spurious emissions from 1MHz to 20GHz with sufficient bandwidth and video resolution. Data plots are included. Multiple sweeps were recorded in maximum hold mode using a peak detector to ensure that the worst-case emissions were captured. Refer to Test Setup 2.

8.2 Test Results

Band	Channel	Frequency	Configuration	Plot No.	Status
BC0	384	836.52	SO2	8.2.1.1, 8.2.1.2	PASS
			1x EvDo	8.2.2.1, 8.2.2.2	PASS
BC1	600	1880	SO2	8.2.1.3 – 8.2.1.5	PASS
			1x EvDo	8.2.2.3 – 8.2.2.5	PASS
BC10	560	820	SO2	8.2.1.6, 8.2.1.7	PASS
			1x EvDo	8.2.2.6, 8.2.2.7	PASS

The plots below show that the conducted emission limits requirements are met.

8.2.1 CDMA Test Plots

8.2.1.1 Out of Band Emissions at Antenna Terminals CDMA BC0, Mid channel, 836.52 MHz, 2 Hz to 1 GHz

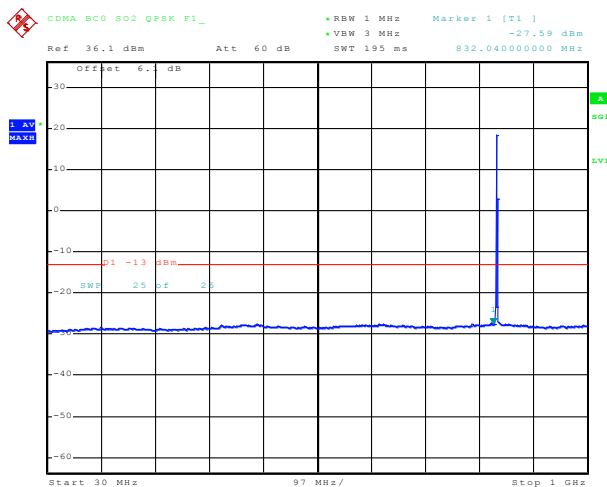

Date: 4.OCT.2012 12:07:30

Note: The strong emission shown in each case is the carrier signal.

8.2.1.2 Out of Band Emissions at Antenna Terminals CDMA BC0, Mid channel, 836.52 MHz, 1 GHz to 10 GHz

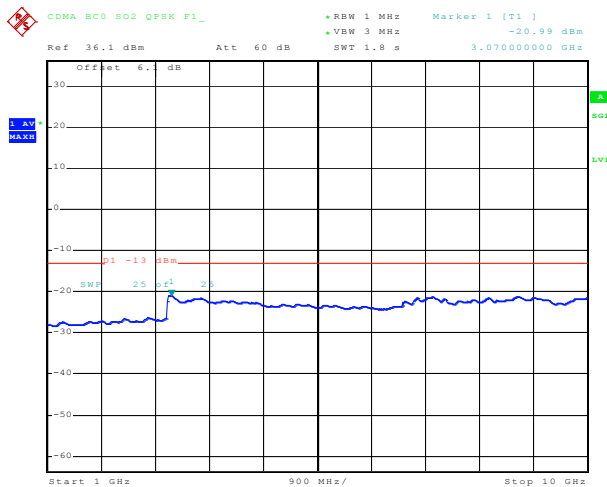

Date: 4.OCT.2012 12:08:41

SIERRA WIRELESS, INC.

8.2.1.3 Out of Band Emissions at Antenna Terminals CDMA BC1, Mid channel, 1880.0 MHz, 2 Hz to 1 GHz

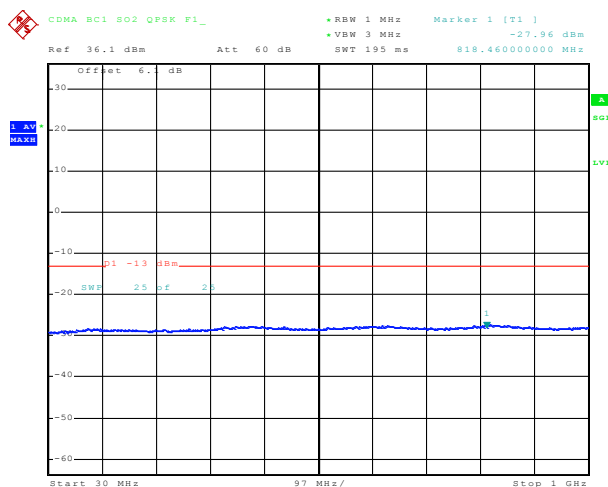

Date: 4.OCT.2012 13:21:17

8.2.1.4 Out of Band Emissions at Antenna Terminals CDMA BC1, Mid channel, 1880.0 MHz, 1 GHz to 10 GHz

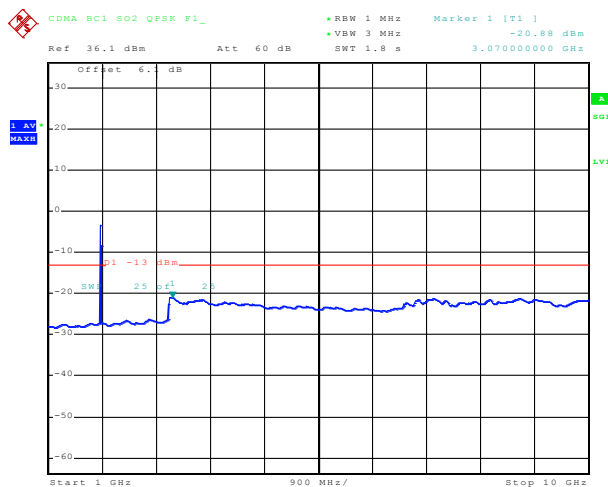

Date: 4.OCT.2012 13:22:28

Note: The strong emission shown in each case is the carrier signal.

SIERRA WIRELESS, INC.

8.2.1.5 Out of Band Emissions at Antenna Terminals CDMA BC1, Mid channel, 1880.0 MHz, 10 GHz to 20 GHz

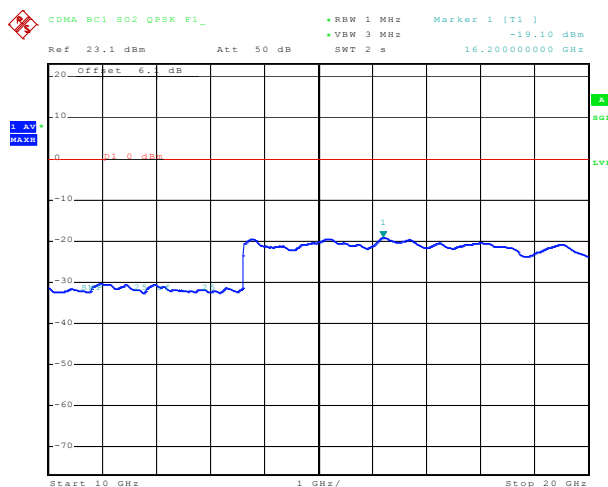

Date: 4.OCT.2012 13:23:36

8.2.1.6 Out of Band Emissions at Antenna Terminals CDMA BC10, Mid channel, 820.0 MHz, 2 Hz to 1 GHz

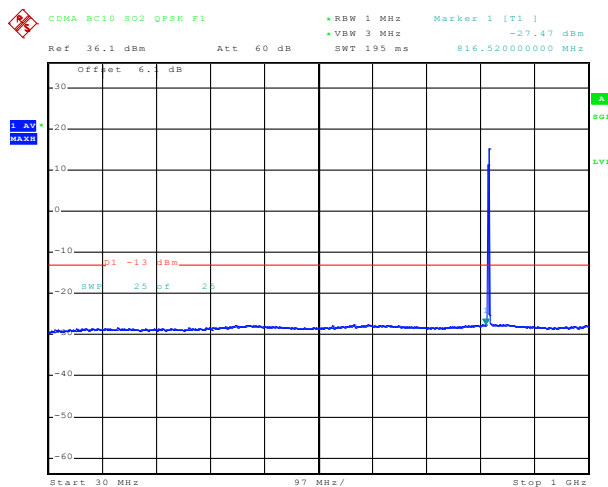

Date: 4.OCT.2012 10:54:28

Note: The strong emission shown in each case is the carrier signal.

SIERRA WIRELESS, INC.

8.2.1.7 Out of Band Emissions at Antenna Terminals CDMA BC10, Mid channel, 820.0 MHz, 1 GHz to 10 GHz

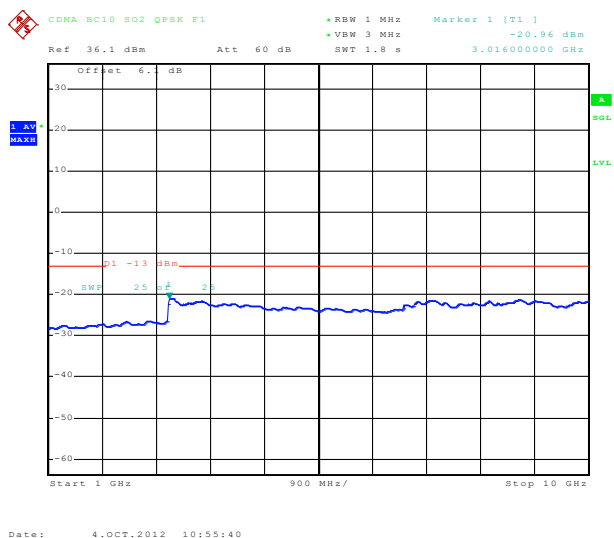

8.2.2 EVDO Rel. A Test Plots

8.2.2.1 Out of Band Emissions at Antenna Terminals 1x EvDO BC0, Mid channel, 836.52 MHz, 2 Hz to 1 GHz

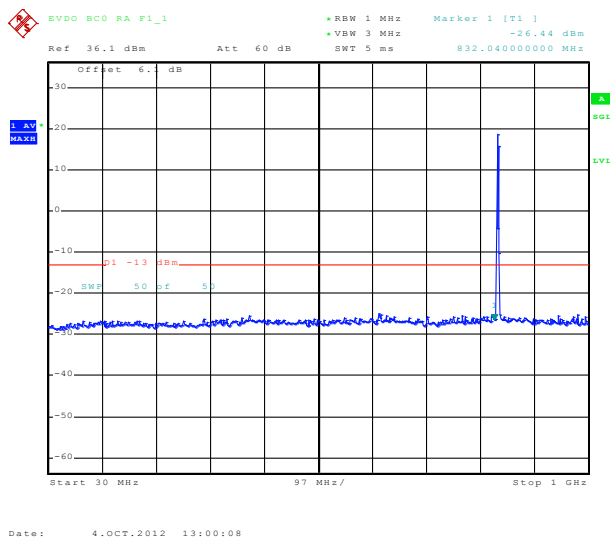

Note: The strong emission shown in each case is the carrier signal.

SIERRA WIRELESS, INC.

8.2.2.2 Out of Band Emissions at Antenna Terminals 1x EvDO BC0, Mid channel, 836.52 MHz, 1 GHz to 10 GHz

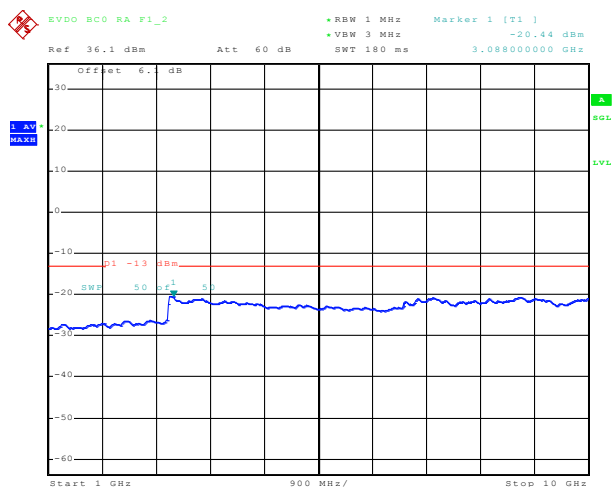

Date: 4.OCT.2012 13:00:56

8.2.2.3 Out of Band Emissions at Antenna Terminals 1x EvDO BC1, Mid channel, 1880.0 MHz, 2 Hz to 1 GHz

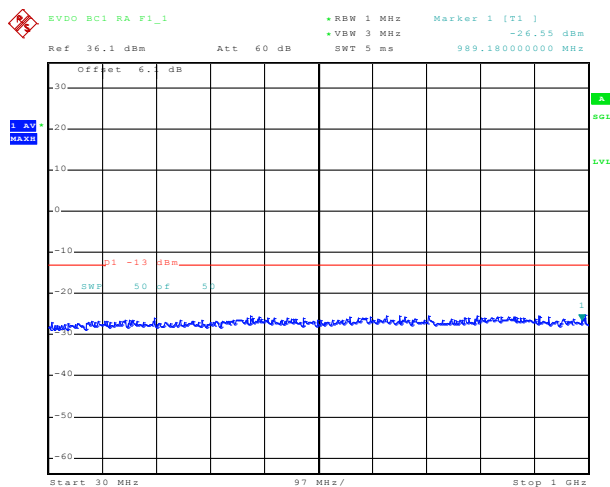

Date: 4.OCT.2012 14:25:32

SIERRA WIRELESS, INC.

8.2.2.4 Out of Band Emissions at Antenna Terminals 1x EvDO BC1, Mid channel, 1880.0 MHz, 1 GHz to 10 GHz

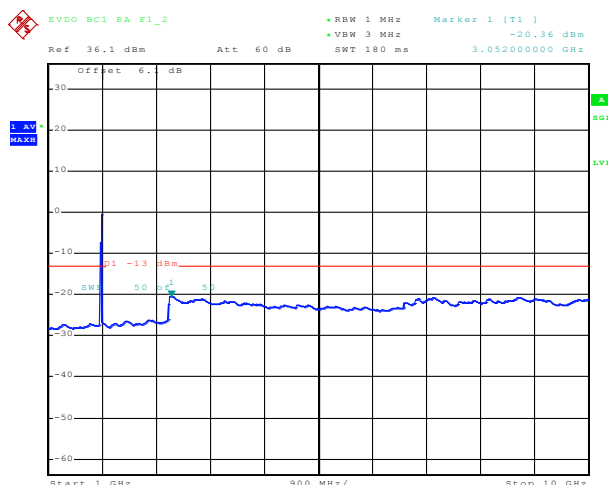

Date: 4.OCT.2012 14:26:20

Note: The strong emission shown in each case is the carrier signal.

8.2.2.5 Out of Band Emissions at Antenna Terminals 1x EvDO BC1, Mid channel, 1880.0 MHz, 10 GHz to 20 GHz

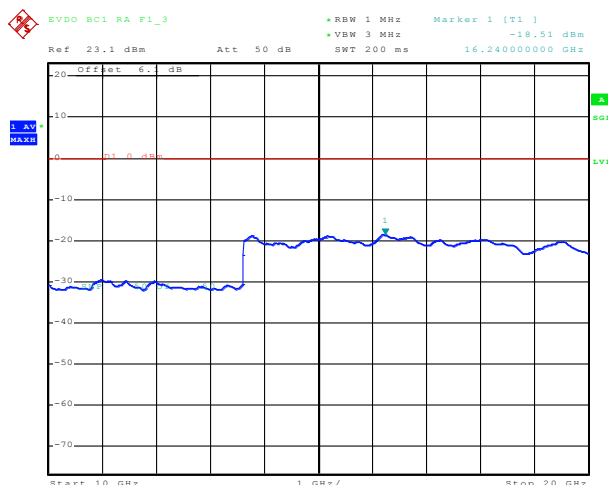

Date: 4.OCT.2012 14:26:55

8.2.2.6 *Out of Band Emissions at Antenna Terminals 1x EvDO BC10, Mid channel, 820.0 MHz, 2 Hz to 1 GHz*

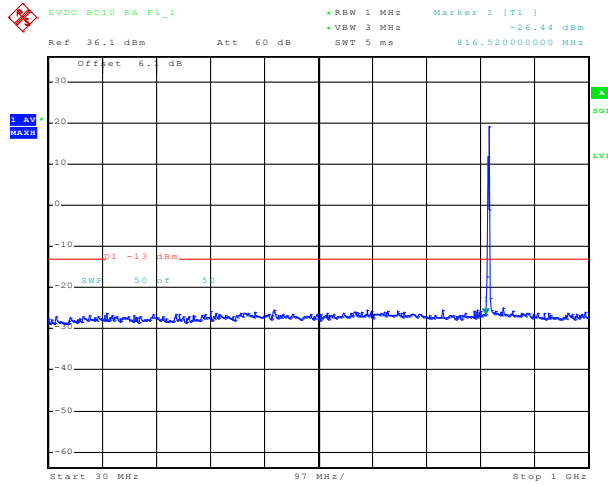

Date: 4.OCT.2012 11:47:28

Note: The strong emission shown in each case is the carrier signal.

8.2.2.7 *Out of Band Emissions at Antenna Terminals 1x EvDO BC10, Mid channel, 820.0 MHz, 1 GHz to 10 GHz*

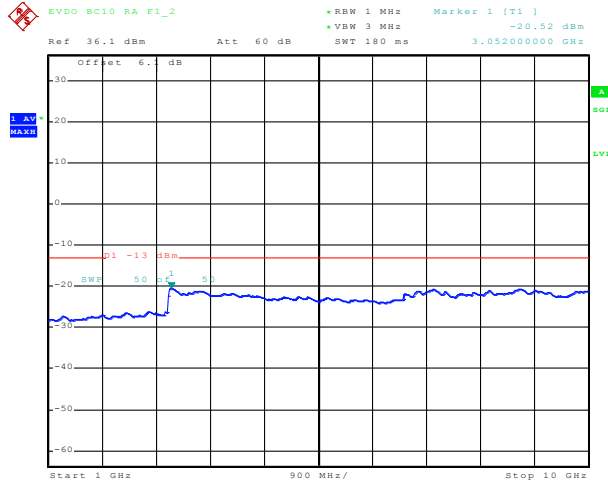

Date: 4.OCT.2012 11:48:16

9 Block Edge Compliance

FCC Part 2.1051, 22.917, 24.238, 90.691(a)

9.1 Test Procedure

The transmitter output was connected to a Rohde & Schwarz CMU200 Test Set (or CMW500 for LTE), through a coaxial RF cable and a directional coupler, and configured to operate at maximum power. The block edge emissions were measured at the required operating frequencies in each band on the Spectrum Analyzer. Refer to Test Setup 1.

© 2010 Sierra Wireless, Inc.

The contents of this page are subject to the confidentiality information on page one.

SIERRA WIRELESS, INC.

FCC Part 22/24/90, RSS-132/133	EM7355	Feb. 05, 2013	Page 21 of 35
--------------------------------	--------	---------------	---------------

The resolution bandwidth was set to at least 1% of the emission bandwidth (where applicable). The power was scaled accordingly:

$$\text{Power offset} = 10 * \log(\text{FCC_RBW} / \text{Measurement_RBW})$$

9.2 Test Results

Block Test	Band	Frequency Boundaries (MHz)	Channels Tested	Channel Frequency (MHz)	Configuration	Corresponding Plots	Result
CDMA	BC0	Below 824 MHz, above 849 MHz	128, 251	824.7, 848.31	RC1 (OQPSK)	9.2.1.1, 9.2.1.2	Complies
					RC3 (HPSK)	9.2.1.3, 9.2.1.4	
	BC1	Below 1850MHz, above 1910MHz	512, 810	1851.25, 1908.75	RC1 (OQPSK)	9.2.1.5, 9.2.1.6	Complies
					RC3 (HPSK)	9.2.1.7, 9.2.1.8	
	BC10*	Below 817MHz, above 824MHz	457, 684	817.90, 823.10	RC1 (OQPSK)	9.2.1.9, 9.2.1.10	Complies
					RC3 (HPSK)	9.2.1.11, 9.2.1.12	
1x EvDO	BC0	Below 824 MHz, above 849 MHz	128, 251	824.7, 848.31	Rel. A	9.2.2.1, 9.2.2.2	Complies
	BC1	Below 1850MHz, above 1910MHz	512, 810	1851.25, 1908.75	Rel. A	9.2.2.3, 9.2.2.4	Complies
	BC10*	Below 817MHz, above 824MHz	457, 684	817.90, 823.10	Rel. A	9.2.2.5, 9.2.2.6	Complies

*Note: Only BC10 Sub-Band 2 and 3 are supported by hardware and firmware

SIERRA WIRELESS, INC.

9.2.1 CDMA Test Plots

9.2.1.1 CDMA BC0, RC1, low channel, below 824 MHz

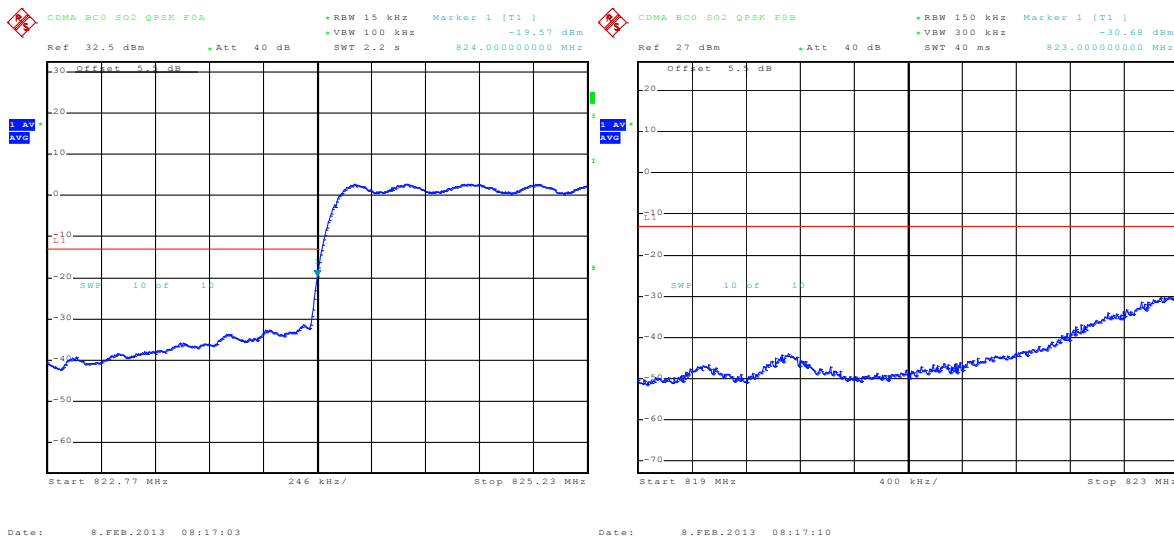

9.2.1.2 CDMA BC0, RC1, high channel, above 849 MHz

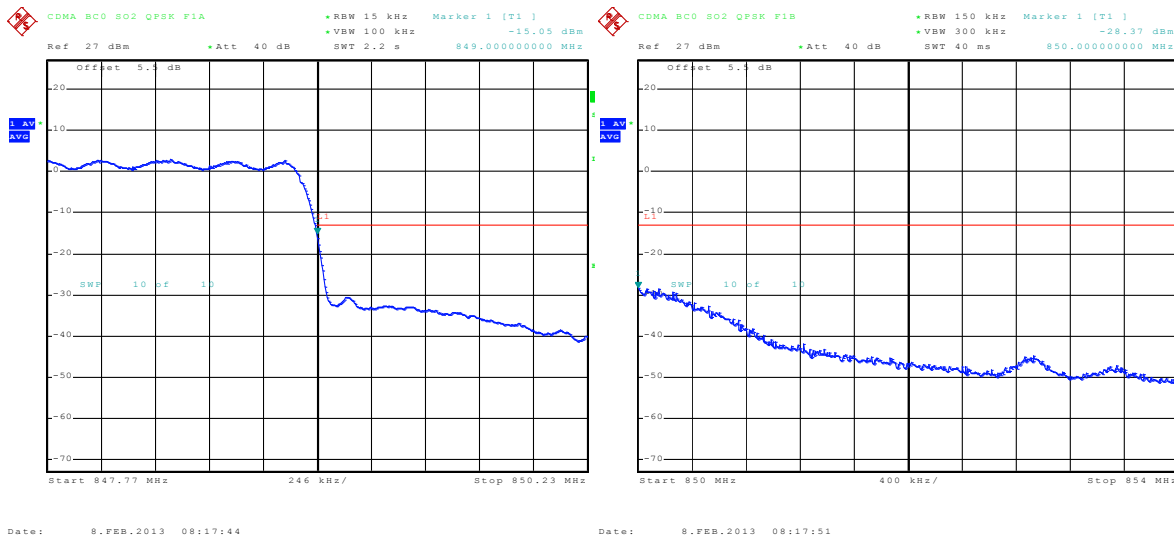

SIERRA WIRELESS, INC.

9.2.1.3 CDMA BC0, RC3, low channel, below 824 MHz

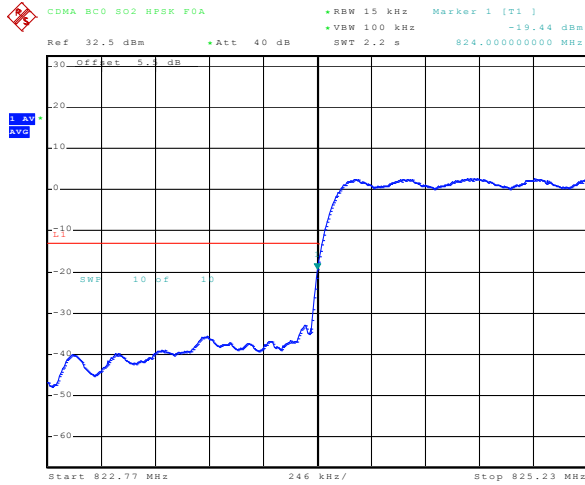

Date: 7.FEB.2013 18:28:31

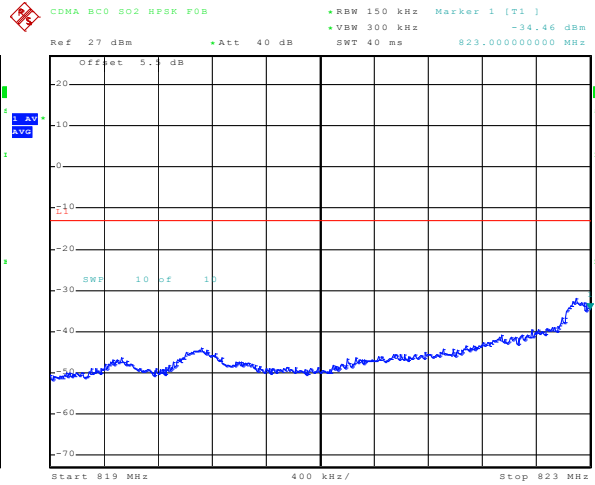

Date: 7.FEB.2013 18:28:38

9.2.1.4 CDMA BC0, RC3, high channel, above 849 MHz

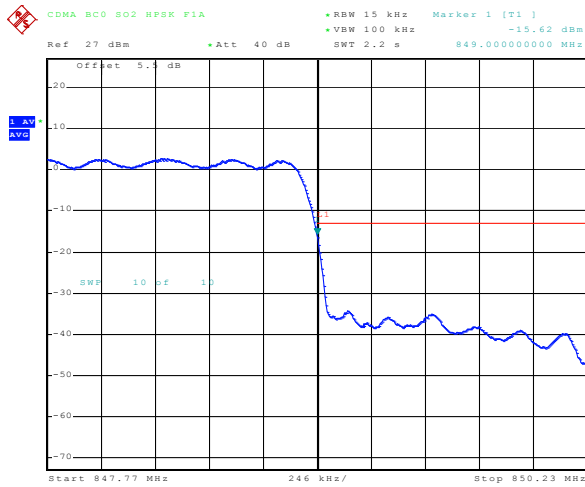

Date: 7.FEB.2013 18:29:12

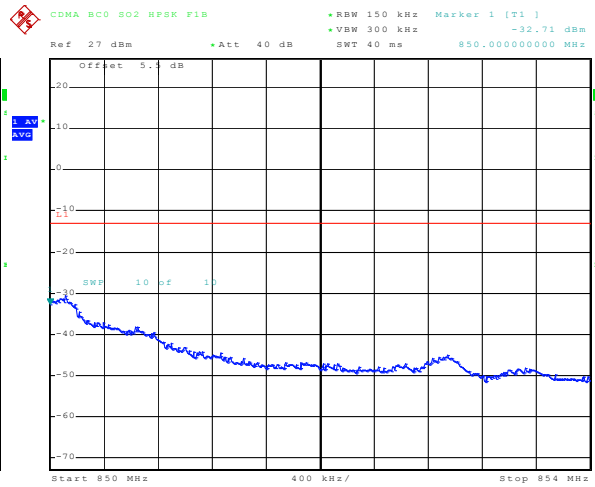

Date: 7.FEB.2013 18:29:19

SIERRA WIRELESS, INC.

9.2.1.5 CDMA BC1, RC1, low channel, below 1850 MHz

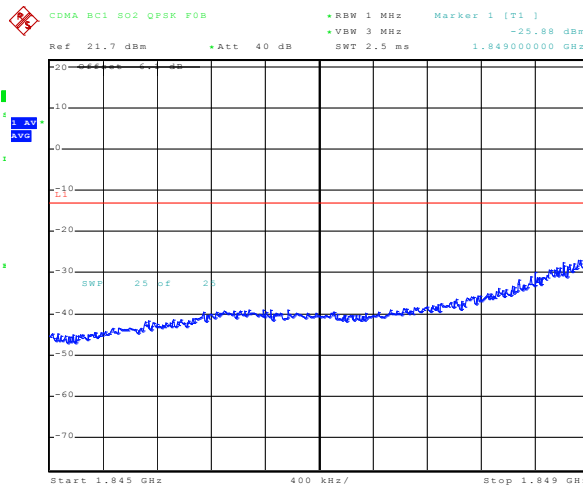
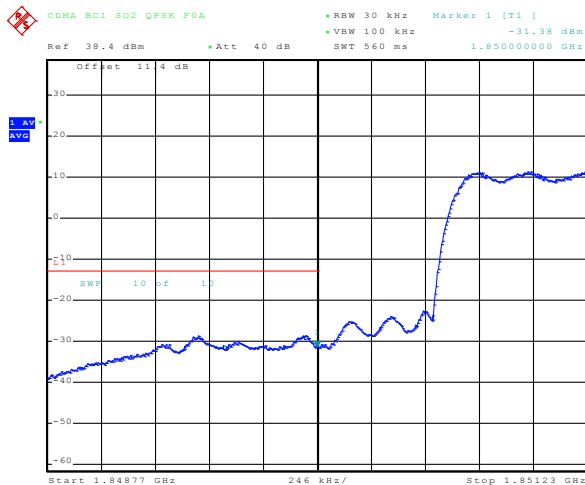

Date: 8.FEB.2013 09:51:11

Date: 8.FEB.2013 09:51:19

9.2.1.6 CDMA BC1, RC1, high channel, above 1910 MHz

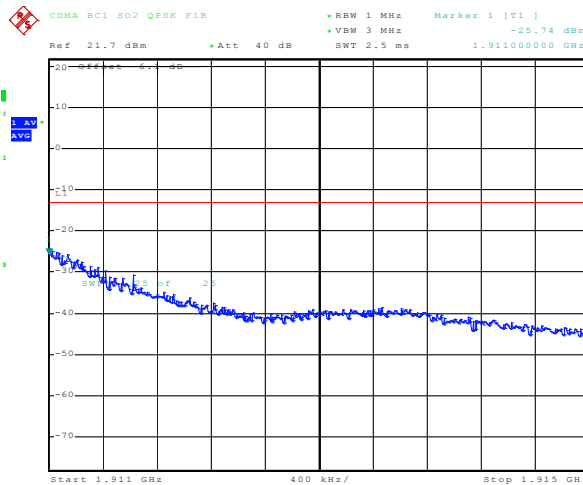
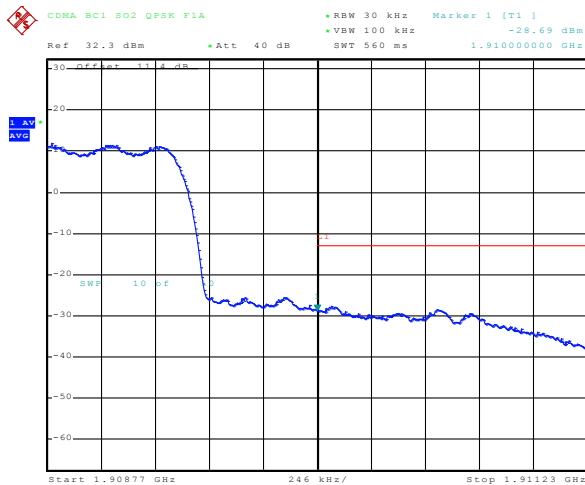

Date: 8.FEB.2013 09:51:36

Date: 8.FEB.2013 09:51:43

SIERRA WIRELESS, INC.

9.2.1.7 CDMA BC1,RC3, low channel, below 1850 MHz

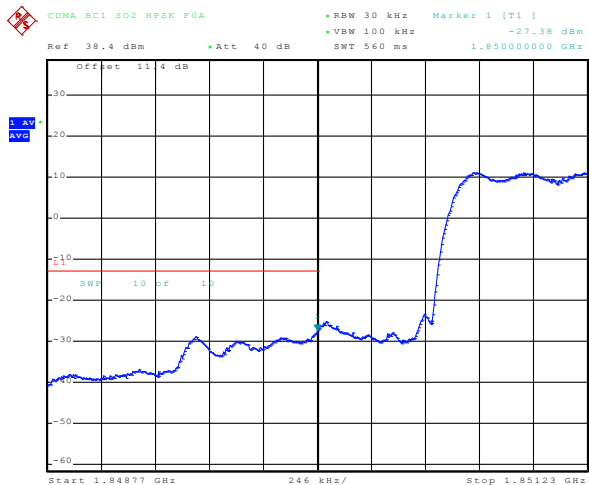

Date: 8.FEB.2013 09:53:14

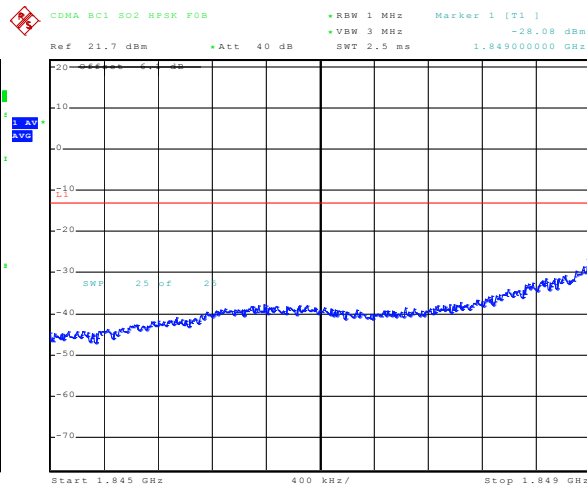

Date: 8.FEB.2013 09:53:22

9.2.1.8 CDMA BC1, RC3, high channel, above 1910 MHz

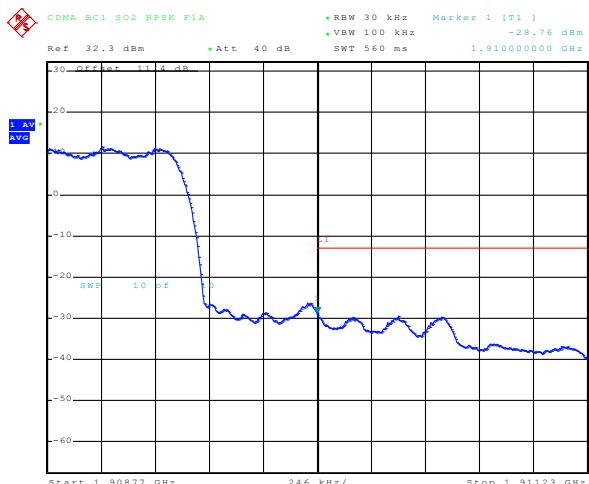

Date: 8.FEB.2013 09:53:39

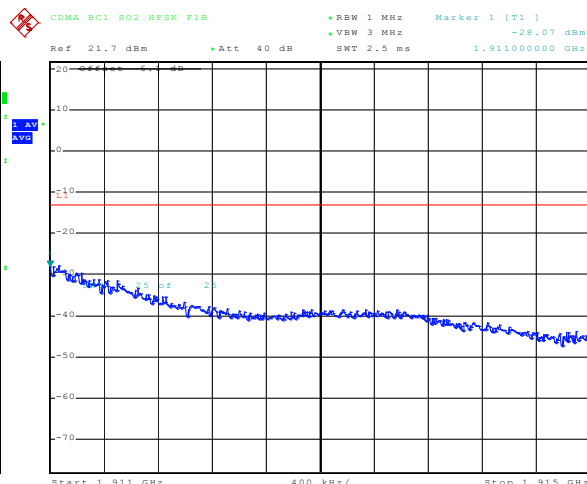

Date: 8.FEB.2013 09:53:46

SIERRA WIRELESS, INC.

9.2.1.9 CDMA BC10, RC1, low channel, below 817 MHz (90.691 a(1),a(2))

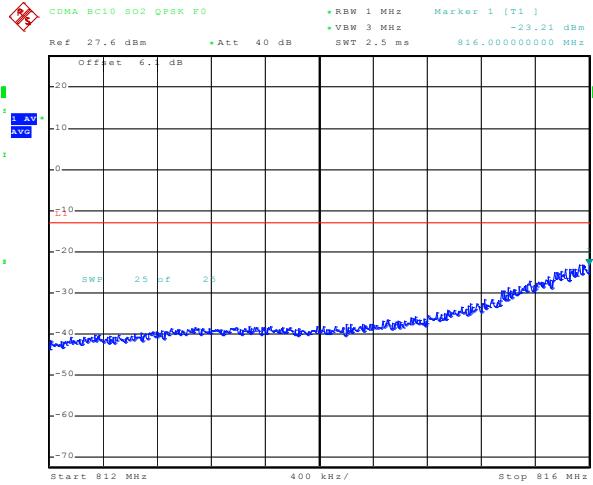
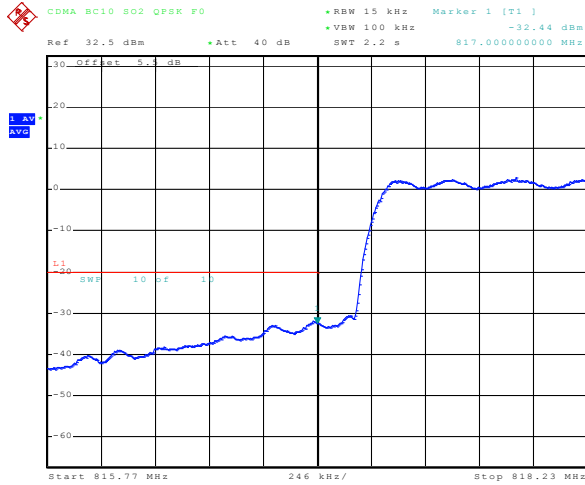

Date: 7.FEB.2013 18:36:19

Date: 7.FEB.2013 18:36:27

9.2.1.10 CDMA BC10, RC1, high channel, above 824 MHz (90.691 a(1),a(2))

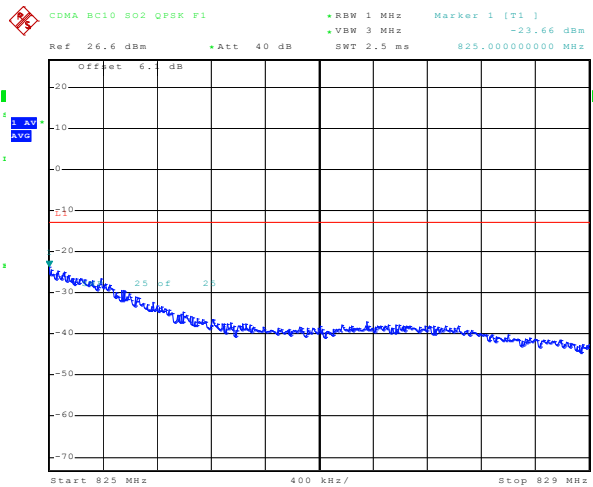
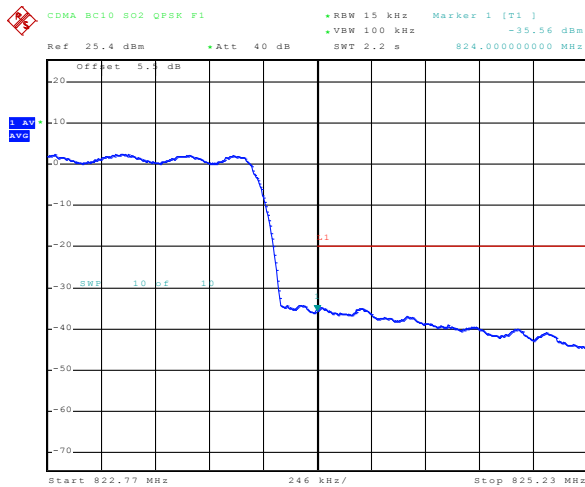

Date: 7.FEB.2013 18:37:00

Date: 7.FEB.2013 18:37:08

SIERRA WIRELESS, INC.

9.2.1.11 CDMA BC10, RC3, low channel, below 817 MHz(90.691 a(1),a(2))

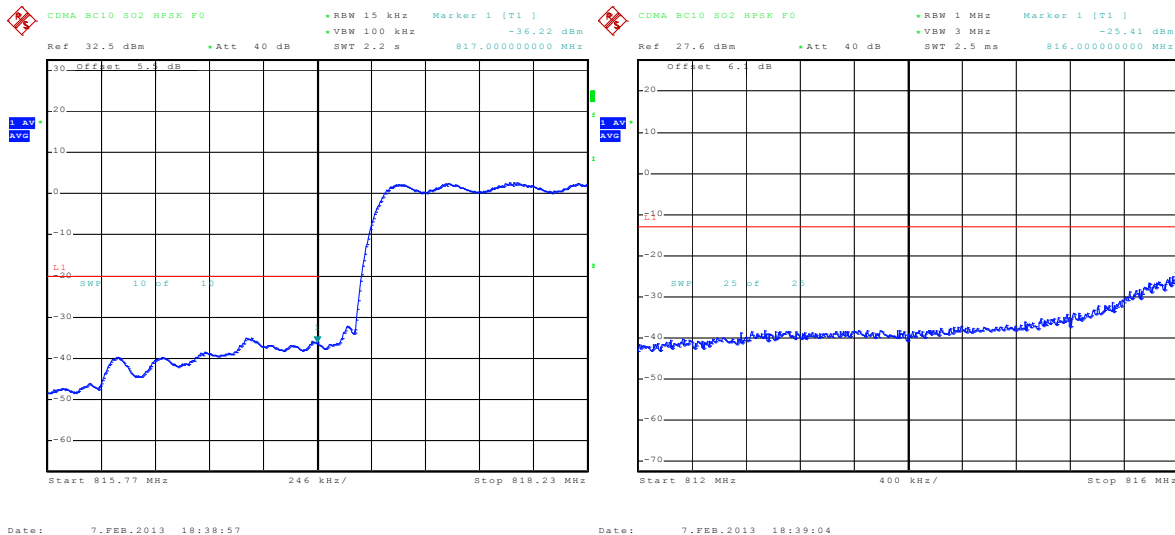

9.2.1.12 CDMA BC10, RC3, high channel, above 824 MHz(90.691 a(1),a(2))

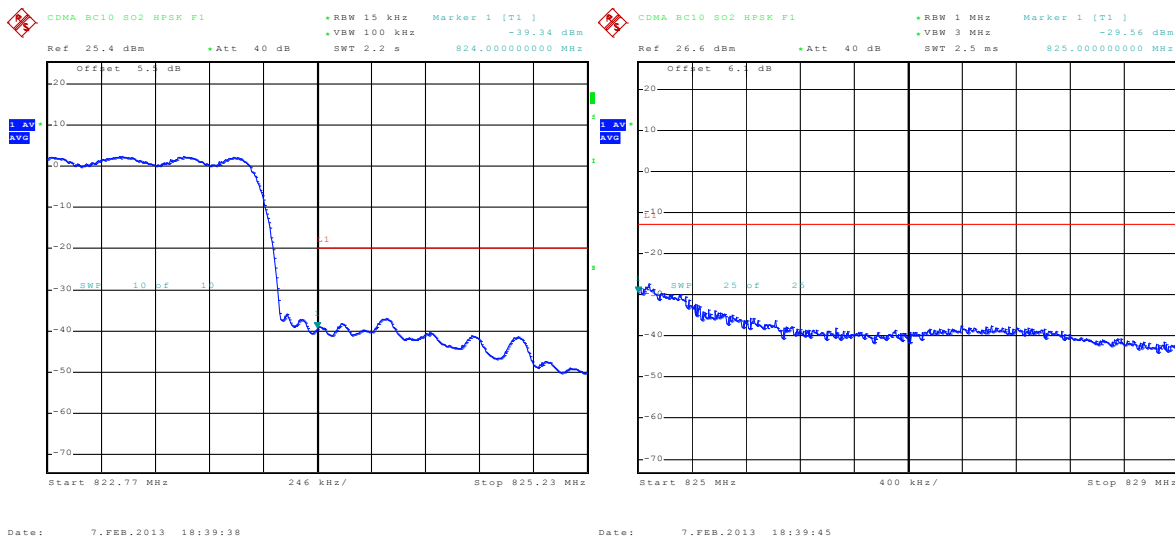

SIERRA WIRELESS, INC.

9.2.2 1x EvDO Test Plots

9.2.2.1 1x EvDO BC0, Rel. A, low channel, below 824 MHz

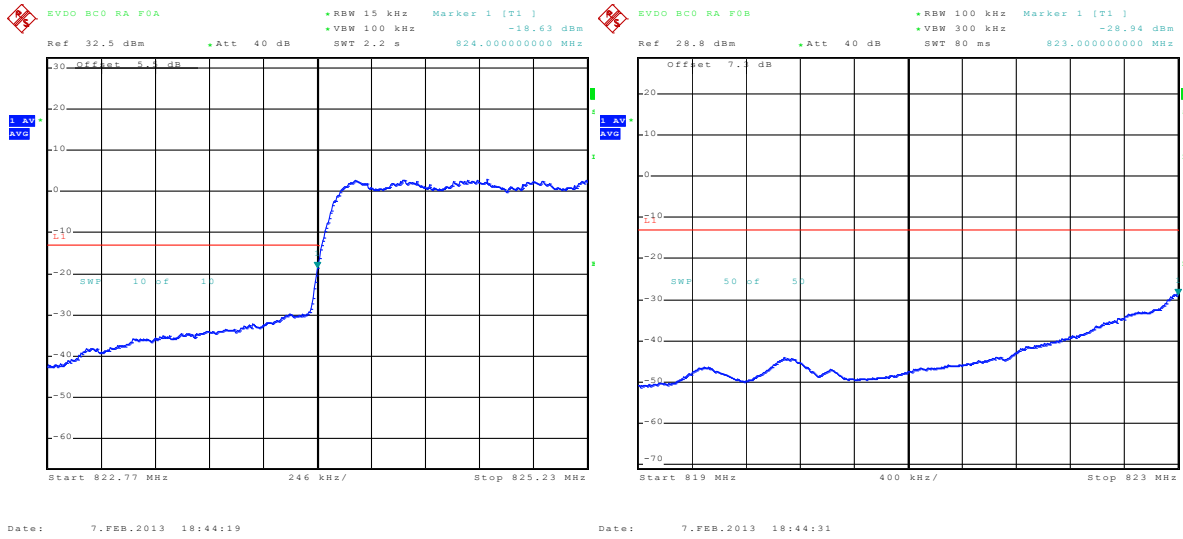

9.2.2.2 1x EvDO BC0, Rel. A, high channel, above 849 MHz

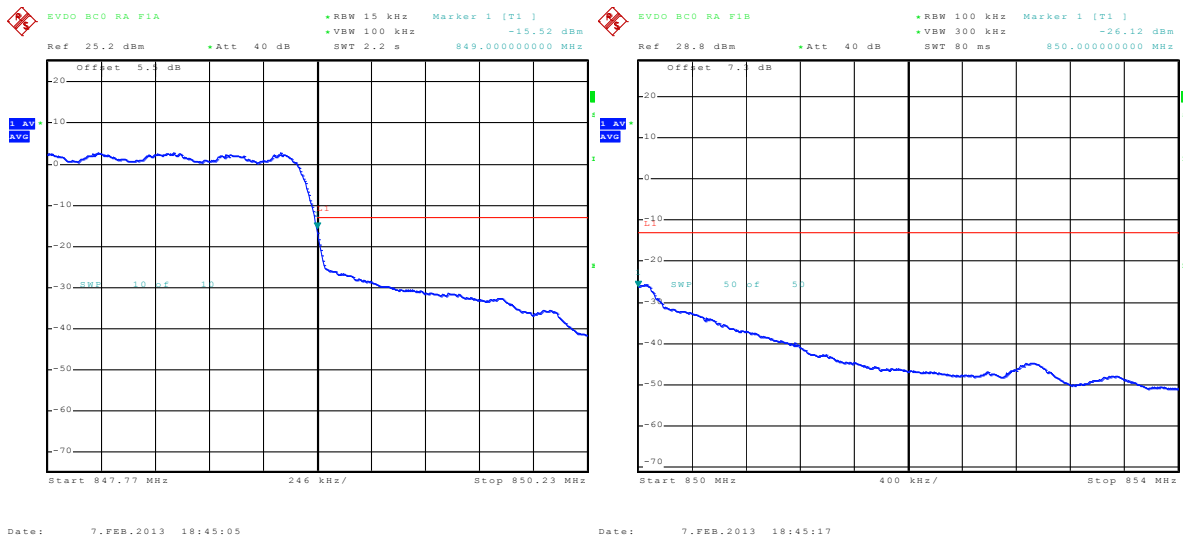

SIERRA WIRELESS, INC.

9.2.2.3 1x EvDO BC1, Rel. A, low channel, below 1850 MHz

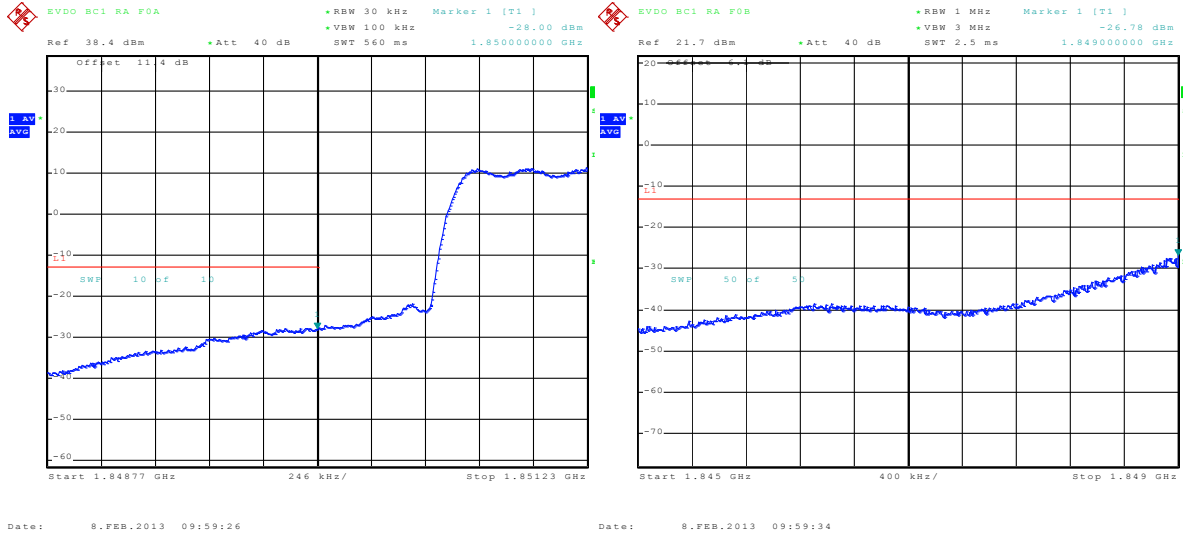

9.2.2.4 1x EvDO BC1, Rel. A, high channel, above 1910 MHz

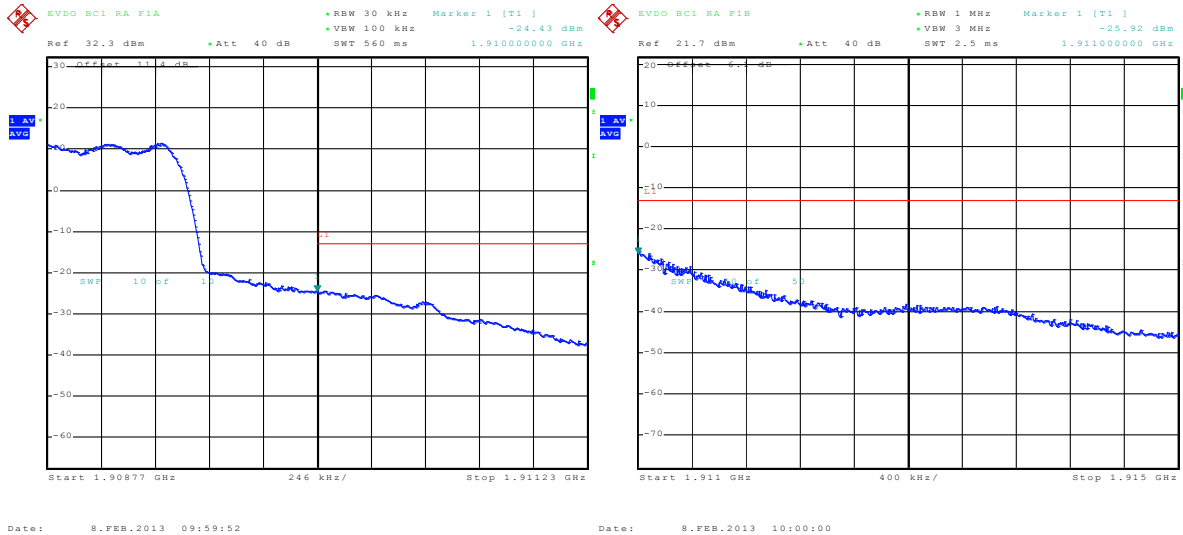

SIERRA WIRELESS, INC.

9.2.2.5 1x EvDO BC10, Rel. A, low channel, below 817 MHz (90.691 a(1),a(2))

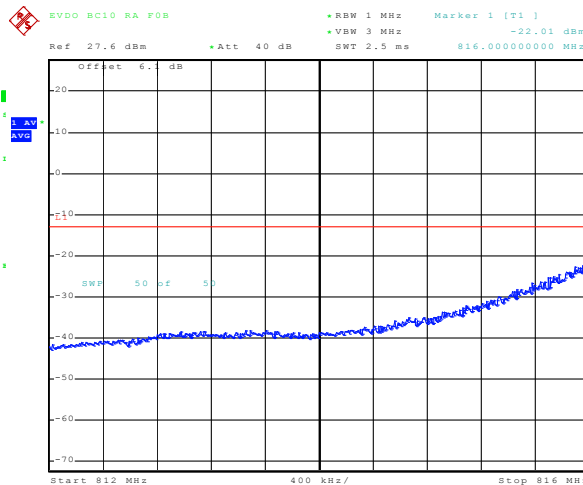
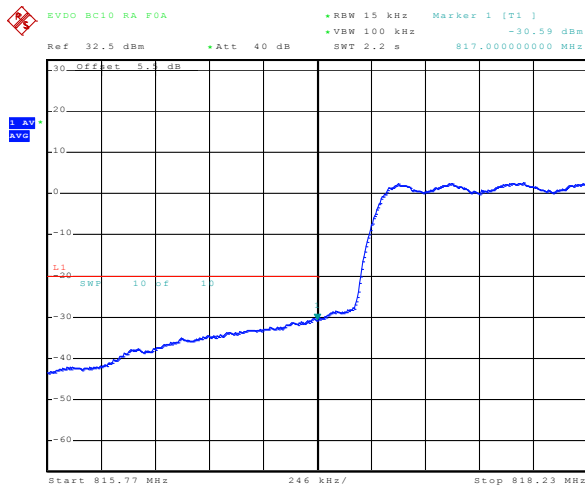

Date: 7.FEB.2013 18:55:03

Date: 7.FEB.2013 18:55:11

9.2.2.6 1x EvDO BC10, Rel. A, high channel, above 824 MHz (90.691 a(1),a(2))

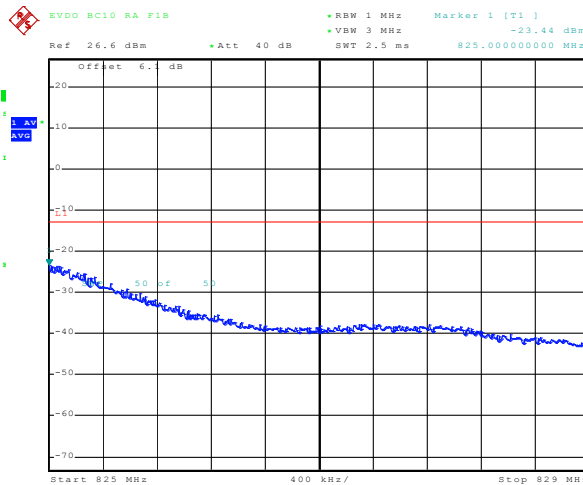
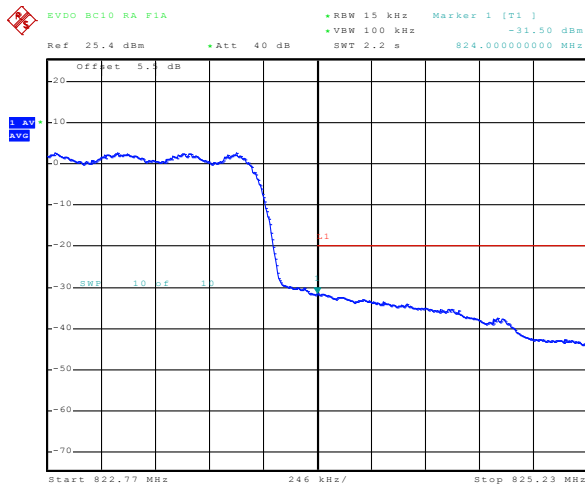

Date: 7.FEB.2013 18:55:45

Date: 7.FEB.2013 18:55:54

10 Frequency Stability versus Temperature

FCC 2.1055, FCC 22.355, FCC 24.235, FCC 90.213

SIERRA WIRELESS, INC.

10.1 Summary of Results

The EUT's Frequency Stability versus temperature meets the requirements of less than 2.5ppm when temperature varies from -30°C to +50°C.

10.2 Test Procedure

The EUT was placed inside a temperature chamber. The temperature was set to -30°C and maintained to stabilize. After sufficient soak time, the transmitting frequency error was measured. The temperature was then increased by 10 degrees, maintained to stabilize, and the measurement was repeated. This procedure was repeated until +50°C is reached. Frequency metering included internal averaging of the to stabilize the reading. Reference power supply voltage for these tests is 3.7 volts. Refer to Test Setup 2.

10.3 Test Results

10.3.1 CDMA Frequency Error over Temperature

Temp (°C)	CDMA Mode					
	BC0		BC1		BC10	
	Offset (Hz)	Offset (ppm)	Offset (Hz)	Offset (ppm)	Offset (Hz)	Offset (ppm)
-30	1.5	0.0018	5.1	0.0027	1.9	0.0023
-20	-23.8	-0.0289	3.8	0.0020	0.1	0.0001
-10	-53.8	-0.0652	3.0	0.0016	-38.3	-0.0458
0	-45.4	-0.0551	-19.4	-0.0103	-3.5	-0.0042
10	-36.6	-0.0444	-25.1	-0.0134	-18.3	-0.0219
20	-38.6	-0.0468	3.6	0.0019	-3.3	-0.0039
30	-3.4	-0.0041	-10.6	-0.0056	-10.9	-0.0130
40	-3.5	-0.0043	-10.3	-0.0055	-2.2	-0.0026
50	-3.2	-0.0039	-19.2	-0.0102	-2.1	-0.0024

11 Frequency Stability versus Voltage

FCC 2.1055, FCC 22.355, FCC 24.235, FCC 90.213

11.1 Summary of Results

The EUT is specified to operate with a supply voltage varying between 3.0 VDC and 4.2 VDC, having a nominal voltage of 3.7 VDC. It meets the frequency stability limit of less than 2.5ppm when supply voltage varies within the specified limits. Operation above or below these voltage limits is prohibited by firmware in order to prevent improper operation.

SIERRA WIRELESS, INC.

11.2 Test Procedure

The EUT was connected to a DC Power Supply and a CDMA test set (CMW500) with frequency error measurement capability. The power supply output was adjusted to the test voltage as measured at the input terminals to the device while transmitting. A voltmeter was used to confirm the terminal voltage. The peak frequency error is recorded (worst case). The test voltages are 3.0 volts to 4.2 volts. Refer to Test Setup 2.

11.3 Test Results

11.3.1 CDMA Frequency Error over Voltage

Voltage (V)	CDMA Mode					
	BC0		BC1		BC10	
	Offset (Hz)	Offset (ppm)	Offset (Hz)	Offset (ppm)	Offset (Hz)	Offset (ppm)
3	-22.49	-0.0273	-5.71	-0.0030	2.05	0.0024
3.7	-8.5	-0.0103	2.86	0.0015	-33.18	-0.0396
4.2	-16.11	-0.0196	3.08	0.0016	-1.32	-0.0016

12 Peak to Average Ratio

FCC 24.232

12.1 Summary of Results

The EUT meets the requirement of having a peak to average ratio of less than 13dB.

12.2 Test Procedure

The transmitter output was connected to a Rohde & Schwarz CMW500 through a coaxial RF cable and directional coupler, and configured to operate at maximum power. The peak to average ratio was measured at the required operating frequencies in each band on the Spectrum Analyzer. Refer to Test Setup 1.

12.3 Test Results

Band	Frequency (MHz)	Channel	Modulation	Plots	Peak to Average Ratio (dB)
BC0	836.52	384	RC1 (OQPSK)	12.3.1.1	4.32
			RC3 (HPSK)	12.3.1.2	3.88
BC1	836.52	600	RC1 (OQPSK)	12.3.1.3	4.26

SIERRA WIRELESS, INC.

			RC3 (HPSK)	12.3.1.4	3.86
BC10	836.52	560	RC1 (OQPSK)	12.3.1.5	4.12
			RC3 (HPSK)	12.3.1.6	3.66

12.3.1 Test Plots

12.3.1.1 CDMA BC0, peak to average ratio, RC1, Mid channel, 836.52 MHz

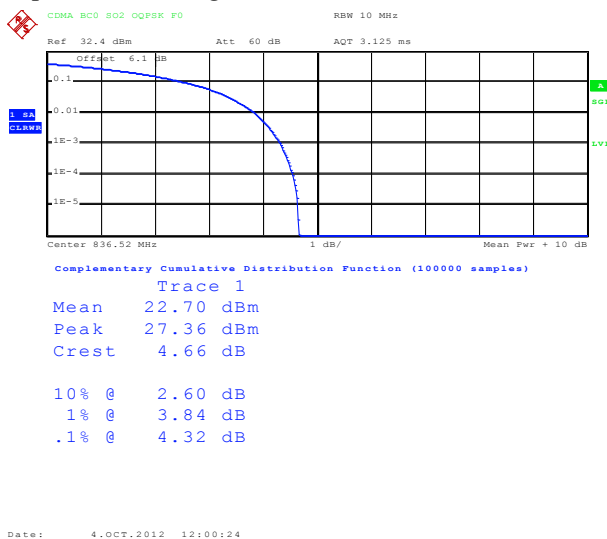

12.3.1.2 CDMA BC0, peak to average ratio, RC3, Mid channel, 836.52 MHz

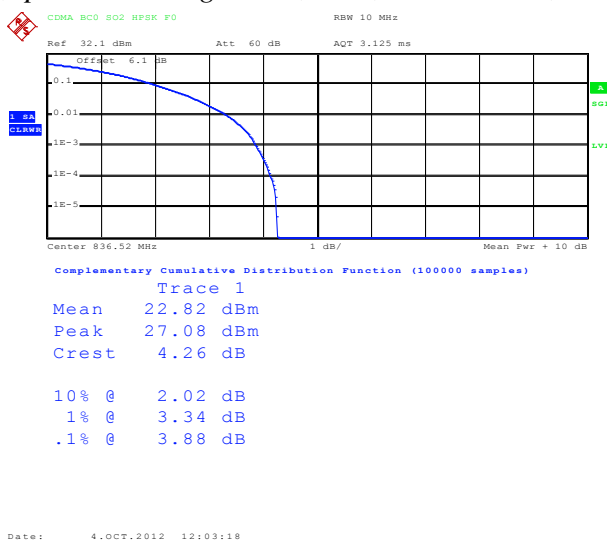

12.3.1.3 CDMA BC1, peak to average ratio, RC1, Mid channel, 1880.0MHz

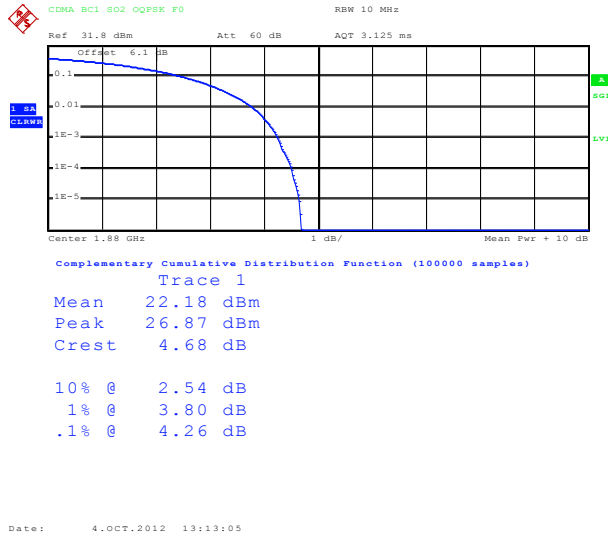

12.3.1.4 CDMA BC1, peak to average ratio, RC3, Mid channel, 1880.0 MHz

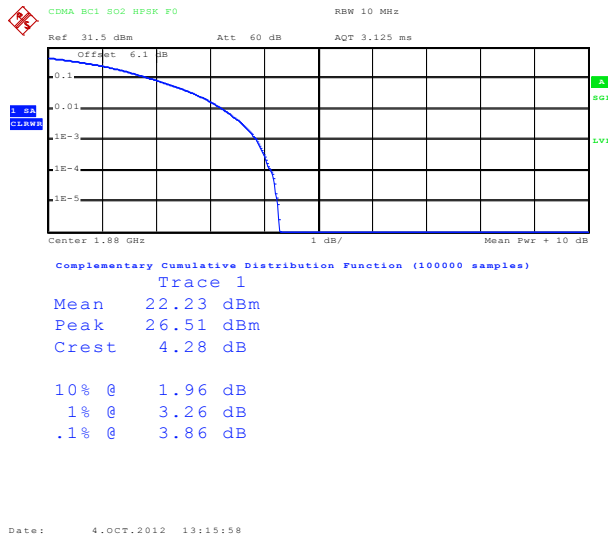

12.3.1.5 CDMA BC10, peak to average ratio, RC1, Mid channel, 820.0 MHz

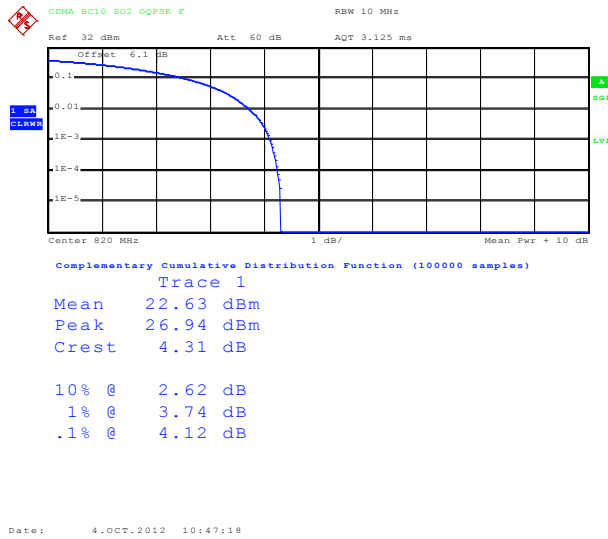

12.3.1.6 CDMA BC10, peak to average ratio, RC3, Mid channel, 820.0 MHz

