



FCC RF Test Report

APPLICANT : Zebra Technologies Corporation
EQUIPMENT : Enterprise Tablet
BRAND NAME : Zebra
MODEL NAME : ET55BT
FCC ID : UZ7ET55BT
STANDARD : FCC Part 15 Subpart C §15.247
CLASSIFICATION : (DTS) Digital Transmission System

The product was received on Jun. 01, 2016 and testing was completed on Jul. 15, 2016. We, SPORTON INTERNATIONAL INC., would like to declare that the tested sample has been evaluated in accordance with the test procedures and has been in compliance with the applicable technical standards.

The test results in this report apply exclusively to the tested model / sample. Without written approval of SPORTON INTERNATIONAL INC., the test report shall not be reproduced except in full.

Reviewed by: Joseph Lin / Supervisor

Approved by: Jones Tsai / Manager



SPORTON INTERNATIONAL INC.

No. 52, Hwa Ya 1st Rd., Hwa Ya Technology Park, Kwei-Shan District, Tao Yuan City, Taiwan, R.O.C.

SPORTON INTERNATIONAL INC.

TEL : 886-3-327-3456

FAX : 886-3-328-4978

FCC ID : UZ7ET55BT

Page Number : 1 of 36

Report Issued Date : Aug. 04, 2016

Report Version : Rev. 01

Report Template No.: BU5-FR15CBT4.0 Version 1.3



TABLE OF CONTENTS

SUMMARY OF TEST RESULT 4

1 GENERAL DESCRIPTION..... 5

1.1 Applicant 5

1.2 Manufacturer..... 5

1.3 Product Feature of Equipment Under Test..... 5

1.4 Product Specification of Equipment Under Test..... 5

1.5 Modification of EUT 6

1.6 Testing Location 6

1.7 Applicable Standards..... 6

2 TEST CONFIGURATION OF EQUIPMENT UNDER TEST..... 7

2.1 Descriptions of Test Mode 7

2.2 Test Mode..... 7

2.3 Connection Diagram of Test System..... 8

2.4 Support Unit used in test configuration and system 9

2.5 EUT Operation Test Setup 9

2.6 Measurement Results Explanation Example..... 9

3 TEST RESULT 10

3.1 6dB and 99% Bandwidth Measurement 10

3.2 Peak Output Power Measurement 15

3.3 Power Spectral Density Measurement 16

3.4 Conducted Band Edges and Spurious Emission Measurement 21

3.5 Radiated Band Edges and Spurious Emission Measurement 26

3.6 AC Conducted Emission Measurement..... 30

3.7 Antenna Requirements 34

4 LIST OF MEASURING EQUIPMENT..... 35

5 UNCERTAINTY OF EVALUATION..... 36

APPENDIX A. CONDUCTED TEST RESULTS

APPENDIX B. RADIATED SPURIOUS EMISSION

APPENDIX C. RADIATED SPURIOUS EMISSION PLOTS

APPENDIX D. DUTY CYCLE PLOTS

APPENDIX E. SETUP PHOTOGRAPHS



REVISION HISTORY

REPORT NO.	VERSION	DESCRIPTION	ISSUED DATE
FR660115B	Rev. 01	Initial issue of report	Aug. 04, 2016



SUMMARY OF TEST RESULT

Report Section	FCC Rule	Description	Limit	Result	Remark
3.1	15.247(a)(2)	6dB Bandwidth	$\geq 0.5\text{MHz}$	Pass	-
3.1	-	99% Bandwidth	-	Pass	-
3.2	15.247(b)(1)	Peak Output Power	$\leq 30\text{dBm}$	Pass	-
3.3	15.247(e)	Power Spectral Density	$\leq 8\text{dBm}/3\text{kHz}$	Pass	-
3.4	15.247(d)	Conducted Band Edges and Spurious Emission	$\leq 20\text{dBc}$	Pass	-
3.5	15.247(d)	Radiated Band Edges and Spurious Emission	15.209(a) & 15.247(d)	Pass	Under limit 7.33 dB at 2499.480 MHz
3.6	15.207	AC Conducted Emission	15.207(a)	Pass	Under limit 16.80 dB at 0.206 MHz
3.7	15.203 & 15.247(b)	Antenna Requirement	N/A	Pass	-



1 General Description

1.1 Applicant

Zebra Technologies Corporation
1 Zebra Plaza, Holtsville, NY 11742

1.2 Manufacturer

Zebra Technologies Corporation
1 Zebra Plaza, Holtsville, NY 11742

1.3 Product Feature of Equipment Under Test

Product Feature	
Equipment	Enterprise Tablet
Brand Name	Zebra
Model Name	ET55BT
FCC ID	UZ7ET55BT
EUT supports Radios application	CDMA/EV-DO/GSM/EGPRS/WCDMA/HSPA/LTE/NFC WLAN 11a/b/g/n HT20/HT40 WLAN 11ac VHT20/VHT40/VHT80 Bluetooth v4.0 EDR/LE
HW Version	DV1
SW Version	5.1.1
FW Version	BCM4350C0_003.001.012.0379.0796
MFD	31-Mar-16
EUT Stage	Identical Prototype

Remark: The above EUT's information was declared by manufacturer. Please refer to the specifications or user's manual for more detailed description.

1.4 Product Specification of Equipment Under Test

Standards-related Product Specification	
Tx/Rx Frequency Range	2402 MHz ~ 2480 MHz
Number of Channels	40
Carrier Frequency of Each Channel	40 Channel(37 hopping + 3 advertising channel)
Maximum Output Power to Antenna	5.56 dBm (0.0036 W)
99% Occupied Bandwidth	1.052MHz
Antenna Type	Ceramic Chip Antenna type with gain 1.90 dBi
Type of Modulation	Bluetooth LE : GFSK



1.5 Modification of EUT

No modifications are made to the EUT during all test items.

1.6 Testing Location

Sporton Lab is accredited to ISO 17025 by Taiwan Accreditation Foundation (TAF code : 1190) and the FCC designation No. TW1022 under the FCC 2.948(e) by Mutual Recognition Agreement (MRA) in FCC Test.

Test Site	SPORTON INTERNATIONAL INC.		
Test Site Location	No. 52, Hwa Ya 1 st Rd., Hwa Ya Technology Park, Kwei-Shan District, Tao Yuan City, Taiwan, R.O.C. TEL: +886-3-327-3456 FAX: +886-3-328-4978		
Test Site No.	Sporton Site No.		
	TH05-HY	CO05-HY	03CH07-HY

Note: The test site complies with ANSI C63.4 2014 requirement.

1.7 Applicable Standards

According to the specifications of the manufacturer, the EUT must comply with the requirements of the following standards:

- FCC Part 15 Subpart C §15.247
- FCC KDB Publication No. 558074 D01 DTS Meas. Guidance v03r05
- ANSI C63.10-2013

Remark:

1. All test items were verified and recorded according to the standards and without any deviation during the test.
2. This EUT has also been tested and complied with the requirements of FCC Part 15, Subpart B, recorded in a separate test report.



2 Test Configuration of Equipment Under Test

2.1 Descriptions of Test Mode

The RF output power was recorded in the following table:

Channel	Frequency	Bluetooth 4.0 – LE RF Output Power	
		Data Rate / Modulation	
		GFSK	
		1Mbps	
Ch00	2402MHz	3.92 dBm	
Ch19	2440MHz	4.75 dBm	
Ch39	2480MHz	5.56 dBm	

- a. The EUT has been associated with peripherals and configuration operated in a manner tended to maximize its emission characteristics in a typical application. Frequency range investigated: conduction (150 kHz to 30 MHz), radiation (9 kHz to the 10th harmonic of the highest fundamental frequency or to 40 GHz, whichever is lower). Pre-scanned tests, X, Y, Z in three orthogonal panels to determine the final configuration from all possible combinations.
- b. AC power line Conducted Emission was tested under maximum output power.

2.2 Test Mode

The following summary table is showing all test modes to demonstrate in compliance with the standard.

Summary table of Test Cases	
Test Item	Data Rate / Modulation
	Bluetooth 4.0 – LE / GFSK
Conducted TCs	Mode 1: Bluetooth Tx CH00_2402 MHz_1Mbps Mode 2: Bluetooth Tx CH19_2440 MHz_1Mbps Mode 3: Bluetooth Tx CH39_2480 MHz_1Mbps
Radiated TCs	Mode 1: Bluetooth Tx CH00_2402 MHz_1Mbps Mode 2: Bluetooth Tx CH19_2440 MHz_1Mbps Mode 3: Bluetooth Tx CH39_2480 MHz_1Mbps
AC Conducted Emission	Mode 1: Bluetooth Link + WLAN (2.4GHz) Link + Battery + Earphone + USB Cable (Charging from Adapter)

2.3 Connection Diagram of Test System

<Bluetooth 4.0 – LE Tx Mode>

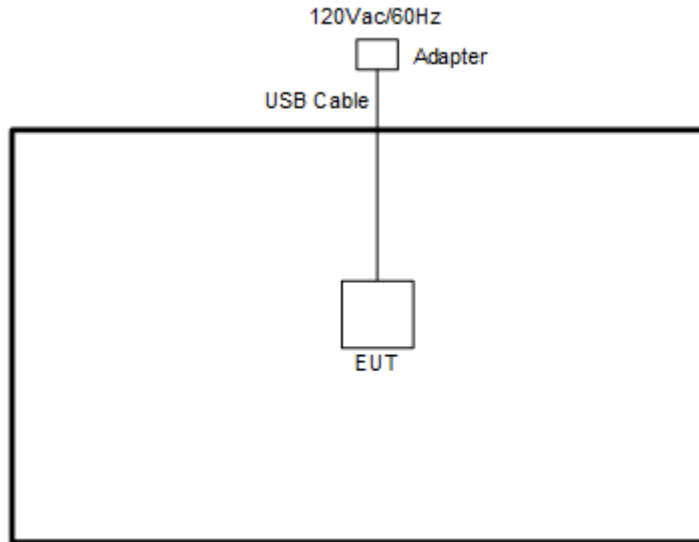

<AC Conducted Emission Mode>

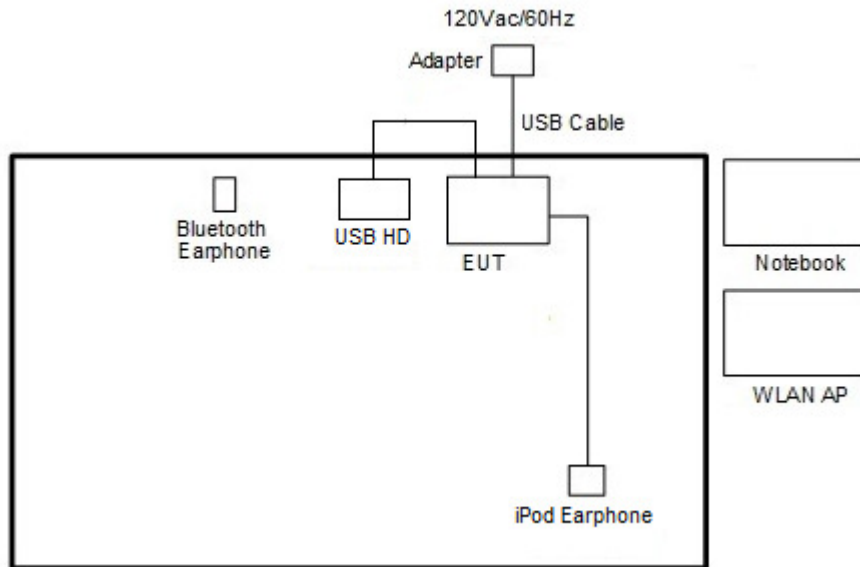



2.4 Support Unit used in test configuration and system

Item	Equipment	Trade Name	Model Name	FCC ID	Data Cable	Power Cord
1.	WLAN AP	D-Link	DIR-865L	KA2IR865LA1	N/A	Unshielded, 1.8 m
2.	Notebook	DELL	Latitude E6320	FCC DoC/ Contains FCC ID: QDS-BRCM1054	N/A	AC I/P: Unshielded, 1.2 m DC O/P: Shielded, 1.8 m
3.	Bluetooth Earphone	Sony Ericsson	MW600	PY7DDA-2029	N/A	N/A
4.	iPod Earphone	Apple	N/A	Verification	Unshielded, 1.0 m	N/A
5.	Adapter	Delta Electronics	ADP-10BWC	FCC DoC	N/A	N/A
6.	SD Card	SanDisk	MicroSD HC	FCC DoC	N/A	N/A
7.	USB HD	WD	WDBAAR3200A BK-PESN	FCC DoC	Unshielded, 0.5 m	N/A

2.5 EUT Operation Test Setup

For Bluetooth function, programmed RF utility installed in the notebook make the EUT provide functions like channel selection and power level for continuous transmitting and receiving signals.

2.6 Measurement Results Explanation Example

For all conducted test items:

The offset level is set in the spectrum analyzer to compensate the RF cable loss and attenuator factor between EUT conducted output port and spectrum analyzer. With the offset compensation, the spectrum analyzer reading level is exactly the EUT RF output level.

Example :

The spectrum analyzer offset is derived from RF cable loss and attenuator factor.

Offset = RF cable loss + attenuator factor.

Following shows an offset computation example with cable loss 4.2 dB and 10dB attenuator.

$$\begin{aligned} \text{Offset(dB)} &= \text{RF cable loss(dB)} + \text{attenuator factor(dB)}. \\ &= 4.2 + 10 = 14.2 \text{ (dB)} \end{aligned}$$

3 Test Result

3.1 6dB and 99% Bandwidth Measurement

3.1.1 Limit of 6dB and 99% Bandwidth

The minimum 6 dB bandwidth shall be at least 500 kHz.

3.1.2 Measuring Instruments

The section 4.0 of List of Measuring Equipment of this test report is used for test.

3.1.3 Test Procedures

1. The testing follows FCC KDB Publication No. 558074 D01 DTS Meas. Guidance v03r05.
2. The RF output of EUT was connected to the spectrum analyzer by RF cable and attenuator. The path loss was compensated to the results for each measurement.
3. Set to the maximum power setting and enable the EUT transmit continuously.
4. Make the measurement with the spectrum analyzer's resolution bandwidth (RBW) = 100 kHz. Set the Video bandwidth (VBW) = 300 kHz. In order to make an accurate measurement. The 6 dB bandwidth must be greater than 500 kHz.
5. For 99% Bandwidth Measurement, the spectrum analyzer's resolution bandwidth (RBW) is set 30kHz and set the Video bandwidth (VBW) = 100kHz.
6. Measure and record the results in the test report.

3.1.4 Test Setup





3.1.5 Test Result of 6dB Bandwidth

Test data refer to Appendix A.

6 dB Bandwidth Plot on Channel 00

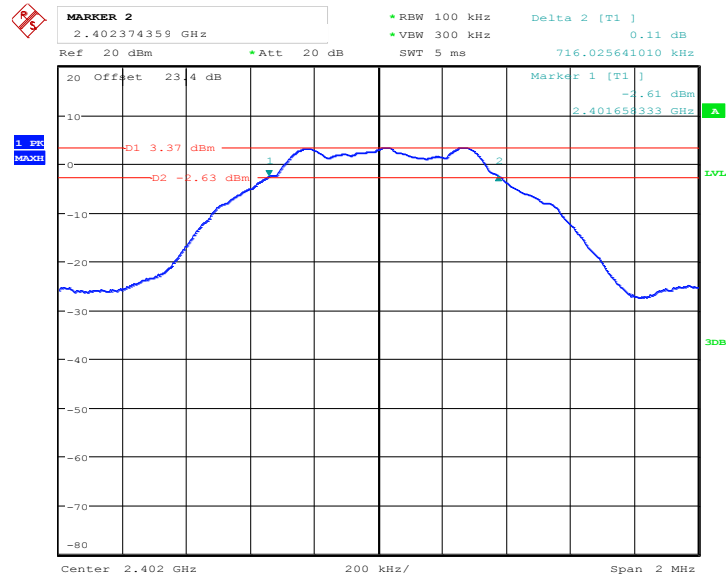

Date: 21.JUN.2016 11:56:38



6 dB Bandwidth Plot on Channel 19

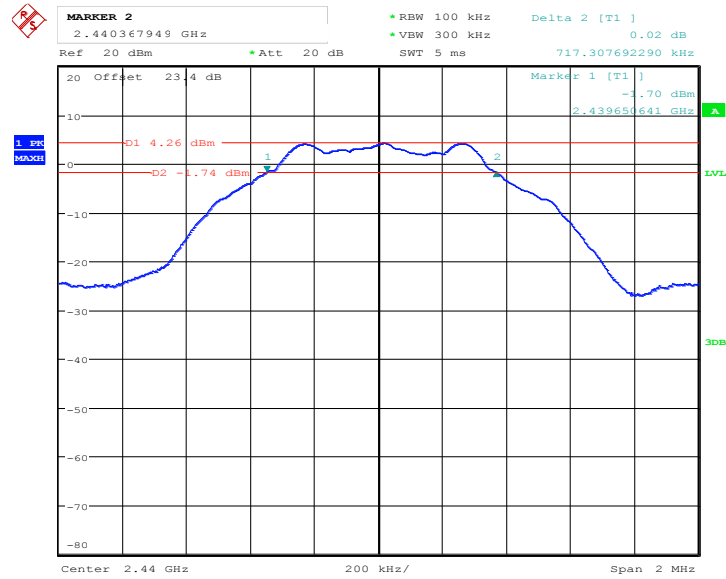

Date: 21.JUN.2016 11:48:36

6 dB Bandwidth Plot on Channel 39

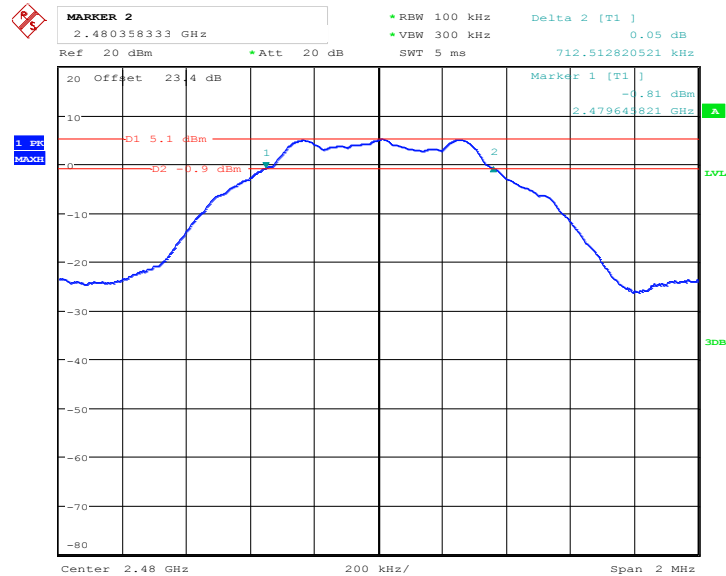

Date: 21.JUN.2016 11:59:56



3.1.6 Test Result of 99% Occupied Bandwidth

Test data refer to Appendix A.

99% Bandwidth Plot on Channel 00

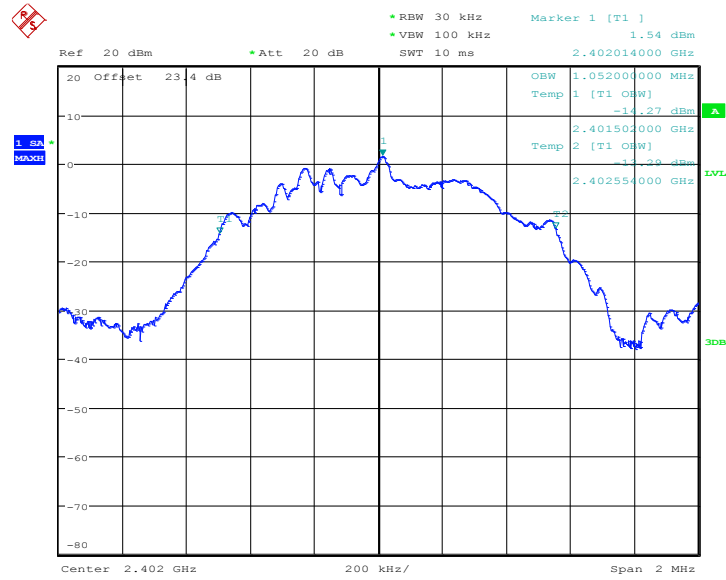

Date: 21.JUN.2016 11:58:37



99% Occupied Bandwidth Plot on Channel 19

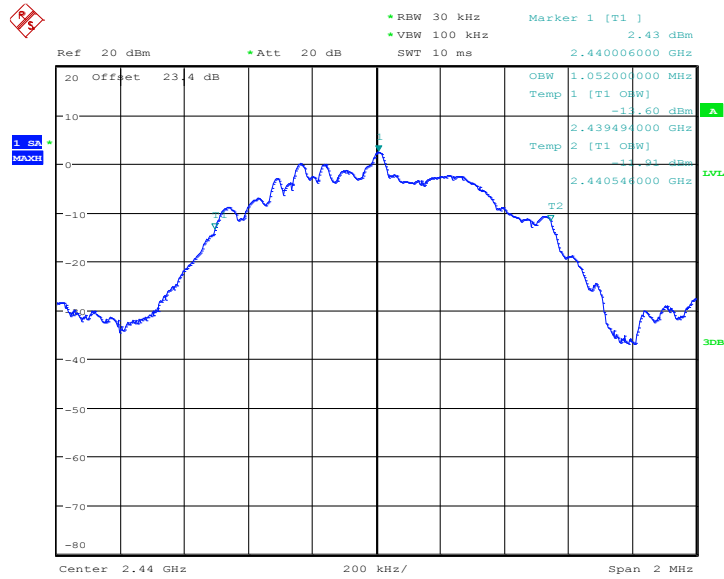

Date: 21.JUN.2016 11:52:51

99% Occupied Bandwidth Plot on Channel 39

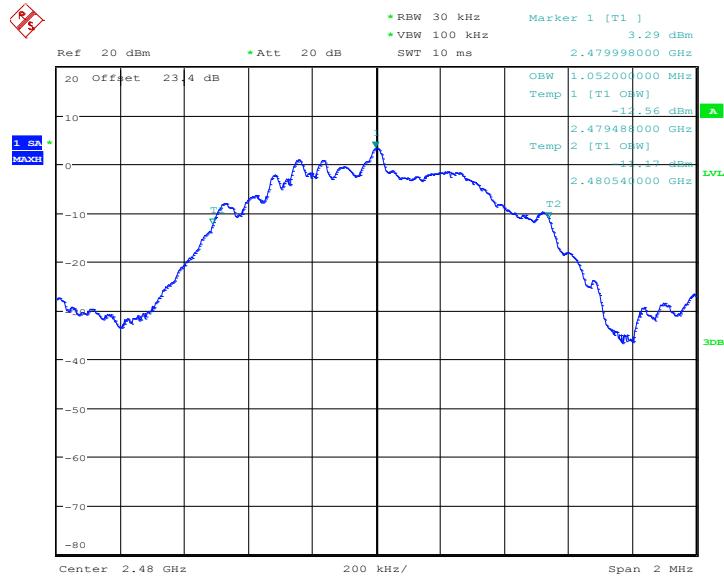

Date: 21.JUN.2016 12:01:50

Note: The occupied channel bandwidth is maintained within the band of operation for all of the modulations.

3.2 Peak Output Power Measurement

3.2.1 Limit of Peak Output Power

For systems using digital modulation in the 2400-2483.5MHz, the limit for peak output power is 30dBm. If transmitting antenna of directional gain greater than 6dBi is used, the peak output power from the intentional radiator shall be reduced below the above stated value by the amount in dB that the directional gain of the antenna exceeds 6 dBi. In case of point-to-point operation, the limit has to be reduced by 1dB for every 3dB that the directional gain of the antenna exceeds 6dBi.

3.2.2 Measuring Instruments

The section 4.0 of List of Measuring Equipment of this test report is used for test.

3.2.3 Test Procedures

1. The testing follows the Measurement Procedure of FCC KDB No. 558074 DTS D01 Meas. Guidance v03r05 section 9.1.2 PKPM1 Peak power meter method.
2. The RF output of EUT was connected to the power meter by RF cable and attenuator. The path loss was compensated to the results for each measurement.
3. Set to the maximum power setting and enable the EUT transmit continuously.
4. Measure the conducted output power and record the results in the test report.

3.2.4 Test Setup

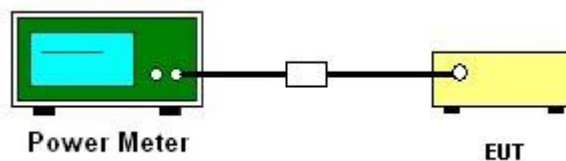

3.2.5 Test Result of Peak Output Power

Test data refers to Appendix A.

3.3 Power Spectral Density Measurement

3.3.1 Limit of Power Spectral Density

The peak power spectral density shall not be greater than 8dBm in any 3kHz band at any time interval of continuous transmission.

3.3.2 Measuring Instruments

The section 4.0 of List of Measuring Equipment of this test report is used for test.

3.3.3 Test Procedures

1. The testing follows Measurement Procedure 10.2 Method PKPSD of FCC KDB Publication No. 558074 D01 DTS Meas. Guidance v03r05
2. The RF output of EUT was connected to the spectrum analyzer by RF cable and attenuator. The path loss was compensated to the results for each measurement.
3. Set to the maximum power setting and enable the EUT transmit continuously.
4. Make the measurement with the spectrum analyzer's resolution bandwidth (RBW) = 3 kHz. Video bandwidth VBW = 10 kHz In order to make an accurate measurement, set the span to 1.5 times DTS Channel Bandwidth. (6dB BW)
5. Detector = peak, Sweep time = auto couple, Trace mode = max hold, Allow trace to fully stabilize. Use the peak marker function to determine the maximum power level.
6. Measure and record the results in the test report.
7. The Measured power density (dBm)/ 100kHz is a reference level and used as 20dBc down limit line for Conducted Band Edges and Conducted Spurious Emission.

3.3.4 Test Setup

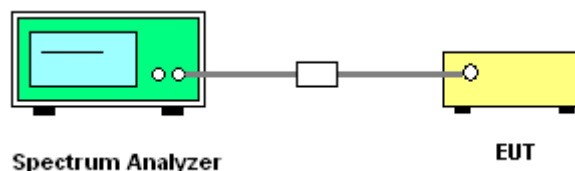



3.3.5 Test Result of Power Spectral Density

Test data refers to Appendix A.

3.3.6 Test Result of Power Spectral Density Plots (100kHz)

PSD 100kHz Plot on Channel 00

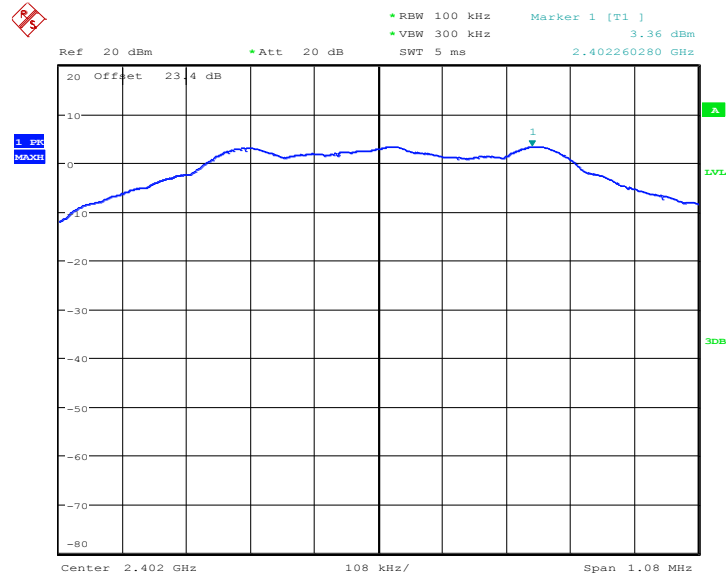

Date: 21.JUN.2016 11:57:47



PSD 100kHz Plot on Channel 19

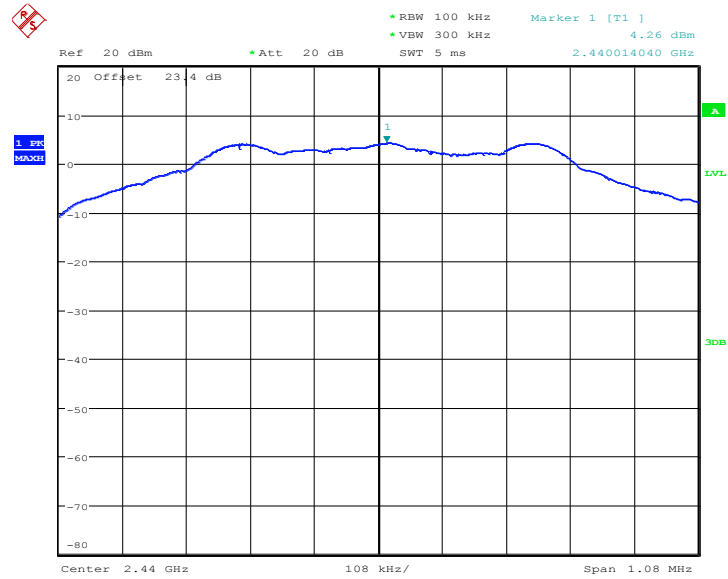

Date: 21.JUN.2016 11:51:59

PSD 100kHz Plot on Channel 39

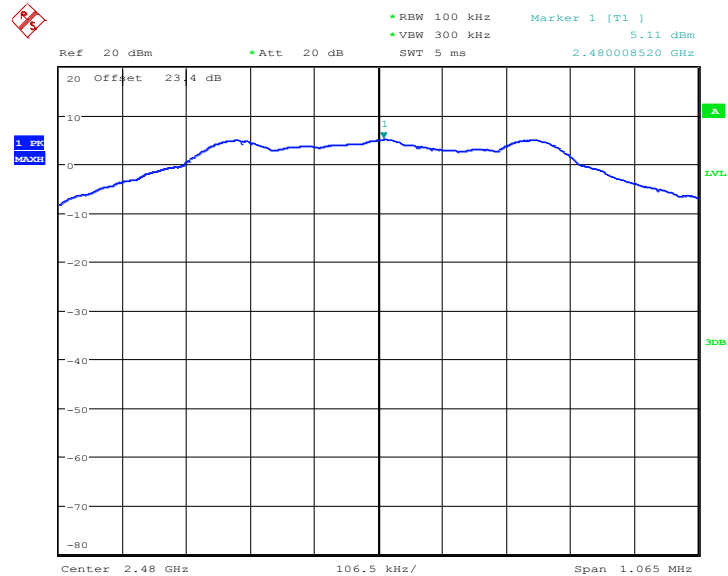

Date: 21.JUN.2016 12:00:43



3.3.7 Test Result of Power Spectral Density Plots (3kHz)

PSD 3kHz Plot on Channel 00

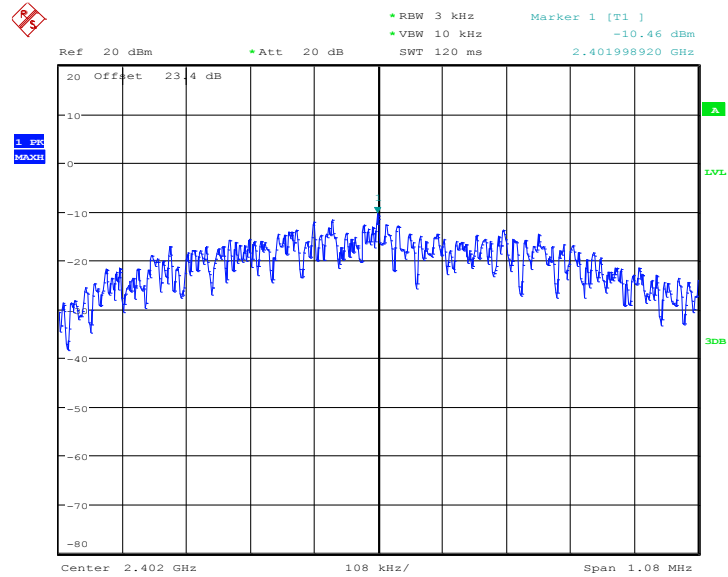

Date: 21.JUN.2016 11:57:35



PSD 3kHz Plot on Channel 19

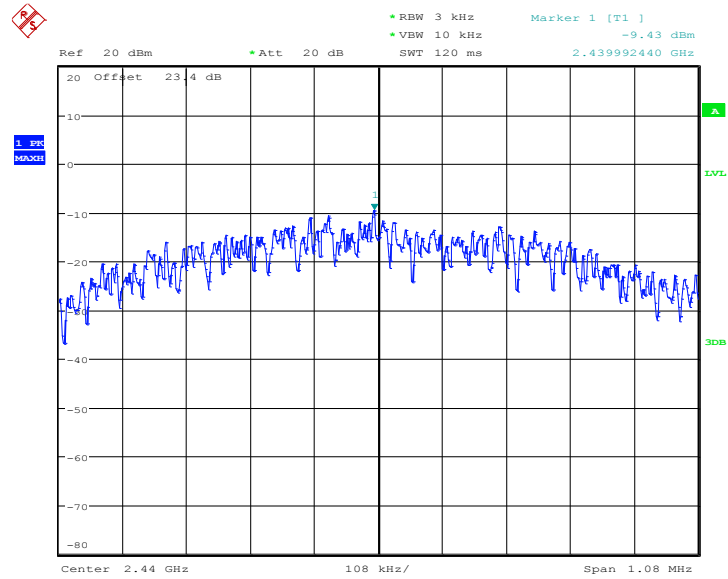

Date: 21.JUN.2016 11:51:47

PSD 3kHz Plot on Channel 39

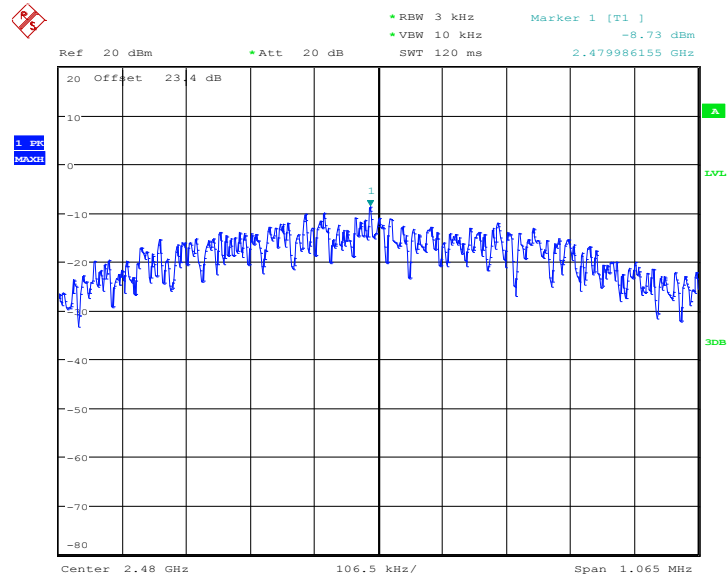

Date: 21.JUN.2016 12:00:29

3.4 Conducted Band Edges and Spurious Emission Measurement

3.4.1 Limit of Conducted Band Edges and Spurious Emission

All harmonics/spurious must be at least 20 dB down from the highest emission level within the authorized band.

3.4.2 Measuring Instruments

The section 4.0 of List of Measuring Equipment of this test report is used for test.

3.4.3 Test Procedure

1. The testing follows FCC KDB Publication No. 558074 D01 DTS Meas. Guidance v03r05.
2. The RF output of EUT was connected to the spectrum analyzer by RF cable and attenuator. The path loss was compensated to the results for each measurement.
3. Set to the maximum power setting and enable the EUT transmit continuously.
4. Set RBW = 100 kHz, VBW=300 kHz, Peak Detector. Unwanted Emissions measured in any 100 kHz bandwidth outside of the authorized frequency band shall be attenuated by at least 20 dB relative to the maximum in-band peak PSD level in 100 kHz when maximum peak conducted output power procedure is used. If the transmitter complies with the conducted power limits based on the use of RMS averaging over a time interval, the attenuation required under this paragraph shall be 30 dB instead of 20 dB per 15.247(d).
5. Measure and record the results in the test report.
6. The RF fundamental frequency should be excluded against the limit line in the operating frequency band.

3.4.4 Test Setup

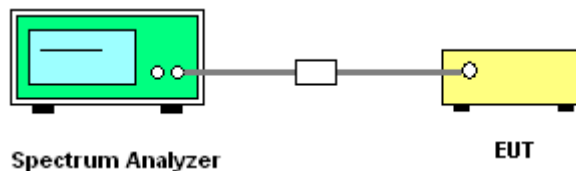



3.4.5 Test Result of Conducted Band Edges Plots

Low Band Edge Plot on Channel 00

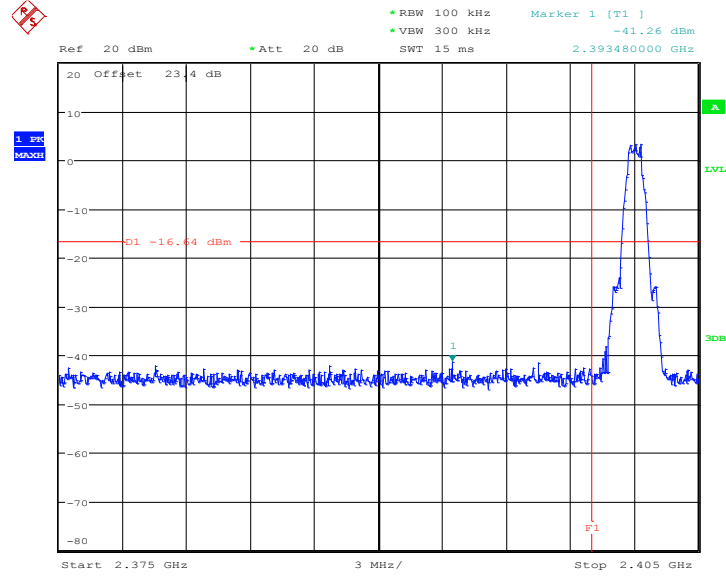

Date: 21.JUN.2016 11:58:01

High Band Edge Plot on Channel 39

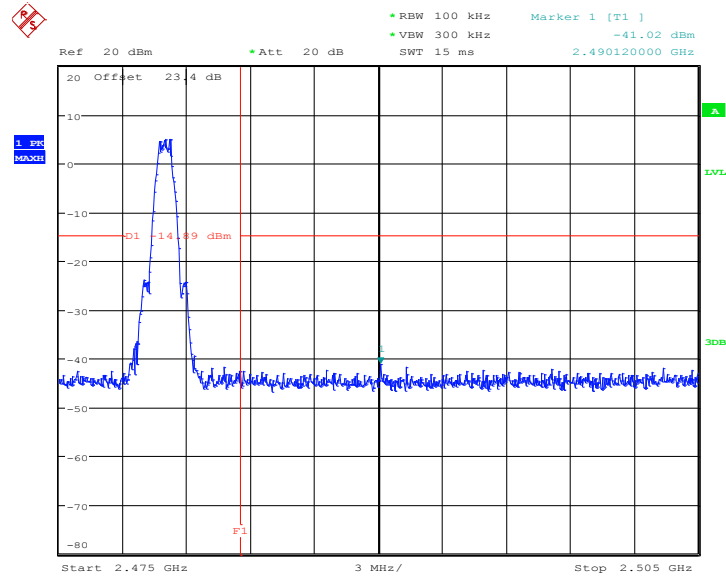

Date: 21.JUN.2016 12:00:58



3.4.6 Test Result of Conducted Spurious Emission Plots

Conducted Spurious Emission Plot on Bluetooth LE 1Mbps GFSK Channel 00

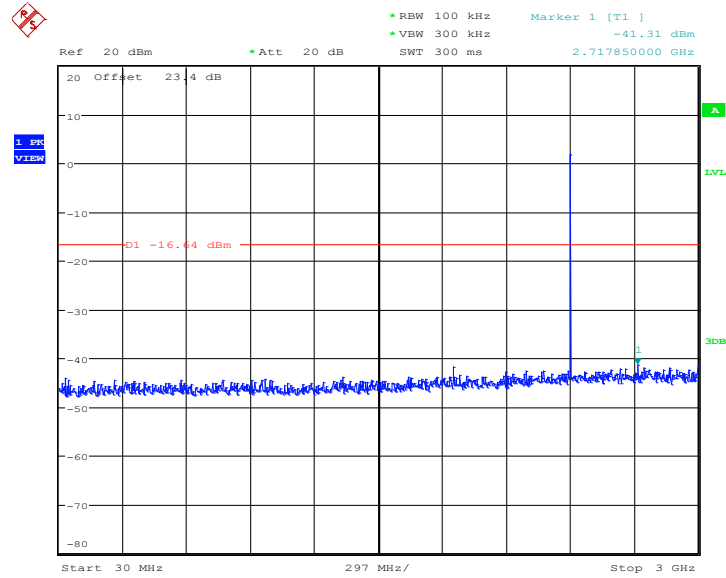

Date: 21.JUN.2016 11:58:12

Conducted Spurious Emission Plot on Bluetooth LE 1Mbps GFSK Channel 00

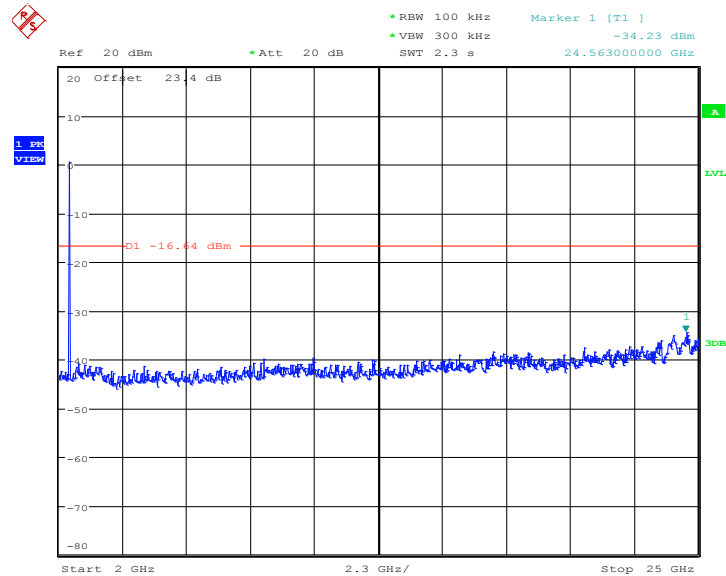

Date: 21.JUN.2016 11:58:20



Conducted Spurious Emission Plot on Bluetooth LE 1Mbps GFSK Channel 19

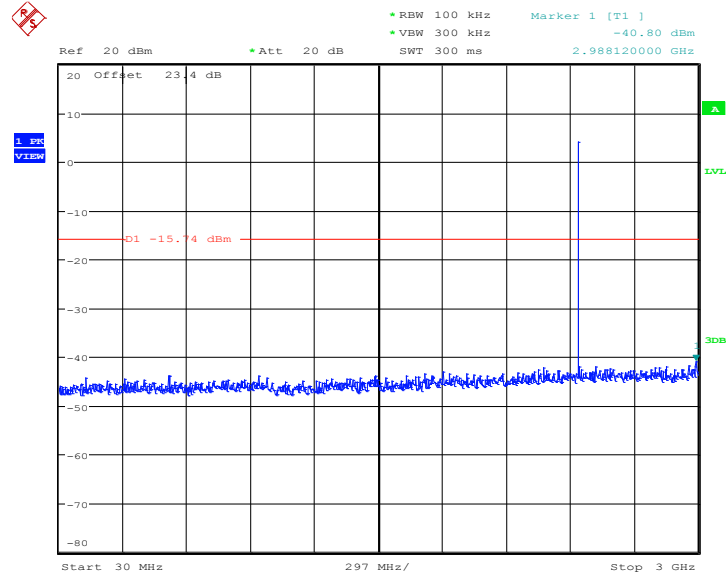

Date: 21.JUN.2016 11:52:22

Conducted Spurious Emission Plot on Bluetooth LE 1Mbps GFSK Channel 19

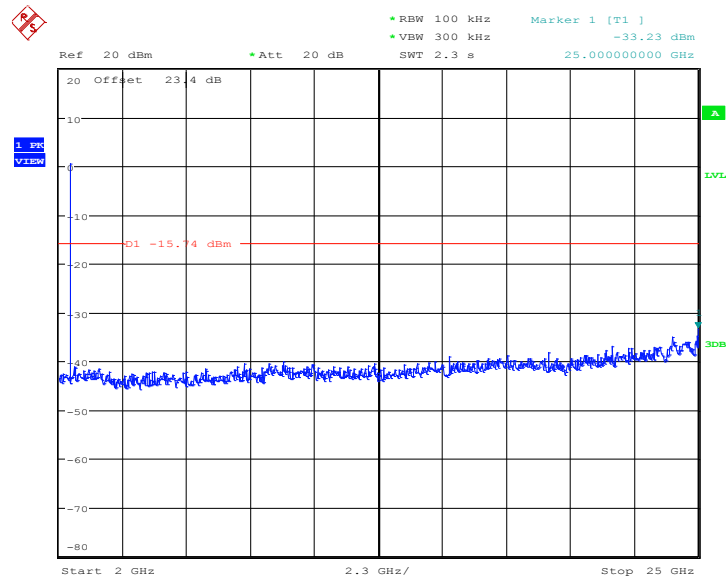

Date: 21.JUN.2016 11:52:30



Conducted Spurious Emission Plot on Bluetooth LE 1Mbps GFSK Channel 39

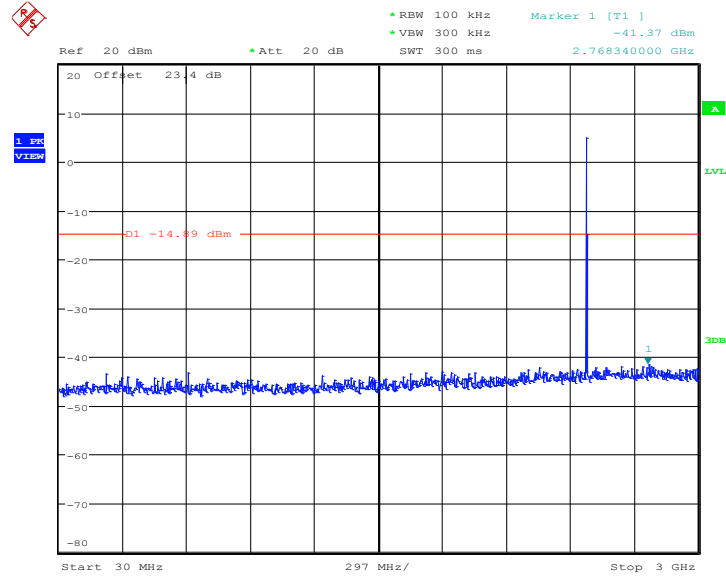

Date: 21.JUN.2016 12:01:11

Conducted Spurious Emission Plot on Bluetooth LE 1Mbps GFSK Channel 39

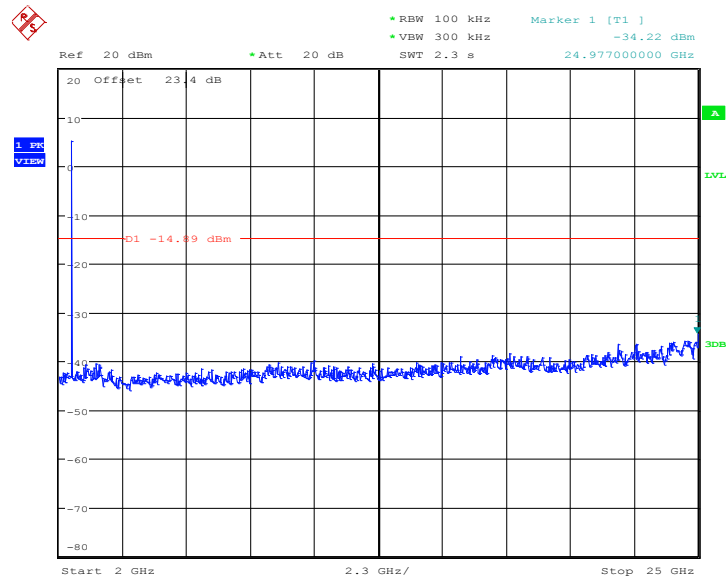

Date: 21.JUN.2016 12:01:19



3.5 Radiated Band Edges and Spurious Emission Measurement

3.5.1 Limit of Radiated Band Edges and Spurious Emission

In any 100 kHz bandwidth outside the intentional radiator frequency band, all harmonics/spurious must be at least 20 dB below the highest emission level within the authorized band. If the output power of this device was measured by spectrum analyzer, the attenuation under this paragraph shall be 30 dB instead of 20 dB. In addition, radiated emissions which fall in the restricted bands must also comply with the FCC section 15.209 limits as below.

Frequency (MHz)	Field Strength (microvolts/meter)	Measurement Distance (meters)
0.009 – 0.490	2400/F(kHz)	300
0.490 – 1.705	24000/F(kHz)	30
1.705 – 30.0	30	30
30 – 88	100	3
88 – 216	150	3
216 - 960	200	3
Above 960	500	3

3.5.2 Measuring Instruments

The section 4.0 of List of Measuring Equipment of this test report is used for test.



3.5.3 Test Procedures

1. The testing follows FCC KDB Publication No. 558074 D01 DTS Meas. Guidance v03r05.
2. The EUT was arranged and then tune the antenna tower (from 1 m to 4 m) and turntable (from 0 degree to 360 degrees) to find the maximum reading. A pre-amp and a high pass filter are used for the test in order to get better signal level.
3. The EUT was placed on a turntable with 0.8 meter for frequency below 1GHz and 1.5 meter for frequency above 1GHz respectively above ground.
4. The EUT was set 3 meters from the interference receiving antenna, which was mounted on the top of a variable height antenna tower.
5. Corrected Reading: Antenna Factor + Cable Loss + Read Level - Preamp Factor = Level
6. For measurement below 1GHz, If the emission level of the EUT measured by the peak detector is 3 dB lower than the applicable limit, the peak emission level will be reported. Otherwise, the emission measurement will be repeated using the quasi-peak detector and reported.
7. Use the following spectrum analyzer settings:
 - (1) Span shall wide enough to fully capture the emission being measured;
 - (2) Set RBW=100 kHz for $f < 1$ GHz; VBW \geq RBW; Sweep = auto; Detector function = peak; Trace = max hold;
 - (3) Set RBW = 1 MHz, VBW= 3MHz for $f \geq 1$ GHz for peak measurement.
For average measurement:
 - VBW = 10 Hz, when duty cycle is no less than 98 percent.
 - VBW $\geq 1/T$, when duty cycle is less than 98 percent where T is the minimum transmission duration over which the transmitter is on and is transmitting at its maximum power control level for the tested mode of operation.

3.5.4 Test Setup

For radiated emissions below 30MHz

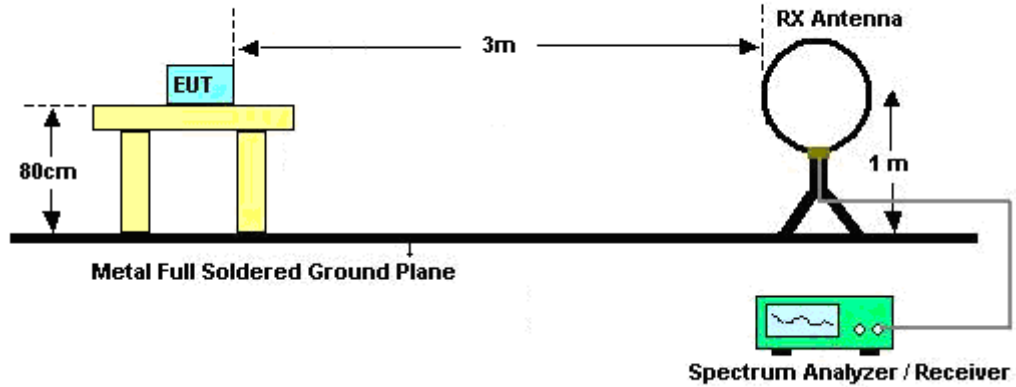

For radiated emissions from 30MHz to 1GHz

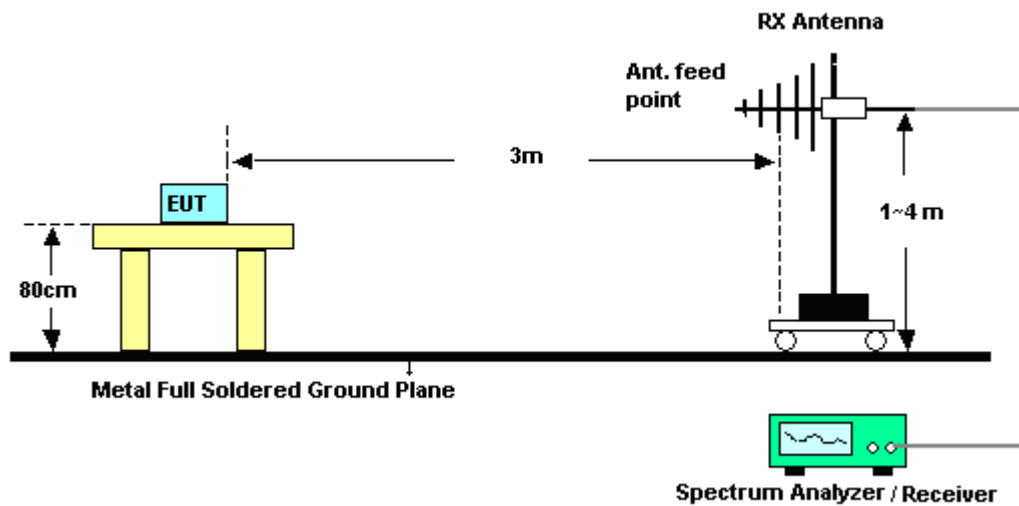

For radiated emissions above 1GHz

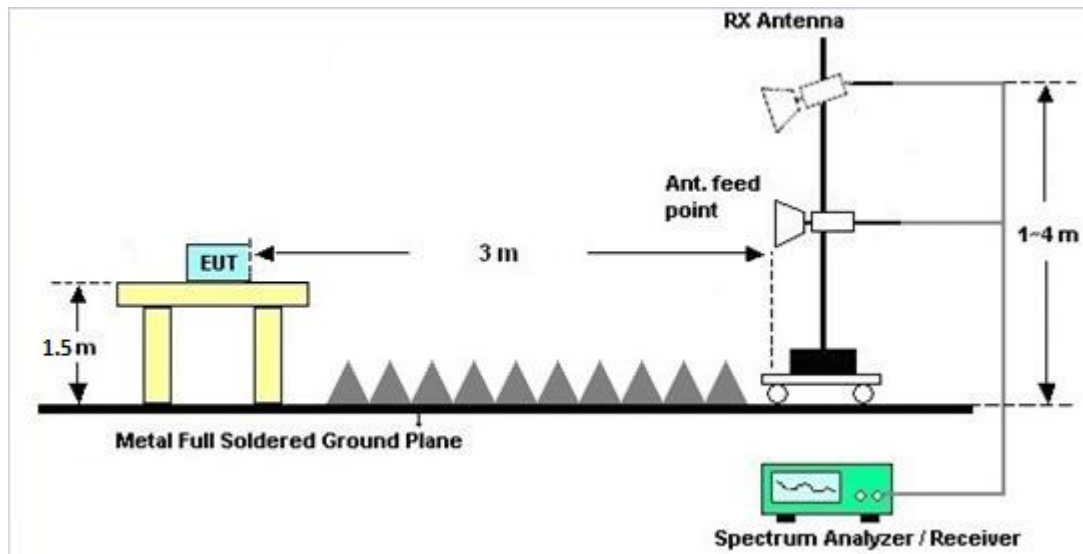

3.5.5 Test Results of Radiated Spurious Emissions (9 kHz ~ 30 MHz)

The low frequency, which started from 9 kHz to 30MHz, was pre-scanned and the result which was 20dB lower than the limit line per 15.31(o) was not reported.

3.5.6 Test Result of Radiated Spurious at Band Edges

Please refer to Appendix B and C.

3.5.7 Duty Cycle

Please refer to Appendix D.

3.5.8 Test Result of Radiated Spurious Emission (30MHz ~ 10th Harmonic)

Please refer to Appendix B and C.



3.6 AC Conducted Emission Measurement

3.6.1 Limit of AC Conducted Emission

For equipment that is designed to be connected to the public utility (AC) power line, the radio frequency voltage that is conducted back onto the AC power line on any frequency or frequencies within the band 150 kHz to 30 MHz shall not exceed the limits in the following table.

Frequency of emission (MHz)	Conducted limit (dBµV)	
	Quasi-peak	Average
0.15-0.5	66 to 56*	56 to 46*
0.5-5	56	46
5-30	60	50

*Decreases with the logarithm of the frequency.

3.6.2 Measuring Instruments

The section 4.0 of List of Measuring Equipment of this test report is used for test.

3.6.3 Test Procedures

1. The EUT was placed 0.4 meter from the conducting wall of the shielding room was kept at least 80 centimeters from any other grounded conducting surface.
2. Connect EUT to the power mains through a line impedance stabilization network (LISN).
3. All the support units are connecting to the other LISN.
4. The LISN provides 50 ohm coupling impedance for the measuring instrument.
5. The FCC states that a 50 ohm, 50 microhenry LISN should be used.
6. Both sides of AC line were checked for maximum conducted interference.
7. The frequency range from 150 kHz to 30 MHz was searched.
8. Set the test-receiver system to Peak Detect Function and specified bandwidth (IF Bandwidth = 9kHz) with Maximum Hold Mode. Then measurement is also conducted by Average Detector and Quasi-Peak Detector Function respectively.

3.6.4 Test Setup





3.6.5 Test Result of AC Conducted Emission

Test Mode :	Mode 1	Temperature :	25~26°C
Test Engineer :	Arthur Hsieh	Relative Humidity :	54~55%
Test Voltage :	120Vac / 60Hz	Phase :	Line
Function Type :	Bluetooth Link + WLAN (2.4GHz) Link + Battery + Earphone + USB Cable (Charging from Adapter)		

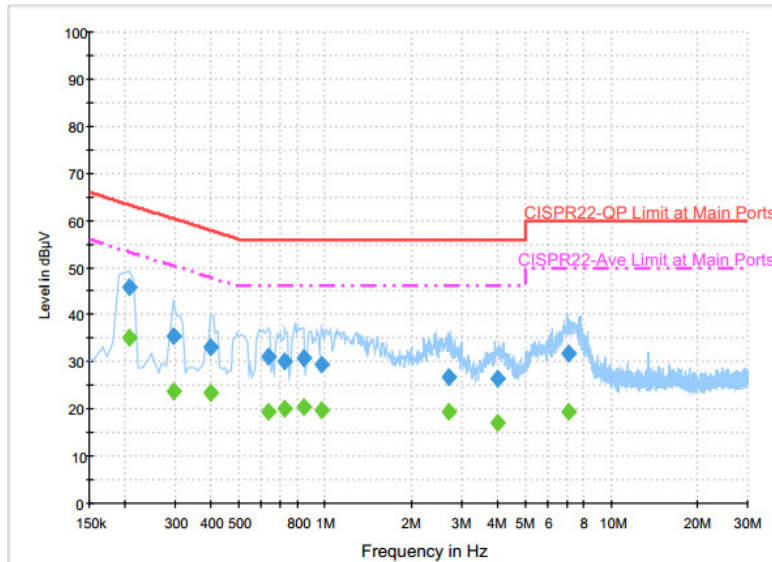

Final Result : Quasi-Peak

Frequency (MHz)	Quasi-Peak (dBµV)	Filter	Line	Corr. (dB)	Margin (dB)	Limit (dBµV)
0.206000	45.8	Off	L1	19.6	17.6	63.4
0.294000	35.5	Off	L1	19.6	24.9	60.4
0.398000	33.1	Off	L1	19.6	24.8	57.9
0.630000	31.2	Off	L1	19.6	24.8	56.0
0.726000	30.0	Off	L1	19.6	26.0	56.0
0.846000	30.9	Off	L1	19.6	25.1	56.0
0.974000	29.3	Off	L1	19.7	26.7	56.0
2.702000	26.8	Off	L1	19.7	29.2	56.0
4.022000	26.5	Off	L1	19.8	29.5	56.0
7.102000	31.9	Off	L1	19.9	28.1	60.0

Final Result : Average

Frequency (MHz)	Average (dBµV)	Filter	Line	Corr. (dB)	Margin (dB)	Limit (dBµV)
0.206000	35.1	Off	L1	19.6	18.3	53.4
0.294000	23.9	Off	L1	19.6	26.5	50.4
0.398000	23.4	Off	L1	19.6	24.5	47.9
0.630000	19.5	Off	L1	19.6	26.5	46.0
0.726000	20.2	Off	L1	19.6	25.8	46.0
0.846000	20.3	Off	L1	19.6	25.7	46.0
0.974000	19.8	Off	L1	19.7	26.2	46.0
2.702000	19.2	Off	L1	19.7	26.8	46.0
4.022000	16.9	Off	L1	19.8	29.1	46.0
7.102000	19.5	Off	L1	19.9	30.5	50.0



Test Mode :	Mode 1	Temperature :	25~26°C
Test Engineer :	Arthur Hsieh	Relative Humidity :	54~55%
Test Voltage :	120Vac / 60Hz	Phase :	Neutral
Function Type :	Bluetooth Link + WLAN (2.4GHz) Link + Battery + Earphone + USB Cable (Charging from Adapter)		

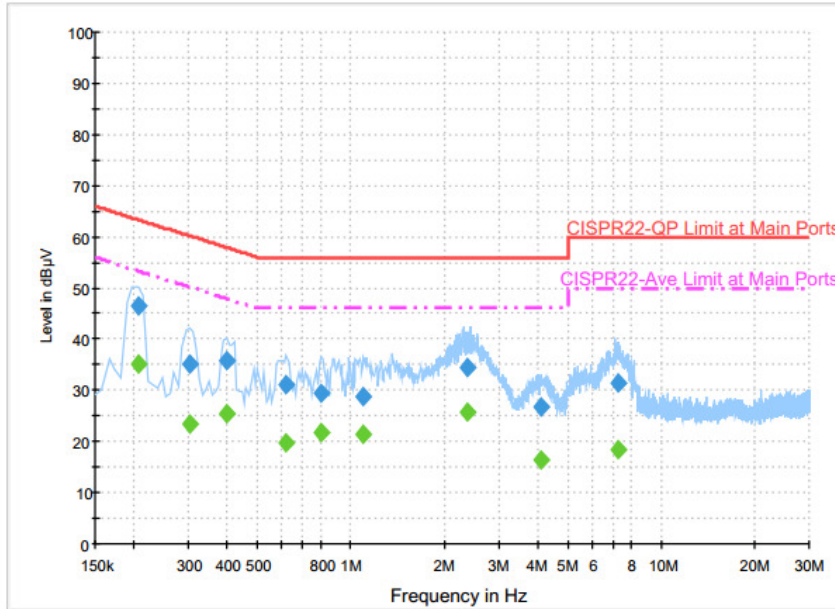

Final Result : Quasi-Peak

Frequency (MHz)	Quasi-Peak (dBµV)	Filter	Line	Corr. (dB)	Margin (dB)	Limit (dBµV)
0.206000	46.6	Off	N	19.6	16.8	63.4
0.302000	35.2	Off	N	19.6	25.0	60.2
0.398000	35.8	Off	N	19.6	22.1	57.9
0.622000	31.1	Off	N	19.6	24.9	56.0
0.806000	29.4	Off	N	19.6	26.6	56.0
1.102000	28.9	Off	N	19.6	27.1	56.0
2.374000	34.6	Off	N	19.6	21.4	56.0
4.126000	26.7	Off	N	19.8	29.3	56.0
7.302000	31.4	Off	N	19.9	28.6	60.0

Final Result : Average

Frequency (MHz)	Average (dBµV)	Filter	Line	Corr. (dB)	Margin (dB)	Limit (dBµV)
0.206000	35.2	Off	N	19.6	18.2	53.4
0.302000	23.5	Off	N	19.6	26.7	50.2
0.398000	25.4	Off	N	19.6	22.5	47.9
0.622000	19.7	Off	N	19.6	26.3	46.0
0.806000	21.6	Off	N	19.6	24.4	46.0
1.102000	21.3	Off	N	19.6	24.7	46.0
2.374000	25.6	Off	N	19.6	20.4	46.0
4.126000	16.4	Off	N	19.8	29.6	46.0
7.302000	18.5	Off	N	19.9	31.5	50.0



3.7 Antenna Requirements

3.7.1 Standard Applicable

If directional gain of transmitting antennas is greater than 6dBi, the power shall be reduced by the same level in dB comparing to gain minus 6dBi. The use of a permanently attached antenna or of an antenna that uses a unique coupling to the intentional radiator shall be considered sufficient to comply with the FCC rule.

3.7.2 Antenna Anti-Replacement Construction

An embedded-in antenna design is used.

3.7.3 Antenna Gain

The antenna peak gain of EUT is less than 6 dBi. Therefore, it is not necessary to reduce maximum peak output power limit.



4 List of Measuring Equipment

Instrument	Manufacturer	Model No.	Serial No.	Characteristics	Calibration Date	Test Date	Due Date	Remark
Power Meter	Anritsu	ML2495A	1132003	300MHz~40GHz	Aug. 12, 2015	Jun. 21, 2016	Aug. 11, 2016	Conducted (TH05-HY)
Power Sensor	Anritsu	MA2411B	1126017	300MHz~40GHz	Aug. 12, 2015	Jun. 21, 2016	Aug. 11, 2016	Conducted (TH05-HY)
Spectrum Analyzer	Rohde & Schwarz	FSP40	100057	9kHz-40GHz	Nov. 23, 2015	Jun. 21, 2016	Nov. 22, 2016	Conducted (TH05-HY)
Bilog Antenna	TESEQ	CBL 6111D	35419	30MHz to 1GHz	Jan. 13, 2016	Jun. 14, 2016 ~ Jul. 15, 2016	Jan. 12, 2017	Radiation (03CH07-HY)
Double Ridge Horn Antenna	ESCO	3117	00075962	1GHz ~ 18GHz	Aug. 21, 2015	Jun. 14, 2016 ~ Jul. 15, 2016	Aug. 20, 2016	Radiation (03CH07-HY)
EMI Test Receiver	Keysight	N9038A(MXE)	MY541300 85	20Hz ~ 8.4GHz	Nov. 04, 2015	Jun. 14, 2016 ~ Jul. 15, 2016	Nov. 03, 2016	Radiation (03CH07-HY)
Loop Antenna	Rohde & Schwarz	HFH2-Z2	100315	9 kHz~30 MHz	Sep. 02, 2015	Jun. 14, 2016 ~ Jul. 15, 2016	Sep. 01, 2016	Radiation (03CH07-HY)
Preamplifier	MITEQ	AMF-7D-00101 800-30-10P	1590075	1GHz ~ 18GHz	Apr. 15, 2016	Jun. 14, 2016 ~ Jul. 15, 2016	Apr. 14, 2017	Radiation (03CH07-HY)
Preamplifier	COM-POWER	PA-103A	161241	10MHz-1GHz	Mar. 18, 2016	Jun. 14, 2016 ~ Jul. 15, 2016	Mar. 17, 2017	Radiation (03CH07-HY)
Preamplifier	Agilent	8449B	3008A023 62	1GHz~ 26.5GHz	Oct. 19, 2015	Jun. 14, 2016 ~ Jul. 15, 2016	Oct. 18, 2016	Radiation (03CH07-HY)
Spectrum Analyzer	Agilent	N9010A	MY534701 18	10Hz~44GHz	Feb. 27, 2016	Jun. 14, 2016 ~ Jul. 15, 2016	Feb. 26, 2017	Radiation (03CH07-HY)
Antenna Mast	Max-Full	MFA520BS	N/A	1m~4m	N/A	Jun. 14, 2016 ~ Jul. 15, 2016	N/A	Radiation (03CH07-HY)
Turn Table	ChainTek	Chaintek 3000	N/A	0~360 Degree	N/A	Jun. 14, 2016 ~ Jul. 15, 2016	N/A	Radiation (03CH07-HY)
Preamplifier	MITEQ	TTA0204	1872107	2GHz~40GHz	Feb. 15, 2015	Jun. 14, 2016 ~ Jul. 15, 2016	Feb. 14, 2017	Radiation (03CH07-HY)
SHF-EHF Horn Antenna	SCHWARZBECK	BBHA 9170	BBHA9170 584	18GHz- 40GHz	Nov. 02, 2015	Jun. 14, 2016 ~ Jul. 15, 2016	Nov. 01, 2016	Radiation (03CH07-HY)
AC Power Source	ChainTek	APC-1000W	N/A	N/A	N/A	Jun. 13, 2016	N/A	Conduction (CO05-HY)
EMI Test Receiver	Rohde & Schwarz	ESCI 7	100724	9kHz~7GHz	Aug. 26, 2015	Jun. 13, 2016	Aug. 25, 2016	Conduction (CO05-HY)
LISN	Rohde & Schwarz	ENV216	100080	9kHz~30MHz	Dec. 02, 2015	Jun. 13, 2016	Dec. 01, 2016	Conduction (CO05-HY)



5 Uncertainty of Evaluation

Uncertainty of Conducted Emission Measurement (150 kHz ~ 30 MHz)

Measuring Uncertainty for a Level of Confidence of 95% ($U = 2Uc(y)$)	2.26
---	------

Uncertainty of Radiated Emission Measurement (30 MHz ~ 1000 MHz)

Measuring Uncertainty for a Level of Confidence of 95% ($U = 2Uc(y)$)	4.50
---	------



Appendix A. Conducted Test Results

Bluetooth Low Energy

Test Engineer:	AnAn Wu	Temperature:	21~25	°C
Test Date:	2016/6/21	Relative Humidity:	51~54	%

TEST RESULTS DATA
6dB and 99% Occupied Bandwidth

Mod.	Data Rate	NTX	CH.	Freq. (MHz)	99% Occupied BW (MHz)	6dB BW (MHz)	6dB BW Limit (MHz)	Pass/Fail
BLE	1Mbps	1	0	2402	1.05	0.72	0.50	Pass
BLE	1Mbps	1	19	2440	1.05	0.72	0.50	Pass
BLE	1Mbps	1	39	2480	1.05	0.71	0.50	Pass

TEST RESULTS DATA
Peak Power Table

Mod.	Data Rate	NTX	CH.	Freq. (MHz)	Peak Conducted Power (dBm)	Conducted Power Limit (dBm)	DG (dBi)	EIRP Power (dBm)	EIRP Power Limit (dBm)	Pass /Fail
BLE	1Mbps	1	0	2402	3.92	30.00	1.90	5.82	36.00	Pass
BLE	1Mbps	1	19	2440	4.75	30.00	1.90	6.65	36.00	Pass
BLE	1Mbps	1	39	2480	5.56	30.00	1.90	7.46	36.00	Pass

TEST RESULTS DATA
Average Power Table
(Reporting Only)

Mod.	Data Rate	NTX	CH.	Freq. (MHz)	Duty Factor (dB)	Average Conducted Power (dBm)
BLE	1Mbps	1	0	2402	2.08	3.49
BLE	1Mbps	1	19	2440	2.08	4.40
BLE	1Mbps	1	39	2480	2.08	5.28

TEST RESULTS DATA
Peak Power Density

Mod.	Data Rate	NTX	CH.	Freq. (MHz)	Peak PSD (dBm /100kHz)	Peak PSD (dBm /3kHz)	DG (dBi)	Peak PSD Limit (dBm /3kHz)	Pass/Fail
BLE	1Mbps	1	0	2402	3.36	-10.46	1.90	8.00	Pass
BLE	1Mbps	1	19	2440	4.26	-9.43	1.90	8.00	Pass
BLE	1Mbps	1	39	2480	5.11	-8.73	1.90	8.00	Pass

Note: PSD (dBm/ 100kHz) is a reference level used for Conducted Band Edges and Conducted Spurious Emission 20dBc limit.



Appendix B. Radiated Spurious Emission

Test Engineer :	Luke Chang/Jesse Wang/Derreck Chen/James Chiu	Temperature :	21~24°C
		Relative Humidity :	50~54%

2.4GHz 2400~2483.5MHz

BLE (Band Edge @ 3m)

BLE	Note	Frequency	Level	Over	Limit	Read	Antenna	Cable	Preamp	Ant	Table	Peak	Pol.	
		(MHz)	(dBμV/m)	(dB)	Limit Line (dBμV/m)	(dBμV)	(dB/m)	(dB)	(dB)	(cm)	(deg)	(P/A)	(H/V)	
BLE CH 00 2402MHz		2356.35	55.66	-18.34	74	50.97	31.84	7.24	34.39	158	156	P	H	
		2388.48	45.85	-8.15	54	40.95	31.93	7.31	34.34	158	156	A	H	
		2402	99.88	-31.42	131.3	94.95	31.93	7.31	34.31	158	156	P	H	
		2402	99.13	-12.17	111.3	94.2	31.93	7.31	34.31	158	156	A	H	
													H	
														H
			2352.21	55.43	-18.57	74	50.75	31.84	7.24	34.4	302	260	P	V
			2385.33	45.84	-8.16	54	40.98	31.89	7.31	34.34	302	260	A	V
			2402	101.7	-29.6	131.3	96.77	31.93	7.31	34.31	302	260	P	V
			2402	100.73	-10.57	111.3	95.8	31.93	7.31	34.31	302	260	A	V
BLE CH 19 2440MHz													V	
													V	
			2388.12	55.13	-18.87	74	50.23	31.93	7.31	34.34	249	233	P	H
			2377.86	46.06	-7.94	54	41.28	31.89	7.24	34.35	249	233	A	H
			2440	100.21	-31.09	131.3	95.03	32.07	7.36	34.25	249	233	P	H
			2440	99.41	-11.89	111.3	94.23	32.07	7.36	34.25	249	233	A	H
			2488.96	56.27	-17.73	74	50.84	32.2	7.4	34.17	249	233	P	H
			2497.44	46.65	-7.35	54	41.2	32.2	7.4	34.15	249	233	A	H
			2361.03	55.19	-18.81	74	50.49	31.84	7.24	34.38	313	254	P	V
			2385.96	46.25	-7.75	54	41.35	31.93	7.31	34.34	313	254	A	V
			2440	103.15	-28.15	131.3	97.97	32.07	7.36	34.25	313	254	P	V
			2440	102.59	-8.71	111.3	97.41	32.07	7.36	34.25	313	254	A	V
		2496.4	56.09	-17.91	74	50.65	32.2	7.4	34.16	313	254	P	V	
		2499.48	46.67	-7.33	54	41.22	32.2	7.4	34.15	313	254	A	V	



BLE CH 39 2480MHz		2480	101.79	-29.51	131.3	96.41	32.16	7.4	34.18	245	234	P	H
		2480	101.14	-10.16	111.3	95.76	32.16	7.4	34.18	245	234	A	H
		2500	56.2	-17.8	74	50.75	32.2	7.4	34.15	245	234	P	H
		2499.16	46.56	-7.44	54	41.11	32.2	7.4	34.15	245	234	A	H
													H
													H
		2480	103.5	-27.8	131.3	98.12	32.16	7.4	34.18	308	256	P	V
		2480	102.86	-8.44	111.3	97.48	32.16	7.4	34.18	308	256	A	V
		2489.16	55.49	-18.51	74	50.06	32.2	7.4	34.17	308	256	P	V
		2494.44	46.65	-7.35	54	41.21	32.2	7.4	34.16	308	256	A	V
													V
													V
Remark	<ol style="list-style-type: none"> 1. No other spurious found. 2. All results are PASS against Peak and Average limit line. 												



2.4GHz 2400~2483.5MHz
BLE (Harmonic @ 3m)

BLE	Note	Frequency (MHz)	Level (dBμV/m)	Over Limit (dB)	Limit Line (dBμV/m)	Read Level (dBμV)	Antenna Factor (dB/m)	Cable Loss (dB)	Preamp Factor (dB)	Ant Pos (cm)	Table Pos (deg)	Peak Avg. (P/A)	Pol. (H/V)
BLE CH 00 2402MHz		4806	42.61	-31.39	74	55.67	34.19	11.83	59.08	100	0	P	H
													H
													H
													H
		4806	43.21	-30.79	74	56.27	34.19	11.83	59.08	100	0	P	V
													V
													V
BLE CH 19 2440MHz		4878	40.08	-33.92	74	53.26	34.23	11.53	58.94	100	0	P	H
		7320	40.54	-33.46	74	49.09	35.6	13.81	57.96	100	0	P	H
													H
													H
		4878	41.08	-32.92	74	54.26	34.23	11.53	58.94	100	0	P	V
		7320	40.23	-33.77	74	48.78	35.6	13.81	57.96	100	0	P	V
													V
BLE CH 39 2480MHz		4962	41.6	-32.4	74	54.87	34.28	11.22	58.77	100	0	P	H
		7440	41.37	-32.63	74	49.85	35.6	14.05	58.13	100	0	P	H
													H
													H
		4962	41.74	-32.26	74	55.01	34.28	11.22	58.77	100	0	P	V
		7440	41.26	-32.74	74	49.74	35.6	14.05	58.13	100	0	P	V
													V
Remark	1. No other spurious found. 2. All results are PASS against Peak and Average limit line.												



Emission below 1GHz

2.4GHz BLE (LF)

BLE	Note	Frequency	Level	Over	Limit	Read	Antenna	Cable	Preamp	Ant	Table	Peak	Pol.	
		(MHz)	(dBμV/m)	(dB)	(dBμV/m)	(dBμV)	(dB/m)	(dB)	(dB)	(cm)	(deg)	(P/A)	(H/V)	
2.4GHz BLE LF		30.27	28.15	-11.85	40	32.43	26	1.07	31.35			P	H	
		100.47	31.38	-12.12	43.5	44.86	16.49	1.55	31.52			P	H	
		236.55	37.36	-8.64	46	48.93	17.76	2.07	31.4	100	0	P	H	
		465.2	26.87	-19.13	46	31.46	23.44	3.04	31.07			P	H	
		659.8	36.37	-9.63	46	37.56	26	3.57	30.76			P	H	
		780.2	35.35	-10.65	46	34.57	27.5	3.9	30.62			P	H	
														H
														H
														H
														H
														H
														H
			35.13	31.71	-8.29	40	38.75	23.3	1.07	31.41	100	0	P	V
			105.33	22.08	-21.42	43.5	35.11	16.94	1.55	31.52			P	V
			236.55	26.43	-19.57	46	38	17.76	2.07	31.4			P	V
			316.1	37.36	-8.64	46	45.94	20.26	2.41	31.25			P	V
			659.8	33.69	-12.31	46	34.88	26	3.57	30.76			P	V
			780.2	33.75	-12.25	46	32.97	27.5	3.9	30.62			P	V
														V
														V
													V	
													V	
													V	
													V	
Remark	1. No other spurious found. 2. All results are PASS against limit line.													



Note symbol

*	Fundamental Frequency which can be ignored. However, the level of any unwanted emissions shall not exceed the level of the fundamental frequency.
!	Test result is over limit line.
P/A	Peak or Average
H/V	Horizontal or Vertical



A calculation example for radiated spurious emission is shown as below:

WIFI	Note	Frequency	Level	Over	Limit	Read	Antenna	Cable	Preamp	Ant	Table	Peak	Pol.
Ant.				Limit	Line	Level	Factor	Loss	Factor	Pos	Pos	Avg.	
1+2		(MHz)	(dBμV/m)	(dB)	(dBμV/m)	(dBμV)	(dB/m)	(dB)	(dB)	(cm)	(deg)	(P/A)	(H/V)
802.11b		2390	55.45	-18.55	74	54.51	32.22	4.58	35.86	103	308	P	H
CH 01													
2412MHz		2390	43.54	-10.46	54	42.6	32.22	4.58	35.86	103	308	A	H

- Level(dBμV/m) =
Antenna Factor(dB/m) + Cable Loss(dB) + Read Level(dBμV) - Preamp Factor(dB)
- Over Limit(dB) = Level(dBμV/m) – Limit Line(dBμV/m)

For Peak Limit @ 2390MHz:

- Level(dBμV/m)
= Antenna Factor(dB/m) + Cable Loss(dB) + Read Level(dBμV) - Preamp Factor(dB)
= 32.22(dB/m) + 4.58(dB) + 54.51(dBμV) – 35.86 (dB)
= 55.45 (dBμV/m)
- Over Limit(dB)
= Level(dBμV/m) – Limit Line(dBμV/m)
= 55.45(dBμV/m) – 74(dBμV/m)
= -18.55(dB)

For Average Limit @ 2390MHz:

- Level(dBμV/m)
= Antenna Factor(dB/m) + Cable Loss(dB) + Read Level(dBμV) - Preamp Factor(dB)
= 32.22(dB/m) + 4.58(dB) + 42.6(dBμV) – 35.86 (dB)
= 43.54 (dBμV/m)
- Over Limit(dB)
= Level(dBμV/m) – Limit Line(dBμV/m)
= 43.54(dBμV/m) – 54(dBμV/m)
= -10.46(dB)

Both peak and average measured complies with the limit line, so test result is “PASS”.



Appendix C. Radiated Spurious Emission

Test Engineer :	Luke Chang/Jesse Wang/Derreck Chen/James Chiu	Temperature :	21~24°C
		Relative Humidity :	50~54%

Note symbol

-L	Low channel location
-R	High channel location



2.4GHz 2400~2483.5MHz

BLE (Band Edge @ 3m)

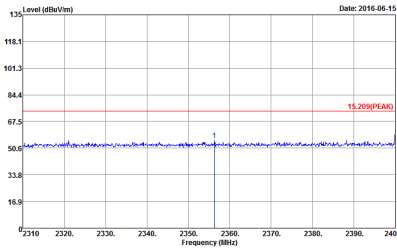
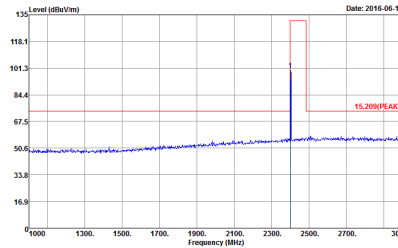
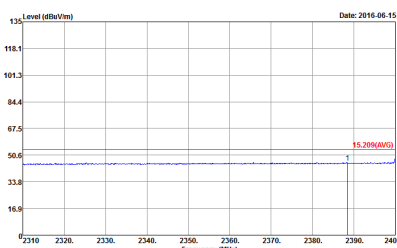
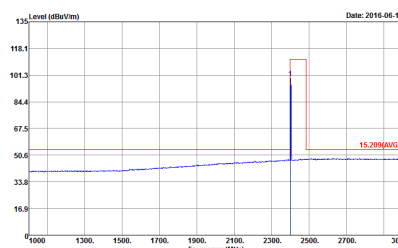
BLE	2.4GHz 2400~2483.5MHz Band Edge @ 3m	
ANT	BLE CH00 2402MHz	
1+2	Horizontal	Fundamental
Peak	 <p>Site : 03CH07-4Y Condition : 15.209(Peak) 3m HF-ANT_130829 HORIZONTAL Detector : Peak Project : 660115 Mode : 5</p>	 <p>Site : 03CH07-4Y Condition : 15.209(Peak) 3m HF-ANT_130829 HORIZONTAL Detector : Peak Project : 660115 Mode : 5</p>
Avg.	 <p>Site : 03CH07-4Y Condition : 15.209(AVG) 3m HF-ANT_130829 HORIZONTAL Detector : Peak Project : 660115 Mode : 5</p>	 <p>Site : 03CH07-4Y Condition : 15.209(AVG) 3m HF-ANT_130829 HORIZONTAL Detector : Peak Project : 660115 Mode : 5</p>

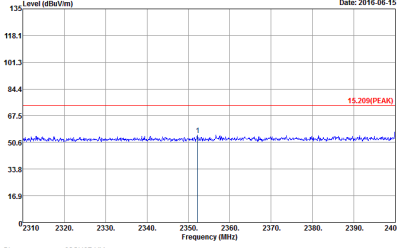
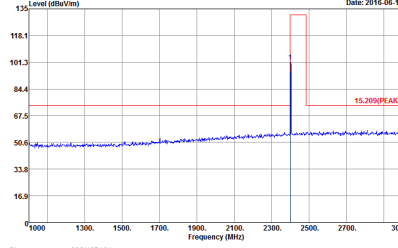
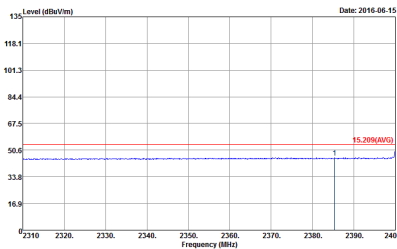
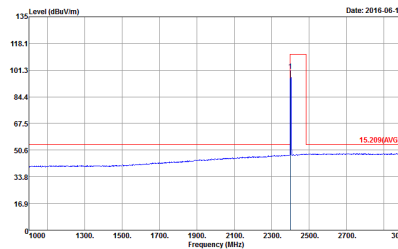

BLE	2.4GHz 2400~2483.5MHz Band Edge @ 3m	
ANT	BLE CH00 2402MHz	
1+2	Vertical	Fundamental
Peak	 <p>Date: 2016-06-15</p> <p>Site : 03CH07-HY Condition : 15.209(PEAK) 3m HF-ANT_130829 VERTICAL RBW: 1000.000kHz VBW: 3000.000kHz SWT: Auto Detector : Peak Project : 660115 Mode : 5</p>	 <p>Date: 2016-06-15</p> <p>Site : 03CH07-HY Condition : 15.209(PEAK) 3m HF-ANT_130829 VERTICAL RBW: 1000.000kHz VBW: 3000.000kHz SWT: Auto Detector : Peak Project : 660115 Mode : 5</p>
Avg	 <p>Date: 2016-06-15</p> <p>Site : 03CH07-HY Condition : 15.209(AVG) 3m HF-ANT_130829 VERTICAL RBW: 1000.000kHz VBW: 3.000kHz SWT: Auto Detector : Peak Project : 660115 Mode : 5</p>	 <p>Date: 2016-06-15</p> <p>Site : 03CH07-HY Condition : 15.209(AVG) 3m HF-ANT_130829 VERTICAL RBW: 1000.000kHz VBW: 3.000kHz SWT: Auto Detector : Peak Project : 660115 Mode : 5</p>

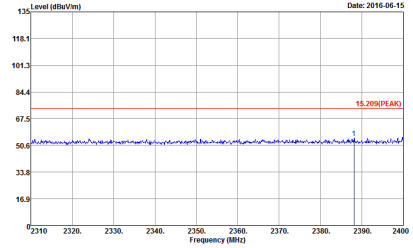
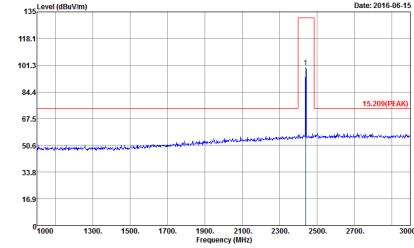
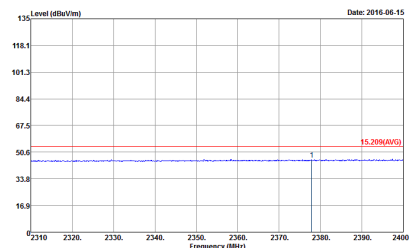
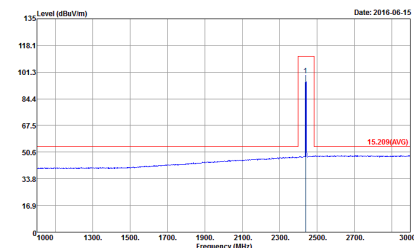

BLE	2.4GHz 2400~2483.5MHz Band Edge @ 3m	
ANT	BLE CH19 2440MHz - L	
1+2	Horizontal	Fundamental
Peak	 <p>Site : 03CH07-HY Condition : 15.209(Peak) 3m HF-ANT_130829 HORIZONTAL RBW: 1000.000kHz VBW: 3000.000kHz SWT: Auto Detector : Peak Project : 660115 Mode : 6</p>	 <p>Site : 03CH07-HY Condition : 15.209(Peak) 3m HF-ANT_130829 HORIZONTAL RBW: 1000.000kHz VBW: 3000.000kHz SWT: Auto Detector : Peak Project : 660115 Mode : 6</p>
Avg.	 <p>Site : 03CH07-HY Condition : 15.209(AVG) 3m HF-ANT_130829 HORIZONTAL RBW: 1000.000kHz VBW: 3.000kHz SWT: Auto Detector : Peak Project : 660115 Mode : 6</p>	 <p>Site : 03CH07-HY Condition : 15.209(AVG) 3m HF-ANT_130829 HORIZONTAL RBW: 1000.000kHz VBW: 3.000kHz SWT: Auto Detector : Peak Project : 660115 Mode : 6</p>

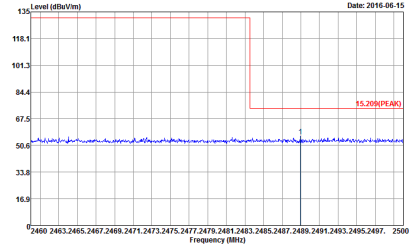
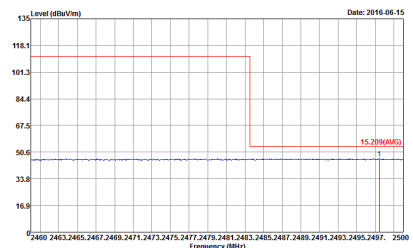

BLE	2.4GHz 2400~2483.5MHz Band Edge @ 3m	
ANT	BLE CH19 2440MHz - R	
1+2	Horizontal	
Peak	 <p>Site : 03CH07-4HY Condition : 15.209(PEAK) 3m HF-ANT_130829 HORIZONTAL : RBW:1000.000kHz VBW:3000.000kHz SWT:Auto Detector : Peak Project : 660115 Mode : 6</p>	
Avg.	 <p>Site : 03CH07-4HY Condition : 15.209(AVG) 3m HF-ANT_130829 HORIZONTAL : RBW:1000.000kHz VBW:3.000kHz SWT:Auto Detector : Peak Project : 660115 Mode : 6</p>	

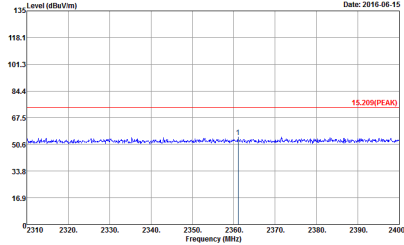
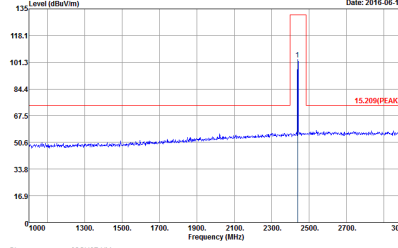
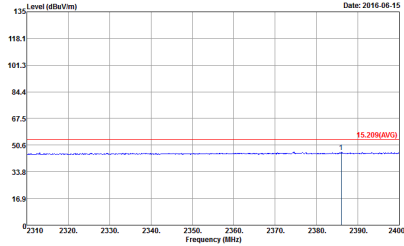
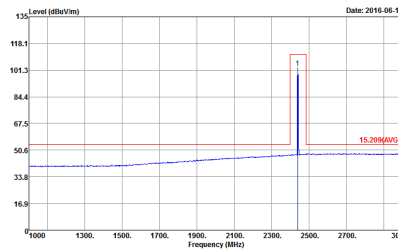

BLE	2.4GHz 2400~2483.5MHz Band Edge @ 3m	
ANT	BLE CH19 2440MHz - L	
1+2	Vertical	Fundamental
Peak	 <p>Site : 03CH07-HY Condition : 15.209(Peak) 3m HF-ANT_130829 VERTICAL RBW: 1000.000kHz VBW: 3000.000kHz SWT: Auto Detector : Peak Project : 660115 Mode : 6</p>	 <p>Site : 03CH07-HY Condition : 15.209(Peak) 3m HF-ANT_130829 VERTICAL RBW: 1000.000kHz VBW: 3000.000kHz SWT: Auto Detector : Peak Project : 660115 Mode : 6</p>
Avg.	 <p>Site : 03CH07-HY Condition : 15.209(Avg) 3m HF-ANT_130829 VERTICAL RBW: 1000.000kHz VBW: 3.000kHz SWT: Auto Detector : Peak Project : 660115 Mode : 6</p>	 <p>Site : 03CH07-HY Condition : 15.209(Avg) 3m HF-ANT_130829 VERTICAL RBW: 1000.000kHz VBW: 3.000kHz SWT: Auto Detector : Peak Project : 660115 Mode : 6</p>

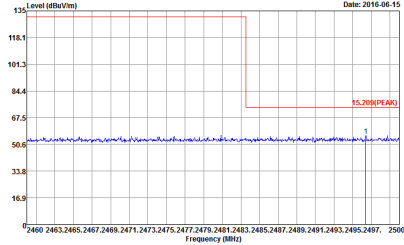
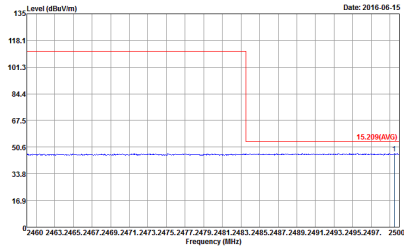

BLE	2.4GHz 2400~2483.5MHz Band Edge @ 3m	
ANT	BLE CH19 2440MHz - R	
1+2	Vertical	
Peak	 <p>Date: 2016-06-15</p> <p>115.209(PKAW)</p> <p>130 118.1 101.3 84.4 67.5 50.6 33.8 16.9</p> <p>2460 2463.2465.2467.2469.2471.2473.2475.2477.2479.2481.2483.2485.2487.2489.2491.2493.2495.2497. 2500</p> <p>Frequency (MHz)</p> <p>Site : 03CH07-4HY Condition : 15.209(PKAW) 3m HF-ANT_130829 VERTICAL Detector : RBW:1000.000kHz VBW:3000.000kHz SWT:Auto Project : 660115 Mode : 6</p>	
Avg.	 <p>Date: 2016-06-15</p> <p>115.209(AVG)</p> <p>130 118.1 101.3 84.4 67.5 50.6 33.8 16.9</p> <p>2460 2463.2465.2467.2469.2471.2473.2475.2477.2479.2481.2483.2485.2487.2489.2491.2493.2495.2497. 2500</p> <p>Frequency (MHz)</p> <p>Site : 03CH07-4HY Condition : 15.209(AVG) 3m HF-ANT_130829 VERTICAL Detector : Peak Project : 660115 Mode : 6</p>	

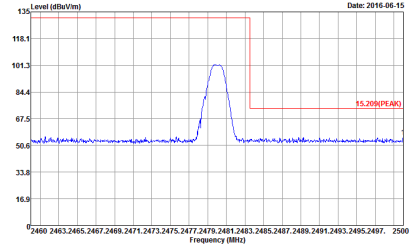
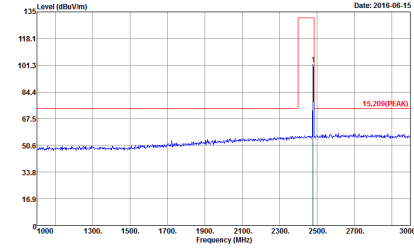
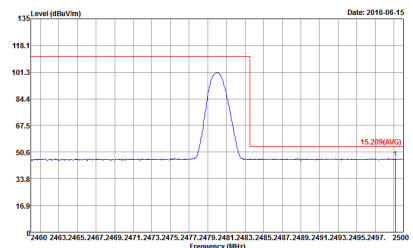
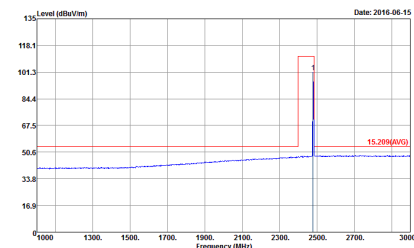

BLE	2.4GHz 2400~2483.5MHz Band Edge @ 3m	
ANT	BLE CH39 2480MHz	
1+2	Horizontal	Fundamental
Peak	 <p>Site : 03CH07-HY Condition : 15.209(Peak) 3m HF-ANT_130829 HORIZONTAL RBW: 1000.000kHz VBW: 3000.000kHz SWT: Auto Detector : Peak Project : 660115 Mode : 7</p>	 <p>Site : 03CH07-HY Condition : 15.209(Peak) 3m HF-ANT_130829 HORIZONTAL RBW: 1000.000kHz VBW: 3000.000kHz SWT: Auto Detector : Peak Project : 660115 Mode : 7</p>
Avg.	 <p>Site : 03CH07-HY Condition : 15.209(Avg) 3m HF-ANT_130829 HORIZONTAL RBW: 1000.000kHz VBW: 3.000kHz SWT: Auto Detector : Peak Project : 660115 Mode : 7</p>	 <p>Site : 03CH07-HY Condition : 15.209(Avg) 3m HF-ANT_130829 HORIZONTAL RBW: 1000.000kHz VBW: 3.000kHz SWT: Auto Detector : Peak Project : 660115 Mode : 7</p>

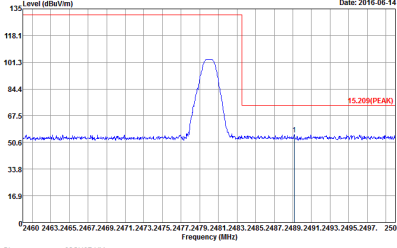
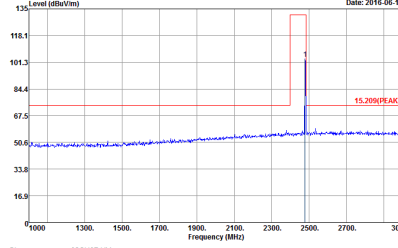
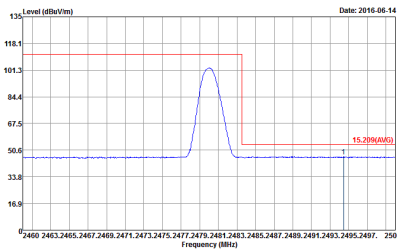
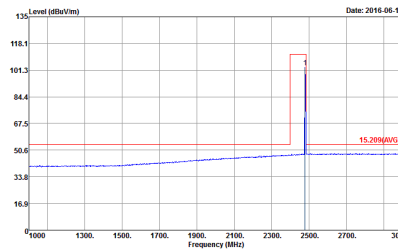

BLE	2.4GHz 2400~2483.5MHz Band Edge @ 3m	
ANT	BLE CH39 2480MHz	
1+2	Vertical	Fundamental
Peak	 <p>Site : 03CH07-HY Condition : 15.209(Peak) 3m HF-ANT_130829 VERTICAL RBW: 1000.000kHz VBW: 3000.000kHz SWT: Auto Detector : Peak Project : 660115 Mode : 7</p>	 <p>Site : 03CH07-HY Condition : 15.209(Peak) 3m HF-ANT_130829 VERTICAL RBW: 1000.000kHz VBW: 3000.000kHz SWT: Auto Detector : Peak Project : 660115 Mode : 7</p>
Avg.	 <p>Site : 03CH07-HY Condition : 15.209(Avg) 3m HF-ANT_130829 VERTICAL RBW: 1000.000kHz VBW: 3.000kHz SWT: Auto Detector : Peak Project : 660115 Mode : 7</p>	 <p>Site : 03CH07-HY Condition : 15.209(Avg) 3m HF-ANT_130829 VERTICAL RBW: 1000.000kHz VBW: 3.000kHz SWT: Auto Detector : Peak Project : 660115 Mode : 7</p>



2.4GHz 2400~2483.5MHz

BLE (Harmonic @ 3m)

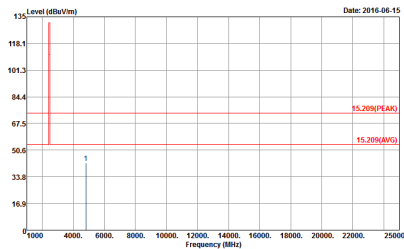
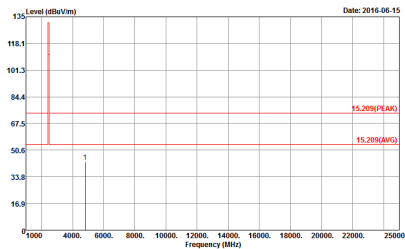
BLE	2.4GHz 2400~2483.5MHz Harmonic @ 3m	
ANT	BLE CH00 2402MHz	
1+2	Horizontal	Vertical
Peak Avg.	 <p>Site : 03CH07-11Y Condition : 15.209(PEAK) 3m SHF-EHF_131029 HORIZONTAL Detector : Peak Project : 660115 Mode : 5</p>	 <p>Site : 03CH07-11Y Condition : 15.209(PEAK) 3m SHF-EHF_131029 VERTICAL Detector : Peak Project : 660115 Mode : 5</p>



BLE	2.4GHz 2400~2483.5MHz Harmonic @ 3m	
ANT	BLE CH19 2440MHz	
1+2	Horizontal	Vertical
Peak Avg.	<p>Site : 03CH07-HY Condition : 15.209(PEAK) 3m SHF-EHF_131029 HORIZONTAL Detector : Peak Project : 660115 Mode : 6</p>	<p>Site : 03CH07-HY Condition : 15.209(PEAK) 3m SHF-EHF_131029 VERTICAL Detector : Peak Project : 660115 Mode : 6</p>



BLE	2.4GHz 2400~2483.5MHz Harmonic @ 3m	
ANT	BLE CH39 2480MHz	
1+2	Horizontal	Vertical
Peak	<p>Site : 03CH07-HY Condition : 15.209(PEAK) 3m SHF-EHF_131029 HORIZONTAL Detector : Peak Project : 660115 Mode : 7</p>	<p>Site : 03CH07-HY Condition : 15.209(PEAK) 3m SHF-EHF_131029 VERTICAL Detector : Peak Project : 660115 Mode : 7</p>



Emission below 1GHz

2.4GHz BLE (LF)

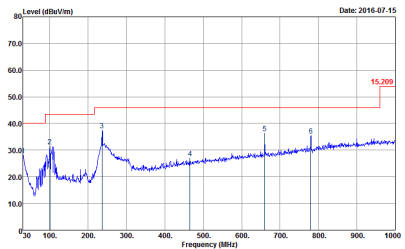
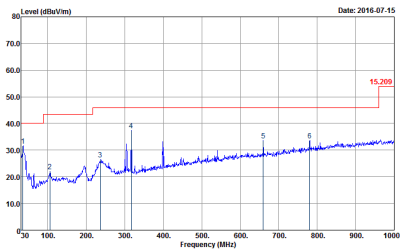
BLE	2.4GHz 2400~2483.5MHz	
ANT	BLE LF	
1+2	Horizontal	Vertical
QP / Peak	 <p>Site : 03CH07-4HY Condition : 15.209 3m LF-ANT-35419(6) HORIZONTAL Detector : Peak Project : 660115 Mode : 8</p>	 <p>Site : 03CH07-4HY Condition : 15.209 3m LF-ANT-35419(6) VERTICAL Detector : Peak Project : 660115 Mode : 8</p>

Appendix D. Duty Cycle Plots

Band	Duty Cycle(%)	T(us)	1/T(kHz)	VBW Setting
Bluetooth 4.0-LE	61.91	390	2.564102564	3kHz

Bluetooth 4.0-LE

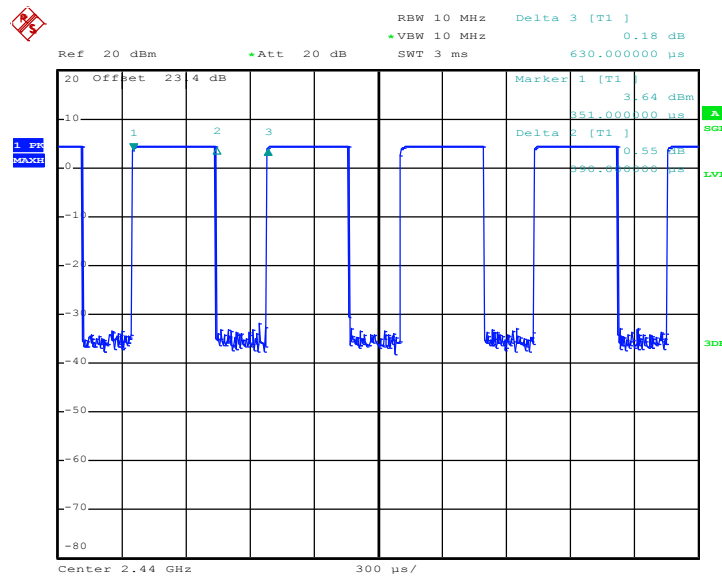

Date: 21.JUN.2016 05:11:00