



FCC RF Test Report

APPLICANT : Zebra Technologies Corporation
EQUIPMENT : Enterprise Tablet
BRAND NAME : Zebra
MODEL NAME : ET55BE
FCC ID : UZ7ET55BE
STANDARD : FCC Part 15 Subpart C §15.247
CLASSIFICATION : (DTS) Digital Transmission System

The product was received on May 03, 2016 and testing was completed on Jun. 13, 2016. We, SPORTON INTERNATIONAL INC., would like to declare that the tested sample has been evaluated in accordance with the test procedures and has been in compliance with the applicable technical standards.

The test results in this report apply exclusively to the tested model / sample. Without written approval of SPORTON INTERNATIONAL INC., the test report shall not be reproduced except in full.

Reviewed by: Joseph Lin / Supervisor

Approved by: Jones Tsai / Manager



SPORTON INTERNATIONAL INC.

No. 52, Hwa Ya 1st Rd., Hwa Ya Technology Park, Kwei-Shan District, Tao Yuan City, Taiwan, R.O.C.

SPORTON INTERNATIONAL INC.

TEL : 886-3-327-3456

FAX : 886-3-328-4978

FCC ID : UZ7ET55BE

Page Number : 1 of 103

Report Issued Date : Jun. 21, 2016

Report Version : Rev. 01

Report Template No.: BU5-FR15CWLAC MA Version 1.3



TABLE OF CONTENTS

REVISION HISTORY..... 3

SUMMARY OF TEST RESULT 4

1 GENERAL DESCRIPTION 5

 1.1 Applicant 5

 1.2 Manufacturer 5

 1.3 Product Feature of Equipment Under Test..... 5

 1.4 Product Specification of Equipment Under Test..... 6

 1.5 Modification of EUT 7

 1.6 Testing Location 7

 1.7 Applicable Standards..... 8

2 TEST CONFIGURATION OF EQUIPMENT UNDER TEST 9

 2.1 Carrier Frequency and Channel 9

 2.2 Pre-Scanned RF Power 10

 2.3 Test Mode 17

 2.4 Connection Diagram of Test System 18

 2.5 Support Unit used in test configuration and system 19

 2.6 EUT Operation Test Setup 20

 2.7 Measurement Results Explanation Example..... 20

3 TEST RESULT 21

 3.1 6dB and 99% Bandwidth Measurement 21

 3.2 Average Output Power Measurement 23

 3.3 Power Spectral Density Measurement 25

 3.4 Conducted Band Edges and Spurious Emission Measurement 29

 3.5 Radiated Band Edges and Spurious Emission Measurement 91

 3.6 AC Conducted Emission Measurement..... 96

 3.7 Antenna Requirements 100

4 LIST OF MEASURING EQUIPMENT 102

5 UNCERTAINTY OF EVALUATION 103

APPENDIX A. CONDUCTED TEST RESULTS

APPENDIX B. RADIATED SPURIOUS EMISSION

APPENDIX C. RADIATED SPURIOUS EMISSION PLOTS

APPENDIX D. DUTY CYCLE PLOTS

APPENDIX E. SETUP PHOTOGRAPHS



SUMMARY OF TEST RESULT

| Report Section | FCC Rule | Description | Limit | Result | Remark |
|----------------|--------------------|--|--------------------------------|--------|-------------------------------------|
| 3.1 | 15.247(a)(2) | 6dB Bandwidth | $\geq 0.5\text{MHz}$ | Pass | - |
| 3.1 | - | 99% Bandwidth | - | Pass | - |
| 3.2 | 15.247(b) | Power Output Measurement | $\leq 30\text{dBm}$ | Pass | - |
| 3.3 | 15.247(e) | Power Spectral Density | $\leq 8\text{dBm}/3\text{kHz}$ | Pass | - |
| 3.4 | 15.247(d) | Conducted Band Edges | $\leq 20\text{dBc}$ | Pass | - |
| | | Conducted Spurious Emission | | Pass | - |
| 3.5 | 15.247(d) | Radiated Band Edges and Radiated Spurious Emission | 15.209(a) & 15.247(d) | Pass | Under limit 1.04 dB at 2483.520 MHz |
| 3.6 | 15.207 | AC Conducted Emission | 15.207(a) | Pass | Under limit 14.60 dB at 1.030 MHz |
| 3.7 | 15.203 & 15.247(b) | Antenna Requirement | N/A | Pass | - |



1 General Description

1.1 Applicant

Zebra Technologies Corporation
1 Zebra Plaza, Holtsville, NY 11742

1.2 Manufacturer

Zebra Technologies Corporation
1 Zebra Plaza, Holtsville, NY 11742

1.3 Product Feature of Equipment Under Test

| Product Feature | |
|---------------------------------|---|
| Equipment | Enterprise Tablet |
| Brand Name | Zebra |
| Model Name | ET55BE |
| FCC ID | UZ7ET55BE |
| Integrated WWAN Module | Brand Name: Sierra Model Name: EM7355 FCC ID: N7NEM7355 |
| EUT supports Radios application | CDMA/EV-DO/GSM/EGPRS/WCDMA/HSPA/LTE/NFC WLAN 11a/b/g/n HT20/HT40 WLAN 11ac VHT20/VHT40/VHT80 Bluetooth v4.0 EDR/LE |
| HW Version | DV1 |
| SW Version | 5.1.1 |
| FW Version | 7.35.205.4 |
| MFD | 23-Mar-16 |
| EUT Stage | Identical Prototype |

Remark: The above EUT's information was declared by manufacturer. Please refer to the specifications or user's manual for more detailed description.



1.4 Product Specification of Equipment Under Test

| Standards-related Product Specification | |
|---|---|
| Tx/Rx Channel Frequency Range | 802.11b/g/n/ac : 2412 MHz ~ 2462 MHz |
| Maximum Output Power to antenna <Non-TXBF Modes> | <p>SISO <Ant. 1> 802.11b : 15.46 dBm (0.0352 W) 802.11g : 15.38 dBm (0.0345 W) 802.11n HT20 : 15.29 dBm (0.0338 W) 802.11n HT40 : 15.33 dBm (0.0341 W) 802.11ac VHT20 : 15.39 dBm (0.0346 W) 802.11ac VHT40 : 15.35 dBm (0.0343 W)</p> <p>SISO <Ant. 2> 802.11b : 15.44 dBm (0.0350 W) 802.11g : 15.35 dBm (0.0343 W) 802.11n HT20 : 15.36 dBm (0.0344 W) 802.11n HT40 : 15.32 dBm (0.0340 W) 802.11ac VHT20 : 15.33 dBm (0.0341 W) 802.11ac VHT40 : 15.37 dBm (0.0344 W)</p> <p>MIMO <Ant. 1+2> 802.11b : 18.49 dBm (0.0706 W) 802.11g : 18.42 dBm (0.0695 W) 802.11n HT20 : 18.45 dBm (0.0700 W) 802.11n HT40 : 18.40 dBm (0.0692 W) 802.11ac VHT20 : 18.44 dBm (0.0698 W) 802.11ac VHT40 : 18.41 dBm (0.0693 W)</p> |
| Maximum Output Power to antenna <TXBF Modes> | <p>MIMO <Ant. 1+2> 802.11n HT20 : 18.31 dBm (0.0678 W) 802.11n HT40 : 18.37 dBm (0.0687 W) 802.11ac VHT20 : 18.36 dBm (0.0685 W) 802.11ac VHT40 : 18.36 dBm (0.0685 W)</p> |
| 99% Occupied Bandwidth <Non-TXBF Modes> | 802.11b : 11.90MHz 802.11g : 18.35MHz 802.11n HT20 : 19.15MHz 802.11n HT40 : 36.80MHz 802.11ac VHT20 : 19.10MHz 802.11ac VHT40 : 36.90MHz |
| 99% Occupied Bandwidth <TXBF Modes> | 802.11n HT20 : 19.05MHz 802.11n HT40 : 36.50MHz 802.11ac VHT20 : 18.75MHz 802.11ac VHT40 : 36.50MHz |
| Antenna Type | <p><Ant 1> 802.11b/g/n/ac : Ceramic Chip Antenna type with gain 1.90 dBi</p> <p><Ant 2> 802.11b/g/n/ac : Ceramic Chip Antenna type with gain 1.50 dBi</p> |
| Type of Modulation | 802.11b : DSSS (DBPSK / DQPSK / CCK) 802.11g/n : OFDM (BPSK / QPSK / 16QAM / 64QAM) 802.11ac : OFDM (BPSK / QPSK / 16QAM / 64QAM / 256QAM) |



| Standards-related Product Specification | | | |
|---|----------------------|--------|--------|
| Antenna Function for Transmitter | | Ant. 1 | Ant. 2 |
| | 802.11 b/g/n/ac SISO | V | V |
| | 802.11 b/g/n/ac MIMO | V | V |

1.5 Modification of EUT

No modifications are made to the EUT during all test items.

1.6 Testing Location

Sporton Lab is accredited to ISO 17025 by Taiwan Accreditation Foundation (TAF code : 1190) and the FCC designation No. TW1022 under the FCC 2.948(e) by Mutual Recognition Agreement (MRA) in FCC Test.

| | | | |
|--------------------|--|---------|-----------|
| Test Site | SPORTON INTERNATIONAL INC. | | |
| Test Site Location | No. 52, Hwa Ya 1 st Rd., Hwa Ya Technology Park, Kwei-Shan District, Tao Yuan City, Taiwan, R.O.C. TEL: +886-3-327-3456 FAX: +886-3-328-4978 | | |
| Test Site No. | Sporton Site No. | | |
| | TH05-HY | CO05-HY | 03CH07-HY |

Note: The test site complies with ANSI C63.4 2014 requirement.



1.7 Applicable Standards

According to the specifications of the manufacturer, the EUT must comply with the requirements of the following standards:

- ♦ FCC Part 15 Subpart C §15.247
- ♦ FCC KDB Publication No. 558074 D01 DTS Meas. Guidance v03r05
- ♦ FCC KDB 662911 D01 Multiple Transmitter Output v02r01.
- ♦ FCC KDB 644545 D03 Guidance for IEEE 802 11ac New Rules v01
- ♦ ANSI C63.10-2013

Remark:

1. All test items were verified and recorded according to the standards and without any deviation during the test.
2. This EUT has also been tested and complied with the requirements of FCC Part 15, Subpart B, recorded in a separate test report.



2 Test Configuration of Equipment Under Test

The EUT has been associated with peripherals and configuration operated in a manner tended to maximize its emission characteristics in a typical application. Frequency range investigated: conducted emission (150 kHz to 30 MHz) and radiated emission (9 kHz to the 10th harmonic of the highest fundamental frequency or to 40 GHz, whichever is lower). For radiated measurement, pre-scanned in three orthogonal panels, X, Y, Z. The worst cases (X and Z plane) were recorded in this report.

The final configuration from all the combinations and the worst-case data rates were investigated by measuring the maximum power across all the data rates and modulation modes under section 2.2.

Based on the worst configuration found above, the RF power setting is set individually to meet FCC compliance limit for the final conducted and radiated tests shown in section 2.3.

2.1 Carrier Frequency and Channel

| Frequency Band | Channel | Freq. (MHz) | Channel | Freq. (MHz) |
|-----------------|---------|-------------|---------|-------------|
| 2400-2483.5 MHz | 1 | 2412 | 7 | 2442 |
| | 2 | 2417 | 8 | 2447 |
| | 3 | 2422 | 9 | 2452 |
| | 4 | 2427 | 10 | 2457 |
| | 5 | 2432 | 11 | 2462 |
| | 6 | 2437 | | |



2.2 Pre-Scanned RF Power

Preliminary tests were performed in different data rate and data rate associated with the highest power were chosen for full test shown in the following tables.

<Non-TXBF Modes>

SISO <Ant. 1>

| Channel | Frequency | 2.4GHz 802.11b RF Average Power (dBm) | | | |
|---------|-----------|---------------------------------------|--------|----------|---------|
| | | DSSS Data Rate | | | |
| | | 1 Mbps | 2 Mbps | 5.5 Mbps | 11 Mbps |
| CH 01 | 2412MHz | 15.42 | 15.37 | 15.36 | 15.38 |
| CH 06 | 2437MHz | 15.46 | 15.34 | 15.38 | 15.41 |
| CH 11 | 2462MHz | 15.38 | 15.23 | 15.29 | 15.23 |

| Channel | Frequency | 2.4GHz 802.11g RF Average Power (dBm) | | | | | | | |
|---------|-----------|---------------------------------------|--------|---------|---------|---------|---------|---------|---------|
| | | OFDM Data Rate | | | | | | | |
| | | 6 Mbps | 9 Mbps | 12 Mbps | 18 Mbps | 24 Mbps | 36 Mbps | 48 Mbps | 54 Mbps |
| CH 01 | 2412MHz | 15.38 | 15.37 | 15.34 | 15.33 | 15.36 | 15.03 | 14.64 | 14.43 |
| CH 06 | 2437MHz | 15.32 | 15.28 | 15.30 | 15.24 | 15.27 | 14.90 | 14.55 | 14.34 |
| CH 11 | 2462MHz | 15.37 | 15.33 | 15.35 | 15.31 | 15.26 | 14.96 | 14.66 | 14.36 |

| Channel | Frequency | 2.4GHz 802.11n HT20 RF Average Power (dBm) | | | | | | | |
|---------|-----------|--|-------|-------|-------|-------|-------|-------|-------|
| | | OFDM Data Rate | | | | | | | |
| | | MCS0 | MCS1 | MCS2 | MCS3 | MCS4 | MCS5 | MCS6 | MCS7 |
| CH 01 | 2412MHz | 15.26 | 15.14 | 15.18 | 13.57 | 13.62 | 13.64 | 13.64 | 12.61 |
| CH 06 | 2437MHz | 15.29 | 15.19 | 15.25 | 13.65 | 13.65 | 13.71 | 13.78 | 12.62 |
| CH 11 | 2462MHz | 15.27 | 15.12 | 15.20 | 13.62 | 13.70 | 13.68 | 13.84 | 12.70 |



| Channel | Frequency | 2.4GHz 802.11n HT40 RF Average Power (dBm) | | | | | | | |
|---------|-----------|--|-------|-------|-------|-------|-------|-------|-------|
| | | OFDM Data Rate | | | | | | | |
| | | MCS0 | MCS1 | MCS2 | MCS3 | MCS4 | MCS5 | MCS6 | MCS7 |
| CH 03 | 2422MHz | 15.21 | 15.11 | 15.20 | 15.17 | 14.22 | 13.67 | 12.82 | 11.24 |
| CH 06 | 2437MHz | 15.33 | 15.20 | 15.31 | 15.29 | 14.34 | 13.74 | 12.91 | 11.34 |
| CH 09 | 2452MHz | 15.23 | 15.08 | 15.18 | 15.17 | 14.22 | 13.69 | 12.82 | 11.26 |

| Channel | Frequency | 2.4GHz 802.11ac VHT20 RF Average Power (dBm) | | | | | | | | |
|---------|-----------|--|-------|-------|-------|-------|-------|-------|-------|-------|
| | | OFDM Data Rate | | | | | | | | |
| | | MCS0 | MCS1 | MCS2 | MCS3 | MCS4 | MCS5 | MCS6 | MCS7 | MCS8 |
| CH 01 | 2412MHz | 15.22 | 14.96 | 15.09 | 13.70 | 13.84 | 13.67 | 13.79 | 12.72 | 12.74 |
| CH 06 | 2437MHz | 15.39 | 15.13 | 15.25 | 13.86 | 13.98 | 13.79 | 13.95 | 12.88 | 12.91 |
| CH 11 | 2462MHz | 15.35 | 15.07 | 15.18 | 13.79 | 13.95 | 13.79 | 13.88 | 12.80 | 12.86 |

| Channel | Frequency | 2.4GHz 802.11ac VHT40 RF Average Power (dBm) | | | | | | | | | |
|---------|-----------|--|-------|-------|-------|-------|-------|-------|-------|-------|-------|
| | | OFDM Data Rate | | | | | | | | | |
| | | MCS0 | MCS1 | MCS2 | MCS3 | MCS4 | MCS5 | MCS6 | MCS7 | MCS8 | MCS9 |
| CH 03 | 2422MHz | 15.35 | 15.27 | 15.16 | 15.16 | 14.43 | 13.82 | 13.86 | 12.32 | 11.85 | 11.52 |
| CH 06 | 2437MHz | 15.34 | 15.22 | 15.10 | 15.31 | 14.37 | 13.79 | 13.80 | 12.28 | 11.79 | 11.46 |
| CH 09 | 2452MHz | 15.23 | 15.15 | 15.01 | 15.19 | 14.30 | 13.68 | 13.70 | 12.18 | 11.70 | 11.36 |



SISO <Ant. 2>

| Channel | Frequency | 2.4GHz 802.11b RF Average Power (dBm) | | | |
|---------|-----------|---------------------------------------|--------|----------|---------|
| | | DSSS Data Rate | | | |
| | | 1 Mbps | 2 Mbps | 5.5 Mbps | 11 Mbps |
| CH 01 | 2412MHz | 15.44 | 15.38 | 15.41 | 15.42 |
| CH 06 | 2437MHz | 15.44 | 15.25 | 15.36 | 15.39 |
| CH 11 | 2462MHz | 15.39 | 15.20 | 15.29 | 15.35 |

| Channel | Frequency | 2.4GHz 802.11g RF Average Power (dBm) | | | | | | | |
|---------|-----------|---------------------------------------|--------|---------|---------|---------|---------|---------|---------|
| | | OFDM Data Rate | | | | | | | |
| | | 6 Mbps | 9 Mbps | 12 Mbps | 18 Mbps | 24 Mbps | 36 Mbps | 48 Mbps | 54 Mbps |
| CH 01 | 2412MHz | 15.30 | 15.25 | 15.21 | 15.24 | 15.22 | 14.83 | 14.43 | 14.39 |
| CH 06 | 2437MHz | 15.25 | 15.18 | 15.24 | 15.16 | 15.04 | 14.77 | 14.50 | 14.27 |
| CH 11 | 2462MHz | 15.35 | 15.29 | 15.27 | 15.15 | 15.27 | 14.97 | 14.46 | 14.43 |

| Channel | Frequency | 2.4GHz 802.11n HT20 RF Average Power (dBm) | | | | | | | |
|---------|-----------|--|-------|-------|-------|-------|-------|-------|-------|
| | | OFDM Data Rate | | | | | | | |
| | | MCS0 | MCS1 | MCS2 | MCS3 | MCS4 | MCS5 | MCS6 | MCS7 |
| CH 01 | 2412MHz | 15.36 | 15.26 | 15.31 | 13.84 | 13.81 | 13.90 | 13.76 | 12.88 |
| CH 06 | 2437MHz | 15.33 | 15.28 | 15.22 | 13.75 | 13.78 | 13.75 | 13.62 | 12.83 |
| CH 11 | 2462MHz | 15.21 | 15.15 | 15.11 | 13.64 | 13.59 | 13.51 | 13.49 | 12.77 |



| Channel | Frequency | 2.4GHz 802.11n HT40 RF Average Power (dBm) | | | | | | | |
|---------|-----------|--|-------|-------|-------|-------|-------|-------|-------|
| | | OFDM Data Rate | | | | | | | |
| | | MCS0 | MCS1 | MCS2 | MCS3 | MCS4 | MCS5 | MCS6 | MCS7 |
| CH 03 | 2422MHz | 15.26 | 15.17 | 15.19 | 15.10 | 14.56 | 14.05 | 13.79 | 12.44 |
| CH 06 | 2437MHz | 15.32 | 15.22 | 15.25 | 15.11 | 14.62 | 14.09 | 13.82 | 12.46 |
| CH 09 | 2452MHz | 15.27 | 15.18 | 15.18 | 15.06 | 14.52 | 14.04 | 13.77 | 12.41 |

| Channel | Frequency | 2.4GHz 802.11ac VHT20 RF Average Power (dBm) | | | | | | | | |
|---------|-----------|--|-------|-------|-------|-------|-------|-------|-------|-------|
| | | OFDM Data Rate | | | | | | | | |
| | | MCS0 | MCS1 | MCS2 | MCS3 | MCS4 | MCS5 | MCS6 | MCS7 | MCS8 |
| CH 01 | 2412MHz | 15.23 | 15.19 | 15.21 | 14.02 | 13.61 | 13.84 | 13.80 | 13.05 | 12.82 |
| CH 06 | 2437MHz | 15.33 | 15.27 | 15.29 | 14.09 | 13.71 | 13.91 | 13.86 | 13.10 | 12.88 |
| CH 11 | 2462MHz | 15.31 | 15.25 | 15.24 | 14.10 | 13.64 | 13.89 | 13.88 | 13.12 | 12.86 |

| Channel | Frequency | 2.4GHz 802.11ac VHT40 RF Average Power (dBm) | | | | | | | | | |
|---------|-----------|--|-------|-------|-------|-------|-------|-------|-------|-------|-------|
| | | OFDM Data Rate | | | | | | | | | |
| | | MCS0 | MCS1 | MCS2 | MCS3 | MCS4 | MCS5 | MCS6 | MCS7 | MCS8 | MCS9 |
| CH 03 | 2422MHz | 15.29 | 15.17 | 15.28 | 15.12 | 14.61 | 14.05 | 14.16 | 12.71 | 11.96 | 11.42 |
| CH 06 | 2437MHz | 15.34 | 15.18 | 15.33 | 15.26 | 14.64 | 14.08 | 14.19 | 12.72 | 11.99 | 11.44 |
| CH 09 | 2452MHz | 15.37 | 15.25 | 15.31 | 15.28 | 14.64 | 14.13 | 14.23 | 12.74 | 12.01 | 11.46 |



MIMO <Ant. 1+2>

| Channel | Frequency | 2.4GHz 802.11b RF Average Power (dBm) | | | |
|---------|-----------|---------------------------------------|--------|----------|---------|
| | | DSSS Data Rate | | | |
| | | 1 Mbps | 2 Mbps | 5.5 Mbps | 11 Mbps |
| CH 01 | 2412MHz | 18.48 | 18.44 | 18.42 | 18.45 |
| CH 06 | 2437MHz | 18.49 | 18.46 | 18.44 | 18.48 |
| CH 11 | 2462MHz | 18.43 | 18.32 | 18.33 | 18.38 |

| Channel | Frequency | 2.4GHz 802.11g RF Average Power (dBm) | | | | | | | |
|---------|-----------|---------------------------------------|--------|---------|---------|---------|---------|---------|---------|
| | | OFDM Data Rate | | | | | | | |
| | | 6 Mbps | 9 Mbps | 12 Mbps | 18 Mbps | 24 Mbps | 36 Mbps | 48 Mbps | 54 Mbps |
| CH 01 | 2412MHz | 18.42 | 18.38 | 18.40 | 18.38 | 18.36 | 17.80 | 17.50 | 17.41 |
| CH 06 | 2437MHz | 18.34 | 18.29 | 18.30 | 18.26 | 18.21 | 17.68 | 17.41 | 17.37 |
| CH 11 | 2462MHz | 18.39 | 18.36 | 18.28 | 18.30 | 18.31 | 17.74 | 17.41 | 17.41 |

| Channel | Frequency | 2.4GHz 802.11n HT20 RF Average Power (dBm) | | | | | | | |
|---------|-----------|--|-------|-------|-------|-------|-------|-------|-------|
| | | OFDM Data Rate | | | | | | | |
| | | MCS0 | MCS1 | MCS2 | MCS3 | MCS4 | MCS5 | MCS6 | MCS7 |
| CH 01 | 2412MHz | 18.45 | 18.34 | 18.32 | 17.00 | 16.93 | 16.83 | 16.89 | 15.95 |
| CH 06 | 2437MHz | 18.39 | 18.25 | 18.23 | 16.92 | 16.82 | 16.71 | 16.76 | 15.93 |
| CH 11 | 2462MHz | 18.40 | 18.27 | 18.27 | 16.99 | 16.87 | 16.78 | 16.82 | 15.82 |



| Channel | Frequency | 2.4GHz 802.11n HT40 RF Average Power (dBm) | | | | | | | |
|---------|-----------|--|-------|-------|-------|-------|-------|-------|-------|
| | | OFDM Data Rate | | | | | | | |
| | | MCS0 | MCS1 | MCS2 | MCS3 | MCS4 | MCS5 | MCS6 | MCS7 |
| CH 03 | 2422MHz | 18.30 | 18.12 | 17.99 | 18.16 | 17.28 | 16.80 | 16.83 | 15.30 |
| CH 06 | 2437MHz | 18.40 | 18.18 | 18.05 | 18.24 | 17.36 | 16.87 | 16.91 | 15.37 |
| CH 09 | 2452MHz | 18.32 | 18.09 | 17.97 | 18.15 | 17.28 | 16.77 | 16.82 | 15.30 |

| Channel | Frequency | 2.4GHz 802.11ac VHT20 RF Average Power (dBm) | | | | | | | | |
|---------|-----------|--|-------|-------|-------|-------|-------|-------|-------|-------|
| | | OFDM Data Rate | | | | | | | | |
| | | MCS0 | MCS1 | MCS2 | MCS3 | MCS4 | MCS5 | MCS6 | MCS7 | MCS8 |
| CH 01 | 2412MHz | 18.38 | 18.24 | 18.31 | 16.88 | 16.98 | 16.70 | 16.83 | 15.86 | 16.00 |
| CH 06 | 2437MHz | 18.44 | 18.35 | 18.43 | 16.93 | 17.00 | 16.72 | 16.89 | 15.91 | 16.03 |
| CH 11 | 2462MHz | 18.41 | 18.33 | 18.29 | 16.89 | 17.00 | 16.71 | 16.83 | 15.87 | 16.02 |

| Channel | Frequency | 2.4GHz 802.11ac VHT40 RF Average Power (dBm) | | | | | | | | | |
|---------|-----------|--|-------|-------|-------|-------|-------|-------|-------|-------|-------|
| | | OFDM Data Rate | | | | | | | | | |
| | | MCS0 | MCS1 | MCS2 | MCS3 | MCS4 | MCS5 | MCS6 | MCS7 | MCS8 | MCS9 |
| CH 03 | 2422MHz | 18.37 | 18.29 | 18.29 | 18.34 | 17.48 | 17.12 | 17.06 | 15.52 | 14.99 | 14.47 |
| CH 06 | 2437MHz | 18.41 | 18.30 | 18.31 | 18.40 | 17.47 | 17.13 | 17.07 | 15.56 | 15.00 | 14.48 |
| CH 09 | 2452MHz | 18.39 | 18.26 | 18.27 | 18.28 | 17.47 | 17.12 | 17.06 | 15.50 | 14.97 | 14.46 |

Note: MIMO Ant. 1+2 is a calculated result from sum of the power MIMO Ant. 1 and MIMO Ant. 2.



<TXBF Modes>

MIMO <Ant. 1+2>

| Channel | Frequency | 2.4GHz 802.11n HT20 RF Average Power (dBm) | | | | | | | |
|---------|-----------|--|-------|-------|-------|-------|-------|-------|-------|
| | | OFDM Data Rate | | | | | | | |
| | | MCS0 | MCS1 | MCS2 | MCS3 | MCS4 | MCS5 | MCS6 | MCS7 |
| CH 01 | 2412MHz | 18.31 | 18.21 | 18.21 | 18.16 | 18.11 | 18.06 | 17.96 | 17.96 |
| CH 06 | 2437MHz | 18.01 | 17.91 | 17.91 | 17.81 | 17.86 | 17.86 | 17.76 | 17.76 |
| CH 11 | 2462MHz | 18.03 | 17.93 | 17.93 | 17.83 | 17.88 | 17.87 | 17.77 | 17.83 |

| Channel | Frequency | 2.4GHz 802.11n HT40 RF Average Power (dBm) | | | | | | | |
|---------|-----------|--|-------|-------|-------|-------|-------|-------|-------|
| | | OFDM Data Rate | | | | | | | |
| | | MCS0 | MCS1 | MCS2 | MCS3 | MCS4 | MCS5 | MCS6 | MCS7 |
| CH 03 | 2422MHz | 18.01 | 17.91 | 17.91 | 17.81 | 17.86 | 17.76 | 17.71 | 17.66 |
| CH 06 | 2437MHz | 18.37 | 18.27 | 18.27 | 18.21 | 18.22 | 18.21 | 18.12 | 18.02 |
| CH 09 | 2452MHz | 18.26 | 18.16 | 18.16 | 18.06 | 18.01 | 18.06 | 18.01 | 17.96 |

| Channel | Frequency | 2.4GHz 802.11ac VHT20 RF Average Power (dBm) | | | | | | | | |
|---------|-----------|--|-------|-------|-------|-------|-------|-------|-------|-------|
| | | OFDM Data Rate | | | | | | | | |
| | | MCS0 | MCS1 | MCS2 | MCS3 | MCS4 | MCS5 | MCS6 | MCS7 | MCS8 |
| CH 01 | 2412MHz | 18.26 | 18.16 | 18.16 | 18.06 | 18.11 | 18.01 | 18.11 | 18.01 | 18.01 |
| CH 06 | 2437MHz | 18.21 | 18.11 | 18.06 | 18.06 | 18.06 | 18.01 | 18.01 | 17.96 | 17.96 |
| CH 11 | 2462MHz | 18.36 | 18.26 | 18.26 | 18.16 | 18.16 | 18.16 | 18.06 | 18.11 | 18.11 |

| Channel | Frequency | 2.4GHz 802.11ac VHT40 RF Average Power (dBm) | | | | | | | | | |
|---------|-----------|--|-------|-------|-------|-------|-------|-------|-------|-------|-------|
| | | OFDM Data Rate | | | | | | | | | |
| | | MCS0 | MCS1 | MCS2 | MCS3 | MCS4 | MCS5 | MCS6 | MCS7 | MCS8 | MCS9 |
| CH 03 | 2422MHz | 18.36 | 18.26 | 18.21 | 18.21 | 18.26 | 18.16 | 18.11 | 18.16 | 18.16 | 18.06 |
| CH 06 | 2437MHz | 18.31 | 18.21 | 18.21 | 18.11 | 18.16 | 18.17 | 18.07 | 18.06 | 18.01 | 18.01 |
| CH 09 | 2452MHz | 18.21 | 18.11 | 18.11 | 18.01 | 18.11 | 18.06 | 18.06 | 18.01 | 17.96 | 17.91 |

Note: MIMO Ant. 1+2 is a calculated result from sum of the power MIMO Ant. 1 and MIMO Ant. 2.



2.3 Test Mode

Final test mode of conducted test items and radiated spurious emissions are considering the modulation and worse data rates from the power table described in section 2.2.

<Non-TXBF Modes>

Single Antenna

| Modulation | Data Rate |
|----------------|-----------|
| 802.11b | 1 Mbps |
| 802.11g | 6 Mbps |
| 802.11n HT20 | MCS0 |
| 802.11n HT40 | MCS0 |
| 802.11ac VHT20 | MCS0 |
| 802.11ac VHT40 | MCS0 |

MIMO Antenna

| Modulation | Data Rate |
|----------------|-----------|
| 802.11b | 1 Mbps |
| 802.11g | 6 Mbps |
| 802.11n HT20 | MCS0 |
| 802.11n HT40 | MCS0 |
| 802.11ac VHT20 | MCS0 |
| 802.11ac VHT40 | MCS0 |

<TXBF Modes>

MIMO Antenna

| Modulation | Data Rate |
|----------------|-----------|
| 802.11n HT20 | MCS0 |
| 802.11n HT40 | MCS0 |
| 802.11ac VHT20 | MCS0 |
| 802.11ac VHT40 | MCS0 |

| Test Cases | |
|-----------------------|---|
| AC Conducted Emission | Mode 1 : Bluetooth Link + WLAN (2.4GHz) Link + Battery + Earphone + USB Cable (Charging from Adapter) |

2.4 Connection Diagram of Test System

<WLAN Tx Non-TXBF Mode>

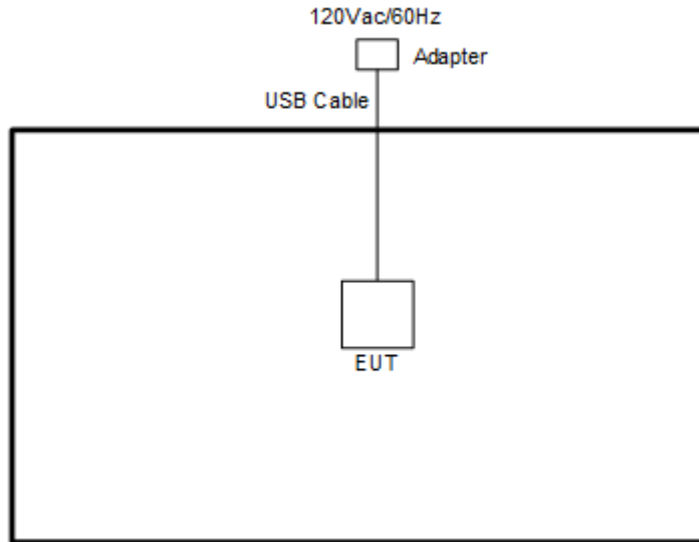

<WLAN Tx TXBF Mode>

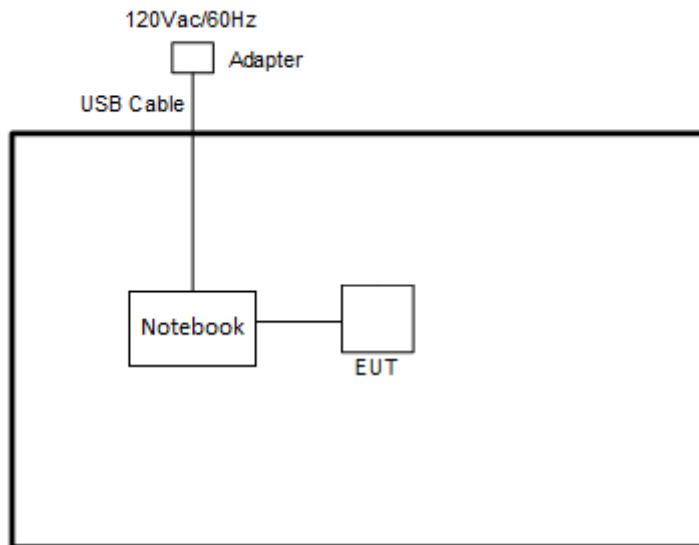

<AC Conducted Emission Mode>

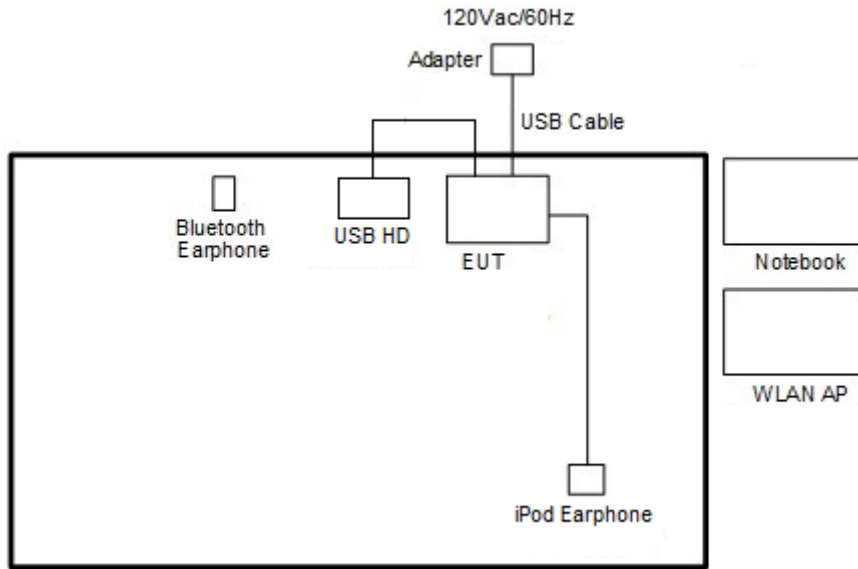

2.5 Support Unit used in test configuration and system

| Item | Equipment | Trade Name | Model Name | FCC ID | Data Cable | Power Cord |
|------|--------------------|-------------------|------------------------|--|-------------------|--|
| 1. | WLAN AP | D-Link | DIR-865L | KA2IR865LA1 | N/A | Unshielded, 1.8 m |
| 2. | Notebook | DELL | Latitude E6320 | FCC DoC/ Contains FCC ID: QDS-BRCM1054 | N/A | AC I/P: Unshielded, 1.2 m DC O/P: Shielded, 1.8 m |
| 3. | iPod Earphone | Apple | N/A | Verification | Unshielded, 1.0 m | N/A |
| 4. | Bluetooth Earphone | Sony Ericsson | MW600 | PY7DDA-2029 | N/A | N/A |
| 5. | USB HD | WD | WDBAAR3200 ABK-PESN | FCC DoC | Unshielded, 0.5 m | N/A |
| 6. | Adapter | Delta Electronics | ADP-10BWC | FCC DoC | N/A | N/A |
| 7. | SD Card | SanDisk | MicroSD HC | FCC DoC | N/A | N/A |



2.6 EUT Operation Test Setup

For WLAN RF test items, an engineering test program was provided and enabled to make EUT continuous transmit/receive.

For WLAN MIMO TXBF modes, the EUT was tested under normal operation and link to another EUT with power, modulation modes and data rates controlled by engineer mode command lines. The iperf software tool was used to make EUT continuous transmitting signals.

2.7 Measurement Results Explanation Example

For all conducted test items:

The offset level is set in the spectrum analyzer to compensate the RF cable loss and attenuator factor between EUT conducted output port and spectrum analyzer. With the offset compensation, the spectrum analyzer reading level is exactly the EUT RF output level.

Example:

The spectrum analyzer offset is derived from RF cable loss and attenuator factor.

Offset = RF cable loss + attenuator factor.

Following shows an offset computation example with cable loss 4.2 dB and 10dB attenuator.

$$\begin{aligned} \text{Offset(dB)} &= \text{RF cable loss(dB)} + \text{attenuator factor(dB)}. \\ &= 4.2 + 10 = 14.2 \text{ (dB)} \end{aligned}$$

3 Test Result

3.1 6dB and 99% Bandwidth Measurement

3.1.1 Limit of 6dB and 99% Bandwidth

The minimum 6 dB bandwidth shall be at least 500 kHz.

3.1.2 Measuring Instruments

The measuring equipment is listed in the section 4 of this test report.

3.1.3 Test Procedures

1. The testing follows FCC KDB Publication No. 558074 DTS D01 Meas. Guidance v03r05.
2. The RF output of EUT was connected to the spectrum analyzer by RF cable and attenuator. The path loss was compensated to the results for each measurement.
3. Set to the maximum power setting and enable the EUT transmit continuously.
4. Make the measurement with the spectrum analyzer's resolution bandwidth (RBW) = 100 kHz. Set the Video bandwidth (VBW) = 300 kHz. In order to make an accurate measurement. The 6 dB bandwidth must be greater than 500 kHz.
5. For 99% Bandwidth Measurement, the spectrum analyzer's resolution bandwidth (RBW) = 1MHz and set the Video bandwidth (VBW) = 3MHz.
6. Measure and record the results in the test report.

3.1.4 Test Setup

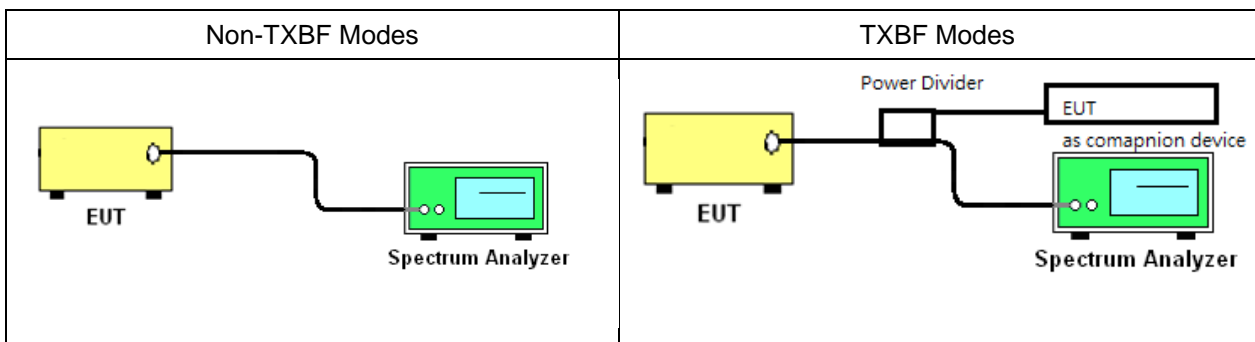



3.1.5 Test Result of 6dB and 99% Occupied Bandwidth

Please refer to Appendix A of this report.

<Non-TXBF Modes>

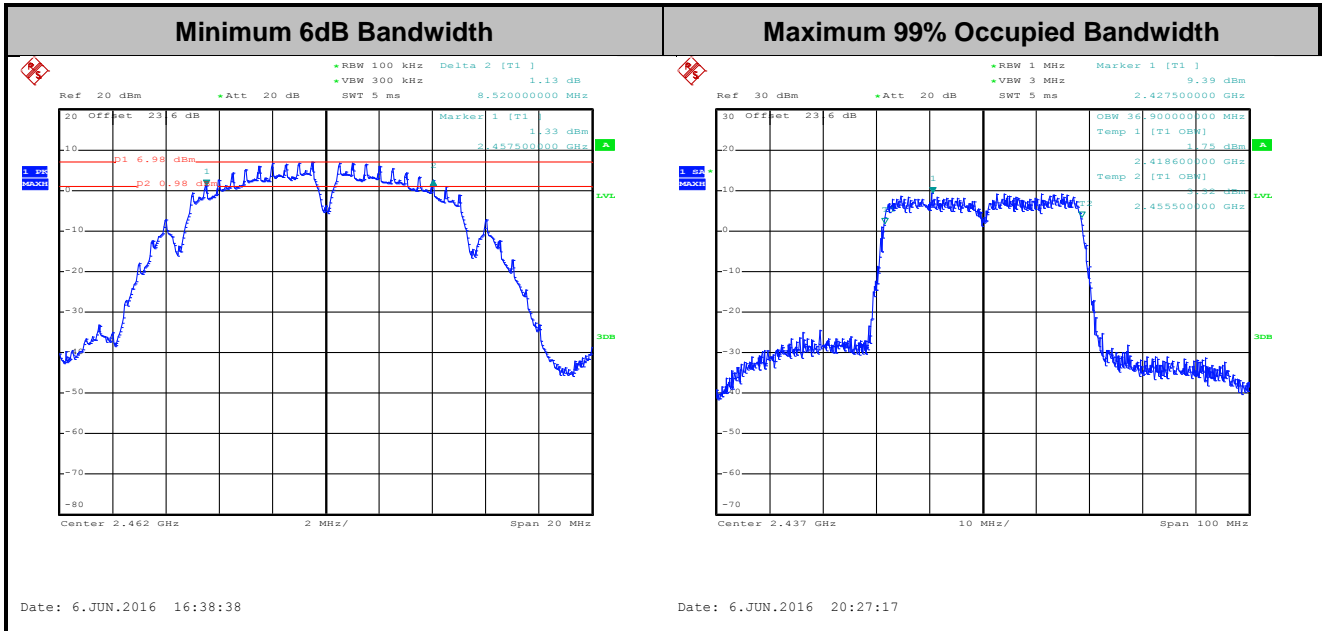

Note: The occupied channel bandwidth is maintained within the band of operation for all of the modulations.

<TXBF Modes>

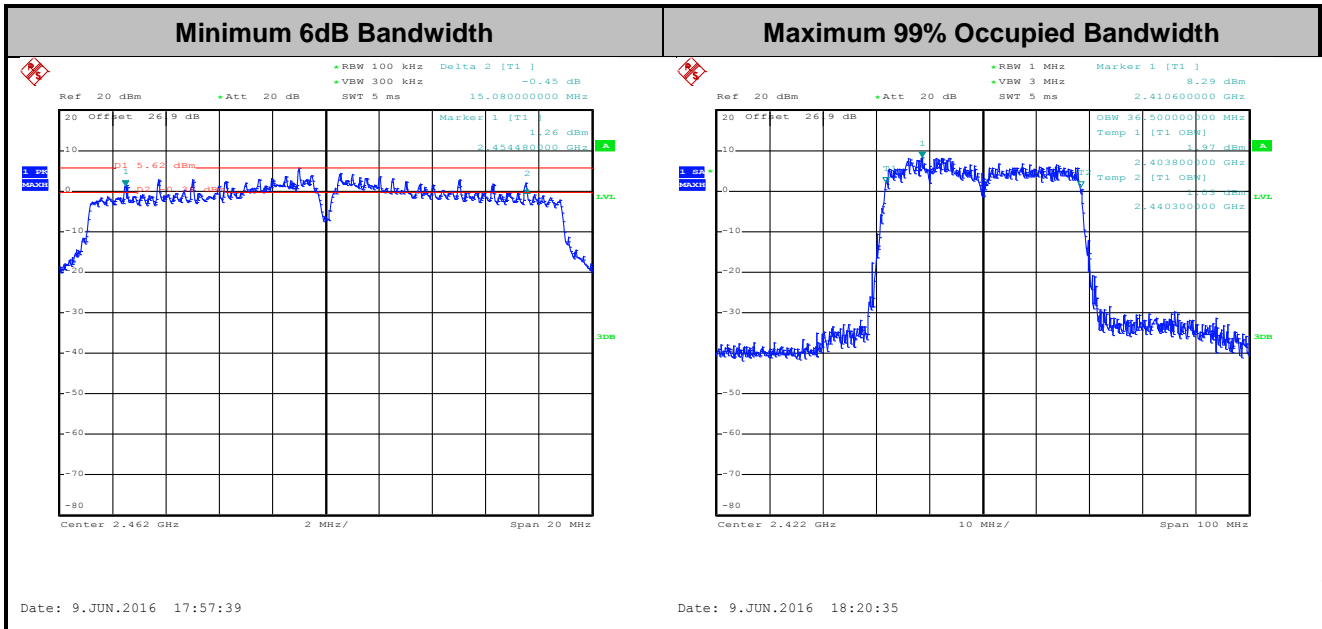

Note: The occupied channel bandwidth is maintained within the band of operation for all of the modulations.

3.2 Average Output Power Measurement

3.2.1 Limit of Average Output Power

For systems using digital modulation in the 2400-2483.5MHz, the limit for average output power is 30dBm. If transmitting antenna with directional gain greater than 6dBi is used, the average output power from the intentional radiator shall be reduced below the above stated value by the amount in dB that the directional gain of the antenna exceeds 6 dBi. In case of point-to-point operation, the limit has to be reduced by 1dB for every 3dB that the directional gain of the antenna exceeds 6dBi.

3.2.2 Measuring Instruments

The measuring equipment is listed in the section 4 of this test report.

3.2.3 Test Procedures

1. The testing follows the Measurement Procedure of FCC KDB No. 558074 DTS D01 Meas. Guidance v03r05 section 9.2.3.1 Method AVGPM for Non-TXBF modes
2. The testing follows the Measurement Procedure of FCC KDB No. 558074 DTS D01 Meas. Guidance v03r05 section 9.2.3.2 Method AVGPM-G for TXBF modes
3. The RF output of EUT was connected to the power meter by RF cable and attenuator. The path loss was compensated to the results for each measurement.
4. Set to the maximum power setting and enable the EUT transmit continuously.
5. Measure the conducted output power and record the results in the test report.
6. For MIMO mode, calculation method follows FCC KDB 662911 D01 Multiple Transmitter Output v02r01.

3.2.4 Test Setup

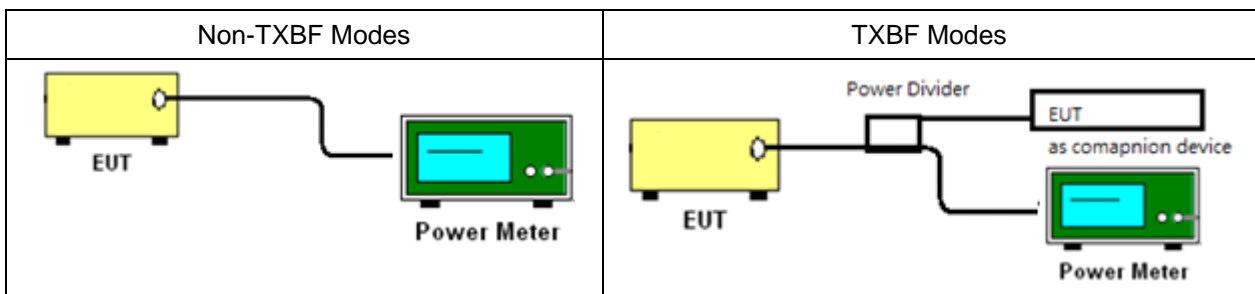



3.2.5 Test Result of Peak Output Power (Reporting Only)

Please refer to Appendix A of this report.

3.2.6 Test Result of Average output Power

Please refer to Appendix A of this report.



3.3 Power Spectral Density Measurement

3.3.1 Limit of Power Spectral Density

The power spectral density shall not be greater than 8dBm in any 3kHz band at any time interval of continuous transmission.

3.3.2 Measuring Instruments

The measuring equipment is listed in the section 4 of this test report.

3.3.3 Test Procedures

1. The testing follows Measurement Procedure 10.2 Method AVGPSD-2 of FCC KDB Publication No. 558074 D01 DTS Meas. Guidance v03r05 for Non-TXBF modes
2. The testing follows Measurement Procedure 10.2 Method AVGPSD-3 of FCC KDB Publication No. 558074 D01 DTS Meas. Guidance v03r05 for TXBF modes
3. The RF output of EUT was connected to the spectrum analyzer by RF cable and attenuator. The path loss was compensated to the results for each measurement.
4. Set to the maximum power setting and enable the EUT transmit continuously.
5. Measure and record the results in the test report.
6. For MIMO mode, calculation method follows FCC KDB 662911 D01 Multiple Transmitter Output v02r01.

If measurements performed using method (2) plus $10 \log(N)$ exceeds the emission limit, the test should choose method (1) before declaring that the device fails the emission limit.

Method (1): Measure and sum the spectra across the outputs.

The total final Power Spectral Density is from a device with 2 transmitter outputs. The spectrum measurements of the individual outputs are all performed with the same span and number of points, the spectrum value in the first spectral bin of output 1 is summed with that in the first spectral bin of output 2 to obtain the value for the first frequency bin of the summed spectrum.

Method (2): Measure and add $10 \log(N)$ dB, where N is the number of outputs. (N=2)

3.3.4 Test Setup

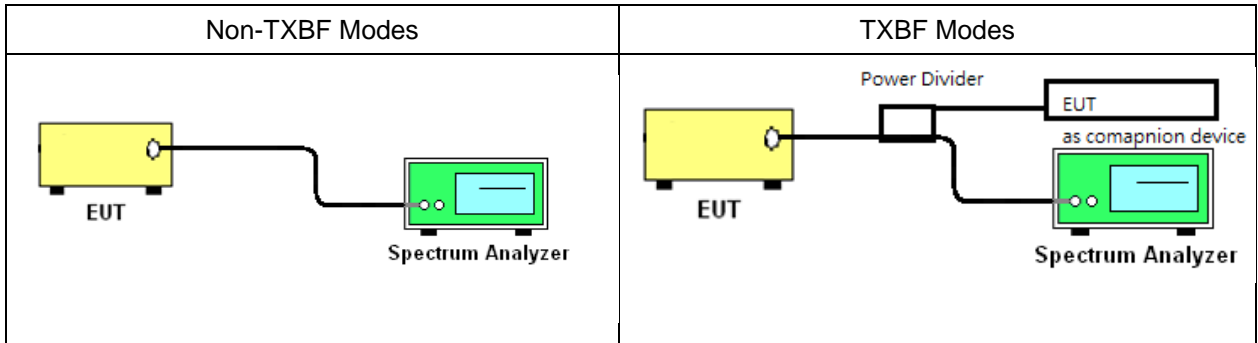

3.3.5 Test Result of Power Spectral Density

Please refer to Appendix A of this report.



<Non-TXBF Modes>

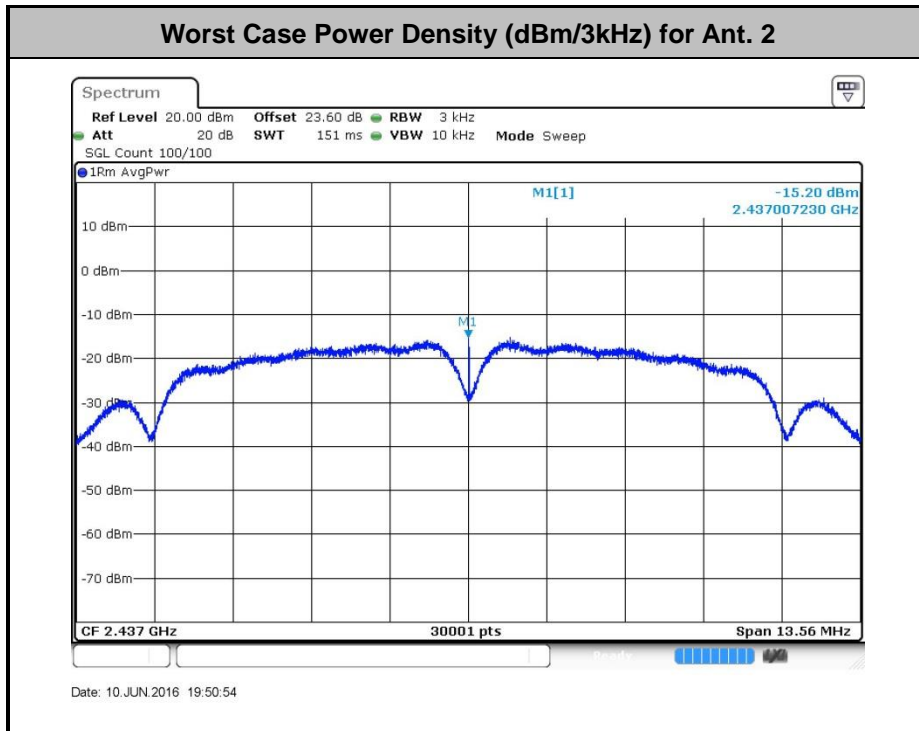
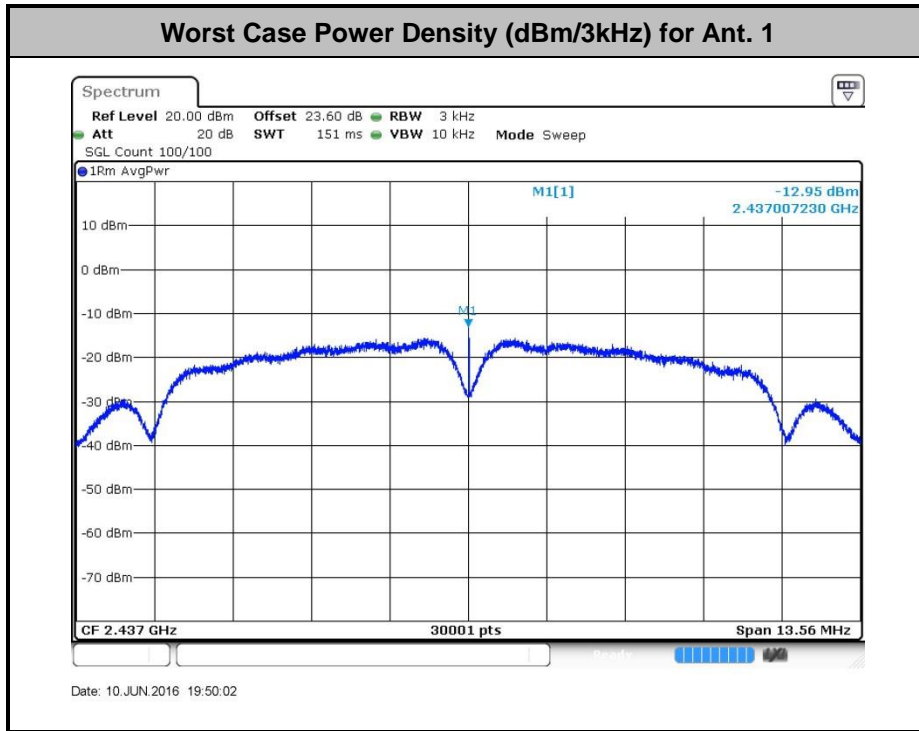



<TXBF Modes>

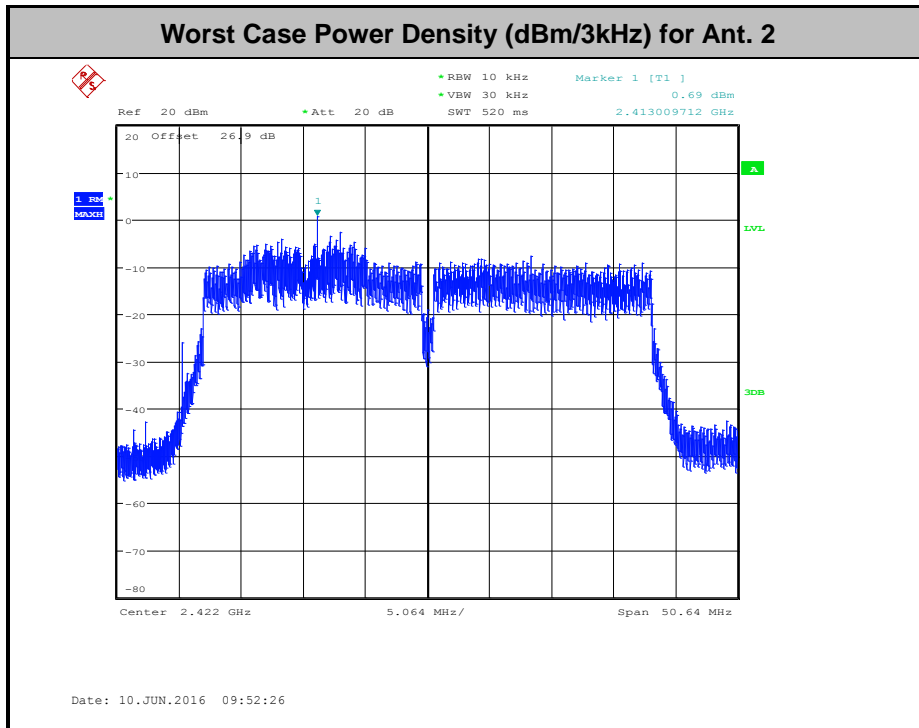
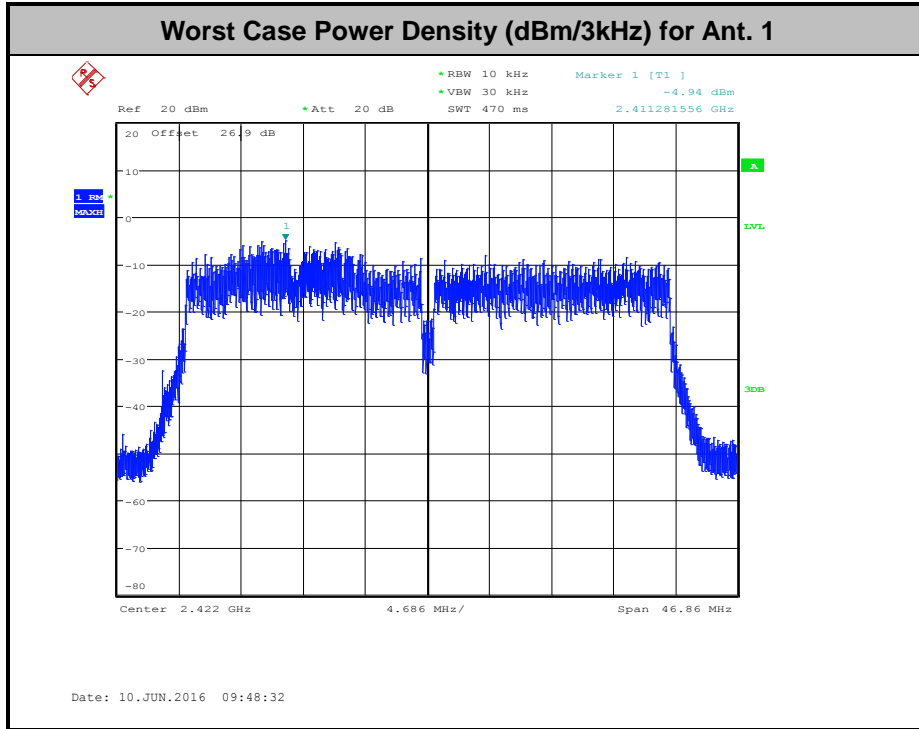



3.4 Conducted Band Edges and Spurious Emission Measurement

3.4.1 Limit of Conducted Band Edges and Spurious Emission Measurement

In any 100 kHz bandwidth outside of the authorized frequency band, the emissions which fall in the non-restricted bands shall be attenuated at least 20 dB / 30dB relative to the maximum PSD level in 100 kHz by RF conducted measurement and radiated emissions which fall in the restricted bands, as defined in Section 15.205(a), must also comply with the radiated emission limits specified in Section 15.209(a).

3.4.2 Measuring Instruments

The measuring equipment is listed in the section 4 of this test report.

3.4.3 Test Procedures

1. The testing follows FCC KDB Publication No. 558074 D01 DTS Meas. Guidance v03r05.
2. The RF output of EUT was connected to the spectrum analyzer by RF cable and attenuator. The path loss was compensated to the results for each measurement.
3. Set to the maximum power setting and enable the EUT transmit continuously.
4. Set RBW = 100 kHz, VBW=300 kHz, Peak Detector. Unwanted Emissions measured in any 100 kHz bandwidth outside of the authorized frequency band shall be attenuated by at least 20 dB relative to the maximum in-band peak PSD level in 100 kHz when maximum average conducted output power procedure is used. If the transmitter complies with the conducted power limits based on the use of RMS averaging over a time interval, the attenuation required under this paragraph shall be 30 dB instead of 20 dB per 15.247(d).
5. Measure and record the results in the test report.
6. The RF fundamental frequency should be excluded against the limit line in the operating frequency band.

3.4.4 Test Setup

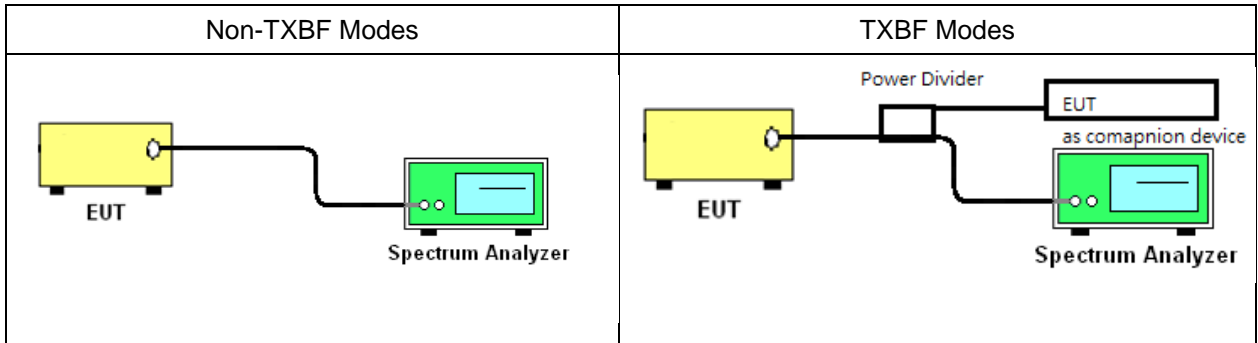



3.4.5 Test Result of Conducted Band Edges and Spurious Emission

Number of TX = 2, Ant. 1 (Measured)

| | | | |
|----------------|------------|---------------------|------------|
| Number of TX | 2 | Ant. : | 1 |
| Test Mode : | 802.11b | Temperature : | 21~25°C |
| Test Band : | 2.4GHz Low | Relative Humidity : | 51~54% |
| Test Channel : | 01 | Test Engineer : | Kenny Chen |

WLAN 802.11b Channel 01

100kHz PSD reference Level

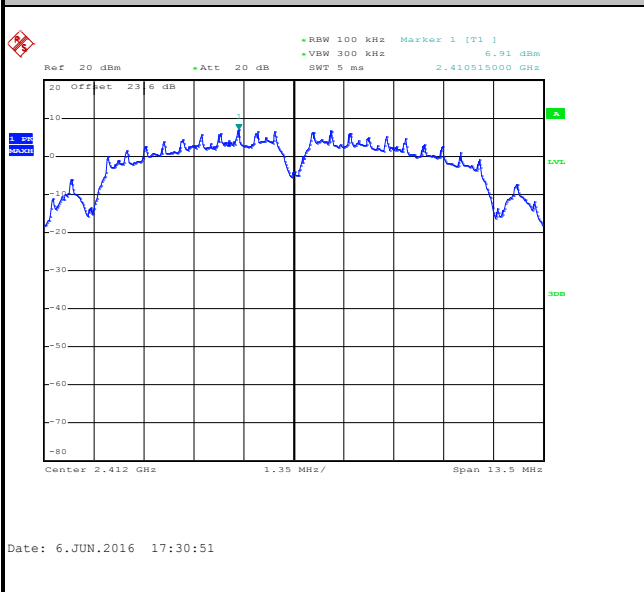

Low Channel Plot

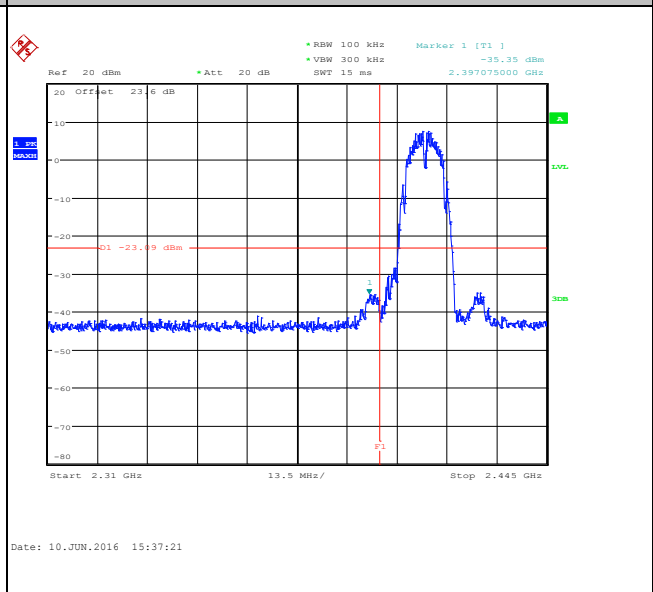

Spurious Emission 30MHz~3GHz

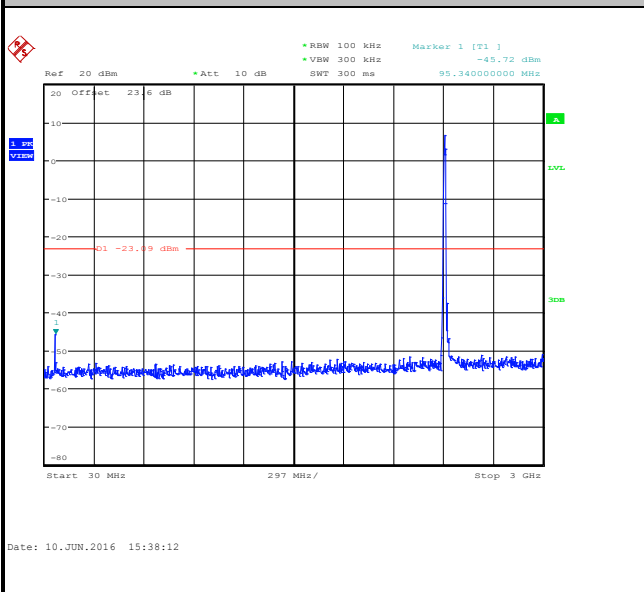

Spurious Emission 2GHz~25GHz

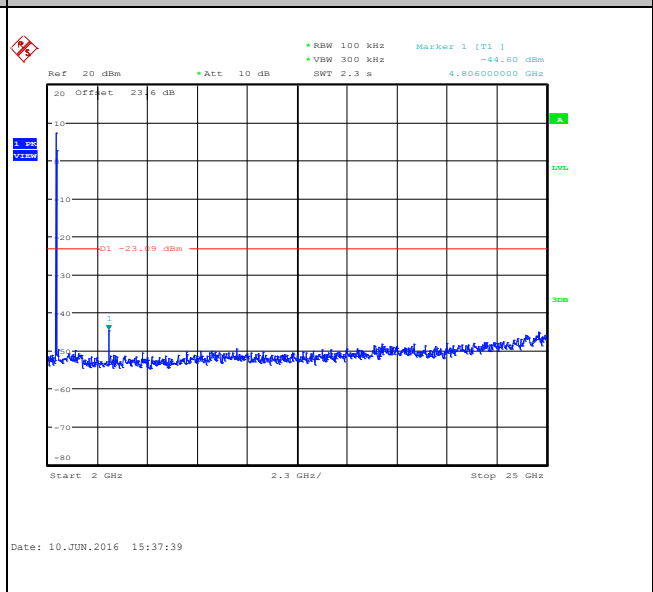



| | | | |
|----------------|------------|---------------------|------------|
| Number of TX : | 2 | Ant. : | 1 |
| Test Mode : | 802.11b | Temperature : | 21~25°C |
| Test Band : | 2.4GHz Mid | Relative Humidity : | 51~54% |
| Test Channel : | 06 | Test Engineer : | Kenny Chen |

WLAN 802.11b Channel 06

100kHz PSD reference Level

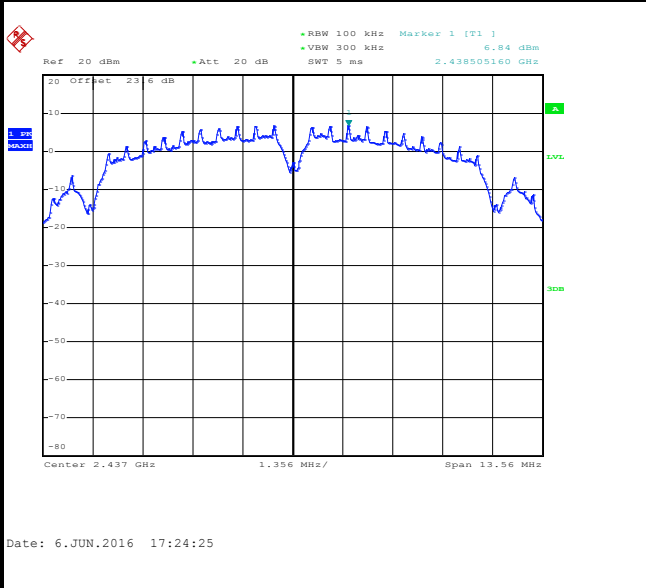

Spurious Emission 30MHz~3GHz

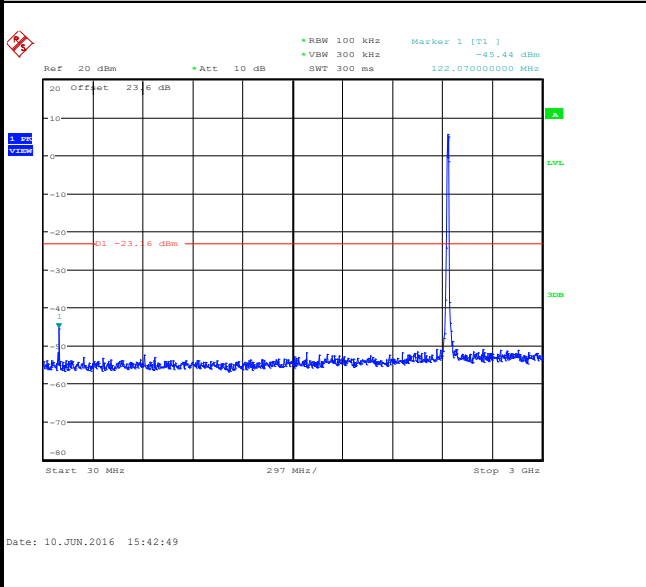

Spurious Emission 2GHz~25GHz

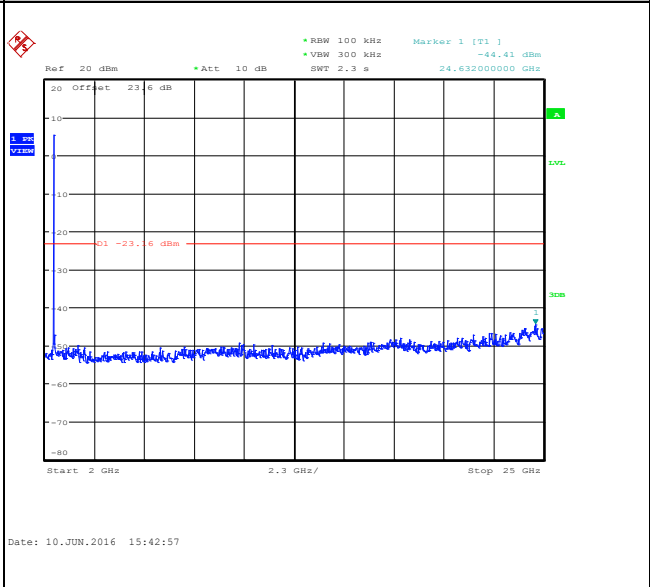



| | | | |
|----------------|-------------|---------------------|------------|
| Number of TX : | 2 | Ant. : | 1 |
| Test Mode : | 802.11b | Temperature : | 21~25°C |
| Test Band : | 2.4GHz High | Relative Humidity : | 51~54% |
| Test Channel : | 11 | Test Engineer : | Kenny Chen |

WLAN 802.11b Channel 11

100kHz PSD reference Level

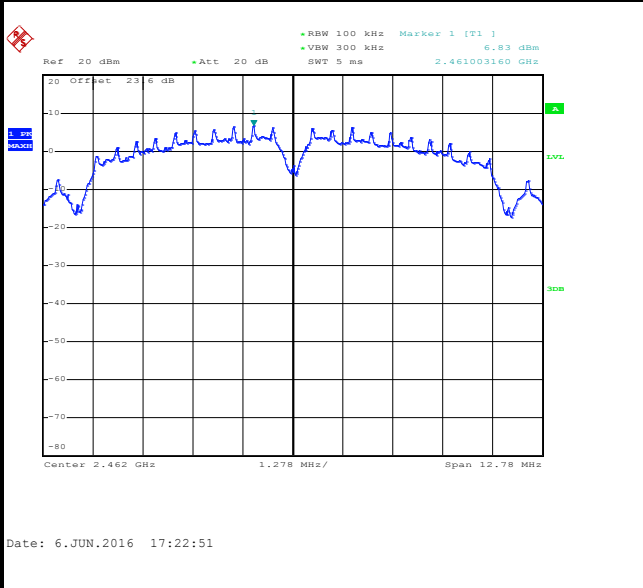

High Channel Plot

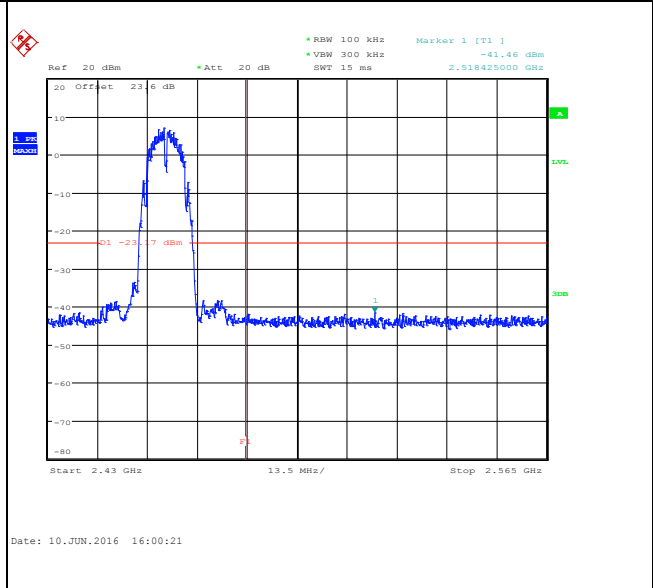

Spurious Emission 30MHz~3GHz

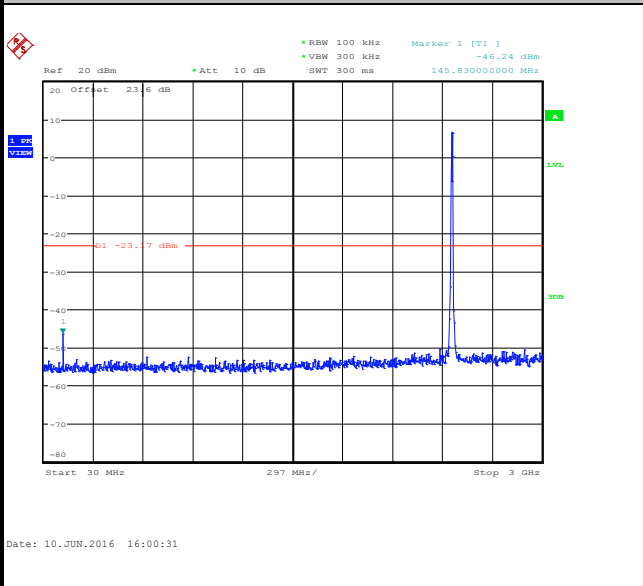

Spurious Emission 2GHz~25GHz

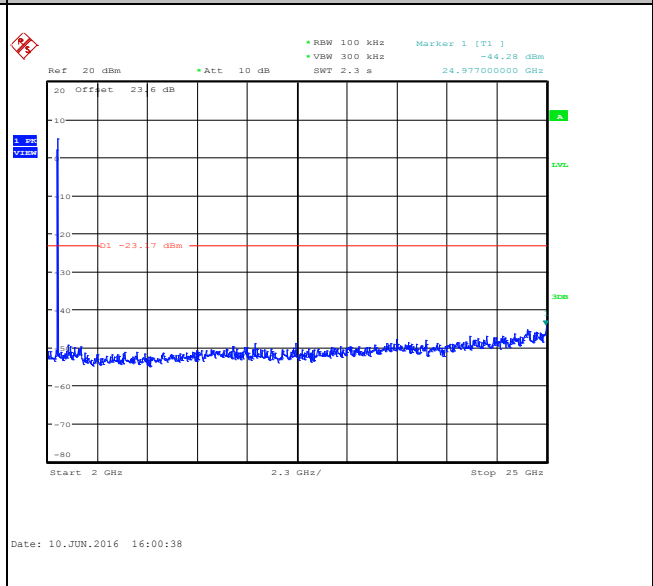



| | | | |
|----------------|------------|---------------------|------------|
| Number of TX : | 2 | Ant. : | 1 |
| Test Mode : | 802.11g | Temperature : | 21~25°C |
| Test Band : | 2.4GHz Low | Relative Humidity : | 51~54% |
| Test Channel : | 01 | Test Engineer : | Kenny Chen |

WLAN 802.11g Channel 01

100kHz PSD reference Level

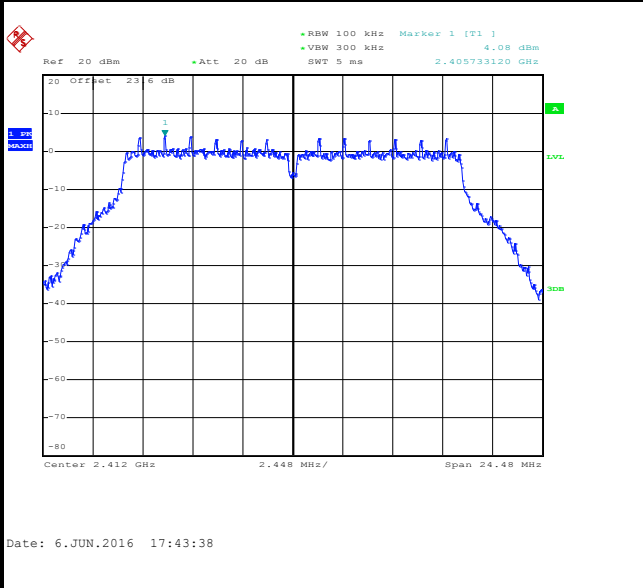

Low Channel Plot

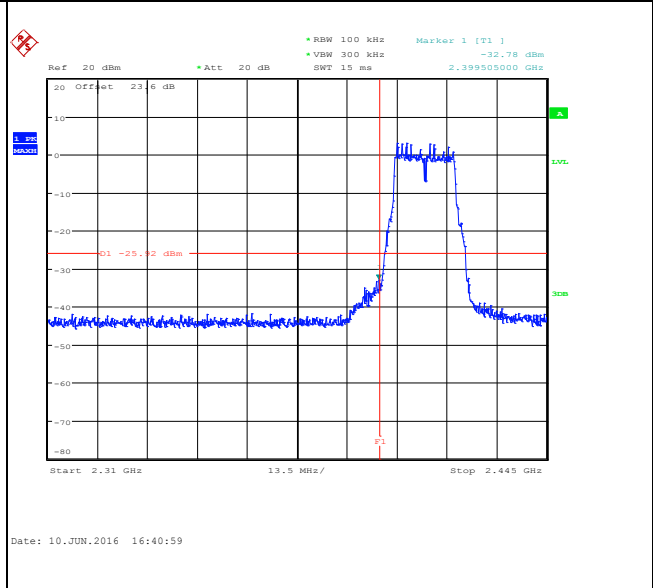

Spurious Emission 30MHz~3GHz

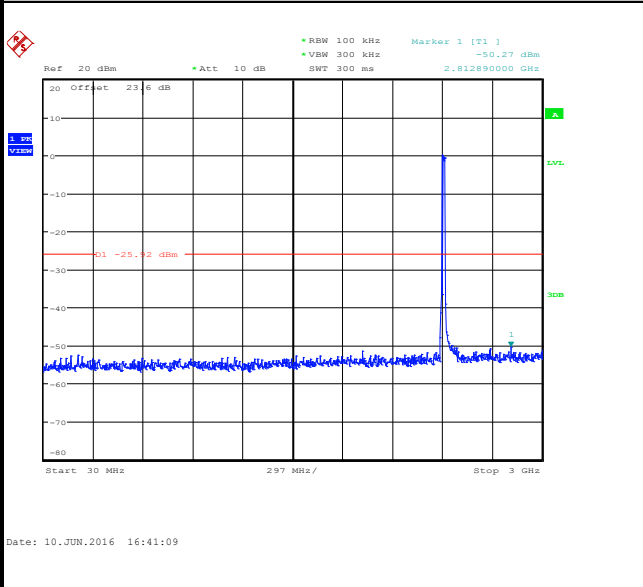

Spurious Emission 2GHz~25GHz

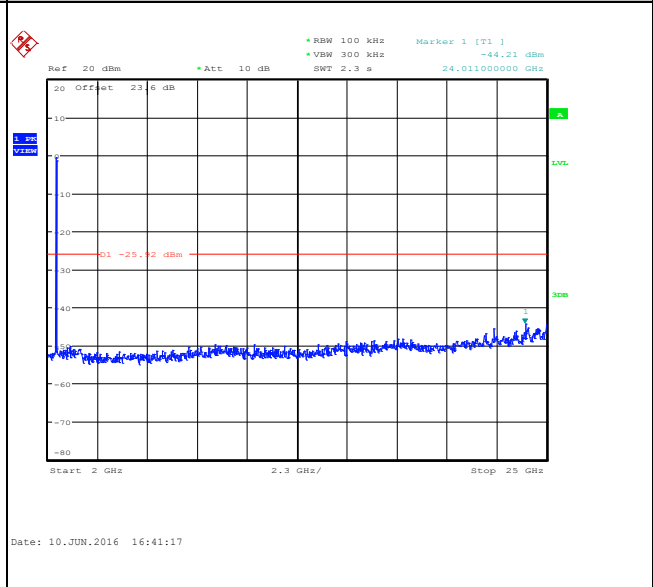



| | | | |
|----------------|------------|---------------------|------------|
| Number of TX : | 2 | Ant. : | 1 |
| Test Mode : | 802.11g | Temperature : | 21~25°C |
| Test Band : | 2.4GHz Mid | Relative Humidity : | 51~54% |
| Test Channel : | 06 | Test Engineer : | Kenny Chen |

WLAN 802.11g Channel 06

100kHz PSD reference Level

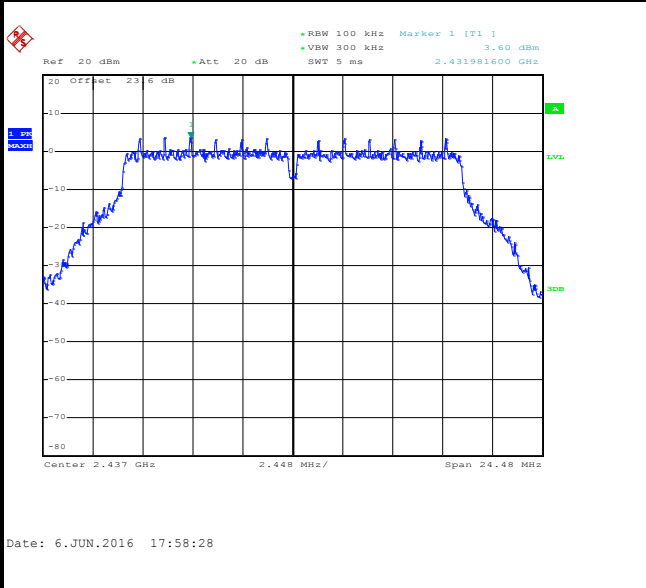

Spurious Emission 30MHz~3GHz

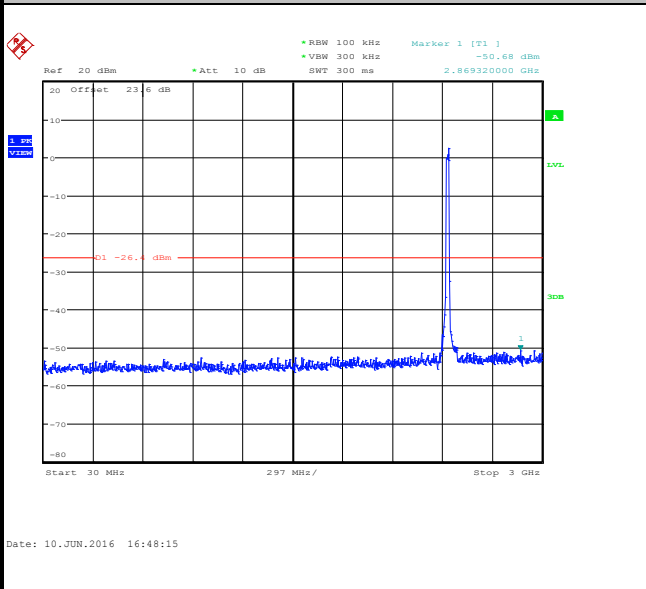

Spurious Emission 2GHz~25GHz

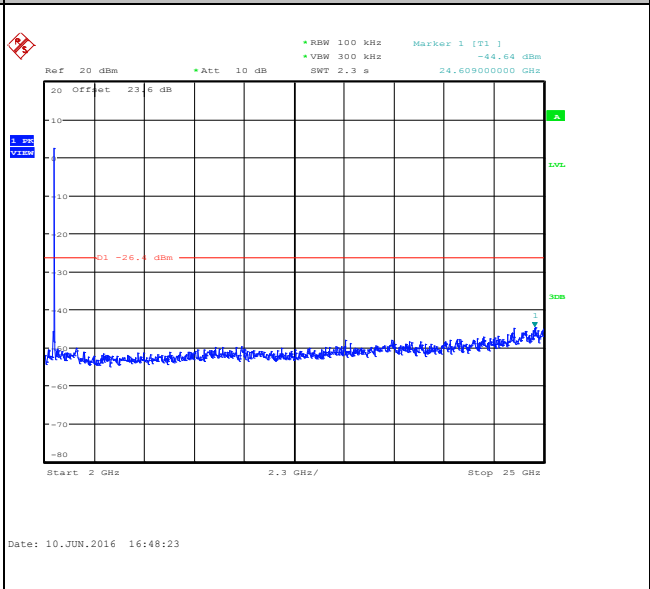



| | | | |
|----------------|-------------|---------------------|------------|
| Number of TX : | 2 | Ant. : | 1 |
| Test Mode : | 802.11g | Temperature : | 21~25°C |
| Test Band : | 2.4GHz High | Relative Humidity : | 51~54% |
| Test Channel : | 11 | Test Engineer : | Kenny Chen |

WLAN 802.11g Channel 11

100kHz PSD reference Level

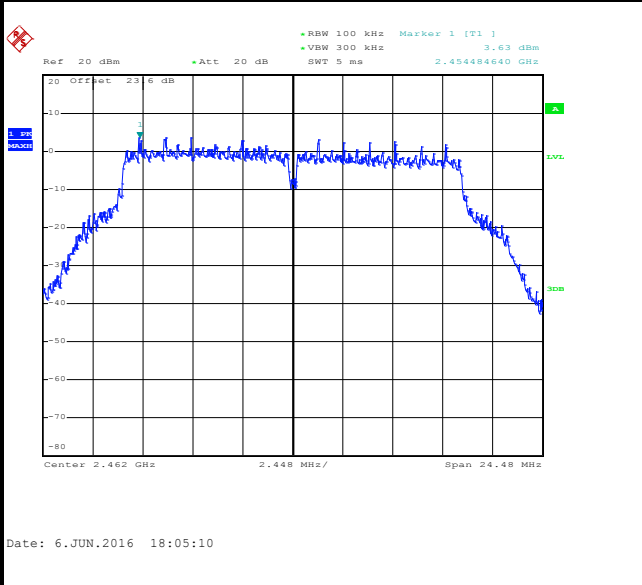

High Channel Plot

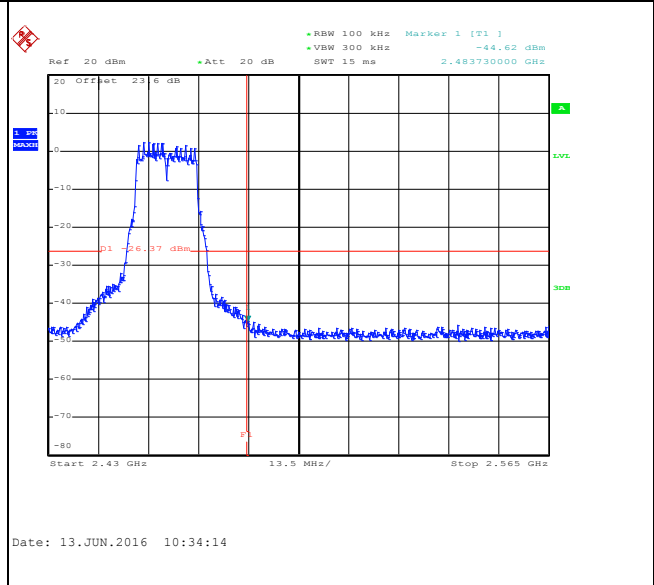

Spurious Emission 30MHz~3GHz

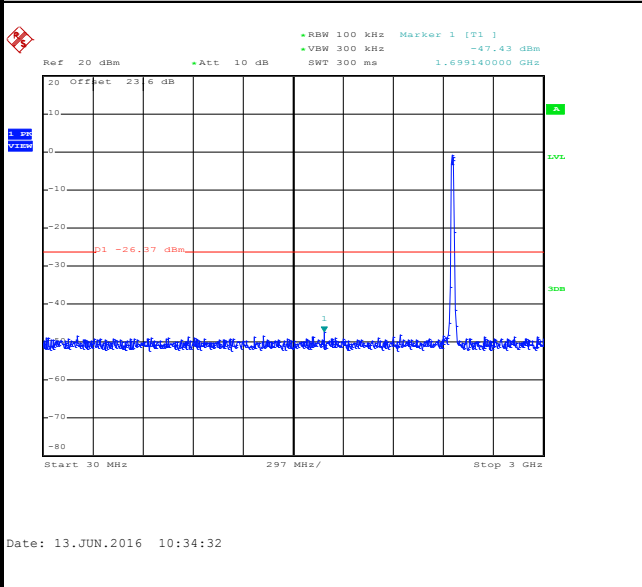

Spurious Emission 2GHz~25GHz

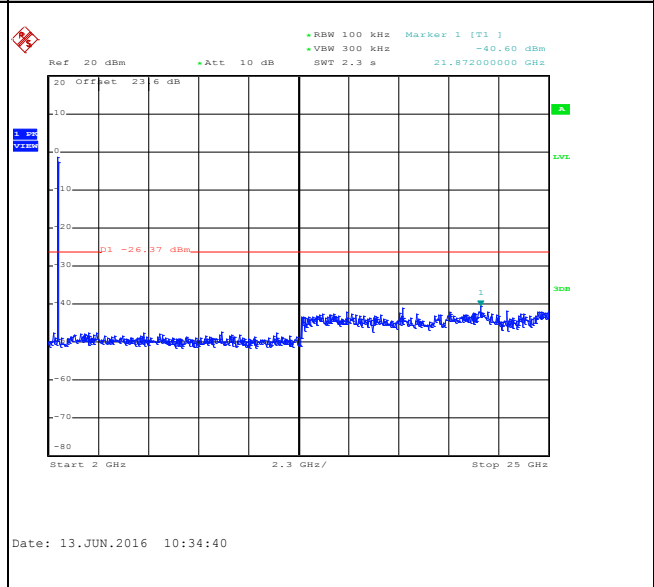



| | | | |
|----------------|--------------|---------------------|------------|
| Number of TX : | 2 | Ant. : | 1 |
| Test Mode : | 802.11n HT20 | Temperature : | 21~25°C |
| Test Band : | 2.4GHz Low | Relative Humidity : | 51~54% |
| Test Channel : | 01 | Test Engineer : | Kenny Chen |

WLAN 802.11n HT20 Channel 01

100kHz PSD reference Level

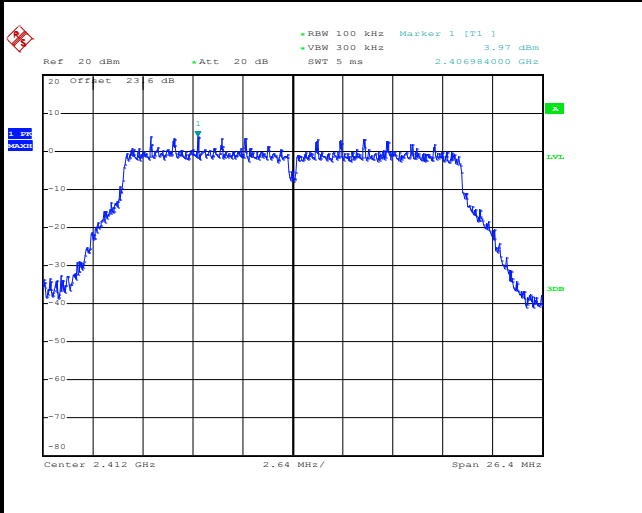

Date: 6.JUN.2016 18:08:39

Low Channel Plot

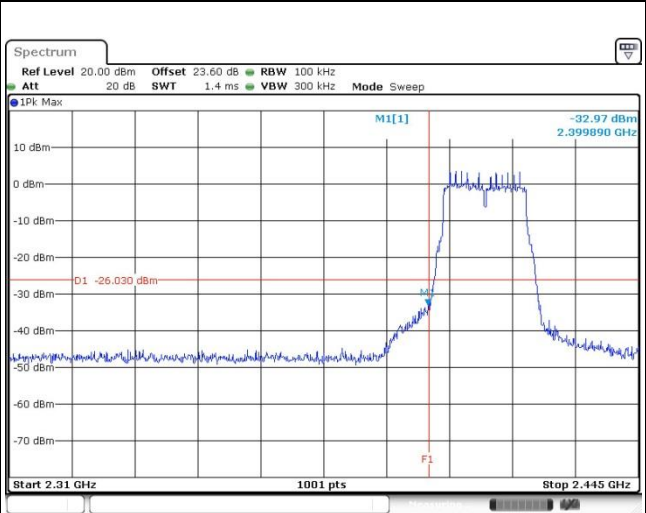

Date: 10.JUN.2016 18:16:29

Spurious Emission 30MHz~3GHz

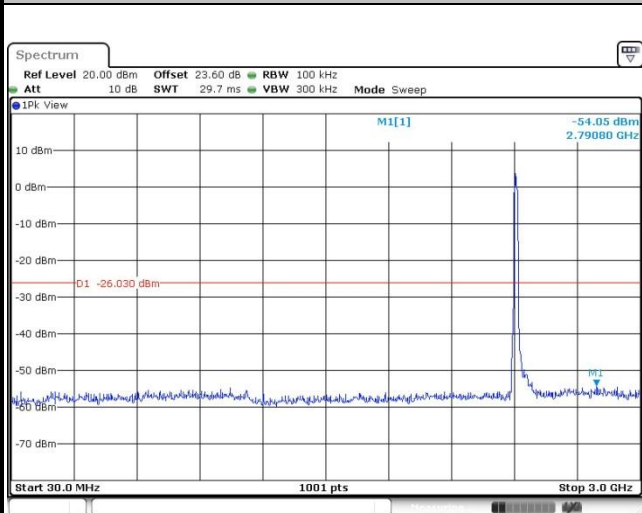

Date: 10.JUN.2016 18:16:39

Spurious Emission 2GHz~25GHz

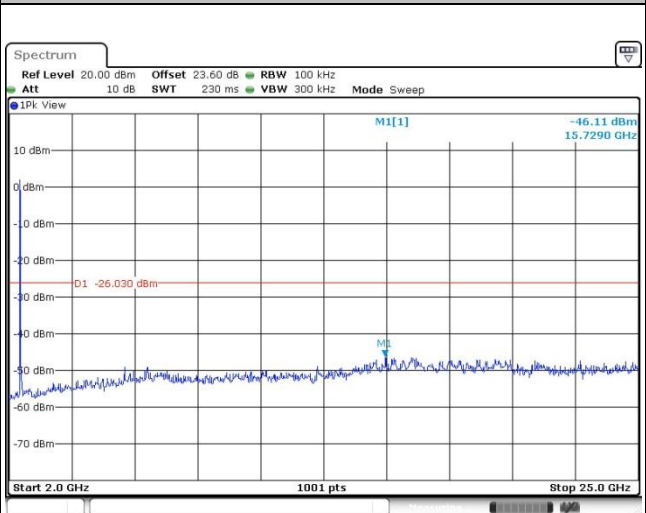

Date: 10.JUN.2016 18:16:48



| | | | |
|----------------|--------------|---------------------|------------|
| Number of TX : | 2 | Ant. : | 1 |
| Test Mode : | 802.11n HT20 | Temperature : | 21~25°C |
| Test Band : | 2.4GHz Mid | Relative Humidity : | 51~54% |
| Test Channel : | 06 | Test Engineer : | Kenny Chen |

WLAN 802.11n HT20 Channel 06

100kHz PSD reference Level

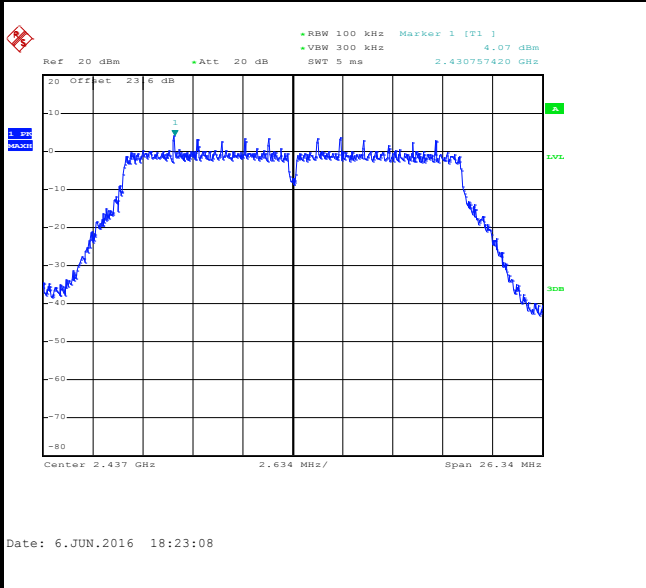

Spurious Emission 30MHz~3GHz

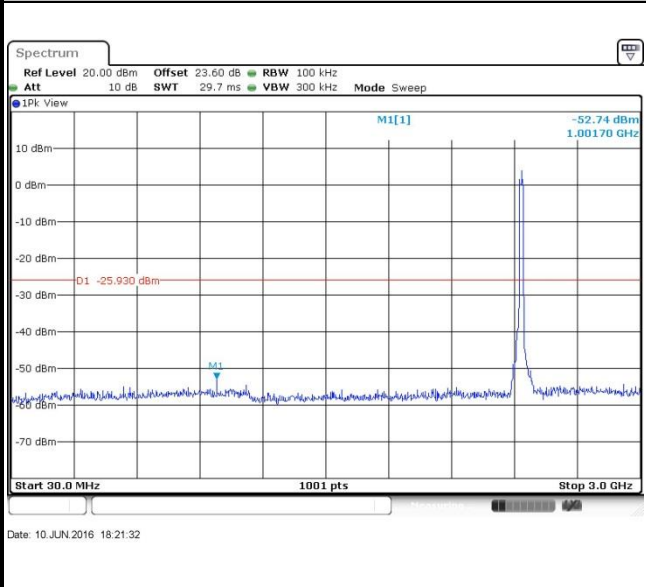

Spurious Emission 2GHz~25GHz

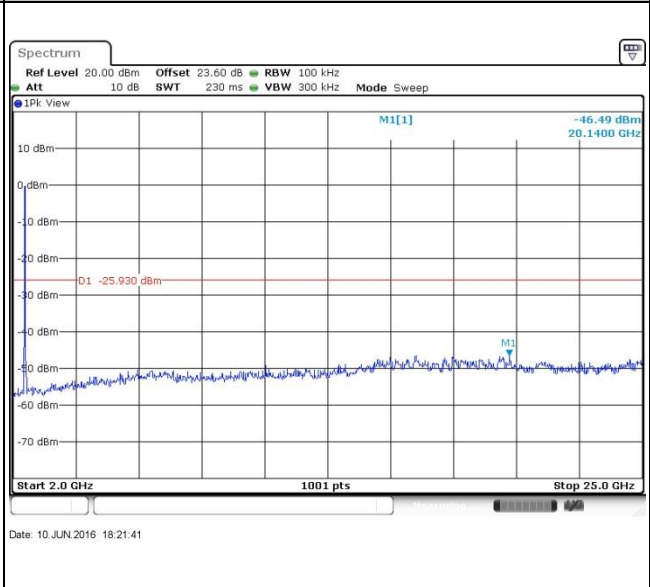



| | | | |
|----------------|--------------|---------------------|------------|
| Number of TX : | 2 | Ant. : | 1 |
| Test Mode : | 802.11n HT20 | Temperature : | 21~25°C |
| Test Band : | 2.4GHz High | Relative Humidity : | 51~54% |
| Test Channel : | 11 | Test Engineer : | Kenny Chen |

WLAN 802.11n HT20 Channel 11

100kHz PSD reference Level

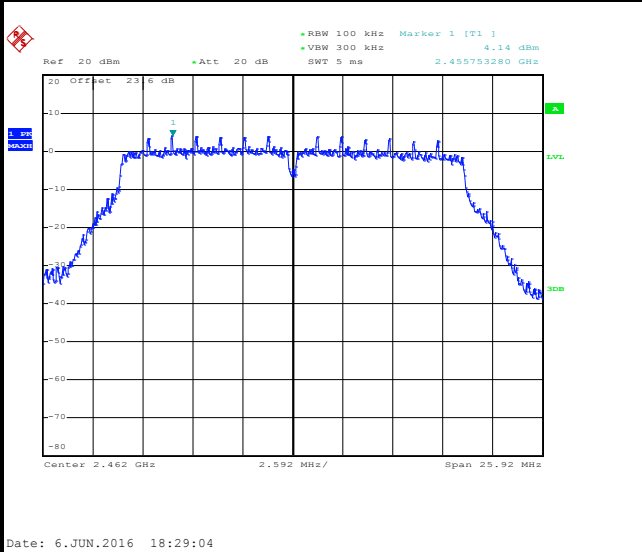

High Channel Plot

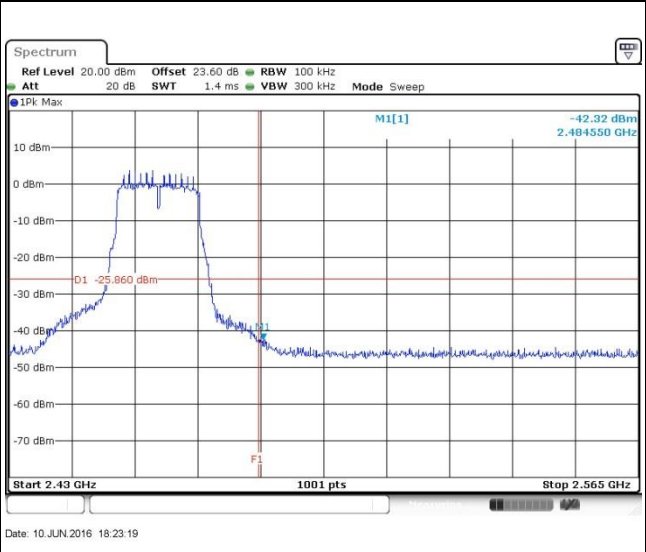

Spurious Emission 30MHz~3GHz

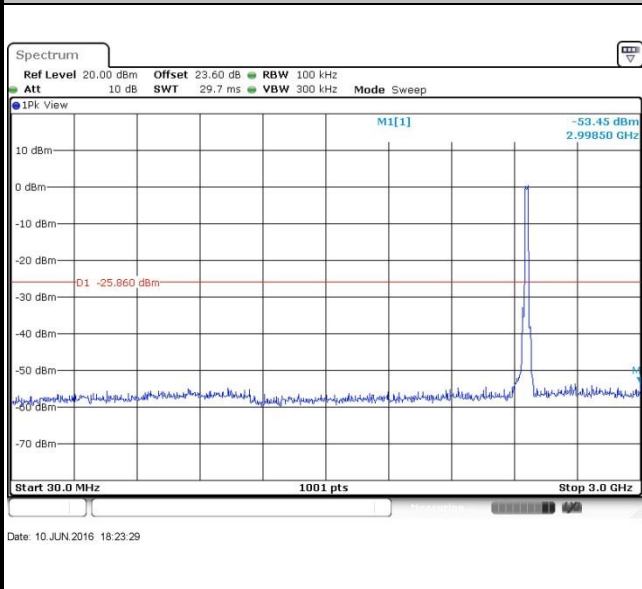

Spurious Emission 2GHz~25GHz

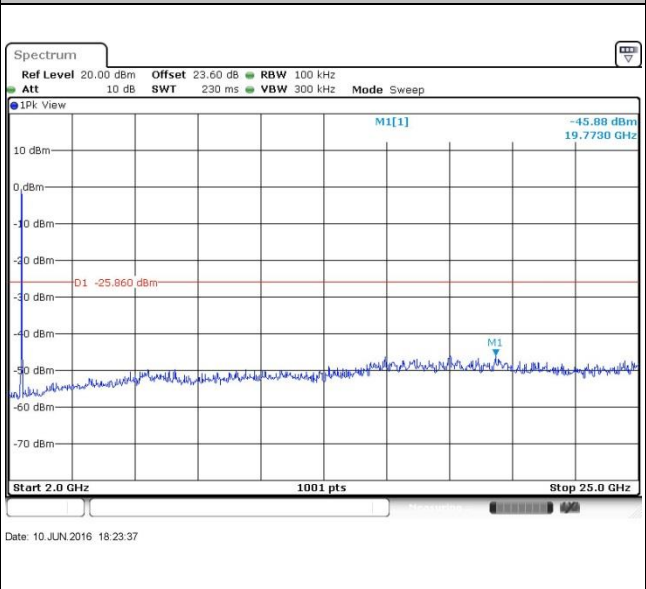



| | | | |
|----------------|--------------|---------------------|------------|
| Number of TX : | 2 | Ant. : | 1 |
| Test Mode : | 802.11n HT40 | Temperature : | 21~25°C |
| Test Band : | 2.4GHz Low | Relative Humidity : | 51~54% |
| Test Channel : | 03 | Test Engineer : | Kenny Chen |

WLAN 802.11n HT40 Channel 03

100kHz PSD reference Level

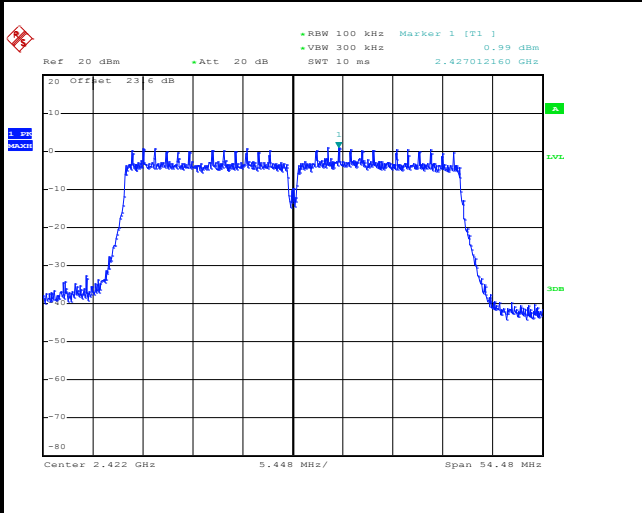

Date: 6.JUN.2016 19:14:43

Low Channel Plot

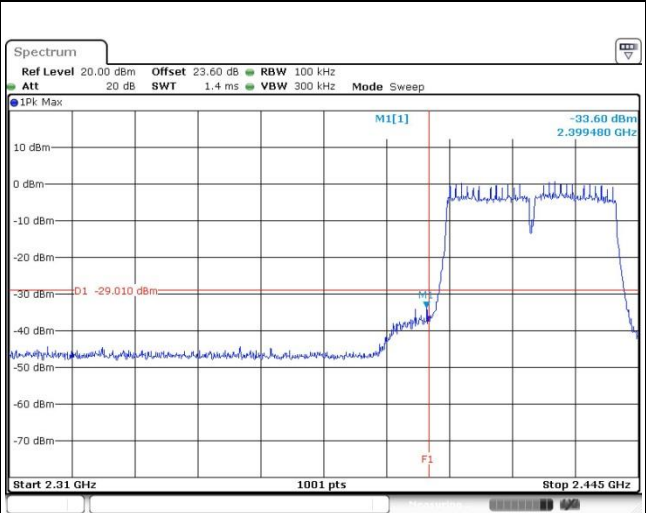

Date: 10.JUN.2016 18:50:16

Spurious Emission 30MHz~3GHz

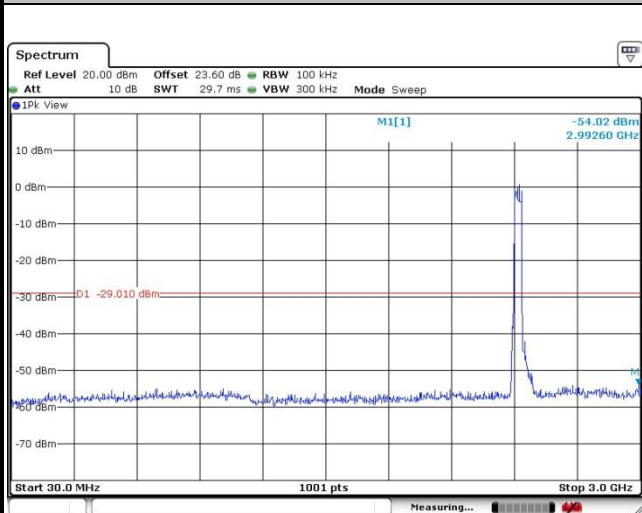

Date: 10.JUN.2016 18:50:58

Spurious Emission 2GHz~25GHz

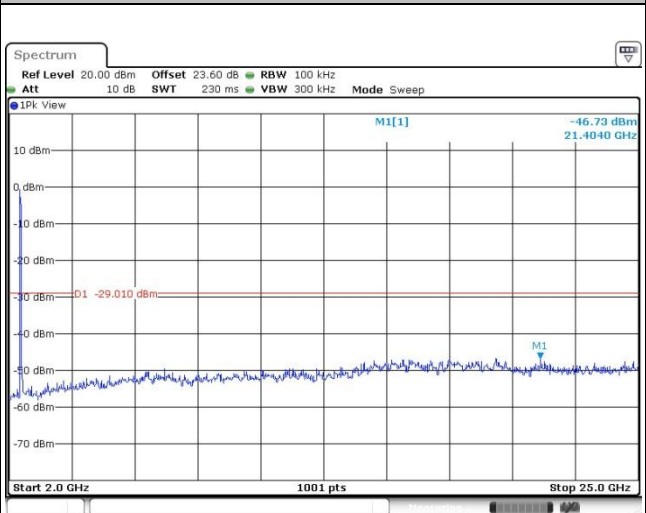

Date: 10.JUN.2016 18:50:39



| | | | |
|----------------|--------------|---------------------|------------|
| Number of TX : | 2 | Ant. : | 1 |
| Test Mode : | 802.11n HT40 | Temperature : | 21~25°C |
| Test Band : | 2.4GHz Mid | Relative Humidity : | 51~54% |
| Test Channel : | 06 | Test Engineer : | Kenny Chen |

WLAN 802.11n HT40 Channel 06

100kHz PSD reference Level

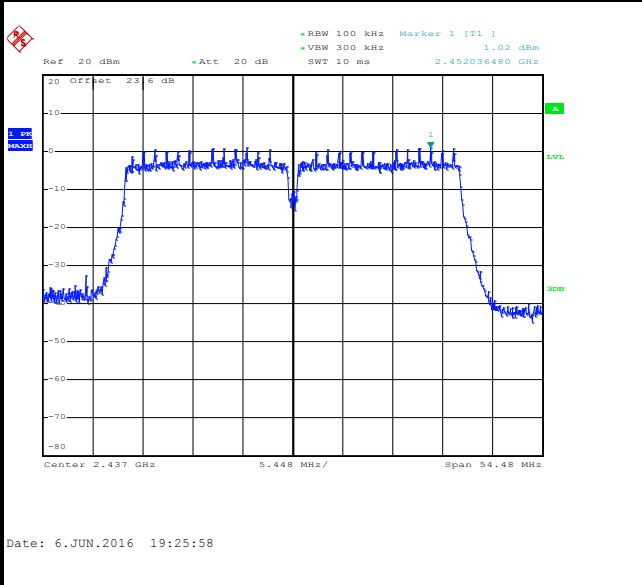

Spurious Emission 30MHz~3GHz

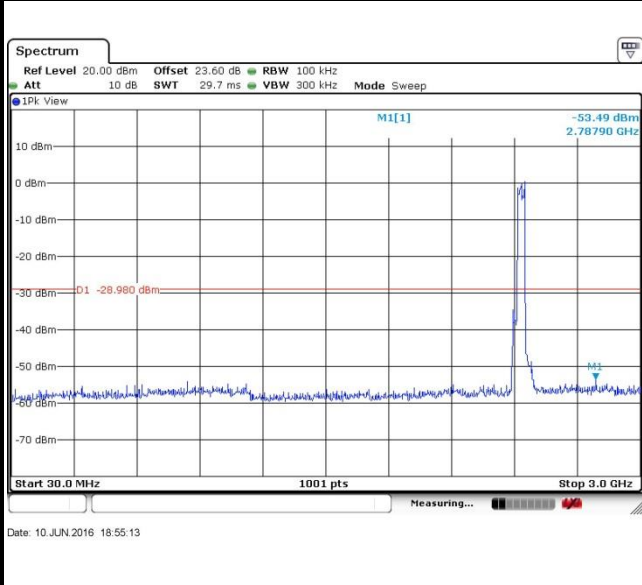

Spurious Emission 2GHz~25GHz

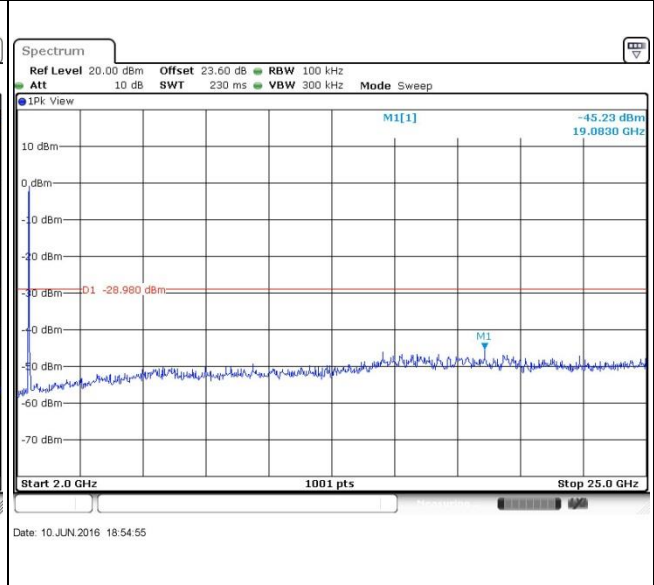



| | | | |
|----------------|--------------|---------------------|------------|
| Number of TX : | 2 | Ant. : | 1 |
| Test Mode : | 802.11n HT40 | Temperature : | 21~25°C |
| Test Band : | 2.4GHz High | Relative Humidity : | 51~54% |
| Test Channel : | 09 | Test Engineer : | Kenny Chen |

WLAN 802.11n HT40 Channel 09

100kHz PSD reference Level

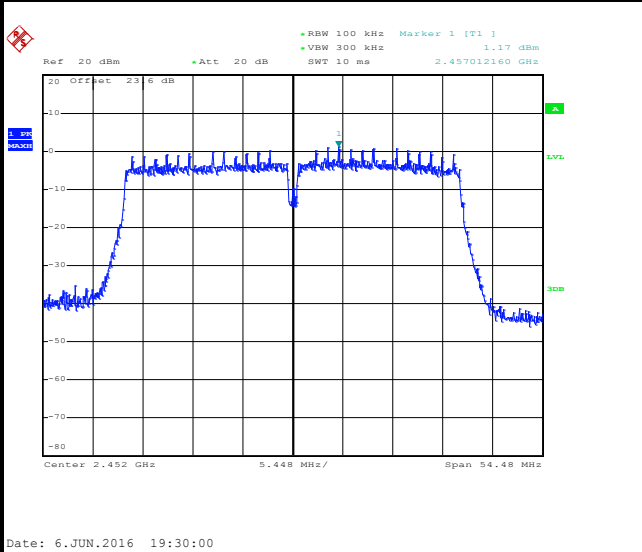

High Channel Plot

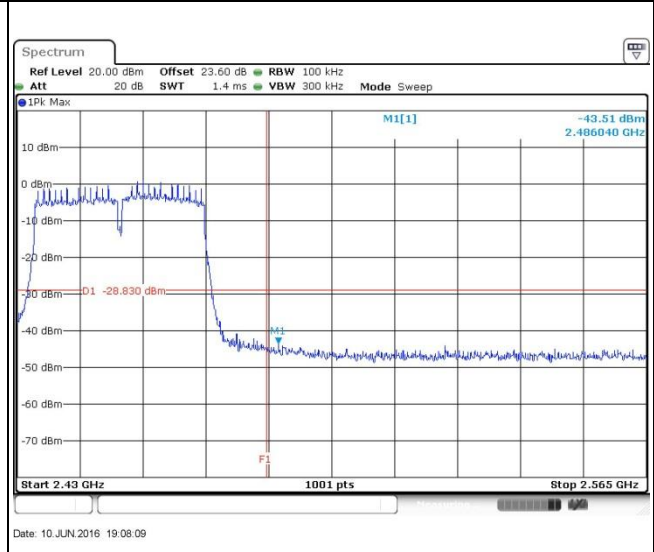

Spurious Emission 30MHz~3GHz

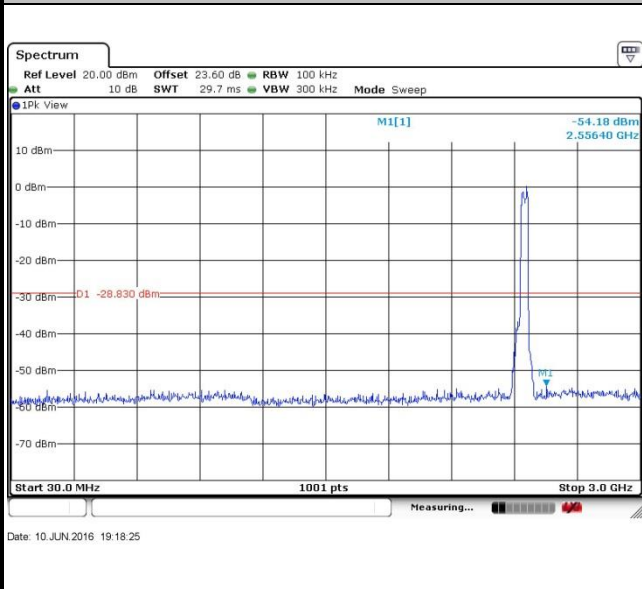

Spurious Emission 2GHz~25GHz

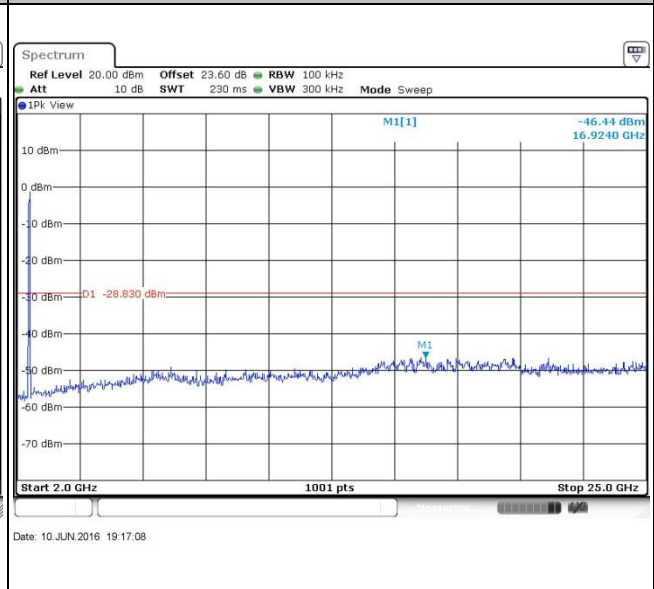



| | | | |
|----------------|----------------|---------------------|------------|
| Number of TX : | 2 | Ant. : | 1 |
| Test Mode : | 802.11ac VHT20 | Temperature : | 21~25°C |
| Test Band : | 2.4GHz Low | Relative Humidity : | 51~54% |
| Test Channel : | 01 | Test Engineer : | Kenny Chen |

WLAN 802.11ac VHT20 Channel 01

100kHz PSD reference Level

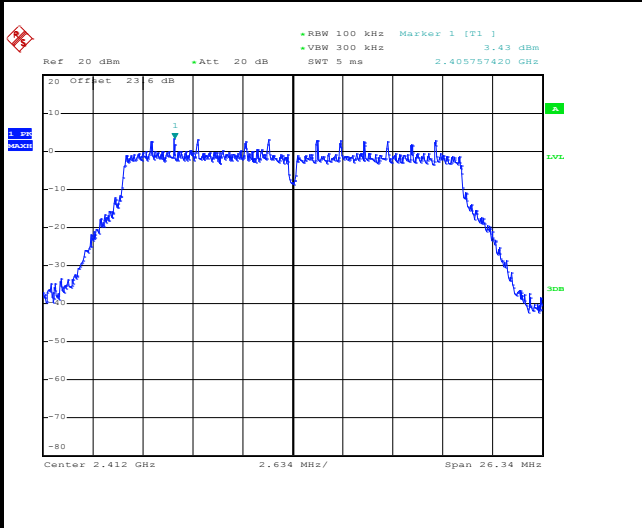

Date: 6.JUN.2016 19:41:27

Low Channel Plot

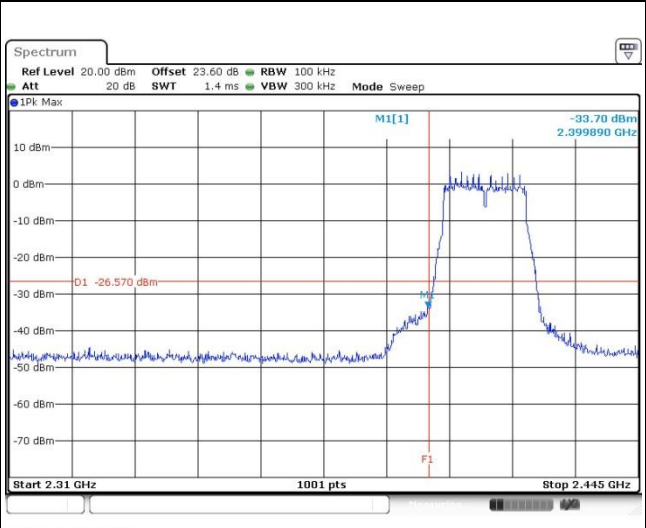

Date: 10.JUN.2016 20:46:55

Spurious Emission 30MHz~3GHz

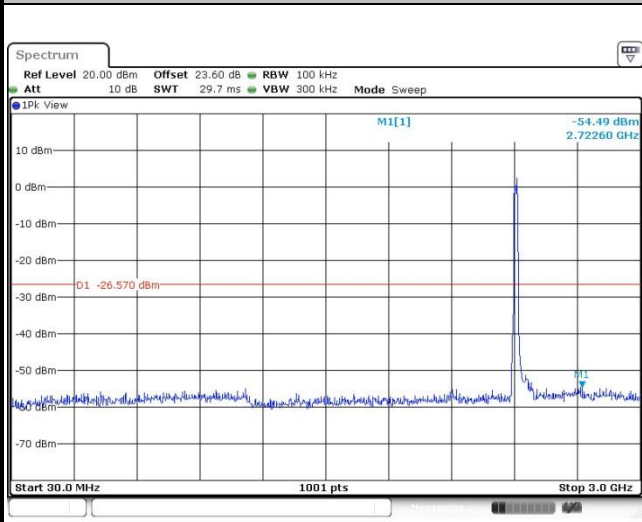

Date: 10.JUN.2016 20:47:28

Spurious Emission 2GHz~25GHz

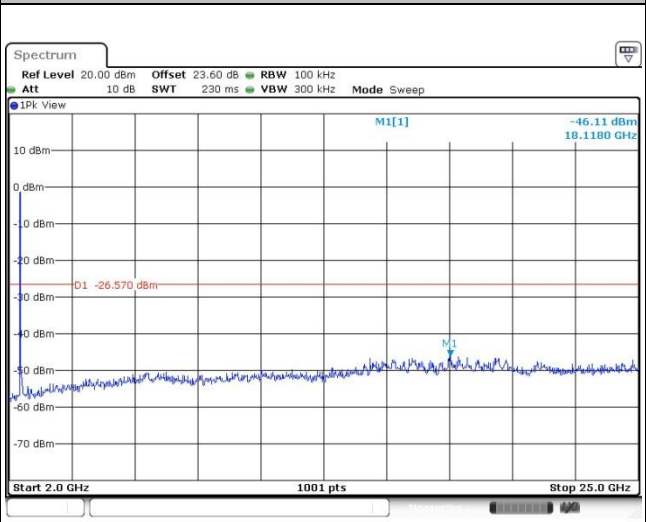

Date: 10.JUN.2016 20:47:36



| | | | |
|----------------|----------------|---------------------|------------|
| Number of TX : | 2 | Ant. : | 1 |
| Test Mode : | 802.11ac VHT20 | Temperature : | 21~25°C |
| Test Band : | 2.4GHz Mid | Relative Humidity : | 51~54% |
| Test Channel : | 06 | Test Engineer : | Kenny Chen |

WLAN 802.11ac VHT20 Channel 06

100kHz PSD reference Level

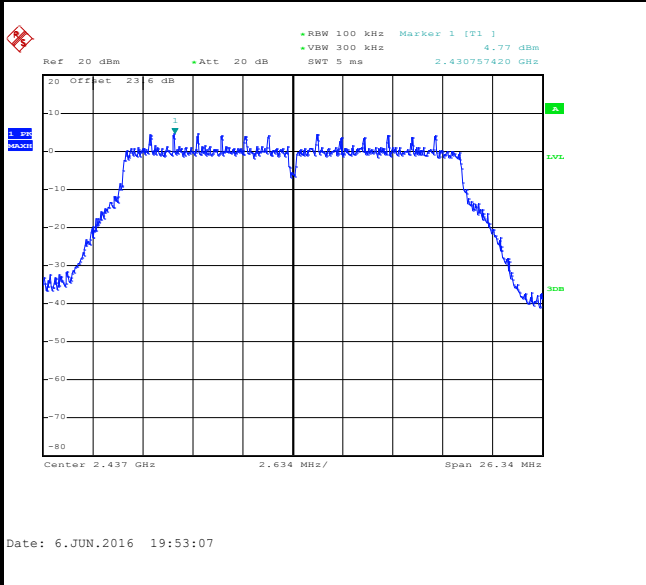

Spurious Emission 30MHz~3GHz

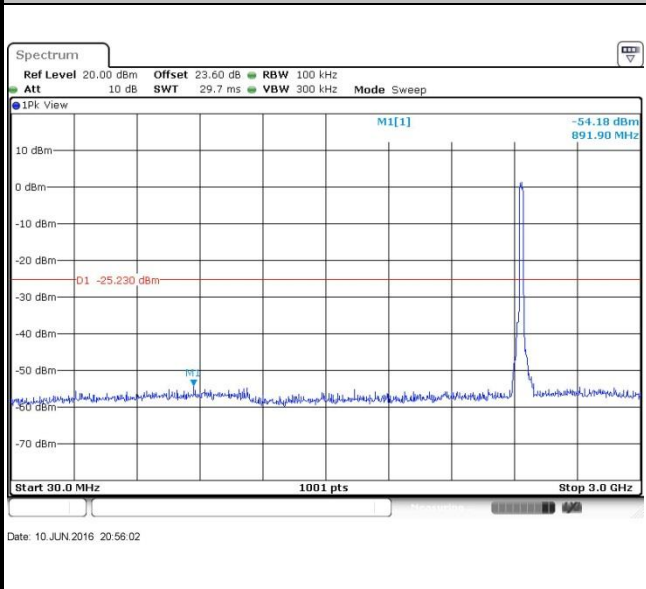

Spurious Emission 2GHz~25GHz

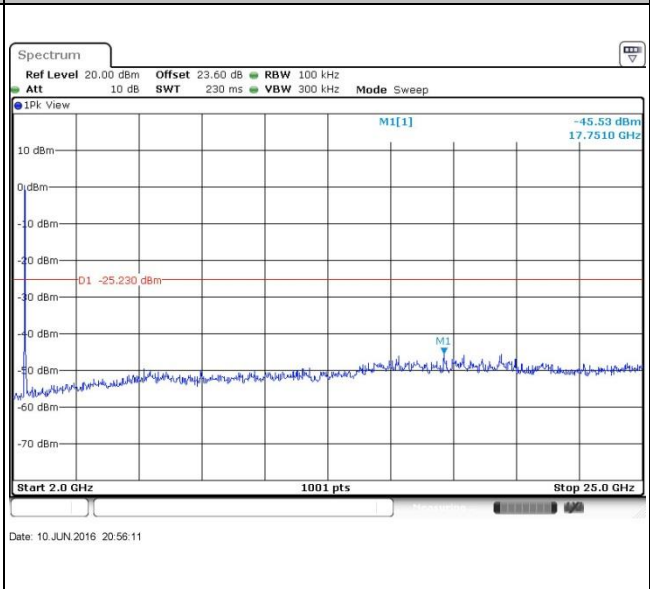



| | | | |
|----------------|----------------|---------------------|------------|
| Number of TX : | 2 | Ant. : | 1 |
| Test Mode : | 802.11ac VHT20 | Temperature : | 21~25°C |
| Test Band : | 2.4GHz High | Relative Humidity : | 51~54% |
| Test Channel : | 11 | Test Engineer : | Kenny Chen |

WLAN 802.11ac VHT20 Channel 11

100kHz PSD reference Level

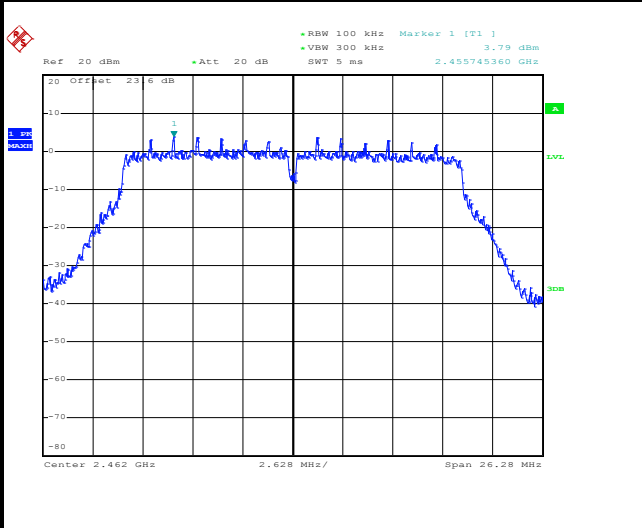

Date: 6.JUN.2016 20:15:36

High Channel Plot

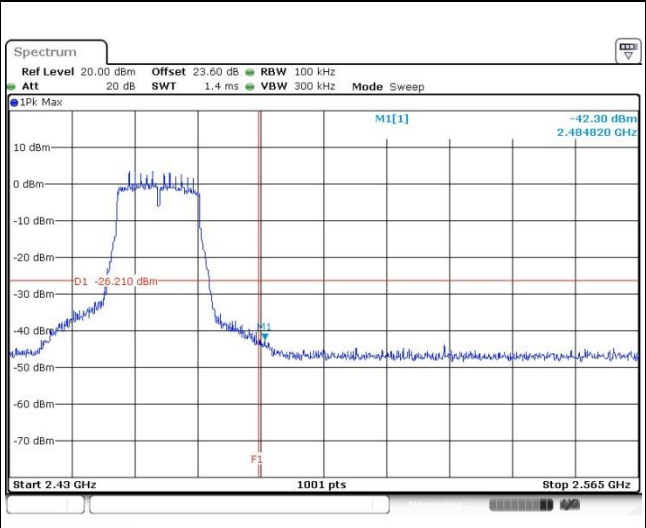

Date: 10.JUN.2016 20:59:04

Spurious Emission 30MHz~3GHz

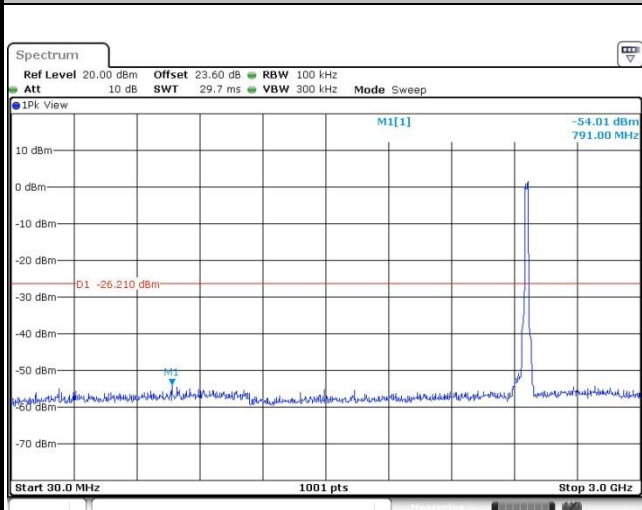

Date: 10.JUN.2016 20:59:15

Spurious Emission 2GHz~25GHz

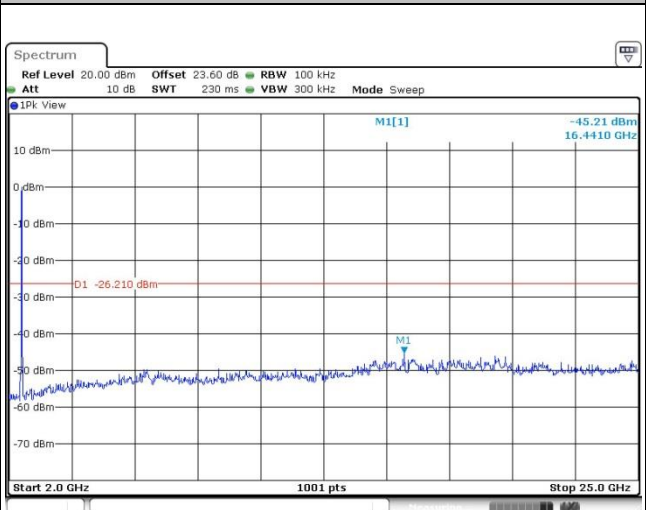

Date: 10.JUN.2016 20:59:23



| | | | |
|----------------|----------------|---------------------|------------|
| Number of TX : | 2 | Ant. : | 1 |
| Test Mode : | 802.11ac VHT40 | Temperature : | 21~25°C |
| Test Band : | 2.4GHz Low | Relative Humidity : | 51~54% |
| Test Channel : | 03 | Test Engineer : | Kenny Chen |

WLAN 802.11ac VHT40 Channel 03

100kHz PSD reference Level

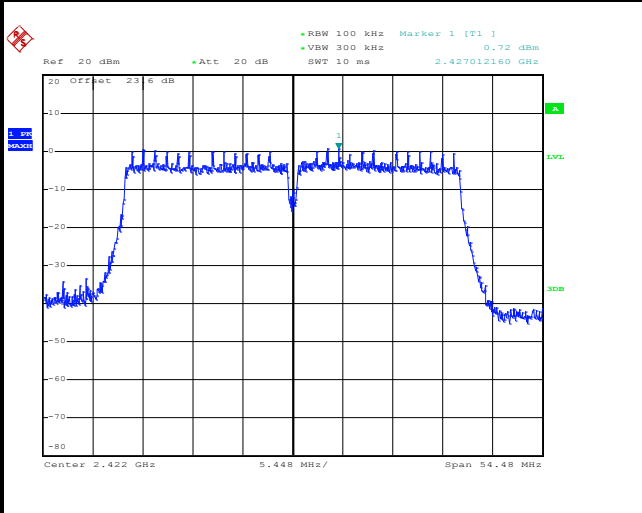

Date: 6.JUN.2016 20:19:14

Low Channel Plot

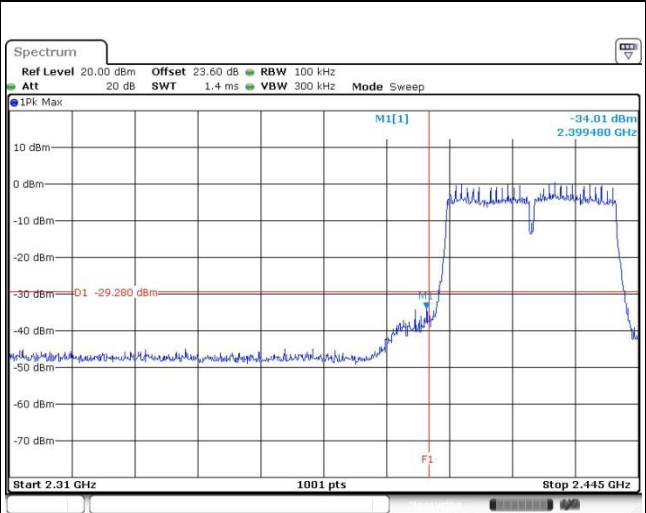

Date: 10.JUN.2016 21:14:45

Spurious Emission 30MHz~3GHz

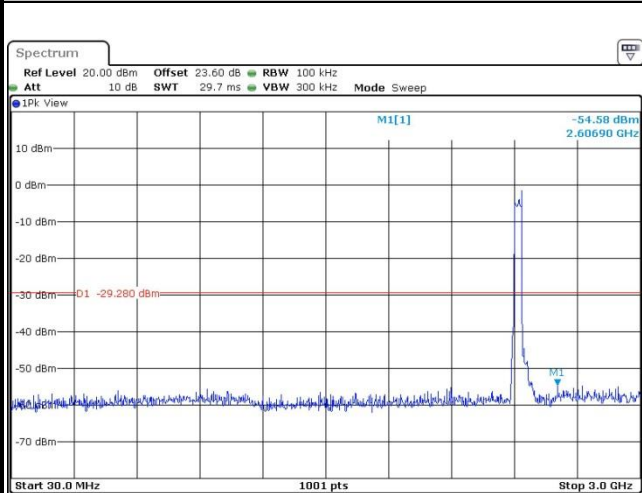

Date: 10.JUN.2016 21:15:22

Spurious Emission 2GHz~25GHz

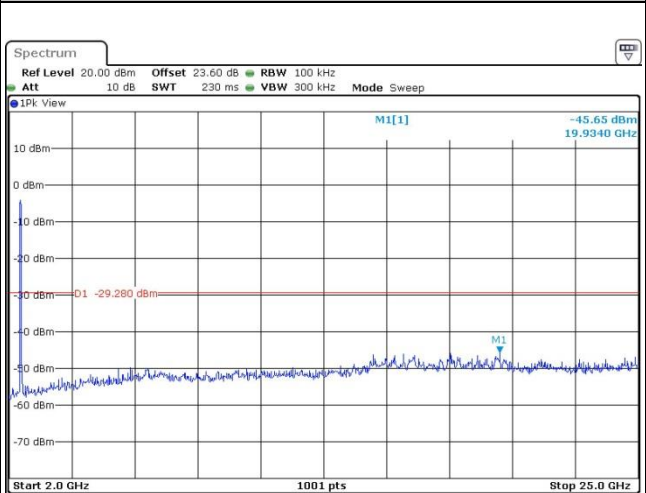

Date: 10.JUN.2016 21:15:31



| | | | |
|----------------|----------------|---------------------|------------|
| Number of TX : | 2 | Ant. : | 1 |
| Test Mode : | 802.11ac VHT40 | Temperature : | 21~25°C |
| Test Band : | 2.4GHz Mid | Relative Humidity : | 51~54% |
| Test Channel : | 06 | Test Engineer : | Kenny Chen |

WLAN 802.11ac VHT40 Channel 06

100kHz PSD reference Level

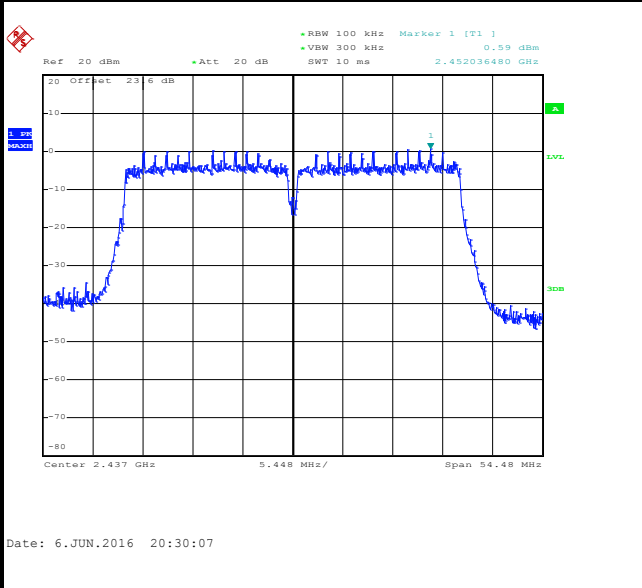

Spurious Emission 30MHz~3GHz

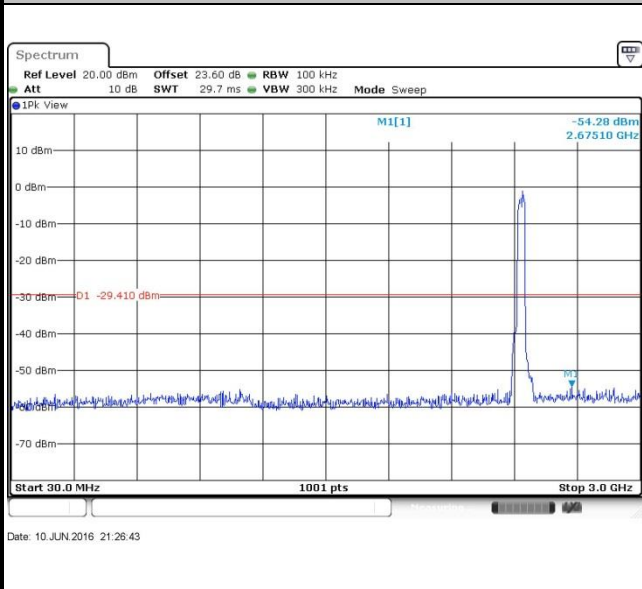

Spurious Emission 2GHz~25GHz

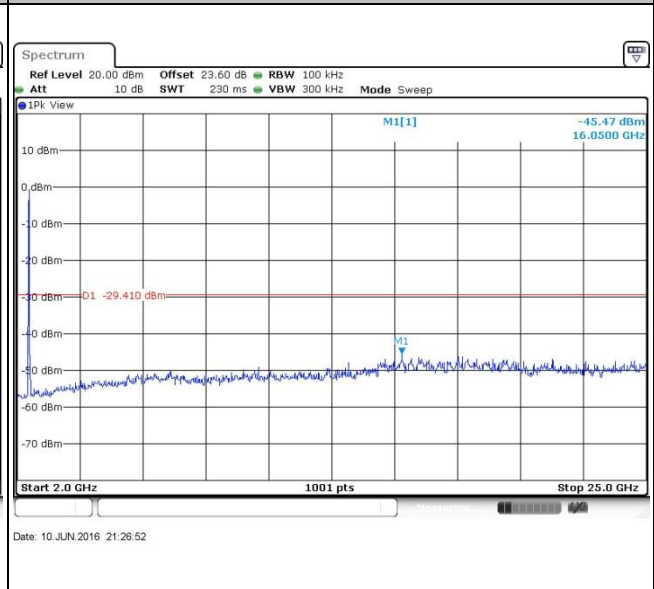



| | | | |
|----------------|----------------|---------------------|------------|
| Number of TX : | 2 | Ant. : | 1 |
| Test Mode : | 802.11ac VHT40 | Temperature : | 21~25°C |
| Test Band : | 2.4GHz High | Relative Humidity : | 51~54% |
| Test Channel : | 09 | Test Engineer : | Kenny Chen |

WLAN 802.11ac VHT40 Channel 09

100kHz PSD reference Level

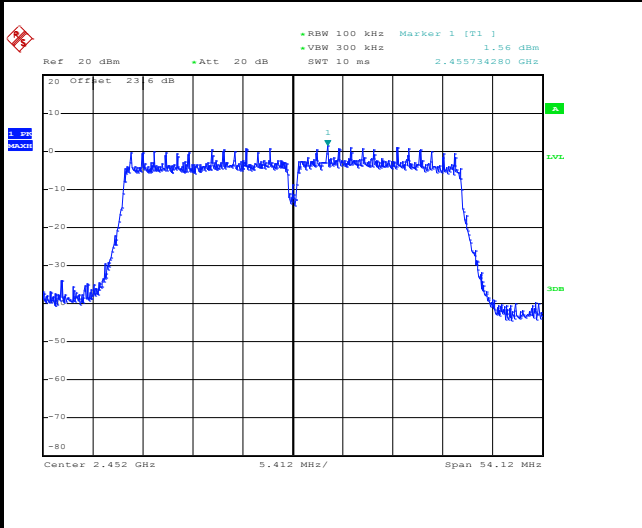

High Channel Plot

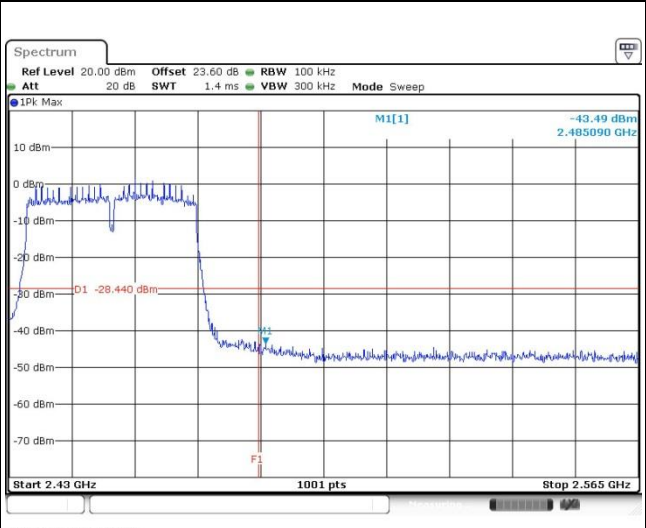

Spurious Emission 30MHz~3GHz

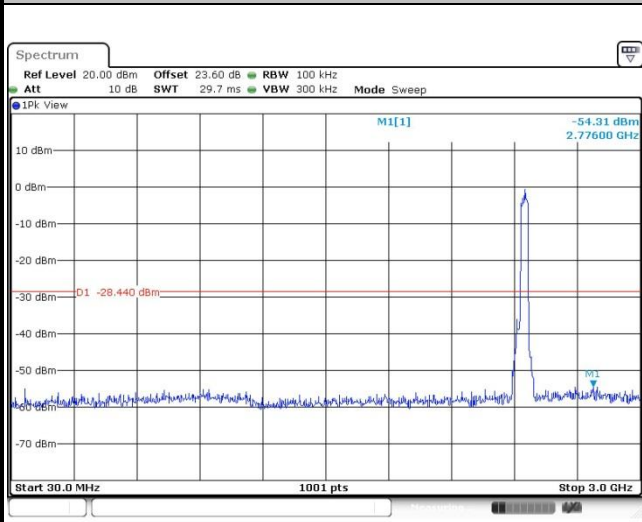

Spurious Emission 2GHz~25GHz

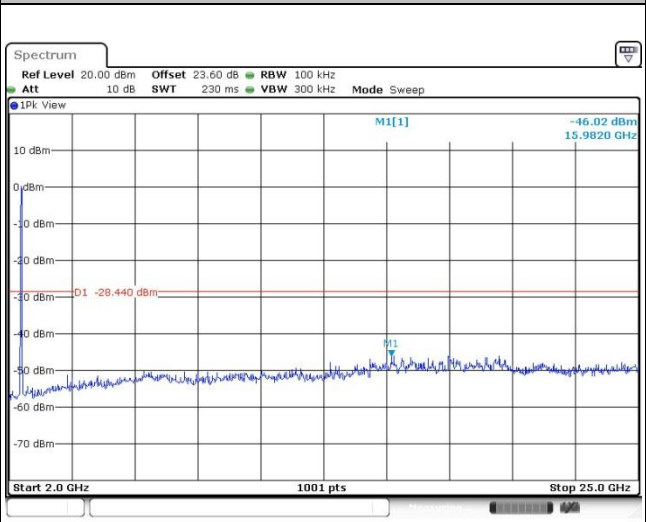



Number of TX = 2, Ant. 2 (Measured)

| | | | |
|----------------|------------|---------------------|------------|
| Number of TX : | 2 | Ant. : | 2 |
| Test Mode : | 802.11b | Temperature : | 21~25°C |
| Test Band : | 2.4GHz Low | Relative Humidity : | 51~54% |
| Test Channel : | 01 | Test Engineer : | Kenny Chen |

WLAN 802.11b Channel 01

100kHz PSD reference Level

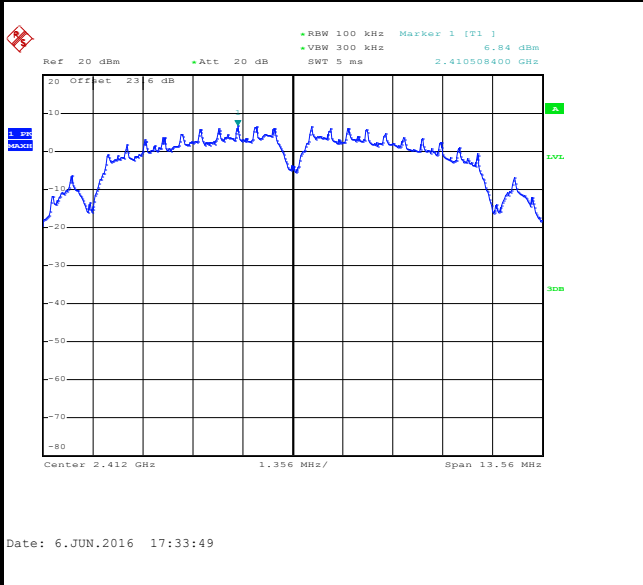

Low Channel Plot

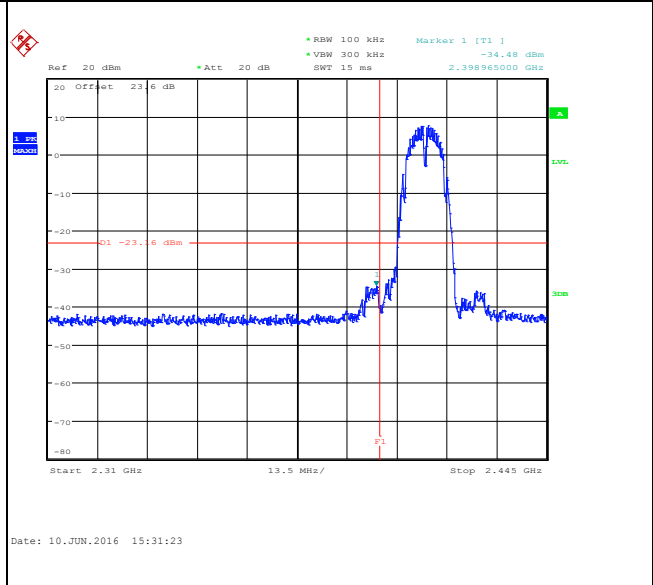

Spurious Emission 30MHz~3GHz

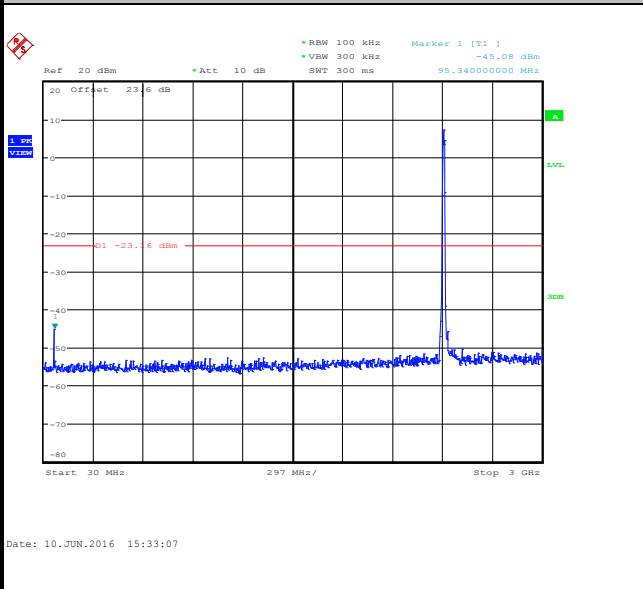

Spurious Emission 2GHz~25GHz

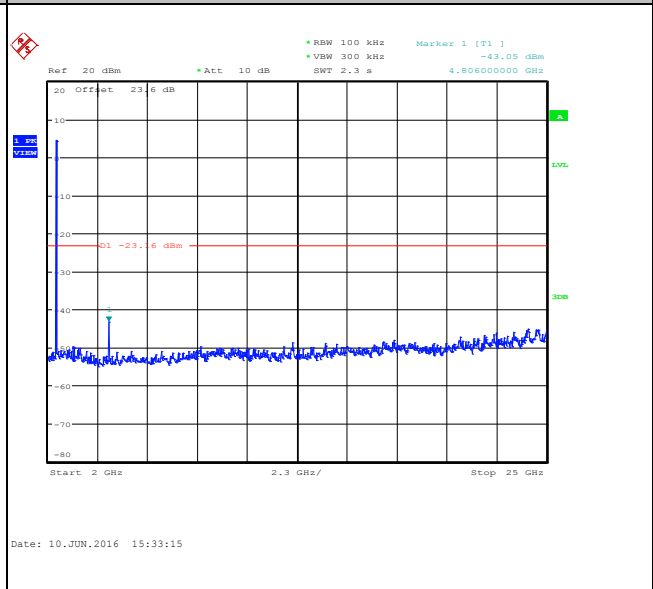



| | | | |
|----------------|------------|---------------------|------------|
| Number of TX : | 2 | Ant. : | 2 |
| Test Mode : | 802.11b | Temperature : | 21~25°C |
| Test Band : | 2.4GHz Mid | Relative Humidity : | 51~54% |
| Test Channel : | 06 | Test Engineer : | Kenny Chen |

WLAN 802.11b Channel 06

100kHz PSD reference Level

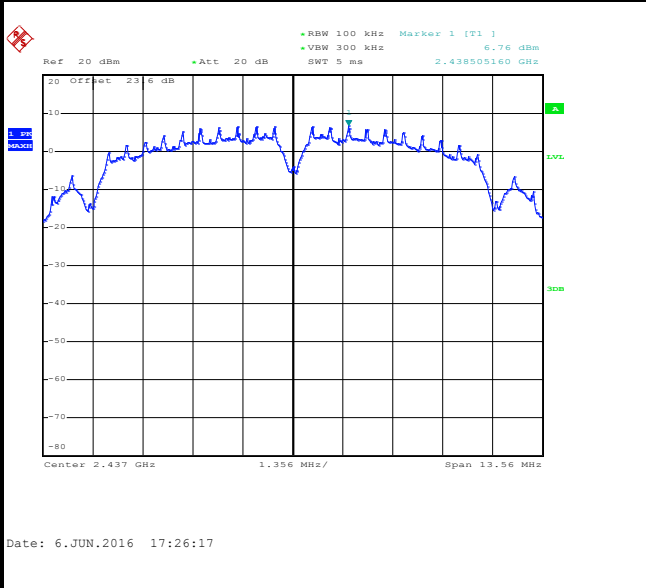

Spurious Emission 30MHz~3GHz

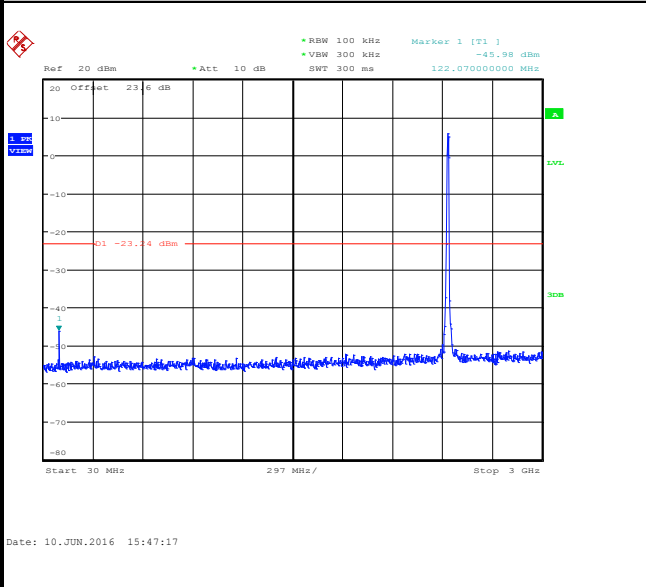

Spurious Emission 2GHz~25GHz

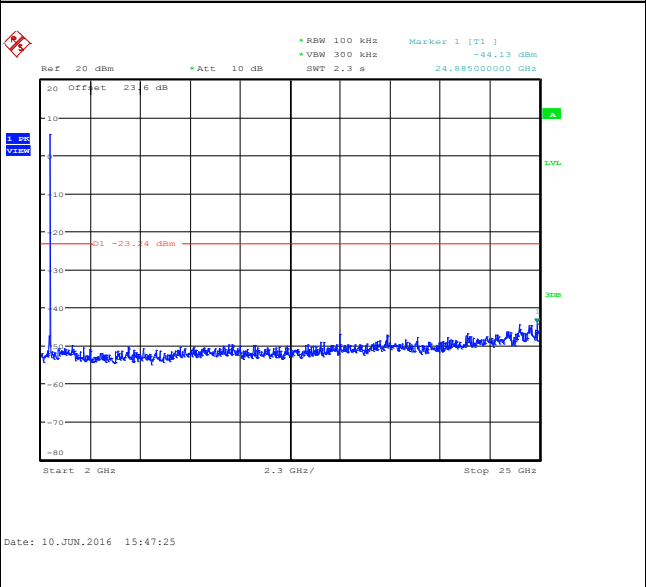



| | | | |
|----------------|-------------|---------------------|------------|
| Number of TX : | 2 | Ant. : | 2 |
| Test Mode : | 802.11b | Temperature : | 21~25°C |
| Test Band : | 2.4GHz High | Relative Humidity : | 51~54% |
| Test Channel : | 11 | Test Engineer : | Kenny Chen |

WLAN 802.11b Channel 11

100kHz PSD reference Level

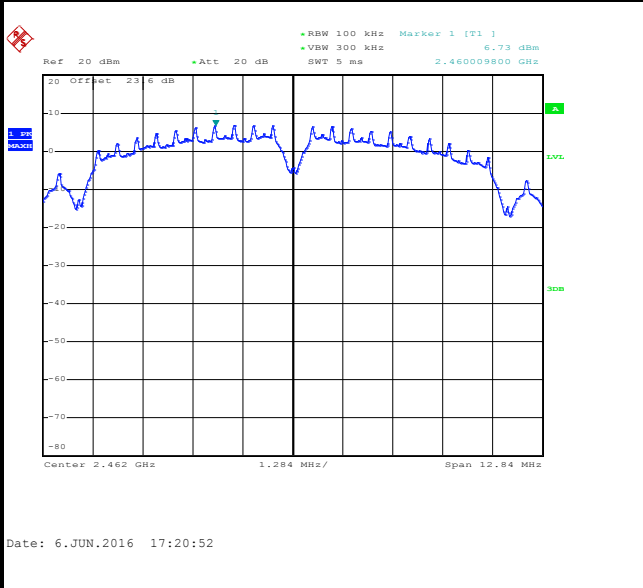

High Channel Plot

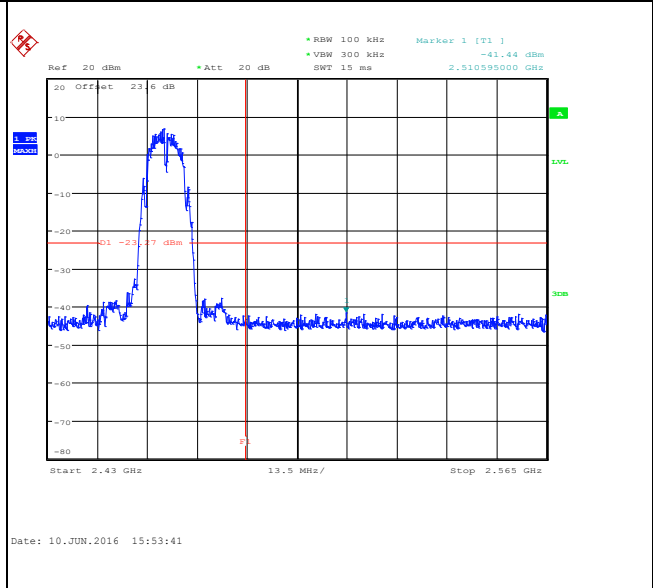

Spurious Emission 30MHz~3GHz

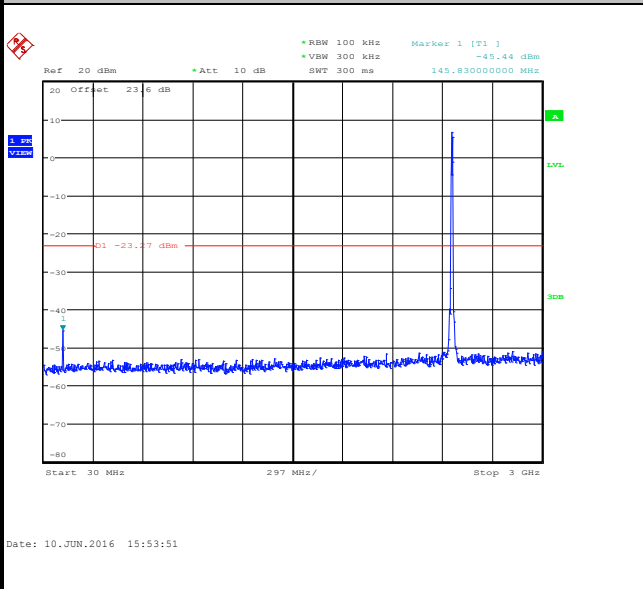

Spurious Emission 2GHz~25GHz

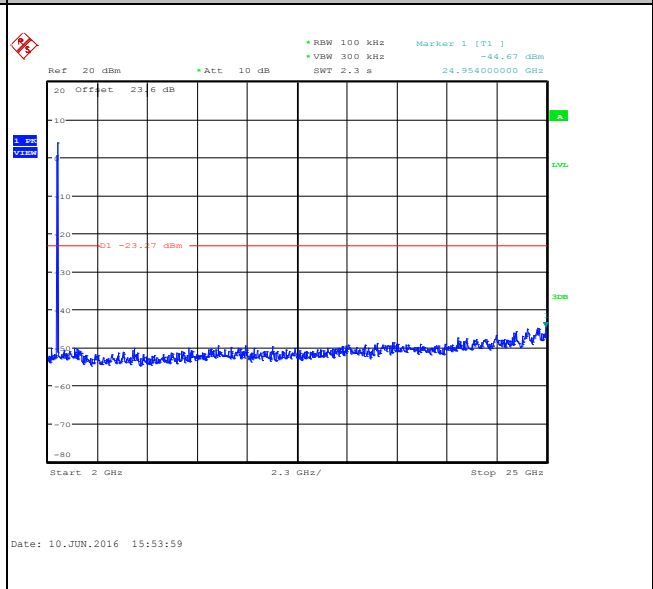



| | | | |
|----------------|------------|---------------------|------------|
| Number of TX : | 2 | Ant. : | 2 |
| Test Mode : | 802.11g | Temperature : | 21~25°C |
| Test Band : | 2.4GHz Low | Relative Humidity : | 51~54% |
| Test Channel : | 01 | Test Engineer : | Kenny Chen |

WLAN 802.11g Channel 01

100kHz PSD reference Level

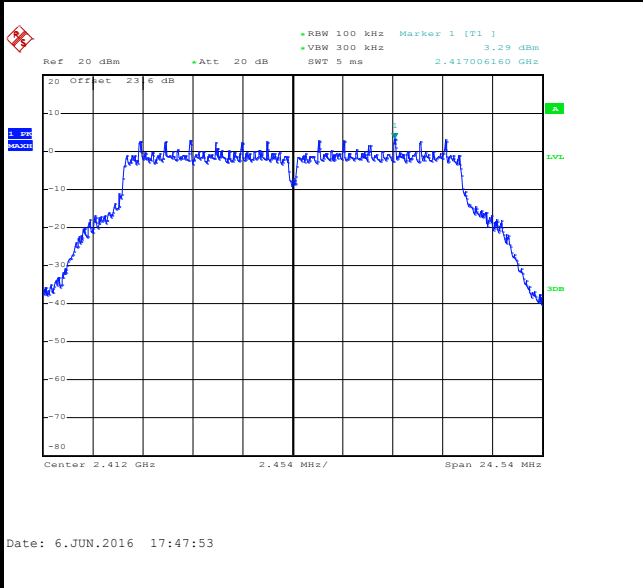

Low Channel Plot

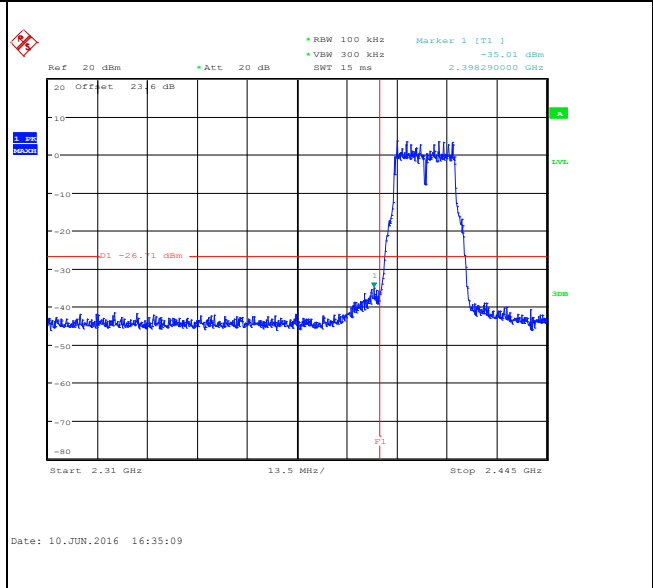

Spurious Emission 30MHz~3GHz

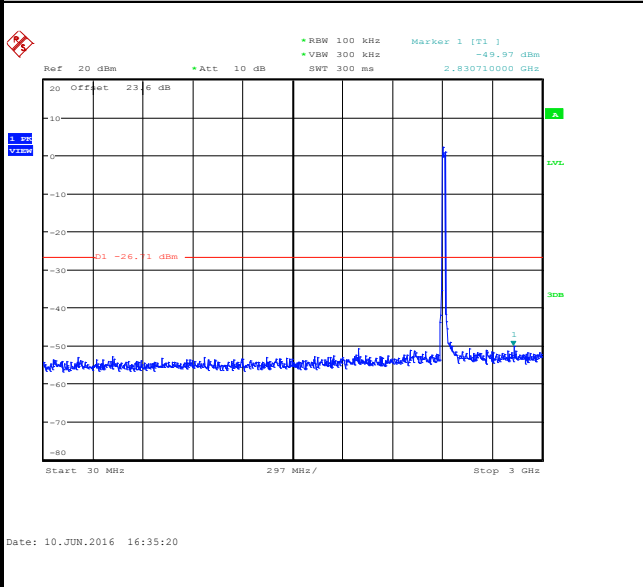

Spurious Emission 2GHz~25GHz

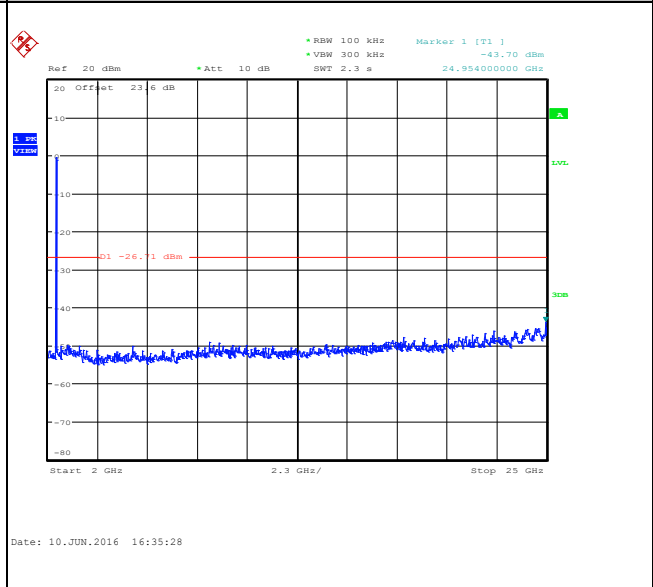



| | | | |
|----------------|------------|---------------------|------------|
| Number of TX : | 2 | Ant. : | 2 |
| Test Mode : | 802.11g | Temperature : | 21~25°C |
| Test Band : | 2.4GHz Mid | Relative Humidity : | 51~54% |
| Test Channel : | 06 | Test Engineer : | Kenny Chen |

WLAN 802.11g Channel 06

100kHz PSD reference Level

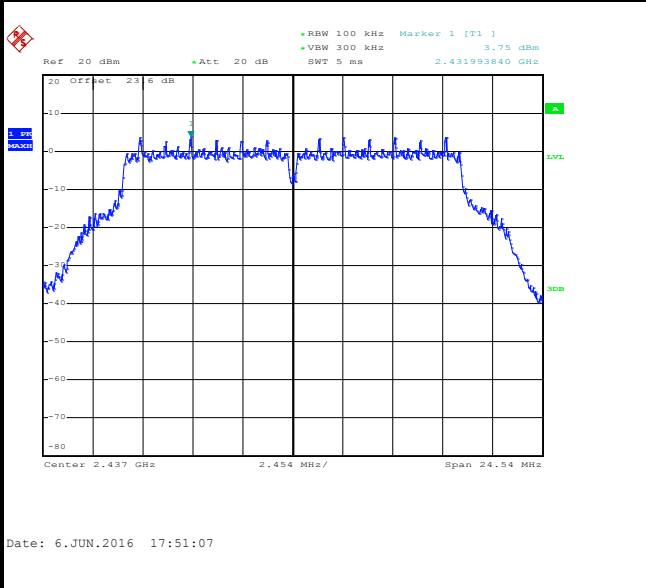

Spurious Emission 30MHz~3GHz

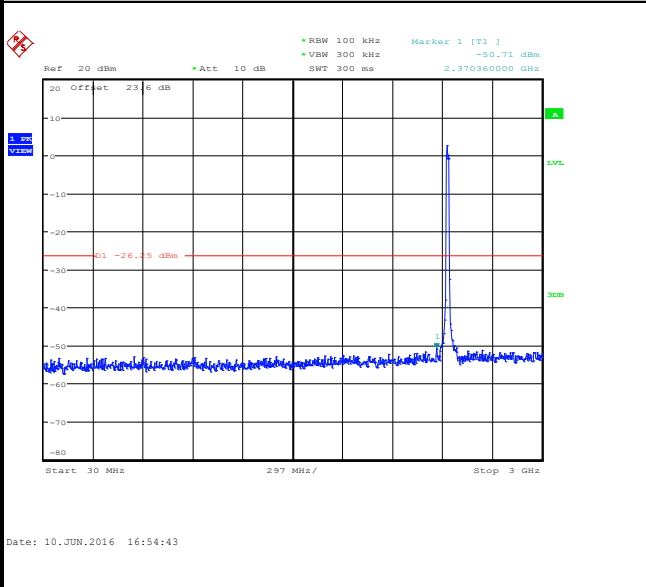

Spurious Emission 2GHz~25GHz

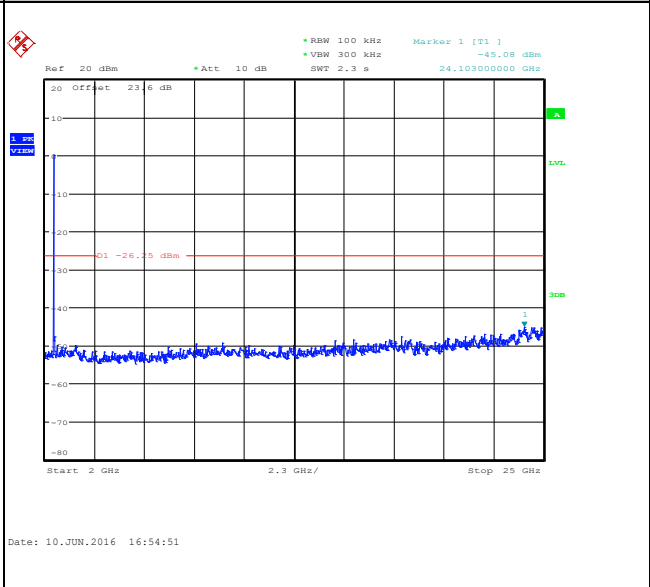



| | | | |
|----------------|-------------|---------------------|------------|
| Number of TX : | 2 | Ant. : | 2 |
| Test Mode : | 802.11g | Temperature : | 21~25°C |
| Test Band : | 2.4GHz High | Relative Humidity : | 51~54% |
| Test Channel : | 11 | Test Engineer : | Kenny Chen |

WLAN 802.11g Channel 11

100kHz PSD reference Level

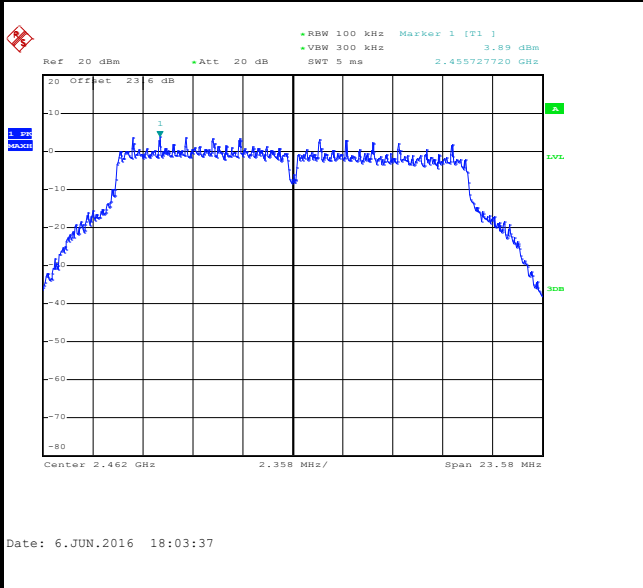

High Channel Plot

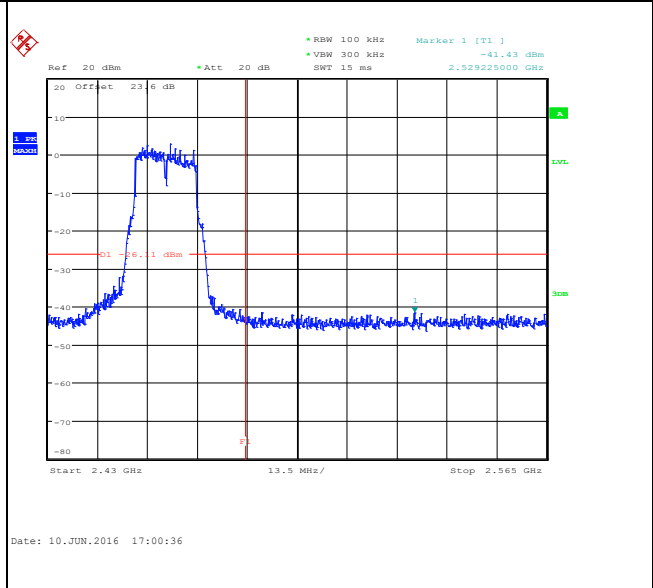

Spurious Emission 30MHz~3GHz

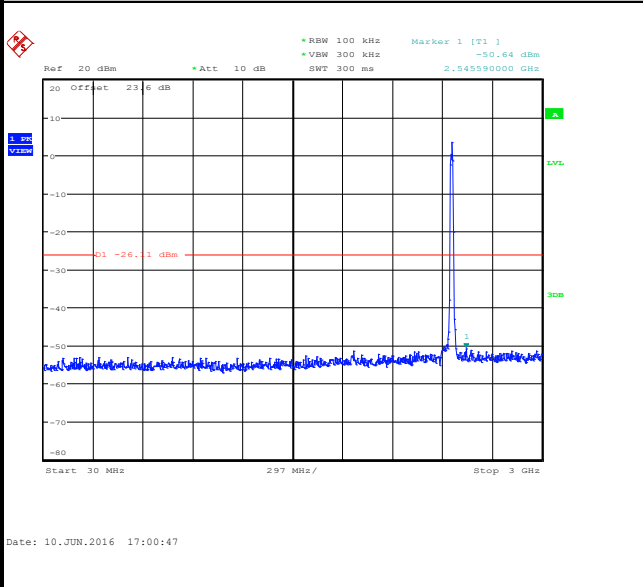

Spurious Emission 2GHz~25GHz

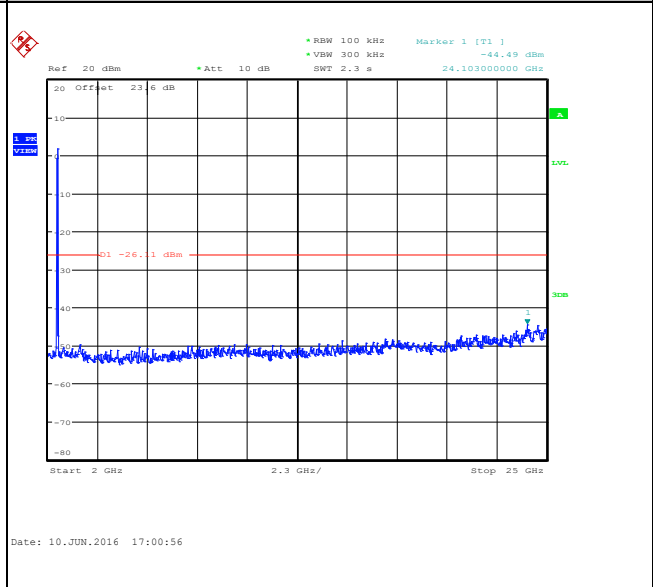



| | | | |
|----------------|--------------|---------------------|------------|
| Number of TX : | 2 | Ant. : | 2 |
| Test Mode : | 802.11n HT20 | Temperature : | 21~25°C |
| Test Band : | 2.4GHz Low | Relative Humidity : | 51~54% |
| Test Channel : | 01 | Test Engineer : | Kenny Chen |

WLAN 802.11n HT20 Channel 01

100kHz PSD reference Level

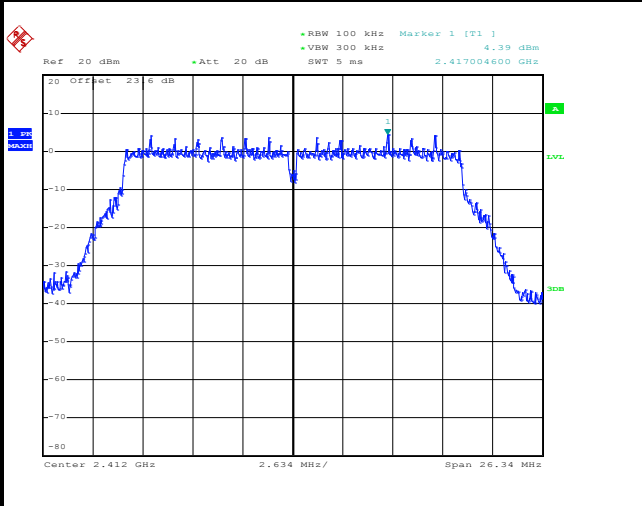

Date: 6.JUN.2016 18:13:34

Low Channel Plot

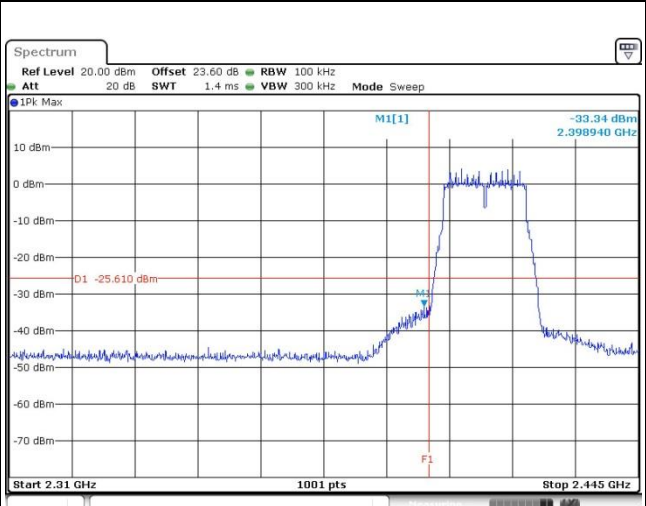

Date: 10.JUN.2016 18:18:15

Spurious Emission 30MHz~3GHz

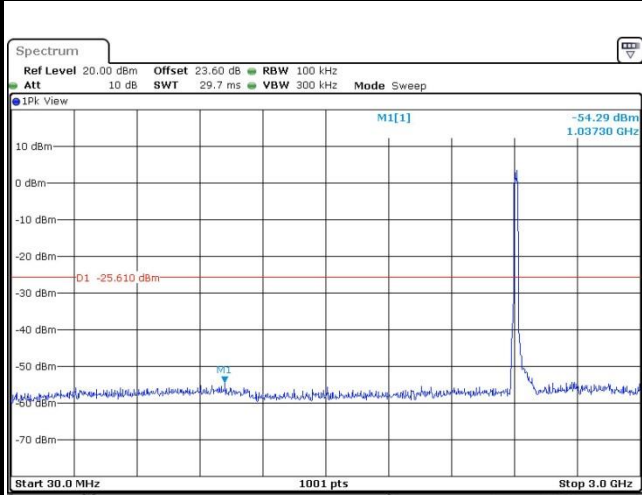

Date: 10.JUN.2016 18:18:26

Spurious Emission 2GHz~25GHz

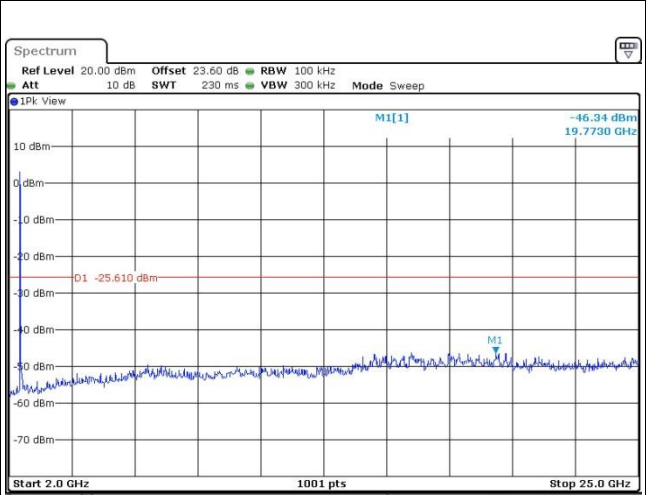

Date: 10.JUN.2016 18:18:34



| | | | |
|----------------|--------------|---------------------|------------|
| Number of TX : | 2 | Ant. : | 2 |
| Test Mode : | 802.11n HT20 | Temperature : | 21~25°C |
| Test Band : | 2.4GHz Mid | Relative Humidity : | 51~54% |
| Test Channel : | 06 | Test Engineer : | Kenny Chen |

WLAN 802.11n HT20 Channel 06

100kHz PSD reference Level

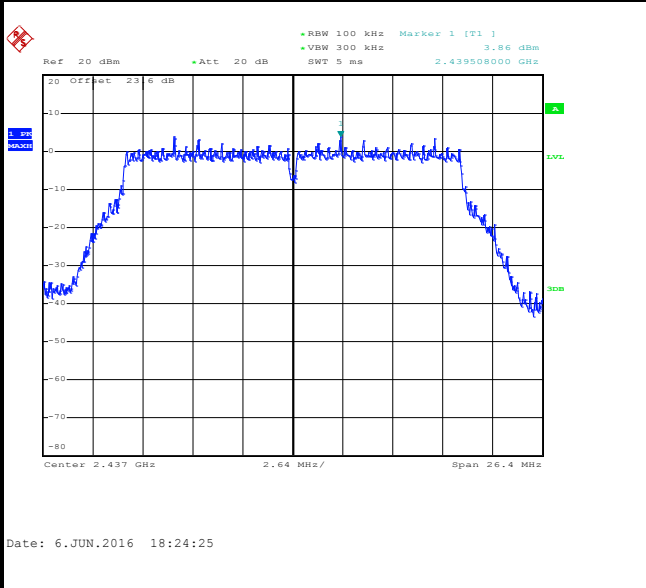

Spurious Emission 30MHz~3GHz

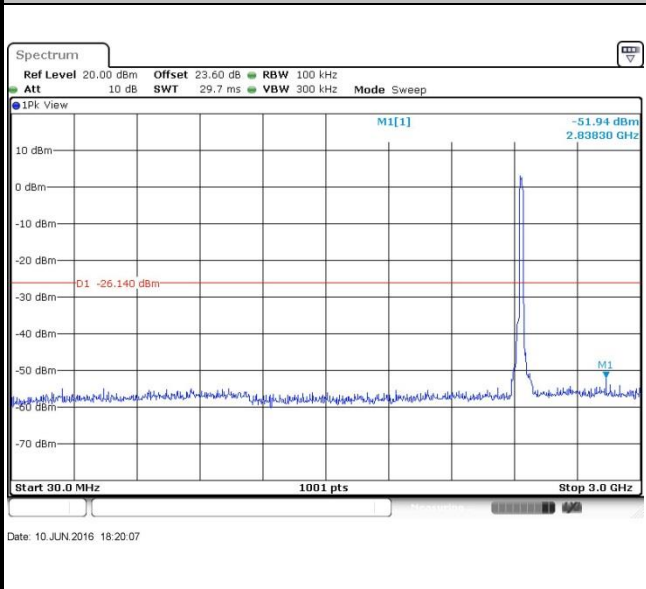

Spurious Emission 2GHz~25GHz

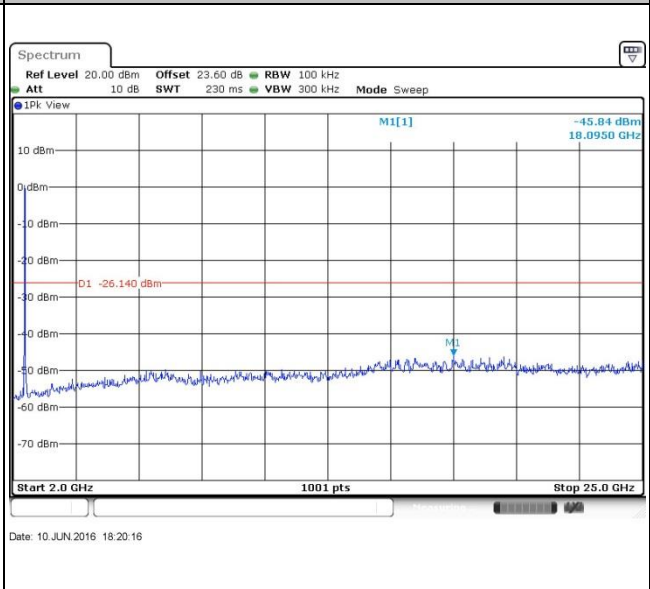



| | | | |
|----------------|--------------|---------------------|------------|
| Number of TX : | 2 | Ant. : | 2 |
| Test Mode : | 802.11n HT20 | Temperature : | 21~25°C |
| Test Band : | 2.4GHz High | Relative Humidity : | 51~54% |
| Test Channel : | 11 | Test Engineer : | Kenny Chen |

WLAN 802.11n HT20 Channel 11

100kHz PSD reference Level

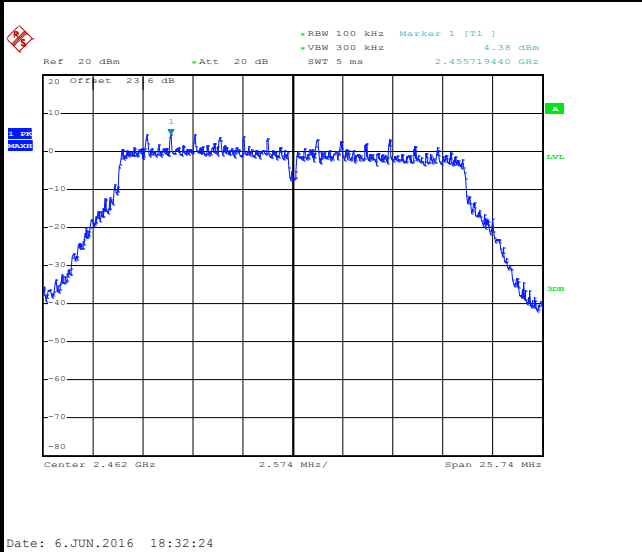

High Channel Plot

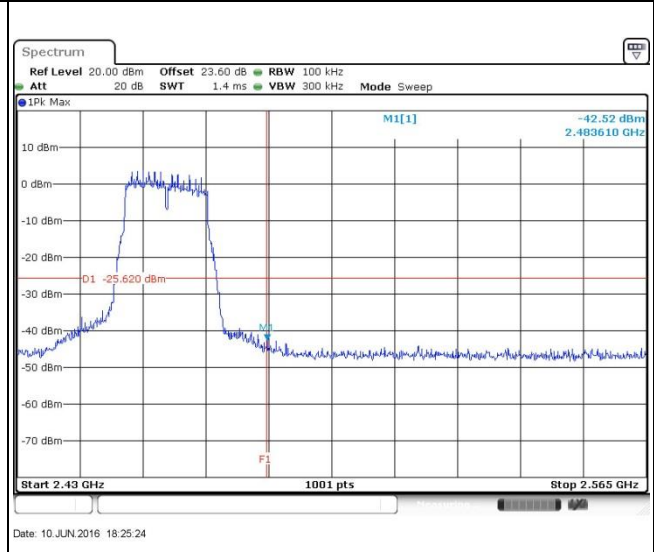

Spurious Emission 30MHz~3GHz

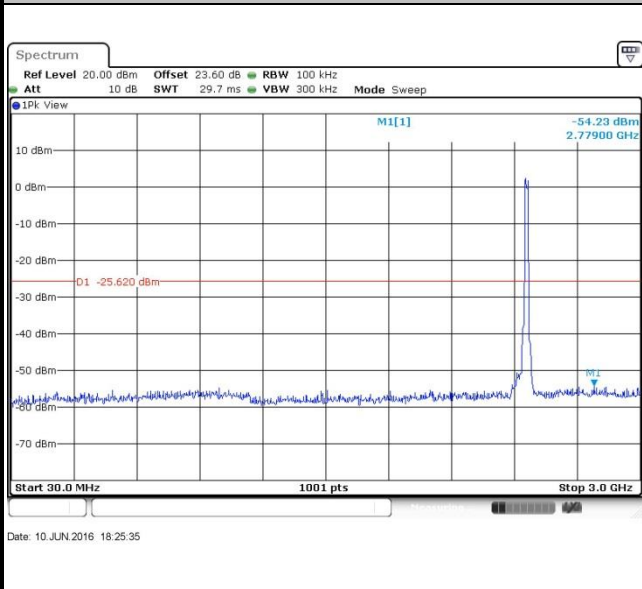

Spurious Emission 2GHz~25GHz

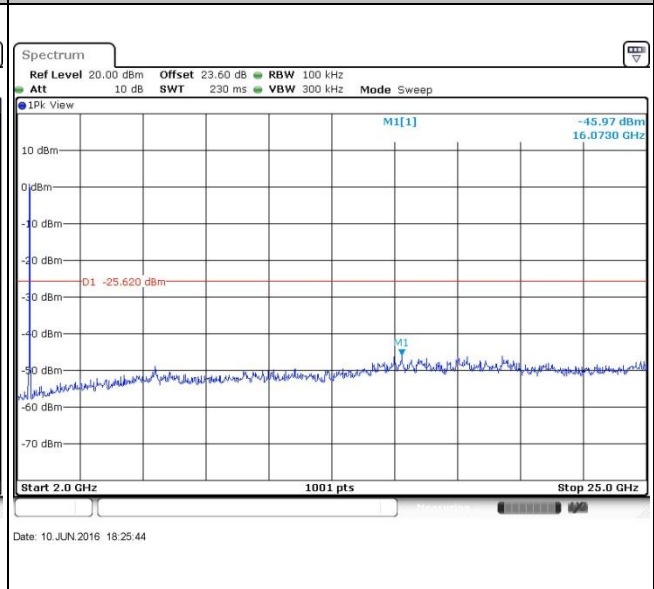



| | | | |
|----------------|--------------|---------------------|------------|
| Number of TX : | 2 | Ant. : | 2 |
| Test Mode : | 802.11n HT40 | Temperature : | 21~25°C |
| Test Band : | 2.4GHz Low | Relative Humidity : | 51~54% |
| Test Channel : | 03 | Test Engineer : | Kenny Chen |

WLAN 802.11n HT40 Channel 03

100kHz PSD reference Level

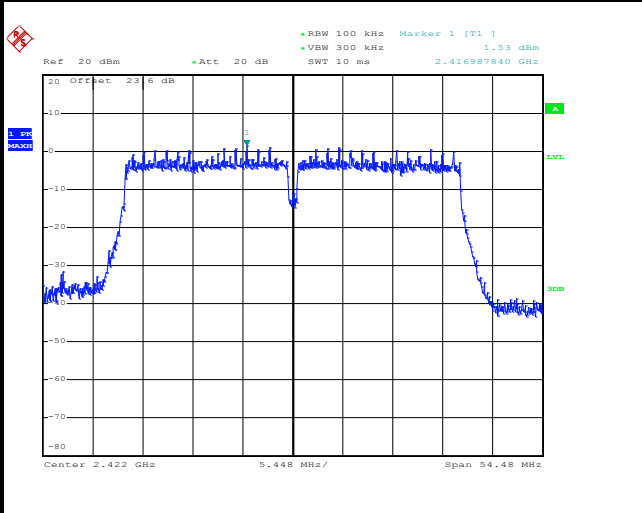

Date: 6.JUN.2016 19:19:59

Low Channel Plot

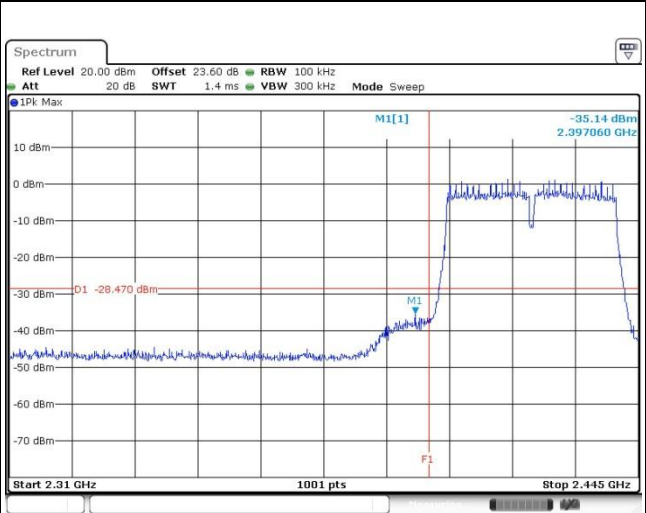

Date: 10.JUN.2016 18:46:48

Spurious Emission 30MHz~3GHz

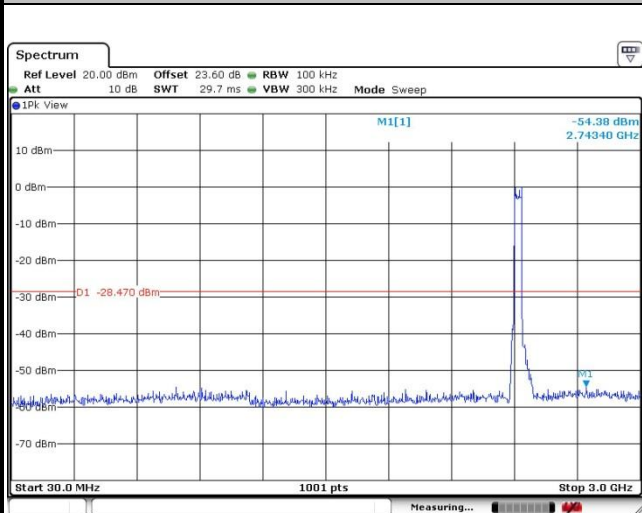

Date: 10.JUN.2016 18:47:45

Spurious Emission 2GHz~25GHz

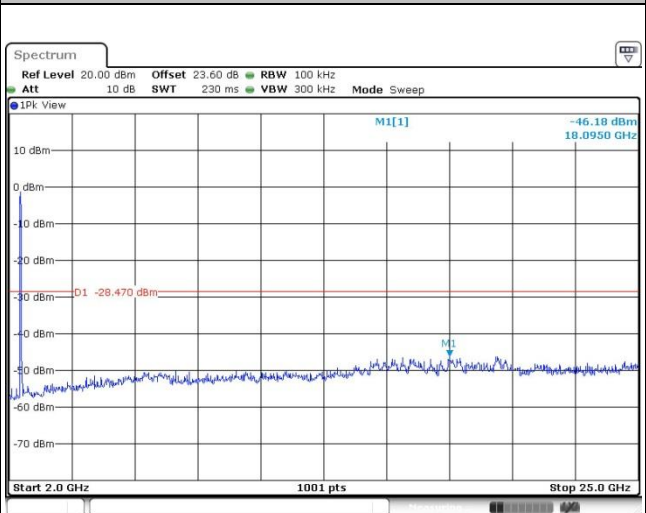

Date: 10.JUN.2016 18:47:05



| | | | |
|----------------|--------------|---------------------|------------|
| Number of TX : | 2 | Ant. : | 2 |
| Test Mode : | 802.11n HT40 | Temperature : | 21~25°C |
| Test Band : | 2.4GHz Mid | Relative Humidity : | 51~54% |
| Test Channel : | 06 | Test Engineer : | Kenny Chen |

WLAN 802.11n HT40 Channel 06

100kHz PSD reference Level

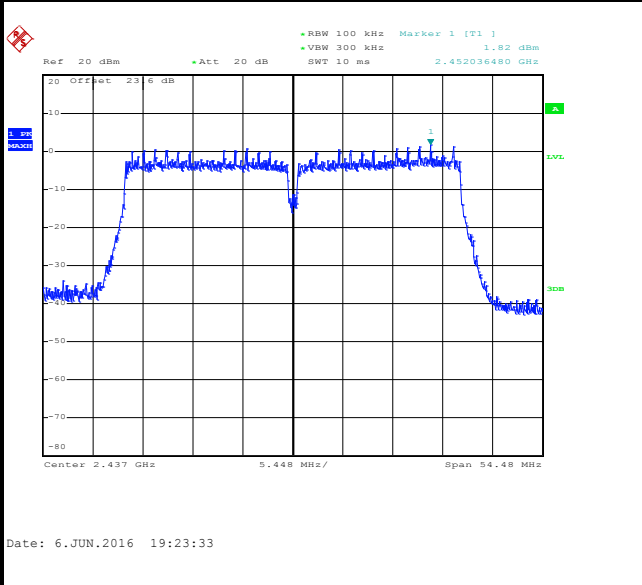

Spurious Emission 30MHz~3GHz

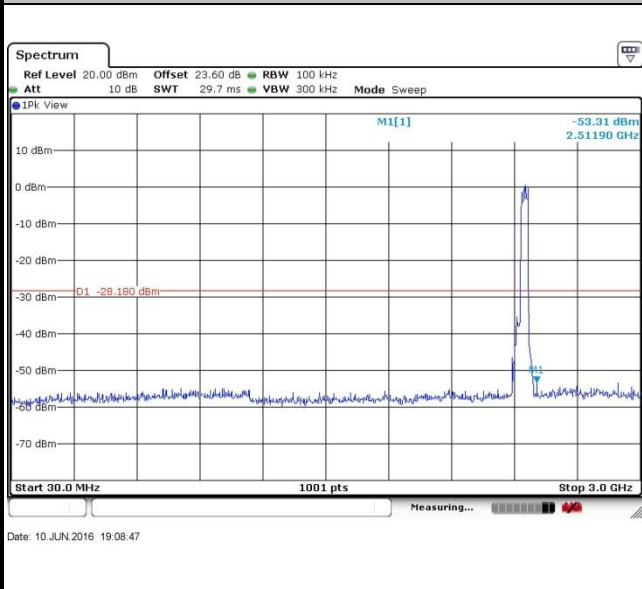

Spurious Emission 2GHz~25GHz

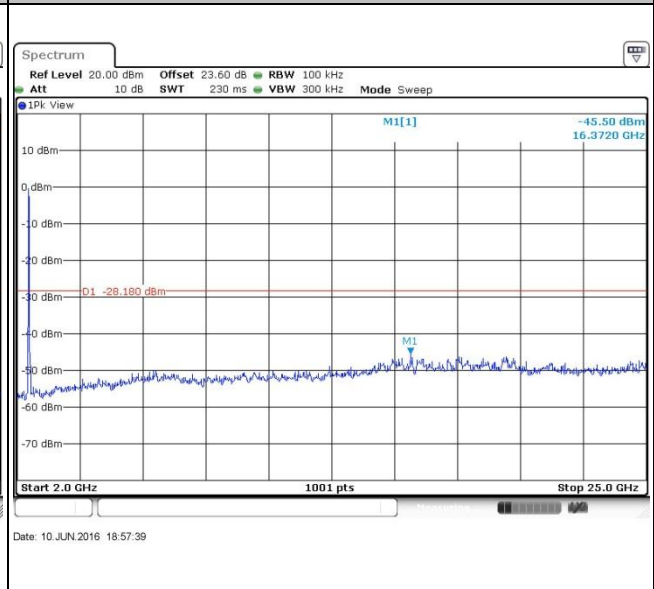



| | | | |
|----------------|--------------|---------------------|------------|
| Number of TX : | 2 | Ant. : | 2 |
| Test Mode : | 802.11n HT40 | Temperature : | 21~25°C |
| Test Band : | 2.4GHz High | Relative Humidity : | 51~54% |
| Test Channel : | 09 | Test Engineer : | Kenny Chen |

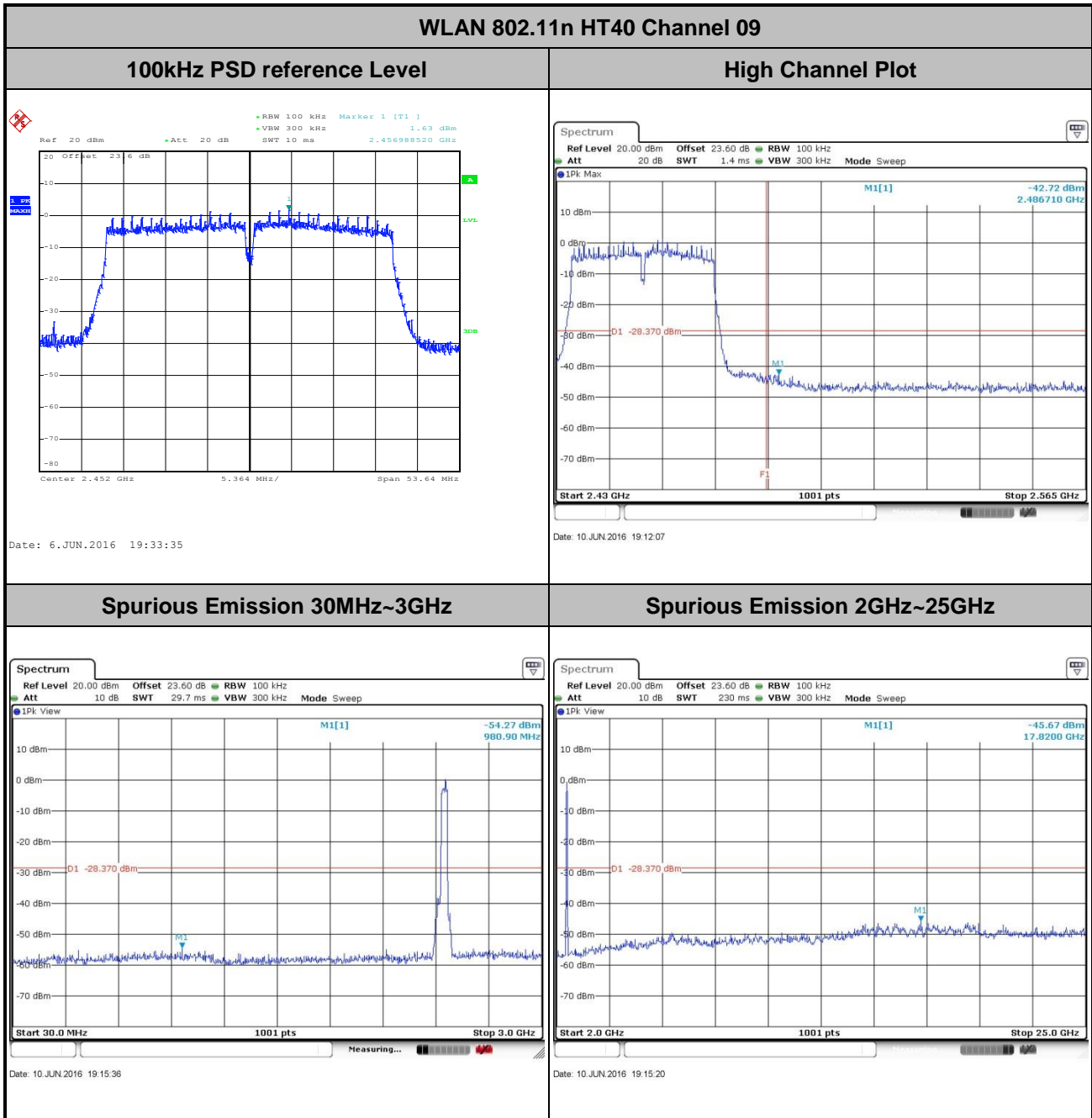



| | | | |
|----------------|----------------|---------------------|------------|
| Number of TX : | 2 | Ant. : | 2 |
| Test Mode : | 802.11ac VHT20 | Temperature : | 21~25°C |
| Test Band : | 2.4GHz Low | Relative Humidity : | 51~54% |
| Test Channel : | 01 | Test Engineer : | Kenny Chen |

WLAN 802.11ac VHT20 Channel 01

100kHz PSD reference Level

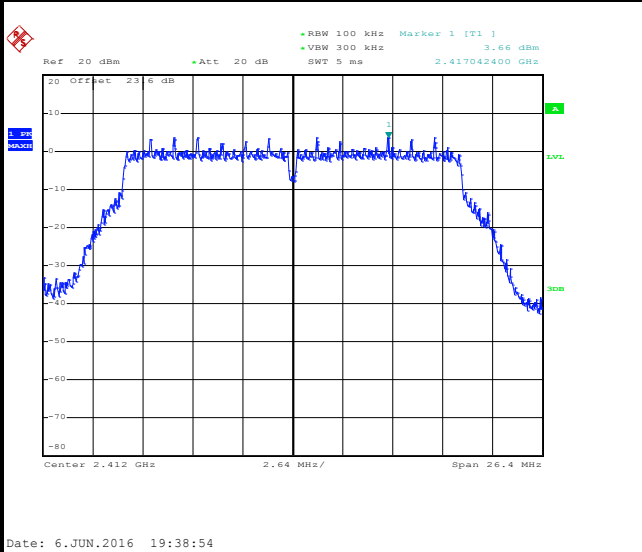

Low Channel Plot

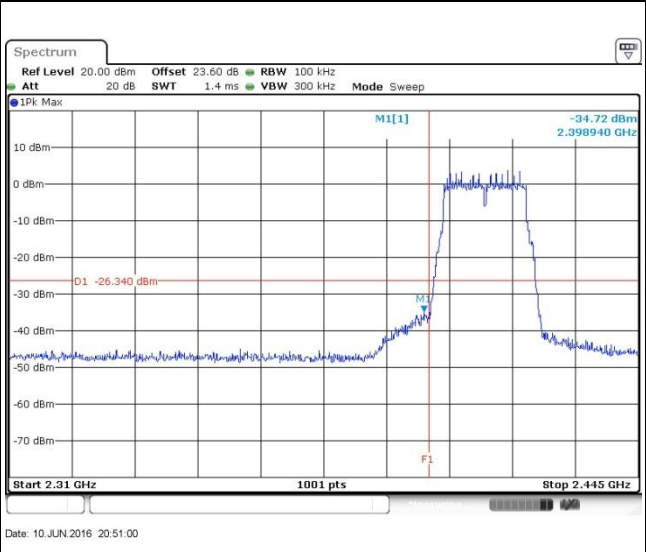

Spurious Emission 30MHz~3GHz

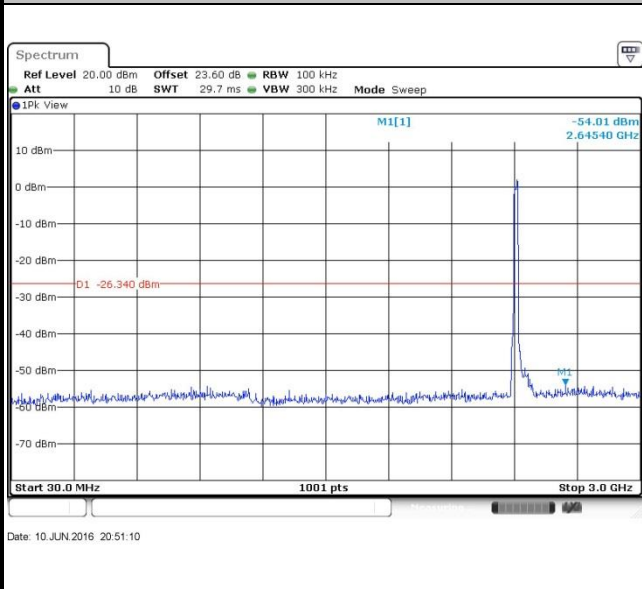

Spurious Emission 2GHz~25GHz

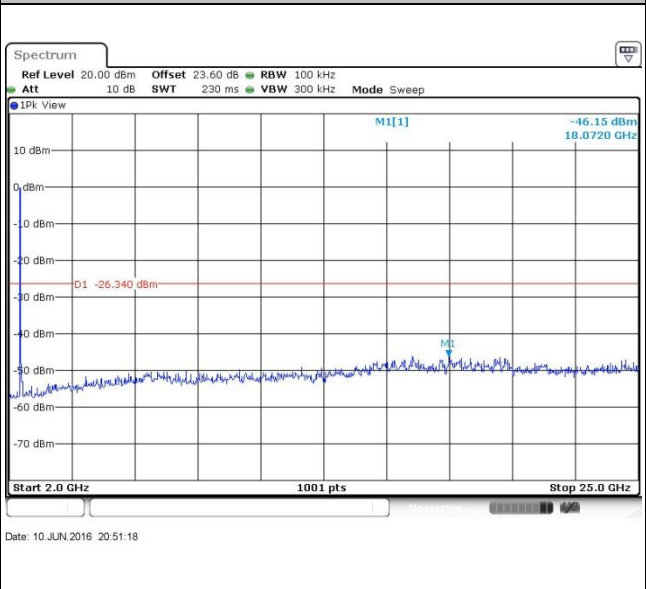



| | | | |
|----------------|----------------|---------------------|------------|
| Number of TX : | 2 | Ant. : | 2 |
| Test Mode : | 802.11ac VHT20 | Temperature : | 21~25°C |
| Test Band : | 2.4GHz Mid | Relative Humidity : | 51~54% |
| Test Channel : | 06 | Test Engineer : | Kenny Chen |

WLAN 802.11ac VHT20 Channel 06

100kHz PSD reference Level

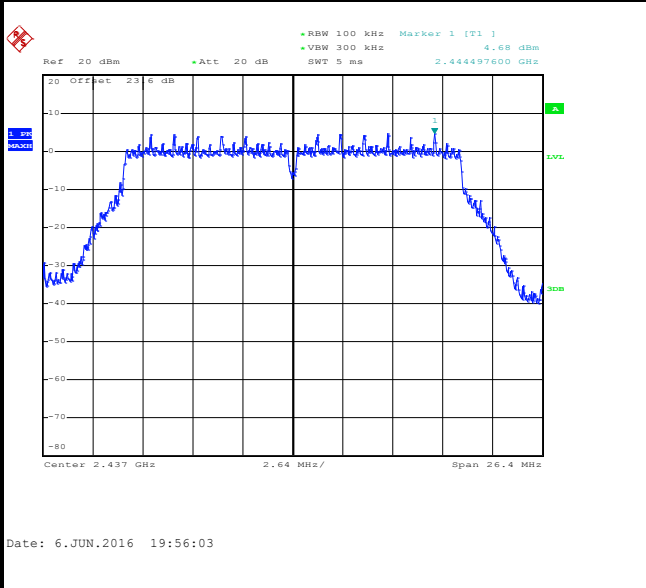

Spurious Emission 30MHz~3GHz

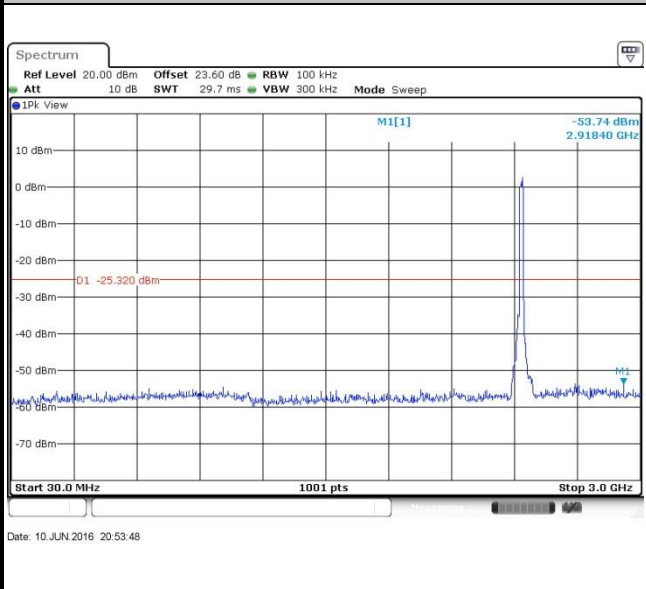

Spurious Emission 2GHz~25GHz

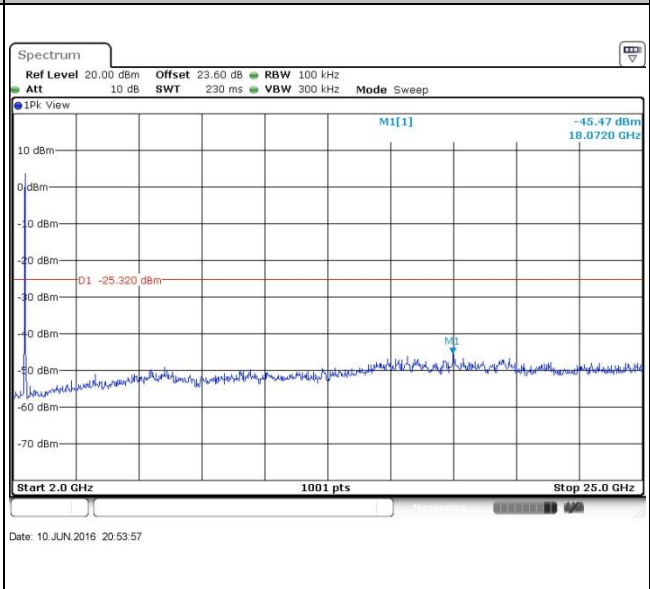



| | | | |
|----------------|----------------|---------------------|------------|
| Number of TX : | 2 | Ant. : | 2 |
| Test Mode : | 802.11ac VHT20 | Temperature : | 21~25°C |
| Test Band : | 2.4GHz High | Relative Humidity : | 51~54% |
| Test Channel : | 11 | Test Engineer : | Kenny Chen |

WLAN 802.11ac VHT20 Channel 11

100kHz PSD reference Level

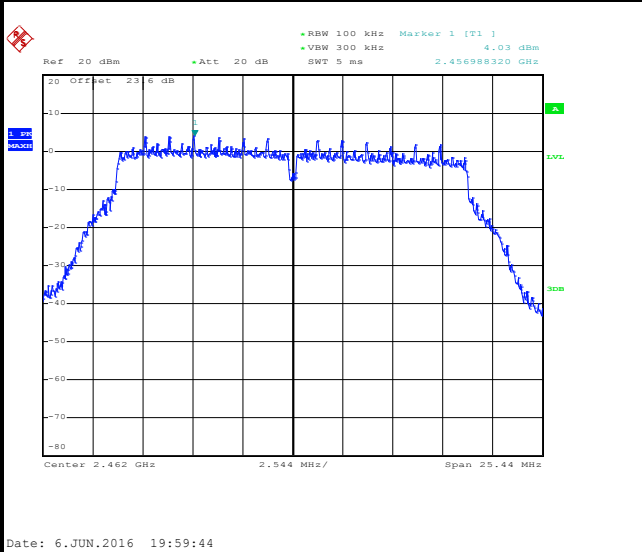

High Channel Plot

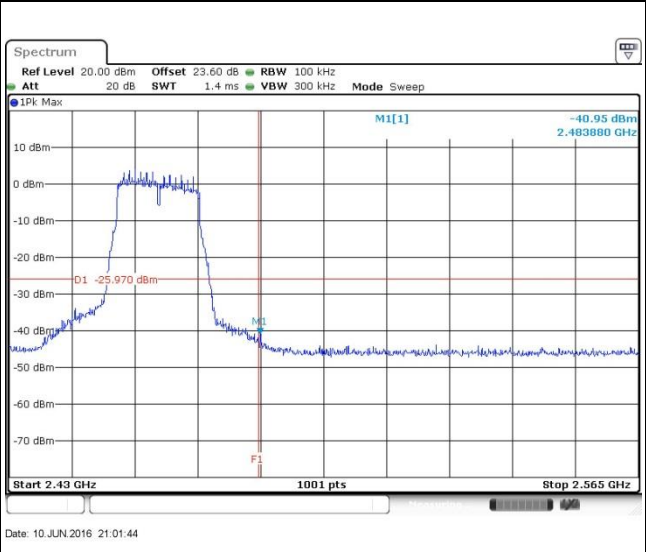

Spurious Emission 30MHz~3GHz

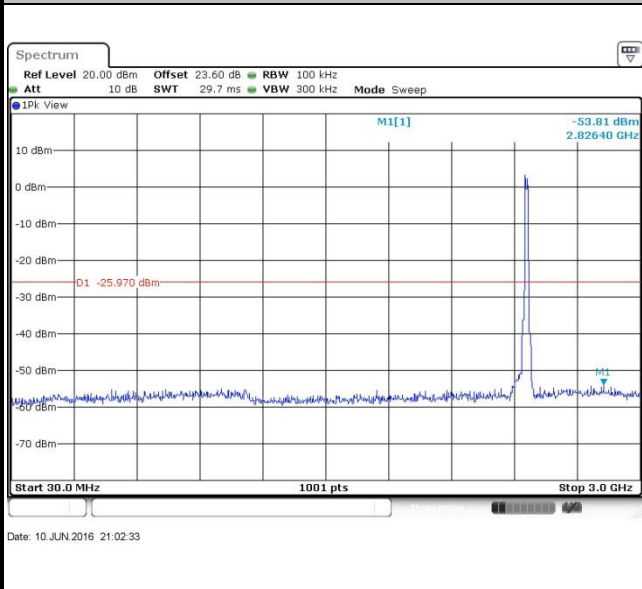

Spurious Emission 2GHz~25GHz

