



EM7355/EM7655 Modem

Test Report

FOR

LTE

Rev.2

FCC and IC Certifications

IC: 2417C-EM7355

FCC ID: N7NEM7355

© 2010 Sierra Wireless, Inc.

This document contains information which is proprietary and confidential to Sierra Wireless, Inc. Disclosure to persons other than the officers, employees, agents, or subcontractors of the Company or licensee of this document without the prior written permission of Sierra Wireless, Inc. is strictly prohibited.

Table of Contents

- 1 Introduction and Purpose4
 - 1.1 Revision history..... 4
- 2 Test Summary.....4
- 3 Description of Equipment under Test4
 - 3.1 Differences between EM7355 and EM7655 5
- 4 Compliance Test Equipment List.....5
- 5 Test Setup Block Diagrams.....6
 - 5.1 Test Setup 1 6
 - 5.2 Test Setup 3..... 6
- 6 RF Power Output.....6
 - 6.1 Test Procedure 6
 - 6.1.1 LTE Max Power Setup..... 8
 - 6.2 Maximum Transmit Power Test Results 8
 - 6.2.1 LTE B2 Output Power Results 9
 - 6.2.2 LTE B4 Output Power Results 11
 - 6.2.3 LTE B5 Output Power Results 13
 - 6.2.4 LTE B13 Output Power Results 14
 - 6.2.5 LTE B17 Output Power Results 15
 - 6.2.6 LTE B25 Output Power Results 15
- 7 Occupied Bandwidth17
 - 7.1 Test Procedure 17
 - 7.2 Test Results 18
 - 7.2.1 LTE Summary Results 18
 - 7.2.2 LTE Test Plots 19
- 8 Out of Band Emissions at Antenna Terminals36
 - 8.1 Test Procedure 37
 - 8.2 Test Results 37
 - 8.2.1 LTE Test Plots 37
- 9 Block Edge Compliance.....61
 - 9.1 Test Procedure 61
 - 9.2 Test Results 62
 - 9.2.1 LTE Test Plots 65
- 10 Frequency Stability versus Temperature102
 - 10.1 Summary of Results..... 102
 - 10.2 Test Procedure 102
 - 10.3 Test Results 103
 - 10.3.1 LTE Frequency Error over Temperature..... 103
- 11 Frequency Stability versus Voltage103
 - 11.1 Summary of Results..... 103
 - 11.2 Test Procedure 103
 - 11.3 Test Results 104
 - 11.3.1 LTE Frequency Error over Voltage 104

SIERRA WIRELESS, INC.

12 Peak to Average Ratio 104

 12.1 Summary of Results 104

 12.2 Test Procedure 104

 12.3 Test Results 104

 12.3.1 Test Plots 105

SIERRA WIRELESS, INC.

1 Introduction and Purpose

This document provides test data for the EM7355 modem output power intended for FCC and Industry Canada certifications.

1.1 Revision history

Rev	Date	Author	Summary of changes	ECO #
1.0	Aug.15, 2012	Markus Myers	First Release	
2.0	Jan. 14, 2013	Markus Myers	Updated tables with channel frequencies.	

2 Test Summary

FCC Rule	IC Standards	DESCRIPTION OF TEST	RESULT	PAGE
2.1046	RSS-132, 4.4 RSS-133, 6.4 RSS-139, 4.4	RF Power Output	Complies	5
2.1049	RSS-Gen, 4.6	Occupied Bandwidth	Complies	16
2.1051, 22.917, 24.238, 27.53	RSS-132, 4.5 RSS-133, 6.5	Out of Band Emissions at Antenna Terminals	Complies	45
22.917, 24.238, 27.53	RSS-Gen, 4.6	Block Edge Compliance	Complies	106
2.1055, 22.355, 24.235, 27.54	RSS-132, 4.3 RSS-133, 6.3	Frequency Stability versus Temperature	Complies	122
2.1055, 22.355, 24.235, 27.54	RSS-132, 4.3 RSS-133, 6.3	Frequency Stability versus Voltage	Complies	124
24.232, 27.50		Peak to Average Ratio	Complies	126

3 Description of Equipment under Test

The EM7355/EM7655 modem, referred to as “EUT” hereafter, is a multi-band wireless modem operating on the GSM/GPRS/EDGE/UMTS/LTE/CDMA networks. The table below shows the supported North American bands for the device.

Technology	Band	UL Freq. (MHz)	DL Freq. (MHz)	Max Power
LTE	B2	1850 – 1910	1930 – 1990	23 dBm (+/- 1 dB)
	B4	1710 – 1755	2110 – 2155	23 dBm (+/- 1 dB)
	B5	824 – 849	869 – 894	23 dBm (+/- 1 dB)
	B13	777 – 787	746 – 756	23 dBm (+/- 1 dB)

SIERRA WIRELESS, INC.

WCDMA / HSDPA/ HSUPA / HSPA+	B17	704 – 716	734 – 746	23 dBm (+/- 1 dB)
	B25	1850 – 1915	1930 – 1995	23 dBm (+/- 1 dB)
	B2	1850 – 1910	1930 – 1990	23 dBm (+/- 1 dB)
	B4	1710 – 1755	2110 – 2155	23 dBm (+/- 1 dB)
	B5	824 – 849	869 – 894	23 dBm (+/- 1 dB)
CDMA / EVDO	BC0	824 – 849	869 – 894	24 dBm (+/- 1 dB)
	BC1	1850 – 1910	1930 – 1990	24 dBm (+/- 1 dB)
	BC10*	817 – 824	862 – 869	24 dBm (+/- 1 dB)
GSM	G850	824 – 849	869 – 894	32.5 dBm (+/-1dB)
	G1900	1850 – 1910	1930 – 1990	29.5 dBm (+/-1dB)
EDGE	G850	824 – 849	869 – 894	27dBm (+/-1dB)
	G1900	1850 – 1910	1930 – 1990	26dBm (+/-1dB)

* Only BC10 subclass 2 and 3 frequencies are supported by hardware and firmware.

3.1 Differences between EM7355 and EM7655

The EM7355 and EM7655 differ only in pcb length and host interface connector. Both products utilize the same pcb RF layout, components and firmware. Please refer to document “7x55 Comparison.pdf”.

4 Compliance Test Equipment List

EQUIPMENT	MANUFACTURER	MODEL NO.	SERIAL NO.	CAL. DUE DATE
Control Computer	TC	Generic PC	100488	N/A
Wireless Test Set	Rohde & Schwarz	CMU200	110521	October 27, 2013
Wireless Test Set	Rohde & Schwarz	CMW500	101060	June 06, 2014
Spectrum Analyzer	Rohde & Schwarz	FSP	100060	October 27, 2013
DC Power Supply	HP	6632A	3530A	N/A
Interface Board	Shop built	ATEMux	N/A	N/A
Directional Coupler	Pasternack	PE2209-10	N/A	N/A

5 Test Setup Block Diagrams

5.1 Test Setup 1

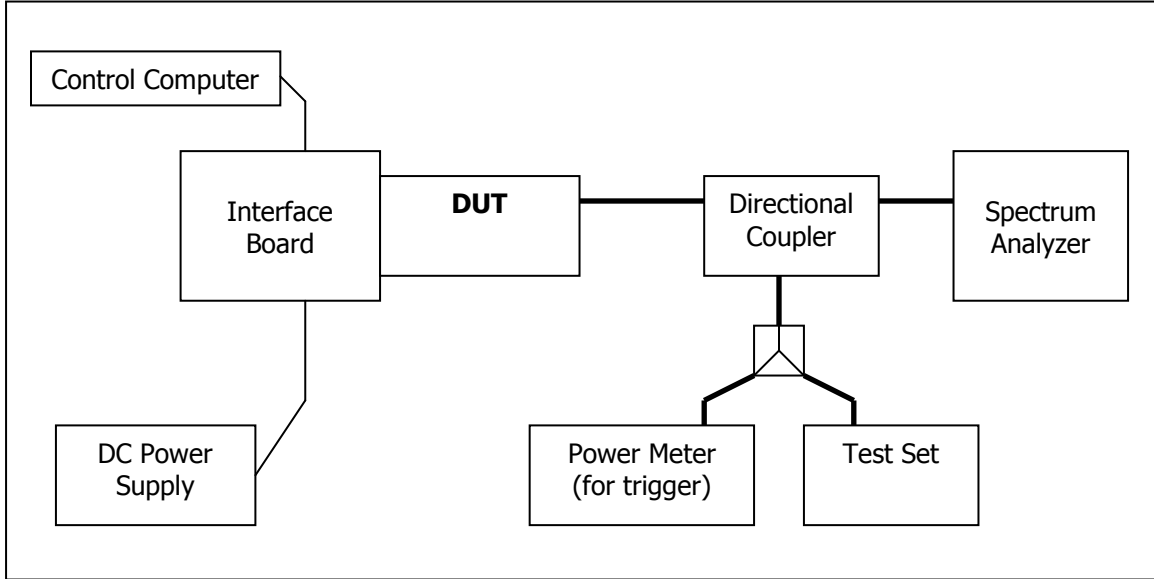

5.2 Test Setup 3

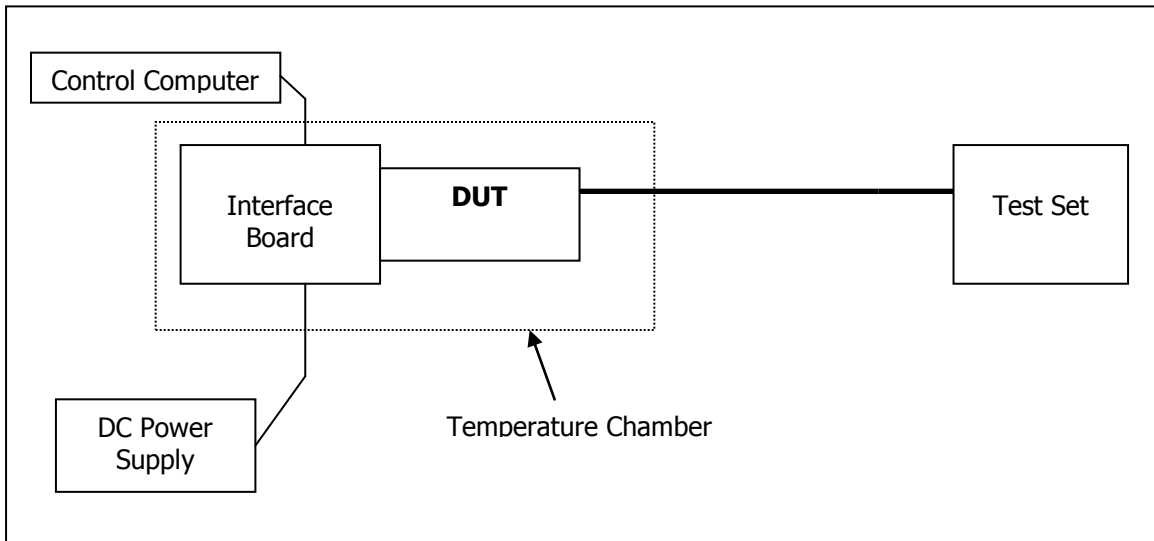

6 RF Power Output

FCC 2.1046

6.1 Test Procedure

The transmitter output was connected to a Rohde & Schwarz CMW500 and configured to operate at maximum power in a call. The maximum power was measured using the LTE power measurement of the CMW500. Refer to Test Setup 1.

© 2010 Sierra Wireless, Inc.

The contents of this page are subject to the confidentiality information on page one.

SIERRA WIRELESS, INC.

FCC Part 22/24/27, RSS-132/133/139	EM7355	Feb. 05, 2013	Page 7 of 111
------------------------------------	--------	---------------	---------------

6.1.1 LTE Max Power Setup

Configure the CMW500 call box to support all LTE tests in respect to the 3GPP 36.521.

- UE term. Conn: User defined Channels
- Exp. Nominal Power Mode: According to UL Power Control Settings
- RS EPRE: -75.0 dBm/15kHz Full Cell BW Power: -50.2 dBm
- PSS Power Offset = SSS Power Offset = PBCH Power Offset = PCFICH Power Offset = PDCCH Power Offset = 0.0 dB
- PHICH Power Offset = -12 dB
- OCNG ON
- PDSCH Power Offset PA: 0 dB, Power Ratio Index PB: 0 (rhoB/rhoA: 1)
- Active TPC Setup: Max Power
- Security Settings: Authentication OFF, NAS Security OFF, AS Security OFF
- Integrity Algorithm: NULL
- Milenage OFF

- Configure the desired channel, BW, resource block allocation and modulation.
- Connect to test set.
- Set CMW500 TPC Setup to Max Power (Up power control command).
- Measure the power at the EM7355 module antenna connector using the CMW multi evaluation LTE measurement.

6.2 Maximum Transmit Power Test Results

According to 3GPP 36.521, V9.1.0., the output power level for Power Class 3 LTE is to be 23.0dBm ± 2.7dB. The lower limit is shifted down by the MPR amount allowed for certain configurations.

Maximum Power Reduction (MPR) is allowed due to higher order modulation and transmit bandwidth configurations. These MPR levels reduce the lower limit of each output power by the either 1 or 2dB per 3GPP 36.521.

Modulation	Channel bandwidth / Transmission bandwidth configuration [RB]						MPR (dB)
	1.4 MHz	3.0 MHz	5 MHz	10 MHz	15 MHz	20 MHz	
QPSK	> 5	> 4	> 8	> 12	> 16	> 18	≤ 1
16 QAM	≤ 5	≤ 4	≤ 8	≤ 12	≤ 16	≤ 18	≤ 1
16 QAM	> 5	> 4	> 8	> 12	> 16	> 18	≤ 2

© 2010 Sierra Wireless, Inc.

This document contains information which is proprietary and confidential to Sierra Wireless, Inc. Disclosure to persons other than the officers, employees, agents, or subcontractors of the Company or licensee of this document without the prior written permission of Sierra Wireless, Inc. is strictly prohibited.

SIERRA WIRELESS, INC.

6.2.1 LTE B2 Output Power Results

6.2.1.1 Output Power Results for LTE Band 2, 5 MHz Bandwidth

CHANNEL	Frequency (MHz)	NO. RB	RB START	MODULATION	MAX POWER (RMS)	MAX POWER (PK)	MPR
18625	1852.5	1	0	QPSK	23.2	28.41	0
		1	24	QPSK	23.15	28.19	0
		25	0	QPSK	22.04	28.83	1
		1	0	16QAM	22.27	27.79	1
		1	24	16QAM	22.15	27.63	1
		25	0	16QAM	20.97	28.9	2
18900	1880	1	0	QPSK	23.27	28.25	0
		1	24	QPSK	23.2	28.22	0
		25	0	QPSK	22.18	28.94	1
		1	0	16QAM	21.97	27.78	1
		1	24	16QAM	22.02	27.79	1
		25	0	16QAM	21.18	28.82	2
19175	1907.5	1	0	QPSK	23.22	27.71	0
		1	24	QPSK	23.46	27.38	0
		25	0	QPSK	22.14	28.39	1
		1	0	16QAM	22.47	28.23	1
		1	24	16QAM	22.72	27.81	1
		25	0	16QAM	20.96	28.12	2

6.2.1.2 Output Power Results for LTE Band 2, 10 MHz Bandwidth

CHANNEL	Frequency (MHz)	NO. RB	RB START	MODULATION	MAX POWER (RMS)	MAX POWER (PK)	MPR
18650	1855	1	0	QPSK	23.23	28.08	0
		1	49	QPSK	23.36	28	0
		50	0	QPSK	21.97	28.24	1
		1	0	16QAM	21.93	27.65	1
		1	49	16QAM	22.08	27.65	1
		50	0	16QAM	21	28.55	2
18900	1880	1	0	QPSK	23.19	28.16	0
		1	49	QPSK	23.12	28.1	0
		50	0	QPSK	21.95	28.45	1
		1	0	16QAM	22.58	28.75	1
		1	49	16QAM	22.49	28.81	1
		50	0	16QAM	21.13	29.16	2
19150	1905	1	0	QPSK	23.12	28.08	0
		1	49	QPSK	23.38	27.56	0
		50	0	QPSK	21.96	28.24	1
		1	0	16QAM	22.04	28.22	1
		1	49	16QAM	22.31	27.75	1
		50	0	16QAM	20.82	27.89	2

SIERRA WIRELESS, INC.

6.2.1.3 Output Power Results for LTE Band 2, 15 MHz Bandwidth

CHANNEL	Frequency (MHz)	NO. RB	RB START	MODULATION	MAX POWER (RMS)	MAX POWER (PK)	MPR
18675	1857.5	1	0	QPSK	23.22	27.83	0
		1	74	QPSK	23.4	27.83	0
		75	0	QPSK	21.96	28.52	1
		1	0	16QAM	22.04	27.78	1
		1	74	16QAM	22.33	27.83	1
		75	0	16QAM	20.95	28.51	2
18900	1880	1	0	QPSK	23.18	28.06	0
		1	74	QPSK	23.2	28.01	0
		75	0	QPSK	22	29.08	1
		1	0	16QAM	22.52	28.59	1
		1	74	16QAM	22.42	28.64	1
		75	0	16QAM	21.02	29.08	2
19125	1902.5	1	0	QPSK	23.19	27.95	0
		1	74	QPSK	23.35	27.5	0
		75	0	QPSK	21.89	28.61	1
		1	0	16QAM	22.18	28.15	1
		1	74	16QAM	22.23	27.65	1
		75	0	16QAM	20.95	28.28	2

6.2.1.4 Output Power Results for LTE Band 2, 20 MHz Bandwidth

CHANNEL	Frequency (MHz)	NO. RB	RB START	MODULATION	MAX POWER (RMS)	MAX POWER (PK)	MPR
18700	1860	1	0	QPSK	23.19	28.03	0
		1	99	QPSK	23.25	28.04	0
		100	0	QPSK	22.01	28.57	1
		1	0	16QAM	21.91	27.61	1
		1	99	16QAM	21.99	27.65	1
		100	0	16QAM	20.97	28.44	2
18900	1880	1	0	QPSK	23.17	27.92	0
		1	99	QPSK	22.99	27.8	0
		100	0	QPSK	22.05	29	1
		1	0	16QAM	22.36	28.35	1
		1	99	16QAM	22.08	28.29	1
		100	0	16QAM	20.96	28.95	2
19100	1900	1	0	QPSK	23.06	27.93	0
		1	99	QPSK	23.21	27.54	0
		100	0	QPSK	21.97	28.48	1
		1	0	16QAM	21.98	28.09	1
		1	99	16QAM	22.1	27.68	1
		100	0	16QAM	21	28.3	2

SIERRA WIRELESS, INC.

6.2.2 LTE B4 Output Power Results

6.2.2.1 Output Power Results for LTE Band 4, 5 MHz Bandwidth

CHANNEL	Frequency (MHz)	NO. RB	RB START	MODULATION	MAX POWER (RMS)	MAX POWER (PK)	MPR
19975	1712.5	1	0	QPSK	23.36	28.18	0
		1	24	QPSK	23.24	27.73	0
		25	0	QPSK	22.07	28.27	1
		1	0	16QAM	22.33	27.62	1
		1	24	16QAM	22.3	27.3	1
		25	0	16QAM	20.98	28.74	2
20175	1732.5	1	0	QPSK	23.28	27.02	0
		1	24	QPSK	23.35	27.43	0
		25	0	QPSK	22.08	28.09	1
		1	0	16QAM	22.04	26.8	1
		1	24	16QAM	22.1	27.14	1
		25	0	16QAM	21.03	27.85	2
20375	1752.5	1	0	QPSK	23.39	27.86	0
		1	24	QPSK	23.4	27.52	0
		25	0	QPSK	22.05	28.39	1
		1	0	16QAM	22.74	28.43	1
		1	24	16QAM	22.56	28.01	1
		25	0	16QAM	21.17	28.55	2

6.2.2.2 Output Power Results for LTE Band 4, 10 MHz Bandwidth

CHANNEL	Frequency (MHz)	NO. RB	RB START	MODULATION	MAX POWER (RMS)	MAX POWER (PK)	MPR
20000	1715	1	0	QPSK	23.2	27.85	0
		1	49	QPSK	23.36	27.18	0
		50	0	QPSK	21.94	27.91	1
		1	0	16QAM	21.96	27.48	1
		1	49	16QAM	22.03	26.85	1
		50	0	16QAM	20.97	28.1	2
20175	1732.5	1	0	QPSK	23.26	26.88	0
		1	49	QPSK	23.12	27.56	0
		50	0	QPSK	21.98	27.84	1
		1	0	16QAM	22.41	27.17	1
		1	49	16QAM	22.46	28.15	1
		50	0	16QAM	20.96	28.03	2
20350	1750	1	0	QPSK	23.26	28.13	0
		1	49	QPSK	23.21	27.71	0
		50	0	QPSK	22.01	28.31	1
		1	0	16QAM	22.35	28.4	1

SIERRA WIRELESS, INC.

		1	49	16QAM	22.28	27.99	1
		50	0	16QAM	20.94	28.08	2

6.2.2.3 Output Power Results for LTE Band 4, 15 MHz Bandwidth

CHANNEL	Frequency (MHz)	NO. RB	RB START	MODULATION	MAX POWER (RMS)	MAX POWER (PK)	MPR
20025	1717.5	1	0	QPSK	23.21	27.62	0
		1	74	QPSK	23.17	26.77	0
		75	0	QPSK	21.98	28.02	1
		1	0	16QAM	22.19	27.61	1
		1	74	16QAM	22.2	26.77	1
		75	0	16QAM	20.84	27.97	2
20175	1732.5	1	0	QPSK	23.18	26.72	0
		1	74	QPSK	23.34	27.83	0
		75	0	QPSK	21.94	28.21	1
		1	0	16QAM	22.36	27.01	1
		1	74	16QAM	22.57	28.39	1
		75	0	16QAM	20.88	28.03	2
20325	1747.5	1	0	QPSK	23.39	28.08	0
		1	74	QPSK	23.29	27.68	0
		75	0	QPSK	22.14	28.69	1
		1	0	16QAM	22.29	28.24	1
		1	74	16QAM	22.2	27.89	1
		75	0	16QAM	21.16	28.39	2

6.2.2.4 Output Power Results for LTE Band 4, 20 MHz Bandwidth

CHANNEL	Frequency (MHz)	NO. RB	RB START	MODULATION	MAX POWER (RMS)	MAX POWER (PK)	MPR
20050	1720	1	0	QPSK	23.22	27.83	0
		1	99	QPSK	23.3	27.02	0
		100	0	QPSK	22.03	27.9	1
		1	0	16QAM	21.79	27.34	1
		1	99	16QAM	22.08	26.8	1
		100	0	16QAM	21	27.71	2
20175	1732.5	1	0	QPSK	23.03	26.68	0
		1	99	QPSK	23.24	27.84	0
		100	0	QPSK	22.01	28.1	1
		1	0	16QAM	22.12	26.91	1
		1	99	16QAM	22.41	28.29	1
		100	0	16QAM	21.01	28.15	2
20300	1745	1	0	QPSK	23.3	27.7	0
		1	99	QPSK	23.18	27.69	0
		100	0	QPSK	22	28.51	1

SIERRA WIRELESS, INC.

		1	0	16QAM	22.31	27.88	1
		1	99	16QAM	22.32	27.99	1
		100	0	16QAM	20.99	28.35	2

6.2.3 LTE B5 Output Power Results

6.2.3.1 Output Power Results for LTE Band 5, 5 MHz Bandwidth

CHANNEL	Frequency (MHz)	NO. RB	RB START	MODULATION	MAX POWER (RMS)	MAX POWER (PK)	MPR
20425	826.5	1	0	QPSK	22.7	27.67	0
		1	24	QPSK	22.73	27.99	0
		25	0	QPSK	21.61	28.31	1
		1	0	16QAM	21.7	27.07	1
		1	24	16QAM	21.69	27.29	1
		25	0	16QAM	20.53	28.39	2
20525	836.5	1	0	QPSK	22.81	27.67	0
		1	24	QPSK	22.74	27.34	0
		25	0	QPSK	21.77	28.4	1
		1	0	16QAM	21.63	27.27	1
		1	24	16QAM	21.52	26.93	1
		25	0	16QAM	20.72	28.15	2
20625	846.5	1	0	QPSK	22.94	27.12	0
		1	24	QPSK	22.71	26.83	0
		25	0	QPSK	21.68	27.78	1
		1	0	16QAM	21.99	27.6	1
		1	24	16QAM	21.91	27.33	1
		25	0	16QAM	20.58	27.79	2

6.2.3.2 Output Power Results for LTE Band 5, 10 MHz Bandwidth

CHANNEL	Frequency (MHz)	NO. RB	RB START	MODULATION	MAX POWER (RMS)	MAX POWER (PK)	MPR
20450	829	1	0	QPSK	22.66	27.36	0
		1	49	QPSK	22.73	27.8	0
		50	0	QPSK	21.61	27.96	1
		1	0	16QAM	21.51	27	1
		1	49	16QAM	21.5	27.31	1
		50	0	16QAM	20.53	28.28	2
20525	836.5	1	0	QPSK	22.65	27.7	0
		1	49	QPSK	22.91	27.26	0
		50	0	QPSK	21.64	27.97	1
		1	0	16QAM	22.04	28.47	1
		1	49	16QAM	22.08	27.77	1
		50	0	16QAM	20.72	28.45	2
20600	844	1	0	QPSK	22.78	27.41	0

SIERRA WIRELESS, INC.

		1	49	QPSK	22.64	27.13	0
		50	0	QPSK	21.61	27.7	1
		1	0	16QAM	21.8	27.65	1
		1	49	16QAM	21.64	27.38	1
		50	0	16QAM	20.56	27.43	2

6.2.4 LTE B13 Output Power Results

6.2.4.1 Output Power Results for LTE Band 13, 5 MHz Bandwidth

CHANNEL	Frequency (MHz)	NO. RB	RB START	MODULATION	MAX POWER (RMS)	MAX POWER (PK)	MPR
23205	779.5	1	0	QPSK	23	27.63	0
		1	24	QPSK	22.79	27.42	0
		25	0	QPSK	21.61	27.97	1
		1	0	16QAM	21.91	27.02	1
		1	24	16QAM	21.76	26.88	1
		25	0	16QAM	20.58	28.02	2
23230	782	1	0	QPSK	22.7	27.03	0
		1	24	QPSK	22.7	27.32	0
		25	0	QPSK	21.76	27.67	1
		1	0	16QAM	21.5	26.69	1
		1	24	16QAM	21.7	27.03	1
		25	0	16QAM	20.66	27.7	2
23255	784.5	1	0	QPSK	22.86	27.1	0
		1	24	QPSK	22.83	27.09	0
		25	0	QPSK	21.65	27.87	1
		1	0	16QAM	22.08	27.65	1
		1	24	16QAM	22.04	27.55	1
		25	0	16QAM	20.59	27.72	2

6.2.4.2 Output Power Results for LTE Band 13, 10 MHz Bandwidth

CHANNEL	Frequency (MHz)	NO. RB	RB START	MODULATION	MAX POWER (RMS)	MAX POWER (PK)	MPR
23230	782	1	0	QPSK	22.66	27.36	0
		1	49	QPSK	22.73	27.8	0
		50	0	QPSK	21.61	27.96	1
		1	0	16QAM	21.51	27	1
		1	49	16QAM	21.5	27.31	1
		50	0	16QAM	20.53	28.28	2

SIERRA WIRELESS, INC.

6.2.5 LTE B17 Output Power Results

6.2.5.1 Output Power Results for LTE Band 17, 5 MHz Bandwidth

CHANNEL	Frequency (MHz)	NO. RB	RB START	MODULATION	MAX POWER (RMS)	MAX POWER (PK)	MPR
23755	706.5	1	0	QPSK	22.72	28.19	0
		1	24	QPSK	23.02	27.59	0
		25	0	QPSK	21.66	28.36	1
		1	0	16QAM	21.83	27.43	1
		1	24	16QAM	22.06	27.1	1
		25	0	16QAM	20.6	28.39	2
23790	710	1	0	QPSK	22.91	27.31	0
		1	24	QPSK	22.97	27.53	0
		25	0	QPSK	21.95	27.95	1
		1	0	16QAM	21.84	27.07	1
		1	24	16QAM	21.68	27.1	1
		25	0	16QAM	20.87	27.8	2
23825	713.5	1	0	QPSK	23.13	27.29	0
		1	24	QPSK	22.66	27.16	0
		25	0	QPSK	21.67	27.94	1
		1	0	16QAM	22.37	27.84	1
		1	24	16QAM	21.33	27.58	1
		25	0	16QAM	20.66	28.1	2

6.2.5.2 Output Power Results for LTE Band 17, 10 MHz Bandwidth

CHANNEL	Frequency (MHz)	NO. RB	RB START	MODULATION	MAX POWER (RMS)	MAX POWER (PK)	MPR
23790	710	1	0	QPSK	22.92	27.98	0
		1	49	QPSK	22.88	27.97	0
		50	0	QPSK	21.85	27.8	1
		1	0	16QAM	21.67	27.93	1
		1	49	16QAM	21.77	28.04	1
		50	0	16QAM	20.82	27.46	2

6.2.6 LTE B25 Output Power Results

6.2.6.1 Output Power Results for LTE Band 25, 5 MHz Bandwidth

CHANNEL	Frequency (MHz)	NO. RB	RB START	MODULATION	MAX POWER (RMS)	MAX POWER (PK)	MPR
26065	1852.5	1	0	QPSK	23.35	28.46	0
		1	24	QPSK	23.48	28.3	0
		25	0	QPSK	22.19	28.71	1
		1	0	16QAM	22.36	27.81	1

SIERRA WIRELESS, INC.

26365	1882.5	1	24	16QAM	22.41	27.74	1
		25	0	16QAM	21.19	28.87	2
		1	0	QPSK	23.23	28.19	0
		1	24	QPSK	23.26	28.16	0
		25	0	QPSK	22.25	28.89	1
		1	0	16QAM	22.09	27.85	1
26665	1912.5	1	24	16QAM	22.09	27.78	1
		25	0	16QAM	21.24	28.73	2
		1	0	QPSK	23.4	27.23	0
		1	24	QPSK	23.45	26.92	0
		25	0	QPSK	22.36	28.15	1
		1	0	16QAM	22.47	27.65	1
26665	1912.5	1	24	16QAM	22.68	27.36	1
		25	0	16QAM	21.11	27.62	2

6.2.6.2 Output Power Results for LTE Band 25, 10 MHz Bandwidth

CHANNEL	Frequency (MHz)	NO. RB	RB START	MODULATION	MAX POWER (RMS)	MAX POWER (PK)	MPR
26090	1855	1	0	QPSK	23.41	28.16	0
		1	49	QPSK	23.38	28.01	0
		50	0	QPSK	22.13	28.28	1
		1	0	16QAM	22.14	27.78	1
		1	49	16QAM	22.18	27.69	1
		50	0	16QAM	21.14	28.66	2
26365	1882.5	1	0	QPSK	23.28	28.26	0
		1	49	QPSK	23.2	28.08	0
		50	0	QPSK	22.08	28.6	1
		1	0	16QAM	22.64	28.9	1
		1	49	16QAM	22.53	28.73	1
		50	0	16QAM	21.09	28.97	2
26640	1910	1	0	QPSK	23.41	28.06	0
		1	49	QPSK	23.39	27.08	0
		50	0	QPSK	22.19	27.93	1
		1	0	16QAM	22.25	28.13	1
		1	49	16QAM	22.32	27.31	1
		50	0	16QAM	21.09	27.87	2

6.2.6.3 Output Power Results for LTE Band 25, 15 MHz Bandwidth

CHANNEL	Frequency (MHz)	NO. RB	RB START	MODULATION	MAX POWER (RMS)	MAX POWER (PK)	MPR
26115	1857.5	1	0	QPSK	23.32	27.87	0
		1	74	QPSK	23.28	27.76	0
		75	0	QPSK	22.17	28.64	1
		1	0	16QAM	22.3	27.87	1

SIERRA WIRELESS, INC.

26365	1882.5	1	74	16QAM	22.31	27.82	1
		75	0	16QAM	21.06	28.63	2
		1	0	QPSK	23.25	28.14	0
		1	74	QPSK	23.11	27.9	0
		75	0	QPSK	22.07	29.11	1
		1	0	16QAM	22.62	28.71	1
26615	1907.5	1	74	16QAM	22.5	28.56	1
		75	0	16QAM	21.1	28.85	2
		1	0	QPSK	23.24	28.07	0
		1	74	QPSK	23.42	27.05	0
		75	0	QPSK	22.16	28.48	1
		1	0	16QAM	22.2	28.22	1
26615	1907.5	1	74	16QAM	22.25	27.22	1
		75	0	16QAM	21.17	28.35	2

6.2.6.4 Output Power Results for LTE Band 25, 20 MHz Bandwidth

CHANNEL	Frequency (MHz)	NO. RB	RB START	MODULATION	MAX POWER (RMS)	MAX POWER (PK)	MPR
26140	1860	1	0	QPSK	23.39	28.12	0
		1	99	QPSK	23.25	28.04	0
		100	0	QPSK	22.11	28.59	1
		1	0	16QAM	22.09	27.69	1
		1	99	16QAM	22.09	27.7	1
		100	0	16QAM	21.19	28.45	2
26365	1882.5	1	0	QPSK	23.39	28.14	0
		1	99	QPSK	23.23	27.82	0
		100	0	QPSK	22.06	28.94	1
		1	0	16QAM	22.51	28.57	1
		1	99	16QAM	22.29	28.26	1
		100	0	16QAM	21.09	29.07	2
26590	1905	1	0	QPSK	23.25	28.03	0
		1	99	QPSK	23.35	27.08	0
		100	0	QPSK	22.14	28.63	1
		1	0	16QAM	22.2	28.21	1
		1	99	16QAM	22.27	27.28	1
		100	0	16QAM	21.18	28.57	2

7 Occupied Bandwidth

FCC 2.1049

7.1 Test Procedure

The transmitter output was connected to a spectrum analyzer through a calibrated coaxial cable and a directional coupler. The occupied bandwidth (defined as the 99% Power Bandwidth) was measured with

SIERRA WIRELESS, INC.

the spectrum analyzer at mid frequency in each band. The -26dB bandwidth was also measured and recorded. Refer to Test Setup 1.

7.2 Test Results

Occupied Bandwidth was only measured at maximum resource block allocation and at center of band for each supported LTE BW.

7.2.1 LTE Summary Results

Mode		Band	BW (MHz)	No. RB	RB Offset	Frequency (MHz)	Channel	99% Occupied Bandwidth (MHz)	-26dBc Occupied Bandwidth (MHz)	Corresponding Plot number
LTE	QPSK	B2	5	25	0	1880.0	18900	4.50	4.82	7.2.2.1
			10	50				9.04	10.12	7.2.2.2
			15	75				13.44	14.58	7.2.2.3
			20	100				17.92	19.04	7.2.2.4
		B4	5	25	0	1732.5	20175	4.48	4.76	7.2.2.5
			10	50				9.04	9.96	7.2.2.6
			15	75				13.44	14.52	7.2.2.7
			20	100				17.84	18.96	7.2.2.8
		B5	5	25	0	836.5	20525	4.48	4.80	7.2.2.9
			10	50				9.04	9.96	7.2.2.10
		B13	5	25	0	782.0	23230	4.50	4.78	7.2.2.11
			10	50				9.08	10.00	7.2.2.12
		B17	5	25	0	710.0	23790	4.52	4.76	7.2.2.13
			10	50				9.04	10.12	7.2.2.14
		B25	5	25	0	1882.5	26365	4.50	4.82	7.2.2.15
			10	50				9.04	10.04	7.2.2.16
	15		75	13.44				14.58	7.2.2.17	
	20		100	17.92				19.12	7.2.2.18	
	16-QAM	B2	5	25	0	1880.0	18900	4.52	4.78	7.2.2.19
			10	50				9.04	10.08	7.2.2.20
			15	75				13.50	14.52	7.2.2.21
			20	100				17.84	19.12	7.2.2.22
		B4	5	25	0	1732.5	20175	4.48	4.76	7.2.2.23
			10	50				9.04	10.00	7.2.2.24
			15	75				13.44	14.40	7.2.2.25
			20	100				17.92	19.04	7.2.2.26
		B5	5	25	0	836.5	20525	4.52	4.78	7.2.2.27
			10	50				9.04	10.00	7.2.2.28
B13		5	25	0	782.0	23230	4.52	4.76	7.2.2.29	
		10	50				9.08	9.96	7.2.2.30	
B17	5	25	0	710.0	23790	4.50	4.78	7.2.2.31		
	10	50				9.08	10.08	7.2.2.32		

SIERRA WIRELESS, INC.

		B25	5	25	0	1882.5	26365	4.48	4.78	7.2.2.33
			10	50				9.04	10.08	7.2.2.34
			15	75				13.44	14.52	7.2.2.35
			20	100				17.84	19.12	7.2.2.36

7.2.2 LTE Test Plots

7.2.2.1 LTE Occupied Bandwidth, Band2 mid channel (18900) BW=5MHz RB=25 RB Offset=0 QPSK 99% BW

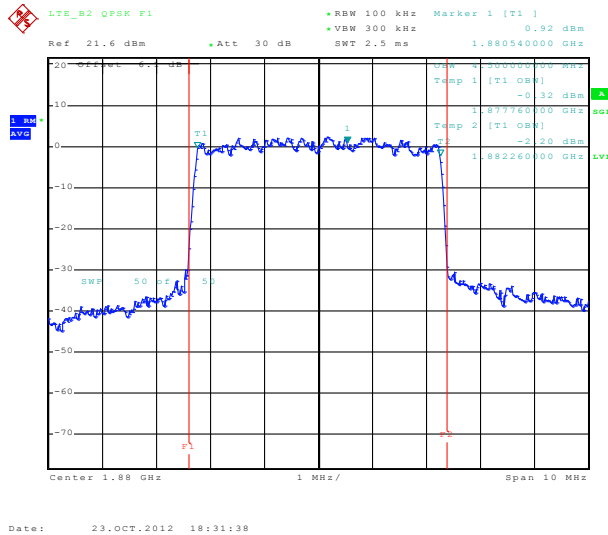

7.2.2.2 LTE Occupied Bandwidth, Band2 mid channel (18900) BW=10MHz RB=50 RB Offset=0 QPSK 99% BW

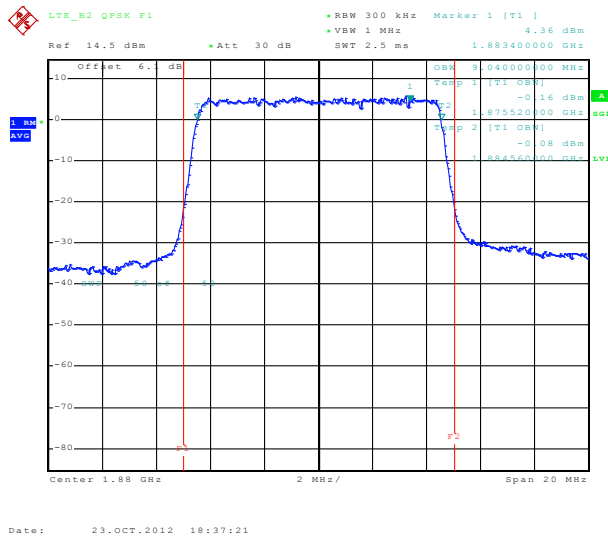

7.2.2.3 LTE Occupied Bandwidth, Band2 mid channel (18900) BW=15MHz RB=75 RB Offset=0 QPSK 99% BW

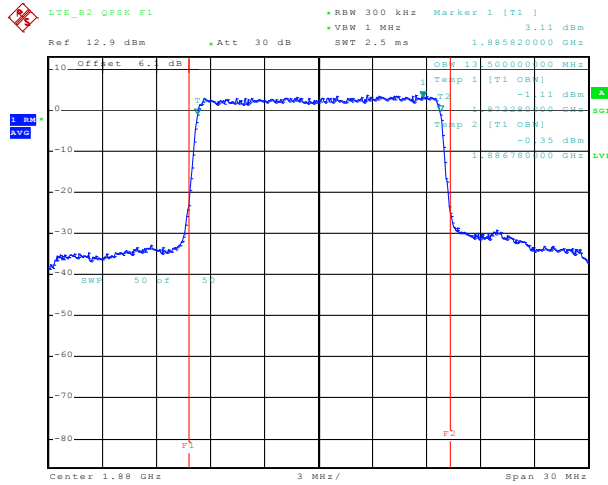

Date: 23.OCT.2012 18:43:04

7.2.2.4 LTE Occupied Bandwidth, Band2 mid channel (18900) BW=20MHz RB=100 RB Offset=0 QPSK 99% BW

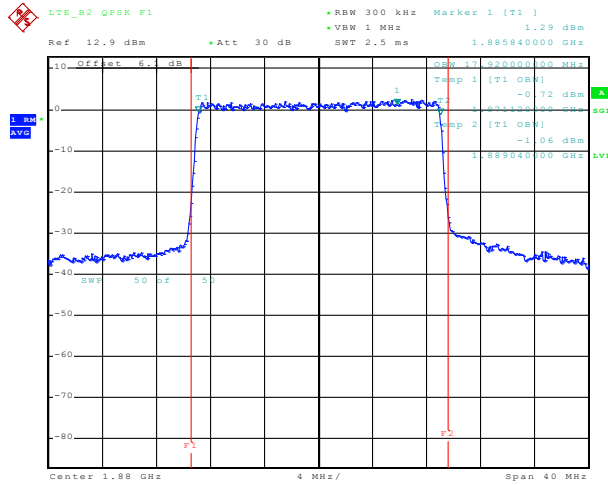

Date: 23.OCT.2012 18:48:59

SIERRA WIRELESS, INC.

7.2.2.5 LTE Occupied Bandwidth, Band4 mid channel (20175) BW=5MHz RB=25 RB Offset=0 QPSK 99% BW

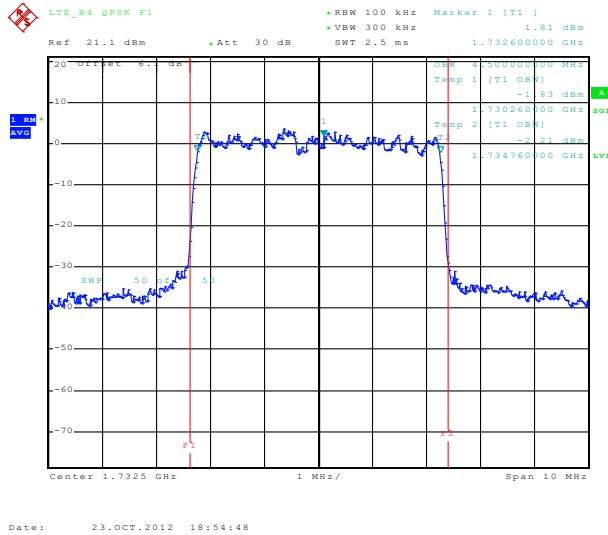

7.2.2.6 LTE Occupied Bandwidth, Band4 mid channel (20175) BW=10MHz RB=50 RB Offset=0 QPSK 99% BW

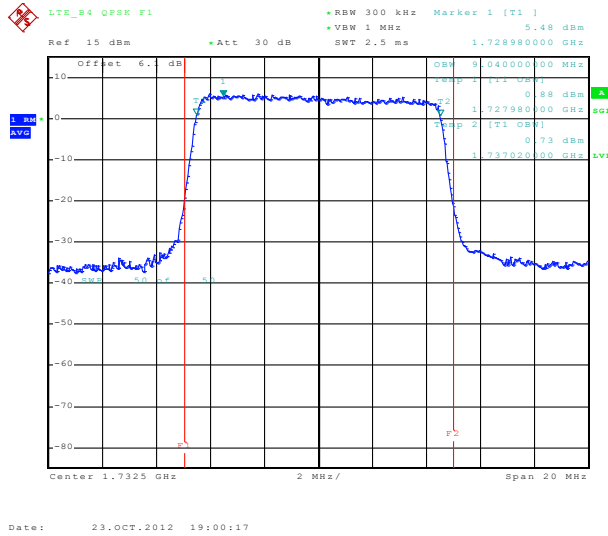

7.2.2.7 LTE Occupied Bandwidth, Band4 mid channel (20175) BW=15MHz RB=75 RB Offset=0 QPSK 99% BW

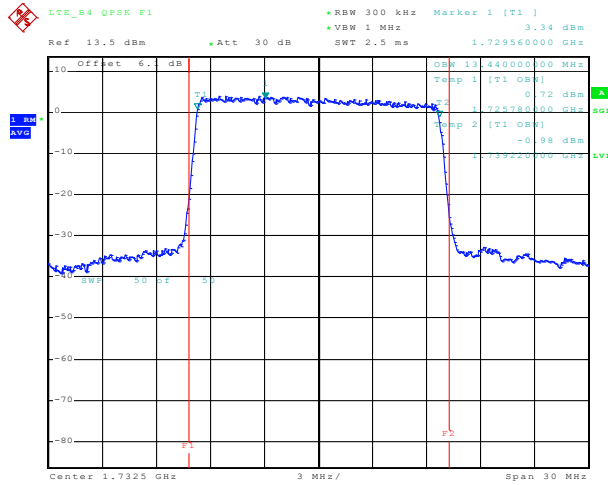

7.2.2.8 LTE Occupied Bandwidth, Band4 mid channel (20175) BW=20MHz RB=100 RB Offset=0 QPSK 99% BW

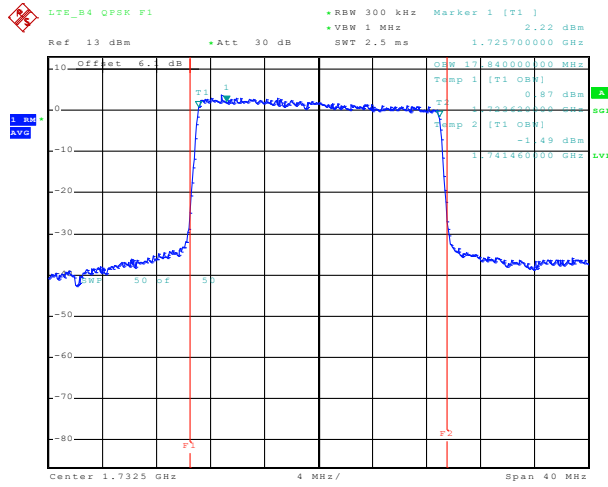

SIERRA WIRELESS, INC.

7.2.2.9 LTE Occupied Bandwidth, Band5 mid channel (20525) BW=5MHz RB=25 RB Offset=0 QPSK 99% BW

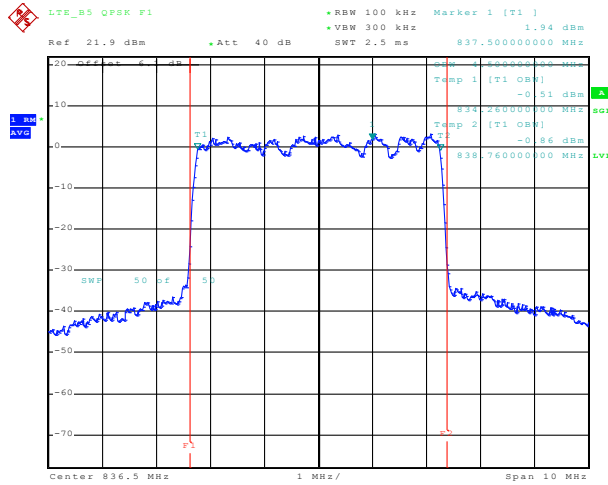

Date: 23.OCT.2012 19:17:27

7.2.2.10 LTE Occupied Bandwidth, Band5 mid channel (20525) BW=10MHz RB=50 RB Offset=0 QPSK 99% BW

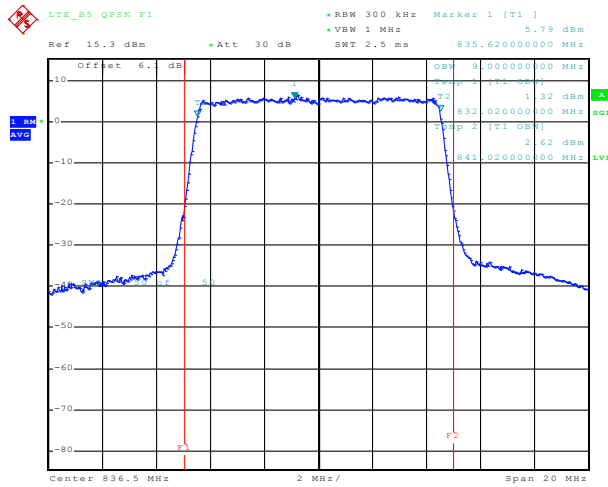

Date: 23.OCT.2012 19:23:15

SIERRA WIRELESS, INC.

7.2.2.11 LTE Occupied Bandwidth, Band13 mid channel (23230) BW=5MHz RB=25 RB Offset=0 QPSK 99% BW

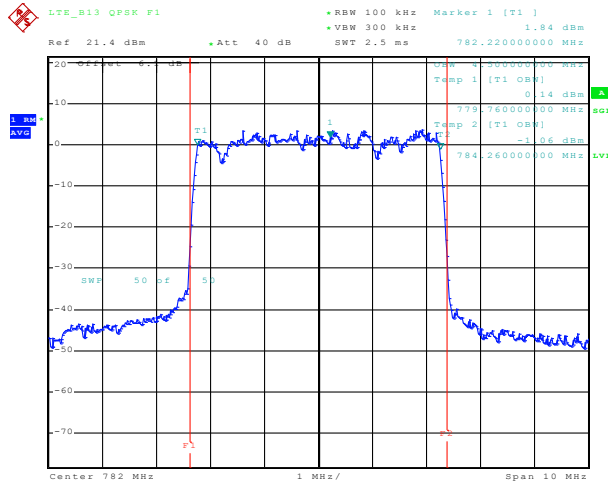

Date: 23.OCT.2012 19:29:00

7.2.2.12 LTE Occupied Bandwidth, Band13 mid channel (23230) BW=10MHz RB=50 RB Offset=0 QPSK 99% BW

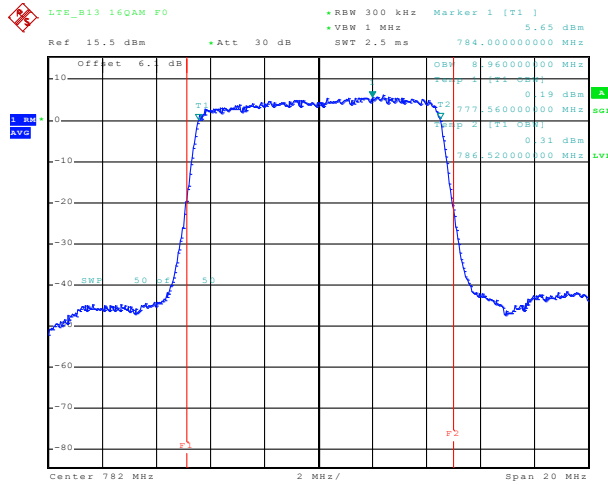

Date: 23.OCT.2012 19:36:11

SIERRA WIRELESS, INC.

7.2.2.13 LTE Occupied Bandwidth, Band17 mid channel (23790) BW=5MHz RB=25 RB Offset=0 QPSK 99% BW

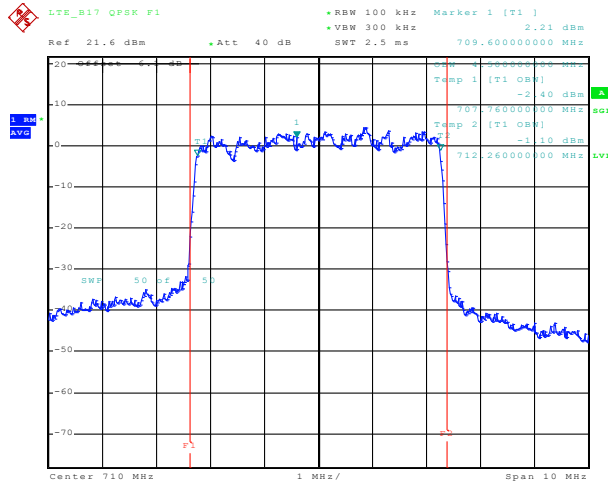

Date: 23.OCT.2012 19:38:35

7.2.2.14 LTE Occupied Bandwidth, Band17 mid channel (23790) BW=10MHz RB=50 RB Offset=0 QPSK 99% BW

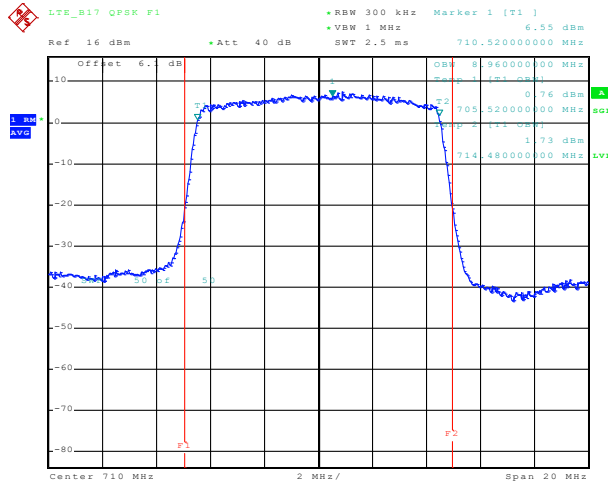

Date: 23.OCT.2012 19:44:29

SIERRA WIRELESS, INC.

7.2.2.17 LTE Occupied Bandwidth, Band25 mid channel (26365) BW=15MHz RB=75 RB Offset=0 QPSK 99% BW

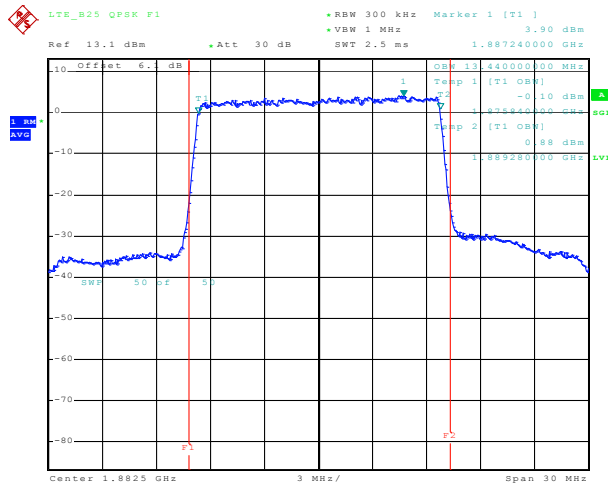

Date: 23.OCT.2012 20:01:21

7.2.2.18 LTE Occupied Bandwidth, Band25 mid channel (26365) BW=20MHz RB=100 RB Offset=0 QPSK 99% BW

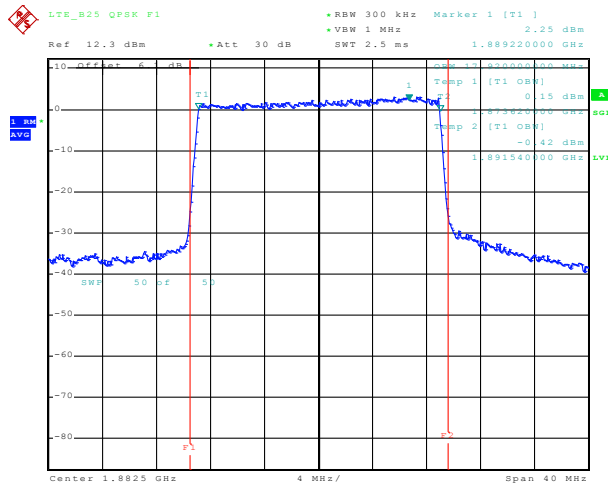

Date: 23.OCT.2012 20:07:14

SIERRA WIRELESS, INC.

7.2.2.19 LTE Occupied Bandwidth, Band2 mid channel (18900) BW=5MHz RB=25 RB Offset=0 16-QAM 99% BW

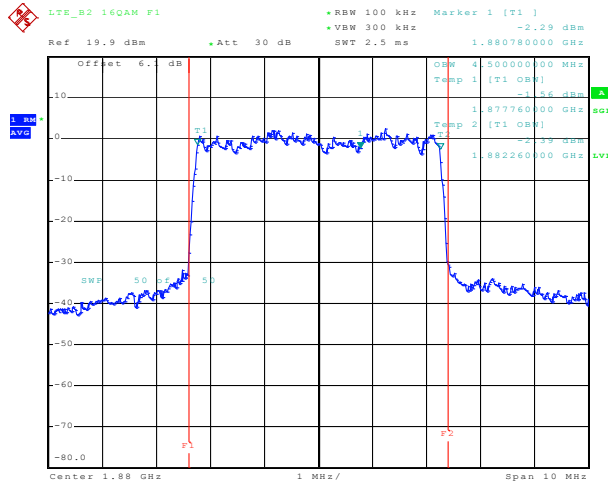

Date: 23.OCT.2012 18:34:34

7.2.2.20 LTE Occupied Bandwidth, Band2 mid channel (18900) BW=10MHz RB=50 RB Offset=0 16-QAM 99% BW

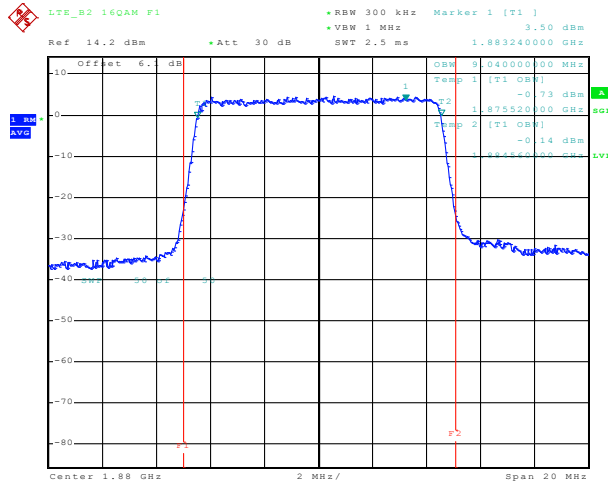

Date: 23.OCT.2012 18:40:14

SIERRA WIRELESS, INC.

7.2.2.21 LTE Occupied Bandwidth, Band2 mid channel (18900) BW=15MHz RB=75 RB Offset=0 16-QAM 99% BW

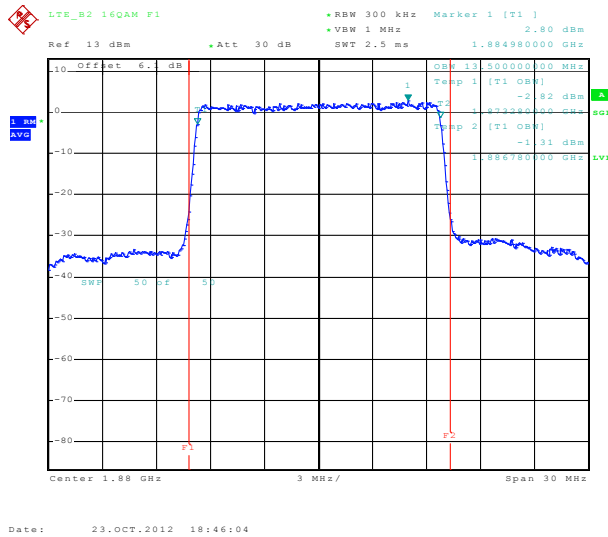

7.2.2.22 LTE Occupied Bandwidth, Band2 mid channel (18900) BW=20MHz RB=100 RB Offset=0 16-QAM 99% BW

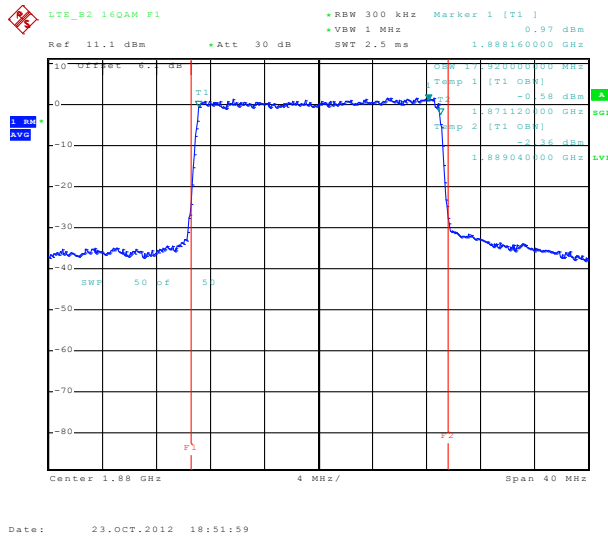

SIERRA WIRELESS, INC.

7.2.2.23 LTE Occupied Bandwidth, Band4 mid channel (20175) BW=5MHz RB=25 RB Offset=0 16-QAM 99% BW

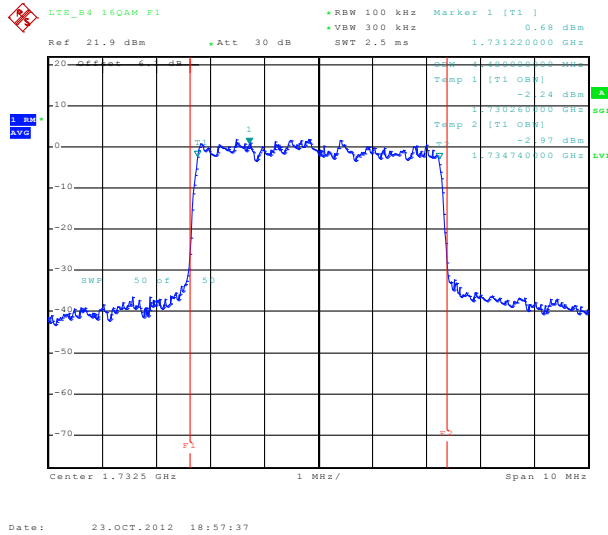

7.2.2.24 LTE Occupied Bandwidth, Band4 mid channel (20175) BW=10MHz RB=50 RB Offset=0 16-QAM 99% BW

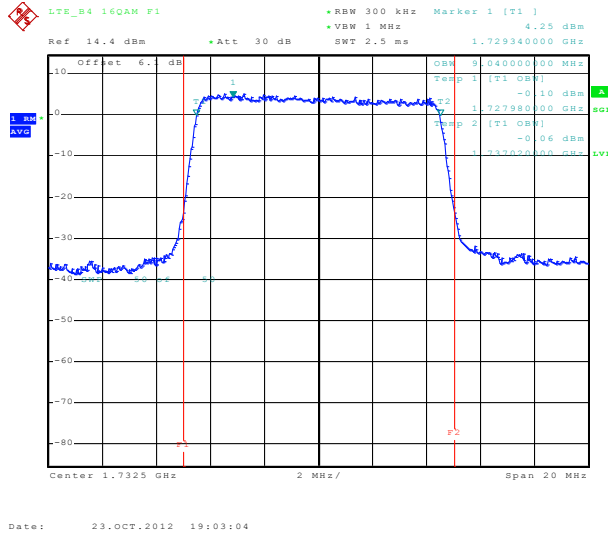

7.2.2.25 LTE Occupied Bandwidth, Band4 mid channel (20175) BW=15MHz RB=75 RB Offset=0 16-QAM 99% BW

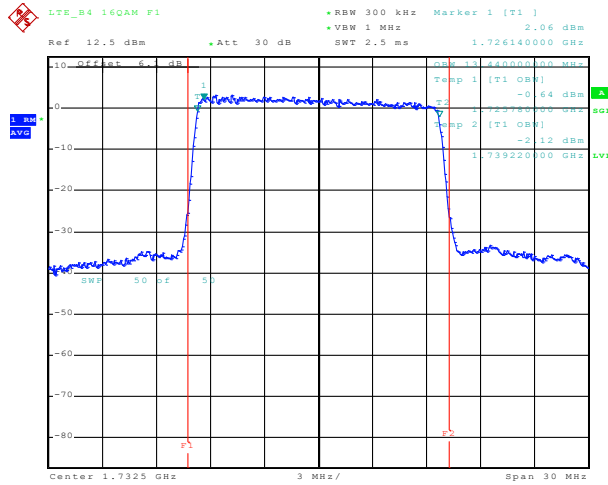

Date: 23.OCT.2012 19:08:43

7.2.2.26 LTE Occupied Bandwidth, Band4 mid channel (20175) BW=20MHz RB=100 RB Offset=0 16-QAM 99% BW

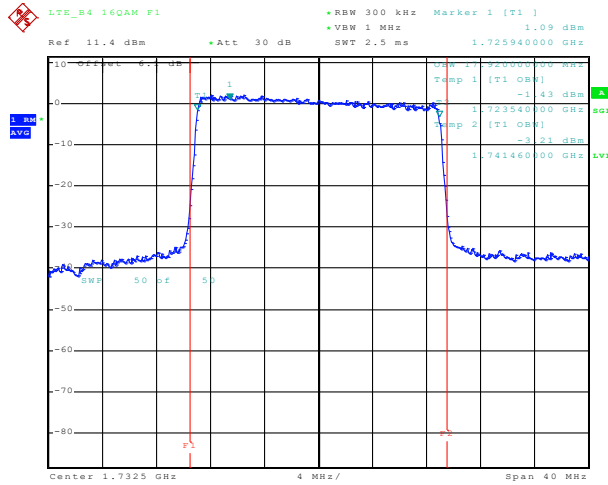

Date: 23.OCT.2012 19:14:30

SIERRA WIRELESS, INC.

7.2.2.27 LTE Occupied Bandwidth, Band5 mid channel (20525) BW=5MHz RB=25 RB Offset=0 16-QAM 99% BW

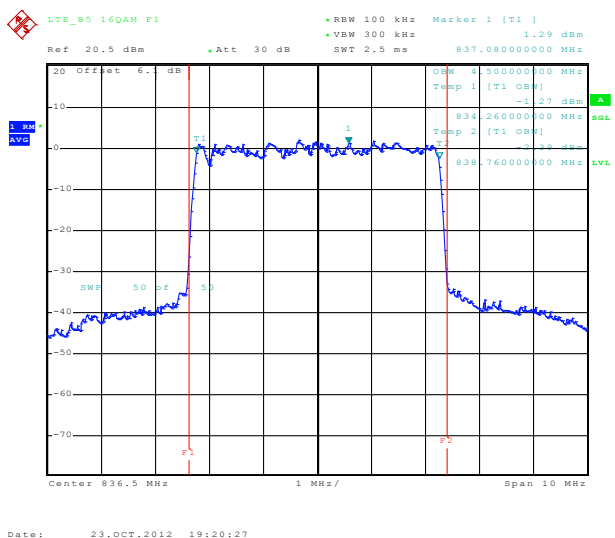

7.2.2.28 LTE Occupied Bandwidth, Band5 mid channel (20525) BW=10MHz RB=50 RB Offset=0 16-QAM 99% BW

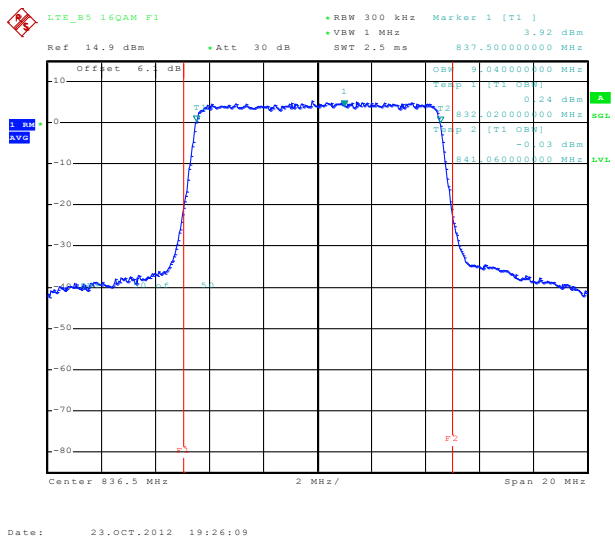

SIERRA WIRELESS, INC.

7.2.2.29 LTE Occupied Bandwidth, Band13 mid channel (23230) BW=5MHz RB=25 RB Offset=0 16-QAM 99% BW

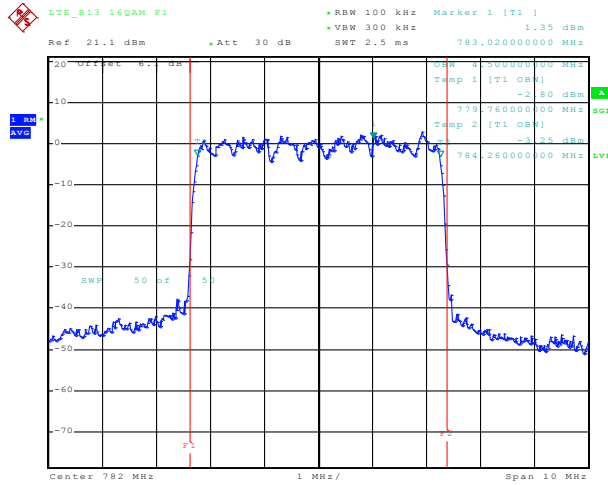

Date: 23.OCT.2012 19:31:58

7.2.2.30 LTE Occupied Bandwidth, Band13 mid channel (23230) BW=10MHz RB=50 RB Offset=0 16-QAM 99% BW

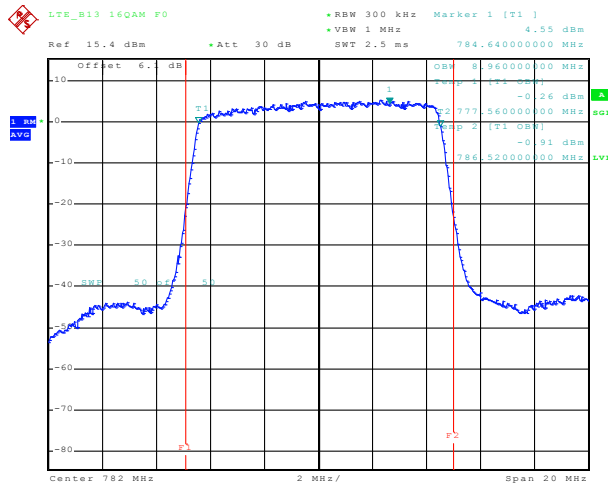

Date: 25.OCT.2012 16:46:33

SIERRA WIRELESS, INC.

7.2.2.31 LTE Occupied Bandwidth, Band17 mid channel (23790) BW=5MHz RB=25 RB Offset=0 16-QAM 99% BW

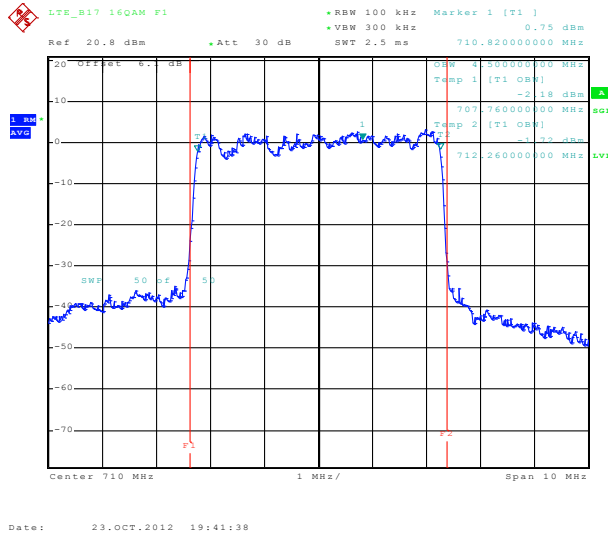

7.2.2.32 LTE Occupied Bandwidth, Band17 mid channel (23790) BW=10MHz RB=50 RB Offset=0 16-QAM 99% BW

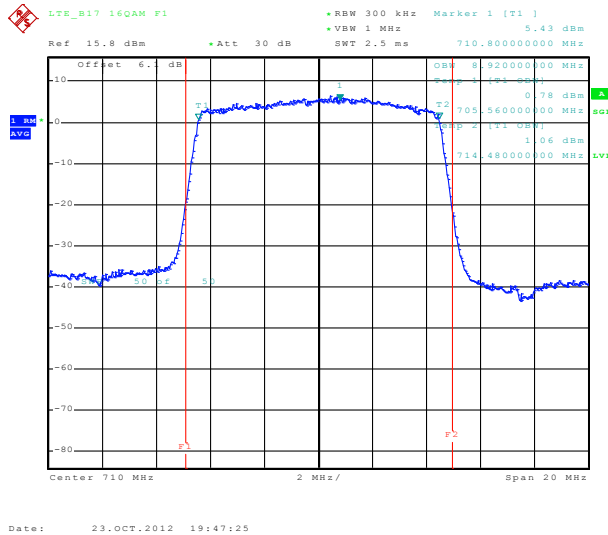

SIERRA WIRELESS, INC.

7.2.2.33 LTE Occupied Bandwidth, Band25 mid channel (26365) BW=5MHz RB=25 RB Offset=0 16-QAM 99% BW

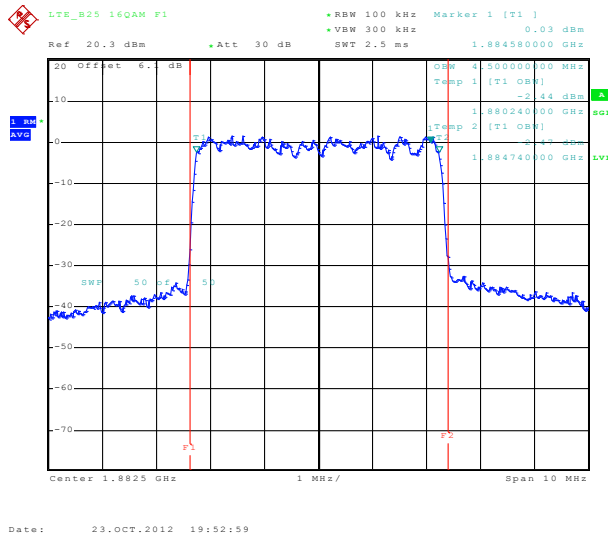

7.2.2.34 LTE Occupied Bandwidth, Band25 mid channel (26365) BW=10MHz RB=50 RB Offset=0 16-QAM 99% BW

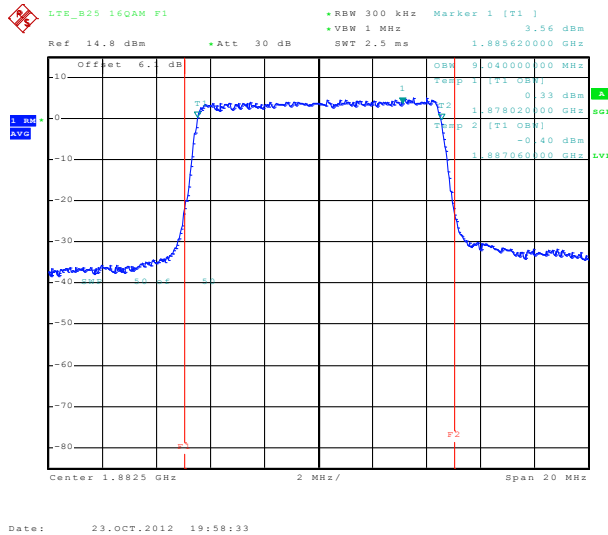

7.2.2.35 LTE Occupied Bandwidth, Band25 mid channel (26365) BW=15MHz RB=75 RB Offset=0 16-QAM 99% BW

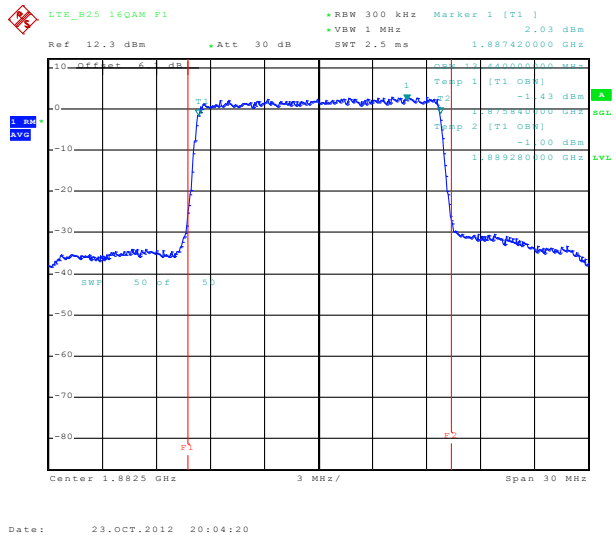

7.2.2.36 LTE Occupied Bandwidth, Band25 mid channel (26365) BW=20MHz RB=100 RB Offset=0 16-QAM 99% BW

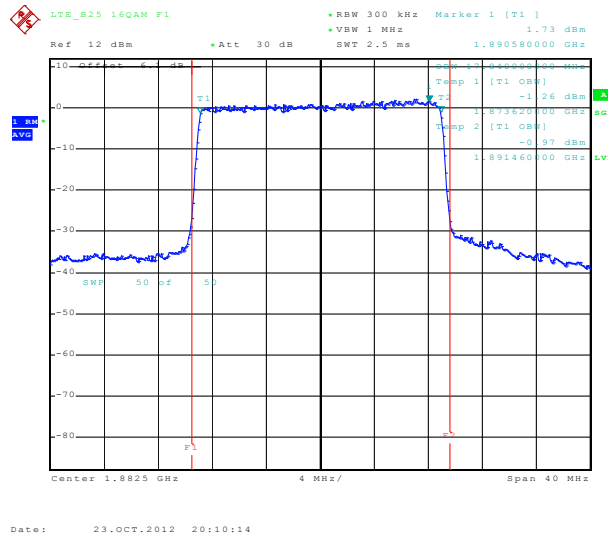

8 Out of Band Emissions at Antenna Terminals

FCC 2.1051, 22.917, 24.238(a), 27.53(h)(m)

Out of Band Emissions:

The mean power of emissions must be attenuated below the mean power of the unmodulated carrier (P) on any frequency outside the frequency band by at least $(43 + 10 \log P)$ dB. The out of band emission limit translates to a worst case absolute limit of -13dBm in this case.

SIERRA WIRELESS, INC.

8.1 Test Procedure

The RF output of the transmitter was connected to a spectrum analyzer through a calibrated coaxial cable. Sufficient scans were taken to show the out-of-band emissions, if any, up to 10th harmonic. The EUT was scanned for spurious emissions from 1MHz to 20GHz with sufficient bandwidth and video resolution. Data plots are included. Multiple sweeps were recorded in maximum hold mode using a peak detector to ensure that the worst-case emissions were captured. Refer to Test Setup 2.

8.2 Test Results

Refer to the following plots.

Mode	Band	BW (MHz)	No. RB	RB Offset	Frequency (MHz)	Channel	Corresponding Plot number
LTE	QPSK	B2	1	12	1880.0	18900	8.2.1.1 -8.2.1.3
				25			8.2.1.4 -8.2.1.6
				32			8.2.1.7 -8.2.1.9
				50			8.2.1.10 -8.2.1.12
		B4	1	12	1732.5	20175	8.2.1.13 -8.2.1.15
				25			8.2.1.16 -8.2.1.18
				32			8.2.1.19 -8.2.1.21
				50			8.2.1.22 -8.2.1.24
		B5	1	12	836.5	20525	8.2.1.25 -8.2.1.26
				25			8.2.1.27 -8.2.1.28
		B13	1	12	782.0	23230	8.2.1.29 -8.2.1.30
				25			8.2.1.31 -8.2.1.32
		B17	1	12	710.0	23790	8.2.1.33 -8.2.1.34
				25			8.2.1.35 -8.2.1.36
		B25	1	12	1882.5	26365	8.2.1.37 -8.2.1.39
				25			8.2.1.40 -8.2.1.42
				32			8.2.1.43 -8.2.1.45
				50			8.2.1.46 -8.2.1.48

The plots below show that the conducted emission limits requirements are met.

8.2.1 LTE Test Plots

LTE B2

8.2.1.1 Out of Band Emissions at Antenna Terminals LTE B2, Mid channel, 1880.0 MHz, 5MHz BW, 1RB, RB Offset 12, QPSK, 30MHz to 1 GHz

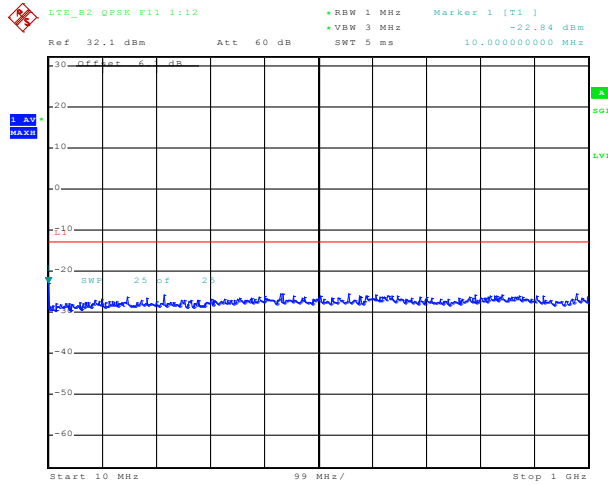

Date: 23.OCT.2012 21:09:24

8.2.1.2 Out of Band Emissions at Antenna Terminals LTE B2, Mid channel, 1880.0 MHz, 5MHz BW, 1RB, RB Offset 12, QPSK, 1 GHz to 10 GHz

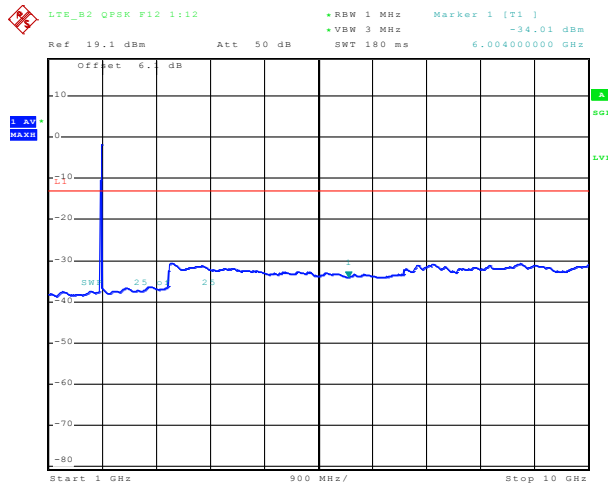

Date: 23.OCT.2012 21:09:53

Note: The strong emission shown in each case is the carrier signal.

SIERRA WIRELESS, INC.

8.2.1.3 Out of Band Emissions at Antenna Terminals LTE B2, Mid channel, 1880.0 MHz, 5MHz BW, 1RB, RB Offset 12, QPSK, 10 GHz to 20 GHz

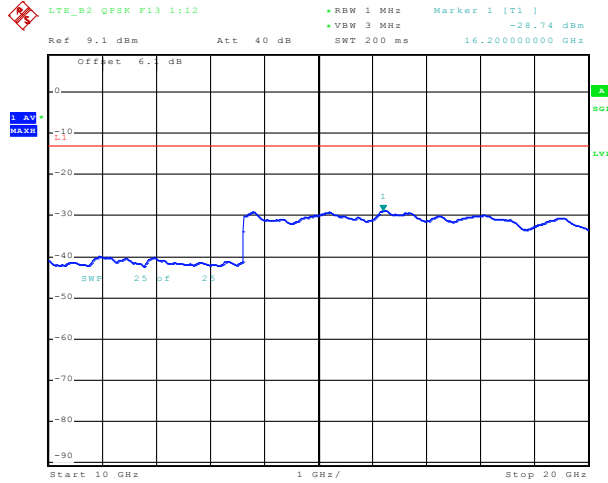

8.2.1.4 Out of Band Emissions at Antenna Terminals LTE B2, Mid channel, 1880.0 MHz, 10MHz BW, 1RB, RB Offset 25, QPSK, 30MHz to 1 GHz

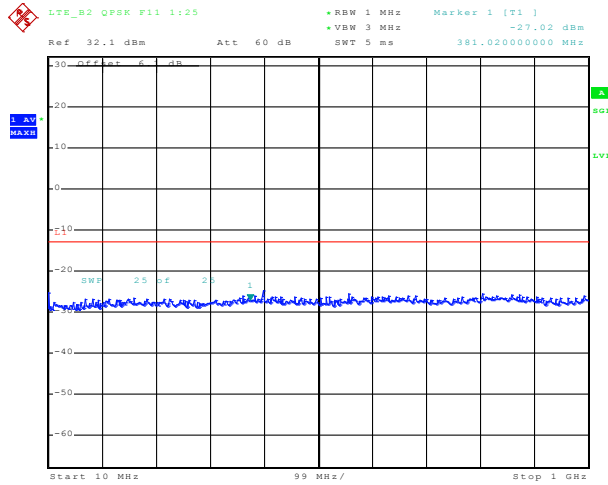

8.2.1.5 Out of Band Emissions at Antenna Terminals LTE B2, Mid channel, 1880.0 MHz, 10MHz BW, 1RB, RB Offset 25, QPSK, 1 GHz to 10 GHz

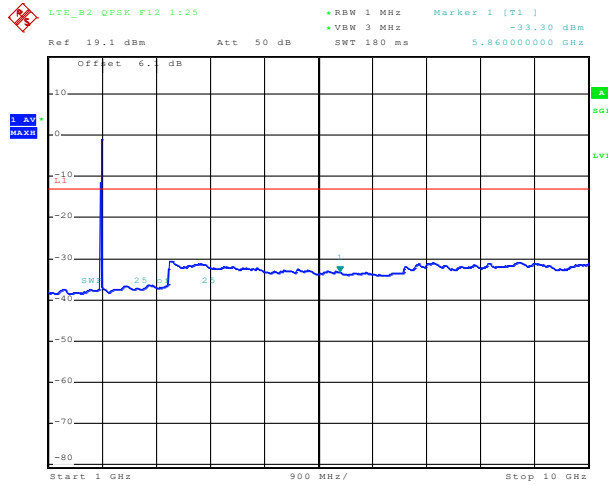

Date: 23.OCT.2012 21:39:02

Note: The strong emission shown in each case is the carrier signal.

8.2.1.6 Out of Band Emissions at Antenna Terminals LTE B2, Mid channel, 1880.0 MHz, 10MHz BW, 1RB, RB Offset 25, QPSK, 10 GHz to 20 GHz

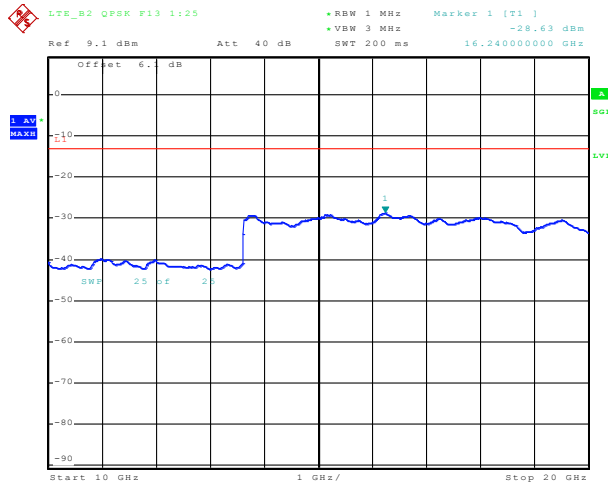

Date: 23.OCT.2012 21:39:24

SIERRA WIRELESS, INC.

8.2.1.7 Out of Band Emissions at Antenna Terminals LTE B2, Mid channel, 1880.0 MHz, 15MHz BW, 1RB, RB Offset 32, QPSK, 30MHz to 1 GHz

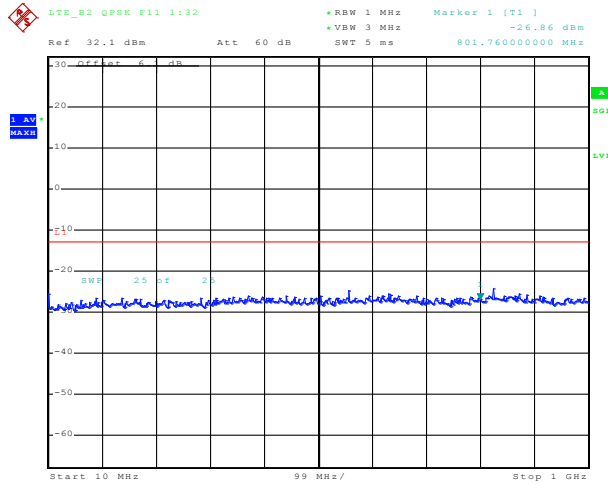

Date: 23.OCT.2012 22:05:32

8.2.1.8 Out of Band Emissions at Antenna Terminals LTE B2, Mid channel, 1880.0 MHz, 15MHz BW, 1RB, RB Offset 32, QPSK, 1 GHz to 10 GHz

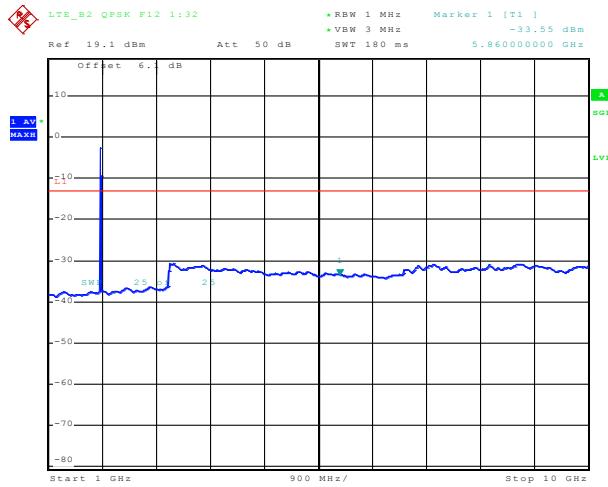

Date: 23.OCT.2012 22:06:01

Note: The strong emission shown in each case is the carrier signal.

SIERRA WIRELESS, INC.

8.2.1.9 Out of Band Emissions at Antenna Terminals LTE B2, Mid channel, 1880.0 MHz, 15MHz BW, 1RB, RB Offset 32, QPSK, 10 GHz to 20 GHz

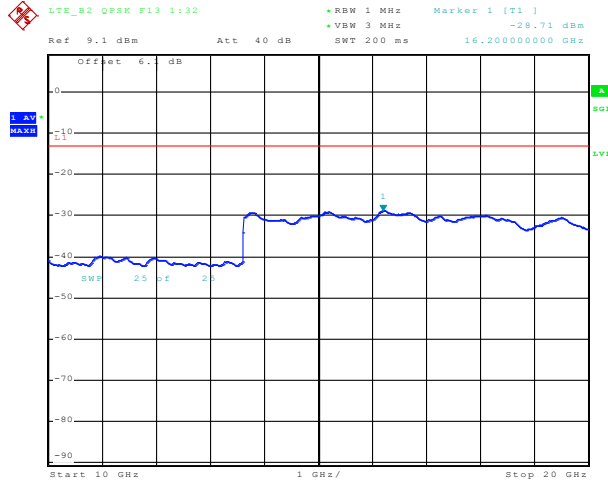

8.2.1.10 Out of Band Emissions at Antenna Terminals LTE B2, Mid channel, 1880.0 MHz, 20MHz BW, 1RB, RB Offset 50, QPSK, 30MHz to 1 GHz

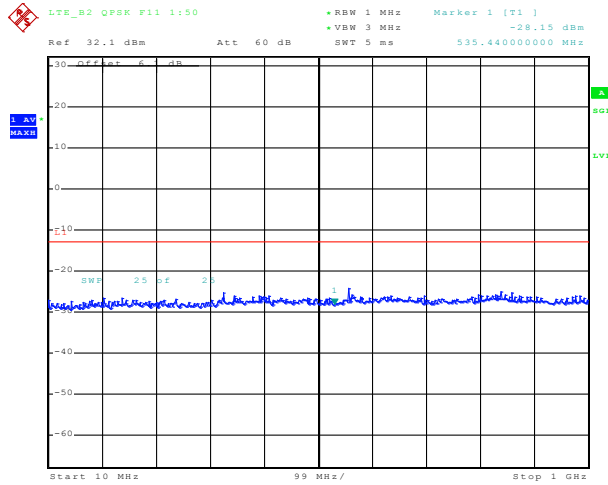

8.2.1.11 Out of Band Emissions at Antenna Terminals LTE B2, Mid channel, 1880.0 MHz, 20MHz BW, 1RB, RB Offset 50, QPSK, 1 GHz to 10 GHz

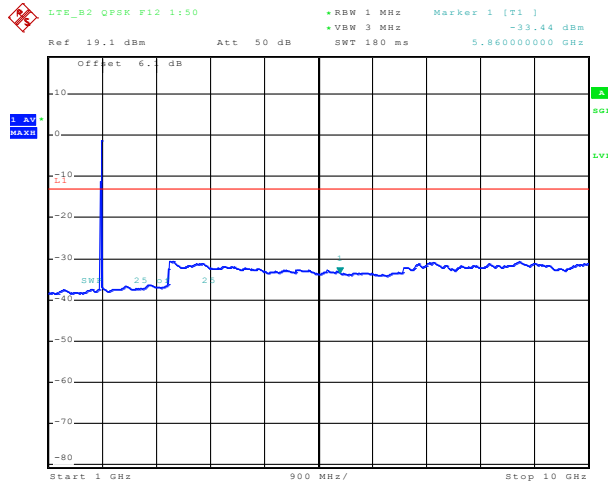

Date: 23.OCT.2012 22:21:14

Note: The strong emission shown in each case is the carrier signal.

8.2.1.12 Out of Band Emissions at Antenna Terminals LTE B2, Mid channel, 1880.0 MHz, 20MHz BW, 1RB, RB Offset 50, QPSK, 10 GHz to 20 GHz

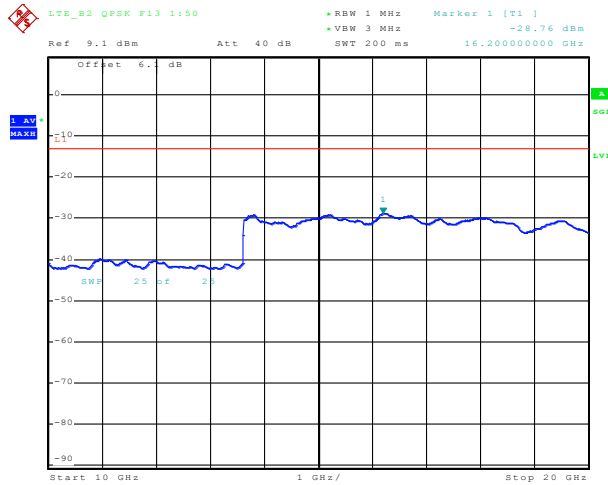

Date: 23.OCT.2012 22:21:36

LTE B4

8.2.1.13 Out of Band Emissions at Antenna Terminals LTE B4, Mid channel, 1732.5 MHz, 5MHz BW, 1RB, RB Offset 12, QPSK, 30MHz to 1 GHz

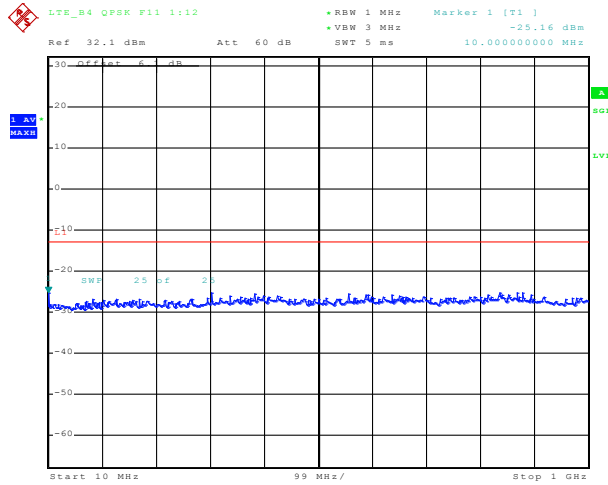

8.2.1.14 Out of Band Emissions at Antenna Terminals LTE B4, Mid channel, 1732.5 MHz, 5MHz BW, 1RB, RB Offset 12, QPSK, 1 GHz to 10 GHz

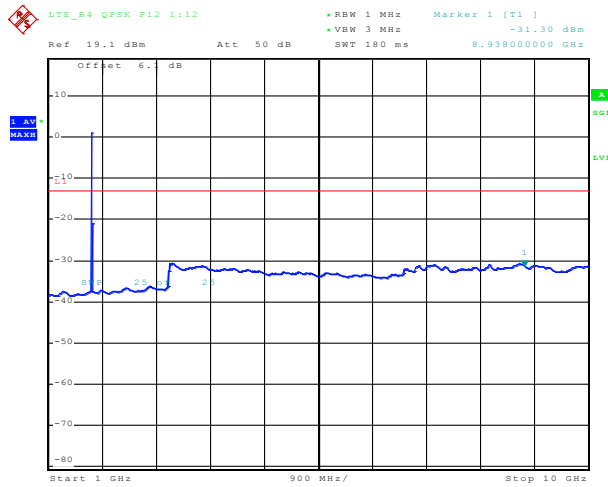

Note: The strong emission shown in each case is the carrier signal.

SIERRA WIRELESS, INC.

8.2.1.15 Out of Band Emissions at Antenna Terminals LTE B4, Mid channel, 1732.5 MHz, 5MHz BW, 1RB, RB Offset 12, QPSK, 10 GHz to 20 GHz

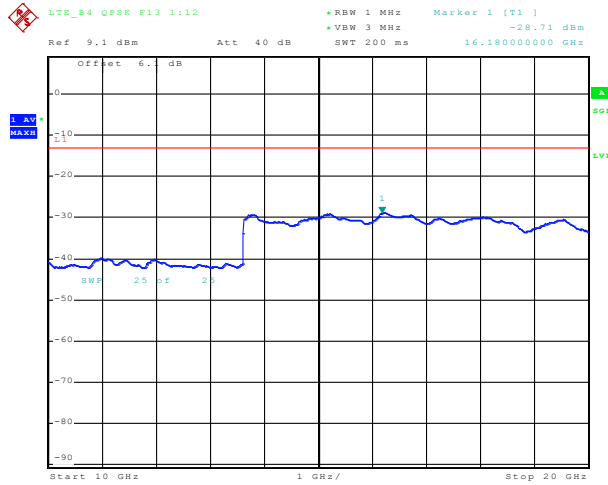

Date: 23.OCT.2012 21:15:02

8.2.1.16 Out of Band Emissions at Antenna Terminals LTE B4, Mid channel, 1732.5 MHz, 10MHz BW, 1RB, RB Offset 25, QPSK, 30MHz to 1 GHz

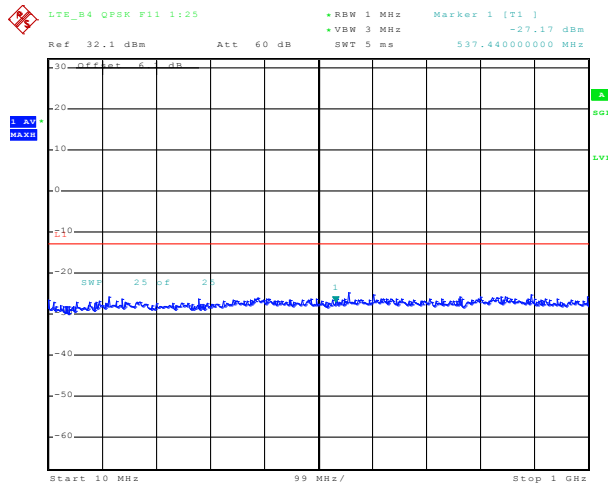

Date: 23.OCT.2012 21:43:22

8.2.1.17 Out of Band Emissions at Antenna Terminals LTE B4, Mid channel, 1732.5 MHz, 10MHz BW, 1RB, RB Offset 25, QPSK, 1 GHz to 10 GHz

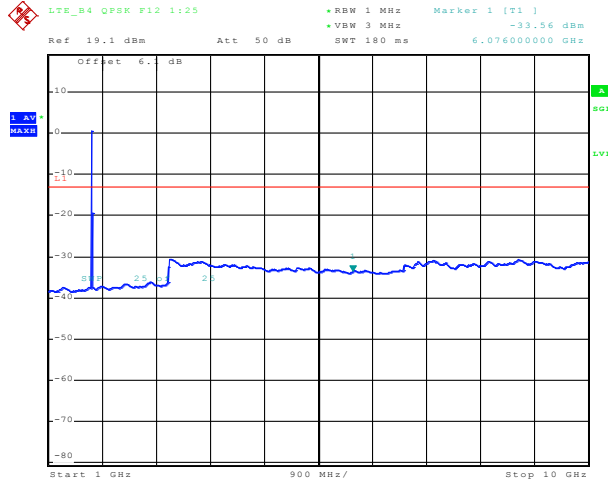

Date: 23.OCT.2012 21:43:51

Note: The strong emission shown in each case is the carrier signal.

8.2.1.18 Out of Band Emissions at Antenna Terminals LTE B4, Mid channel, 1732.5 MHz, 10MHz BW, 1RB, RB Offset 25, QPSK, 10 GHz to 20 GHz

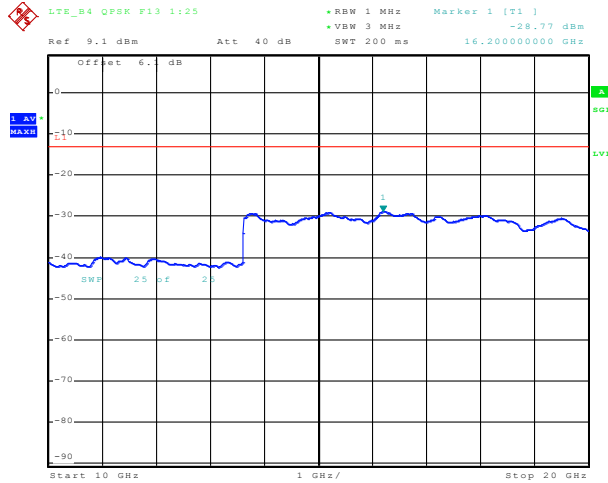

Date: 23.OCT.2012 21:44:13

SIERRA WIRELESS, INC.

8.2.1.19 Out of Band Emissions at Antenna Terminals LTE B4, Mid channel, 1732.5 MHz, 15MHz BW, 1RB, RB Offset 32, QPSK, 30MHz to 1 GHz

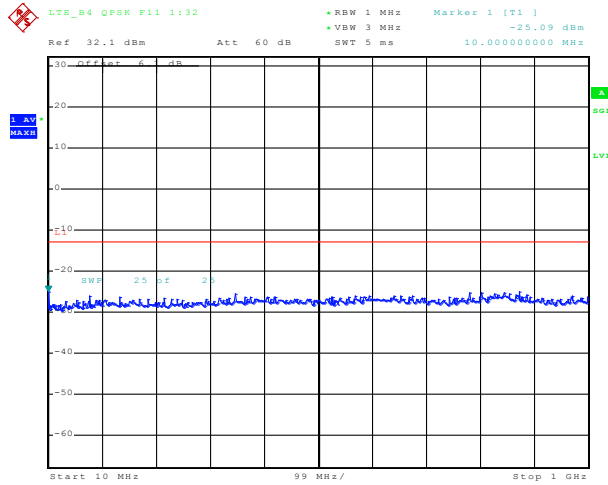

8.2.1.20 Out of Band Emissions at Antenna Terminals LTE B4, Mid channel, 1732.5 MHz, 15MHz BW, 1RB, RB Offset 32, QPSK, 1 GHz to 10 GHz

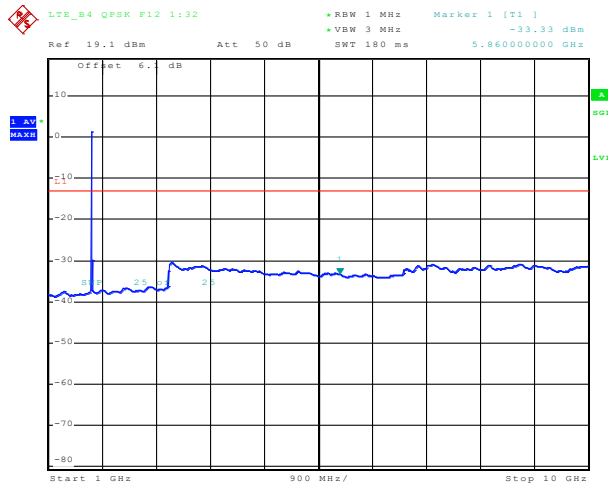

Note: The strong emission shown in each case is the carrier signal.

SIERRA WIRELESS, INC.

8.2.1.21 Out of Band Emissions at Antenna Terminals LTE B4, Mid channel, 1732.5 MHz, 15MHz BW, 1RB, RB Offset 32, QPSK, 10 GHz to 20 GHz

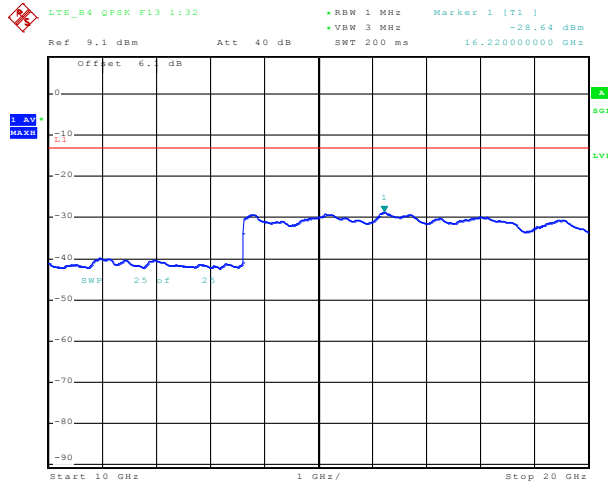

8.2.1.22 Out of Band Emissions at Antenna Terminals LTE B4, Mid channel, 1732.5 MHz, 20MHz BW, 1RB, RB Offset 50, QPSK, 30MHz to 1 GHz

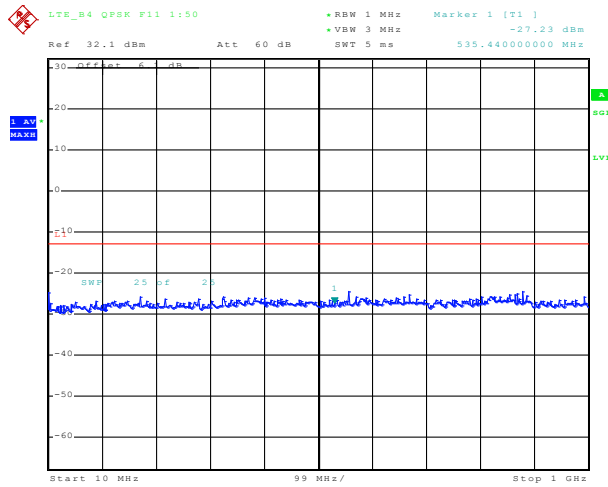

SIERRA WIRELESS, INC.

8.2.1.23 Out of Band Emissions at Antenna Terminals LTE B4, Mid channel, 1732.5 MHz, 20MHz BW, 1RB, RB Offset 50, QPSK, 1 GHz to 10 GHz

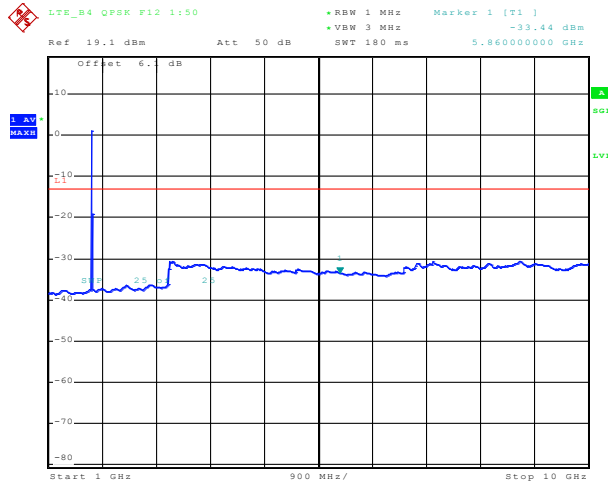

Date: 23.OCT.2012 22:26:22

Note: The strong emission shown in each case is the carrier signal.

8.2.1.24 Out of Band Emissions at Antenna Terminals LTE B4, Mid channel, 1732.5 MHz, 20MHz BW, 1RB, RB Offset 50, QPSK, 10 GHz to 20 GHz

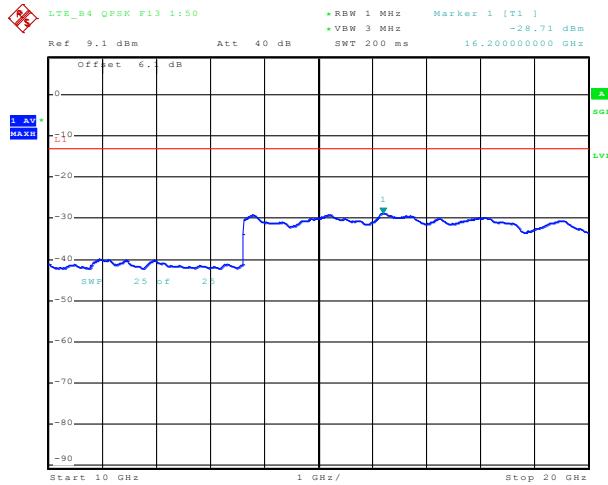

Date: 23.OCT.2012 22:26:44

LTE B5

SIERRA WIRELESS, INC.

8.2.1.27 Out of Band Emissions at Antenna Terminals LTE B5, Mid channel, 836.5 MHz, 10MHz BW, 1RB, RB Offset 25, QPSK, 30MHz to 1 GHz

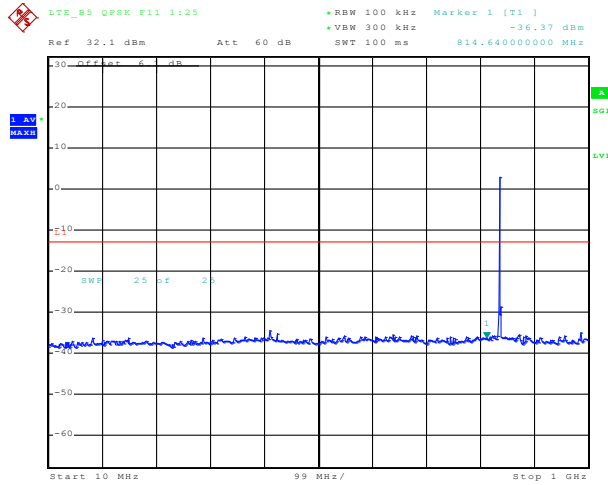

Note: The strong emission shown in each case is the carrier signal.

8.2.1.28 Out of Band Emissions at Antenna Terminals LTE B5, Mid channel, 836.5 MHz, 10MHz BW, 1RB, RB Offset 25, QPSK, 1 GHz to 10 GHz

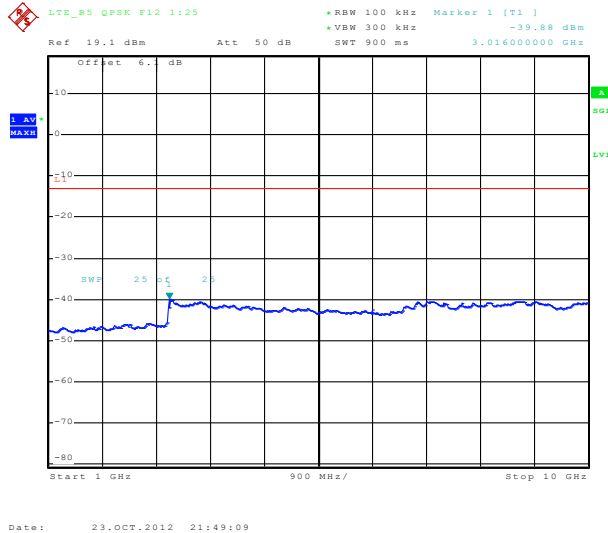

LTE B13

8.2.1.29 Out of Band Emissions at Antenna Terminals LTE B13, Mid channel, 782.0 MHz, 5MHz BW, 1RB, RB Offset 12, QPSK, 30MHz to 1 GHz

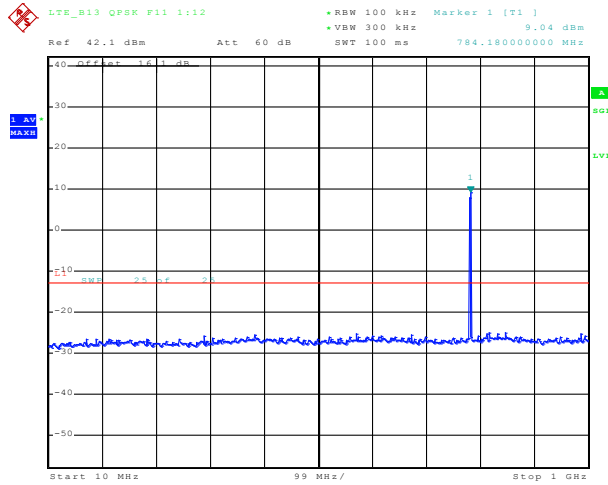

Date: 23.OCT.2012 21:24:04

Note: The strong emission shown in each case is the carrier signal.

8.2.1.30 Out of Band Emissions at Antenna Terminals LTE B13, Mid channel, 782.0 MHz, 5MHz BW, 1RB, RB Offset 12, QPSK, 1 GHz to 10 GHz

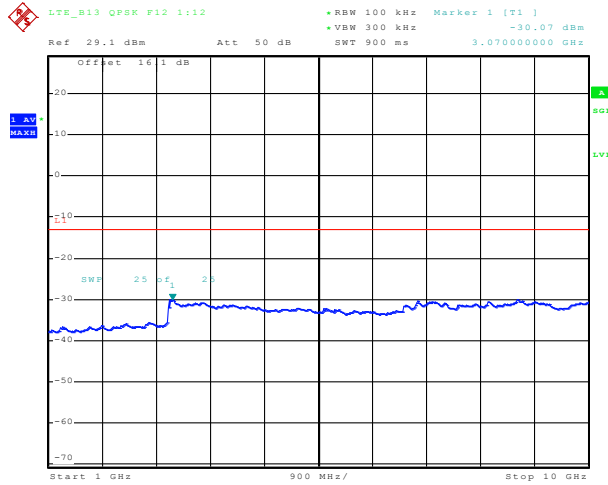

Date: 23.OCT.2012 21:24:52

8.2.1.31 Out of Band Emissions at Antenna Terminals LTE B13, Mid channel, 782.0 MHz, 10MHz BW, 1RB, RB Offset 25, QPSK, 30MHz to 1 GHz

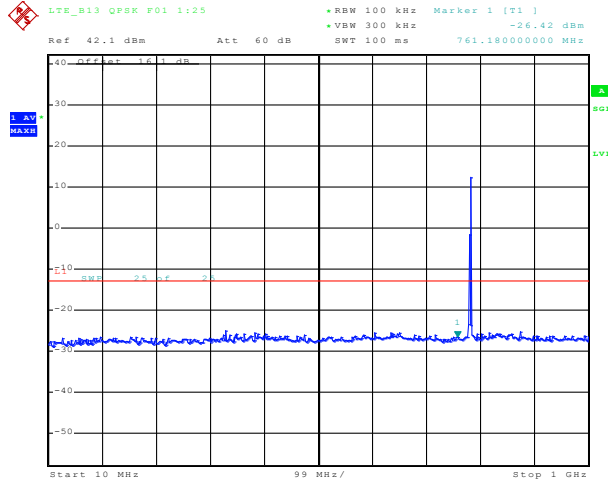

Date: 23.OCT.2012 21:52:03

Note: The strong emission shown in each case is the carrier signal.

8.2.1.32 Out of Band Emissions at Antenna Terminals LTE B13, Mid channel, 782.0 MHz, 10MHz BW, 1RB, RB Offset 25, QPSK, 1 GHz to 10 GHz

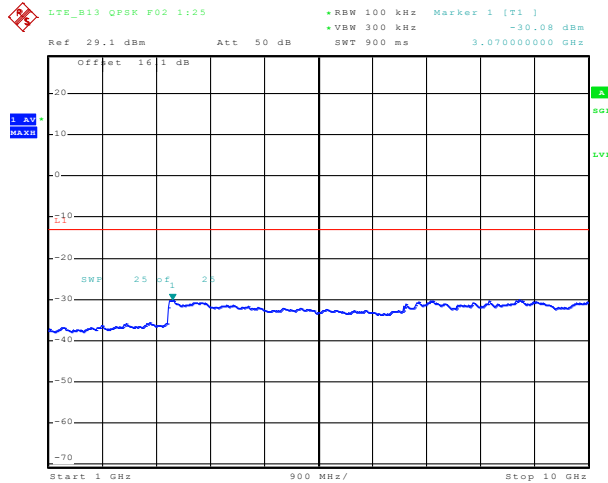

Date: 23.OCT.2012 21:52:51

LTE B17

8.2.1.33 Out of Band Emissions at Antenna Terminals LTE B17, Mid channel, 710.0 MHz, 5MHz BW, 1RB, RB Offset 12, QPSK, 30MHz to 1 GHz

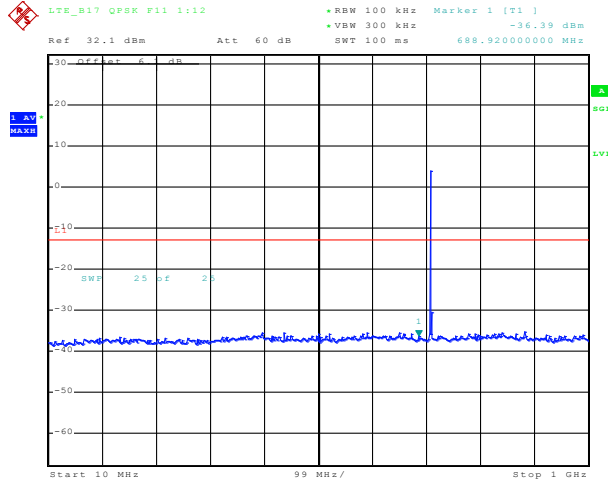

Date: 23.OCT.2012 21:29:01

Note: The strong emission shown in each case is the carrier signal.

8.2.1.34 Out of Band Emissions at Antenna Terminals LTE B17, Mid channel, 710.0 MHz, 5MHz BW, 1RB, RB Offset 12, QPSK, 1 GHz to 10 GHz

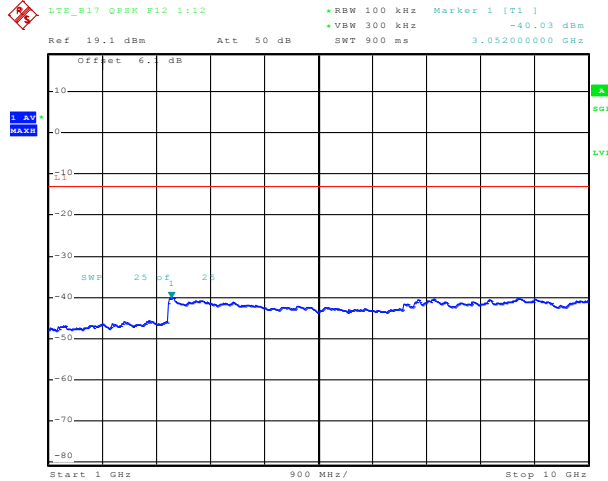

Date: 23.OCT.2012 21:29:49

SIERRA WIRELESS, INC.

8.2.1.35 Out of Band Emissions at Antenna Terminals LTE B17, Mid channel, 710.0 MHz, 10MHz BW, 1RB, RB Offset 25, QPSK, 30MHz to 1 GHz

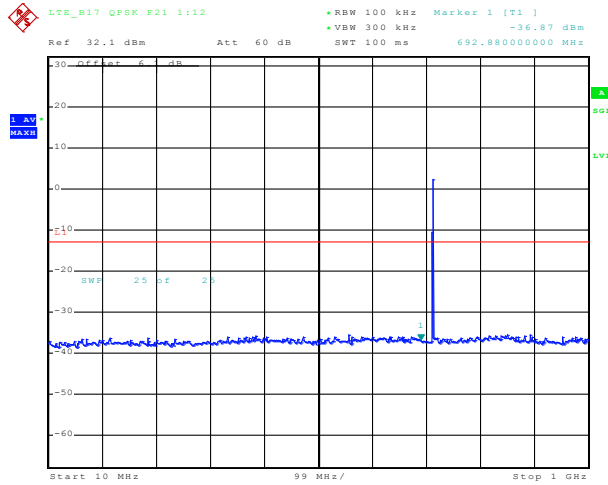

Date: 23.OCT.2012 21:30:14

Note: The strong emission shown in each case is the carrier signal.

8.2.1.36 Out of Band Emissions at Antenna Terminals LTE B17, Mid channel, 710.0 MHz, 10MHz BW, 1RB, RB Offset 25, QPSK, 1 GHz to 10 GHz

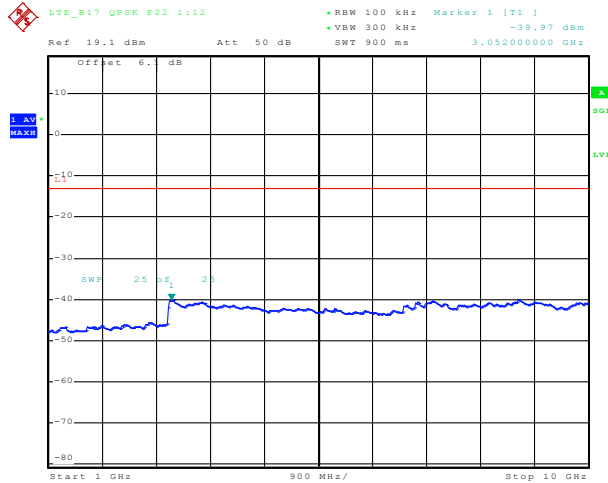

Date: 23.OCT.2012 21:31:02

LTE B25

SIERRA WIRELESS, INC.

8.2.1.37 Out of Band Emissions at Antenna Terminals LTE B25, Mid channel, 1882.5 MHz, 5MHz BW, 1RB, RB Offset 12, QPSK, 30MHz to 1 GHz

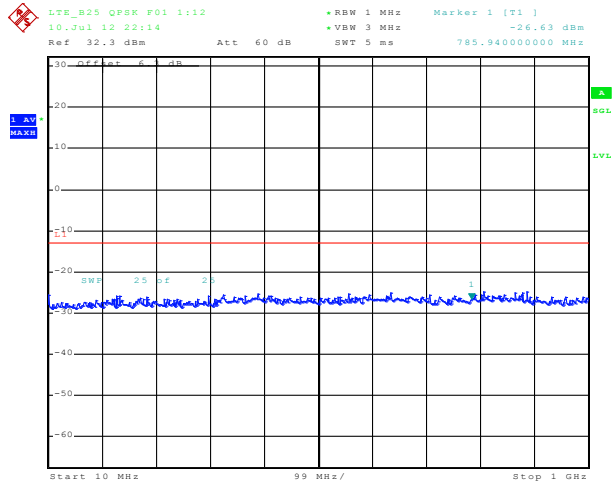

Date: 10 JUL 2012 22:14:53

8.2.1.38 Out of Band Emissions at Antenna Terminals LTE B25, Mid channel, 1882.5 MHz, 5MHz BW, 1RB, RB Offset 12, QPSK, 1 GHz to 10 GHz

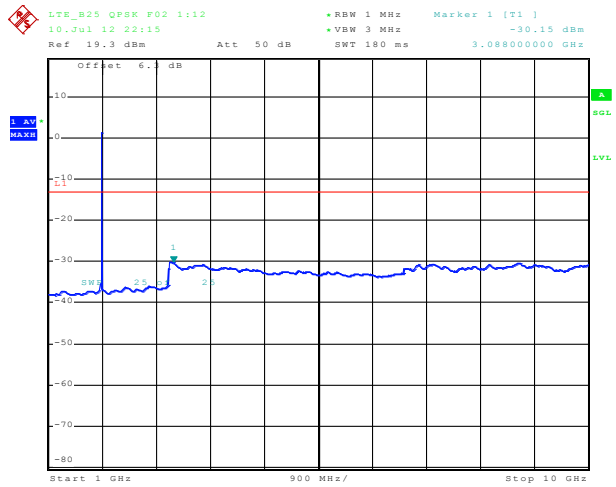

Date: 10 JUL 2012 22:15:22

Note: The strong emission shown in each case is the carrier signal.

SIERRA WIRELESS, INC.

8.2.1.39 Out of Band Emissions at Antenna Terminals LTE B25, Mid channel, 1882.5 MHz, 5MHz BW, 1RB, RB Offset 12, QPSK, 10 GHz to 20 GHz

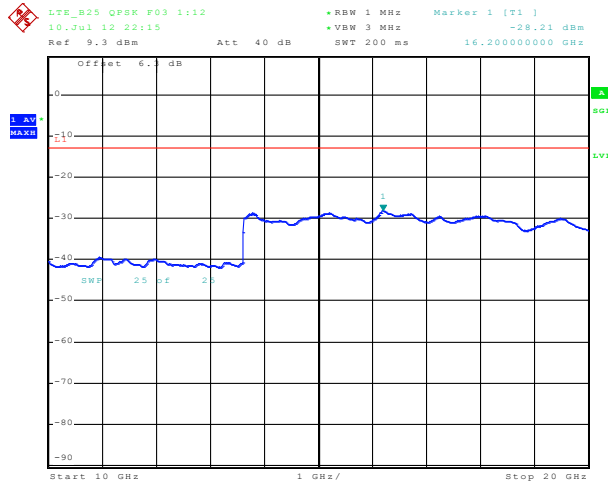

8.2.1.40 Out of Band Emissions at Antenna Terminals LTE B25, Mid channel, 1882.5 MHz, 10MHz BW, 1RB, RB Offset 25, QPSK, 30MHz to 1 GHz

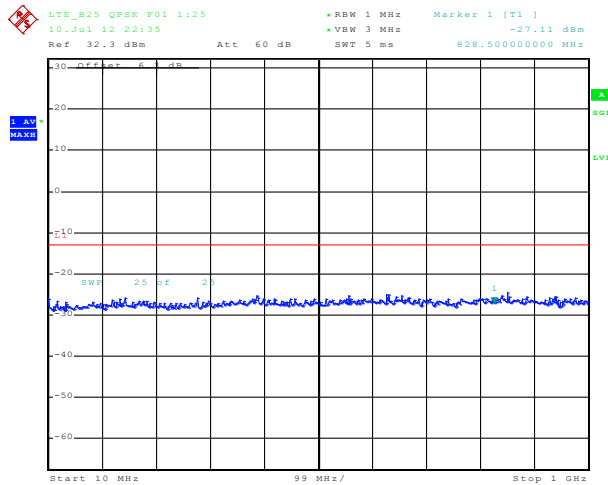

8.2.1.41 Out of Band Emissions at Antenna Terminals LTE B25, Mid channel, 1882.5 MHz, 10MHz BW, 1RB, RB Offset 25, QPSK, 1 GHz to 10 GHz

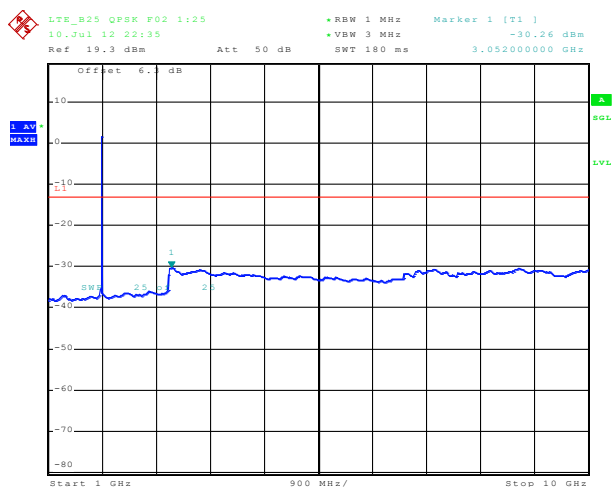

Date: 10.JUL.2012 22:35:55

Note: The strong emission shown in each case is the carrier signal.

8.2.1.42 Out of Band Emissions at Antenna Terminals LTE B25, Mid channel, 1882.5 MHz, 10MHz BW, 1RB, RB Offset 25, QPSK, 10 GHz to 20 GHz

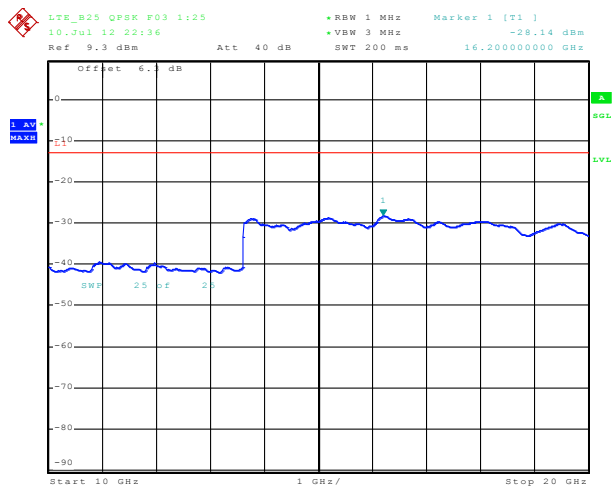

Date: 10.JUL.2012 22:36:17

8.2.1.43 Out of Band Emissions at Antenna Terminals LTE B25, Mid channel, 1882.5 MHz, 15MHz BW, 1RB, RB Offset 32, QPSK, 30MHz to 1 GHz

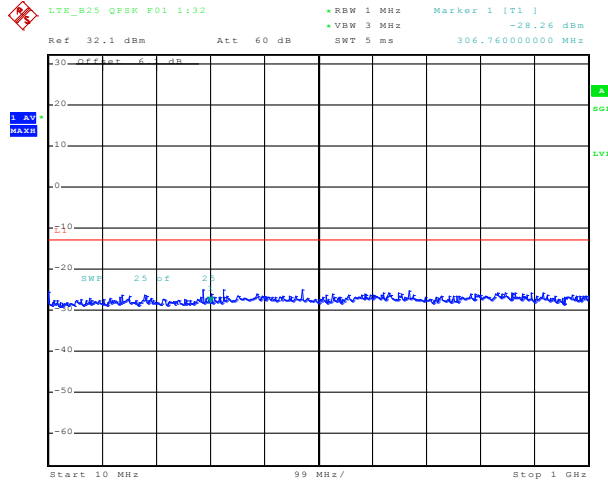

Date: 6.SEP.2012 09:06:09

8.2.1.44 Out of Band Emissions at Antenna Terminals LTE B25, Mid channel, 1882.5 MHz, 15MHz BW, 1RB, RB Offset 32, QPSK, 1 GHz to 10 GHz

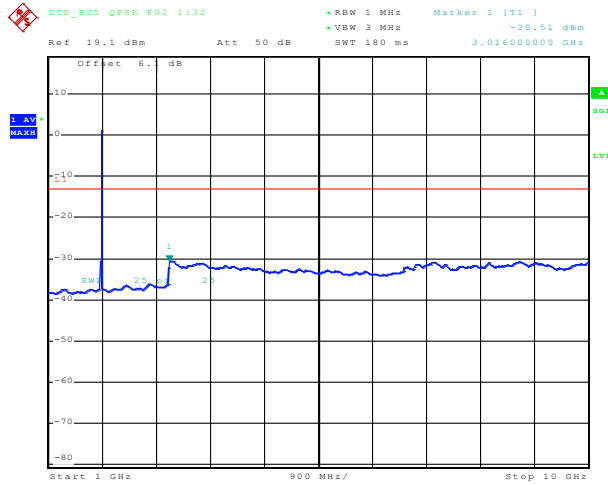

Date: 6.SEP.2012 09:06:38

Note: The strong emission shown in each case is the carrier signal.

SIERRA WIRELESS, INC.

8.2.1.45 Out of Band Emissions at Antenna Terminals LTE B25, Mid channel, 1882.5 MHz, 15MHz BW, 1RB, RB Offset 32, QPSK, 10 GHz to 20 GHz

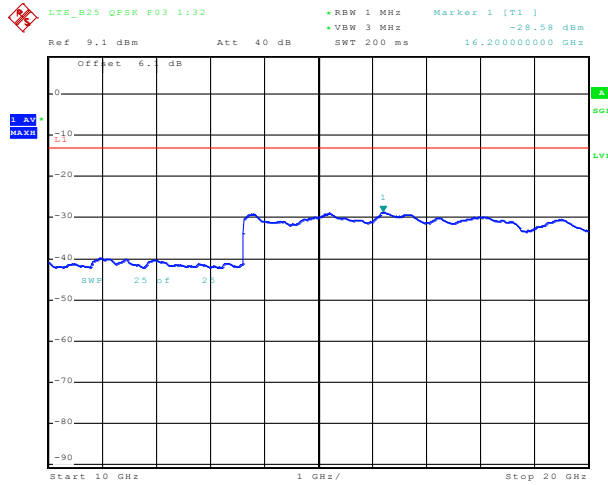

Date: 6.SEP.2012 09:07:00

8.2.1.46 Out of Band Emissions at Antenna Terminals LTE B25, Mid channel, 1882.5 MHz, 20MHz BW, 1RB, RB Offset 50, QPSK, 30MHz to 1 GHz

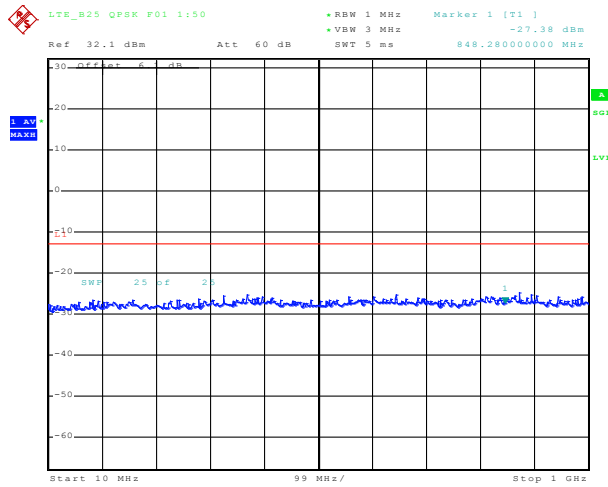

Date: 6.SEP.2012 09:13:47

8.2.1.47 Out of Band Emissions at Antenna Terminals LTE B25, Mid channel, 1882.5 MHz, 20MHz BW, 1RB, RB Offset 50, QPSK, 1 GHz to 10 GHz

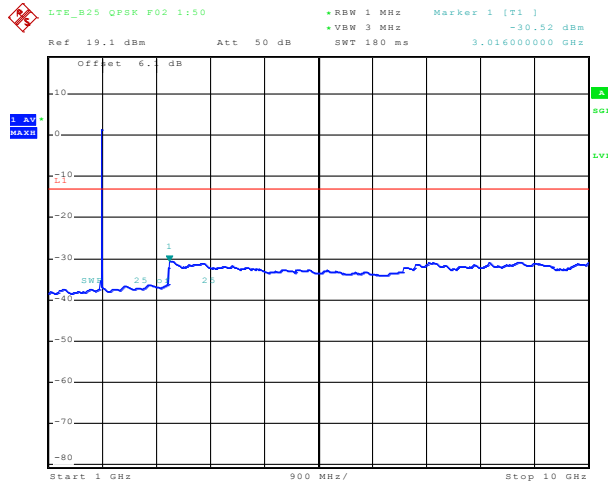

Date: 6.SEP.2012 09:14:16

Note: The strong emission shown in each case is the carrier signal.

8.2.1.48 Out of Band Emissions at Antenna Terminals LTE B25, Mid channel, 1882.5 MHz, 20MHz BW, 1RB, RB Offset 50, QPSK, 10 GHz to 20 GHz

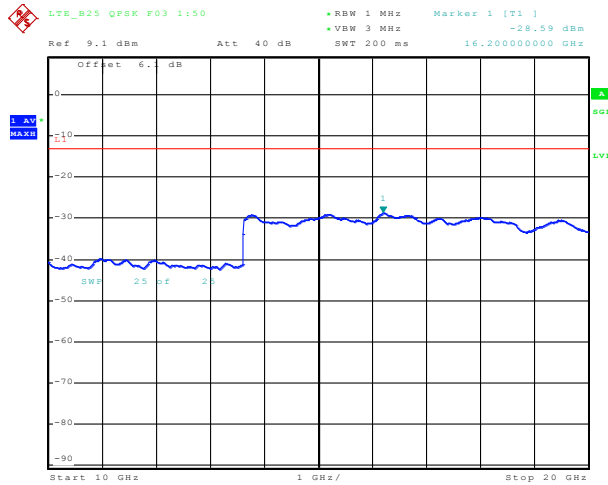

Date: 6.SEP.2012 09:14:38

9 Block Edge Compliance

FCC Part 2.1051, 22.917, 24.238(a), 27.53(h)(m)

9.1 Test Procedure

The transmitter output was connected to a Rohde & Schwarz CMW500, through a coaxial RF cable and a directional coupler, and configured to operate at maximum power. The block edge emissions were

SIERRA WIRELESS, INC.

measured at the required operating frequencies in each band on the Spectrum Analyzer. Refer to Test Setup 1.

The resolution bandwidth was set to at least 1% of the emission bandwidth (where applicable). The power was scaled accordingly:

$$\text{Power offset} = 10 * \log(\text{FCC_RBW} / \text{Measurement_RBW})$$

9.2 Test Results

LL = lower left, LR = lower right, UL = upper left, UR = upper right

Mode	Band	BW (MHz)	No. RB	RB Offset	Frequency (MHz)	Channel	Corresponding Plot number			
LTE	QPSK	B2	5	1	0	1852.5	18625	9.2.1.1 LL		
				25	0			9.2.1.1 UL		
			10	10	1	24	1907.5	19175	9.2.1.1 LR	
					25	0			9.2.1.1 UR	
		B2	10	10	1	0	1855.0	18650	9.2.1.2 LL	
					50	0			9.2.1.2 UL	
			15	15	1	49	1905.0	19150	9.2.1.2 LR	
					50	0			9.2.1.2 UR	
		B2	15	15	1	0	1857.5	18675	9.2.1.3 LL	
					75	0			9.2.1.3 UL	
			20	20	1	74	1902.5	19125	9.2.1.3 LR	
					75	0			9.2.1.3 UR	
		B2	20	20	1	0	1860.0	18700	9.2.1.4 LL	
					100	0			9.2.1.4 UL	
			B4	5	5	1	99	1900.0	19100	9.2.1.4 LR
						100	0			9.2.1.4 UR
		B4	5	5	1	0	1712.5	19975	9.2.1.5 LL	
					25	0			9.2.1.5 UL	
			10	10	1	24	1752.5	20375	9.2.1.5 LR	
					25	0			9.2.1.5 UR	
		B4	10	10	1	0	1715.0	20000	9.2.1.6 LL	
					50	0			9.2.1.6 UL	
			15	15	1	49	1750.0	20350	9.2.1.6 LR	
					50	0			9.2.1.6 UR	
		B4	15	15	1	0	1717.5	20025	9.2.1.7 LL	
					75	0			9.2.1.7 UL	
			20	20	1	74	1747.5	20325	9.2.1.7 LR	
					75	0			9.2.1.7 UR	
		B4	20	20	1	0	1720.0	20050	9.2.1.8 LL	
					100	0			9.2.1.8 UL	
					1	99			1745.0	20300

SIERRA WIRELESS, INC.

LTE	16-QAM			100	0			9.2.1.8 UR		
				B5	5	1	0	826.5	20425	9.2.1.9 LL
						25	0			9.2.1.9 UL
						1	24	846.5	20625	9.2.1.9 LR
		25	0			9.2.1.9 UR				
		B5	10	1	0	829.0	20450	9.2.1.10 LL		
				50	0			9.2.1.10 UL		
				1	49	844.0	20600	9.2.1.10 LR		
				50	0			9.2.1.10 UR		
		B13	5	1	0	779.5	23205	9.2.1.11 LL		
				25	0			9.2.1.11 UL		
				1	24	784.5	23255	9.2.1.11 LR		
				25	0			9.2.1.11 UR		
		B13	10	1	0	782.0	23230	9.2.1.12 LL		
				50	0			9.2.1.12 UL		
				1	49	782.0	23230	9.2.1.12 LR		
				50	0			9.2.1.12 UR		
		B17	5	1	0	706.5	23755	9.2.1.13 LL		
				25	0			9.2.1.13 UL		
				1	24	713.5	23825	9.2.1.13 LR		
				25	0			9.2.1.13 UR		
		B17	10	1	0	709.0	23780	9.2.1.14 LL		
				50	0			9.2.1.14 UL		
				1	49	711.0	23800	9.2.1.14 LR		
				50	0			9.2.1.14 UR		
		B25	5	1	0	1852.5	26065	9.2.1.15 LL		
				25	0			9.2.1.15 UL		
				1	24	1912.5	26665	9.2.1.15 LR		
				25	0			9.2.1.15 UR		
		B25	10	1	0	1855.0	26090	9.2.1.16 LL		
				50	0			9.2.1.16 UL		
				1	49	1910.0	26640	9.2.1.16 LR		
				50	0			9.2.1.16 UR		
		B25	15	1	0	1857.5	26115	9.2.1.17 LL		
				75	0			9.2.1.17 UL		
				1	74	1907.5	26615	9.2.1.17 LR		
				75	0			9.2.1.17 UR		
		B25	20	1	0	1860.0	26140	9.2.1.18 LL		
				100	0			9.2.1.18 UL		
				1	99	1905.0	26590	9.2.1.18 LR		
				100	0			9.2.1.18 UR		
		B2	5	1	0	1852.5	18625	9.2.1.19 LL		
				25	0			9.2.1.19 UL		
				1	24	1907.5	19175	9.2.1.19 LR		
				25	0			9.2.1.19 UR		

SIERRA WIRELESS, INC.

B2	10	1	0	1855.0	18650	9.2.1.20 LL
		50	0			9.2.1.20 UL
B2	15	1	49	1905.0	19150	9.2.1.20 LR
		50	0			9.2.1.20 UR
B2	20	1	0	1860.0	18700	9.2.1.22 LL
		100	0			9.2.1.22 UL
		1	99	1900.0	19100	9.2.1.22 LR
		100	0			9.2.1.22 UR
B4	5	1	0	1712.5	19975	9.2.1.23 LL
		25	0			9.2.1.23 UL
		1	24	1752.5	20375	9.2.1.23 LR
		25	0			9.2.1.23 UR
B4	10	1	0	1715.0	20000	9.2.1.24 LL
		50	0			9.2.1.24 UL
		1	49	1750.0	20350	9.2.1.24 LR
		50	0			9.2.1.24 UR
B4	15	1	0	1717.5	20025	9.2.1.25 LL
		75	0			9.2.1.25 UL
		1	74	1747.5	20325	9.2.1.25 LR
		75	0			9.2.1.25 UR
B4	20	1	0	1720.0	20050	9.2.1.26 LL
		100	0			9.2.1.26 UL
		1	99	1745.0	20300	9.2.1.26 LR
		100	0			9.2.1.26 UR
B5	5	1	0	826.5	20425	9.2.1.27 LL
		25	0			9.2.1.27 UL
		1	24	846.5	20625	9.2.1.27 LR
		25	0			9.2.1.27 UR
B5	10	1	0	829.0	20450	9.2.1.28 LL
		50	0			9.2.1.28 UL
		1	49	844.0	20600	9.2.1.28 LR
		50	0			9.2.1.28 UR
B13	5	1	0	779.5	23205	9.2.1.29 LL
		25	0			9.2.1.29 UL
		1	24	784.5	23255	9.2.1.29 LR
		25	0			9.2.1.29 UR
B13	10	1	0	782.0	23230	9.2.1.30 LL
		50	0			9.2.1.30 UL
		1	49	782.0	23230	9.2.1.30 LR
		50	0			9.2.1.30 UR
B17	5	1	0	706.5	23755	9.2.1.31 LL

SIERRA WIRELESS, INC.

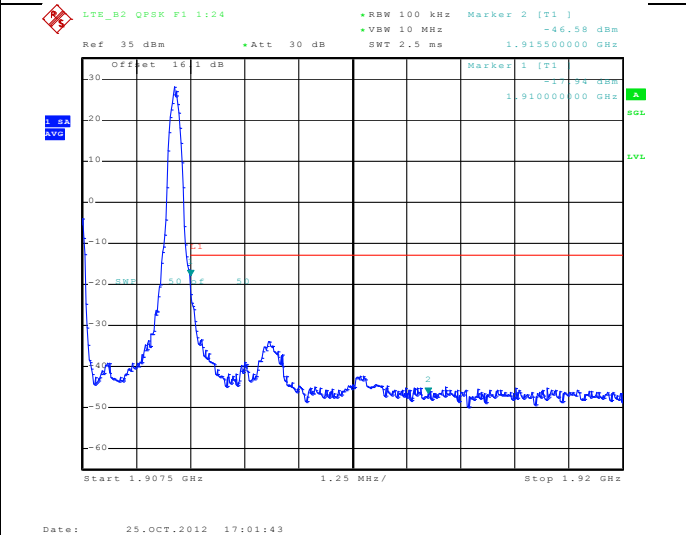
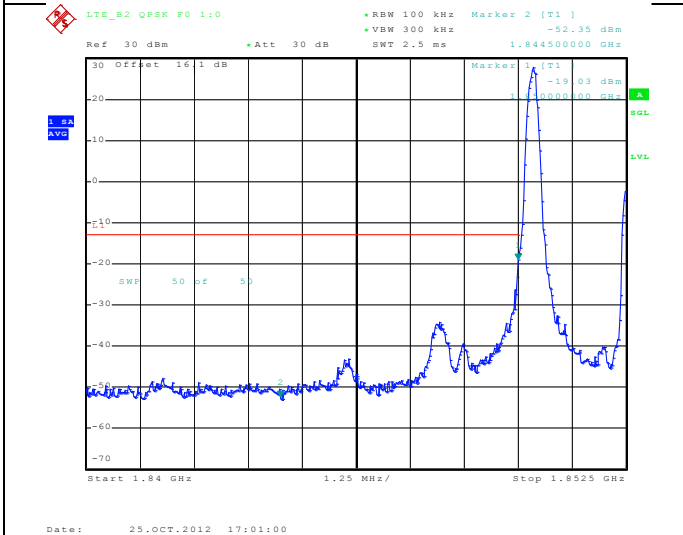
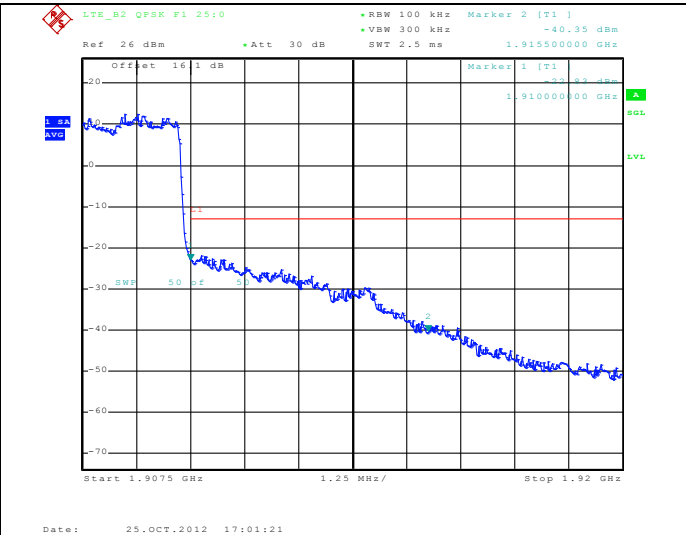
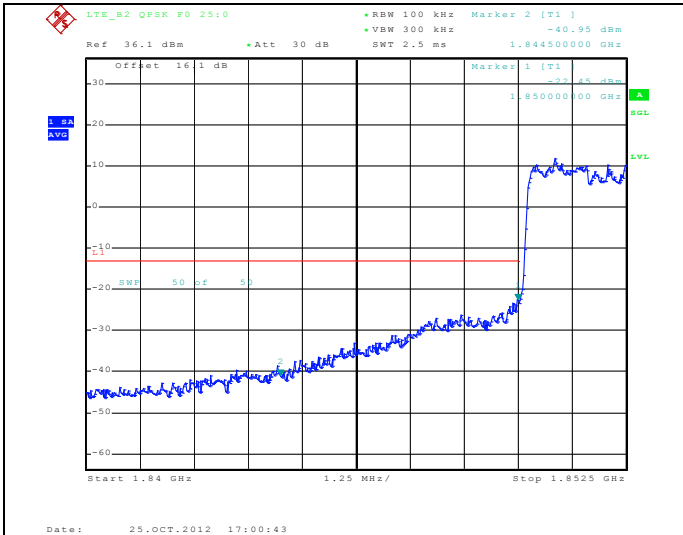

9.2.1.2 LTE; Band2, 10 MHz BW, QPSK

Below 1850 MHz	Above 1910 MHz
-----------------------	-----------------------

SIERRA WIRELESS, INC.

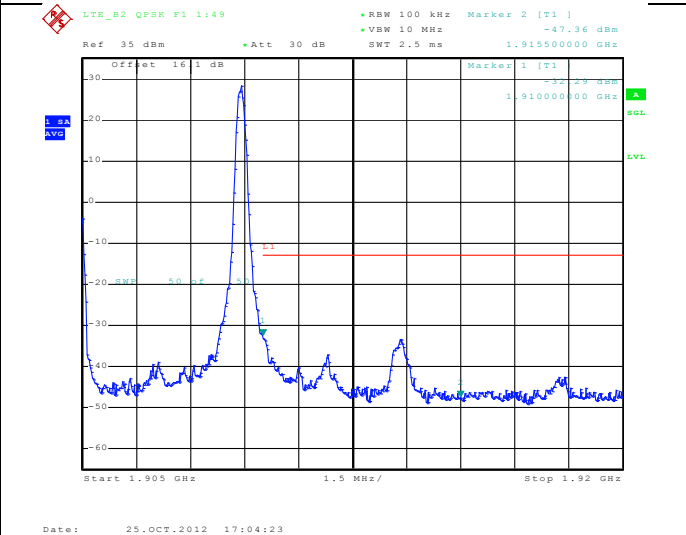
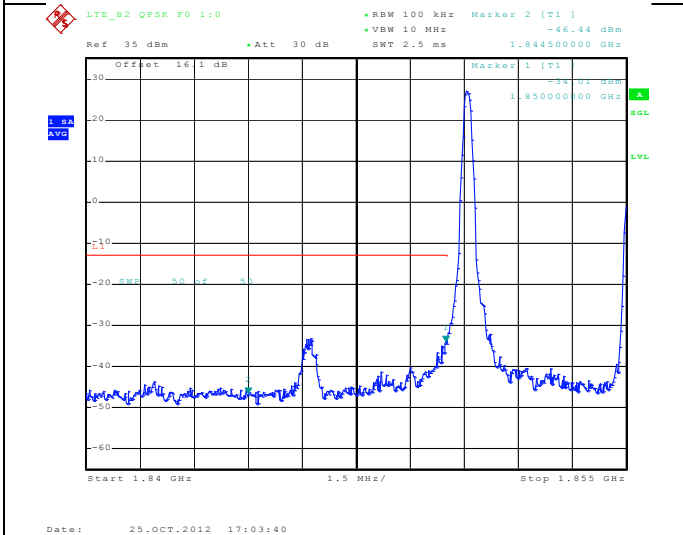
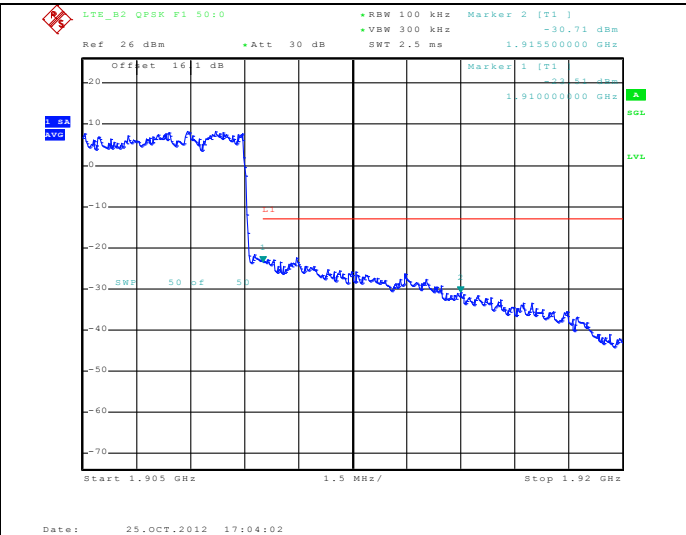
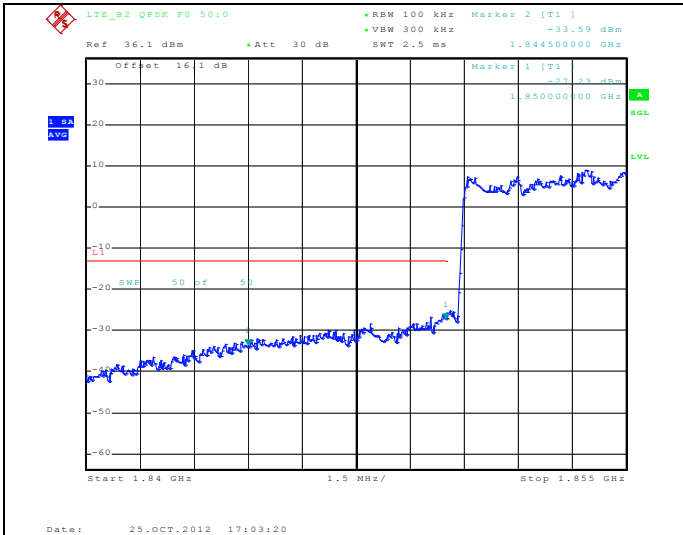

9.2.1.3 LTE; Band2, 15 MHz BW, QPSK

Below 1850 MHz	Above 1910 MHz
-----------------------	-----------------------

SIERRA WIRELESS, INC.

FCC Part 22/24/27, RSS-132/133/139

EM7355

Feb. 05, 2013

Page 68 of 111

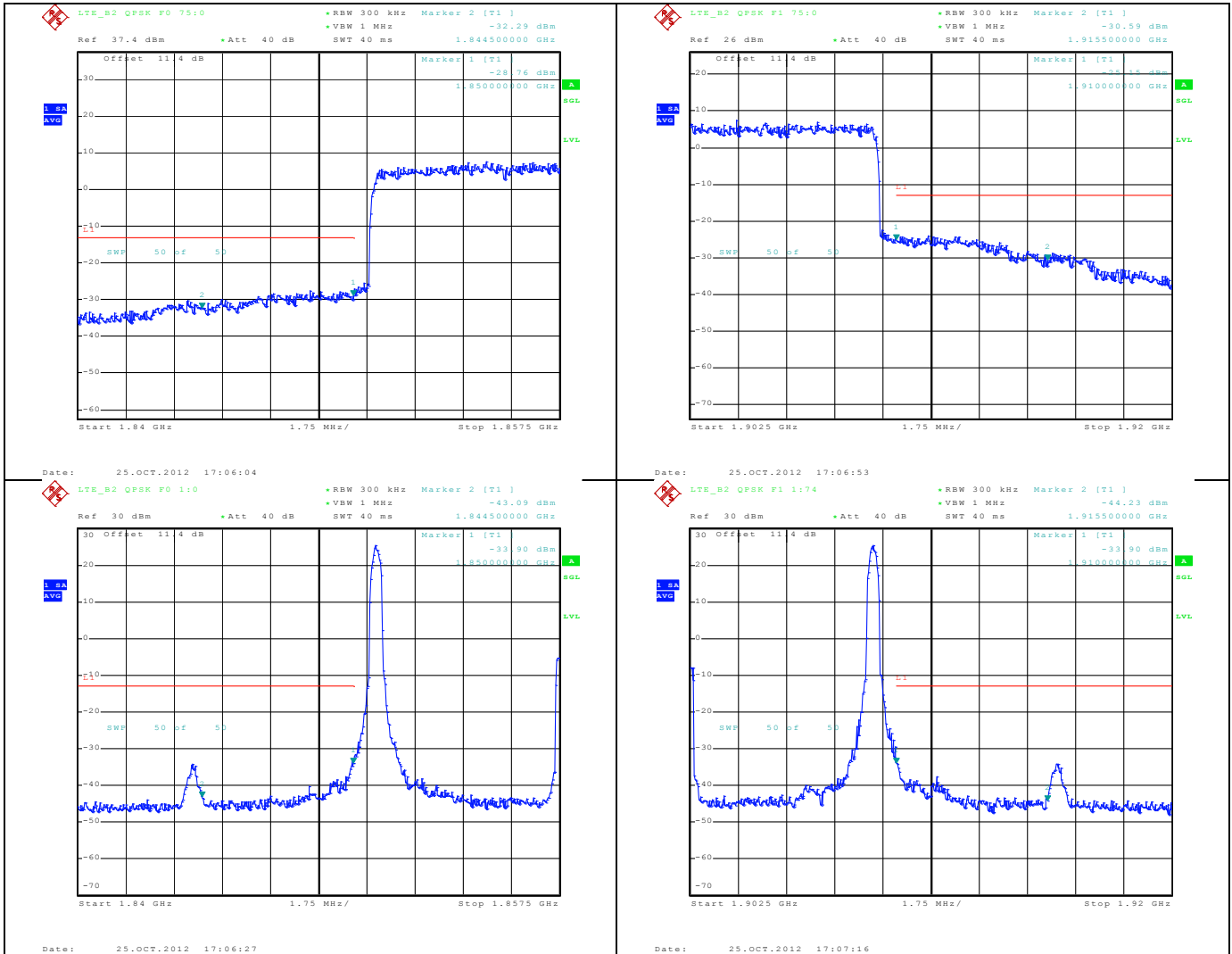

9.2.1.4 LTE; Band2, 20 MHz BW, QPSK

Below 1850 MHz	Above 1910 MHz
----------------	----------------

SIERRA WIRELESS, INC.

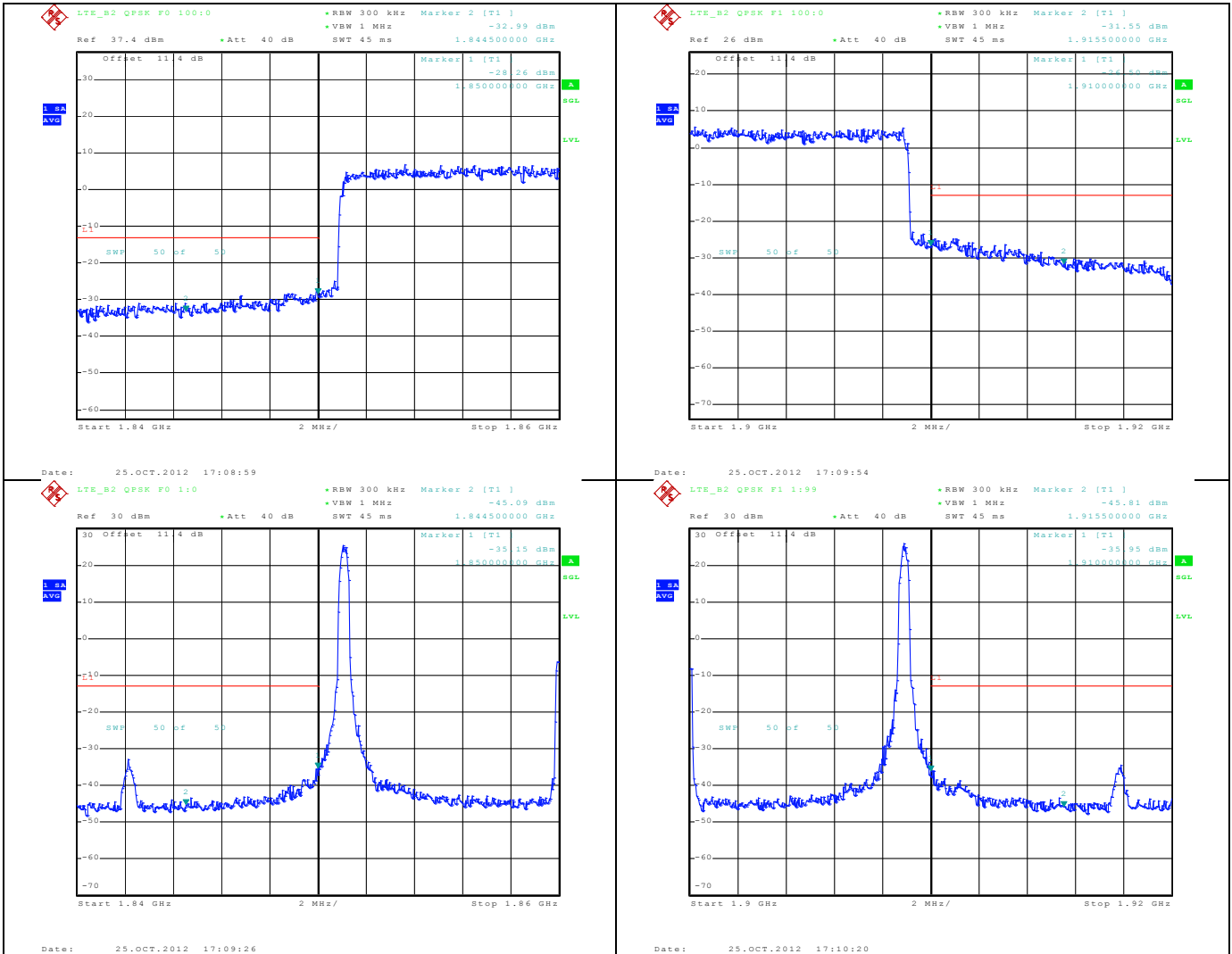

LTE B4

9.2.1.5 LTE; Band4, 5 MHz BW, QPSK

Below 1710 MHz	Above 1755 MHz
-----------------------	-----------------------

SIERRA WIRELESS, INC.

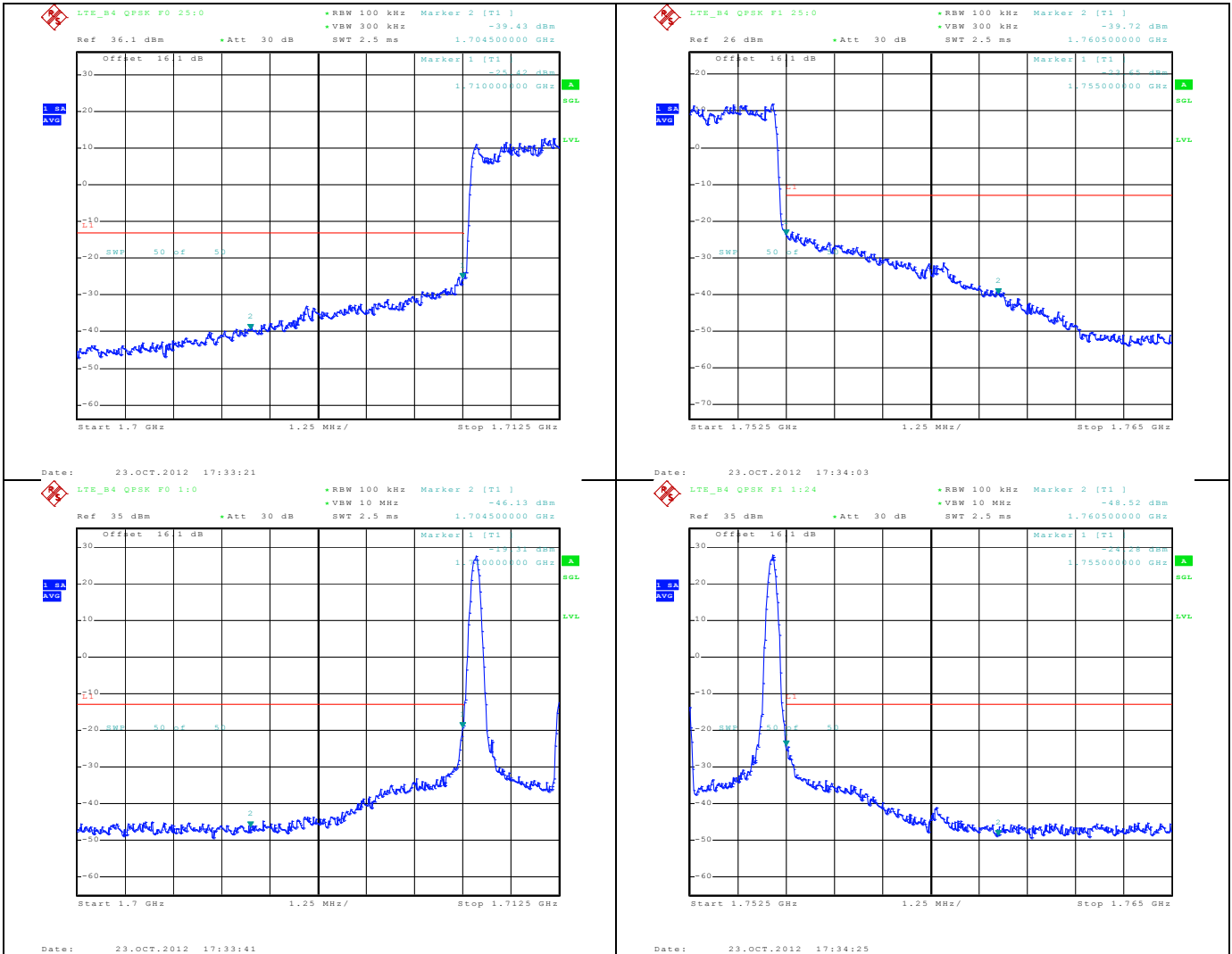

9.2.1.6 LTE; Band4, 10 MHz BW, QPSK

Below 1710 MHz	Above 1755 MHz
-----------------------	-----------------------

SIERRA WIRELESS, INC.

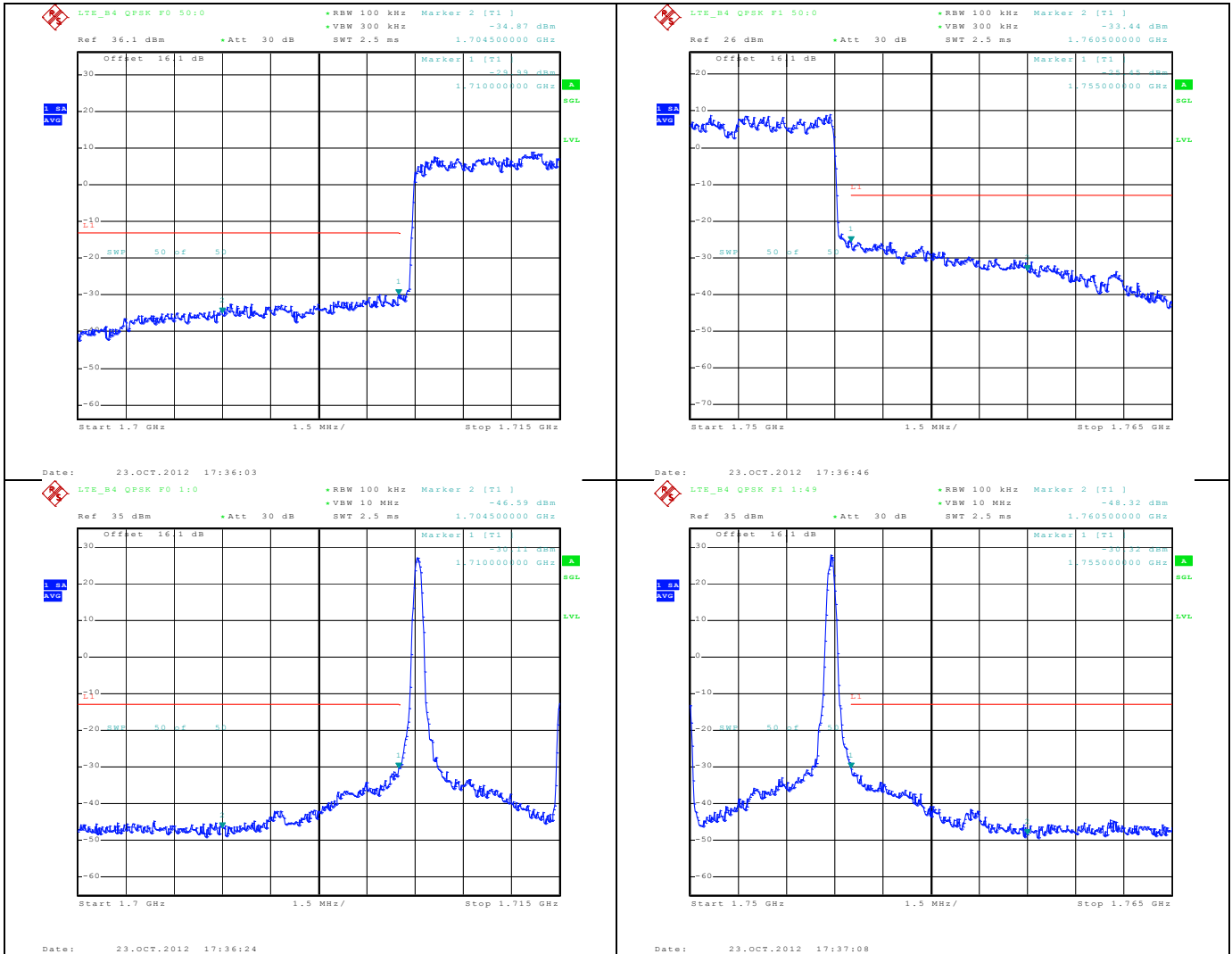

9.2.1.7 LTE; Band4, 15 MHz BW, QPSK

Below 1710 MHz	Above 1755 MHz
----------------	----------------

SIERRA WIRELESS, INC.

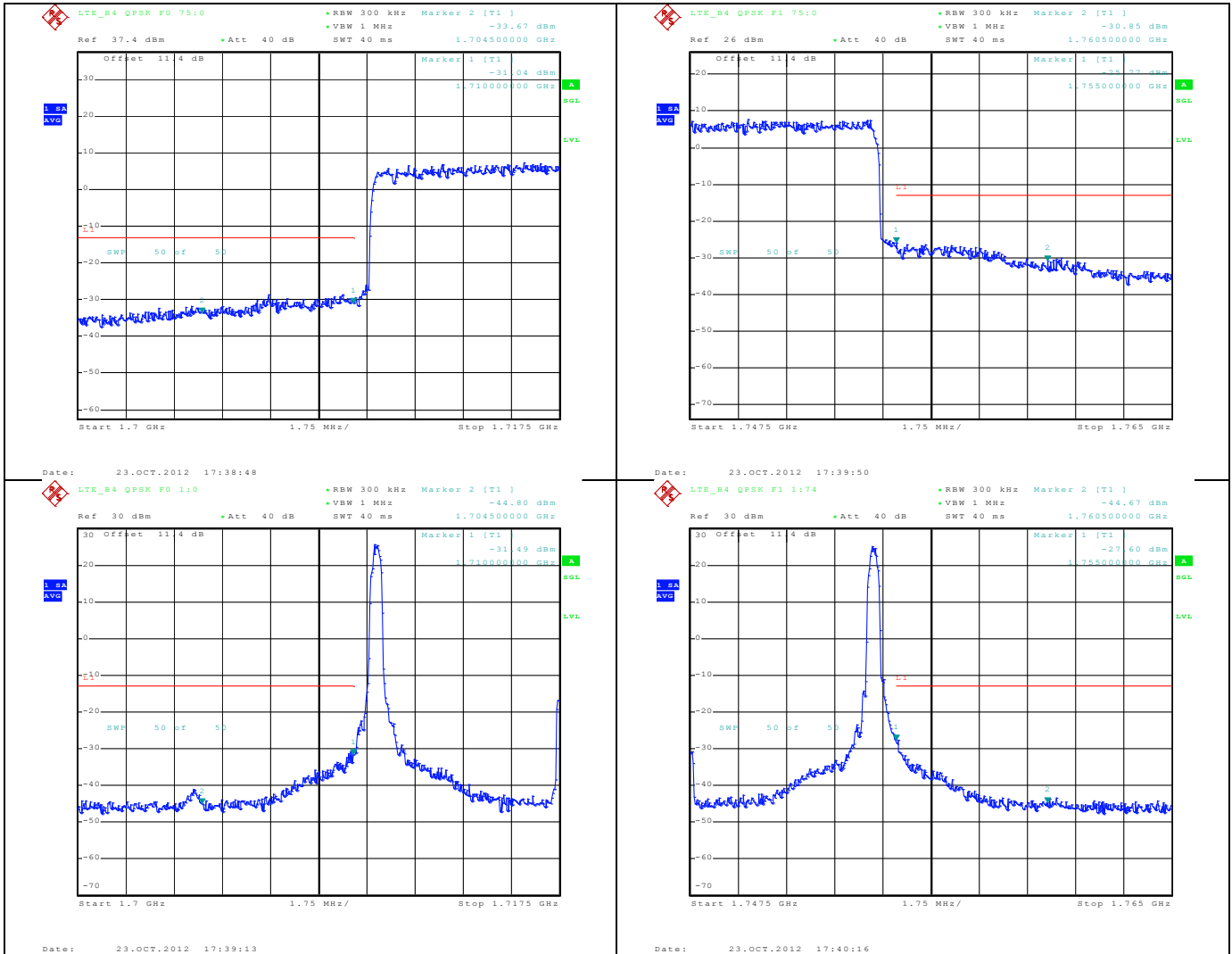

9.2.1.8 LTE; Band4, 20 MHz BW, QPSK

Below 1710 MHz	Above 1755 MHz
-----------------------	-----------------------

SIERRA WIRELESS, INC.

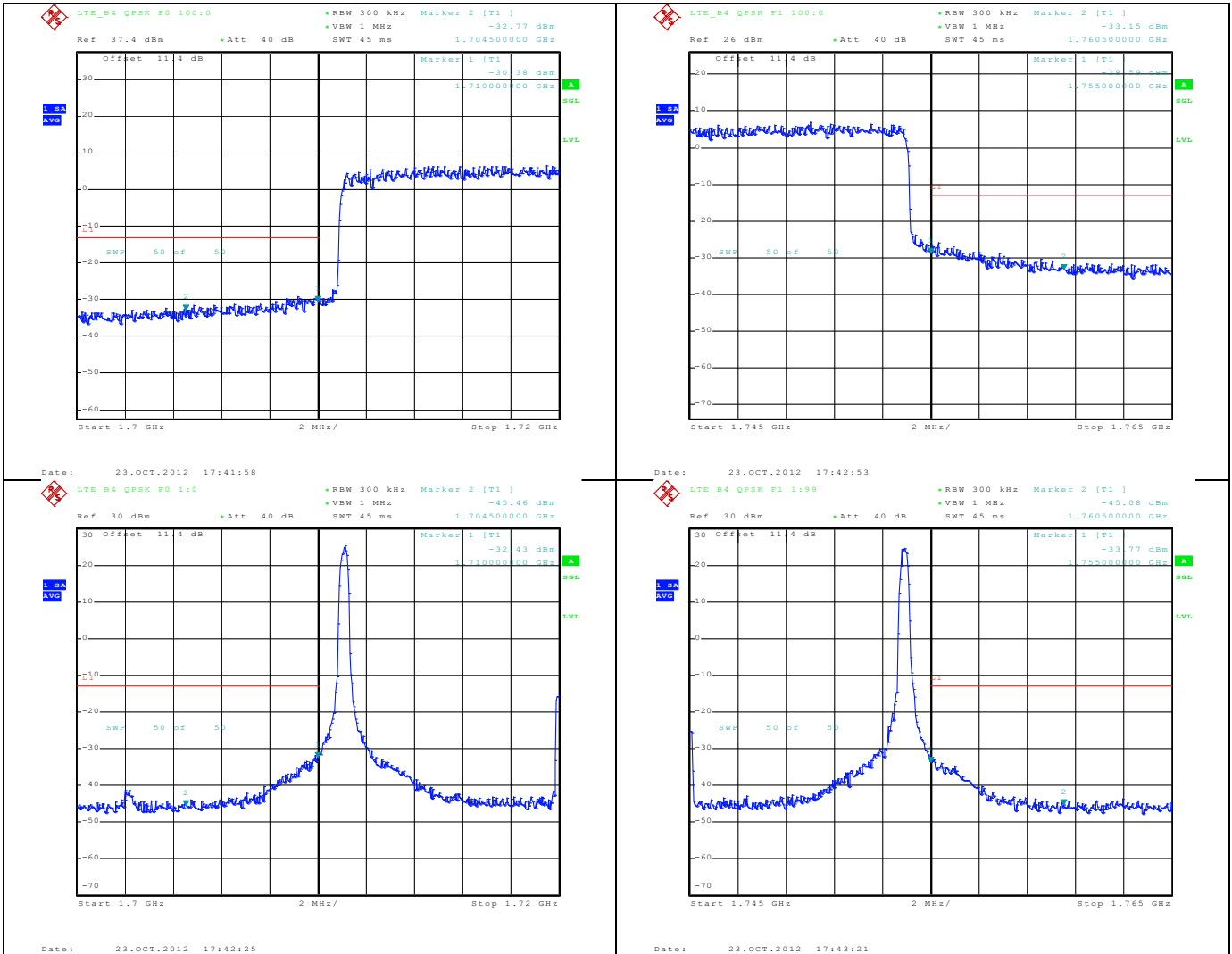

LTE B5

9.2.1.9 LTE; Band5, 5 MHz BW, QPSK

Below 824 MHz	Above 849 MHz
----------------------	----------------------

SIERRA WIRELESS, INC.

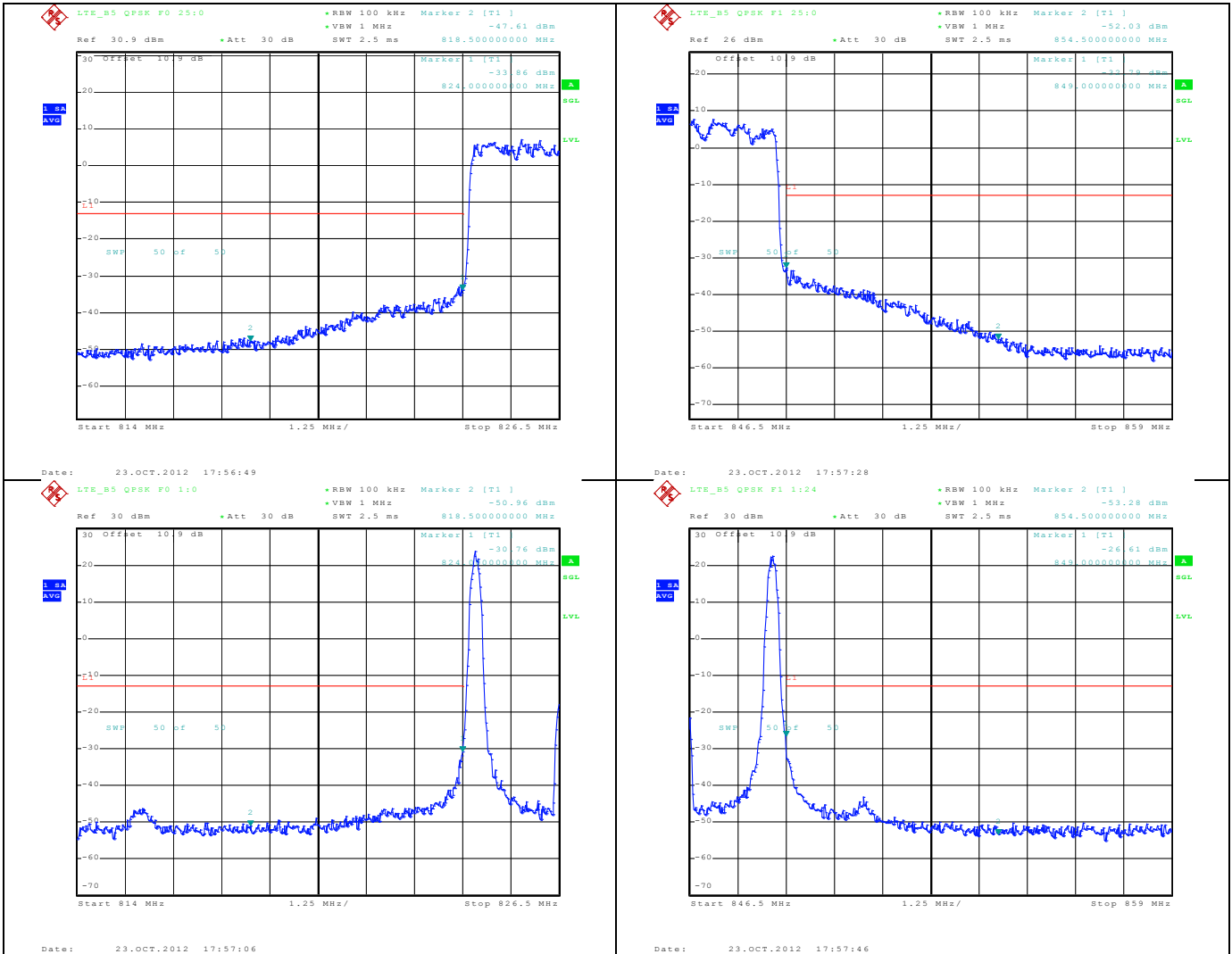

9.2.1.10 LTE; Band5, 10 MHz BW, QPSK

Below 824 MHz	Above 849 MHz
---------------	---------------

SIERRA WIRELESS, INC.

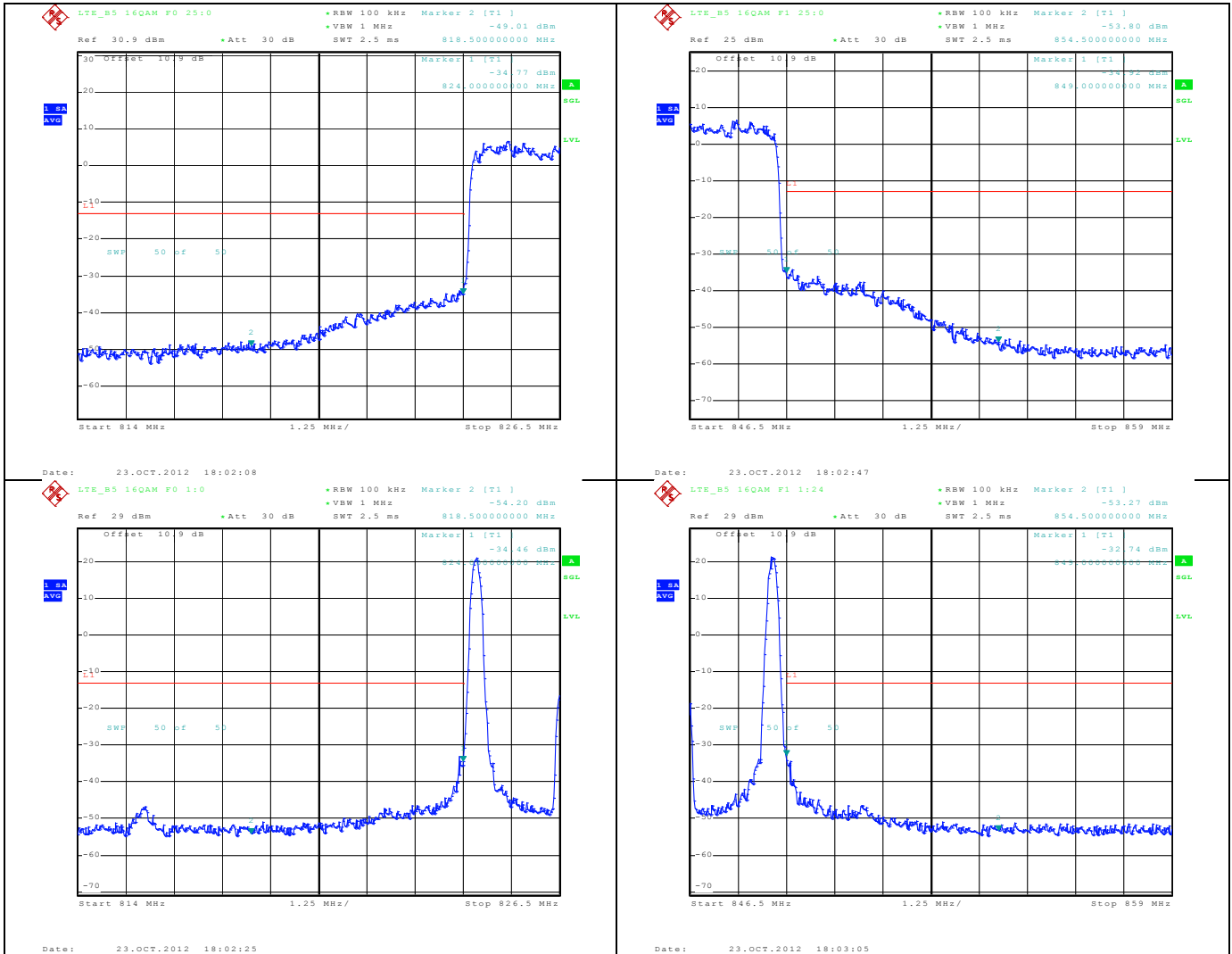

LTE B13

9.2.1.11 LTE; Band13, 5 MHz BW, QPSK

Below 777 MHz	Above 787 MHz
----------------------	----------------------

SIERRA WIRELESS, INC.

FCC Part 22/24/27, RSS-132/133/139

EM7355

Feb. 05, 2013

Page 76 of 111

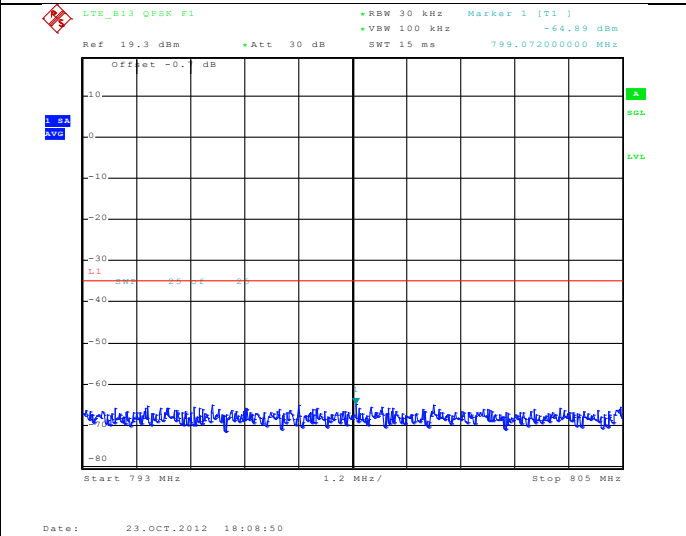
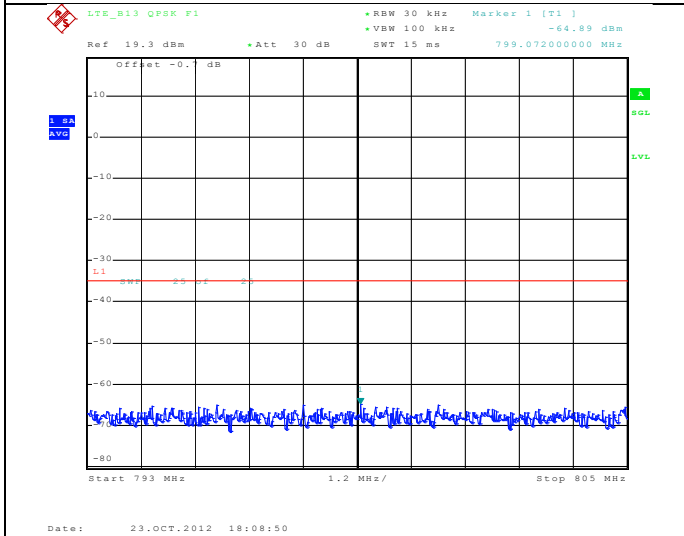
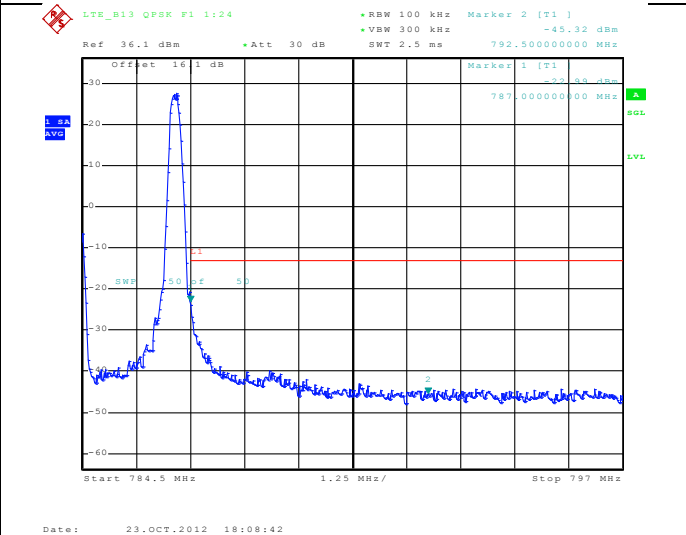
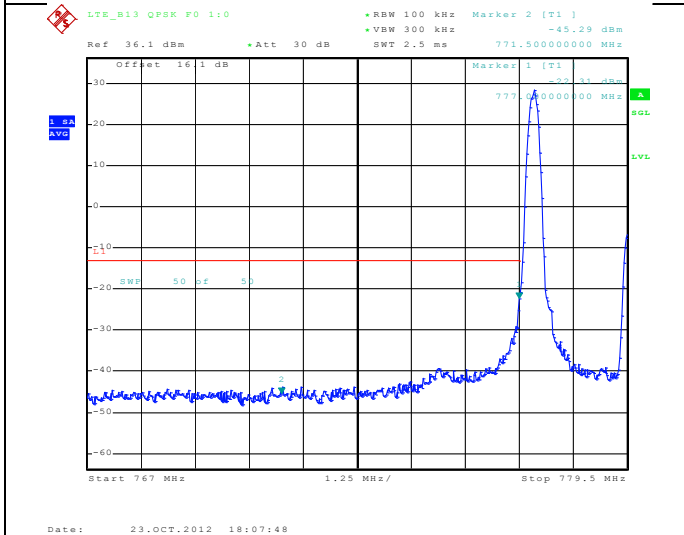
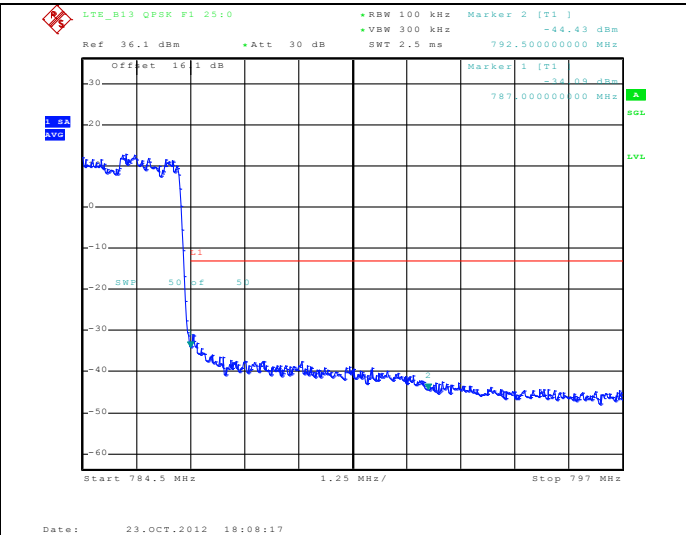
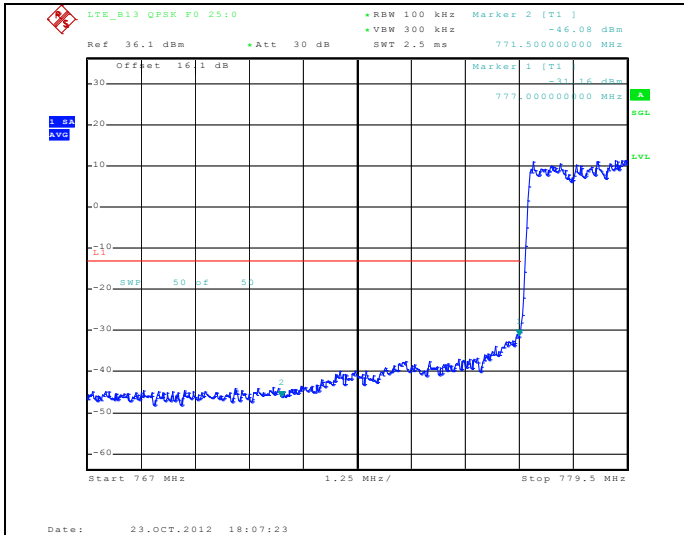

SIERRA WIRELESS, INC.

9.2.1.12 LTE; Band13, 10 MHz BW, QPSK

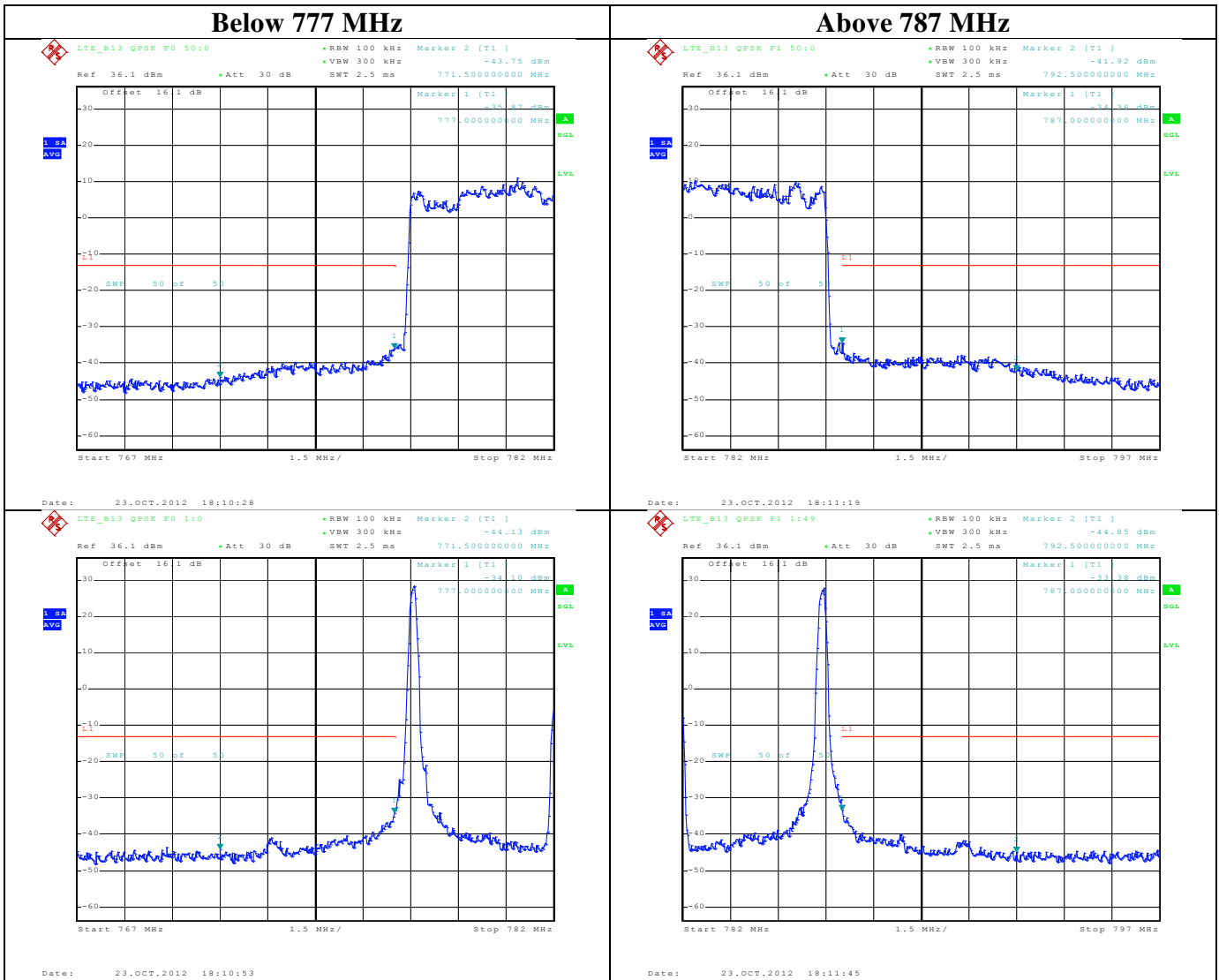

SIERRA WIRELESS, INC.

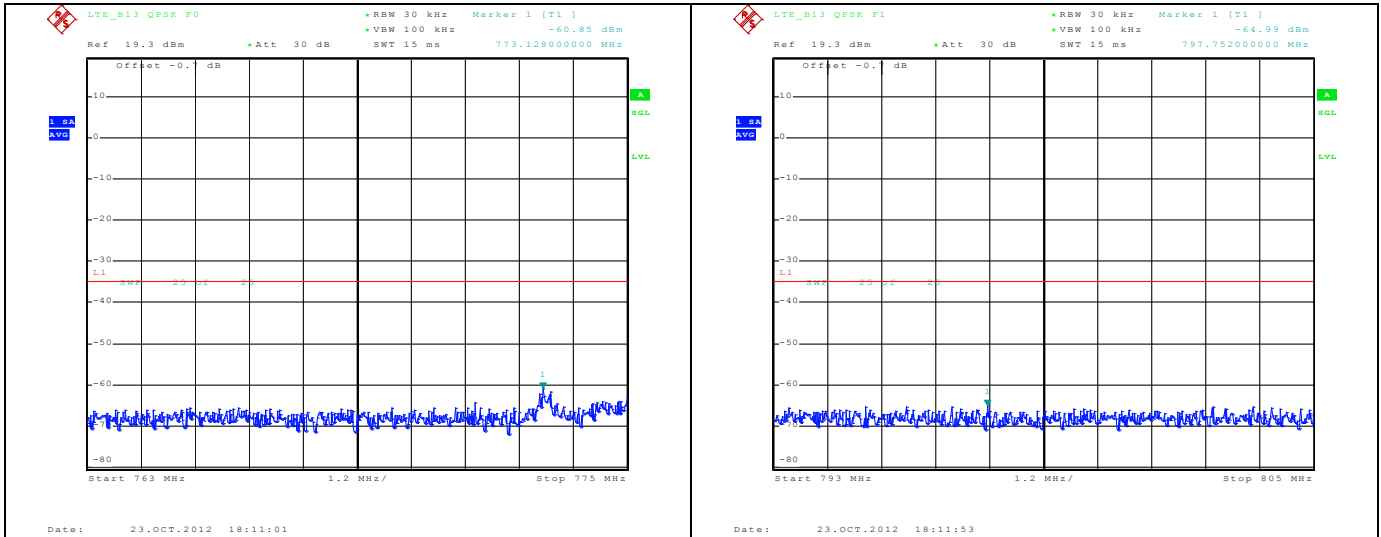

LTE B17

9.2.1.13 LTE; Band17, 5 MHz BW, QPSK

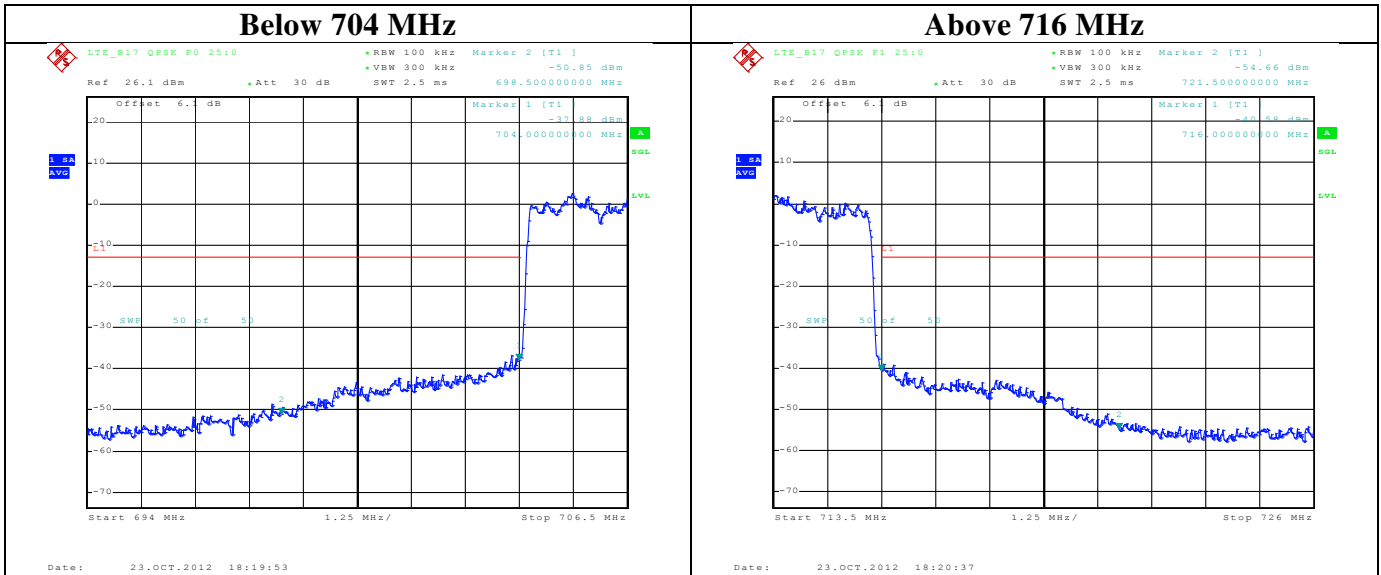

SIERRA WIRELESS, INC.

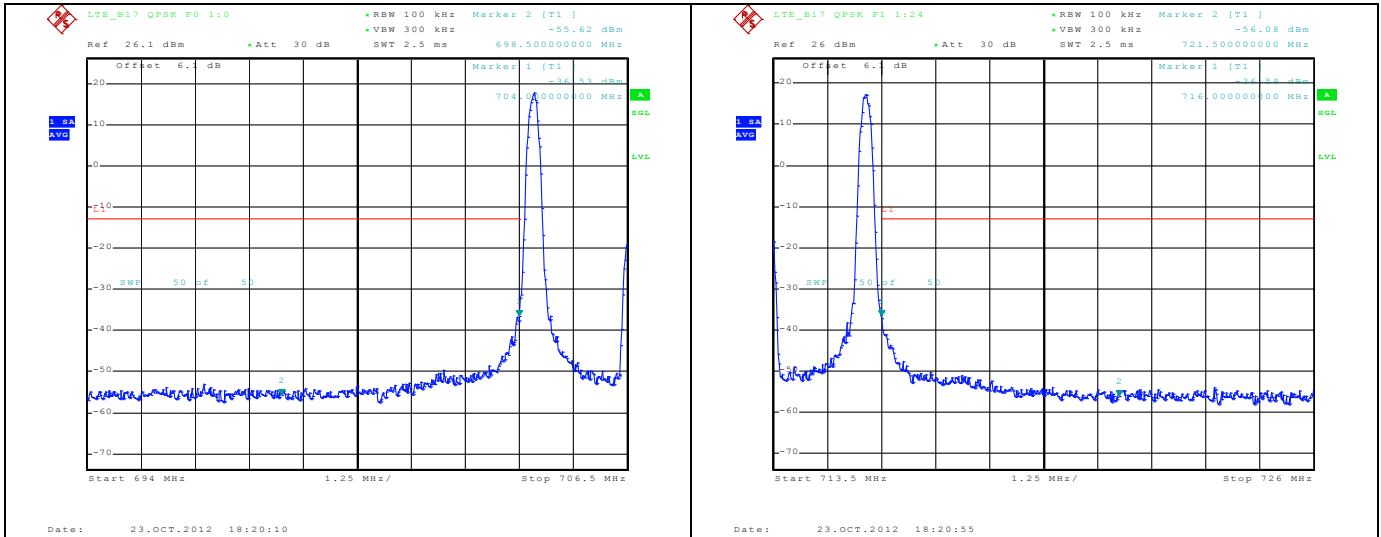

9.2.1.14 LTE; Band17, 10 MHz BW, QPSK

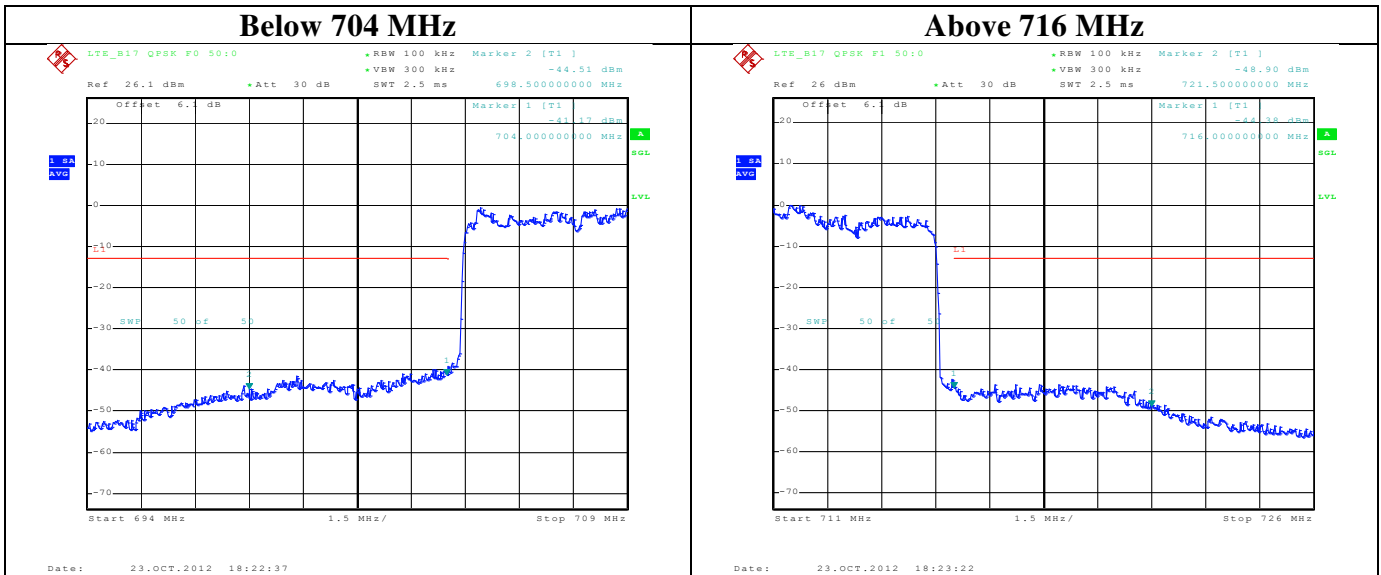

SIERRA WIRELESS, INC.

FCC Part 22/24/27, RSS-132/133/139

EM7355

Feb. 05, 2013

Page 80 of 111

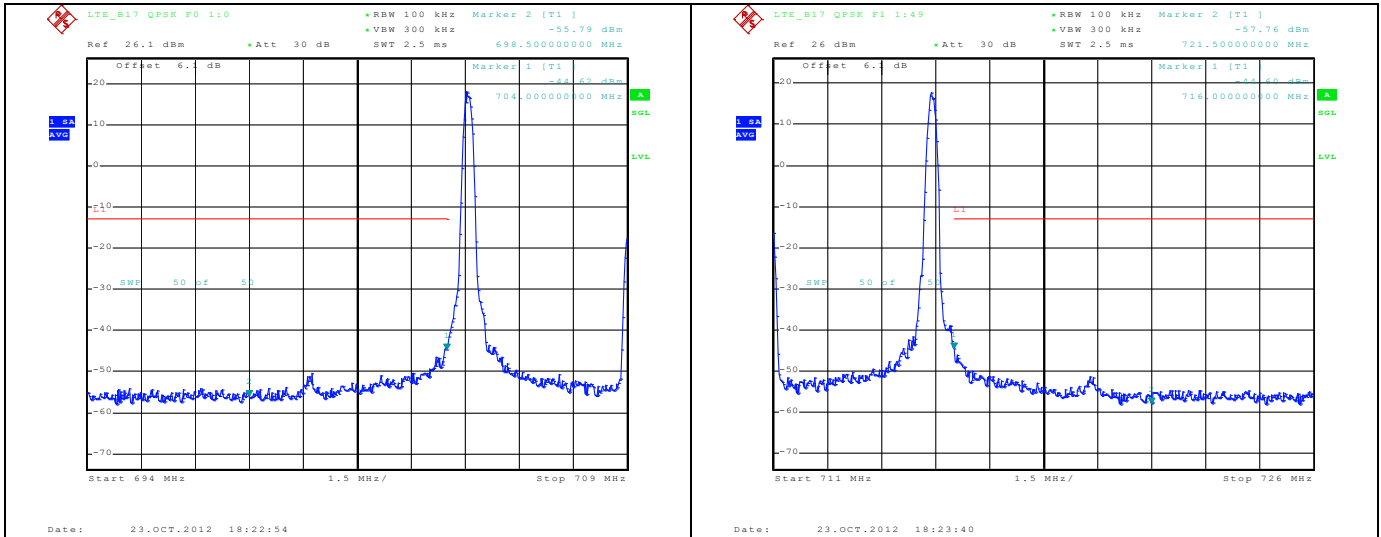

LTE B25

9.2.1.15 LTE; Band25, 5 MHz BW, QPSK

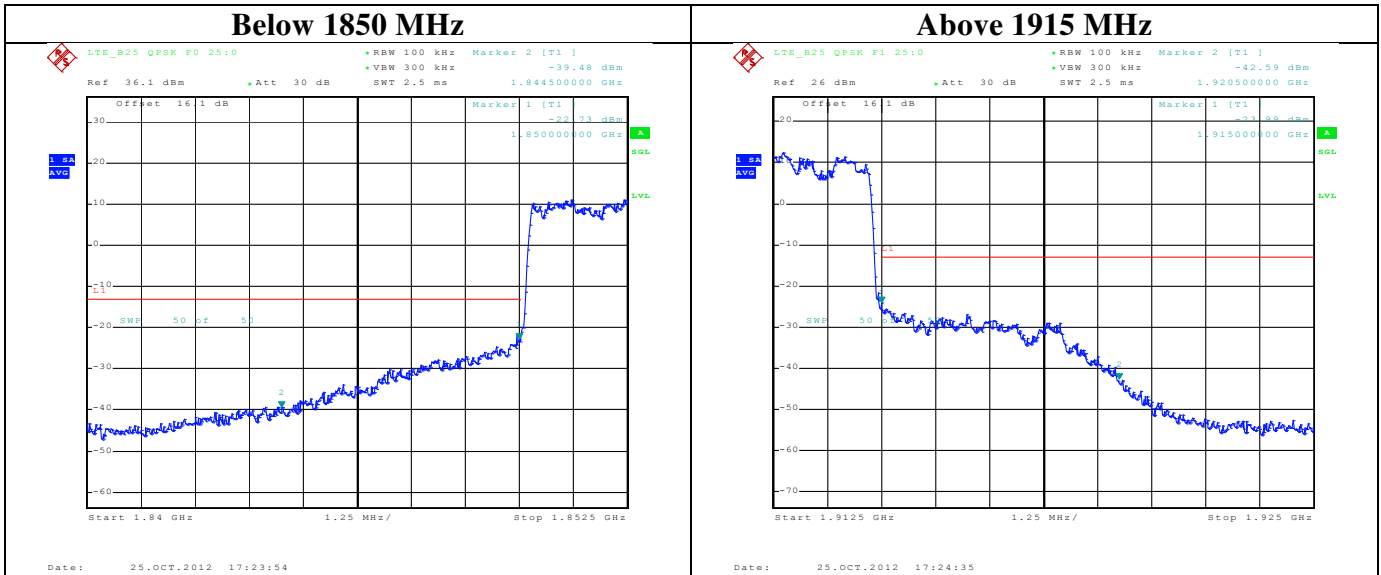

SIERRA WIRELESS, INC.

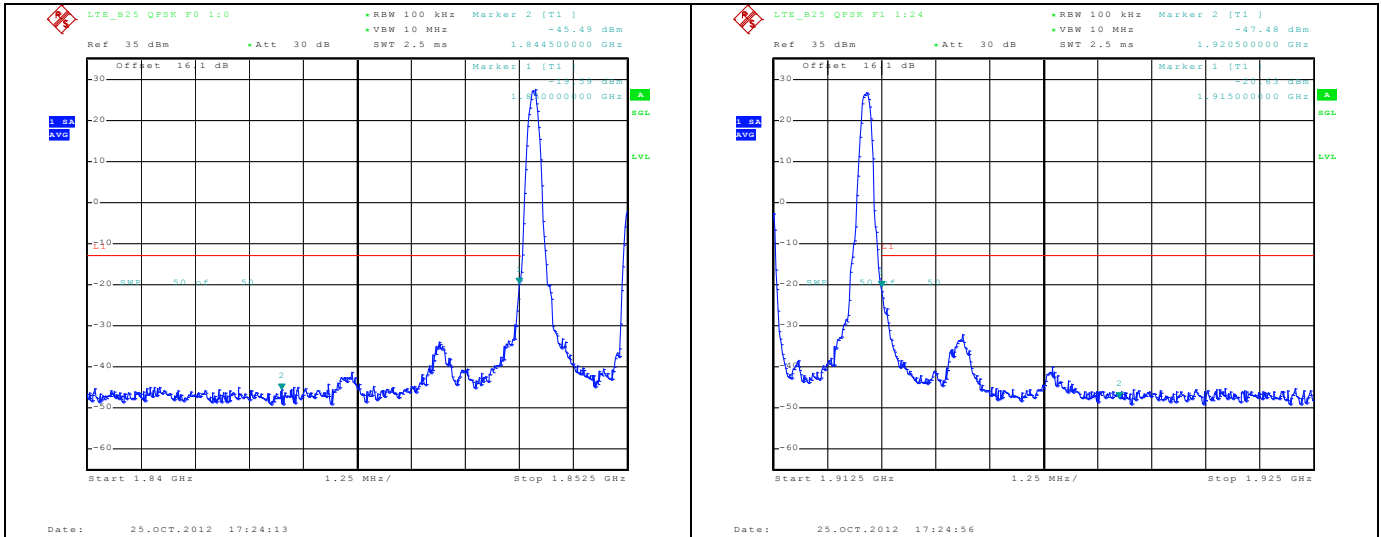

9.2.1.16 LTE; Band25, 10 MHz BW, QPSK

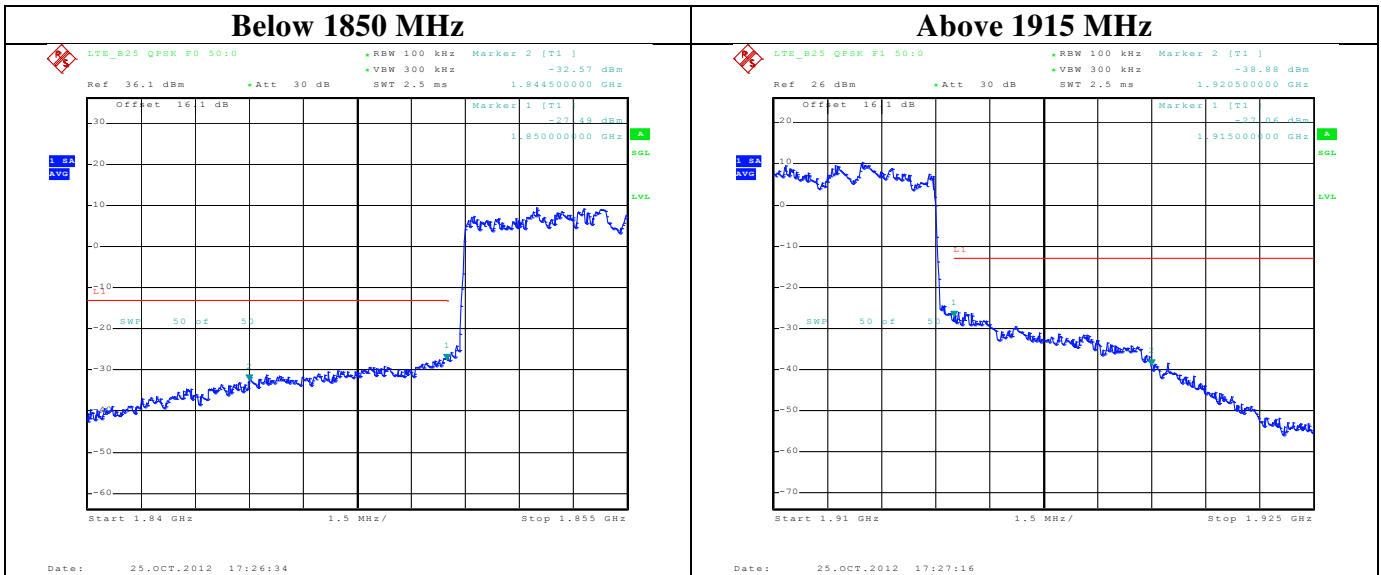

SIERRA WIRELESS, INC.

FCC Part 22/24/27, RSS-132/133/139

EM7355

Feb. 05, 2013

Page 82 of 111

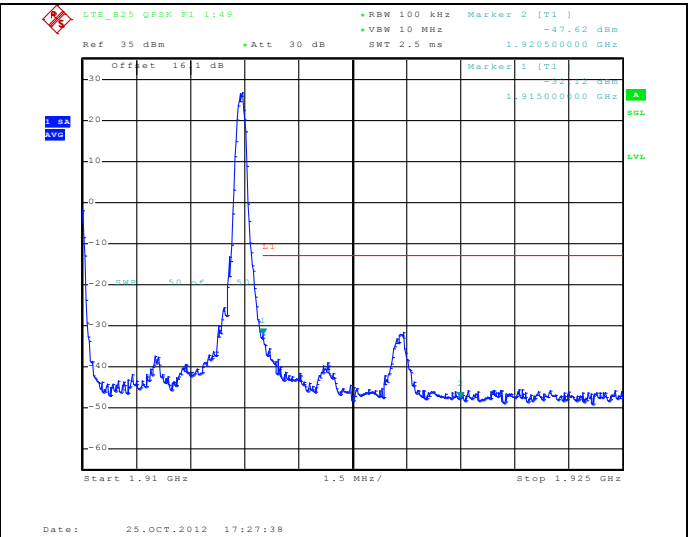
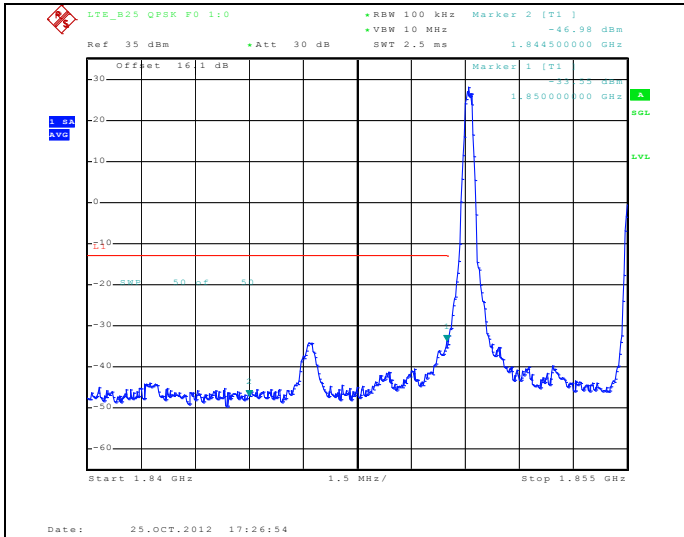

9.2.1.17 LTE; Band25, 15 MHz BW, QPSK

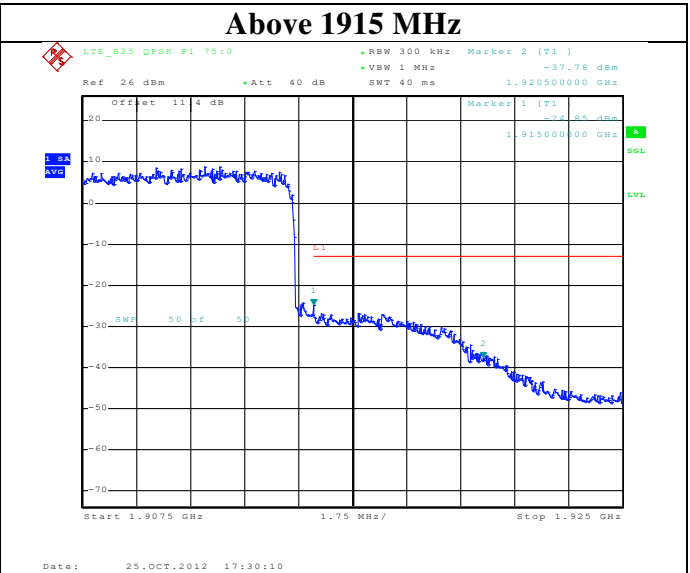
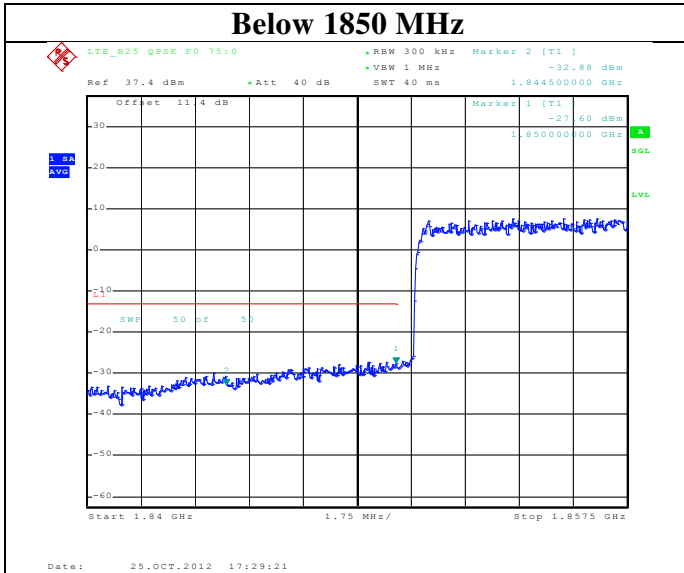

SIERRA WIRELESS, INC.

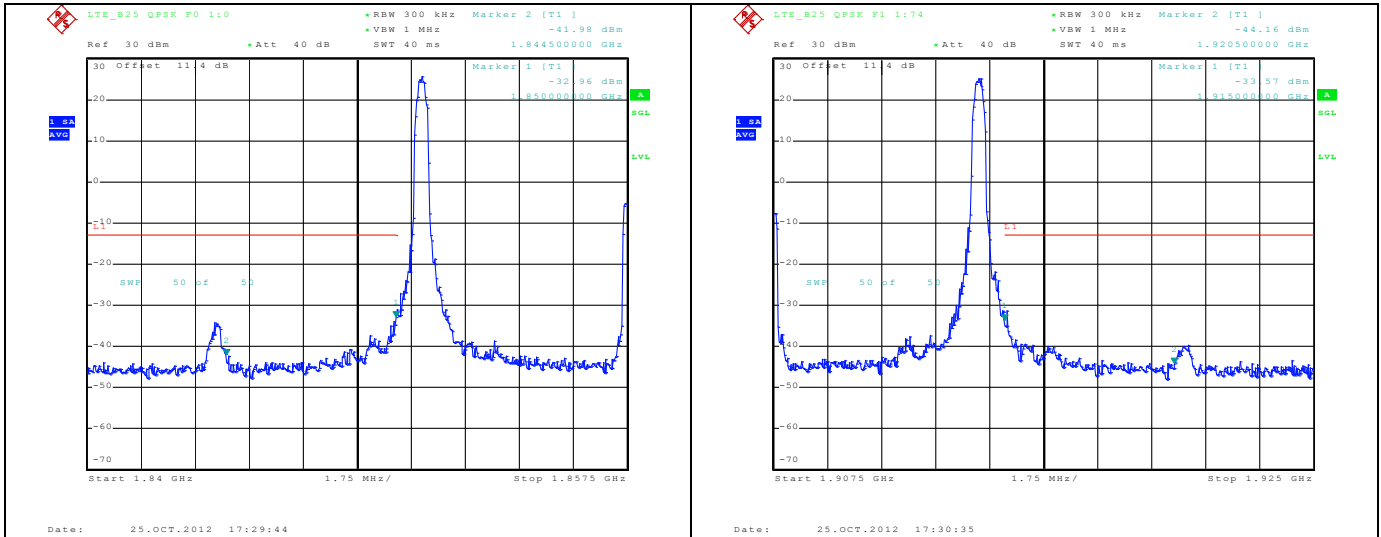

9.2.1.18 LTE; Band25, 20 MHz BW, QPSK

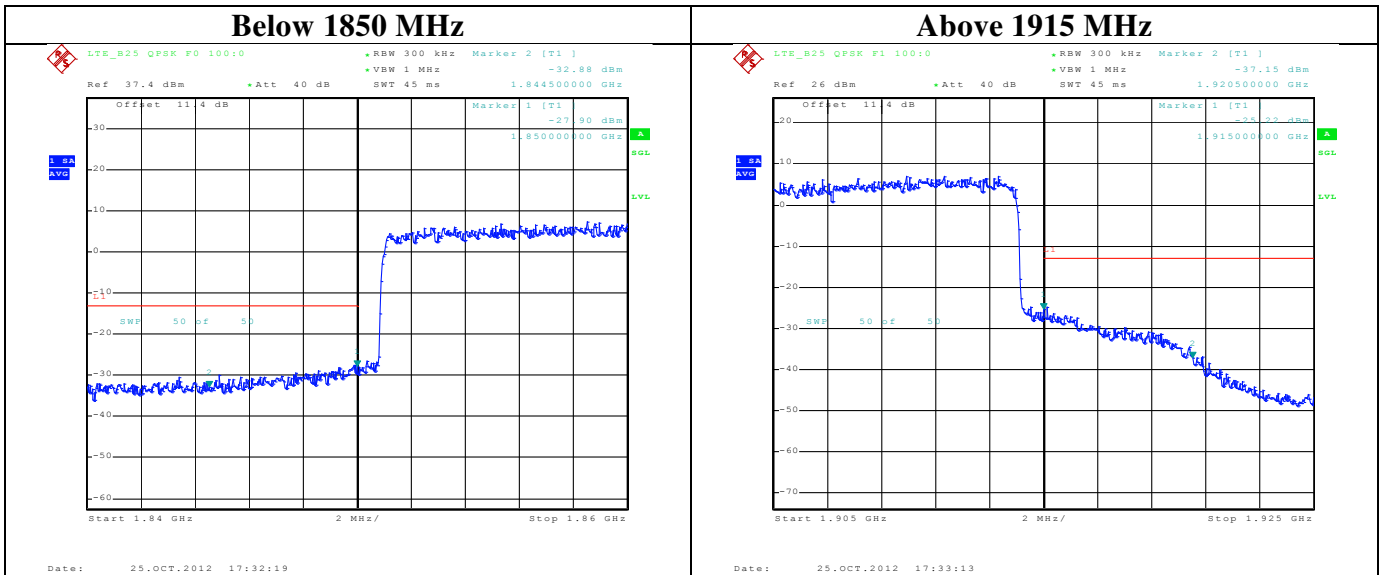

SIERRA WIRELESS, INC.

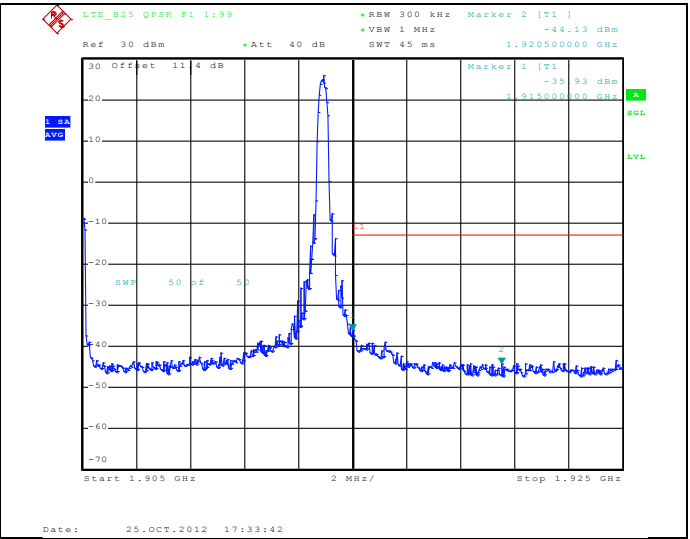
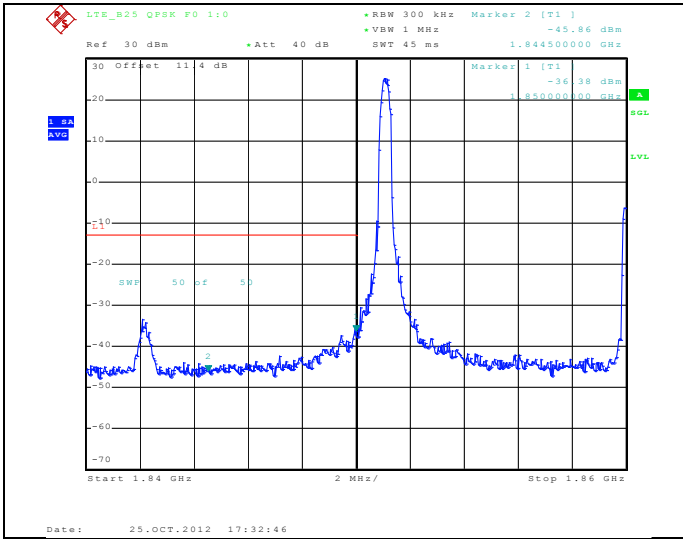

LTE B2

9.2.1.19 LTE; Band2, 5 MHz BW, 16-QAM

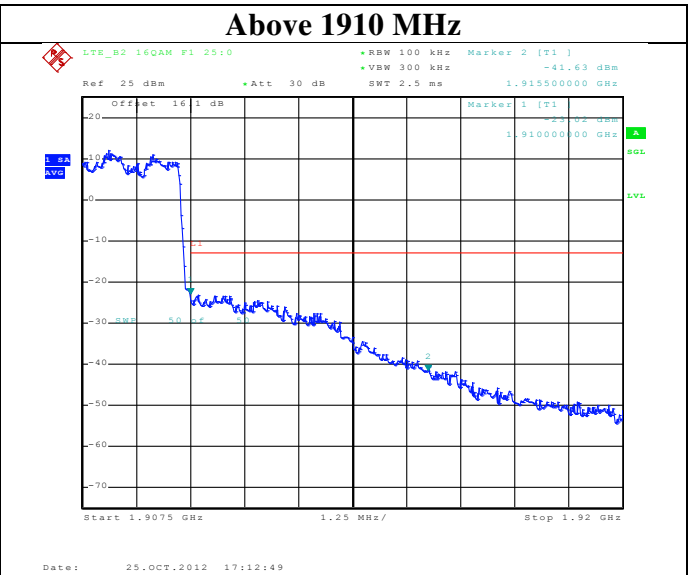
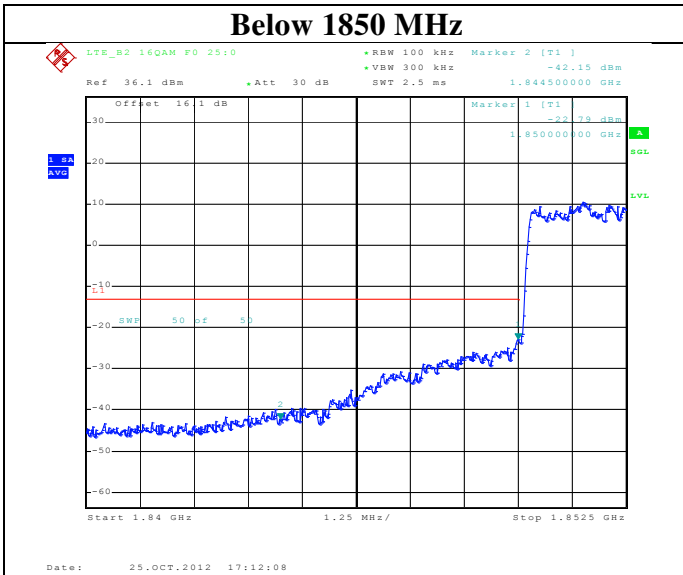

SIERRA WIRELESS, INC.

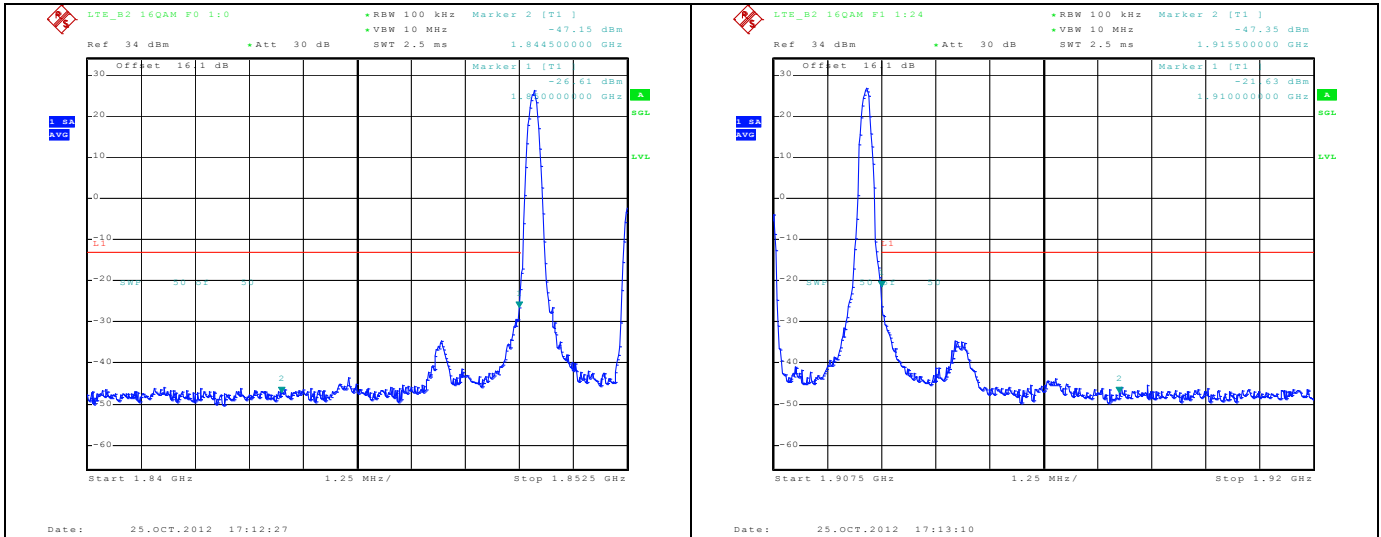

9.2.1.20 LTE; Band2, 10 MHz BW, 16-QAM

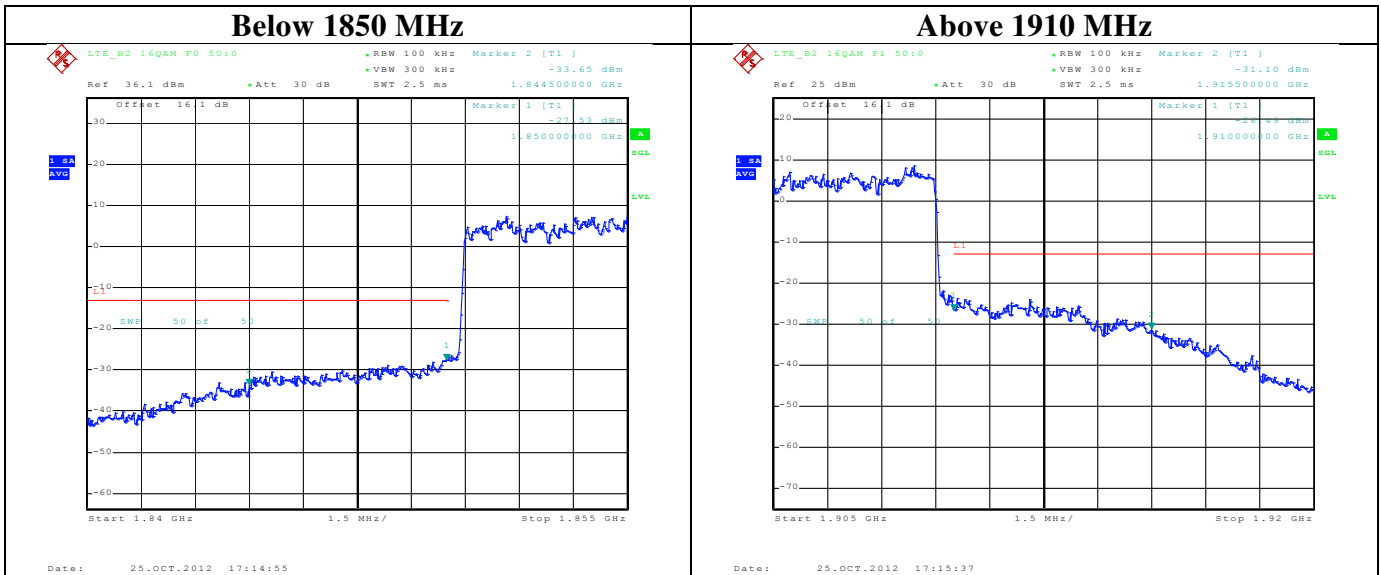

SIERRA WIRELESS, INC.

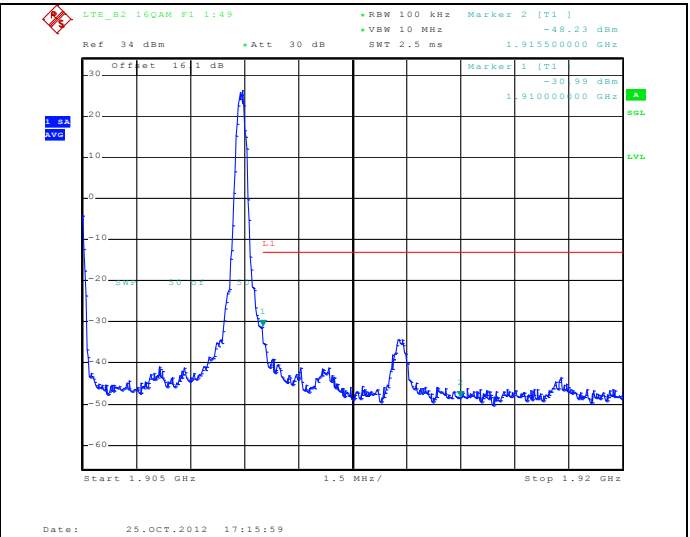
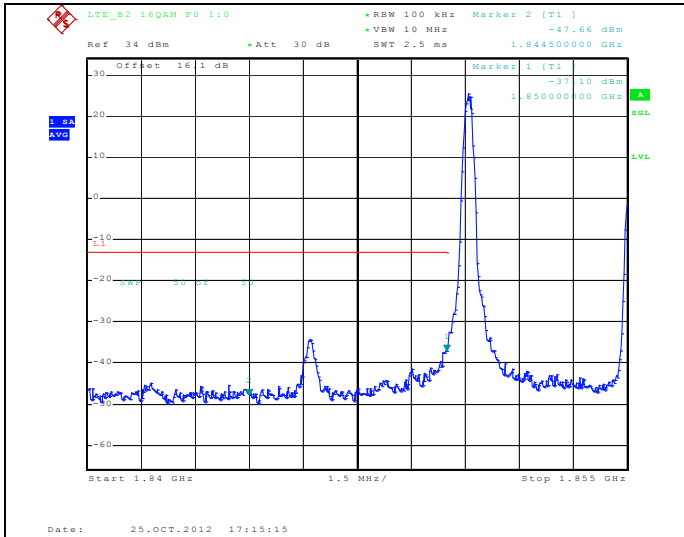

9.2.1.21 LTE; Band2, 15 MHz BW, 16-QAM

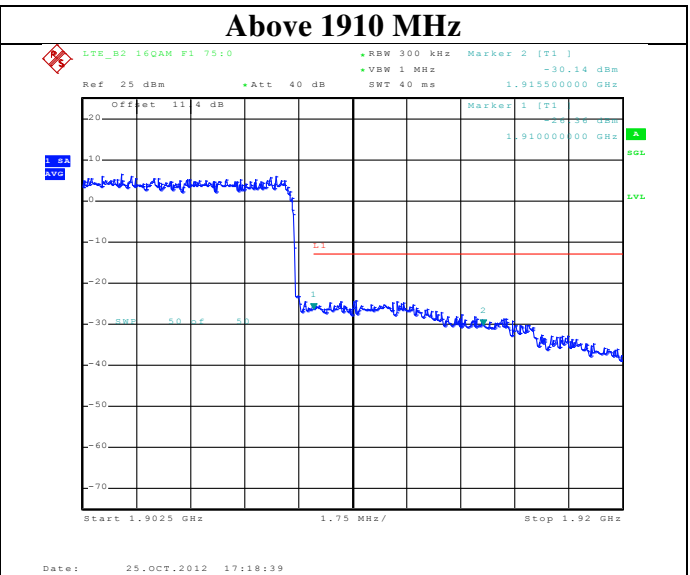
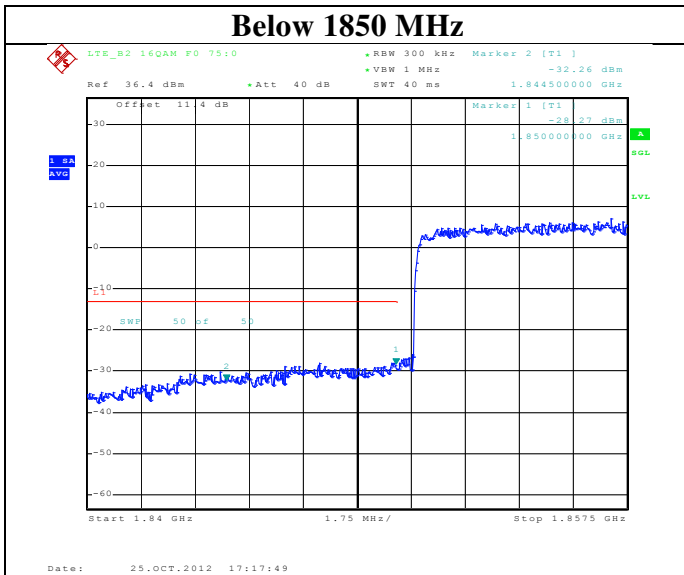

SIERRA WIRELESS, INC.

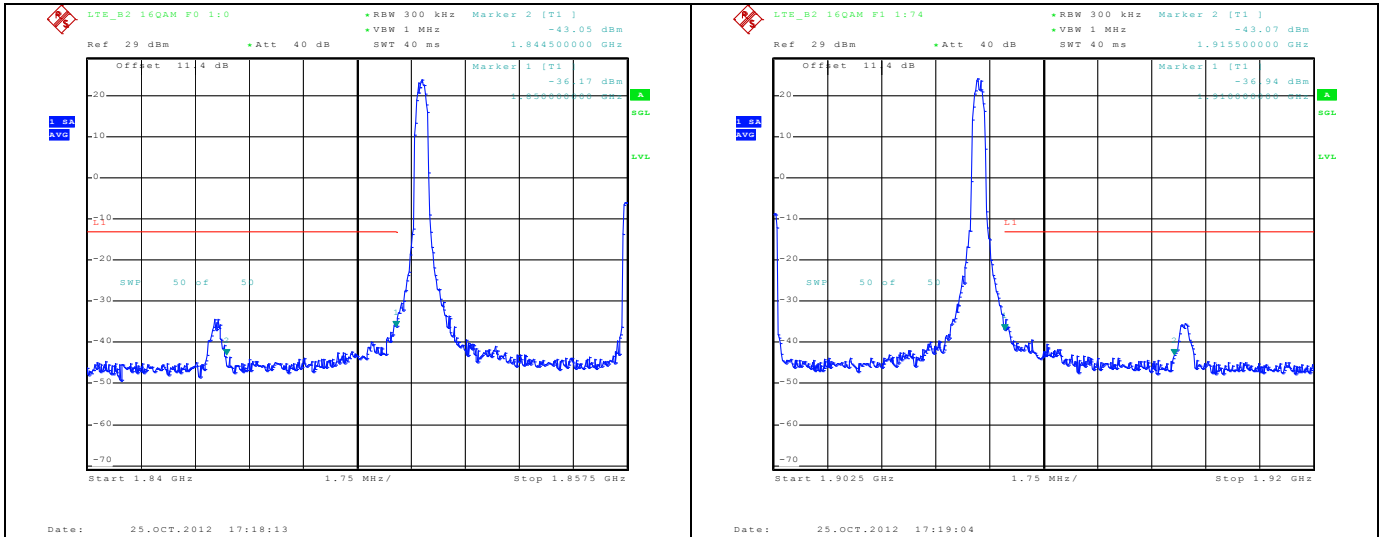

9.2.1.22 LTE; Band2, 20 MHz BW, 16-QAM

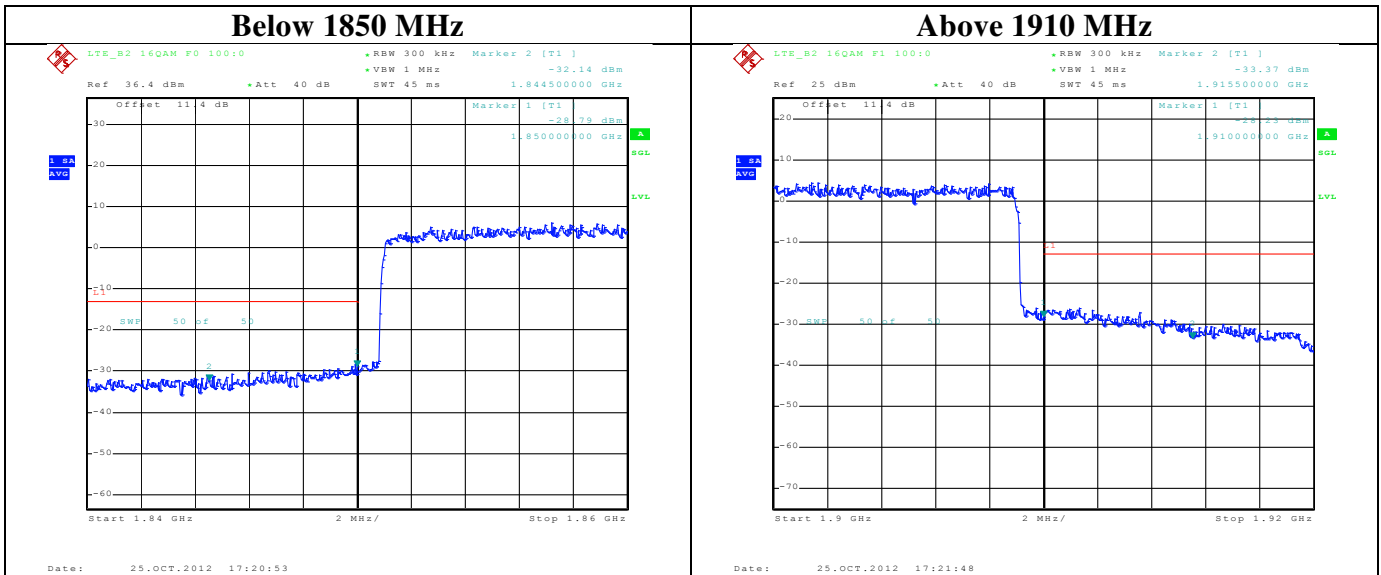

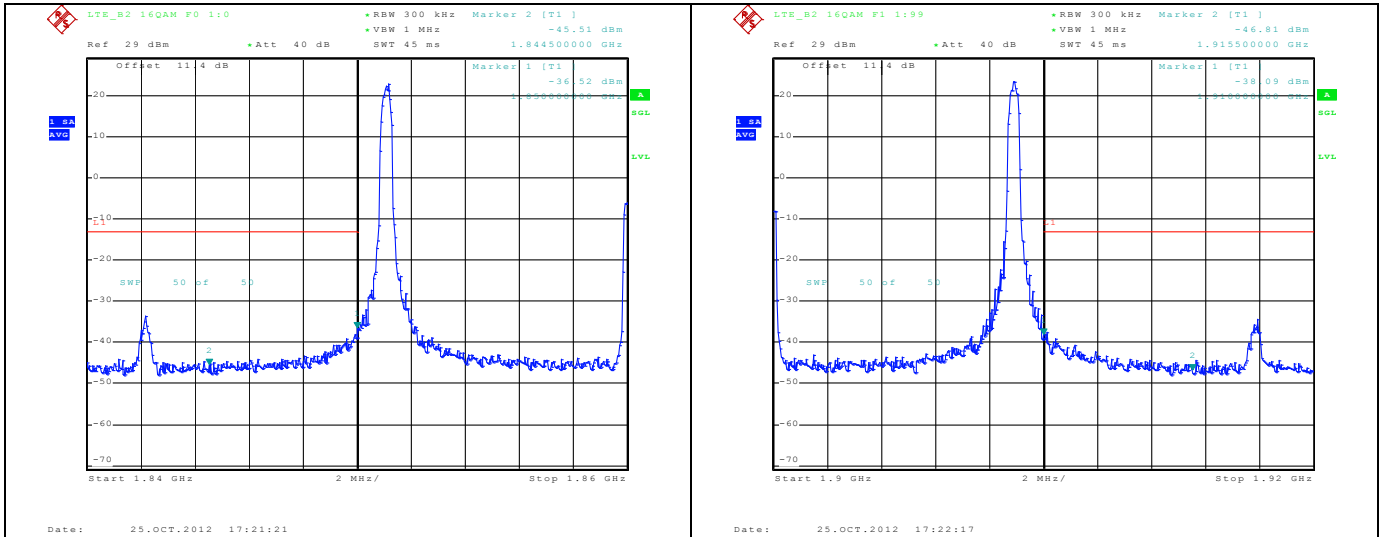

LTE B4

9.2.1.23 LTE; Band4, 5 MHz BW, 16-QAM

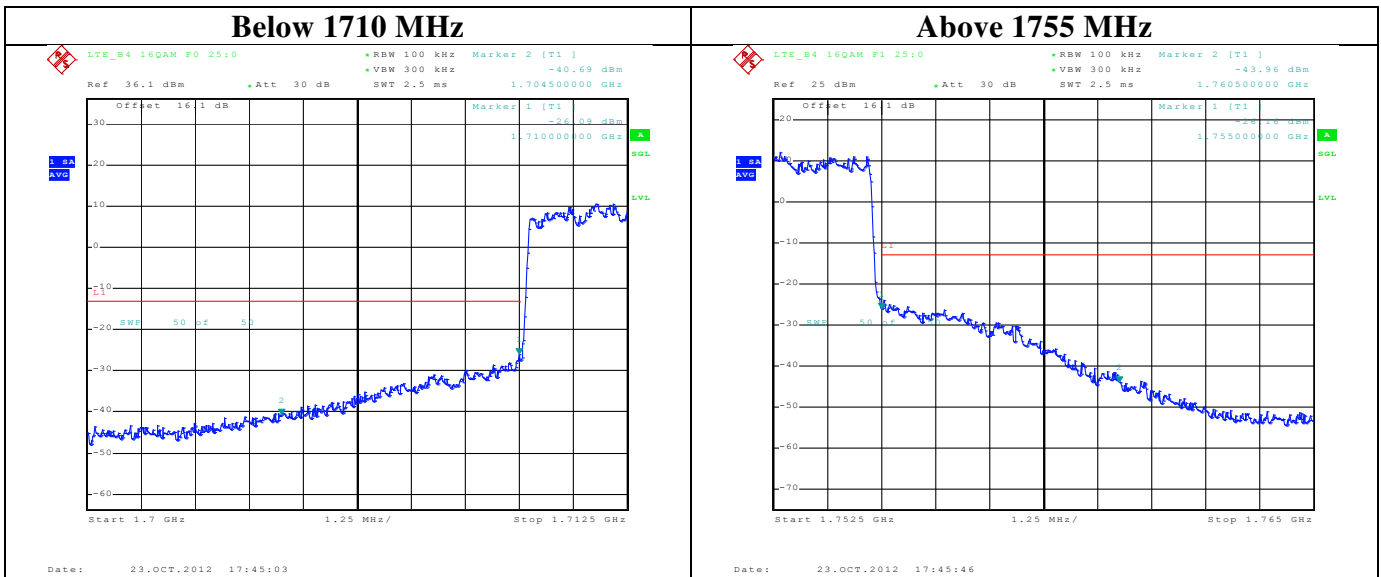

SIERRA WIRELESS, INC.

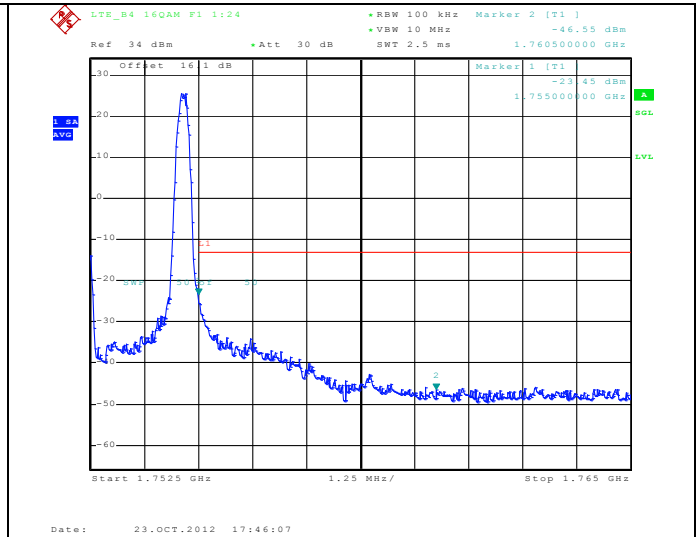
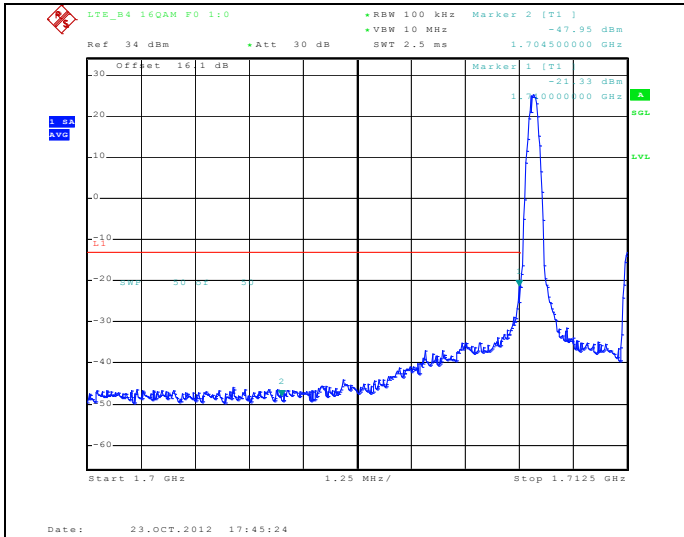

9.2.1.24 LTE; Band4, 10 MHz BW, 16-QAM

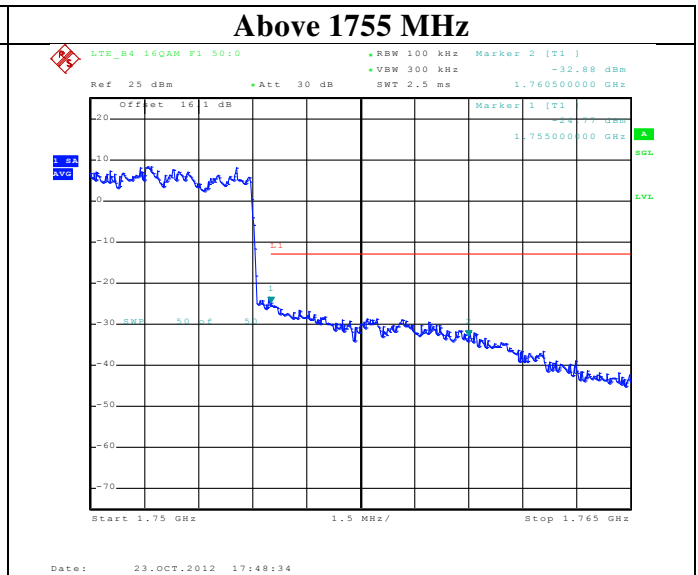
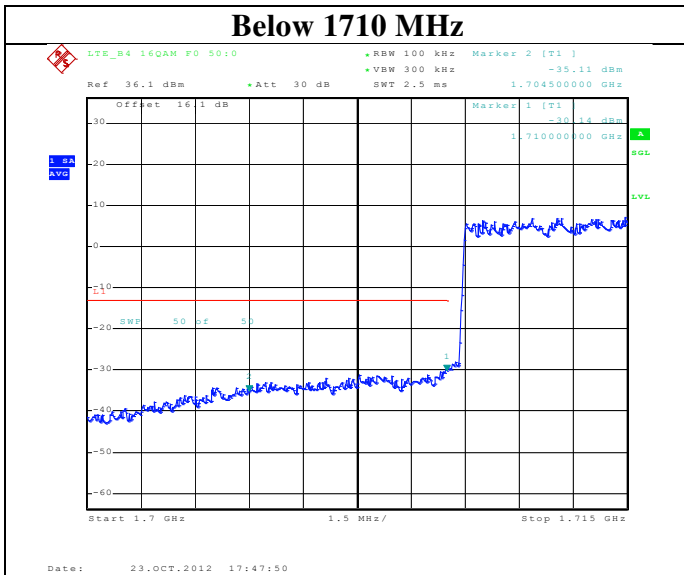

SIERRA WIRELESS, INC.

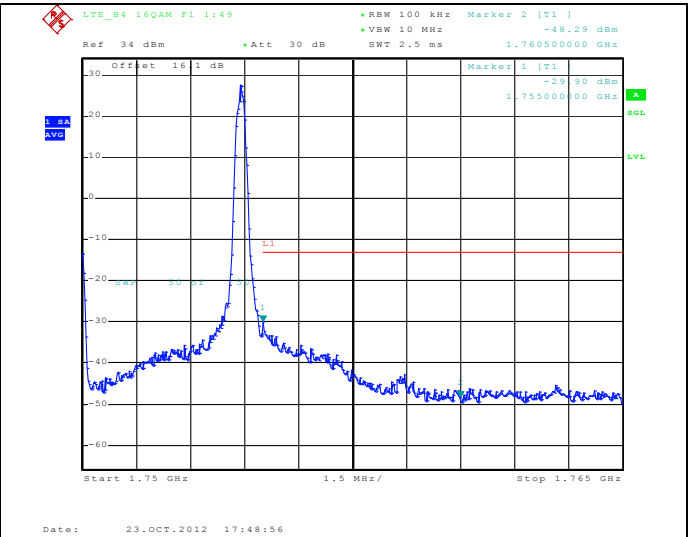
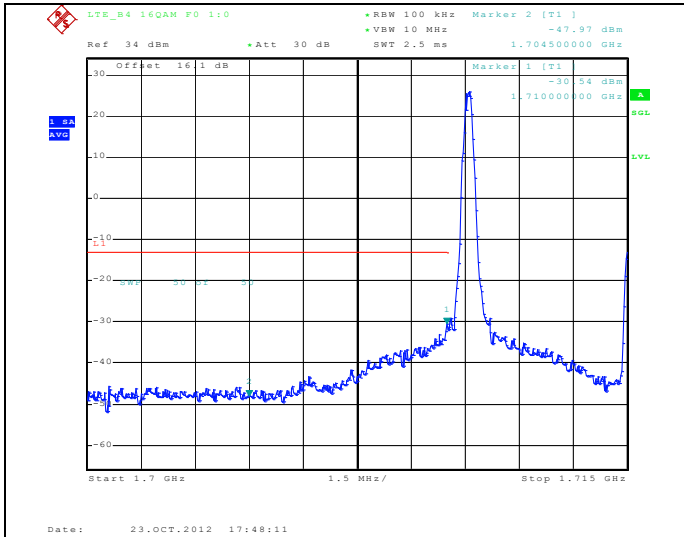

9.2.1.25 LTE; Band4, 15 MHz BW, 16-QAM

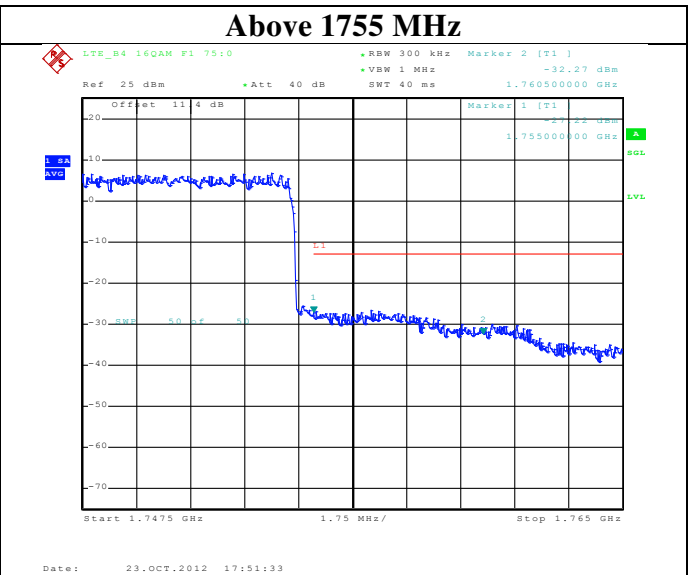
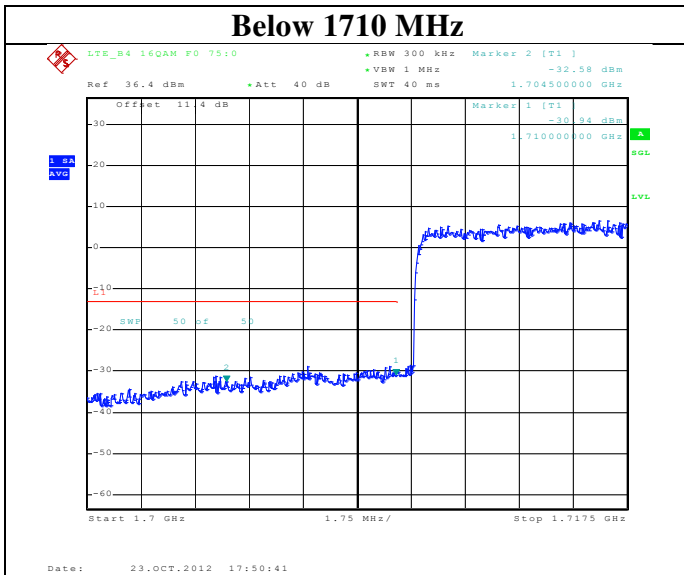

SIERRA WIRELESS, INC.

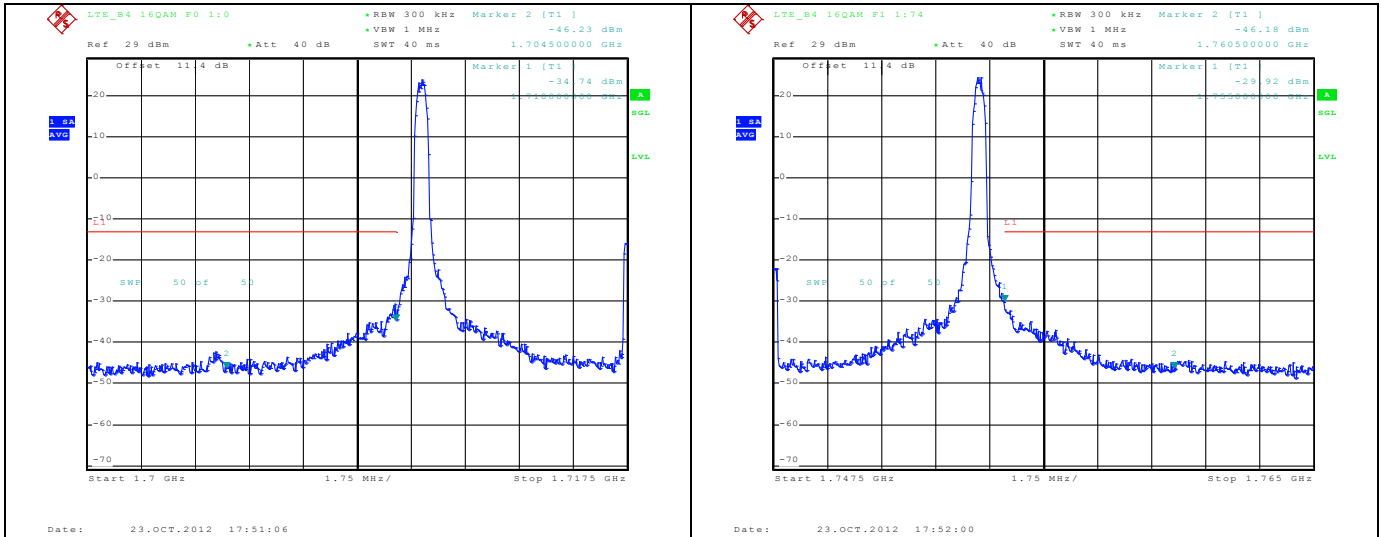

9.2.1.26 LTE; Band4, 20 MHz BW, 16-QAM

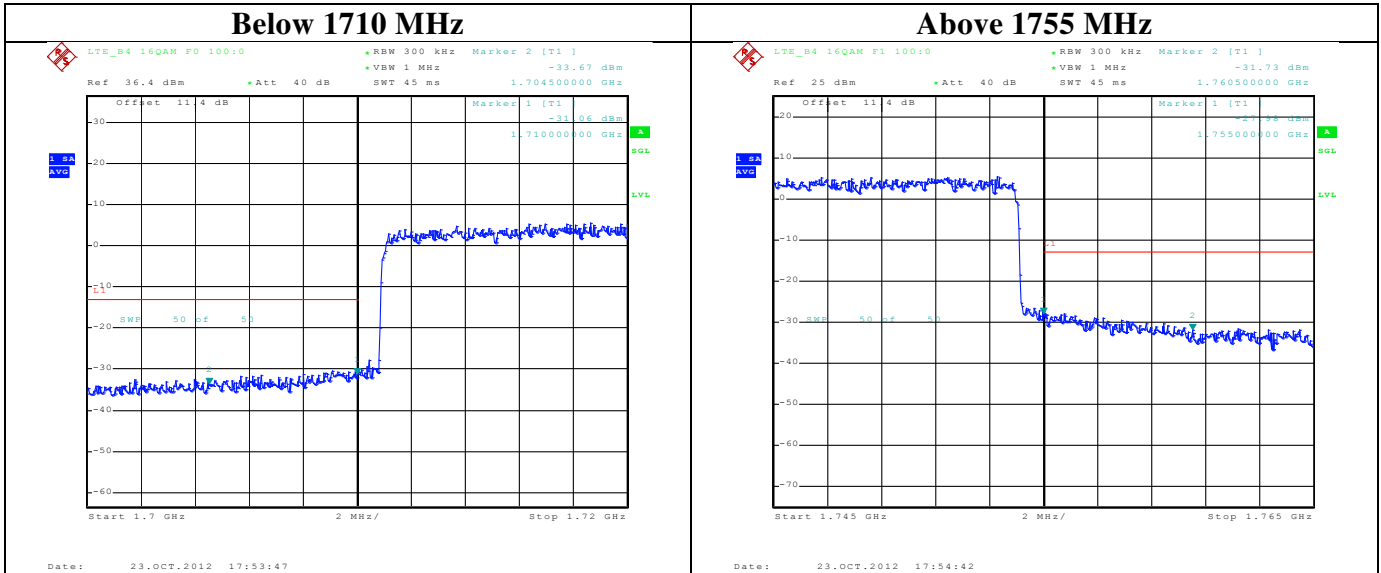

SIERRA WIRELESS, INC.

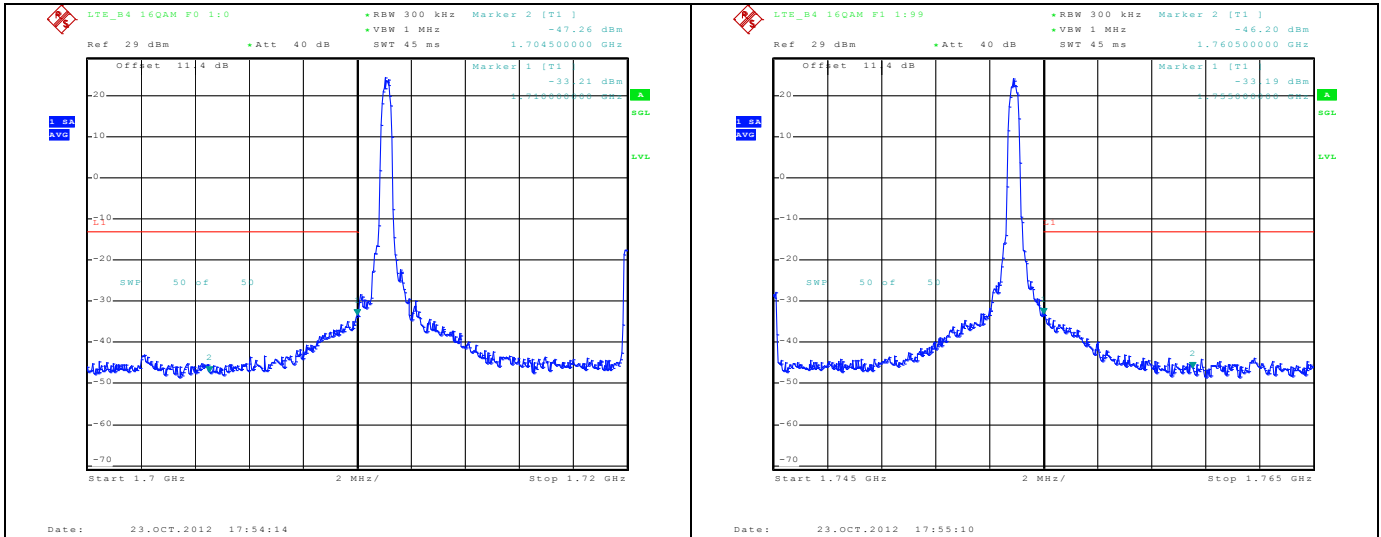

LTE B5

9.2.1.27 LTE; Band5, 5 MHz BW, 16-QAM

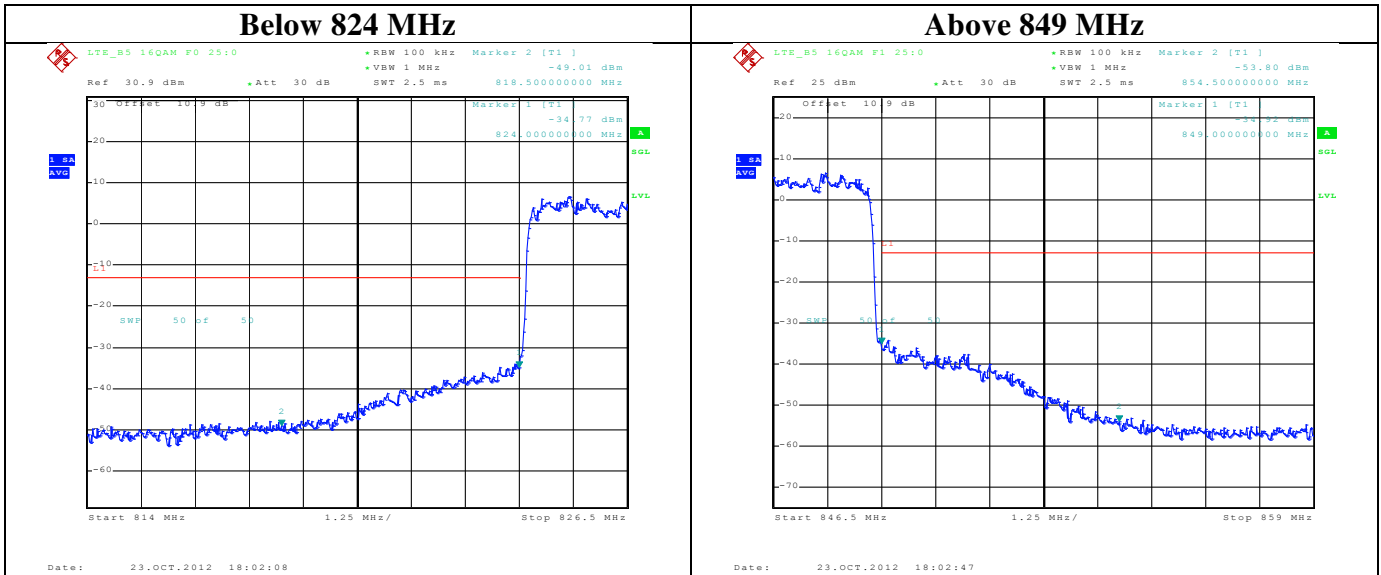

SIERRA WIRELESS, INC.

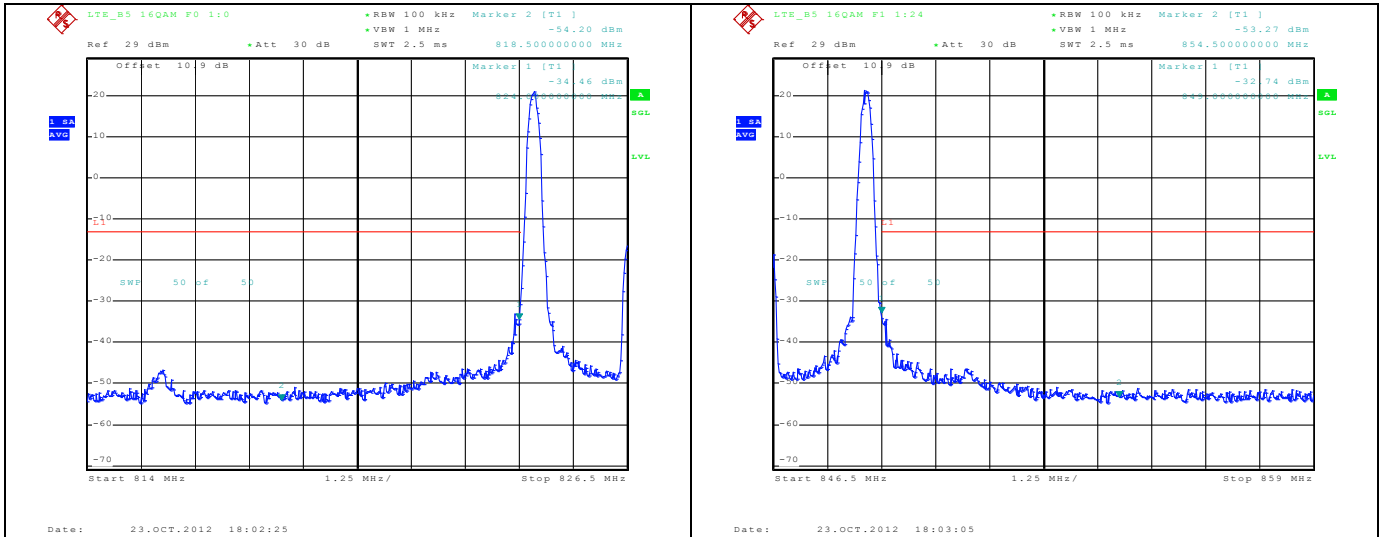

9.2.1.28 LTE; Band5, 10 MHz BW, 16-QAM

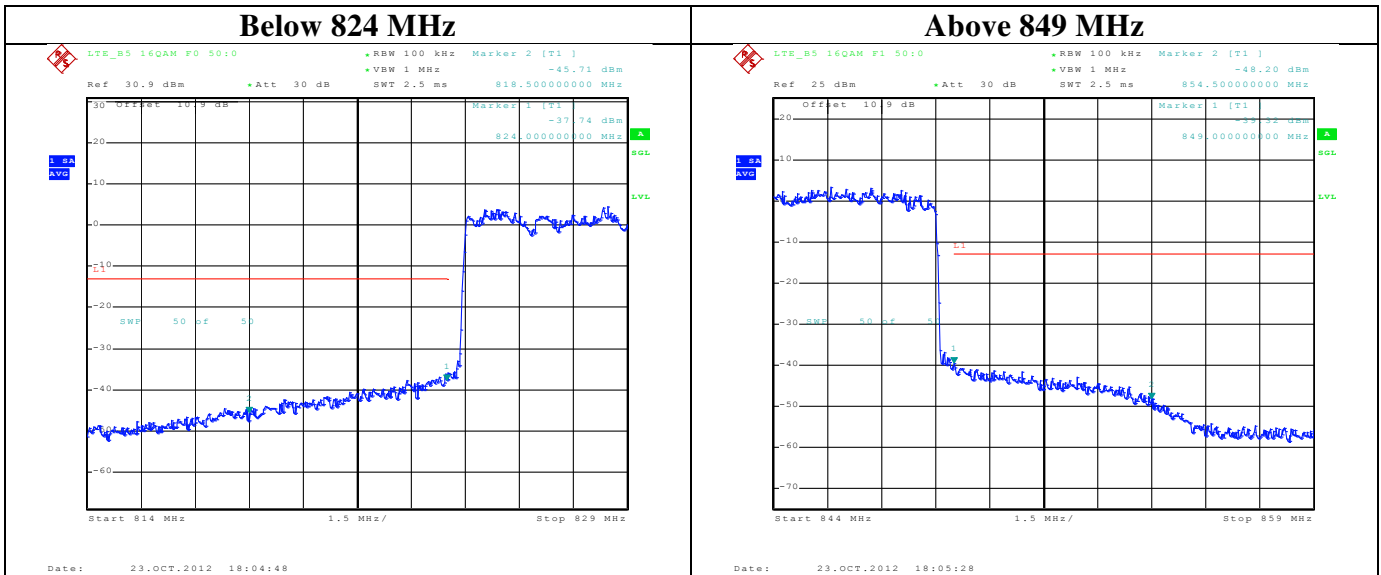

SIERRA WIRELESS, INC.

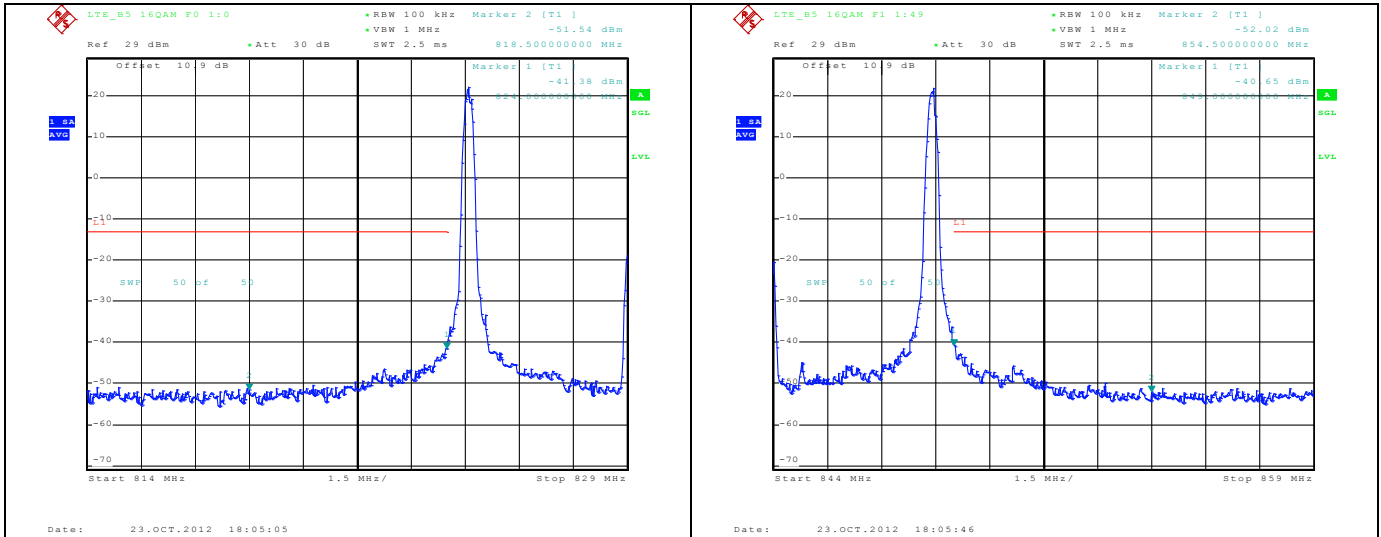

LTE B13

9.2.1.29 LTE; Band13, 5 MHz BW, 16-QAM

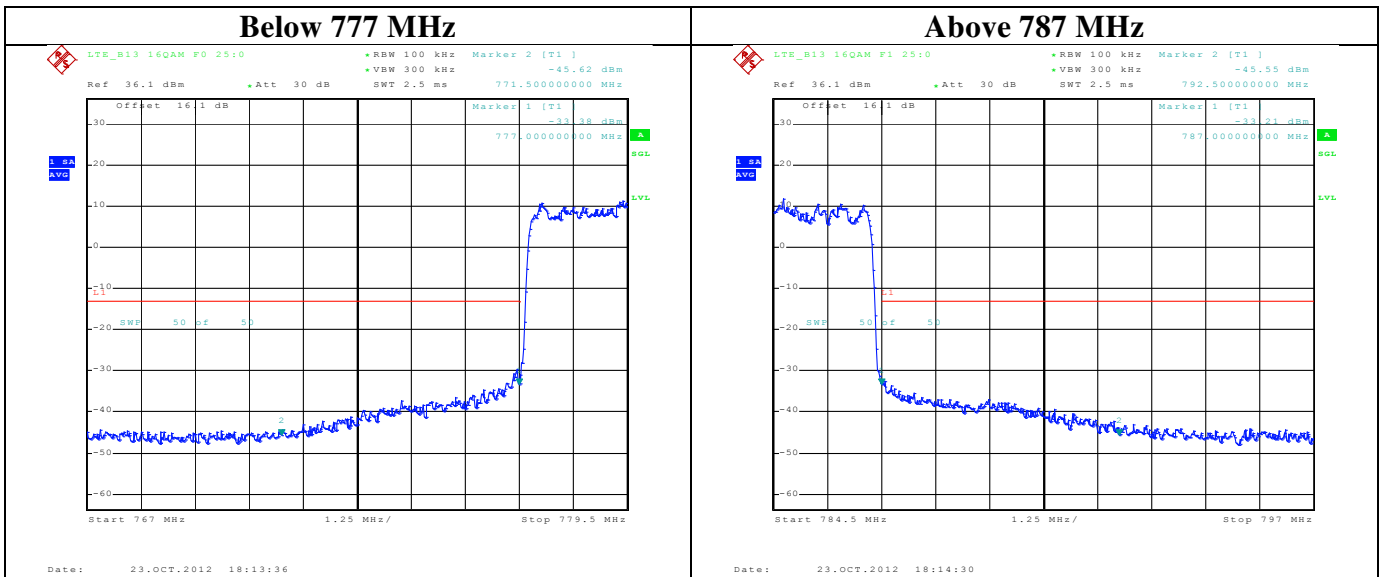

SIERRA WIRELESS, INC.

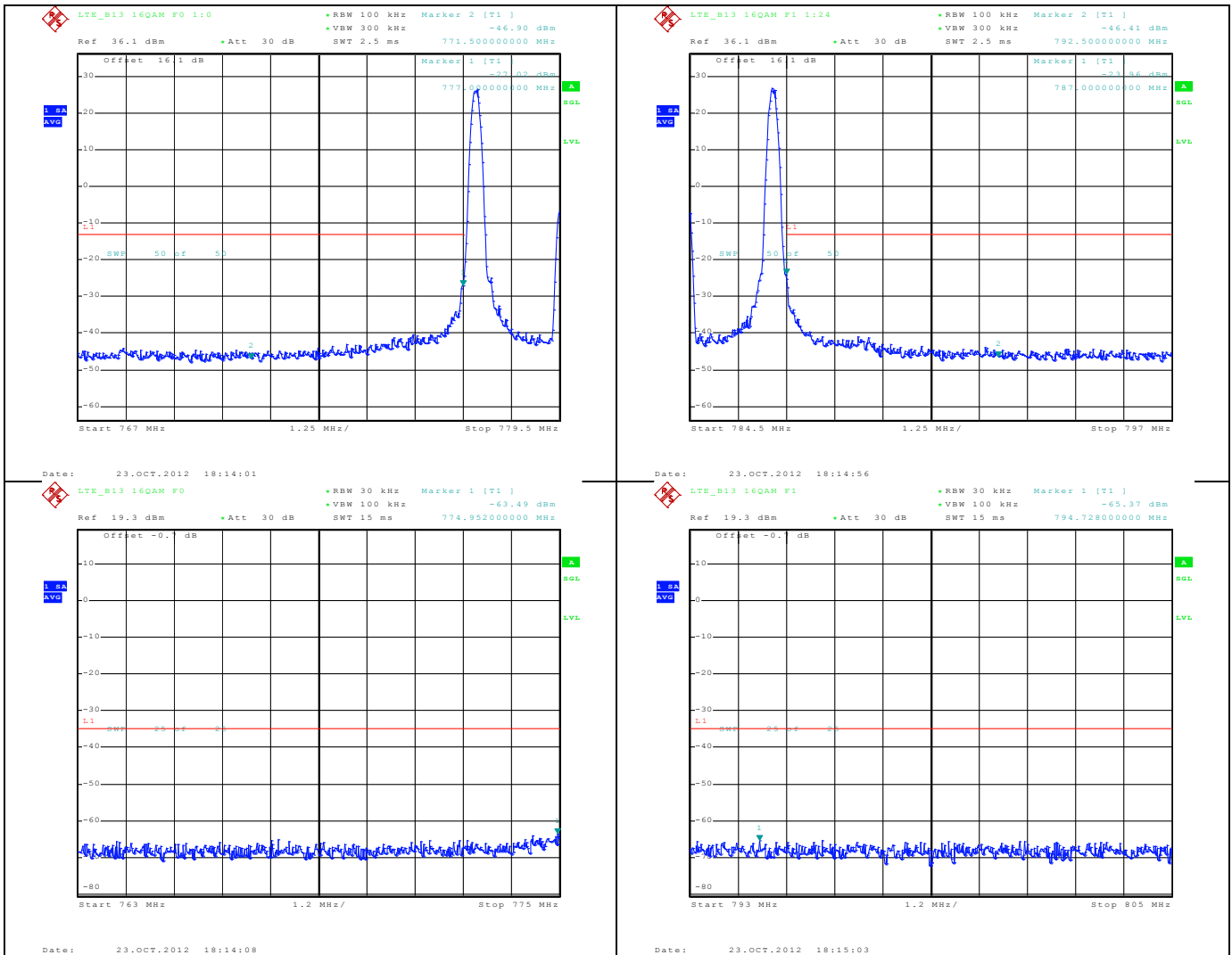

9.2.1.30 LTE; Band13, 10 MHz BW, 16-QAM

Below 777 MHz	Above 787 MHz
----------------------	----------------------

SIERRA WIRELESS, INC.

FCC Part 22/24/27, RSS-132/133/139

EM7355

Feb. 05, 2013

Page 96 of 111

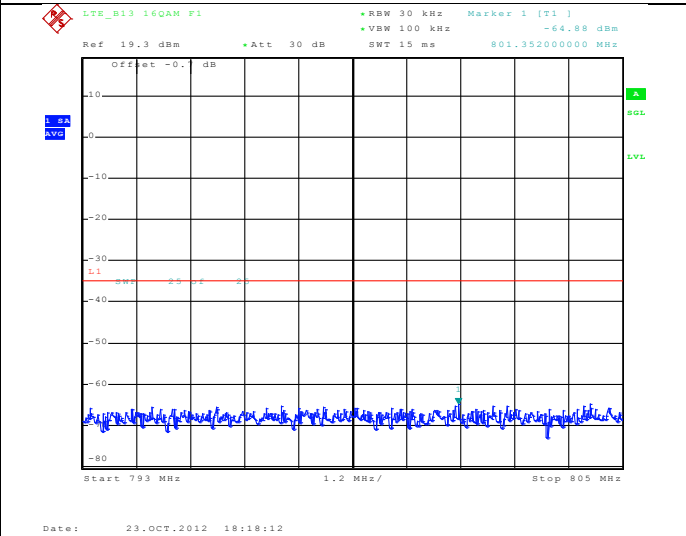
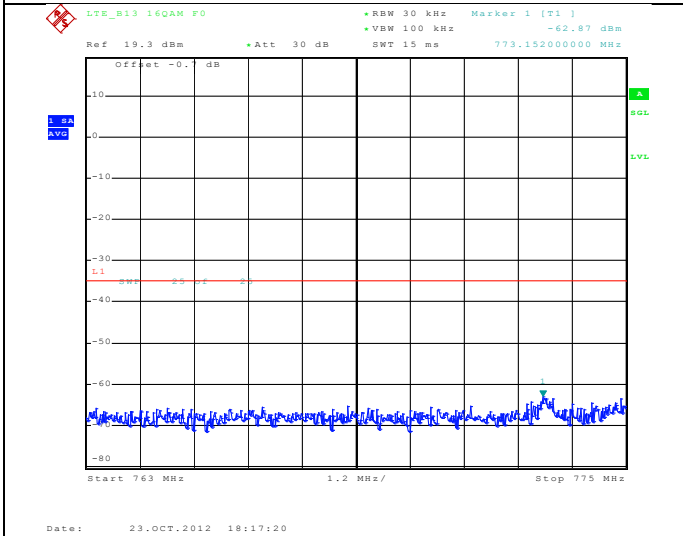
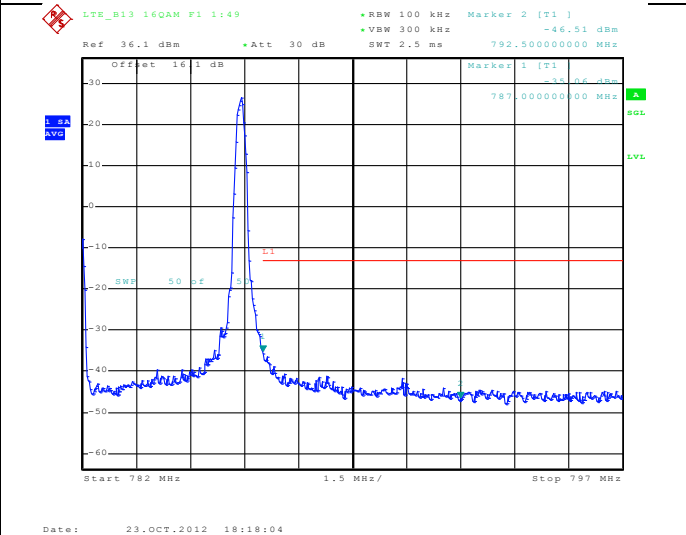
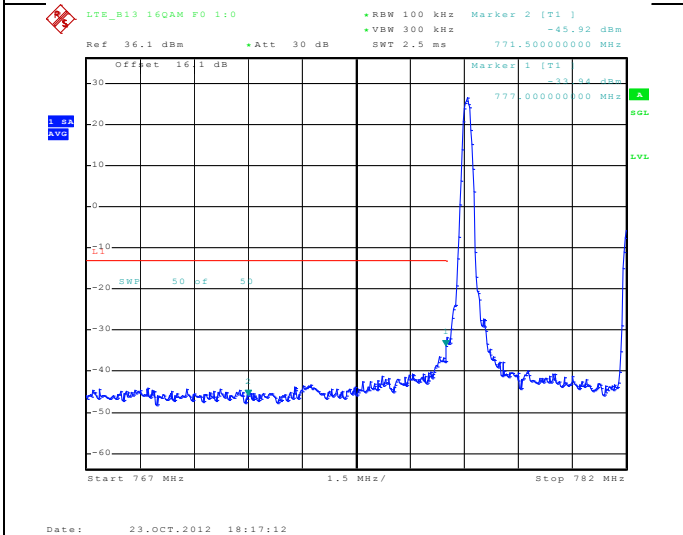
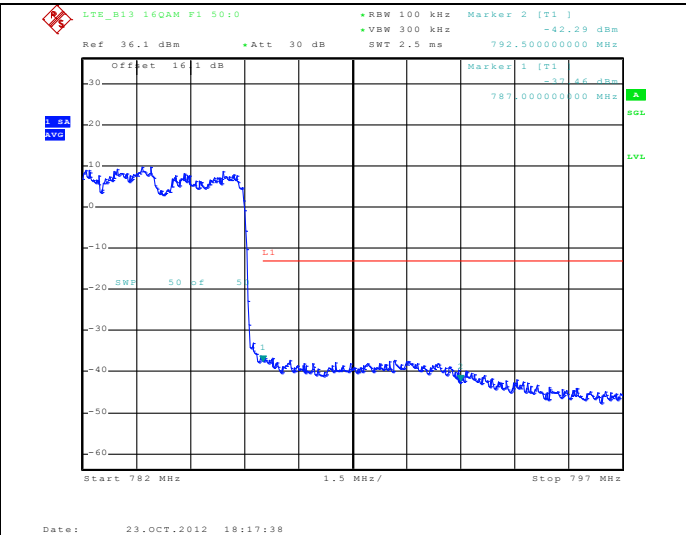
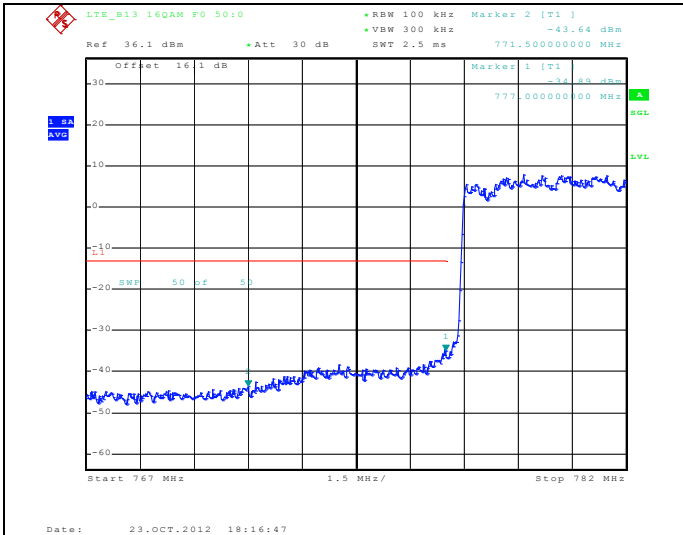

SIERRA WIRELESS, INC.

LTE B17

9.2.1.31 LTE; Band17, 5 MHz BW, 16-QAM

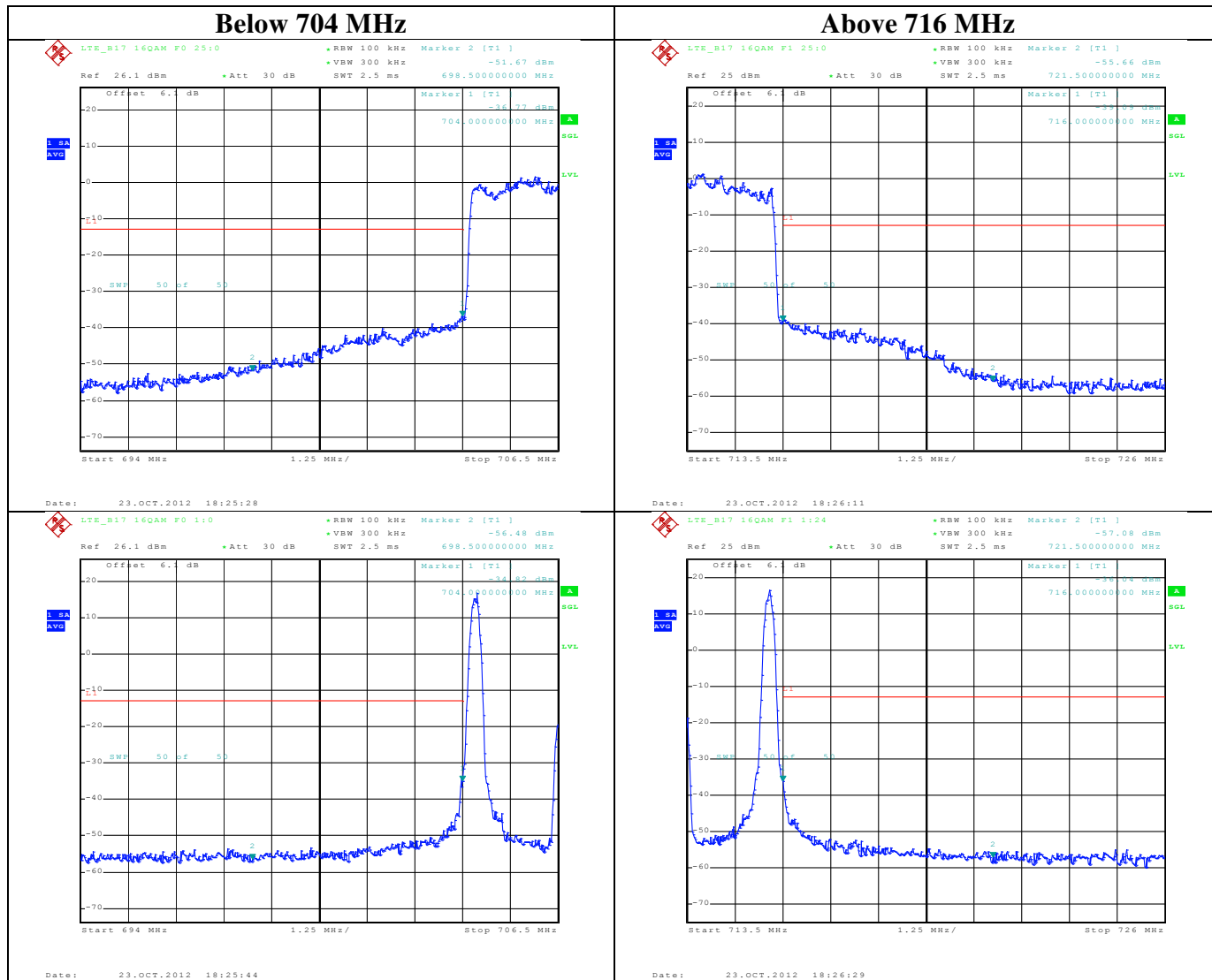

9.2.1.32 LTE; Band17, 10 MHz BW, 16-QAM

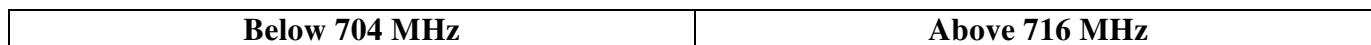

SIERRA WIRELESS, INC.

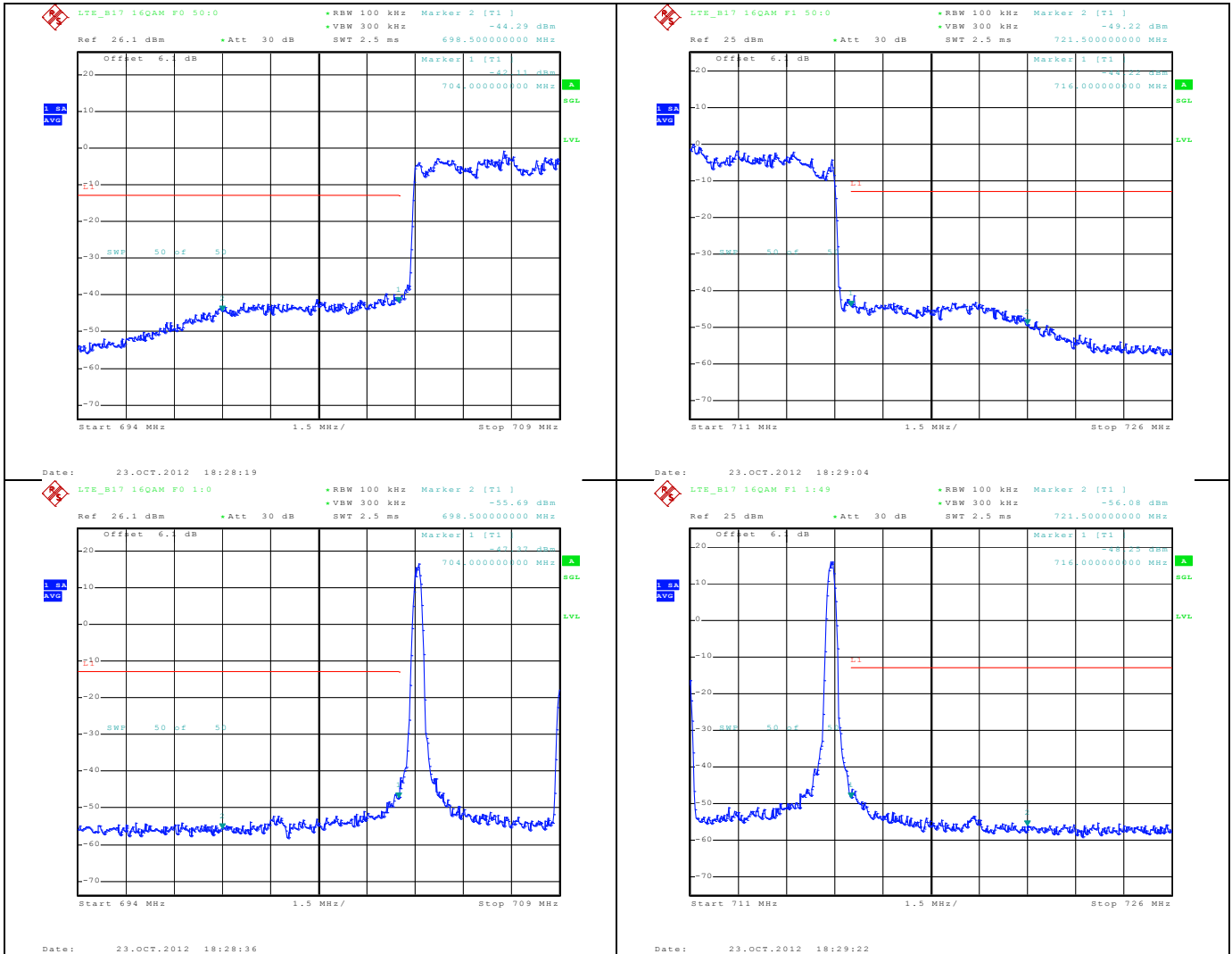

LTE B25

9.2.1.33 LTE; Band25, 5 MHz BW, 16-QAM

Below 1850 MHz	Above 1915 MHz
----------------	----------------

SIERRA WIRELESS, INC.

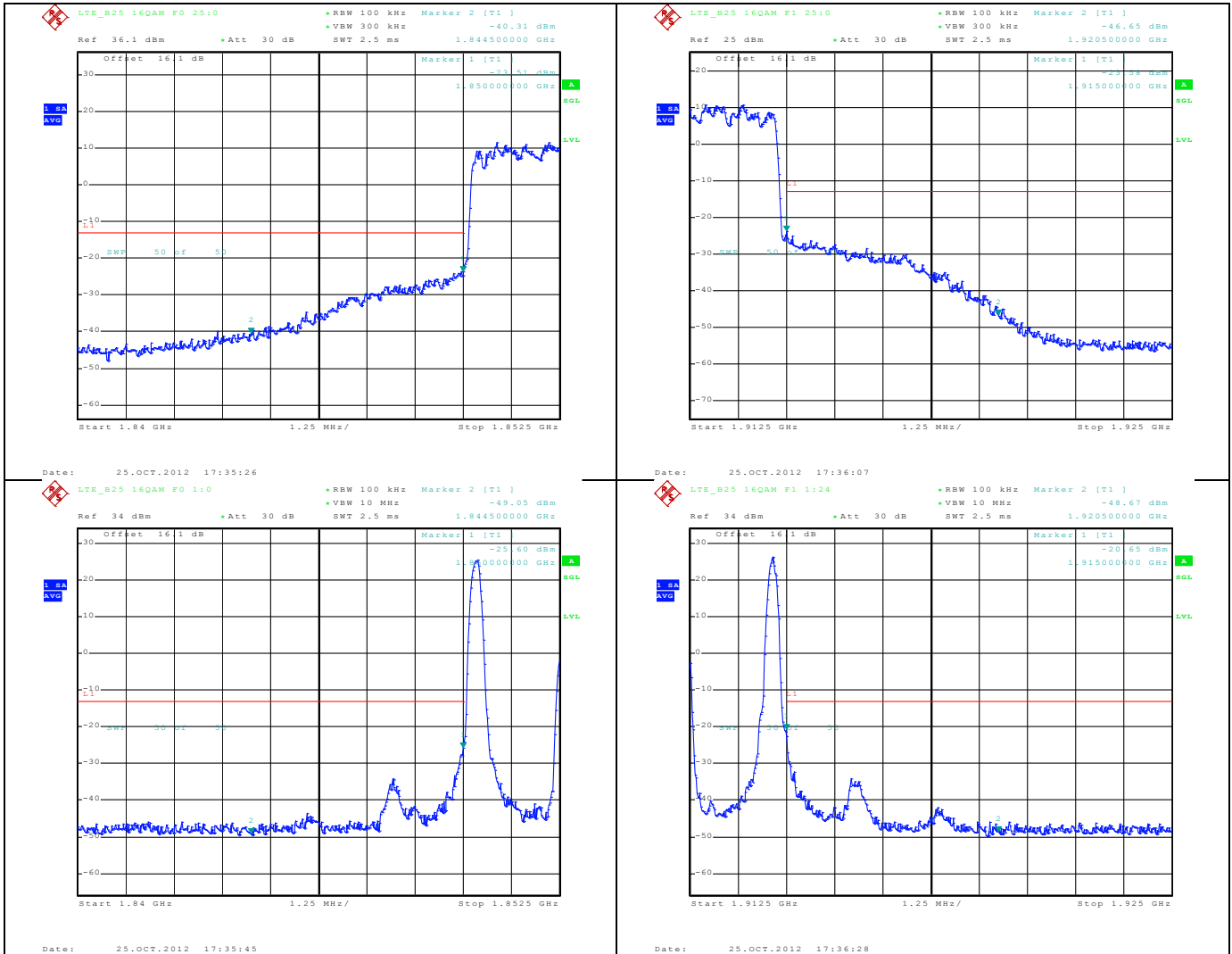

9.2.1.34 LTE; Band25, 10 MHz BW, 16-QAM

Below 1850 MHz	Above 1915 MHz
-----------------------	-----------------------

SIERRA WIRELESS, INC.

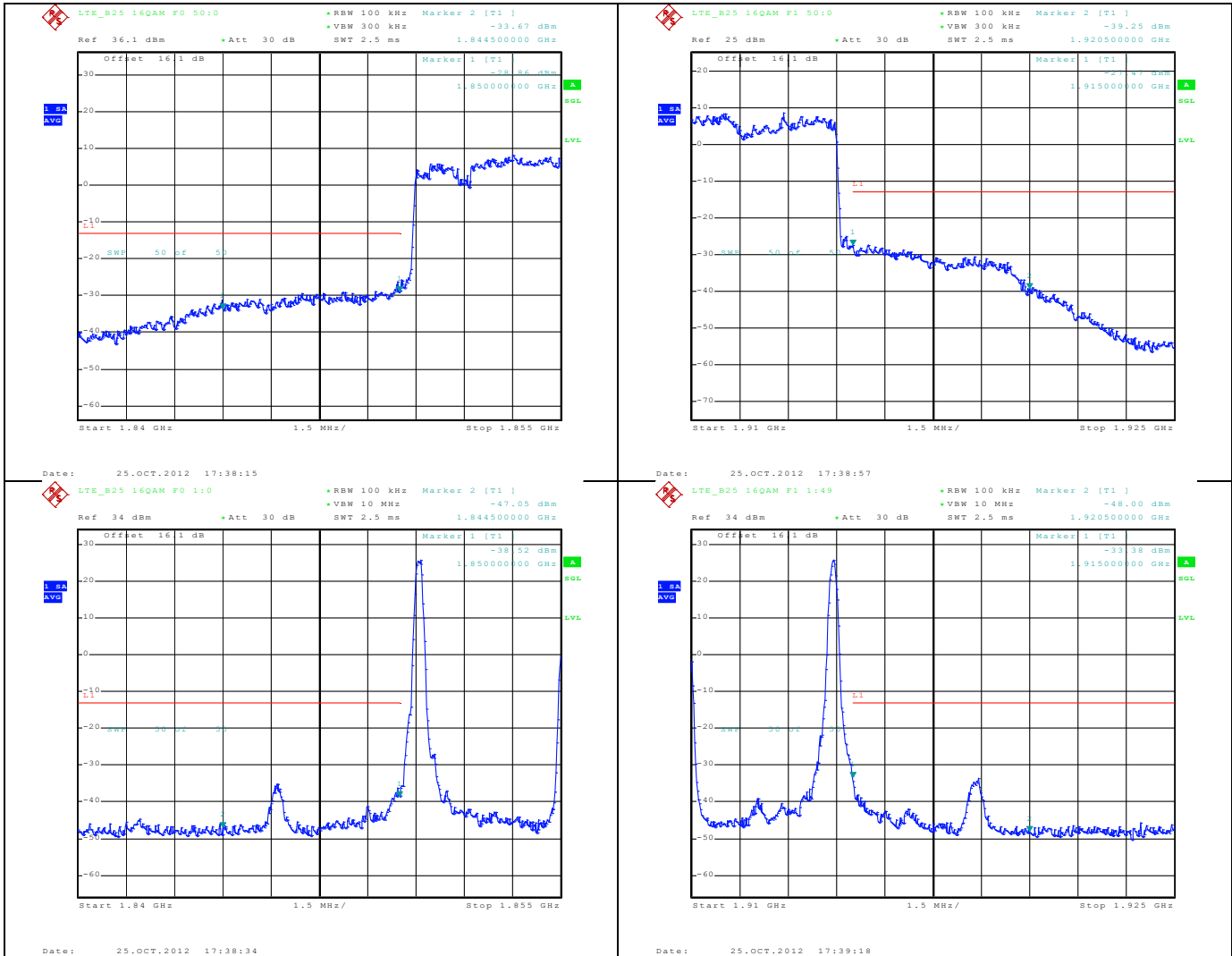

9.2.1.35 LTE; Band25, 15 MHz BW, 16-QAM

Below 1850 MHz	Above 1915 MHz
-----------------------	-----------------------

SIERRA WIRELESS, INC.

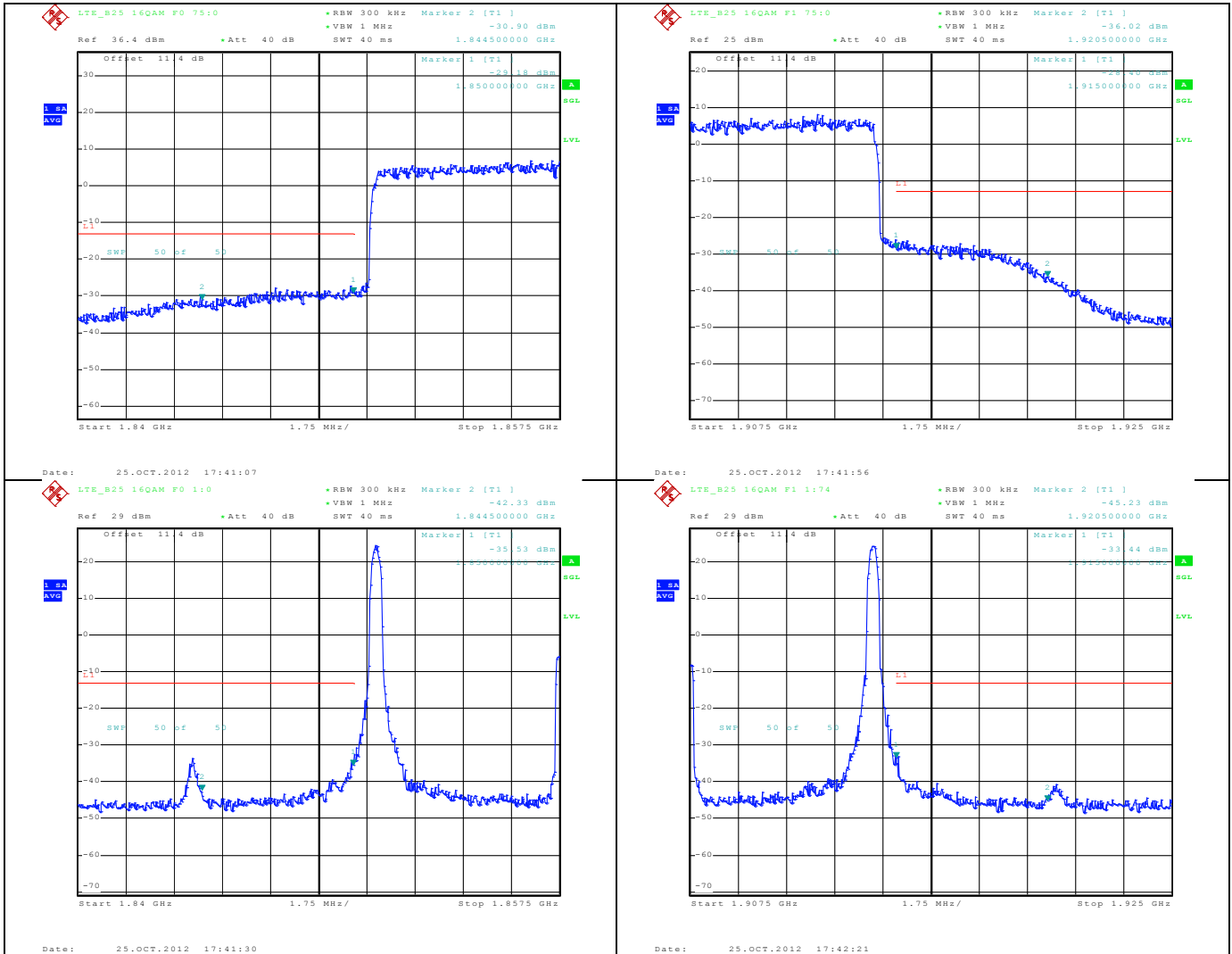

9.2.1.36 LTE; Band25, 20 MHz BW, 16-QAM

Below 1850 MHz	Above 1915 MHz
----------------	----------------

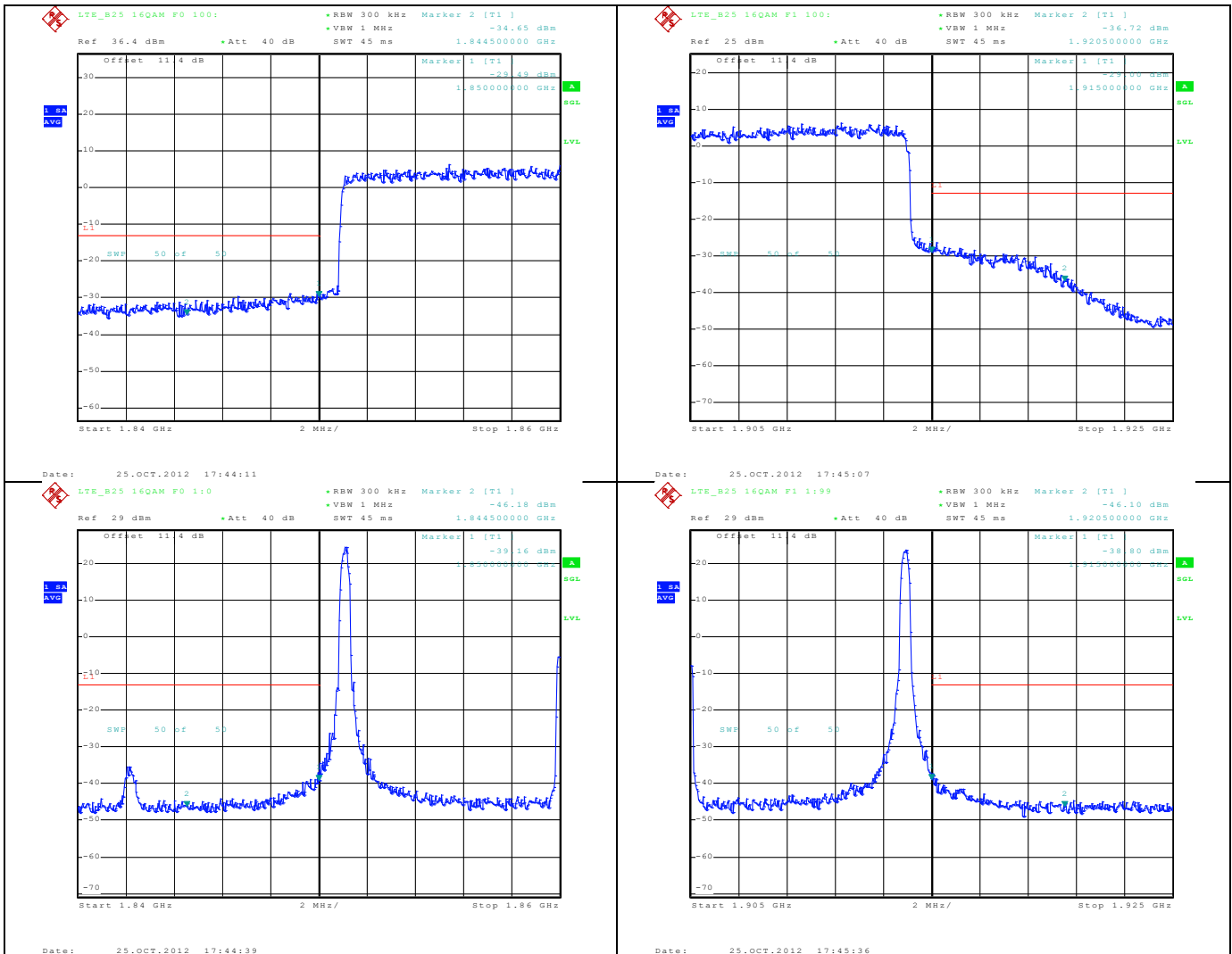

10 Frequency Stability versus Temperature

FCC 2.1055, FCC 22.355, FCC 24.235, FCC 27.54

10.1 Summary of Results

The EUT's Frequency Stability versus temperature meets the requirements of less than 2.5ppm when temperature varies from -30°C to +50°C.

10.2 Test Procedure

The EUT was placed inside a temperature chamber. The temperature was set to -30°C and maintained to stabilize. After sufficient soak time, the transmitting frequency error was measured. The temperature was then increased by 10 degrees, maintained to stabilize, and the measurement was repeated. This procedure

SIERRA WIRELESS, INC.

was repeated until +50°C is reached. Frequency metering included internal averaging of the CMW500 to stabilize the reading. Reference power supply voltage for these tests is 3.7 volts. Refer to Test Setup 2.

10.3 Test Results

Frequency stability is not affected by transmission bandwidth or modulation mode (QPSK, 16-QAM). The measurements below were performed with a 10 MHz transmission bandwidth and QPSK modulation.

10.3.1 LTE Frequency Error over Temperature

Band	Offset	Temperature (°C)									
		-30	-20	-10	0	10	20	30	40	50	60
B2	Hz	-4.92	1.56	-12.03	-2.46	-4.13	-3.39	4.16	-15.59	-7.08	-4.26
	ppm	-0.0026	0.0008	-0.0064	-0.0013	-0.0022	-0.0018	0.0022	-0.0083	-0.0038	-0.0023
B4	Hz	0.27	-0.53	0.37	0.13	1.83	2.63	0.7	2.06	2.46	1.07
	ppm	0.0002	-0.0003	0.0002	0.0001	0.0011	0.0015	0.0004	0.0012	0.0014	0.0006
B5	Hz	0.07	0.27	1.24	0.06	1.24	0.47	0.36	2.82	1.79	-0.04
	ppm	0.0001	0.0003	0.0015	0.0001	0.0015	0.0006	0.0004	0.0034	0.0021	0.0000
B13	Hz	-1.1	-3.39	-1.69	-0.99	-0.79	-0.53	-0.21	-1.5	-1.46	-0.86
	ppm	-0.0014	-0.0043	-0.0022	-0.0013	-0.0010	-0.0007	-0.0003	-0.0019	-0.0019	-0.0011
B17	Hz	-1.79	-1.04	-0.69	-1.24	-0.36	-0.62	-3.48	-1.65	-1.57	-0.92
	ppm	-0.0025	-0.0015	-0.0010	-0.0017	-0.0005	-0.0009	-0.0049	-0.0023	-0.0022	-0.0013
B25	Hz	5.94	5.19	-3.32	-2.07	-2	0.24	-11.92	4.02	1.83	4.62
	ppm	0.0032	0.0028	-0.0018	-0.0011	-0.0011	0.0001	-0.0063	0.0021	0.0010	0.0025

11 Frequency Stability versus Voltage

FCC 2.1055, FCC 22.355, FCC 24.235, FCC 27.54

11.1 Summary of Results

The EUT is specified to operate with a supply voltage varying between 3.0 VDC and 4.2 VDC, having a nominal voltage of 3.7 VDC. It meets the frequency stability limit of less than 2.5ppm when supply voltage varies within the specified limits. Operation above or below these voltage limits is prohibited by firmware in order to prevent improper operation.

11.2 Test Procedure

The EUT was connected to a DC Power Supply and a LTE test set (CMW500) with frequency error measurement capability. The power supply output was adjusted to the test voltage as measured at the input terminals to the device while transmitting. A voltmeter was used to confirm the terminal voltage. The peak frequency error is recorded (worst case). The test voltages are 3.0 volts to 4.2 volts. Refer to Test Setup 2.

SIERRA WIRELESS, INC.

11.3 Test Results

11.3.1 LTE Frequency Error over Voltage

Band	Offset	Voltage (V)		
		3	3.7	4.2
B2	Hz	-7.52	-8.77	-1.04
	ppm	-0.0040	-0.0047	-0.0006
B4	Hz	-5.71	-3.83	-2.16
	ppm	-0.0033	-0.0022	-0.0012
B5	Hz	-3.3	-1.49	-3.38
	ppm	-0.0039	-0.0018	-0.0040
B13	Hz	-0.84	-0.92	-0.84
	ppm	-0.0011	-0.0012	-0.0011
B17	Hz	-0.49	0.16	-1.27
	ppm	-0.0007	0.0002	-0.0018
B25	Hz	-6.48	2.22	2.6
	ppm	-0.0034	0.0012	0.0014

12 Peak to Average Ratio

FCC 24.232, 27.50(d)

12.1 Summary of Results

The EUT meets the requirement of having a peak to average ratio of less than 13dB.

12.2 Test Procedure

The transmitter output was connected to a Rohde & Schwarz CMW500 through a coaxial RF cable and directional coupler, and configured to operate at maximum power. The peak to average ratio was measured at the required operating frequencies in each band on the Spectrum Analyzer. Refer to Test Setup 1.

12.3 Test Results

The Peak to Average ration is not bandwidth dependent. The results below were measured with a 5 MHz transmission bandwidth (25 RB).

Band	Channel	Frequency (MHz)	Modulation	Plot No.	Peak to Average Ratio
B2	18900	1880	QPSK	12.3.1.1	5.94
			16-QAM	12.3.1.2	6.97
B4	20175	1732.5	QPSK	12.3.1.3	5.46
			16-QAM	12.3.1.4	6.18
B5	20525	836.5	QPSK	12.3.1.5	5.64

SIERRA WIRELESS, INC.

			16-QAM	12.3.1.6	6.24
B13	23230	782	QPSK	12.3.1.7	5.61
			16-QAM	12.3.1.8	6.24
B17	23790	710	QPSK	12.3.1.9	6.00
			16-QAM	12.3.1.10	6.78
B25	26365	1882.5	QPSK	12.3.1.11	5.82
			16-QAM	12.3.1.12	6.63

12.3.1 Test Plots

12.3.1.1 LTE peak to average ratio, QPSK Band2, Mid channel, 1880.0 MHz

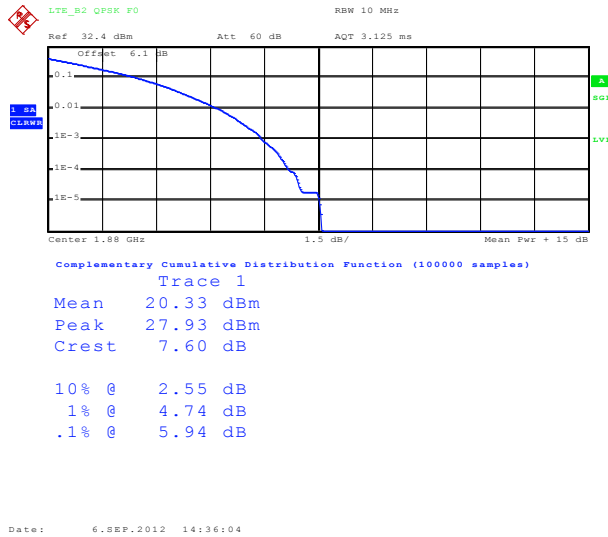

12.3.1.2 LTE peak to average ratio, 16-QAM Band2, Mid channel, 1880.0 MHz

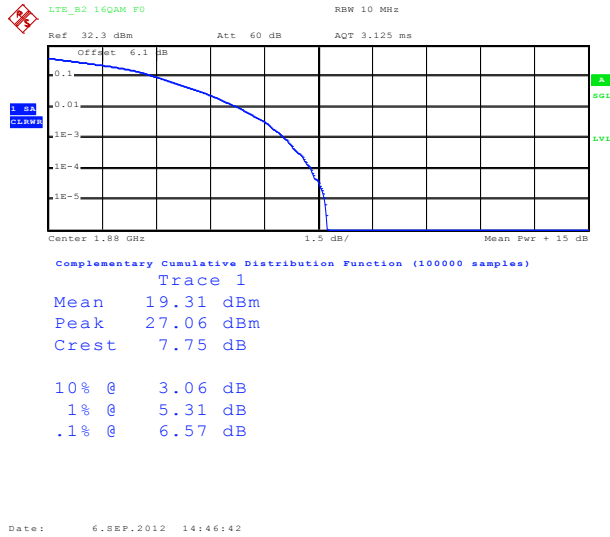

12.3.1.3 LTE peak to average ratio, QPSK Band4, Mid channel, 1732.5 MHz

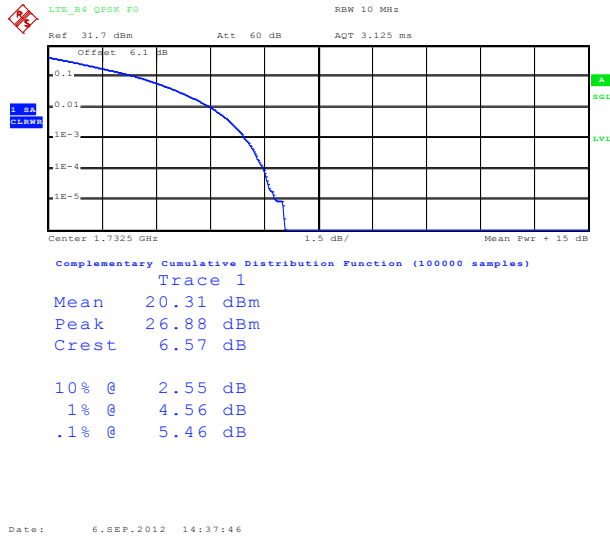

12.3.1.4 LTE peak to average ratio, 16-QAM Band4, Mid channel, 1732.5 MHz

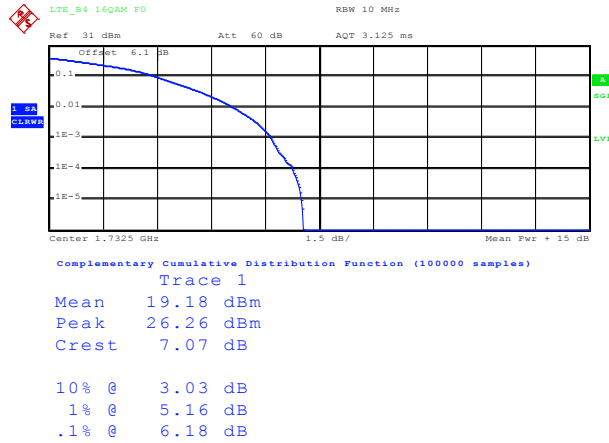

Date: 6.SEP.2012 14:48:37

12.3.1.5 LTE peak to average ratio, QPSK Band5, Mid channel, 836.5 MHz

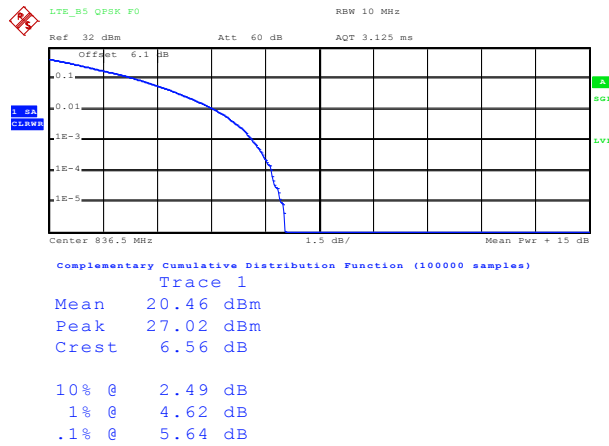

Date: 6.SEP.2012 14:39:27

12.3.1.6 LTE peak to average ratio, 16-QAM Band5, Mid channel, 836.5 MHz

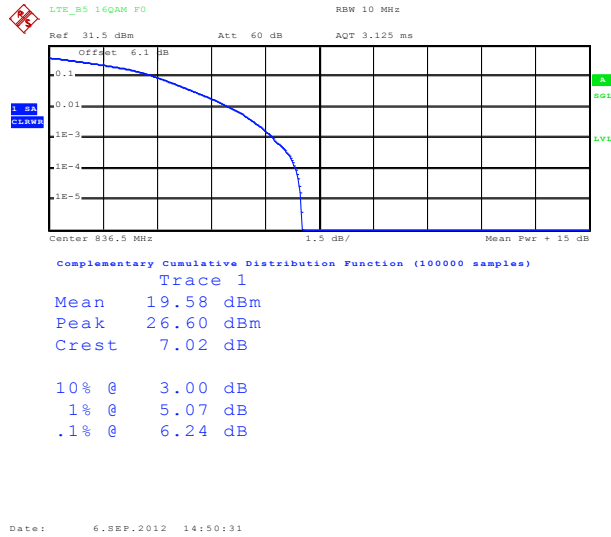

12.3.1.7 LTE peak to average ratio, QPSK Band13, Mid channel, 782.0 MHz

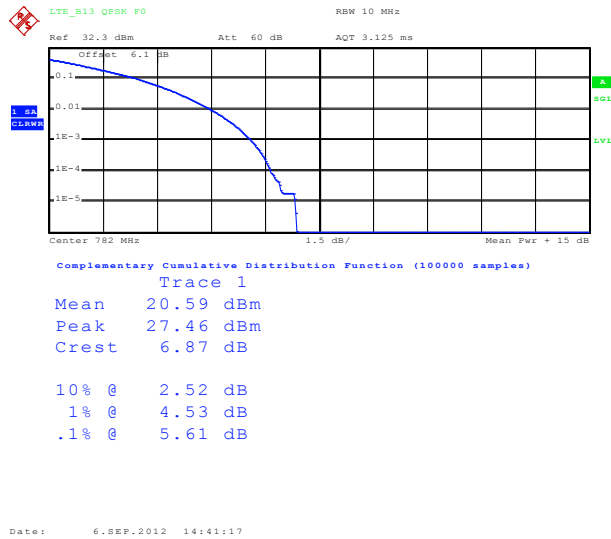

12.3.1.8 LTE peak to average ratio, 16-QAM Band13, Mid channel, 782.0 MHz

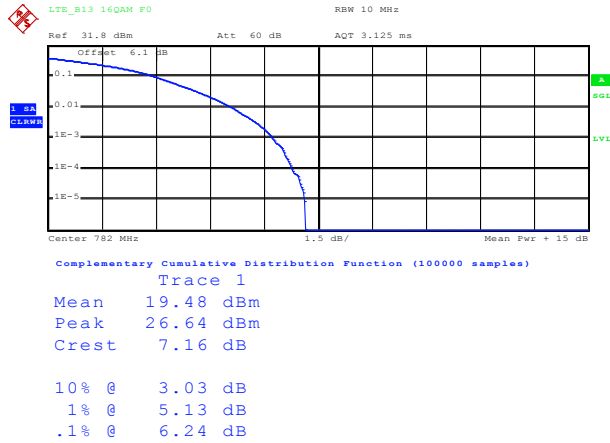

Date: 6.SEP.2012 14:52:35

12.3.1.9 LTE peak to average ratio, QPSK Band17, Mid channel, 710.0 MHz

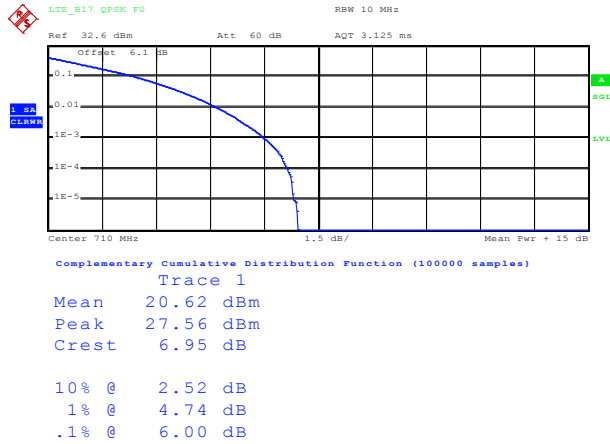

Date: 6.SEP.2012 14:43:07

12.3.1.10 LTE peak to average ratio, 16-QAM Band17, Mid channel, 710.0 MHz

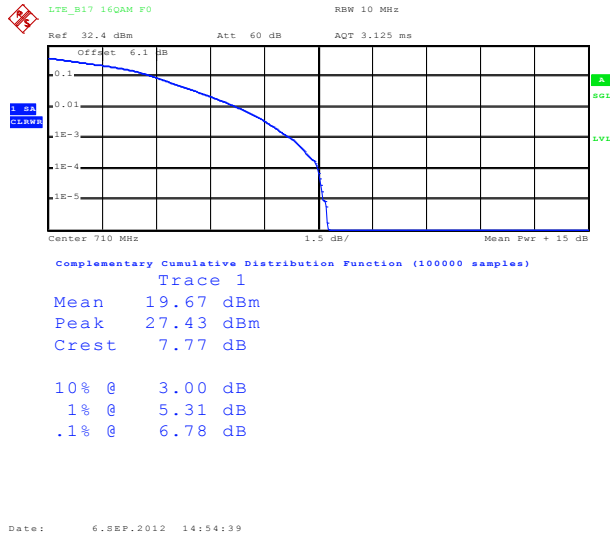

12.3.1.11 LTE peak to average ratio, QPSK Band25, Mid channel, 1882.5 MHz

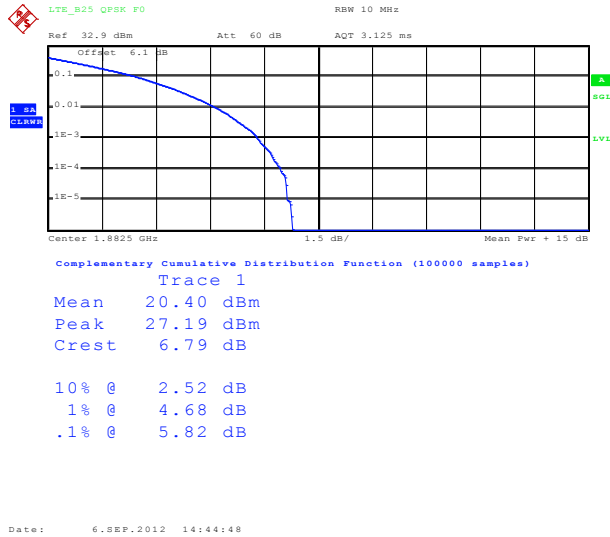

SIERRA WIRELESS, INC.

12.3.1.12 LTE peak to average ratio, 16-QAM Band25, Mid channel, 1882.5 MHz

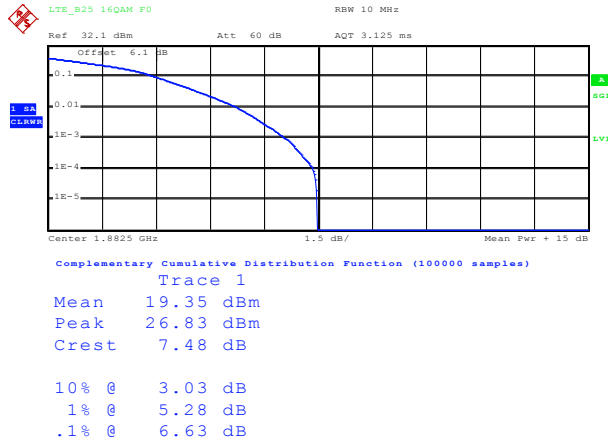

Date: 6.SEP.2012 14:56:33