



EM7355/EM7655 Modem

FOR

GSM / EDGE

Rev.2

FCC and IC Certifications

IC: 2417C-EM7355
FCC ID: N7NEM7355

© 2010 Sierra Wireless, Inc.

This document contains information which is proprietary and confidential to Sierra Wireless, Inc. Disclosure to persons other than the officers, employees, agents, or subcontractors of the Company or licensee of this document without the prior written permission of Sierra Wireless, Inc. is strictly prohibited.

SIERRA WIRELESS, INC.

FCC Part 22/24, RSS-132/133	EM7355	Feb. 05, 2013	Page 2 of 21
-----------------------------	--------	---------------	--------------

Table of Contents

1	Introduction and Purpose	3
1.1	Revision history.....	3
2	Test Summary	3
3	Description of Equipment under Test.....	3
3.1	Differences between EM7355 and EM7655	4
4	Compliance Test Equipment List	4
5	Test Setup Block Diagrams	5
5.1	Test Setup 1	5
5.2	Test Setup 2.....	5
6	RF Power Output	5
6.1	Test Procedure	5
6.1.1	GSM/GPRS/EDGE Max Power Setup	6
6.2	Maximum Transmit Power Test Results	6
6.2.1	Test Results GSM/EDGE Output Power	6
7	Occupied Bandwidth.....	7
7.1	Test Procedure	7
7.2	Test Results	7
7.2.1	GSM Summary Results.....	7
7.2.2	GSM Test Plots.....	8
8	Out of Band Emissions at Antenna Terminals	9
8.1	Test Procedure	10
8.2	Test Results	10
8.2.1	GSM Test Plots.....	10
9	Block Edge Compliance	15
9.1	Test Procedure	15
9.2	Test Results	15
9.2.1	GSM Test Plots.....	16
10	Frequency Stability versus Temperature.....	19
10.1	Summary of Results.....	19
10.2	Test Procedure	19
10.3	Test Results	20
10.3.1	GSM Frequency Error over Temperature	20
11	Frequency Stability versus Voltage.....	20
11.1	Summary of Results.....	20
11.2	Test Procedure	20
11.3	Test Results	21
11.3.1	GSM Frequency Error over Voltage.....	21

SIERRA WIRELESS, INC.

FCC Part 22/24, RSS-132/133	EM7355	Feb. 05, 2013	Page 3 of 21
-----------------------------	--------	---------------	--------------

1 Introduction and Purpose

This document provides test data for the EM7355 modem output power intended for FCC and Industry Canada certifications.

1.1 Revision history

Rev	Date	Author	Summary of changes	ECO #
1.0	Aug.15, 2012	Markus Myers	First Release	
2.0	Feb. 05, 2013	Markus Myers	Updated with FCC rule information and channel frequencies	

2 Test Summary

FCC Rule	IC Standards	DESCRIPTION OF TEST	RESULT	PAGE
2.1046	RSS-132, 4.4 RSS-133, 6.4	RF Power Output	Complies	6
2.1049	RSS-Gen, 4.6	Occupied Bandwidth	Complies	7
2.1051, 22.917, 24.238	RSS-132, 4.5 RSS-133, 6.5	Out of Band Emissions at Antenna Terminals	Complies	9
22.917, 24.238	RSS-Gen, 4.6	Block Edge Compliance	Complies	15
2.1055, 22.355, 24.235	RSS-132, 4.3 RSS-133, 6.3	Frequency Stability versus Temperature	Complies	19
2.1055, 22.355, 24.235	RSS-132, 4.3 RSS-133, 6.3	Frequency Stability versus Voltage	Complies	20

3 Description of Equipment under Test

The EM7355 modem, referred to as “EUT” hereafter, is a multi-band wireless modem operating on the GSM/GPRS/EDGE/UMTS/LTE/CDMA networks. The table below shows the supported North American bands for the device.

Technology	Band	UL Freq. (MHz)	DL Freq. (MHz)	Max Power
LTE	B2	1850 – 1910	1930 – 1990	23 dBm (+/- 1 dB)
	B4	1710 – 1755	2110 – 2155	23 dBm (+/- 1 dB)
	B5	824 – 849	869 – 894	23 dBm (+/- 1 dB)
	B13	777 – 787	746 – 756	23 dBm (+/- 1 dB)
	B17	704 – 716	734 – 746	23 dBm (+/- 1 dB)
	B25	1850 – 1915	1930 – 1995	23 dBm (+/- 1 dB)
WCDMA / HSDPA/ HSUPA	B2	1850 – 1910	1930 – 1990	23 dBm (+/- 1 dB)

© 2010 Sierra Wireless, Inc.

The contents of this page are subject to the confidentiality information on page one.

SIERRA WIRELESS, INC.

FCC Part 22/24, RSS-132/133	EM7355	Feb. 05, 2013	Page 4 of 21
-----------------------------	--------	---------------	--------------

/ HSPA+	B4	1710 – 1755	2110 – 2155	23 dBm (+/- 1 dB)
	B5	824 – 849	869 – 894	23 dBm (+/- 1 dB)
CDMA / EVDO	BC0	824 – 849	869 – 894	24 dBm (+/- 1 dB)
	BC1	1850 – 1910	1930 – 1990	24 dBm (+/- 1 dB)
	BC10*	817.0 – 824	862 – 869	24 dBm (+/- 1 dB)
GSM	G850	824 – 849	869 – 894	32.5dBm (+/-1dB)
	G1900	1850 – 1910	1930 – 1990	29.5dBm (+/-1dB)
EDGE	G850	824 – 849	869 – 894	27dBm (+/-1dB)
	G1900	1850 – 1910	1930 – 1990	26dBm (+/-1dB)

* Only BC10 subclass 2 and 3 frequencies are supported by hardware and firmware.

3.1 Differences between EM7355 and EM7655

The EM7355 and EM7655 differ only in pcb length and host interface connector. Both products utilize the same pcb RF layout, components and firmware. Please refer to document “7x55 Comparison.pdf”.

This report only contains the test data for bands supporting GSM / EDGE technologies.

4 Compliance Test Equipment List

EQUIPMENT	MANUFACTURER	MODEL NO.	SERIAL NO.	CAL. DUE DATE
Control Computer	TC	Generic PC	100488	N/A
Wireless Test Set	Rohde & Schwarz	CMU200	110521	October 27, 2013
Wireless Test Set	Rohde & Schwarz	CMW500	101060	June 06, 2014
Spectrum Analyzer	Rohde & Schwarz	FSP	100060	October 27, 2013
DC Power Supply	HP	6632A	3530A	N/A
Interface Board	Shop built	ATEMux	N/A	N/A
Directional Coupler	Pasternack	PE2209-10	N/A	N/A

5 Test Setup Block Diagrams

5.1 Test Setup 1

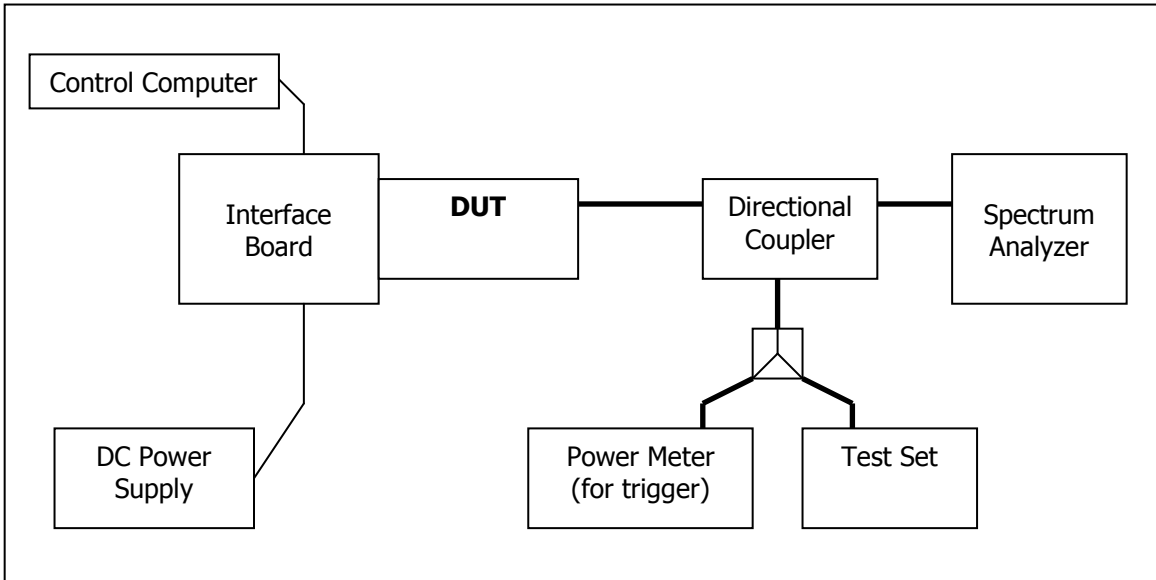

5.2 Test Setup 2

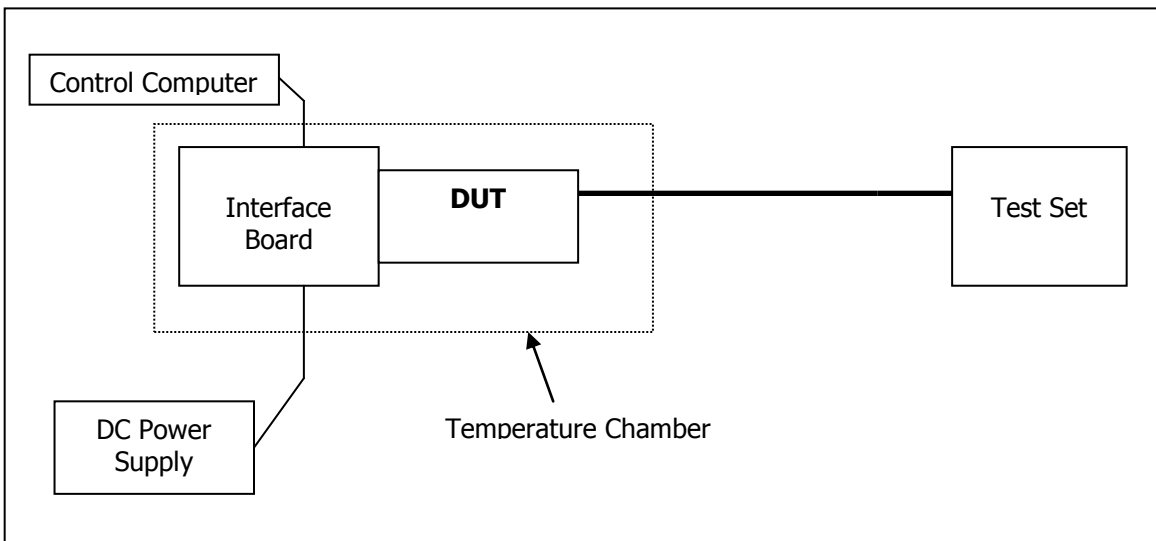

6 RF Power Output

FCC 2.1046

6.1 Test Procedure

The transmitter output was connected to a Rohde & Schwarz Radio Communication Tester and configured to operate at maximum power in a call. The power was measured using the spectrum analyzer at three equally spaced operating frequencies for each band.

© 2010 Sierra Wireless, Inc.

The contents of this page are subject to the confidentiality information on page one.

SIERRA WIRELESS, INC.

The RBW was set to 300 KHz for the GSM and EDGE measurements. The spectrum analyzer was set to measure the RF output power with the cable and coupler losses accounted for. Refer to Test Setup 1.

6.1.1 GSM/GPRS/EDGE Max Power Setup

Configure the Radio Communication Tester to support GMSK and 8PSK call respectively, and set one timeslot transmission for GMSK GSM/GPRS and 8PSK EDGE. Measure and record power outputs for both modulations.

6.2 Maximum Transmit Power Test Results

6.2.1 Test Results GSM/EDGE Output Power

Band	Frequency (MHz)	Channel	GMSK Mode (MCS4)					
			1 Time Slot		2 Time Slots		3 Time Slots	4 Time Slots
			RMS Power (dBm)	Peak Power (dBm)	RMS Power (dBm)	Peak Power (dBm)	Peak Power (dBm)	Peak Power (dBm)
GSM850	824.2	128	32.53	32.68	32.44	32.58	EM7355 is Class 10 for GMSK Mode.	
	836.6	190	32.57	32.71	32.49	32.63		
	848.8	251	32.65	32.78	32.44	32.58		
GSM1900	1850.2	512	29.59	29.76	29.52	29.67		
	1880	661	29.33	29.5	29.25	29.4		
	1909.8	810	29.47	29.64	29.4	29.57		

Band	Frequency (MHz)	Channel	8PSK Mode (MCS9)							
			1 Time Slot		2 Time Slots		3 Time Slots		4 Time Slots	
			RMS Power (dBm)	Peak Power (dBm)	RMS Power (dBm)	Peak Power (dBm)	RMS Power (dBm)	Peak Power (dBm)	RMS Power (dBm)	Peak Power (dBm)
GSM850	824.2	128	27.41	30.5	27.31	30.44	27.19	30.31	27.05	30.21
	836.6	190	27.36	30.4	27.27	30.4	27.14	30.27	27.1	30.25
	848.8	251	27.33	30.45	27.23	30.3	27.22	30.26	27.07	30.22
GSM1900	1850.2	512	25.77	29.03	25.77	29.07	25.67	28.91	25.57	28.91
	1880	661	25.81	29.07	25.73	29	25.65	28.97	25.54	28.68
	1909.8	810	25.63	28.9	25.66	28.93	25.58	28.83	25.47	28.79

SIERRA WIRELESS, INC.

FCC Part 22/24, RSS-132/133	EM7355	Feb. 05, 2013	Page 7 of 21
-----------------------------	--------	---------------	--------------

7 Occupied Bandwidth

FCC 2.1049

7.1 Test Procedure

The transmitter output was connected to a spectrum analyzer through a calibrated coaxial cable and a directional coupler. The occupied bandwidth (defined as the 99% Power Bandwidth) was measured with the spectrum analyzer at low, middle, and high frequencies in each band. The -26dB bandwidth was also measured and recorded. Refer to Test Setup 1.

7.2 Test Results

The following GSM test results are based on single slot, and use coding scheme CS1 for GMSK and MCS9 for 8PSK mode.

7.2.1 GSM Summary Results

Mode		Frequency (MHz)	Channel	99% Occupied Bandwidth (kHz)	Corresponding Plot
GSM / GPRS / EGPRS	GMSK	836.4	189 (mid)	249.65	Plot 7.2.2.1
		1880	661 (mid)	244.41	Plot 7.2.2.3
	EDGE	836.4	189 (mid)	240.10	Plot 7.2.2.2
		1880	661 (mid)	239.97	Plot 7.2.2.4

7.2.2 GSM Test Plots

7.2.2.1 GMSK Occupied Bandwidth, Cell Middle channel, 836.4 MHz, 99% bandwidth

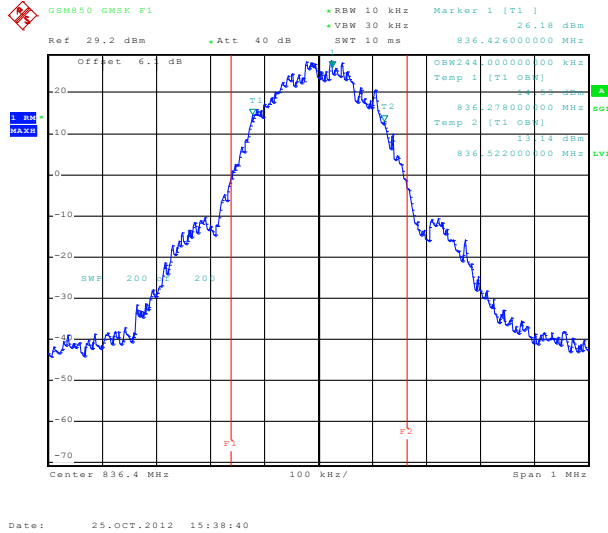

7.2.2.2 8-PSK Occupied Bandwidth, Cell Middle channel, 836.4 MHz, 99% bandwidth

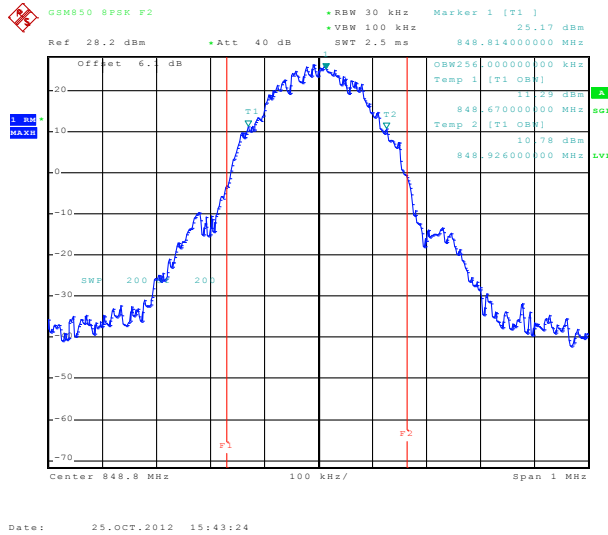

7.2.2.3 GMSK Occupied Bandwidth, PCS Middle channel, 1880.0 MHz, 99% BW

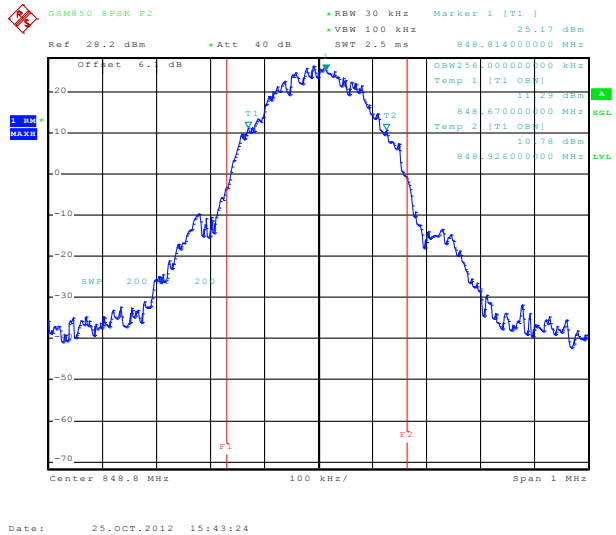

7.2.2.4 8-PSK Occupied Bandwidth, PCS Middle channel, 1880.0 MHz, 99% BW

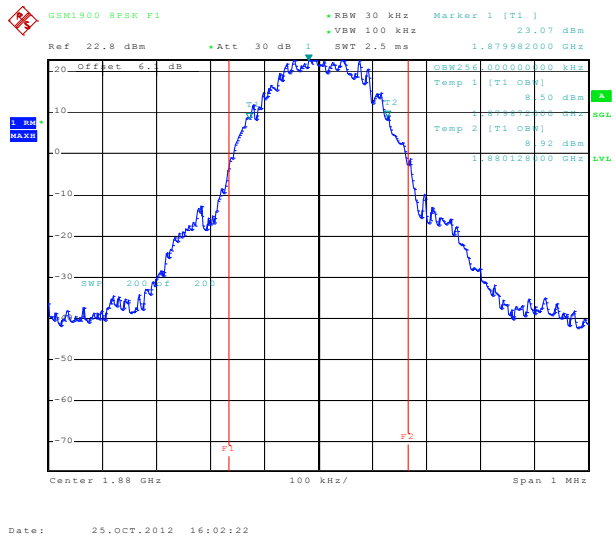

8 Out of Band Emissions at Antenna Terminals

FCC 2.1051, 22.917, 24.238(a)

Out of Band Emissions:

The mean power of emissions must be attenuated below the mean power of the unmodulated carrier (P) on any frequency outside the frequency band by at least (43 + 10 log P) dB. The out of band emission limit translates to a worst case absolute limit of -13dBm in this case.

SIERRA WIRELESS, INC.

8.1 Test Procedure

The RF output of the transmitter was connected to a spectrum analyzer through a calibrated coaxial cable. Sufficient scans were taken to show the out-of-band emissions, if any, up to 10th harmonic. The EUT was scanned for spurious emissions from 1MHz to 20GHz with sufficient bandwidth and video resolution. Data plots are included. Multiple sweeps were recorded in maximum hold mode using a peak detector to ensure that the worst-case emissions were captured. Refer to Test Setup 1.

8.2 Test Results

Mode	Band	Frequency (MHz)	Channel	Corresponding Plot	
GSM / GPRS / EGPRS	GMSK	GSM850	836.6	190 (mid)	Plot 8.2.1.1, Plot 8.2.1.2
		GSM1900	1880	661 (mid)	Plot 8.2.1.5, Plot 8.2.1.7
	EDGE	GSM850	836.6	190 (mid)	Plot 8.2.1.3, Plot 8.2.1.4
		GSM1900	1880	661 (mid)	Plot 8.2.1.8, Plot 8.2.1.10

Refer to the following plots.

The plots below show that the conducted emission limits requirements are met.

8.2.1 GSM Test Plots

8.2.1.1 Out of Band Emissions at Antenna Terminals GMSK, Cell Mid Channel, 836.6 MHz, 30MHz to 1 GHz

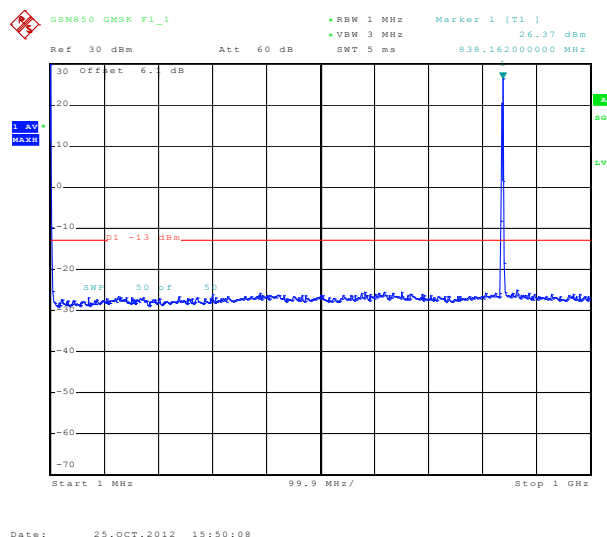

Note: The strong emission shown in each case is the carrier signal.

8.2.1.2 *Out of Band Emissions at Antenna Terminals GMSK, Cell Mid Channel, 836.6 MHz, 1 GHz to 10 GHz*

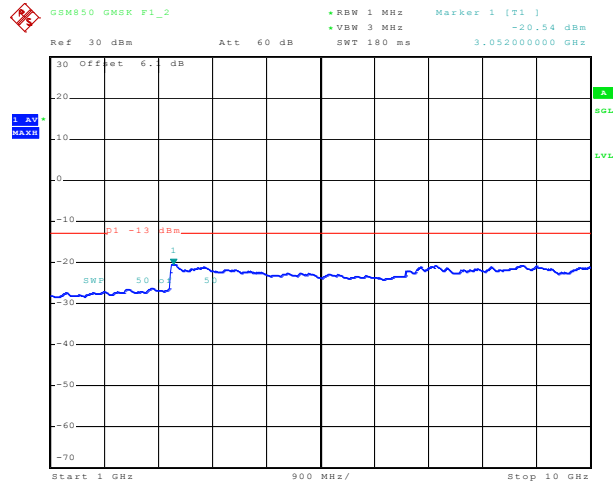

8.2.1.3 *Out of Band Emissions at Antenna Terminals 8-PSK, Cell Mid Channel, 836.6 MHz, 2 Hz to 1 GHz*

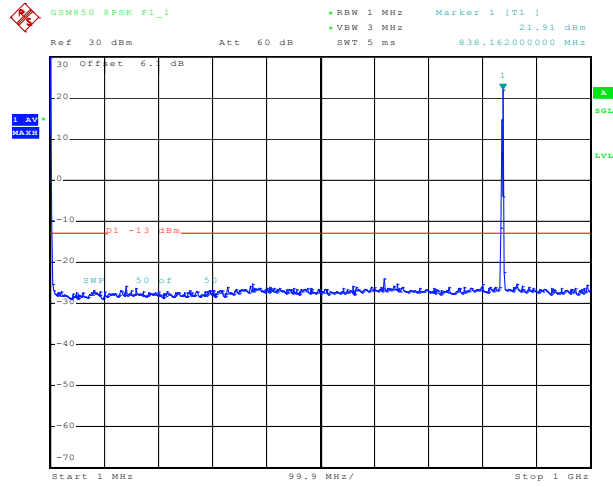

Note: The strong emission shown in each case is the carrier signal.

SIERRA WIRELESS, INC.

8.2.1.4 Out of Band Emissions at Antenna Terminals 8-PSK, Cell Mid Channel, 836.6 MHz, 1 GHz to 10 GHz

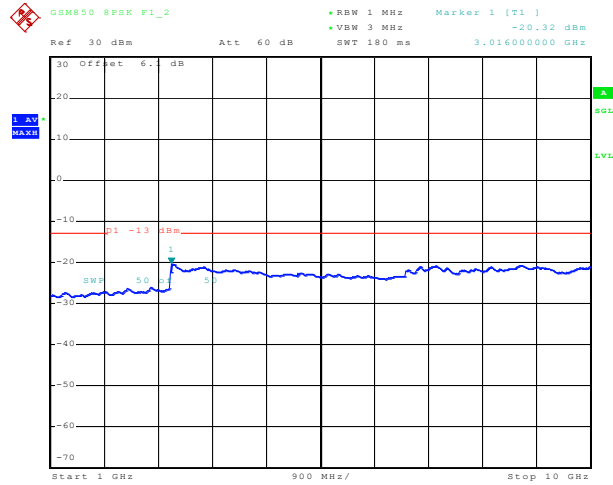

8.2.1.5 Out of Band Emissions at Antenna Terminals GMSK, PCS Middle channel, 1880.0 MHz, 2 Hz to 1 GHz

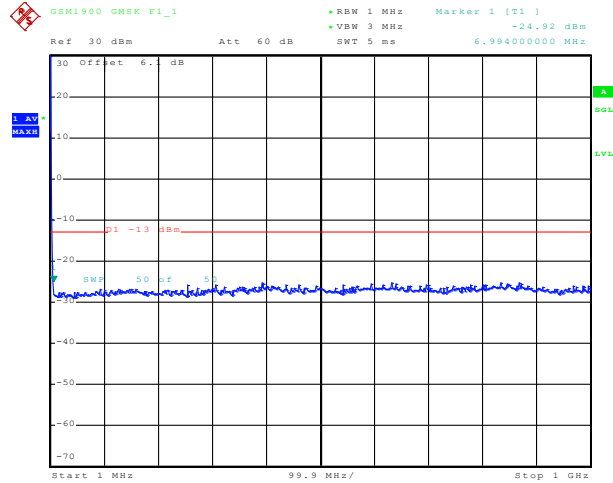

SIERRA WIRELESS, INC.

8.2.1.6 Out of Band Emissions at Antenna Terminals GMSK, PCS Middle channel, 1880.0 MHz, 1 GHz to 10 GHz

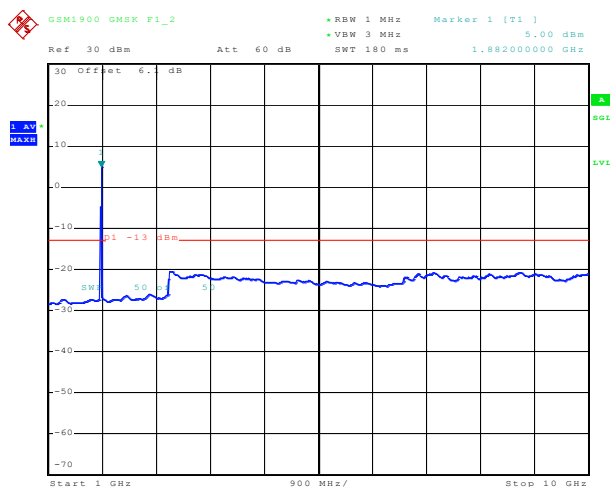

Date: 25.OCT.2012 16:12:07

Note: The strong emission shown is the carrier signal.

8.2.1.7 Out of Band Emissions at Antenna Terminals GMSK, PCS Middle channel, 1880.0 MHz, 10 GHz to 20 GHz

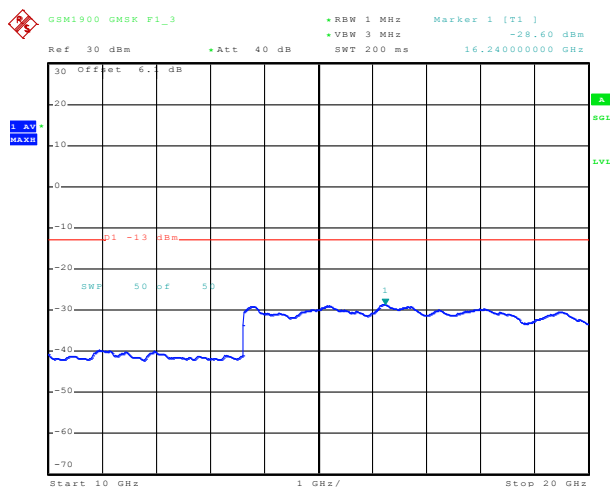

Date: 25.OCT.2012 16:12:41

8.2.1.8 *Out of Band Emissions at Antenna Terminals 8-PSK, PCS Middle channel, 1880.0 MHz, 2 Hz to 1 GHz*

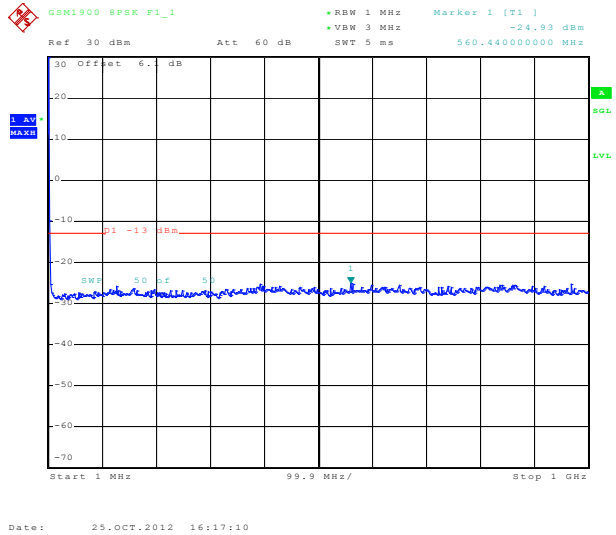

8.2.1.9 *Out of Band Emissions at Antenna Terminals 8-PSK, PCS Middle channel, 1880.0 MHz, 1GHz to 10 GHz*

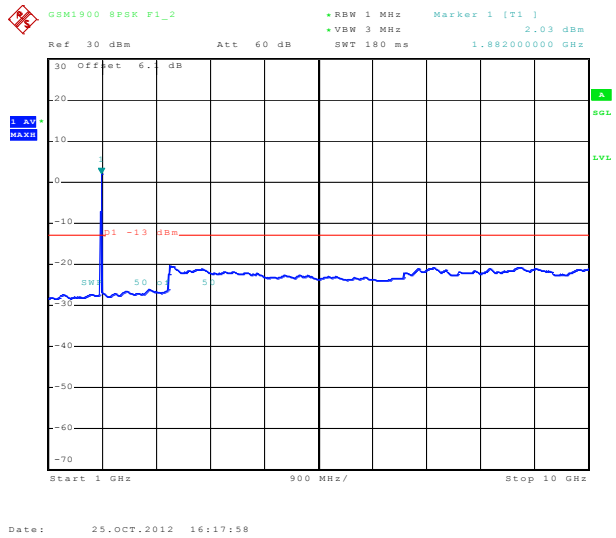

Note: The strong emission shown is the carrier signal.

8.2.1.10 Out of Band Emissions at Antenna Terminals 8-PSK, PCS Middle channel, 1880.0 MHz, 10GHz to 20 GHz

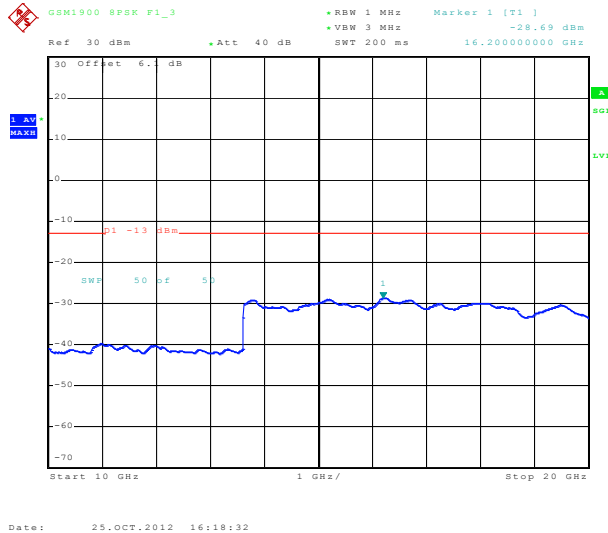

9 Block Edge Compliance

FCC Part 2.1051, 22.917, 24.238

9.1 Test Procedure

The transmitter output was connected to a Rohde & Schwarz Radio Communication Tester, through a coaxial RF cable and a directional coupler, and configured to operate at maximum power. The block edge emissions were measured at the required operating frequencies in each band on the Spectrum Analyzer. Refer to Test Setup 1.

9.2 Test Results

Block Test	Frequency Boundaries (MHz)	Channels Tested	Channel Frequencies (MHz)	Corresponding Plots	Result
GMSK	Below 824 MHz, above 849 MHz	128, 251	824.2, 848.8	9.2.1.1, 9.2.1.2	Complies
	Below 1850MHz, above 1910MHz	512, 810	1850.2, 1909.8	9.2.1.5, 9.2.1.6	Complies
8PSK	Below 824 MHz, above 849 MHz	128, 251	824.2, 848.8	9.2.1.3, 9.2.1.4	Complies
	Below 1850MHz, above 1910MHz	512, 810	1850.2, 1909.8	9.2.1.7, 9.2.1.8	Complies

SIERRA WIRELESS, INC.

9.2.1 GSM Test Plots

9.2.1.1 GSMK; Cellular low channel, below 824 MHz

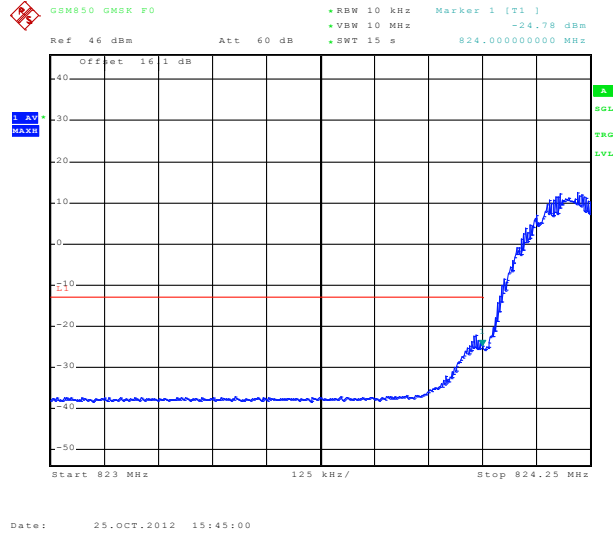

9.2.1.2 GSMK; Cellular high channel, above 849 MHz

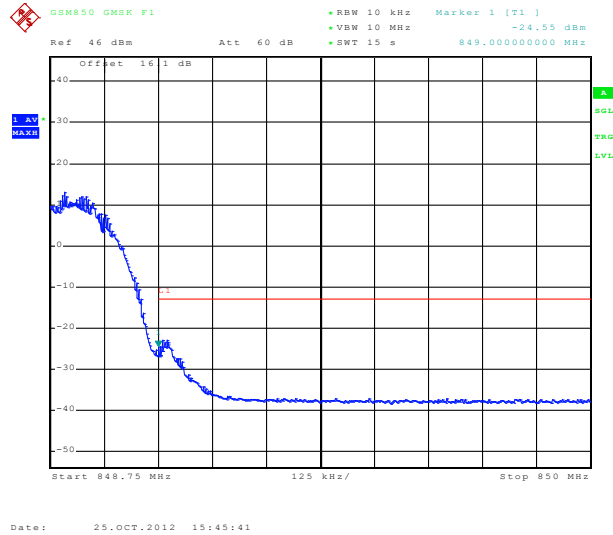

9.2.1.3 8-PSK; Cellular low channel, below 824 MHz

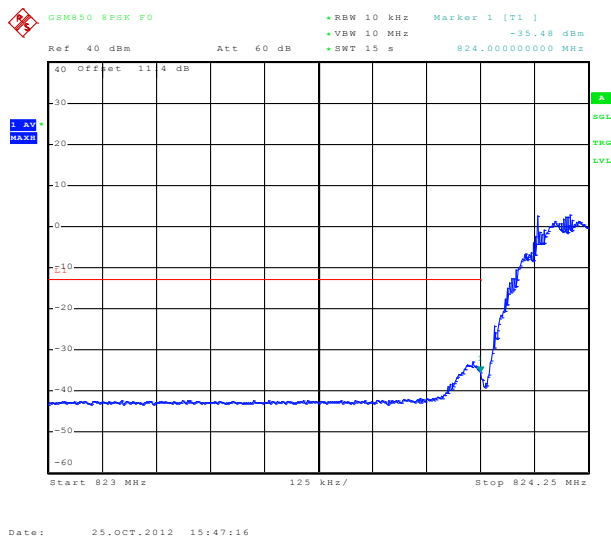

9.2.1.4 8-PSK; Cellular high channel, above 849 MHz

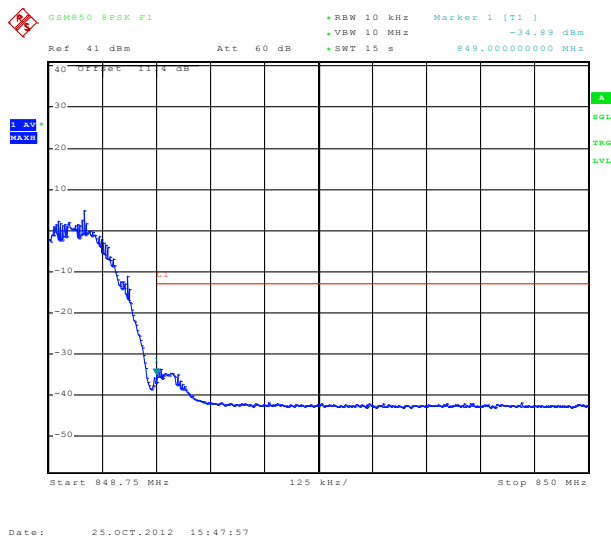

9.2.1.5 GMSK; PCS low channel, below 1850 MHz

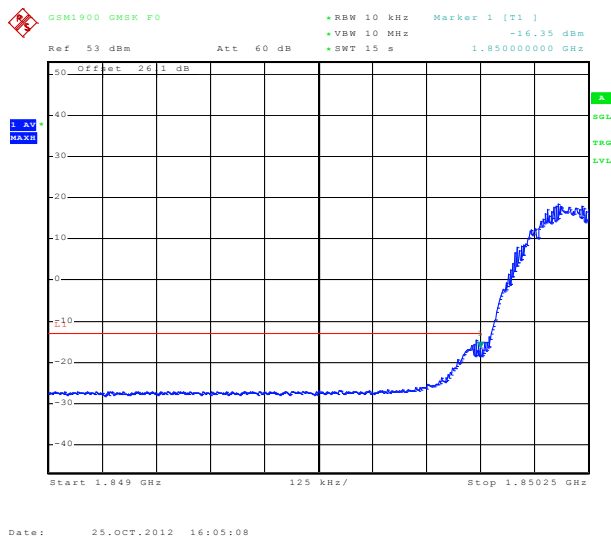

9.2.1.6 GMSK; PCS high channel, above 1910 MHz

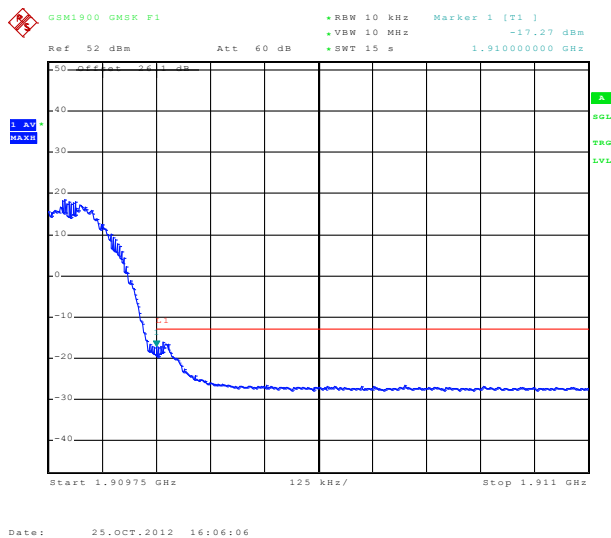

9.2.1.7 8-PSK; PCS low channel, below 1850 MHz

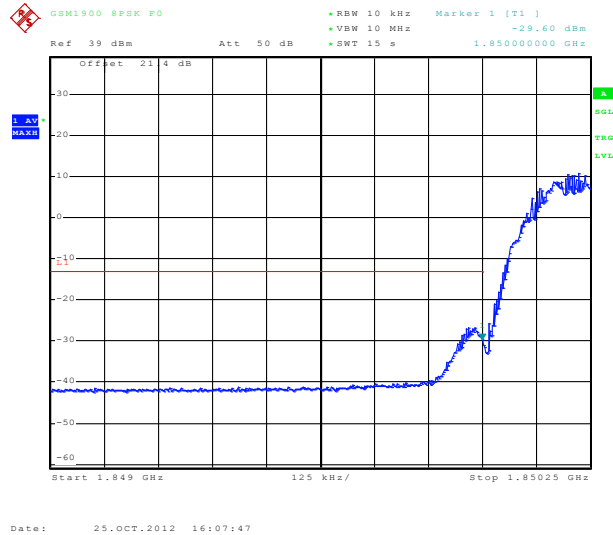

9.2.1.8 8-PSK; PCS high channel, above 1910 MHz

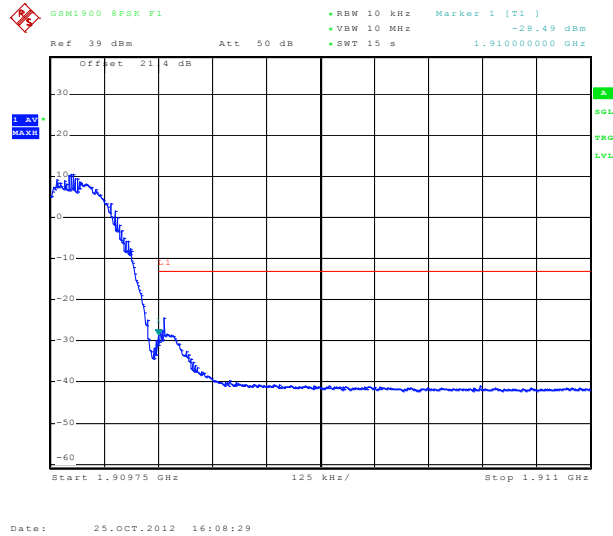

10 Frequency Stability versus Temperature

FCC 2.1055, FCC 22.355, FCC 24.235

10.1 Summary of Results

The EUT's Frequency Stability versus temperature meets the requirements of less than 2.5ppm when temperature varies from -30°C to +50°C.

10.2 Test Procedure

The EUT was placed inside a temperature chamber. The temperature was set to -30°C and maintained to stabilize. After sufficient soak time, the transmitting frequency error was

SIERRA WIRELESS, INC.

FCC Part 22/24, RSS-132/133	EM7355	Feb. 05, 2013	Page 20 of 21
-----------------------------	--------	---------------	---------------

measured. The temperature was then increased by 10 degrees, maintained to stabilize, and the measurement was repeated. This procedure was repeated until +50°C is reached. Frequency metering included internal averaging of the Radio Communication Tester to stabilize the reading. Reference power supply voltage for these tests is 3.7 volts. Refer to Test Setup 2.

10.3 Test Results

10.3.1 GSM Frequency Error over Temperature

Temp (°C)	Cellular Band: 824MHz to 848MHz				PCS Band: 1850MHz to 1910MHz			
	GMSK Mode		8PSK Mode		GMSK Mode		8PSK Mode	
	Offset (Hz)	Offset (ppm)	Offset (Hz)	Offset (ppm)	Offset (Hz)	Offset (ppm)	Offset (Hz)	Offset (ppm)
-30	-34.09	-0.0407	-34.45	-0.0412	-42.36	-0.0225	-36.35	-0.0193
-20	-31.93	-0.0381	-34.93	-0.0417	-43.68	-0.0232	-33.03	-0.0176
-10	-36.77	-0.0439	-37.65	-0.0450	-43.36	-0.0231	-35.03	-0.0186
0	-37.84	-0.0452	-39.71	-0.0474	-16.5	-0.0088	-30.96	-0.0165
10	-41.68	-0.0498	-37.58	-0.0449	-42.71	-0.0227	-32.96	-0.0175
20	-33.16	-0.0396	-32.45	-0.0388	-41.33	-0.0220	-35.71	-0.0190
30	-28.67	-0.0343	-35.81	-0.0428	-8.17	-0.0043	-30.35	-0.0161
40	-36.64	-0.0438	-20.47	-0.0245	-37.77	-0.0201	-29.38	-0.0156
50	-24.76	-0.0296	-24.99	-0.0299	-35.51	-0.0189	-35.55	-0.0189

11 Frequency Stability versus Voltage

FCC 2.1055, FCC 22.355, FCC 24.235

11.1 Summary of Results

The EUT is specified to operate with a supply voltage varying between 3.0 VDC and 4.2 VDC, having a nominal voltage of 3.7 VDC. It meets the frequency stability limit of less than 2.5ppm when supply voltage varies within the specified limits. Operation above or below these voltage limits is prohibited by firmware in order to prevent improper operation.

11.2 Test Procedure

The EUT was connected to a DC Power Supply and a Radio Communication Tester with frequency error measurement capability. The power supply output was adjusted to the test voltage as measured at the input terminals to the device while transmitting. A voltmeter was used to confirm the terminal voltage. The peak frequency error is recorded (worst case). The test voltages are 3.0 volts to 4.2 volts. Refer to Test Setup 2.

SIERRA WIRELESS, INC.

11.3 Test Results

11.3.1 GSM Frequency Error over Voltage

Voltage (V)	Cellular Band: 824MHz to 848MHz				PCS Band: 1850MHz to 1910MHz			
	GMSK Mode		8PSK Mode		GMSK Mode		8PSK Mode	
	Offset (Hz)	Offset (ppm)	Offset (Hz)	Offset (ppm)	Offset (Hz)	Offset (ppm)	Offset (Hz)	Offset (ppm)
3	-15.88	-0.0190	-22.37	-0.0267	7.85	0.0042	-49.72	-0.0264
3.7	-19.44	-0.0232	-33.77	-0.0403	-11.11	-0.0059	-50.21	-0.0267
4.2	-32.67	-0.0390	-33.71	-0.0403	-21.18	-0.0113	-50.46	-0.0268