



FCC RADIO TEST REPORT

FCC ID : UZ7ET51CT
Equipment : Tablet
Brand Name : Zebra
Model name : ET51CT
Applicant : Zebra Technologies Corporation
1 Zebra Plaza, Holtsville, NY 11742
Manufacturer : Zebra Technologies Corporation
1 Zebra Plaza, Holtsville, NY 11742
Standard : FCC Part 15 Subpart E §15.407

The product was received on Jun. 16, 2019 and testing was started from Jun. 30, 2019 and completed on Jul. 29, 2019. We, SPORTON INTERNATIONAL INC., EMC & Wireless Communications Laboratory, would like to declare that the tested sample has been evaluated in accordance with the test procedures and has been in compliance with the applicable technical standards.

The report must not be used by the client to claim product certification, approval, or endorsement by TAF or any agency of government.

The test results in this report apply exclusively to the tested model / sample. Without written approval of SPORTON INTERNATIONAL INC. EMC & Wireless Communications Laboratory, the test report shall not be reproduced except in full.

Louis Wu

Approved by: Louis Wu

SPORTON INTERNATIONAL INC. EMC & Wireless Communications Laboratory
No. 52, Huaya 1st Rd., Guishan Dist., Taoyuan City, Taiwan (R.O.C.)



Table of Contents

History of this test report.....	3
Summary of Test Result.....	4
1 General Description	5
1.1 Product Feature of Equipment Under Test.....	5
1.2 Product Specification of Equipment Under Test.....	6
1.3 Modification of EUT	7
1.4 Testing Location	8
1.5 Applicable Standards.....	8
2 Test Configuration of Equipment Under Test	9
2.1 Carrier Frequency and Channel	9
2.2 Test Mode.....	10
2.3 Connection Diagram of Test System.....	16
2.4 Support Unit used in test configuration and system	17
2.5 EUT Operation Test Setup	17
2.6 Measurement Results Explanation Example.....	17
3 Test Result	18
3.1 6dB and 26dB and 99% Occupied Bandwidth Measurement	18
3.2 Maximum Conducted Output Power Measurement	24
3.3 Power Spectral Density Measurement	27
3.4 Unwanted Emissions Measurement.....	33
3.5 AC Conducted Emission Measurement.....	39
3.6 Automatically Discontinue Transmission	41
3.7 Antenna Requirements.....	42
4 List of Measuring Equipment.....	44
5 Uncertainty of Evaluation.....	46
Appendix A. AC Conducted Emission Test Result	
Appendix B. Radiated Spurious Emission	
Appendix C. Radiated Spurious Emission Plots	
Appendix D. Duty Cycle Plots	
Appendix E. Setup Photographs	



Summary of Test Result

Report Clause	Ref Std. Clause	Test Items	Result (PASS/FAIL)	Remark
3.1	15.403 (i)	6dB & 26dB Bandwidth	Pass	-
3.1	2.1049	99% Occupied Bandwidth	Reporting only	-
3.2	15.407 (a)	Maximum Conducted Output Power	Pass	-
3.3	15.407 (a)	Power Spectral Density	Pass	-
3.4	15.407(b)	Unwanted Emissions	Pass	Under limit 6.17 dB at 53.280 MHz
3.5	15.207	AC Conducted Emission	Pass	Under limit 7.20 dB at 13.560 MHz
3.6	15.407 (c)	Automatically Discontinue Transmission	Pass	-
3.7	15.203 & 15.407 (a)	Antenna Requirement	Pass	-

Declaration of Conformity:

The test results with all measurement uncertainty excluded are presented in accordance with the regulation limits or requirements declared by manufacturers.

Comments and Explanations:

The declared of product specification for EUT presented in the report are provided by the manufacturer, and the manufacturer takes all the responsibilities for the accuracy of product specification.

Reviewed by: Wii Chang

Report Producer: Ann Lee



1 General Description

1.1 Product Feature of Equipment Under Test

Product Feature	
Equipment	Tablet
Brand Name	Zebra
Model Name	ET51CT
FCC ID	UZ7ET51CT
EUT supports Radios application	NFC WLAN 11a/b/g/n HT20/HT40 WLAN 11ac VHT20/VHT40/VHT80 Bluetooth BR/EDR/LE
HW Version	DV2
SW Version	Android version 8.1.0
FW Version	01-20-16-00-OG-U00-PRD
FW Version for TXBF	01-20-19-00-OG-U00-PLT
MFD	19JUN20
EUT Stage	Identical Prototype

Remark: The above EUT's information was declared by manufacturer.

Specification of Accessories				
Spare Standard Battery 36.75Wh	Brand Name	Zebra	Model Name	BT-000394

Supported Unit Used in Test Configuration and System				
Cradle (Dock) for EMC	Brand Name	Zebra	Part Number	CRD-ET5X-1SCG1
Cradle (Dock) for RSE	Brand Name	Zebra	Part Number	CHG-ET5X-CBL1-01
Adapter	Brand Name	Zebra	Part Number	PWRBGA12V50W0WW
DC Cable	Brand Name	Zebra	Part Number	CBL-DC-388A1-01



1.2 Product Specification of Equipment Under Test

Standards-related Product Specification	
Tx/Rx Channel Frequency Range	5745 MHz ~ 5825 MHz
Maximum Output Power <CDD Modes>	<p><Ant. 1> 802.11a : 19.80 dBm / 0.0955 W 802.11n HT20 : 19.60 dBm / 0.0912 W 802.11n HT40 : 18.80 dBm / 0.0759 W 802.11ac VHT20: 19.70 dBm / 0.0933 W 802.11ac VHT40: 18.90 dBm / 0.0776 W 802.11ac VHT80: 19.10 dBm / 0.0813 W</p> <p><Ant. 2> 802.11a : 19.80 dBm / 0.0955 W 802.11n HT20 : 19.60 dBm / 0.0912 W 802.11n HT40 : 18.60 dBm / 0.0724 W 802.11ac VHT20: 19.70 dBm / 0.0933 W 802.11ac VHT40: 18.70 dBm / 0.0741 W 802.11ac VHT80: 19.10 dBm / 0.0813 W</p> <p>MIMO <Ant. 1 + 2> 802.11a : 22.91 dBm / 0.1954 W 802.11n HT20 : 22.71 dBm / 0.1866 W 802.11n HT40 : 21.76 dBm / 0.1500 W 802.11ac VHT20: 22.81 dBm / 0.1910 W 802.11ac VHT40: 21.86 dBm / 0.1535 W 802.11ac VHT80: 22.16 dBm / 0.1644 W</p>
Maximum Output Power <TXBF Modes>	<p>MIMO <Ant. 1 + 2> 802.11ac VHT20: 22.57 dBm / 0.1807 W 802.11ac VHT40: 21.61 dBm / 0.1449 W 802.11ac VHT80: 22.36 dBm / 0.1722 W</p>
99% Occupied Bandwidth <CDD Modes>	<p><Ant. 1> 802.11a : 17.50 MHz 802.11ac VHT20 : 18.20 MHz 802.11ac VHT40 : 36.70 MHz 802.11ac VHT80 : 76.92 MHz</p> <p><Ant. 2> 802.11a : 16.90 MHz 802.11ac VHT20 : 18.00 MHz 802.11ac VHT40 : 36.60 MHz 802.11ac VHT80 : 77.04 MHz</p> <p>MIMO <Ant. 1> 802.11a : 17.10 MHz 802.11ac VHT20 : 18.20 MHz 802.11ac VHT40 : 36.70 MHz 802.11ac VHT80 : 76.80 MHz</p> <p>MIMO <Ant. 2> 802.11a : 16.75 MHz 802.11ac VHT20 : 17.90 MHz 802.11ac VHT40 : 36.60 MHz 802.11ac VHT80 : 76.80 MHz</p>



Standards-related Product Specification													
99% Occupied Bandwidth <TXBF Modes>	MIMO <Ant. 1> 802.11ac VHT20 : 17.95 MHz 802.11ac VHT40 : 36.70 MHz 802.11ac VHT80 : 76.92 MHz MIMO <Ant. 2> 802.11ac VHT20 : 18.75 MHz 802.11ac VHT40 : 36.60 MHz 802.11ac VHT80 : 76.92 MHz												
Antenna Type / Gain	<Ant. 1> : Chip Antenna with gain 2.60 dBi <Ant. 2> : Chip Antenna with gain 2.87 dBi												
Type of Modulation	802.11a/n : OFDM (BPSK / QPSK / 16QAM / 64QAM) 802.11ac : OFDM (BPSK / QPSK / 16QAM / 64QAM / 256QAM)												
Antenna Function Description	<table border="1"> <thead> <tr> <th></th> <th>Ant. 1</th> <th>Ant. 2</th> </tr> </thead> <tbody> <tr> <td>802.11 a/n/ac</td> <td>V</td> <td>V</td> </tr> <tr> <td>802.11 a/n/ac MIMO</td> <td>V</td> <td>V</td> </tr> <tr> <td>802.11ac TXBF</td> <td>V</td> <td>V</td> </tr> </tbody> </table>		Ant. 1	Ant. 2	802.11 a/n/ac	V	V	802.11 a/n/ac MIMO	V	V	802.11ac TXBF	V	V
	Ant. 1	Ant. 2											
802.11 a/n/ac	V	V											
802.11 a/n/ac MIMO	V	V											
802.11ac TXBF	V	V											

Note: MIMO Ant. 1+2 is a calculated result from sum of the power MIMO Ant. 1 and MIMO Ant. 2.

1.3 Modification of EUT

No modifications are made to the EUT during all test items.



1.4 Testing Location

Test Site	SPORTON INTERNATIONAL INC. EMC & Wireless Communications Laboratory	
Test Site Location	No.52, Huaya 1st Rd., Guishan Dist., Taoyuan City, Taiwan (R.O.C.) TEL: +886-3-327-3456 FAX: +886-3-328-4978	
Test Site No.	Sporton Site No.	
	TH05-HY	CO05-HY

Note: The test site complies with ANSI C63.4 2014 requirement.

Test Site	SPORTON INTERNATIONAL INC. EMC & Wireless Communications Laboratory	
Test Site Location	No.58, Aly. 75, Ln. 564, Wenhua 3rd, Rd., Guishan Dist., Taoyuan City, Taiwan (R.O.C.) TEL: +886-3-327-0868 FAX: +886-3-327-0855	
Test Site No.	Sporton Site No.	
	03CH11-HY	

Note: The test site complies with ANSI C63.4 2014 requirement.

FCC designation No.: TW1190 and TW0007

1.5 Applicable Standards

According to the specifications of the manufacturer, the EUT must comply with the requirements of the following standards:

- ♦ FCC Part 15 Subpart E
- ♦ FCC KDB 789033 D02 General UNII Test Procedures New Rules v02r01.
- ♦ FCC KDB 414788 D01 Radiated Test Site v01r01.
- ♦ FCC KDB 662911 D01 Multiple Transmitter Output v02r01.
- ♦ ANSI C63.10-2013

Remark:

1. All test items were verified and recorded according to the standards and without any deviation during the test.
2. This EUT has also been tested and complied with the requirements of FCC Part 15, Subpart B, recorded in a separate test report.



2 Test Configuration of Equipment Under Test

- a. The EUT has been associated with peripherals and configuration operated in a manner tended to maximize its emission characteristics in a typical application. Frequency range investigated: conduction emission (150 kHz to 30 MHz), radiation emission (9 kHz to the 10th harmonic of the highest fundamental frequency or to 40 GHz, whichever is lower). For radiated measurement, pre-scanned in three orthogonal panels, X, Y, Z. The worst cases (X plane) were recorded in this report.
- b. AC power line Conducted Emission was tested under maximum output power.

2.1 Carrier Frequency and Channel

Frequency Band	Channel	Freq. (MHz)	Channel	Freq. (MHz)
5725-5850 MHz Band 4 (U-NII-3)	149	5745	157	5785
	151*	5755	159*	5795
	153	5765	161	5805
	155 [#]	5775	165	5825

Note:

1. The above Frequency and Channel in "*" were 802.11n HT40 and 802.11ac VHT40.
2. The above Frequency and Channel in "[#]" were 802.11ac VHT80.



2.2 Test Mode

Final test modes are considering the modulation and worse data rates as below table.

Single Mode

Modulation	Data Rate
802.11a	6 Mbps
802.11n HT20 (Covered by VHT20)	MCS0
802.11n HT40 (Covered by VHT40)	MCS0
802.11ac VHT20	MCS0
802.11ac VHT40	MCS0
802.11ac VHT80	MCS0

MIMO Mode

Modulation	Data Rate
802.11a	6 Mbps
802.11n HT20 (Covered by VHT20)	MCS0
802.11n HT40 (Covered by VHT40)	MCS0
802.11ac VHT20	MCS0
802.11ac VHT40	MCS0
802.11ac VHT80	MCS0

TXBF Mode

Modulation	Data Rate
802.11ac VHT20	MCS0
802.11ac VHT40	MCS0
802.11ac VHT80	MCS0



Test Cases	
AC Conducted Emission	Mode 1 : WLAN (5GHz) Link + Bluetooth Link + USB Type C Cable with LCD Monitor + Adapter (PWRBGA12V50W0WW) with DC cable (CBL-DC-388A1-01) + Rear Camera + NFC On + SD Card (Play MP3) + Dock (CRD-ET5X-1SCG1) (Charging with EUT)

<CDD Mode>

Ch. #		Band IV : 5725-5850 MHz			
		802.11a	802.11ac VHT20	802.11ac VHT40	802.11ac VHT80
L	Low	149	149	151	-
M	Middle	157	157	-	155
H	High	165	165	159	-

<TXBF Mode>

Ch. #		Band IV : 5725-5850 MHz		
		802.11ac VHT20	802.11ac VHT40	802.11ac VHT80
L	Low	149	151	-
M	Middle	157	-	155
H	High	165	159	-



<CDD Mode>

<Ant. 1>

802.11a RF Output Power (dBm)										
Power vs. Channel			Power vs Data Rate							
Channel	Frequency (MHz)	Data Rate (bps)	channel	Data Rate (bps)						
		6M		9M	12M	18M	24M	36M	48M	54M
CH 149	5745	19.70	CH 165	19.70	19.60	19.70	19.70	19.70	19.70	19.70
CH 157	5785	19.70								
CH 165	5825	19.80								

802.11n HT20 RF Output Power (dBm)										
Power vs. Channel			Power vs Data Rate							
Channel	Frequency (MHz)	MCS Index	channel	MCS Index						
		MCS0		MCS1	MCS2	MCS3	MCS4	MCS5	MCS6	MCS7
CH 149	5745	19.50	CH 165	19.50	19.50	19.50	19.50	19.50	19.50	19.50
CH 157	5785	19.50								
CH 165	5825	19.60								

802.11n HT40 RF Output Power (dBm)										
Power vs. Channel			Power vs Data Rate							
Channel	Frequency (MHz)	MCS Index	channel	MCS Index						
		MCS0		MCS1	MCS2	MCS3	MCS4	MCS5	MCS6	MCS7
CH 151	5755	18.80	CH 151	18.70	18.70	18.70	18.70	18.70	18.70	18.70
CH 159	5795	18.70								

802.11ac VHT20 RF Output Power (dBm)											
Power vs. Channel			Power vs Data Rate								
Channel	Frequency (MHz)	MCS Index	channel	MCS Index							
		MCS0		MCS1	MCS2	MCS3	MCS4	MCS5	MCS6	MCS7	MCS8
CH 149	5745	19.60	CH 165	19.60	19.60	19.50	19.60	19.60	19.60	19.50	19.60
CH 157	5785	19.60									
CH 165	5825	19.70									

802.11ac VHT40 RF Output Power (dBm)												
Power vs. Channel			Power vs Data Rate									
Channel	Frequency (MHz)	MCS Index	channel	MCS Index								
		MCS0		MCS1	MCS2	MCS3	MCS4	MCS5	MCS6	MCS7	MCS8	MCS9
CH 151	5755	18.90	CH 151	18.80	18.80	18.80	18.70	18.80	18.80	18.80	18.70	18.80
CH 159	5795	18.80										

802.11ac VHT80 RF Output Power (dBm)													
Power vs. Channel			Power vs Data Rate										
Channel	Frequency (MHz)	MCS Index	channel	MCS Index									
		MCS0		MCS1	MCS2	MCS3	MCS4	MCS5	MCS6	MCS7	MCS8	MCS9	
CH155	5775	19.10	CH155	19.00	19.00	19.00	19.00	19.00	19.00	19.00	19.00	19.00	19.00



<Ant. 2>

802.11a RF Output Power (dBm)										
Power vs. Channel			Power vs Data Rate							
Channel	Frequency (MHz)	Data Rate (bps)	channel	Data Rate (bps)						
		6M		9M	12M	18M	24M	36M	48M	54M
CH 149	5745	19.70	CH 157	19.70	19.70	19.60	19.60	19.70	19.70	19.70
CH 157	5785	19.80								
CH 165	5825	19.70								

802.11n HT20 RF Output Power (dBm)										
Power vs. Channel			Power vs Data Rate							
Channel	Frequency (MHz)	MCS Index	channel	MCS Index						
		MCS0		MCS1	MCS2	MCS3	MCS4	MCS5	MCS6	MCS7
CH 149	5745	19.50	CH 157	19.50	19.50	19.50	19.40	19.50	19.40	19.50
CH 157	5785	19.60								
CH 165	5825	19.50								

802.11n HT40 RF Output Power (dBm)										
Power vs. Channel			Power vs Data Rate							
Channel	Frequency (MHz)	MCS Index	channel	MCS Index						
		MCS0		MCS1	MCS2	MCS3	MCS4	MCS5	MCS6	MCS7
CH 151	5755	18.60	CH 151	18.50	18.50	18.50	18.50	18.50	18.50	18.50
CH 159	5795	18.50								

802.11ac VHT20 RF Output Power (dBm)										
Power vs. Channel			Power vs Data Rate							
Channel	Frequency (MHz)	MCS Index	channel	MCS Index						
		MCS0		MCS1	MCS2	MCS3	MCS4	MCS5	MCS6	MCS7
CH 149	5745	19.60	CH 157	19.60	19.50	19.50	19.60	19.60	19.60	19.60
CH 157	5785	19.70								
CH 165	5825	19.60								

802.11ac VHT40 RF Output Power (dBm)										
Power vs. Channel			Power vs Data Rate							
Channel	Frequency (MHz)	MCS Index	channel	MCS Index						
		MCS0		MCS1	MCS2	MCS3	MCS4	MCS5	MCS6	MCS7
CH 151	5755	18.70	CH 151	18.60	18.60	18.60	18.60	18.60	18.60	18.50
CH 159	5795	18.60								

802.11ac VHT80 RF Output Power (dBm)												
Power vs. Channel			Power vs Data Rate									
Channel	Frequency (MHz)	MCS Index	channel	MCS Index								
		MCS0		MCS1	MCS2	MCS3	MCS4	MCS5	MCS6	MCS7	MCS8	MCS9
CH155	5775	19.10	CH155	19.00	19.00	19.00	19.00	19.00	19.00	19.00	19.00	19.00



MIMO <Ant. 1 + 2>

802.11a RF Output Power (dBm)										
Power vs. Channel			Power vs Data Rate							
Channel	Frequency (MHz)	Data Rate (bps)	channel	Data Rate (bps)						
		6M		9M	12M	18M	24M	36M	48M	54M
CH 149	5745	22.91	CH 149	22.81	22.81	22.76	22.76	22.81	22.71	22.71
CH 157	5785	22.91								
CH 165	5825	22.86								

802.11n HT20 RF Output Power (dBm)										
Power vs. Channel			Power vs Data Rate							
Channel	Frequency (MHz)	MCS Index	channel	MCS Index						
		MCS0		MCS1	MCS2	MCS3	MCS4	MCS5	MCS6	MCS7
CH 149	5745	22.66	CH 157	22.61	22.61	22.61	22.56	22.61	22.61	22.56
CH 157	5785	22.71								
CH 165	5825	22.61								

802.11n HT40 RF Output Power (dBm)										
Power vs. Channel			Power vs Data Rate							
Channel	Frequency (MHz)	MCS Index	channel	MCS Index						
		MCS0		MCS1	MCS2	MCS3	MCS4	MCS5	MCS6	MCS7
CH 151	5755	21.66	CH 159	21.66	21.66	21.66	21.66	21.66	21.66	21.66
CH 159	5795	21.76								

802.11ac VHT20 RF Output Power (dBm)											
Power vs. Channel			Power vs Data Rate								
Channel	Frequency (MHz)	MCS Index	channel	MCS Index							
		MCS0		MCS1	MCS2	MCS3	MCS4	MCS5	MCS6	MCS7	MCS8
CH 149	5745	22.76	CH 157	22.71	22.71	22.71	22.71	22.71	22.71	22.71	22.71
CH 157	5785	22.81									
CH 165	5825	22.71									

802.11ac VHT40 RF Output Power (dBm)												
Power vs. Channel			Power vs Data Rate									
Channel	Frequency (MHz)	MCS Index	channel	MCS Index								
		MCS0		MCS1	MCS2	MCS3	MCS4	MCS5	MCS6	MCS7	MCS8	MCS9
CH 151	5755	21.76	CH 159	21.76	21.76	21.76	21.76	21.76	21.71	21.66	21.76	21.76
CH 159	5795	21.86										

802.11ac VHT80 RF Output Power (dBm)												
Power vs. Channel			Power vs Data Rate									
Channel	Frequency (MHz)	MCS Index	channel	MCS Index								
		MCS0		MCS1	MCS2	MCS3	MCS4	MCS5	MCS6	MCS7	MCS8	MCS9
CH155	5775	22.16	CH155	22.06	22.06	22.01	22.06	22.06	22.06	22.06	22.06	22.06



<TXBF Mode>

MIMO <Ant. 1 + 2>

802.11ac VHT20 RF Output Power (dBm)											
Power vs. Channel			Power vs Data Rate								
Channel	Frequency (MHz)	MCS Index	channel	MCS Index							
		MCS0		MCS1	MCS2	MCS3	MCS4	MCS5	MCS6	MCS7	MCS8
CH 149	5745	22.57	CH 149	22.48	22.36	22.32	22.46	22.33	22.23	22.18	22.26
CH 157	5785	22.53									
CH 165	5825	22.37									

802.11ac VHT40 RF Output Power (dBm)												
Power vs. Channel			Power vs Data Rate									
Channel	Frequency (MHz)	MCS Index	channel	MCS Index								
		MCS0		MCS1	MCS2	MCS3	MCS4	MCS5	MCS6	MCS7	MCS8	MCS9
CH 151	5755	21.61	CH 151	21.51	21.45	21.51	21.20	21.23	21.24	21.27	21.21	21.17
CH 159	5795	21.51										

802.11ac VHT80 RF Output Power (dBm)												
Power vs. Channel			Power vs Data Rate									
Channel	Frequency (MHz)	MCS Index	channel	MCS Index								
		MCS0		MCS1	MCS2	MCS3	MCS4	MCS5	MCS6	MCS7	MCS8	MCS9
CH155	5775	22.36	CH155	22.26	22.32	22.31	22.15	22.04	22.15	22.08	22.04	21.94

2.3 Connection Diagram of Test System

<WLAN Tx Mode>

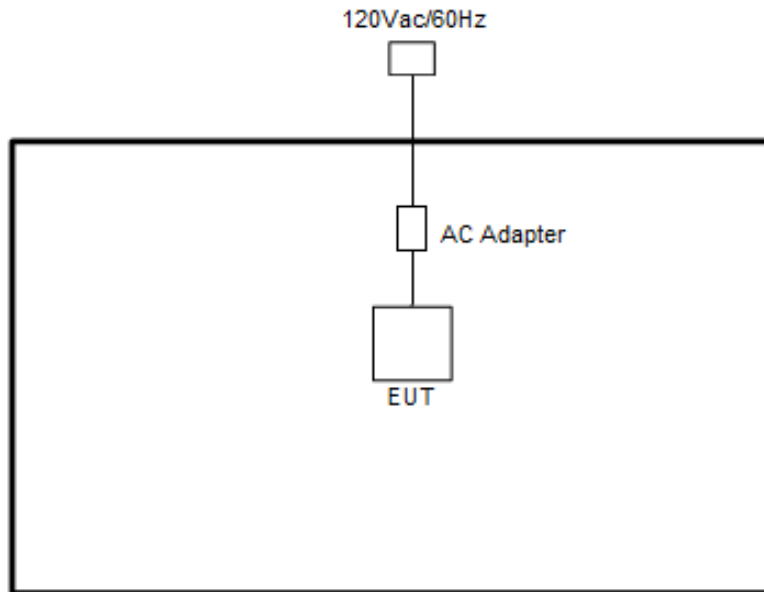

<AC Conducted Emission Mode>

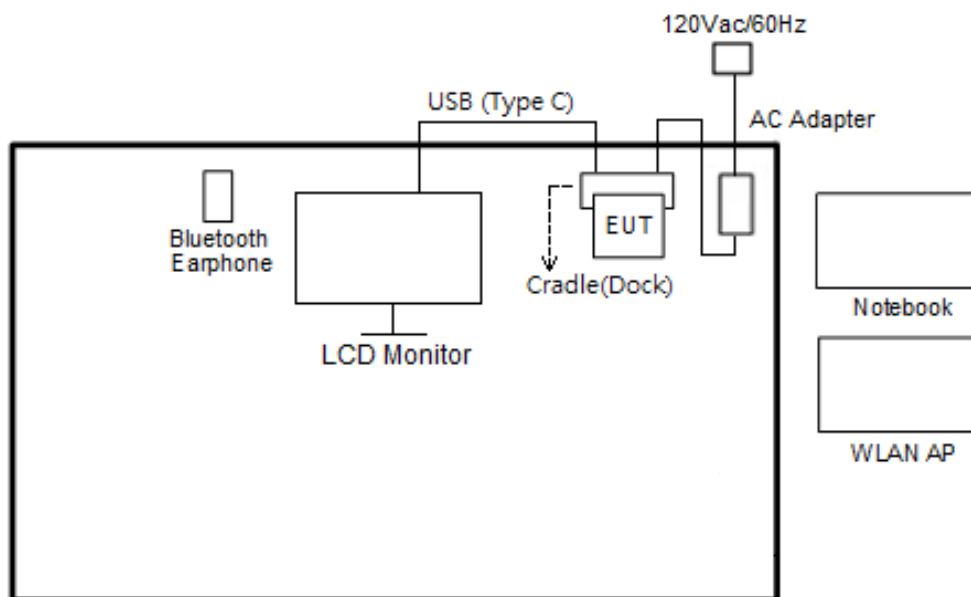



2.4 Support Unit used in test configuration and system

Item	Equipment	Trade Name	Model Name	FCC ID	Data Cable	Power Cord
1.	Bluetooth Earphone	Sony Ericsson	MW600	PY7DDA-2029	N/A	N/A
2.	WLAN AP	ASUS	RT-AC66U	MSQ-RTAC66U	N/A	Unshielded, 1.8 m
3.	Notebook	DELL	Latitude E3340	FCC DoC/ Contains FCC ID: PD97260NGU	N/A	AC I/P: Unshielded, 1.2 m DC O/P: Shielded, 1.8 m
4.	LCD Monitor	DELL	P2715Qt	FCC DoC	Shielded, 1.6 m	Unshielded, 1.8 m

2.5 EUT Operation Test Setup

The RF test items, utility "QRCT v3.0-00271" was installed in Notebook which was programmed in order to make the EUT get into the engineering modes to provide channel selection, power level, data rate and the application type and for continuous transmitting signals.

For TXBF mode, the modulation modes and data rates manipulated by the command lines in the engineering program made the EUT link to another EUT by power under the normal operation. The "adb" software tool was used to enable the EUT to transmit signals continuously.

2.6 Measurement Results Explanation Example

For all conducted test items:

The offset level is set in the spectrum analyzer to compensate the RF cable loss and attenuator factor between EUT conducted output port and spectrum analyzer. With the offset compensation, the spectrum analyzer reading level is exactly the EUT RF output level.

Example :

The spectrum analyzer offset is derived from RF cable loss and attenuator factor.

Offset = RF cable loss + attenuator factor.

Following shows an offset computation example with cable loss 4.2 dB and 10dB attenuator.

Offset(dB) = RF cable loss(dB) + attenuator factor(dB).

$$= 4.2 + 10 = 14.2 \text{ (dB)}$$

3 Test Result

3.1 6dB and 26dB and 99% Occupied Bandwidth Measurement

3.1.1 Description of 6dB and 26dB and 99% Occupied Bandwidth

The minimum 6 dB bandwidth shall be at least 500 kHz.

26dB and 99% Occupied bandwidth are reporting only.

3.1.2 Measuring Instruments

See list of measuring equipment of this test report.

3.1.3 Test Procedures

1. The testing follows FCC KDB 789033 D02 General UNII Test Procedures New Rules v02r01. Section C) Emission bandwidth for the band 5.725-5.85GHz
2. Set RBW = 100kHz.
3. Set the VBW $\geq 3 \times$ RBW.
4. Detector = Peak.
5. Trace mode = max hold
6. Measure the maximum width of the emission that is 6 dB down from the peak of the emission.
7. Measure and record the results in the test report.

3.1.4 Test Setup

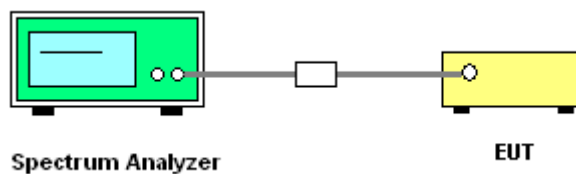



3.1.5 Test Result of 6dB and 26dB and 99% Occupied Bandwidth

<CDD Mode>

Test Engineer :	Shiming Liu	Temperature :	21~25°C
		Relative Humidity :	51~54%

Band IV												
Mod.	Data Rate	NTX	CH.	Freq. (MHz)	99% Bandwidth (MHz)		26dB Bandwidth (MHz)		6 dB Bandwidth (MHz)		6 dB Bandwidth Min. Limit (MHz)	Pass/Fail
					Ant 1	Ant 2	Ant 1	Ant 2	Ant 1	Ant 2		
11a	6Mbps	1	149	5745	16.85	16.85	25.20	24.90	15.90	15.50	0.5	Pass
11a	6Mbps	1	157	5785	16.80	16.90	25.40	25.20	15.45	15.30	0.5	Pass
11a	6Mbps	1	165	5825	17.05	16.85	26.70	25.30	15.05	15.05	0.5	Pass
VHT20	MCS0	1	149	5745	18.00	17.95	26.60	25.75	16.55	15.10	0.5	Pass
VHT20	MCS0	1	157	5785	18.00	18.00	26.90	26.65	16.80	15.95	0.5	Pass
VHT20	MCS0	1	165	5825	18.20	17.95	28.80	25.90	16.50	16.50	0.5	Pass
VHT40	MCS0	1	151	5755	36.70	36.60	41.63	41.76	35.64	35.01	0.5	Pass
VHT40	MCS0	1	159	5795	36.60	36.60	41.65	41.76	35.64	35.42	0.5	Pass
VHT80	MCS0	1	155	5775	76.92	77.04	83.84	84.01	74.01	73.92	0.5	Pass
11a	6Mbps	2	149	5745	16.90	16.70	25.60	24.70	15.55	15.00	0.5	Pass
11a	6Mbps	2	157	5785	16.95	16.75	26.15	25.20	15.30	15.40	0.5	Pass
11a	6Mbps	2	165	5825	17.10	16.75	29.00	25.30	15.30	15.10	0.5	Pass
VHT20	MCS0	2	149	5745	18.05	17.85	27.60	25.50	15.10	16.55	0.5	Pass
VHT20	MCS0	2	157	5785	18.10	17.90	28.20	25.60	15.70	16.50	0.5	Pass
VHT20	MCS0	2	165	5825	18.20	17.90	29.30	25.80	15.95	15.30	0.5	Pass
VHT40	MCS0	2	151	5755	36.70	36.60	41.76	41.94	35.08	35.08	0.5	Pass
VHT40	MCS0	2	159	5795	36.60	36.60	42.48	41.58	35.02	35.64	0.5	Pass
VHT80	MCS0	2	155	5775	76.80	76.80	96.35	83.20	75.05	75.20	0.5	Pass

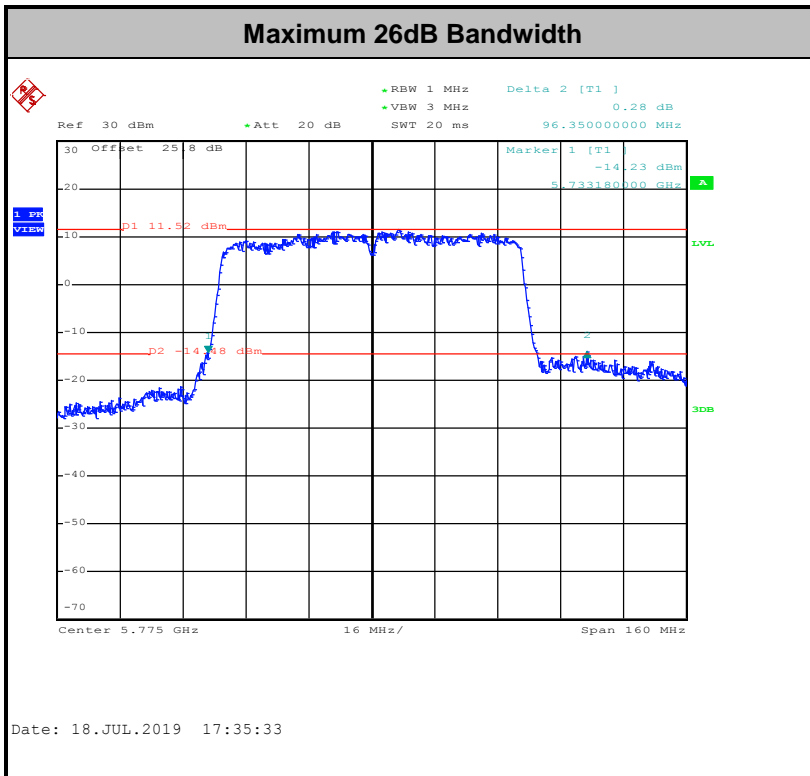
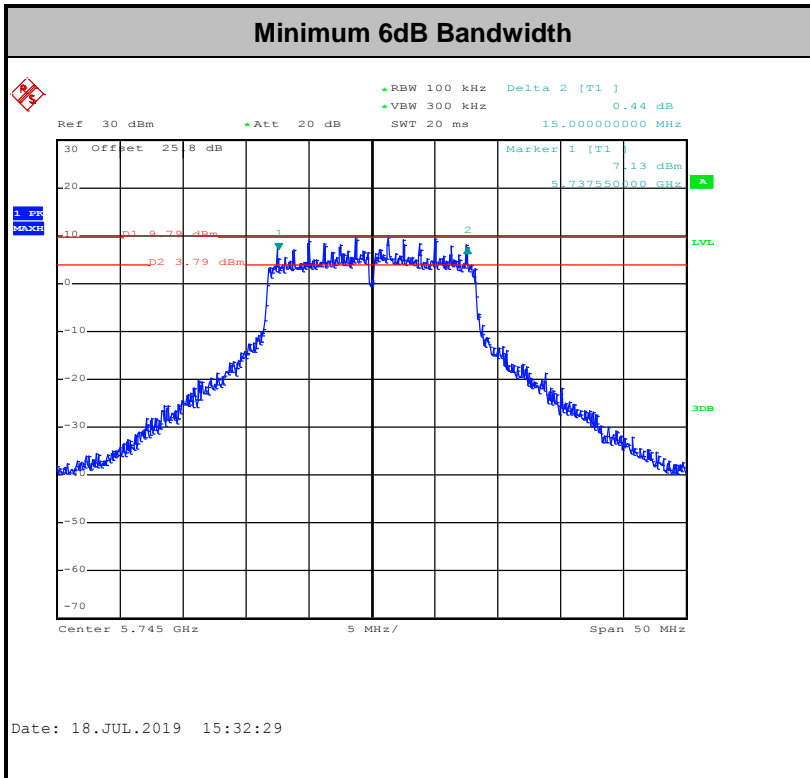

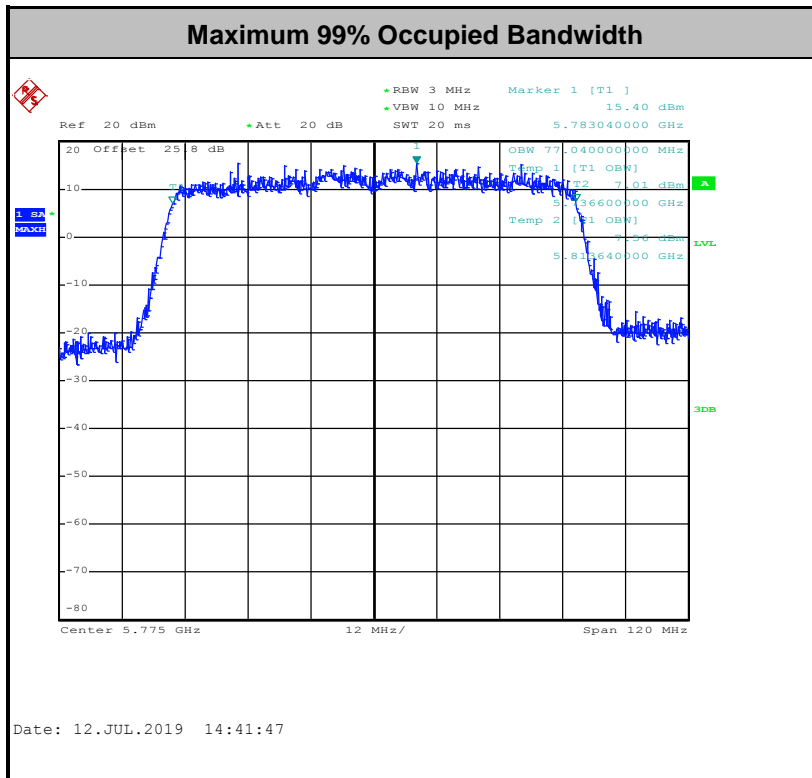

Note: The occupied channel bandwidth is maintained within the band of operation for all of the modulations.



<TXBF Modes>

Test Engineer :	Luffy Lin	Temperature :	21~25°C
		Relative Humidity :	51~54%

Band IV												
Mod.	Data Rate	NTX	CH.	Freq. (MHz)	99% Bandwidth (MHz)		26dB Bandwidth (MHz)		6 dB Bandwidth (MHz)		6 dB Bandwidth Min. Limit (MHz)	Pass/Fail
					Ant 1	Ant 2	Ant 1	Ant 2	Ant 1	Ant 2		
VHT20	MCS0	2	149	5745	17.80	18.60	23.70	27.90	15.80	17.30	0.5	Pass
VHT20	MCS0	2	157	5785	17.75	18.65	25.20	28.50	15.20	17.60	0.5	Pass
VHT20	MCS0	2	165	5825	17.95	18.75	26.30	27.50	15.10	17.70	0.5	Pass
VHT40	MCS0	2	151	5755	36.70	36.50	48.42	42.12	35.28	36.36	0.5	Pass
VHT40	MCS0	2	159	5795	36.60	36.60	56.16	42.66	35.10	36.36	0.5	Pass
VHT80	MCS0	2	155	5775	76.92	76.92	92.16	83.84	74.56	75.84	0.5	Pass

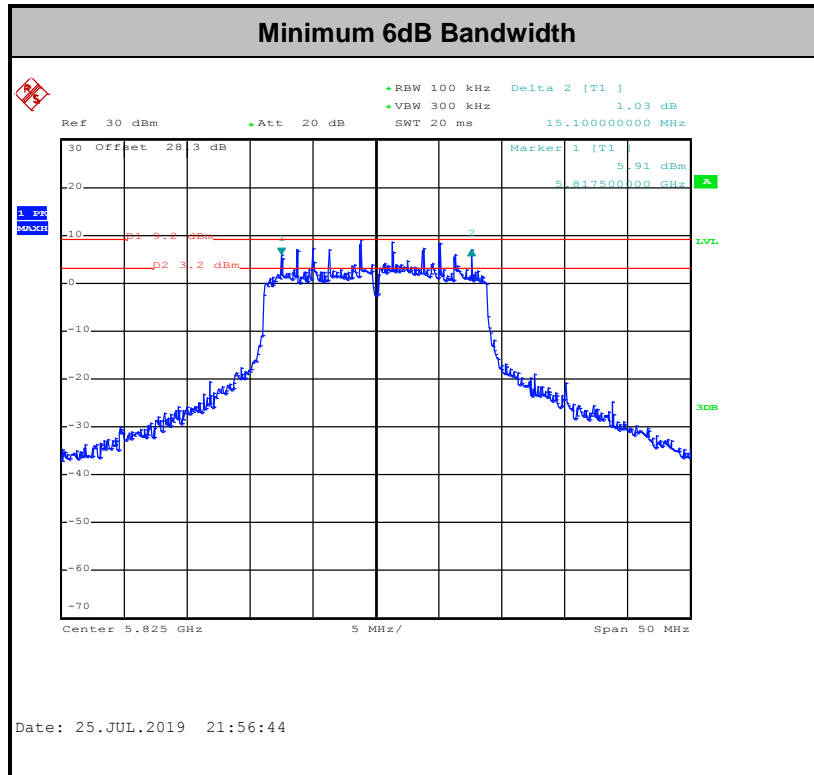

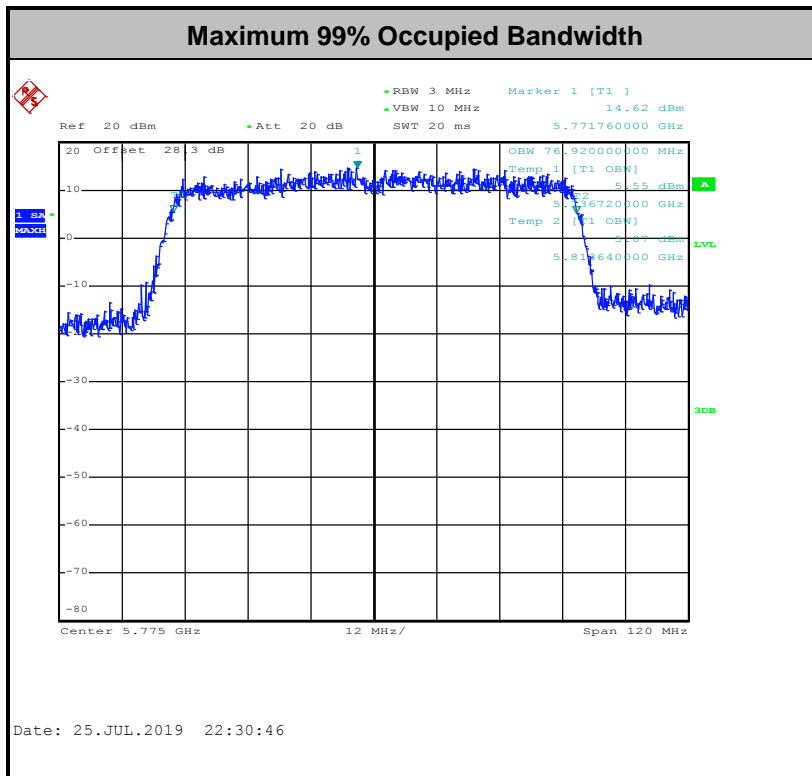
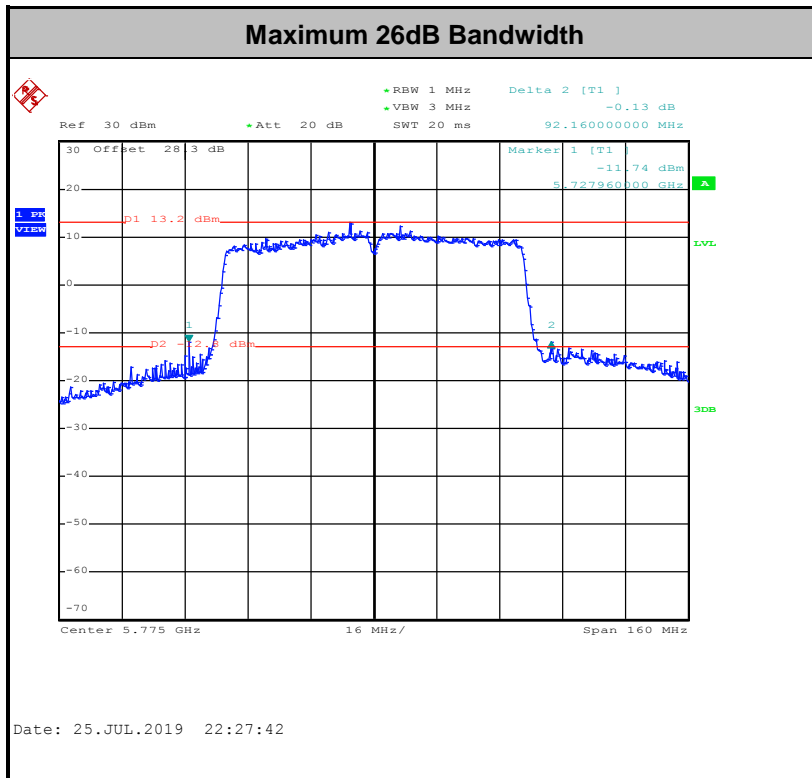

Note: The occupied channel bandwidth is maintained within the band of operation for all of the modulations.

3.2 Maximum Conducted Output Power Measurement

3.2.1 Limit of Maximum Conducted Output Power

For the band 5.725–5.85 GHz, the maximum conducted output power over the frequency band of operation shall not exceed 1 W.

If transmitting antennas of directional gain greater than 6 dBi are used, the peak output power shall be reduced by the amount in dB that the directional gain of the antenna exceeds 6 dBi.

3.2.2 Measuring Instruments

See list of measuring equipment of this test report.

3.2.3 Test Procedures

<CDD Modes>

The testing follows Method PM-G of FCC KDB 789033 D02 General UNII Test Procedures New Rules v02r01.

Method PM-G (Measurement using a gated RF average power meter):

1. Measurement is performed using a wideband RF power meter.
2. The EUT is configured to transmit at its maximum power control level.
3. Measure the average power of the transmitter
4. Since the measurement is made only during the ON time of the transmitter, no duty cycle correction factor is required.

<TXBF Modes>

The testing follows Method PM-G of FCC KDB 789033 D02 General UNII Test Procedures New Rules v02r01 for TXBF modes.

Method PM-G (Measurement using a gated RF average power meter):

1. Measurement is performed using a wideband RF power meter.
2. The EUT is configured to transmit at its maximum power control level.
3. Measure the average power of the transmitter
4. Since the measurement is made only during the ON time of the transmitter, no duty cycle correction factor is required.

3.2.4 Test Setup

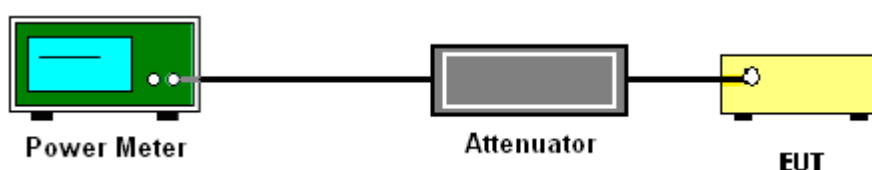



3.2.5 Test Result of Maximum Conducted Output Power

<CDD Mode>

Test Engineer :	Shiming Liu	Temperature :	21~25°C
		Relative Humidity :	51~54%

Band IV												
Mod.	Data Rate	NTX	CH.	Freq. (MHz)	Average Conducted Power (dBm)			FCC Conducted Power Limit (dBm)		DG (dBi)		Pass/Fail
					Ant 1	Ant 2	SUM	Ant 1	Ant 2	Ant 1	Ant 2	
11a	6Mbps	1	149	5745	19.70	19.70		30.00	30.00	2.60	2.87	Pass
11a	6Mbps	1	157	5785	19.70	19.80		30.00	30.00	2.60	2.87	Pass
11a	6Mbps	1	165	5825	19.80	19.70		30.00	30.00	2.60	2.87	Pass
HT20	MCS0	1	149	5745	19.50	19.50		30.00	30.00	2.60	2.87	Pass
HT20	MCS0	1	157	5785	19.50	19.60		30.00	30.00	2.60	2.87	Pass
HT20	MCS0	1	165	5825	19.60	19.50		30.00	30.00	2.60	2.87	Pass
HT40	MCS0	1	151	5755	18.80	18.60		30.00	30.00	2.60	2.87	Pass
HT40	MCS0	1	159	5795	18.70	18.50		30.00	30.00	2.60	2.87	Pass
VHT20	MCS0	1	149	5745	19.60	19.60		30.00	30.00	2.60	2.87	Pass
VHT20	MCS0	1	157	5785	19.60	19.70		30.00	30.00	2.60	2.87	Pass
VHT20	MCS0	1	165	5825	19.70	19.60		30.00	30.00	2.60	2.87	Pass
VHT40	MCS0	1	151	5755	18.90	18.70		30.00	30.00	2.60	2.87	Pass
VHT40	MCS0	1	159	5795	18.80	18.60		30.00	30.00	2.60	2.87	Pass
VHT80	MCS0	1	155	5775	19.10	19.10		30.00	30.00	2.60	2.87	Pass
11a	6Mbps	2	149	5745	19.90	19.90	22.91	30.00		2.87		Pass
11a	6Mbps	2	157	5785	19.90	19.90	22.91	30.00		2.87		Pass
11a	6Mbps	2	165	5825	19.80	19.90	22.86	30.00		2.87		Pass
HT20	MCS0	2	149	5745	19.70	19.60	22.66	30.00		2.87		Pass
HT20	MCS0	2	157	5785	19.60	19.80	22.71	30.00		2.87		Pass
HT20	MCS0	2	165	5825	19.60	19.60	22.61	30.00		2.87		Pass
HT40	MCS0	2	151	5755	18.80	18.50	21.66	30.00		2.87		Pass
HT40	MCS0	2	159	5795	18.90	18.60	21.76	30.00		2.87		Pass
VHT20	MCS0	2	149	5745	19.80	19.70	22.76	30.00		2.87		Pass
VHT20	MCS0	2	157	5785	19.70	19.90	22.81	30.00		2.87		Pass
VHT20	MCS0	2	165	5825	19.70	19.70	22.71	30.00		2.87		Pass
VHT40	MCS0	2	151	5755	18.90	18.60	21.76	30.00		2.87		Pass
VHT40	MCS0	2	159	5795	19.00	18.70	21.86	30.00		2.87		Pass
VHT80	MCS0	2	155	5775	19.20	19.10	22.16	30.00		2.87		Pass



<TXBF Mode>

Test Engineer :	Luffy Lin	Temperature :	21~25°C
		Relative Humidity :	51~54%

Band IV												
Mod.	Data Rate	NTX	CH.	Freq. (MHz)	Average Conducted Power (dBm)			FCC Conducted Power Limit (dBm)		DG (dBi)		Pass/Fail
					Ant 1	Ant 2	SUM	Ant 1	Ant 2	Ant 1	Ant 2	
VHT20	MCS0	2	149	5745	19.20	19.90	22.57	30.00		5.75		Pass
VHT20	MCS0	2	157	5785	19.10	19.90	22.53	30.00		5.75		Pass
VHT20	MCS0	2	165	5825	19.00	19.70	22.37	30.00		5.75		Pass
VHT40	MCS0	2	151	5755	18.50	18.70	21.61	30.00		5.75		Pass
VHT40	MCS0	2	159	5795	18.30	18.70	21.51	30.00		5.75		Pass
VHT80	MCS0	2	155	5775	19.40	19.30	22.36	30.00		5.75		Pass



3.3 Power Spectral Density Measurement

3.3.1 Limit of Power Spectral Density

For the band 5.725–5.85 GHz, the maximum power spectral density shall not exceed 30 dBm in any 500-kHz band.

If transmitting antennas of directional gain greater than 6 dBi are used, the peak output power shall be reduced by the amount in dB that the directional gain of the antenna exceeds 6 dBi.

3.3.2 Measuring Instruments

See list of measuring equipment of this test report.

3.3.3 Test Procedures

The testing follows FCC KDB 789033 D02 General UNII Test Procedures New Rules v02r01. Section F) Maximum power spectral density.

<CDD Modes>

Method SA-2

(trace averaging across on and off times of the EUT transmissions, followed by duty cycle correction).

- Measure the duty cycle.
- Set span to encompass the entire emission bandwidth (EBW) of the signal.
- Set RBW = 300 kHz.
- Set VBW \geq 1 MHz.
- Number of points in sweep \geq 2 Span / RBW.
- Sweep time = auto.
- Detector = RMS
- Trace average at least 100 traces in power averaging mode.
- Add $10 \log(500\text{kHz}/\text{RBW})$ to the test result.
- Add $10 \log(1/x)$, where x is the duty cycle, to the measured power in order to compute the average power during the actual transmission times. For example, add $10 \log(1/0.25) = 6$ dB if the duty cycle is 25 percent.

<TXBF Modes>**# Method SA-3 #**

(power averaging (rms) detection with max hold):

- Set span to encompass the entire emission bandwidth (EBW) of the signal.
 - Set RBW = 300 kHz.
 - Set VBW \geq 1 MHz.
 - Number of points in sweep \geq 2 Span / RBW.
 - Sweep time \leq (number of points in sweep) \times T, when duty cycle is less than 98 percent where T is the minimum transmission duration over which the transmitter is on and is transmitting at its maximum power control level for the tested mode of operation.
 - Detector = power averaging (rms).
 - Trace mode = max hold.
 - Allow max hold to run for at least 60 seconds, or longer as needed to allow the trace to stabilize.
1. The RF output of EUT was connected to the spectrum analyzer by a low loss cable.
 2. Each plot has already offset with cable loss, and attenuator loss. Measure the PPSD and record it.
 3. For MIMO mode, calculation method follows FCC KDB 662911 D01 Multiple Transmitter Output v02r01.

Method (c): Measure and add $10 \log(N_{ANT})$ dB.

With this technique, spectrum measurements are performed at each output of the device, but rather than summing the spectra or the spectral peaks across the outputs, the quantity $10 \log(N_{ANT})$ dB is added to each spectrum value before comparing to the emission limit. The addition of $10 \log(N_{ANT})$ dB serves to apportion the emission limit among the N_{ANT} outputs so that each output is permitted to contribute no more than $1/N_{ANT}^{th}$ of the PSD limit.

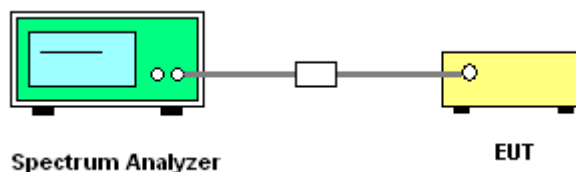
3.3.4 Test Setup



3.3.5 Test Result of Power Spectral Density

<CDD Modes>

Test Engineer :	Shiming Liu	Temperature :	21~25°C
		Relative Humidity :	51~54%

Band IV																
Mod.	Data Rate	NTX	CH.	Freq. (MHz)	Duty Factor (dB)		10log (500kHz /RBW) Factor (dB)		Average Power Density (dBm/500kHz)			Average PSD Limit (dBm/500kHz)		DG (dBi)		Pass /Fail
					Ant 1	Ant 2	Ant 1	Ant 2	Ant 1	Ant 2	SUM	Ant 1	Ant 2	Ant 1	Ant 2	
11a	6Mbps	1	149	5745	0.00	0.00	2.22	2.22	9.85	10.09		30.00	30.00	2.60	2.87	Pass
11a	6Mbps	1	157	5785	0.00	0.00	2.22	2.22	10.60	10.78		30.00	30.00	2.60	2.87	Pass
11a	6Mbps	1	165	5825	0.00	0.00	2.22	2.22	10.64	10.34		30.00	30.00	2.60	2.87	Pass
VHT20	MCS0	1	149	5745	0.00	0.00	2.22	2.22	9.91	10.16		30.00	30.00	2.60	2.87	Pass
VHT20	MCS0	1	157	5785	0.00	0.00	2.22	2.22	10.50	10.23		30.00	30.00	2.60	2.87	Pass
VHT20	MCS0	1	165	5825	0.00	0.00	2.22	2.22	10.38	10.67		30.00	30.00	2.60	2.87	Pass
VHT40	MCS0	1	151	5755	0.00	0.00	2.22	2.22	5.65	4.59		30.00	30.00	2.60	2.87	Pass
VHT40	MCS0	1	159	5795	0.00	0.00	2.22	2.22	5.62	5.34		30.00	30.00	2.60	2.87	Pass
VHT80	MCS0	1	155	5775	0.00	0.00	2.22	2.22	4.60	2.84		30.00	30.00	2.60	2.87	Pass
11a	6Mbps	2	149	5745	0.00	0.00	2.22		9.98	9.68	12.99	30.00		5.75		Pass
11a	6Mbps	2	157	5785	0.00	0.00	2.22		10.77	10.81	13.82	30.00		5.75		Pass
11a	6Mbps	2	165	5825	0.00	0.00	2.22		10.36	10.64	13.65	30.00		5.75		Pass
VHT20	MCS0	2	149	5745	0.00	0.00	2.22		10.55	9.90	13.56	30.00		5.75		Pass
VHT20	MCS0	2	157	5785	0.00	0.00	2.22		10.94	10.96	13.97	30.00		5.75		Pass
VHT20	MCS0	2	165	5825	0.00	0.00	2.22		10.35	10.55	13.56	30.00		5.75		Pass
VHT40	MCS0	2	151	5755	0.00	0.00	2.22		5.91	5.48	8.92	30.00		5.75		Pass
VHT40	MCS0	2	159	5795	0.00	0.00	2.22		5.75	5.96	8.97	30.00		5.75		Pass
VHT80	MCS0	2	155	5775	0.00	0.00	2.22		4.36	3.15	7.37	30.00		5.75		Pass

Note: PSD Sum = Max PSD(Ant. 1, Ant. 2) + 10 log (n)



Worst Case Power Density (dBm/MHz) for MIMO Ant. 1

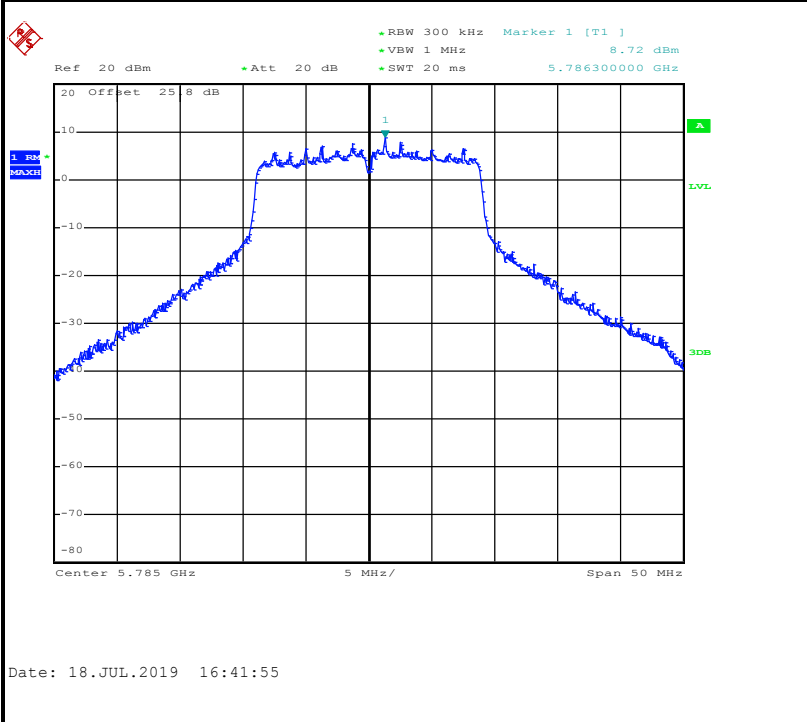

Worst Case Power Density (dBm/MHz) for MIMO Ant. 2

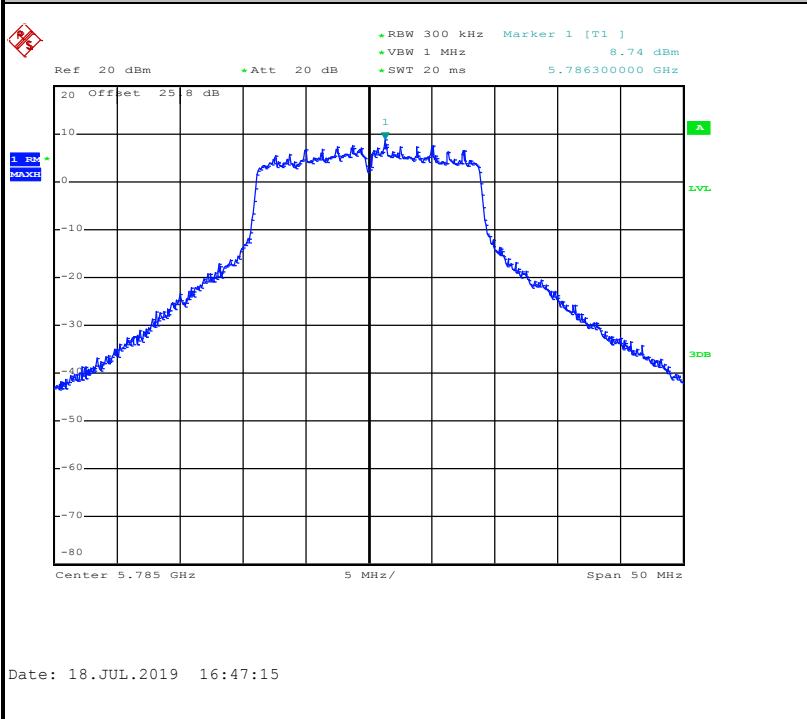



<TXBF Modes>

Test Engineer :	Luffy Lin	Temperature :	21~25°C
		Relative Humidity :	51~54%

Band IV																
Mod.	Data Rate	NTX	CH.	Freq. (MHz)	Duty Factor (dB)		10log (500kHz /RBW) Factor (dB)		Average Power Density (dBm/500kHz)			Average PSD Limit (dBm/500kHz)		DG (dBi)		Pass /Fail
					Ant 1	Ant 2	Ant 1	Ant 2	Ant 1	Ant 2	SUM	Ant 1	Ant 2	Ant 1	Ant 2	
VHT20	MCS0	2	149	5745	0.00	0.00	2.22	9.78	9.69	12.79	30.00	5.75	Pass			
VHT20	MCS0	2	157	5785	0.00	0.00	2.22	8.96	10.39	13.40	30.00	5.75	Pass			
VHT20	MCS0	2	165	5825	0.00	0.00	2.22	9.62	9.77	12.78	30.00	5.75	Pass			
VHT40	MCS0	2	151	5755	0.00	0.00	2.22	6.02	5.43	9.03	30.00	5.75	Pass			
VHT40	MCS0	2	159	5795	0.00	0.00	2.22	6.02	5.49	9.03	30.00	5.75	Pass			
VHT80	MCS0	2	155	5775	0.00	0.00	2.22	3.68	3.27	6.69	30.00	5.75	Pass			



Worst Case Power Density (dBm/MHz) for MIMO Ant. 1

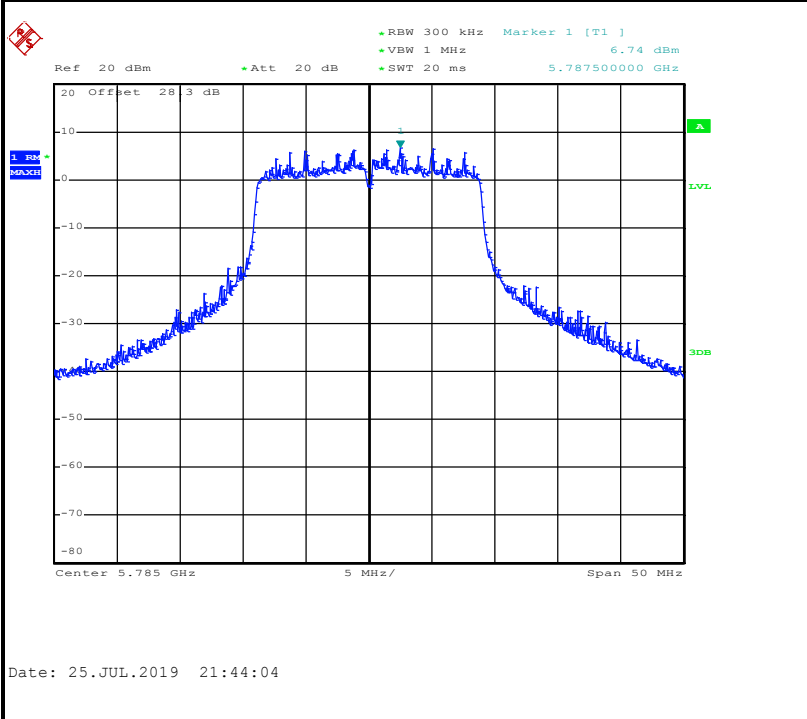

Worst Case Power Density (dBm/MHz) for MIMO Ant. 2

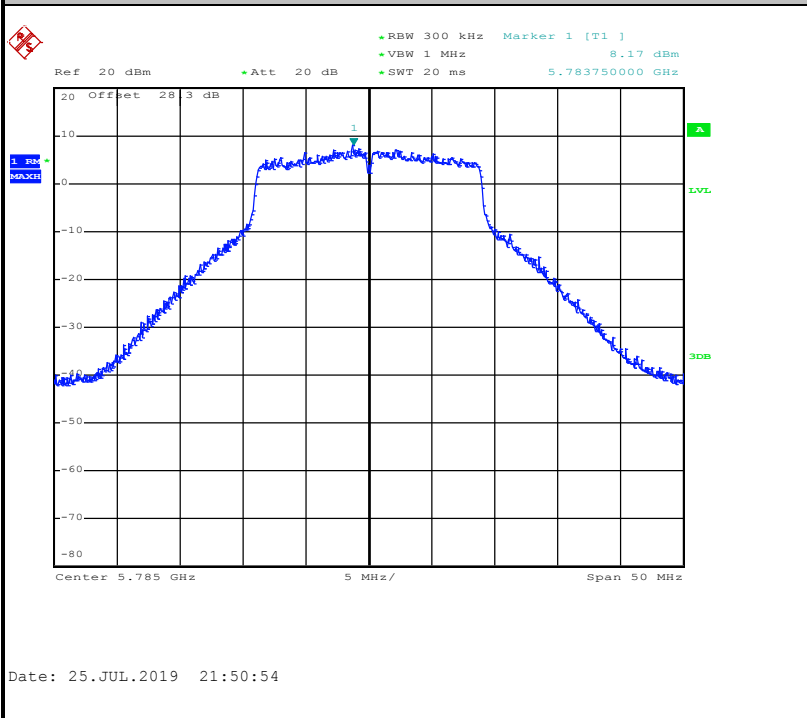



3.4 Unwanted Emissions Measurement

This section is to measure unwanted emissions through radiated measurement for band edge spurious emissions and out of band emissions measurement.

3.4.1 Limit of Unwanted Emissions

- (1) For transmitters operating in the 5.725-5.85 GHz band:
 15.407(b)(4)(i) All emissions shall be limited to a level of -27 dBm/MHz at 75 MHz or more above or below the band edge increasing linearly to 10 dBm/MHz at 25 MHz above or below the band edge, and from 25 MHz above or below the band edge increasing linearly to a level of 15.6 dBm/MHz at 5 MHz above or below the band edge, and from 5 MHz above or below the band edge increasing linearly to a level of 27 dBm/MHz at the band edge.
- (2) Unwanted spurious emissions fallen in restricted bands shall comply with the general field strength limits as below table,

Frequency (MHz)	Field Strength (microvolts/meter)	Measurement Distance (meters)
0.009 – 0.490	2400/F(kHz)	300
0.490 – 1.705	24000/F(kHz)	30
1.705 – 30.0	30	30
30 – 88	100	3
88 – 216	150	3
216 - 960	200	3
Above 960	500	3

Note: The following formula is used to convert the EIRP to field strength.

$$E = \frac{1000000\sqrt{30P}}{3} \mu\text{V/m, where P is the eirp (Watts)}$$

EIRP (dBm)	Field Strength at 3m (dBμV/m)
- 27	68.3



(3) KDB789033 D02 v02r01 G)2)c)

- (i) Section 15.407(b)(1) to (b)(3) specify the unwanted emission limits for the U-NII-1 and U-NII-2 bands. As specified, emissions above 1000 MHz that are outside of the restricted bands are subject to a peak emission limit of -27 dBm/MHz.³
- (ii) Section 15.407(b)(4) specifies the unwanted emission limit for the U-NII-3 band. A band emissions mask is specified in Section 15.407(b)(4)(i). The emission limits are in terms of a Peak detector. An alternative to the band emissions mask is specified in Section 15.407(b)(4)(ii). The alternative limits are based on the highest antenna gain specified in the filing. There are also marketing and importation restrictions for the devices using the alternative limit.⁴

Note 3: An out-of-band emission that complies with both the average and peak limits of Section 15.209 is not required to satisfy the -27 dBm/MHz peak emission limit.

Note 4: Only devices with antenna gains of 10 dBi or less may be approved using the emission limits specified in Section 15.247(d) till March 2, 2018; all other devices operating in this band must use the mask specified in Section 15.407(b)(4)(i).

3.4.2 Measuring Instruments

See list of measuring equipment of this test report.

3.4.3 Test Procedures

1. The testing follows FCC KDB 789033 D02 General UNII Test Procedures New Rules v02r01. Section G) Unwanted emissions measurement.

(1) Procedure for Unwanted Emissions Measurements Below 1000MHz

- RBW = 120 kHz
- VBW = 300 kHz
- Detector = Peak
- Trace mode = max hold

(2) Procedure for Peak Unwanted Emissions Measurements Above 1000 MHz

- RBW = 1 MHz
- VBW ≥ 3 MHz
- Detector = Peak
- Sweep time = auto
- Trace mode = max hold

(3) Procedures for Average Unwanted Emissions Measurements Above 1000MHz

- RBW = 1 MHz
- VBW = 10 Hz, when duty cycle is no less than 98 percent.
- VBW ≥ 1/T, when duty cycle is less than 98 percent where T is the minimum transmission duration over which the transmitter is on and is transmitting at its maximum power control level for the tested mode of operation.

2. The EUT was placed on a turntable with 0.8 meter for frequency below 1GHz and 1.5 meter for frequency above 1GHz respectively above ground.
3. The EUT was set 3 meters from the interference receiving antenna which was mounted on the top of a variable height antenna tower.
4. The antenna is a broadband antenna and its height is adjusted between one meter and four meters above ground to find the maximum value of the field strength for both horizontal polarization and vertical polarization of the antenna.
5. For each suspected emission, the EUT was arranged to its worst case and then adjust the antenna tower (from 1 m to 4 m) and turntable (from 0 degree to 360 degrees) to find the maximum reading.
6. For testing below 1GHz, if the emission level of the EUT in peak mode was 3 dB lower than the limit specified, then peak values of EUT will be reported, otherwise, the emissions will be repeated one by one using the CISPR quasi-peak method and reported.
7. For testing above 1GHz, the emission level of the EUT in peak mode was 20dB lower than average limit (that means the emission level in average mode also complies with the limit in average mode), then peak values of EUT will be reported, otherwise, the emissions will be measured in average mode again and reported.

3.4.4 Test Setup

For radiated emissions below 30MHz

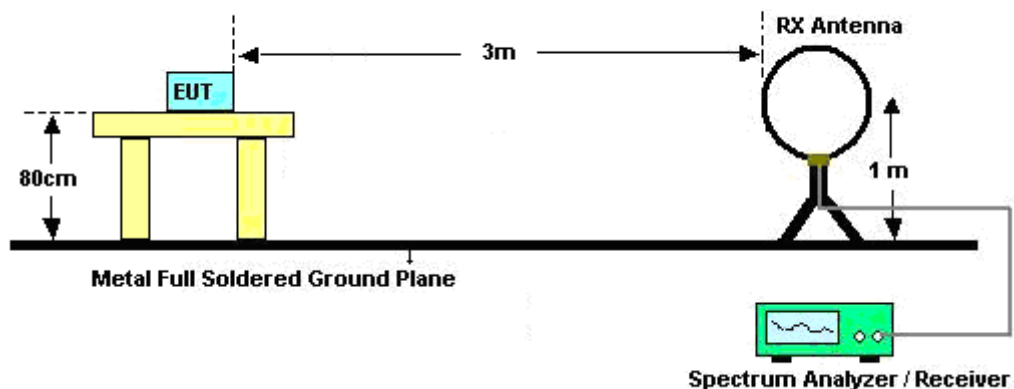

For radiated emissions from 30MHz to 1GHz

<CDD Mode>

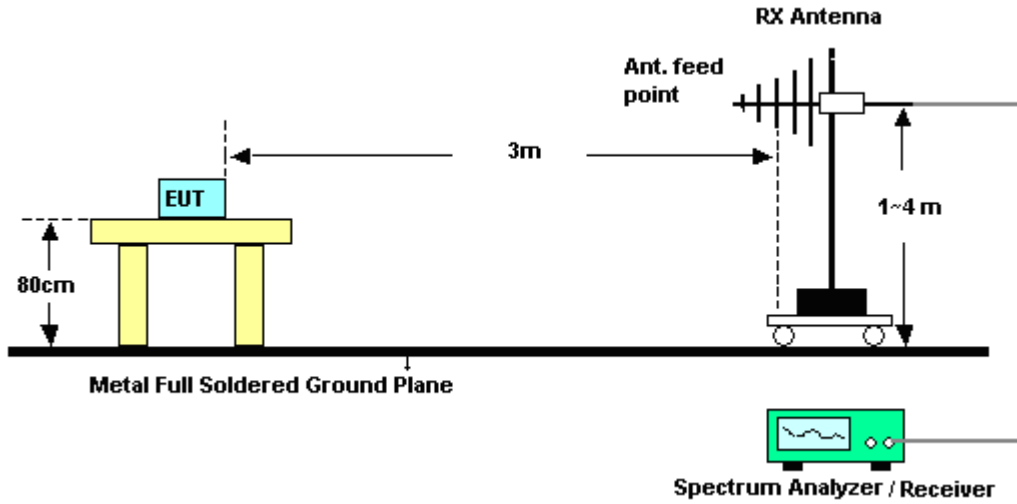

<TXBF Modes>

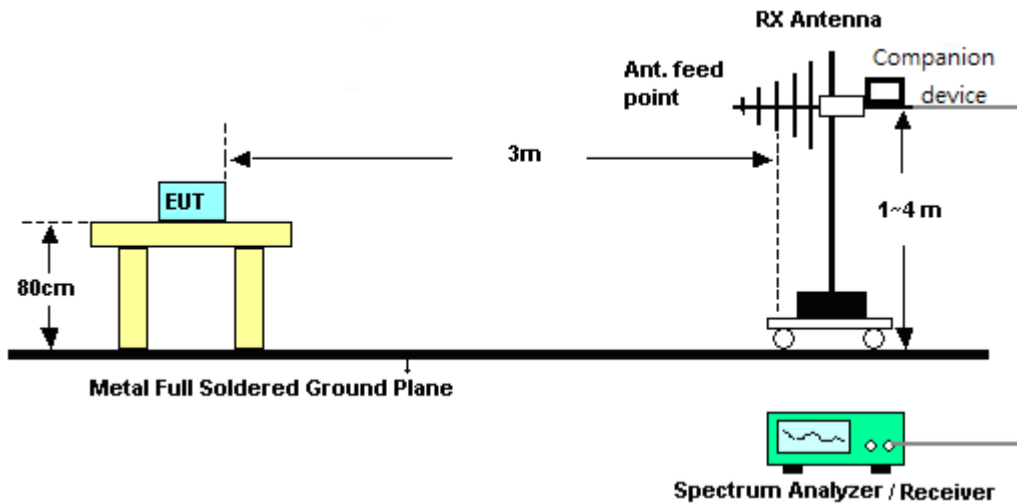

For radiated emissions above 1GHz

<CDD Mode>

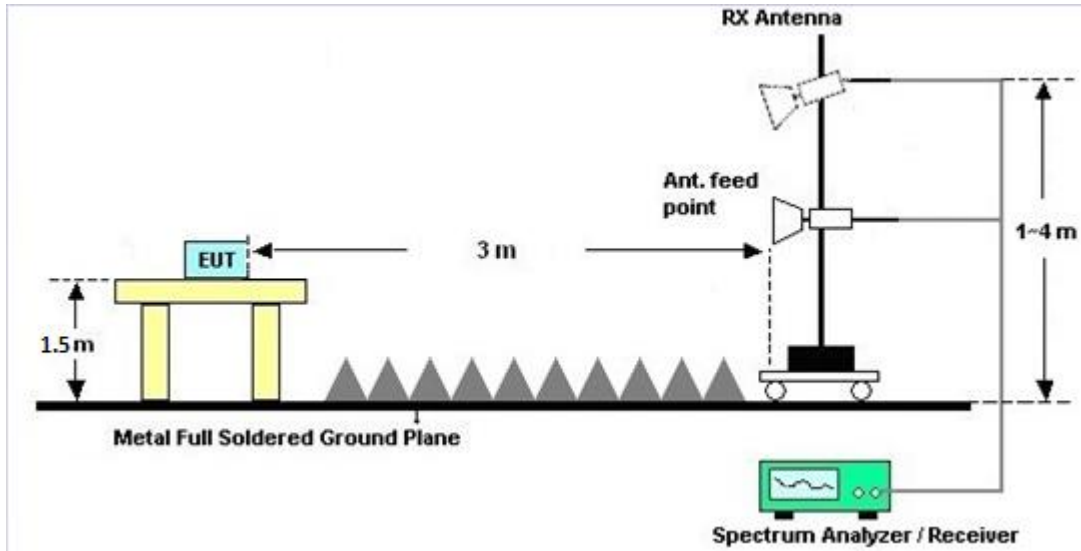

<TXBF Modes>

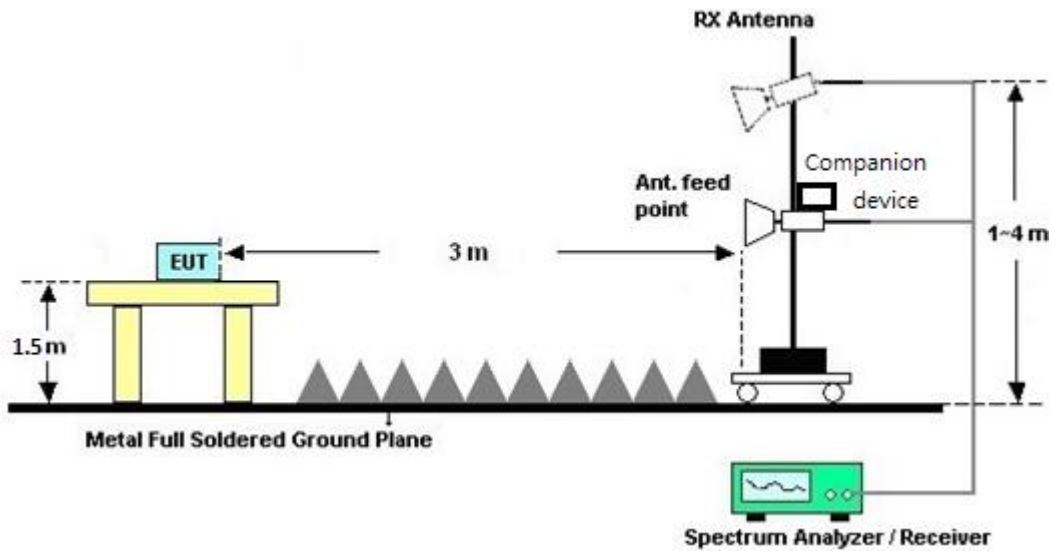



3.4.5 Test Results of Radiated Emissions (9 kHz ~ 30 MHz)

The low frequency, which started from 9 kHz to 30MHz, was pre-scanned and the result which was 20dB lower than the limit line was not reported.

There is a comparison data of both open-field test site and alternative test site - semi-Anechoic chamber according to 414788 D01 Radiated Test Site v01r01, and the result came out very similar.

3.4.6 Test Result of Radiated Band Edges

Please refer to Appendix B and C.

3.4.7 Duty Cycle

Please refer to Appendix D.

3.4.8 Test Result of Unwanted Radiated Emission (30MHz ~ 10th Harmonic)

Please refer to Appendix B and C.



3.5 AC Conducted Emission Measurement

3.5.1 Limit of AC Conducted Emission

For equipment that is designed to be connected to the public utility (AC) power line, the radio frequency voltage that is conducted back onto the AC power line on any frequency or frequencies within the band 150 kHz to 30 MHz shall not exceed the limits in the following table.

Frequency of emission (MHz)	Conducted limit (dB μ V)	
	Quasi-peak	Average
0.15-0.5	66 to 56*	56 to 46*
0.5-5	56	46
5-30	60	50

*Decreases with the logarithm of the frequency.

3.5.2 Measuring Instruments

See list of measuring equipment of this test report.

3.5.3 Test Procedures

1. The EUT was placed 0.4 meter from the conducting wall of the shielding room was kept at least 80 centimeters from any other grounded conducting surface.
2. Connect EUT to the power mains through a line impedance stabilization network (LISN).
3. All the support units are connecting to the other LISN.
4. The LISN provides 50 ohm coupling impedance for the measuring instrument.
5. The FCC states that a 50 ohm, 50 microhenry LISN should be used.
6. Both sides of AC line were checked for maximum conducted interference.
7. The frequency range from 150 kHz to 30 MHz was searched.
8. Set the test-receiver system to Peak Detect Function and specified bandwidth with Maximum Hold Mode.

3.5.4 Test Setup



3.5.5 Test Result of AC Conducted Emission

Please refer to Appendix A.



3.6 Automatically Discontinue Transmission

3.6.1 Limit of Automatically Discontinue Transmission

The device shall automatically discontinue transmission in case of either absence of information to transmit or operational failure. These provisions are not intended to preclude the transmission of control or signaling information or the use of repetitive codes used by certain digital technologies to complete frame or burst intervals. Applicants shall include in their application for equipment authorization to describe how this requirement is met.

3.6.2 Measuring Instruments

See list of measuring equipment of this test report.

3.6.3 Test Result of Automatically Discontinue Transmission

While the EUT is not transmitting any information, the EUT can automatically discontinue transmission and become standby mode for power saving. The EUT can detect the controlling signal of ACK message transmitting from remote device and verify whether it shall resend or discontinue transmission.



3.7 Antenna Requirements

3.7.1 Standard Applicable

If transmitting antenna directional gain is greater than 6 dBi, both the peak transmit power and the peak power spectral density shall be reduced by the amount in dB that the directional gain of the antenna exceeds 6 dBi.

3.7.2 Antenna Anti-Replacement Construction

An embedded-in antenna design is used.

3.7.3 Antenna Gain

<CDD Modes >

FCC KDB 662911 D01 Multiple Transmitter Output v02r01

For CDD transmissions, directional gain is calculated as

Directional gain = GANT + Array Gain, where Array Gain is as follows.

For power spectral density (PSD) measurements on all devices,

Array Gain = 10 log(NANT/NSS=1) dB.

For power measurements on IEEE 802.11 devices,

Array Gain = 0 dB (i.e., no array gain) for NANT ≤ 4.

Directional gain may be calculated by using the formulas applicable to equal gain antennas with GANT set equal to the gain of the antenna having the highest gain;

The EUT supports CDD mode.

For power, the directional gain G_{ANT} is set equal to the antenna having the highest gain, i.e., F)2)f)i).

For PSD, the directional gain calculation is following F)2)f)ii) of KDB 662911 D01 v02r01.

The power and PSD limit should be modified if the directional gain of EUT is over 6 dBi,

The directional gain "DG" is calculated as following table.

<CDD Modes>						
			DG	DG	Power	PSD
	Ant. 1	Ant. 2	for	for	Limit	Limit
	(dBi)	(dBi)	Power	PSD	Reduction	Reduction
			(dBi)	(dBi)	(dB)	(dB)
Band IV	2.60	2.87	2.87	5.75	0.00	0.00

$$\text{Power Limit Reduction} = DG(\text{Power}) - 6\text{dBi}, (\text{min} = 0)$$

$$\text{PSD Limit Reduction} = DG(\text{PSD}) - 6\text{dBi}, (\text{min} = 0)$$

TXBF modes

FCC KDB 662911 D01 Multiple Transmitter Output v02r01

For CDD transmissions, directional gain is calculated as

$$DirectionalGain = 10 \cdot \log \left[\frac{\sum_{j=1}^{N_{SS}} \left\{ \sum_{k=1}^{N_{ANT}} g_{j,k} \right\}^2}{N_{ANT}} \right]$$

where

Each antenna is driven by no more than one spatial stream;

N_{SS} = the number of independent spatial streams of data;

N_{ANT} = the total number of antennas

$g_{j,k} = 10^{G_k / 20}$ if the k th antenna is being fed by spatial stream j , or zero if it is not;
 G_k is the gain in dBi of the k th antenna.

The EUT supports beamforming for 802.11ac modes.

The directional gain calculation is following F)2)e)ii) of KDB 662911 D01 v02r01.

The power and PSD limit should be modified if the directional gain of EUT is over 6 dBi,

The directional gain “DG” is calculated as following table.

			DG	DG	Power	PSD
			for	for	Limit	Limit
	Ant 1	Ant 2	Power	PSD	Reduction	Reduction
	(dBi)	(dBi)	(dBi)	(dBi)	(dB)	(dB)
Band IV	2.60	2.87	5.75	5.75	0.00	0.00

$Power\ Limit\ Reduction = DG(Power) - 6dBi, (min = 0)$

$PSD\ Limit\ Reduction = DG(PSD) - 6dBi, (min = 0)$



4 List of Measuring Equipment

Instrument	Manufacturer	Model No.	Serial No.	Characteristics	Calibration Date	Test Date	Due Date	Remark
Preamplifier	EMEC	EM18G40G	060715	18GHz ~ 40GHz	Dec. 06, 2018	Jun. 30, 2019~ Jul. 18, 2019	Dec. 05, 2019	Radiation (03CH11-HY)
Amplifier	SONOMA	310N	187312	9kHz~1GHz	Dec. 04, 2018	Jun. 30, 2019~ Jul. 18, 2019	Dec. 03, 2019	Radiation (03CH11-HY)
Bilog Antenna	TESEQ	CBL 6111D&N-6-0 6	35414&AT- N0602	30MHz~1GHz	Oct. 13, 2018	Jun. 30, 2019~ Jul. 18, 2019	Oct. 12, 2019	Radiation (03CH11-HY)
Horn Antenna	SCHWARZBE CK	BBHA 9120 D	9120D-132 6	1GHz ~ 18GHz	Oct. 30, 2018	Jun. 30, 2019~ Jul. 18, 2019	Oct. 29, 2019	Radiation (03CH11-HY)
Loop Antenna	Rohde & Schwarz	HFH2-Z2	100488	9 kHz~30 MHz	Nov. 22, 2018	Jun. 30, 2019~ Jul. 18, 2019	Nov. 21, 2019	Radiation (03CH11-HY)
Preamplifier	Keysight	83017A	MY532700 80	1GHz~26.5GHz	Nov. 14, 2018	Jun. 30, 2019~ Jul. 18, 2019	Nov. 13, 2020	Radiation (03CH11-HY)
Spectrum Analyzer	Keysight	N9010A	MY542004 86	10Hz ~ 44GHz	Oct. 19, 2018	Jun. 30, 2019~ Jul. 18, 2019	Oct. 18, 2019	Radiation (03CH11-HY)
Antenna Mast	EMEC	AM-BS-4500- B	N/A	1~4m	N/A	Jun. 30, 2019~ Jul. 18, 2019	N/A	Radiation (03CH11-HY)
Turn Table	EMEC	TT 2000	N/A	0~360 Degree	N/A	Jun. 30, 2019~ Jul. 18, 2019	N/A	Radiation (03CH11-HY)
Preamplifier	Jet-Power	JPA0118-55-3 03	171000180 0055007	1GHz~18GHz	Apr. 01, 2019	Jun. 30, 2019~ Jul. 18, 2019	Mar. 31, 2020	Radiation (03CH11-HY)
SHF-EHF Horn Antenna	SCHWARZBE CK	BBHA 9170	BBHA9170 584	18GHz- 40GHz	Dec. 05, 2018	Jun. 30, 2019~ Jul. 18, 2019	Dec. 04, 2019	Radiation (03CH11-HY)
EMI Test Receiver	Keysight	N9038A (MXE)	MY541300 85	N/A	Nov. 01, 2018	Jun. 30, 2019~ Jul. 18, 2019	Oct. 31, 2019	Radiation (03CH11-HY)
Software	Audix	E3 6.2009-8-24	RK-00104 2	N/A	N/A	Jun. 30, 2019~ Jul. 18, 2019	N/A	Radiation (03CH11-HY)
RF Cable	HUBER + SUHNER	SUCOFLEX 104	MY9837/4 PE	9kHz-30MHz	Mar. 13, 2019	Jun. 30, 2019~ Jul. 18, 2019	Mar. 12, 2020	Radiation (03CH11-HY)
RF Cable	HUBER + SUHNER	SUCOFLEX 102	MY2859/2	30MHz-40GHz	Mar. 13, 2019	Jun. 30, 2019~ Jul. 18, 2019	Mar. 12, 2020	Radiation (03CH11-HY)
RF Cable	HUBER + SUHNER	SUCOFLEX 104	MY9837/4 PE	30M-18G	Mar. 13, 2019	Jun. 30, 2019~ Jul. 18, 2019	Mar. 12, 2020	Radiation (03CH11-HY)
RF Cable	HUBER + SUHNER	SUCOFLEX 102	MY4274/2	30MHz-40GHz	Mar. 13, 2019	Jun. 30, 2019~ Jul. 18, 2019	Mar. 12, 2020	Radiation (03CH11-HY)
Filter	Wainwright	WLK4-1000-1 530-8000-40S S	SN11	1G Low Pass	Sep. 16, 2018	Jun. 30, 2019~ Jul. 18, 2019	Sep. 17, 2019	Radiation (03CH11-HY)
Filter	Wainwright	WHKX12-270 0-3000-18000 -60SS	SN3	2.7G High Pass	Sep. 17, 2018	Jun. 30, 2019~ Jul. 18, 2019	Sep. 16, 2019	Radiation (03CH11-HY)
Filter	Wainwright	WHKX8-5872. 5-6750-18000 -40ST	SN3	6.75GHz High Pass	Sep. 17, 2018	Jun. 30, 2019~ Jul. 18, 2019	Sep. 16, 2019	Radiation (03CH11-HY)



Instrument	Manufacturer	Model No.	Serial No.	Characteristics	Calibration Date	Test Date	Due Date	Remark
AC Power Source	ChainTek	APC-1000W	N/A	N/A	N/A	Jul. 06, 2019	N/A	Conduction (CO05-HY)
EMI Test Receiver	Rohde & Schwarz	ESR3	102388	9kHz~3.6GHz	Nov. 12, 2018	Jul. 06, 2019	Nov. 11, 2019	Conduction (CO05-HY)
LISN	Rohde & Schwarz	ENV216	100080	9kHz~30MHz	Nov. 14, 2018	Jul. 06, 2019	Nov. 13, 2019	Conduction (CO05-HY)
Software	Rohde & Schwarz	EMC32 V10.30	N/A	N/A	N/A	Jul. 06, 2019	N/A	Conduction (CO05-HY)
LF Cable	HUBER + SUHNER	RG-214/U	LF01	N/A	Dec. 31, 2018	Jul. 06, 2019	Dec. 30, 2019	Conduction (CO05-HY)
Pulse Limiter	Rohde & Schwarz	ESH3-Z2	100851	N/A	Dec. 31, 2018	Jul. 06, 2019	Dec. 30, 2019	Conduction (CO05-HY)
<CDD Mode>								
Power Sensor	DARE	RPR3006W	13I00030S NO32	9kHz~6GHz	Dec. 03, 2018	Jul. 05, 2019~ Jul. 25, 2019	Dec. 02, 2019	Conducted (TH05-HY)
Spectrum Analyzer	Rohde & Schwarz	FSP40	100057	9kHz-40GHz	Nov. 21, 2018	Jul. 05, 2019~ Jul. 25, 2019	Nov. 20, 2019	Conducted (TH05-HY)
Switch Box & RF Cable	Burgeon	ETF-058	EC120838 2	N/A	Mar. 27, 2019	Jul. 05, 2019~ Jul. 25, 2019	Mar. 26, 2020	Conducted (TH05-HY)
<TXBF Mode>								
Power Sensor	DARE	RPR3006W	16I00054S NO10	10MHz~6GHz	Dec. 19, 2018	Jul. 16, 2019~ Jul. 29, 2019	Dec. 18, 2019	Conducted (TH05-HY)
Spectrum Analyzer	Rohde & Schwarz	FSP40	100057	9kHz-40GHz	Nov. 21, 2018	Jul. 16, 2019~ Jul. 29, 2019	Nov. 20, 2019	Conducted (TH05-HY)
Programmable Power Supply	GW Instek	PSS-2005	GEO82176 3	N/A	Oct. 08, 2018	Jul. 16, 2019~ Jul. 29, 2019	Oct. 07, 2020	Conducted (TH05-HY)
Switch Box & RF Cable	EM	EMSW18	SW107090 3	N/A	Dec. 19, 2018	Jul. 16, 2019~ Jul. 29, 2019	Dec. 18, 2019	Conducted (TH05-HY)



5 Uncertainty of Evaluation

Uncertainty of Conducted Emission Measurement (150kHz ~ 30MHz)

Measuring Uncertainty for a Level of Confidence of 95% ($U = 2Uc(y)$)	2.20
---	------

Uncertainty of Radiated Emission Measurement (30 MHz ~ 1000 MHz)

Measuring Uncertainty for a Level of Confidence of 95% ($U = 2Uc(y)$)	5.20
---	------

Uncertainty of Radiated Emission Measurement (1000 MHz ~ 18000 MHz)

Measuring Uncertainty for a Level of Confidence of 95% ($U = 2Uc(y)$)	5.50
---	------

Uncertainty of Radiated Emission Measurement (18000 MHz ~ 40000 MHz)

Measuring Uncertainty for a Level of Confidence of 95% ($U = 2Uc(y)$)	5.20
---	------



Appendix A. AC Conducted Emission Test Results

Test Engineer :	Louis Chung	Temperature :	22~24°C
		Relative Humidity :	64.4~68.2%
Test Voltage :	120Vac / 60Hz	Phase :	Line

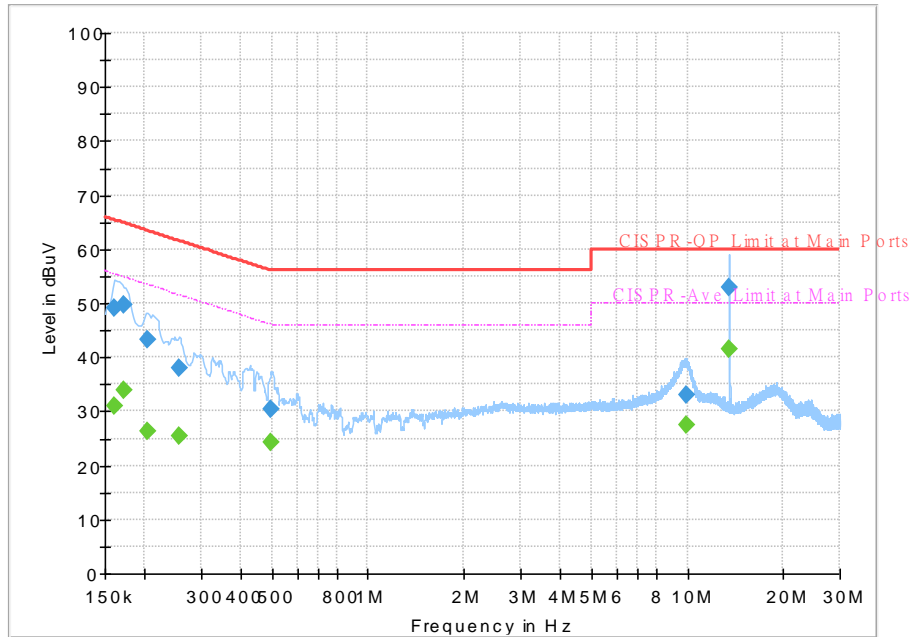

Final Result

Frequency (MHz)	QuasiPeak (dBuV)	CAverage (dBuV)	Limit (dBuV)	Margin (dB)	Line	Filter	Corr. (dB)
0.161250	---	31.12	55.40	24.28	L1	OFF	19.4
0.161250	49.20	---	65.40	16.20	L1	OFF	19.4
0.172500	---	33.99	54.84	20.85	L1	OFF	19.4
0.172500	49.78	---	64.84	15.06	L1	OFF	19.4
0.204000	---	26.26	53.45	27.19	L1	OFF	19.4
0.204000	43.29	---	63.45	20.16	L1	OFF	19.4
0.255750	---	25.42	51.57	26.15	L1	OFF	19.4
0.255750	37.94	---	61.57	23.63	L1	OFF	19.4
0.496500	---	24.15	46.06	21.91	L1	OFF	19.4
0.496500	30.35	---	56.06	25.71	L1	OFF	19.4
9.906000	---	27.56	50.00	22.44	L1	OFF	19.6
9.906000	33.10	---	60.00	26.90	L1	OFF	19.6
13.560000	---	41.46	50.00	8.54	L1	OFF	19.6
13.560000	52.80	---	60.00	7.20	L1	OFF	19.6



Test Engineer :	Louis Chung	Temperature :	22~24°C
		Relative Humidity :	64.4~68.2%
Test Voltage :	120Vac / 60Hz	Phase :	Neutral

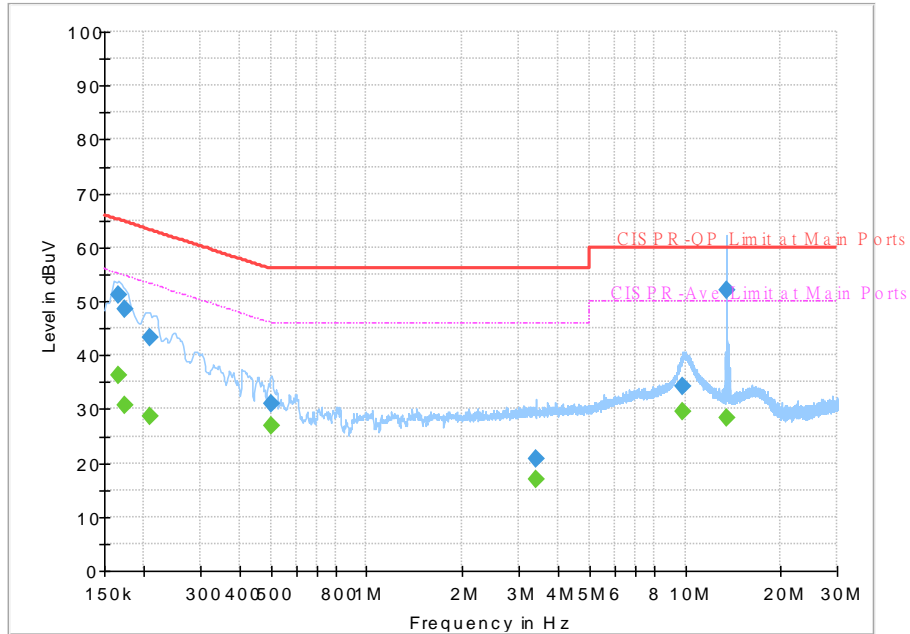

Final Result

Frequency (MHz)	QuasiPeak (dBuV)	CAverage (dBuV)	Limit (dBuV)	Margin (dB)	Line	Filter	Corr. (dB)
0.165750	---	36.32	55.17	18.85	N	OFF	19.4
0.165750	51.07	---	65.17	14.10	N	OFF	19.4
0.174750	---	30.59	54.73	24.14	N	OFF	19.4
0.174750	48.46	---	64.73	16.27	N	OFF	19.4
0.208500	---	28.72	53.27	24.55	N	OFF	19.4
0.208500	43.42	---	63.27	19.85	N	OFF	19.4
0.501000	---	26.85	46.00	19.15	N	OFF	19.5
0.501000	30.98	---	56.00	25.02	N	OFF	19.5
3.408000	---	16.82	46.00	29.18	N	OFF	19.5
3.408000	20.87	---	56.00	35.13	N	OFF	19.5
9.861000	---	29.55	50.00	20.45	N	OFF	19.7
9.861000	34.24	---	60.00	25.76	N	OFF	19.7
13.560000	---	28.48	50.00	21.52	N	OFF	19.7
13.560000	52.15	---	60.00	7.85	N	OFF	19.7



Appendix B. Radiated Spurious Emission

Test Engineer :	Hao Xu, Fu Chen and Troye Hsieh	Temperature :	21~26°C
		Relative Humidity :	50.2~67.6%

<CCD Mode>

Band 4 - 5725~5850MHz

WIFI 802.11a (Band Edge @ 3m)

WIFI Ant.	Note	Frequency (MHz)	Level (dBμV/m)	Over Limit (dB)	Limit Line (dBμV/m)	Read Level (dBμV)	Antenna Factor (dB/m)	Path Loss (dB)	Preamp Factor (dB)	Ant Pos (cm)	Table Pos (deg)	Peak Avg. (P/A)	Pol. (H/V)	
802.11a CH 149 5745MHz		5604.5	51.2	-17	68.2	42.09	31.79	10.46	33.14	100	243	P	H	
		5685.275	56.47	-37.87	94.34	47.22	31.91	10.51	33.17	100	243	P	H	
		5712.275	62.66	-45.98	108.64	53.3	32.02	10.52	33.18	100	243	P	H	
		5725.1	75.28	-58.92	134.2	65.88	32.05	10.53	33.18	100	243	P	H	
	*	5745	114.61	-	-	105.17	32.09	10.54	33.19	100	243	P	H	
	*	5745	107.05	-	-	97.61	32.09	10.54	33.19	100	243	A	H	
														H
														H
			5604.725	49.77	-18.43	68.2	40.66	31.79	10.46	33.14	272	322	P	V
			5699	51.95	-52.51	104.46	42.62	31.99	10.51	33.17	272	322	P	V
			5716.775	56.88	-53.02	109.9	47.51	32.03	10.52	33.18	272	322	P	V
			5724.875	70.69	-51.23	121.92	61.29	32.05	10.53	33.18	272	322	P	V
	*		5745	110.45	-	-	101.01	32.09	10.54	33.19	272	322	P	V
	*		5745	103.01	-	-	93.57	32.09	10.54	33.19	272	322	A	V
													V	
													V	



WIFI Ant. 1	Note	Frequency (MHz)	Level (dBμV/m)	Over Limit (dB)	Limit Line (dBμV/m)	Read Level (dBμV)	Antenna Factor (dB/m)	Path Loss (dB)	Preamp Factor (dB)	Ant Pos (cm)	Table Pos (deg)	Peak Avg. (P/A)	Pol. (H/V)
		5646	50.67	-17.53	68.2	41.63	31.71	10.49	33.16	100	241	P	H
		5692.5	51.59	-48.08	99.67	42.3	31.95	10.51	33.17	100	241	P	H
		5719.5	53.33	-57.33	110.66	43.94	32.04	10.53	33.18	100	241	P	H
		5721.25	54.6	-59.05	113.65	45.21	32.04	10.53	33.18	100	241	P	H
	*	5785	114.33	-	-	104.8	32.17	10.56	33.2	100	241	P	H
	*	5785	106.87	-	-	97.34	32.17	10.56	33.2	100	241	A	H
		5851	55.11	-64.81	119.92	45.44	32.3	10.59	33.22	100	241	P	H
		5855.75	57.18	-53.41	110.59	47.49	32.32	10.59	33.22	100	241	P	H
		5892.75	54.51	-37.52	92.03	44.67	32.47	10.61	33.24	100	241	P	H
		5933.75	52.78	-15.42	68.2	42.84	32.57	10.62	33.25	100	241	P	H
													H
													H
802.11a													
CH 157													
5785MHz		5620.75	49.1	-19.1	68.2	40.02	31.76	10.47	33.15	301	314	P	V
		5699.25	50.42	-54.23	104.65	41.08	32	10.51	33.17	301	314	P	V
		5714.5	51.37	-57.89	109.26	42	32.03	10.52	33.18	301	314	P	V
		5721	50.07	-63.01	113.08	40.68	32.04	10.53	33.18	301	314	P	V
	*	5785	111.32	-	-	101.79	32.17	10.56	33.2	301	314	P	V
	*	5785	104.03	-	-	94.5	32.17	10.56	33.2	301	314	A	V
		5854	53.72	-59.36	113.08	44.03	32.32	10.59	33.22	301	314	P	V
		5861	53.13	-55.99	109.12	43.43	32.34	10.59	33.23	301	314	P	V
		5882.25	51.6	-48.22	99.82	41.8	32.43	10.6	33.23	301	314	P	V
		5928.25	51.75	-16.45	68.2	41.82	32.56	10.62	33.25	301	314	P	V
													V
													V



WiFi Ant. 1	Note	Frequency (MHz)	Level (dBµV/m)	Over Limit (dB)	Limit Line (dBµV/m)	Read Level (dBµV)	Antenna Factor (dB/m)	Path Loss (dB)	Preamp Factor (dB)	Ant Pos (cm)	Table Pos (deg)	Peak Avg. (P/A)	Pol. (H/V)	
802.11a CH 165 5825MHz	*	5825	114.68	-	-	105.06	32.25	10.58	33.21	104	240	P	H	
	*	5825	107.34	-	-	97.72	32.25	10.58	33.21	104	240	A	H	
		5850.165	69.59	-52.23	121.82	59.92	32.3	10.59	33.22	104	240	P	H	
		5856.11	66.48	-44.01	110.49	56.79	32.32	10.59	33.22	104	240	P	H	
		5880.505	61.28	-39.83	101.11	51.49	32.42	10.6	33.23	104	240	P	H	
		5934.215	54.45	-13.75	68.2	44.51	32.57	10.62	33.25	104	240	P	H	
														H
														H
	*	5825	110.33	-	-	100.71	32.25	10.58	33.21	315	323	P	V	
	*	5825	102.93	-	-	93.31	32.25	10.58	33.21	315	323	A	V	
		5849.96	68.03	-66.17	134.2	58.36	32.3	10.59	33.22	315	323	P	V	
		5855.085	59.65	-51.13	110.78	49.96	32.32	10.59	33.22	315	323	P	V	
		5879.89	54.2	-47.37	101.57	44.41	32.42	10.6	33.23	315	323	P	V	
		5928.68	50.76	-17.44	68.2	40.83	32.56	10.62	33.25	315	323	P	V	
														V
														V
													V	
Remark	1. No other spurious found. 2. All results are PASS against Peak and Average limit line.													



Band 4 5725~5850MHz

WIFI 802.11a (Harmonic @ 3m)

WIFI Ant. 1	Note	Frequency (MHz)	Level (dBµV/m)	Over Limit (dB)	Limit Line (dBµV/m)	Read Level (dBµV)	Antenna Factor (dB/m)	Path Loss (dB)	Preamp Factor (dB)	Ant Pos (cm)	Table Pos (deg)	Peak Avg. (P/A)	Pol. (H/V)
802.11a CH 149 5745MHz		11490	44.42	-29.58	74	49.68	39.7	17.23	62.19	100	0	P	H
		17235	46.23	-21.97	68.2	42.74	40.51	22.06	59.08	100	0	P	H
													H
													H
		11490	45.08	-28.92	74	50.34	39.7	17.23	62.19	100	0	P	V
		17235	45.91	-22.29	68.2	42.42	40.51	22.06	59.08	100	0	P	V
													V
802.11a CH 157 5785MHz		11570	44.02	-29.98	74	49.45	39.49	17.34	62.26	100	0	P	H
		17355	44.97	-23.23	68.2	40.63	40.98	22.18	58.82	100	0	P	H
													H
													H
		11570	44.7	-29.3	74	50.13	39.49	17.34	62.26	100	0	P	V
		17355	46.21	-21.99	68.2	41.87	40.98	22.18	58.82	100	0	P	V
													V
802.11a CH 165 5825MHz		11650	44.28	-29.72	74	49.94	39.2	17.46	62.32	100	0	P	H
		17475	47.65	-20.55	68.2	42.34	41.58	22.29	58.56	100	0	P	H
													H
													H
		11650	44.64	-29.36	74	50.3	39.2	17.46	62.32	100	0	P	V
		17475	47.04	-21.16	68.2	41.73	41.58	22.29	58.56	100	0	P	V
													V
Remark	1. No other spurious found.												
	2. All results are PASS against Peak and Average limit line.												



Band 4 5725~5850MHz

WIFI 802.11ac VHT20 (Band Edge @ 3m)

WIFI Ant. 1	Note	Frequency (MHz)	Level (dBμV/m)	Over Limit (dB)	Limit Line (dBμV/m)	Read Level (dBμV)	Antenna Factor (dB/m)	Path Loss (dB)	Preamp Factor (dB)	Ant Pos (cm)	Table Pos (deg)	Peak Avg. (P/A)	Pol. (H/V)	
802.11ac VHT20 CH 149 5745MHz		5633.4	52.71	-15.49	68.2	43.65	31.73	10.48	33.15	102	242	P	H	
		5697.6	60.32	-43.11	103.43	50.99	31.99	10.51	33.17	102	242	P	H	
		5719	65.2	-45.32	110.52	55.81	32.04	10.53	33.18	102	242	P	H	
		5724.2	76.34	-44.04	120.38	66.94	32.05	10.53	33.18	102	242	P	H	
	*	5745	114.17	-	-	104.73	32.09	10.54	33.19	102	242	P	H	
	*	5745	106.56	-	-	97.12	32.09	10.54	33.19	102	242	A	H	
														H
														H
			5634.8	50.37	-17.83	68.2	41.31	31.73	10.48	33.15	114	180	P	V
			5698.2	53.5	-50.37	103.87	44.17	31.99	10.51	33.17	114	180	P	V
			5719.8	61.35	-49.39	110.74	51.96	32.04	10.53	33.18	114	180	P	V
			5723.6	71.76	-47.25	119.01	62.36	32.05	10.53	33.18	114	180	P	V
	*		5745	111.06	-	-	101.62	32.09	10.54	33.19	114	180	P	V
	*		5745	103.53	-	-	94.09	32.09	10.54	33.19	114	180	A	V
													V	
													V	



WIFI Ant. 1	Note	Frequency (MHz)	Level (dBμV/m)	Over Limit (dB)	Limit Line (dBμV/m)	Read Level (dBμV)	Antenna Factor (dB/m)	Path Loss (dB)	Preamp Factor (dB)	Ant Pos (cm)	Table Pos (deg)	Peak Avg. (P/A)	Pol. (H/V)
		5637.25	49.69	-18.51	68.2	40.63	31.73	10.48	33.15	103	240	P	H
		5664	52.33	-26.26	78.59	43.21	31.78	10.5	33.16	103	240	P	H
		5712.75	52.39	-56.38	108.77	43.02	32.03	10.52	33.18	103	240	P	H
		5721	53.38	-59.7	113.08	43.99	32.04	10.53	33.18	103	240	P	H
	*	5785	114.45	-	-	104.92	32.17	10.56	33.2	103	240	P	H
	*	5785	106.8	-	-	97.27	32.17	10.56	33.2	103	240	A	H
		5850	56.71	-65.49	122.2	47.04	32.3	10.59	33.22	103	240	P	H
		5859.75	59.05	-50.42	109.47	49.35	32.34	10.59	33.23	103	240	P	H
		5890.75	55.48	-38.03	93.51	45.65	32.46	10.61	33.24	103	240	P	H
		5927.5	53.92	-14.28	68.2	43.99	32.56	10.62	33.25	103	240	P	H
802.11ac													H
VHT20													H
CH 157		5604.75	49.52	-18.68	68.2	40.41	31.79	10.46	33.14	301	315	P	V
5785MHz		5672.25	50.31	-34.4	84.71	41.15	31.83	10.5	33.17	301	315	P	V
		5716.75	50.28	-59.61	109.89	40.91	32.03	10.52	33.18	301	315	P	V
		5722.75	52.19	-64.88	117.07	42.79	32.05	10.53	33.18	301	315	P	V
	*	5785	110.91	-	-	101.38	32.17	10.56	33.2	301	315	P	V
	*	5785	103.26	-	-	93.73	32.17	10.56	33.2	301	315	A	V
		5852.75	53.86	-62.07	115.93	44.18	32.31	10.59	33.22	301	315	P	V
		5864.5	52.59	-55.55	108.14	42.86	32.36	10.6	33.23	301	315	P	V
		5922.75	53.23	-16.63	69.86	43.31	32.55	10.62	33.25	301	315	P	V
		5935	52.07	-16.13	68.2	42.13	32.57	10.62	33.25	301	315	P	V
													V
													V



WIFI Ant. 1	Note	Frequency (MHz)	Level (dBμV/m)	Over Limit (dB)	Limit Line (dBμV/m)	Read Level (dBμV)	Antenna Factor (dB/m)	Path Loss (dB)	Preamp Factor (dB)	Ant Pos (cm)	Table Pos (deg)	Peak Avg. (P/A)	Pol. (H/V)	
802.11ac VHT20 CH 165 5825MHz	*	5825	115.24	-	-	105.62	32.25	10.58	33.21	105	240	P	H	
	*	5825	106.64	-	-	97.02	32.25	10.58	33.21	105	240	A	H	
		5850	70.71	-51.49	122.2	61.04	32.3	10.59	33.22	105	240	P	H	
		5856.6	64.18	-46.17	110.35	54.48	32.33	10.59	33.22	105	240	P	H	
		5889.8	61.11	-33.11	94.22	51.27	32.46	10.61	33.23	105	240	P	H	
		5936.4	52.99	-15.21	68.2	43.05	32.57	10.62	33.25	105	240	P	H	
														H
														H
	*	5825	111.85	-	-	102.23	32.25	10.58	33.21	100	181	P	V	
	*	5825	104.17	-	-	94.55	32.25	10.58	33.21	100	181	A	V	
		5850	72.85	-49.35	122.2	63.18	32.3	10.59	33.22	100	181	P	V	
		5856	60.84	-49.68	110.52	51.15	32.32	10.59	33.22	100	181	P	V	
		5878.4	56.87	-45.8	102.67	47.09	32.41	10.6	33.23	100	181	P	V	
		5929	51.1	-17.1	68.2	41.17	32.56	10.62	33.25	100	181	P	V	
														V
														V
Remark	1. No other spurious found. 2. All results are PASS against Peak and Average limit line.													



Band 4 5725~5850MHz

WIFI 802.11ac VHT20 (Harmonic @ 3m)

WIFI Ant. 1	Note	Frequency (MHz)	Level (dBμV/m)	Over Limit (dB)	Limit Line (dBμV/m)	Read Level (dBμV)	Antenna Factor (dB/m)	Path Loss (dB)	Preamp Factor (dB)	Ant Pos (cm)	Table Pos (deg)	Peak Avg. (P/A)	Pol. (H/V)	
802.11ac VHT20 CH 149 5745MHz		11490	44.99	-29.01	74	50.25	39.7	17.23	62.19	100	0	P	H	
		17235	45.6	-22.6	68.2	42.11	40.51	22.06	59.08	100	0	P	H	
													H	
													H	
			11490	45.66	-28.34	74	50.92	39.7	17.23	62.19	100	0	P	V
			17235	45.83	-22.37	68.2	42.34	40.51	22.06	59.08	100	0	P	V
														V
802.11ac VHT20 CH 157 5785MHz		11570	44.61	-29.39	74	50.04	39.49	17.34	62.26	100	0	P	H	
		17355	45.57	-22.63	68.2	41.23	40.98	22.18	58.82	100	0	P	H	
													H	
													H	
			11570	44.04	-29.96	74	49.47	39.49	17.34	62.26	100	0	P	V
			17355	46.33	-21.87	68.2	41.99	40.98	22.18	58.82	100	0	P	V
														V
802.11ac VHT20 CH 165 5825MHz		11650	44.45	-29.55	74	50.11	39.2	17.46	62.32	100	0	P	H	
		17475	46.72	-21.48	68.2	41.41	41.58	22.29	58.56	100	0	P	H	
													H	
													H	
			11650	44.7	-29.3	74	50.36	39.2	17.46	62.32	100	0	P	V
			17475	48.16	-20.04	68.2	42.85	41.58	22.29	58.56	100	0	P	V
														V
Remark	1. No other spurious found.													
	2. All results are PASS against Peak and Average limit line.													



Band 4 5725~5850MHz

WIFI 802.11ac VHT40 (Band Edge @ 3m)

WIFI Ant. 1	Note	Frequency (MHz)	Level (dBμV/m)	Over Limit (dB)	Limit Line (dBμV/m)	Read Level (dBμV)	Antenna Factor (dB/m)	Path Loss (dB)	Preamp Factor (dB)	Ant Pos (cm)	Table Pos (deg)	Peak Avg. (P/A)	Pol. (H/V)
		5649.25	53.75	-14.45	68.2	44.72	31.7	10.49	33.16	100	240	P	H
		5698.25	61.52	-42.39	103.91	52.19	31.99	10.51	33.17	100	240	P	H
		5719	82.59	-27.93	110.52	73.2	32.04	10.53	33.18	100	240	P	H
		5724.75	84.72	-36.91	121.63	75.32	32.05	10.53	33.18	100	240	P	H
	*	5755	113.2	-	-	103.73	32.11	10.55	33.19	100	240	P	H
	*	5755	104.87	-	-	95.4	32.11	10.55	33.19	100	240	A	H
		5851.25	56.45	-62.9	119.35	46.77	32.31	10.59	33.22	100	240	P	H
		5869.5	55.39	-51.35	106.74	45.64	32.38	10.6	33.23	100	240	P	H
		5878.25	53.19	-49.6	102.79	43.41	32.41	10.6	33.23	100	240	P	H
		5930.75	51.93	-16.27	68.2	42	32.56	10.62	33.25	100	240	P	H
													H
													H
802.11ac													
VHT40													
CH 151		5641.5	50.72	-17.48	68.2	41.68	31.72	10.48	33.16	100	147	P	V
5755MHz		5696	59.24	-43.01	102.25	49.92	31.98	10.51	33.17	100	147	P	V
		5719.25	79.39	-31.2	110.59	70	32.04	10.53	33.18	100	147	P	V
		5725	80.74	-41.46	122.2	71.34	32.05	10.53	33.18	100	147	P	V
	*	5755	110.47	-	-	101	32.11	10.55	33.19	100	147	P	V
	*	5755	102.32	-	-	92.85	32.11	10.55	33.19	100	147	A	V
		5850.25	53.58	-68.05	121.63	43.91	32.3	10.59	33.22	100	147	P	V
		5854.75	52.22	-59.15	111.37	42.53	32.32	10.59	33.22	100	147	P	V
		5874.75	52.05	-53.22	105.27	42.28	32.4	10.6	33.23	100	147	P	V
		5932.5	51.28	-16.92	68.2	41.35	32.56	10.62	33.25	100	147	P	V
													V
													V



WIFI Ant. 1	Note	Frequency (MHz)	Level (dBμV/m)	Over Limit (dB)	Limit Line (dBμV/m)	Read Level (dBμV)	Antenna Factor (dB/m)	Path Loss (dB)	Preamp Factor (dB)	Ant Pos (cm)	Table Pos (deg)	Peak Avg. (P/A)	Pol. (H/V)
		5646.25	50.82	-17.38	68.2	41.78	31.71	10.49	33.16	100	240	P	H
		5690.5	54.67	-43.53	98.2	45.39	31.94	10.51	33.17	100	240	P	H
		5719.5	57.26	-53.4	110.66	47.87	32.04	10.53	33.18	100	240	P	H
		5723.75	58.78	-60.57	119.35	49.38	32.05	10.53	33.18	100	240	P	H
	*	5795	113.39	-	-	103.83	32.19	10.57	33.2	100	240	P	H
	*	5795	105.3	-	-	95.74	32.19	10.57	33.2	100	240	A	H
		5851	67.38	-52.54	119.92	57.71	32.3	10.59	33.22	100	240	P	H
		5858	65.02	-44.94	109.96	55.32	32.33	10.59	33.22	100	240	P	H
		5887.5	59.02	-36.9	95.92	49.2	32.45	10.6	33.23	100	240	P	H
		5932.75	54.77	-13.43	68.2	44.83	32.57	10.62	33.25	100	240	P	H
802.11ac													H
VHT40													H
CH 159		5619	49.8	-18.4	68.2	40.72	31.76	10.47	33.15	100	180	P	V
5795MHz		5697	51.31	-51.68	102.99	41.99	31.98	10.51	33.17	100	180	P	V
		5714.75	55.23	-54.1	109.33	45.86	32.03	10.52	33.18	100	180	P	V
		5720.75	57.83	-54.68	112.51	48.44	32.04	10.53	33.18	100	180	P	V
	*	5795	110.39	-	-	100.83	32.19	10.57	33.2	100	180	P	V
	*	5795	102.44	-	-	92.88	32.19	10.57	33.2	100	180	A	V
		5852	65.35	-52.29	117.64	55.67	32.31	10.59	33.22	100	180	P	V
		5856	62.78	-47.74	110.52	53.09	32.32	10.59	33.22	100	180	P	V
		5875.25	56.44	-48.57	105.01	46.67	32.4	10.6	33.23	100	180	P	V
		5946.5	51.95	-16.25	68.2	41.98	32.59	10.63	33.25	100	180	P	V
													V
													V
Remark	1. No other spurious found. 2. All results are PASS against Peak and Average limit line.												



Band 4 5725~5850MHz

WIFI 802.11ac VHT40 (Harmonic @ 3m)

WIFI Ant. 1	Note	Frequency (MHz)	Level (dBµV/m)	Over Limit (dB)	Limit Line (dBµV/m)	Read Level (dBµV)	Antenna Factor (dB/m)	Path Loss (dB)	Preamp Factor (dB)	Ant Pos (cm)	Table Pos (deg)	Peak Avg. (P/A)	Pol. (H/V)	
802.11ac VHT40 CH 151 5755MHz		11510	44.96	-29.04	74	50.25	39.67	17.25	62.21	100	0	P	H	
		17265	46.04	-22.16	68.2	42.37	40.6	22.09	59.02	100	0	P	H	
													H	
													H	
			11510	45.03	-28.97	74	50.32	39.67	17.25	62.21	100	0	P	V
			17265	46.12	-22.08	68.2	42.45	40.6	22.09	59.02	100	0	P	V
														V
802.11ac VHT40 CH 159 5795MHz		11590	46.2	-27.8	74	51.67	39.43	17.37	62.27	100	0	P	H	
		17385	47.05	-21.15	68.2	42.48	41.12	22.2	58.75	100	0	P	H	
													H	
													H	
			11590	45.29	-28.71	74	50.76	39.43	17.37	62.27	100	0	P	V
			17385	47.31	-20.89	68.2	42.74	41.12	22.2	58.75	100	0	P	V
														V
Remark	1. No other spurious found.													
	2. All results are PASS against Peak and Average limit line.													



Band 4 5725~5850MHz

WIFI 802.11ac VHT80 (Band Edge @ 3m)

WIFI Ant. 1	Note	Frequency (MHz)	Level (dBμV/m)	Over Limit (dB)	Limit Line (dBμV/m)	Read Level (dBμV)	Antenna Factor (dB/m)	Path Loss (dB)	Preamp Factor (dB)	Ant Pos (cm)	Table Pos (deg)	Peak Avg. (P/A)	Pol. (H/V)
		5636.75	57.4	-10.8	68.2	48.34	31.73	10.48	33.15	103	240	P	H
		5696	78.07	-24.18	102.25	68.75	31.98	10.51	33.17	103	240	P	H
		5719.5	81.36	-29.3	110.66	71.97	32.04	10.53	33.18	103	240	P	H
		5723.25	82.19	-36.02	118.21	72.79	32.05	10.53	33.18	103	240	P	H
	*	5775	109.91	-	-	100.4	32.15	10.56	33.2	103	240	P	H
	*	5775	101.93	-	-	92.42	32.15	10.56	33.2	103	240	A	H
		5854	82.92	-30.16	113.08	73.23	32.32	10.59	33.22	103	240	P	H
		5856.5	80.12	-30.26	110.38	70.42	32.33	10.59	33.22	103	240	P	H
		5875.75	74.17	-30.47	104.64	64.4	32.4	10.6	33.23	103	240	P	H
		5932	59.32	-8.88	68.2	49.39	32.56	10.62	33.25	103	240	P	H
													H
													H
802.11ac VHT80 CH 155 5775MHz		5640.25	53.03	-15.17	68.2	43.98	31.72	10.48	33.15	100	144	P	V
		5696.25	73.77	-28.67	102.44	64.45	31.98	10.51	33.17	100	144	P	V
		5719.5	77.52	-33.14	110.66	68.13	32.04	10.53	33.18	100	144	P	V
		5721.5	79.05	-35.17	114.22	69.66	32.04	10.53	33.18	100	144	P	V
	*	5775	106.81	-	-	97.3	32.15	10.56	33.2	100	144	P	V
	*	5775	99.08	-	-	89.57	32.15	10.56	33.2	100	144	A	V
		5851.75	78.8	-39.41	118.21	69.12	32.31	10.59	33.22	100	144	P	V
		5855.5	77.72	-32.94	110.66	68.03	32.32	10.59	33.22	100	144	P	V
		5875.75	70.14	-34.5	104.64	60.37	32.4	10.6	33.23	100	144	P	V
		5925.75	54.7	-13.5	68.2	44.78	32.55	10.62	33.25	100	144	P	V
													V
													V
Remark	1. No other spurious found. 2. All results are PASS against Peak and Average limit line.												



Band 4 5725~5850MHz

WIFI 802.11ac VHT80 (Harmonic @ 3m)

WIFI Ant. 1	Note	Frequency (MHz)	Level (dBμV/m)	Over Limit (dB)	Limit Line (dBμV/m)	Read Level (dBμV)	Antenna Factor (dB/m)	Path Loss (dB)	Preamp Factor (dB)	Ant Pos (cm)	Table Pos (deg)	Peak Avg. (P/A)	Pol. (H/V)	
802.11ac VHT80 CH 155 5775MHz		11550	44.44	-29.56	74	49.82	39.55	17.31	62.24	100	0	P	H	
		17325	46.17	-22.03	68.2	42.07	40.83	22.15	58.88	100	0	P	H	
													H	
													H	
			11550	44.65	-29.35	74	50.03	39.55	17.31	62.24	100	0	P	V
			17325	46.72	-21.48	68.2	42.62	40.83	22.15	58.88	100	0	P	V
														V
Remark	1. No other spurious found. 2. All results are PASS against Peak and Average limit line.													



Band 4 - 5725~5850MHz

WIFI 802.11a (Band Edge @ 3m)

WIFI	Note	Frequency	Level	Over	Limit	Read	Antenna	Path	Preamp	Ant	Table	Peak	Pol.	
Ant.				Limit	Line	Level	Factor	Loss	Factor	Pos	Pos	Avg.		
2		(MHz)	(dBμV/m)	(dB)	(dBμV/m)	(dBμV)	(dB/m)	(dB)	(dB)	(cm)	(deg)	(P/A)	(H/V)	
802.11a CH 149 5745MHz		5612.2	51.92	-16.28	68.2	42.82	31.78	10.47	33.15	100	298	P	H	
		5698.4	56.17	-47.85	104.02	46.84	31.99	10.51	33.17	100	298	P	H	
		5720	69.63	-41.17	110.8	60.24	32.04	10.53	33.18	100	298	P	H	
		5724.8	82.07	-39.67	121.74	72.67	32.05	10.53	33.18	100	298	P	H	
	*	5745	115.83	-	-	106.39	32.09	10.54	33.19	100	298	P	H	
	*	5745	108.35	-	-	98.91	32.09	10.54	33.19	100	298	A	H	
														H
														H
			5647	50.94	-17.26	68.2	41.9	31.71	10.49	33.16	359	171	P	V
			5697.6	56.36	-47.07	103.43	47.03	31.99	10.51	33.17	359	171	P	V
			5717.6	68.77	-41.36	110.13	59.39	32.04	10.52	33.18	359	171	P	V
			5725	81	-41.2	122.2	71.6	32.05	10.53	33.18	359	171	P	V
	*		5745	115.15	-	-	105.71	32.09	10.54	33.19	359	171	P	V
	*		5745	107.43	-	-	97.99	32.09	10.54	33.19	359	171	A	V
														V
													V	



WIFI Ant. 2	Note	Frequency (MHz)	Level (dBμV/m)	Over Limit (dB)	Limit Line (dBμV/m)	Read Level (dBμV)	Antenna Factor (dB/m)	Path Loss (dB)	Preamp Factor (dB)	Ant Pos (cm)	Table Pos (deg)	Peak Avg. (P/A)	Pol. (H/V)
		5606	50.46	-17.74	68.2	41.35	31.79	10.46	33.14	100	297	P	H
		5697.75	51	-52.54	103.54	41.67	31.99	10.51	33.17	100	297	P	H
		5719	52.33	-58.19	110.52	42.94	32.04	10.53	33.18	100	297	P	H
		5721.75	52.5	-62.29	114.79	43.11	32.04	10.53	33.18	100	297	P	H
	*	5785	116.77	-	-	107.24	32.17	10.56	33.2	100	297	P	H
	*	5785	109.14	-	-	99.61	32.17	10.56	33.2	100	297	A	H
		5852.75	60.41	-55.52	115.93	50.73	32.31	10.59	33.22	100	297	P	H
		5855	57.22	-53.58	110.8	47.53	32.32	10.59	33.22	100	297	P	H
		5883.5	54.64	-44.25	98.89	44.84	32.43	10.6	33.23	100	297	P	H
		5926.75	51.98	-16.22	68.2	42.06	32.55	10.62	33.25	100	297	P	H
													H
													H
802.11a													
CH 157													
5785MHz		5604.25	50.53	-17.67	68.2	41.42	31.79	10.46	33.14	354	174	P	V
		5681.5	51.3	-40.25	91.55	42.08	31.89	10.5	33.17	354	174	P	V
		5713.75	52.04	-57.01	109.05	42.67	32.03	10.52	33.18	354	174	P	V
		5723	55.2	-62.44	117.64	45.8	32.05	10.53	33.18	354	174	P	V
	*	5785	116.12	-	-	106.59	32.17	10.56	33.2	354	174	P	V
	*	5785	108.84	-	-	99.31	32.17	10.56	33.2	354	174	A	V
		5850	53.03	-69.17	122.2	43.36	32.3	10.59	33.22	354	174	P	V
		5871.5	52.15	-54.03	106.18	42.39	32.39	10.6	33.23	354	174	P	V
		5880.25	52.5	-48.8	101.3	42.71	32.42	10.6	33.23	354	174	P	V
		5937.5	50.11	-18.09	68.2	40.17	32.57	10.62	33.25	354	174	P	V
													V
													V



WIFI Ant. 2	Note	Frequency (MHz)	Level (dBμV/m)	Over Limit (dB)	Limit Line (dBμV/m)	Read Level (dBμV)	Antenna Factor (dB/m)	Path Loss (dB)	Preamp Factor (dB)	Ant Pos (cm)	Table Pos (deg)	Peak Avg. (P/A)	Pol. (H/V)	
802.11a CH 165 5825MHz	*	5825	116.47	-	-	106.85	32.25	10.58	33.21	100	298	P	H	
	*	5825	109.04	-	-	99.42	32.25	10.58	33.21	100	298	A	H	
		5850	76.2	-46	122.2	66.53	32.3	10.59	33.22	100	298	P	H	
		5855.8	66.82	-43.76	110.58	57.13	32.32	10.59	33.22	100	298	P	H	
		5883.6	56.89	-41.92	98.81	47.09	32.43	10.6	33.23	100	298	P	H	
		5942.2	52.43	-15.77	68.2	42.47	32.58	10.63	33.25	100	298	P	H	
														H
														H
	*	5825	116.09	-	-	106.47	32.25	10.58	33.21	325	172	P	V	
	*	5825	108.43	-	-	98.81	32.25	10.58	33.21	325	172	A	V	
		5850.8	72.88	-47.5	120.38	63.21	32.3	10.59	33.22	325	172	P	V	
		5855.2	64.93	-45.81	110.74	55.24	32.32	10.59	33.22	325	172	P	V	
		5880.2	57.83	-43.51	101.34	48.04	32.42	10.6	33.23	325	172	P	V	
		5938.4	52.07	-16.13	68.2	42.11	32.58	10.63	33.25	325	172	P	V	
														V
														V
														V
	Remark	1. No other spurious found. 2. All results are PASS against Peak and Average limit line.												



Band 4 5725~5850MHz

WIFI 802.11a (Harmonic @ 3m)

WIFI Ant. 2	Note	Frequency (MHz)	Level (dBµV/m)	Over Limit (dB)	Limit Line (dBµV/m)	Read Level (dBµV)	Antenna Factor (dB/m)	Path Loss (dB)	Preamp Factor (dB)	Ant Pos (cm)	Table Pos (deg)	Peak Avg. (P/A)	Pol. (H/V)
802.11a CH 149 5745MHz		11490	44.82	-29.18	74	50.08	39.7	17.23	62.19	100	0	P	H
		17235	46.5	-21.7	68.2	43.01	40.51	22.06	59.08	100	0	P	H
													H
													H
		11490	45.35	-28.65	74	50.61	39.7	17.23	62.19	100	0	P	V
		17235	46.14	-22.06	68.2	42.65	40.51	22.06	59.08	100	0	P	V
													V
													V
802.11a CH 157 5785MHz		11570	45.05	-28.95	74	50.48	39.49	17.34	62.26	100	0	P	H
		17355	46	-22.2	68.2	41.66	40.98	22.18	58.82	100	0	P	H
													H
													H
		11570	44.52	-29.48	74	49.95	39.49	17.34	62.26	100	0	P	V
		17355	47.16	-21.04	68.2	42.82	40.98	22.18	58.82	100	0	P	V
													V
													V
802.11a CH 165 5825MHz		11650	44.89	-29.11	74	50.55	39.2	17.46	62.32	100	0	P	H
		17475	47.39	-20.81	68.2	42.08	41.58	22.29	58.56	100	0	P	H
													H
													H
		11650	44.64	-29.36	74	50.3	39.2	17.46	62.32	100	0	P	V
		17475	48.05	-20.15	68.2	42.74	41.58	22.29	58.56	100	0	P	V
													V
													V
Remark	1. No other spurious found. 2. All results are PASS against Peak and Average limit line.												



Band 4 5725~5850MHz

WIFI 802.11ac VHT20 (Band Edge @ 3m)

WIFI Ant. 2	Note	Frequency (MHz)	Level (dBμV/m)	Over Limit (dB)	Limit Line (dBμV/m)	Read Level (dBμV)	Antenna Factor (dB/m)	Path Loss (dB)	Preamp Factor (dB)	Ant Pos (cm)	Table Pos (deg)	Peak Avg. (P/A)	Pol. (H/V)	
802.11ac VHT20 CH 149 5745MHz		5645.6	51.41	-16.79	68.2	42.37	31.71	10.49	33.16	100	298	P	H	
		5688.6	58.43	-38.36	96.79	49.16	31.93	10.51	33.17	100	298	P	H	
		5720	75.98	-34.82	110.8	66.59	32.04	10.53	33.18	100	298	P	H	
		5724.8	83.69	-38.05	121.74	74.29	32.05	10.53	33.18	100	298	P	H	
	*	5745	115.68	-	-	106.24	32.09	10.54	33.19	100	298	P	H	
	*	5745	108.15	-	-	98.71	32.09	10.54	33.19	100	298	A	H	
														H
														H
			5639.4	50.28	-17.92	68.2	41.23	31.72	10.48	33.15	311	159	P	V
			5697.2	56.72	-46.42	103.14	47.4	31.98	10.51	33.17	311	159	P	V
			5719.8	71.52	-39.22	110.74	62.13	32.04	10.53	33.18	311	159	P	V
			5723	80.47	-37.17	117.64	71.07	32.05	10.53	33.18	311	159	P	V
	*		5745	114.3	-	-	104.86	32.09	10.54	33.19	311	159	P	V
	*		5745	106.29	-	-	96.85	32.09	10.54	33.19	311	159	A	V
														V
														V



WIFI Ant. 2	Note	Frequency (MHz)	Level (dBμV/m)	Over Limit (dB)	Limit Line (dBμV/m)	Read Level (dBμV)	Antenna Factor (dB/m)	Path Loss (dB)	Preamp Factor (dB)	Ant Pos (cm)	Table Pos (deg)	Peak Avg. (P/A)	Pol. (H/V)
		5629.25	50.82	-17.38	68.2	41.75	31.74	10.48	33.15	100	298	P	H
		5683.75	51.8	-41.41	93.21	42.56	31.9	10.51	33.17	100	298	P	H
		5715.5	53.15	-56.39	109.54	43.78	32.03	10.52	33.18	100	298	P	H
		5724	54.22	-65.7	119.92	44.82	32.05	10.53	33.18	100	298	P	H
	*	5785	116.31	-	-	106.78	32.17	10.56	33.2	100	298	P	H
	*	5785	108.67	-	-	99.14	32.17	10.56	33.2	100	298	A	H
		5851.75	57.8	-60.41	118.21	48.12	32.31	10.59	33.22	100	298	P	H
		5871	57.15	-49.17	106.32	47.4	32.38	10.6	33.23	100	298	P	H
		5887.75	53.98	-41.76	95.74	44.15	32.45	10.61	33.23	100	298	P	H
		5929.75	51.91	-16.29	68.2	41.98	32.56	10.62	33.25	100	298	P	H
802.11ac													H
VHT20													H
CH 157		5616.75	49.83	-18.37	68.2	40.74	31.77	10.47	33.15	329	178	P	V
5785MHz		5689.75	50.57	-47.07	97.64	41.29	31.94	10.51	33.17	329	178	P	V
		5715.5	52.08	-57.46	109.54	42.71	32.03	10.52	33.18	329	178	P	V
		5725	51.66	-70.54	122.2	42.26	32.05	10.53	33.18	329	178	P	V
	*	5785	114.87	-	-	105.34	32.17	10.56	33.2	329	178	P	V
	*	5785	107.19	-	-	97.66	32.17	10.56	33.2	329	178	A	V
		5854	54.64	-58.44	113.08	44.95	32.32	10.59	33.22	329	178	P	V
		5860.5	54.89	-54.37	109.26	45.19	32.34	10.59	33.23	329	178	P	V
		5875.75	52.29	-52.35	104.64	42.52	32.4	10.6	33.23	329	178	P	V
		5932.75	51.97	-16.23	68.2	42.03	32.57	10.62	33.25	329	178	P	V
													V
													V



WIFI Ant. 2	Note	Frequency (MHz)	Level (dBμV/m)	Over Limit (dB)	Limit Line (dBμV/m)	Read Level (dBμV)	Antenna Factor (dB/m)	Path Loss (dB)	Preamp Factor (dB)	Ant Pos (cm)	Table Pos (deg)	Peak Avg. (P/A)	Pol. (H/V)	
802.11ac VHT20 CH 165 5825MHz	*	5825	116.16	-	-	106.54	32.25	10.58	33.21	100	298	P	H	
	*	5825	108.58	-	-	98.96	32.25	10.58	33.21	100	298	A	H	
		5850	79.25	-42.95	122.2	69.58	32.3	10.59	33.22	100	298	P	H	
		5855	67.99	-42.81	110.8	58.3	32.32	10.59	33.22	100	298	P	H	
		5880.4	58.89	-42.3	101.19	49.1	32.42	10.6	33.23	100	298	P	H	
		5925.2	52.24	-15.96	68.2	42.32	32.55	10.62	33.25	100	298	P	H	
														H
														H
	*	5825	115.59	-	-	105.97	32.25	10.58	33.21	349	174	P	V	
	*	5825	107.88	-	-	98.26	32.25	10.58	33.21	349	174	A	V	
		5850	77.27	-44.93	122.2	67.6	32.3	10.59	33.22	349	174	P	V	
		5855.2	66.04	-44.7	110.74	56.35	32.32	10.59	33.22	349	174	P	V	
		5883	58.11	-41.15	99.26	48.31	32.43	10.6	33.23	349	174	P	V	
		5929	51.41	-16.79	68.2	41.48	32.56	10.62	33.25	349	174	P	V	
														V
														V
Remark	1. No other spurious found. 2. All results are PASS against Peak and Average limit line.													



Band 4 5725~5850MHz

WIFI 802.11ac VHT20 (Harmonic @ 3m)

WIFI Ant. 2	Note	Frequency (MHz)	Level (dBμV/m)	Over Limit (dB)	Limit Line (dBμV/m)	Read Level (dBμV)	Antenna Factor (dB/m)	Path Loss (dB)	Preamp Factor (dB)	Ant Pos (cm)	Table Pos (deg)	Peak Avg. (P/A)	Pol. (H/V)	
802.11ac VHT20 CH 149 5745MHz		11490	44.98	-29.02	74	50.24	39.7	17.23	62.19	100	0	P	H	
		17235	46.17	-22.03	68.2	42.68	40.51	22.06	59.08	100	0	P	H	
													H	
													H	
			11490	45.02	-28.98	74	50.28	39.7	17.23	62.19	100	0	P	V
			17235	46.61	-21.59	68.2	43.12	40.51	22.06	59.08	100	0	P	V
														V
802.11ac VHT20 CH 157 5785MHz		11570	44.82	-29.18	74	50.25	39.49	17.34	62.26	100	0	P	H	
		17355	46.32	-21.88	68.2	41.98	40.98	22.18	58.82	100	0	P	H	
													H	
													H	
			11570	44.43	-29.57	74	49.86	39.49	17.34	62.26	100	0	P	V
			17355	46.27	-21.93	68.2	41.93	40.98	22.18	58.82	100	0	P	V
														V
802.11ac VHT20 CH 165 5825MHz		11650	44.83	-29.17	74	50.49	39.2	17.46	62.32	100	0	P	H	
		17475	47.7	-20.5	68.2	42.39	41.58	22.29	58.56	100	0	P	H	
													H	
													H	
			11650	45.25	-28.75	74	50.91	39.2	17.46	62.32	100	0	P	V
			17475	47.63	-20.57	68.2	42.32	41.58	22.29	58.56	100	0	P	V
														V
Remark	1. No other spurious found.													
	2. All results are PASS against Peak and Average limit line.													



Band 4 5725~5850MHz

WIFI 802.11ac VHT40 (Band Edge @ 3m)

WIFI Ant. 2	Note	Frequency (MHz)	Level (dBμV/m)	Over Limit (dB)	Limit Line (dBμV/m)	Read Level (dBμV)	Antenna Factor (dB/m)	Path Loss (dB)	Preamp Factor (dB)	Ant Pos (cm)	Table Pos (deg)	Peak Avg. (P/A)	Pol. (H/V)
		5639.5	52	-16.2	68.2	42.95	31.72	10.48	33.15	100	299	P	H
		5699	69.2	-35.26	104.46	59.87	31.99	10.51	33.17	100	299	P	H
		5719	86.88	-23.64	110.52	77.49	32.04	10.53	33.18	100	299	P	H
		5721.5	88.13	-26.09	114.22	78.74	32.04	10.53	33.18	100	299	P	H
	*	5755	114.39	-	-	104.92	32.11	10.55	33.19	100	299	P	H
	*	5755	106.18	-	-	96.71	32.11	10.55	33.19	100	299	A	H
		5852.5	54.93	-61.57	116.5	45.25	32.31	10.59	33.22	100	299	P	H
		5870	54.19	-52.41	106.6	44.44	32.38	10.6	33.23	100	299	P	H
		5889.25	52.7	-41.92	94.62	42.86	32.46	10.61	33.23	100	299	P	H
		5929	50.63	-17.57	68.2	40.7	32.56	10.62	33.25	100	299	P	H
													H
													H
802.11ac VHT40 CH 151 5755MHz		5639.75	51.74	-16.46	68.2	42.69	31.72	10.48	33.15	311	158	P	V
		5699	68.82	-35.64	104.46	59.49	31.99	10.51	33.17	311	158	P	V
		5718.5	84.02	-26.36	110.38	74.63	32.04	10.53	33.18	311	158	P	V
		5721.75	86.35	-28.44	114.79	76.96	32.04	10.53	33.18	311	158	P	V
	*	5755	112.41	-	-	102.94	32.11	10.55	33.19	311	158	P	V
	*	5755	104.3	-	-	94.83	32.11	10.55	33.19	311	158	A	V
		5852.5	52.94	-63.56	116.5	43.26	32.31	10.59	33.22	311	158	P	V
		5861.5	52.82	-56.16	108.98	43.11	32.35	10.59	33.23	311	158	P	V
		5895.25	51.66	-38.52	90.18	41.81	32.48	10.61	33.24	311	158	P	V
		5926.5	50.84	-17.36	68.2	40.92	32.55	10.62	33.25	311	158	P	V
													V
													V



WIFI Ant. 2	Note	Frequency (MHz)	Level (dBμV/m)	Over Limit (dB)	Limit Line (dBμV/m)	Read Level (dBμV)	Antenna Factor (dB/m)	Path Loss (dB)	Preamp Factor (dB)	Ant Pos (cm)	Table Pos (deg)	Peak Avg. (P/A)	Pol. (H/V)
		5616	51.83	-16.37	68.2	42.74	31.77	10.47	33.15	103	299	P	H
		5698.25	55.55	-48.36	103.91	46.22	31.99	10.51	33.17	103	299	P	H
		5719.5	63.07	-47.59	110.66	53.68	32.04	10.53	33.18	103	299	P	H
		5724.75	64.37	-57.26	121.63	54.97	32.05	10.53	33.18	103	299	P	H
	*	5795	114.52	-	-	104.96	32.19	10.57	33.2	103	299	P	H
	*	5795	106.64	-	-	97.08	32.19	10.57	33.2	103	299	A	H
		5851.25	69.01	-50.34	119.35	59.33	32.31	10.59	33.22	103	299	P	H
		5855.75	68.25	-42.34	110.59	58.56	32.32	10.59	33.22	103	299	P	H
		5875.25	58.81	-46.2	105.01	49.04	32.4	10.6	33.23	103	299	P	H
		5944.75	53.32	-14.88	68.2	43.35	32.59	10.63	33.25	103	299	P	H
802.11ac													H
VHT40													H
CH 159		5601.75	49.86	-18.34	68.2	40.74	31.8	10.46	33.14	334	175	P	V
5795MHz		5696.75	51.83	-50.97	102.8	42.51	31.98	10.51	33.17	334	175	P	V
		5714.5	60.24	-49.02	109.26	50.87	32.03	10.52	33.18	334	175	P	V
		5724.25	60.79	-59.7	120.49	51.39	32.05	10.53	33.18	334	175	P	V
	*	5795	114.01	-	-	104.45	32.19	10.57	33.2	334	175	P	V
	*	5795	105.95	-	-	96.39	32.19	10.57	33.2	334	175	A	V
		5850.75	68.3	-52.19	120.49	58.63	32.3	10.59	33.22	334	175	P	V
		5856	64.59	-45.93	110.52	54.9	32.32	10.59	33.22	334	175	P	V
		5875	57.61	-47.59	105.2	47.84	32.4	10.6	33.23	334	175	P	V
		5929.25	53.39	-14.81	68.2	43.46	32.56	10.62	33.25	334	175	P	V
													V
													V
Remark	1. No other spurious found. 2. All results are PASS against Peak and Average limit line.												



Band 4 5725~5850MHz

WIFI 802.11ac VHT40 (Harmonic @ 3m)

WIFI Ant. 2	Note	Frequency (MHz)	Level (dBµV/m)	Over Limit (dB)	Limit Line (dBµV/m)	Read Level (dBµV)	Antenna Factor (dB/m)	Path Loss (dB)	Preamp Factor (dB)	Ant Pos (cm)	Table Pos (deg)	Peak Avg. (P/A)	Pol. (H/V)	
802.11ac VHT40 CH 151 5755MHz		11510	44.88	-29.12	74	50.17	39.67	17.25	62.21	100	0	P	H	
		17265	47.21	-20.99	68.2	43.54	40.6	22.09	59.02	100	0	P	H	
													H	
													H	
			11510	45.11	-28.89	74	50.4	39.67	17.25	62.21	100	0	P	V
			17265	46.95	-21.25	68.2	43.28	40.6	22.09	59.02	100	0	P	V
														V
802.11ac VHT40 CH 159 5795MHz		11590	46.23	-27.77	74	51.7	39.43	17.37	62.27	100	0	P	H	
		17385	46.96	-21.24	68.2	42.39	41.12	22.2	58.75	100	0	P	H	
													H	
													H	
			11590	45.49	-28.51	74	50.96	39.43	17.37	62.27	100	0	P	V
			17385	46.71	-21.49	68.2	42.14	41.12	22.2	58.75	100	0	P	V
														V
Remark	1. No other spurious found.													
	2. All results are PASS against Peak and Average limit line.													



Band 4 5725~5850MHz

WIFI 802.11ac VHT80 (Band Edge @ 3m)

WIFI Ant. 2	Note	Frequency (MHz)	Level (dBμV/m)	Over Limit (dB)	Limit Line (dBμV/m)	Read Level (dBμV)	Antenna Factor (dB/m)	Path Loss (dB)	Preamp Factor (dB)	Ant Pos (cm)	Table Pos (deg)	Peak Avg. (P/A)	Pol. (H/V)
		5649	60.75	-7.45	68.2	51.72	31.7	10.49	33.16	100	298	P	H
		5695.75	82.13	-19.94	102.07	72.82	31.97	10.51	33.17	100	298	P	H
		5719	85.49	-25.03	110.52	76.1	32.04	10.53	33.18	100	298	P	H
		5720.75	85.52	-26.99	112.51	76.13	32.04	10.53	33.18	100	298	P	H
	*	5775	111.48	-	-	101.97	32.15	10.56	33.2	100	298	P	H
	*	5775	103.55	-	-	94.04	32.15	10.56	33.2	100	298	A	H
		5853.75	85.8	-27.85	113.65	76.12	32.31	10.59	33.22	100	298	P	H
		5859	82.16	-27.52	109.68	72.45	32.34	10.59	33.22	100	298	P	H
		5875	75.81	-29.39	105.2	66.04	32.4	10.6	33.23	100	298	P	H
		5928.5	59.17	-9.03	68.2	49.24	32.56	10.62	33.25	100	298	P	H
													H
													H
802.11ac VHT80 CH 155 5775MHz		5649.5	57.88	-10.32	68.2	48.85	31.7	10.49	33.16	353	176	P	V
		5698.5	79	-25.09	104.09	69.67	31.99	10.51	33.17	353	176	P	V
		5720	83.71	-27.09	110.8	74.32	32.04	10.53	33.18	353	176	P	V
		5720.25	83.74	-27.63	111.37	74.35	32.04	10.53	33.18	353	176	P	V
	*	5775	110.33	-	-	100.82	32.15	10.56	33.2	353	176	P	V
	*	5775	102.41	-	-	92.9	32.15	10.56	33.2	353	176	A	V
		5850.5	82.51	-38.55	121.06	72.84	32.3	10.59	33.22	353	176	P	V
		5855.75	79.15	-31.44	110.59	69.46	32.32	10.59	33.22	353	176	P	V
		5877.25	70.94	-32.59	103.53	61.16	32.41	10.6	33.23	353	176	P	V
		5925	57.52	-10.68	68.2	47.6	32.55	10.62	33.25	353	176	P	V
													V
													V
Remark	1. No other spurious found. 2. All results are PASS against Peak and Average limit line.												



Band 4 5725~5850MHz

WIFI 802.11ac VHT80 (Harmonic @ 3m)

WIFI Ant. 2	Note	Frequency (MHz)	Level (dBμV/m)	Over Limit (dB)	Limit Line (dBμV/m)	Read Level (dBμV)	Antenna Factor (dB/m)	Path Loss (dB)	Preamp Factor (dB)	Ant Pos (cm)	Table Pos (deg)	Peak Avg. (P/A)	Pol. (H/V)	
802.11ac VHT80 CH 155 5775MHz		11550	45	-29	74	50.38	39.55	17.31	62.24	100	0	P	H	
		17325	46.88	-21.32	68.2	42.78	40.83	22.15	58.88	100	0	P	H	
													H	
													H	
			11550	45.17	-28.83	74	50.55	39.55	17.31	62.24	100	0	P	V
			17325	46.24	-21.96	68.2	42.14	40.83	22.15	58.88	100	0	P	V
														V
Remark	1. No other spurious found. 2. All results are PASS against Peak and Average limit line.													



Band 4 - 5725~5850MHz

WIFI 802.11a (Band Edge @ 3m)

WIFI	Note	Frequency	Level	Over	Limit	Read	Antenna	Path	Preamp	Ant	Table	Peak	Pol.	
Ant.				Limit	Line	Level	Factor	Loss	Factor	Pos	Pos	Avg.		
1+2		(MHz)	(dBμV/m)	(dB)	(dBμV/m)	(dBμV)	(dB/m)	(dB)	(dB)	(cm)	(deg)	(P/A)	(H/V)	
802.11a CH 149 5745MHz		5648.825	51.31	-16.89	68.2	42.28	31.7	10.49	33.16	100	216	P	H	
		5699.45	55.53	-49.26	104.79	46.19	32	10.51	33.17	100	216	P	H	
		5719.7	64.11	-46.61	110.72	54.72	32.04	10.53	33.18	100	216	P	H	
		5724.65	79.74	-41.66	121.4	70.34	32.05	10.53	33.18	100	216	P	H	
	*	5745	117.98	-	-	108.54	32.09	10.54	33.19	100	216	P	H	
	*	5745	110.69	-	-	101.25	32.09	10.54	33.19	100	216	A	H	
														H
														H
			5644.325	50.68	-17.52	68.2	41.65	31.71	10.48	33.16	340	170	P	V
			5698.55	53.88	-50.25	104.13	44.55	31.99	10.51	33.17	340	170	P	V
			5719.7	65.22	-45.5	110.72	55.83	32.04	10.53	33.18	340	170	P	V
			5724.65	79.66	-41.74	121.4	70.26	32.05	10.53	33.18	340	170	P	V
	*		5745	116.57	-	-	107.13	32.09	10.54	33.19	340	170	P	V
	*		5745	109.53	-	-	100.09	32.09	10.54	33.19	340	170	A	V
														V
													V	



WIFI Ant. 1+2	Note	Frequency (MHz)	Level (dBμV/m)	Over Limit (dB)	Limit Line (dBμV/m)	Read Level (dBμV)	Antenna Factor (dB/m)	Path Loss (dB)	Preamp Factor (dB)	Ant Pos (cm)	Table Pos (deg)	Peak Avg. (P/A)	Pol. (H/V)	
802.11a CH 157 5785MHz		5608.25	50.61	-17.59	68.2	41.51	31.78	10.46	33.14	100	219	P	H	
		5682.25	52.35	-39.75	92.1	43.12	31.89	10.51	33.17	100	219	P	H	
		5719	52.93	-57.59	110.52	43.54	32.04	10.53	33.18	100	219	P	H	
		5724.25	53.92	-66.57	120.49	44.52	32.05	10.53	33.18	100	219	P	H	
	*	5785	118.05	-	-	108.52	32.17	10.56	33.2	100	219	P	H	
	*	5785	110.82	-	-	101.29	32.17	10.56	33.2	100	219	A	H	
		5850.5	53.73	-67.33	121.06	44.06	32.3	10.59	33.22	100	219	P	H	
		5857	54.66	-55.58	110.24	44.96	32.33	10.59	33.22	100	219	P	H	
		5880.75	54.38	-46.55	100.93	44.59	32.42	10.6	33.23	100	219	P	H	
		5930.5	51.72	-16.48	68.2	41.79	32.56	10.62	33.25	100	219	P	H	
														H
														H
			5644.5	50.48	-17.72	68.2	41.45	31.71	10.48	33.16	396	164	P	V
			5657.5	50.28	-23.49	73.77	41.2	31.75	10.49	33.16	396	164	P	V
			5716.5	52.24	-57.58	109.82	42.87	32.03	10.52	33.18	396	164	P	V
			5721.25	50.36	-63.29	113.65	40.97	32.04	10.53	33.18	396	164	P	V
	*		5785	116.19	-	-	106.66	32.17	10.56	33.2	396	164	P	V
	*		5785	108.98	-	-	99.45	32.17	10.56	33.2	396	164	A	V
			5851	51.66	-68.26	119.92	41.99	32.3	10.59	33.22	396	164	P	V
			5860.5	52.3	-56.96	109.26	42.6	32.34	10.59	33.23	396	164	P	V
		5883.75	52.77	-45.93	98.7	42.96	32.44	10.6	33.23	396	164	P	V	
		5942	51.21	-16.99	68.2	41.25	32.58	10.63	33.25	396	164	P	V	
													V	
													V	



WiFi Ant. 1+2	Note	Frequency (MHz)	Level (dBμV/m)	Over Limit (dB)	Limit Line (dBμV/m)	Read Level (dBμV)	Antenna Factor (dB/m)	Path Loss (dB)	Preamp Factor (dB)	Ant Pos (cm)	Table Pos (deg)	Peak Avg. (P/A)	Pol. (H/V)	
802.11a CH 165 5825MHz	*	5825	118.19	-	-	108.57	32.25	10.58	33.21	100	217	P	H	
	*	5825	111.16	-	-	101.54	32.25	10.58	33.21	100	217	A	H	
		5850.37	76.98	-44.38	121.36	67.31	32.3	10.59	33.22	100	217	P	H	
		5855.29	68.67	-42.05	110.72	58.98	32.32	10.59	33.22	100	217	P	H	
		5876.405	57.28	-46.88	104.16	47.5	32.41	10.6	33.23	100	217	P	H	
		5948.975	52.79	-15.41	68.2	42.81	32.6	10.63	33.25	100	217	P	H	
														H
														H
	*	5825	116.73	-	-	107.11	32.25	10.58	33.21	332	170	P	V	
	*	5825	108.6	-	-	98.98	32.25	10.58	33.21	332	170	A	V	
		5850.37	72.51	-48.85	121.36	62.84	32.3	10.59	33.22	332	170	P	V	
		5855.905	64.7	-45.85	110.55	55.01	32.32	10.59	33.22	332	170	P	V	
		5879.89	55.19	-46.38	101.57	45.4	32.42	10.6	33.23	332	170	P	V	
		5939.955	53.1	-15.1	68.2	43.14	32.58	10.63	33.25	332	170	P	V	
														V
														V
													V	
Remark	1. No other spurious found. 2. All results are PASS against Peak and Average limit line.													



Band 4 5725~5850MHz

WIFI 802.11a (Harmonic @ 3m)

WIFI Ant. 1+2	Note	Frequency (MHz)	Level (dBµV/m)	Over Limit (dB)	Limit Line (dBµV/m)	Read Level (dBµV)	Antenna Factor (dB/m)	Path Loss (dB)	Preamp Factor (dB)	Ant Pos (cm)	Table Pos (deg)	Peak Avg. (P/A)	Pol. (H/V)
802.11a CH 149 5745MHz		11490	45.33	-28.67	74	50.59	39.7	17.23	62.19	100	0	P	H
		17235	46.77	-21.43	68.2	43.28	40.51	22.06	59.08	100	0	P	H
													H
													H
		11490	46.05	-27.95	74	51.31	39.7	17.23	62.19	100	0	P	V
		17235	47.04	-21.16	68.2	43.55	40.51	22.06	59.08	100	0	P	V
													V
													V
802.11a CH 157 5785MHz		11570	44.66	-29.34	74	50.09	39.49	17.34	62.26	100	0	P	H
		17355	45.7	-22.5	68.2	41.36	40.98	22.18	58.82	100	0	P	H
													H
													H
		11570	45.72	-28.28	74	51.15	39.49	17.34	62.26	100	0	P	V
		17355	46.5	-21.7	68.2	42.16	40.98	22.18	58.82	100	0	P	V
													V
													V
802.11a CH 165 5825MHz		11650	44.81	-29.19	74	50.47	39.2	17.46	62.32	100	0	P	H
		17475	47.01	-21.19	68.2	41.7	41.58	22.29	58.56	100	0	P	H
													H
													H
		11650	44.47	-29.53	74	50.13	39.2	17.46	62.32	100	0	P	V
		17475	47.47	-20.73	68.2	42.16	41.58	22.29	58.56	100	0	P	V
													V
													V
Remark	1. No other spurious found. 2. All results are PASS against Peak and Average limit line.												



Band 4 5725~5850MHz

WIFI 802.11ac VHT20 (Band Edge @ 3m)

WIFI Ant. 1+2	Note	Frequency (MHz)	Level (dBμV/m)	Over Limit (dB)	Limit Line (dBμV/m)	Read Level (dBμV)	Antenna Factor (dB/m)	Path Loss (dB)	Preamp Factor (dB)	Ant Pos (cm)	Table Pos (deg)	Peak Avg. (P/A)	Pol. (H/V)	
802.11ac VHT20 CH 149 5745MHz		5633.75	51.16	-17.04	68.2	42.1	31.73	10.48	33.15	100	206	P	H	
		5689.1	55.62	-41.54	97.16	46.35	31.93	10.51	33.17	100	206	P	H	
		5719.925	69.33	-41.45	110.78	59.94	32.04	10.53	33.18	100	206	P	H	
		5724.875	81.17	-40.75	121.92	71.77	32.05	10.53	33.18	100	206	P	H	
	*	5745	118.04	-	-	108.6	32.09	10.54	33.19	100	206	P	H	
	*	5745	110.79	-	-	101.35	32.09	10.54	33.19	100	206	A	H	
														H
														H
			5648.825	51.38	-16.82	68.2	42.35	31.7	10.49	33.16	342	169	P	V
			5693.375	56.02	-44.3	100.32	46.72	31.96	10.51	33.17	342	169	P	V
			5719.925	65.87	-44.91	110.78	56.48	32.04	10.53	33.18	342	169	P	V
			5723.75	79.2	-40.15	119.35	69.8	32.05	10.53	33.18	342	169	P	V
	*		5745	116.78	-	-	107.34	32.09	10.54	33.19	342	169	P	V
	*		5745	109.17	-	-	99.73	32.09	10.54	33.19	342	169	A	V
													V	
													V	



WIFI Ant. 1+2	Note	Frequency (MHz)	Level (dBμV/m)	Over Limit (dB)	Limit Line (dBμV/m)	Read Level (dBμV)	Antenna Factor (dB/m)	Path Loss (dB)	Preamp Factor (dB)	Ant Pos (cm)	Table Pos (deg)	Peak Avg. (P/A)	Pol. (H/V)
		5643.75	49.76	-18.44	68.2	40.73	31.71	10.48	33.16	110	204	P	H
		5693	50.9	-49.14	100.04	41.6	31.96	10.51	33.17	110	204	P	H
		5720.25	54.14	-57.23	111.37	44.75	32.04	10.53	33.18	110	204	P	H
		5722.25	53.37	-62.56	115.93	43.98	32.04	10.53	33.18	110	204	P	H
	*	5785	118.08	-	-	108.55	32.17	10.56	33.2	110	204	P	H
	*	5785	110.74	-	-	101.21	32.17	10.56	33.2	110	204	A	H
		5853.25	54.78	-60.01	114.79	45.1	32.31	10.59	33.22	110	204	P	H
		5860	55.45	-53.95	109.4	45.75	32.34	10.59	33.23	110	204	P	H
		5881.25	54.93	-45.63	100.56	45.14	32.42	10.6	33.23	110	204	P	H
		5929.75	51.78	-16.42	68.2	41.85	32.56	10.62	33.25	110	204	P	H
802.11ac													H
VHT20													H
CH 157		5634.5	50.32	-17.88	68.2	41.26	31.73	10.48	33.15	341	156	P	V
5785MHz		5699.75	50.45	-54.57	105.02	41.11	32	10.51	33.17	341	156	P	V
		5715.75	53.02	-56.59	109.61	43.65	32.03	10.52	33.18	341	156	P	V
		5720	52.14	-58.66	110.8	42.75	32.04	10.53	33.18	341	156	P	V
	*	5785	115.95	-	-	106.42	32.17	10.56	33.2	341	156	P	V
	*	5785	108.45	-	-	98.92	32.17	10.56	33.2	341	156	A	V
		5852	52.64	-65	117.64	42.96	32.31	10.59	33.22	341	156	P	V
		5855	53.27	-57.53	110.8	43.58	32.32	10.59	33.22	341	156	P	V
		5892	51.89	-40.69	92.58	42.05	32.47	10.61	33.24	341	156	P	V
		5943.75	51.06	-17.14	68.2	41.09	32.59	10.63	33.25	341	156	P	V
													V
													V



WiFi Ant. 1+2	Note	Frequency (MHz)	Level (dBμV/m)	Over Limit (dB)	Limit Line (dBμV/m)	Read Level (dBμV)	Antenna Factor (dB/m)	Path Loss (dB)	Preamp Factor (dB)	Ant Pos (cm)	Table Pos (deg)	Peak Avg. (P/A)	Pol. (H/V)	
802.11ac VHT20 CH 165 5825MHz	*	5825	118.46	-	-	108.84	32.25	10.58	33.21	100	204	P	H	
	*	5825	111.32	-	-	101.7	32.25	10.58	33.21	100	204	A	H	
		5849.96	78.23	-55.97	134.2	68.56	32.3	10.59	33.22	100	204	P	H	
		5855.085	65.03	-45.75	110.78	55.34	32.32	10.59	33.22	100	204	P	H	
		5886.86	58.58	-37.82	96.4	48.76	32.45	10.6	33.23	100	204	P	H	
		5942.62	53.34	-14.86	68.2	43.37	32.59	10.63	33.25	100	204	P	H	
														H
														H
	*	5825	116.7	-	-	107.08	32.25	10.58	33.21	331	173	P	V	
	*	5825	108.86	-	-	99.24	32.25	10.58	33.21	331	173	A	V	
		5850.165	75.26	-46.56	121.82	65.59	32.3	10.59	33.22	331	173	P	V	
		5860.005	60.7	-48.7	109.4	51	32.34	10.59	33.23	331	173	P	V	
		5885.22	57.67	-39.94	97.61	47.86	32.44	10.6	33.23	331	173	P	V	
		5929.09	51.74	-16.46	68.2	41.81	32.56	10.62	33.25	331	173	P	V	
														V
														V
Remark	1. No other spurious found. 2. All results are PASS against Peak and Average limit line.													



Band 4 5725~5850MHz

WIFI 802.11ac VHT20 (Harmonic @ 3m)

WIFI Ant. 1+2	Note	Frequency (MHz)	Level (dBμV/m)	Over Limit (dB)	Limit Line (dBμV/m)	Read Level (dBμV)	Antenna Factor (dB/m)	Path Loss (dB)	Preamp Factor (dB)	Ant Pos (cm)	Table Pos (deg)	Peak Avg. (P/A)	Pol. (H/V)	
802.11ac VHT20 CH 149 5745MHz		11490	45.15	-28.85	74	50.41	39.7	17.23	62.19	100	0	P	H	
		17235	47.18	-21.02	68.2	43.69	40.51	22.06	59.08	100	0	P	H	
													H	
													H	
			11490	45.1	-28.9	74	50.36	39.7	17.23	62.19	100	0	P	V
			17235	45.7	-22.5	68.2	42.21	40.51	22.06	59.08	100	0	P	V
														V
802.11ac VHT20 CH 157 5785MHz		11570	44.5	-29.5	74	49.93	39.49	17.34	62.26	100	0	P	H	
		17355	46.38	-21.82	68.2	42.04	40.98	22.18	58.82	100	0	P	H	
													H	
													H	
			11570	44.31	-29.69	74	49.74	39.49	17.34	62.26	100	0	P	V
			17355	45.42	-22.78	68.2	41.08	40.98	22.18	58.82	100	0	P	V
														V
802.11ac VHT20 CH 165 5825MHz		11650	44.59	-29.41	74	50.25	39.2	17.46	62.32	100	0	P	H	
		17475	47.62	-20.58	68.2	42.31	41.58	22.29	58.56	100	0	P	H	
													H	
													H	
			11650	45.17	-28.83	74	50.83	39.2	17.46	62.32	100	0	P	V
			17475	46.61	-21.59	68.2	41.3	41.58	22.29	58.56	100	0	P	V
														V
Remark	1. No other spurious found.													
	2. All results are PASS against Peak and Average limit line.													



Band 4 5725~5850MHz

WIFI 802.11ac VHT40 (Band Edge @ 3m)

WIFI Ant. 1+2	Note	Frequency (MHz)	Level (dBμV/m)	Over Limit (dB)	Limit Line (dBμV/m)	Read Level (dBμV)	Antenna Factor (dB/m)	Path Loss (dB)	Preamp Factor (dB)	Ant Pos (cm)	Table Pos (deg)	Peak Avg. (P/A)	Pol. (H/V)
		5644.75	51.23	-16.97	68.2	42.2	31.71	10.48	33.16	100	219	P	H
		5700	58.89	-46.31	105.2	49.55	32	10.51	33.17	100	219	P	H
		5717.25	81.03	-29	110.03	71.66	32.03	10.52	33.18	100	219	P	H
		5722	85.12	-30.24	115.36	75.73	32.04	10.53	33.18	100	219	P	H
	*	5755	115.94	-	-	106.47	32.11	10.55	33.19	100	219	P	H
	*	5755	107.61	-	-	98.14	32.11	10.55	33.19	100	219	A	H
		5852.5	53.49	-63.01	116.5	43.81	32.31	10.59	33.22	100	219	P	H
		5860.5	53.85	-55.41	109.26	44.15	32.34	10.59	33.23	100	219	P	H
		5900	52.01	-34.65	86.66	42.14	32.5	10.61	33.24	100	219	P	H
		5928	50.79	-17.41	68.2	40.86	32.56	10.62	33.25	100	219	P	H
													H
													H
802.11ac VHT40 CH 151 5755MHz		5640	50.82	-17.38	68.2	41.77	31.72	10.48	33.15	324	172	P	V
		5699.25	55.53	-49.12	104.65	46.19	32	10.51	33.17	324	172	P	V
		5717.75	78.5	-31.67	110.17	69.12	32.04	10.52	33.18	324	172	P	V
		5723.75	81.14	-38.21	119.35	71.74	32.05	10.53	33.18	324	172	P	V
	*	5755	113.02	-	-	103.55	32.11	10.55	33.19	324	172	P	V
	*	5755	105.05	-	-	95.58	32.11	10.55	33.19	324	172	A	V
		5852	53.13	-64.51	117.64	43.45	32.31	10.59	33.22	324	172	P	V
		5869.75	53.83	-52.84	106.67	44.08	32.38	10.6	33.23	324	172	P	V
		5890.25	53.66	-40.22	93.88	43.82	32.46	10.61	33.23	324	172	P	V
		5950	52.24	-15.96	68.2	42.26	32.6	10.63	33.25	324	172	P	V
													V
													V



WIFI Ant. 1+2	Note	Frequency (MHz)	Level (dBμV/m)	Over Limit (dB)	Limit Line (dBμV/m)	Read Level (dBμV)	Antenna Factor (dB/m)	Path Loss (dB)	Preamp Factor (dB)	Ant Pos (cm)	Table Pos (deg)	Peak Avg. (P/A)	Pol. (H/V)
		5613.75	50.13	-18.07	68.2	41.04	31.77	10.47	33.15	100	205	P	H
		5699.25	51.83	-52.82	104.65	42.49	32	10.51	33.17	100	205	P	H
		5711.25	54.65	-53.7	108.35	45.29	32.02	10.52	33.18	100	205	P	H
		5725	56	-66.2	122.2	46.6	32.05	10.53	33.18	100	205	P	H
	*	5795	116.11	-	-	106.55	32.19	10.57	33.2	100	205	P	H
	*	5795	108.12	-	-	98.56	32.19	10.57	33.2	100	205	A	H
		5852.5	67.2	-49.3	116.5	57.52	32.31	10.59	33.22	100	205	P	H
		5855	66.5	-44.3	110.8	56.81	32.32	10.59	33.22	100	205	P	H
		5876.25	59.16	-45.11	104.27	49.39	32.4	10.6	33.23	100	205	P	H
		5928.5	52.72	-15.48	68.2	42.79	32.56	10.62	33.25	100	205	P	H
802.11ac													H
VHT40													H
CH 159		5632.5	50.1	-18.1	68.2	41.03	31.74	10.48	33.15	317	171	P	V
5795MHz		5688.25	50.98	-45.55	96.53	41.71	31.93	10.51	33.17	317	171	P	V
		5716.5	53.54	-56.28	109.82	44.17	32.03	10.52	33.18	317	171	P	V
		5724.75	53.77	-67.86	121.63	44.37	32.05	10.53	33.18	317	171	P	V
	*	5795	113.67	-	-	104.11	32.19	10.57	33.2	317	171	P	V
	*	5795	105.68	-	-	96.12	32.19	10.57	33.2	317	171	A	V
		5853.75	63.06	-50.59	113.65	53.38	32.31	10.59	33.22	317	171	P	V
		5856.5	61.8	-48.58	110.38	52.1	32.33	10.59	33.22	317	171	P	V
		5876.25	55.28	-48.99	104.27	45.51	32.4	10.6	33.23	317	171	P	V
		5947	53.17	-15.03	68.2	43.2	32.59	10.63	33.25	317	171	P	V
													V
													V
Remark	1. No other spurious found. 2. All results are PASS against Peak and Average limit line.												



Band 4 5725~5850MHz

WIFI 802.11ac VHT40 (Harmonic @ 3m)

WIFI Ant. 1+2	Note	Frequency (MHz)	Level (dBµV/m)	Over Limit (dB)	Limit Line (dBµV/m)	Read Level (dBµV)	Antenna Factor (dB/m)	Path Loss (dB)	Preamp Factor (dB)	Ant Pos (cm)	Table Pos (deg)	Peak Avg. (P/A)	Pol. (H/V)	
802.11ac VHT40 CH 151 5755MHz		11510	45.06	-28.94	74	50.35	39.67	17.25	62.21	100	0	P	H	
		17265	45.95	-22.25	68.2	42.28	40.6	22.09	59.02	100	0	P	H	
													H	
													H	
			11510	44.21	-29.79	74	49.5	39.67	17.25	62.21	100	0	P	V
			17265	46.01	-22.19	68.2	42.34	40.6	22.09	59.02	100	0	P	V
														V
802.11ac VHT40 CH 159 5795MHz		11590	44.94	-29.06	74	50.41	39.43	17.37	62.27	100	0	P	H	
		17385	46.8	-21.4	68.2	42.23	41.12	22.2	58.75	100	0	P	H	
													H	
													H	
			11590	45.25	-28.75	74	50.72	39.43	17.37	62.27	100	0	P	V
			17385	47.48	-20.72	68.2	42.91	41.12	22.2	58.75	100	0	P	V
														V
Remark	1. No other spurious found.													
	2. All results are PASS against Peak and Average limit line.													



Band 4 5725~5850MHz

WIFI 802.11ac VHT80 (Band Edge @ 3m)

WIFI Ant. 1+2	Note	Frequency (MHz)	Level (dBμV/m)	Over Limit (dB)	Limit Line (dBμV/m)	Read Level (dBμV)	Antenna Factor (dB/m)	Path Loss (dB)	Preamp Factor (dB)	Ant Pos (cm)	Table Pos (deg)	Peak Avg. (P/A)	Pol. (H/V)
		5639	57.21	-10.99	68.2	48.16	31.72	10.48	33.15	100	219	P	H
		5695.25	80.09	-21.61	101.7	70.78	31.97	10.51	33.17	100	219	P	H
		5719	84.37	-26.15	110.52	74.98	32.04	10.53	33.18	100	219	P	H
		5720.25	83.93	-27.44	111.37	74.54	32.04	10.53	33.18	100	219	P	H
	*	5775	113.38	-	-	103.87	32.15	10.56	33.2	100	219	P	H
	*	5775	105.33	-	-	95.82	32.15	10.56	33.2	100	219	A	H
		5850.5	84.63	-36.43	121.06	74.96	32.3	10.59	33.22	100	219	P	H
		5855.5	81.5	-29.16	110.66	71.81	32.32	10.59	33.22	100	219	P	H
		5875	77.16	-28.04	105.2	67.39	32.4	10.6	33.23	100	219	P	H
		5931.25	59.33	-8.87	68.2	49.4	32.56	10.62	33.25	100	219	P	H
													H
													H
802.11ac VHT80 CH 155 5775MHz		5640.25	53.3	-14.9	68.2	44.25	31.72	10.48	33.15	344	157	P	V
		5696	77.22	-25.03	102.25	67.9	31.98	10.51	33.17	344	157	P	V
		5720.25	80.39	-30.98	111.37	71	32.04	10.53	33.18	344	157	P	V
		5724.5	79.18	-41.88	121.06	69.78	32.05	10.53	33.18	344	157	P	V
	*	5775	111.03	-	-	101.52	32.15	10.56	33.2	344	157	P	V
	*	5775	102.74	-	-	93.23	32.15	10.56	33.2	344	157	A	V
		5851.25	81.92	-37.43	119.35	72.24	32.31	10.59	33.22	344	157	P	V
		5855	79.07	-31.73	110.8	69.38	32.32	10.59	33.22	344	157	P	V
		5875	73.17	-32.03	105.2	63.4	32.4	10.6	33.23	344	157	P	V
		5930.5	53.68	-14.52	68.2	43.75	32.56	10.62	33.25	344	157	P	V
													V
													V
Remark	1. No other spurious found. 2. All results are PASS against Peak and Average limit line.												



Band 4 5725~5850MHz

WIFI 802.11ac VHT80 (Harmonic @ 3m)

WIFI Ant. 1+2	Note	Frequency (MHz)	Level (dBμV/m)	Over Limit (dB)	Limit Line (dBμV/m)	Read Level (dBμV)	Antenna Factor (dB/m)	Path Loss (dB)	Preamp Factor (dB)	Ant Pos (cm)	Table Pos (deg)	Peak Avg. (P/A)	Pol. (H/V)	
802.11ac VHT80 CH 155 5775MHz		11550	44.94	-29.06	74	50.32	39.55	17.31	62.24	100	0	P	H	
		17325	45.48	-22.72	68.2	41.38	40.83	22.15	58.88	100	0	P	H	
													H	
													H	
			11550	45.32	-28.68	74	50.7	39.55	17.31	62.24	100	0	P	V
			17325	46.38	-21.82	68.2	42.28	40.83	22.15	58.88	100	0	P	V
														V
Remark	1. No other spurious found. 2. All results are PASS against Peak and Average limit line.													



<TXBF Mode>

Band 4 - 5725~5850MHz

WIFI 802.11ac VHT20 (Band Edge @ 3m)

WIFI Ant.	Note	Frequency	Level	Over Limit	Limit Line	Read Level	Antenna Factor	Path Loss	Preamp Factor	Ant Pos	Table Pos	Peak Avg.	Pol.	
1+2		(MHz)	(dBµV/m)	(dB)	(dBµV/m)	(dBµV)	(dB/m)	(dB)	(dB)	(cm)	(deg)	(P/A)	(H/V)	
802.11ac VHT20 CH 149 5745MHz		5645.675	51.18	-17.02	68.2	42.14	31.71	10.49	33.16	100	298	P	H	
		5693.6	55.96	-44.52	100.48	46.66	31.96	10.51	33.17	100	298	P	H	
		5719.925	66.19	-44.59	110.78	56.8	32.04	10.53	33.18	100	298	P	H	
		5725.1	75.83	-58.37	134.2	66.43	32.05	10.53	33.18	100	298	P	H	
	*	5745	116.56	-	-	107.12	32.09	10.54	33.19	100	298	P	H	
	*	5745	107.45	-	-	98.01	32.09	10.54	33.19	100	298	A	H	
														H
														H
			5647.25	50.24	-17.96	68.2	41.2	31.71	10.49	33.16	324	172	P	V
			5699.9	52.38	-52.75	105.13	43.04	32	10.51	33.17	324	172	P	V
			5719.925	65.11	-45.67	110.78	55.72	32.04	10.53	33.18	324	172	P	V
			5725.1	75.49	-58.71	134.2	66.09	32.05	10.53	33.18	324	172	P	V
	*		5745	114.95	-	-	105.51	32.09	10.54	33.19	324	172	P	V
	*		5745	105.83	-	-	96.39	32.09	10.54	33.19	324	172	A	V
													V	
													V	



WIFI Ant. 1+2	Note	Frequency (MHz)	Level (dBμV/m)	Over Limit (dB)	Limit Line (dBμV/m)	Read Level (dBμV)	Antenna Factor (dB/m)	Path Loss (dB)	Preamp Factor (dB)	Ant Pos (cm)	Table Pos (deg)	Peak Avg. (P/A)	Pol. (H/V)
		5621.25	49.57	-18.63	68.2	40.49	31.76	10.47	33.15	100	298	P	H
		5688.75	51.21	-45.69	96.9	41.94	31.93	10.51	33.17	100	298	P	H
		5714.25	53.17	-56.02	109.19	43.8	32.03	10.52	33.18	100	298	P	H
		5724.75	54.37	-67.26	121.63	44.97	32.05	10.53	33.18	100	298	P	H
	*	5785	117.27	-	-	107.74	32.17	10.56	33.2	100	298	P	H
	*	5785	107.99	-	-	98.46	32.17	10.56	33.2	100	298	A	H
		5851	55.54	-64.38	119.92	45.87	32.3	10.59	33.22	100	298	P	H
		5860.25	54.71	-54.62	109.33	45.01	32.34	10.59	33.23	100	298	P	H
		5877.75	54.23	-48.93	103.16	44.45	32.41	10.6	33.23	100	298	P	H
		5929.5	52.1	-16.1	68.2	42.17	32.56	10.62	33.25	100	298	P	H
802.11ac													H
VHT20													H
CH 157		5639.5	49.81	-18.39	68.2	40.76	31.72	10.48	33.15	317	175	P	V
5785MHz		5692.25	50.84	-48.65	99.49	41.55	31.95	10.51	33.17	317	175	P	V
		5719.25	51.16	-59.43	110.59	41.77	32.04	10.53	33.18	317	175	P	V
		5724.75	51	-70.63	121.63	41.6	32.05	10.53	33.18	317	175	P	V
	*	5785	115.42	-	-	105.89	32.17	10.56	33.2	317	175	P	V
	*	5785	105.72	-	-	96.19	32.17	10.56	33.2	317	175	A	V
		5854.25	53.66	-58.85	112.51	43.97	32.32	10.59	33.22	317	175	P	V
		5870.5	53.43	-53.03	106.46	43.68	32.38	10.6	33.23	317	175	P	V
		5875.25	52.6	-52.41	105.01	42.83	32.4	10.6	33.23	317	175	P	V
		5948	51.6	-16.6	68.2	41.62	32.6	10.63	33.25	317	175	P	V
													V
													V



WiFi Ant. 1+2	Note	Frequency (MHz)	Level (dBμV/m)	Over Limit (dB)	Limit Line (dBμV/m)	Read Level (dBμV)	Antenna Factor (dB/m)	Path Loss (dB)	Preamp Factor (dB)	Ant Pos (cm)	Table Pos (deg)	Peak Avg. (P/A)	Pol. (H/V)	
802.11ac VHT20 CH 165 5825MHz	*	5825	116.87	-	-	107.25	32.25	10.58	33.21	100	298	P	H	
	*	5825	107.8	-	-	98.18	32.25	10.58	33.21	100	298	A	H	
		5850.165	72.57	-49.25	121.82	62.9	32.3	10.59	33.22	100	298	P	H	
		5858.365	61.65	-48.21	109.86	51.95	32.33	10.59	33.22	100	298	P	H	
		5881.735	56.43	-43.77	100.2	46.63	32.43	10.6	33.23	100	298	P	H	
		5925.4	52.01	-16.19	68.2	42.09	32.55	10.62	33.25	100	298	P	H	
														H
														H
	*	5825	116.1	-	-	106.48	32.25	10.58	33.21	315	172	P	V	
	*	5825	106.26	-	-	96.64	32.25	10.58	33.21	315	172	A	V	
		5850.985	69.94	-50.01	119.95	60.27	32.3	10.59	33.22	315	172	P	V	
		5855.29	61.54	-49.18	110.72	51.85	32.32	10.59	33.22	315	172	P	V	
		5875.175	55.64	-49.43	105.07	45.87	32.4	10.6	33.23	315	172	P	V	
		5931.345	52.12	-16.08	68.2	42.19	32.56	10.62	33.25	315	172	P	V	
														V
													V	
Remark	1. No other spurious found. 2. All results are PASS against Peak and Average limit line.													



Band 4 5725~5850MHz

WIFI 802.11ac VHT20 (Harmonic @ 3m)

WIFI Ant. 1+2	Note	Frequency (MHz)	Level (dBμV/m)	Over Limit (dB)	Limit Line (dBμV/m)	Read Level (dBμV)	Antenna Factor (dB/m)	Path Loss (dB)	Preamp Factor (dB)	Ant Pos (cm)	Table Pos (deg)	Peak Avg. (P/A)	Pol. (H/V)
802.11ac VHT20 CH 149 5745MHz		11490	44.26	-29.74	74	49.52	39.7	17.23	62.19	100	0	P	H
		17235	46.28	-21.92	68.2	42.79	40.51	22.06	59.08	100	0	P	H
													H
													H
		11490	44.75	-29.25	74	50.01	39.7	17.23	62.19	100	0	P	V
		17235	45.93	-22.27	68.2	42.44	40.51	22.06	59.08	100	0	P	V
													V
802.11ac VHT20 CH 157 5785MHz		11570	43.72	-30.28	74	49.15	39.49	17.34	62.26	100	0	P	H
		17355	46.96	-21.24	68.2	42.62	40.98	22.18	58.82	100	0	P	H
													H
													H
		11570	44.63	-29.37	74	50.06	39.49	17.34	62.26	100	0	P	V
		17355	45.67	-22.53	68.2	41.33	40.98	22.18	58.82	100	0	P	V
													V
802.11ac VHT20 CH 165 5825MHz		11650	44.35	-29.65	74	50.01	39.2	17.46	62.32	100	0	P	H
		17475	47.08	-21.12	68.2	41.77	41.58	22.29	58.56	100	0	P	H
													H
													H
		11650	44.51	-29.49	74	50.17	39.2	17.46	62.32	100	0	P	V
		17475	47.35	-20.85	68.2	42.04	41.58	22.29	58.56	100	0	P	V
													V
Remark	1. No other spurious found.												
	2. All results are PASS against Peak and Average limit line.												



Band 4 5725~5850MHz

WIFI 802.11ac VHT40 (Band Edge @ 3m)

WIFI Ant. 1+2	Note	Frequency (MHz)	Level (dBμV/m)	Over Limit (dB)	Limit Line (dBμV/m)	Read Level (dBμV)	Antenna Factor (dB/m)	Path Loss (dB)	Preamp Factor (dB)	Ant Pos (cm)	Table Pos (deg)	Peak Avg. (P/A)	Pol. (H/V)	
		5641.5	52.86	-15.34	68.2	43.82	31.72	10.48	33.16	100	298	P	H	
		5699.5	68.07	-36.76	104.83	58.73	32	10.51	33.17	100	298	P	H	
		5720	79.31	-31.49	110.8	69.92	32.04	10.53	33.18	100	298	P	H	
		5724.25	81.93	-38.56	120.49	72.53	32.05	10.53	33.18	100	298	P	H	
	*	5755	114.84	-	-	105.37	32.11	10.55	33.19	100	298	P	H	
	*	5755	105.08	-	-	95.61	32.11	10.55	33.19	100	298	A	H	
		5850.5	54.88	-66.18	121.06	45.21	32.3	10.59	33.22	100	298	P	H	
		5874.25	53.85	-51.56	105.41	44.08	32.4	10.6	33.23	100	298	P	H	
		5880.25	53.17	-48.13	101.3	43.38	32.42	10.6	33.23	100	298	P	H	
		5933.5	52.17	-16.03	68.2	42.23	32.57	10.62	33.25	100	298	P	H	
802.11ac VHT40 CH 151 5755MHz													H	
													H	
			5647.25	50.94	-17.26	68.2	41.9	31.71	10.49	33.16	308	177	P	V
			5696.25	57.3	-45.14	102.44	47.98	31.98	10.51	33.17	308	177	P	V
			5719.25	77.22	-33.37	110.59	67.83	32.04	10.53	33.18	308	177	P	V
			5721.5	78.18	-36.04	114.22	68.79	32.04	10.53	33.18	308	177	P	V
		*	5755	111.68	-	-	102.21	32.11	10.55	33.19	308	177	P	V
		*	5755	103.02	-	-	93.55	32.11	10.55	33.19	308	177	A	V
			5851.25	52.32	-67.03	119.35	42.64	32.31	10.59	33.22	308	177	P	V
			5855.25	53.75	-56.98	110.73	44.06	32.32	10.59	33.22	308	177	P	V
			5915.5	52.57	-22.64	75.21	42.66	32.53	10.62	33.24	308	177	P	V
			5948	51.59	-16.61	68.2	41.61	32.6	10.63	33.25	308	177	P	V
														V
														V



WIFI Ant. 1+2	Note	Frequency (MHz)	Level (dBµV/m)	Over Limit (dB)	Limit Line (dBµV/m)	Read Level (dBµV)	Antenna Factor (dB/m)	Path Loss (dB)	Preamp Factor (dB)	Ant Pos (cm)	Table Pos (deg)	Peak Avg. (P/A)	Pol. (H/V)
		5624.5	50.97	-17.23	68.2	41.9	31.75	10.47	33.15	100	299	P	H
		5687.25	54.1	-41.7	95.8	44.84	31.92	10.51	33.17	100	299	P	H
		5711.75	58.81	-49.68	108.49	49.45	32.02	10.52	33.18	100	299	P	H
		5721.25	58.35	-55.3	113.65	48.96	32.04	10.53	33.18	100	299	P	H
	*	5795	115.45	-	-	105.89	32.19	10.57	33.2	100	299	P	H
	*	5795	105.79	-	-	96.23	32.19	10.57	33.2	100	299	A	H
		5851.75	66.92	-51.29	118.21	57.24	32.31	10.59	33.22	100	299	P	H
		5858	65.12	-44.84	109.96	55.42	32.33	10.59	33.22	100	299	P	H
		5887.5	58.19	-37.73	95.92	48.37	32.45	10.6	33.23	100	299	P	H
		5941.75	52.46	-15.74	68.2	42.5	32.58	10.63	33.25	100	299	P	H
802.11ac													H
VHT40													H
CH 159		5623.25	50.97	-17.23	68.2	41.9	31.75	10.47	33.15	334	174	P	V
5795MHz		5698.75	51.66	-52.62	104.28	42.33	31.99	10.51	33.17	334	174	P	V
		5720	52.58	-58.22	110.8	43.19	32.04	10.53	33.18	334	174	P	V
		5725	53.24	-68.96	122.2	43.84	32.05	10.53	33.18	334	174	P	V
	*	5795	113.58	-	-	104.02	32.19	10.57	33.2	334	174	P	V
	*	5795	104.09	-	-	94.53	32.19	10.57	33.2	334	174	A	V
		5851	60.49	-59.43	119.92	50.82	32.3	10.59	33.22	334	174	P	V
		5857.75	59.9	-50.13	110.03	50.2	32.33	10.59	33.22	334	174	P	V
		5886.5	54.09	-42.57	96.66	44.27	32.45	10.6	33.23	334	174	P	V
		5933.25	51.46	-16.74	68.2	41.52	32.57	10.62	33.25	334	174	P	V
													V
													V
Remark	1. No other spurious found. 2. All results are PASS against Peak and Average limit line.												



Band 4 5725~5850MHz

WIFI 802.11ac VHT40 (Harmonic @ 3m)

WIFI Ant. 1+2	Note	Frequency (MHz)	Level (dBµV/m)	Over Limit (dB)	Limit Line (dBµV/m)	Read Level (dBµV)	Antenna Factor (dB/m)	Path Loss (dB)	Preamp Factor (dB)	Ant Pos (cm)	Table Pos (deg)	Peak Avg. (P/A)	Pol. (H/V)	
802.11ac VHT40 CH 151 5755MHz		11510	44.69	-29.31	74	49.98	39.67	17.25	62.21	100	0	P	H	
		17265	45.71	-22.49	68.2	42.04	40.6	22.09	59.02	100	0	P	H	
													H	
													H	
			11510	43.99	-30.01	74	49.28	39.67	17.25	62.21	100	0	P	V
			17265	46.35	-21.85	68.2	42.68	40.6	22.09	59.02	100	0	P	V
														V
802.11ac VHT40 CH 159 5795MHz		11590	44.82	-29.18	74	50.29	39.43	17.37	62.27	100	0	P	H	
		17385	46.76	-21.44	68.2	42.19	41.12	22.2	58.75	100	0	P	H	
													H	
													H	
			11590	44.55	-29.45	74	50.02	39.43	17.37	62.27	100	0	P	V
			17385	47.88	-20.32	68.2	43.31	41.12	22.2	58.75	100	0	P	V
														V
Remark	1. No other spurious found.													
	2. All results are PASS against Peak and Average limit line.													



Band 4 5725~5850MHz

WIFI 802.11ac VHT80 (Band Edge @ 3m)

WIFI Ant. 1+2	Note	Frequency (MHz)	Level (dBμV/m)	Over Limit (dB)	Limit Line (dBμV/m)	Read Level (dBμV)	Antenna Factor (dB/m)	Path Loss (dB)	Preamp Factor (dB)	Ant Pos (cm)	Table Pos (deg)	Peak Avg. (P/A)	Pol. (H/V)
		5623.75	56.48	-11.72	68.2	47.41	31.75	10.47	33.15	100	297	P	H
		5699	76.18	-28.28	104.46	66.85	31.99	10.51	33.17	100	297	P	H
		5719.5	82.1	-28.56	110.66	72.71	32.04	10.53	33.18	100	297	P	H
		5720.75	80.92	-31.59	112.51	71.53	32.04	10.53	33.18	100	297	P	H
	*	5775	112.05	-	-	102.54	32.15	10.56	33.2	100	297	A	H
	*	5775	102.74	-	-	93.23	32.15	10.56	33.2	100	297	A	H
		5850	79.46	-42.74	122.2	69.79	32.3	10.59	33.22	100	297	P	H
		5859.25	79.42	-30.19	109.61	69.71	32.34	10.59	33.22	100	297	P	H
		5876.5	71.15	-32.94	104.09	61.37	32.41	10.6	33.23	100	297	P	H
		5926.5	59.3	-8.9	68.2	49.38	32.55	10.62	33.25	100	297	P	H
													H
													H
802.11ac VHT80 CH 155 5775MHz		5646.25	54.7	-13.5	68.2	45.66	31.71	10.49	33.16	354	176	P	V
		5698.5	71.47	-32.62	104.09	62.14	31.99	10.51	33.17	354	176	P	V
		5718.75	76.55	-33.9	110.45	67.16	32.04	10.53	33.18	354	176	P	V
		5723.75	76.5	-42.85	119.35	67.1	32.05	10.53	33.18	354	176	P	V
	*	5775	109.77	-	-	100.26	32.15	10.56	33.2	354	176	P	V
	*	5775	100.02	-	-	90.51	32.15	10.56	33.2	354	176	A	V
		5850.5	77.94	-43.12	121.06	68.27	32.3	10.59	33.22	354	176	P	V
		5869.5	75.31	-31.43	106.74	65.56	32.38	10.6	33.23	354	176	P	V
		5876.75	67.04	-36.86	103.9	57.26	32.41	10.6	33.23	354	176	P	V
		5928.25	53.89	-14.31	68.2	43.96	32.56	10.62	33.25	354	176	P	V
													V
													V
Remark	1. No other spurious found. 2. All results are PASS against Peak and Average limit line.												



Band 4 5725~5850MHz

WIFI 802.11ac VHT80 (Harmonic @ 3m)

WIFI Ant. 1+2	Note	Frequency (MHz)	Level (dBμV/m)	Over Limit (dB)	Limit Line (dBμV/m)	Read Level (dBμV)	Antenna Factor (dB/m)	Path Loss (dB)	Preamp Factor (dB)	Ant Pos (cm)	Table Pos (deg)	Peak Avg. (P/A)	Pol. (H/V)	
802.11ac VHT80 CH 155 5775MHz		11550	45.01	-28.99	74	50.39	39.55	17.31	62.24	100	0	P	H	
		17325	46.95	-21.25	68.2	42.85	40.83	22.15	58.88	100	0	P	H	
													H	
													H	
			11550	45.55	-28.45	74	50.93	39.55	17.31	62.24	100	0	P	V
			17325	46.28	-21.92	68.2	42.18	40.83	22.15	58.88	100	0	P	V
														V
Remark	1. No other spurious found. 2. All results are PASS against Peak and Average limit line.													



Emission below 1GHz

5GHz WIFI 802.11ac VHT80 (LF @ 3m)

WIFI	Note	Frequency	Level	Over	Limit	Read	Antenna	Path	Preamp	Ant	Table	Peak	Pol.	
Ant.				Limit	Line	Level	Factor	Loss	Factor	Pos	Pos	Avg.		
1+2		(MHz)	(dBμV/m)	(dB)	(dBμV/m)	(dBμV)	(dB/m)	(dB)	(dB)	(cm)	(deg)	(P/A)	(H/V)	
5GHz 802.11ac VHT80 LF		108.57	30.6	-12.9	43.5	44.82	16.69	1.4	32.31	-	-	P	H	
		169.68	24.05	-19.45	43.5	39.1	15.39	1.82	32.26	-	-	P	H	
		178.41	26.56	-16.94	43.5	42.05	14.88	1.89	32.26	-	-	P	H	
		936.95	33.06	-12.94	46	30	29.8	4.27	31.01	-	-	P	H	
		949.56	33.39	-12.61	46	29.42	30.55	4.31	30.89	-	-	P	H	
		955.38	33.67	-12.33	46	29.38	30.81	4.32	30.84	100	0	P	H	
														H
														H
														H
														H
														H
														H
														H
														H
														H
														H
														H
														H
			30.97	31.72	-8.28	40	39.73	23.58	0.78	32.37	-	-	P	V
			53.28	33.83	-6.17	40	52.51	12.72	0.97	32.37	100	0	P	V
		63.95	26.61	-13.39	40	46.27	11.61	1.09	32.36	-	-	P	V	
		943.74	33.37	-12.63	46	29.83	30.19	4.3	30.95	-	-	P	V	
		950.53	33.54	-12.46	46	29.52	30.6	4.31	30.89	-	-	P	V	
		953.44	33.31	-12.69	46	29.13	30.72	4.32	30.86	-	-	P	V	
													V	
													V	
													V	
													V	
													V	
													V	
													V	
Remark	1. No other spurious found. 2. All results are PASS against limit line.													



Note symbol

*	Fundamental Frequency which can be ignored. However, the level of any unwanted emissions shall not exceed the level of the fundamental frequency.
!	Test result is over limit line.
P/A	Peak or Average
H/V	Horizontal or Vertical



A calculation example for radiated spurious emission is shown as below:

WIFI	Note	Frequency	Level	Over	Limit	Read	Antenna	Path	Preamp	Ant	Table	Peak	Pol.
Ant.				Limit	Line	Level	Factor	Loss	Factor	Pos	Pos	Avg.	
1+2		(MHz)	(dBμV/m)	(dB)	(dBμV/m)	(dBμV)	(dB/m)	(dB)	(dB)	(cm)	(deg)	(P/A)	(H/V)
802.11b		2390	55.45	-18.55	74	54.51	32.22	4.58	35.86	103	308	P	H
CH 01		2390	43.54	-10.46	54	42.6	32.22	4.58	35.86	103	308	A	H
2412MHz													

1. Path Loss(dB) = Cable loss(dB) + Filter loss(dB) + Attenuator loss(dB)
2. Level(dBμV/m) = Antenna Factor(dB/m) + Path Loss(dB) + Read Level(dBμV) - Preamp Factor(dB)
3. Over Limit(dB) = Level(dBμV/m) – Limit Line(dBμV/m)

For Peak Limit @ 2390MHz:

1. Level(dBμV/m)
= Antenna Factor(dB/m) + Path Loss(dB) + Read Level(dBμV) - Preamp Factor(dB)
= 32.22(dB/m) + 4.58(dB) + 54.51(dBμV) – 35.86 (dB)
= 55.45 (dBμV/m)
2. Over Limit(dB)
= Level(dBμV/m) – Limit Line(dBμV/m)
= 55.45(dBμV/m) – 74(dBμV/m)
= -18.55(dB)

For Average Limit @ 2390MHz:

1. Level(dBμV/m)
= Antenna Factor(dB/m) + Path Loss(dB) + Read Level(dBμV) - Preamp Factor(dB)
= 32.22(dB/m) + 4.58(dB) + 42.6(dBμV) – 35.86 (dB)
= 43.54 (dBμV/m)
2. Over Limit(dB) = Level(dBμV/m) – Limit Line(dBμV/m)
= 43.54(dBμV/m) – 54(dBμV/m)
= -10.46(dB)

Both peak and average measured complies with the limit line, so test result is “PASS”.



Appendix C. Radiated Spurious Emission Plots

Test Engineer :	Hao Xu, Fu Chen and Troye Hsieh	Temperature :	21~26°C
		Relative Humidity :	50.2~67.6%

Note symbol

-L	Low channel location
-R	High channel location

<CCD Mode>

Band 4 - 5725~5850MHz WIFI 802.11a (Band Edge @ 3m)

WIFI	Band 4 5725~5850MHz Band Edge @ 3m	
ANT	802.11a CH149 5745MHz	
1	Horizontal	Fundamental
Peak	<p>Site : 03CH11-HY Condition : PEAK_BE(84)_16-24 3m HORN 9120D-HF HORIZONTAL Detector : Peak Project : 911641</p>	<p>Site : 03CH11-HY Condition : PEAK(UNIT) 3m HORN 9120D-HF HORIZONTAL Detector : Peak Project : 911641</p>

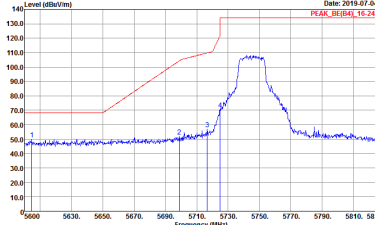
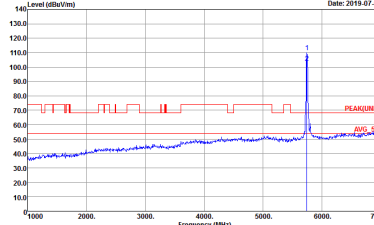

WIFI	Band 4 5725~5850MHz Band Edge @ 3m	
ANT	802.11a CH149 5745MHz	
1	Vertical	Fundamental
<p>Peak</p>	 <p>Site : 03CH11-HY Condition : PEAK_BE(04)_16-24 3m HORN 91200-HF VERTICAL RBW:1000.000KHz VBW:3000.000KHz SWT:Auto Detector : Peak Project : 911641</p>	 <p>Site : 03CH11-HY Condition : PEAK_UN(04)_16-24 3m HORN 91200-HF VERTICAL RBW:1000.000KHz VBW:3000.000KHz SWT:Auto Detector : Peak Project : 911641</p>



WIFI	Band 4 5725~5850MHz Band Edge @ 3m	
ANT	802.11a CH157 5785MHz	
1	Horizontal	Fundamental
Peak	<p>Site : 03CH11-HY Condition : PEAK_BE(B4)_16-24 3m HORN 9120D-HF HORIZONTAL RBW:1000.000KHz VBW:3000.000KHz SWF:Auto Detector : Peak Project : 911641</p>	<p>Site : 03CH11-HY Condition : PEAK(UNI) 3m HORN 9120D-HF HORIZONTAL RBW:1000.000KHz VBW:3000.000KHz SWF:Auto Detector : Peak Project : 911641</p>
Peak	<p>Site : 03CH11-HY Condition : PEAK_BE(B4)_16-24 3m HORN 9120D-HF HORIZONTAL RBW:1000.000KHz VBW:3000.000KHz SWF:Auto Detector : Peak Project : 911641</p>	Left blank



WIFI	Band 4 5725~5850MHz Band Edge @ 3m	
ANT	802.11a CH157 5785MHz	
1	Vertical	Fundamental
Peak	<p>Site : 03CH11-HY Condition : PEAK_BE(B4)_16-24 3m HORN 91200-HF VERTICAL RBW:1000.000KHz VBW:3000.000KHz SWT:Auto Detector : Peak Project : 911641</p>	<p>Site : 03CH11-HY Condition : PEAK(UNII) 3m HORN 91200-HF VERTICAL RBW:1000.000KHz VBW:3000.000KHz SWT:Auto Detector : Peak Project : 911641</p>
Peak	<p>Site : 03CH11-HY Condition : PEAK_BE(B4)_16-24 3m HORN 91200-HF VERTICAL RBW:1000.000KHz VBW:3000.000KHz SWT:Auto Detector : Peak Project : 911641</p>	Left blank

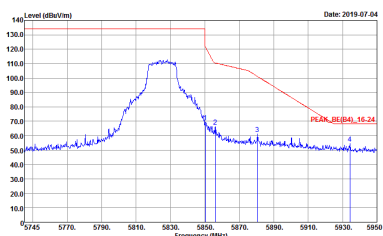
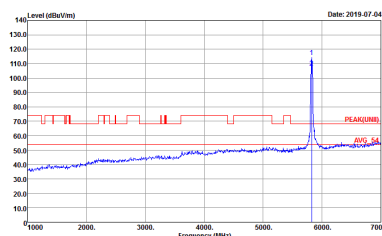

WIFI	Band 4 5725~5850MHz Band Edge @ 3m	
ANT	802.11a CH165 5825MHz	
1	Horizontal	Fundamental
<p>Peak</p>	 <p>Site : 03CH11-HY Condition : PEAK_BE(B4)_16-24 3m HORN 9120D-HF HORIZONTAL RBW:1000.000KHz VBW:3000.000KHz SWT:Auto Detector : Peak Project : 911641</p>	 <p>Site : 03CH11-HY Condition : PEAK(UNII) 3m HORN 9120D-HF HORIZONTAL RBW:1000.000KHz VBW:3000.000KHz SWT:Auto Detector : Peak Project : 911641</p>



WIFI	Band 4 5725~5850MHz Band Edge @ 3m	
ANT	802.11a CH165 5825MHz	
1	Vertical	Fundamental
<p>Peak</p>	<p>Site : 03CH11-HY Condition : PEAK_BE(84)_16-24 3m HORN 91200-HF VERTICAL RBW:1000.000KHz VBW:3000.000KHz SWT:Auto Detector : Peak Project : 911641</p>	<p>Site : 03CH11-HY Condition : PEAK(UNII) 3m HORN 91200-HF VERTICAL RBW:1000.000KHz VBW:3000.000KHz SWT:Auto Detector : Peak Project : 911641</p>



Band 4 5725~5850MHz
WIFI 802.11ac VHT20 (Band Edge @ 3m)

Table with 2 columns: WIFI (Band 4 5725~5850MHz Band Edge @ 3m), ANT (802.11ac VHT20 CH149 5745MHz). Row 1: 1, Horizontal, Fundamental. Each plot shows Level (dBu/m) vs Frequency (MHz) with a peak at 5745MHz. Includes site and condition details.



WIFI	Band 4 5725~5850MHz Band Edge @ 3m	
ANT	802.11ac VHT20 CH149 5745MHz	
1	Vertical	Fundamental
Peak Avg.	<div style="display: flex; justify-content: space-around;"> <div style="width: 45%;"> <p>Date: 2019-07-04 PEAK: 85.045, 15.24</p> <p>Site : 03CH11-HY Condition : PEAK_BE(84)_16-24 3m HORN 91200-HF VERTICAL RBW:1000.000KHz VBW:3000.000KHz SWT:Auto Detector : Peak Project : 911641</p> </div> <div style="width: 45%;"> <p>Date: 2019-07-04 PEAK: 85.045, 15.24</p> <p>Site : 03CH11-HY Condition : PEAK(UNII) 3m HORN 91200-HF VERTICAL RBW:1000.000KHz VBW:3000.000KHz SWT:Auto Detector : Peak Project : 911641</p> </div> </div>	



WIFI	Band 4 5725~5850MHz Band Edge @ 3m	
ANT	802.11ac VHT20 CH157 5785MHz	
1	Horizontal	Fundamental
Peak	<p>Date: 2019-07-04</p> <p>PEAK_BE(B4)_16-24</p> <p>Site : 03CH11-HY Condition : PEAK_BE(B4)_16-24 3m HORN 9120D-HF HORIZONTAL RBW:1000.000KHz VBW:3000.000KHz SWF:Auto Detector : Peak Project : 911641</p>	<p>Date: 2019-07-04</p> <p>PEAK(BE)</p> <p>Site : 03CH11-HY Condition : PEAK(UNII) 3m HORN 9120D-HF HORIZONTAL RBW:1000.000KHz VBW:3000.000KHz SWF:Auto Detector : Peak Project : 911641</p>
Peak	<p>Date: 2019-07-04</p> <p>PEAK_BE(B4)_16-24</p> <p>Site : 03CH11-HY Condition : PEAK_BE(B4)_16-24 3m HORN 9120D-HF HORIZONTAL RBW:1000.000KHz VBW:3000.000KHz SWF:Auto Detector : Peak Project : 911641</p>	Left blank



WIFI	Band 4 5725~5850MHz Band Edge @ 3m	
ANT	802.11ac VHT20 CH157 5785MHz	
1	Vertical	Fundamental
Peak	<p>Site : 03CH11-HY Condition : PEAK_BE(B4)_16-24 3m HORN 91200-HF VERTICAL RBW:1000.000KHz VBW:3000.000KHz SWT:Auto Detector : Peak Project : 911641</p>	<p>Site : 03CH11-HY Condition : PEAK(UNII) 3m HORN 91200-HF VERTICAL RBW:1000.000KHz VBW:3000.000KHz SWT:Auto Detector : Peak Project : 911641</p>
Peak	<p>Site : 03CH11-HY Condition : PEAK_BE(B4)_16-24 3m HORN 91200-HF VERTICAL RBW:1000.000KHz VBW:3000.000KHz SWT:Auto Detector : Peak Project : 911641</p>	Left blank



WIFI	Band 4 5725~5850MHz Band Edge @ 3m	
ANT	802.11ac VHT20 CH165 5825MHz	
1	Horizontal	Fundamental
Peak	<p>Site : 03CH11-HY Condition : PEAK_BE(B4)_16-24 3m HORN 91200-HF HORIZONTAL RBW:1000.000KHz VBW:3000.000KHz SWT:Auto Detector : Peak Project : 911641</p>	<p>Site : 03CH11-HY Condition : PEAK(U)B 3m HORN 91200-HF HORIZONTAL RBW:1000.000KHz VBW:3000.000KHz SWT:Auto Detector : Peak Project : 911641</p>



WIFI	Band 4 5725~5850MHz Band Edge @ 3m	
ANT	802.11ac VHT20 CH165 5825MHz	
1	Vertical	Fundamental
Peak Avg.	<p>Site : 03CH11-HY Condition : PEAK_BE(B4)_16-24 3m HORN 91200-HF VERTICAL RBW:1000.000KHz VBW:3000.000KHz SWT:Auto Detector : Peak Project : 911641</p>	<p>Site : 03CH11-HY Condition : PEAK(UN)I 3m HORN 91200-HF VERTICAL RBW:1000.000KHz VBW:3000.000KHz SWT:Auto Detector : Peak Project : 911641</p>



Band 4 5725~5850MHz
WIFI 802.11ac VHT40 (Band Edge @ 3m)

WIFI	Band 4 5725~5850MHz Band Edge @ 3m	
ANT	802.11ac VHT40 CH151 5755MHz	
1	Horizontal	Fundamental
Peak	<p>Site : 03CH11-HY Condition : PEAK_BE(B4)_16-24 3m HORN 91200-HF HORIZONTAL Detector : Peak Project : 911641</p>	<p>Site : 03CH11-HY Condition : PEAK(UNB) 3m HORN 91200-HF HORIZONTAL Detector : Peak Project : 911641</p>
Peak	<p>Site : 03CH11-HY Condition : PEAK_NE(B4)_16-24 3m HORN 91200-HF HORIZONTAL Detector : Peak Project : 911641</p>	Left blank



WIFI	Band 4 5725~5850MHz Band Edge @ 3m	
ANT	802.11ac VHT40 CH151 5755MHz	
1	Vertical	Fundamental
Peak	<p>Site : 03CH11-HY Condition : PEAK_BE(B4)_16-24 3m HORN 91200-HF VERTICAL RBW:1000.000KHz VBW:3000.000KHz SWT:Auto Detector : Peak Project : 911641</p>	<p>Site : 03CH11-HY Condition : PEAK(UNII) 3m HORN 91200-HF VERTICAL RBW:1000.000KHz VBW:3000.000KHz SWT:Auto Detector : Peak Project : 911641</p>
Peak	<p>Site : 03CH11-HY Condition : PEAK_BE(B4)_16-24 3m HORN 91200-HF VERTICAL RBW:1000.000KHz VBW:3000.000KHz SWT:Auto Detector : Peak Project : 911641</p>	Left blank



WIFI	Band 4 5725~5850MHz Band Edge @ 3m	
ANT	802.11ac VHT40 CH159 5795MHz	
1	Horizontal	Fundamental
Peak	<p>Site : 03CH11-HY Condition : PEAK_BE(B4)_16-24 3m HORN 9120D-HF HORIZONTAL RBW:1000.000KHz VBW:3000.000KHz SWT:Auto Detector : Peak Project : 911641</p>	<p>Site : 03CH11-HY Condition : PEAK(UNIT) 3m HORN 9120D-HF HORIZONTAL RBW:1000.000KHz VBW:3000.000KHz SWT:Auto Detector : Peak Project : 911641</p>
Peak	<p>Site : 03CH11-HY Condition : PEAK_BE(B4)_16-24 3m HORN 9120D-HF HORIZONTAL RBW:1000.000KHz VBW:3000.000KHz SWT:Auto Detector : Peak Project : 911641</p>	Left blank



WIFI	Band 4 5725~5850MHz Band Edge @ 3m	
ANT	802.11ac VHT40 CH159 5795MHz	
1	Vertical	Fundamental
Peak	<p>Site : 03CH11-HY Condition : PEAK_BE(B4)_16-24 3m HORN 91200-HF VERTICAL RBW:1000.000KHz VBW:3000.000KHz SWT:Auto Detector : Peak Project : 911641</p>	<p>Site : 03CH11-HY Condition : PEAK(UNII) 3m HORN 91200-HF VERTICAL RBW:1000.000KHz VBW:3000.000KHz SWT:Auto Detector : Peak Project : 911641</p>
Peak	<p>Site : 03CH11-HY Condition : PEAK_BE(B4)_16-24 3m HORN 91200-HF VERTICAL RBW:1000.000KHz VBW:3000.000KHz SWT:Auto Detector : Peak Project : 911641</p>	Left blank



Band 4 5725~5850MHz
WIFI 802.11ac VHT80 (Band Edge @ 3m)

WIFI	Band 4 5725~5850MHz Band Edge @ 3m	
ANT	802.11ac VHT80 CH155 5775MHz	
1	Horizontal	Fundamental
Peak	<p>Site : 03CH11-HY Condition : PEAK_BE(84)_16-24 3m HORN 91200-HF HORIZONTAL Detector : Peak Project : 911641</p>	<p>Site : 03CH11-HY Condition : PEAK(UNB) 3m HORN 91200-HF HORIZONTAL Detector : Peak Project : 911641</p>
Peak	<p>Site : 03CH11-HY Condition : PEAK_NE(84)_16-24 3m HORN 91200-HF HORIZONTAL Detector : Peak Project : 911641</p>	Left blank



WIFI	Band 4 5725~5850MHz Band Edge @ 3m	
ANT	802.11ac VHT80 CH155 5775MHz	
1	Vertical	Fundamental
Peak	<p>Site : 03CH11-HY Condition : PEAK_BE(B4)_16-24 3m HORN 91200-HF VERTICAL RBW:1000.000KHz VBW:3000.000KHz SWT:Auto Detector : Peak Project : 911641</p>	<p>Site : 03CH11-HY Condition : PEAK(UNII) 3m HORN 91200-HF VERTICAL RBW:1000.000KHz VBW:3000.000KHz SWT:Auto Detector : Peak Project : 911641</p>
Peak	<p>Site : 03CH11-HY Condition : PEAK_BE(B4)_16-24 3m HORN 91200-HF VERTICAL RBW:1000.000KHz VBW:3000.000KHz SWT:Auto Detector : Peak Project : 911641</p>	Left blank



Band 4 - 5725~5850MHz
WIFI 802.11a (Harmonic @ 3m)

Table with 2 columns: Horizontal and Vertical. Each column contains a spectral plot showing Level (dBuV/m) vs Frequency (MHz) with peak and average values indicated. Includes site and condition details for both orientations.

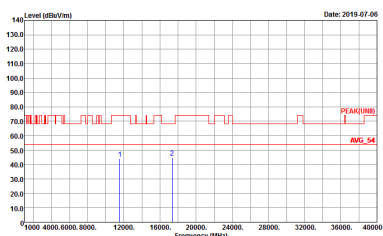
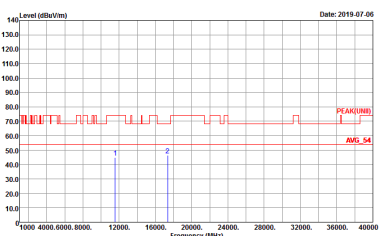

WIFI	Band 4 5725~5850MHz Harmonic @ 3m	
ANT	802.11a CH157 5785MHz	
1	Horizontal	Vertical
<p>Peak</p> <p>Avg.</p>	 <p>Site : 03CH11-HY Condition : PEAK(UNED) 3m HORN 9120D-HF HORIZONTAL Detector : Peak Project : 911641</p>	 <p>Site : 03CH11-HY Condition : PEAK(UNED) 3m HORN 9120D-HF VERTICAL Detector : Peak Project : 911641</p>



WIFI	Band 4 5725~5850MHz Harmonic @ 3m	
ANT	802.11a CH165 5825MHz	
1	Horizontal	Vertical
Peak Avg.	<p>Site : 03CH11-HY Condition : PEAK(UNED) 3m HORN 9120D-HF HORIZONTAL Detector : Peak Project : 911641</p>	<p>Site : 03CH11-HY Condition : PEAK(UNED) 3m HORN 9120D-HF VERTICAL Detector : Peak Project : 911641</p>



Band 4 5725~5850MHz
WIFI 802.11ac VHT20 (Harmonic @ 3m)

Table with 2 columns: WIFI (Band 4 5725~5850MHz Harmonic @ 3m), ANT (802.11ac VHT20 CH149 5745MHz). Row 1: 1, Horizontal, Vertical. Each plot shows Level (dBu/m) vs Frequency (MHz) with Peak and Avg. markers.



WIFI	Band 4 5725~5850MHz Harmonic @ 3m	
ANT	802.11ac VHT20 CH157 5785MHz	
1	Horizontal	Vertical
Peak Avg.	<p>Site : 03CH11-HY Condition : PEAK(UNED) 3m HORN 9120D-HF HORIZONTAL Detector : Peak Project : 911641</p>	<p>Site : 03CH11-HY Condition : PEAK(UNED) 3m HORN 9120D-HF VERTICAL Detector : Peak Project : 911641</p>

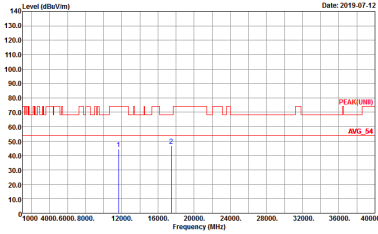
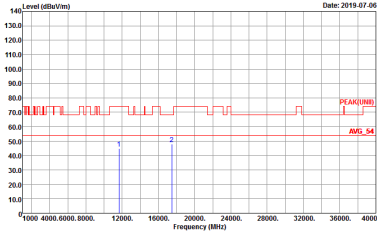

WIFI	Band 4 5725~5850MHz Harmonic @ 3m	
ANT	802.11ac VHT20 CH165 5825MHz	
1	Horizontal	Vertical
<p>Peak</p> <p>Avg.</p>	 <p>Site : 03CH11-HY Condition : PEAK(UNED) 3m HORN 9120D-HF HORIZONTAL Detector : Peak Project : 911641</p>	 <p>Site : 03CH11-HY Condition : PEAK(UNED) 3m HORN 9120D-HF VERTICAL Detector : Peak Project : 911641</p>



Band 4 5725~5850MHz
WIFI 802.11ac VHT40 (Harmonic @ 3m)

WIFI	Band 4 5725~5850MHz Harmonic @ 3m	
ANT	802.11ac VHT40 CH151 5755MHz	
1	Horizontal	Vertical
Peak Avg.	<p>Site : 03CH11-HY Condition : PEAK(LINE) 3m HORN 91200-HF HORIZONTAL Detector : Peak Project : 911641</p>	<p>Site : 03CH11-HY Condition : PEAK(LINE) 3m HORN 91200-HF VERTICAL Detector : Peak Project : 911641</p>

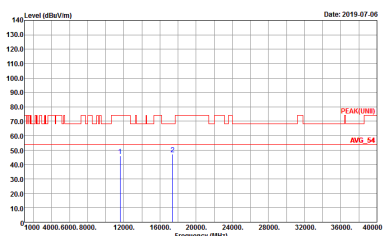
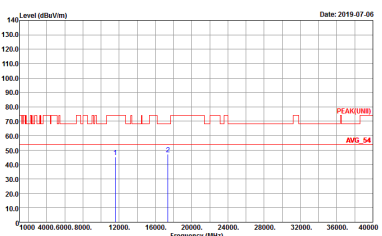

WIFI	Band 4 5725~5850MHz Harmonic @ 3m	
ANT	802.11ac VHT40 CH159 5795MHz	
1	Horizontal	Vertical
<p>Peak</p> <p>Avg.</p>	 <p>Site : 03CH11-HY Condition : PEAK(UNED) 3m HORN 91200-HF HORIZONTAL Detector : Peak Project : 911641</p>	 <p>Site : 03CH11-HY Condition : PEAK(UNED) 3m HORN 91200-HF VERTICAL Detector : Peak Project : 911641</p>



Band 4 5725~5850MHz
WIFI 802.11ac VHT80 (Harmonic @ 3m)

WIFI	Band 4 5725~5850MHz Harmonic @ 3m	
ANT	802.11ac VHT80 CH155 5775MHz	
1	Horizontal	Vertical
Peak Avg.	<p>Site : 03CH11-HY Condition : PEAK(UNII) 3m HORN 91200-HF HORIZONTAL Detector : Peak Project : 911641</p>	<p>Site : 03CH11-HY Condition : PEAK(UNII) 3m HORN 91200-HF VERTICAL Detector : Peak Project : 911641</p>



Emission below 1GHz
5GHz WIFI 802.11ac VHT80 (LF)

Table with 2 columns: Horizontal and Vertical. Each column contains a spectral plot of Level (dBuV/m) vs Frequency (MHz) from 50 to 1000 MHz. The plots show a blue signal line and a red QP peak marker. Metadata includes Site: 03CH11-4FY, Condition: QP 3m BT-LOG 6111D-LF_ETC, Detector: Peak, and Project: 911641.

QP / Peak



Band 4 - 5725~5850MHz
WIFI 802.11a (Band Edge @ 3m)

WIFI	Band 4 5725~5850MHz Band Edge @ 3m	
ANT	802.11a CH149 5745MHz	
2	Horizontal	Fundamental
Peak	<p> Date: 2019-07-04 PEAK_BE(04)_TC(3) </p> <p> Site : 03CH11-4FY Condition : PEAK_BE(04)_16-24 3m HORN 91200-HF HORIZONTAL Detector : Peak Project : 911641 </p>	<p> Date: 2019-07-04 PEAK(04)_TC(3) </p> <p> Site : 03CH11-4FY Condition : PEAK(UNII) 3m HORN 91200-HF HORIZONTAL Detector : Peak Project : 911641 </p>
	<p> Date: 2019-07-04 PEAK_BE(04)_TC(3) </p> <p> Site : 03CH11-4FY Condition : PEAK_BE(04)_16-24 3m HORN 91200-HF HORIZONTAL Detector : Peak Project : 911641 </p>	<p> Date: 2019-07-04 PEAK(04)_TC(3) </p> <p> Site : 03CH11-4FY Condition : PEAK(UNII) 3m HORN 91200-HF HORIZONTAL Detector : Peak Project : 911641 </p>



WIFI	Band 4 5725~5850MHz Band Edge @ 3m	
ANT	802.11a CH149 5745MHz	
2	Vertical	Fundamental
Peak	<p>Site : 03CH11-HY Condition : PEAK_BE(84)_16-24 3m HORN 91200-HF VERTICAL RBW:1000.000KHz VBW:3000.000KHz SWT:Auto Detector : Peak Project : 911641</p>	<p>Site : 03CH11-HY Condition : PEAK(UN)I 3m HORN 91200-HF VERTICAL RBW:1000.000KHz VBW:3000.000KHz SWT:Auto Detector : Peak Project : 911641</p>



WIFI	Band 4 5725~5850MHz Band Edge @ 3m	
ANT	802.11a CH157 5785MHz	
2	Horizontal	Fundamental
Peak	<p>Site : 03CH11-HY Condition : PEAK_BE(B4)_16-24 3m HORN 9120D-HF HORIZONTAL RBW:1000.000KHz VBW:3000.000KHz SWF:Auto Detector : Peak Project : 911641</p>	<p>Site : 03CH11-HY Condition : PEAK(UNII) 3m HORN 9120D-HF HORIZONTAL RBW:1000.000KHz VBW:3000.000KHz SWF:Auto Detector : Peak Project : 911641</p>
Peak	<p>Site : 03CH11-HY Condition : PEAK_BE(B4)_16-24 3m HORN 9120D-HF HORIZONTAL RBW:1000.000KHz VBW:3000.000KHz SWF:Auto Detector : Peak Project : 911641</p>	Left blank



WIFI	Band 4 5725~5850MHz Band Edge @ 3m	
ANT	802.11a CH157 5785MHz	
2	Vertical	Fundamental
<p>Peak</p>	<p>Site : 03CH11-HY Condition : PEAK_BE(B4)_16-24 3m HORN 91200-HF VERTICAL RBW:1000.000KHz VBW:3000.000KHz SWT:Auto Detector : Peak Project : 911641</p>	<p>Site : 03CH11-HY Condition : PEAK(UNII) 3m HORN 91200-HF VERTICAL RBW:1000.000KHz VBW:3000.000KHz SWT:Auto Detector : Peak Project : 911641</p>
<p>Peak</p>	<p>Site : 03CH11-HY Condition : PEAK_BE(B4)_16-24 3m HORN 91200-HF VERTICAL RBW:1000.000KHz VBW:3000.000KHz SWT:Auto Detector : Peak Project : 911641</p>	<p>Left blank</p>

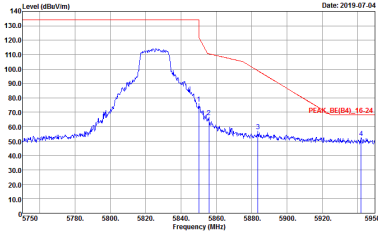
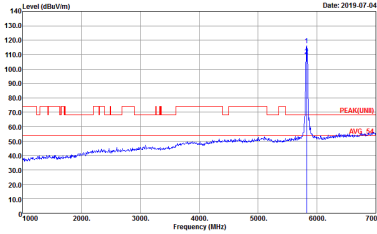

WIFI	Band 4 5725~5850MHz Band Edge @ 3m	
ANT	802.11a CH165 5825MHz	
2	Horizontal	Fundamental
Peak	 <p>Site : 03CH11-HY Condition : PEAK_BE(B4)_16-24 3m HORN 91200-HF HORIZONTAL Detector : Peak Project : 911641</p>	 <p>Site : 03CH11-HY Condition : PEAK(UNI) 3m HORN 91200-HF HORIZONTAL Detector : Peak Project : 911641</p>



WIFI	Band 4 5725~5850MHz Band Edge @ 3m	
ANT	802.11a CH165 5825MHz	
2	Vertical	Fundamental
Peak	<p>Site : 03CH11-HY Condition : PEAK_BE(B4)_16-24 3m HORN 9120D-HF VERTICAL RBW:1000.000KHz VBW:3000.000KHz SWT:Auto Detector : Peak Project : 911641</p>	<p>Site : 03CH11-HY Condition : PEAK(UNII) 3m HORN 9120D-HF VERTICAL RBW:1000.000KHz VBW:3000.000KHz SWT:Auto Detector : Peak Project : 911641</p>



Band 4 5725~5850MHz
WIFI 802.11ac VHT20 (Band Edge @ 3m)

WIFI	Band 4 5725~5850MHz Band Edge @ 3m	
ANT	802.11ac VHT20 CH149 5745MHz	
2	Horizontal	Fundamental
Peak	<p>Site : 03CH11-HY Condition : PEAK_BE(B4)_16-24 3m HORN 91200-HF HORIZONTAL Detector : Peak Project : 911641</p>	<p>Site : 03CH11-HY Condition : PEAK(UNIT) 3m HORN 91200-HF HORIZONTAL Detector : Peak Project : 911641</p>



WIFI	Band 4 5725~5850MHz Band Edge @ 3m	
ANT	802.11ac VHT20 CH149 5745MHz	
2	Vertical	Fundamental
Peak Avg.	<p>Site : 03CH11-HY Condition : PEAK_BE(84)_16-24 3m HORN 91200-HF VERTICAL RBW:1000.000KHz VBW:3000.000KHz SWT:Auto Detector : Peak Project : 911641</p>	<p>Site : 03CH11-HY Condition : PEAK(UNII) 3m HORN 91200-HF VERTICAL RBW:1000.000KHz VBW:3000.000KHz SWT:Auto Detector : Peak Project : 911641</p>



WIFI	Band 4 5725~5850MHz Band Edge @ 3m	
ANT	802.11ac VHT20 CH157 5785MHz	
2	Horizontal	Fundamental
Peak	<p>Site : 03CH11-HY Condition : PEAK_BE(B4)_16-24 3m HORN 9120D-HF HORIZONTAL RBW:1000.000KHz VBW:3000.000KHz SWT:Auto Detector : Peak Project : 911641</p>	<p>Site : 03CH11-HY Condition : PEAK(UNII) 3m HORN 9120D-HF HORIZONTAL RBW:1000.000KHz VBW:3000.000KHz SWT:Auto Detector : Peak Project : 911641</p>
Peak	<p>Site : 03CH11-HY Condition : PEAK_BE(B4)_16-24 3m HORN 9120D-HF HORIZONTAL RBW:1000.000KHz VBW:3000.000KHz SWT:Auto Detector : Peak Project : 911641</p>	Left blank

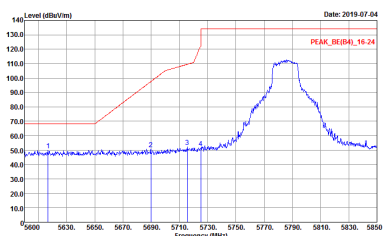
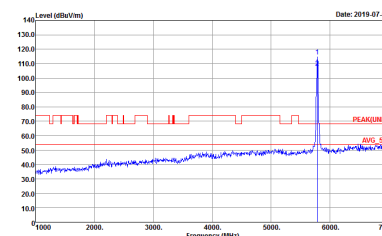
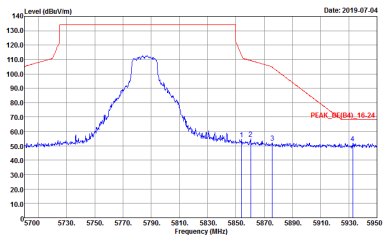

WIFI	Band 4 5725~5850MHz Band Edge @ 3m	
ANT	802.11ac VHT20 CH157 5785MHz	
2	Vertical	Fundamental
Peak	 <p>Site : 03CH11-HY Condition : PEAK_BE(B4)_16-24 3m HORN 9120D-HF VERTICAL RBW:1000.000KHz VBW:3000.000KHz SWT:Auto Detector : Peak Project : 911641</p>	 <p>Site : 03CH11-HY Condition : PEAK(UNII) 3m HORN 9120D-HF VERTICAL RBW:1000.000KHz VBW:3000.000KHz SWT:Auto Detector : Peak Project : 911641</p>
Peak	 <p>Site : 03CH11-HY Condition : PEAK_BE(B4)_16-24 3m HORN 9120D-HF VERTICAL RBW:1000.000KHz VBW:3000.000KHz SWT:Auto Detector : Peak Project : 911641</p>	Left blank



WIFI	Band 4 5725~5850MHz Band Edge @ 3m	
ANT	802.11ac VHT20 CH165 5825MHz	
2	Horizontal	Fundamental
Peak	<p>Site : 03CH11-HY Condition : PEAK_BE(B4)_16-24 3m HORN 91200-HF HORIZONTAL RBW:1000.000KHz VBW:3000.000KHz SWT:Auto Detector : Peak Project : 911641</p>	<p>Site : 03CH11-HY Condition : PEAK(UNII) 3m HORN 91200-HF HORIZONTAL RBW:1000.000KHz VBW:3000.000KHz SWT:Auto Detector : Peak Project : 911641</p>

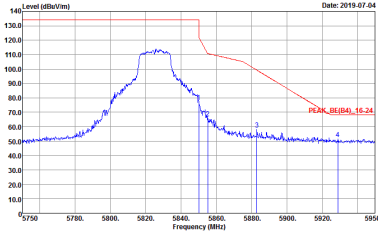
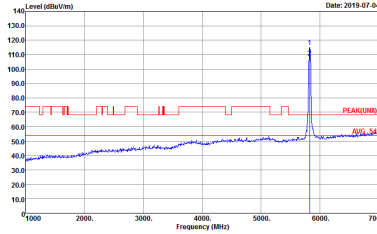

WIFI	Band 4 5725~5850MHz Band Edge @ 3m	
ANT	802.11ac VHT20 CH165 5825MHz	
2	Vertical	Fundamental
<p>Peak Avg.</p>	 <p>Site : 03CH11-HY Condition : PEAK_BE(84)_16-24 3m HORN 91200-HF VERTICAL Detector : Peak Project : 911641</p>	 <p>Site : 03CH11-HY Condition : PEAK(UNII) 3m HORN 91200-HF VERTICAL Detector : Peak Project : 911641</p>

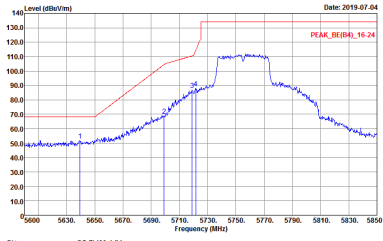
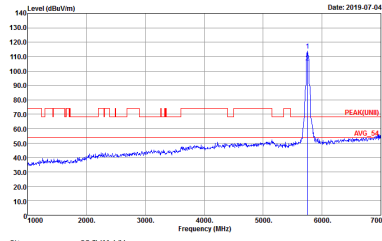
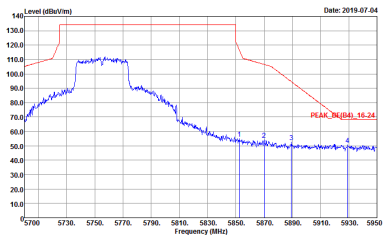

Band 4 5725~5850MHz
WIFI 802.11ac VHT40 (Band Edge @ 3m)

WIFI	Band 4 5725~5850MHz Band Edge @ 3m	
ANT	802.11ac VHT40 CH151 5755MHz	
2	Horizontal	Fundamental
<p>Peak</p>	 <p>Site : 03CH11-HY Condition : PEAK_BE(B4)_16-24 3m HORN 91200-HF HORIZONTAL Detector : Peak Project : 911641</p>	 <p>Site : 03CH11-HY Condition : PEAK(UNB) 3m HORN 91200-HF HORIZONTAL Detector : Peak Project : 911641</p>
<p>Peak</p>	 <p>Site : 03CH11-HY Condition : PEAK_BE(B4)_16-24 3m HORN 91200-HF HORIZONTAL Detector : Peak Project : 911641</p>	<p align="center">Left blank</p>



WIFI	Band 4 5725~5850MHz Band Edge @ 3m	
ANT	802.11ac VHT40 CH151 5755MHz	
2	Vertical	Fundamental
Peak	<p>Site : 03CH11-HY Condition : PEAK_BE(B4)_16-24 3m HORN 91200-HF VERTICAL RBW:1000.000KHz VBW:3000.000KHz SWT:Auto Detector : Peak Project : 911641</p>	<p>Site : 03CH11-HY Condition : PEAK(UNII) 3m HORN 91200-HF VERTICAL RBW:1000.000KHz VBW:3000.000KHz SWT:Auto Detector : Peak Project : 911641</p>
Peak	<p>Site : 03CH11-HY Condition : PEAK_BE(B4)_16-24 3m HORN 91200-HF VERTICAL RBW:1000.000KHz VBW:3000.000KHz SWT:Auto Detector : Peak Project : 911641</p>	Left blank

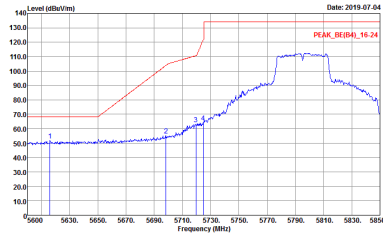
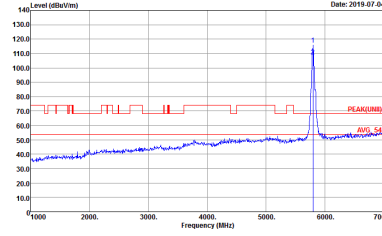
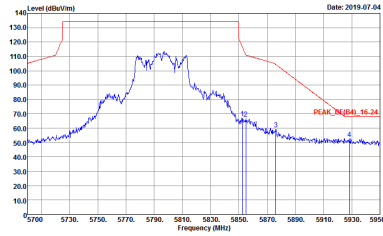

WIFI	Band 4 5725~5850MHz Band Edge @ 3m	
ANT	802.11ac VHT40 CH159 5795MHz	
2	Horizontal	Fundamental
Peak	 <p>Site : 03CH11-HY Condition : PEAK_BE(B4)_16-24 3m HORN 9120D-HF HORIZONTAL RBW:1000.000KHz VBW:3000.000KHz SWT:Auto Detector : Peak Project : 911641</p>	 <p>Site : 03CH11-HY Condition : PEAK(UNIT) 3m HORN 9120D-HF HORIZONTAL RBW:1000.000KHz VBW:3000.000KHz SWT:Auto Detector : Peak Project : 911641</p>
Peak	 <p>Site : 03CH11-HY Condition : PEAK_BE(B4)_16-24 3m HORN 9120D-HF HORIZONTAL RBW:1000.000KHz VBW:3000.000KHz SWT:Auto Detector : Peak Project : 911641</p>	Left blank



WIFI	Band 4 5725~5850MHz Band Edge @ 3m	
ANT	802.11ac VHT40 CH159 5795MHz	
2	Vertical	Fundamental
Peak	<p>Site : 03CH11-HY Condition : PEAK_BE(B4)_16-24 3m HORN 91200-HF VERTICAL RBW:1000.000KHz VBW:3000.000KHz SWT:Auto Detector : Peak Project : 911641</p>	<p>Site : 03CH11-HY Condition : PEAK(UNII) 3m HORN 91200-HF VERTICAL RBW:1000.000KHz VBW:3000.000KHz SWT:Auto Detector : Peak Project : 911641</p>
Peak	<p>Site : 03CH11-HY Condition : PEAK_BE(B4)_16-24 3m HORN 91200-HF VERTICAL RBW:1000.000KHz VBW:3000.000KHz SWT:Auto Detector : Peak Project : 911641</p>	Left blank



Band 4 5725~5850MHz
WIFI 802.11ac VHT80 (Band Edge @ 3m)

WIFI	Band 4 5725~5850MHz Band Edge @ 3m	
ANT	802.11ac VHT80 CH155 5775MHz	
2	Horizontal	Fundamental
Peak	<p>Site : 03CH11-HY Condition : PEAK_BE(B4)_16-24 3m HORN 91200-HF HORIZONTAL Detector : Peak Project : 911641</p>	<p>Site : 03CH11-HY Condition : PEAK(UNIT) 3m HORN 91200-HF HORIZONTAL Detector : Peak Project : 911641</p>
Peak	<p>Site : 03CH11-HY Condition : PEAK_BE(B4)_16-24 3m HORN 91200-HF HORIZONTAL Detector : Peak Project : 911641</p>	Left blank



WIFI	Band 4 5725~5850MHz Band Edge @ 3m	
ANT	802.11ac VHT80 CH155 5775MHz	
2	Vertical	Fundamental
Peak	<p>Site : 03CH11-HY Condition : PEAK_BE(B4)_16-24 3m HORN 91200-HF VERTICAL : RBW:1000.000KHz VBW:3000.000KHz SWT:Auto Detector : Peak Project : 911641</p>	<p>Site : 03CH11-HY Condition : PEAK(UNII) 3m HORN 91200-HF VERTICAL : RBW:1000.000KHz VBW:3000.000KHz SWT:Auto Detector : Peak Project : 911641</p>
Peak	<p>Site : 03CH11-HY Condition : PEAK_BE(B4)_16-24 3m HORN 91200-HF VERTICAL : RBW:1000.000KHz VBW:3000.000KHz SWT:Auto Detector : Peak Project : 911641</p>	Left blank



Band 4 - 5725~5850MHz
WIFI 802.11a (Harmonic @ 3m)

WIFI	Band 4 5725~5850MHz Harmonic @ 3m	
ANT	802.11a CH149 5745MHz	
2	Horizontal	Vertical
Peak Avg.	<p>Site : 03CH11-4FY Condition : PEAK(UNII) 3m HORN 9120D-HF HORIZONTAL Detector : Peak Project : 911641</p>	<p>Site : 03CH11-4FY Condition : PEAK(UNII) 3m HORN 9120D-HF VERTICAL Detector : Peak Project : 911641</p>



WIFI	Band 4 5725~5850MHz Harmonic @ 3m	
ANT	802.11a CH157 5785MHz	
2	Horizontal	Vertical
Peak Avg.	<p>Site : 03CH11-HY Condition : PEAK(UNED) 3m HORN 9120D-HF HORIZONTAL Detector : Peak Project : 911641</p>	<p>Site : 03CH11-HY Condition : PEAK(UNED) 3m HORN 9120D-HF VERTICAL Detector : Peak Project : 911641</p>

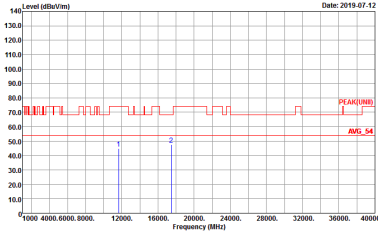
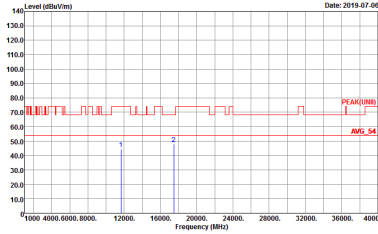

WIFI	Band 4 5725~5850MHz Harmonic @ 3m	
ANT	802.11a CH165 5825MHz	
2	Horizontal	Vertical
<p>Peak Avg.</p>	 <p>Site : 03CH11-HY Condition : PEAK(UNED) 3m HORN 9120D-HF HORIZONTAL Detector : Peak Project : 911641</p>	 <p>Site : 03CH11-HY Condition : PEAK(UNED) 3m HORN 9120D-HF VERTICAL Detector : Peak Project : 911641</p>



**Band 4 5725~5850MHz
WIFI 802.11ac VHT20 (Harmonic @ 3m)**

WIFI	Band 4 5725~5850MHz Harmonic @ 3m	
ANT	802.11ac VHT20 CH149 5745MHz	
2	Horizontal	Vertical
Peak Avg.	<p>Site : 03CH11-HY Condition : PEAK(LINE) 3m HORN 9120D-HF HORIZONTAL Detector : Peak Project : 911641</p>	<p>Site : 03CH11-HY Condition : PEAK(LINE) 3m HORN 9120D-HF VERTICAL Detector : Peak Project : 911641</p>



WIFI	Band 4 5725~5850MHz Harmonic @ 3m	
ANT	802.11ac VHT20 CH157 5785MHz	
2	Horizontal	Vertical
Peak Avg.	<p>Site : 03CH11-HY Condition : PEAK(UNED) 3m HORN 9120D-HF HORIZONTAL Detector : Peak Project : 911641</p>	<p>Site : 03CH11-HY Condition : PEAK(UNED) 3m HORN 9120D-HF VERTICAL Detector : Peak Project : 911641</p>

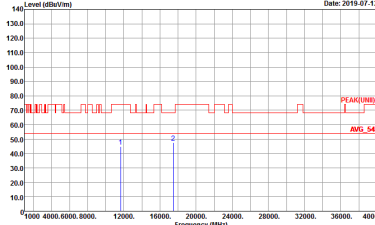
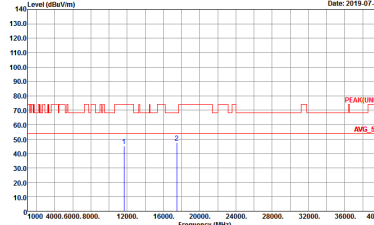

WIFI	Band 4 5725~5850MHz Harmonic @ 3m	
ANT	802.11ac VHT20 CH165 5825MHz	
2	Horizontal	Vertical
<p>Peak</p> <p>Avg.</p>	 <p>Date: 2019-07-12</p> <p>Site : 03CH11-HY Condition : PEAK(UNED) 3m HORN 9120D-HF HORIZONTAL Detector : Peak Project : 911641</p>	 <p>Date: 2019-07-06</p> <p>Site : 03CH11-HY Condition : PEAK(UNED) 3m HORN 9120D-HF VERTICAL Detector : Peak Project : 911641</p>



Band 4 5725~5850MHz
WIFI 802.11ac VHT40 (Harmonic @ 3m)

WIFI	Band 4 5725~5850MHz Harmonic @ 3m	
ANT	802.11ac VHT40 CH151 5755MHz	
2	Horizontal	Vertical
Peak Avg.	<p>Site : 03CH11-HY Condition : PEAK(UNII) 3m HORN 91200-HF HORIZONTAL Detector : Peak Project : 911641</p>	<p>Site : 03CH11-HY Condition : PEAK(UNII) 3m HORN 91200-HF VERTICAL Detector : Peak Project : 911641</p>

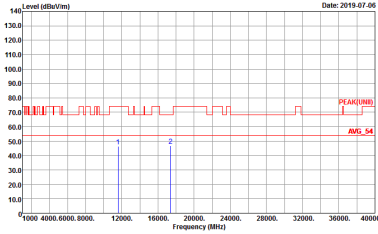
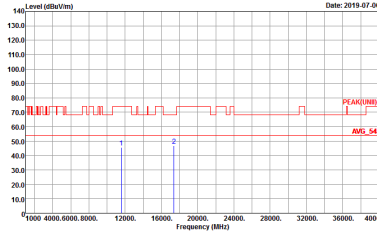

WIFI	Band 4 5725~5850MHz Harmonic @ 3m	
ANT	802.11ac VHT40 CH159 5795MHz	
2	Horizontal	Vertical
<p>Peak</p> <p>Avg.</p>	 <p>Site : 03CH11-HY Condition : PEAK(UNED) 3m HORN 91200-HF HORIZONTAL Detector : Peak Project : 911641</p>	 <p>Site : 03CH11-HY Condition : PEAK(UNED) 3m HORN 91200-HF VERTICAL Detector : Peak Project : 911641</p>



Band 4 5725~5850MHz
WIFI 802.11ac VHT80 (Harmonic @ 3m)

WIFI	Band 4 5725~5850MHz Harmonic @ 3m	
ANT	802.11ac VHT80 CH155 5775MHz	
2	Horizontal	Vertical
Peak Avg.	<p>Site : 03CH11-HY Condition : PEAK(UNII) 3m HORN 91200-HF HORIZONTAL Detector : Peak Project : 911641</p>	<p>Site : 03CH11-HY Condition : PEAK(UNII) 3m HORN 91200-HF VERTICAL Detector : Peak Project : 911641</p>



Emission below 1GHz
5GHz WIFI 802.11ac VHT80 (LF)

WIFI	5GHz 5725~5850MHz	
ANT	802.11ac VHT80 LF	
2	Horizontal	Vertical
QP / Peak	<p>Site : 03CH11-4FY Condition : QP 3m BT-LOG 6111D-LF_ETC HORIZONTAL Detector : Peak Project : 911641</p>	<p>Site : 03CH11-4FY Condition : QP 3m BT-LOG 6111D-LF_ETC VERTICAL Detector : Peak Project : 911641</p>



Band 4 - 5725~5850MHz
WIFI 802.11a (Band Edge @ 3m)

WIFI	Band 4 5725~5850MHz Band Edge @ 3m	
ANT	802.11a CH149 5745MHz	
1+2	Horizontal	Fundamental
Peak	<p> Site : 03CH11-FY Condition : PEAK_BE(84)_16-24 3m HORN 91200-HF HORIZONTAL Detector : Peak Project : 911641 </p>	<p> Site : 03CH11-FY Condition : PEAK(UNII) 3m HORN 91200-HF HORIZONTAL Detector : Peak Project : 911641 </p>



WIFI	Band 4 5725~5850MHz Band Edge @ 3m	
ANT	802.11a CH149 5745MHz	
1+2	Vertical	Fundamental
<p>Peak</p>	<p>Date: 2019-07-04 PEAK_BE(04)_16-24</p> <p>Site : 03CH11-HY Condition : PEAK_BE(04)_16-24 3m HORN 91200-HF VERTICAL RBW:1000.000KHz VBW:3000.000KHz SWT:Auto Detector : Peak Project : 911641</p>	<p>Date: 2019-07-04 PEAK_UN(01)_16-24</p> <p>Site : 03CH11-HY Condition : PEAK_UN(01)_16-24 3m HORN 91200-HF VERTICAL RBW:1000.000KHz VBW:3000.000KHz SWT:Auto Detector : Peak Project : 911641</p>
	<p>Date: 2019-07-04 PEAK_UN(02)_16-24</p> <p>Site : 03CH11-HY Condition : PEAK_UN(02)_16-24 3m HORN 91200-HF VERTICAL RBW:1000.000KHz VBW:3000.000KHz SWT:Auto Detector : Peak Project : 911641</p>	<p>Date: 2019-07-04 PEAK_UN(03)_16-24</p> <p>Site : 03CH11-HY Condition : PEAK_UN(03)_16-24 3m HORN 91200-HF VERTICAL RBW:1000.000KHz VBW:3000.000KHz SWT:Auto Detector : Peak Project : 911641</p>



WIFI	Band 4 5725~5850MHz Band Edge @ 3m	
ANT	802.11a CH157 5785MHz	
1+2	Horizontal	Fundamental
Peak	<p>Site : 03CH11-HY Condition : PEAK_BE(B4)_16-24 3m HORN 9120D-HF HORIZONTAL RBW:1000.000KHz VBW:3000.000KHz SWT:Auto Detector : Peak Project : 911641</p>	<p>Site : 03CH11-HY Condition : PEAK(UNII) 3m HORN 9120D-HF HORIZONTAL RBW:1000.000KHz VBW:3000.000KHz SWT:Auto Detector : Peak Project : 911641</p>
Peak	<p>Site : 03CH11-HY Condition : PEAK_BE(B4)_16-24 3m HORN 9120D-HF HORIZONTAL RBW:1000.000KHz VBW:3000.000KHz SWT:Auto Detector : Peak Project : 911641</p>	Left blank



WIFI	Band 4 5725~5850MHz Band Edge @ 3m	
ANT	802.11a CH157 5785MHz	
1+2	Vertical	Fundamental
Peak	<p>Site : 03CH11-HY Condition : PEAK_BE(B4)_16-24 3m HORN 91200-HF VERTICAL RBW:1000.000KHz VBW:3000.000KHz SWT:Auto Detector : Peak Project : 911641</p>	<p>Site : 03CH11-HY Condition : PEAK(UNII) 3m HORN 91200-HF VERTICAL RBW:1000.000KHz VBW:3000.000KHz SWT:Auto Detector : Peak Project : 911641</p>
Peak	<p>Site : 03CH11-HY Condition : PEAK_BE(B4)_16-24 3m HORN 91200-HF VERTICAL RBW:1000.000KHz VBW:3000.000KHz SWT:Auto Detector : Peak Project : 911641</p>	Left blank



WIFI	Band 4 5725~5850MHz Band Edge @ 3m	
ANT	802.11a CH165 5825MHz	
1+2	Horizontal	Fundamental
Peak	<p>Site : 03CH11-HY Condition : PEAK_BE(B4)_16-24 3m HORN 91200-HF HORIZONTAL RBW:1000.000KHz VBW:3000.000KHz SWT:Auto Detector : Peak Project : 911641</p>	<p>Site : 03CH11-HY Condition : PEAK(UNI) 3m HORN 91200-HF HORIZONTAL RBW:1000.000KHz VBW:3000.000KHz SWT:Auto Detector : Peak Project : 911641</p>

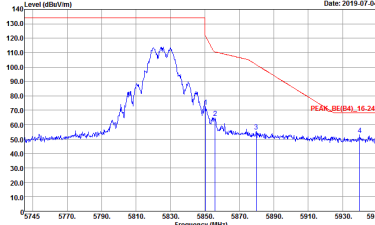
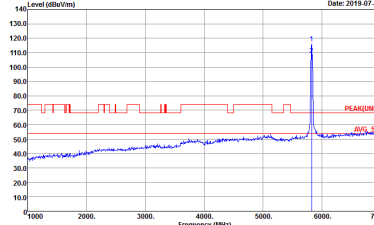

WIFI	Band 4 5725~5850MHz Band Edge @ 3m	
ANT	802.11a CH165 5825MHz	
1+2	Vertical	Fundamental
Peak	 <p>Site : 03CH11-HY Condition : PEAK_BE(84)_16-24 3m HORN 91200-HF VERTICAL RBW:1000.000KHz VBW:3000.000KHz SWT:Auto Detector : Peak Project : 911641</p>	 <p>Site : 03CH11-HY Condition : PEAK(UNI) 3m HORN 91200-HF VERTICAL RBW:1000.000KHz VBW:3000.000KHz SWT:Auto Detector : Peak Project : 911641</p>



Band 4 5725~5850MHz
WIFI 802.11ac VHT20 (Band Edge @ 3m)

WIFI	Band 4 5725~5850MHz Band Edge @ 3m	
ANT	802.11ac VHT20 CH149 5745MHz	
1+2	Horizontal	Fundamental
Peak	<p>Site : 03CH11-HY Condition : PEAK_BE(B4)_16-24 3m HORN 91200-HF HORIZONTAL Detector : Peak Project : 911641</p>	<p>Site : 03CH11-HY Condition : PEAK(UNIT) 3m HORN 91200-HF HORIZONTAL Detector : Peak Project : 911641</p>

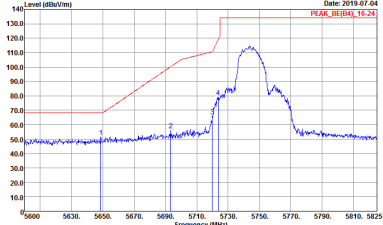
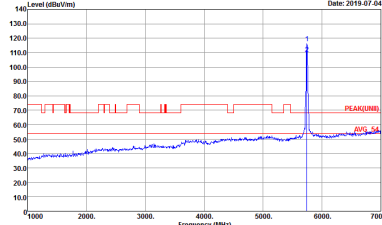

WIFI	Band 4 5725~5850MHz Band Edge @ 3m	
ANT	802.11ac VHT20 CH149 5745MHz	
1+2	Vertical	Fundamental
Peak Avg.	<div style="display: flex; justify-content: space-around;"> <div style="width: 45%;">  <p style="font-size: small;">Date: 2019-07-04 PEAK_BE(04)_16-24</p> <p style="font-size: x-small;">Site : 03CH11-HY Condition : PEAK_BE(04)_16-24 3m HORN 91200-HF VERTICAL RBW:1000.000KHz VBW:3000.000KHz SWT:Auto Detector : Peak Project : 911641</p> </div> <div style="width: 45%;">  <p style="font-size: small;">Date: 2019-07-04 PEAK_UN(01)_3m</p> <p style="font-size: x-small;">Site : 03CH11-HY Condition : PEAK_UN(01)_3m HORN 91200-HF VERTICAL RBW:1000.000KHz VBW:3000.000KHz SWT:Auto Detector : Peak Project : 911641</p> </div> </div>	

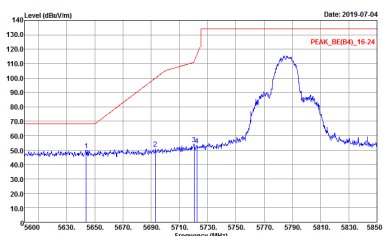
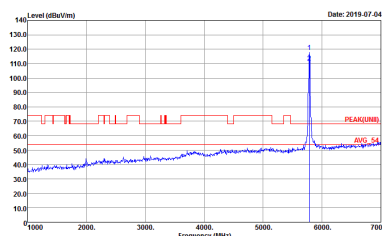
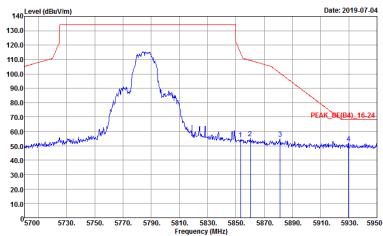

WIFI	Band 4 5725~5850MHz Band Edge @ 3m	
ANT	802.11ac VHT20 CH157 5785MHz	
1+2	Horizontal	Fundamental
<p>Peak</p>	 <p>Site : 03CH11-HY Condition : PEAK_BE(B4)_16-24 3m HORN 9120D-HF HORIZONTAL RBW:1000.000KHz VBW:3000.000KHz SWT:Auto Detector : Peak Project : 911641</p>	 <p>Site : 03CH11-HY Condition : PEAK_UN(B)_16-24 3m HORN 9120D-HF HORIZONTAL RBW:1000.000KHz VBW:3000.000KHz SWT:Auto Detector : Peak Project : 911641</p>
<p>Peak</p>	 <p>Site : 03CH11-HY Condition : PEAK_BE(B4)_16-24 3m HORN 9120D-HF HORIZONTAL RBW:1000.000KHz VBW:3000.000KHz SWT:Auto Detector : Peak Project : 911641</p>	<p>Left blank</p>



WIFI	Band 4 5725~5850MHz Band Edge @ 3m	
ANT	802.11ac VHT20 CH157 5785MHz	
1+2	Vertical	Fundamental
Peak	<p>Date: 2019-07-04</p> <p>PEAK_BE(B4)_16-24</p> <p>Site : 03CH11-HY Condition : PEAK_BE(B4)_16-24 3m HORN 91200-HF VERTICAL RBW:1000.000KHz VBW:3000.000KHz SWT:Auto Detector : Peak Project : 911641</p>	<p>Date: 2019-07-04</p> <p>PEAK(FUNB)</p> <p>Site : 03CH11-HY Condition : PEAK(FUNB)_16-24 3m HORN 91200-HF VERTICAL RBW:1000.000KHz VBW:3000.000KHz SWT:Auto Detector : Peak Project : 911641</p>
Peak	<p>Date: 2019-07-04</p> <p>PEAK_BE(B4)_16-24</p> <p>Site : 03CH11-HY Condition : PEAK_BE(B4)_16-24 3m HORN 91200-HF VERTICAL RBW:1000.000KHz VBW:3000.000KHz SWT:Auto Detector : Peak Project : 911641</p>	Left blank

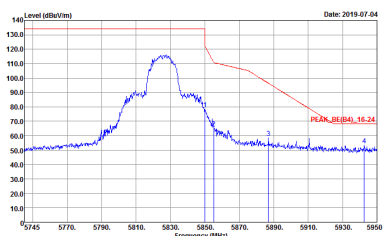
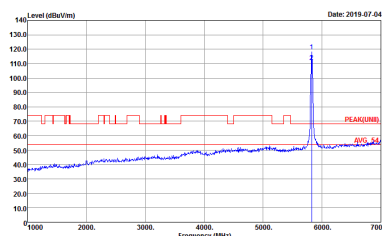

WIFI	Band 4 5725~5850MHz Band Edge @ 3m	
ANT	802.11ac VHT20 CH165 5825MHz	
1+2	Horizontal	Fundamental
Peak	 <p> Site : 03CH11-HY Condition : PEAK_BE(B4)_16-24 3m HORN 91200-HF HORIZONTAL RBW:1000.000KHz VBW:3000.000KHz SWT:Auto Detector : Peak Project : 911641 </p>	 <p> Site : 03CH11-HY Condition : PEAK(UNI) 3m HORN 91200-HF HORIZONTAL RBW:1000.000KHz VBW:3000.000KHz SWT:Auto Detector : Peak Project : 911641 </p>

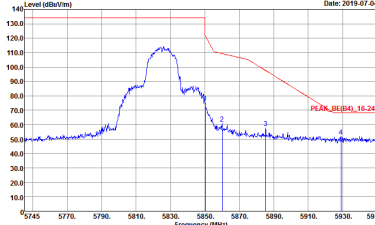
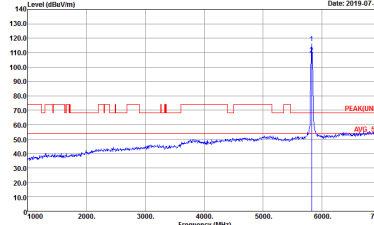

WIFI	Band 4 5725~5850MHz Band Edge @ 3m	
ANT	802.11ac VHT20 CH165 5825MHz	
1+2	Vertical	Fundamental
Peak Avg.	 <p>Site : 03CH11-HY Condition : PEAK_BE(B4)_16-24 3m HORN 91200-HF VERTICAL RBW:1000.000KHz VBW:3000.000KHz SWT:Auto Detector : Peak Project : 911641</p>	 <p>Site : 03CH11-HY Condition : PEAK(U)B 3m HORN 91200-HF VERTICAL RBW:1000.000KHz VBW:3000.000KHz SWT:Auto Detector : Peak Project : 911641</p>



Band 4 5725~5850MHz
WIFI 802.11ac VHT40 (Band Edge @ 3m)

WIFI	Band 4 5725~5850MHz Band Edge @ 3m	
ANT	802.11ac VHT40 CH151 5755MHz	
1+2	Horizontal	Fundamental
<p>Peak</p>	<p>Site : 03CH11-HY Condition : PEAK_BE(B4)_16-24 3m HORN 91200-HF HORIZONTAL Detector : Peak Project : 911641</p>	<p>Site : 03CH11-HY Condition : PEAK(UNB) 3m HORN 91200-HF HORIZONTAL Detector : Peak Project : 911641</p>
<p>Peak</p>	<p>Site : 03CH11-HY Condition : PEAK_BE(B4)_16-24 3m HORN 91200-HF HORIZONTAL Detector : Peak Project : 911641</p>	<p align="center">Left blank</p>



WIFI	Band 4 5725~5850MHz Band Edge @ 3m	
ANT	802.11ac VHT40 CH151 5755MHz	
1+2	Vertical	Fundamental
Peak	<p>Site : 03CH11-HY Condition : PEAK_BE(B4)_16-24 3m HORN 91200-HF VERTICAL RBW:1000.000KHz VBW:3000.000KHz SWT:Auto Detector : Peak Project : 911641</p>	<p>Site : 03CH11-HY Condition : PEAK(UNII) 3m HORN 91200-HF VERTICAL RBW:1000.000KHz VBW:3000.000KHz SWT:Auto Detector : Peak Project : 911641</p>
Peak	<p>Site : 03CH11-HY Condition : PEAK_BE(B4)_16-24 3m HORN 91200-HF VERTICAL RBW:1000.000KHz VBW:3000.000KHz SWT:Auto Detector : Peak Project : 911641</p>	Left blank



WIFI	Band 4 5725~5850MHz Band Edge @ 3m	
ANT	802.11ac VHT40 CH159 5795MHz	
1+2	Horizontal	Fundamental
<p>Peak</p>		
<p>Peak</p>		<p>Left blank</p>



WIFI	Band 4 5725~5850MHz Band Edge @ 3m	
ANT	802.11ac VHT40 CH159 5795MHz	
1+2	Vertical	Fundamental
Peak	<p> Date: 2019-07-04 PEAK_BE(B4)_16-24 Site : 03CH11-HY Condition : PEAK_BE(B4)_16-24 3m HORN 91200-HF VERTICAL : RBW:1000.000KHz VBW:3000.000KHz SWT:Auto Detector : Peak Project : 911641 </p>	<p> Date: 2019-07-04 PEAK(FB) Site : 03CH11-HY Condition : PEAK(UNII) 3m HORN 91200-HF VERTICAL : RBW:1000.000KHz VBW:3000.000KHz SWT:Auto Detector : Peak Project : 911641 </p>
Peak	<p> Date: 2019-07-04 PEAK_BE(B4)_16-24 Site : 03CH11-HY Condition : PEAK_BE(B4)_16-24 3m HORN 91200-HF VERTICAL : RBW:1000.000KHz VBW:3000.000KHz SWT:Auto Detector : Peak Project : 911641 </p>	Left blank

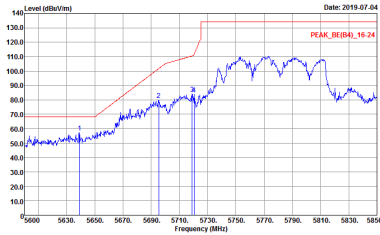
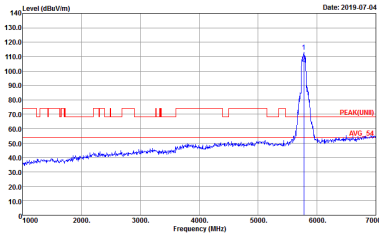
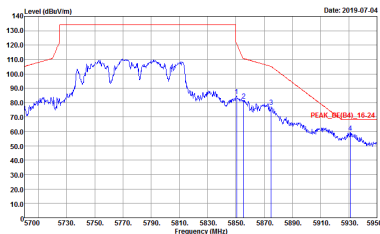

Band 4 5725~5850MHz
WIFI 802.11ac VHT80 (Band Edge @ 3m)

WIFI	Band 4 5725~5850MHz Band Edge @ 3m	
ANT	802.11ac VHT80 CH155 5775MHz	
1+2	Horizontal	Fundamental
<p>Peak</p>	 <p>Site : 03CH11-HY Condition : PEAK_BE(B4)_16-24 3m HORN 91200-HF HORIZONTAL RBW:1000.000KHz VBW:3000.000KHz SWT:Auto Detector : Peak Project : 911641</p>	 <p>Site : 03CH11-HY Condition : PEAK(UNIT) 3m HORN 91200-HF HORIZONTAL RBW:1000.000KHz VBW:3000.000KHz SWT:Auto Detector : Peak Project : 911641</p>
<p>Peak</p>	 <p>Site : 03CH11-HY Condition : PEAK_BE(B4)_16-24 3m HORN 91200-HF HORIZONTAL RBW:1000.000KHz VBW:3000.000KHz SWT:Auto Detector : Peak Project : 911641</p>	<p align="center">Left blank</p>



WIFI	Band 4 5725~5850MHz Band Edge @ 3m	
ANT	802.11ac VHT80 CH155 5775MHz	
1+2	Vertical	Fundamental
Peak	<p>Site : 03CH11-HY Condition : PEAK_BE(B4)_16-24 3m HORN 91200-HF VERTICAL RBW:1000.000KHz VBW:3000.000KHz SWT:Auto Detector : Peak Project : 911641</p>	<p>Site : 03CH11-HY Condition : PEAK(U)B 3m HORN 91200-HF VERTICAL RBW:1000.000KHz VBW:3000.000KHz SWT:Auto Detector : Peak Project : 911641</p>
Peak	<p>Site : 03CH11-HY Condition : PEAK_BE(B4)_16-24 3m HORN 91200-HF VERTICAL RBW:1000.000KHz VBW:3000.000KHz SWT:Auto Detector : Peak Project : 911641</p>	Left blank



Band 4 - 5725~5850MHz
WIFI 802.11a (Harmonic @ 3m)

WIFI	Band 4 5725~5850MHz Harmonic @ 3m	
ANT	802.11a CH149 5745MHz	
1+2	Horizontal	Vertical
Peak Avg.	<p>Site : 03CH11-4FY Condition : PEAK(UNII) 3m HORN 9120D-HF HORIZONTAL Detector : Peak Project : 911641</p>	<p>Site : 03CH11-4FY Condition : PEAK(UNII) 3m HORN 9120D-HF VERTICAL Detector : Peak Project : 911641</p>

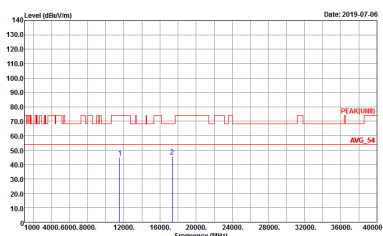
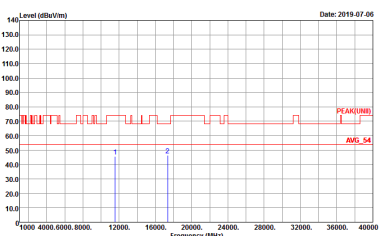

WIFI	Band 4 5725~5850MHz Harmonic @ 3m	
ANT	802.11a CH157 5785MHz	
1+2	Horizontal	Vertical
<p>Peak Avg.</p>	 <p>Site : 03CH11-HY Condition : PEAK(UNED) 3m HORN 9120D-HF HORIZONTAL Detector : Peak Project : 911641</p>	 <p>Site : 03CH11-HY Condition : PEAK(UNED) 3m HORN 9120D-HF VERTICAL Detector : Peak Project : 911641</p>

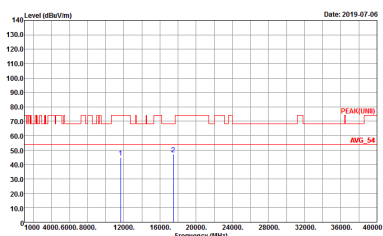
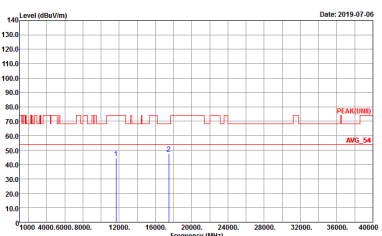

WIFI	Band 4 5725~5850MHz Harmonic @ 3m	
ANT	802.11a CH165 5825MHz	
1+2	Horizontal	Vertical
<p>Peak</p> <p>Avg.</p>	 <p>Site : 03CH11-HY Condition : PEAK(UNED) 3m HORN 9120D-HF HORIZONTAL Detector : Peak Project : 911641</p>	 <p>Site : 03CH11-HY Condition : PEAK(UNED) 3m HORN 9120D-HF VERTICAL Detector : Peak Project : 911641</p>



**Band 4 5725~5850MHz
WIFI 802.11ac VHT20 (Harmonic @ 3m)**

WIFI	Band 4 5725~5850MHz Harmonic @ 3m	
ANT	802.11ac VHT20 CH149 5745MHz	
1+2	Horizontal	Vertical
Peak Avg.	<p>Site : 03CH11-HY Condition : PEAK(UNII) 3m HORN 91200-HF HORIZONTAL Detector : Peak Project : 911641</p>	<p>Site : 03CH11-HY Condition : PEAK(UNII) 3m HORN 91200-HF VERTICAL Detector : Peak Project : 911641</p>

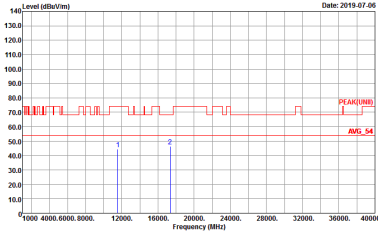
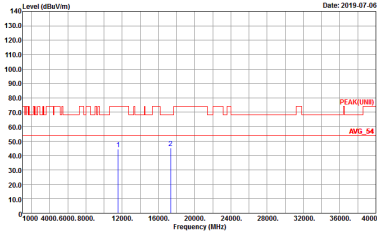

WIFI	Band 4 5725~5850MHz Harmonic @ 3m	
ANT	802.11ac VHT20 CH157 5785MHz	
1+2	Horizontal	Vertical
<p>Peak</p> <p>Avg.</p>	 <p>Site : 03CH11-HY Condition : PEAK(UNED) 3m HORN 9120D-HF HORIZONTAL Detector : Peak Project : 911641</p>	 <p>Site : 03CH11-HY Condition : PEAK(UNED) 3m HORN 9120D-HF VERTICAL Detector : Peak Project : 911641</p>

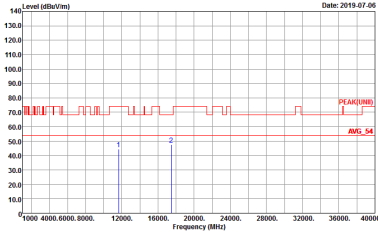
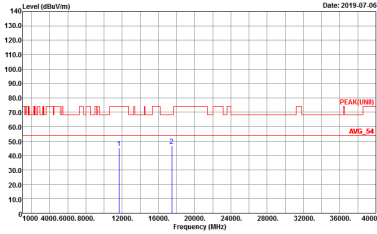

WIFI	Band 4 5725~5850MHz Harmonic @ 3m	
ANT	802.11ac VHT20 CH165 5825MHz	
1+2	Horizontal	Vertical
<p>Peak</p> <p>Avg.</p>	 <p>Site : 03CH11-HY Condition : PEAK(UNED) 3m HORN 9120D-HF HORIZONTAL Detector : Peak Project : 911641</p>	 <p>Site : 03CH11-HY Condition : PEAK(UNED) 3m HORN 9120D-HF VERTICAL Detector : Peak Project : 911641</p>



**Band 4 5725~5850MHz
WIFI 802.11ac VHT40 (Harmonic @ 3m)**

WIFI	Band 4 5725~5850MHz Harmonic @ 3m	
ANT	802.11ac VHT40 CH151 5755MHz	
1+2	Horizontal	Vertical
Peak Avg.	<p>Site : 03CH11-HY Condition : PEAK(LINE) 3m HORN 91200-HF HORIZONTAL Detector : Peak Project : 911641</p>	<p>Site : 03CH11-HY Condition : PEAK(LINE) 3m HORN 91200-HF VERTICAL Detector : Peak Project : 911641</p>



WIFI	Band 4 5725~5850MHz Harmonic @ 3m	
ANT	802.11ac VHT40 CH159 5795MHz	
1+2	Horizontal	Vertical
Peak Avg.	<p>Site : 03CH11-HY Condition : PEAK(UNED) 3m HORN 91200-HF HORIZONTAL Detector : Peak Project : 911641</p>	<p>Site : 03CH11-HY Condition : PEAK(UNED) 3m HORN 91200-HF VERTICAL Detector : Peak Project : 911641</p>



**Band 4 5725~5850MHz
WIFI 802.11ac VHT80 (Harmonic @ 3m)**

WIFI	Band 4 5725~5850MHz Harmonic @ 3m	
ANT	802.11ac VHT80 CH155 5775MHz	
1+2	Horizontal	Vertical
Peak Avg.	<p>Site : 03CH11-HY Condition : PEAK(UNII) 3m HORN 91200-HF HORIZONTAL Detector : Peak Project : 911641</p>	<p>Site : 03CH11-HY Condition : PEAK(UNII) 3m HORN 91200-HF VERTICAL Detector : Peak Project : 911641</p>



Emission below 1GHz
5GHz WIFI 802.11ac VHT80 (LF)

WIFI	5GHz 5725~5850MHz	
ANT	802.11ac VHT80 LF	
1+2	Horizontal	Vertical
QP / Peak	<p>Site : 03CH11-4FY Condition : QP 3m BT-LOG 6111D-LF_ETC HORIZONTAL Detector : Peak Project : 911641</p>	<p>Site : 03CH11-4FY Condition : QP 3m BT-LOG 6111D-LF_ETC VERTICAL Detector : Peak Project : 911641</p>



<TXBF Mode>

Band 4 - 5725~5850MHz

WIFI 802.11ac VHT20 (Band Edge @ 3m)

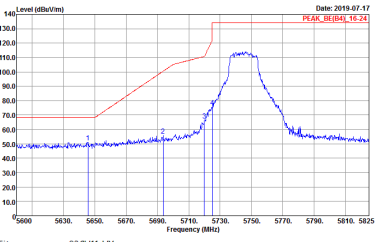
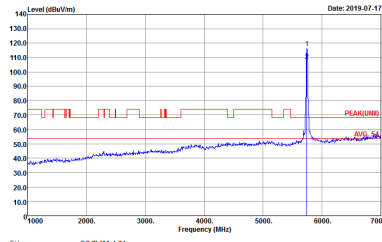
WIFI	Band 4 5725~5850MHz Band Edge @ 3m	
ANT	802.11ac VHT20 CH149 5745MHz	
1+2	Horizontal	Fundamental
Peak	 <p>Site : 03CH11-4FY Condition : PEAK_BE(84)_16-24 3m HORN 91200-HF HORIZONTAL Detector : Peak Project : 911641 Setting : 20</p>	 <p>Site : 03CH11-4FY Condition : PEAK(FUN) 3m HORN 91200-HF HORIZONTAL Detector : Peak Project : 911641 Setting : 20</p>



WIFI	Band 4 5725-5850MHz Band Edge @ 3m	
ANT	802.11ac VHT20 CH149 5745MHz	
1+2	Vertical	Fundamental
Peak Avg.	<p>Site : 03CH11-HY Condition : PEAK_8E(84)_16-24 3m HORN 91200-HF VERTICAL RBW:1000.000KHz VBW:3000.000KHz SWT:Auto Detector : Peak Project : 911641 Setting : 20</p>	<p>Site : 03CH11-HY Condition : PEAK(UNII) 3m HORN 91200-HF VERTICAL RBW:1000.000KHz VBW:3000.000KHz SWT:Auto Detector : Peak Project : 911641 Setting : 20</p>



WIFI	Band 4 5725~5850MHz Band Edge @ 3m	
ANT	802.11ac VHT20 CH157 5785MHz	
1+2	Horizontal	Fundamental
Peak	<p>Site : 03CH11-HY Condition : PEAK_BE(B4)_16-24 3m HORN 91200-HF HORIZONTAL Detector : Peak Project : 911641 Setting : 20</p>	<p>Site : 03CH11-HY Condition : PEAK(UNII) 3m HORN 91200-HF HORIZONTAL Detector : Peak Project : 911641 Setting : 20</p>
Peak	<p>Site : 03CH11-HY Condition : PEAK_BE(B4)_16-24 3m HORN 91200-HF HORIZONTAL Detector : Peak Project : 911641 Setting : 20</p>	Left blank

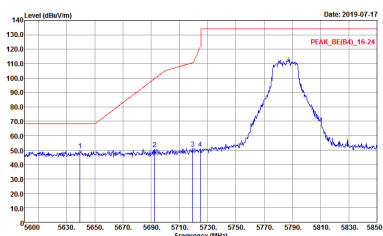
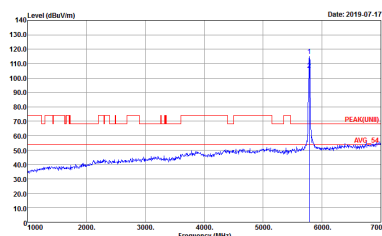
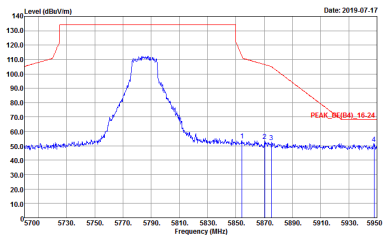

WIFI	Band 4 5725~5850MHz Band Edge @ 3m	
ANT	802.11ac VHT20 CH157 5785MHz	
1+2	Vertical	Fundamental
<p>Peak</p>	 <p>Date: 2019-07-17</p> <p>Site : 03CH11-HY Condition : PEAK_BE(B4)_16-24 3m HORN 91200-HF VERTICAL RBW:1000.000KHz VBW:3000.000KHz SWT:Auto Detector : Peak Project : 911641 Setting : 20</p>	 <p>Date: 2019-07-17</p> <p>Site : 03CH11-HY Condition : PEAK(FB) 3m HORN 91200-HF VERTICAL RBW:1000.000KHz VBW:3000.000KHz SWT:Auto Detector : Peak Project : 911641 Setting : 20</p>
<p>Peak</p>	 <p>Date: 2019-07-17</p> <p>Site : 03CH11-HY Condition : PEAK_BE(B4)_16-24 3m HORN 91200-HF VERTICAL RBW:1000.000KHz VBW:3000.000KHz SWT:Auto Detector : Peak Project : 911641 Setting : 20</p>	<p>Left blank</p>

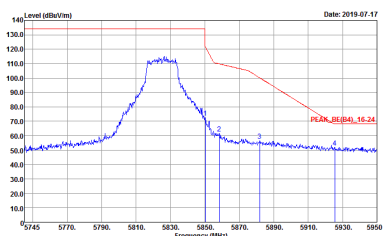
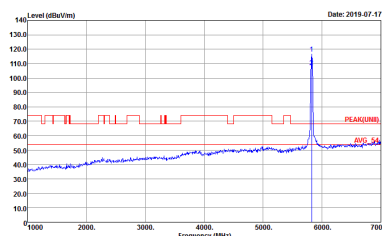

WIFI	Band 4 5725~5850MHz Band Edge @ 3m	
ANT	802.11ac VHT20 CH165 5825MHz	
1+2	Horizontal	Fundamental
Peak	 <p>Date: 2019-07-17</p> <p>Site : 03CH11-HY Condition : PEAK_BE(B4)_16-24 3m HORN 91200-HF HORIZONTAL RBW:1000.000KHz VBW:3000.000KHz SWT:Auto Detector : Peak Project : 911641 Setting : 20</p>	 <p>Date: 2019-07-17</p> <p>Site : 03CH11-HY Condition : PEAK(UNI) 3m HORN 91200-HF HORIZONTAL RBW:1000.000KHz VBW:3000.000KHz SWT:Auto Detector : Peak Project : 911641 Setting : 20</p>

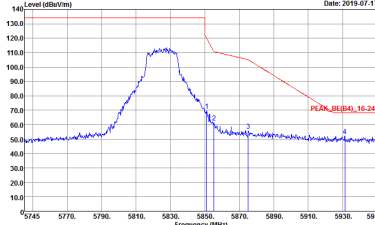
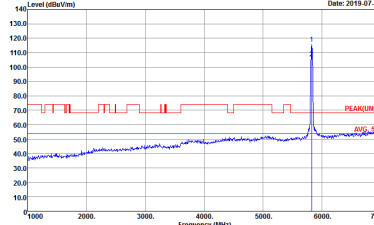

WIFI	Band 4 5725~5850MHz Band Edge @ 3m	
ANT	802.11ac VHT20 CH165 5825MHz	
1+2	Vertical	Fundamental
<p>Peak</p> <p>Avg.</p>	 <p>Site : 03CH11-HY Condition : PEAK_BE(B4)_16-24 3m HORN 91200-HF VERTICAL RBW:1000.000KHz VBW:3000.000KHz SWT:Auto Detector : Peak Project : 911641 Setting : 20</p>	 <p>Site : 03CH11-HY Condition : PEAK(U)B 3m HORN 91200-HF VERTICAL RBW:1000.000KHz VBW:3000.000KHz SWT:Auto Detector : Peak Project : 911641 Setting : 20</p>



Band 4 5725~5850MHz
WIFI 802.11ac VHT40 (Band Edge @ 3m)

WIFI	Band 4 5725~5850MHz Band Edge @ 3m	
ANT	802.11ac VHT40 CH151 5755MHz	
1+2	Horizontal	Fundamental
Peak	<p>Site : 03CH11-HY Condition : PEAK_BE(84)_16-24 3m HORN 91200-HF HORIZONTAL Detector : Peak Project : 911641 Setting : 20</p>	<p>Site : 03CH11-HY Condition : PEAK(UNIT) 3m HORN 91200-HF HORIZONTAL Detector : Peak Project : 911641 Setting : 20</p>
Peak	<p>Site : 03CH11-HY Condition : PEAK_BE(84)_16-24 3m HORN 91200-HF HORIZONTAL Detector : Peak Project : 911641 Setting : 20</p>	Left blank



WIFI	Band 4 5725~5850MHz Band Edge @ 3m	
ANT	802.11ac VHT40 CH151 5755MHz	
1+2	Vertical	Fundamental
Peak	<p>Site : 03CH11-HY Condition : PEAK_BE(B4)_16-24 3m HORN 91200-HF VERTICAL RBW:1000.000KHz VBW:3000.000KHz SWT:Auto Detector : Peak Project : 911641 Setting : 20</p>	<p>Site : 03CH11-HY Condition : PEAK(UNII) 3m HORN 91200-HF VERTICAL RBW:1000.000KHz VBW:3000.000KHz SWT:Auto Detector : Peak Project : 911641 Setting : 20</p>
Peak	<p>Site : 03CH11-HY Condition : PEAK_BE(B4)_16-24 3m HORN 91200-HF VERTICAL RBW:1000.000KHz VBW:3000.000KHz SWT:Auto Detector : Peak Project : 911641 Setting : 20</p>	Left blank



WIFI	Band 4 5725~5850MHz Band Edge @ 3m	
ANT	802.11ac VHT40 CH159 5795MHz	
1+2	Horizontal	Fundamental
<p>Peak</p>	<p>Date: 2019-07-17</p> <p>PEAK_BE(B4)_16-24</p> <p>Site : 03CH11-HY Condition : PEAK_BE(B4)_16-24 3m HORN 9120D-HF HORIZONTAL RBW:1000.000KHz VBW:3000.000KHz SWT:Auto Detector : Peak Project : 911641 Setting : 20</p>	<p>Date: 2019-07-17</p> <p>PEAK(FUN)</p> <p>AVG_5s</p> <p>Site : 03CH11-HY Condition : PEAK(FUN) 3m HORN 9120D-HF HORIZONTAL RBW:1000.000KHz VBW:3000.000KHz SWT:Auto Detector : Peak Project : 911641 Setting : 20</p>
<p>Peak</p>	<p>Date: 2019-07-17</p> <p>PEAK_BE(B4)_16-24</p> <p>Site : 03CH11-HY Condition : PEAK_BE(B4)_16-24 3m HORN 9120D-HF HORIZONTAL RBW:1000.000KHz VBW:3000.000KHz SWT:Auto Detector : Peak Project : 911641 Setting : 20</p>	<p>Left blank</p>



WIFI	Band 4 5725-5850MHz Band Edge @ 3m	
ANT	802.11ac VHT40 CH159 5795MHz	
1+2	Vertical	Fundamental
Peak	<p>Site : 03CH11-HY Condition : PEAK_BE(B4)_16-24 3m HORN 91200-HF VERTICAL Detector : Peak Project : 911641 Setting : 20</p>	<p>Site : 03CH11-HY Condition : PEAK(UNII) 3m HORN 91200-HF VERTICAL Detector : Peak Project : 911641 Setting : 20</p>
Peak	<p>Site : 03CH11-HY Condition : PEAK_BE(B4)_16-24 3m HORN 91200-HF VERTICAL Detector : Peak Project : 911641 Setting : 20</p>	Left blank



Band 4 5725~5850MHz
WIFI 802.11ac VHT80 (Band Edge @ 3m)

WIFI	Band 4 5725~5850MHz Band Edge @ 3m	
ANT	802.11ac VHT80 CH155 5775MHz	
1+2	Horizontal	Fundamental
Peak		
Peak		Left blank



WIFI	Band 4 5725~5850MHz Band Edge @ 3m	
ANT	802.11ac VHT80 CH155 5775MHz	
1+2	Vertical	Fundamental
Peak	<p>Site : 03CH11-HY Condition : PEAK_BE(B4)_16-24 3m HORN 9120D-HF VERTICAL RBW:1000.000KHz VBW:3000.000KHz SWT:Auto Detector : Peak Project : 911641 Setting : 20</p>	<p>Site : 03CH11-HY Condition : PEAK(UNII) 3m HORN 9120D-HF VERTICAL RBW:1000.000KHz VBW:3000.000KHz SWT:Auto Detector : Peak Project : 911641 Setting : 20</p>
Peak	<p>Site : 03CH11-HY Condition : PEAK_BE(B4)_16-24 3m HORN 9120D-HF VERTICAL RBW:1000.000KHz VBW:3000.000KHz SWT:Auto Detector : Peak Project : 911641 Setting : 20</p>	Left blank



Band 4 - 5725~5850MHz
WIFI 802.11ac VHT20 (Harmonic @ 3m)

Table with 2 columns: Horizontal and Vertical. Each column contains a spectral plot showing Level (dBuV/m) vs Frequency (MHz) with Peak and Avg. values. Includes metadata like Site, Condition, Detector, Project, and Setting.



WIFI	Band 4 5725~5850MHz Harmonic @ 3m	
ANT	802.11ac VHT20 CH157 5785MHz	
1+2	Horizontal	Vertical
Peak Avg.	<p>Site : 03CH11-HY Condition : PEAK(UNED) 3m HORN 91200-HF HORIZONTAL Detector : Peak Project : 911641 Setting : 20</p>	<p>Site : 03CH11-HY Condition : PEAK(UNED) 3m HORN 91200-HF VERTICAL Detector : Peak Project : 911641 Setting : 20</p>



WIFI	Band 4 5725~5850MHz Harmonic @ 3m	
ANT	802.11ac VHT20 CH165 5825MHz	
1+2	Horizontal	Vertical
Peak Avg.	<p>Site : 03CH11-HY Condition : PEAK(UNED) 3m HORN 9120D-HF HORIZONTAL Detector : Peak Project : 911641 Setting : 20</p>	<p>Site : 03CH11-HY Condition : PEAK(UNED) 3m HORN 9120D-HF VERTICAL Detector : Peak Project : 911641 Setting : 20</p>



Band 4 5725~5850MHz
WIFI 802.11ac VHT40 (Harmonic @ 3m)

WIFI	Band 4 5725~5850MHz Harmonic @ 3m	
ANT	802.11ac VHT40 CH151 5755MHz	
1+2	Horizontal	Vertical
Peak Avg.	<p>Site : 03CH11-HY Condition : PEAK(LINE) 3m HORN 91200-HF HORIZONTAL Detector : Peak Project : 911641 Setting : 20</p>	<p>Site : 03CH11-HY Condition : PEAK(LINE) 3m HORN 91200-HF VERTICAL Detector : Peak Project : 911641 Setting : 20</p>



WIFI	Band 4 5725~5850MHz Harmonic @ 3m	
ANT	802.11ac VHT40 CH159 5795MHz	
1+2	Horizontal	Vertical
Peak Avg.	<p>Site : 03CH11-HY Condition : PEAK(UNED) 3m HORN 91200-HF HORIZONTAL Detector : Peak Project : 911641 Setting : 20</p>	<p>Site : 03CH11-HY Condition : PEAK(UNED) 3m HORN 91200-HF VERTICAL Detector : Peak Project : 911641 Setting : 20</p>



Band 4 5725~5850MHz
WIFI 802.11ac VHT80 (Harmonic @ 3m)

WIFI	Band 4 5725~5850MHz Harmonic @ 3m	
ANT	802.11ac VHT80 CH155 5775MHz	
1+2	Horizontal	Vertical
Peak Avg.	<p>Site : 03CH11-HY Condition : PEAK(UNII) 3m HORN 91200-HF HORIZONTAL Detector : Peak Project : 911641 Setting : 20</p>	<p>Site : 03CH11-HY Condition : PEAK(UNII) 3m HORN 91200-HF VERTICAL Detector : Peak Project : 911641 Setting : 20</p>

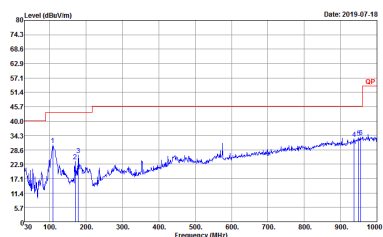
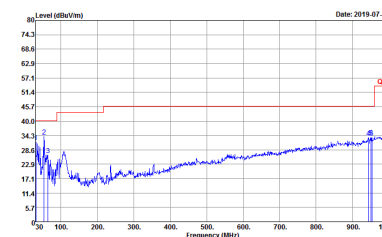

Emission below 1GHz
5GHz WIFI 802.11ac VHT80 (LF)

WIFI	5GHz 5725~5850MHz	
ANT	802.11ac VHT80 LF	
1+2	Horizontal	Vertical
QP / Peak	 <p>Site : 03CH11-FF Condition : QP 3m BT-LOG 6111D-LF_ETC HORIZONTAL Detector : Peak Project : 911641</p>	 <p>Site : 03CH11-FF Condition : QP 3m BT-LOG 6111D-LF_ETC VERTICAL Detector : Peak Project : 911641</p>



Appendix D. Duty Cycle Plots

Antenna	Band	Duty Cycle(%)	T(us)	1/T(kHz)	VBW Setting	Duty Factor(dB)
1	802.11a	95.83	2066	0.48	1kHz	0.18
2	802.11a	95.82	2064	0.48	1kHz	0.19
1+2	802.11a for Ant. 1	95.37	2059	0.49	1kHz	0.21
1+2	802.11a for Ant. 2	95.32	2059	0.49	1kHz	0.21
1	5GHz 802.11n HT20	94.53	1919	0.52	1kHz	0.24
2	5GHz 802.11n HT20	95.32	1935	0.52	1kHz	0.21
1+2	5GHz 802.11n HT20 for Ant. 1	94.25	1919	0.52	1kHz	0.26
1+2	5GHz 802.11n HT20 for Ant. 2	95.32	1935	0.52	1kHz	0.21
1	5GHz 802.11n HT40	93.61	1539	0.65	1kHz	0.29
2	5GHz 802.11n HT40	94.19	1539	0.65	1kHz	0.26
1+2	5GHz 802.11n HT40 for Ant. 1	94.82	1539	0.65	1kHz	0.23
1+2	5GHz 802.11n HT40 for Ant. 2	94.59	1539	0.65	1kHz	0.24
1	5GHz 802.11ac VHT20	94.33	1929	0.52	1kHz	0.25
2	5GHz 802.11ac VHT20	94.79	1929	0.52	1kHz	0.23
1+2	5GHz 802.11ac VHT20 for Ant. 1	94.56	1929	0.52	1kHz	0.24
1+2	5GHz 802.11ac VHT20 for Ant. 2	94.79	1929	0.52	1kHz	0.23
1	5GHz 802.11ac VHT40	94.30	1540	0.65	1kHz	0.25
2	5GHz 802.11ac VHT40	94.91	1549	0.65	1kHz	0.23
1+2	5GHz 802.11ac VHT40 for Ant. 1	95.02	1547	0.65	1kHz	0.22
1+2	5GHz 802.11ac VHT40 for Ant. 2	94.91	1547	0.65	1kHz	0.23
1	5GHz 802.11ac VHT80	88.58	729	1.37	3kHz	0.53
2	5GHz 802.11ac VHT80	88.50	731	1.37	3kHz	0.53
1+2	5GHz 802.11ac VHT80 for Ant. 1	89.29	734	1.36	3kHz	0.49
1+2	5GHz 802.11ac VHT80 for Ant. 2	88.70	730	1.37	3kHz	0.52



<Ant. 1>

802.11a

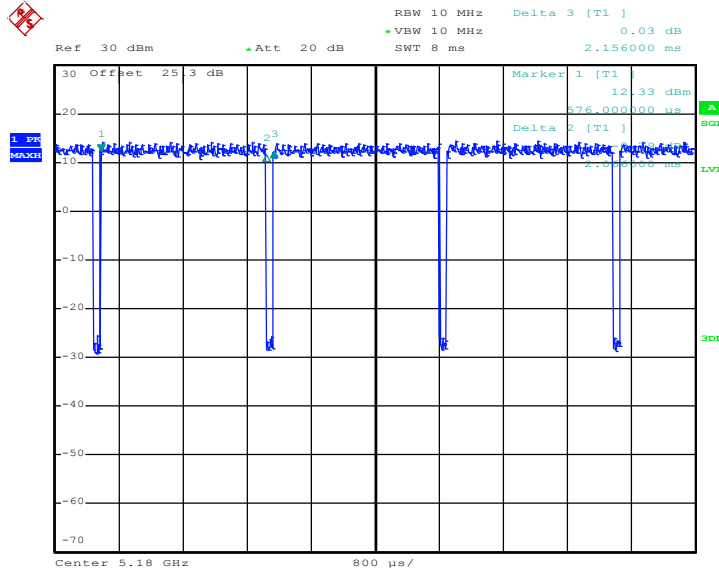

Date: 5.JUL.2019 04:17:49

802.11n HT20

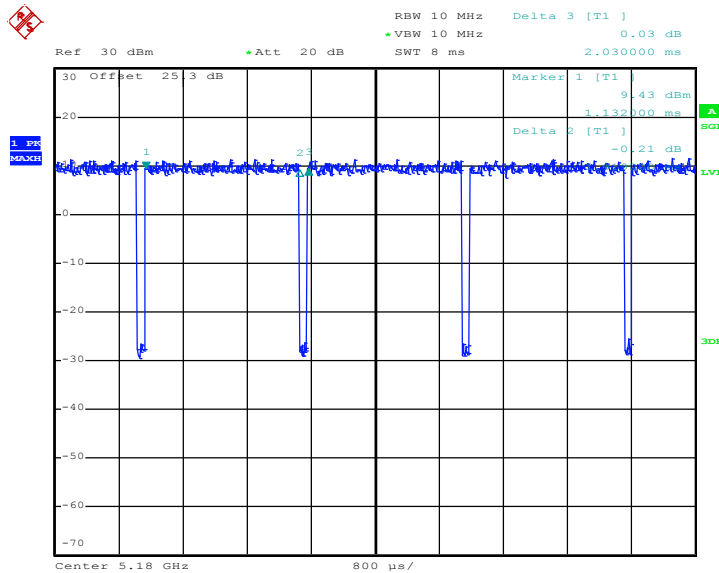

Date: 5.JUL.2019 04:43:18



802.11n HT40

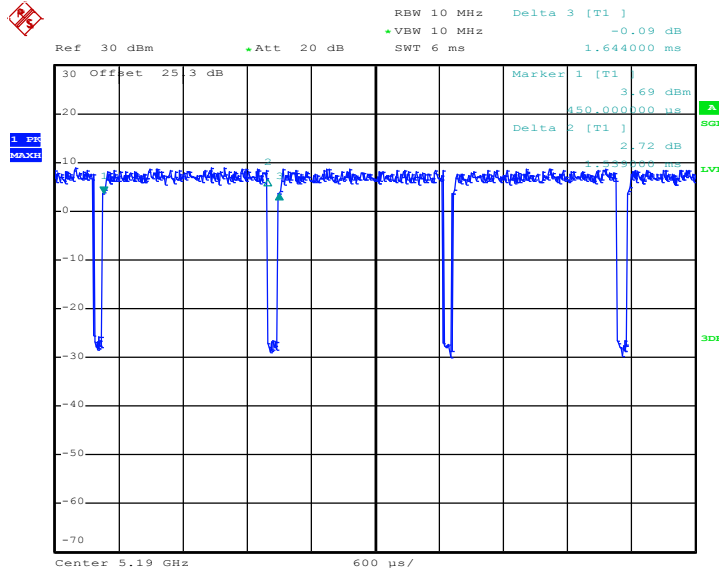

Date: 5.JUL.2019 04:53:45

802.11ac VHT20

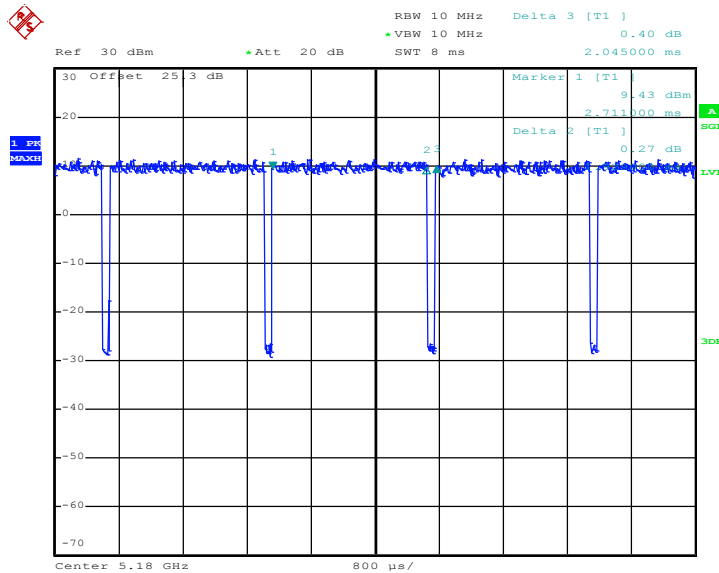

Date: 5.JUL.2019 04:49:36



802.11ac VHT40

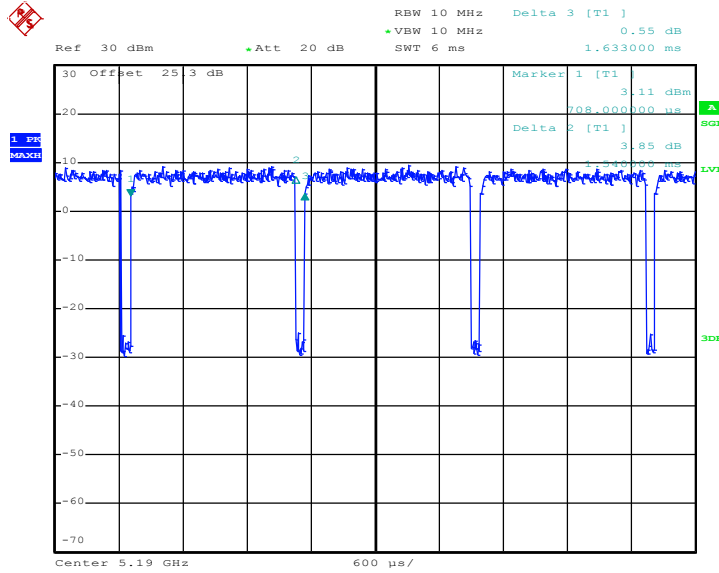

Date: 5.JUL.2019 04:58:00

802.11ac VHT80

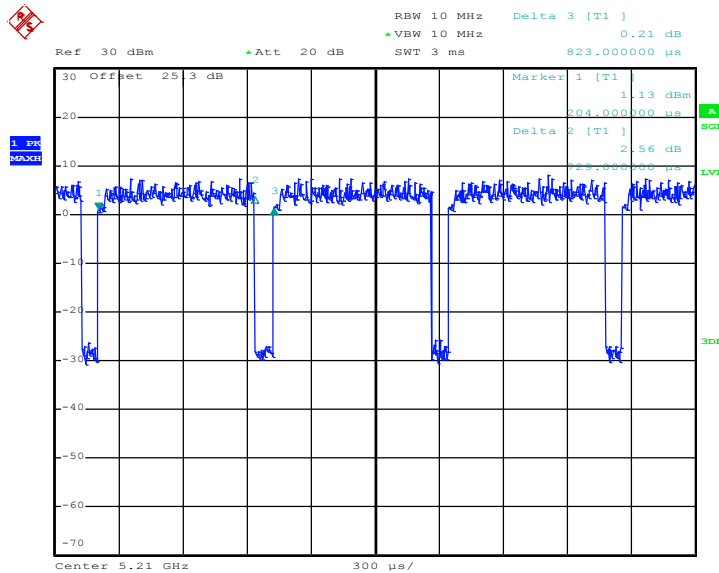

Date: 5.JUL.2019 05:04:20



<Ant. 2>

802.11a

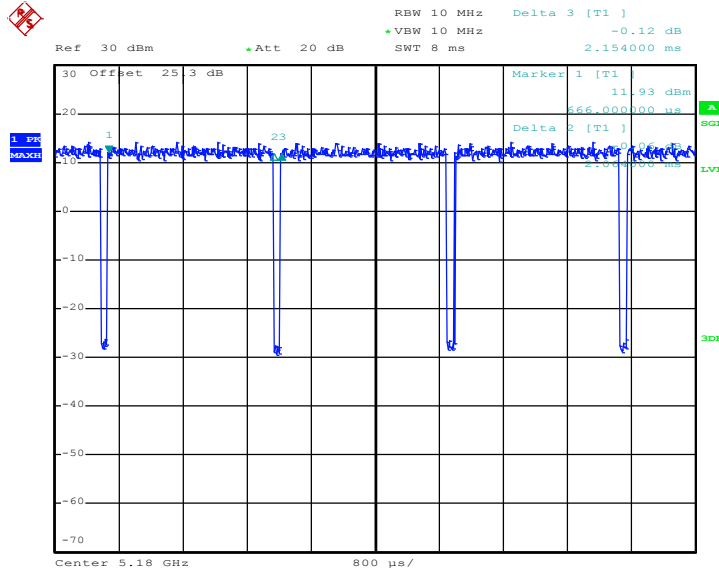

Date: 5.JUL.2019 04:21:15

802.11n HT20

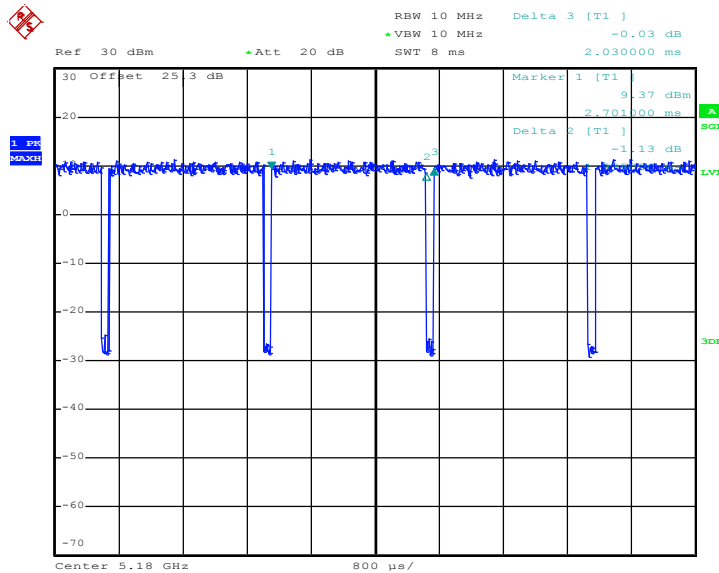

Date: 5.JUL.2019 04:45:45



802.11n HT40

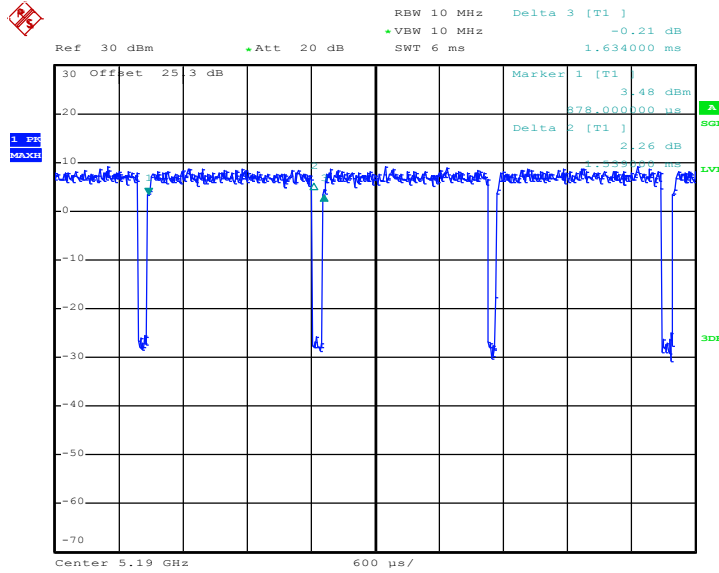

Date: 5.JUL.2019 04:54:55

802.11ac VHT20

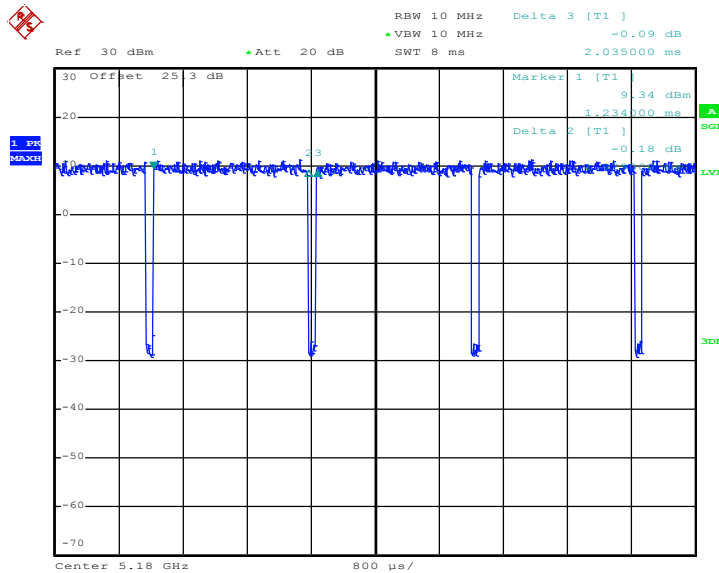

Date: 5.JUL.2019 04:50:33



802.11ac VHT40

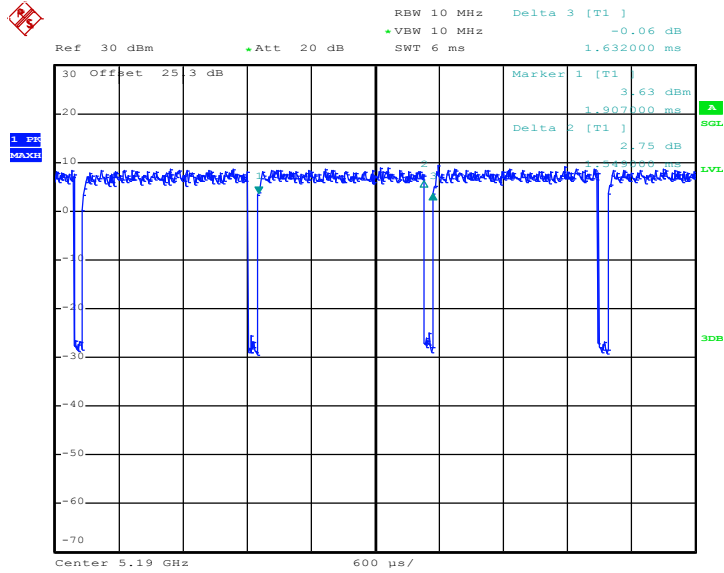

Date: 5.JUL.2019 04:58:57

802.11ac VHT80

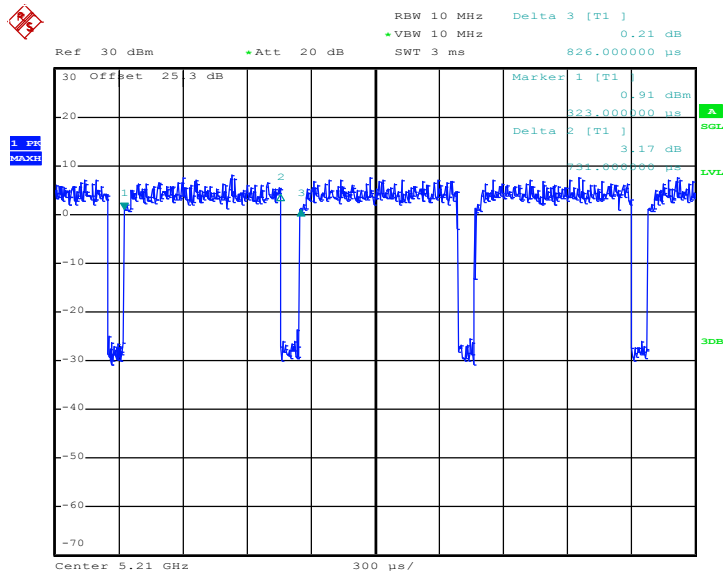

Date: 5.JUL.2019 05:03:11



MIMO <Ant. 1>

802.11 a

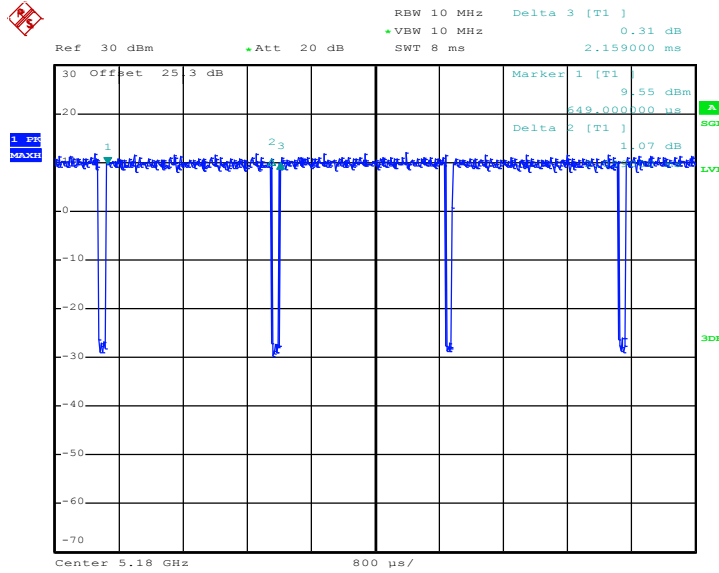

Date: 5.JUL.2019 04:40:15

802.11n HT20

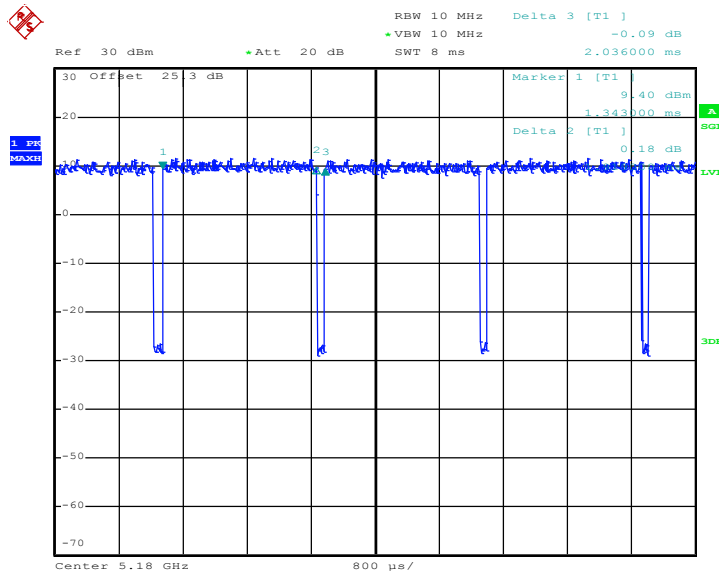

Date: 5.JUL.2019 04:46:52



802.11n HT40

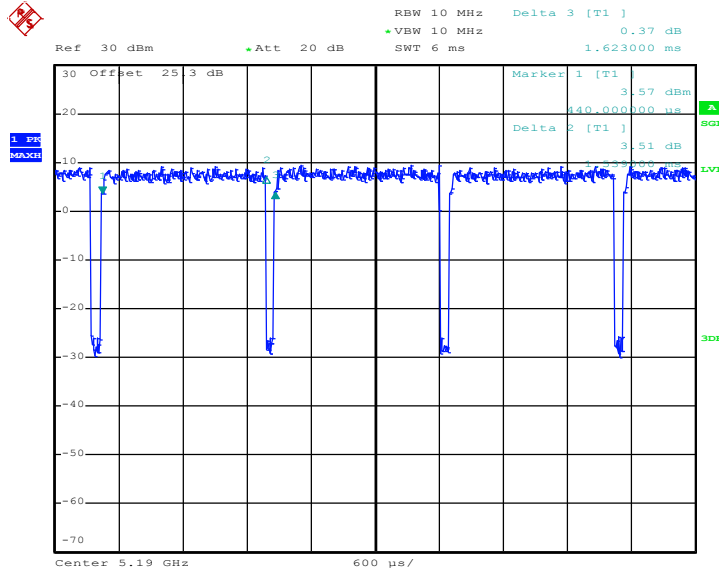

Date: 5.JUL.2019 04:56:02

802.11ac VHT20

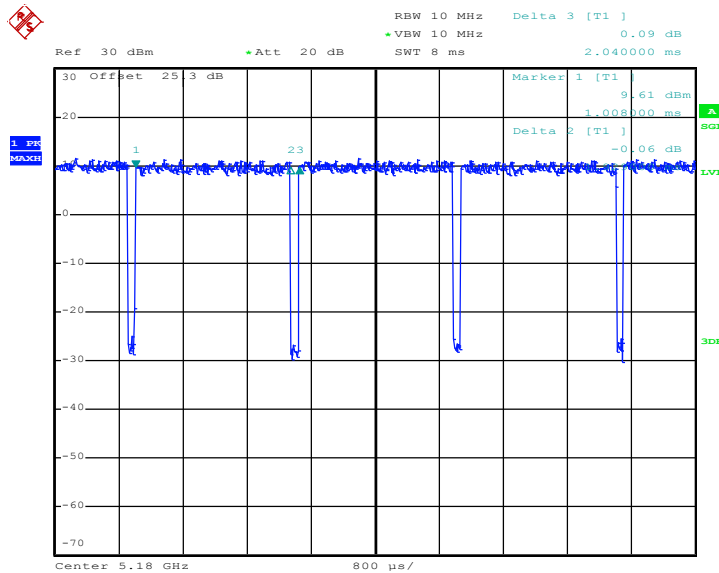

Date: 5.JUL.2019 04:51:42



802.11ac VHT40

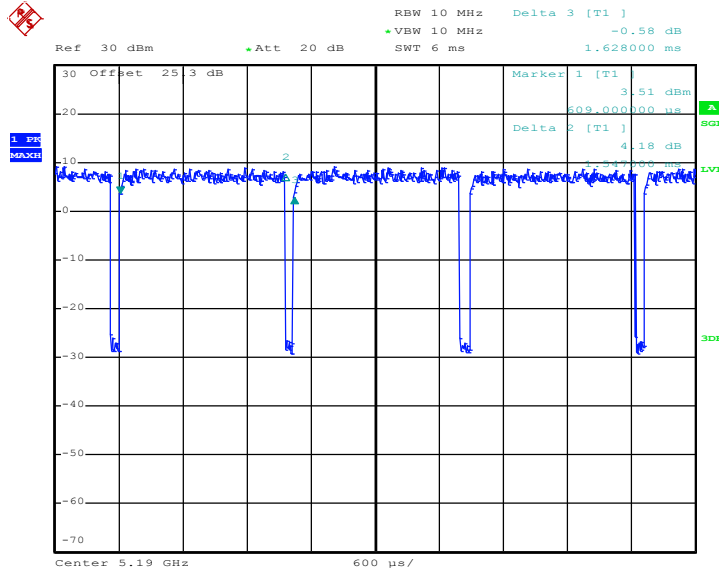

Date: 5.JUL.2019 04:59:53

802.11ac VHT80

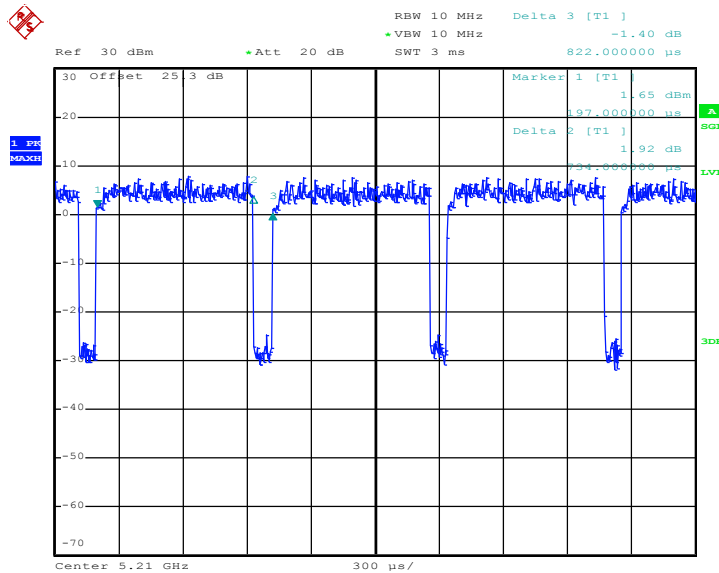

Date: 5.JUL.2019 05:05:26



MIMO <Ant. 2>

802.11a

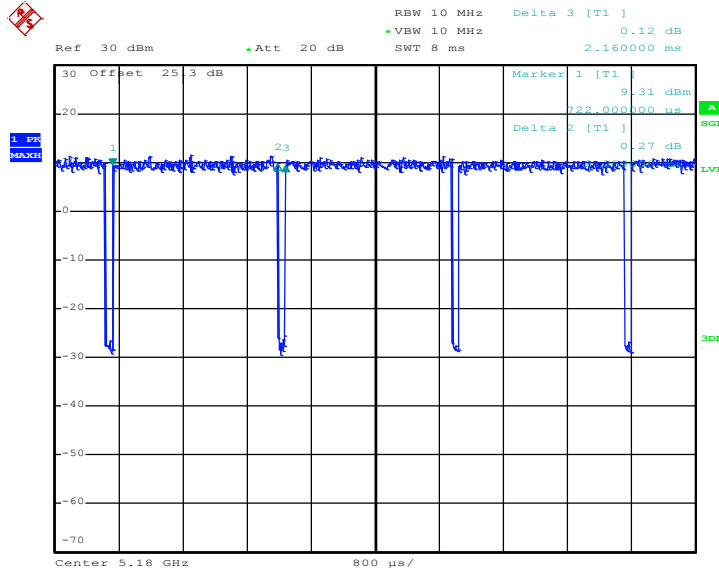

Date: 5.JUL.2019 04:41:29

802.11n HT20

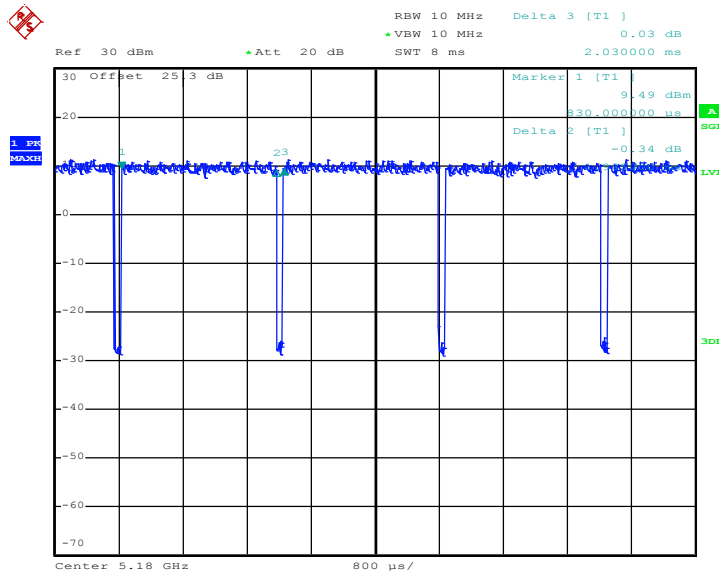

Date: 5.JUL.2019 04:48:06



802.11n HT40

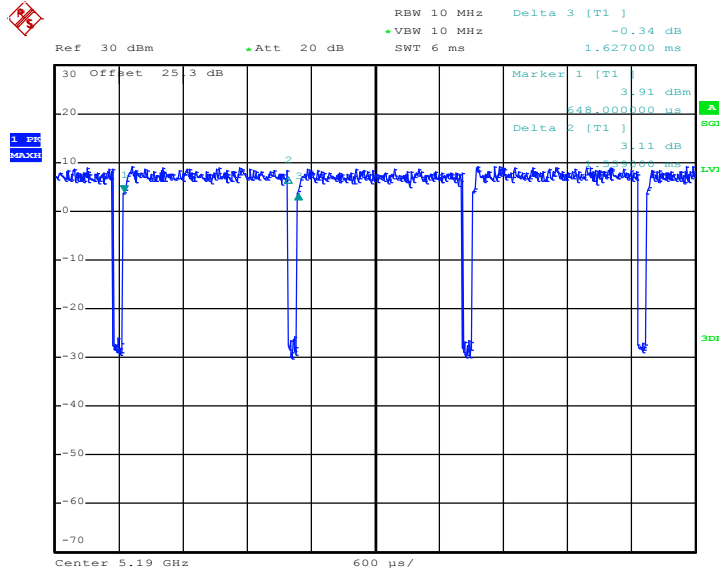

Date: 5.JUL.2019 04:56:49

802.11ac VHT20

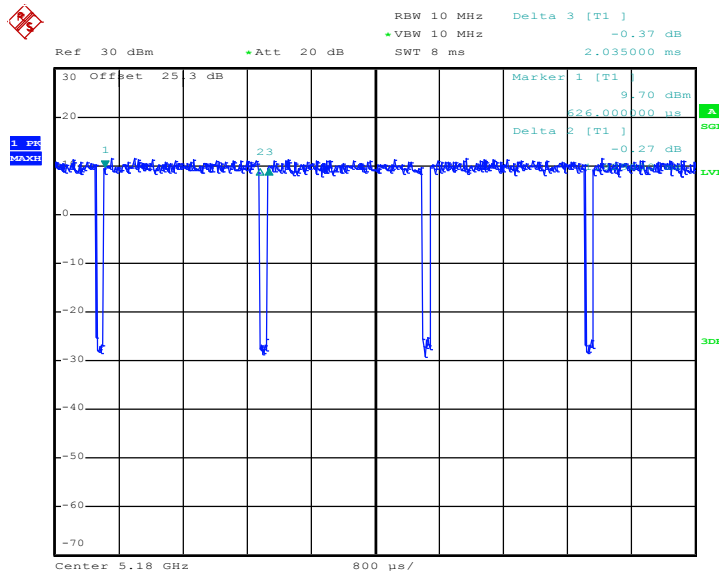

Date: 5.JUL.2019 04:52:27



802.11ac VHT40

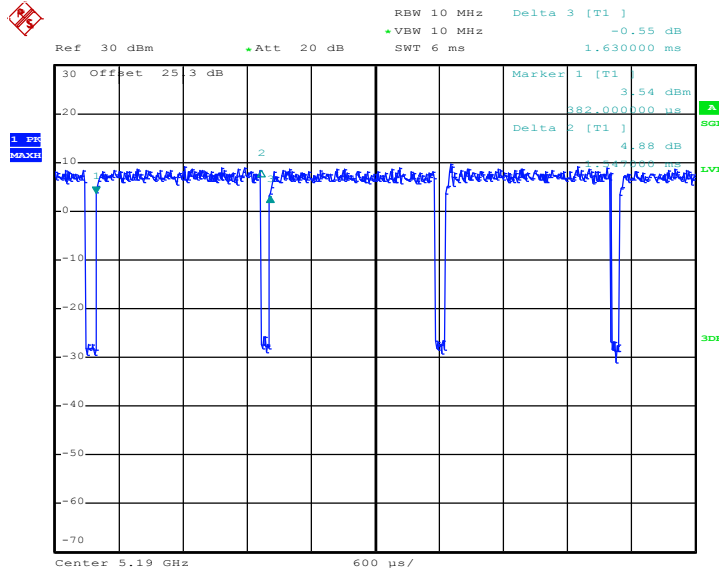

Date: 5.JUL.2019 05:00:36

802.11ac VHT80

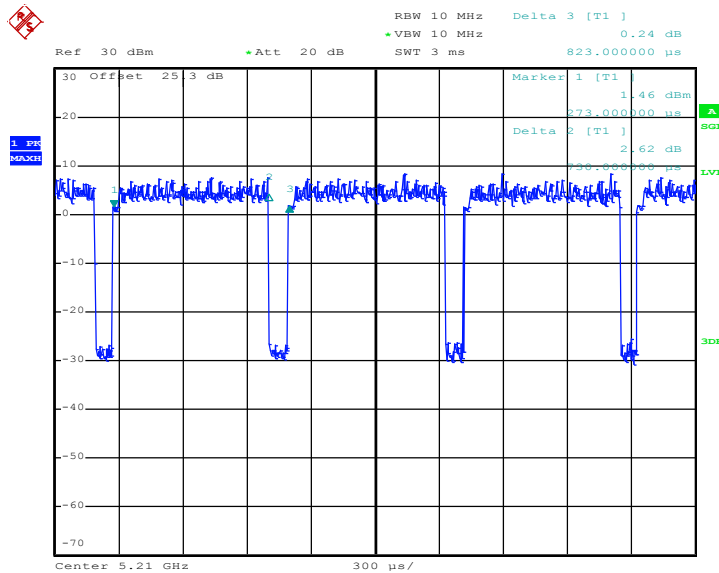

Date: 5.JUL.2019 05:06:10