

# FCC SAR Test Report

**APPLICANT** : Zebra Technologies Corporation  
**EQUIPMENT** : Enterprise Tablet  
**BRAND NAME** : Zebra  
**MODEL NAME** : ET55BT  
**FCC ID** : UZ7ET55BT  
**STANDARD** : FCC 47 CFR Part 2 (2.1093)  
ANSI/IEEE C95.1-1992  
IEEE 1528-2013

We, SPORTON INTERNATIONAL INC., would like to declare that the tested sample has been evaluated in accordance with the procedures and had been in compliance with the applicable technical standards.

The test results in this report apply exclusively to the tested model / sample. Without written approval of SPORTON INTERNATIONAL INC., the test report shall not be reproduced except in full.

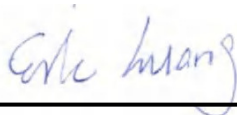

Reviewed by: Eric Huang / Deputy Manager



Approved by: Jones Tsai / Manager



## **SPORTON INTERNATIONAL INC.**

No.52, Hwa Ya 1st Rd., Hwa Ya Technology Park, Kwei-Shan District, Taoyuan City, Taiwan (R.O.C.)



**Table of Contents**

**1. Statement of Compliance ..... 4**

**2. Administration Data ..... 5**

**3. Guidance Standard ..... 5**

**4. Equipment Under Test (EUT) Information ..... 6**

    4.1 General Information ..... 6

    4.2 General LTE SAR Test and Reporting Considerations ..... 7

**5. Proximity Sensor Triggering Test..... 9**

**6. RF Exposure Limits.....10**

    6.1 Uncontrolled Environment .....10

    6.2 Controlled Environment.....10

**7. Specific Absorption Rate (SAR).....11**

    7.1 Introduction ..... 11

    7.2 SAR Definition..... 11

**8. System Description and Setup .....12**

    8.1 E-Field Probe .....13

    8.2 Data Acquisition Electronics (DAE) .....13

    8.3 Phantom.....14

    8.4 Device Holder.....15

**9. Measurement Procedures .....16**

    9.1 Spatial Peak SAR Evaluation .....16

    9.2 Power Reference Measurement.....17

    9.3 Area Scan .....17

    9.4 Zoom Scan.....18

    9.5 Volume Scan Procedures .....18

    9.6 Power Drift Monitoring.....18

**10. Test Equipment List.....19**

**11. System Verification .....20**

    11.1 Tissue Verification .....20

    11.2 System Performance Check Results .....23

**12. RF Exposure Positions .....23**

    12.1 SAR Testing for Tablet.....23

**13. Conducted RF Output Power (Unit: dBm).....24**

**14. SAR Test Results .....64**

    14.1 Body SAR .....66

    14.2 Repeated SAR Measurement .....70

**15. Simultaneous Transmission Analysis .....71**

    15.1 Body Exposure Conditions .....72

    15.2 SPLSR Evaluation and Analysis.....78

**16. Uncertainty Assessment .....105**

**17. References.....108**

**Appendix A. Plots of System Performance Check**

**Appendix B. Plots of High SAR Measurement**

**Appendix C. DASy Calibration Certificate**

**Appendix D. Test Setup Photos**



### Revision History

REPORT NO.	VERSION	DESCRIPTION	ISSUED DATE
FA660115	Rev. 01	Initial issue of report	Jul. 15, 2016



**1. Statement of Compliance**

The maximum results of Specific Absorption Rate (SAR) found during testing for Zebra Technologies Corporation, Enterprise Tablet, ET55BT, are as follows.

Equipment Class	Frequency Band		Highest SAR Summary	Highest Simultaneous Transmission 1g SAR (W/kg)
			Body 1g SAR (W/kg)	
Licensed	GSM	GSM850	0.98	1.59
		GSM1900	0.57	
	WCDMA	WCDMA II	0.88	
		WCDMA IV	0.48	
		WCDMA V	0.59	
	CDMA	CDMA BC0	0.65	
		CDMA BC1	0.74	
		CDMA BC10	0.57	
	LTE	LTE Band 2	0.40	
		LTE Band 4	0.40	
		LTE Band 5	0.57	
		LTE Band 13	0.72	
LTE Band 17		0.72		
LTE Band 25		0.79		
DTS	WLAN	2.4GHz WLAN	1.05	1.59
NII		5GHz WLAN	1.38	1.56
DSS	2.4GHz Band	Bluetooth	0.19	1.12
Date of Testing:			2016/6/21 ~ 2016/7/2	

This device is in compliance with Specific Absorption Rate (SAR) for general population/uncontrolled exposure limits (1.6 W/kg) specified in FCC 47 CFR part 2 (2.1093) and ANSI/IEEE C95.1-1992, and had been tested in accordance with the measurement methods and procedures specified in IEEE 1528-2013 and FCC KDB publications





## 2. Administration Data

Testing Laboratory	
Test Site	SPORTON INTERNATIONAL INC.
Test Site Location	No.52, Hwa Ya 1st Rd., Hwa Ya Technology Park, Kwei-Shan District, Taoyuan City, Taiwan (R.O.C.) TEL: +886-3-327-3456 FAX: +886-3-328-4978

Applicant	
Company Name	Zebra Technologies Corporation
Address	1 Zebra Plaza, Holtsville, NY 11742

Manufacturer	
Company Name	Zebra Technologies Corporation
Address	1 Zebra Plaza, Holtsville, NY 11742

## 3. Guidance Standard

The Specific Absorption Rate (SAR) testing specification, method, and procedure for this device is in accordance with the following standards:

- FCC 47 CFR Part 2 (2.1093)
- ANSI/IEEE C95.1-1992
- IEEE 1528-2013
- FCC KDB 865664 D01 SAR Measurement 100 MHz to 6 GHz v01r04
- FCC KDB 865664 D02 SAR Reporting v01r02
- FCC KDB 447498 D01 General RF Exposure Guidance v06
- FCC KDB 248227 D01 802.11 Wi-Fi SAR v02r02
- FCC KDB 616217 D04 SAR for laptop and tablets v01r02
- FCC KDB 941225 D01 3G SAR Procedures v03r01
- FCC KDB 941225 D05 SAR for LTE Devices v02r05



4. Equipment Under Test (EUT) Information

4.1 General Information

Product Feature & Specification	
Equipment Name	Enterprise Tablet
Brand Name	Zebra
Model Name	ET55BT
FCC ID	UZ7ET55BT
IMEI Code	352236070051101
Wireless Technology and Frequency Range	GSM850: 824.2 MHz ~ 848.8 MHz GSM1900: 1850.2 MHz ~ 1909.8 MHz WCDMA Band II: 1852.4 MHz ~ 1907.6 MHz WCDMA Band IV: 1712.4 MHz ~ 1752.6 MHz WCDMA Band V: 826.4 MHz ~ 846.6 MHz CDMA2000 BC0: 824.7 MHz ~ 848.31 MHz CDMA 2000 BC1: 1851.25 MHz ~ 1908.75 MHz CDMA 2000 BC10: 817.9 MHz ~ 823.1 MHz LTE Band 2: 1850 MHz ~ 1910 MHz LTE Band 4: 1710 MHz ~ 1755 MHz LTE Band 5: 824 MHz ~ 849 MHz LTE Band 13: 777 MHz ~ 787 MHz LTE Band 17: 704 MHz ~ 716 MHz LTE Band 25: 1850 MHz ~ 1915 MHz WLAN 2.4GHz Band: 2412 MHz ~ 2462 MHz WLAN 5.2GHz Band: 5180 MHz ~ 5240 MHz WLAN 5.3GHz Band: 5260 MHz ~ 5320 MHz WLAN 5.5GHz Band: 5500 MHz ~ 5700 MHz WLAN 5.8GHz Band: 5745 MHz ~ 5825 MHz Bluetooth: 2402 MHz ~ 2480 MHz NFC : 13.56 MHz
Mode	· GPRS/EGPRS · RMC 12.2Kbps · HSDPA · HSUPA · DC-HSDPA · CDMA2000 : 1xRTT/1xEv-Do(Rev.0)/1xEv-Do(Rev.A) · LTE: QPSK, 16QAM · 802.11a/b/g/n/ac HT20/HT40/VHT20/VHT40/VHT80 · Bluetooth EDR/LE · NFC:ASK
HW Version	DV1
SW Version	5.1.1
FW Version	7.35.205.4
MFD	31-Mar-16
EUT Stage	Identical Prototype



**4.2 General LTE SAR Test and Reporting Considerations**

Summarized necessary items addressed in KDB 941225 D05 v02r05																																																		
FCC ID	UZ7ET55BT																																																	
Equipment Name	Enterprise Tablet																																																	
Operating Frequency Range of each LTE transmission band	LTE Band 02: 1850 MHz ~ 1910 MHz LTE Band 04: 1710 MHz ~ 1755 MHz LTE Band 05: 824 MHz ~ 849 MHz LTE Band 07: 2500 MHz ~ 2570 MHz LTE Band 13: 777 MHz ~ 787 MHz LTE Band 17: 704 MHz ~ 716 MHz LTE Band 25: 1850 MHz ~ 1915 MHz																																																	
Channel Bandwidth	LTE Band 02: 1.4MHz, 3MHz, 5MHz, 10MHz, 15MHz, 20MHz LTE Band 04: 1.4MHz, 3MHz, 5MHz, 10MHz, 15MHz, 20MHz LTE Band 05: 1.4MHz, 3MHz, 5MHz, 10MHz LTE Band 07: 5MHz, 10MHz, 15MHz, 20MHz LTE Band 13: 5MHz, 10MHz LTE Band 17: 5MHz, 10MHz LTE Band 25: 1.4MHz, 3MHz, 5MHz, 10MHz, 15MHz, 20MHz																																																	
uplink modulations used	QPSK, and 16QAM																																																	
LTE Voice / Data requirements	Data only																																																	
LTE MPR permanently built-in by design	<p align="center"><b>Table 6.2.3-1: Maximum Power Reduction (MPR) for Power Class 3</b></p> <table border="1"> <thead> <tr> <th rowspan="2">Modulation</th> <th colspan="6">Channel bandwidth / Transmission bandwidth (RB)</th> <th rowspan="2">MPR (dB)</th> </tr> <tr> <th>1.4 MHz</th> <th>3.0 MHz</th> <th>5 MHz</th> <th>10 MHz</th> <th>15 MHz</th> <th>20 MHz</th> </tr> </thead> <tbody> <tr> <td>QPSK</td> <td>&gt; 5</td> <td>&gt; 4</td> <td>&gt; 8</td> <td>&gt; 12</td> <td>&gt; 16</td> <td>&gt; 18</td> <td>≤ 1</td> </tr> <tr> <td>16 QAM</td> <td>≤ 5</td> <td>≤ 4</td> <td>≤ 8</td> <td>≤ 12</td> <td>≤ 16</td> <td>≤ 18</td> <td>≤ 1</td> </tr> <tr> <td>16 QAM</td> <td>&gt; 5</td> <td>&gt; 4</td> <td>&gt; 8</td> <td>&gt; 12</td> <td>&gt; 16</td> <td>&gt; 18</td> <td>≤ 2</td> </tr> </tbody> </table>												Modulation	Channel bandwidth / Transmission bandwidth (RB)						MPR (dB)	1.4 MHz	3.0 MHz	5 MHz	10 MHz	15 MHz	20 MHz	QPSK	> 5	> 4	> 8	> 12	> 16	> 18	≤ 1	16 QAM	≤ 5	≤ 4	≤ 8	≤ 12	≤ 16	≤ 18	≤ 1	16 QAM	> 5	> 4	> 8	> 12	> 16	> 18	≤ 2
Modulation	Channel bandwidth / Transmission bandwidth (RB)						MPR (dB)																																											
	1.4 MHz	3.0 MHz	5 MHz	10 MHz	15 MHz	20 MHz																																												
QPSK	> 5	> 4	> 8	> 12	> 16	> 18	≤ 1																																											
16 QAM	≤ 5	≤ 4	≤ 8	≤ 12	≤ 16	≤ 18	≤ 1																																											
16 QAM	> 5	> 4	> 8	> 12	> 16	> 18	≤ 2																																											
LTE A-MPR	In the base station simulator configuration, Network Setting value is set to NS_01 to disable A-MPR during SAR testing and the LTE SAR tests was transmitting on all TTI frames (Maximum TTI)																																																	
Spectrum plots for RB configuration	A properly configured base station simulator was used for the SAR and power measurement; therefore, spectrum plots for each RB allocation and offset configuration are not included in the SAR report.																																																	
Power reduction applied to satisfy SAR compliance	1. Yes, Proximity Sensor.																																																	
Transmission (H, M, L) channel numbers and frequencies in each LTE band																																																		
LTE Band 2																																																		
	Bandwidth 1.4 MHz		Bandwidth 3 MHz		Bandwidth 5 MHz		Bandwidth 10 MHz		Bandwidth 15 MHz		Bandwidth 20 MHz																																							
	Ch. #	Freq. (MHz)	Ch. #	Freq. (MHz)	Ch. #	Freq. (MHz)	Ch. #	Freq. (MHz)	Ch. #	Freq. (MHz)	Ch. #	Freq. (MHz)																																						
L	18607	1850.7	18615	1851.5	18625	1852.5	18650	1855	18675	1857.5	18700	1860																																						
M	18900	1880	18900	1880	18900	1880	18900	1880	18900	1880	18900	1880																																						
H	19193	1909.3	19185	1908.5	19175	1907.5	19150	1905	19125	1902.5	19100	1900																																						
LTE Band 4																																																		
	Bandwidth 1.4 MHz		Bandwidth 3 MHz		Bandwidth 5 MHz		Bandwidth 10 MHz		Bandwidth 15 MHz		Bandwidth 20 MHz																																							
	Ch. #	Freq. (MHz)	Ch. #	Freq. (MHz)	Ch. #	Freq. (MHz)	Ch. #	Freq. (MHz)	Ch. #	Freq. (MHz)	Ch. #	Freq. (MHz)																																						
L	19957	1710.7	19965	1711.5	19975	1712.5	20000	1715	20025	1717.5	20050	1720																																						
M	20175	1732.5	20175	1732.5	20175	1732.5	20175	1732.5	20175	1732.5	20175	1732.5																																						
H	20393	1754.3	20385	1753.5	20375	1752.5	20350	1750	20325	1747.5	20300	1745																																						
LTE Band 5																																																		
	Bandwidth 1.4 MHz		Bandwidth 3 MHz		Bandwidth 5 MHz		Bandwidth 10 MHz																																											
	Ch. #	Freq. (MHz)	Ch. #	Freq. (MHz)	Ch. #	Freq. (MHz)	Ch. #	Freq. (MHz)	Ch. #	Freq. (MHz)																																								
L	20407	824.7	20415	825.5	20425	826.5	20450	829																																										
M	20525	836.5	20525	836.5	20525	836.5	20525	836.5																																										
H	20643	848.3	20635	847.5	20625	846.5	20600	844																																										



LTE Band 13												
	Bandwidth 5 MHz				Bandwidth 10 MHz							
	Channel #		Freq.(MHz)		Channel #		Freq.(MHz)					
L	23205		779.5		23230		782					
M	23230		782									
H	23255		784.5									
LTE Band 17												
	Bandwidth 5 MHz				Bandwidth 10 MHz							
	Channel #		Freq.(MHz)		Channel #		Freq. (MHz)					
L	23755		706.5		23780		709					
M	23790		710		23790		710					
H	23825		713.5		23800		711					
LTE Band 25												
	Bandwidth 1.4 MHz		Bandwidth 3 MHz		Bandwidth 5 MHz		Bandwidth 10 MHz		Bandwidth 15 MHz		Bandwidth 20 MHz	
	Ch. #	Freq. (MHz)	Ch. #	Freq. (MHz)	Ch. #	Freq. (MHz)	Ch. #	Freq. (MHz)	Ch. #	Freq. (MHz)	Ch. #	Freq. (MHz)
L	26047	1850.7	26055	1851.5	26065	1852.5	26090	1855	26115	1857.5	26140	1860
M	26340	1880	26340	1880	26340	1880	26340	1880	26340	1880	26340	1880
H	26683	1914.3	26675	1913.5	26665	1912.5	26640	1910	26615	1907.5	26590	1905

## 5. Proximity Sensor Triggering Test

### <Power Reduction by Proximity Sensing>

EUT uses capacitive proximity sensing to reduce the power in the cellular mode. The proximity sensor does not effect to WLAN and Bluetooth bands. Refer operation description for antenna schematics.

### <Bottom Face and Side Triggering Distances>

The Proximity sensors are located near the cellular main antenna and trigger on the “Bottom Face (back side)” and on the Edge 1 (Top Edge) of the EUT.

SAR proximity sensor’s detection distance was determined as described in FCC KDB 616217 D04 section6.2.

Back side trigger 3mm steps													
40mm	37mm	34mm	31mm	28mm	25mm	22mm	19mm	16mm	13mm	10mm	7mm	4mm	0mm
OFF	OFF	OFF	OFF	OFF	OFF	OFF	OFF	OFF	ON	ON	ON	ON	ON

Back side trigger 1mm steps													
18mm	17mm	16mm	15mm	14mm	13mm	12mm	11mm	10mm	9mm	8mm	7mm	6mm	0mm
OFF	OFF	OFF	ON	ON	ON	ON	ON	ON	ON	ON	ON	ON	ON

Top edge trigger 3mm steps													
40mm	37mm	34mm	31mm	28mm	25mm	22mm	19mm	16mm	13mm	10mm	7mm	4mm	0mm
OFF	OFF	OFF	OFF	OFF	OFF	OFF	OFF	OFF	ON	ON	ON	ON	ON

Top edge trigger 1mm steps													
15mm	14mm	13mm	12mm	11mm	10mm	9mm	8mm	7mm	6mm	5mm	4mm	3mm	0mm
OFF	OFF	ON	ON	ON	ON	ON	ON	ON	ON	ON	ON	ON	ON

Tilt angle test, distance 13mm													
-50°	-45°	-40°	-30°	-20°	-10°	0°	10°	20°	30°	40°	45°	50°	60°
OFF	ON	ON	ON	ON	ON	ON	ON	ON	ON	ON	ON	ON	ON

The most conservative human proximity detections distances are 13mm for Edge1 and 15mm for bottom face. It is made sure that the tablet can be tilted at least ±45 degrees along the Edge 1 at 13mm distance without restoring full output power.

### <SAR test distances and summary>

Exposure Position		Bottom Face	Edge 1	Edge 2	Edge 3	Edge 4
cellular mode	Full Power	Yes 14mm	Yes 12mm	No > 5cm(**)	No > 5cm(**)	Yes 0mm
	Reduced Power	Yes 0mm	Yes 0mm	No > 5cm(**)	No > 5cm(**)	No > 5cm(**)
WLAN/BT	Full Power	Yes 0mm	No	Yes 0mm	No > 5cm(**)	No > 5cm(**)

#### Remark:

\*\*the distance is 0mm to the flat phantom, and SAR evaluation is required for bottom face and the edges with the antenna within 5cm to the user.



**6. RF Exposure Limits**

**6.1 Uncontrolled Environment**

Uncontrolled Environments are defined as locations where there is the exposure of individuals who have no knowledge or control of their exposure. The general population/uncontrolled exposure limits are applicable to situations in which the general public may be exposed or in which persons who are exposed as a consequence of their employment may not be made fully aware of the potential for exposure or cannot exercise control over their exposure. Members of the general public would come under this category when exposure is not employment-related; for example, in the case of a wireless transmitter that exposes persons in its vicinity.

**6.2 Controlled Environment**

Controlled Environments are defined as locations where there is exposure that may be incurred by persons who are aware of the potential for exposure, (i.e. as a result of employment or occupation). In general, occupational/controlled exposure limits are applicable to situations in which persons are exposed as a consequence of their employment, who have been made fully aware of the potential for exposure and can exercise control over their exposure. The exposure category is also applicable when the exposure is of a transient nature due to incidental passage through a location where the exposure levels may be higher than the general population/uncontrolled limits, but the exposed person is fully aware of the potential for exposure and can exercise control over his or her exposure by leaving the area or by some other appropriate means.

**Limits for Occupational/Controlled Exposure (W/kg)**

Whole-Body	Partial-Body	Hands, Wrists, Feet and Ankles
0.4	8.0	20.0

**Limits for General Population/Uncontrolled Exposure (W/kg)**

Whole-Body	Partial-Body	Hands, Wrists, Feet and Ankles
0.08	1.6	4.0

1. Whole-Body SAR is averaged over the entire body, partial-body SAR is averaged over any 1gram of tissue defined as a tissue volume in the shape of a cube. SAR for hands, wrists, feet and ankles is averaged over any 10 grams of tissue defined as a tissue volume in the shape of a cube.

## **7. Specific Absorption Rate (SAR)**

### **7.1 Introduction**

SAR is related to the rate at which energy is absorbed per unit mass in an object exposed to a radio field. The SAR distribution in a biological body is complicated and is usually carried out by experimental techniques or numerical modeling. The standard recommends limits for two tiers of groups, occupational/controlled and general population/uncontrolled, based on a person's awareness and ability to exercise control over his or her exposure. In general, occupational/controlled exposure limits are higher than the limits for general population/uncontrolled.

### **7.2 SAR Definition**

The SAR definition is the time derivative (rate) of the incremental energy (dW) absorbed by (dissipated in) an incremental mass (dm) contained in a volume element (dv) of a given density ( $\rho$ ). The equation description is as below:

$$SAR = \frac{d}{dt} \left( \frac{dW}{dm} \right) = \frac{d}{dt} \left( \frac{dW}{\rho dv} \right)$$

SAR is expressed in units of Watts per kilogram (W/kg)

$$SAR = \frac{\sigma |E|^2}{\rho}$$

Where:  $\sigma$  is the conductivity of the tissue,  $\rho$  is the mass density of the tissue and E is the RMS electrical field strength.

## 8. System Description and Setup

The DASY system used for performing compliance tests consists of the following items:

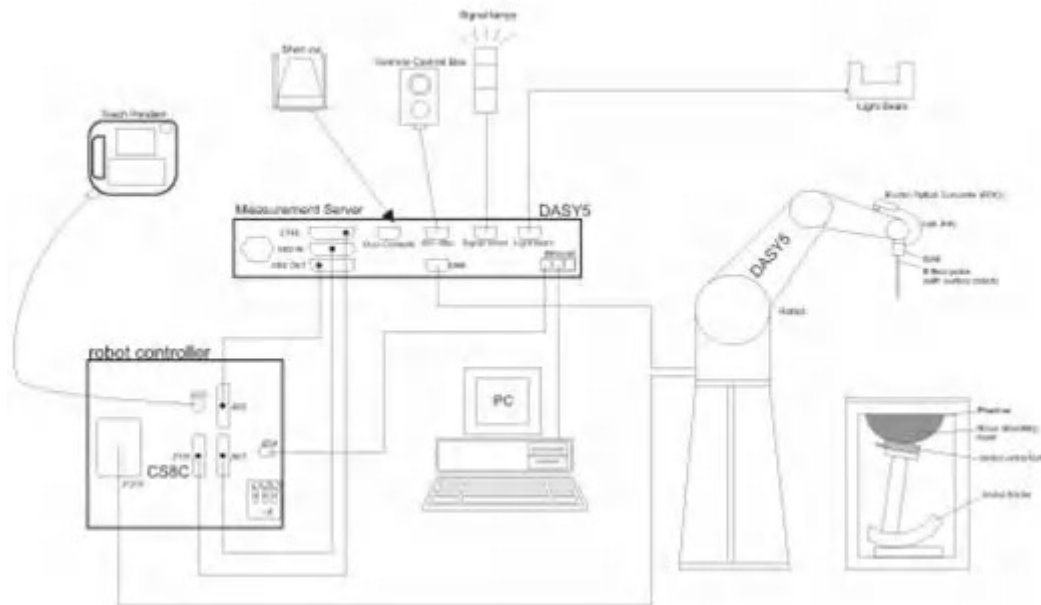

- A standard high precision 6-axis robot with controller, teach pendant and software. An arm extension for accommodating the data acquisition electronics (DAE).
- An isotropic Field probe optimized and calibrated for the targeted measurement.
- A data acquisition electronics (DAE) which performs the signal amplification, signal multiplexing, AD-conversion, offset measurements, mechanical surface detection, collision detection, etc. The unit is battery powered with standard or rechargeable batteries. The signal is optically transmitted to the EOC.
- The Electro-optical converter (EOC) performs the conversion from optical to electrical signals for the digital communication to the DAE. To use optical surface detection, a special version of the EOC is required. The EOC signal is transmitted to the measurement server.
- The function of the measurement server is to perform the time critical tasks such as signal filtering, control of the robot operation and fast movement interrupts.
- The Light Beam used is for probe alignment. This improves the (absolute) accuracy of the probe positioning.
- A computer running WinXP or Win7 and the DASY5 software.
- Remote control and teach pendant as well as additional circuitry for robot safety such as warning lamps, etc.
- The phantom, the device holder and other accessories according to the targeted measurement.



**8.1 E-Field Probe**

The SAR measurement is conducted with the dosimetric probe (manufactured by SPEAG). The probe is specially designed and calibrated for use in liquid with high permittivity. The dosimetric probe has special calibration in liquid at different frequency. This probe has a built in optical surface detection system to prevent from collision with phantom.

**<ES3DV3 Probe>**

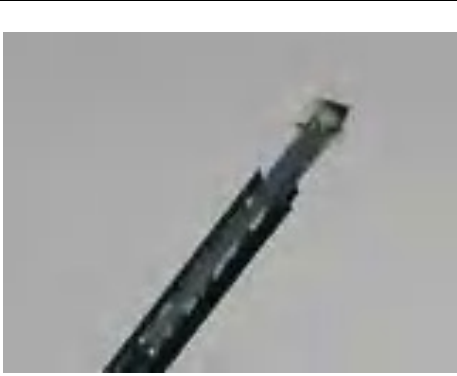
<b>Construction</b>	Symmetric design with triangular core Interleaved sensors Built-in shielding against static charges PEEK enclosure material (resistant to organic solvents, e.g., DGBE)	
<b>Frequency</b>	10 MHz – 4 GHz; Linearity: $\pm 0.2$ dB (30 MHz – 4 GHz)	
<b>Directivity</b>	$\pm 0.2$ dB in TSL (rotation around probe axis) $\pm 0.3$ dB in TSL (rotation normal to probe axis)	
<b>Dynamic Range</b>	5 $\mu$ W/g – >100 mW/g; Linearity: $\pm 0.2$ dB	
<b>Dimensions</b>	Overall length: 337 mm (tip: 20 mm) Tip diameter: 3.9 mm (body: 12 mm) Distance from probe tip to dipole centers: 3.0 mm	

**<EX3DV4 Probe>**

<b>Construction</b>	Symmetric design with triangular core Built-in shielding against static charges PEEK enclosure material (resistant to organic solvents, e.g., DGBE)	
<b>Frequency</b>	10 MHz – >6 GHz Linearity: $\pm 0.2$ dB (30 MHz – 6 GHz)	
<b>Directivity</b>	$\pm 0.3$ dB in TSL (rotation around probe axis) $\pm 0.5$ dB in TSL (rotation normal to probe axis)	
<b>Dynamic Range</b>	10 $\mu$ W/g – >100 mW/g Linearity: $\pm 0.2$ dB (noise: typically <1 $\mu$ W/g)	
<b>Dimensions</b>	Overall length: 337 mm (tip: 20 mm) Tip diameter: 2.5 mm (body: 12 mm) Typical distance from probe tip to dipole centers: 1 mm	

**8.2 Data Acquisition Electronics (DAE)**

The data acquisition electronics (DAE) consists of a highly sensitive electrometer-grade preamplifier with auto-zeroing, a channel and gain-switching multiplexer, a fast 16 bit AD-converter and a command decoder and control logic unit. Transmission to the measurement server is accomplished through an optical downlink for data and status information as well as an optical uplink for commands and the clock.

The input impedance of the DAE is 200 MOhm; the inputs are symmetrical and floating. Common mode rejection is above 80 dB.

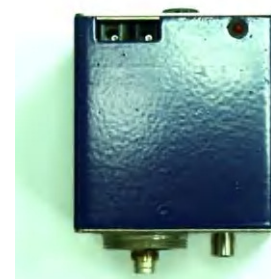

**Fig 5.1 Photo of DAE**

**8.3 Phantom**

**<SAM Twin Phantom>**

<b>Shell Thickness</b>	2 ± 0.2 mm; Center ear point: 6 ± 0.2 mm	
<b>Filling Volume</b>	Approx. 25 liters	
<b>Dimensions</b>	Length: 1000 mm; Width: 500 mm; Height: adjustable feet	
<b>Measurement Areas</b>	Left Hand, Right Hand, Flat Phantom	

The bottom plate contains three pair of bolts for locking the device holder. The device holder positions are adjusted to the standard measurement positions in the three sections. A white cover is provided to tap the phantom during off-periods to prevent water evaporation and changes in the liquid parameters. On the phantom top, three reference markers are provided to identify the phantom position with respect to the robot.

**<ELI Phantom>**

<b>Shell Thickness</b>	2 ± 0.2 mm (sagging: <1%)	
<b>Filling Volume</b>	Approx. 30 liters	
<b>Dimensions</b>	Major ellipse axis: 600 mm Minor axis: 400 mm	

The ELI phantom is intended for compliance testing of handheld and body-mounted wireless devices in the frequency range of 30 MHz to 6 GHz. ELI4 is fully compatible with standard and all known tissue simulating liquids.

### **8.4 Device Holder**

#### **<Mounting Device for Hand-Held Transmitter>**

In combination with the Twin SAM V5.0/V5.0c or ELI phantoms, the Mounting Device for Hand-Held Transmitters enables rotation of the mounted transmitter device to specified spherical coordinates. At the heads, the rotation axis is at the ear opening. Transmitter devices can be easily and accurately positioned according to IEC 62209-1, IEEE 1528, FCC, or other specifications. The device holder can be locked for positioning at different phantom sections (left head, right head, flat). And upgrade kit to Mounting Device to enable easy mounting of wider devices like big smart-phones, e-books, small tablets, etc. It holds devices with width up to 140 mm.



Mounting Device for Hand-Held Transmitters



Mounting Device Adaptor for Wide-Phones

#### **<Mounting Device for Laptops and other Body-Worn Transmitters>**

The extension is lightweight and made of POM, acrylic glass and foam. It fits easily on the upper part of the mounting device in place of the phone positioned. The extension is fully compatible with the SAM Twin and ELI phantoms.



Mounting Device for Laptops



## 9. Measurement Procedures

The measurement procedures are as follows:

### <Conducted power measurement>

- (a) For WWAN power measurement, use base station simulator to configure EUT WWAN transmission in conducted connection with RF cable, at maximum power in each supported wireless interface and frequency band.
- (b) Read the WWAN RF power level from the base station simulator.
- (c) For WLAN/BT power measurement, use engineering software to configure EUT WLAN/BT continuously transmission, at maximum RF power in each supported wireless interface and frequency band
- (d) Connect EUT RF port through RF cable to the power meter, and measure WLAN/BT output power

### <SAR measurement>

- (a) Use base station simulator to configure EUT WWAN transmission in radiated connection, and engineering software to configure EUT WLAN/BT continuously transmission, at maximum RF power, in the highest power channel.
- (b) Place the EUT in the positions as Appendix D demonstrates.
- (c) Set scan area, grid size and other setting on the DASY software.
- (d) Measure SAR results for the highest power channel on each testing position.
- (e) Find out the largest SAR result on these testing positions of each band
- (f) Measure SAR results for other channels in worst SAR testing position if the reported SAR of highest power channel is larger than 0.8 W/kg

According to the test standard, the recommended procedure for assessing the peak spatial-average SAR value consists of the following steps:

- (a) Power reference measurement
- (b) Area scan
- (c) Zoom scan
- (d) Power drift measurement

### 9.1 Spatial Peak SAR Evaluation

The procedure for spatial peak SAR evaluation has been implemented according to the test standard. It can be conducted for 1g and 10g, as well as for user-specific masses. The DASY software includes all numerical procedures necessary to evaluate the spatial peak SAR value.

The base for the evaluation is a "cube" measurement. The measured volume must include the 1g and 10g cubes with the highest averaged SAR values. For that purpose, the center of the measured volume is aligned to the interpolated peak SAR value of a previously performed area scan.

The entire evaluation of the spatial peak values is performed within the post-processing engine (SEMCAD). The system always gives the maximum values for the 1g and 10g cubes. The algorithm to find the cube with highest averaged SAR is divided into the following stages:

- (a) Extraction of the measured data (grid and values) from the Zoom Scan
- (b) Calculation of the SAR value at every measurement point based on all stored data (A/D values and measurement parameters)
- (c) Generation of a high-resolution mesh within the measured volume
- (d) Interpolation of all measured values from the measurement grid to the high-resolution grid
- (e) Extrapolation of the entire 3-D field distribution to the phantom surface over the distance from sensor to surface
- (f) Calculation of the averaged SAR within masses of 1g and 10g

**9.2 Power Reference Measurement**

The Power Reference Measurement and Power Drift Measurements are for monitoring the power drift of the device under test in the batch process. The minimum distance of probe sensors to surface determines the closest measurement point to phantom surface. This distance cannot be smaller than the distance of sensor calibration points to probe tip as defined in the probe properties.

**9.3 Area Scan**

The area scan is used as a fast scan in two dimensions to find the area of high field values, before doing a fine measurement around the hot spot. The sophisticated interpolation routines implemented in DASY software can find the maximum found in the scanned area, within a range of the global maximum. The range (in dB0 is specified in the standards for compliance testing. For example, a 2 dB range is required in IEEE standard 1528 and IEC 62209 standards, whereby 3 dB is a requirement when compliance is assessed in accordance with the ARIB standard (Japan), if only one zoom scan follows the area scan, then only the absolute maximum will be taken as reference. For cases where multiple maximums are detected, the number of zoom scans has to be increased accordingly.

Area scan parameters extracted from FCC KDB 865664 D01v01r04 SAR measurement 100 MHz to 6 GHz.

	≤ 3 GHz	> 3 GHz
Maximum distance from closest measurement point (geometric center of probe sensors) to phantom surface	5 ± 1 mm	$\frac{1}{2} \cdot \delta \cdot \ln(2) \pm 0.5 \text{ mm}$
Maximum probe angle from probe axis to phantom surface normal at the measurement location	30° ± 1°	20° ± 1°
Maximum area scan spatial resolution: $\Delta x_{Area}, \Delta y_{Area}$	≤ 2 GHz: ≤ 15 mm 2 – 3 GHz: ≤ 12 mm	3 – 4 GHz: ≤ 12 mm 4 – 6 GHz: ≤ 10 mm
	When the x or y dimension of the test device, in the measurement plane orientation, is smaller than the above, the measurement resolution must be ≤ the corresponding x or y dimension of the test device with at least one measurement point on the test device.	

### 9.4 Zoom Scan

Zoom scans are used assess the peak spatial SAR values within a cubic averaging volume containing 1 gram and 10 gram of simulated tissue. The zoom scan measures points (refer to table below) within a cube shoes base faces are centered on the maxima found in a preceding area scan job within the same procedure. When the measurement is done, the zoom scan evaluates the averaged SAR for 1 gram and 10 gram and displays these values next to the job's label.

Zoom scan parameters extracted from FCC KDB 865664 D01v01r04 SAR measurement 100 MHz to 6 GHz.

		≤ 3 GHz	> 3 GHz	
Maximum zoom scan spatial resolution: $\Delta x_{Zoom}, \Delta y_{Zoom}$		$\leq 2$ GHz: $\leq 8$ mm 2 – 3 GHz: $\leq 5$ mm*	3 – 4 GHz: $\leq 5$ mm* 4 – 6 GHz: $\leq 4$ mm*	
Maximum zoom scan spatial resolution, normal to phantom surface	uniform grid: $\Delta z_{Zoom}(n)$	$\leq 5$ mm	3 – 4 GHz: $\leq 4$ mm 4 – 5 GHz: $\leq 3$ mm 5 – 6 GHz: $\leq 2$ mm	
	graded grid	$\Delta z_{Zoom}(1)$ : between 1 <sup>st</sup> two points closest to phantom surface	$\leq 4$ mm	3 – 4 GHz: $\leq 3$ mm 4 – 5 GHz: $\leq 2.5$ mm 5 – 6 GHz: $\leq 2$ mm
		$\Delta z_{Zoom}(n>1)$ : between subsequent points	$\leq 1.5 \cdot \Delta z_{Zoom}(n-1)$	
Minimum zoom scan volume	x, y, z	$\geq 30$ mm	3 – 4 GHz: $\geq 28$ mm 4 – 5 GHz: $\geq 25$ mm 5 – 6 GHz: $\geq 22$ mm	
Note: $\delta$ is the penetration depth of a plane-wave at normal incidence to the tissue medium; see draft standard IEEE P1528-2011 for details. * When zoom scan is required and the <i>reported</i> SAR from the <i>area scan based 1-g SAR estimation</i> procedures of KDB 447498 is $\leq 1.4$ W/kg, $\leq 8$ mm, $\leq 7$ mm and $\leq 5$ mm zoom scan resolution may be applied, respectively, for 2 GHz to 3 GHz, 3 GHz to 4 GHz and 4 GHz to 6 GHz.				

### 9.5 Volume Scan Procedures

The volume scan is used for assess overlapping SAR distributions for antennas transmitting in different frequency bands. It is equivalent to an oversized zoom scan used in standalone measurements. The measurement volume will be used to enclose all the simultaneous transmitting antennas. For antennas transmitting simultaneously in different frequency bands, the volume scan is measured separately in each frequency band. In order to sum correctly to compute the 1g aggregate SAR, the EUT remain in the same test position for all measurements and all volume scan use the same spatial resolution and grid spacing. When all volume scan were completed, the software, SEMCAD postprocessor can combine and subsequently superpose these measurement data to calculating the multiband SAR.

### 9.6 Power Drift Monitoring

All SAR testing is under the EUT install full charged battery and transmit maximum output power. In DASY measurement software, the power reference measurement and power drift measurement procedures are used for monitoring the power drift of EUT during SAR test. Both these procedures measure the field at a specified reference position before and after the SAR testing. The software will calculate the field difference in dB. If the power drifts more than 5%, the SAR will be retested.





**10. Test Equipment List**

Manufacturer	Name of Equipment	Type/Model	Serial Number	Calibration	
				Last Cal.	Due Date
SPEAG	750MHz System Validation Kit	D750V3	1012	May. 18, 2016	May. 17, 2017
SPEAG	835MHz System Validation Kit	D835V2	499	Mar. 21, 2016	Mar. 20, 2017
SPEAG	1750MHz System Validation Kit	D1750V2	1068	Nov. 23, 2015	Nov. 22, 2016
SPEAG	1900MHz System Validation Kit	D1900V2	5d041	Oct. 22, 2015	Oct. 21, 2016
SPEAG	2450MHz System Validation Kit	D2450V2	736	Aug. 20, 2015	Aug. 19, 2016
SPEAG	5GHz System Validation Kit	D5GHzV2	1128	Jul. 20, 2015	Jul. 19, 2016
SPEAG	Data Acquisition Electronics	DAE4	1399	Nov. 23, 2015	Nov. 22, 2016
SPEAG	Dosimetric E-Field Probe	ES3DV3	3270	Sep. 28, 2015	Sep. 27, 2016
SPEAG	Dosimetric E-Field Probe	EX3DV4	3955	Nov. 24, 2015	Nov. 23, 2016
Wisewind	Thermometer	HTC-1	TM560	Oct. 16, 2015	Oct. 15, 2016
Anritsu	Radio Communication Analyzer	MT8820C	6201381760	May. 10, 2016	May. 09, 2017
Agilent	Wireless Communication Test Set	E5515C	MY50266977	May. 17, 2016	May. 16, 2017
R&S	BT Base Station	CBT	101136	Sep. 17, 2015	Sep. 16, 2016
SPEAG	Device Holder	N/A	N/A	N/A	N/A
R&S	Signal Generator	MG3710A	6201502524	Dec. 18, 2015	Dec. 17, 2016
Agilent	ENA Network Analyzer	E5071C	MY46316648	Jan. 12, 2016	Jan. 11, 2017
SPEAG	Dielectric Probe Kit	DAK-3.5	1126	Jul. 21, 2015	Jul. 20, 2016
LINE SEIKI	Digital Thermometer	LKMelectronic	DTM3000SPEZIAL/90900	Aug. 26, 2015	Aug. 25, 2016
Anritsu	Power Meter	ML2495A	1419002	May. 10, 2016	May. 09, 2017
Anritsu	Power Sensor	MA2411B	1339124	May. 10, 2016	May. 09, 2017
Agilent	Spectrum Analyzer	E4408B	MY44211028	Aug. 24, 2015	Aug. 23, 2016
ATM	Dual Directional Coupler	C122H-10	P610410z-02	Note 1	
Woken	Attenuator 1	WK0602-XX	N/A	Note 1	
PE	Attenuator 2	PE7005-10	N/A	Note 1	
PE	Attenuator 3	PE7005- 3	N/A	Note 1	
AR	Power Amplifier	5S1G4M2	0328767	Note 1	
Mini-Circuits	Power Amplifier	ZVE-3W	162601250	Note 1	

**General Note:**

1. Prior to system verification and validation, the path loss from the signal generator to the system check source and the power meter, which includes the amplifier, cable, attenuator and directional coupler, was measured by the network analyzer. The reading of the power meter was offset by the path loss difference between the path to the power meter and the path to the system check source to monitor the actual power level fed to the system check source.



## 11. System Verification

### 11.1 Tissue Verification

The following tissue formulations are provided for reference only as some of the parameters have not been thoroughly verified. The composition of ingredients may be modified accordingly to achieve the desired target tissue parameters required for routine SAR evaluation.

Frequency (MHz)	Water (%)	Sugar (%)	Cellulose (%)	Salt (%)	Preventol (%)	DGBE (%)	Conductivity ( $\sigma$ )	Permittivity ( $\epsilon_r$ )
For Head								
750	41.1	57.0	0.2	1.4	0.2	0	0.89	41.9
835	40.3	57.9	0.2	1.4	0.2	0	0.90	41.5
900	40.3	57.9	0.2	1.4	0.2	0	0.97	41.5
1800, 1900, 2000	55.2	0	0	0.3	0	44.5	1.40	40.0
2450	55.0	0	0	0	0	45.0	1.80	39.2
2600	54.8	0	0	0.1	0	45.1	1.96	39.0
For Body								
750	51.7	47.2	0	0.9	0.1	0	0.96	55.5
835	50.8	48.2	0	0.9	0.1	0	0.97	55.2
900	50.8	48.2	0	0.9	0.1	0	1.05	55.0
1800, 1900, 2000	70.2	0	0	0.4	0	29.4	1.52	53.3
2450	68.6	0	0	0	0	31.4	1.95	52.7
2600	68.1	0	0	0.1	0	31.8	2.16	52.5

#### Simulating Liquid for 5GHz, Manufactured by SPEAG

Ingredients	(% by weight)
Water	64~78%
Mineral oil	11~18%
Emulsifiers	9~15%
Additives and Salt	2~3%

#### <Tissue Dielectric Parameter Check Results>

Frequency (MHz)	Tissue Type	Liquid Temp. (°C)	Conductivity ( $\sigma$ )	Permittivity ( $\epsilon_r$ )	Conductivity Target ( $\sigma$ )	Permittivity Target ( $\epsilon_r$ )	Delta ( $\sigma$ ) (%)	Delta ( $\epsilon_r$ ) (%)	Limit (%)	Date
750	MSL	22.5	0.958	54.623	0.96	55.50	-0.21	-1.58	±5	2016/6/23
835	MSL	22.5	1.002	57.843	0.97	55.20	3.30	4.79	±5	2016/6/21
835	MSL	22.4	0.980	57.469	0.97	55.20	1.03	4.11	±5	2016/6/24
1750	MSL	22.8	1.537	55.571	1.49	53.40	3.15	4.07	±5	2016/6/25
1900	MSL	22.8	1.526	53.847	1.52	53.30	0.39	1.03	±5	2016/6/24
2450	MSL	22.5	1.986	52.136	1.95	52.70	1.85	-1.07	±5	2016/7/2
5250	MSL	22.4	5.479	47.354	5.36	48.95	2.22	-3.26	±5	2016/7/2
5600	MSL	22.4	5.924	46.763	5.77	48.50	2.67	-3.58	±5	2016/7/2
5750	MSL	22.4	6.123	46.530	5.94	48.28	3.08	-3.62	±5	2016/7/2





**<Tissue Dielectric Parameter Check for Low / Middle / High Frequencies>**

**General Note:**

The tissue measure results for low / middle / high frequencies list below, the results were used in the Dasy SAR system to perform interpolation to determine the dielectric parameters on the SAR test device. The SAR test plots may slightly difference between the tables below due to the digit rounding in the software calculated.

CH	Frequency (MHz)	Liquid Type	Conductivity ( $\sigma$ )	Permittivity ( $\epsilon_r$ )	Conductivity Target ( $\sigma$ )	Permittivity Target ( $\epsilon_r$ )	Delta ( $\sigma$ ) (%)	Delta ( $\epsilon_r$ ) (%)	Limit (%)	Date
128	824.2	Body	0.992	57.937	0.969	55.238	2.23	4.96	±5	Jun. 21, 2016
189	836.4	Body	1.004	57.830	0.972	55.196	3.49	4.76	±5	Jun. 21, 2016
251	848.8	Body	1.016	57.716	0.987	55.158	2.63	4.56	±5	Jun. 21, 2016
4132	826.4	Body	0.994	57.922	0.969	55.230	2.45	4.93	±5	Jun. 21, 2016
4182	836.4	Body	1.004	57.830	0.972	55.196	3.49	4.76	±5	Jun. 21, 2016
4233	846.6	Body	1.014	57.736	0.984	55.164	3.46	4.59	±5	Jun. 21, 2016
476	817.9	Body	0.985	57.995	0.968	55.260	1.57	4.87	±5	Jun. 21, 2016
580	820.5	Body	0.988	57.969	0.968	55.251	1.84	4.83	±5	Jun. 21, 2016
684	823.1	Body	0.991	57.948	0.969	55.242	2.12	4.98	±5	Jun. 21, 2016
1013	824.7	Body	0.992	57.934	0.969	55.236	2.28	4.95	±5	Jun. 21, 2016
384	836.52	Body	1.004	57.829	0.972	55.195	3.50	4.76	±5	Jun. 21, 2016
777	848.31	Body	1.016	57.720	0.986	55.159	2.59	4.57	±5	Jun. 21, 2016
20450	829	Body	0.996	57.900	0.969	55.221	2.68	4.89	±5	Jun. 21, 2016
20525	836.5	Body	1.004	57.829	0.972	55.195	3.50	4.76	±5	Jun. 21, 2016
20600	844	Body	1.011	57.763	0.981	55.172	3.20	4.64	±5	Jun. 21, 2016
23780	709	Body	0.920	55.036	0.957	55.664	-4.22	-1.19	±5	Jun. 23, 2016
23790	710	Body	0.920	55.029	0.957	55.660	-4.12	-1.21	±5	Jun. 23, 2016
23800	711	Body	0.921	55.018	0.957	55.656	-4.02	-1.22	±5	Jun. 23, 2016
23230	782	Body	0.988	54.298	0.964	55.684	2.94	-2.52	±5	Jun. 23, 2016
1013	824.7	Body	0.971	57.558	0.969	55.236	0.07	4.27	±5	Jun. 24, 2016
384	836.52	Body	0.982	57.454	0.972	55.195	1.21	4.08	±5	Jun. 24, 2016
777	848.31	Body	0.993	57.353	0.986	55.159	0.30	3.90	±5	Jun. 24, 2016
476	817.9	Body	0.965	57.615	0.968	55.260	-0.56	4.19	±5	Jun. 24, 2016
580	820.5	Body	0.967	57.591	0.968	55.251	-0.30	4.14	±5	Jun. 24, 2016
684	823.1	Body	0.969	57.575	0.969	55.242	-0.09	4.30	±5	Jun. 24, 2016
25	1851.25	Body	1.471	53.954	1.520	53.300	-3.20	1.23	±5	Jun. 24, 2016
600	1880	Body	1.503	53.894	1.520	53.300	-1.13	1.11	±5	Jun. 24, 2016
1175	1908.75	Body	1.537	53.828	1.520	53.300	1.10	0.99	±5	Jun. 24, 2016
26140	1860	Body	1.481	53.945	1.520	53.300	-2.57	1.21	±5	Jun. 24, 2016
26340	1880	Body	1.503	53.894	1.520	53.300	-1.13	1.11	±5	Jun. 24, 2016
26590	1905	Body	1.532	53.837	1.520	53.300	0.80	1.01	±5	Jun. 24, 2016
20050	1720	Body	1.504	55.708	1.474	53.456	2.31	4.13	±5	Jun. 25, 2016
20175	1732.5	Body	1.518	55.649	1.481	53.433	2.56	4.21	±5	Jun. 25, 2016
20300	1745	Body	1.532	55.587	1.487	53.409	2.81	4.09	±5	Jun. 25, 2016
36	5180	Body	5.391	47.460	5.276	49.030	2.10	-3.14	±5	Jul. 02, 2016
38	5190	Body	5.402	47.450	5.288	49.010	2.12	-3.16	±5	Jul. 02, 2016
40	5200	Body	5.414	47.420	5.300	49.000	2.15	-3.22	±5	Jul. 02, 2016
42	5210	Body	5.428	47.400	5.312	48.990	2.22	-3.27	±5	Jul. 02, 2016
44	5220	Body	5.442	47.390	5.323	48.980	2.29	-3.29	±5	Jul. 02, 2016
46	5230	Body	5.457	47.370	5.335	48.970	2.19	-3.33	±5	Jul. 02, 2016
48	5240	Body	5.470	47.370	5.346	48.960	2.24	-3.33	±5	Jul. 02, 2016
52	5260	Body	5.490	47.330	5.370	48.940	2.23	-3.21	±5	Jul. 02, 2016
54	5270	Body	5.505	47.300	5.381	48.930	2.32	-3.27	±5	Jul. 02, 2016
56	5280	Body	5.518	47.290	5.393	48.920	2.37	-3.29	±5	Jul. 02, 2016

**Table of Low/Middle/High Channel for Liquid Validation**



CH	Frequency (MHz)	Liquid Type	Conductivity ( $\sigma$ )	Permittivity ( $\epsilon_r$ )	Conductivity Target ( $\sigma$ )	Permittivity Target ( $\epsilon_r$ )	Delta ( $\sigma$ ) (%)	Delta ( $\epsilon_r$ ) (%)	Limit (%)	Date
58	5290	Body	5.529	47.280	5.404	48.910	2.39	-3.31	±5	Jul. 02, 2016
60	5300	Body	5.540	47.260	5.416	48.900	2.21	-3.35	±5	Jul. 02, 2016
62	5310	Body	5.552	47.230	5.428	48.790	2.25	-3.22	±5	Jul. 02, 2016
64	5320	Body	5.567	47.210	5.439	48.670	2.33	-3.06	±5	Jul. 02, 2016
100	5500	Body	5.791	46.930	5.650	48.600	2.50	-3.44	±5	Jul. 02, 2016
102	5510	Body	5.802	46.920	5.661	48.590	2.51	-3.46	±5	Jul. 02, 2016
104	5520	Body	5.814	46.890	5.673	48.580	2.54	-3.52	±5	Jul. 02, 2016
106	5530	Body	5.829	46.870	5.685	48.570	2.44	-3.56	±5	Jul. 02, 2016
108	5540	Body	5.844	46.860	5.696	48.560	2.53	-3.58	±5	Jul. 02, 2016
110	5550	Body	5.859	46.840	5.708	48.550	2.61	-3.62	±5	Jul. 02, 2016
112	5560	Body	5.872	46.830	5.720	48.540	2.66	-3.44	±5	Jul. 02, 2016
116	5580	Body	5.893	46.790	5.743	48.520	2.67	-3.53	±5	Jul. 02, 2016
132	5660	Body	6.005	46.670	5.837	48.410	2.83	-3.57	±5	Jul. 02, 2016
134	5670	Body	6.015	46.660	5.848	48.400	2.82	-3.60	±5	Jul. 02, 2016
136	5680	Body	6.025	46.640	5.860	48.380	2.82	-3.64	±5	Jul. 02, 2016
138	5690	Body	6.039	46.610	5.872	48.370	2.88	-3.70	±5	Jul. 02, 2016
140	5700	Body	6.056	46.600	5.883	48.350	2.99	-3.72	±5	Jul. 02, 2016
142	5710	Body	6.069	46.590	5.895	48.340	2.86	-3.54	±5	Jul. 02, 2016
144	5720	Body	6.082	46.570	5.907	48.320	2.91	-3.58	±5	Jul. 02, 2016
149	5745	Body	6.117	46.540	5.936	48.280	2.98	-3.64	±5	Jul. 02, 2016
151	5755	Body	6.131	46.520	5.947	48.270	3.04	-3.69	±5	Jul. 02, 2016
153	5765	Body	6.145	46.520	5.959	48.250	3.10	-3.69	±5	Jul. 02, 2016
155	5775	Body	6.154	46.510	5.971	48.240	3.08	-3.51	±5	Jul. 02, 2016
157	5785	Body	6.163	46.490	5.982	48.220	3.06	-3.55	±5	Jul. 02, 2016
159	5795	Body	6.175	46.460	5.994	48.210	3.09	-3.61	±5	Jul. 02, 2016
161	5805	Body	6.191	46.440	6.000	48.200	3.18	-3.65	±5	Jul. 02, 2016
165	5825	Body	6.220	46.410	6.000	48.200	3.67	-3.71	±5	Jul. 02, 2016
1	2412	Body	1.937	52.290	1.914	52.750	1.41	-0.97	±5	Jul. 02, 2016
3	2422	Body	1.951	52.250	1.923	52.740	1.61	-0.85	±5	Jul. 02, 2016
6	2437	Body	1.970	52.190	1.938	52.720	1.55	-0.97	±5	Jul. 02, 2016
9	2452	Body	1.988	52.130	1.953	52.700	1.95	-1.08	±5	Jul. 02, 2016
11	2462	Body	2.001	52.090	1.967	52.680	1.57	-1.16	±5	Jul. 02, 2016
0	2402	Body	1.923	52.34	1.904	52.764	1.21	-0.87	±5	Jul. 02, 2016
39	2441	Body	1.975	52.18	1.941	52.712	1.80	-1.00	±5	Jul. 02, 2016
78	2480	Body	2.025	52.02	1.950	52.700	3.85	-1.30	±5	Jul. 02, 2016

**Table of Low/Middle/High Channel for Liquid Validation**

**11.2 System Performance Check Results**

Comparing to the original SAR value provided by SPEAG, the verification data should be within its specification of 10 %. Below table shows the target SAR and measured SAR after normalized to 1W input power. The table below indicates the system performance check can meet the variation criterion and the plots can be referred to Appendix A of this report.

Date	Frequency (MHz)	Tissue Type	Input Power (mW)	Dipole S/N	Probe S/N	DAE S/N	Measured 1g SAR (W/kg)	Targeted 1g SAR (W/kg)	Normalized 1g SAR (W/kg)	Deviation (%)
2016/6/23	750	MSL	250	D750V3-1012	ES3DV3 - SN3270	DAE4 Sn1399	2.15	8.72	8.60	-1.38
2016/6/21	835	MSL	250	D835V2-499	ES3DV3 - SN3270	DAE4 Sn1399	2.32	9.52	9.28	-2.52
2016/6/24	835	MSL	250	D835V2-499	ES3DV3 - SN3270	DAE4 Sn1399	2.35	9.52	9.40	-1.26
2016/6/25	1750	MSL	250	D1750V2-1068	ES3DV3 - SN3270	DAE4 Sn1399	9.39	35.70	37.56	5.21
2016/6/24	1900	MSL	250	D1900V2-5d041	ES3DV3 - SN3270	DAE4 Sn1399	9.63	40.00	38.52	-3.70
2016/7/2	2450	MSL	250	D2450V2-736	EX3DV4 - SN3955	DAE4 Sn1399	12.90	51.90	51.60	-0.58
2016/7/2	5250	MSL	100	D5GHzV2-1128-5250	EX3DV4 - SN3955	DAE4 Sn1399	7.86	76.20	78.60	3.15
2016/7/2	5600	MSL	100	D5GHzV2-1128-5600	EX3DV4 - SN3955	DAE4 Sn1399	8.26	79.30	82.60	4.16
2016/7/2	5750	MSL	100	D5GHzV2-1128-5750	EX3DV4 - SN3955	DAE4 Sn1399	7.92	75.90	79.20	4.35

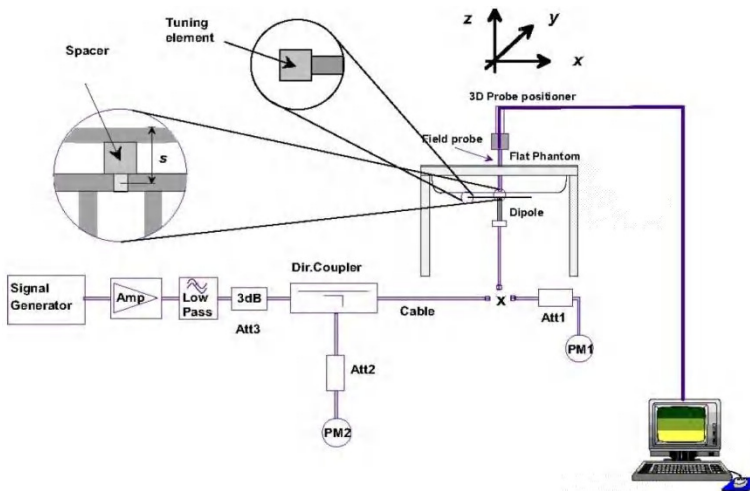

**Fig 8.3.1 System Performance Check Setup**

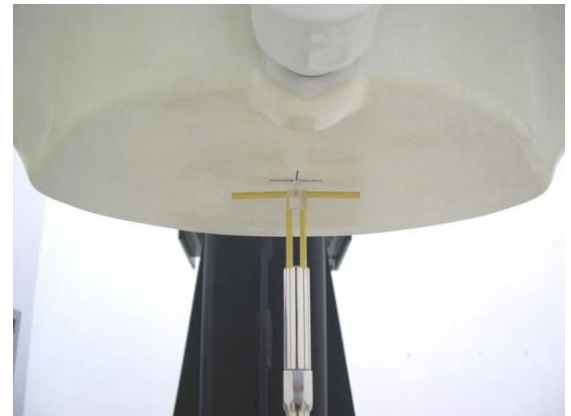

**Fig 8.3.2 Setup Photo**

**12. RF Exposure Positions**

**12.1 SAR Testing for Tablet**

This device can be used also in full sized tablet exposure conditions, due to its size. Per FCC KDB 616217, the back surface and edges of the tablet should be tested for SAR compliance with the tablet touching the phantom. The SAR exclusion threshold in KDB 447498 D01v06 can be applied to determine SAR test exclusion for adjacent edge configurations. The closest distance from the antenna to an adjacent tablet edge is used to determine if SAR testing is required for the adjacent edges, with the adjacent edge positioned against the phantom and the edge containing the antenna positioned perpendicular to the phantom.



**13. Conducted RF Output Power (Unit: dBm)**

**<GSM Conducted Power>**

1. Per KDB 447498 D01v06, the maximum output power channel is used for SAR testing and for further SAR test reduction.
2. Per KDB 941225 D01v03r01, for SAR test reduction for GSM / GPRS / EDGE modes is determined by the source-based time-averaged output power including tune-up tolerance. The mode with highest specified time-averaged output power should be tested for SAR compliance in the applicable exposure conditions. For modes with the same specified maximum output power and tolerance, the higher number time-slot configuration should be tested. Therefore, the EDGE (4Tx slots) for GSM850/GSM1900 is considered as the primary mode when the power reduction is active, the GPRS (2Tx slots) for GSM850, the EDGE (4Tx slots) for GSM1900 is considered as the primary mode when the power reduction is inactive.
3. Other configurations of GSM / GPRS / EDGE are considered as secondary modes. The 3G SAR test reduction procedure is applied, when the maximum output power and tune-up tolerance specified for production units in a secondary mode is  $\leq \frac{1}{4}$  dB higher than the primary mode, SAR measurement is not required for the secondary mode

**Default Power Mode**

GSM850 TX Channel	Burst Average Power (dBm)			Tune-up Limit (dBm)	Frame-Average Power (dBm)			Tune-up Limit (dBm)
	128	189	251		128	189	251	
Frequency (MHz)	824.2	836.4	848.8		824.2	836.4	848.8	
GPRS 1 Tx slot	32.21	32.09	32.00	33.00	23.21	23.09	23.00	24.00
GPRS 2 Tx slots	32.01	31.99	31.92	33.00	26.01	25.99	25.92	27.00
EDGE 1 Tx slot	27.16	27.14	27.22	28.00	18.16	18.14	18.22	19.00
EDGE 2 Tx slots	27.14	27.10	27.18	28.00	21.14	21.10	21.18	22.00
EDGE 3 Tx slots	27.01	26.95	27.05	28.00	22.75	22.69	22.79	23.74
EDGE 4 Tx slots	26.80	26.78	26.87	28.00	23.80	23.78	23.87	25.00

GSM1900 TX Channel	Burst Average Power (dBm)			Tune-up Limit (dBm)	Frame-Average Power (dBm)			Tune-up Limit (dBm)
	512	661	810		512	661	810	
Frequency (MHz)	1850.2	1880	1909.8		1850.2	1880	1909.8	
GPRS 1 Tx slot	29.87	29.62	29.85	30.00	20.87	20.62	20.85	21.00
GPRS 2 Tx slots	29.71	29.51	29.79	30.00	23.71	23.51	23.79	24.00
EDGE 1 Tx slot	25.62	25.60	25.58	27.00	16.62	16.60	16.58	18.00
EDGE 2 Tx slots	25.56	25.53	25.51	27.00	19.56	19.53	19.51	21.00
EDGE 3 Tx slots	25.55	25.52	25.50	27.00	21.29	21.26	21.24	22.74
EDGE 4 Tx slots	25.44	25.40	25.38	27.00	22.44	22.40	22.38	24.00



**Reduced Power Mode**

GSM850 TX Channel	Burst Average Power (dBm)			Tune-up Limit (dBm)	Frame-Average Power (dBm)			Tune-up Limit (dBm)
	128	189	251		128	189	251	
Frequency (MHz)	824.2	836.4	848.8		824.2	836.4	848.8	
GPRS 1 Tx slot	26.23	26.16	26.25	26.50	17.23	17.16	17.25	17.50
GPRS 2 Tx slots	23.11	23.08	23.16	23.50	17.11	17.08	17.16	17.50
EDGE 1 Tx slot	26.71	26.64	26.72	27.00	17.71	17.64	17.72	18.00
EDGE 2 Tx slots	23.55	23.53	23.58	24.00	17.55	17.53	17.58	18.00
EDGE 3 Tx slots	21.48	21.46	21.49	22.00	17.22	17.20	17.23	17.74
EDGE 4 Tx slots	20.37	20.32	20.42	21.00	17.37	17.32	17.42	18.00

GSM1900 TX Channel	Burst Average Power (dBm)			Tune-up Limit (dBm)	Frame-Average Power (dBm)			Tune-up Limit (dBm)
	512	661	810		512	661	810	
Frequency (MHz)	1850.2	1880	1909.8		1850.2	1880	1909.8	
GPRS 1 Tx slot	22.11	22.18	22.12	23.00	13.11	13.18	13.12	14.00
GPRS 2 Tx slots	19.26	19.45	19.34	20.00	13.26	13.45	13.34	14.00
EDGE 1 Tx slot	22.03	22.10	22.07	23.00	13.03	13.10	13.07	14.00
EDGE 2 Tx slots	19.24	19.41	19.31	20.00	13.24	13.41	13.31	14.00
EDGE 3 Tx slots	17.22	17.30	17.27	18.00	12.96	13.04	13.01	13.74
EDGE 4 Tx slots	16.21	16.31	16.25	17.00	13.21	13.31	13.25	14.00

**<WCDMA Conducted Power>**

1. The following tests were conducted according to the test requirements outlines in 3GPP TS 34.121 specification.
2. The procedures in KDB 941225 D01v03r01 are applied for 3GPP Rel. 6 HSPA to configure the device in the required sub-test mode(s) to determine SAR test exclusion.
3. For DC-HSDPA, the device was configured according to the H-Set 12, Fixed Reference Channel (FRC) configuration in Table C.8.1.12 of 3GPP TS 34.121-1, with the primary and the secondary serving HS-DSCH Cell enabled during the power measurement.

A summary of these settings are illustrated below:

**HSDPA Setup Configuration:**

- a. The EUT was connected to Base Station Agilent E5515C referred to the Setup Configuration.
- b. The RF path losses were compensated into the measurements.
- c. A call was established between EUT and Base Station with following setting:
  - i. Set Gain Factors ( $\beta_c$  and  $\beta_d$ ) and parameters were set according to each
  - ii. Specific sub-test in the following table, C10.1.4, quoted from the TS 34.121
  - iii. Set RMC 12.2Kbps + HSDPA mode.
  - iv. Set Cell Power = -86 dBm
  - v. Set HS-DSCH Configuration Type to FRC (H-set 1, QPSK)
  - vi. Select HSDPA Uplink Parameters
  - vii. Set Delta ACK, Delta NACK and Delta CQI = 8
  - viii. Set Ack-Nack Repetition Factor to 3
  - ix. Set CQI Feedback Cycle (k) to 4 ms
  - x. Set CQI Repetition Factor to 2
  - xi. Power Ctrl Mode = All Up bits
- d. The transmitted maximum output power was recorded.

**Table C.10.1.4:  $\beta$  values for transmitter characteristics tests with HS-DPCCH**

Sub-test	$\beta_c$	$\beta_d$	$\beta_d$ (SF)	$\beta_c/\beta_d$	$\beta_{MS}$ (Note 1, Note 2)	CM (dB) (Note 3)	MPR (dB) (Note 3)
1	2/15	15/15	64	2/15	4/15	0.0	0.0
2	12/15 (Note 4)	15/15 (Note 4)	64	12/15 (Note 4)	24/15	1.0	0.0
3	15/15	8/15	64	15/8	30/15	1.5	0.5
4	15/15	4/15	64	15/4	30/15	1.5	0.5

Note 1:  $\Delta_{ACK}$ ,  $\Delta_{NACK}$  and  $\Delta_{CQI} = 30/15$  with  $\beta_{MS} = 30/15 * \beta_c$ .

Note 2: For the HS-DPCCH power mask requirement test in clause 5.2C, 5.7A, and the Error Vector Magnitude (EVM) with HS-DPCCH test in clause 5.13.1A, and HSDPA EVM with phase discontinuity in clause 5.13.1AA,  $\Delta_{ACK}$  and  $\Delta_{NACK} = 30/15$  with  $\beta_{MS} = 30/15 * \beta_c$ , and  $\Delta_{CQI} = 24/15$  with  $\beta_{MS} = 24/15 * \beta_c$ .

Note 3: CM = 1 for  $\beta_c/\beta_d = 12/15$ ,  $\beta_{MS}/\beta_c = 24/15$ . For all other combinations of DPCCH, DPCH and HS-DPCCH the MPR is based on the relative CM difference. This is applicable for only UEs that support HSDPA in release 6 and later releases.

Note 4: For subtest 2 the  $\beta_c/\beta_d$  ratio of 12/15 for the TFC during the measurement period (TF1, TF0) is achieved by setting the signalled gain factors for the reference TFC (TF1, TF1) to  $\beta_c = 11/15$  and  $\beta_d = 15/15$ .

**Setup Configuration**



**HSUPA Setup Configuration:**

- a. The EUT was connected to Base Station Agilent E5515C referred to the Setup Configuration.
- b. The RF path losses were compensated into the measurements.
- c. A call was established between EUT and Base Station with following setting \* :
  - i. Call Configs = 5.2B, 5.9B, 5.10B, and 5.13.2B with QPSK
  - ii. Set the Gain Factors ( $\beta_c$  and  $\beta_d$ ) and parameters (AG Index) were set according to each specific sub-test in the following table, C11.1.3, quoted from the TS 34.121
  - iii. Set Cell Power = -86 dBm
  - iv. Set Channel Type = 12.2k + HSPA
  - v. Set UE Target Power
  - vi. Power Ctrl Mode= Alternating bits
  - vii. Set and observe the E-TFCl
  - viii. Confirm that E-TFCl is equal to the target E-TFCl of 75 for sub-test 1, and other subtest's E-TFCl
- d. The transmitted maximum output power was recorded.

**Table C.11.1.3:  $\beta$  values for transmitter characteristics tests with HS-DPCCH and E-DCH**

Sub-test	$\beta_c$	$\beta_d$	$\beta_d$ (SF)	$\beta_c/\beta_d$	$\beta_{HS}$ (Note 1)	$\beta_{ec}$	$\beta_{ed}$ (Note 5) (Note 6)	$\beta_{ed}$ (SF)	$\beta_{ed}$ (Codes)	CM (dB) (Note 2)	MPR (dB) (Note 2)	AG Index (Note 6)	E-TFCl
1	11/15 (Note 3)	15/15 (Note 3)	64	11/15 (Note 3)	22/15	209/25	1309/225	4	1	1.0	0.0	20	75
2	6/15	15/15	64	6/15	12/15	12/15	94/75	4	1	3.0	2.0	12	67
3	15/15	9/15	64	15/9	30/15	30/15	$\beta_{ed1}: 47/15$ $\beta_{ed2}: 47/15$	4 4	2	2.0	1.0	15	92
4	2/15	15/15	64	2/15	4/15	2/15	56/75	4	1	3.0	2.0	17	71
5	15/15 (Note 4)	15/15 (Note 4)	64	15/15 (Note 4)	30/15	24/15	134/15	4	1	1.0	0.0	21	81

Note 1:  $\Delta_{ACK}, \Delta_{NACK}$  and  $\Delta_{CQI} = 30/15$  with  $\beta_{HS} = 30/15 * \beta_c$ .

Note 2: CM = 1 for  $\beta_c/\beta_d = 12/15, \beta_{HS}/\beta_c = 24/15$ . For all other combinations of DPDCCH, DPCCH, HS-DPCCH, E-DPDCCH and E-DPCCH the MPR is based on the relative CM difference.

Note 3: For subtest 1 the  $\beta_c/\beta_d$  ratio of 11/15 for the TFC during the measurement period (TF1, TF0) is achieved by setting the signalled gain factors for the reference TFC (TF1, TF1) to  $\beta_c = 10/15$  and  $\beta_d = 15/15$ .

Note 4: For subtest 5 the  $\beta_c/\beta_d$  ratio of 15/15 for the TFC during the measurement period (TF1, TF0) is achieved by setting the signalled gain factors for the reference TFC (TF1, TF1) to  $\beta_c = 14/15$  and  $\beta_d = 15/15$ .

Note 5: In case of testing by UE using E-DPDCCH Physical Layer category 1, Sub-test 3 is omitted according to TS25.306 Table 5.1g.

Note 6:  $\beta_{ed}$  can not be set directly, it is set by Absolute Grant Value.

**Setup Configuration**

**DC-HSDPA 3GPP release 8 Setup Configuration:**

- a. The EUT was connected to Base Station Agilent E5515C referred to the Setup Configuration below
- b. The RF path losses were compensated into the measurements.
- c. A call was established between EUT and Base Station with following setting:
  - i. Set RMC 12.2Kbps + HSDPA mode.
  - ii. Set Cell Power = -25 dBm
  - iii. Set HS-DSCH Configuration Type to FRC (H-set 12, QPSK)
  - iv. Select HSDPA Uplink Parameters
  - v. Set Gain Factors ( $\beta_c$  and  $\beta_d$ ) and parameters were set according to each Specific sub-test in the following table, C10.1.4, quoted from the TS 34.121
    - a). Subtest 1:  $\beta_c/\beta_d=2/15$
    - b). Subtest 2:  $\beta_c/\beta_d=12/15$
    - c). Subtest 3:  $\beta_c/\beta_d=15/8$
    - d). Subtest 4:  $\beta_c/\beta_d=15/4$
  - vi. Set Delta ACK, Delta NACK and Delta CQI = 8
  - vii. Set Ack-Nack Repetition Factor to 3
  - viii. Set CQI Feedback Cycle (k) to 4 ms
  - ix. Set CQI Repetition Factor to 2
  - x. Power Ctrl Mode = All Up bits
- d. The transmitted maximum output power was recorded.

The following tests were conducted according to the test requirements outlines in 3GPP TS 34.121 specification. A summary of these settings are illustrated below:

**C.8.1.12 Fixed Reference Channel Definition H-Set 12**

**Table C.8.1.12: Fixed Reference Channel H-Set 12**

Parameter	Unit	Value
Nominal Avg. Inf. Bit Rate	kbps	60
Inter-TTI Distance	TTI's	1
Number of HARQ Processes	Processes	6
Information Bit Payload ( $N_{INF}$ )	Bits	120
Number Code Blocks	Blocks	1
Binary Channel Bits Per TTI	Bits	960
Total Available SML's in UE	SML's	19200
Number of SML's per HARQ Proc.	SML's	3200
Coding Rate		0.15
Number of Physical Channel Codes	Codes	1
Modulation		QPSK
Note 1: The RMC is intended to be used for DC-HSDPA mode and both cells shall transmit with identical parameters as listed in the table. Note 2: Maximum number of transmission is limited to 1, i.e., retransmission is not allowed. The redundancy and constellation version 0 shall be used.		

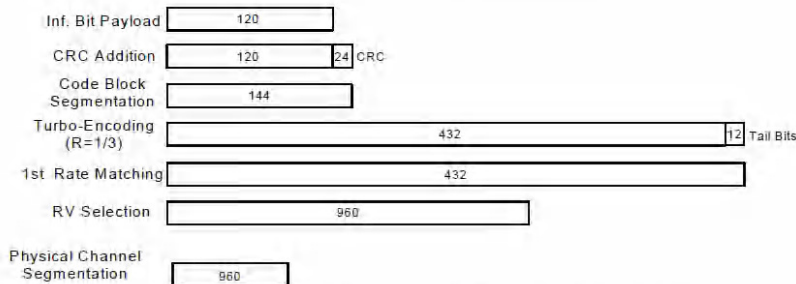

**Figure C.8.19: Coding rate for Fixed reference Channel H-Set 12 (QPSK)**

**Setup Configuration**





**<WCDMA Conducted Power>**

**General Note:**

1. Per KDB 941225 D01v03r01, for SAR testing is measured using a 12.2 kbps RMC with TPC bits configured to all "1's".
2. Per KDB 941225 D01v03r01, RMC 12.2kbps setting is used to evaluate SAR. If the maximum output power and tune-up tolerance specified for production units in HSDPA / HSUPA / DC-HSDPA is  $\leq \frac{1}{4}$  dB higher than RMC 12.2Kbps or when the highest reported SAR of the RMC12.2Kbps is scaled by the ratio of specified maximum output power and tune-up tolerance of HSDPA / HSUPA / DC-HSDPA to RMC12.2Kbps and the adjusted SAR is  $\leq 1.2$  W/kg, SAR measurement is not required for HSDPA / HSUPA / DC-HSDPA.

**Default Power Mode**

Band		WCDMA II			Tune-up Limit (dBm)	WCDMA IV			Tune-up Limit (dBm)	WCDMA V			Tune-up Limit (dBm)
TX Channel		9262	9400	9538		1312	1413	1513		4132	4182	4233	
Rx Channel		9662	9800	9938	1537	1638	1738	4357	4407	4458			
Frequency (MHz)		1852.4	1880	1907.6	1712.4	1732.6	1752.6	826.4	836.4	846.6			
3GPP Rel 99	RMC 12.2Kbps	22.89	22.95	23.02	24.00	22.99	22.95	22.92	24.00	23.01	22.84	22.81	24.00
3GPP Rel 6	HSDPA Subtest-1	22.57	22.50	22.64	24.00	22.50	22.45	22.42	24.00	22.55	22.41	22.36	24.00
3GPP Rel 6	HSDPA Subtest-2	22.56	22.60	22.67	24.00	22.51	22.44	22.43	24.00	22.63	22.52	22.45	24.00
3GPP Rel 6	HSDPA Subtest-3	22.07	22.12	22.24	23.50	22.05	22.00	21.97	23.50	22.11	22.09	21.92	23.50
3GPP Rel 6	HSDPA Subtest-4	22.12	22.16	22.30	23.50	22.07	22.02	22.01	23.50	22.15	22.14	21.97	23.50
3GPP Rel 8	DC-HSDPA Subtest-1	22.50	22.40	22.61	24.00	22.42	22.34	22.36	24.00	22.46	22.35	22.30	24.00
3GPP Rel 8	DC-HSDPA Subtest-2	22.57	22.50	22.57	24.00	22.47	22.37	22.35	24.00	22.55	22.44	22.40	24.00
3GPP Rel 8	DC-HSDPA Subtest-3	22.05	21.97	22.16	23.50	22.02	21.99	21.92	23.50	22.04	22.00	21.87	23.50
3GPP Rel 8	DC-HSDPA Subtest-4	22.12	22.10	22.22	23.50	21.99	21.97	21.99	23.50	22.08	22.12	21.87	23.50
3GPP Rel 6	HSUPA Subtest-1	22.42	22.49	22.76	24.00	22.08	22.04	22.00	24.00	22.17	22.14	22.05	24.00
3GPP Rel 6	HSUPA Subtest-2	21.23	21.29	21.19	22.00	20.92	20.91	20.86	22.00	21.02	21.07	20.90	22.00
3GPP Rel 6	HSUPA Subtest-3	21.38	21.55	21.77	23.00	21.46	21.20	21.05	23.00	21.34	21.24	21.17	23.00
3GPP Rel 6	HSUPA Subtest-4	21.42	21.51	21.83	22.00	21.55	21.25	21.02	22.00	21.56	21.33	20.89	22.00
3GPP Rel 6	HSUPA Subtest-5	22.55	22.57	22.74	24.00	22.42	22.22	22.12	24.00	22.57	22.55	22.32	24.00

**Reduced Power Mode**

Band		WCDMA II			Tune-up Limit (dBm)	WCDMA IV			Tune-up Limit (dBm)	WCDMA V			Tune-up Limit (dBm)
TX Channel		9262	9400	9538		1312	1413	1513		4132	4182	4233	
Rx Channel		9662	9800	9938	1537	1638	1738	4357	4407	4458			
Frequency (MHz)		1852.4	1880	1907.6	1712.4	1732.6	1752.6	826.4	836.4	846.6			
3GPP Rel 99	RMC 12.2Kbps	14.66	14.21	14.54	15.00	13.58	13.72	13.18	14.00	17.85	17.57	17.54	18.00
3GPP Rel 6	HSDPA Subtest-1	14.11	13.65	14.07	15.00	12.99	13.13	12.65	14.00	17.26	17.17	17.09	18.00
3GPP Rel 6	HSDPA Subtest-2	14.15	13.70	14.11	15.00	13.10	13.27	12.80	14.00	17.33	17.22	17.13	18.00
3GPP Rel 6	HSDPA Subtest-3	13.67	13.16	13.57	14.50	12.64	12.79	12.16	13.50	16.80	16.63	16.65	17.50
3GPP Rel 6	HSDPA Subtest-4	13.71	13.20	13.60	14.50	12.60	12.70	12.12	13.50	16.85	16.68	16.67	17.50
3GPP Rel 8	DC-HSDPA Subtest-1	14.08	13.62	14.06	15.00	12.97	13.10	12.63	14.00	17.23	17.15	17.04	18.00
3GPP Rel 8	DC-HSDPA Subtest-2	14.12	13.68	14.08	15.00	13.07	13.24	12.78	14.00	17.32	17.20	17.14	18.00
3GPP Rel 8	DC-HSDPA Subtest-3	13.65	13.15	13.54	14.50	12.62	12.75	12.13	13.50	16.77	16.56	16.58	17.50
3GPP Rel 8	DC-HSDPA Subtest-4	13.68	13.15	13.57	14.50	12.57	12.69	12.10	13.50	16.80	16.62	16.62	17.50
3GPP Rel 6	HSUPA Subtest-1	13.76	13.41	13.63	15.00	12.21	12.53	12.09	14.00	16.94	16.79	16.89	18.00
3GPP Rel 6	HSUPA Subtest-2	12.23	11.96	12.15	13.00	11.18	11.27	11.02	12.00	15.63	15.87	15.52	16.00
3GPP Rel 6	HSUPA Subtest-3	12.38	12.07	12.26	14.00	11.30	11.33	11.09	13.00	15.96	15.78	15.87	17.00
3GPP Rel 6	HSUPA Subtest-4	12.52	12.12	12.45	13.00	11.41	11.52	11.33	12.00	15.82	15.70	15.74	16.00
3GPP Rel 6	HSUPA Subtest-5	14.13	13.72	14.01	15.00	12.51	12.68	12.16	14.00	17.28	17.11	17.19	18.00



**<CDMA2000 Conducted Power>**

**General Note:**

- Per KDB 941225 D01v03r01, when in body SAR testing, the EUT is treated as data device and SAR is tested with Ev-Do Rev 0 (RTAP 153.6kbps) as the primary mode.

**Default Power Mode**

Band	CDMA2000 BC0			Tune-up Limit (dBm)	CDMA2000 BC1			Tune-up Limit (dBm)	CDMA2000 BC10			Tune-up Limit (dBm)
	1013	384	777		25	600	1175		476	580	684	
TX Channel	824.7	836.52	848.31		1851.25	1880	1908.75		817.9	820.5	823.1	
Frequency (MHz)												
RC1 SO55	23.66	23.46	23.34	24.50	23.58	23.65	23.71	24.50	23.44	23.48	23.50	24.50
RC3 SO55	23.67	23.48	23.37	24.50	23.64	23.69	23.72	24.50	23.51	23.54	23.53	24.50
RTAP 153.6Kbps	23.49	23.47	23.39	24.50	23.54	23.57	23.68	24.50	23.45	23.55	23.54	24.50
RETAP 4096Bits	23.58	23.46	23.36	24.50	23.52	23.59	23.67	24.50	23.48	23.52	23.53	24.50

**Reduced Power Mode**

Band	CDMA2000 BC0			Tune-up Limit (dBm)	CDMA2000 BC1			Tune-up Limit (dBm)	CDMA2000 BC10			Tune-up Limit (dBm)
	1013	384	777		25	600	1175		476	580	684	
TX Channel	824.7	836.52	848.31		1851.25	1880	1908.75		817.9	820.5	823.1	
Frequency (MHz)												
RC1 SO55	16.63	16.72	16.85	17.50	12.37	12.40	12.71	13.50	16.63	16.55	16.62	17.50
RC3 SO55	16.66	16.77	16.91	17.50	12.40	12.44	12.76	13.50	16.82	16.84	16.78	17.50
RTAP 153.6Kbps	16.69	16.72	16.85	17.50	12.33	12.36	12.67	13.50	16.68	16.71	16.65	17.50
RETAP 4096Bits	16.58	16.46	16.63	17.50	12.31	12.35	12.66	13.50	16.69	16.61	16.63	17.50

**<LTE Conducted Power>****General Note:**

1. Anritsu MT8820C base station simulator was used to setup the connection with EUT; the frequency band, channel bandwidth, RB allocation configuration, modulation type are set in the base station simulator to configure EUT transmitting at maximum power and at different configurations which are requested to be reported to FCC, for conducted power measurement and SAR testing.
2. Per KDB 941225 D05v02r05, when a properly configured base station simulator is used for the SAR and power measurements, spectrum plots for each RB allocation and offset configuration is not required.
3. Per KDB 941225 D05v02r05, start with the largest channel bandwidth and measure SAR for QPSK with 1 RB allocation, using the RB offset and required test channel combination with the highest maximum output power for RB offsets at the upper edge, middle and lower edge of each required test channel.
4. Per KDB 941225 D05v02r05, 50% RB allocation for QPSK SAR testing follows 1RB QPSK allocation procedure.
5. Per KDB 941225 D05v02r05, For QPSK with 100% RB allocation, SAR is not required when the highest maximum output power for 100 % RB allocation is less than the highest maximum output power in 50% and 1 RB allocations and the highest reported SAR for 1 RB and 50% RB allocation are  $\leq 0.8$  W/kg. Otherwise, SAR is measured for the highest output power channel; and if the reported SAR is  $> 1.45$  W/kg, the remaining required test channels must also be tested.
6. Per KDB 941225 D05v02r05, 16QAM output power for each RB allocation configuration is  $>$  not  $\frac{1}{2}$  dB higher than the same configuration in QPSK and the reported SAR for the QPSK configuration is  $\leq 1.45$  W/kg; Per KDB 941225 D05v02r05, 16QAM SAR testing is not required.
7. Per KDB 941225 D05v02r05, Smaller bandwidth output power for each RB allocation configuration is  $>$  not  $\frac{1}{2}$  dB higher than the same configuration in the largest supported bandwidth, and the reported SAR for the largest supported bandwidth is  $\leq 1.45$  W/kg; Per KDB 941225 D05v02r05, smaller bandwidth SAR testing is not required.
8. For LTE B4/B5/B17 the maximum bandwidth does not support three non-overlapping channels, per KDB 941225 D05v02r05, when a device supports overlapping channel assignment in a channel bandwidth configuration, the middle channel of the group of overlapping channels should be selected for testing.
9. LTE band 2 SAR test was covered by Band 25; according to April 2015 TCB workshop, SAR test for overlapping LTE bands can be reduced if
  - a. the maximum output power, including tolerance, for the smaller band is  $\leq$  the larger band to qualify for the SAR test exclusion
  - b. the channel bandwidth and other operating parameters for the smaller band are fully supported by the larger band



**Default Power Mode**

**<LTE Band 2>**

BW [MHz]	Modulation	RB Size	RB Offset	Power Low Ch. / Freq.	Power Middle Ch. / Freq.	Power High Ch. / Freq.	Tune-up limit (dBm)	MPR (dB)
Channel				18700	18900	19100		
Frequency (MHz)				1860	1880	1900		
20	QPSK	1	0	22.95	22.99	22.96	24	0
20	QPSK	1	49	22.76	22.88	22.84		
20	QPSK	1	99	22.71	22.83	22.80		
20	QPSK	50	0	21.87	21.94	21.90	23	1
20	QPSK	50	24	21.86	21.91	21.88		
20	QPSK	50	50	21.78	21.83	21.85		
20	QPSK	100	0	21.80	21.94	21.91	23	1
20	16QAM	1	0	21.96	22.02	21.86		
20	16QAM	1	49	21.77	21.91	21.85		
20	16QAM	1	99	21.82	21.84	21.94	22	2
20	16QAM	50	0	20.89	20.91	20.88		
20	16QAM	50	24	20.79	20.92	20.87		
20	16QAM	50	50	20.89	20.82	20.93	22	2
20	16QAM	50	0	20.89	20.82	20.93		
20	16QAM	100	0	20.83	20.90	20.96		
Channel				18675	18900	19125		
Frequency (MHz)				1857.5	1880	1902.5		
15	QPSK	1	0	23.00	22.85	22.94	24	0
15	QPSK	1	37	22.77	22.88	22.93		
15	QPSK	1	74	22.66	22.78	22.82		
15	QPSK	36	0	21.85	21.90	21.92	23	1
15	QPSK	36	20	21.78	21.89	21.93		
15	QPSK	36	39	21.81	21.85	21.94		
15	QPSK	75	0	21.71	21.83	21.82	23	1
15	16QAM	1	0	22.00	21.95	21.98		
15	16QAM	1	37	21.79	21.94	21.91		
15	16QAM	1	74	21.74	21.82	21.81	23	1
15	16QAM	36	0	20.92	20.99	20.92		
15	16QAM	36	20	20.82	20.97	21.02		
15	16QAM	36	39	20.79	20.91	21.00	22	2
15	16QAM	36	0	20.92	20.99	20.92		
15	16QAM	75	0	20.75	20.84	20.86		
Channel				18650	18900	19150		
Frequency (MHz)				1855	1880	1905		
10	QPSK	1	0	22.99	22.90	22.95	24	0
10	QPSK	1	25	22.77	22.87	22.94		
10	QPSK	1	49	22.67	22.82	22.86		
10	QPSK	25	0	21.97	21.90	21.97	23	1
10	QPSK	25	12	21.79	22.00	21.93		
10	QPSK	25	25	21.84	21.98	21.93		
10	QPSK	50	0	21.77	21.87	21.97	23	1
10	16QAM	1	0	21.99	21.96	21.97		
10	16QAM	1	25	21.78	21.96	21.93		
10	16QAM	1	49	21.67	21.88	21.86	23	1
10	16QAM	25	0	20.93	20.98	20.98		
10	16QAM	25	12	20.86	20.98	21.05		
10	16QAM	25	25	20.78	20.88	20.95	22	2
10	16QAM	25	0	20.93	20.98	20.98		
10	16QAM	50	0	20.78	20.87	21.00		



Channel				18625	18900	19175	Tune-up limit (dBm)	MPR (dB)
Frequency (MHz)				1852.5	1880	1907.5		
5	QPSK	1	0	23.00	22.87	22.94	24	0
5	QPSK	1	12	22.89	22.85	22.91		
5	QPSK	1	24	22.74	22.87	22.90		
5	QPSK	12	0	22.02	21.95	21.93	23	1
5	QPSK	12	7	22.01	21.97	21.99		
5	QPSK	12	13	21.95	21.96	22.01		
5	QPSK	25	0	21.90	21.96	21.98	23	1
5	16QAM	1	0	21.99	21.91	21.95		
5	16QAM	1	12	21.90	21.95	21.95		
5	16QAM	1	24	21.74	21.93	21.92	22	2
5	16QAM	12	0	21.08	21.04	20.95		
5	16QAM	12	7	21.08	20.98	21.01		
5	16QAM	12	13	21.05	20.98	21.03	22	2
5	16QAM	25	0	20.98	20.95	20.95		
5	16QAM	25	0	20.98	20.95	20.95		
Channel				18615	18900	19185	Tune-up limit (dBm)	MPR (dB)
Frequency (MHz)				1851.5	1880	1908.5		
3	QPSK	1	0	23.33	23.22	23.12	24	0
3	QPSK	1	8	23.26	23.22	23.10		
3	QPSK	1	14	23.25	23.24	23.18		
3	QPSK	8	0	22.36	22.26	22.12	23	1
3	QPSK	8	4	22.39	22.26	22.16		
3	QPSK	8	7	22.39	22.29	22.15		
3	QPSK	15	0	22.36	22.26	22.08	23	1
3	16QAM	1	0	22.27	22.20	22.08		
3	16QAM	1	8	22.24	22.19	22.11		
3	16QAM	1	14	22.22	22.26	22.11	22	2
3	16QAM	8	0	21.27	21.17	21.05		
3	16QAM	8	4	21.29	21.18	21.05		
3	16QAM	8	7	21.31	21.20	21.09	22	2
3	16QAM	8	7	21.31	21.20	21.09		
3	16QAM	15	0	21.34	21.24	21.11		
Channel				18607	18900	19193	Tune-up limit (dBm)	MPR (dB)
Frequency (MHz)				1850.7	1880	1909.3		
1.4	QPSK	1	0	23.23	23.20	23.09	24	0
1.4	QPSK	1	3	23.21	23.21	23.10		
1.4	QPSK	1	5	23.19	23.10	23.16		
1.4	QPSK	3	0	23.21	23.19	23.10		
1.4	QPSK	3	1	23.20	23.21	23.10		
1.4	QPSK	3	3	23.17	23.21	23.15		
1.4	QPSK	6	0	22.47	22.30	22.13	23	1
1.4	16QAM	1	0	22.35	22.20	22.05	23	1
1.4	16QAM	1	3	22.24	22.23	22.09		
1.4	16QAM	1	5	22.20	22.26	22.08		
1.4	16QAM	3	0	22.22	22.28	22.13		
1.4	16QAM	3	1	22.18	22.26	22.12		
1.4	16QAM	3	3	22.12	22.27	22.17		
1.4	16QAM	6	0	21.41	21.28	21.18	22	2



<LTE Band 4>

BW [MHz]	Modulation	RB Size	RB Offset	Power Low Ch. / Freq.	Power Middle Ch. / Freq.	Power High Ch. / Freq.	Tune-up limit (dBm)	MPR (dB)
Channel				20050	20175	20300		
Frequency (MHz)				1720	1732.5	1745		
20	QPSK	1	0	22.98	23.12	23.08	24	0
20	QPSK	1	49	22.82	22.97	23.05		
20	QPSK	1	99	22.90	22.97	22.93		
20	QPSK	50	0	21.99	22.16	22.15	23	1
20	QPSK	50	24	21.82	22.06	22.13		
20	QPSK	50	50	21.94	22.05	21.90		
20	QPSK	100	0	21.97	22.01	22.00		
20	16QAM	1	0	22.04	22.05	21.99	23	1
20	16QAM	1	49	21.91	22.05	22.11		
20	16QAM	1	99	21.95	22.05	21.93		
20	16QAM	50	0	20.99	21.03	21.18	22	2
20	16QAM	50	24	20.88	21.06	21.15		
20	16QAM	50	50	20.92	21.12	20.96		
20	16QAM	100	0	20.97	21.05	21.00		
Channel				20025	20175	20325	Tune-up limit (dBm)	MPR (dB)
Frequency (MHz)				1717.5	1732.5	1747.5		
15	QPSK	1	0	23.00	23.02	23.09	24	0
15	QPSK	1	37	22.94	22.98	23.00		
15	QPSK	1	74	22.91	22.98	22.88		
15	QPSK	36	0	22.01	22.00	22.14	23	1
15	QPSK	36	20	21.96	22.06	22.07		
15	QPSK	36	39	21.89	22.09	21.83		
15	QPSK	75	0	21.91	22.00	21.91		
15	16QAM	1	0	22.03	22.07	22.12	23	1
15	16QAM	1	37	21.88	22.02	22.03		
15	16QAM	1	74	21.92	22.02	21.92		
15	16QAM	36	0	21.03	21.04	21.18	22	2
15	16QAM	36	20	21.02	21.09	21.11		
15	16QAM	36	39	20.93	21.11	20.95		
15	16QAM	75	0	20.87	21.03	21.04		
Channel				20000	20175	20350	Tune-up limit (dBm)	MPR (dB)
Frequency (MHz)				1715	1732.5	1750		
10	QPSK	1	0	23.00	23.06	23.13	24	0
10	QPSK	1	25	22.99	22.99	22.97		
10	QPSK	1	49	22.88	22.93	22.95		
10	QPSK	25	0	22.07	22.07	22.08	23	1
10	QPSK	25	12	22.07	22.04	21.97		
10	QPSK	25	25	22.06	22.10	21.94		
10	QPSK	50	0	22.01	22.05	21.96		
10	16QAM	1	0	22.05	22.12	22.14	23	1
10	16QAM	1	25	21.99	22.03	21.95		
10	16QAM	1	49	21.90	21.96	21.98		
10	16QAM	25	0	21.03	21.08	21.09	22	2
10	16QAM	25	12	21.04	21.08	20.98		
10	16QAM	25	25	21.04	21.09	20.93		
10	16QAM	50	0	20.99	21.11	20.97		



Channel				19975	20175	20375	Tune-up limit (dBm)	MPR (dB)
Frequency (MHz)				1712.5	1732.5	1752.5		
5	QPSK	1	0	23.02	22.97	23.12	24	0
5	QPSK	1	12	22.99	22.96	22.89		
5	QPSK	1	24	22.93	23.01	22.97		
5	QPSK	12	0	22.06	22.08	21.98	23	1
5	QPSK	12	7	22.07	22.07	21.99		
5	QPSK	12	13	22.08	22.04	21.97		
5	QPSK	25	0	22.01	22.03	21.98	23	1
5	16QAM	1	0	22.01	22.04	22.11		
5	16QAM	1	12	22.00	22.03	21.91		
5	16QAM	1	24	21.95	22.06	21.98	22	2
5	16QAM	12	0	21.09	21.10	21.02		
5	16QAM	12	7	21.08	21.11	21.03		
5	16QAM	12	13	21.09	21.15	21.07	22	2
5	16QAM	12	13	21.09	21.15	21.07		
5	16QAM	25	0	21.01	21.06	20.98		
Channel				19965	20175	20385	Tune-up limit (dBm)	MPR (dB)
Frequency (MHz)				1711.5	1732.5	1753.5		
3	QPSK	1	0	23.35	23.25	23.36	24	0
3	QPSK	1	8	23.30	23.28	23.22		
3	QPSK	1	14	23.31	23.31	23.29		
3	QPSK	8	0	22.41	22.31	22.23	23	1
3	QPSK	8	4	22.33	22.34	22.24		
3	QPSK	8	7	22.42	22.35	22.23		
3	QPSK	15	0	22.33	22.27	22.20	23	1
3	16QAM	1	0	22.23	22.23	22.29		
3	16QAM	1	8	22.24	22.28	22.24		
3	16QAM	1	14	22.27	22.26	22.19	22	2
3	16QAM	8	0	21.24	21.26	21.22		
3	16QAM	8	4	21.27	21.26	21.24		
3	16QAM	8	7	21.25	21.24	21.17	22	2
3	16QAM	8	7	21.25	21.24	21.17		
3	16QAM	15	0	21.34	21.29	21.22	22	2
Channel				19957	20175	20393	Tune-up limit (dBm)	MPR (dB)
Frequency (MHz)				1710.7	1732.5	1754.3		
1.4	QPSK	1	0	23.22	23.17	23.33	24	0
1.4	QPSK	1	3	23.28	23.22	23.30		
1.4	QPSK	1	5	23.25	23.29	23.27		
1.4	QPSK	3	0	23.24	23.23	23.31		
1.4	QPSK	3	1	23.27	23.24	23.29		
1.4	QPSK	3	3	23.22	23.20	23.29	23	1
1.4	QPSK	6	0	22.26	22.38	22.31		
1.4	16QAM	1	0	22.22	22.21	22.22	23	1
1.4	16QAM	1	3	22.25	22.26	22.25		
1.4	16QAM	1	5	22.28	22.26	22.26		
1.4	16QAM	3	0	22.26	22.32	22.36		
1.4	16QAM	3	1	22.28	22.31	22.38		
1.4	16QAM	3	3	22.30	22.32	22.37		
1.4	16QAM	6	0	21.33	21.37	21.31	22	2



**<LTE Band 5>**

BW [MHz]	Modulation	RB Size	RB Offset	Power Low Ch. / Freq.	Power Middle Ch. / Freq.	Power High Ch. / Freq.	Tune-up limit (dBm)	MPR (dB)
Channel				20450	20525	20600		
Frequency (MHz)				829	836.5	844		
10	QPSK	1	0	22.82	22.86	22.82	24	0
10	QPSK	1	25	22.73	22.72	22.72		
10	QPSK	1	49	22.71	22.67	22.72		
10	QPSK	25	0	21.84	21.86	21.83	23	1
10	QPSK	25	12	21.83	21.74	21.82		
10	QPSK	25	25	21.83	21.69	21.82		
10	QPSK	50	0	21.74	21.78	21.76		
10	16QAM	1	0	21.79	21.71	21.82	23	1
10	16QAM	1	25	21.74	21.78	21.76		
10	16QAM	1	49	21.74	21.73	21.68		
10	16QAM	25	0	20.73	20.68	20.76	22	2
10	16QAM	25	12	20.75	20.74	20.81		
10	16QAM	25	25	20.80	20.73	20.80		
10	16QAM	50	0	20.69	20.68	20.76		
Channel				20425	20525	20625	Tune-up limit (dBm)	MPR (dB)
Frequency (MHz)				826.5	836.5	846.5		
5	QPSK	1	0	22.74	22.77	22.84	24	0
5	QPSK	1	12	22.71	22.77	22.83		
5	QPSK	1	24	22.80	22.72	22.68		
5	QPSK	12	0	21.79	21.79	21.83	23	1
5	QPSK	12	7	21.77	21.77	21.86		
5	QPSK	12	13	21.85	21.82	21.74		
5	QPSK	25	0	21.79	21.76	21.83		
5	16QAM	1	0	21.73	21.76	21.83	23	1
5	16QAM	1	12	21.82	21.80	21.81		
5	16QAM	1	24	21.77	21.74	21.69		
5	16QAM	12	0	20.81	20.79	20.82	22	2
5	16QAM	12	7	20.76	20.81	20.85		
5	16QAM	12	13	20.79	20.81	20.74		
5	16QAM	25	0	20.73	20.75	20.74		
Channel				20415	20525	20635	Tune-up limit (dBm)	MPR (dB)
Frequency (MHz)				825.5	836.5	847.5		
3	QPSK	1	0	22.71	22.77	22.81	24	0
3	QPSK	1	8	22.72	22.75	22.79		
3	QPSK	1	14	22.76	22.79	22.76		
3	QPSK	8	0	21.79	21.81	21.82	23	1
3	QPSK	8	4	21.78	21.82	21.82		
3	QPSK	8	7	21.76	21.79	21.77		
3	QPSK	15	0	21.77	21.86	21.80		
3	16QAM	1	0	21.74	21.78	21.82	23	1
3	16QAM	1	8	21.74	21.75	21.74		
3	16QAM	1	14	21.75	21.73	21.72		
3	16QAM	8	0	20.71	20.69	20.77	22	2
3	16QAM	8	4	20.71	20.68	20.73		
3	16QAM	8	7	20.68	20.71	20.73		
3	16QAM	15	0	20.77	20.81	20.77		





Channel				20407	20525	20643	Tune-up limit (dBm)	MPR (dB)
Frequency (MHz)				824.7	836.5	848.3		
1.4	QPSK	1	0	22.73	22.79	22.84	24	0
1.4	QPSK	1	3	22.75	22.81	22.83		
1.4	QPSK	1	5	22.78	22.76	22.78		
1.4	QPSK	3	0	22.79	22.80	22.82		
1.4	QPSK	3	1	22.79	22.79	22.77		
1.4	QPSK	3	3	22.77	22.79	22.76		
1.4	QPSK	6	0	21.79	21.85	21.82	23	1
1.4	16QAM	1	0	21.72	21.87	21.89	23	1
1.4	16QAM	1	3	21.80	21.79	21.73		
1.4	16QAM	1	5	21.77	21.80	21.72		
1.4	16QAM	3	0	21.77	21.81	21.82		
1.4	16QAM	3	1	21.77	21.85	21.82		
1.4	16QAM	3	3	21.82	21.75	21.75		
1.4	16QAM	6	0	20.83	20.84	20.80	22	2



<LTE Band 13>

BW [MHz]	Modulation	RB Size	RB Offset	Power Low Ch. / Freq.	Power Middle Ch. / Freq.	Power High Ch. / Freq.	Tune-up limit (dBm)	MPR (dB)
Channel				23230				
Frequency (MHz)				782				
10	QPSK	1	0	22.73			24	0
10	QPSK	1	25	22.62				
10	QPSK	1	49	22.33				
10	QPSK	25	0	21.71			23	1
10	QPSK	25	12	21.63				
10	QPSK	25	25	21.57				
10	QPSK	50	0	21.66				
10	16QAM	1	0	21.35			23	1
10	16QAM	1	25	21.68				
10	16QAM	1	49	21.64				
10	16QAM	25	0	20.53			22	2
10	16QAM	25	12	20.65				
10	16QAM	25	25	20.67				
10	16QAM	50	0	20.63				
Channel				23205	23230	23255	Tune-up limit (dBm)	MPR (dB)
Frequency (MHz)				779.5	782	784.5		
5	QPSK	1	0	22.56	22.72	22.66	24	0
5	QPSK	1	12	22.53	22.69	22.58		
5	QPSK	1	24	22.51	22.63	22.54		
5	QPSK	12	0	21.55	21.76	21.74	23	1
5	QPSK	12	7	21.60	21.71	21.67		
5	QPSK	12	13	21.78	21.84	21.64		
5	QPSK	25	0	21.64	21.67	21.58		
5	16QAM	1	0	21.74	21.76	21.62	23	1
5	16QAM	1	12	21.61	21.71	21.56		
5	16QAM	1	24	21.48	21.70	21.53		
5	16QAM	12	0	20.59	20.69	20.78	22	2
5	16QAM	12	7	20.65	20.76	20.66		
5	16QAM	12	13	20.78	20.79	20.65		
5	16QAM	25	0	20.64	20.65	20.63		



<LTE Band 17>

BW [MHz]	Modulation	RB Size	RB Offset	Power Low Ch. / Freq.	Power Middle Ch. / Freq.	Power High Ch. / Freq.	Tune-up limit (dBm)	MPR (dB)
Channel				23780	23790	23800		
Frequency (MHz)				709	710	711		
10	QPSK	1	0	22.73	22.81	22.76		
10	QPSK	1	25	22.65	22.63	22.66	24	0
10	QPSK	1	49	22.54	22.49	22.57		
10	QPSK	25	0	21.80	21.84	21.81		
10	QPSK	25	12	21.79	21.76	21.80	23	1
10	QPSK	25	25	21.74	21.76	21.77		
10	QPSK	50	0	21.65	21.74	21.71		
10	16QAM	1	0	21.64	21.82	21.70	23	1
10	16QAM	1	25	21.78	21.78	21.89		
10	16QAM	1	49	21.64	21.63	21.57		
10	16QAM	25	0	20.73	20.69	20.75	22	2
10	16QAM	25	12	20.72	20.74	20.82		
10	16QAM	25	25	20.82	20.78	20.77		
10	16QAM	50	0	20.61	20.63	20.75		
Channel				23755	23790	23825	Tune-up limit (dBm)	MPR (dB)
Frequency (MHz)				706.5	710	713.5		
5	QPSK	1	0	22.54	22.73	22.80	24	0
5	QPSK	1	12	22.66	22.68	22.76		
5	QPSK	1	24	22.73	22.68	22.49		
5	QPSK	12	0	21.65	21.80	21.75	23	1
5	QPSK	12	7	21.72	21.84	21.86		
5	QPSK	12	13	21.83	21.80	21.78		
5	QPSK	25	0	21.80	21.83	21.77	23	1
5	16QAM	1	0	21.57	21.77	21.83		
5	16QAM	1	12	21.67	21.72	21.79		
5	16QAM	1	24	21.76	21.76	21.49	22	2
5	16QAM	12	0	20.64	20.82	20.84		
5	16QAM	12	7	20.74	20.85	20.88		
5	16QAM	12	13	20.82	20.84	20.80		
5	16QAM	25	0	20.79	20.77	20.77		



<LTE Band 25>

BW [MHz]	Modulation	RB Size	RB Offset	Power Low Ch. / Freq.	Power Middle Ch. / Freq.	Power High Ch. / Freq.	Tune-up limit (dBm)	MPR (dB)
Channel				26140	26340	26590		
Frequency (MHz)				1860	1880	1905		
20	QPSK	1	0	23.05	22.97	22.92	24	0
20	QPSK	1	49	23.04	22.94	22.83		
20	QPSK	1	99	23.03	22.89	22.82		
20	QPSK	50	0	22.14	22.02	21.95	23	1
20	QPSK	50	24	22.09	21.99	21.87		
20	QPSK	50	50	21.96	21.90	21.86		
20	QPSK	100	0	21.96	21.92	21.90		
20	16QAM	1	0	22.02	21.96	21.99	23	1
20	16QAM	1	49	22.03	21.95	21.87		
20	16QAM	1	99	21.93	21.90	21.84		
20	16QAM	50	0	21.08	20.98	20.88	22	2
20	16QAM	50	24	21.04	20.93	20.88		
20	16QAM	50	50	20.93	20.87	20.89		
20	16QAM	100	0	20.91	20.94	20.93		
Channel				26115	26340	26615	Tune-up limit (dBm)	MPR (dB)
Frequency (MHz)				1857.5	1880	1907.5		
15	QPSK	1	0	23.14	22.93	22.98	24	0
15	QPSK	1	37	22.93	22.95	22.89		
15	QPSK	1	74	22.90	22.82	22.83		
15	QPSK	36	0	22.04	21.97	21.87	23	1
15	QPSK	36	20	22.03	21.98	21.91		
15	QPSK	36	39	21.96	21.91	21.98		
15	QPSK	75	0	21.95	21.88	21.89		
15	16QAM	1	0	22.05	21.95	22.00	23	1
15	16QAM	1	37	21.94	22.02	21.89		
15	16QAM	1	74	21.89	21.92	21.82		
15	16QAM	36	0	20.96	20.98	20.89	22	2
15	16QAM	36	20	20.98	20.97	20.91		
15	16QAM	36	39	20.92	20.91	21.00		
15	16QAM	75	0	20.88	20.88	20.83		
Channel				26090	26340	26640	Tune-up limit (dBm)	MPR (dB)
Frequency (MHz)				1855	1880	1910		
10	QPSK	1	0	23.06	22.98	22.92	24	0
10	QPSK	1	25	22.99	22.94	22.87		
10	QPSK	1	49	22.98	22.87	22.86		
10	QPSK	25	0	22.01	21.99	21.90	23	1
10	QPSK	25	12	22.06	22.01	21.98		
10	QPSK	25	25	22.01	21.99	22.02		
10	QPSK	50	0	21.99	21.97	21.95		
10	16QAM	1	0	22.06	21.98	21.92	23	1
10	16QAM	1	25	21.95	21.98	21.86		
10	16QAM	1	49	21.94	21.90	21.85		
10	16QAM	25	0	21.03	20.98	20.90	22	2
10	16QAM	25	12	21.02	20.99	20.97		
10	16QAM	25	25	20.90	20.97	20.95		
10	16QAM	50	0	20.93	20.94	20.96		



Channel				26065	26340	26665	Tune-up limit (dBm)	MPR (dB)
Frequency (MHz)				1852.5	1880	1912.5		
5	QPSK	1	0	23.09	22.97	23.00	24	0
5	QPSK	1	12	22.99	22.96	22.95		
5	QPSK	1	24	22.92	22.94	22.90		
5	QPSK	12	0	22.04	22.07	21.98	23	1
5	QPSK	12	7	21.99	22.02	22.01		
5	QPSK	12	13	21.94	22.03	21.99		
5	QPSK	25	0	22.07	21.97	22.01	23	1
5	16QAM	1	0	22.04	21.96	22.01		
5	16QAM	1	12	21.99	22.00	21.94		
5	16QAM	1	24	21.94	21.98	21.92	22	2
5	16QAM	12	0	21.06	21.07	20.98		
5	16QAM	12	7	21.09	21.04	21.02		
5	16QAM	12	13	20.96	21.03	21.00	22	2
5	16QAM	12	13	20.96	21.03	21.00		
5	16QAM	25	0	21.02	20.99	21.02		
Channel				26055	26340	26675	Tune-up limit (dBm)	MPR (dB)
Frequency (MHz)				1851.5	1880	1913.5		
3	QPSK	1	0	23.37	23.33	23.34	24	0
3	QPSK	1	8	23.34	23.32	23.33		
3	QPSK	1	14	23.33	23.33	23.31		
3	QPSK	8	0	22.34	22.32	22.30	23	1
3	QPSK	8	4	22.33	22.29	22.24		
3	QPSK	8	7	22.31	22.32	22.22		
3	QPSK	15	0	22.32	22.39	22.36	23	1
3	16QAM	1	0	22.40	22.30	22.35		
3	16QAM	1	8	22.33	22.38	22.36		
3	16QAM	1	14	22.20	22.37	22.32	22	2
3	16QAM	8	0	21.34	21.33	21.34		
3	16QAM	8	4	21.34	21.33	21.39		
3	16QAM	8	7	21.37	21.36	21.36	22	2
3	16QAM	8	7	21.37	21.36	21.36		
3	16QAM	15	0	21.34	21.41	21.37	22	2
Channel				26047	26340	26683	Tune-up limit (dBm)	MPR (dB)
Frequency (MHz)				1850.7	1880	1914.3		
1.4	QPSK	1	0	23.40	23.30	23.33	24	0
1.4	QPSK	1	3	23.34	23.34	23.24		
1.4	QPSK	1	5	23.37	23.37	23.27		
1.4	QPSK	3	0	23.35	23.32	23.37		
1.4	QPSK	3	1	23.30	23.34	23.26		
1.4	QPSK	3	3	23.35	23.34	23.29		
1.4	QPSK	6	0	22.40	22.43	22.39	23	1
1.4	16QAM	1	0	22.29	22.36	22.36	23	1
1.4	16QAM	1	3	22.40	22.37	22.28		
1.4	16QAM	1	5	22.32	22.37	22.34		
1.4	16QAM	3	0	22.36	22.24	22.21		
1.4	16QAM	3	1	22.36	22.38	22.35		
1.4	16QAM	3	3	22.38	22.30	22.38		
1.4	16QAM	6	0	21.40	21.42	21.41	22	2



**Reduced Power Mode**

**<LTE Band 2>**

BW [MHz]	Modulation	RB Size	RB Offset	Power Low Ch. / Freq.	Power Middle Ch. / Freq.	Power High Ch. / Freq.	Tune-up limit (dBm)	MPR (dB)
Channel				18700	18900	19100		
Frequency (MHz)				1860	1880	1900		
20	QPSK	1	0	12.29	12.00	13.29	13.5	0
20	QPSK	1	49	13.18	12.15	11.74		
20	QPSK	1	99	11.55	13.08	12.78		
20	QPSK	50	0	13.11	12.17	13.12	13.5	0
20	QPSK	50	24	13.09	12.47	12.02		
20	QPSK	50	50	12.25	12.76	11.97		
20	QPSK	100	0	12.49	12.55	12.38	13.5	0
20	16QAM	1	0	12.49	12.09	13.42		
20	16QAM	1	49	13.18	12.57	11.89		
20	16QAM	1	99	11.57	13.21	13.17	13.5	0
20	16QAM	50	0	12.81	11.96	12.49		
20	16QAM	50	24	12.78	12.28	12.04		
20	16QAM	50	50	12.07	12.55	11.72	13.5	0
20	16QAM	100	0	12.56	12.30	12.17		
Channel				18675	18900	19125		
Frequency (MHz)				1857.5	1880	1902.5		
15	QPSK	1	0	12.04	11.67	12.77	13.5	0
15	QPSK	1	37	13.22	12.21	11.77		
15	QPSK	1	74	12.09	12.90	12.88		
15	QPSK	36	0	12.84	11.95	12.09	13.5	0
15	QPSK	36	20	13.06	12.38	11.92		
15	QPSK	36	39	12.94	12.68	12.18		
15	QPSK	75	0	12.96	12.51	12.30	13.5	0
15	16QAM	1	0	12.23	12.02	12.85		
15	16QAM	1	37	13.24	12.62	11.95		
15	16QAM	1	74	12.22	13.04	13.25	13.5	0
15	16QAM	36	0	12.56	11.95	11.90		
15	16QAM	36	20	12.77	12.17	11.71		
15	16QAM	36	39	12.63	12.43	11.90	13.5	0
15	16QAM	75	0	12.64	12.31	12.08		
Channel				18650	18900	19150		
Frequency (MHz)				1855	1880	1905		
10	QPSK	1	0	12.19	12.13	12.37	13.5	0
10	QPSK	1	25	12.95	12.16	11.93		
10	QPSK	1	49	13.38	13.03	13.39		
10	QPSK	25	0	12.70	12.17	12.04	13.5	0
10	QPSK	25	12	12.99	12.23	12.09		
10	QPSK	25	25	13.31	12.73	12.72		
10	QPSK	50	0	13.15	12.43	12.39	13.5	0
10	16QAM	1	0	12.39	12.19	12.52		
10	16QAM	1	25	12.98	12.60	12.02		
10	16QAM	1	49	13.42	13.18	13.49	13.5	0
10	16QAM	25	0	12.55	11.92	11.77		
10	16QAM	25	12	12.69	12.30	11.80		
10	16QAM	25	25	12.99	12.52	12.44	13.5	0
10	16QAM	50	0	12.89	12.45	12.14		



Channel				18625	18900	19175	Tune-up limit (dBm)	MPR (dB)
Frequency (MHz)				1852.5	1880	1907.5		
5	QPSK	1	0	11.83	11.83	11.80	13.5	0
5	QPSK	1	12	12.61	12.24	12.41		
5	QPSK	1	24	13.01	12.21	13.36		
5	QPSK	12	0	12.32	12.13	12.09	13.5	0
5	QPSK	12	7	12.65	12.28	12.49		
5	QPSK	12	13	12.94	12.45	12.83		
5	QPSK	25	0	12.62	12.16	12.59	13.5	0
5	16QAM	1	0	12.04	11.92	11.90		
5	16QAM	1	12	13.01	12.68	12.52		
5	16QAM	1	24	13.10	12.65	13.43	13.5	0
5	16QAM	12	0	12.18	12.17	11.85		
5	16QAM	12	7	12.70	12.38	12.26		
5	16QAM	12	13	12.70	12.27	12.60	13.5	0
5	16QAM	25	0	12.47	12.24	12.35		
Channel				18615	18900	19185	Tune-up limit (dBm)	MPR (dB)
Frequency (MHz)				1851.5	1880	1908.5		
3	QPSK	1	0	12.28	12.69	12.83	13.5	0
3	QPSK	1	8	12.71	12.88	13.29		
3	QPSK	1	14	12.80	12.71	13.24		
3	QPSK	8	0	12.51	12.79	13.02	13.5	0
3	QPSK	8	4	12.82	12.95	13.20		
3	QPSK	8	7	12.89	13.06	13.12		
3	QPSK	15	0	12.72	12.86	13.27	13.5	0
3	16QAM	1	0	12.47	12.76	12.87		
3	16QAM	1	8	12.90	13.33	13.36		
3	16QAM	1	14	12.97	13.12	13.30	13.5	0
3	16QAM	8	0	12.41	12.94	12.84		
3	16QAM	8	4	12.73	13.09	13.17		
3	16QAM	8	7	12.80	12.93	13.29	13.5	0
3	16QAM	15	0	12.57	12.96	13.04		
Channel				18607	18900	19193	Tune-up limit (dBm)	MPR (dB)
Frequency (MHz)				1850.7	1880	1909.3		
1.4	QPSK	1	0	12.16	12.93	13.04	13.5	0
1.4	QPSK	1	3	12.33	12.80	13.25		
1.4	QPSK	1	5	12.45	12.93	13.45		
1.4	QPSK	3	0	12.30	12.79	13.20	13.5	0
1.4	QPSK	3	1	12.38	12.83	13.29		
1.4	QPSK	3	3	12.44	12.85	13.38		
1.4	QPSK	6	0	12.41	12.83	13.33	13.5	0
1.4	16QAM	1	0	12.56	13.09	13.09	13.5	0
1.4	16QAM	1	3	12.54	13.24	13.35		
1.4	16QAM	1	5	12.84	13.05	13.25		
1.4	16QAM	3	0	12.19	12.92	12.99	13.5	0
1.4	16QAM	3	1	12.26	12.95	13.10		
1.4	16QAM	3	3	12.33	12.97	13.16		
1.4	16QAM	6	0	12.35	13.00	13.18	13.5	0





<LTE Band 4>

BW [MHz]	Modulation	RB Size	RB Offset	Power Low Ch. / Freq.	Power Middle Ch. / Freq.	Power High Ch. / Freq.	Tune-up limit (dBm)	MPR (dB)
Channel				20050	20175	20300		
Frequency (MHz)				1720	1732.5	1745		
20	QPSK	1	0	12.58	12.73	12.59	13	0
20	QPSK	1	49	12.50	12.33	12.27		
20	QPSK	1	99	12.23	11.95	12.25		
20	QPSK	50	0	12.57	12.63	12.31	13	0
20	QPSK	50	24	12.48	12.39	12.25		
20	QPSK	50	50	12.45	12.15	12.29		
20	QPSK	100	0	12.48	12.54	12.38	13	0
20	16QAM	1	0	12.20	12.76	12.74		
20	16QAM	1	49	12.53	12.41	12.34		
20	16QAM	1	99	12.60	12.02	12.65	13	0
20	16QAM	50	0	12.32	12.26	12.36		
20	16QAM	50	24	12.17	12.12	12.01		
20	16QAM	50	50	12.27	11.96	12.03	13	0
20	16QAM	100	0	12.22	12.17	12.10		
Channel				20025	20175	20325		
Frequency (MHz)				1717.5	1732.5	1747.5		
15	QPSK	1	0	12.15	12.73	12.36	13	0
15	QPSK	1	37	12.53	12.34	12.31		
15	QPSK	1	74	12.65	11.91	12.25		
15	QPSK	36	0	12.26	12.49	12.30	13	0
15	QPSK	36	20	12.51	12.35	12.30		
15	QPSK	36	39	12.52	12.15	12.40		
15	QPSK	75	0	12.56	12.46	12.37	13	0
15	16QAM	1	0	12.09	12.75	12.46		
15	16QAM	1	37	12.53	12.40	12.40		
15	16QAM	1	74	12.66	11.97	12.62	13	0
15	16QAM	36	0	11.90	12.19	12.06		
15	16QAM	36	20	12.18	12.08	12.07		
15	16QAM	36	39	12.19	11.97	12.13	13	0
15	16QAM	75	0	12.23	12.18	12.09		
Channel				20000	20175	20350		
Frequency (MHz)				1715	1732.5	1750		
10	QPSK	1	0	12.27	12.87	12.69	13	0
10	QPSK	1	25	12.35	12.36	12.26		
10	QPSK	1	49	12.83	11.95	12.72		
10	QPSK	25	0	12.22	12.71	12.51	13	0
10	QPSK	25	12	12.55	12.43	12.39		
10	QPSK	25	25	12.67	12.29	12.60		
10	QPSK	50	0	12.62	12.55	12.50	13	0
10	16QAM	1	0	12.23	12.91	12.78		
10	16QAM	1	25	12.38	12.42	12.34		
10	16QAM	1	49	12.86	12.34	12.84	13	0
10	16QAM	25	0	11.86	12.43	12.23		
10	16QAM	25	12	12.23	12.16	12.11		
10	16QAM	25	25	12.34	12.10	12.33	13	0
10	16QAM	50	0	12.29	12.28	12.23		



Channel				19975	20175	20375	Tune-up limit (dBm)	MPR (dB)
Frequency (MHz)				1712.5	1732.5	1752.5		
5	QPSK	1	0	11.87	12.36	12.25	13	0
5	QPSK	1	12	12.43	12.36	12.44		
5	QPSK	1	24	12.06	11.99	12.34		
5	QPSK	12	0	12.03	12.38	12.26	13	0
5	QPSK	12	7	12.45	12.48	12.38		
5	QPSK	12	13	12.24	12.30	12.37		
5	QPSK	25	0	12.09	12.41	12.37		
5	16QAM	1	0	11.86	12.42	12.31	13	0
5	16QAM	1	12	12.51	12.54	12.45		
5	16QAM	1	24	12.08	12.19	12.44		
5	16QAM	12	0	11.69	12.13	12.01	13	0
5	16QAM	12	7	12.18	12.21	12.17		
5	16QAM	12	13	11.92	12.05	12.15		
5	16QAM	25	0	11.75	12.15	12.11		
Channel				19965	20175	20385	Tune-up limit (dBm)	MPR (dB)
Frequency (MHz)				1711.5	1732.5	1753.5		
3	QPSK	1	0	12.50	12.80	12.59	13	0
3	QPSK	1	8	12.62	12.71	12.64		
3	QPSK	1	14	12.61	12.73	12.25		
3	QPSK	8	0	12.51	12.73	12.75	13	0
3	QPSK	8	4	12.69	12.77	12.72		
3	QPSK	8	7	12.65	12.74	12.65		
3	QPSK	15	0	12.59	12.70	12.67		
3	16QAM	1	0	12.50	12.69	12.62	13	0
3	16QAM	1	8	12.62	12.68	12.52		
3	16QAM	1	14	12.57	12.51	12.43		
3	16QAM	8	0	12.20	12.56	12.55	13	0
3	16QAM	8	4	12.40	12.59	12.52		
3	16QAM	8	7	12.36	12.67	12.45		
3	16QAM	15	0	12.26	12.58	12.53		
Channel				19957	20175	20393	Tune-up limit (dBm)	MPR (dB)
Frequency (MHz)				1710.7	1732.5	1754.3		
1.4	QPSK	1	0	12.04	12.50	12.26	13	0
1.4	QPSK	1	3	12.29	12.49	12.41		
1.4	QPSK	1	5	12.17	12.40	12.34		
1.4	QPSK	3	0	12.25	12.49	12.47		
1.4	QPSK	3	1	12.33	12.42	12.46		
1.4	QPSK	3	3	12.28	12.45	12.44		
1.4	QPSK	6	0	12.36	12.43	12.46	13	0
1.4	16QAM	1	0	12.12	12.54	12.36	13	0
1.4	16QAM	1	3	12.26	12.48	12.51		
1.4	16QAM	1	5	12.20	12.52	12.43		
1.4	16QAM	3	0	11.92	12.27	12.28		
1.4	16QAM	3	1	12.00	12.29	12.28		
1.4	16QAM	3	3	11.97	12.31	12.24		
1.4	16QAM	6	0	12.08	12.34	12.31	13	0



<LTE Band 5>

BW [MHz]	Modulation	RB Size	RB Offset	Power Low Ch. / Freq.	Power Middle Ch. / Freq.	Power High Ch. / Freq.	Tune-up limit (dBm)	MPR (dB)
Channel				20450	20525	20600		
Frequency (MHz)				829	836.5	844		
10	QPSK	1	0	15.98	15.38	16.01	17	0
10	QPSK	1	25	16.31	16.32	16.28		
10	QPSK	1	49	15.59	15.49	15.60		
10	QPSK	25	0	16.39	16.33	16.27	17	0
10	QPSK	25	12	16.40	16.47	16.35		
10	QPSK	25	25	15.77	16.28	15.79		
10	QPSK	50	0	16.35	16.36	16.31		
10	16QAM	1	0	15.66	15.78	15.74	17	0
10	16QAM	1	25	16.03	15.89	16.07		
10	16QAM	1	49	15.38	15.28	15.64		
10	16QAM	25	0	15.67	15.66	15.63	17	0
10	16QAM	25	12	15.77	15.64	15.76		
10	16QAM	25	25	15.87	15.60	15.87		
10	16QAM	50	0	15.77	15.62	15.75		
Channel				20425	20525	20625	Tune-up limit (dBm)	MPR (dB)
Frequency (MHz)				826.5	836.5	846.5		
5	QPSK	1	0	15.69	15.20	15.45	17	0
5	QPSK	1	12	16.22	16.31	15.94		
5	QPSK	1	24	15.85	15.16	15.44		
5	QPSK	12	0	15.96	16.22	16.37	17	0
5	QPSK	12	7	16.21	16.38	16.54		
5	QPSK	12	13	16.15	16.22	15.80		
5	QPSK	25	0	16.03	16.22	15.75		
5	16QAM	1	0	15.34	15.61	15.84	17	0
5	16QAM	1	12	15.93	15.97	16.37		
5	16QAM	1	24	15.55	15.56	15.83		
5	16QAM	12	0	15.28	15.49	15.78	17	0
5	16QAM	12	7	15.54	15.70	15.95		
5	16QAM	12	13	15.48	15.53	15.87		
5	16QAM	25	0	15.38	15.49	15.82		
Channel				20415	20525	20635	Tune-up limit (dBm)	MPR (dB)
Frequency (MHz)				825.5	836.5	847.5		
3	QPSK	1	0	16.15	16.34	15.84	17	0
3	QPSK	1	8	16.32	16.50	15.52		
3	QPSK	1	14	16.15	16.37	16.48		
3	QPSK	8	0	16.13	16.49	15.68	17	0
3	QPSK	8	4	16.37	16.31	16.41		
3	QPSK	8	7	16.37	16.48	16.35		
3	QPSK	15	0	16.27	16.43	16.44		
3	16QAM	1	0	15.74	15.93	16.10	17	0
3	16QAM	1	8	15.94	16.21	15.91		
3	16QAM	1	14	15.80	15.99	16.27		
3	16QAM	8	0	15.51	15.86	16.06	17	0
3	16QAM	8	4	15.72	16.00	15.89		
3	16QAM	8	7	15.72	15.88	16.03		
3	16QAM	15	0	15.58	15.84	15.91		



Channel				20407	20525	20643	Tune-up limit (dBm)	MPR (dB)
Frequency (MHz)				824.7	836.5	848.3		
1.4	QPSK	1	0	16.33	16.32	15.88	17	0
1.4	QPSK	1	3	16.40	16.49	15.95		
1.4	QPSK	1	5	16.31	16.34	15.87		
1.4	QPSK	3	0	16.41	16.45	16.00		
1.4	QPSK	3	1	16.43	16.47	15.99		
1.4	QPSK	3	3	16.42	16.48	15.97		
1.4	QPSK	6	0	16.41	16.47	15.98	17	0
1.4	16QAM	1	0	16.03	15.96	16.31	17	0
1.4	16QAM	1	3	16.16	16.09	16.34		
1.4	16QAM	1	5	16.03	15.99	16.26		
1.4	16QAM	3	0	15.86	15.79	16.07		
1.4	16QAM	3	1	15.89	15.82	16.08		
1.4	16QAM	3	3	15.89	15.81	16.04		
1.4	16QAM	6	0	15.93	15.86	16.11	17	0



<LTE Band 13>

BW [MHz]	Modulation	RB Size	RB Offset	Power Low Ch. / Freq.	Power Middle Ch. / Freq.	Power High Ch. / Freq.	Tune-up limit (dBm)	MPR (dB)
Channel				23230				
Frequency (MHz)				782				
10	QPSK	1	0	18.78			19	0
10	QPSK	1	25	18.96				
10	QPSK	1	49	18.88				
10	QPSK	25	0	18.83			19	0
10	QPSK	25	12	18.90				
10	QPSK	25	25	18.89				
10	QPSK	50	0	18.83				
10	16QAM	1	0	18.70			19	0
10	16QAM	1	25	18.85				
10	16QAM	1	49	18.87				
10	16QAM	25	0	18.77			19	0
10	16QAM	25	12	18.88				
10	16QAM	25	25	18.84				
10	16QAM	50	0	18.86				
Channel				23205	23230	23255	Tune-up limit (dBm)	MPR (dB)
Frequency (MHz)				779.5	782	784.5		
5	QPSK	1	0	18.74	18.85	18.90	19	0
5	QPSK	1	12	18.81	18.89	18.89		
5	QPSK	1	24	18.86	18.87	18.81		
5	QPSK	12	0	18.72	18.85	18.89	19	0
5	QPSK	12	7	18.79	18.88	18.95		
5	QPSK	12	13	18.94	18.98	18.88		
5	QPSK	25	0	18.82	18.87	18.87		
5	16QAM	1	0	18.78	18.83	18.91	19	0
5	16QAM	1	12	18.91	18.90	18.87		
5	16QAM	1	24	18.82	18.85	18.80		
5	16QAM	12	0	18.75	18.93	18.90	19	0
5	16QAM	12	7	18.82	18.98	18.88		
5	16QAM	12	13	18.91	18.97	18.85		
5	16QAM	25	0	18.74	18.83	18.84		



<LTE Band 17>

BW [MHz]	Modulation	RB Size	RB Offset	Power Low Ch. / Freq.	Power Middle Ch. / Freq.	Power High Ch. / Freq.	Tune-up limit (dBm)	MPR (dB)
Channel				23780	23790	23800		
Frequency (MHz)				709	710	711		
10	QPSK	1	0	18.62	18.65	18.71		
10	QPSK	1	25	18.83	18.91	18.89	19	0
10	QPSK	1	49	18.82	18.88	18.71		
10	QPSK	25	0	18.79	18.82	18.81		
10	QPSK	25	12	18.88	18.91	18.90	19	0
10	QPSK	25	25	18.86	18.85	18.83		
10	QPSK	50	0	18.75	18.78	18.76		
10	16QAM	1	0	18.58	18.67	18.67	19	0
10	16QAM	1	25	18.85	18.92	18.88		
10	16QAM	1	49	18.80	18.88	18.73		
10	16QAM	25	0	18.75	18.77	18.75	19	0
10	16QAM	25	12	18.83	18.84	18.87		
10	16QAM	25	25	18.82	18.91	18.79		
10	16QAM	50	0	18.72	18.76	18.71		
Channel				23755	23790	23825	Tune-up limit (dBm)	MPR (dB)
Frequency (MHz)				706.5	710	713.5		
5	QPSK	1	0	18.67	18.81	18.91	19	0
5	QPSK	1	12	18.76	18.80	18.87		
5	QPSK	1	24	18.90	18.89	18.68		
5	QPSK	12	0	18.75	18.91	18.91	19	0
5	QPSK	12	7	18.84	18.96	18.90		
5	QPSK	12	13	18.92	18.88	18.81		
5	QPSK	25	0	18.88	18.87	18.81	19	0
5	16QAM	1	0	18.61	18.79	18.84		
5	16QAM	1	12	18.84	18.84	18.86		
5	16QAM	1	24	18.86	18.90	18.66	19	0
5	16QAM	12	0	18.80	18.91	18.86		
5	16QAM	12	7	18.78	18.92	18.86		
5	16QAM	12	13	18.89	18.91	18.79	19	0
5	16QAM	25	0	18.84	18.82	18.76		



**<LTE Band 25>**

BW [MHz]	Modulation	RB Size	RB Offset	Power Low Ch. / Freq.	Power Middle Ch. / Freq.	Power High Ch. / Freq.	Tune-up limit (dBm)	MPR (dB)
Channel				26140	26340	26590		
Frequency (MHz)				1860	1880	1905		
20	QPSK	1	0	12.44	11.80	12.85	13.5	0
20	QPSK	1	49	13.18	12.21	12.04		
20	QPSK	1	99	11.56	13.07	13.49		
20	QPSK	50	0	13.05	12.06	12.47	13.5	0
20	QPSK	50	24	13.09	12.25	12.28		
20	QPSK	50	50	12.26	12.82	12.98		
20	QPSK	100	0	12.52	12.72	12.89		
20	16QAM	1	0	12.83	12.23	13.23	13.5	0
20	16QAM	1	49	13.20	12.59	12.24		
20	16QAM	1	99	11.57	13.29	13.49		
20	16QAM	50	0	12.83	12.08	12.12	13.5	0
20	16QAM	50	24	12.79	12.33	12.12		
20	16QAM	50	50	12.08	12.49	13.00		
20	16QAM	100	0	12.54	12.36	12.60		
Channel				26115	26340	26615		
Frequency (MHz)				1857.5	1880	1907.5		
15	QPSK	1	0	12.31	11.79	11.77	13.5	0
15	QPSK	1	37	13.24	12.27	11.99		
15	QPSK	1	74	12.08	13.08	13.49		
15	QPSK	36	0	12.66	12.08	11.90	13.5	0
15	QPSK	36	20	13.08	12.28	12.36		
15	QPSK	36	39	13.01	12.86	13.17		
15	QPSK	75	0	12.93	12.42	12.48		
15	16QAM	1	0	12.70	11.95	12.13	13.5	0
15	16QAM	1	37	13.23	12.63	12.22		
15	16QAM	1	74	12.22	13.11	13.47		
15	16QAM	36	0	12.67	11.90	11.73	13.5	0
15	16QAM	36	20	12.76	12.29	12.19		
15	16QAM	36	39	12.73	12.49	12.83		
15	16QAM	75	0	12.66	12.43	12.56		
Channel				26090	26340	26640		
Frequency (MHz)				1855	1880	1910		
10	QPSK	1	0	12.44	12.25	12.08	13.5	0
10	QPSK	1	25	12.97	12.21	12.71		
10	QPSK	1	49	13.17	12.76	13.46		
10	QPSK	25	0	12.74	12.21	12.29	13.5	0
10	QPSK	25	12	13.13	12.37	13.04		
10	QPSK	25	25	13.43	12.49	13.45		
10	QPSK	50	0	12.83	12.43	12.86		
10	16QAM	1	0	12.87	12.43	12.45	13.5	0
10	16QAM	1	25	13.01	12.59	12.76		
10	16QAM	1	49	13.37	13.23	13.44		
10	16QAM	25	0	12.58	12.05	12.13	13.5	0
10	16QAM	25	12	12.82	12.24	12.73		
10	16QAM	25	25	13.11	12.57	13.32		
10	16QAM	50	0	12.90	12.31	12.95		





Channel				26065	26340	26665	Tune-up limit (dBm)	MPR (dB)
Frequency (MHz)				1852.5	1880	1912.5		
5	QPSK	1	0	12.24	11.93	12.80	13.5	0
5	QPSK	1	12	12.78	12.23	13.49		
5	QPSK	1	24	12.84	12.21	12.97		
5	QPSK	12	0	12.62	12.07	13.35	13.5	0
5	QPSK	12	7	12.84	12.28	13.47		
5	QPSK	12	13	12.78	12.29	13.41		
5	QPSK	25	0	12.73	12.24	13.44	13.5	0
5	16QAM	1	0	12.72	12.14	12.87		
5	16QAM	1	12	13.00	12.63	13.42		
5	16QAM	1	24	13.05	12.61	13.03	13.5	0
5	16QAM	12	0	12.51	11.97	13.08		
5	16QAM	12	7	12.72	12.32	13.39		
5	16QAM	12	13	12.65	12.34	13.44	13.5	0
5	16QAM	25	0	12.59	12.13	13.16		
Channel				26055	26340	26675	Tune-up limit (dBm)	MPR (dB)
Frequency (MHz)				1851.5	1880	1913.5		
3	QPSK	1	0	12.95	12.81	13.44	13.5	0
3	QPSK	1	8	13.02	13.00	13.50		
3	QPSK	1	14	13.03	12.84	12.99		
3	QPSK	8	0	13.07	13.00	13.43	13.5	0
3	QPSK	8	4	13.06	13.08	13.44		
3	QPSK	8	7	13.13	12.91	13.39		
3	QPSK	15	0	13.04	12.99	13.44	13.5	0
3	16QAM	1	0	13.11	12.97	13.42		
3	16QAM	1	8	13.23	13.39	13.38		
3	16QAM	1	14	13.21	13.22	13.02	13.5	0
3	16QAM	8	0	12.99	13.02	13.38		
3	16QAM	8	4	12.97	13.17	13.35		
3	16QAM	8	7	13.05	13.06	13.15	13.5	0
3	16QAM	15	0	12.91	13.04	13.16		
Channel				26047	26340	26683	Tune-up limit (dBm)	MPR (dB)
Frequency (MHz)				1850.7	1880	1914.3		
1.4	QPSK	1	0	12.83	12.80	13.50	13.5	0
1.4	QPSK	1	3	12.92	12.94	13.43		
1.4	QPSK	1	5	12.88	12.87	13.10		
1.4	QPSK	3	0	13.02	12.95	13.48	13.5	0
1.4	QPSK	3	1	12.98	12.98	13.47		
1.4	QPSK	3	3	13.04	13.00	13.41		
1.4	QPSK	6	0	13.00	12.97	13.31	13.5	0
1.4	16QAM	1	0	13.05	13.20	13.23	13.5	0
1.4	16QAM	1	3	13.14	13.33	13.35		
1.4	16QAM	1	5	13.07	13.31	13.13		
1.4	16QAM	3	0	12.90	13.00	13.36	13.5	0
1.4	16QAM	3	1	12.89	13.05	13.22		
1.4	16QAM	3	3	12.93	13.06	13.15		
1.4	16QAM	6	0	12.95	13.10	13.10	13.5	0

**<WLAN Conducted Power>****General Note:**

1. For WLAN SAR testing was performed on single antenna RF power in SISO mode is larger or equal to the single antenna RF power in MIMO mode, and for RF exposure assessment of MIMO mode simultaneous transmission exclusion analysis was performed with SAR test results of each antenna in SISO mode.
2. Per KDB 248227 D01v02r02, the simultaneous SAR provisions in KDB publication 447498 should be applied to determine simultaneous transmission SAR test exclusion for WiFi MIMO. If the sum of 1g single transmission chain SAR measurements is < 1.6W/kg and SAR peak to location ratio < 0.04, no additional SAR measurements for MIMO.
3. Per KDB 248227 D01v02r02, SAR test reduction is determined according to 802.11 transmission mode configurations and certain exposure conditions with multiple test positions. In the 2.4 GHz band, separate SAR procedures are applied to DSSS and OFDM configurations to simplify DSSS test requirements. For OFDM, in both 2.4 and 5 GHz bands, an initial test configuration must be determined for each standalone and aggregated frequency band, according to the transmission mode configuration with the highest maximum output power specified for production units to perform SAR measurements. If the same highest maximum output power applies to different combinations of channel bandwidths, modulations and data rates, additional procedures are applied to determine which test configurations require SAR measurement. When applicable, an initial test position may be applied to reduce the number of SAR measurements required for next to the ear, UMPC mini-tablet or hotspot mode configurations with multiple test positions.
4. For 2.4 GHz 802.11b DSSS, either the initial test position procedure for multiple exposure test positions or the DSSS procedure for fixed exposure position is applied; these are mutually exclusive. For 2.4 GHz and 5 GHz OFDM configurations, the initial test configuration is applied to measure SAR using either the initial test position procedure for multiple exposure test position configurations or the initial test configuration procedures for fixed exposure test conditions. Based on the reported SAR of the measured configurations and maximum output power of the transmission mode configurations that are not included in the initial test configuration, the subsequent test configuration and initial test position procedures are applied to determine if SAR measurements are required for the remaining OFDM transmission configurations. In general, the number of test channels that require SAR measurement is minimized based on maximum output power measured for the test sample(s).
5. For OFDM transmission configurations in the 2.4 GHz and 5 GHz bands, When the same maximum power is specified for multiple transmission modes in a frequency band, the largest channel bandwidth, lowest order modulation, lowest data rate and lowest order 802.11a/g/n/ac mode is used for SAR measurement, on the highest measured output power channel for each frequency band.
6. DSSS and OFDM configurations are considered separately according to the required SAR procedures. SAR is measured in the initial test position using the 802.11 transmission mode configuration required by the DSSS procedure or initial test configuration and subsequent test configuration(s) according to the OFDM procedures.18 The initial test position procedure is described in the following:
  - a. When the reported SAR of the initial test position is  $\leq 0.4$  W/kg, further SAR measurement is not required for the other test positions in that exposure configuration and 802.11 transmission mode combinations within the frequency band or aggregated band.
  - b. When the reported SAR of the test position is  $> 0.4$  W/kg, SAR is repeated for the 802.11 transmission mode configuration tested in the initial test position to measure the subsequent next closet/smallest test separation distance and maximum coupling test position on the highest maximum output power channel, until the report SAR is  $\leq 0.8$  W/kg or all required test position are tested.
  - c. For all positions/configurations, when the reported SAR is  $> 0.8$  W/kg, SAR is measured for these test positions/configurations on the subsequent next highest measured output power channel(s) until the reported SAR is  $\leq 1.2$  W/kg or all required channels are tested.



<2.4GHz WLAN ANT 1>

	Mode	Channel	Frequency (MHz)	Data Rate	Average power (dBm)	Tune-Up Limit	Duty Cycle %
2.4GHz WLAN ANT 1	802.11b	CH 1	2412	1Mbps	13.11	13.50	98.62
		CH 6	2437		13.24	13.50	
		CH 11	2462		13.05	13.50	
	802.11g	CH 1	2412	6Mbps	13.39	13.50	92.21
		CH 6	2437		13.41	13.50	
		CH 11	2462		13.33	13.50	
	802.11n-HT20	CH 1	2412	MCS0	13.26	13.50	93.06
		CH 6	2437		13.32	13.50	
		CH 11	2462		13.28	13.50	
	802.11ac-VHT20	CH 1	2412	MCS0	13.40	13.50	91.78
		CH 6	2437		13.46	13.50	
		CH 11	2462		13.43	13.50	
	802.11n-HT40	CH 3	2422	MCS0	13.18	13.50	85.71
		CH 6	2437		13.32	13.50	
		CH 9	2452		13.22	13.50	
802.11ac-VHT40	CH 3	2422	MCS0	13.25	13.50	85.90	
	CH 6	2437		13.38	13.50		
	CH 9	2452		13.23	13.50		

<2.4GHz WLAN ANT 2>

	Mode	Channel	Frequency (MHz)	Data Rate	Average power (dBm)	Tune-Up Limit	Duty Cycle %
2.4GHz WLAN ANT 2	802.11b	CH 1	2412	1Mbps	15.39	15.50	98.62
		CH 6	2437		15.41	15.50	
		CH 11	2462		15.25	15.50	
	802.11g	CH 1	2412	6Mbps	15.30	15.50	92.21
		CH 6	2437		15.34	15.50	
		CH 11	2462		15.23	15.50	
	802.11n-HT20	CH 1	2412	MCS0	15.23	15.50	93.06
		CH 6	2437		15.32	15.50	
		CH 11	2462		15.19	15.50	
	802.11ac-VHT20	CH 1	2412	MCS0	15.38	15.50	93.06
		CH 6	2437		15.42	15.50	
		CH 11	2462		15.30	15.50	
	802.11n-HT40	CH 3	2422	MCS0	15.20	15.50	85.71
		CH 6	2437		15.29	15.50	
		CH 9	2452		14.21	14.50	
802.11ac-VHT40	CH 3	2422	MCS0	15.33	15.50	85.71	
	CH 6	2437		15.43	15.50		
	CH 9	2452		14.26	14.50		



<2.4GHz WLAN ANT 1+2>

	Mode	Channel	Frequency (MHz)	Data Rate	Average power (dBm)	Tune-Up Limit	Duty Cycle %
2.4GHz WLAN ANT 1+2	802.11b	CH 1	2412	1Mbps	16.40	16.50	98.62
		CH 6	2437		16.42	16.50	
		CH 11	2462		16.38	16.50	
	802.11g	CH 1	2412	6Mbps	16.42	16.50	92.21
		CH 6	2437		16.46	16.50	
		CH 11	2462		16.40	16.50	
	802.11n-HT20	CH 1	2412	MCS0	16.38	16.50	93.06
		CH 6	2437		16.40	16.50	
		CH 11	2462		16.28	16.50	
	802.11ac-VHT20	CH 1	2412	MCS0	16.43	16.50	93.06
		CH 6	2437		16.45	16.50	
		CH 11	2462		16.29	16.50	
	802.11n-HT40	CH 3	2422	MCS0	16.24	16.50	85.71
		CH 6	2437		16.30	16.50	
		CH 9	2452		16.17	16.50	
802.11ac-VHT40	CH 3	2422	MCS0	16.37	16.50	85.71	
	CH 6	2437		16.40	16.50		
	CH 9	2452		16.26	16.50		



<5GHz WLAN ANT1>

	Mode	Channel	Frequency (MHz)	Data Rate	Average power (dBm)	Tune-Up Limit	Duty Cycle %
5.2GHz WLAN ANT 1	802.11a	CH 36	5180	6Mbps	11.31	11.50	92.73
		CH 40	5200		10.90	11.50	
		CH 44	5220		11.33	11.50	
		CH 48	5240		11.24	11.50	
	802.11n-HT20	CH 36	5180	MCS0	11.31	11.50	93.20
		CH 40	5200		10.75	11.50	
		CH 44	5220		11.37	11.50	
		CH 48	5240		11.26	11.50	
	802.11n-HT40	CH 38	5190	MCS0	11.38	11.50	86.84
		CH 46	5230		11.30	11.50	
	802.11ac-VHT20	CH 36	5180	MCS0	11.36	11.50	93.20
		CH 40	5200		10.87	11.50	
		CH 44	5220		11.34	11.50	
CH 48		5240	11.22		11.50		
802.11ac-VHT40	CH 38	5190	MCS0	11.47	11.50	85.94	
	CH 46	5230		11.35	11.50		
802.11ac-VHT80	CH 42	5210	MCS0	10.89	11.00	76.85	

	Mode	Channel	Frequency (MHz)	Data Rate	Average power (dBm)	Tune-Up Limit	Duty Cycle %
5.3GHz WLAN ANT 1	802.11a	CH 52	5260	6Mbps	11.38	11.50	92.73
		CH 56	5280		10.77	11.50	
		CH 60	5300		11.32	11.50	
		CH 64	5320		11.31	11.50	
	802.11n-HT20	CH 52	5260	MCS0	11.31	11.50	93.20
		CH 56	5280		10.71	11.50	
		CH 60	5300		11.32	11.50	
		CH 64	5320		11.13	11.50	
	802.11n-HT40	CH 54	5270	MCS0	11.34	11.50	86.84
		CH 62	5310		11.20	11.50	
	802.11ac-VHT20	CH 52	5260	MCS0	11.37	11.50	93.20
		CH 56	5280		10.77	11.50	
		CH 60	5300		11.31	11.50	
CH 64		5320	11.34		11.50		
802.11ac-VHT40	CH 54	5270	MCS0	11.31	11.50	85.94	
	CH 62	5310		11.35	11.50		
802.11ac-VHT80	CH 58	5290	MCS0	10.78	11.00	76.85	



5.5GHz WLAN ANT 1	Mode	Channel	Frequency (MHz)	Data Rate	Average power (dBm)	Tune-Up Limit	Duty Cycle %
	802.11a	CH 100	5500	6Mbps	10.42	10.50	92.73
		CH 116	5580		10.48		
		CH 132	5660		9.85		
		CH 140	5700		10.37		
	802.11n-HT20	CH 100	5500	MCS0	10.19	10.50	93.20
		CH 116	5580		10.21		
		CH 132	5660		9.75		
		CH 140	5700		10.42		
	802.11n-HT40	CH 102	5510	MCS0	10.35	10.50	86.84
CH 110		5550	10.21				
CH 134		5670	10.33				
802.11ac-VHT20	CH 100	5500	MCS0	10.35	10.50	93.20	
	CH 116	5580		10.33			
	CH 132	5660		9.80			
	CH 140	5700		10.44			
802.11ac-VHT40	CH 102	5510	MCS0	10.48	10.50	85.94	
	CH 110	5550		10.30			
	CH 134	5670		10.43			
802.11ac-VHT80	CH 106	5530	MCS0	9.89	10.00	76.85	

5.8GHz WLAN ANT 1	Mode	Channel	Frequency (MHz)	Data Rate	Average power (dBm)	Tune-Up Limit	Duty Cycle %
	802.11a	CH 149	5745	MCS0	11.34	11.50	92.73
		CH 157	5785		11.30		
		CH 165	5825		11.36		
	802.11n-HT20	CH 149	5745	MCS0	11.43	11.50	93.20
		CH 157	5785		11.35		
		CH 165	5825		11.23		
	802.11n-HT40	CH 151	5755	MCS0	11.21	11.50	86.84
		CH 159	5795		11.31		
	802.11ac-VHT20	CH 149	5745	MCS0	11.49	11.50	93.20
CH 157		5785	11.37				
CH 165		5825	11.36				
802.11ac-VHT40	CH 151	5755	MCS0	11.49	11.50	85.94	
	CH 159	5795		11.47			
802.11ac-VHT80	CH 155	5775	MCS0	10.98	11.00	76.85	



<5GHz WLAN ANT2>

	Mode	Channel	Frequency (MHz)	Data Rate	Average power (dBm)	Tune-Up Limit	Duty Cycle %
5.2GHz WLAN ANT 2	802.11a	CH 36	5180	6Mbps	11.16	11.50	92.69
		CH 40	5200		10.87	11.50	
		CH 44	5220		11.30	11.50	
		CH 48	5240		11.32	11.50	
	802.11n-HT20	CH 36	5180	MCS0	11.17	11.50	93.20
		CH 40	5200		10.68	11.50	
		CH 44	5220		11.38	11.50	
		CH 48	5240		11.32	11.50	
	802.11n-HT40	CH 38	5190	MCS0	11.43	11.50	86.84
		CH 46	5230		11.26	11.50	
	802.11ac-VHT20	CH 36	5180	MCS0	11.26	11.50	93.20
		CH 40	5200		10.75	11.50	
		CH 44	5220		11.39	11.50	
		CH 48	5240		11.24	11.50	
802.11ac-VHT40	CH 38	5190	MCS0	11.46	11.50	86.46	
	CH 46	5230		11.33	11.50		
802.11ac-VHT80	CH 42	5210	MCS0	10.90	11.00	76.50	

	Mode	Channel	Frequency (MHz)	Data Rate	Average power (dBm)	Tune-Up Limit	Duty Cycle %
5.3GHz WLAN ANT 2	802.11a	CH 52	5260	6Mbps	11.44	11.50	92.69
		CH 56	5280		10.82	11.50	
		CH 60	5300		11.29	11.50	
		CH 64	5320		11.26	11.50	
	802.11n-HT20	CH 52	5260	MCS0	11.30	11.50	93.20
		CH 56	5280		10.83	11.50	
		CH 60	5300		11.33	11.50	
		CH 64	5320		11.37	11.50	
	802.11n-HT40	CH 54	5270	MCS0	11.23	11.50	86.84
		CH 62	5310		11.31	11.50	
	802.11ac-VHT20	CH 52	5260	MCS0	11.37	11.50	93.20
		CH 56	5280		10.88	11.50	
		CH 60	5300		11.31	11.50	
		CH 64	5320		11.39	11.50	
802.11ac-VHT40	CH 54	5270	MCS0	11.33	11.50	86.46	
	CH 62	5310		11.41	11.50		
802.11ac-VHT80	CH 58	5290	MCS0	10.79	11.00	76.50	





	Mode	Channel	Frequency (MHz)	Data Rate	Average power (dBm)	Tune-Up Limit	Duty Cycle %
5.5GHz WLAN ANT 2	802.11a	CH 100	5500	6Mbps	12.76	13.00	92.69
		CH 116	5580		12.64	13.00	
		CH 132	5660		12.39	13.00	
		CH 140	5700		12.60	13.00	
	802.11n-HT20	CH 100	5500	MCS0	12.77	13.00	93.20
		CH 116	5580		12.67	13.00	
		CH 132	5660		12.28	13.00	
		CH 140	5700		12.73	13.00	
	802.11n-HT40	CH 102	5510	MCS0	12.77	13.00	86.84
		CH 110	5550		12.62	13.00	
		CH 134	5670		12.82	13.00	
	802.11ac-VHT20	CH 100	5500	MCS0	12.82	13.00	93.20
		CH 116	5580		12.80	13.00	
		CH 132	5660		12.22	13.00	
CH 140		5700	12.76		13.00		
802.11ac-VHT40	CH 102	5510	MCS0	12.81	13.00	86.46	
	CH 110	5550		12.78	13.00		
	CH 134	5670		12.89	13.00		
802.11ac-VHT80	CH 106	5530	MCS0	12.30	12.50	76.50	

	Mode	Channel	Frequency (MHz)	Data Rate	Average power (dBm)	Tune-Up Limit	Duty Cycle %
5.8GHz WLAN ANT 2	802.11a	CH 149	5745	MCS0	12.99	13.00	92.69
		CH 157	5785		12.98	13.00	
		CH 165	5825		12.80	13.00	
	802.11n-HT20	CH 149	5745	MCS0	12.85	13.00	93.20
		CH 157	5785		12.84	13.00	
		CH 165	5825		12.70	13.00	
	802.11n-HT40	CH 151	5755	MCS0	12.77	13.00	86.84
		CH 159	5795		12.61	13.00	
	802.11ac-VHT20	CH 149	5745	MCS0	12.86	13.00	93.20
		CH 157	5785		12.90	13.00	
		CH 165	5825		12.88	13.00	
	802.11ac-VHT40	CH 151	5755	MCS0	12.79	13.00	86.46
		CH 159	5795		12.76	13.00	
	802.11ac-VHT80	CH 155	5775	MCS0	12.37	12.50	76.50



<5GHz WLAN ANT1+2>

	Mode	Channel	Frequency (MHz)	Data Rate	Average power (dBm)	Tune-Up Limit	Duty Cycle %
5.2GHz WLAN ANT 1+2	802.11a	CH 36	5180	6Mbps	14.32	14.50	92.73
		CH 40	5200		13.92	14.50	
		CH 44	5220		14.34	14.50	
		CH 48	5240		14.39	14.50	
	802.11n-HT20	CH 36	5180	MCS0	14.38	14.50	92.23
		CH 40	5200		13.88	14.50	
		CH 44	5220		14.39	14.50	
		CH 48	5240		14.36	14.50	
	802.11n-HT40	CH 38	5190	MCS0	14.48	14.50	85.49
		CH 46	5230		14.31	14.50	
	802.11ac-VHT20	CH 36	5180	MCS0	14.37	14.50	92.31
		CH 40	5200		13.91	14.50	
		CH 44	5220		14.44	14.50	
		CH 48	5240		14.39	14.50	
802.11ac-VHT40	CH 38	5190	MCS0	14.49	14.50	86.46	
	CH 46	5230		14.35	14.50		
802.11ac-VHT80	CH 42	5210	MCS0	12.56	14.00	75.93	

	Mode	Channel	Frequency (MHz)	Data Rate	Average power (dBm)	Tune-Up Limit	Duty Cycle %
5.3GHz WLAN ANT 1+2	802.11a	CH 52	5260	6Mbps	14.49	14.50	92.73
		CH 56	5280		13.88	14.50	
		CH 60	5300		14.35	14.50	
		CH 64	5320		14.33	14.50	
	802.11n-HT20	CH 52	5260	MCS0	14.32	14.50	92.23
		CH 56	5280		13.82	14.50	
		CH 60	5300		14.35	14.50	
		CH 64	5320		14.41	14.50	
	802.11n-HT40	CH 54	5270	MCS0	14.32	14.50	85.49
		CH 62	5310		14.44	14.50	
	802.11ac-VHT20	CH 52	5260	MCS0	14.39	14.50	92.31
		CH 56	5280		13.91	14.50	
		CH 60	5300		14.32	14.50	
		CH 64	5320		14.43	14.50	
802.11ac-VHT40	CH 54	5270	MCS0	14.34	14.50	86.46	
	CH 62	5310		14.45	14.50		
802.11ac-VHT80	CH 58	5290	MCS0	13.83	14.00	75.93	



	Mode	Channel	Frequency (MHz)	Data Rate	Average power (dBm)	Tune-Up Limit	Duty Cycle %
5.5GHz WLAN ANT 1+2	802.11a	CH 100	5500	6Mbps	13.37	13.50	92.73
		CH 116	5580		13.48	13.50	
		CH 132	5660		12.83	13.50	
		CH 140	5700		13.32	13.50	
	802.11n-HT20	CH 100	5500	MCS0	13.45	13.50	92.23
		CH 116	5580		13.47	13.50	
		CH 132	5660		12.87	13.50	
		CH 140	5700		13.25	13.50	
	802.11n-HT40	CH 102	5510	MCS0	13.21	13.50	85.49
		CH 110	5550		13.43	13.50	
		CH 134	5670		13.22	13.50	
	802.11ac-VHT20	CH 100	5500	MCS0	13.47	13.50	92.31
		CH 116	5580		13.48	13.50	
		CH 132	5660		12.93	13.50	
CH 140		5700	13.46		13.50		
802.11ac-VHT40	CH 102	5510	MCS0	13.36	13.50	86.46	
	CH 110	5550		13.45	13.50		
	CH 134	5670		13.46	13.50		
802.11ac-VHT80	CH 106	5530	MCS0	12.80	13.00	75.93	

	Mode	Channel	Frequency (MHz)	Data Rate	Average power (dBm)	Tune-Up Limit	Duty Cycle %
5.8GHz WLAN ANT 1+2	802.11a	CH 149	5745	MCS0	14.46	14.50	92.73
		CH 157	5785		14.44	14.50	
		CH 165	5825		14.37	14.50	
	802.11n-HT20	CH 149	5745	MCS0	14.24	14.50	92.23
		CH 157	5785		14.14	14.50	
		CH 165	5825		14.23	14.50	
	802.11n-HT40	CH 151	5755	MCS0	14.48	14.50	85.49
		CH 159	5795		14.36	14.50	
	802.11ac-VHT20	CH 149	5745	MCS0	14.31	14.50	92.31
		CH 157	5785		14.21	14.50	
		CH 165	5825		14.27	14.50	
	802.11ac-VHT40	CH 151	5755	MCS0	14.49	14.50	86.46
		CH 159	5795		14.37	14.50	
	802.11ac-VHT80	CH 155	5775	MCS0	13.98	14.00	75.93



**<2.4GHz Bluetooth>**

**General Note:**

1. For 2.4GHz Bluetooth SAR testing was selected 1Mbps, due to its highest average power.
2. The duty factor is selected theoretical 83.3% perform Bluetooth SAR testing.

Mode	Channel	Frequency (MHz)	Average power (dBm)		
			1Mbps	2Mbps	3Mbps
EDR	CH 00	2402	5.78	3.58	3.55
	CH 39	2441	6.62	4.59	4.58
	CH 78	2480	6.87	5.06	5.03
Tune-up Limit			7	5.5	5.5

Mode	Channel	Frequency (MHz)	Average power (dBm)
			GFSK
LE	CH 00	2402	3.49
	CH 19	2440	4.40
	CH 39	2480	5.28
Tune-up Limit			5.5



<SAR test exclusion table>

**General Note:**

1. The below table, when the distance is < 50 mm exclusion threshold is "Ratio", when the distance is > 50 mm exclusion threshold is "mW"
2. Maximum power is the source-based time-average power and represents the maximum RF output power among production units
3. Per KDB 447498 D01v06, for larger devices, the test separation distance of adjacent edge configuration is determined by the closest separation between the antenna and the user.
4. Per KDB 447498 D01v06, standalone SAR test exclusion threshold is applied; If the test separation distance is < 5mm, 5mm is used to determine SAR exclusion threshold.
5. Per KDB 447498 D01v06, the 1-g and 10-g SAR test exclusion thresholds for 100 MHz to 6 GHz at *test separation distances* ≤ 50 mm are determined by:
  - $[(max. \text{ power of channel, including tune-up tolerance, mW}) / (min. \text{ test separation distance, mm})] \cdot \sqrt{f(\text{GHz})} \leq 3.0$  for 1-g SAR and ≤ 7.5 for 10-g extremity SAR
  - f(GHz) is the RF channel transmit frequency in GHz
  - Power and distance are rounded to the nearest mW and mm before calculation
  - The result is rounded to one decimal place for comparison
6. Per KDB 447498 D01v06, at 100 MHz to 6 GHz and for *test separation distances* > 50 mm, the SAR test exclusion threshold is determined according to the following
  - a) [Threshold at 50 mm in step 1) + (test separation distance - 50 mm) · ( f(MHz)/150)] mW, at 100 MHz to 1500 MHz
  - b) [Threshold at 50 mm in step 1) + (test separation distance - 50 mm) · 10] mW at > 1500 MHz and ≤ 6 GHz

Exposure Position	Wireless Interface	GPRS 850	GPRS 1900	WCDMA Band V	WCDMA Band IV	WCDMA Band II	CDMA BC10	CDMA BC0	CDMA BC1	LTE Band 17	LTE Band 13	LTE Band 5	LTE Band 4	LTE Band 2	LTE Band 25
	Calculated Frequency	848MHz	1909MHz	846MHz	1750MHz	1907MHz	846MHz	848MHz	1907MHz	713MHz	784MHz	848MHz	1754MHz	1909MHz	1914MHz
	Maximum power (dBm)	27.0	24.0	24.0	24.0	24.0	24.5	24.5	24.5	24.0	24.0	24.0	24.0	24.0	24.0
	Maximum rated power(mW)	501.0	251.0	251.0	251.0	251.0	282.0	282.0	282.0	251.0	251.0	251.0	251.0	251.0	251.0
Bottom Face	Separation distance(mm)	5.0													
	exclusion threshold	92.3	69.4	46.2	66.4	69.3	51.9	51.9	77.9	42.4	44.5	46.2	66.5	69.4	69.5
	Testing required?	Yes	Yes	Yes	Yes	Yes	Yes	Yes	Yes	Yes	Yes	Yes	Yes	Yes	Yes
Edge 1	Separation distance(mm)	5.0													
	exclusion threshold	92.3	69.4	46.2	66.4	69.3	51.9	51.9	77.9	42.4	44.5	46.2	66.5	69.4	69.5
	Testing required?	Yes	Yes	Yes	Yes	Yes	Yes	Yes	Yes	Yes	Yes	Yes	Yes	Yes	Yes
Edge 2	Separation distance(mm)	138.0													
	exclusion threshold	660.0	989.0	659.0	993.0	989.0	659.0	660.0	989.0	596.0	629.0	660.0	993.0	989.0	988.0
	Testing required?	No	No	No	No	No	No	No	No	No	No	No	No	No	No
Edge 3	Separation distance(mm)	166.0													
	exclusion threshold	819.0	1269.0	817.0	1273.0	1269.0	817.0	819.0	1269.0	729.0	776.0	819.0	1273.0	1269.0	1268.0
	Testing required?	No	No	No	No	No	No	No	No	No	No	No	No	No	No
Edge 4	Separation distance(mm)	74.0													
	exclusion threshold	299.0	349.0	298.0	353.0	349.0	298.0	299.0	349.0	292.0	295.0	299.0	353.0	349.0	348.0
	Testing required?	Yes	No	No	No	No	No	No	No	No	No	No	No	No	No



Exposure Position	Wireless Interface	2.4GHz WLAN ANT 1	2.4GHz WLAN ANT 2	5GHz WLAN ANT 1	5GHz WLAN ANT 2
	Calculated Frequency	2462MHz	2462MHz	5825MHz	5825MHz
	Maximum power (dBm)	13.5	15.0	11.5	13.0
	Maximum rated power(mW)	22.0	32.0	14.0	20.0
Bottom Face	Separation distance(mm)	5.0	5.0	5.0	5.0
	exclusion threshold	6.9	10.0	6.8	9.7
	Testing required?	<b>Yes</b>	<b>Yes</b>	<b>Yes</b>	<b>Yes</b>
Edge 1	Separation distance(mm)	24.0	107.0	24.0	107.0
	exclusion threshold	1.4	666.0	1.4	632.0
	Testing required?	<b>No</b>	<b>No</b>	<b>No</b>	<b>No</b>
Edge 2	Separation distance(mm)	5.0	5.0	5.0	5.0
	exclusion threshold	6.9	10.0	6.8	9.7
	Testing required?	<b>Yes</b>	<b>Yes</b>	<b>Yes</b>	<b>Yes</b>
Edge 3	Separation distance(mm)	146.0	63.0	146.0	63.0
	exclusion threshold	1056.0	226.0	1022.0	192.0
	Testing required?	<b>No</b>	<b>No</b>	<b>No</b>	<b>No</b>
Edge 4	Separation distance(mm)	249.0	249.0	249.0	249.0
	exclusion threshold	2086.0	2086.0	2052.0	2052.0
	Testing required?	<b>No</b>	<b>No</b>	<b>No</b>	<b>No</b>



## 14. SAR Test Results

### General Note:

1. Per KDB 447498 D01v06, the reported SAR is the measured SAR value adjusted for maximum tune-up tolerance.
  - a. Tune-up scaling Factor = tune-up limit power (mW) / EUT RF power (mW), where tune-up limit is the maximum rated power among all production units.
  - b. For SAR testing of WLAN signal with non-100% duty cycle, the measured SAR is scaled-up by the duty cycle scaling factor which is equal to "1/(duty cycle)"
  - c. For WWAN/Bluetooth: Reported SAR(W/kg)= Measured SAR(W/kg)\*Tune-up Scaling Factor
  - d. For WLAN: Reported SAR(W/kg)= Measured SAR(W/kg)\* Duty Cycle scaling factor \* Tune-up scaling factor
2. Per KDB 447498 D01v06, for each exposure position, testing of other required channels within the operating mode of a frequency band is not required when the *reported* 1-g or 10-g SAR for the mid-band or highest output power channel is:
  - $\leq 0.8$  W/kg or 2.0 W/kg, for 1-g or 10-g respectively, when the transmission band is  $\leq 100$  MHz
  - $\leq 0.6$  W/kg or 1.5 W/kg, for 1-g or 10-g respectively, when the transmission band is between 100 MHz and 200 MHz
  - $\leq 0.4$  W/kg or 1.0 W/kg, for 1-g or 10-g respectively, when the transmission band is  $\geq 200$  MHz
3. Per KDB 865664 D01v01r04, for each frequency band, repeated SAR measurement is required only when the measured SAR is  $\geq 0.8$ W/kg.
4. For the exposure positions that proximity sensor power reduction is applied for SAR compliance, additional SAR testing with EUT transmitting full power in normal mode was performed; 14mm for bottom face, 12mm for edge1

### GSM Note:

1. Per KDB 941225 D01v03r01, for SAR test reduction for GSM / GPRS / EDGE modes is determined by the source-based time-averaged output power including tune-up tolerance. The mode with highest specified time-averaged output power should be tested for SAR compliance in the applicable exposure conditions. For modes with the same specified maximum output power and tolerance, the higher number time-slot configuration should be tested. Therefore, the EDGE (4Tx slots) for GSM850/GSM1900 is considered as the primary mode when the power reduction is active, the GPRS (2Tx slots) for GSM850, the EDGE (4Tx slots) for GSM1900 is considered as the primary mode when the power reduction is inactive.
2. Other configurations of GSM / GPRS / EDGE are considered as secondary modes. The 3G SAR test reduction procedure is applied, when the maximum output power and tune-up tolerance specified for production units in a secondary mode is  $\leq 1/4$  dB higher than the primary mode, SAR measurement is not required for the secondary mode

### UMTS Note:

1. Per KDB 941225 D01v03r01, for SAR testing is measured using a 12.2 kbps RMC with TPC bits configured to all "1's".
2. Per KDB 941225 D01v03r01, RMC 12.2kbps setting is used to evaluate SAR. If the maximum output power and tune-up tolerance specified for production units in HSDPA / HSUPA / DC-HSDPA is  $\leq 1/4$  dB higher than RMC 12.2Kbps or when the highest reported SAR of the RMC12.2Kbps is scaled by the ratio of specified maximum output power and tune-up tolerance of HSDPA / HSUPA / DC-HSDPA to RMC12.2Kbps and the adjusted SAR is  $\leq 1.2$  W/kg, SAR measurement is not required for HSDPA / HSUPA / DC-HSDPA.

### CMDA Note:

1. Per KDB 941225 D01v03r01, when in Body SAR testing, the EUT is treated as data device and SAR is tested with Ev-Do Rev 0 (RTAP 153.6kbps) as the primary mode.



**LTE Note:**

1. Per KDB 941225 D05v02r05, start with the largest channel bandwidth and measure SAR for QPSK with 1 RB allocation, using the RB offset and required test channel combination with the highest maximum output power for RB offsets at the upper edge, middle and lower edge of each required test channel.
2. Per KDB 941225 D05v02r05, 50% RB allocation for QPSK SAR testing follows 1RB QPSK allocation procedure.
3. Per KDB 941225 D05v02r05, For QPSK with 100% RB allocation, SAR is not required when the highest maximum output power for 100 % RB allocation is less than the highest maximum output power in 50% and 1 RB allocations and the highest reported SAR for 1 RB and 50% RB allocation are  $\leq 0.8$  W/kg. Otherwise, SAR is measured for the highest output power channel; and if the reported SAR is  $> 1.45$  W/kg, the remaining required test channels must also be tested.
4. Per KDB 941225 D05v02r05, 16QAM output power for each RB allocation configuration is  $>$  not  $\frac{1}{2}$  dB higher than the same configuration in QPSK and the reported SAR for the QPSK configuration is  $\leq 1.45$  W/kg; Per KDB 941225 D05v02r05, 16QAM SAR testing is not required.
5. Per KDB 941225 D05v02r05, Smaller bandwidth output power for each RB allocation configuration is  $>$  not  $\frac{1}{2}$  dB higher than the same configuration in the largest supported bandwidth, and the reported SAR for the largest supported bandwidth is  $\leq 1.45$  W/kg; Per KDB 941225 D05v02r05, smaller bandwidth SAR testing is not required.
6. For LTE B4/B5/B17 the maximum bandwidth does not support three non-overlapping channels, per KDB 941225 D05v02r05, when a device supports overlapping channel assignment in a channel bandwidth configuration, the middle channel of the group of overlapping channels should be selected for testing.
7. LTE band 2 SAR test was covered by Band 25; according to TCB workshop, SAR test for overlapping LTE bands can be reduced if
  - a. The maximum output power, including tolerance, for the smaller band is  $\leq$  the larger band to qualify for the SAR test exclusion.
  - b. The channel bandwidth and other operating parameters for the smaller band are fully supported by the larger band.

**WLAN Note:**

1. Per KDB 248227 D01v02r02, for 2.4GHz 802.11g/n SAR testing is not required when the highest reported SAR for DSSS is adjusted by the ratio of OFDM to DSSS specified maximum output power and the adjusted SAR is  $\leq 1.2$  W/kg.
2. Per KDB 248227 D01v02r02, for U-NII-1 SAR testing is not required when the U-NII-2A band highest reported SAR for a test configuration is  $\leq 1.2$  W/kg, SAR is not required for U-NII-1 band.
3. When the reported SAR of the test position is  $> 0.4$  W/kg, SAR is repeated for the 802.11 transmission mode configuration tested in the initial test position to measure the subsequent next closet/smallest test separation distance and maximum coupling test position on the highest maximum output power channel, until the report SAR is  $\leq 0.8$  W/kg or all required test position are tested.
4. For all positions / configurations, when the reported SAR is  $> 0.8$  W/kg, SAR is measured for these test positions / configurations on the subsequent next highest measured output power channel(s) until the reported SAR is  $\leq 1.2$  W/kg or all required channels are tested.
5. For WLAN SAR testing was performed on single antenna RF power in SISO mode is larger or equal to the single antenna RF power in MIMO mode, and for RF exposure assessment of MIMO mode simultaneous transmission exclusion analysis was performed with SAR test results of each antenna in SISO mode.
6. Per KDB 248227 D01v02r02, the simultaneous SAR provisions in KDB publication 447498 should be applied to determine simultaneous transmission SAR test exclusion for WiFi MIMO. If the sum of 1g single transmission chain SAR measurements is  $< 1.6$ W/kg and SAR peak to location ratio  $< 0.04$ , no additional SAR measurements for MIMO.
7. During SAR testing the WLAN transmission was verified using a spectrum analyzer.



14.1 Body SAR

<GSM SAR>

Plot No.	Band	Mode	Test Position	Gap (mm)	Power Reduction	Ch.	Freq. (MHz)	Average Power (dBm)	Tune-Up Limit (dBm)	Tune-up Scaling Factor	Power Drift (dB)	Measured 1g SAR (W/kg)	Reported 1g SAR (W/kg)
	GSM850	GPRS (2 Tx slots)	Bottom Face	14mm	OFF	128	824.2	32.01	33.00	1.256	-0.14	0.726	0.912
01	GSM850	GPRS (2 Tx slots)	Bottom Face	14mm	OFF	189	836.4	31.99	33.00	1.262	-0.19	0.774	0.977
	GSM850	GPRS (2 Tx slots)	Bottom Face	14mm	OFF	251	848.8	31.92	33.00	1.282	-0.11	0.762	0.977
	GSM850	GPRS (2 Tx slots)	Edge 1	12mm	OFF	128	824.2	32.01	33.00	1.256	0.03	0.638	0.801
	GSM850	GPRS (2 Tx slots)	Edge 1	12mm	OFF	189	836.4	31.99	33.00	1.262	-0.06	0.635	0.801
	GSM850	GPRS (2 Tx slots)	Edge 1	12mm	OFF	251	848.8	31.92	33.00	1.282	-0.12	0.571	0.732
	GSM850	EDGE (4 Tx slots)	Bottom Face	0mm	ON	251	848.8	20.42	21.00	1.143	-0.12	0.286	0.327
	GSM850	EDGE (4 Tx slots)	Edge 1	0mm	ON	251	848.8	20.42	21.00	1.143	-0.07	0.159	0.182
	GSM850	GPRS (2 Tx slots)	Edge 4	0mm	OFF	128	824.2	32.01	33.00	1.256	-0.11	0.340	0.427
	GSM1900	EDGE (4 Tx slots)	Bottom Face	14mm	OFF	512	1850.2	25.44	27.00	1.432	-0.04	0.324	0.464
	GSM1900	EDGE (4 Tx slots)	Edge 1	12mm	OFF	512	1850.2	25.44	27.00	1.432	0	0.309	0.443
	GSM1900	EDGE (4 Tx slots)	Bottom Face	0mm	ON	661	1880	16.31	17.00	1.172	-0.14	0.356	0.417
	GSM1900	EDGE (4 Tx slots)	Edge 1	0mm	ON	661	1880	16.31	17.00	1.172	0.12	0.425	0.498
02	GSM1900	EDGE (4 Tx slots)	Edge 1	0mm	ON	512	1850.2	16.21	17.00	1.199	0.17	0.477	0.572
	GSM1900	EDGE (4 Tx slots)	Edge 1	0mm	ON	810	1909.8	16.25	17.00	1.189	0.08	0.455	0.541

<WCDMA SAR>

Plot No.	Band	Mode	Test Position	Gap (mm)	Power Reduction	Ch.	Freq. (MHz)	Average Power (dBm)	Tune-Up Limit (dBm)	Tune-up Scaling Factor	Power Drift (dB)	Measured 1g SAR (W/kg)	Reported 1g SAR (W/kg)
	WCDMA II	RMC 12.2Kbps	Bottom Face	14mm	OFF	9538	1907.6	23.02	24.00	1.253	0.04	0.437	0.548
	WCDMA II	RMC 12.2Kbps	Edge 1	12mm	OFF	9538	1907.6	23.02	24.00	1.253	0.1	0.466	0.584
	WCDMA II	RMC 12.2Kbps	Bottom Face	0mm	ON	9262	1852.4	14.66	15.00	1.081	-0.15	0.689	0.745
	WCDMA II	RMC 12.2Kbps	Edge 1	0mm	ON	9262	1852.4	14.66	15.00	1.081	0.14	0.799	0.864
	WCDMA II	RMC 12.2Kbps	Edge 1	0mm	ON	9400	1880	14.21	15.00	1.199	0.05	0.601	0.721
03	WCDMA II	RMC 12.2Kbps	Edge 1	0mm	ON	9538	1907.6	14.54	15.00	1.112	0.05	0.788	0.876
	WCDMA IV	RMC 12.2Kbps	Bottom Face	14mm	OFF	1312	1712.4	22.99	24.00	1.262	-0.13	0.328	0.414
	WCDMA IV	RMC 12.2Kbps	Edge 1	12mm	OFF	1312	1712.4	22.99	24.00	1.262	-0.1	0.245	0.309
	WCDMA IV	RMC 12.2Kbps	Bottom Face	0mm	ON	1413	1732.6	13.72	14.00	1.067	-0.19	0.412	0.439
04	WCDMA IV	RMC 12.2Kbps	Edge 1	0mm	ON	1413	1732.6	13.72	14.00	1.067	0.14	0.449	0.479
	WCDMA IV	RMC 12.2Kbps	Edge 1	0mm	ON	1312	1712.4	13.58	14.00	1.102	0.19	0.325	0.358
	WCDMA IV	RMC 12.2Kbps	Edge 1	0mm	ON	1513	1752.6	13.18	14.00	1.208	0.13	0.334	0.403
	WCDMA V	RMC 12.2Kbps	Bottom Face	14mm	OFF	4132	826.4	23.01	24.00	1.256	-0.19	0.425	0.534
	WCDMA V	RMC 12.2Kbps	Bottom Face	14mm	OFF	4182	836.4	22.84	24.00	1.306	-0.13	0.439	0.573
05	WCDMA V	RMC 12.2Kbps	Bottom Face	14mm	OFF	4233	846.6	22.81	24.00	1.315	-0.07	0.447	0.588
	WCDMA V	RMC 12.2Kbps	Edge 1	12mm	OFF	4132	826.4	23.01	24.00	1.256	-0.03	0.405	0.509
	WCDMA V	RMC 12.2Kbps	Bottom Face	0mm	ON	4132	826.4	17.85	18.00	1.035	-0.15	0.425	0.440
	WCDMA V	RMC 12.2Kbps	Edge 1	0mm	ON	4132	826.4	17.85	18.00	1.035	-0.03	0.261	0.270



<CDMA SAR>

Plot No.	Band	Mode	Test Position	Gap (mm)	Power Reduction	Ch.	Freq. (MHz)	Average Power (dBm)	Tune-Up Limit (dBm)	Tune-up Scaling Factor	Power Drift (dB)	Measured 1g SAR (W/kg)	Reported 1g SAR (W/kg)
	CDMA BC0	RTAP 153.6Kbps	Bottom Face	14mm	OFF	1013	824.7	23.49	24.50	1.262	-0.13	0.486	0.613
	CDMA BC0	RTAP 153.6Kbps	Bottom Face	14mm	OFF	384	836.52	23.47	24.50	1.268	-0.07	0.504	0.639
06	CDMA BC0	RTAP 153.6Kbps	Bottom Face	14mm	OFF	777	848.31	23.39	24.50	1.291	-0.13	0.500	0.646
	CDMA BC0	RTAP 153.6Kbps	Edge 1	12mm	OFF	1013	824.7	23.49	24.50	1.262	0.05	0.442	0.558
	CDMA BC0	RTAP 153.6Kbps	Bottom Face	0mm	ON	777	848.31	16.85	17.50	1.161	-0.17	0.321	0.373
	CDMA BC0	RTAP 153.6Kbps	Edge 1	0mm	ON	777	848.31	16.85	17.50	1.161	-0.08	0.184	0.214
	CDMA BC1	RTAP 153.6Kbps	Bottom Face	14mm	OFF	1175	1908.75	23.68	24.50	1.208	-0.03	0.501	0.605
	CDMA BC1	RTAP 153.6Kbps	Edge 1	12mm	OFF	1175	1908.75	23.68	24.50	1.208	-0.12	0.579	0.699
	CDMA BC1	RTAP 153.6Kbps	Bottom Face	0mm	ON	1175	1908.75	12.67	13.50	1.211	-0.18	0.462	0.559
07	CDMA BC1	RTAP 153.6Kbps	Edge 1	0mm	ON	1175	1908.75	12.67	13.50	1.211	-0.14	0.611	0.740
	CDMA BC1	RTAP 153.6Kbps	Edge 1	0mm	ON	25	1851.25	12.33	13.50	1.309	-0.17	0.494	0.647
	CDMA BC1	RTAP 153.6Kbps	Edge 1	0mm	ON	600	1880	12.36	13.50	1.300	-0.1	0.422	0.549
08	CDMA BC10	RTAP 153.6Kbps	Bottom Face	14mm	OFF	580	820.5	23.55	24.50	1.245	-0.11	0.457	0.569
	CDMA BC10	RTAP 153.6Kbps	Edge 1	12mm	OFF	580	820.5	23.55	24.50	1.245	-0.03	0.432	0.538
	CDMA BC10	RTAP 153.6Kbps	Bottom Face	0mm	ON	580	820.5	16.71	17.50	1.199	-0.11	0.393	0.471
	CDMA BC10	RTAP 153.6Kbps	Edge 1	0mm	ON	580	820.5	16.71	17.50	1.199	-0.07	0.210	0.252

<LTE SAR>

Plot No.	Band	BW (MHz)	Modulation	RB Size	RB offset	Test Position	Gap (mm)	Power Reduction	Ch.	Freq. (MHz)	Average Power (dBm)	Tune-Up Limit (dBm)	Tune-up Scaling Factor	Power Drift (dB)	Measured 1g SAR (W/kg)	Reported 1g SAR (W/kg)
	LTE Band 4	20M	QPSK	1	0	Bottom Face	14mm	OFF	20175	1732.5	23.12	24.00	1.225	-0.09	0.316	0.387
	LTE Band 4	20M	QPSK	50	0	Bottom Face	14mm	OFF	20175	1732.5	22.16	23.00	1.213	-0.05	0.244	0.296
	LTE Band 4	20M	QPSK	1	0	Edge 1	12mm	OFF	20175	1732.5	23.12	24.00	1.225	0.06	0.261	0.320
	LTE Band 4	20M	QPSK	50	0	Edge 1	12mm	OFF	20175	1732.5	22.16	23.00	1.213	0.04	0.194	0.235
	LTE Band 4	20M	QPSK	1	0	Bottom Face	0mm	ON	20175	1732.5	12.73	13.00	1.064	0.07	0.321	0.342
09	LTE Band 4	20M	QPSK	50	0	Bottom Face	0mm	ON	20175	1732.5	12.63	13.00	1.089	-0.02	0.364	0.396
	LTE Band 4	20M	QPSK	1	0	Edge 1	0mm	ON	20175	1732.5	12.73	13.00	1.064	-0.02	0.312	0.332
	LTE Band 4	20M	QPSK	50	0	Edge 1	0mm	ON	20175	1732.5	12.63	13.00	1.089	-0.06	0.332	0.362
10	LTE Band 5	10M	QPSK	1	0	Bottom Face	14mm	OFF	20525	836.5	22.86	24.00	1.300	-0.11	0.435	0.566
	LTE Band 5	10M	QPSK	25	0	Bottom Face	14mm	OFF	20525	836.5	21.86	23.00	1.300	-0.16	0.339	0.441
	LTE Band 5	10M	QPSK	1	0	Edge 1	12mm	OFF	20525	836.5	22.86	24.00	1.300	-0.01	0.345	0.449
	LTE Band 5	10M	QPSK	25	0	Edge 1	12mm	OFF	20525	836.5	21.86	23.00	1.300	0.01	0.265	0.345
	LTE Band 5	10M	QPSK	1	25	Bottom Face	0mm	ON	20525	836.5	16.32	17.00	1.169	-0.12	0.355	0.415
	LTE Band 5	10M	QPSK	25	12	Bottom Face	0mm	ON	20525	836.5	16.47	17.00	1.130	-0.15	0.363	0.410
	LTE Band 5	10M	QPSK	1	25	Edge 1	0mm	ON	20525	836.5	16.32	17.00	1.169	-0.12	0.198	0.232
	LTE Band 5	10M	QPSK	25	12	Edge 1	0mm	ON	20525	836.5	16.47	17.00	1.130	-0.18	0.201	0.227



Plot No.	Band	BW (MHz)	Modulation	RB Size	RB offset	Test Position	Gap (mm)	Power Reduction	Ch.	Freq. (MHz)	Average Power (dBm)	Tune-Up Limit (dBm)	Tune-up Scaling Factor	Power Drift (dB)	Measured 1g SAR (W/kg)	Reported 1g SAR (W/kg)
	LTE Band 13	10M	QPSK	1	0	Bottom Face	14mm	OFF	23230	782	22.73	24.00	1.340	-0.1	0.290	0.389
	LTE Band 13	10M	QPSK	25	0	Bottom Face	14mm	OFF	23230	782	21.71	23.00	1.346	-0.03	0.237	0.319
	LTE Band 13	10M	QPSK	1	0	Edge 1	12mm	OFF	23230	782	22.73	24.00	1.340	0	0.250	0.335
	LTE Band 13	10M	QPSK	25	0	Edge 1	12mm	OFF	23230	782	21.71	23.00	1.346	-0.03	0.212	0.285
	LTE Band 13	10M	QPSK	1	25	Bottom Face	0mm	ON	23230	782	18.96	19.00	1.009	-0.13	0.710	0.717
11	LTE Band 13	10M	QPSK	25	12	Bottom Face	0mm	ON	23230	782	18.90	19.00	1.023	-0.14	0.703	0.719
	LTE Band 13	10M	QPSK	1	25	Edge 1	0mm	ON	23230	782	18.96	19.00	1.009	0.05	0.399	0.403
	LTE Band 13	10M	QPSK	25	12	Edge 1	0mm	ON	23230	782	18.90	19.00	1.023	-0.03	0.395	0.404
	LTE Band 17	10M	QPSK	1	0	Bottom Face	14mm	OFF	23790	710	22.81	24.00	1.315	-0.04	0.227	0.299
	LTE Band 17	10M	QPSK	25	0	Bottom Face	14mm	OFF	23790	710	21.84	23.00	1.306	-0.03	0.189	0.247
	LTE Band 17	10M	QPSK	1	0	Edge 1	12mm	OFF	23790	710	22.81	24.00	1.315	0.03	0.216	0.284
	LTE Band 17	10M	QPSK	25	0	Edge 1	12mm	OFF	23790	710	21.84	23.00	1.306	0.03	0.179	0.234
	LTE Band 17	10M	QPSK	1	25	Bottom Face	0mm	ON	23790	710	18.91	19.00	1.021	-0.12	0.702	0.717
12	LTE Band 17	10M	QPSK	25	12	Bottom Face	0mm	ON	23790	710	18.91	19.00	1.021	-0.08	0.707	0.722
	LTE Band 17	10M	QPSK	1	25	Edge 1	0mm	ON	23790	710	18.91	19.00	1.021	0.04	0.458	0.468
	LTE Band 17	10M	QPSK	25	12	Edge 1	0mm	ON	23790	710	18.91	19.00	1.021	0.01	0.464	0.474
	LTE Band 25	20M	QPSK	1	0	Bottom Face	14mm	OFF	26140	1860	23.05	24.00	1.245	-0.06	0.328	0.408
	LTE Band 25	20M	QPSK	50	0	Bottom Face	14mm	OFF	26140	1860	22.14	23.00	1.219	0	0.270	0.329
	LTE Band 25	20M	QPSK	1	0	Edge 1	12mm	OFF	26140	1860	23.05	24.00	1.245	-0.13	0.311	0.387
	LTE Band 25	20M	QPSK	50	0	Edge 1	12mm	OFF	26140	1860	22.14	23.00	1.219	-0.11	0.257	0.313
	LTE Band 25	20M	QPSK	1	99	Bottom Face	0mm	ON	26590	1905	13.49	13.50	1.002	-0.14	0.613	0.614
	LTE Band 25	20M	QPSK	50	24	Bottom Face	0mm	ON	26140	1860	13.09	13.50	1.099	-0.04	0.478	0.525
13	LTE Band 25	20M	QPSK	1	99	Edge 1	0mm	ON	26590	1905	13.49	13.50	1.002	0.1	0.792	0.794
	LTE Band 25	20M	QPSK	1	49	Edge 1	0mm	ON	26140	1860	13.18	13.50	1.076	0.14	0.635	0.684
	LTE Band 25	20M	QPSK	1	99	Edge 1	0mm	ON	26340	1880	13.07	13.50	1.104	0.1	0.692	0.764
	LTE Band 25	20M	QPSK	50	24	Edge 1	0mm	ON	26140	1860	13.09	13.50	1.099	0.13	0.621	0.682



<WLAN SAR>

Plot No.	Band	Mode	Test Position	Gap (mm)	Antenna	Ch.	Freq. (MHz)	Average Power (dBm)	Tune-Up Limit (dBm)	Tune-up Scaling Factor	Duty Cycle %	Duty Cycle Scaling Factor	Power Drift (dB)	Measured 1g SAR (W/kg)	Reported 1g SAR (W/kg)
	WLAN2.4GHz	802.11b 1Mbps	Bottom Face	0mm	Ant 1	6	2437	13.24	13.50	1.062	98.62	1.014	-0.14	0.701	0.755
14	WLAN2.4GHz	802.11b 1Mbps	Edge 2	0mm	Ant 1	6	2437	13.24	13.50	1.062	98.62	1.014	0.19	0.974	1.049
	WLAN2.4GHz	802.11b 1Mbps	Edge 2	0mm	Ant 1	1	2412	13.11	13.50	1.094	98.62	1.014	0.15	0.714	0.792
	WLAN2.4GHz	802.11b 1Mbps	Bottom Face	0mm	Ant 2	6	2437	15.41	15.50	1.021	98.62	1.014	0.16	0.941	0.974
	WLAN2.4GHz	802.11b 1Mbps	Bottom Face	0mm	Ant 2	1	2412	15.39	15.50	1.026	98.62	1.014	0.18	0.868	0.903
	WLAN2.4GHz	802.11b 1Mbps	Edge 2	0mm	Ant 2	6	2437	15.41	15.50	1.021	98.62	1.014	0.07	0.973	1.007
	WLAN2.4GHz	802.11b 1Mbps	Edge 2	0mm	Ant 2	1	2412	15.39	15.50	1.026	98.62	1.014	0.14	0.991	1.031
	WLAN5GHz	802.11n-HT40 MCS0	Bottom Face	0mm	Ant 1	54	5270	11.34	11.50	1.037	86.84	1.152	-0.12	0.676	0.807
	WLAN5GHz	802.11n-HT40 MCS0	Bottom Face	0mm	Ant 1	62	5310	11.20	11.50	1.071	86.84	1.152	-0.11	0.516	0.637
	WLAN5GHz	802.11n-HT40 MCS0	Edge 2	0mm	Ant 1	54	5270	11.34	11.50	1.037	86.84	1.152	-0.14	0.930	1.111
	WLAN5GHz	802.11n-HT40 MCS0	Edge 2	0mm	Ant 1	62	5310	11.20	11.50	1.071	86.84	1.152	-0.1	0.932	1.150
	WLAN5GHz	802.11n-HT40 MCS0	Bottom Face	0mm	Ant 2	62	5310	11.31	11.50	1.044	86.84	1.152	-0.04	0.315	0.379
	WLAN5GHz	802.11n-HT40 MCS0	Edge 2	0mm	Ant 2	62	5310	11.31	11.50	1.044	86.84	1.152	0.02	0.953	1.146
15	WLAN5GHz	802.11n-HT40 MCS0	Edge 2	0mm	Ant 2	54	5270	11.23	11.50	1.063	86.84	1.152	0.16	0.978	1.198
	WLAN5GHz	802.11n-HT40 MCS0	Bottom Face	0mm	Ant 1	102	5510	10.35	10.50	1.034	86.84	1.152	-0.12	0.540	0.644
	WLAN5GHz	802.11n-HT40 MCS0	Edge 2	0mm	Ant 1	102	5510	10.35	10.50	1.034	86.84	1.152	-0.01	0.900	1.073
	WLAN5GHz	802.11n-HT40 MCS0	Edge 2	0mm	Ant 1	134	5670	10.33	10.50	1.039	86.84	1.152	-0.18	0.961	1.151
	WLAN5GHz	802.11n-HT40 MCS0	Bottom Face	0mm	Ant 2	134	5670	12.82	13.00	1.042	86.84	1.152	0.14	0.356	0.427
	WLAN5GHz	802.11n-HT40 MCS0	Edge 2	0mm	Ant 2	134	5670	12.82	13.00	1.042	86.84	1.152	0.17	0.879	1.055
16	WLAN5GHz	802.11n-HT40 MCS0	Edge 2	0mm	Ant 2	102	5510	12.77	13.00	1.054	86.84	1.152	0.13	1.140	1.384
	WLAN5GHz	802.11n-HT40 MCS0	Edge 2	0mm	Ant 2	110	5550	12.62	13.00	1.091	86.84	1.152	0.14	0.897	1.127
	WLAN5GHz	802.11n-HT40 MCS0	Bottom Face	0mm	Ant 1	159	5795	11.31	11.50	1.044	86.84	1.152	-0.11	0.418	0.503
17	WLAN5GHz	802.11n-HT40 MCS0	Edge 2	0mm	Ant 1	159	5795	11.31	11.50	1.044	86.84	1.152	-0.02	1.020	1.227
	WLAN5GHz	802.11n-HT40 MCS0	Edge 2	0mm	Ant 1	151	5755	11.21	11.50	1.068	86.84	1.152	-0.04	0.996	1.226
	WLAN5GHz	802.11a 6Mbps	Edge 2	0mm	Ant 1	165	5825	11.36	11.50	1.033	92.73	1.078	-0.19	0.963	1.073
	WLAN5GHz	802.11n-HT40 MCS0	Bottom Face	0mm	Ant 2	151	5755	12.77	13.00	1.054	86.84	1.152	0.11	0.347	0.421
	WLAN5GHz	802.11n-HT40 MCS0	Edge 2	0mm	Ant 2	151	5755	12.77	13.00	1.054	86.84	1.152	0.12	1.010	1.226
	WLAN5GHz	802.11n-HT40 MCS0	Edge 2	0mm	Ant 2	159	5795	12.61	13.00	1.093	86.84	1.152	0.13	0.747	0.941

<Bluetooth SAR>

Plot No.	Band	Mode	Test Position	Gap (mm)	Antenna	Ch.	Freq. (MHz)	Average Power (dBm)	Tune-Up Limit (dBm)	Tune-up Scaling Factor	Power Drift (dB)	Measured 1g SAR (W/kg)	Reported 1g SAR (W/kg)
	Bluetooth	1Mbps	Bottom Face	0mm	Ant 1	78	2480	6.87	7.00	1.030	-0.1	0.138	0.142
18	Bluetooth	1Mbps	Edge 2	0mm	Ant 1	78	2480	6.87	7.00	1.030	0.18	0.187	0.193
	Bluetooth	1Mbps	Edge 2	0mm	Ant 1	0	2402	5.78	7.00	1.324	0.14	0.089	0.118
	Bluetooth	1Mbps	Edge 2	0mm	Ant 1	39	2441	6.62	7.00	1.091	0.16	0.174	0.190



**14.2 Repeated SAR Measurement**

No.	Band	Mode	Test Position	Gap (mm)	Antenna	Ch.	Freq. (MHz)	Average Power (dBm)	Tune-Up Limit (dBm)	Tune-up Scaling Factor	Duty Cycle %	Duty Cycle Scaling Factor	Power Drift (dB)	Measured 1g SAR (W/kg)	Ratio	Reported 1g SAR (W/kg)
1st	WLAN2.4GHz	802.11b 1Mbps	Edge 2	0mm	Ant 2	1	2412	15.39	15.50	1.026	98.62	1.014	0.14	0.991		1.031
2nd	WLAN2.4GHz	802.11b 1Mbps	Edge 2	0mm	Ant 2	1	2412	15.39	15.50	1.026	98.62	1.014	-0.15	0.953	1.04	0.991
1st	WLAN5GHz	802.11n-HT40 MCS0	Edge 2	0mm	Ant 2	54	5270	11.23	11.50	1.063	86.84	1.152	0.16	0.978		1.198
2nd	WLAN5GHz	802.11n-HT40 MCS0	Edge 2	0mm	Ant 2	54	5270	11.23	11.50	1.063	86.84	1.152	0.14	0.858	1.14	1.051
1st	WLAN5GHz	802.11n-HT40 MCS0	Edge 2	0mm	Ant 2	102	5510	12.77	13.00	1.054	86.84	1.152	0.13	1.140		1.384
2nd	WLAN5GHz	802.11n-HT40 MCS0	Edge 2	0mm	Ant 2	102	5510	12.77	13.00	1.054	86.84	1.152	0.11	1.090	1.05	1.323
1st	WLAN5GHz	802.11n-HT40 MCS0	Edge 2	0mm	Ant 1	159	5795	11.31	11.50	1.044	86.84	1.152	-0.02	1.020		1.227
2nd	WLAN5GHz	802.11n-HT40 MCS0	Edge 2	0mm	Ant 1	159	5795	11.31	11.50	1.044	86.84	1.152	-0.11	0.941	1.08	1.132

**General Note:**

1. Per KDB 865664 D01v01r04, for each frequency band, repeated SAR measurement is required only when the measured SAR is  $\geq 0.8W/kg$ .
2. Per KDB 865664 D01v01r04, if the ratio among the repeated measurement is  $\leq 1.2$  and the measured SAR  $< 1.45W/kg$ , only one repeated measurement is required.
3. The ratio is the difference in percentage between original and repeated *measured SAR*.
4. All measurement SAR result is scaled-up to account for tune-up tolerance and is compliant.



15. Simultaneous Transmission Analysis

NO.	Simultaneous Transmission Configurations	Tablet
		Body
1.	GPRS/EDGE + WLAN2.4GHz	Yes
2.	WCDMA + WLAN2.4GHz	Yes
3.	LTE + WLAN2.4GHz	Yes
4.	GPRS/EDGE + Bluetooth	Yes
5.	WCDMA+ Bluetooth	Yes
6.	LTE + Bluetooth	Yes
7.	GPRS/EDGE + WLAN5GHz	Yes
8.	WCDMA + WLAN5GHz	Yes
9.	LTE + WLAN5GHz	Yes

General Note:

- The worst case WLAN reported SAR for each configuration was used for SAR summation. Therefore, the following summations represent the absolute worst cases for simultaneous transmission with WLAN.
- WLAN RF exposure assessment of MIMO mode simultaneous transmission exclusion analysis was performed with SAR test results of each antenna in SISO mode. Therefore SPLSR calculation was choose worst case with SAR test results of each antenna in SISO mode perform evaluation.
- For SAR testing was performed on single antenna RF power in SISO mode is larger or equal to the single antenna RF power in MIMO mode, and for RF exposure assessment of MIMO mode simultaneous transmission exclusion analysis was performed with SAR test results of each antenna in SISO mode.
- For simultaneous transmission analysis for exposure position of edge1 14mm and bottom face12mm, WLAN SAR tested at 0mm separation is worse and the test data is used for conservative SAR summation.
- WLAN and Bluetooth cannot transmit simultaneously.
- EUT will choose either WLAN 2.4GHz or WLAN 5GHz according to the network signal condition; therefore, 2.4GHz WLAN and 5GHz WLAN will not operate simultaneously at any moment.
- The Scaled SAR summation is calculated based on the same configuration and test position.
- Per KDB 447498 D01v06, simultaneous transmission SAR is compliant if,
  - Scalar SAR summation < 1.6W/kg.
  - $SPLSR = (SAR1 + SAR2)^{1.5} / (\text{min. separation distance, mm})$ , and the peak separation distance is determined from the square root of  $[(x1-x2)^2 + (y1-y2)^2 + (z1-z2)^2]$ , where (x1, y1, z1) and (x2, y2, z2) are the coordinates of the extrapolated peak SAR locations in the zoom scan.
  - If  $SPLSR \leq 0.04$ , simultaneously transmission SAR measurement is not necessary.
  - Simultaneously transmission SAR measurement, and the reported multi-band SAR < 1.6W/kg.
  - The SPLSR calculated results please refer to section 15.2.





**15.1 Body Exposure Conditions**

WWAN Band	Exposure Position	1	2	3	1+2 Summed 1g SAR (W/kg)	1+3 Summed 1g SAR (W/kg)	2+3 Summed 1g SAR (W/kg)	1+2+3 Summed 1g SAR (W/kg)	SPLSR	Case No	
		WWAN	2.4GHz WLAN Ant 1	2.4GHz WLAN Ant 2							
		1g SAR (W/kg)	1g SAR (W/kg)	1g SAR (W/kg)							
GSM	GSM850	Bottom Face at 14mm	0.977	0.755	0.974	1.732	1.951	1.729	2.706	0.03	Case 1
		Edge 1 at 12mm	0.801			0.801	0.801	0.000	0.801		
		Bottom Face at 0mm	0.327	0.755	0.974	1.082	1.301	1.729	2.056	0.03	Case 2
		Edge 1 at 0mm	0.182			0.182	0.182	0.000	0.182		
	Edge 4 at 0mm	0.427			0.427	0.427	0.000	0.427			
	GSM1900	Bottom Face at 14mm	0.464	0.755	0.974	1.219	1.438	1.729	2.193	0.03	Case 3
		Edge 1 at 12mm	0.443			0.443	0.443	0.000	0.443		
		Bottom Face at 0mm	0.417	0.755	0.974	1.172	1.391	1.729	2.146	0.03	Case 4
Edge 1 at 0mm		0.572			0.572	0.572	0.000	0.572			
WCDMA	WCDMA II	Bottom Face at 14mm	0.548	0.755	0.974	1.303	1.522	1.729	2.277	0.03	Case 5
		Edge 1 at 12mm	0.584			0.584	0.584	0.000	0.584		
		Bottom Face at 0mm	0.745	0.755	0.974	1.500	1.719	1.729	2.474	0.03	Case 6
		Edge 1 at 0mm	0.876			0.876	0.876	0.000	0.876		
	WCDMA IV	Bottom Face at 14mm	0.414	0.755	0.974	1.169	1.388	1.729	2.143	0.03	Case 7
		Edge 1 at 12mm	0.309			0.309	0.309	0.000	0.309		
		Bottom Face at 0mm	0.439	0.755	0.974	1.194	1.413	1.729	2.168	0.03	Case 8
		Edge 1 at 0mm	0.479			0.479	0.479	0.000	0.479		
	WCDMA V	Bottom Face at 14mm	0.588	0.755	0.974	1.343	1.562	1.729	2.317	0.03	Case 9
		Edge 1 at 12mm	0.509			0.509	0.509	0.000	0.509		
		Bottom Face at 0mm	0.440	0.755	0.974	1.195	1.414	1.729	2.169	0.03	Case 10
		Edge 1 at 0mm	0.270			0.270	0.270	0.000	0.270		
CDMA	CDMA BC0	Bottom Face at 14mm	0.646	0.755	0.974	1.401	1.620	1.729	2.375	0.03	Case 11
		Edge 1 at 12mm	0.558			0.558	0.558	0.000	0.558		
		Bottom Face at 0mm	0.373	0.755	0.974	1.128	1.347	1.729	2.102	0.03	Case 12
		Edge 1 at 0mm	0.214			0.214	0.214	0.000	0.214		
	CDMA BC1	Bottom Face at 14mm	0.605	0.755	0.974	1.360	1.579	1.729	2.334	0.03	Case 13
		Edge 1 at 12mm	0.699			0.699	0.699	0.000	0.699		
		Bottom Face at 0mm	0.559	0.755	0.974	1.314	1.533	1.729	2.288	0.03	Case 14
		Edge 1 at 0mm	0.740			0.740	0.740	0.000	0.740		
	CDMA BC10	Bottom Face at 14mm	0.569	0.755	0.974	1.324	1.543	1.729	2.298	0.03	Case 15
		Edge 1 at 12mm	0.538			0.538	0.538	0.000	0.538		
		Bottom Face at 0mm	0.471	0.755	0.974	1.226	1.445	1.729	2.200	0.03	Case 16
		Edge 1 at 0mm	0.252			0.252	0.252	0.000	0.252		



WWAN Band	Exposure Position	1	2	3	1+2 Summed 1g SAR (W/kg)	1+3 Summed 1g SAR (W/kg)	2+3 Summed 1g SAR (W/kg)	1+2+3 Summed 1g SAR (W/kg)	SPLSR	Case No	
		WWAN	2.4GHz WLAN Ant 1	2.4GHz WLAN Ant 2							
		1g SAR (W/kg)	1g SAR (W/kg)	1g SAR (W/kg)							
LTE	LTE Band 4	Bottom Face at 14mm	0.387	0.755	0.974	1.142	1.361	1.729	2.116	0.03	Case 17
		Edge 1 at 12mm	0.320			0.320	0.320	0.000	0.320		
		Bottom Face at 0mm	0.396	0.755	0.974	1.151	1.370	1.729	2.125	0.03	Case 18
		Edge 1 at 0mm	0.362			0.362	0.362	0.000	0.362		
	LTE Band 5	Bottom Face at 14mm	0.566	0.755	0.974	1.321	1.540	1.729	2.295	0.03	Case 19
		Edge 1 at 12mm	0.449			0.449	0.449	0.000	0.449		
		Bottom Face at 0mm	0.415	0.755	0.974	1.170	1.389	1.729	2.144	0.03	Case 20
		Edge 1 at 0mm	0.232			0.232	0.232	0.000	0.232		
	LTE Band 13	Bottom Face at 14mm	0.389	0.755	0.974	1.144	1.363	1.729	2.118	0.03	Case 21
		Edge 1 at 12mm	0.335			0.335	0.335	0.000	0.335		
		Bottom Face at 0mm	0.719	0.755	0.974	1.474	1.693	1.729	2.448	0.03	Case 22
		Edge 1 at 0mm	0.404			0.404	0.404	0.000	0.404		
	LTE Band 17	Bottom Face at 14mm	0.299	0.755	0.974	1.054	1.273	1.729	2.028	0.03	Case 23
		Edge 1 at 12mm	0.284			0.284	0.284	0.000	0.284		
		Bottom Face at 0mm	0.722	0.755	0.974	1.477	1.696	1.729	2.451	0.03	Case 24
		Edge 1 at 0mm	0.474			0.474	0.474	0.000	0.474		
	LTE Band 25	Bottom Face at 14mm	0.408	0.755	0.974	1.163	1.382	1.729	2.137	0.03	Case 25
		Edge 1 at 12mm	0.387			0.387	0.387	0.000	0.387		
		Bottom Face at 0mm	0.614	0.755	0.974	1.369	1.588	1.729	2.343	0.03	Case 26
		Edge 1 at 0mm	0.794			0.794	0.794	0.000	0.794		



WWAN Band	Exposure Position	1	4	5	1+4 Summed 1g SAR (W/kg)	1+5 Summed 1g SAR (W/kg)	4+5 Summed 1g SAR (W/kg)	1+4+5 Summed 1g SAR (W/kg)	SPLSR	Case No	
		WWAN	5GHz WLAN Ant 1	5GHz WLAN Ant 2							
		1g SAR (W/kg)	1g SAR (W/kg)	1g SAR (W/kg)							
GSM	GSM850	Bottom Face at 14mm	0.977	0.807	0.427	1.784	1.404	1.234	2.211	0.01	Case 27
		Edge 1 at 12mm	0.801			0.801	0.801	0.000	0.801		
		Bottom Face at 0mm	0.327	0.807	0.427	1.134	0.754	1.234	1.561		
		Edge 1 at 0mm	0.182			0.182	0.182	0.000	0.182		
	Edge 4 at 0mm	0.427			0.427	0.427	0.000	0.427			
	GSM1900	Bottom Face at 14mm	0.464	0.807	0.427	1.271	0.891	1.234	1.698	0.01	Case 28
		Edge 1 at 12mm	0.443			0.443	0.443	0.000	0.443		
		Bottom Face at 0mm	0.417	0.807	0.427	1.224	0.844	1.234	1.651	0.01	Case 29
Edge 1 at 0mm		0.572			0.572	0.572	0.000	0.572			
WCDMA	WCDMA II	Bottom Face at 14mm	0.548	0.807	0.427	1.355	0.975	1.234	1.782	0.01	Case 30
		Edge 1 at 12mm	0.584			0.584	0.584	0.000	0.584		
		Bottom Face at 0mm	0.745	0.807	0.427	1.552	1.172	1.234	1.979	0.01	Case 31
		Edge 1 at 0mm	0.876			0.876	0.876	0.000	0.876		
	WCDMA IV	Bottom Face at 14mm	0.414	0.807	0.427	1.221	0.841	1.234	1.648	0.01	Case 32
		Edge 1 at 12mm	0.309			0.309	0.309	0.000	0.309		
		Bottom Face at 0mm	0.439	0.807	0.427	1.246	0.866	1.234	1.673	0.01	Case 33
		Edge 1 at 0mm	0.479			0.479	0.479	0.000	0.479		
	WCDMA V	Bottom Face at 14mm	0.588	0.807	0.427	1.395	1.015	1.234	1.822	0.01	Case 34
		Edge 1 at 12mm	0.509			0.509	0.509	0.000	0.509		
		Bottom Face at 0mm	0.440	0.807	0.427	1.247	0.867	1.234	1.674	0.01	Case 35
		Edge 1 at 0mm	0.270			0.270	0.270	0.000	0.270		
CDMA	CDMA BC0	Bottom Face at 14mm	0.646	0.807	0.427	1.453	1.073	1.234	1.880	0.01	Case 36
		Edge 1 at 12mm	0.558			0.558	0.558	0.000	0.558		
		Bottom Face at 0mm	0.373	0.807	0.427	1.180	0.800	1.234	1.607	0.01	Case 37
		Edge 1 at 0mm	0.214			0.214	0.214	0.000	0.214		
	CDMA BC1	Bottom Face at 14mm	0.605	0.807	0.427	1.412	1.032	1.234	1.839	0.01	Case 38
		Edge 1 at 12mm	0.699			0.699	0.699	0.000	0.699		
		Bottom Face at 0mm	0.559	0.807	0.427	1.366	0.986	1.234	1.793	0.01	Case 39
		Edge 1 at 0mm	0.740			0.740	0.740	0.000	0.740		
	CDMA BC10	Bottom Face at 14mm	0.569	0.807	0.427	1.376	0.996	1.234	1.803	0.01	Case 40
		Edge 1 at 12mm	0.538			0.538	0.538	0.000	0.538		
		Bottom Face at 0mm	0.471	0.807	0.427	1.278	0.898	1.234	1.705	0.01	Case 41
		Edge 1 at 0mm	0.252			0.252	0.252	0.000	0.252		



WWAN Band	Exposure Position	1	4	5	1+4 Summed 1g SAR (W/kg)	1+5 Summed 1g SAR (W/kg)	4+5 Summed 1g SAR (W/kg)	1+4+5 Summed 1g SAR (W/kg)	SPLSR	Case No	
		WWAN	5GHz WLAN Ant 1	5GHz WLAN Ant 2							
		1g SAR (W/kg)	1g SAR (W/kg)	1g SAR (W/kg)							
LTE	LTE Band 4	Bottom Face at 14mm	0.387	0.807	0.427	1.194	0.814	1.234	1.621	0.01	Case 42
		Edge 1 at 12mm	0.320			0.320	0.320	0.000	0.320		
		Bottom Face at 0mm	0.396	0.807	0.427	1.203	0.823	1.234	1.630	0.01	Case 43
		Edge 1 at 0mm	0.362			0.362	0.362	0.000	0.362		
	LTE Band 5	Bottom Face at 14mm	0.566	0.807	0.427	1.373	0.993	1.234	1.800	0.01	Case 44
		Edge 1 at 12mm	0.449			0.449	0.449	0.000	0.449		
		Bottom Face at 0mm	0.415	0.807	0.427	1.222	0.842	1.234	1.649	0.01	Case 45
		Edge 1 at 0mm	0.232			0.232	0.232	0.000	0.232		
	LTE Band 13	Bottom Face at 14mm	0.389	0.807	0.427	1.196	0.816	1.234	1.623	0.01	Case 46
		Edge 1 at 12mm	0.335			0.335	0.335	0.000	0.335		
		Bottom Face at 0mm	0.719	0.807	0.427	1.526	1.146	1.234	1.953	0.01	Case 47
		Edge 1 at 0mm	0.404			0.404	0.404	0.000	0.404		
	LTE Band 17	Bottom Face at 14mm	0.299	0.807	0.427	1.106	0.726	1.234	1.533		
		Edge 1 at 12mm	0.284			0.284	0.284	0.000	0.284		
		Bottom Face at 0mm	0.722	0.807	0.427	1.529	1.149	1.234	1.956	0.01	Case 48
		Edge 1 at 0mm	0.474			0.474	0.474	0.000	0.474		
	LTE Band 25	Bottom Face at 14mm	0.408	0.807	0.427	1.215	0.835	1.234	1.642	0.01	Case 49
		Edge 1 at 12mm	0.387			0.387	0.387	0.000	0.387		
		Bottom Face at 0mm	0.614	0.807	0.427	1.421	1.041	1.234	1.848	0.01	Case 50
		Edge 1 at 0mm	0.794			0.794	0.794	0.000	0.794		



WWAN Band		Exposure Position	1	6	1+6 Summed 1g SAR (W/kg)	SPLSR	Case No
			WWAN 1g SAR (W/kg)	Bluetooth 1g SAR (W/kg)			
GSM	GSM850	Bottom Face at 14mm	0.977	0.142	<b>1.119</b>		
		Edge 1 at 12mm	0.801		<b>0.801</b>		
		Bottom Face at 0mm	0.327	0.142	<b>0.469</b>		
		Edge 1 at 0mm	0.182		<b>0.182</b>		
	Edge 4 at 0mm	0.427		<b>0.427</b>			
	GSM1900	Bottom Face at 14mm	0.464	0.142	<b>0.606</b>		
		Edge 1 at 12mm	0.443		<b>0.443</b>		
		Bottom Face at 0mm	0.417	0.142	<b>0.559</b>		
Edge 1 at 0mm		0.572		<b>0.572</b>			
WCDMA	WCDMA II	Bottom Face at 14mm	0.548	0.142	<b>0.690</b>		
		Edge 1 at 12mm	0.584		<b>0.584</b>		
		Bottom Face at 0mm	0.745	0.142	<b>0.887</b>		
		Edge 1 at 0mm	0.876		<b>0.876</b>		
	WCDMA IV	Bottom Face at 14mm	0.414	0.142	<b>0.556</b>		
		Edge 1 at 12mm	0.309		<b>0.309</b>		
		Bottom Face at 0mm	0.439	0.142	<b>0.581</b>		
		Edge 1 at 0mm	0.479		<b>0.479</b>		
	WCDMA V	Bottom Face at 14mm	0.588	0.142	<b>0.730</b>		
		Edge 1 at 12mm	0.509		<b>0.509</b>		
		Bottom Face at 0mm	0.440	0.142	<b>0.582</b>		
		Edge 1 at 0mm	0.270		<b>0.270</b>		
CDMA	CDMA BC0	Bottom Face at 14mm	0.646	0.142	<b>0.788</b>		
		Edge 1 at 12mm	0.558		<b>0.558</b>		
		Bottom Face at 0mm	0.373	0.142	<b>0.515</b>		
		Edge 1 at 0mm	0.214		<b>0.214</b>		
	CDMA BC1	Bottom Face at 14mm	0.605	0.142	<b>0.747</b>		
		Edge 1 at 12mm	0.699		<b>0.699</b>		
		Bottom Face at 0mm	0.559	0.142	<b>0.701</b>		
		Edge 1 at 0mm	0.740		<b>0.740</b>		
	CDMA BC10	Bottom Face at 14mm	0.569	0.142	<b>0.711</b>		
		Edge 1 at 12mm	0.538		<b>0.538</b>		
		Bottom Face at 0mm	0.471	0.142	<b>0.613</b>		
		Edge 1 at 0mm	0.252		<b>0.252</b>		



WWAN Band		Exposure Position	1	6	1+6 Summed 1g SAR (W/kg)	SPLSR	Case No
			WWAN 1g SAR (W/kg)	Bluetooth 1g SAR (W/kg)			
LTE	LTE Band 4	Bottom Face at 14mm	0.387	0.142	<b>0.529</b>		
		Edge 1 at 12mm	0.320		<b>0.320</b>		
		Bottom Face at 0mm	0.396	0.142	<b>0.538</b>		
		Edge 1 at 0mm	0.362		<b>0.362</b>		
	LTE Band 5	Bottom Face at 14mm	0.566	0.142	<b>0.708</b>		
		Edge 1 at 12mm	0.449		<b>0.449</b>		
		Bottom Face at 0mm	0.415	0.142	<b>0.557</b>		
		Edge 1 at 0mm	0.232		<b>0.232</b>		
	LTE Band 13	Bottom Face at 14mm	0.389	0.142	<b>0.531</b>		
		Edge 1 at 12mm	0.335		<b>0.335</b>		
		Bottom Face at 0mm	0.719	0.142	<b>0.861</b>		
		Edge 1 at 0mm	0.404		<b>0.404</b>		
	LTE Band 17	Bottom Face at 14mm	0.299	0.142	<b>0.441</b>		
		Edge 1 at 12mm	0.284		<b>0.284</b>		
		Bottom Face at 0mm	0.722	0.142	<b>0.864</b>		
		Edge 1 at 0mm	0.474		<b>0.474</b>		
LTE Band 25	Bottom Face at 14mm	0.408	0.142	<b>0.550</b>			
	Edge 1 at 12mm	0.387		<b>0.387</b>			
	Bottom Face at 0mm	0.614	0.142	<b>0.756</b>			
	Edge 1 at 0mm	0.794		<b>0.794</b>			

Exposure Position	2	3	4	5	2+3 Summed 1g SAR (W/kg)	4+5 Summed 1g SAR (W/kg)	SPLSR	Case No	SPLSR	Case No
	2.4GHz WLAN Ant 1 1g SAR (W/kg)	2.4GHz WLAN Ant 2 1g SAR (W/kg)	5GHz WLAN Ant 1 1g SAR (W/kg)	5GHz WLAN Ant 2 1g SAR (W/kg)						
Bottom Face at 0mm	0.755	0.974	0.807	0.427	<b>1.729</b>	<b>1.234</b>	<b>0.03</b>	<b>Case 51</b>		
Edge 2 at 0mm	1.049	1.031	1.227	1.384	<b>2.080</b>	<b>2.611</b>	<b>0.03</b>	<b>Case 52</b>	<b>0.04</b>	<b>Case 53</b>

**15.2 SPLSR Evaluation and Analysis**

**General Note:**

- SPLSR =  $(SAR_1 + SAR_2)^{1.5} / (\text{min. separation distance, mm})$ . If  $SPLSR \leq 0.04$ , simultaneously transmission SAR measurement is not necessary

Case 1	Band	Position	SAR (W/kg)	Gap (mm)	SAR peak location (cm)			3D distance (mm)	Summed SAR (W/kg)	SPLSR Results	Simultaneous SAR
					X	Y	Z				
Case 1	GSM850	Bottom Face	0.977	14	8.8	-4.61	0.06	178.1	1.732	0.01	Not required
	2.4GHz ANT 1		0.755	0	6	12.98	0.19				
	GSM850		0.977	14	8.8	-4.61	0.06	208.8	1.951	0.01	Not required
	2.4GHz ANT 2		0.974	0	-2.78	12.76	0.19				
	2.4GHz ANT 1		0.755	0	6	12.98	0.19	87.8	1.729	0.03	Not required
	2.4GHz ANT 2		0.974	0	-2.78	12.76	0.19				

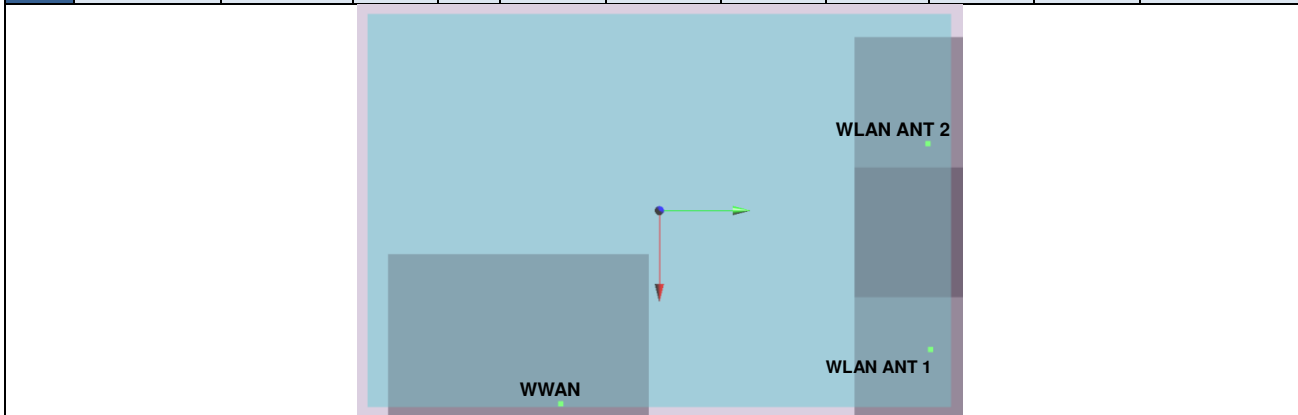

Case 2	Band	Position	SAR (W/kg)	Gap (mm)	SAR peak location (cm)			3D distance (mm)	Summed SAR (W/kg)	SPLSR Results	Simultaneous SAR
					X	Y	Z				
Case 2	GSM850	Bottom Face	0.327	0	8.37	-2.87	0.08	160.3	1.082	0.01	Not required
	2.4GHz ANT 1		0.755	0	6	12.98	0.19				
	GSM850		0.327	0	8.37	-2.87	0.08	192.0	1.301	0.01	Not required
	2.4GHz ANT 2		0.974	0	-2.78	12.76	0.19				
	2.4GHz ANT 1		0.755	0	6	12.98	0.19	87.8	1.729	0.03	Not required
	2.4GHz ANT 2		0.974	0	-2.78	12.76	0.19				

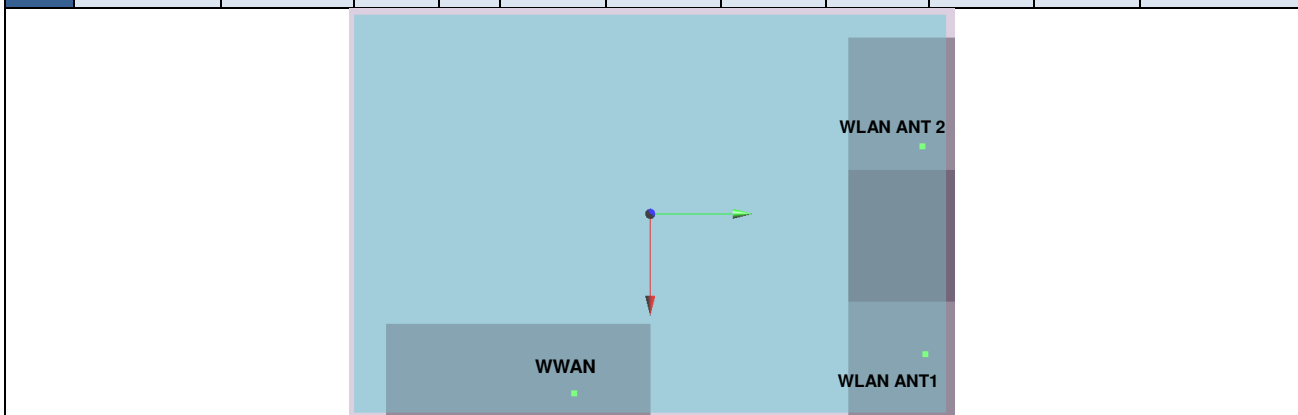

Case 3	Band	Position	SAR (W/kg)	Gap (mm)	SAR peak location (cm)			3D distance (mm)	Summed SAR (W/kg)	SPLSR Results	Simultaneous SAR
					X	Y	Z				
Case 3	GSM1900	Bottom Face	0.464	14	8.8	-4.45	0.1	176.5	1.219	0.01	Not required
	2.4GHz ANT 1		0.755	0	6	12.98	0.19				
	GSM1900		0.464	14	8.8	-4.45	0.1	207.4	1.438	0.01	Not required
	2.4GHz ANT 2		0.974	0	-2.78	12.76	0.19				
	2.4GHz ANT 1		0.755	0	6	12.98	0.19	87.8	1.729	0.03	Not required
	2.4GHz ANT 2		0.974	0	-2.78	12.76	0.19				

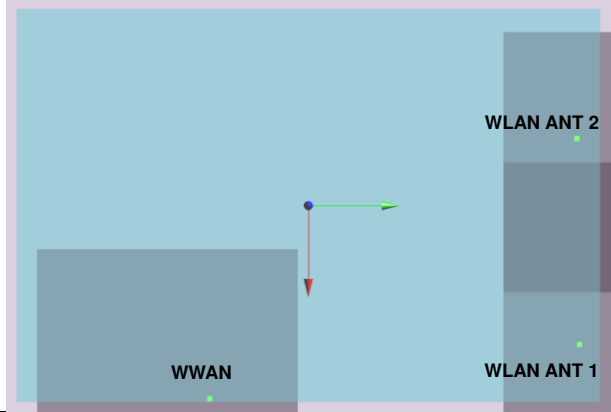

Case 4	Band	Position	SAR (W/kg)	Gap (mm)	SAR peak location (cm)			3D distance (mm)	Summed SAR (W/kg)	SPLSR Results	Simultaneous SAR
					X	Y	Z				
Case 4	GSM1900	Bottom Face	0.417	0	8.86	-3.98	0.2	172.0	1.172	0.01	Not required
	2.4GHz ANT 1		0.755	0	6	12.98	0.19				
	GSM1900		0.417	0	8.86	-3.98	0.2	203.9	1.391	0.01	Not required
	2.4GHz ANT 2		0.974	0	-2.78	12.76	0.19				
	2.4GHz ANT 1		0.755	0	6	12.98	0.19	87.8	1.729	0.03	Not required
	2.4GHz ANT 2		0.974	0	-2.78	12.76	0.19				

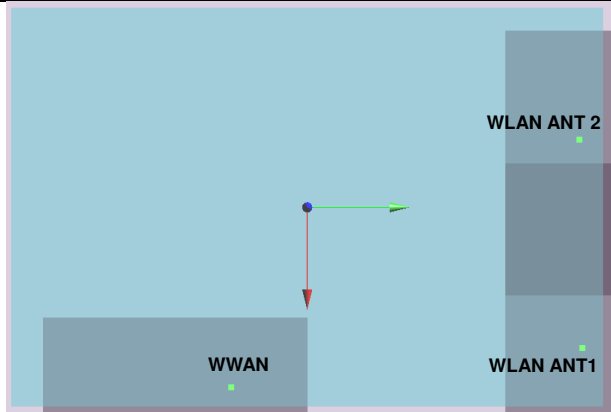



Case 5	Band	Position	SAR (W/kg)	Gap (mm)	SAR peak location (cm)			3D distance (mm)	Summed SAR (W/kg)	SPLSR Results	Simultaneous SAR
	WCDMA II		2.4GHz ANT 1	WCDMA II	2.4GHz ANT 2	2.4GHz ANT 1	2.4GHz ANT 2				
	WCDMA II	Bottom Face	0.548	14	8.91	-4.44	0.1	176.6	1.303	0.01	Not required
	2.4GHz ANT 1		0.755	0	6	12.98	0.19				
	WCDMA II		0.548	14	8.91	-4.44	0.1	208.0	1.522	0.01	Not required
	2.4GHz ANT 2		0.974	0	-2.78	12.76	0.19				
	2.4GHz ANT 1		0.755	0	6	12.98	0.19	87.8	1.729	0.03	Not required
	2.4GHz ANT 2		0.974	0	-2.78	12.76	0.19				

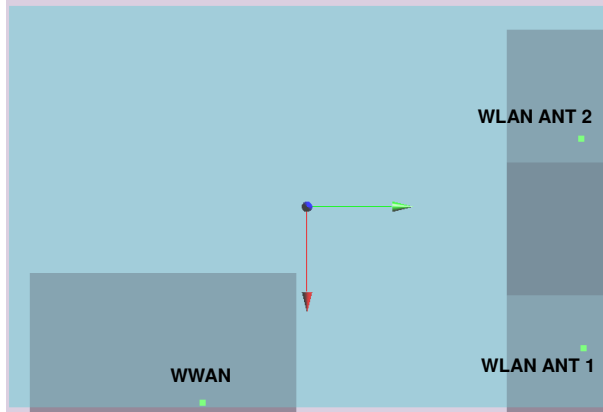

Case 6	Band	Position	SAR (W/kg)	Gap (mm)	SAR peak location (cm)			3D distance (mm)	Summed SAR (W/kg)	SPLSR Results	Simultaneous SAR
	WCDMA II		2.4GHz ANT 1	WCDMA II	2.4GHz ANT 2	2.4GHz ANT 1	2.4GHz ANT 2				
	WCDMA II	Bottom Face	0.745	0	8.6	-4.3	0.22	174.7	1.500	0.01	Not required
	2.4GHz ANT 1		0.755	0	6	12.98	0.19				
	WCDMA II		0.745	0	8.6	-4.3	0.22	205.1	1.719	0.01	Not required
	2.4GHz ANT 2		0.974	0	-2.78	12.76	0.19				
	2.4GHz ANT 1		0.755	0	6	12.98	0.19	87.8	1.729	0.03	Not required
	2.4GHz ANT 2		0.974	0	-2.78	12.76	0.19				

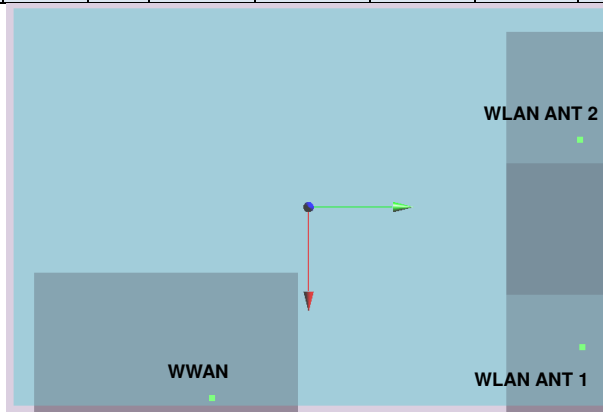

Case 7	Band	Position	SAR (W/kg)	Gap (mm)	SAR peak location (cm)			3D distance (mm)	Summed SAR (W/kg)	SPLSR Results	Simultaneous SAR
					X	Y	Z				
Case 7	WCDMA IV	Bottom Face	0.414	14	8.38	-4.89	0.09	180.3	1.169	0.01	Not required
	2.4GHz ANT 1		0.755	0	6	12.98	0.19				
	WCDMA IV		0.414	14	8.38	-4.89	0.09	208.8	1.388	0.01	Not required
	2.4GHz ANT 2		0.974	0	-2.78	12.76	0.19				
	2.4GHz ANT 1		0.755	0	6	12.98	0.19	87.8	1.729	0.03	Not required
	2.4GHz ANT 2		0.974	0	-2.78	12.76	0.19				

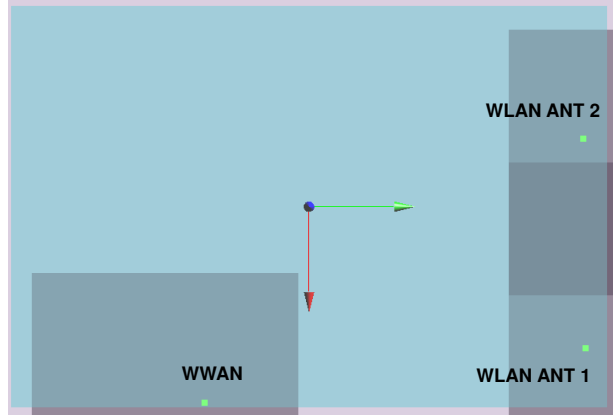

Case 8	Band	Position	SAR (W/kg)	Gap (mm)	SAR peak location (cm)			3D distance (mm)	Summed SAR (W/kg)	SPLSR Results	Simultaneous SAR
					X	Y	Z				
Case 8	WCDMA IV	Bottom Face	0.439	0	8.55	-4.27	0.21	174.4	1.194	0.01	Not required
	2.4GHz ANT 1		0.755	0	6	12.98	0.19				
	WCDMA IV		0.439	0	8.55	-4.27	0.21	204.5	1.413	0.01	Not required
	2.4GHz ANT 2		0.974	0	-2.78	12.76	0.19				
	2.4GHz ANT 1		0.755	0	6	12.98	0.19	87.8	1.729	0.03	Not required
	2.4GHz ANT 2		0.974	0	-2.78	12.76	0.19				

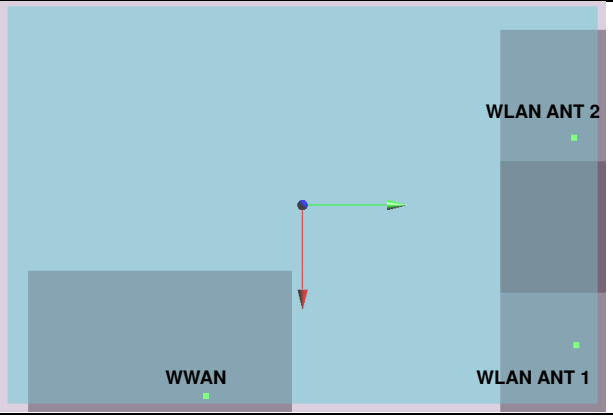

Case 9	Band	Position	SAR (W/kg)	Gap (mm)	SAR peak location (cm)			3D distance (mm)	Summed SAR (W/kg)	SPLSR Results	Simultaneous SAR
					X	Y	Z				
Case 9	WCDMA V	Bottom Face	0.588	14	8.65	-4.31	0.07	174.9	1.343	0.01	Not required
	2.4GHz ANT 1		0.755	0	6	12.98	0.19				
	WCDMA V		0.588	14	8.65	-4.31	0.07	205.4	1.562	0.01	Not required
	2.4GHz ANT 2		0.974	0	-2.78	12.76	0.19				
	2.4GHz ANT 1		0.755	0	6	12.98	0.19	87.8	1.729	0.03	Not required
	2.4GHz ANT 2		0.974	0	-2.78	12.76	0.19				

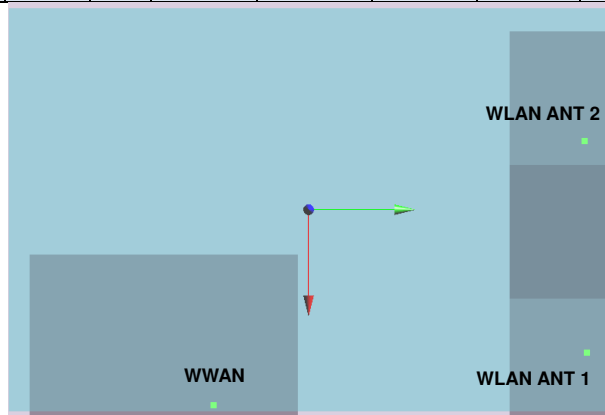

Case 10	Band	Position	SAR (W/kg)	Gap (mm)	SAR peak location (cm)			3D distance (mm)	Summed SAR (W/kg)	SPLSR Results	Simultaneous SAR
					X	Y	Z				
Case 10	WCDMA V	Bottom Face	0.44	0	8.38	-3.4	0.1	165.5	1.195	0.01	Not required
	2.4GHz ANT 1		0.755	0	6	12.98	0.19				
	WCDMA V		0.44	0	8.38	-3.4	0.1	196.4	1.414	0.01	Not required
	2.4GHz ANT 2		0.974	0	-2.78	12.76	0.19				
	2.4GHz ANT 1		0.755	0	6	12.98	0.19	87.8	1.729	0.03	Not required
	2.4GHz ANT 2		0.974	0	-2.78	12.76	0.19				

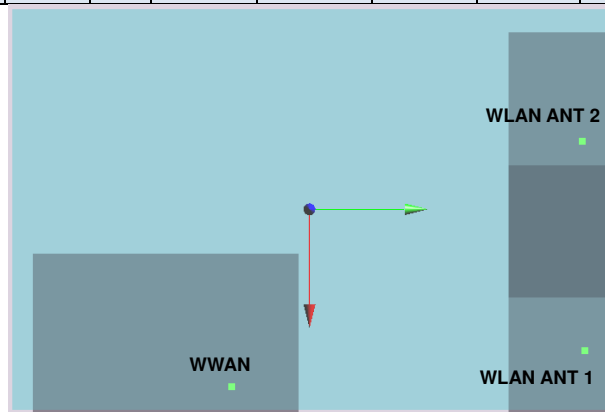



Case	Band	Position	SAR (W/kg)	Gap	SAR peak location (cm)			3D distance (mm)	Summed SAR (W/kg)	SPLSR Results	Simultaneous SAR
				(mm)	X	Y	Z				
11	CDMA BC0	Bottom Face	0.646	14	8.8	-4.76	0.11	179.6	1.401	0.01	Not required
	2.4GHz ANT 1		0.755	0	6	12.98	0.19				
	CDMA BC0		0.646	14	8.8	-4.76	0.11	210.0	1.620	0.01	Not required
	2.4GHz ANT 2		0.974	0	-2.78	12.76	0.19				
	2.4GHz ANT 1		0.755	0	6	12.98	0.19	87.8	1.729	0.03	Not required
	2.4GHz ANT 2		0.974	0	-2.78	12.76	0.19				

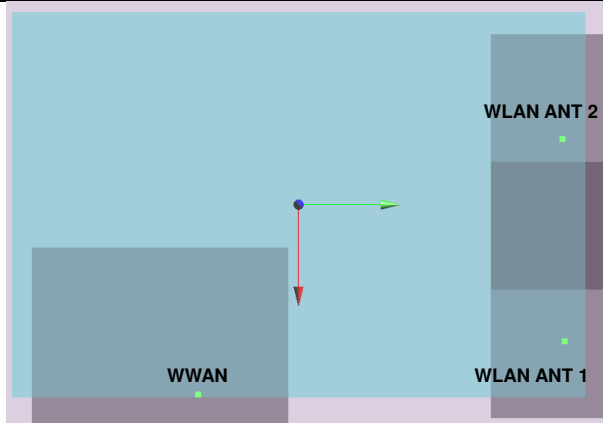

Case	Band	Position	SAR (W/kg)	Gap	SAR peak location (cm)			3D distance (mm)	Summed SAR (W/kg)	SPLSR Results	Simultaneous SAR
				(mm)	X	Y	Z				
12	CDMA BC0	Bottom Face	0.373	0	8.37	-3.23	0.14	163.8	1.128	0.01	Not required
	2.4GHz ANT 1		0.755	0	6	12.98	0.19				
	CDMA BC0		0.373	0	8.37	-3.23	0.14	194.9	1.347	0.01	Not required
	2.4GHz ANT 2		0.974	0	-2.78	12.76	0.19				
	2.4GHz ANT 1		0.755	0	6	12.98	0.19	87.8	1.729	0.03	Not required
	2.4GHz ANT 2		0.974	0	-2.78	12.76	0.19				

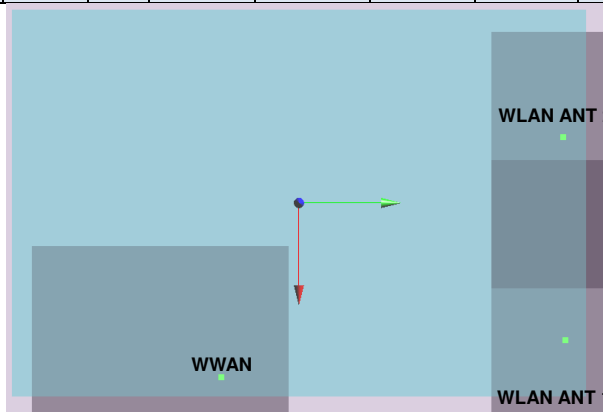

Case	Band	Position	SAR (W/kg)	Gap (mm)	SAR peak location (cm)			3D distance (mm)	Summed SAR (W/kg)	SPLSR Results	Simultaneous SAR
					X	Y	Z				
Case 13	CDMA BC1	Bottom Face	0.605	14	8.06	-4.55	0.06	176.5	1.360	0.01	Not required
	2.4GHz ANT 1		0.755	0	6	12.98	0.19				
	CDMA BC1		0.605	14	8.06	-4.55	0.06	204.2	1.579	0.01	Not required
	2.4GHz ANT 2		0.974	0	-2.78	12.76	0.19				
	2.4GHz ANT 1		0.755	0	6	12.98	0.19	87.8	1.729	0.03	Not required
	2.4GHz ANT 2		0.974	0	-2.78	12.76	0.19				

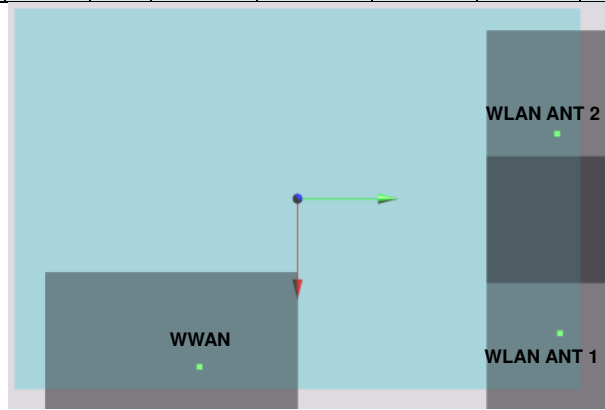

Case	Band	Position	SAR (W/kg)	Gap (mm)	SAR peak location (cm)			3D distance (mm)	Summed SAR (W/kg)	SPLSR Results	Simultaneous SAR
					X	Y	Z				
Case 14	CDMA BC1	Bottom Face	0.559	0	8.38	-4.4	0.16	175.4	1.314	0.01	Not required
	2.4GHz ANT 1		0.755	0	6	12.98	0.19				
	CDMA BC1		0.559	0	8.38	-4.4	0.16	204.7	1.533	0.01	Not required
	2.4GHz ANT 2		0.974	0	-2.78	12.76	0.19				
	2.4GHz ANT 1		0.755	0	6	12.98	0.19	87.8	1.729	0.03	Not required
	2.4GHz ANT 2		0.974	0	-2.78	12.76	0.19				

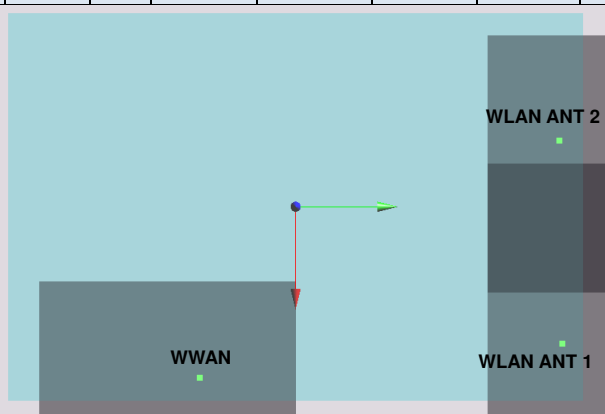

Case	Band	Position	SAR (W/kg)	Gap (mm)	SAR peak location (cm)			3D distance (mm)	Summed SAR (W/kg)	SPLSR Results	Simultaneous SAR
					X	Y	Z				
15	CDMA BC10	Bottom Face	0.569	14	8.8	-4.76	0.11	179.6	1.324	0.01	Not required
	2.4GHz ANT 1		0.755	0	6	12.98	0.19				
	CDMA BC10		0.569	14	8.8	-4.76	0.11	210.0	1.543	0.01	Not required
	2.4GHz ANT 2		0.974	0	-2.78	12.76	0.19				
	2.4GHz ANT 1		0.755	0	6	12.98	0.19	87.8	1.729	0.03	Not required
	2.4GHz ANT 2		0.974	0	-2.78	12.76	0.19				

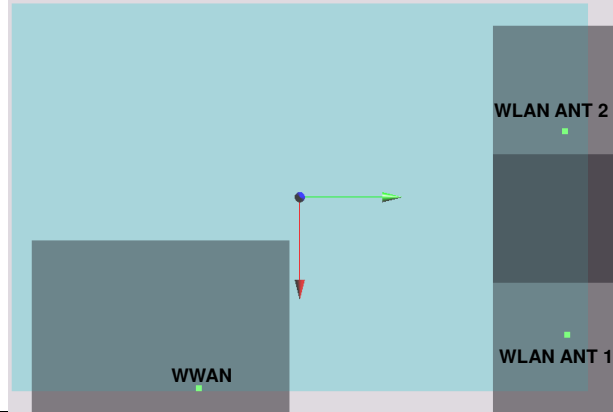

Case	Band	Position	SAR (W/kg)	Gap (mm)	SAR peak location (cm)			3D distance (mm)	Summed SAR (W/kg)	SPLSR Results	Simultaneous SAR
					X	Y	Z				
16	CDMA BC10	Bottom Face	0.471	0	8.37	-3.39	0.14	165.4	1.226	0.01	Not required
	2.4GHz ANT 1		0.755	0	6	12.98	0.19				
	CDMA BC10		0.471	0	8.37	-3.39	0.14	196.3	1.445	0.01	Not required
	2.4GHz ANT 2		0.974	0	-2.78	12.76	0.19				
	2.4GHz ANT 1		0.755	0	6	12.98	0.19	87.8	1.729	0.03	Not required
	2.4GHz ANT 2		0.974	0	-2.78	12.76	0.19				

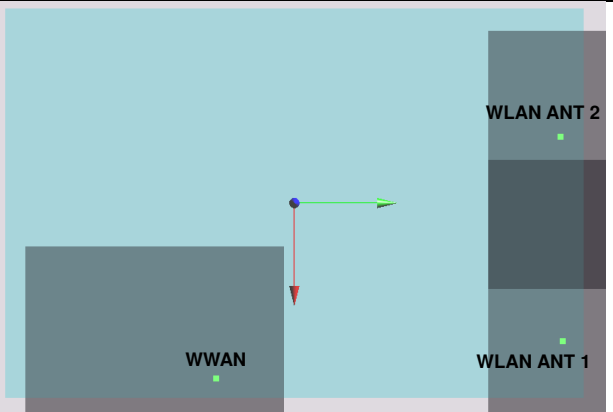

Case	Band	Position	SAR (W/kg)	Gap (mm)	SAR peak location (cm)			3D distance (mm)	Summed SAR (W/kg)	SPLSR Results	Simultaneous SAR
					X	Y	Z				
Case 17	LTE Band 4	Bottom Face	0.387	14	8.49	-4.9	0.09	180.5	1.142	0.01	Not required
	2.4GHz ANT 1		0.755	0	6	12.98	0.19				
	LTE Band 4		0.387	14	8.49	-4.9	0.09	209.5	1.361	0.01	Not required
	2.4GHz ANT 2		0.974	0	-2.78	12.76	0.19				
	2.4GHz ANT 1		0.755	0	6	12.98	0.19	87.8	1.729	0.03	Not required
	2.4GHz ANT 2		0.974	0	-2.78	12.76	0.19				

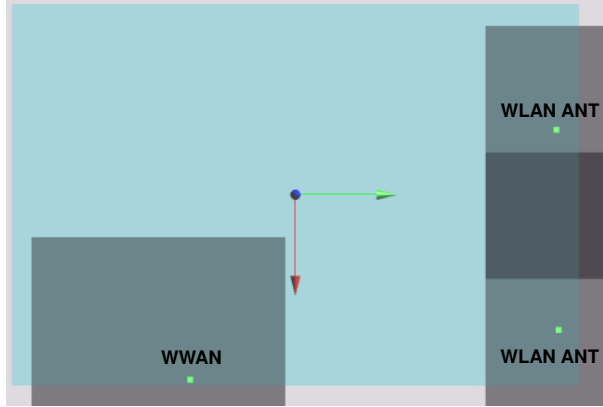

Case	Band	Position	SAR (W/kg)	Gap (mm)	SAR peak location (cm)			3D distance (mm)	Summed SAR (W/kg)	SPLSR Results	Simultaneous SAR
					X	Y	Z				
Case 18	LTE Band 4	Bottom Face	0.396	0	8.65	-4.45	0.19	176.3	1.151	0.01	Not required
	2.4GHz ANT 1		0.755	0	6	12.98	0.19				
	LTE Band 4		0.396	0	8.65	-4.45	0.19	206.6	1.370	0.01	Not required
	2.4GHz ANT 2		0.974	0	-2.78	12.76	0.19				
	2.4GHz ANT 1		0.755	0	6	12.98	0.19	87.8	1.729	0.03	Not required
	2.4GHz ANT 2		0.974	0	-2.78	12.76	0.19				

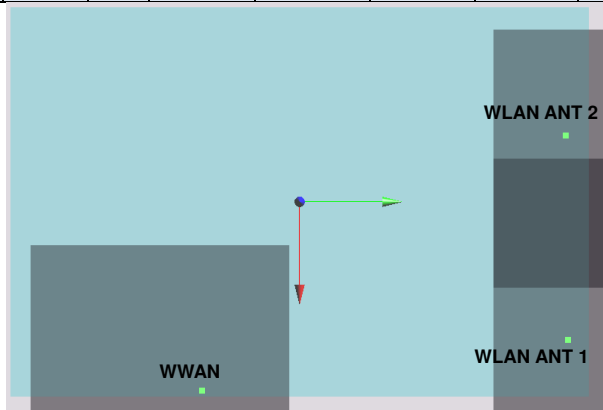

Case	Band	Position	SAR (W/kg)	Gap (mm)	SAR peak location (cm)			3D distance (mm)	Summed SAR (W/kg)	SPLSR Results	Simultaneous SAR
					X	Y	Z				
Case 19	LTE Band 5	Bottom Face	0.566	14	8.8	-4.31	0.05	175.2	1.321	0.01	Not required
	2.4GHz ANT 1		0.755	0	6	12.98	0.19				
	LTE Band 5		0.566	14	8.8	-4.31	0.05	206.3	1.540	0.01	Not required
	2.4GHz ANT 2		0.974	0	-2.78	12.76	0.19				
	2.4GHz ANT 1		0.755	0	6	12.98	0.19	87.8	1.729	0.03	Not required
	2.4GHz ANT 2		0.974	0	-2.78	12.76	0.19				

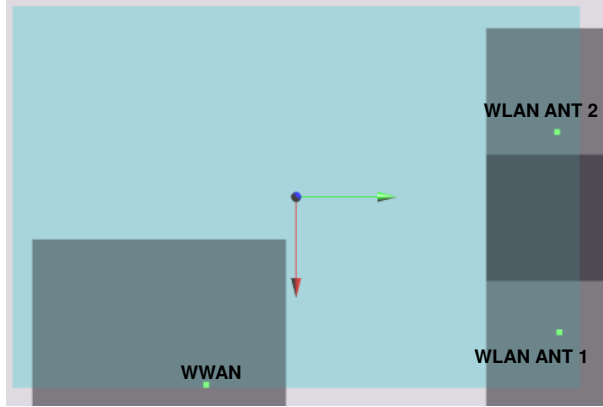

Case	Band	Position	SAR (W/kg)	Gap (mm)	SAR peak location (cm)			3D distance (mm)	Summed SAR (W/kg)	SPLSR Results	Simultaneous SAR
					X	Y	Z				
Case 20	LTE Band 5	Bottom Face	0.415	0	8.37	-3.55	0.14	167.0	1.170	0.01	Not required
	2.4GHz ANT 1		0.755	0	6	12.98	0.19				
	LTE Band 5		0.415	0	8.37	-3.55	0.14	197.6	1.389	0.01	Not required
	2.4GHz ANT 2		0.974	0	-2.78	12.76	0.19				
	2.4GHz ANT 1		0.755	0	6	12.98	0.19	87.8	1.729	0.03	Not required
	2.4GHz ANT 2		0.974	0	-2.78	12.76	0.19				

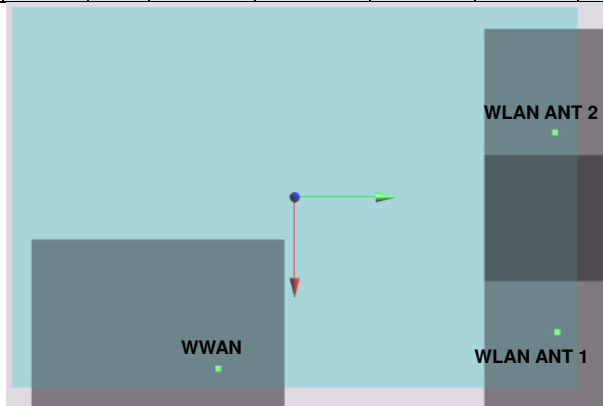





Case	Band	Position	SAR (W/kg)	Gap (mm)	SAR peak location (cm)			3D distance (mm)	Summed SAR (W/kg)	SPLSR Results	Simultaneous SAR
					X	Y	Z				
21	LTE Band 13	Bottom Face	0.389	14	8.64	-4.91	0.04	180.8	1.144	0.01	Not required
	2.4GHz ANT 1		0.755	0	6	12.98	0.19				
	LTE Band 13		0.389	14	8.64	-4.91	0.04	210.4	1.363	0.01	Not required
	2.4GHz ANT 2		0.974	0	-2.78	12.76	0.19				
	2.4GHz ANT 1		0.755	0	6	12.98	0.19	87.8	1.729	0.03	Not required
	2.4GHz ANT 2		0.974	0	-2.78	12.76	0.19				

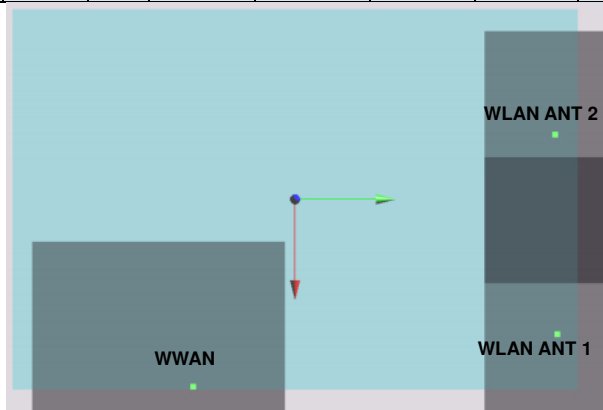

Case	Band	Position	SAR (W/kg)	Gap (mm)	SAR peak location (cm)			3D distance (mm)	Summed SAR (W/kg)	SPLSR Results	Simultaneous SAR
					X	Y	Z				
22	LTE Band 13	Bottom Face	0.719	0	7.91	-3.55	0.15	166.4	1.474	0.01	Not required
	2.4GHz ANT 1		0.755	0	6	12.98	0.19				
	LTE Band 13		0.719	0	7.91	-3.55	0.15	195.0	1.693	0.01	Not required
	2.4GHz ANT 2		0.974	0	-2.78	12.76	0.19				
	2.4GHz ANT 1		0.755	0	6	12.98	0.19	87.8	1.729	0.03	Not required
	2.4GHz ANT 2		0.974	0	-2.78	12.76	0.19				

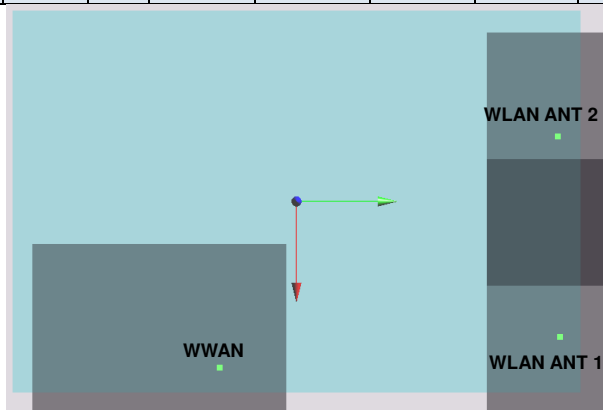



Case	Band	Position	SAR (W/kg)	Gap (mm)	SAR peak location (cm)			3D distance (mm)	Summed SAR (W/kg)	SPLSR Results	Simultaneous SAR
					X	Y	Z				
23	LTE Band 17	Bottom Face	0.299	14	8.65	-5.05	0.04	182.2	1.054	0.01	Not required
	2.4GHz ANT 1		0.755	0	6	12.98	0.19				
	LTE Band 17		0.299	14	8.65	-5.05	0.04	211.6	1.273	0.01	Not required
	2.4GHz ANT 2		0.974	0	-2.78	12.76	0.19				
	2.4GHz ANT 1		0.755	0	6	12.98	0.19	87.8	1.729	0.03	Not required
	2.4GHz ANT 2		0.974	0	-2.78	12.76	0.19				

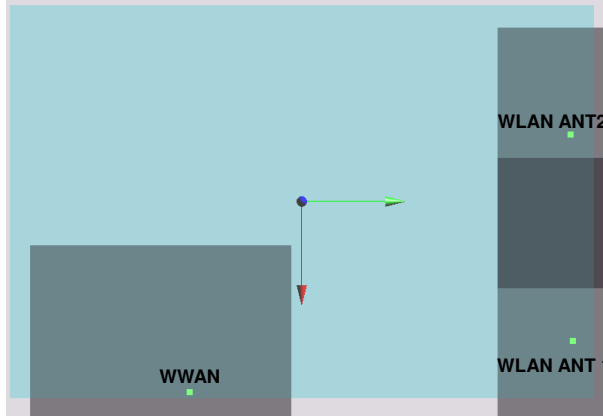

Case	Band	Position	SAR (W/kg)	Gap (mm)	SAR peak location (cm)			3D distance (mm)	Summed SAR (W/kg)	SPLSR Results	Simultaneous SAR
					X	Y	Z				
24	LTE Band 17	Bottom Face	0.722	0	7.91	-3.55	0.15	166.4	1.477	0.01	Not required
	2.4GHz ANT 1		0.755	0	6	12.98	0.19				
	LTE Band 17		0.722	0	7.91	-3.55	0.15	195.0	1.696	0.01	Not required
	2.4GHz ANT 2		0.974	0	-2.78	12.76	0.19				
	2.4GHz ANT 1		0.755	0	6	12.98	0.19	87.8	1.729	0.03	Not required
	2.4GHz ANT 2		0.974	0	-2.78	12.76	0.19				

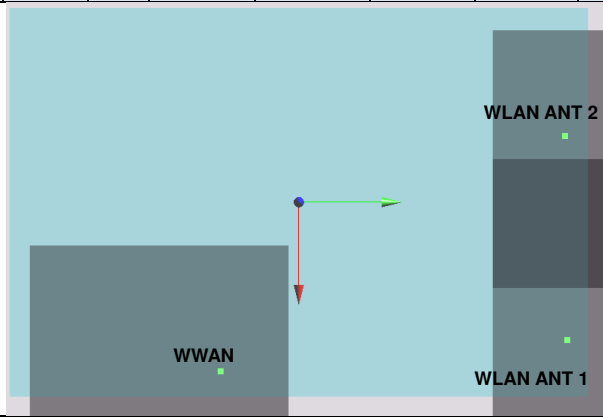



Case	Band	Position	SAR (W/kg)	Gap (mm)	SAR peak location (cm)			3D distance (mm)	Summed SAR (W/kg)	SPLSR Results	Simultaneous SAR
					X	Y	Z				
Case 25	LTE Band 25	Bottom Face	0.408	14	8.64	-4.45	0.09	176.3	1.163	0.01	Not required
	2.4GHz ANT 1		0.755	0	6	12.98	0.19				
	LTE Band 25		0.408	14	8.64	-4.45	0.09	206.5	1.382	0.01	Not required
	2.4GHz ANT 2		0.974	0	-2.78	12.76	0.19				
	2.4GHz ANT 1		0.755	0	6	12.98	0.19	87.8	1.729	0.03	Not required
	2.4GHz ANT 2		0.974	0	-2.78	12.76	0.19				

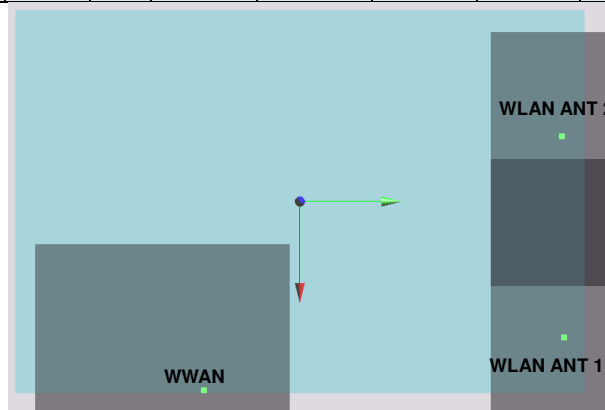

Case	Band	Position	SAR (W/kg)	Gap (mm)	SAR peak location (cm)			3D distance (mm)	Summed SAR (W/kg)	SPLSR Results	Simultaneous SAR
					X	Y	Z				
Case 26	LTE Band 25	Bottom Face	0.614	0	8.64	-4.3	0.2	174.8	1.369	0.01	Not required
	2.4GHz ANT 1		0.755	0	6	12.98	0.19				
	LTE Band 25		0.614	0	8.64	-4.3	0.2	205.3	1.588	0.01	Not required
	2.4GHz ANT 2		0.974	0	-2.78	12.76	0.19				
	2.4GHz ANT 1		0.755	0	6	12.98	0.19	87.8	1.729	0.03	Not required
	2.4GHz ANT 2		0.974	0	-2.78	12.76	0.19				

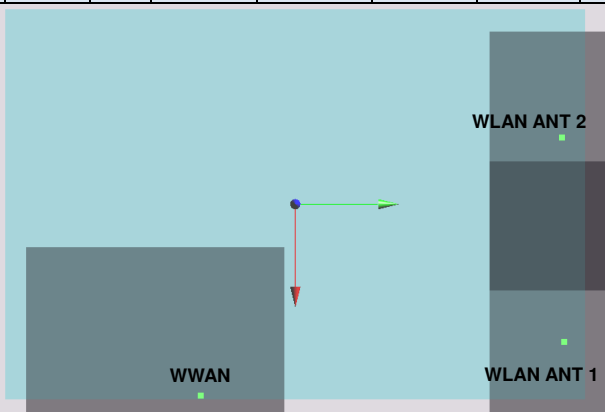

Case	Band	Position	SAR (W/kg)	Gap	SAR peak location (cm)			3D distance (mm)	Summed SAR (W/kg)	SPLSR Results	Simultaneous SAR
				(mm)	X	Y	Z				
Case 27	GSM850	Bottom Face	0.977	14	8.8	-4.61	0.06	174.8	1.784	0.01	Not required
	5GHz ANT 1		0.807	0	6.38	12.7	0.31				
	GSM850		0.977	14	8.8	-4.61	0.06	211.0	1.404	0.01	Not required
	5GHz ANT 2		0.427	0	-3.54	12.5	0.18				
	5GHz ANT 1		0.807	0	6.38	12.7	0.31	99.2	1.234	0.01	Not required
	5GHz ANT 2		0.427	0	-3.54	12.5	0.18				

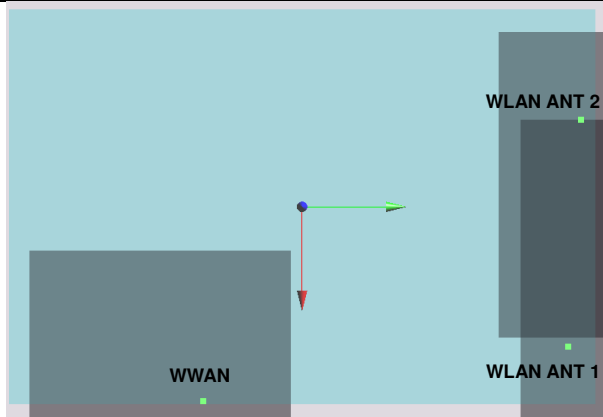

Case	Band	Position	SAR (W/kg)	Gap	SAR peak location (cm)			3D distance (mm)	Summed SAR (W/kg)	SPLSR Results	Simultaneous SAR
				(mm)	X	Y	Z				
Case 28	GSM1900	Bottom Face	0.464	14	8.8	-4.45	0.1	173.2	1.271	0.01	Not required
	5GHz ANT 1		0.807	0	6.38	12.7	0.31				
	GSM1900		0.464	14	8.8	-4.45	0.1	209.7	0.891	0.00	Not required
	5GHz ANT 2		0.427	0	-3.54	12.5	0.18				
	5GHz ANT 1		0.807	0	6.38	12.7	0.31	99.2	1.234	0.01	Not required
	5GHz ANT 2		0.427	0	-3.54	12.5	0.18				

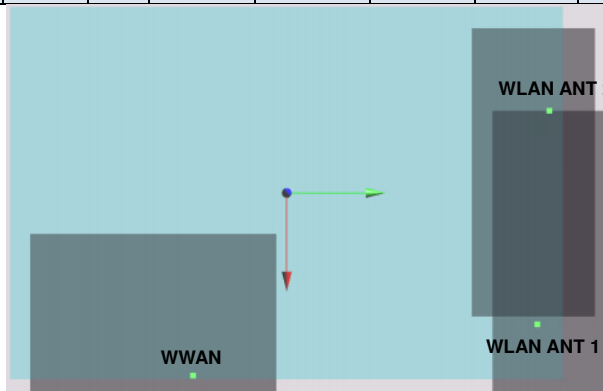

Case 29	Band	Position	SAR (W/kg)	Gap	SAR peak location (cm)			3D distance (mm)	Summed SAR (W/kg)	SPLSR Results	Simultaneous SAR
				(mm)	X	Y	Z				
Case 29	GSM1900	Bottom Face	0.417	0	8.86	-3.98	0.2	168.6	1.224	0.01	Not required
	5GHz ANT 1		0.807	0	6.38	12.7	0.31				
	GSM1900		0.417	0	8.86	-3.98	0.2	206.2	0.844	0.00	Not required
	5GHz ANT 2		0.427	0	-3.54	12.5	0.18				
	5GHz ANT 1		0.807	0	6.38	12.7	0.31	99.2	1.234	0.01	Not required
	5GHz ANT 2		0.427	0	-3.54	12.5	0.18				

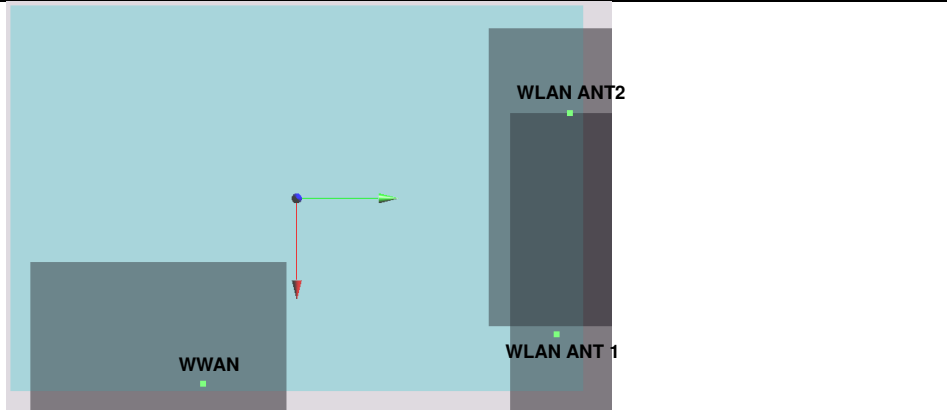

Case 30	Band	Position	SAR (W/kg)	Gap	SAR peak location (cm)			3D distance (mm)	Summed SAR (W/kg)	SPLSR Results	Simultaneous SAR
				(mm)	X	Y	Z				
Case 30	WCDMA II	Bottom Face	0.548	14	8.91	-4.44	0.1	173.3	1.355	0.01	Not required
	5GHz ANT 1		0.807	0	6.38	12.7	0.31				
	WCDMA II		0.548	14	8.91	-4.44	0.1	210.2	0.975	0.00	Not required
	5GHz ANT 2		0.427	0	-3.54	12.5	0.18				
	5GHz ANT 1		0.807	0	6.38	12.7	0.31	99.2	1.234	0.01	Not required
	5GHz ANT 2		0.427	0	-3.54	12.5	0.18				

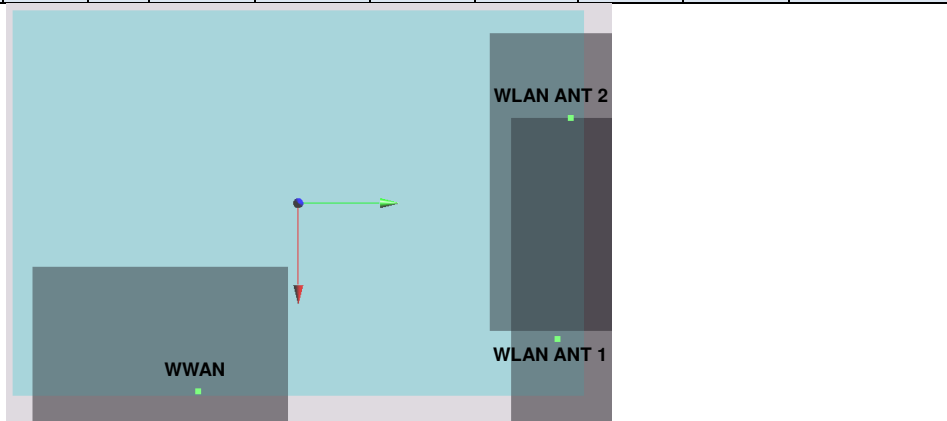

Case	Band	Position	SAR (W/kg)	Gap	SAR peak location (cm)			3D distance (mm)	Summed SAR (W/kg)	SPLSR Results	Simultaneous SAR
				(mm)	X	Y	Z				
31	WCDMA II	Bottom Face	0.745	0	8.91	-4.44	0.1	173.3	1.552	0.01	Not required
	5GHz ANT 1		0.807	0	6.38	12.7	0.31				
	WCDMA II		0.745	0	8.91	-4.44	0.1	210.2	1.172	0.01	Not required
	5GHz ANT 2		0.427	0	-3.54	12.5	0.18				
	5GHz ANT 1		0.807	0	6.38	12.7	0.31	99.2	1.234	0.01	Not required
	5GHz ANT 2		0.427	0	-3.54	12.5	0.18				

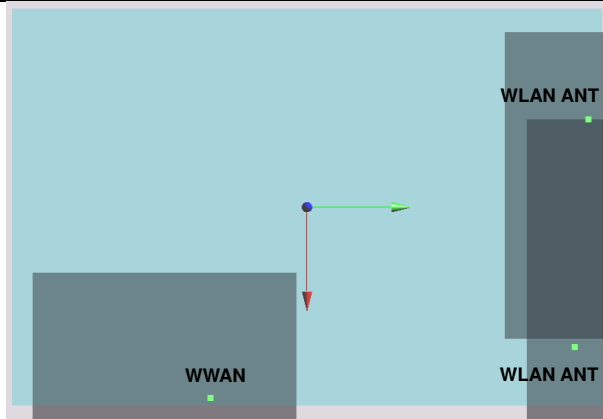

Case	Band	Position	SAR (W/kg)	Gap	SAR peak location (cm)			3D distance (mm)	Summed SAR (W/kg)	SPLSR Results	Simultaneous SAR
				(mm)	X	Y	Z				
32	WCDMA IV	Bottom Face	0.414	14	8.38	-4.89	0.09	177.0	1.221	0.01	Not required
	5GHz ANT 1		0.807	0	6.38	12.7	0.31				
	WCDMA IV		0.414	14	8.38	-4.89	0.09	210.8	0.841	0.00	Not required
	5GHz ANT 2		0.427	0	-3.54	12.5	0.18				
	5GHz ANT 1		0.807	0	6.38	12.7	0.31	99.2	1.234	0.01	Not required
	5GHz ANT 2		0.427	0	-3.54	12.5	0.18				

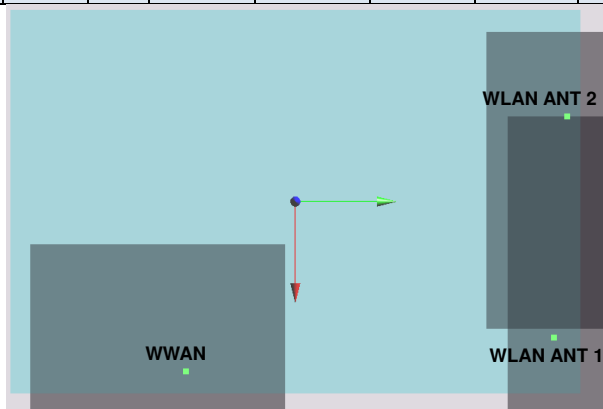

Case	Band	Position	SAR (W/kg)	Gap (mm)	SAR peak location (cm)			3D distance (mm)	Summed SAR (W/kg)	SPLSR Results	Simultaneous SAR
					X	Y	Z				
33	WCDMA IV	Bottom Face	0.439	0	8.55	-4.27	0.21	171.1	1.246	0.01	Not required
	5GHz ANT 1		0.807	0	6.38	12.7	0.31				
	WCDMA IV		0.439	0	8.55	-4.27	0.21	206.7	0.866	0.00	Not required
	5GHz ANT 2		0.427	0	-3.54	12.5	0.18				
	5GHz ANT 1		0.807	0	6.38	12.7	0.31	99.2	1.234	0.01	Not required
	5GHz ANT 2		0.427	0	-3.54	12.5	0.18				

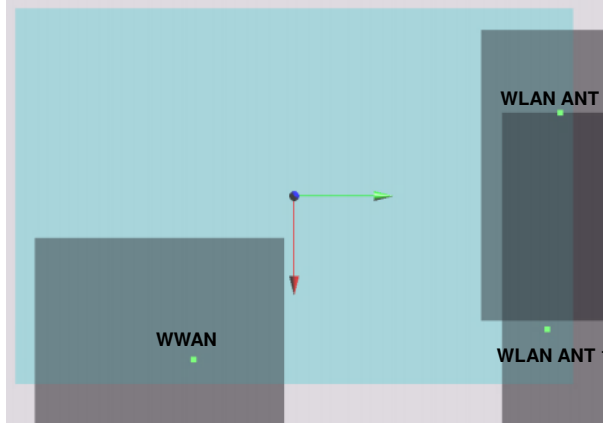

Case	Band	Position	SAR (W/kg)	Gap (mm)	SAR peak location (cm)			3D distance (mm)	Summed SAR (W/kg)	SPLSR Results	Simultaneous SAR
					X	Y	Z				
34	WCDMA V	Bottom Face	0.588	14	8.65	-4.31	0.07	171.6	1.395	0.01	Not required
	5GHz ANT 1		0.807	0	6.38	12.7	0.31				
	WCDMA V		0.588	14	8.65	-4.31	0.07	207.6	1.015	0.00	Not required
	5GHz ANT 2		0.427	0	-3.54	12.5	0.18				
	5GHz ANT 1		0.807	0	6.38	12.7	0.31	99.2	1.234	0.01	Not required
	5GHz ANT 2		0.427	0	-3.54	12.5	0.18				

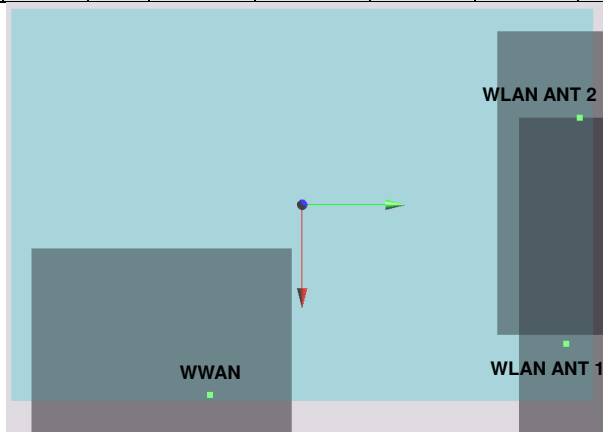



Case	Band	Position	SAR (W/kg)	Gap (mm)	SAR peak location (cm)			3D distance (mm)	Summed SAR (W/kg)	SPLSR Results	Simultaneous SAR
					X	Y	Z				
35	WCDMA V	Bottom Face	0.44	0	8.38	-3.4	0.1	162.3	1.247	0.01	Not required
	5GHz ANT 1		0.807	0	6.38	12.7	0.31				
	WCDMA V		0.44	0	8.38	-3.4	0.1	198.7	0.867	0.00	Not required
	5GHz ANT 2		0.427	0	-3.54	12.5	0.18				
	5GHz ANT 1		0.807	0	6.38	12.7	0.31	99.2	1.234	0.01	Not required
	5GHz ANT 2		0.427	0	-3.54	12.5	0.18				

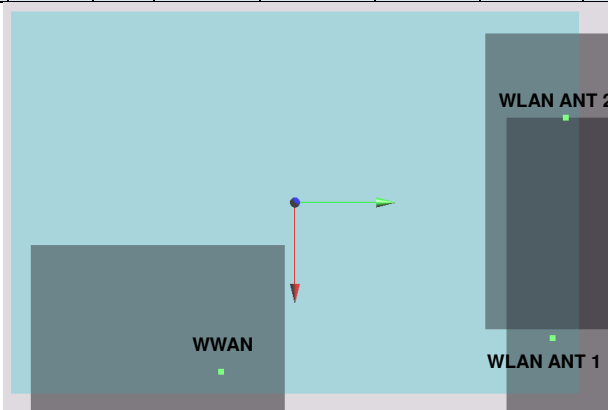

Case	Band	Position	SAR (W/kg)	Gap (mm)	SAR peak location (cm)			3D distance (mm)	Summed SAR (W/kg)	SPLSR Results	Simultaneous SAR
					X	Y	Z				
36	CDMA BC0	Bottom Face	0.646	14	8.8	-4.76	0.11	176.3	1.453	0.01	Not required
	5GHz ANT 1		0.807	0	6.38	12.7	0.31				
	CDMA BC0		0.646	14	8.8	-4.76	0.11	212.2	1.073	0.01	Not required
	5GHz ANT 2		0.427	0	-3.54	12.5	0.18				
	5GHz ANT 1		0.807	0	6.38	12.7	0.31	99.2	1.234	0.01	Not required
	5GHz ANT 2		0.427	0	-3.54	12.5	0.18				

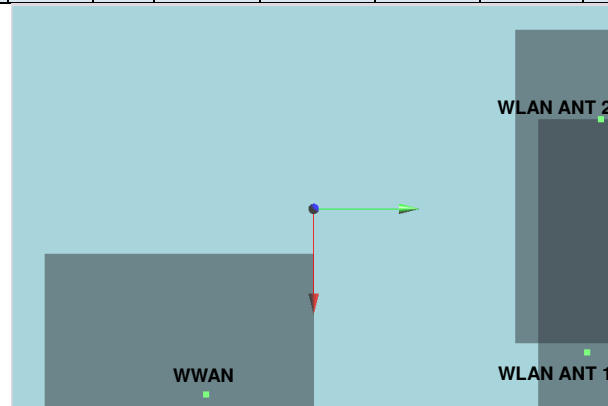





Case	Band	Position	SAR (W/kg)	Gap (mm)	SAR peak location (cm)			3D distance (mm)	Summed SAR (W/kg)	SPLSR Results	Simultaneous SAR
					X	Y	Z				
37	CDMA BC0	Bottom Face	0.373	0	8.37	-3.23	0.14	160.5	1.180	0.01	Not required
	5GHz ANT 1		0.807	0	6.38	12.7	0.31				
	CDMA BC0		0.373	0	8.8	-4.76	0.11	212.2	0.800	0.00	Not required
	5GHz ANT 2		0.427	0	-3.54	12.5	0.18				
	5GHz ANT 1		0.807	0	6.38	12.7	0.31	99.2	1.234	0.01	Not required
	5GHz ANT 2		0.427	0	-3.54	12.5	0.18				

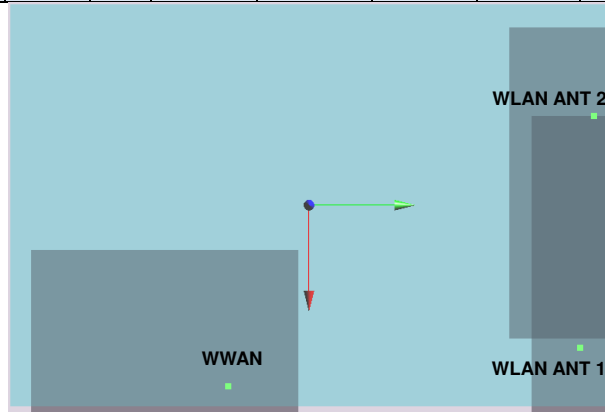

Case	Band	Position	SAR (W/kg)	Gap (mm)	SAR peak location (cm)			3D distance (mm)	Summed SAR (W/kg)	SPLSR Results	Simultaneous SAR
					X	Y	Z				
38	CDMA BC1	Bottom Face	0.605	14	8.06	-4.55	0.06	173.3	1.412	0.01	Not required
	5GHz ANT 1		0.807	0	6.38	12.7	0.31				
	CDMA BC1		0.605	14	8.06	-4.55	0.06	206.2	1.032	0.01	Not required
	5GHz ANT 2		0.427	0	-3.54	12.5	0.18				
	5GHz ANT 1		0.807	0	6.38	12.7	0.31	99.2	1.234	0.01	Not required
	5GHz ANT 2		0.427	0	-3.54	12.5	0.18				

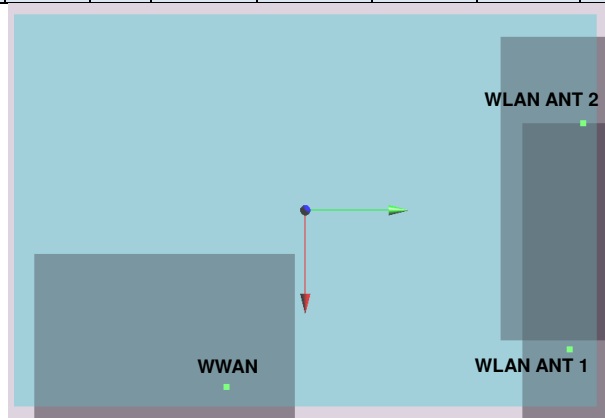



Case	Band	Position	SAR (W/kg)	Gap (mm)	SAR peak location (cm)			3D distance (mm)	Summed SAR (W/kg)	SPLSR Results	Simultaneous SAR
					X	Y	Z				
39	CDMA BC1	Bottom Face	0.559	0	8.38	-4.4	0.16	172.2	1.366	0.01	Not required
	5GHz ANT 1		0.807	0	6.38	12.7	0.31				
	CDMA BC1		0.559	0	8.38	-4.4	0.16	206.8	0.986	0.00	Not required
	5GHz ANT 2		0.427	0	-3.54	12.5	0.18				
	5GHz ANT 1		0.807	0	6.38	12.7	0.31	99.2	1.234	0.01	Not required
	5GHz ANT 2		0.427	0	-3.54	12.5	0.18				

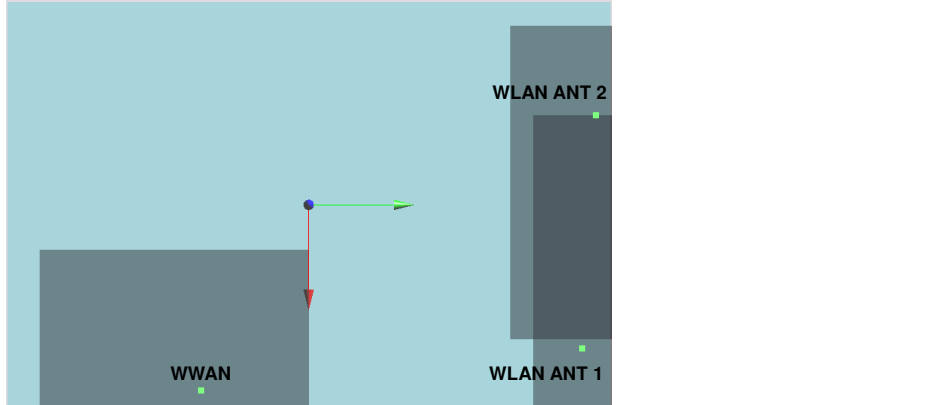

Case	Band	Position	SAR (W/kg)	Gap (mm)	SAR peak location (cm)			3D distance (mm)	Summed SAR (W/kg)	SPLSR Results	Simultaneous SAR
					X	Y	Z				
40	CDMA BC10	Bottom Face	0.569	14	8.8	-4.76	0.11	176.3	1.376	0.01	Not required
	5GHz ANT 1		0.807	0	6.38	12.7	0.31				
	CDMA BC10		0.569	14	8.8	-4.76	0.11	212.2	0.996	0.00	Not required
	5GHz ANT 2		0.427	0	-3.54	12.5	0.18				
	5GHz ANT 1		0.807	0	6.38	12.7	0.31	99.2	1.234	0.01	Not required
	5GHz ANT 2		0.427	0	-3.54	12.5	0.18				

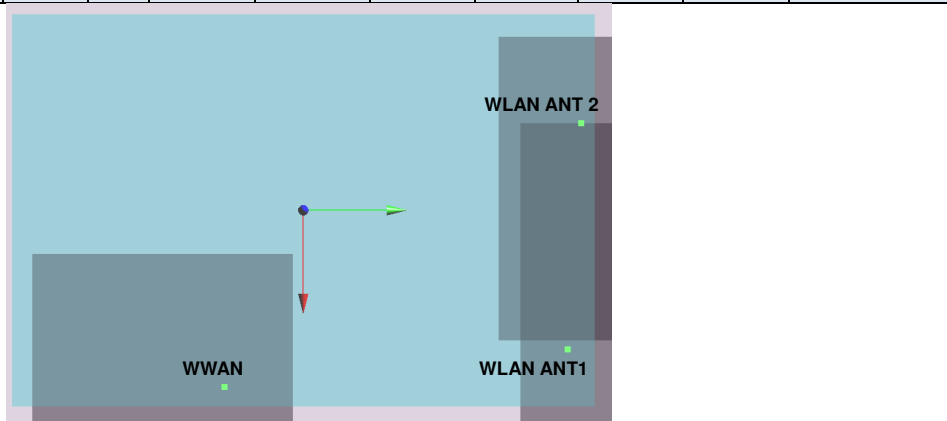



Case	Band	Position	SAR (W/kg)	Gap (mm)	SAR peak location (cm)			3D distance (mm)	Summed SAR (W/kg)	SPLSR Results	Simultaneous SAR
					X	Y	Z				
41	CDMA BC10	Bottom Face	0.471	0	8.37	-3.39	0.14	162.1	1.278	0.01	Not required
	5GHz ANT 1		0.807	0	6.38	12.7	0.31				
	CDMA BC10		0.471	0	8.37	-3.39	0.14	198.6	0.898	0.00	Not required
	5GHz ANT 2		0.427	0	-3.54	12.5	0.18				
	5GHz ANT 1		0.807	0	6.38	12.7	0.31	99.2	1.234	0.01	Not required
	5GHz ANT 2		0.427	0	-3.54	12.5	0.18				

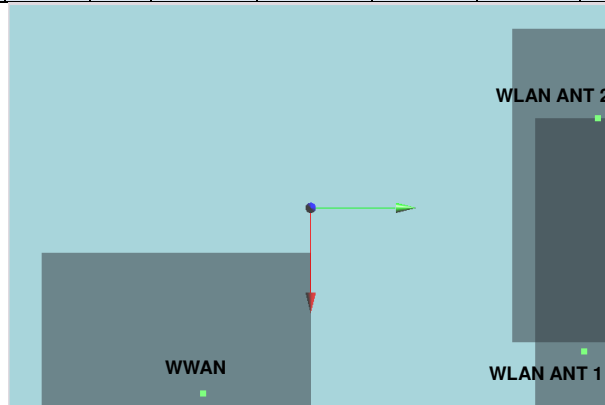

Case	Band	Position	SAR (W/kg)	Gap (mm)	SAR peak location (cm)			3D distance (mm)	Summed SAR (W/kg)	SPLSR Results	Simultaneous SAR
					X	Y	Z				
42	LTE Band 4	Bottom Face	0.387	14	8.49	-4.9	0.09	177.3	1.194	0.01	Not required
	5GHz ANT 1		0.807	0	6.38	12.7	0.31				
	LTE Band 4		0.387	14	8.49	-4.9	0.09	211.5	0.814	0.00	Not required
	5GHz ANT 2		0.427	0	-3.54	12.5	0.18				
	5GHz ANT 1		0.807	0	6.38	12.7	0.31	99.2	1.234	0.01	Not required
	5GHz ANT 2		0.427	0	-3.54	12.5	0.18				

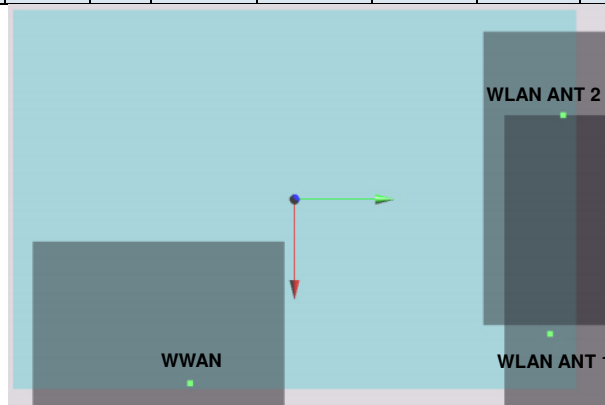



Case	Band	Position	SAR (W/kg)	Gap (mm)	SAR peak location (cm)			3D distance (mm)	Summed SAR (W/kg)	SPLSR Results	Simultaneous SAR
					X	Y	Z				
43	LTE Band 4	Bottom Face	0.396	0	8.65	-4.45	0.19	173.0	1.203	0.01	Not required
	5GHz ANT 1		0.807	0	6.38	12.7	0.31				
	LTE Band 4		0.396	0	8.65	-4.45	0.19	208.8	0.823	0.00	Not required
	5GHz ANT 2		0.427	0	-3.54	12.5	0.18				
	5GHz ANT 1		0.807	0	6.38	12.7	0.31	99.2	1.234	0.01	Not required
	5GHz ANT 2		0.427	0	-3.54	12.5	0.18				

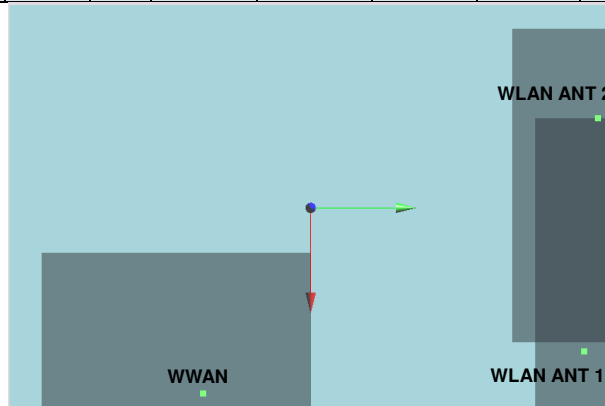

Case	Band	Position	SAR (W/kg)	Gap (mm)	SAR peak location (cm)			3D distance (mm)	Summed SAR (W/kg)	SPLSR Results	Simultaneous SAR
					X	Y	Z				
44	LTE Band 5	Bottom Face	0.566	14	8.8	-4.31	0.05	171.8	1.373	0.01	Not required
	5GHz ANT 1		0.807	0	6.38	12.7	0.31				
	LTE Band 5		0.566	14	8.8	-4.31	0.05	208.5	0.993	0.00	Not required
	5GHz ANT 2		0.427	0	-3.54	12.5	0.18				
	5GHz ANT 1		0.807	0	6.38	12.7	0.31	99.2	1.234	0.01	Not required
	5GHz ANT 2		0.427	0	-3.54	12.5	0.18				

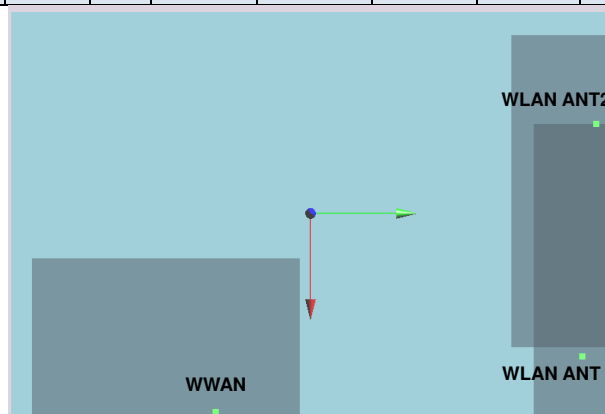



Case	Band	Position	SAR (W/kg)	Gap (mm)	SAR peak location (cm)			3D distance (mm)	Summed SAR (W/kg)	SPLSR Results	Simultaneous SAR
					X	Y	Z				
45	LTE Band 5	Bottom Face	0.415	0	8.37	-3.55	0.14	163.7	1.222	0.01	Not required
	5GHz ANT 1		0.807	0	6.38	12.7	0.31				
	LTE Band 5		0.415	0	8.37	-3.55	0.14	199.9	0.842	0.00	Not required
	5GHz ANT 2		0.427	0	-3.54	12.5	0.18				
	5GHz ANT 1		0.807	0	6.38	12.7	0.31	99.2	1.234	0.01	Not required
	5GHz ANT 2		0.427	0	-3.54	12.5	0.18				

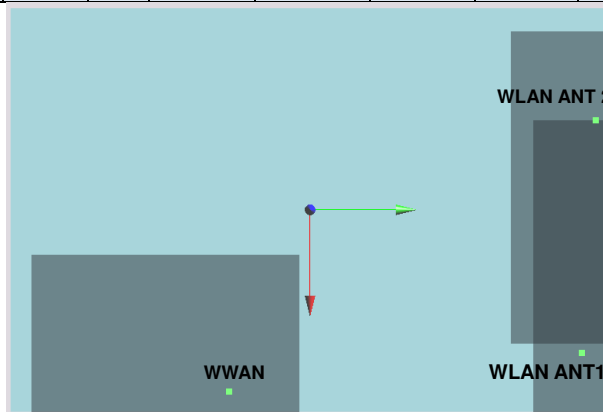

Case	Band	Position	SAR (W/kg)	Gap (mm)	SAR peak location (cm)			3D distance (mm)	Summed SAR (W/kg)	SPLSR Results	Simultaneous SAR
					X	Y	Z				
46	LTE Band 13	Bottom Face	0.389	14	8.64	-4.91	0.04	177.6	1.196	0.01	Not required
	5GHz ANT 1		0.807	0	6.38	12.7	0.31				
	LTE Band 13		0.389	14	8.64	-4.91	0.04	212.5	0.816	0.00	Not required
	5GHz ANT 2		0.427	0	-3.54	12.5	0.18				
	5GHz ANT 1		0.807	0	6.38	12.7	0.31	99.2	1.234	0.01	Not required
	5GHz ANT 2		0.427	0	-3.54	12.5	0.18				

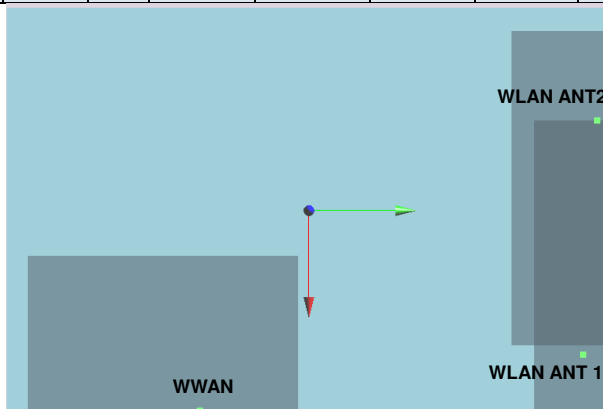



Case	Band	Position	SAR (W/kg)	Gap (mm)	SAR peak location (cm)			3D distance (mm)	Summed SAR (W/kg)	SPLSR Results	Simultaneous SAR
					X	Y	Z				
47	LTE Band 13	Bottom Face	0.719	0	7.91	-3.55	0.15	163.2	1.526	0.01	Not required
	5GHz ANT 1		0.807	0	6.38	12.7	0.31				
	LTE Band 13		0.719	0	7.91	-3.55	0.15	197.2	1.146	0.01	Not required
	5GHz ANT 2		0.427	0	-3.54	12.5	0.18				
	5GHz ANT 1		0.807	0	6.38	12.7	0.31	99.2	1.234	0.01	Not required
	5GHz ANT 2		0.427	0	-3.54	12.5	0.18				

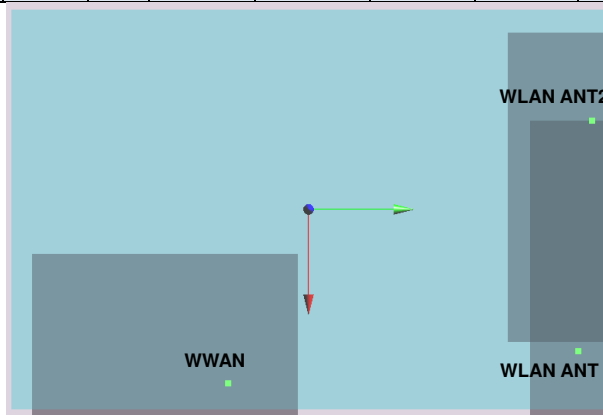

Case	Band	Position	SAR (W/kg)	Gap (mm)	SAR peak location (cm)			3D distance (mm)	Summed SAR (W/kg)	SPLSR Results	Simultaneous SAR
					X	Y	Z				
48	LTE Band 17	Bottom Face	0.722	0	7.91	-3.55	0.15	163.2	1.529	0.01	Not required
	5GHz ANT 1		0.807	0	6.38	12.7	0.31				
	LTE Band 17		0.722	0	7.91	-3.55	0.15	197.2	1.149	0.01	Not required
	5GHz ANT 2		0.427	0	-3.54	12.5	0.18				
	5GHz ANT 1		0.807	0	6.38	12.7	0.31	99.2	1.234	0.01	Not required
	5GHz ANT 2		0.427	0	-3.54	12.5	0.18				

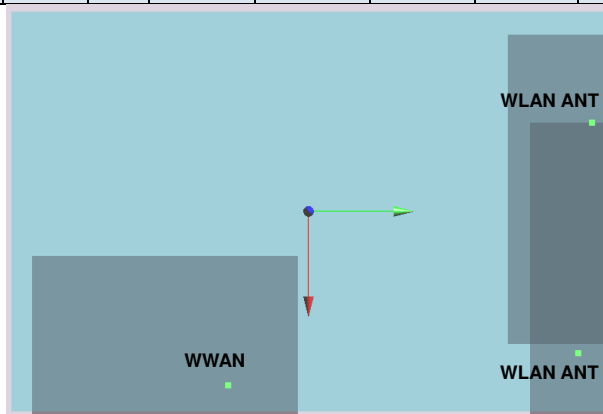



Case	Band	Position	SAR (W/kg)	Gap (mm)	SAR peak location (cm)			3D distance (mm)	Summed SAR (W/kg)	SPLSR Results	Simultaneous SAR
					X	Y	Z				
49	LTE Band 25	Bottom Face	0.408	14	8.64	-4.45	0.09	173.0	1.215	0.01	Not required
	5GHz ANT 1		0.807	0	6.38	12.7	0.31				
	LTE Band 25		0.408	14	8.64	-4.45	0.09	208.7	0.835	0.00	Not required
	5GHz ANT 2		0.427	0	-3.54	12.5	0.18				
	5GHz ANT 1		0.807	0	6.38	12.7	0.31	99.2	1.234	0.01	Not required
	5GHz ANT 2		0.427	0	-3.54	12.5	0.18				

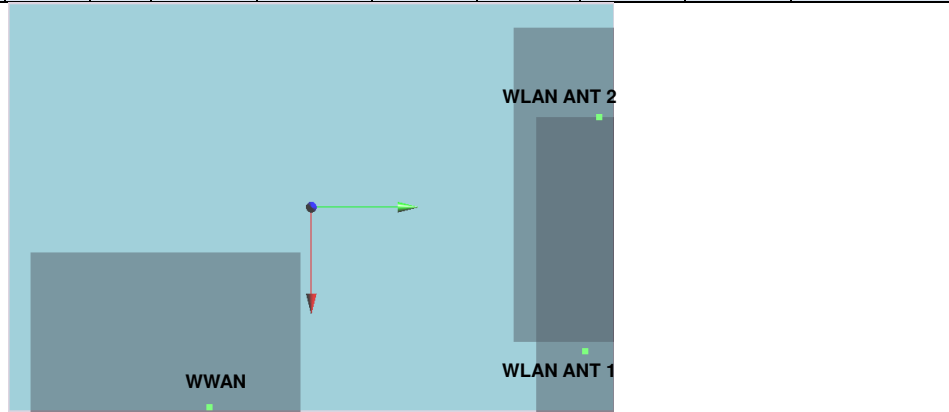

Case	Band	Position	SAR (W/kg)	Gap (mm)	SAR peak location (cm)			3D distance (mm)	Summed SAR (W/kg)	SPLSR Results	Simultaneous SAR
					X	Y	Z				
50	LTE Band 25	Bottom Face	0.614	0	8.64	-4.45	0.09	173.0	1.421	0.01	Not required
	5GHz ANT 1		0.807	0	6.38	12.7	0.31				
	LTE Band 25		0.614	0	8.64	-4.45	0.09	208.7	1.041	0.01	Not required
	5GHz ANT 2		0.427	0	-3.54	12.5	0.18				
	5GHz ANT 1		0.807	0	6.38	12.7	0.31	99.2	1.234	0.01	Not required
	5GHz ANT 2		0.427	0	-3.54	12.5	0.18				

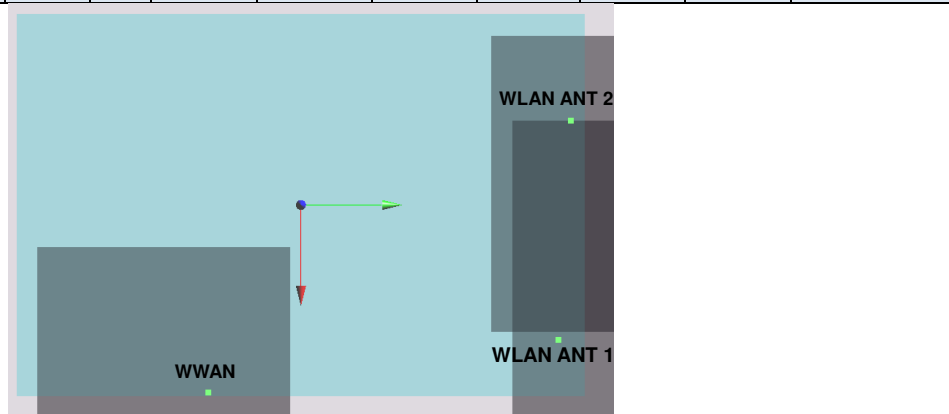

Case	Band	Position	SAR (W/kg)	Gap (mm)	SAR peak location (cm)			3D distance (mm)	Summed SAR (W/kg)	SPLSR Results	Simultaneous SAR
					X	Y	Z				
51	2.4GHz ANT 1	Bottom Face	0.755	0	6	12.98	0.19	87.8	1.729	0.03	Not required
	2.4GHz ANT 2		0.974	0	-2.78	12.76	0.19				

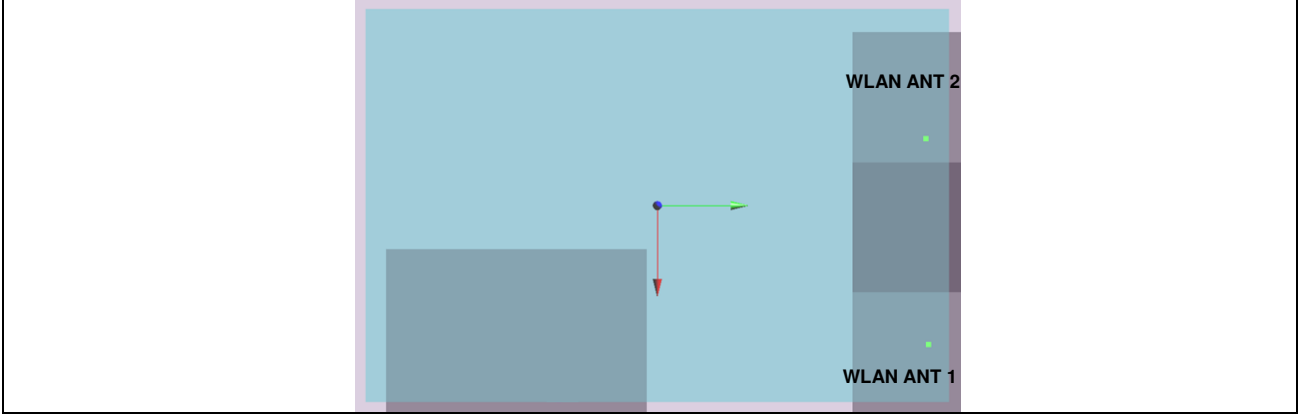

Case	Band	Position	SAR (W/kg)	Gap (mm)	SAR peak location (cm)			3D distance (mm)	Summed SAR (W/kg)	SPLSR Results	Simultaneous SAR
					X	Y	Z				
52	2.4GHz ANT 1	Edge 2	1.049	0	-0.7	-6.62	0.13	93.4	2.080	0.03	Not required
	2.4GHz ANT 2		1.031	0	-0.6	2.72	0.05				

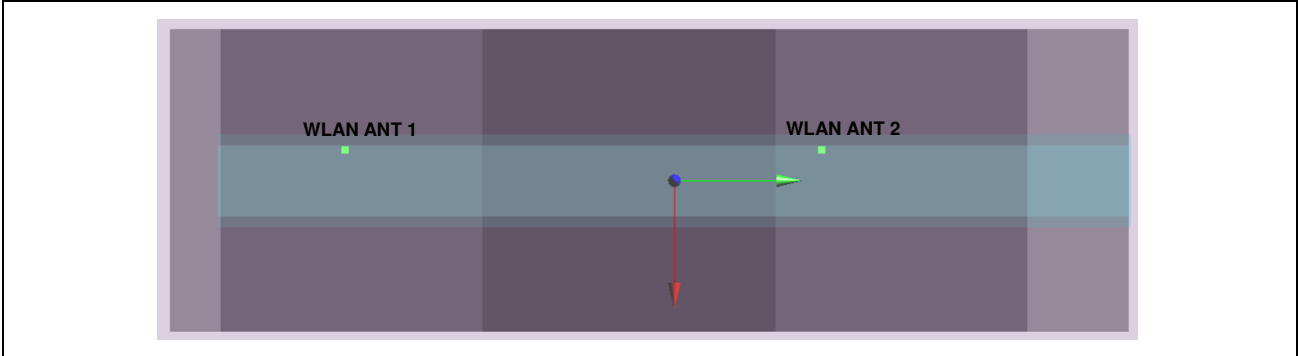



Case 53	Band	Position	SAR (W/kg)	Gap (mm)	SAR peak location (cm)			3D distance (mm)	Summed SAR (W/kg)	SPLSR Results	Simultaneous SAR
					X	Y	Z				
	5GHz ANT 1	Edge 2	1.227	0	-0.22	-6.26	0.17	99.6	2.611	0.04	Not required
	5GHz ANT 2		1.384	0	-0.38	3.7	0.14				

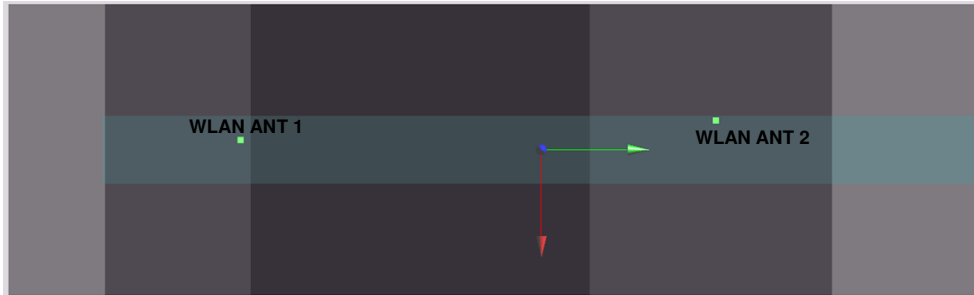

**Test Engineer :** Bevis Chang Galen Zhang Kurt Liu Tom Jiang Tommy Chen and Thomas Wang

## 16. Uncertainty Assessment

The component of uncertainty may generally be categorized according to the methods used to evaluate them. The evaluation of uncertainty by the statistical analysis of a series of observations is termed a Type A evaluation of uncertainty. The evaluation of uncertainty by means other than the statistical analysis of a series of observation is termed a Type B evaluation of uncertainty. Each component of uncertainty, however evaluated, is represented by an estimated standard deviation, termed standard uncertainty, which is determined by the positive square root of the estimated variance.

A Type A evaluation of standard uncertainty may be based on any valid statistical method for treating data. This includes calculating the standard deviation of the mean of a series of independent observations; using the method of least squares to fit a curve to the data in order to estimate the parameter of the curve and their standard deviations; or carrying out an analysis of variance in order to identify and quantify random effects in certain kinds of measurement.

A type B evaluation of standard uncertainty is typically based on scientific judgment using all of the relevant information available. These may include previous measurement data, experience, and knowledge of the behavior and properties of relevant materials and instruments, manufacture’s specification, data provided in calibration reports and uncertainties assigned to reference data taken from handbooks. Broadly speaking, the uncertainty is either obtained from an outdoor source or obtained from an assumed distribution, such as the normal distribution, rectangular or triangular distributions indicated in table below.

Uncertainty Distributions	Normal	Rectangular	Triangular	U-Shape
Multi-plying Factor <sup>(a)</sup>	1/k <sup>(b)</sup>	1/√3	1/√6	1/√2

(a) standard uncertainty is determined as the product of the multiplying factor and the estimated range of variations in the measured quantity

(b)  $\kappa$  is the coverage factor

**Table 16.1. Standard Uncertainty for Assumed Distribution**

The combined standard uncertainty of the measurement result represents the estimated standard deviation of the result. It is obtained by combining the individual standard uncertainties of both Type A and Type B evaluation using the usual “root-sum-squares” (RSS) methods of combining standard deviations by taking the positive square root of the estimated variances.

Expanded uncertainty is a measure of uncertainty that defines an interval about the measurement result within which the measured value is confidently believed to lie. It is obtained by multiplying the combined standard uncertainty by a coverage factor. Typically, the coverage factor ranges from 2 to 3. Using a coverage factor allows the true value of a measured quantity to be specified with a defined probability within the specified uncertainty range. For purpose of this document, a coverage factor two is used, which corresponds to confidence interval of about 95 %. The DASY uncertainty Budget is shown in the following tables.



Error Description	Uncertainty Value (±%)	Probability	Divisor	(Ci) 1g	(Ci) 10g	Standard Uncertainty (1g) (±%)	Standard Uncertainty (10g) (±%)
<b>Measurement System</b>							
Probe Calibration	6.0	N	1	1	1	6.0	6.0
Axial Isotropy	4.7	R	1.732	0.7	0.7	1.9	1.9
Hemispherical Isotropy	9.6	R	1.732	0.7	0.7	3.9	3.9
Boundary Effects	1.0	R	1.732	1	1	0.6	0.6
Linearity	4.7	R	1.732	1	1	2.7	2.7
System Detection Limits	1.0	R	1.732	1	1	0.6	0.6
Modulation Response	3.2	R	1.732	1	1	1.8	1.8
Readout Electronics	0.3	N	1	1	1	0.3	0.3
Response Time	0.0	R	1.732	1	1	0.0	0.0
Integration Time	2.6	R	1.732	1	1	1.5	1.5
RF Ambient Noise	3.0	R	1.732	1	1	1.7	1.7
RF Ambient Reflections	3.0	R	1.732	1	1	1.7	1.7
Probe Positioner	0.4	R	1.732	1	1	0.2	0.2
Probe Positioning	2.9	R	1.732	1	1	1.7	1.7
Max. SAR Eval.	2.0	R	1.732	1	1	1.2	1.2
<b>Test Sample Related</b>							
Device Positioning	3.0	N	1	1	1	3.0	3.0
Device Holder	3.6	N	1	1	1	3.6	3.6
Power Drift	5.0	R	1.732	1	1	2.9	2.9
Power Scaling	0.0	R	1.732	1	1	0.0	0.0
<b>Phantom and Setup</b>							
Phantom Uncertainty	6.1	R	1.732	1	1	3.5	3.5
SAR correction	0.0	R	1.732	1	0.84	0.0	0.0
Liquid Conductivity Repeatability	0.2	N	1	0.78	0.71	0.1	0.1
Liquid Conductivity (target)	5.0	R	1.732	0.78	0.71	2.3	2.0
Liquid Conductivity (mea.)	2.5	R	1.732	0.78	0.71	1.1	1.0
Temp. unc. - Conductivity	3.4	R	1.732	0.78	0.71	1.5	1.4
Liquid Permittivity Repeatability	0.15	N	1	0.23	0.26	0.0	0.0
Liquid Permittivity (target)	5.0	R	1.732	0.23	0.26	0.7	0.8
Liquid Permittivity (mea.)	2.5	R	1.732	0.23	0.26	0.3	0.4
Temp. unc. - Permittivity	0.83	R	1.732	0.23	0.26	0.1	0.1
<b>Combined Std. Uncertainty</b>						11.4%	11.4%
<b>Coverage Factor for 95 %</b>						K=2	K=2
<b>Expanded STD Uncertainty</b>						22.9%	22.7%

Table 16.2. Uncertainty Budget for frequency range 300 MHz to 3 GHz



Error Description	Uncertainty Value (±%)	Probability	Divisor	(Ci) 1g	(Ci) 10g	Standard Uncertainty (1g) (±%)	Standard Uncertainty (10g) (±%)
<b>Measurement System</b>							
Probe Calibration	7.0	N	1	1	1	7.0	7.0
Axial Isotropy	4.7	R	1.732	0.7	0.7	1.9	1.9
Hemispherical Isotropy	9.6	R	1.732	0.7	0.7	3.9	3.9
Boundary Effects	2.0	R	1.732	1	1	1.2	1.2
Linearity	4.7	R	1.732	1	1	2.7	2.7
System Detection Limits	1.0	R	1.732	1	1	0.6	0.6
Modulation Response	3.2	R	1.732	1	1	1.8	1.8
Readout Electronics	0.3	N	1	1	1	0.3	0.3
Response Time	0.0	R	1.732	1	1	0.0	0.0
Integration Time	2.6	R	1.732	1	1	1.5	1.5
RF Ambient Noise	3.0	R	1.732	1	1	1.7	1.7
RF Ambient Reflections	3.0	R	1.732	1	1	1.7	1.7
Probe Positioner	0.4	R	1.732	1	1	0.2	0.2
Probe Positioning	6.7	R	1.732	1	1	3.9	3.9
Max. SAR Eval.	4.0	R	1.732	1	1	2.3	2.3
<b>Test Sample Related</b>							
Device Positioning	3.0	N	1	1	1	3.0	3.0
Device Holder	3.6	N	1	1	1	3.6	3.6
Power Drift	5.0	R	1.732	1	1	2.9	2.9
Power Scaling	0.0	R	1.732	1	1	0.0	0.0
<b>Phantom and Setup</b>							
Phantom Uncertainty	6.6	R	1.732	1	1	3.8	3.8
SAR correction	0.0	R	1.732	1	0.84	0.0	0.0
Liquid Conductivity Repeatability	0.2	N	1	0.78	0.71	0.1	0.1
Liquid Conductivity (target)	5.0	R	1.732	0.78	0.71	2.3	2.0
Liquid Conductivity (mea.)	2.5	R	1.732	0.78	0.71	1.1	1.0
Temp. unc. - Conductivity	3.4	R	1.732	0.78	0.71	1.5	1.4
Liquid Permittivity Repeatability	0.15	N	1	0.23	0.26	0.0	0.0
Liquid Permittivity (target)	5.0	R	1.732	0.23	0.26	0.7	0.8
Liquid Permittivity (mea.)	2.5	R	1.732	0.23	0.26	0.3	0.4
Temp. unc. - Permittivity	0.83	R	1.732	0.23	0.26	0.1	0.1
<b>Combined Std. Uncertainty</b>						12.8%	12.7%
<b>Coverage Factor for 95 %</b>						K=2	K=2
<b>Expanded STD Uncertainty</b>						25.5%	25.4%

Table 16.3. Uncertainty Budget for frequency range 3 GHz to 6 GHz



## **17. References**

- [1] FCC 47 CFR Part 2 “Frequency Allocations and Radio Treaty Matters; General Rules and Regulations”
- [2] ANSI/IEEE Std. C95.1-1992, “IEEE Standard for Safety Levels with Respect to Human Exposure to Radio Frequency Electromagnetic Fields, 3 kHz to 300 GHz”, September 1992
- [3] IEEE Std. 1528-2013, “IEEE Recommended Practice for Determining the Peak Spatial-Average Specific Absorption Rate (SAR) in the Human Head from Wireless Communications Devices: Measurement Techniques”, Sep 2013
- [4] SPEAG DASY System Handbook
- [5] FCC KDB 248227 D01 v02r02, “SAR Guidance for IEEE 802.11 (WiFi) Transmitters”, Oct 2015.
- [6] FCC KDB 447498 D01 v06, “Mobile and Portable Device RF Exposure Procedures and Equipment Authorization Policies”, Oct 2015
- [7] FCC KDB 941225 D01 v03r01, “3G SAR MEAUREMENT PROCEDURES”, Oct 2015
- [8] FCC KDB 941225 D05 v02r05, “SAR Evaluation Considerations for LTE Devices”, Dec 2015
- [9] FCC KDB 616217 D04 v01r02, “SAR Evaluation Considerations for Laptop, Notebook, Netbook and Tablet Computers”, Oct 2015
- [10] FCC KDB 865664 D01 v01r04, "SAR Measurement Requirements for 100 MHz to 6 GHz", Aug 2015.
- [11] FCC KDB 865664 D02 v01r02, “RF Exposure Compliance Reporting and Documentation Considerations” Oct 2015.



---

**Appendix A. Plots of System Performance Check**

The plots are shown as follows.

## System Check\_Body\_750MHz

### DUT: D750V3-1012

Communication System: CW; Frequency: 750 MHz; Duty Cycle: 1:1

Medium: MSL\_750\_160623 Medium parameters used:  $f = 750 \text{ MHz}$ ;  $\sigma = 0.958 \text{ S/m}$ ;  $\epsilon_r = 54.623$ ;  $\rho = 1000 \text{ kg/m}^3$

Ambient Temperature :  $23.5^\circ\text{C}$ ; Liquid Temperature :  $22.5^\circ\text{C}$

### DASY5 Configuration

- Probe: ES3DV3 - SN3270; ConvF(6.3, 6.3, 6.3); Calibrated: 2015/9/28;
- Sensor-Surface: 3mm (Mechanical Surface Detection)
- Electronics: DAE4 Sn1399; Calibrated: 2015/11/23
- Phantom: ELI v4.0; Type: QDOVA001BB; Serial: 1026
- Measurement SW: DASY52, Version 52.8 (7); SEMCAD X Version 14.6.10 (7164)

**Pin=250mW/Area Scan (61x61x1):** Interpolated grid:  $dx=1.500 \text{ mm}$ ,  $dy=1.500 \text{ mm}$

Maximum value of SAR (interpolated) =  $2.46 \text{ W/kg}$

**Pin=250mW/Zoom Scan (5x5x7)/Cube 0:** Measurement grid:  $dx=8\text{mm}$ ,  $dy=8\text{mm}$ ,  $dz=5\text{mm}$

Reference Value =  $52.483 \text{ V/m}$ ; Power Drift =  $-0.01 \text{ dB}$

Peak SAR (extrapolated) =  $3.07 \text{ W/kg}$

**SAR(1 g) =  $2.15 \text{ W/kg}$ ; SAR(10 g) =  $1.45 \text{ W/kg}$**

Maximum value of SAR (measured) =  $2.49 \text{ W/kg}$

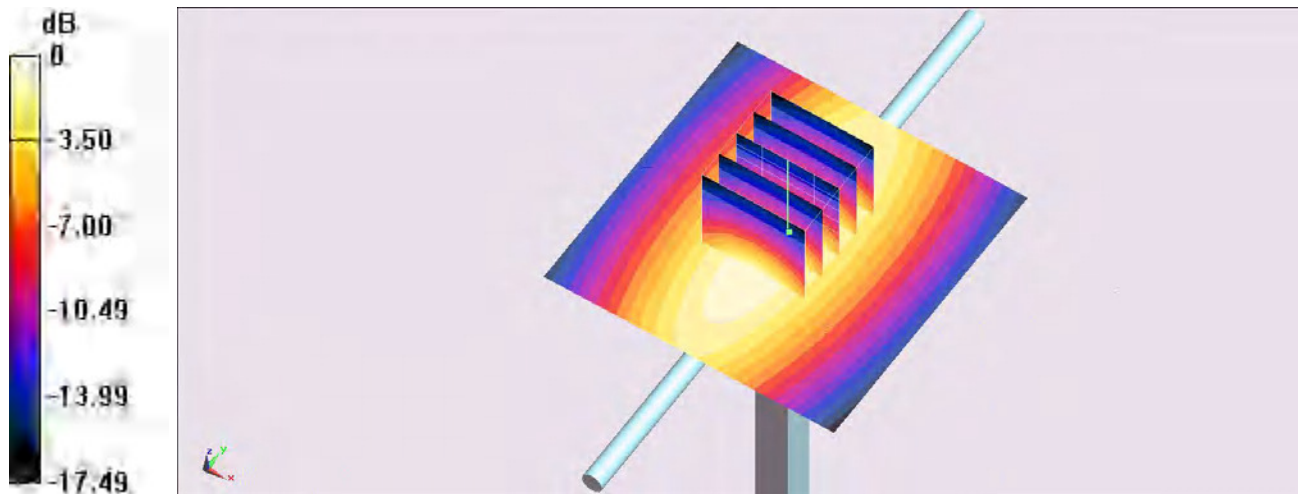

0 dB =  $2.46 \text{ W/kg} = 3.91 \text{ dBW/kg}$

## System Check\_Body\_835MHz

**DUT: D835V2-499**

Communication System: CW; Frequency: 835 MHz; Duty Cycle: 1:1

Medium: MSL\_850\_160621 Medium parameters used:  $f = 835 \text{ MHz}$ ;  $\sigma = 1.002 \text{ S/m}$ ;  $\epsilon_r = 57.843$ ;  $\rho = 1000 \text{ kg/m}^3$

Ambient Temperature :  $23.5^\circ\text{C}$ ; Liquid Temperature :  $22.5^\circ\text{C}$

DASY5 Configuration

- Probe: ES3DV3 - SN3270; ConvF(6.24, 6.24, 6.24); Calibrated: 2015/9/28;
- Sensor-Surface: 3mm (Mechanical Surface Detection)
- Electronics: DAE4 Sn1399; Calibrated: 2015/11/23
- Phantom: ELI v4.0; Type: QDOVA001BB; Serial: 1026
- Measurement SW: DASY52, Version 52.8 (7); SEMCAD X Version 14.6.10 (7164)

**Pin=250mW/Area Scan (61x61x1):** Interpolated grid:  $dx=1.500 \text{ mm}$ ,  $dy=1.500 \text{ mm}$

Maximum value of SAR (interpolated) =  $2.70 \text{ W/kg}$

**Pin=250mW/Zoom Scan (5x5x7)/Cube 0:** Measurement grid:  $dx=8\text{mm}$ ,  $dy=8\text{mm}$ ,  $dz=5\text{mm}$

Reference Value =  $53.841 \text{ V/m}$ ; Power Drift =  $-0.00 \text{ dB}$

Peak SAR (extrapolated) =  $3.30 \text{ W/kg}$

**SAR(1 g) =  $2.32 \text{ W/kg}$ ; SAR(10 g) =  $1.55 \text{ W/kg}$**

Maximum value of SAR (measured) =  $2.68 \text{ W/kg}$

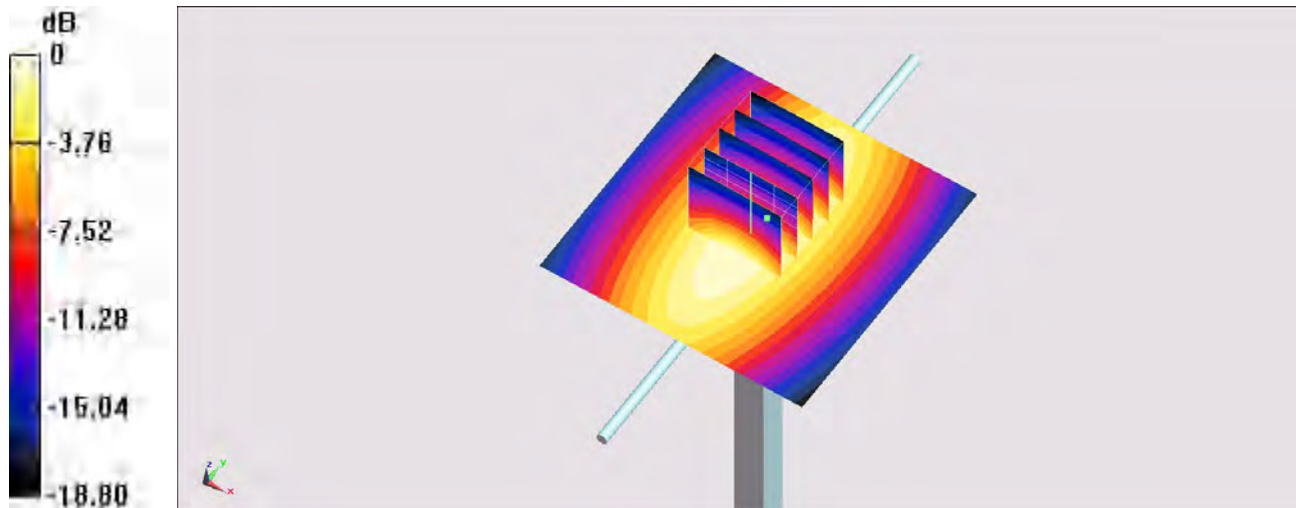

0 dB =  $2.70 \text{ W/kg}$  =  $4.31 \text{ dBW/kg}$



## System Check\_Body\_835MHz

**DUT: D835V2-499**

Communication System: CW; Frequency: 835 MHz; Duty Cycle: 1:1

Medium: MSL\_850\_160624 Medium parameters used:  $f = 835 \text{ MHz}$ ;  $\sigma = 0.98 \text{ S/m}$ ;  $\epsilon_r = 57.469$ ;  $\rho = 1000 \text{ kg/m}^3$

Ambient Temperature :  $23.4^\circ\text{C}$ ; Liquid Temperature :  $22.4^\circ\text{C}$

DASY5 Configuration

- Probe: ES3DV3 - SN3270; ConvF(6.24, 6.24, 6.24); Calibrated: 2015/9/28;
- Sensor-Surface: 3mm (Mechanical Surface Detection)
- Electronics: DAE4 Sn1399; Calibrated: 2015/11/23
- Phantom: ELI v4.0; Type: QDOVA001BB; Serial: 1026
- Measurement SW: DASY52, Version 52.8 (7); SEMCAD X Version 14.6.10 (7164)

**Pin=250mW/Area Scan (61x61x1):** Interpolated grid:  $dx=1.500 \text{ mm}$ ,  $dy=1.500 \text{ mm}$

Maximum value of SAR (interpolated) =  $2.77 \text{ W/kg}$

**Pin=250mW/Zoom Scan (5x5x7)/Cube 0:** Measurement grid:  $dx=8\text{mm}$ ,  $dy=8\text{mm}$ ,  $dz=5\text{mm}$

Reference Value =  $54.620 \text{ V/m}$ ; Power Drift =  $-0.01 \text{ dB}$

Peak SAR (extrapolated) =  $3.31 \text{ W/kg}$

**SAR(1 g) =  $2.35 \text{ W/kg}$ ; SAR(10 g) =  $1.57 \text{ W/kg}$**

Maximum value of SAR (measured) =  $2.71 \text{ W/kg}$

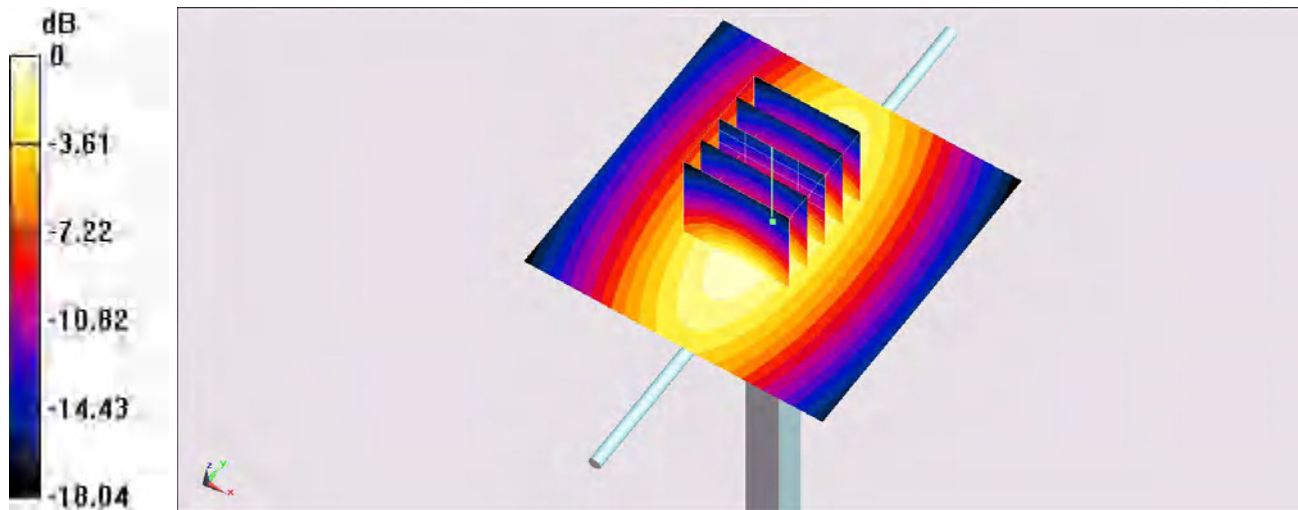

0 dB =  $2.77 \text{ W/kg}$  =  $4.42 \text{ dBW/kg}$

## System Check\_Body\_1750MHz

**DUT: D1750V2-1068**

Communication System: CW; Frequency: 1750 MHz; Duty Cycle: 1:1

Medium: MSL\_1750\_160625 Medium parameters used:  $f = 1750$  MHz;  $\sigma = 1.537$  S/m;  $\epsilon_r = 55.571$ ;  $\rho = 1000$  kg/m<sup>3</sup>

Ambient Temperature : 23.8°C; Liquid Temperature : 22.8°C

DASY5 Configuration

- Probe: ES3DV3 - SN3270; ConvF(4.95, 4.95, 4.95); Calibrated: 2015/9/28;
- Sensor-Surface: 3mm (Mechanical Surface Detection)
- Electronics: DAE4 Sn1399; Calibrated: 2015/11/23
- Phantom: ELI v4.0; Type: QDOVA001BB; Serial: 1026
- Measurement SW: DASY52, Version 52.8 (7); SEMCAD X Version 14.6.10 (7164)

**Pin=250mW/Area Scan (61x61x1):** Interpolated grid: dx=1.500 mm, dy=1.500 mm

Maximum value of SAR (interpolated) = 11.6 W/kg

**Pin=250mW/Zoom Scan (5x5x7)/Cube 0:** Measurement grid: dx=8mm, dy=8mm, dz=5mm

Reference Value = 90.150 V/m; Power Drift = -0.00 dB

Peak SAR (extrapolated) = 15.5 W/kg

**SAR(1 g) = 9.39 W/kg; SAR(10 g) = 5.21 W/kg**

Maximum value of SAR (measured) = 11.5 W/kg

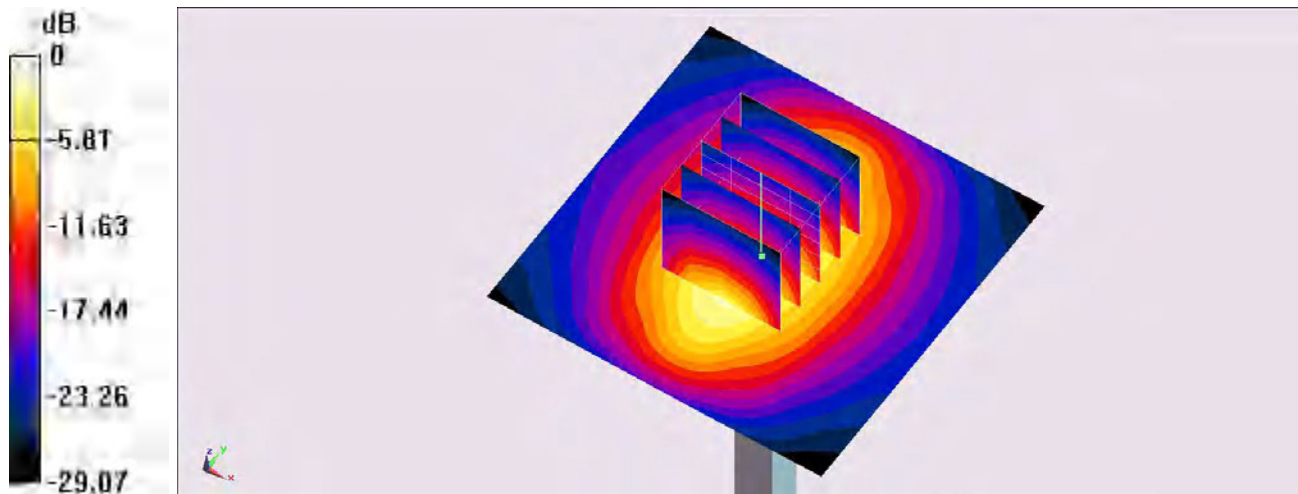

0 dB = 11.6 W/kg = 10.64 dBW/kg

## System Check\_Body\_1900MHz

### DUT: D1900V2-5d041

Communication System: CW; Frequency: 1900 MHz; Duty Cycle: 1:1

Medium: MSL\_1900\_160624 Medium parameters used:  $f = 1900$  MHz;  $\sigma = 1.526$  S/m;  $\epsilon_r = 53.847$ ;  $\rho = 1000$  kg/m<sup>3</sup>

Ambient Temperature : 23.8°C; Liquid Temperature : 22.8°C

### DASY5 Configuration

- Probe: ES3DV3 - SN3270; ConvF(4.78, 4.78, 4.78); Calibrated: 2015/9/28;
- Sensor-Surface: 3mm (Mechanical Surface Detection)
- Electronics: DAE4 Sn1399; Calibrated: 2015/11/23
- Phantom: ELI v4.0; Type: QDOVA001BB; Serial: 1026
- Measurement SW: DASY52, Version 52.8 (7); SEMCAD X Version 14.6.10 (7164)

**Pin=250mW/Area Scan (61x61x1):** Interpolated grid: dx=1.500 mm, dy=1.500 mm

Maximum value of SAR (interpolated) = 12.2 W/kg

**Pin=250mW/Zoom Scan (5x5x7)/Cube 0:** Measurement grid: dx=8mm, dy=8mm, dz=5mm

Reference Value = 91.988 V/m; Power Drift = 0.03 dB

Peak SAR (extrapolated) = 16.8 W/kg

**SAR(1 g) = 9.63 W/kg; SAR(10 g) = 5.1 W/kg**

Maximum value of SAR (measured) = 12.0 W/kg

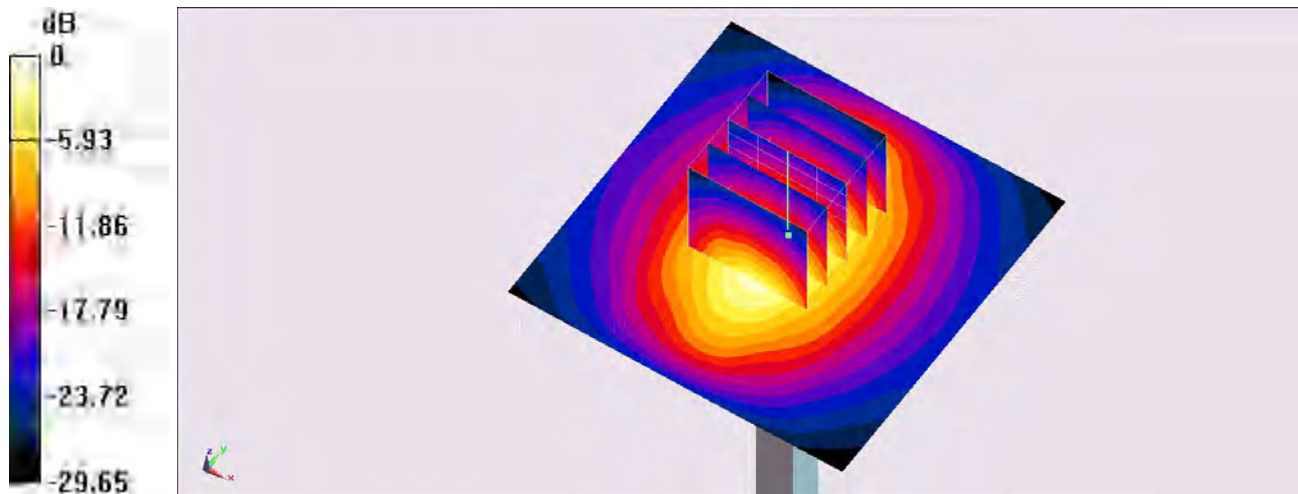

0 dB = 12.2 W/kg = 10.86 dBW/kg

## System Check\_Body\_2450MHz

**DUT: D2450V2-736**

Communication System: CW; Frequency: 2450 MHz; Duty Cycle: 1:1

Medium: MSL\_2450\_160702 Medium parameters used:  $f = 2450$  MHz;  $\sigma = 1.986$  S/m;  $\epsilon_r = 52.136$ ;  $\rho = 1000$  kg/m<sup>3</sup>

Ambient Temperature : 23.5 °C; Liquid Temperature : 22.5 °C

### DASY5 Configuration

- Probe: EX3DV4 - SN3955; ConvF(7.53, 7.53, 7.53); Calibrated: 2015/11/24;
- Sensor-Surface: 1.4mm (Mechanical Surface Detection)
- Electronics: DAE4 Sn1399; Calibrated: 2015/11/23
- Phantom: ELI v4.0; Type: QDOVA001BB; Serial: 1026
- Measurement SW: DASY52, Version 52.8 (7); SEMCAD X Version 14.6.10 (7164)

**Pin=250mW/Area Scan (61x61x1):** Interpolated grid: dx=1.200 mm, dy=1.200 mm

Maximum value of SAR (interpolated) = 21.6 W/kg

**Pin=250mW/Zoom Scan (7x7x7)/Cube 0:** Measurement grid: dx=5mm, dy=5mm, dz=5mm

Reference Value = 108.6 V/m; Power Drift = -0.11 dB

Peak SAR (extrapolated) = 25.1 W/kg

**SAR(1 g) = 12.9 W/kg; SAR(10 g) = 6.11 W/kg**

Maximum value of SAR (measured) = 20.8 W/kg

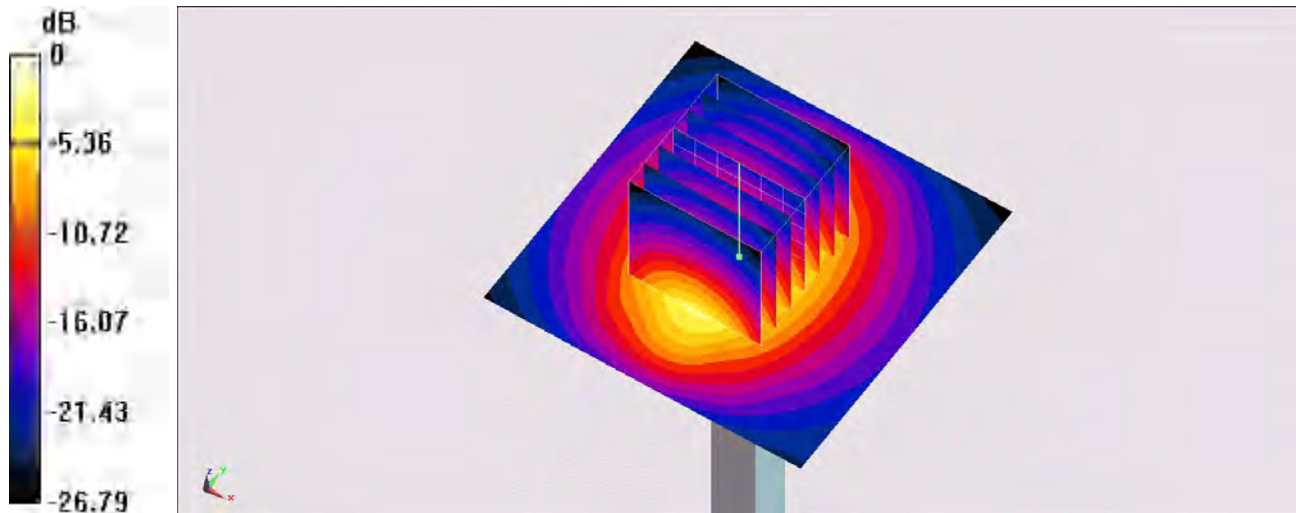

0 dB = 21.6 W/kg = 13.34 dBW/kg

## System Check\_Body\_5250MHz

### DUT: D5GHzV2-1128-5250

Communication System: CW; Frequency: 5250 MHz; Duty Cycle: 1:1

Medium: MSL\_5G\_160702 Medium parameters used:  $f = 5250$  MHz;  $\sigma = 5.479$  S/m;  $\epsilon_r = 47.354$ ;  $\rho = 1000$  kg/m<sup>3</sup>

Ambient Temperature : 23.4 °C; Liquid Temperature : 22.4 °C

### DASY5 Configuration

- Probe: EX3DV4 - SN3955; ConvF(4.42, 4.42, 4.42); Calibrated: 2015/11/24;
- Sensor-Surface: 1.4mm (Mechanical Surface Detection)
- Electronics: DAE4 Sn1399; Calibrated: 2015/11/23
- Phantom: ELI v4.0; Type: QDOVA001BB; Serial: 1026
- Measurement SW: DASY52, Version 52.8 (7); SEMCAD X Version 14.6.10 (7164)

**Pin=100mW/Area Scan (71x71x1):** Interpolated grid: dx=1.000 mm, dy=1.000 mm

Maximum value of SAR (interpolated) = 20.7 W/kg

**Pin=100mW/Zoom Scan (7x7x7)/Cube 0:** Measurement grid: dx=4mm, dy=4mm, dz=1.4mm

Reference Value = 72.839 V/m; Power Drift = -0.13 dB

Peak SAR (extrapolated) = 30.4 W/kg

**SAR(1 g) = 7.86 W/kg; SAR(10 g) = 2.21 W/kg**

Maximum value of SAR (measured) = 19.0 W/kg

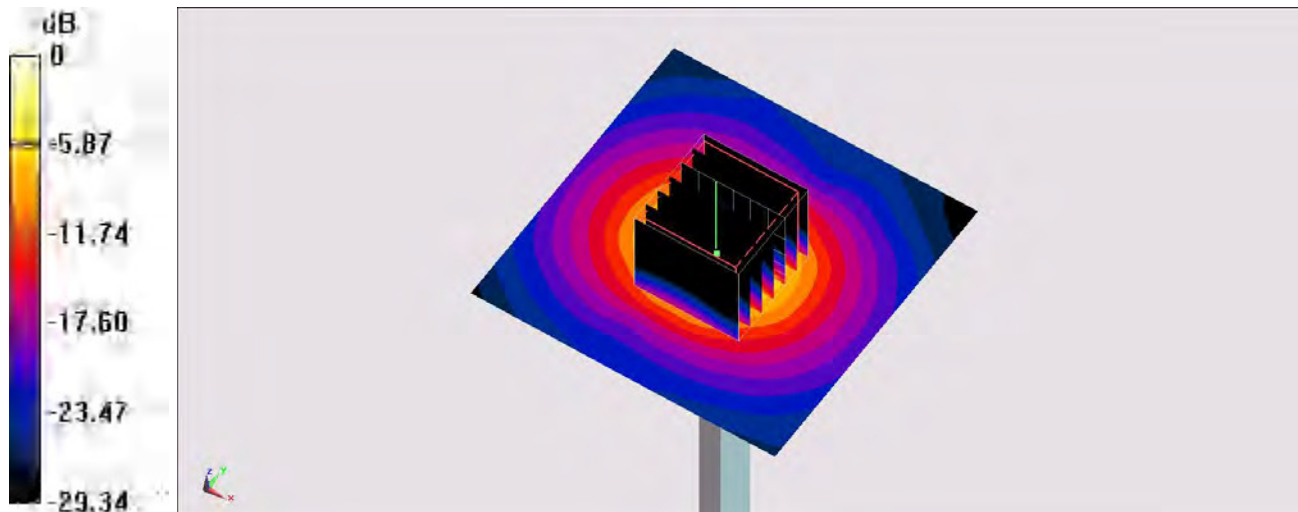

0 dB = 20.7 W/kg = 13.16 dBW/kg

## System Check\_Body\_5600MHz

### DUT: D5GHzV2-1128-5250

Communication System: CW; Frequency: 5600 MHz; Duty Cycle: 1:1

Medium: MSL\_5G\_160702 Medium parameters used:  $f = 5600$  MHz;  $\sigma = 5.924$  S/m;  $\epsilon_r = 46.763$ ;  $\rho = 1000$  kg/m<sup>3</sup>

Ambient Temperature : 23.4 °C; Liquid Temperature : 22.4 °C

### DASY5 Configuration

- Probe: EX3DV4 - SN3955; ConvF(3.81, 3.81, 3.81); Calibrated: 2015/11/24;
- Sensor-Surface: 1.4mm (Mechanical Surface Detection)
- Electronics: DAE4 Sn1399; Calibrated: 2015/11/23
- Phantom: ELI v4.0; Type: QDOVA001BB; Serial: 1026
- Measurement SW: DASY52, Version 52.8 (7); SEMCAD X Version 14.6.10 (7164)

**Pin=100mW/Area Scan (71x71x1):** Interpolated grid: dx=1.000 mm, dy=1.000 mm

Maximum value of SAR (interpolated) = 20.2 W/kg

**Pin=100mW/Zoom Scan (7x7x7)/Cube 0:** Measurement grid: dx=4mm, dy=4mm, dz=1.4mm

Reference Value = 70.218 V/m; Power Drift = -0.05 dB

Peak SAR (extrapolated) = 32.1 W/kg

**SAR(1 g) = 8.26 W/kg; SAR(10 g) = 2.33 W/kg**

Maximum value of SAR (measured) = 20.2 W/kg

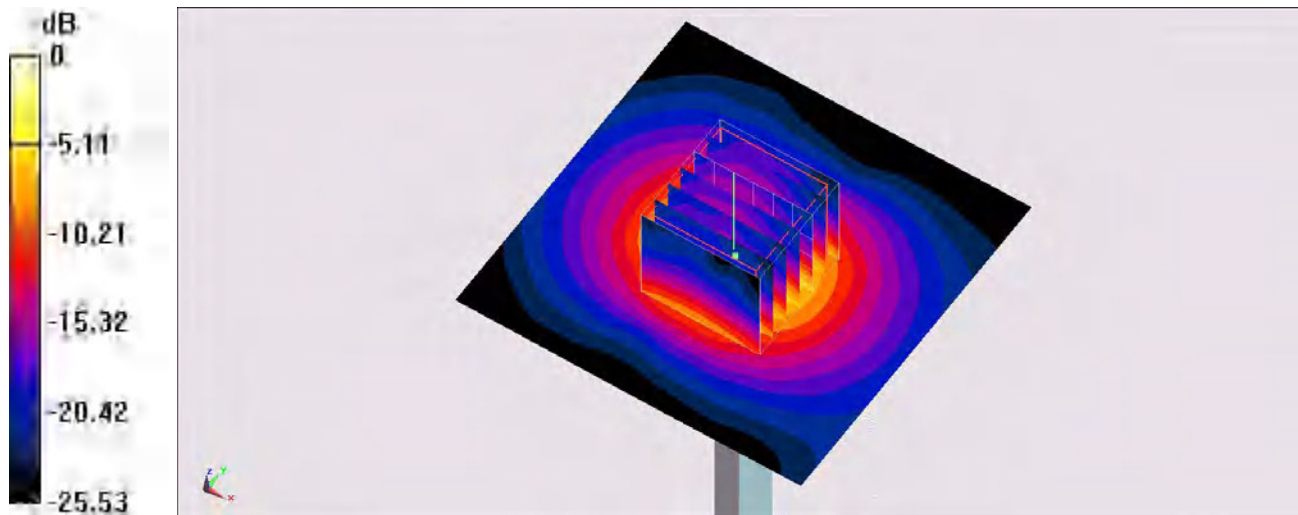

0 dB = 20.2 W/kg = 13.05 dBW/kg



## System Check\_Body\_5750MHz

**DUT: D5GHzV2-1128-5750**

Communication System: CW; Frequency: 5750 MHz; Duty Cycle: 1:1

Medium: MSL\_5G\_160702 Medium parameters used:  $f = 5750$  MHz;  $\sigma = 6.123$  S/m;  $\epsilon_r = 46.53$ ;  $\rho = 1000$  kg/m<sup>3</sup>

Ambient Temperature : 23.4 °C; Liquid Temperature : 22.4 °C

### DASY5 Configuration

- Probe: EX3DV4 - SN3955; ConvF(3.92, 3.92, 3.92); Calibrated: 2015/11/24;
- Sensor-Surface: 1.4mm (Mechanical Surface Detection)
- Electronics: DAE4 Sn1399; Calibrated: 2015/11/23
- Phantom: ELI v4.0; Type: QDOVA001BB; Serial: 1026
- Measurement SW: DASY52, Version 52.8 (7); SEMCAD X Version 14.6.10 (7164)

**Pin=100mW/Area Scan (71x71x1):** Interpolated grid: dx=1.000 mm, dy=1.000 mm

Maximum value of SAR (interpolated) = 19.8 W/kg

**Pin=100mW/Zoom Scan (7x7x7)/Cube 0:** Measurement grid: dx=4mm, dy=4mm, dz=1.4mm

Reference Value = 68.253 V/m; Power Drift = -0.10 dB

Peak SAR (extrapolated) = 31.7 W/kg

**SAR(1 g) = 7.92 W/kg; SAR(10 g) = 2.24 W/kg**

Maximum value of SAR (measured) = 19.5 W/kg

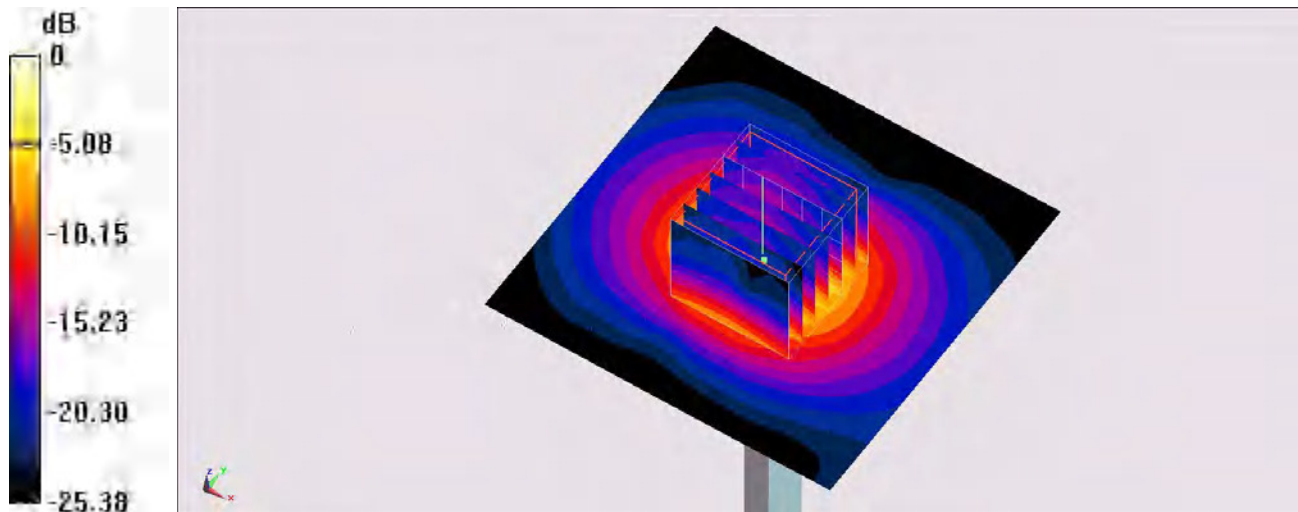

0 dB = 19.8 W/kg = 12.97 dBW/kg



---

**Appendix B. Plots of SAR Measurement**

The plots are shown as follows.



### #01\_GSM850\_GPRS (2 Tx slots)\_Bottom Face\_14mm\_Ch189

Communication System: GSM850 ; Frequency: 836.4 MHz; Duty Cycle: 1:4.15

Medium: MSL\_850\_160621 Medium parameters used:  $f = 836.4$  MHz;  $\sigma = 1.004$  S/m;  $\epsilon_r = 57.83$ ;  $\rho = 1000$  kg/m<sup>3</sup>

Ambient Temperature : 23.5°C; Liquid Temperature : 22.5°C

#### DASY5 Configuration

- Probe: ES3DV3 - SN3270; ConvF(6.24, 6.24, 6.24); Calibrated: 2015/9/28;
- Sensor-Surface: 3mm (Mechanical Surface Detection)
- Electronics: DAE4 Sn1399; Calibrated: 2015/11/23
- Phantom: ELI v4.0; Type: QDOVA001BB; Serial: 1026
- Measurement SW: DASY52, Version 52.8 (7); SEMCAD X Version 14.6.10 (7164)

**Area Scan (61x81x1):** Interpolated grid: dx=1.500 mm, dy=1.500 mm

Maximum value of SAR (interpolated) = 0.882 W/kg

**Zoom Scan (5x5x7)/Cube 0:** Measurement grid: dx=8mm, dy=8mm, dz=5mm

Reference Value = 26.882 V/m; Power Drift = -0.19 dB

Peak SAR (extrapolated) = 1.18 W/kg

**SAR(1 g) = 0.774 W/kg; SAR(10 g) = 0.487 W/kg**

Maximum value of SAR (measured) = 0.919 W/kg

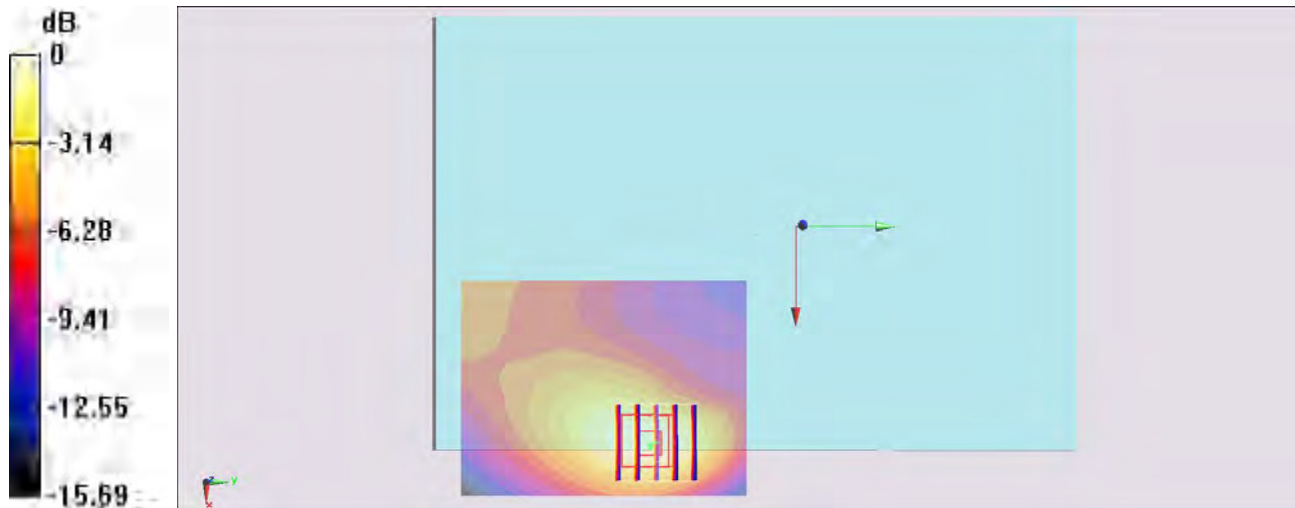

0 dB = 0.882 W/kg = -0.55 dBW/kg

## #02\_GSM1900\_EDGE (4 Tx slots)\_Edge 1\_0mm\_Ch512

Communication System: PCS; Frequency: 1850.2 MHz; Duty Cycle: 1:2.08

Medium: MSL\_1900\_160624 Medium parameters used:  $f = 1850.2$  MHz;  $\sigma = 1.47$  S/m;  $\epsilon_r = 53.956$ ;  $\rho = 1000$  kg/m<sup>3</sup>

Ambient Temperature : 23.8 °C; Liquid Temperature : 22.8 °C

### DASY5 Configuration

- Probe: ES3DV3 - SN3270; ConvF(4.78, 4.78, 4.78); Calibrated: 2015/9/28;
- Sensor-Surface: 3mm (Mechanical Surface Detection)
- Electronics: DAE4 Sn1399; Calibrated: 2015/11/23
- Phantom: ELI v4.0; Type: QDOVA001BB; Serial: 1026
- Measurement SW: DASY52, Version 52.8 (7); SEMCAD X Version 14.6.10 (7164)

**Area Scan (51x81x1):** Interpolated grid: dx=1.500 mm, dy=1.500 mm

Maximum value of SAR (interpolated) = 0.608 W/kg

**Zoom Scan (5x5x7)/Cube 0:** Measurement grid: dx=8mm, dy=8mm, dz=5mm

Reference Value = 19.701 V/m; Power Drift = 0.17 dB

Peak SAR (extrapolated) = 0.971 W/kg

**SAR(1 g) = 0.477 W/kg; SAR(10 g) = 0.207 W/kg**

Maximum value of SAR (measured) = 0.595 W/kg

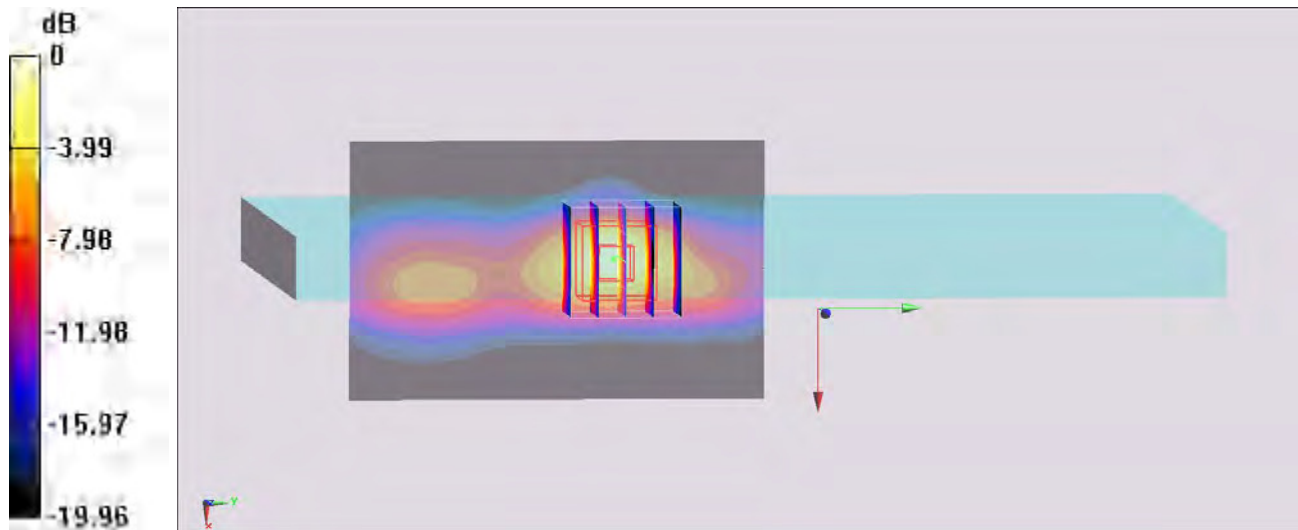

0 dB = 0.608 W/kg = -2.16 dBW/kg

### #03\_WCDMA II\_RMC 12.2Kbps\_Edge 1\_0mm\_Ch9538

Communication System: WCDMA; Frequency: 1907.6 MHz; Duty Cycle: 1:1

Medium: MSL\_1900\_160624 Medium parameters used:  $f = 1908$  MHz;  $\sigma = 1.536$  S/m;  $\epsilon_r = 53.829$ ;  $\rho = 1000$  kg/m<sup>3</sup>

Ambient Temperature : 23.8 °C; Liquid Temperature : 22.8 °C

#### DASY5 Configuration

- Probe: ES3DV3 - SN3270; ConvF(4.78, 4.78, 4.78); Calibrated: 2015/9/28;
- Sensor-Surface: 3mm (Mechanical Surface Detection)
- Electronics: DAE4 Sn1399; Calibrated: 2015/11/23
- Phantom: ELI v4.0; Type: QDOVA001BB; Serial: 1026
- Measurement SW: DASY52, Version 52.8 (7); SEMCAD X Version 14.6.10 (7164)

**Area Scan (41x81x1):** Interpolated grid: dx=1.500 mm, dy=1.500 mm

Maximum value of SAR (interpolated) = 1.03 W/kg

**Zoom Scan (5x5x7)/Cube 0:** Measurement grid: dx=8mm, dy=8mm, dz=5mm

Reference Value = 24.963 V/m; Power Drift = 0.05 dB

Peak SAR (extrapolated) = 1.62 W/kg

**SAR(1 g) = 0.788 W/kg; SAR(10 g) = 0.343 W/kg**

Maximum value of SAR (measured) = 1.05 W/kg

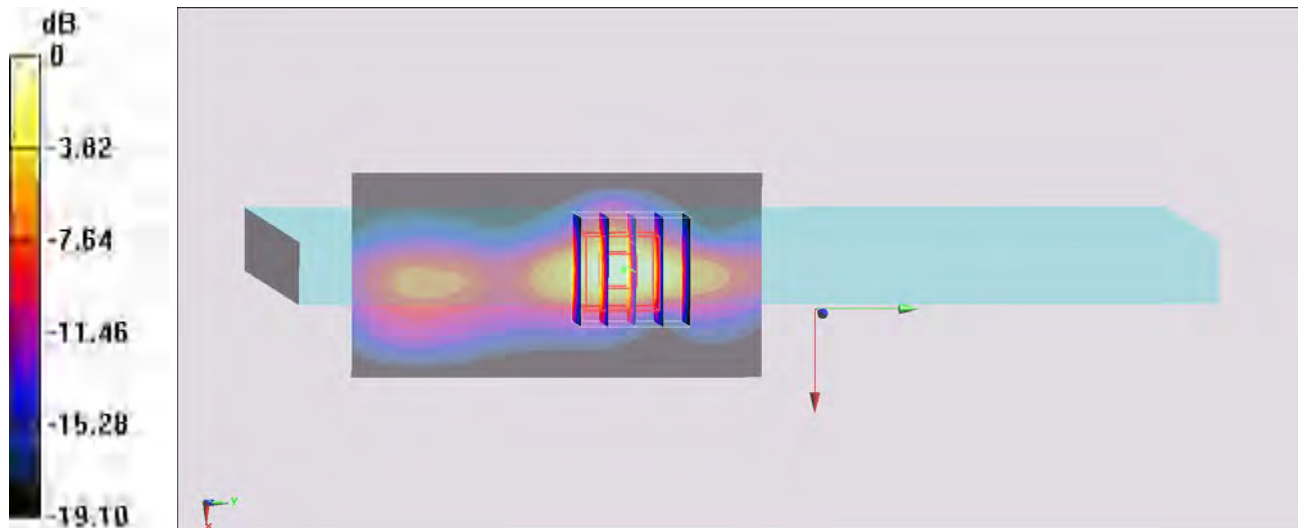

0 dB = 1.03 W/kg = 0.13 dBW/kg

### #04\_WCDMA IV\_RMC 12.2Kbps\_Edge 1\_0mm\_Ch1413

Communication System: WCDMA; Frequency: 1732.6 MHz; Duty Cycle: 1:1

Medium: MSL\_1750\_160625 Medium parameters used:  $f = 1733$  MHz;  $\sigma = 1.519$  S/m;  $\epsilon_r = 55.647$ ;  $\rho = 1000$  kg/m<sup>3</sup>

Ambient Temperature : 23.8°C; Liquid Temperature : 22.8°C

#### DASY5 Configuration

- Probe: ES3DV3 - SN3270; ConvF(4.95, 4.95, 4.95); Calibrated: 2015/9/28;
- Sensor-Surface: 3mm (Mechanical Surface Detection)
- Electronics: DAE4 Sn1399; Calibrated: 2015/11/23
- Phantom: ELI v4.0; Type: QDOVA001BB; Serial: 1026
- Measurement SW: DASY52, Version 52.8 (7); SEMCAD X Version 14.6.10 (7164)

**Area Scan (41x81x1):** Interpolated grid: dx=1.500 mm, dy=1.500 mm

Maximum value of SAR (interpolated) = 0.533 W/kg

**Zoom Scan (5x5x7)/Cube 0:** Measurement grid: dx=8mm, dy=8mm, dz=5mm

Reference Value = 19.661 V/m; Power Drift = 0.14 dB

Peak SAR (extrapolated) = 0.876 W/kg

**SAR(1 g) = 0.449 W/kg; SAR(10 g) = 0.204 W/kg**

Maximum value of SAR (measured) = 0.609 W/kg

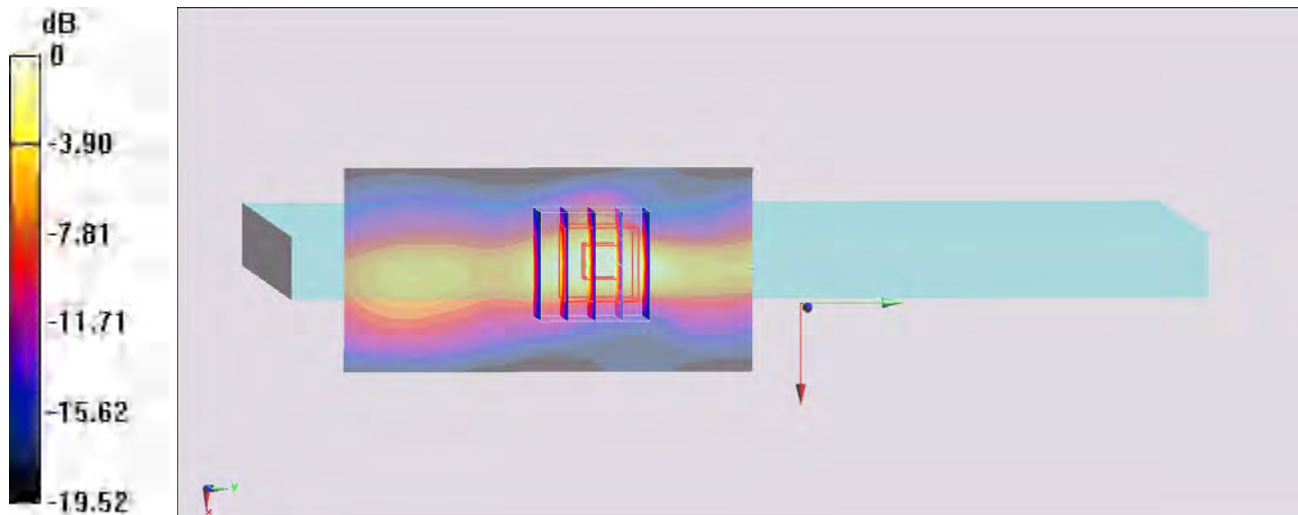

0 dB = 0.533 W/kg = -2.73 dBW/kg

### #05\_WCDMA V\_RMC 12.2Kbps\_Bottom Face\_14mm\_Ch4233

Communication System: WCDMA ; Frequency: 846.6 MHz; Duty Cycle: 1:1

Medium: MSL\_850\_160621 Medium parameters used:  $f = 847$  MHz;  $\sigma = 1.014$  S/m;  $\epsilon_r = 57.734$ ;  $\rho = 1000$  kg/m<sup>3</sup>

Ambient Temperature : 23.5°C; Liquid Temperature : 22.5°C

#### DASY5 Configuration

- Probe: ES3DV3 - SN3270; ConvF(6.24, 6.24, 6.24); Calibrated: 2015/9/28;
- Sensor-Surface: 3mm (Mechanical Surface Detection)
- Electronics: DAE4 Sn1399; Calibrated: 2015/11/23
- Phantom: ELI v4.0; Type: QDOVA001BB; Serial: 1026
- Measurement SW: DASY52, Version 52.8 (7); SEMCAD X Version 14.6.10 (7164)

**Area Scan (61x81x1):** Interpolated grid: dx=1.500 mm, dy=1.500 mm

Maximum value of SAR (interpolated) = 0.531 W/kg

**Zoom Scan (5x5x7)/Cube 0:** Measurement grid: dx=8mm, dy=8mm, dz=5mm

Reference Value = 22.967 V/m; Power Drift = -0.07 dB

Peak SAR (extrapolated) = 0.675 W/kg

**SAR(1 g) = 0.447 W/kg; SAR(10 g) = 0.285 W/kg**

Maximum value of SAR (measured) = 0.528 W/kg

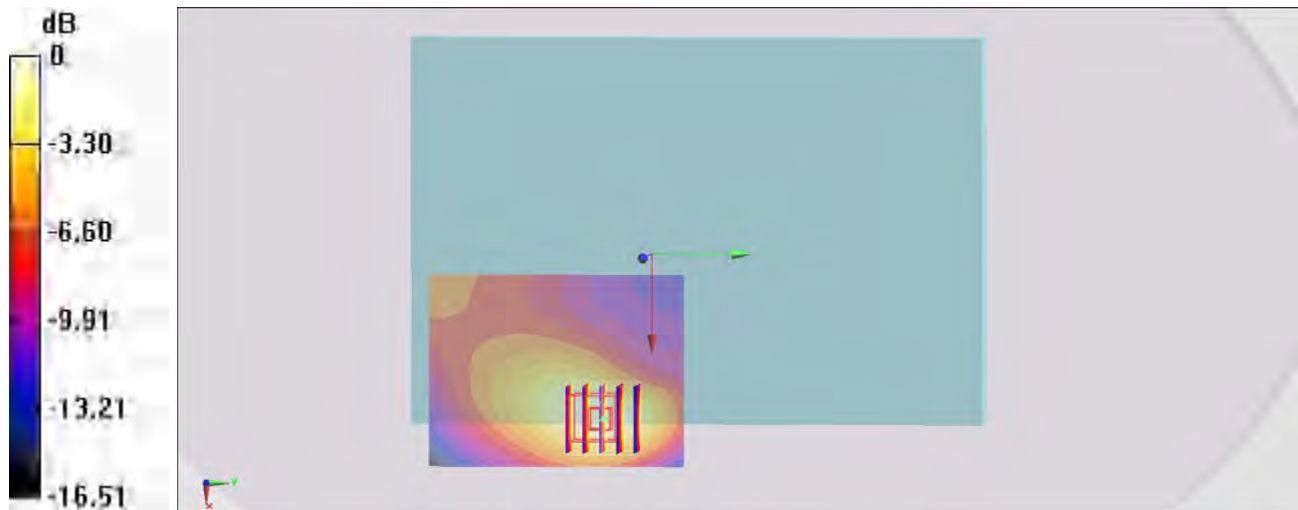

0 dB = 0.531 W/kg = -2.75 dBW/kg

### #06\_CDMA BC0\_RTAP 153.6Kbps\_Bottom Face\_14mm\_Ch777

Communication System: CDMA ; Frequency: 848.31 MHz; Duty Cycle: 1:1  
Medium: MSL\_850\_160621 Medium parameters used:  $f = 848.31$  MHz;  $\sigma = 1.016$  S/m;  $\epsilon_r = 57.72$ ;  $\rho = 1000$  kg/m<sup>3</sup>  
Ambient Temperature : 23.5°C; Liquid Temperature : 22.5°C

#### DASY5 Configuration

- Probe: ES3DV3 - SN3270; ConvF(6.24, 6.24, 6.24); Calibrated: 2015/9/28;
- Sensor-Surface: 3mm (Mechanical Surface Detection)
- Electronics: DAE4 Sn1399; Calibrated: 2015/11/23
- Phantom: ELI v4.0; Type: QDOVA001BB; Serial: 1026
- Measurement SW: DASY52, Version 52.8 (7); SEMCAD X Version 14.6.10 (7164)

**Area Scan (61x81x1):** Interpolated grid: dx=1.500 mm, dy=1.500 mm  
Maximum value of SAR (interpolated) = 0.590 W/kg

**Zoom Scan (5x5x7)/Cube 0:** Measurement grid: dx=8mm, dy=8mm, dz=5mm  
Reference Value = 24.009 V/m; Power Drift = -0.13 dB  
Peak SAR (extrapolated) = 0.749 W/kg  
**SAR(1 g) = 0.500 W/kg; SAR(10 g) = 0.321 W/kg**  
Maximum value of SAR (measured) = 0.590 W/kg

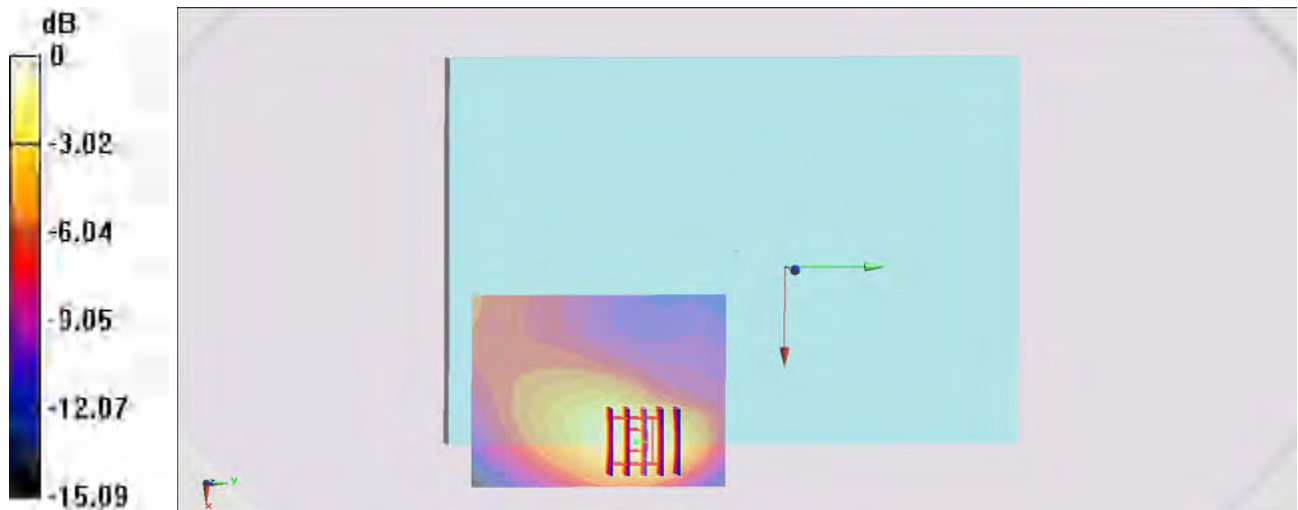

0 dB = 0.590 W/kg = -2.29 dBW/kg

### #07\_CDMA BC1\_RTAP 153.6Kbps\_Edge 1\_0mm\_Ch1175

Communication System: CDMA ; Frequency: 1908.75 MHz; Duty Cycle: 1:1

Medium: MSL\_1900\_160624 Medium parameters used:  $f = 1909$  MHz;  $\sigma = 1.537$  S/m;  $\epsilon_r = 53.827$ ;  $\rho = 1000$  kg/m<sup>3</sup>

Ambient Temperature : 23.8°C; Liquid Temperature : 22.8°C

#### DASY5 Configuration

- Probe: ES3DV3 - SN3270; ConvF(4.78, 4.78, 4.78); Calibrated: 2015/9/28;
- Sensor-Surface: 3mm (Mechanical Surface Detection)
- Electronics: DAE4 Sn1399; Calibrated: 2015/11/23
- Phantom: ELI v4.0; Type: QDOVA001BB; Serial: 1026
- Measurement SW: DASY52, Version 52.8 (7); SEMCAD X Version 14.6.10 (7164)

**Area Scan (51x81x1):** Interpolated grid: dx=1.500 mm, dy=1.500 mm

Maximum value of SAR (interpolated) = 0.854 W/kg

**Zoom Scan (5x5x7)/Cube 0:** Measurement grid: dx=8mm, dy=8mm, dz=5mm

Reference Value = 14.179 V/m; Power Drift = -0.14 dB

Peak SAR (extrapolated) = 1.23 W/kg

**SAR(1 g) = 0.611 W/kg; SAR(10 g) = 0.271 W/kg**

Maximum value of SAR (measured) = 0.783 W/kg

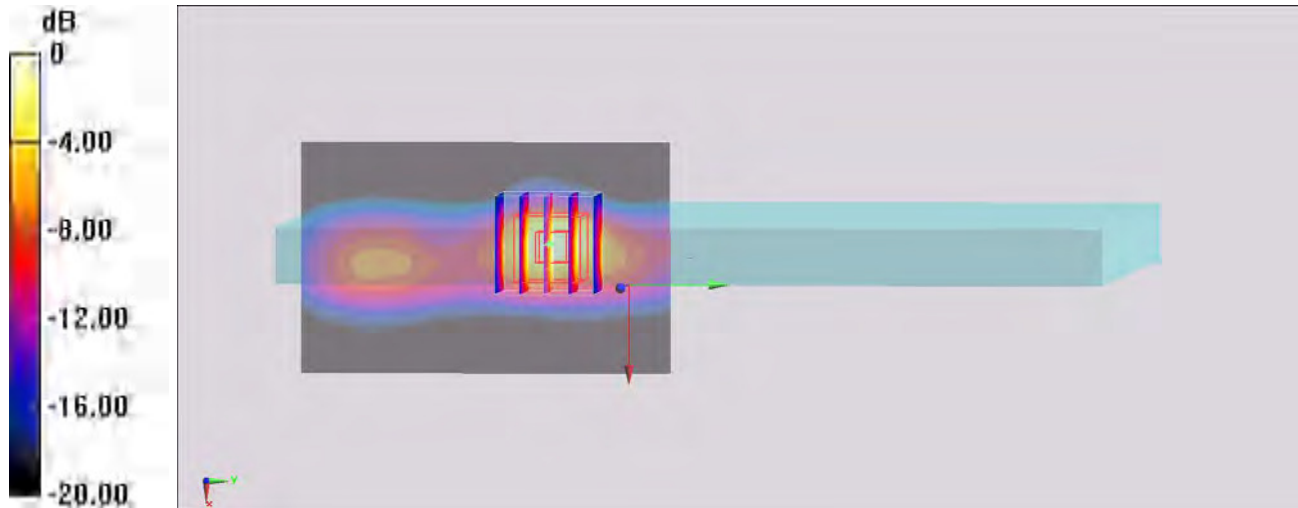

0 dB = 0.854 W/kg = -0.69 dBW/kg



## #08\_CDMA BC10\_RTAP 153.6Kbps\_Bottom Face\_14mm\_Ch580

Communication System: CDMA ; Frequency: 820.5 MHz; Duty Cycle: 1:1

Medium: MSL\_850\_160621 Medium parameters used:  $f = 820.5$  MHz;  $\sigma = 0.988$  S/m;  $\epsilon_r = 57.969$ ;  $\rho = 1000$  kg/m<sup>3</sup>

Ambient Temperature : 23.5°C; Liquid Temperature : 22.5°C

### DASY5 Configuration

- Probe: ES3DV3 - SN3270; ConvF(6.24, 6.24, 6.24); Calibrated: 2015/9/28;
- Sensor-Surface: 3mm (Mechanical Surface Detection)
- Electronics: DAE4 Sn1399; Calibrated: 2015/11/23
- Phantom: ELI v4.0; Type: QDOVA001BB; Serial: 1026
- Measurement SW: DASY52, Version 52.8 (7); SEMCAD X Version 14.6.10 (7164)

**Area Scan (61x81x1):** Interpolated grid: dx=1.500 mm, dy=1.500 mm

Maximum value of SAR (interpolated) = 0.536 W/kg

**Zoom Scan (5x5x7)/Cube 0:** Measurement grid: dx=8mm, dy=8mm, dz=5mm

Reference Value = 23.221 V/m; Power Drift = -0.11 dB

Peak SAR (extrapolated) = 0.674 W/kg

**SAR(1 g) = 0.457 W/kg; SAR(10 g) = 0.294 W/kg**

Maximum value of SAR (measured) = 0.538 W/kg

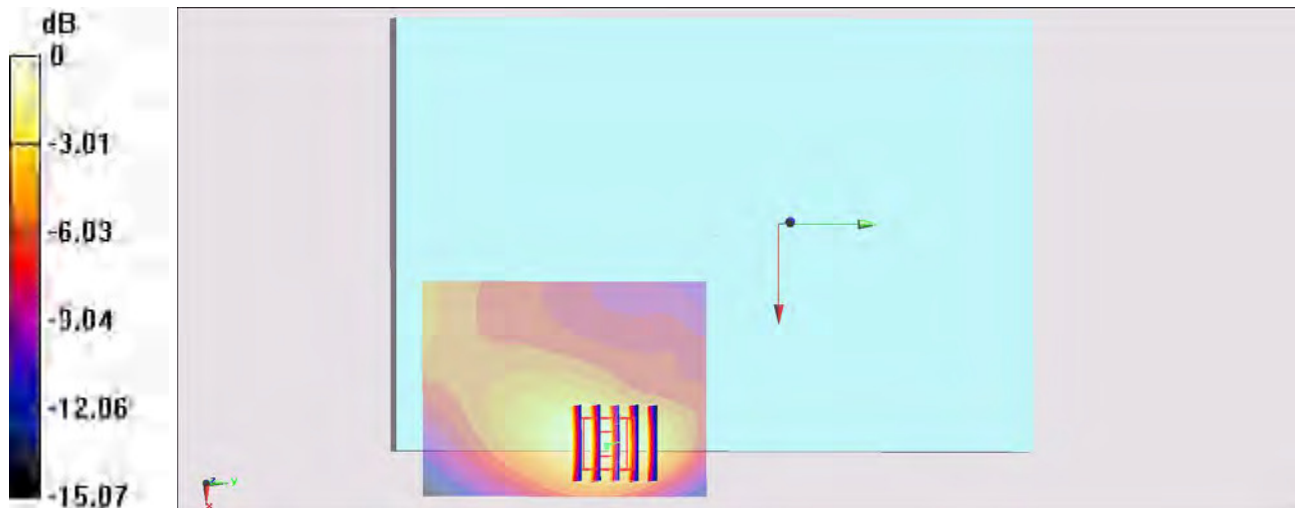

0 dB = 0.536 W/kg = -2.71 dBW/kg



### #09\_LTE Band 4\_20M\_QPSK\_50\_0\_Bottom Face\_0mm\_Ch20175

Communication System: LTE ; Frequency: 1732.5 MHz; Duty Cycle: 1:1

Medium: MSL\_1750\_160625 Medium parameters used:  $f = 1732.5$  MHz;  $\sigma = 1.518$  S/m;  $\epsilon_r = 55.649$ ;  
 $\rho = 1000$  kg/m<sup>3</sup>

Ambient Temperature : 23.8°C; Liquid Temperature : 22.8°C

#### DASY5 Configuration

- Probe: ES3DV3 - SN3270; ConvF(4.95, 4.95, 4.95); Calibrated: 2015/9/28;
- Sensor-Surface: 3mm (Mechanical Surface Detection)
- Electronics: DAE4 Sn1399; Calibrated: 2015/11/23
- Phantom: ELI v4.0; Type: QDOVA001BB; Serial: 1026
- Measurement SW: DASY52, Version 52.8 (7); SEMCAD X Version 14.6.10 (7164)

**Area Scan (61x81x1):** Interpolated grid: dx=1.500 mm, dy=1.500 mm

Maximum value of SAR (interpolated) = 0.394 W/kg

**Zoom Scan (5x5x7)/Cube 0:** Measurement grid: dx=8mm, dy=8mm, dz=5mm

Reference Value = 12.715 V/m; Power Drift = -0.02 dB

Peak SAR (extrapolated) = 0.779 W/kg

**SAR(1 g) = 0.364 W/kg; SAR(10 g) = 0.172 W/kg**

Maximum value of SAR (measured) = 0.507 W/kg

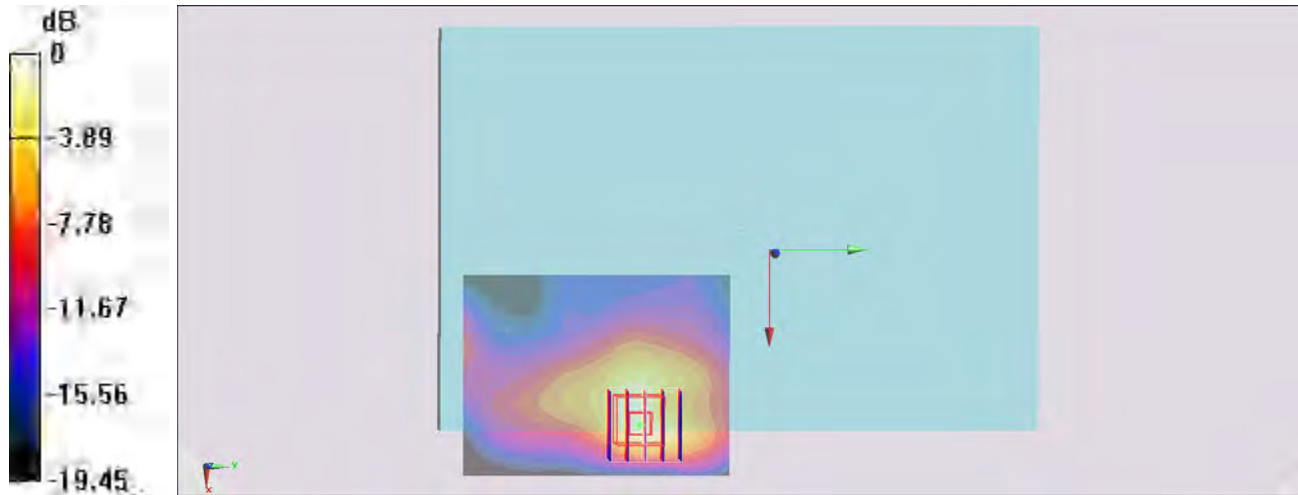

0 dB = 0.394 W/kg = -4.05 dBW/kg

### #10\_LTE Band 5\_10M\_QPSK\_1\_0\_Bottom Face\_14mm\_Ch20525

Communication System: LTE ; Frequency: 836.5 MHz; Duty Cycle: 1:1

Medium: MSL\_850\_160621 Medium parameters used:  $f = 836.5$  MHz;  $\sigma = 1.004$  S/m;  $\epsilon_r = 57.829$ ;  $\rho = 1000$  kg/m<sup>3</sup>

Ambient Temperature : 23.5°C; Liquid Temperature : 22.5°C

#### DASY5 Configuration

- Probe: ES3DV3 - SN3270; ConvF(6.24, 6.24, 6.24); Calibrated: 2015/9/28;
- Sensor-Surface: 3mm (Mechanical Surface Detection)
- Electronics: DAE4 Sn1399; Calibrated: 2015/11/23
- Phantom: ELI v4.0; Type: QDOVA001BB; Serial: 1026
- Measurement SW: DASY52, Version 52.8 (7); SEMCAD X Version 14.6.10 (7164)

**Area Scan (61x81x1):** Interpolated grid: dx=1.500 mm, dy=1.500 mm

Maximum value of SAR (interpolated) = 0.517 W/kg

**Zoom Scan (5x5x7)/Cube 0:** Measurement grid: dx=8mm, dy=8mm, dz=5mm

Reference Value = 22.592 V/m; Power Drift = -0.11 dB

Peak SAR (extrapolated) = 0.651 W/kg

**SAR(1 g) = 0.435 W/kg; SAR(10 g) = 0.277 W/kg**

Maximum value of SAR (measured) = 0.514 W/kg

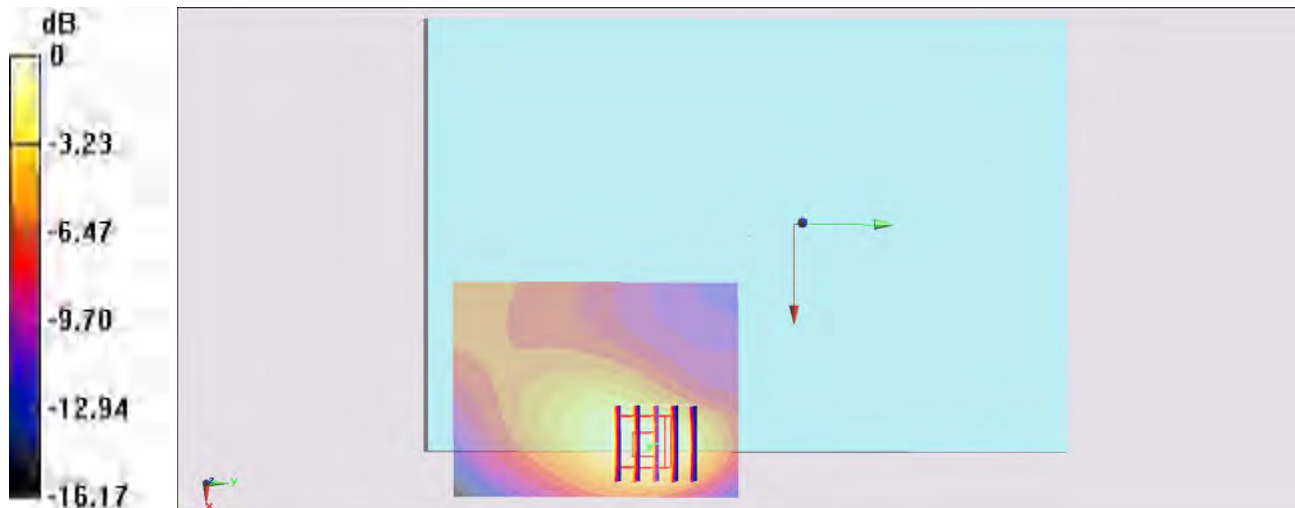

0 dB = 0.517 W/kg = -2.87 dBW/kg

### #11\_LTE Band 13\_10M\_QPSK\_25\_12\_Bottom Face\_0mm\_Ch23230

Communication System: LTE ; Frequency: 782 MHz; Duty Cycle: 1:1

Medium: MSL\_750\_160623 Medium parameters used:  $f = 782 \text{ MHz}$ ;  $\sigma = 0.988 \text{ S/m}$ ;  $\epsilon_r = 54.298$ ;  $\rho = 1000 \text{ kg/m}^3$

Ambient Temperature :  $23.5^\circ\text{C}$ ; Liquid Temperature :  $22.5^\circ\text{C}$

#### DASY5 Configuration

- Probe: ES3DV3 - SN3270; ConvF(6.3, 6.3, 6.3); Calibrated: 2015/9/28;
- Sensor-Surface: 3mm (Mechanical Surface Detection)
- Electronics: DAE4 Sn1399; Calibrated: 2015/11/23
- Phantom: ELI v4.0; Type: QDOVA001BB; Serial: 1026
- Measurement SW: DASY52, Version 52.8 (7); SEMCAD X Version 14.6.10 (7164)

**Area Scan (61x81x1):** Interpolated grid:  $dx=1.500 \text{ mm}$ ,  $dy=1.500 \text{ mm}$

Maximum value of SAR (interpolated) =  $1.01 \text{ W/kg}$

**Zoom Scan (5x5x7)/Cube 0:** Measurement grid:  $dx=8\text{mm}$ ,  $dy=8\text{mm}$ ,  $dz=5\text{mm}$

Reference Value =  $32.174 \text{ V/m}$ ; Power Drift =  $-0.14 \text{ dB}$

Peak SAR (extrapolated) =  $1.51 \text{ W/kg}$

**SAR(1 g) =  $0.703 \text{ W/kg}$ ; SAR(10 g) =  $0.360 \text{ W/kg}$**

Maximum value of SAR (measured) =  $0.978 \text{ W/kg}$

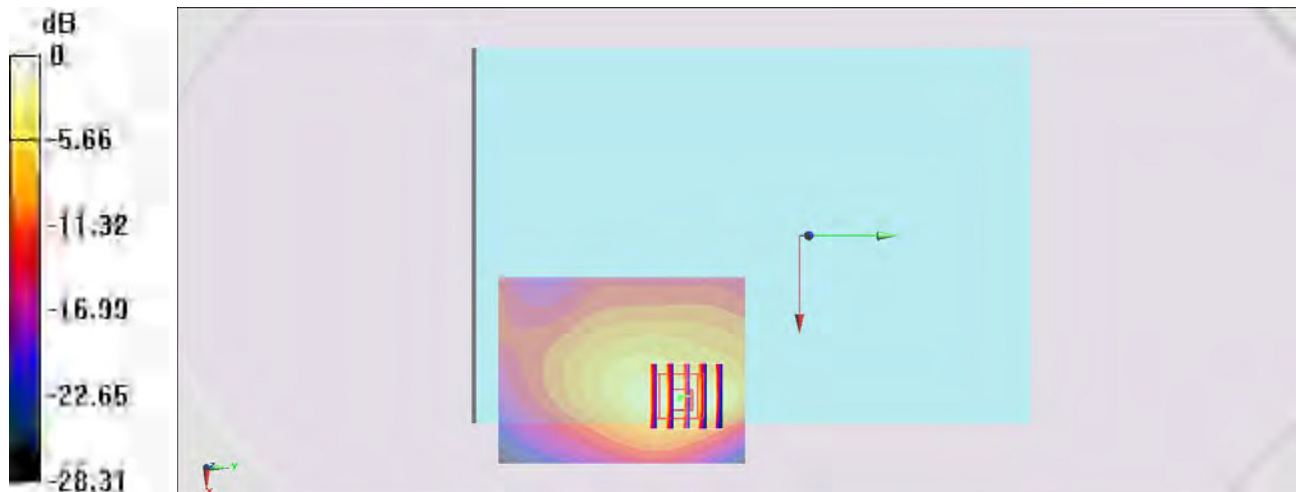

$0 \text{ dB} = 1.01 \text{ W/kg} = 0.04 \text{ dBW/kg}$

## #12\_LTE Band 17\_10M\_QPSK\_25\_12\_Bottom Face\_0mm\_Ch23790

Communication System: LTE ; Frequency: 710 MHz;Duty Cycle: 1:1

Medium: MSL\_750\_160623 Medium parameters used:  $f = 710 \text{ MHz}$ ;  $\sigma = 0.921 \text{ S/m}$ ;  $\epsilon_r = 55.029$ ;  $\rho = 1000 \text{ kg/m}^3$

Ambient Temperature :  $23.5^\circ\text{C}$ ; Liquid Temperature :  $22.5^\circ\text{C}$

### DASY5 Configuration

- Probe: ES3DV3 - SN3270; ConvF(6.3, 6.3, 6.3); Calibrated: 2015/9/28;
- Sensor-Surface: 3mm (Mechanical Surface Detection)
- Electronics: DAE4 Sn1399; Calibrated: 2015/11/23
- Phantom: ELI v4.0; Type: QDOVA001BB; Serial: 1026
- Measurement SW: DASY52, Version 52.8 (7); SEMCAD X Version 14.6.10 (7164)

**Area Scan (61x81x1):** Interpolated grid:  $dx=1.500 \text{ mm}$ ,  $dy=1.500 \text{ mm}$

Maximum value of SAR (interpolated) =  $0.999 \text{ W/kg}$

**Zoom Scan (5x5x7)/Cube 0:** Measurement grid:  $dx=8\text{mm}$ ,  $dy=8\text{mm}$ ,  $dz=5\text{mm}$

Reference Value =  $32.928 \text{ V/m}$ ; Power Drift =  $-0.08 \text{ dB}$

Peak SAR (extrapolated) =  $1.54 \text{ W/kg}$

**SAR(1 g) =  $0.707 \text{ W/kg}$ ; SAR(10 g) =  $0.366 \text{ W/kg}$**

Maximum value of SAR (measured) =  $0.980 \text{ W/kg}$

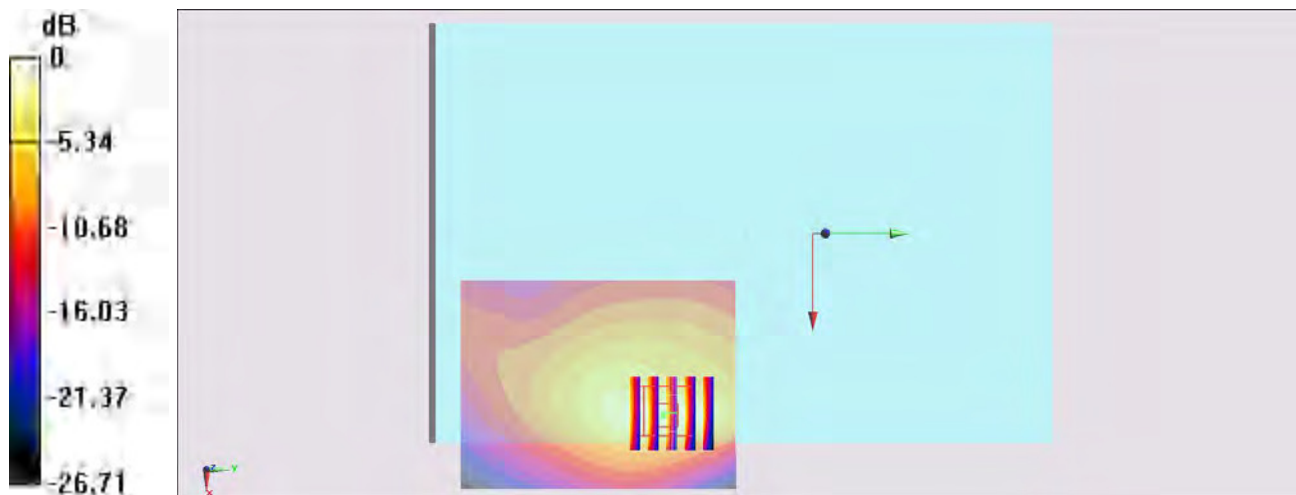

0 dB =  $0.999 \text{ W/kg}$  =  $-0.00 \text{ dBW/kg}$

### #13\_LTE Band 25\_20M\_QPSK\_1\_99\_Edge 1\_0mm\_Ch26590

Communication System: LTE; Frequency: 1905 MHz; Duty Cycle: 1:1

Medium: MSL\_1900\_160624 Medium parameters used:  $f = 1905$  MHz;  $\sigma = 1.532$  S/m;  $\epsilon_r = 53.837$ ;  $\rho = 1000$  kg/m<sup>3</sup>

Ambient Temperature : 23.8 °C; Liquid Temperature : 22.8 °C

#### DASY5 Configuration

- Probe: ES3DV3 - SN3270; ConvF(4.78, 4.78, 4.78); Calibrated: 2015/9/28;
- Sensor-Surface: 3mm (Mechanical Surface Detection)
- Electronics: DAE4 Sn1399; Calibrated: 2015/11/23
- Phantom: ELI v4.0; Type: QDOVA001BB; Serial: 1026
- Measurement SW: DASY52, Version 52.8 (7); SEMCAD X Version 14.6.10 (7164)

**Area Scan (51x81x1):** Interpolated grid: dx=1.500 mm, dy=1.500 mm

Maximum value of SAR (interpolated) = 1.31 W/kg

**Zoom Scan (5x5x7)/Cube 0:** Measurement grid: dx=8mm, dy=8mm, dz=5mm

Reference Value = 9.828 V/m; Power Drift = 0.10 dB

Peak SAR (extrapolated) = 1.60 W/kg

**SAR(1 g) = 0.792 W/kg; SAR(10 g) = 0.345 W/kg**

Maximum value of SAR (measured) = 1.04 W/kg

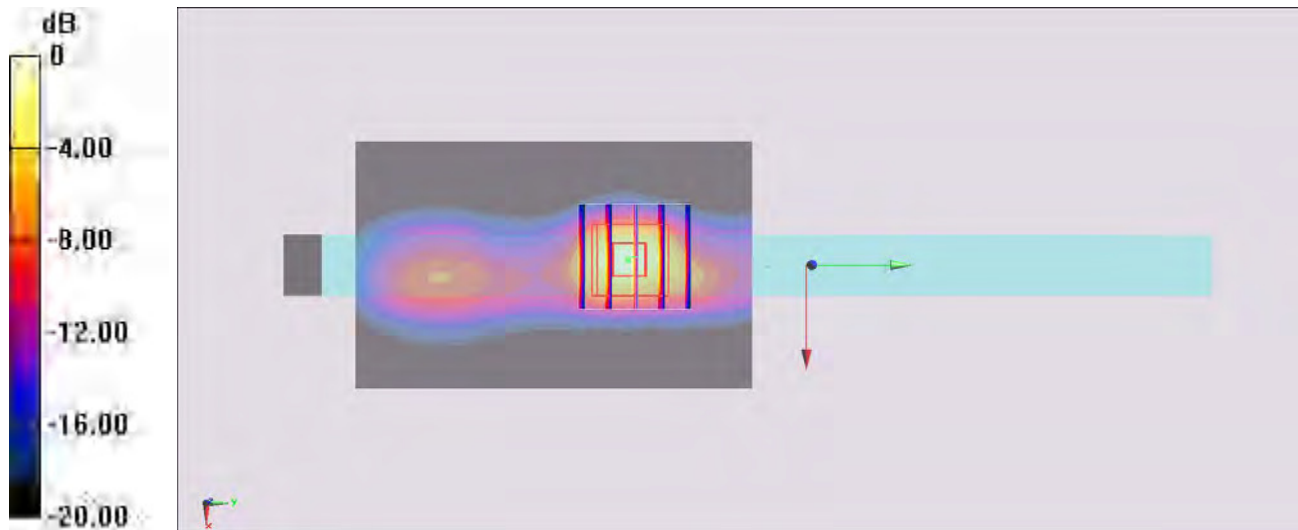

0 dB = 1.31 W/kg = 1.17 dBW/kg

### #14\_WLAN2.4GHz\_802.11b 1Mbps\_Edge 2\_0mm\_Ch6;Ant 1

Communication System: 802.11b ; Frequency: 2437 MHz;Duty Cycle: 1:1.014

Medium: MSL\_2450\_160702 Medium parameters used:  $f = 2437$  MHz;  $\sigma = 1.97$  S/m;  $\epsilon_r = 52.191$ ;  $\rho = 1000$  kg/m<sup>3</sup>

Ambient Temperature : 23.5 °C ; Liquid Temperature : 22.5 °C

#### DASY5 Configuration

- Probe: EX3DV4 - SN3955; ConvF(7.53, 7.53, 7.53); Calibrated: 2015/11/24;
- Sensor-Surface: 1.4mm (Mechanical Surface Detection)
- Electronics: DAE4 Sn1399; Calibrated: 2015/11/23
- Phantom: ELI v4.0; Type: QDOVA001BB; Serial: 1026
- Measurement SW: DASY52, Version 52.8 (7); SEMCAD X Version 14.6.10 (7164)

**Area Scan (51x101x1):** Interpolated grid: dx=1.200 mm, dy=1.200 mm

Maximum value of SAR (interpolated) = 1.87 W/kg

**Zoom Scan (7x7x7)/Cube 0:** Measurement grid: dx=5mm, dy=5mm, dz=5mm

Reference Value = 18.717 V/m; Power Drift = 0.19 dB

Peak SAR (extrapolated) = 2.42 W/kg

**SAR(1 g) = 0.974 W/kg; SAR(10 g) = 0.353 W/kg**

Maximum value of SAR (measured) = 1.85 W/kg

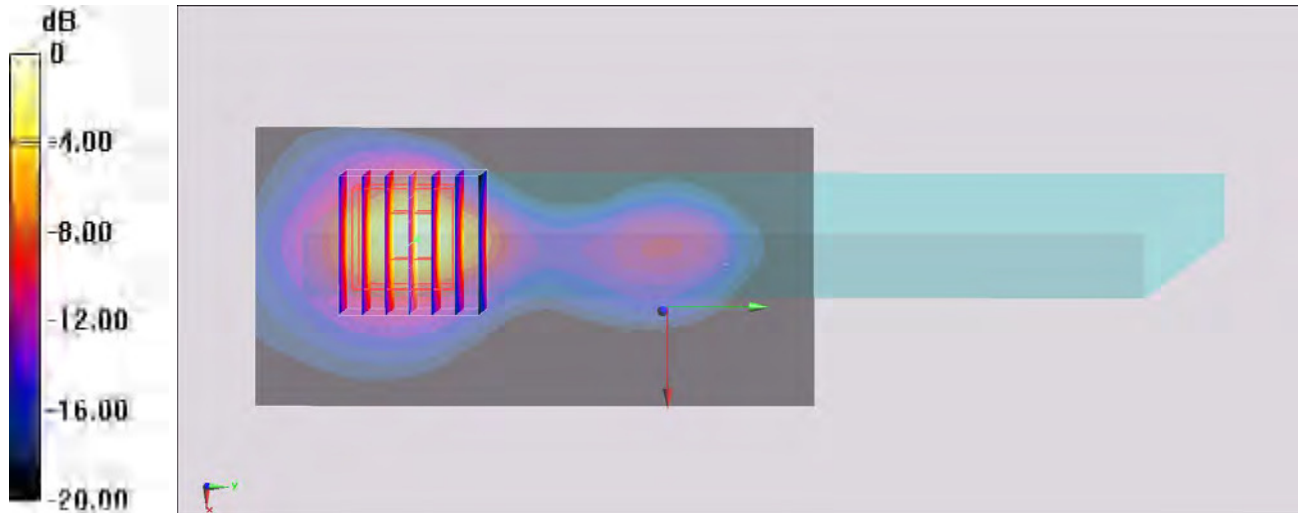

0 dB = 1.87 W/kg = 2.72 dBW/kg

**#15\_WLAN5GHz\_802.11n-HT40 MCS0\_Edge 2\_0mm\_Ch54;Ant 2**

Communication System: 802.11n; Frequency: 5270 MHz; Duty Cycle: 1:1.152

Medium: MSL\_5G\_160702 Medium parameters used:  $f = 5270$  MHz;  $\sigma = 5.505$  S/m;  $\epsilon_r = 47.304$ ;  $\rho = 1000$  kg/m<sup>3</sup>

Ambient Temperature : 23.4 °C; Liquid Temperature : 22.4 °C

**DASY5 Configuration**

- Probe: EX3DV4 - SN3955; ConvF(4.42, 4.42, 4.42); Calibrated: 2015/11/24;
- Sensor-Surface: 1.4mm (Mechanical Surface Detection)
- Electronics: DAE4 Sn1399; Calibrated: 2015/11/23
- Phantom: ELI v4.0; Type: QDOVA001BB; Serial: 1026
- Measurement SW: DASY52, Version 52.8 (7); SEMCAD X Version 14.6.10 (7164)

**Area Scan (61x121x1):** Interpolated grid: dx=1.000 mm, dy=1.000 mm

Maximum value of SAR (interpolated) = 1.80 W/kg

**Zoom Scan (7x7x7)/Cube 0:** Measurement grid: dx=4mm, dy=4mm, dz=1.4mm

Reference Value = 16.533 V/m; Power Drift = 0.16 dB

Peak SAR (extrapolated) = 4.29 W/kg

**SAR(1 g) = 0.978 W/kg; SAR(10 g) = 0.232 W/kg**

Maximum value of SAR (measured) = 2.64 W/kg

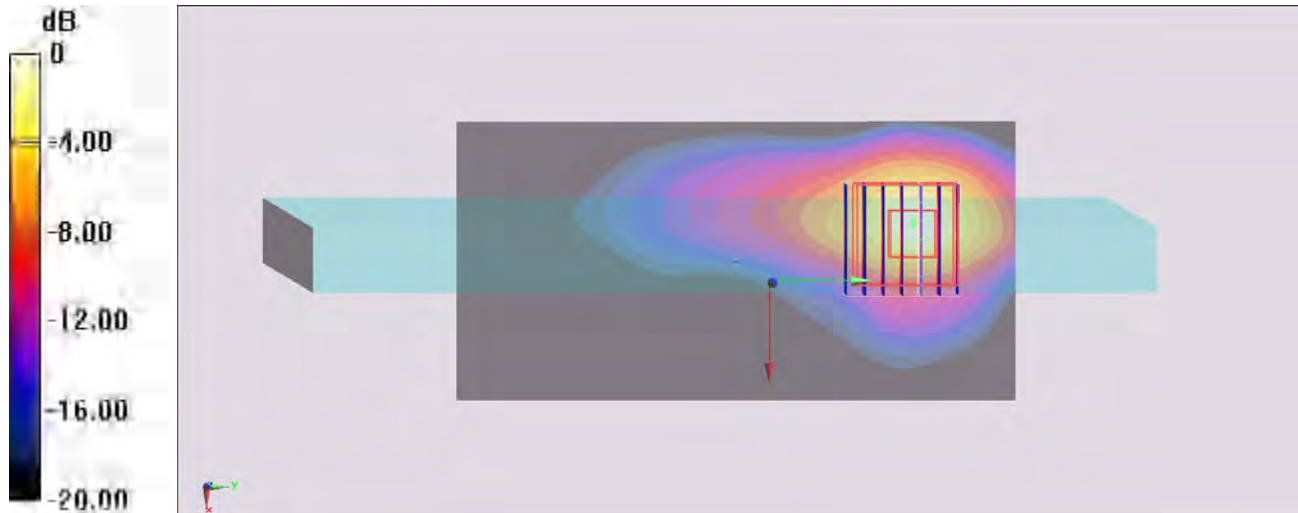

0 dB = 1.80 W/kg = 2.55 dBW/kg



**#16\_WLAN5GHz\_802.11n-HT40 MCS0\_Edge 2\_0mm\_Ch102;Ant 2**

Communication System: 802.11n; Frequency: 5510 MHz; Duty Cycle: 1:1.152

Medium: MSL\_5G\_160702 Medium parameters used:  $f = 5510 \text{ MHz}$ ;  $\sigma = 5.802 \text{ S/m}$ ;  $\epsilon_r = 46.917$ ;  $\rho = 1000 \text{ kg/m}^3$

Ambient Temperature :  $23.4 \text{ }^\circ\text{C}$ ; Liquid Temperature :  $22.4 \text{ }^\circ\text{C}$

**DASY5 Configuration**

- Probe: EX3DV4 - SN3955; ConvF(3.81, 3.81, 3.81); Calibrated: 2015/11/24;
- Sensor-Surface: 1.4mm (Mechanical Surface Detection)
- Electronics: DAE4 Sn1399; Calibrated: 2015/11/23
- Phantom: ELI v4.0; Type: QDOVA001BB; Serial: 1026
- Measurement SW: DASY52, Version 52.8 (7); SEMCAD X Version 14.6.10 (7164)

**Area Scan (61x121x1):** Interpolated grid:  $dx=1.000 \text{ mm}$ ,  $dy=1.000 \text{ mm}$

Maximum value of SAR (interpolated) =  $1.26 \text{ W/kg}$

**Zoom Scan (7x7x7)/Cube 0:** Measurement grid:  $dx=4\text{mm}$ ,  $dy=4\text{mm}$ ,  $dz=1.4\text{mm}$

Reference Value =  $14.497 \text{ V/m}$ ; Power Drift =  $0.13 \text{ dB}$

Peak SAR (extrapolated) =  $4.95 \text{ W/kg}$

**SAR(1 g) =  $1.14 \text{ W/kg}$ ; SAR(10 g) =  $0.282 \text{ W/kg}$**

Maximum value of SAR (measured) =  $3.27 \text{ W/kg}$

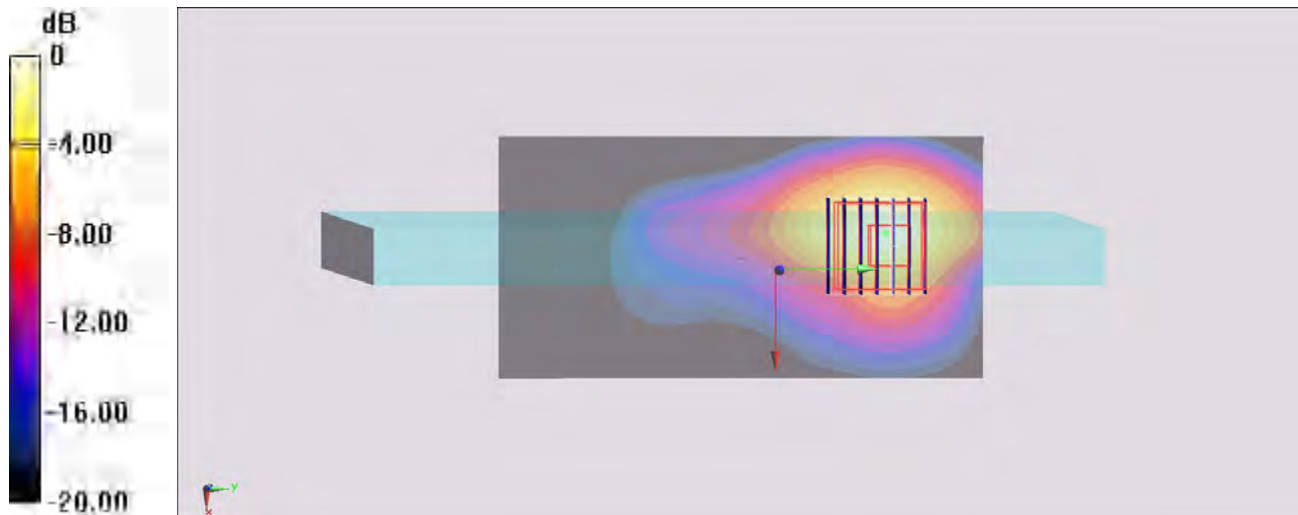

$0 \text{ dB} = 1.26 \text{ W/kg} = 1.00 \text{ dBW/kg}$



**#17\_WLAN5GHz\_802.11n-HT40 MCS0\_Edge 2\_0mm\_Ch159;Ant 1**

Communication System: 802.11n; Frequency: 5795 MHz; Duty Cycle: 1:1.152

Medium: MSL\_5G\_160702 Medium parameters used:  $f = 5795$  MHz;  $\sigma = 6.175$  S/m;  $\epsilon_r = 46.456$ ;  $\rho = 1000$  kg/m<sup>3</sup>

Ambient Temperature : 23.4 °C; Liquid Temperature : 22.4 °C

**DASY5 Configuration**

- Probe: EX3DV4 - SN3955; ConvF(3.92, 3.92, 3.92); Calibrated: 2015/11/24;
- Sensor-Surface: 1.4mm (Mechanical Surface Detection)
- Electronics: DAE4 Sn1399; Calibrated: 2015/11/23
- Phantom: ELI v4.0; Type: QDOVA001BB; Serial: 1026
- Measurement SW: DASY52, Version 52.8 (7); SEMCAD X Version 14.6.10 (7164)

**Area Scan (61x121x1):** Interpolated grid: dx=1.000 mm, dy=1.000 mm

Maximum value of SAR (interpolated) = 0.585 W/kg

**Zoom Scan (7x7x7)/Cube 0:** Measurement grid: dx=4mm, dy=4mm, dz=1.4mm

Reference Value = 16.303 V/m; Power Drift = -0.02 dB

Peak SAR (extrapolated) = 4.72 W/kg

**SAR(1 g) = 1.02 W/kg; SAR(10 g) = 0.267 W/kg**

Maximum value of SAR (measured) = 2.80 W/kg

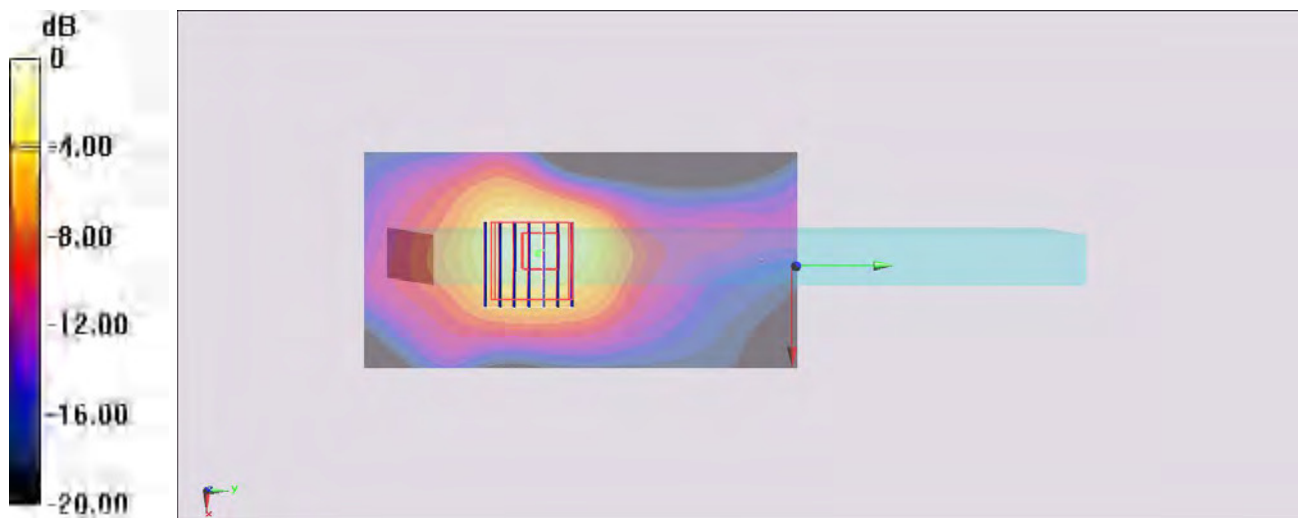

0 dB = 0.585 W/kg = -2.33 dBW/kg

### #18\_Bluetooth\_1Mbps\_Edge 2\_0mm\_Ch78

Communication System: Bluetooth ; Frequency: 2480 MHz;Duty Cycle: 1:1.2

Medium: MSL\_2450\_160702 Medium parameters used:  $f = 2480$  MHz;  $\sigma = 2.025$  S/m;  $\epsilon_r = 52.017$ ;  $\rho = 1000$  kg/m<sup>3</sup>

Ambient Temperature : 23.5 °C; Liquid Temperature : 22.5 °C

#### DASY5 Configuration

- Probe: EX3DV4 - SN3955; ConvF(7.53, 7.53, 7.53); Calibrated: 2015/11/24;
- Sensor-Surface: 1.4mm (Mechanical Surface Detection)
- Electronics: DAE4 Sn1399; Calibrated: 2015/11/23
- Phantom: ELI v4.0; Type: QDOVA001BB; Serial: 1026
- Measurement SW: DASY52, Version 52.8 (7); SEMCAD X Version 14.6.10 (7164)

**Area Scan (51x101x1):** Interpolated grid: dx=1.200 mm, dy=1.200 mm

Maximum value of SAR (interpolated) = 0.346 W/kg

**Zoom Scan (7x7x7)/Cube 0:** Measurement grid: dx=5mm, dy=5mm, dz=5mm

Reference Value = 11.040 V/m; Power Drift = 0.18 dB

Peak SAR (extrapolated) = 0.478 W/kg

**SAR(1 g) = 0.187 W/kg; SAR(10 g) = 0.066 W/kg**

Maximum value of SAR (measured) = 0.369 W/kg

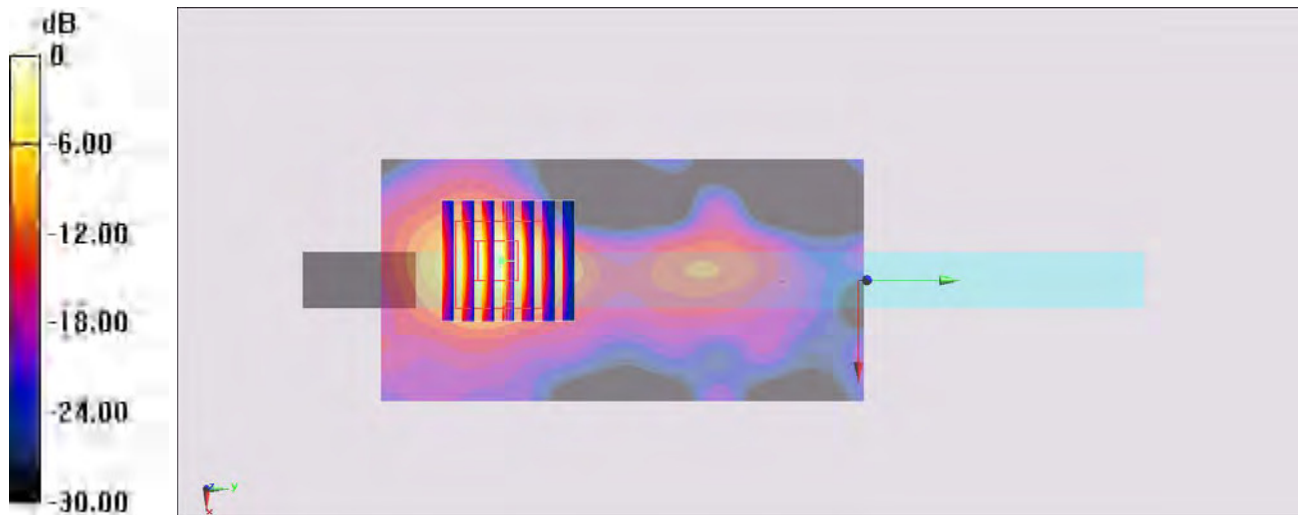

0 dB = 0.346 W/kg = -4.61 dBW/kg



---

**Appendix C. DASYS Calibration Certificate**

The DASYS calibration certificates are shown as follows.



Accredited by the Swiss Accreditation Service (SAS)  
The Swiss Accreditation Service is one of the signatories to the EA  
Multilateral Agreement for the recognition of calibration certificates

Accreditation No.: **SCS 0108**

Client **Sporton-TW (Auden)**

Certificate No: **D750V3-1012\_May16**

## CALIBRATION CERTIFICATE

Object **D750V3 - SN:1012**

Calibration procedure(s) **QA CAL-05.v9**  
Calibration procedure for dipole validation kits above 700 MHz

Calibration date: **May 18, 2016**

This calibration certificate documents the traceability to national standards, which realize the physical units of measurements (SI).  
The measurements and the uncertainties with confidence probability are given on the following pages and are part of the certificate.

All calibrations have been conducted in the closed laboratory facility: environment temperature ( $22 \pm 3$ )°C and humidity < 70%.

Calibration Equipment used (M&TE critical for calibration)

Primary Standards	ID #	Cal Date (Certificate No.)	Scheduled Calibration
Power meter NRP	SN: 104778	06-Apr-16 (No. 217-02288/02289)	Apr-17
Power sensor NRP-Z91	SN: 103244	06-Apr-16 (No. 217-02288)	Apr-17
Power sensor NRP-Z91	SN: 103245	06-Apr-16 (No. 217-02289)	Apr-17
Reference 20 dB Attenuator	SN: 5058 (20k)	05-Apr-16 (No. 217-02292)	Apr-17
Type-N mismatch combination	SN: 5047.2 / 06327	05-Apr-16 (No. 217-02295)	Apr-17
Reference Probe EX3DV4	SN: 7349	31-Dec-15 (No. EX3-7349_Dec15)	Dec-16
DAE4	SN: 601	30-Dec-15 (No. DAE4-601_Dec15)	Dec-16

Secondary Standards	ID #	Check Date (in house)	Scheduled Check
Power meter EPM-442A	SN: GB37480704	07-Oct-15 (No. 217-02222)	In house check: Oct-16
Power sensor HP 8481A	SN: US37292783	07-Oct-15 (No. 217-02222)	In house check: Oct-16
Power sensor HP 8481A	SN: MY41092317	07-Oct-15 (No. 217-02223)	In house check: Oct-16
RF generator R&S SMT-06	SN: 100972	15-Jun-15 (in house check Jun-15)	In house check: Oct-16
Network Analyzer HP 8753E	SN: US37390585	18-Oct-01 (in house check Oct-15)	In house check: Oct-16

	Name	Function	Signature
Calibrated by:	Jeton Kastrati	Laboratory Technician	
Approved by:	Katja Pokovic	Technical Manager	

Issued: May 20, 2016

This calibration certificate shall not be reproduced except in full without written approval of the laboratory.



Accredited by the Swiss Accreditation Service (SAS)  
The Swiss Accreditation Service is one of the signatories to the EA  
Multilateral Agreement for the recognition of calibration certificates

Accreditation No.: **SCS 0108**

**Glossary:**

TSL	tissue simulating liquid
ConvF	sensitivity in TSL / NORM x,y,z
N/A	not applicable or not measured

**Calibration is Performed According to the Following Standards:**

- IEEE Std 1528-2013, "IEEE Recommended Practice for Determining the Peak Spatial-Averaged Specific Absorption Rate (SAR) in the Human Head from Wireless Communications Devices: Measurement Techniques", June 2013
- IEC 62209-1, "Procedure to measure the Specific Absorption Rate (SAR) for hand-held devices used in close proximity to the ear (frequency range of 300 MHz to 3 GHz)", February 2005
- IEC 62209-2, "Procedure to determine the Specific Absorption Rate (SAR) for wireless communication devices used in close proximity to the human body (frequency range of 30 MHz to 6 GHz)", March 2010
- KDB 865664, "SAR Measurement Requirements for 100 MHz to 6 GHz"

**Additional Documentation:**

- DASY4/5 System Handbook

**Methods Applied and Interpretation of Parameters:**

- Measurement Conditions:** Further details are available from the Validation Report at the end of the certificate. All figures stated in the certificate are valid at the frequency indicated.
- Antenna Parameters with TSL:** The dipole is mounted with the spacer to position its feed point exactly below the center marking of the flat phantom section, with the arms oriented parallel to the body axis.
- Feed Point Impedance and Return Loss:** These parameters are measured with the dipole positioned under the liquid filled phantom. The impedance stated is transformed from the measurement at the SMA connector to the feed point. The Return Loss ensures low reflected power. No uncertainty required.
- Electrical Delay:** One-way delay between the SMA connector and the antenna feed point. No uncertainty required.
- SAR measured:** SAR measured at the stated antenna input power.
- SAR normalized:** SAR as measured, normalized to an input power of 1 W at the antenna connector.
- SAR for nominal TSL parameters:** The measured TSL parameters are used to calculate the nominal SAR result.

The reported uncertainty of measurement is stated as the standard uncertainty of measurement multiplied by the coverage factor  $k=2$ , which for a normal distribution corresponds to a coverage probability of approximately 95%.

## Measurement Conditions

DASY system configuration, as far as not given on page 1.

DASY Version	DASY5	V52.8.8
Extrapolation	Advanced Extrapolation	
Phantom	Modular Flat Phantom	
Distance Dipole Center - TSL	15 mm	with Spacer
Zoom Scan Resolution	dx, dy, dz = 5 mm	
Frequency	750 MHz $\pm$ 1 MHz	

## Head TSL parameters

The following parameters and calculations were applied.

	Temperature	Permittivity	Conductivity
Nominal Head TSL parameters	22.0 °C	41.9	0.89 mho/m
Measured Head TSL parameters	(22.0 $\pm$ 0.2) °C	41.6 $\pm$ 6 %	0.91 mho/m $\pm$ 6 %
Head TSL temperature change during test	< 0.5 °C	----	----

## SAR result with Head TSL

SAR averaged over 1 cm <sup>3</sup> (1 g) of Head TSL	Condition	
SAR measured	250 mW input power	2.09 W/kg
SAR for nominal Head TSL parameters	normalized to 1W	<b>8.21 W/kg <math>\pm</math> 17.0 % (k=2)</b>

SAR averaged over 10 cm <sup>3</sup> (10 g) of Head TSL	condition	
SAR measured	250 mW input power	1.37 W/kg
SAR for nominal Head TSL parameters	normalized to 1W	<b>5.40 W/kg <math>\pm</math> 16.5 % (k=2)</b>

## Body TSL parameters

The following parameters and calculations were applied.

	Temperature	Permittivity	Conductivity
Nominal Body TSL parameters	22.0 °C	55.5	0.96 mho/m
Measured Body TSL parameters	(22.0 $\pm$ 0.2) °C	55.4 $\pm$ 6 %	1.00 mho/m $\pm$ 6 %
Body TSL temperature change during test	< 0.5 °C	----	----

## SAR result with Body TSL

SAR averaged over 1 cm <sup>3</sup> (1 g) of Body TSL	Condition	
SAR measured	250 mW input power	2.25 W/kg
SAR for nominal Body TSL parameters	normalized to 1W	<b>8.72 W/kg <math>\pm</math> 17.0 % (k=2)</b>

SAR averaged over 10 cm <sup>3</sup> (10 g) of Body TSL	condition	
SAR measured	250 mW input power	1.47 W/kg
SAR for nominal Body TSL parameters	normalized to 1W	<b>5.73 W/kg <math>\pm</math> 16.5 % (k=2)</b>

## Appendix (Additional assessments outside the scope of SCS 0108)

### Antenna Parameters with Head TSL

Impedance, transformed to feed point	$54.0 \Omega + 1.1 j\Omega$
Return Loss	- 28.1 dB

### Antenna Parameters with Body TSL

Impedance, transformed to feed point	$50.0 \Omega - 0.6 j\Omega$
Return Loss	- 44.7 dB

### General Antenna Parameters and Design

Electrical Delay (one direction)	1.036 ns
----------------------------------	----------

After long term use with 100W radiated power, only a slight warming of the dipole near the feedpoint can be measured.

The dipole is made of standard semirigid coaxial cable. The center conductor of the feeding line is directly connected to the second arm of the dipole. The antenna is therefore short-circuited for DC-signals. On some of the dipoles, small end caps are added to the dipole arms in order to improve matching when loaded according to the position as explained in the "Measurement Conditions" paragraph. The SAR data are not affected by this change. The overall dipole length is still according to the Standard.

No excessive force must be applied to the dipole arms, because they might bend or the soldered connections near the feedpoint may be damaged.

### Additional EUT Data

Manufactured by	SPEAG
Manufactured on	September 29, 2009

# DASY5 Validation Report for Head TSL

Date: 18.05.2016

Test Laboratory: SPEAG, Zurich, Switzerland

**DUT: Dipole 750 MHz; Type: D750V3; Serial: D750V3 - SN:1012**

Communication System: UID 0 - CW; Frequency: 750 MHz

Medium parameters used:  $f = 750 \text{ MHz}$ ;  $\sigma = 0.91 \text{ S/m}$ ;  $\epsilon_r = 41.6$ ;  $\rho = 1000 \text{ kg/m}^3$

Phantom section: Flat Section

Measurement Standard: DASY5 (IEEE/IEC/ANSI C63.19-2011)

DASY52 Configuration:

- Probe: EX3DV4 - SN7349; ConvF(10.28, 10.28, 10.28); Calibrated: 31.12.2015;
- Sensor-Surface: 1.4mm (Mechanical Surface Detection)
- Electronics: DAE4 Sn601; Calibrated: 30.12.2015
- Phantom: Flat Phantom 4.9L; Type: QD000P49AA; Serial: 1001
- DASY52 52.8.8(1258); SEMCAD X 14.6.10(7372)

## Dipole Calibration for Head Tissue/Pin=250 mW, d=15mm/Zoom Scan (7x7x7)/Cube 0:

Measurement grid: dx=5mm, dy=5mm, dz=5mm

Reference Value = 58.14 V/m; Power Drift = 0.01 dB

Peak SAR (extrapolated) = 3.10 W/kg

**SAR(1 g) = 2.09 W/kg; SAR(10 g) = 1.37 W/kg**

Maximum value of SAR (measured) = 2.76 W/kg

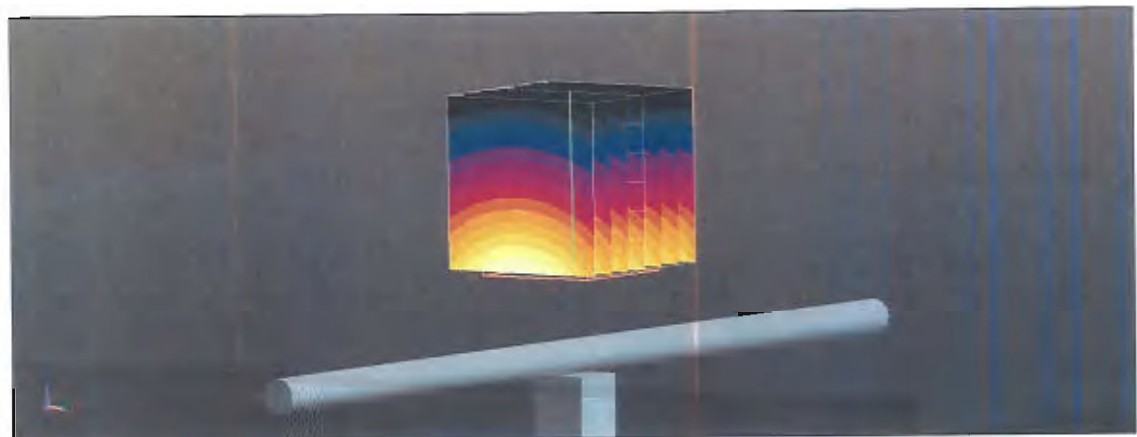
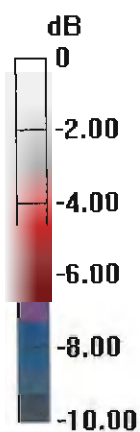

0 dB = 2.76 W/kg = 4.41 dBW/kg



# Impedance Measurement Plot for Head TSL

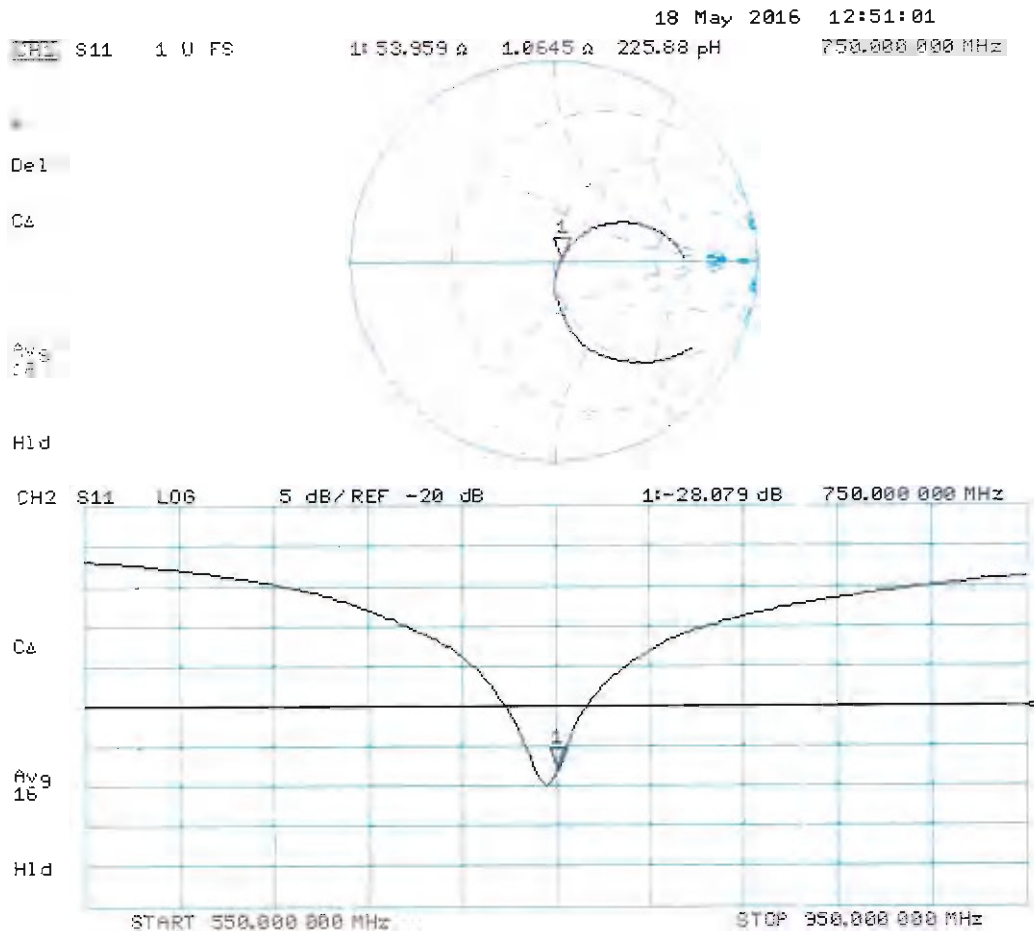

## DASY5 Validation Report for Body TSL

Date: 18.05.2016

Test Laboratory: SPEAG, Zurich, Switzerland

**DUT: Dipole 750 MHz; Type: D750V3; Serial: D750V3 - SN:1012**

Communication System: UID 0 - CW; Frequency: 750 MHz

Medium parameters used:  $f = 750$  MHz;  $\sigma = 1$  S/m;  $\epsilon_r = 55.4$ ;  $\rho = 1000$  kg/m<sup>3</sup>

Phantom section: Flat Section

Measurement Standard: DASY5 (IEEE/IEC/ANSI C63.19-2011)

DASY52 Configuration:

- Probe: EX3DV4 - SN7349; ConvF(9.99, 9.99, 9.99); Calibrated: 31.12.2015;
- Sensor-Surface: 1.4mm (Mechanical Surface Detection)
- Electronics: DAE4 Sn601; Calibrated: 30.12.2015
- Phantom: Flat Phantom 4.9L; Type: QD000P49AA; Serial: 1001
- DASY52 52.8.8(1258); SEMCAD X 14.6.10(7372)

### Dipole Calibration for Body Tissue/Pin=250 mW, d=15mm/Zoom Scan (7x7x7)/Cube 0:

Measurement grid: dx=5mm, dy=5mm, dz=5mm

Reference Value = 57.15 V/m; Power Drift = 0.01 dB

Peak SAR (extrapolated) = 3.38 W/kg

**SAR(1 g) = 2.25 W/kg; SAR(10 g) = 1.47 W/kg**

Maximum value of SAR (measured) = 2.98 W/kg

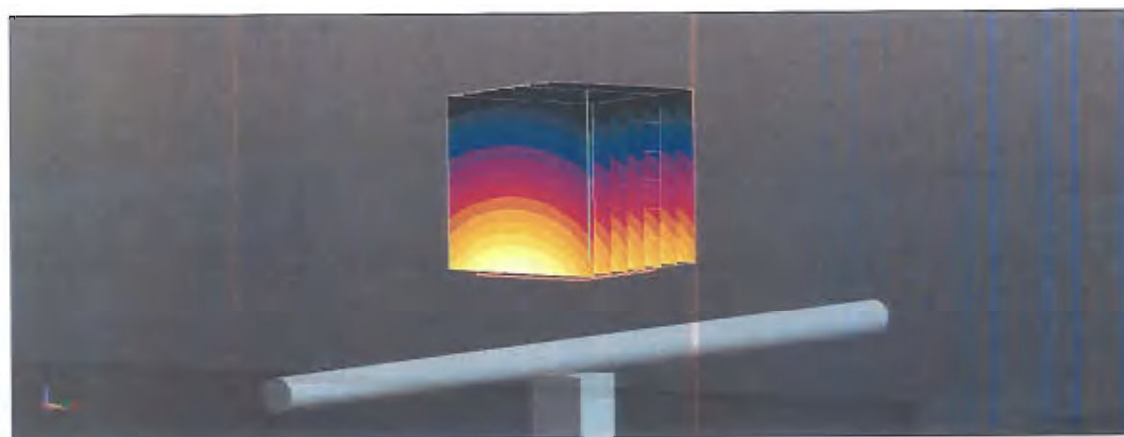
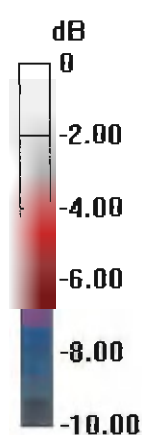

0 dB = 2.98 W/kg = 4.74 dBW/kg

# Impedance Measurement Plot for Body TSL

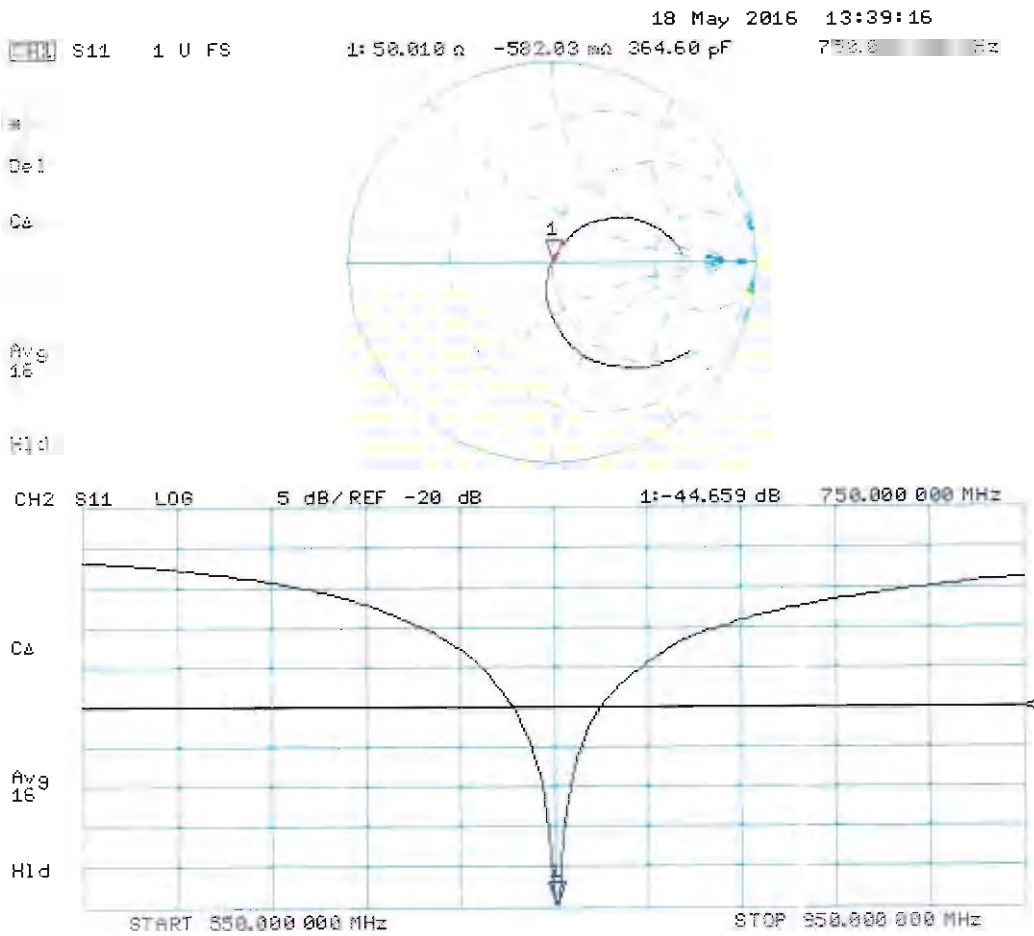



Accredited by the Swiss Accreditation Service (SAS)  
The Swiss Accreditation Service is one of the signatories to the EA  
Multilateral Agreement for the recognition of calibration certificates

Accreditation No.: **SCS 0108**

Client **Sporton-TW (Auden)**

Certificate No: **D835V2-499\_Mar16**

## CALIBRATION CERTIFICATE

Object **D835V2 - SN: 499**

Calibration procedure(s) **QA CAL-05.v9  
Calibration procedure for dipole validation kits above 700 MHz**

Calibration date: **March 21, 2016**

This calibration certificate documents the traceability to national standards, which realize the physical units of measurements (SI).  
The measurements and the uncertainties with confidence probability are given on the following pages and are part of the certificate.

All calibrations have been conducted in the closed laboratory facility: environment temperature ( $22 \pm 3$ )°C and humidity < 70%.

Calibration Equipment used (M&TE critical for calibration)

Primary Standards	ID #	Cal Date (Certificate No.)	Scheduled Calibration
Power meter EPM-442A	GB37480704	07-Oct-15 (No. 217-02222)	Oct-16
Power sensor HP 8481A	US37292783	07-Oct-15 (No. 217-02222)	Oct-16
Power sensor HP 8481A	MY41092317	07-Oct-15 (No. 217-02223)	Oct-16
Reference 20 dB Attenuator	SN: 5058 (20k)	01-Apr-15 (No. 217-02131)	Mar-16
Type-N mismatch combination	SN: 5047.2 / 06327	01-Apr-15 (No. 217-02134)	Mar-16
Reference Probe EX3DV4	SN: 7349	31-Dec-15 (No. EX3-7349_Dec15)	Dec-16
DAE4	SN: 601	30-Dec-15 (No. DAE4-601_Dec15)	Dec-16
Secondary Standards	ID #	Check Date (in house)	Scheduled Check
RF generator R&S SMT-06	100972	15-Jun-15 (in house check Jun-15)	In house check: Jun-18
Network Analyzer HP 8753E	US37390585 S4206	18-Oct-01 (in house check Oct-15)	In house check: Oct-16

Calibrated by: **Michael Weber**      Name: Michael Weber      Function: Laboratory Technician

Approved by: **Katja Pokovic**      Name: Katja Pokovic      Function: Technical Manager

Signature

Issued: March 21, 2016

This calibration certificate shall not be reproduced except in full without written approval of the laboratory.



Accredited by the Swiss Accreditation Service (SAS)  
The Swiss Accreditation Service is one of the signatories to the EA  
Multilateral Agreement for the recognition of calibration certificates

Accreditation No.: **SCS 0108**

### Glossary:

TSL	tissue simulating liquid
ConvF	sensitivity in TSL / NORM x,y,z
N/A	not applicable or not measured

### Calibration is Performed According to the Following Standards:

- IEEE Std 1528-2013, "IEEE Recommended Practice for Determining the Peak Spatial-Averaged Specific Absorption Rate (SAR) in the Human Head from Wireless Communications Devices: Measurement Techniques", June 2013
- IEC 62209-1, "Procedure to measure the Specific Absorption Rate (SAR) for hand-held devices used in close proximity to the ear (frequency range of 300 MHz to 3 GHz)", February 2005
- IEC 62209-2, "Procedure to determine the Specific Absorption Rate (SAR) for wireless communication devices used in close proximity to the human body (frequency range of 30 MHz to 6 GHz)", March 2010
- KDB 865664, "SAR Measurement Requirements for 100 MHz to 6 GHz"

### Additional Documentation:

- DASY4/5 System Handbook

### Methods Applied and Interpretation of Parameters:

- Measurement Conditions:** Further details are available from the Validation Report at the end of the certificate. All figures stated in the certificate are valid at the frequency indicated.
- Antenna Parameters with TSL:** The dipole is mounted with the spacer to position its feed point exactly below the center marking of the flat phantom section, with the arms oriented parallel to the body axis.
- Feed Point Impedance and Return Loss:** These parameters are measured with the dipole positioned under the liquid filled phantom. The impedance stated is transformed from the measurement at the SMA connector to the feed point. The Return Loss ensures low reflected power. No uncertainty required.
- Electrical Delay:** One-way delay between the SMA connector and the antenna feed point. No uncertainty required.
- SAR measured:** SAR measured at the stated antenna input power.
- SAR normalized:** SAR as measured, normalized to an input power of 1 W at the antenna connector.
- SAR for nominal TSL parameters:** The measured TSL parameters are used to calculate the nominal SAR result.

The reported uncertainty of measurement is stated as the standard uncertainty of measurement multiplied by the coverage factor  $k=2$ , which for a normal distribution corresponds to a coverage probability of approximately 95%.

## Measurement Conditions

DASY system configuration, as far as not given on page 1.

<b>DASY Version</b>	DASY5	V52.8.8
<b>Extrapolation</b>	Advanced Extrapolation	
<b>Phantom</b>	Modular Flat Phantom	
<b>Distance Dipole Center - TSL</b>	15 mm	with Spacer
<b>Zoom Scan Resolution</b>	dx, dy, dz = 5 mm	
<b>Frequency</b>	835 MHz $\pm$ 1 MHz	

## Head TSL parameters

The following parameters and calculations were applied.

	Temperature	Permittivity	Conductivity
<b>Nominal Head TSL parameters</b>	22.0 °C	41.5	0.90 mho/m
<b>Measured Head TSL parameters</b>	(22.0 $\pm$ 0.2) °C	41.7 $\pm$ 6 %	0.93 mho/m $\pm$ 6 %
<b>Head TSL temperature change during test</b>	< 0.5 °C	----	----

## SAR result with Head TSL

<b>SAR averaged over 1 cm<sup>3</sup> (1 g) of Head TSL</b>	Condition	
SAR measured	250 mW input power	2.34 W/kg
SAR for nominal Head TSL parameters	normalized to 1W	<b>9.14 W/kg <math>\pm</math> 17.0 % (k=2)</b>

<b>SAR averaged over 10 cm<sup>3</sup> (10 g) of Head TSL</b>	condition	
SAR measured	250 mW input power	1.52 W/kg
SAR for nominal Head TSL parameters	normalized to 1W	<b>5.97 W/kg <math>\pm</math> 16.5 % (k=2)</b>

## Body TSL parameters

The following parameters and calculations were applied.

	Temperature	Permittivity	Conductivity
<b>Nominal Body TSL parameters</b>	22.0 °C	55.2	0.97 mho/m
<b>Measured Body TSL parameters</b>	(22.0 $\pm$ 0.2) °C	54.5 $\pm$ 6 %	1.01 mho/m $\pm$ 6 %
<b>Body TSL temperature change during test</b>	< 0.5 °C	----	----

## SAR result with Body TSL

<b>SAR averaged over 1 cm<sup>3</sup> (1 g) of Body TSL</b>	Condition	
SAR measured	250 mW input power	2.46 W/kg
SAR for nominal Body TSL parameters	normalized to 1W	<b>9.52 W/kg <math>\pm</math> 17.0 % (k=2)</b>

<b>SAR averaged over 10 cm<sup>3</sup> (10 g) of Body TSL</b>	condition	
SAR measured	250 mW input power	1.61 W/kg
SAR for nominal Body TSL parameters	normalized to 1W	<b>6.28 W/kg <math>\pm</math> 16.5 % (k=2)</b>

## Appendix (Additional assessments outside the scope of SCS 0108)

### Antenna Parameters with Head TSL

Impedance, transformed to feed point	53.1 $\Omega$ - 3.2 j $\Omega$
Return Loss	- 27.3 dB

### Antenna Parameters with Body TSL

Impedance, transformed to feed point	49.0 $\Omega$ - 5.3 j $\Omega$
Return Loss	- 25.3 dB

### General Antenna Parameters and Design

Electrical Delay (one direction)	1.390 ns
----------------------------------	----------

After long term use with 100W radiated power, only a slight warming of the dipole near the feedpoint can be measured.

The dipole is made of standard semirigid coaxial cable. The center conductor of the feeding line is directly connected to the second arm of the dipole. The antenna is therefore short-circuited for DC-signals. On some of the dipoles, small end caps are added to the dipole arms in order to improve matching when loaded according to the position as explained in the "Measurement Conditions" paragraph. The SAR data are not affected by this change. The overall dipole length is still according to the Standard.

No excessive force must be applied to the dipole arms, because they might bend or the soldered connections near the feedpoint may be damaged.

### Additional EUT Data

Manufactured by	SPEAG
Manufactured on	July 10, 2003

## DASY5 Validation Report for Head TSL

Date: 21.03.2016

Test Laboratory: SPEAG, Zurich, Switzerland

**DUT: Dipole 835 MHz; Type: D835V2; Serial: D835V2 - SN: 499**

Communication System: UID 0 - CW; Frequency: 835 MHz

Medium parameters used:  $f = 835$  MHz;  $\sigma = 0.93$  S/m;  $\epsilon_r = 41.7$ ;  $\rho = 1000$  kg/m<sup>3</sup>

Phantom section: Flat Section

Measurement Standard: DASY5 (IEEE/IEC/ANSI C63.19-2011)

DASY52 Configuration:

- Probe: EX3DV4 - SN7349; ConvF(9.83, 9.83, 9.83); Calibrated: 31.12.2015;
- Sensor-Surface: 1.4mm (Mechanical Surface Detection)
- Electronics: DAE4 Sn601; Calibrated: 30.12.2015
- Phantom: Flat Phantom 4.9L; Type: QD000P49AA; Serial: 1001
- DASY52 52.8.8(1258); SEMCAD X 14.6.10(7372)

### Dipole Calibration for Head Tissue EX-Probe/Pin=250 mW, d=15mm/Zoom Scan

(7x7x7)/Cube 0: Measurement grid: dx=5mm, dy=5mm, dz=5mm

Reference Value = 60.98 V/m; Power Drift = 0.01 dB

Peak SAR (extrapolated) = 3.47 W/kg

**SAR(1 g) = 2.34 W/kg; SAR(10 g) = 1.52 W/kg**

Maximum value of SAR (measured) = 3.09 W/kg

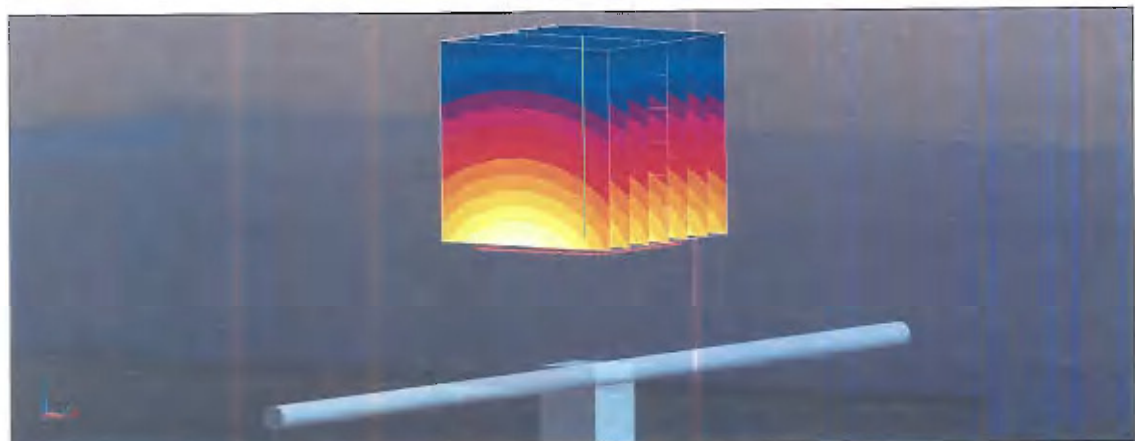
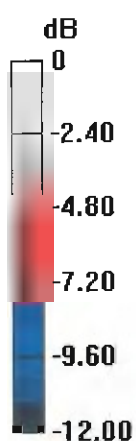

0 dB = 3.09 W/kg = 4.90 dBW/kg



# Impedance Measurement Plot for Head TSL

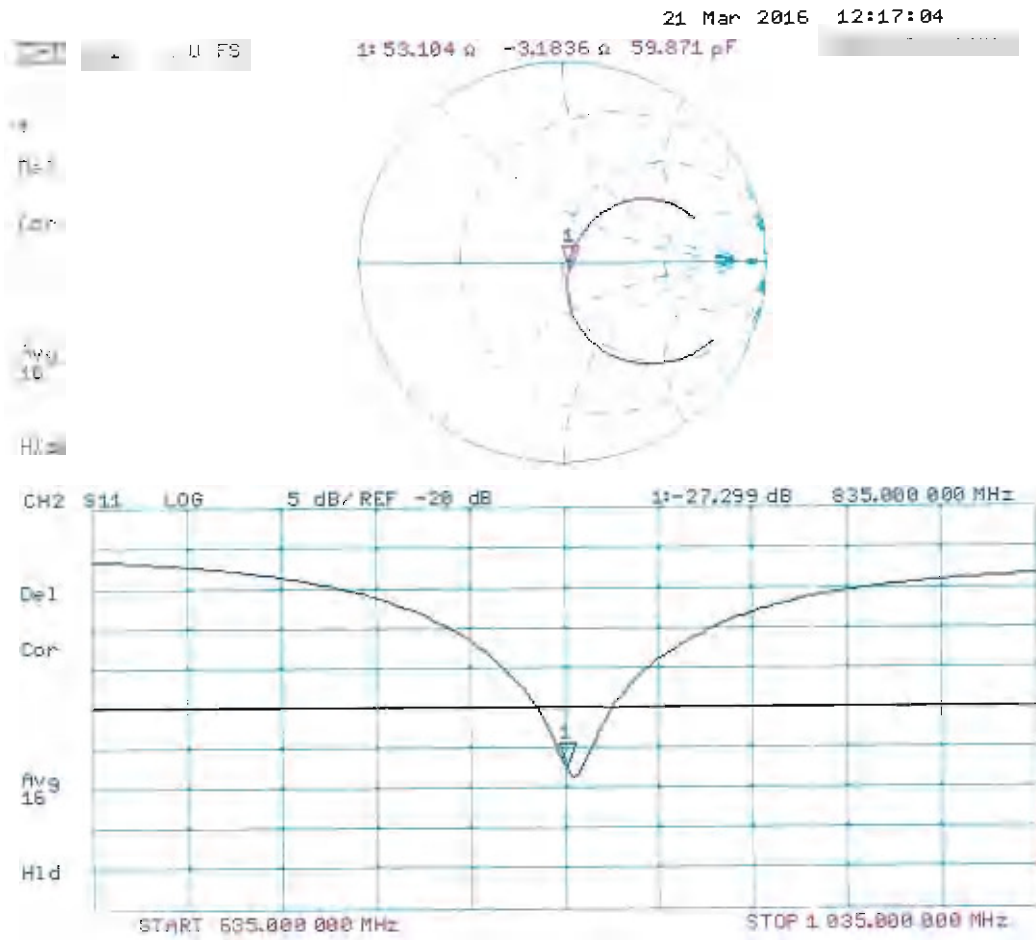

## DASY5 Validation Report for Body TSL

Date: 21.03.2016

Test Laboratory: SPEAG, Zurich, Switzerland

**DUT: Dipole 835 MHz; Type: D835V2; Serial: D835V2 - SN: 499**

Communication System: UID 0 - CW; Frequency: 835 MHz

Medium parameters used:  $f = 835$  MHz;  $\sigma = 1.01$  S/m;  $\epsilon_r = 54.5$ ;  $\rho = 1000$  kg/m<sup>3</sup>

Phantom section: Flat Section

Measurement Standard: DASY5 (IEEE/IEC/ANSI C63.19-2011)

DASY52 Configuration:

- Probe: EX3DV4 - SN7349; ConvF(9.73, 9.73, 9.73); Calibrated: 31.12.2015;
- Sensor-Surface: 1.4mm (Mechanical Surface Detection)
- Electronics: DAE4 Sn601; Calibrated: 30.12.2015
- Phantom: Flat Phantom 4.9L; Type: QD000P49AA; Serial: 1001
- DASY52 52.8.8(1258); SEMCAD X 14.6.10(7372)

### Dipole Calibration for Body Tissue EX-Probe/Pin=250 mW, d=15mm/Zoom Scan

(7x7x7)/Cube 0: Measurement grid: dx=5mm, dy=5mm, dz=5mm

Reference Value = 60.24 V/m; Power Drift = -0.04 dB

Peak SAR (extrapolated) = 3.63 W/kg

**SAR(1 g) = 2.46 W/kg; SAR(10 g) = 1.61 W/kg**

Maximum value of SAR (measured) = 3.26 W/kg

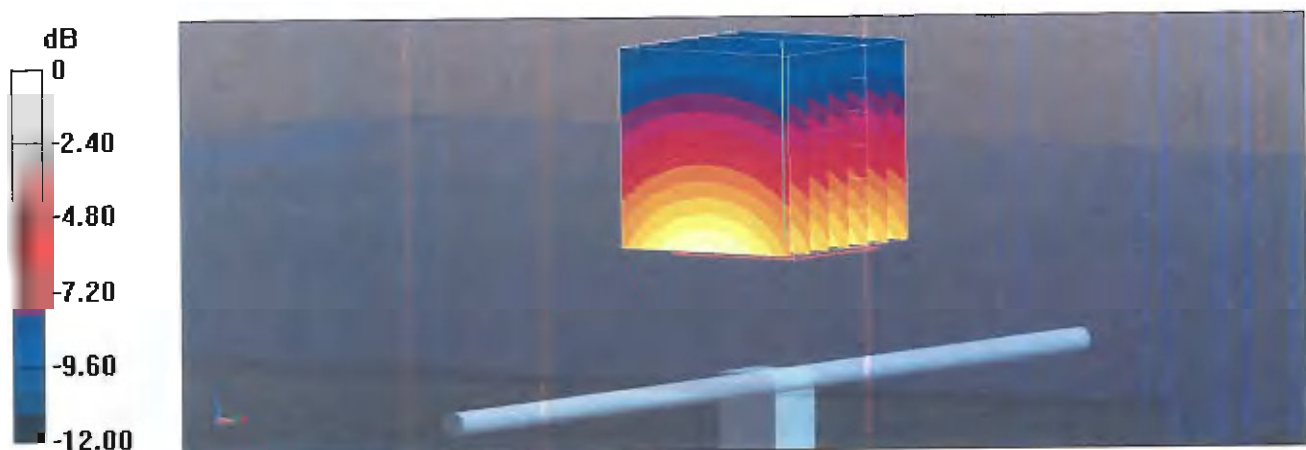

0 dB = 3.26 W/kg = 5.13 dBW/kg

# Impedance Measurement Plot for Body TSL

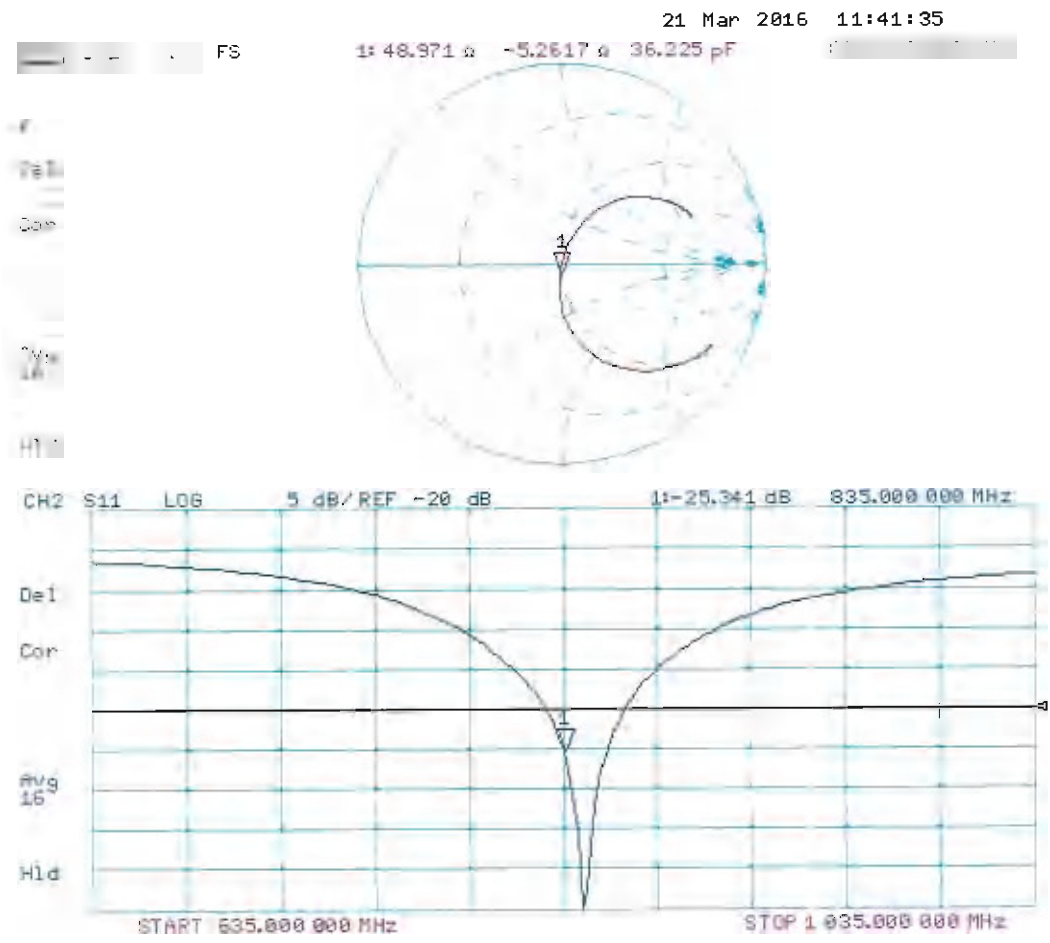



Accredited by the Swiss Accreditation Service (SAS)  
The Swiss Accreditation Service is one of the signatories to the EA  
Multilateral Agreement for the recognition of calibration certificates

Accreditation No.: **SCS 0108**

Client **Sporton-TW (Auden)**

Certificate No: **D1750V2-1068\_Nov15**

## CALIBRATION CERTIFICATE

Object **D1750V2 - SN: 1068**

Calibration procedure(s) **QA CAL-05.v9  
Calibration procedure for dipole validation kits above 700 MHz**

Calibration date: **November 23, 2015**

This calibration certificate documents the traceability to national standards, which realize the physical units of measurements (SI).  
The measurements and the uncertainties with confidence probability are given on the following pages and are part of the certificate.

All calibrations have been conducted in the closed laboratory facility: environment temperature (22 ± 3)°C and humidity < 70%.

Calibration Equipment used (M&TE critical for calibration)

Primary Standards	ID #	Cal Date (Certificate No.)	Scheduled Calibration
Power meter EPM-442A	GB37480704	07-Oct-15 (No. 217-02222)	Oct-16
Power sensor HP 8481A	US37292783	07-Oct-15 (No. 217-02222)	Oct-16
Power sensor HP 8481A	MY41092317	07-Oct-15 (No. 217-02223)	Oct-16
Reference 20 dB Attenuator	SN: 5058 (20k)	01-Apr-15 (No. 217-02131)	Mar-16
Type-N mismatch combination	SN: 5047.2 / 06327	01-Apr-15 (No. 217-02134)	Mar-16
Reference Probe EX3DV4	SN: 7349	30-Dec-14 (No. EX3-7349_Dec14)	Dec-15
DAE4	SN: 601	17-Aug-15 (No. DAE4-601_Aug15)	Aug-16
Secondary Standards	ID #	Check Date (in house)	Scheduled Check
RF generator R&S SMT-06	100972	15-Jun-15 (in house check Jun-15)	In house check: Jun-18
Network Analyzer HP 8753E	US37390585 S4206	18-Oct-01 (in house check Oct-15)	In house check: Oct-16

Calibrated by: **Name** Michael Weber **Function** Laboratory Technician

Approved by: **Name** Katja Pokovic **Function** Technical Manager

**Signature**

Issued: November 24, 2015

This calibration certificate shall not be reproduced except in full without written approval of the laboratory.



Accredited by the Swiss Accreditation Service (SAS)  
The Swiss Accreditation Service is one of the signatories to the EA  
Multilateral Agreement for the recognition of calibration certificates

Accreditation No.: **SCS 0108**

**Glossary:**

TSL	tissue simulating liquid
ConvF	sensitivity in TSL / NORM x,y,z
N/A	not applicable or not measured

**Calibration is Performed According to the Following Standards:**

- a) IEEE Std 1528-2013, "IEEE Recommended Practice for Determining the Peak Spatial-Averaged Specific Absorption Rate (SAR) in the Human Head from Wireless Communications Devices: Measurement Techniques", June 2013
- b) IEC 62209-1, "Procedure to measure the Specific Absorption Rate (SAR) for hand-held devices used in close proximity to the ear (frequency range of 300 MHz to 3 GHz)", February 2005
- c) IEC 62209-2, "Procedure to determine the Specific Absorption Rate (SAR) for wireless communication devices used in close proximity to the human body (frequency range of 30 MHz to 6 GHz)", March 2010
- d) KDB 865664, "SAR Measurement Requirements for 100 MHz to 6 GHz"

**Additional Documentation:**

- e) DASY4/5 System Handbook

**Methods Applied and Interpretation of Parameters:**

- *Measurement Conditions:* Further details are available from the Validation Report at the end of the certificate. All figures stated in the certificate are valid at the frequency indicated.
- *Antenna Parameters with TSL:* The dipole is mounted with the spacer to position its feed point exactly below the center marking of the flat phantom section, with the arms oriented parallel to the body axis.
- *Feed Point Impedance and Return Loss:* These parameters are measured with the dipole positioned under the liquid filled phantom. The impedance stated is transformed from the measurement at the SMA connector to the feed point. The Return Loss ensures low reflected power. No uncertainty required.
- *Electrical Delay:* One-way delay between the SMA connector and the antenna feed point. No uncertainty required.
- *SAR measured:* SAR measured at the stated antenna input power.
- *SAR normalized:* SAR as measured, normalized to an input power of 1 W at the antenna connector.
- *SAR for nominal TSL parameters:* The measured TSL parameters are used to calculate the nominal SAR result.

The reported uncertainty of measurement is stated as the standard uncertainty of measurement multiplied by the coverage factor  $k=2$ , which for a normal distribution corresponds to a coverage probability of approximately 95%.

## Measurement Conditions

DASY system configuration, as far as not given on page 1.

<b>DASY Version</b>	DASY5	V52.8.8
<b>Extrapolation</b>	Advanced Extrapolation	
<b>Phantom</b>	Modular Flat Phantom	
<b>Distance Dipole Center - TSL</b>	10 mm	with Spacer
<b>Zoom Scan Resolution</b>	dx, dy, dz = 5 mm	
<b>Frequency</b>	1750 MHz $\pm$ 1 MHz	

## Head TSL parameters

The following parameters and calculations were applied.

	Temperature	Permittivity	Conductivity
<b>Nominal Head TSL parameters</b>	22.0 °C	40.1	1.37 mho/m
<b>Measured Head TSL parameters</b>	(22.0 $\pm$ 0.2) °C	40.8 $\pm$ 6 %	1.35 mho/m $\pm$ 6 %
<b>Head TSL temperature change during test</b>	< 0.5 °C	----	----

## SAR result with Head TSL

<b>SAR averaged over 1 cm<sup>3</sup> (1 g) of Head TSL</b>	Condition	
SAR measured	250 mW input power	9.07 W/kg
SAR for nominal Head TSL parameters	normalized to 1W	<b>36.8 W/kg <math>\pm</math> 17.0 % (k=2)</b>

<b>SAR averaged over 10 cm<sup>3</sup> (10 g) of Head TSL</b>	condition	
SAR measured	250 mW input power	4.79 W/kg
SAR for nominal Head TSL parameters	normalized to 1W	<b>19.3 W/kg <math>\pm</math> 16.5 % (k=2)</b>

## Body TSL parameters

The following parameters and calculations were applied.

	Temperature	Permittivity	Conductivity
<b>Nominal Body TSL parameters</b>	22.0 °C	53.4	1.49 mho/m
<b>Measured Body TSL parameters</b>	(22.0 $\pm$ 0.2) °C	54.2 $\pm$ 6 %	1.48 mho/m $\pm$ 6 %
<b>Body TSL temperature change during test</b>	< 0.5 °C	----	----

## SAR result with Body TSL

<b>SAR averaged over 1 cm<sup>3</sup> (1 g) of Body TSL</b>	Condition	
SAR measured	250 mW input power	8.85 W/kg
SAR for nominal Body TSL parameters	normalized to 1W	<b>35.7 W/kg <math>\pm</math> 17.0 % (k=2)</b>

<b>SAR averaged over 10 cm<sup>3</sup> (10 g) of Body TSL</b>	condition	
SAR measured	250 mW input power	4.72 W/kg
SAR for nominal Body TSL parameters	normalized to 1W	<b>19.0 W/kg <math>\pm</math> 16.5 % (k=2)</b>

## Appendix (Additional assessments outside the scope of SCS 0108)

### Antenna Parameters with Head TSL

Impedance, transformed to feed point	48.8 $\Omega$ - 1.4 j $\Omega$
Return Loss	- 34.4 dB

### Antenna Parameters with Body TSL

Impedance, transformed to feed point	46.4 $\Omega$ - 1.2 j $\Omega$
Return Loss	- 28.1 dB

### General Antenna Parameters and Design

Electrical Delay (one direction)	1.221 ns
----------------------------------	----------

After long term use with 100W radiated power, only a slight warming of the dipole near the feedpoint can be measured.

The dipole is made of standard semirigid coaxial cable. The center conductor of the feeding line is directly connected to the second arm of the dipole. The antenna is therefore short-circuited for DC-signals. On some of the dipoles, small end caps are added to the dipole arms in order to improve matching when loaded according to the position as explained in the "Measurement Conditions" paragraph. The SAR data are not affected by this change. The overall dipole length is still according to the Standard.

No excessive force must be applied to the dipole arms, because they might bend or the soldered connections near the feedpoint may be damaged.

### Additional EUT Data

Manufactured by	SPEAG
Manufactured on	June 15, 2010

## DASY5 Validation Report for Head TSL

Date: 23.11.2015

Test Laboratory: SPEAG, Zurich, Switzerland

**DUT: Dipole 1750 MHz; Type: D1750V2; Serial: D1750V2 - SN: 1068**

Communication System: UID 0 - CW; Frequency: 1750 MHz

Medium parameters used:  $f = 1750$  MHz;  $\sigma = 1.35$  S/m;  $\epsilon_r = 40.8$ ;  $\rho = 1000$  kg/m<sup>3</sup>

Phantom section: Flat Section

Measurement Standard: DASY5 (IEEE/IEC/ANSI C63.19-2011)

DASY52 Configuration:

- Probe: EX3DV4 - SN7349; ConvF(8.38, 8.38, 8.38); Calibrated: 30.12.2014;
- Sensor-Surface: 1.4mm (Mechanical Surface Detection)
- Electronics: DAE4 Sn601; Calibrated: 17.08.2015
- Phantom: Flat Phantom 5.0 (front); Type: QD000P50AA; Serial: 1001
- DASY52 52.8.8(1222); SEMCAD X 14.6.10(7331)

### Dipole Calibration for Head Tissue/Pin=250 mW, d=10mm/Zoom Scan (7x7x7)/Cube 0:

Measurement grid: dx=5mm, dy=5mm, dz=5mm

Reference Value = 104.3 V/m; Power Drift = 0.03 dB

Peak SAR (extrapolated) = 16.9 W/kg

**SAR(1 g) = 9.07 W/kg; SAR(10 g) = 4.79 W/kg**

Maximum value of SAR (measured) = 13.8 W/kg

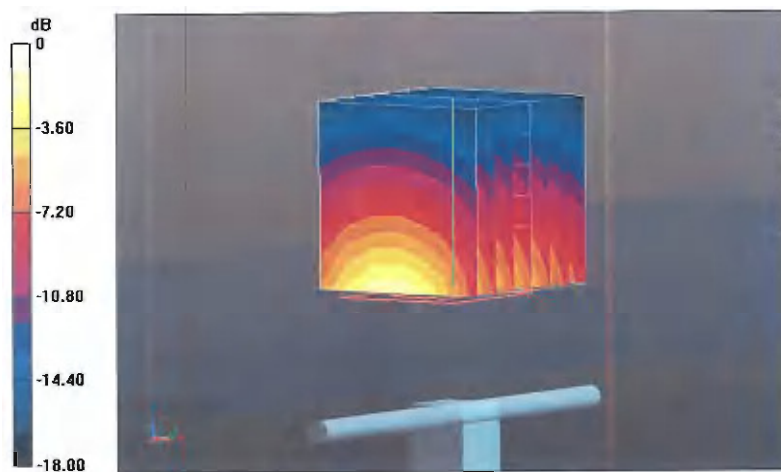

0 dB = 13.8 W/kg = 11.40 dBW/kg



# Impedance Measurement Plot for Head TSL

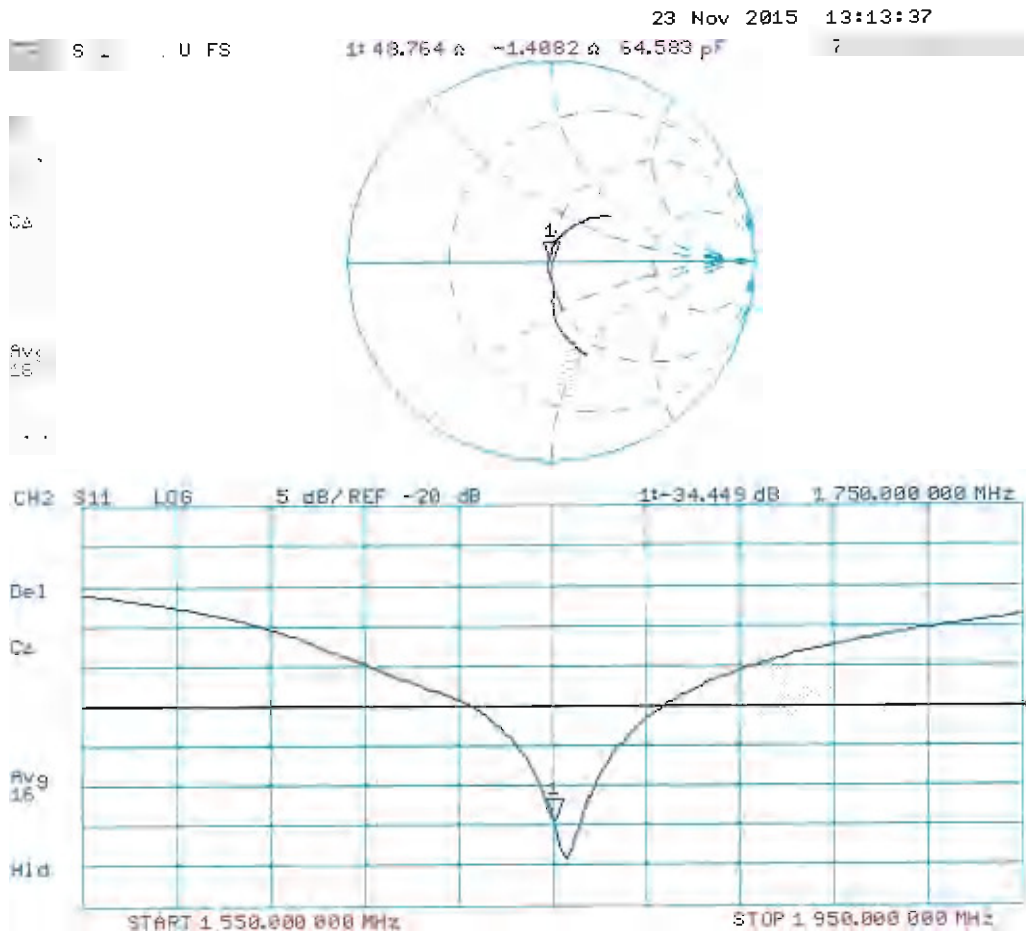

# DASY5 Validation Report for Body TSL

Date: 23.11.2015

Test Laboratory: SPEAG, Zurich, Switzerland

**DUT: Dipole 1750 MHz; Type: D1750V2; Serial: D1750V2 - SN: 1068**

Communication System: UID 0 - CW; Frequency: 1750 MHz

Medium parameters used:  $f = 1750$  MHz;  $\sigma = 1.48$  S/m;  $\epsilon_r = 54.2$ ;  $\rho = 1000$  kg/m<sup>3</sup>

Phantom section: Flat Section

Measurement Standard: DASY5 (IEEE/IEC/ANSI C63.19-2011)

DASY52 Configuration:

- Probe: EX3DV4 - SN7349; ConvF(8.25, 8.25, 8.25); Calibrated: 30.12.2014;
- Sensor-Surface: 1.4mm (Mechanical Surface Detection)
- Electronics: DAE4 Sn601; Calibrated: 17.08.2015
- Phantom: Flat Phantom 5.0 (back); Type: QD000P50AA; Serial: 1002
- DASY52 52.8.8(1222); SEMCAD X 14.6.10(7331)

## Dipole Calibration for Body Tissue/Pin=250 mW, d=10mm/Zoom Scan (7x7x7)/Cube 0:

Measurement grid: dx=5mm, dy=5mm, dz=5mm

Reference Value = 98.87 V/m; Power Drift = -0.01 dB

Peak SAR (extrapolated) = 15.7 W/kg

**SAR(1 g) = 8.85 W/kg; SAR(10 g) = 4.72 W/kg**

Maximum value of SAR (measured) = 13.3 W/kg

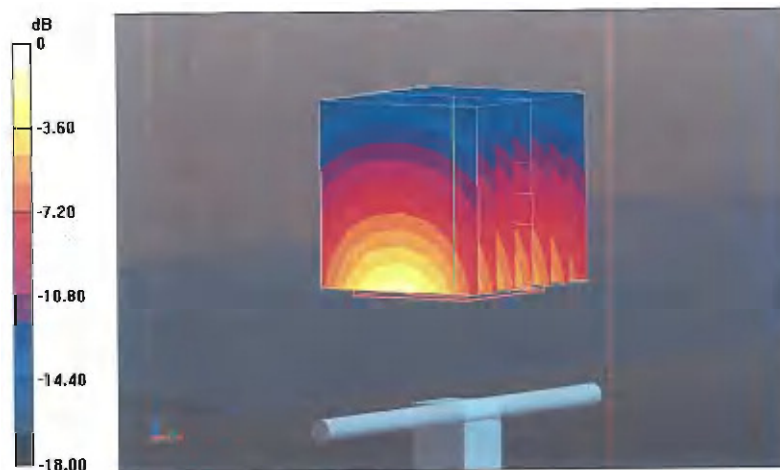

0 dB = 13.3 W/kg = 11.24 dBW/kg

# Impedance Measurement Plot for Body TSL

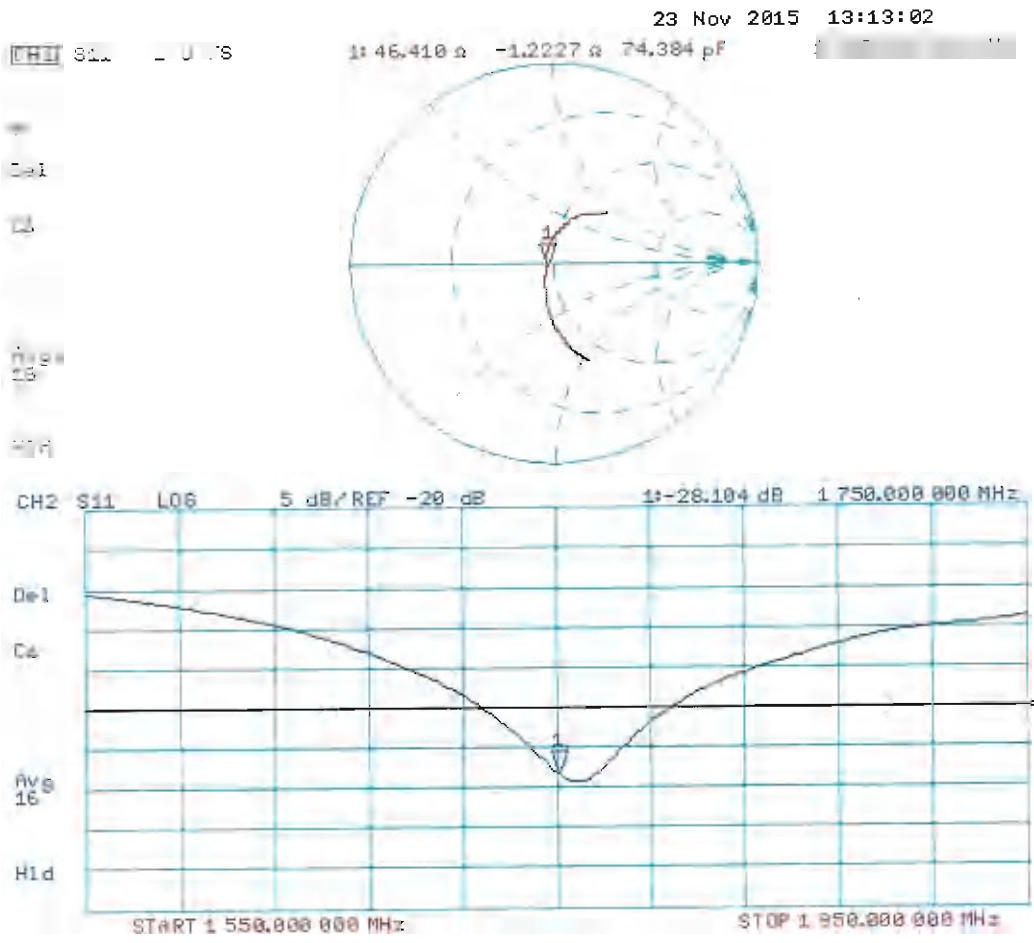



Accredited by the Swiss Accreditation Service (SAS)  
The Swiss Accreditation Service is one of the signatories to the EA  
Multilateral Agreement for the recognition of calibration certificates

Accreditation No.: **SCS 0108**

Client **Sporton-TW (Auden)**

Certificate No: **D1900V2-5d041\_Oct15**

## CALIBRATION CERTIFICATE

Object **D1900V2 - SN: 5d041**

Calibration procedure(s) **QA CAL-05.v9**  
**Calibration procedure for dipole validation kits above 700 MHz**

Calibration date: **October 22, 2015**

This calibration certificate documents the traceability to national standards, which realize the physical units of measurements (SI).  
The measurements and the uncertainties with confidence probability are given on the following pages and are part of the certificate.

All calibrations have been conducted in the closed laboratory facility: environment temperature ( $22 \pm 3$ )°C and humidity < 70%.

Calibration Equipment used (M&TE critical for calibration)

Primary Standards	ID #	Cal Date (Certificate No.)	Scheduled Calibration
Power meter EPM-442A	GB37480704	07-Oct-15 (No. 217-02222)	Oct-16
Power sensor HP 8481A	US37292783	07-Oct-15 (No. 217-02222)	Oct-16
Power sensor HP 8481A	MY41092317	07-Oct-15 (No. 217-02223)	Oct-16
Reference 20 dB Attenuator	SN: 5058 (20k)	01-Apr-15 (No. 217-02131)	Mar-16
Type-N mismatch combination	SN: 5047.2 / 06327	01-Apr-15 (No. 217-02134)	Mar-16
Reference Probe EX3DV4	SN: 7349	30-Dec-14 (No. EX3-7349_Dec14)	Dec-15
DAE4	SN: 601	17-Aug-15 (No. DAE4-601_Aug15)	Aug-16
Secondary Standards	ID #	Check Date (in house)	Scheduled Check
RF generator R&S SMT-06	100972	15-Jun-15 (in house check Jun-15)	In house check: Jun-18
Network Analyzer HP 8753E	US37390585 S4206	18-Oct-01 (in house check Oct-15)	In house check: Oct-16

Calibrated by: **Israe Elnaouq**      Name: **Israe Elnaouq**      Function: **Laboratory Technician**

Approved by: **Katja Pokovic**      Name: **Katja Pokovic**      Function: **Technical Manager**

Signature

Issued: October 22, 2015

This calibration certificate shall not be reproduced except in full without written approval of the laboratory.



Accredited by the Swiss Accreditation Service (SAS)

Accreditation No.: **SCS 0108**

The Swiss Accreditation Service is one of the signatories to the EA  
Multilateral Agreement for the recognition of calibration certificates

### Glossary:

TSL	tissue simulating liquid
ConvF	sensitivity in TSL / NORM x,y,z
N/A	not applicable or not measured

### Calibration is Performed According to the Following Standards:

- IEEE Std 1528-2013, "IEEE Recommended Practice for Determining the Peak Spatial-Averaged Specific Absorption Rate (SAR) in the Human Head from Wireless Communications Devices: Measurement Techniques", June 2013
- IEC 62209-1, "Procedure to measure the Specific Absorption Rate (SAR) for hand-held devices used in close proximity to the ear (frequency range of 300 MHz to 3 GHz)", February 2005
- IEC 62209-2, "Procedure to determine the Specific Absorption Rate (SAR) for wireless communication devices used in close proximity to the human body (frequency range of 30 MHz to 6 GHz)", March 2010
- KDB 865664, "SAR Measurement Requirements for 100 MHz to 6 GHz"

### Additional Documentation:

- DASY4/5 System Handbook

### Methods Applied and Interpretation of Parameters:

- Measurement Conditions:* Further details are available from the Validation Report at the end of the certificate. All figures stated in the certificate are valid at the frequency indicated.
- Antenna Parameters with TSL:* The dipole is mounted with the spacer to position its feed point exactly below the center marking of the flat phantom section, with the arms oriented parallel to the body axis.
- Feed Point Impedance and Return Loss:* These parameters are measured with the dipole positioned under the liquid filled phantom. The impedance stated is transformed from the measurement at the SMA connector to the feed point. The Return Loss ensures low reflected power. No uncertainty required.
- Electrical Delay:* One-way delay between the SMA connector and the antenna feed point. No uncertainty required.
- SAR measured:* SAR measured at the stated antenna input power.
- SAR normalized:* SAR as measured, normalized to an input power of 1 W at the antenna connector.
- SAR for nominal TSL parameters:* The measured TSL parameters are used to calculate the nominal SAR result.

The reported uncertainty of measurement is stated as the standard uncertainty of measurement multiplied by the coverage factor  $k=2$ , which for a normal distribution corresponds to a coverage probability of approximately 95%.

## Measurement Conditions

DASY system configuration, as far as not given on page 1.

<b>DASY Version</b>	DASY5	V52.8.8
<b>Extrapolation</b>	Advanced Extrapolation	
<b>Phantom</b>	Modular Flat Phantom	
<b>Distance Dipole Center - TSL</b>	10 mm	with Spacer
<b>Zoom Scan Resolution</b>	dx, dy, dz = 5 mm	
<b>Frequency</b>	1900 MHz $\pm$ 1 MHz	

## Head TSL parameters

The following parameters and calculations were applied.

	Temperature	Permittivity	Conductivity
<b>Nominal Head TSL parameters</b>	22.0 °C	40.0	1.40 mho/m
<b>Measured Head TSL parameters</b>	(22.0 $\pm$ 0.2) °C	38.9 $\pm$ 6 %	1.38 mho/m $\pm$ 6 %
<b>Head TSL temperature change during test</b>	< 0.5 °C	----	----

## SAR result with Head TSL

<b>SAR averaged over 1 cm<sup>3</sup> (1 g) of Head TSL</b>	Condition	
SAR measured	250 mW input power	9.92 W/kg
SAR for nominal Head TSL parameters	normalized to 1W	<b>39.8 W/kg <math>\pm</math> 17.0 % (k=2)</b>

<b>SAR averaged over 10 cm<sup>3</sup> (10 g) of Head TSL</b>	condition	
SAR measured	250 mW input power	5.19 W/kg
SAR for nominal Head TSL parameters	normalized to 1W	<b>20.8 W/kg <math>\pm</math> 16.5 % (k=2)</b>

## Body TSL parameters

The following parameters and calculations were applied.

	Temperature	Permittivity	Conductivity
<b>Nominal Body TSL parameters</b>	22.0 °C	53.3	1.52 mho/m
<b>Measured Body TSL parameters</b>	(22.0 $\pm$ 0.2) °C	52.3 $\pm$ 6 %	1.51 mho/m $\pm$ 6 %
<b>Body TSL temperature change during test</b>	< 0.5 °C	----	----

## SAR result with Body TSL

<b>SAR averaged over 1 cm<sup>3</sup> (1 g) of Body TSL</b>	Condition	
SAR measured	250 mW input power	10.0 W/kg
SAR for nominal Body TSL parameters	normalized to 1W	<b>40.0 W/kg <math>\pm</math> 17.0 % (k=2)</b>

<b>SAR averaged over 10 cm<sup>3</sup> (10 g) of Body TSL</b>	condition	
SAR measured	250 mW input power	5.30 W/kg
SAR for nominal Body TSL parameters	normalized to 1W	<b>21.2 W/kg <math>\pm</math> 16.5 % (k=2)</b>

## Appendix (Additional assessments outside the scope of SCS 0108)

### Antenna Parameters with Head TSL

Impedance, transformed to feed point	53.0 $\Omega$ + 7.1 j $\Omega$
Return Loss	- 22.5 dB

### Antenna Parameters with Body TSL

Impedance, transformed to feed point	48.8 $\Omega$ + 7.7 j $\Omega$
Return Loss	- 22.1 dB

### General Antenna Parameters and Design

Electrical Delay (one direction)	1.203 ns
----------------------------------	----------

After long term use with 100W radiated power, only a slight warming of the dipole near the feedpoint can be measured.

The dipole is made of standard semirigid coaxial cable. The center conductor of the feeding line is directly connected to the second arm of the dipole. The antenna is therefore short-circuited for DC-signals. On some of the dipoles, small end caps are added to the dipole arms in order to improve matching when loaded according to the position as explained in the "Measurement Conditions" paragraph. The SAR data are not affected by this change. The overall dipole length is still according to the Standard.

No excessive force must be applied to the dipole arms, because they might bend or the soldered connections near the feedpoint may be damaged.

### Additional EUT Data

Manufactured by	SPEAG
Manufactured on	July 04, 2003



## DASY5 Validation Report for Head TSL

Date: 22.10.2015

Test Laboratory: SPEAG, Zurich, Switzerland

**DUT: Dipole 1900 MHz; Type: D1900V2; Serial: D1900V2 - SN: 5d041**

Communication System: UID 0 - CW; Frequency: 1900 MHz

Medium parameters used:  $f = 1900$  MHz;  $\sigma = 1.38$  S/m;  $\epsilon_r = 38.9$ ;  $\rho = 1000$  kg/m<sup>3</sup>

Phantom section: Flat Section

Measurement Standard: DASY5 (IEEE/IEC/ANSI C63.19-2011)

DASY52 Configuration:

- Probe: EX3DV4 - SN7349; ConvF(8.14, 8.14, 8.14); Calibrated: 30.12.2014;
- Sensor-Surface: 1.4mm (Mechanical Surface Detection)
- Electronics: DAE4 Sn601; Calibrated: 17.08.2015
- Phantom: Flat Phantom 5.0 (front); Type: QD000P50AA; Serial: 1001
- DASY52 52.8.8(1222); SEMCAD X 14.6.10(7331)

### Dipole Calibration for Head Tissue/Pin=250 mW, d=10mm/Zoom Scan (7x7x7)/Cube 0:

Measurement grid: dx=5mm, dy=5mm, dz=5mm

Reference Value = 109.2 V/m; Power Drift = 0.04 dB

Peak SAR (extrapolated) = 18.6 W/kg

**SAR(1 g) = 9.92 W/kg; SAR(10 g) = 5.19 W/kg**

Maximum value of SAR (measured) = 15.4 W/kg

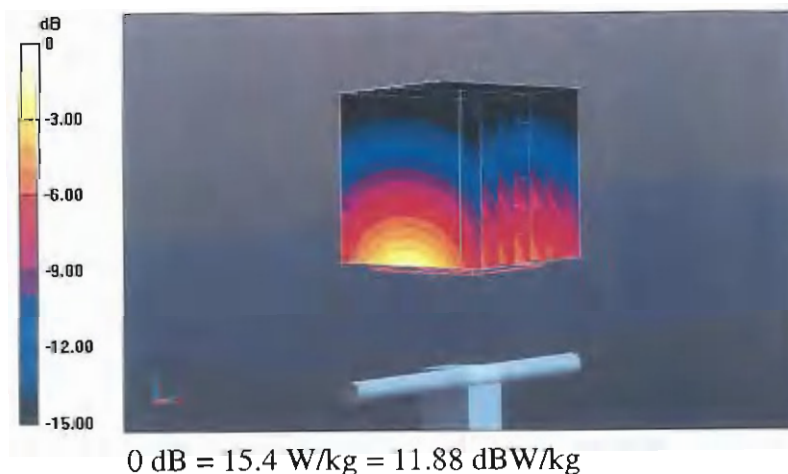



# Impedance Measurement Plot for Head TSL

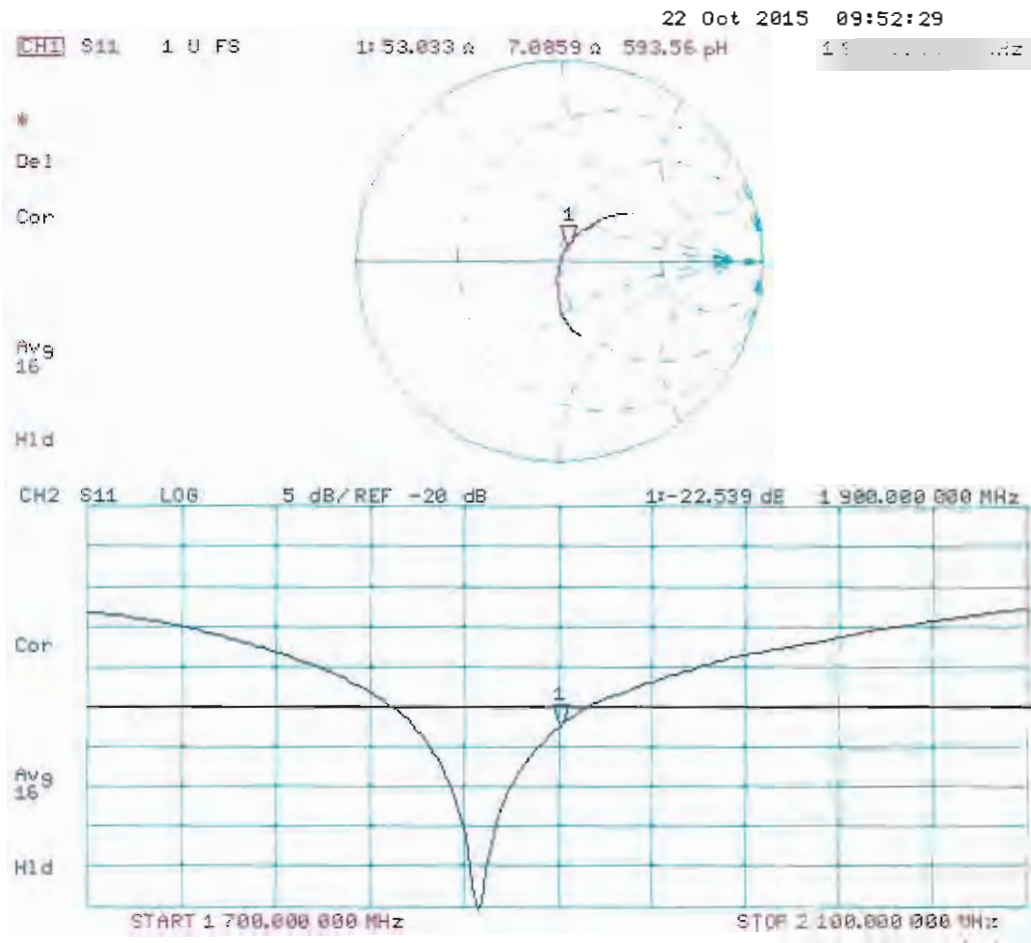

## DASY5 Validation Report for Body TSL

Date: 22.10.2015

Test Laboratory: SPEAG, Zurich, Switzerland

**DUT: Dipole 1900 MHz; Type: D1900V2; Serial: D1900V2 - SN: 5d041**

Communication System: UID 0 - CW; Frequency: 1900 MHz

Medium parameters used:  $f = 1900$  MHz;  $\sigma = 1.51$  S/m;  $\epsilon_r = 52.3$ ;  $\rho = 1000$  kg/m<sup>3</sup>

Phantom section: Flat Section

Measurement Standard: DASY5 (IEEE/IEC/ANSI C63.19-2011)

DASY52 Configuration:

- Probe: EX3DV4 - SN7349; ConvF(7.9, 7.9, 7.9); Calibrated: 30.12.2014;
- Sensor-Surface: 1.4mm (Mechanical Surface Detection)
- Electronics: DAE4 Sn601; Calibrated: 17.08.2015
- Phantom: Flat Phantom 5.0 (back); Type: QD000P50AA; Serial: 1002
- DASY52 52.8.8(1222); SEMCAD X 14.6.10(7331)

### **Dipole Calibration for Body Tissue/Pin=250 mW, d=10mm/Zoom Scan (7x7x7)/Cube 0:**

Measurement grid: dx=5mm, dy=5mm, dz=5mm

Reference Value = 104.2 V/m; Power Drift = 0.02 dB

Peak SAR (extrapolated) = 17.9 W/kg

**SAR(1 g) = 10 W/kg; SAR(10 g) = 5.3 W/kg**

Maximum value of SAR (measured) = 15.2 W/kg

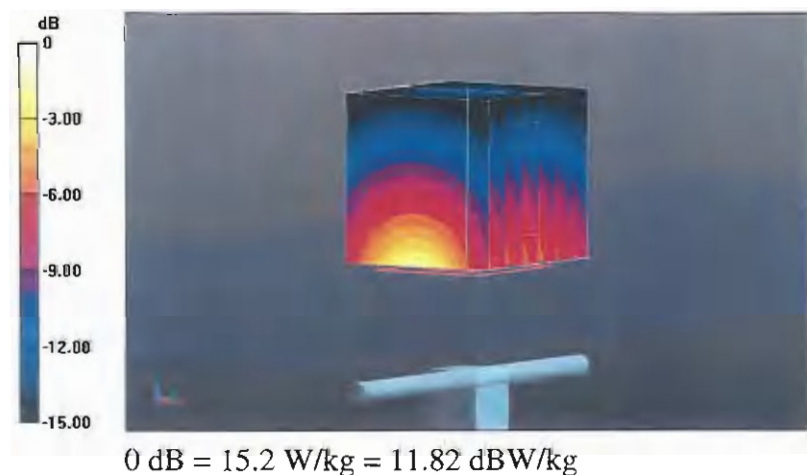

# Impedance Measurement Plot for Body TSL

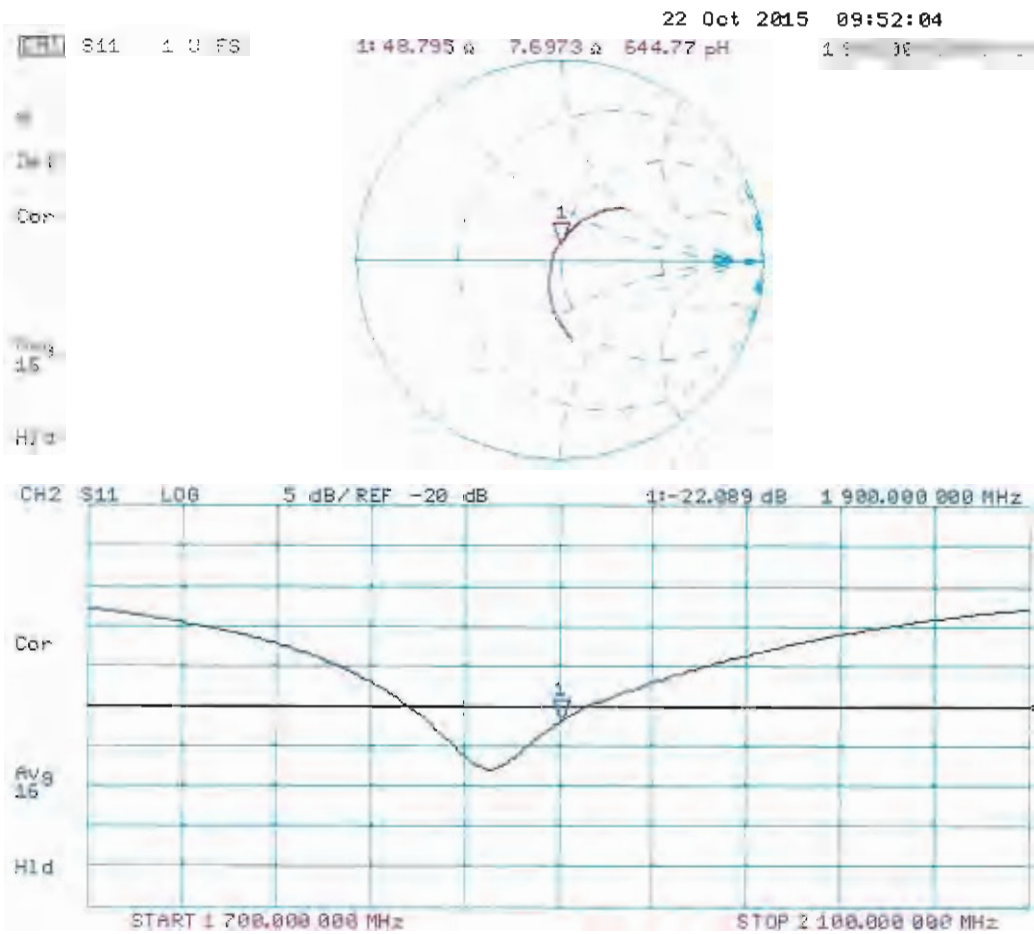



Accredited by the Swiss Accreditation Service (SAS)  
The Swiss Accreditation Service is one of the signatories to the EA  
Multilateral Agreement for the recognition of calibration certificates

Accreditation No.: **SCS 0108**

Client **Sporton-TW (Auden)**

Certificate No: **D2450V2-736\_Aug15**

## CALIBRATION CERTIFICATE

Object **D2450V2 - SN: 736**

Calibration procedure(s) **QA CAL-05.v9  
Calibration procedure for dipole validation kits above 700 MHz**

Calibration date: **August 20, 2015**

This calibration certificate documents the traceability to national standards, which realize the physical units of measurements (SI).  
The measurements and the uncertainties with confidence probability are given on the following pages and are part of the certificate.

All calibrations have been conducted in the closed laboratory facility: environment temperature ( $22 \pm 3$ )°C and humidity < 70%.

Calibration Equipment used (M&TE critical for calibration)

Primary Standards	ID #	Cal Date (Certificate No.)	Scheduled Calibration
Power meter EPM-442A	GB37480704	07-Oct-14 (No. 217-02020)	Oct-15
Power sensor HP 8481A	US37292783	07-Oct-14 (No. 217-02020)	Oct-15
Power sensor HP 8481A	MY41092317	07-Oct-14 (No. 217-02021)	Oct-15
Reference 20 dB Attenuator	SN: 5058 (20k)	01-Apr-15 (No. 217-02131)	Mar-16
Type-N mismatch combination	SN: 5047.2 / 06327	01-Apr-15 (No. 217-02134)	Mar-16
Reference Probe ES3DV3	SN: 3205	30-Dec-14 (No. ES3-3205_Dec14)	Dec-15
DAE4	SN: 601	17-Aug-15 (No. DAE4-601_Aug15)	Aug-16

Secondary Standards	ID #	Check Date (in house)	Scheduled Check
RF generator R&S SMT-06	100005	04-Aug-99 (in house check Oct-13)	In house check: Oct-16
Network Analyzer HP 8753E	US37390585 S4206	18-Oct-01 (in house check Oct-14)	In house check: Oct-15

Calibrated by: **Michael Weber**      Name: Michael Weber      Function: Laboratory Technician

Approved by: **Katja Pokovic**      Name: Katja Pokovic      Function: Technical Manager

Signature

Issued: August 21, 2015

This calibration certificate shall not be reproduced except in full without written approval of the laboratory.



Accredited by the Swiss Accreditation Service (SAS)

The Swiss Accreditation Service is one of the signatories to the EA  
Multilateral Agreement for the recognition of calibration certificates

Accreditation No.: **SCS 0108**

### Glossary:

TSL	tissue simulating liquid
ConvF	sensitivity in TSL / NORM x,y,z
N/A	not applicable or not measured

### Calibration is Performed According to the Following Standards:

- IEEE Std 1528-2013, "IEEE Recommended Practice for Determining the Peak Spatial-Averaged Specific Absorption Rate (SAR) in the Human Head from Wireless Communications Devices: Measurement Techniques", June 2013
- IEC 62209-1, "Procedure to measure the Specific Absorption Rate (SAR) for hand-held devices used in close proximity to the ear (frequency range of 300 MHz to 3 GHz)", February 2005
- IEC 62209-2, "Procedure to determine the Specific Absorption Rate (SAR) for wireless communication devices used in close proximity to the human body (frequency range of 30 MHz to 6 GHz)", March 2010
- KDB 865664, "SAR Measurement Requirements for 100 MHz to 6 GHz"

### Additional Documentation:

- DASY4/5 System Handbook

### Methods Applied and Interpretation of Parameters:

- Measurement Conditions:** Further details are available from the Validation Report at the end of the certificate. All figures stated in the certificate are valid at the frequency indicated.
- Antenna Parameters with TSL:** The dipole is mounted with the spacer to position its feed point exactly below the center marking of the flat phantom section, with the arms oriented parallel to the body axis.
- Feed Point Impedance and Return Loss:** These parameters are measured with the dipole positioned under the liquid filled phantom. The impedance stated is transformed from the measurement at the SMA connector to the feed point. The Return Loss ensures low reflected power. No uncertainty required.
- Electrical Delay:** One-way delay between the SMA connector and the antenna feed point. No uncertainty required.
- SAR measured:** SAR measured at the stated antenna input power.
- SAR normalized:** SAR as measured, normalized to an input power of 1 W at the antenna connector.
- SAR for nominal TSL parameters:** The measured TSL parameters are used to calculate the nominal SAR result.

The reported uncertainty of measurement is stated as the standard uncertainty of measurement multiplied by the coverage factor  $k=2$ , which for a normal distribution corresponds to a coverage probability of approximately 95%.

## Measurement Conditions

DASY system configuration, as far as not given on page 1.

<b>DASY Version</b>	DASY5	V52.8.8
<b>Extrapolation</b>	Advanced Extrapolation	
<b>Phantom</b>	Modular Flat Phantom	
<b>Distance Dipole Center - TSL</b>	10 mm	with Spacer
<b>Zoom Scan Resolution</b>	dx, dy, dz = 5 mm	
<b>Frequency</b>	2450 MHz $\pm$ 1 MHz	

## Head TSL parameters

The following parameters and calculations were applied.

	Temperature	Permittivity	Conductivity
<b>Nominal Head TSL parameters</b>	22.0 °C	39.2	1.80 mho/m
<b>Measured Head TSL parameters</b>	(22.0 $\pm$ 0.2) °C	39.2 $\pm$ 6 %	1.87 mho/m $\pm$ 6 %
<b>Head TSL temperature change during test</b>	< 0.5 °C	----	----

## SAR result with Head TSL

<b>SAR averaged over 1 cm<sup>3</sup> (1 g) of Head TSL</b>	Condition	
SAR measured	250 mW input power	13.6 W/kg
SAR for nominal Head TSL parameters	normalized to 1W	<b>53.4 W/kg <math>\pm</math> 17.0 % (k=2)</b>

<b>SAR averaged over 10 cm<sup>3</sup> (10 g) of Head TSL</b>	condition	
SAR measured	250 mW input power	6.35 W/kg
SAR for nominal Head TSL parameters	normalized to 1W	<b>25.2 W/kg <math>\pm</math> 16.5 % (k=2)</b>

## Body TSL parameters

The following parameters and calculations were applied.

	Temperature	Permittivity	Conductivity
<b>Nominal Body TSL parameters</b>	22.0 °C	52.7	1.95 mho/m
<b>Measured Body TSL parameters</b>	(22.0 $\pm$ 0.2) °C	53.2 $\pm$ 6 %	2.00 mho/m $\pm$ 6 %
<b>Body TSL temperature change during test</b>	< 0.5 °C	----	----

## SAR result with Body TSL

<b>SAR averaged over 1 cm<sup>3</sup> (1 g) of Body TSL</b>	Condition	
SAR measured	250 mW input power	13.1 W/kg
SAR for nominal Body TSL parameters	normalized to 1W	<b>51.9 W/kg <math>\pm</math> 17.0 % (k=2)</b>

<b>SAR averaged over 10 cm<sup>3</sup> (10 g) of Body TSL</b>	condition	
SAR measured	250 mW input power	6.08 W/kg
SAR for nominal Body TSL parameters	normalized to 1W	<b>24.2 W/kg <math>\pm</math> 16.5 % (k=2)</b>



## Appendix (Additional assessments outside the scope of SCS 0108)

### Antenna Parameters with Head TSL

Impedance, transformed to feed point	54.1 $\Omega$ + 2.3 j $\Omega$
Return Loss	- 27.0 dB

### Antenna Parameters with Body TSL

Impedance, transformed to feed point	49.6 $\Omega$ + 3.8 j $\Omega$
Return Loss	- 28.3 dB

### General Antenna Parameters and Design

Electrical Delay (one direction)	1.158 ns
----------------------------------	----------

After long term use with 100W radiated power, only a slight warming of the dipole near the feedpoint can be measured.

The dipole is made of standard semirigid coaxial cable. The center conductor of the feeding line is directly connected to the second arm of the dipole. The antenna is therefore short-circuited for DC-signals. On some of the dipoles, small end caps are added to the dipole arms in order to improve matching when loaded according to the position as explained in the "Measurement Conditions" paragraph. The SAR data are not affected by this change. The overall dipole length is still according to the Standard.

No excessive force must be applied to the dipole arms, because they might bend or the soldered connections near the feedpoint may be damaged.

### Additional EUT Data

Manufactured by	SPEAG
Manufactured on	August 26, 2003

## DASY5 Validation Report for Head TSL

Date: 20.08.2015

Test Laboratory: SPEAG, Zurich, Switzerland

**DUT: Dipole 2450 MHz; Type: D2450V2; Serial: D2450V2 - SN: 736**

Communication System: UID 0 - CW; Frequency: 2450 MHz

Medium parameters used:  $f = 2450$  MHz;  $\sigma = 1.87$  S/m;  $\epsilon_r = 39.2$ ;  $\rho = 1000$  kg/m<sup>3</sup>

Phantom section: Flat Section

Measurement Standard: DASY5 (IEEE/IEC/ANSI C63.19-2011)

DASY52 Configuration:

- Probe: ES3DV3 - SN3205; ConvF(4.54, 4.54, 4.54); Calibrated: 30.12.2014;
- Sensor-Surface: 3mm (Mechanical Surface Detection)
- Electronics: DAE4 Sn601; Calibrated: 17.08.2015
- Phantom: Flat Phantom 5.0 (front); Type: QD000P50AA; Serial: 1001
- DASY52 52.8.8(1222); SEMCAD X 14.6.10(7331)

### Dipole Calibration for Head Tissue/Pin=250 mW, d=10mm/Zoom Scan (7x7x7)/Cube 0:

Measurement grid: dx=5mm, dy=5mm, dz=5mm

Reference Value = 101.5 V/m; Power Drift = -0.00 dB

Peak SAR (extrapolated) = 27.7 W/kg

**SAR(1 g) = 13.6 W/kg; SAR(10 g) = 6.35 W/kg**

Maximum value of SAR (measured) = 18.0 W/kg

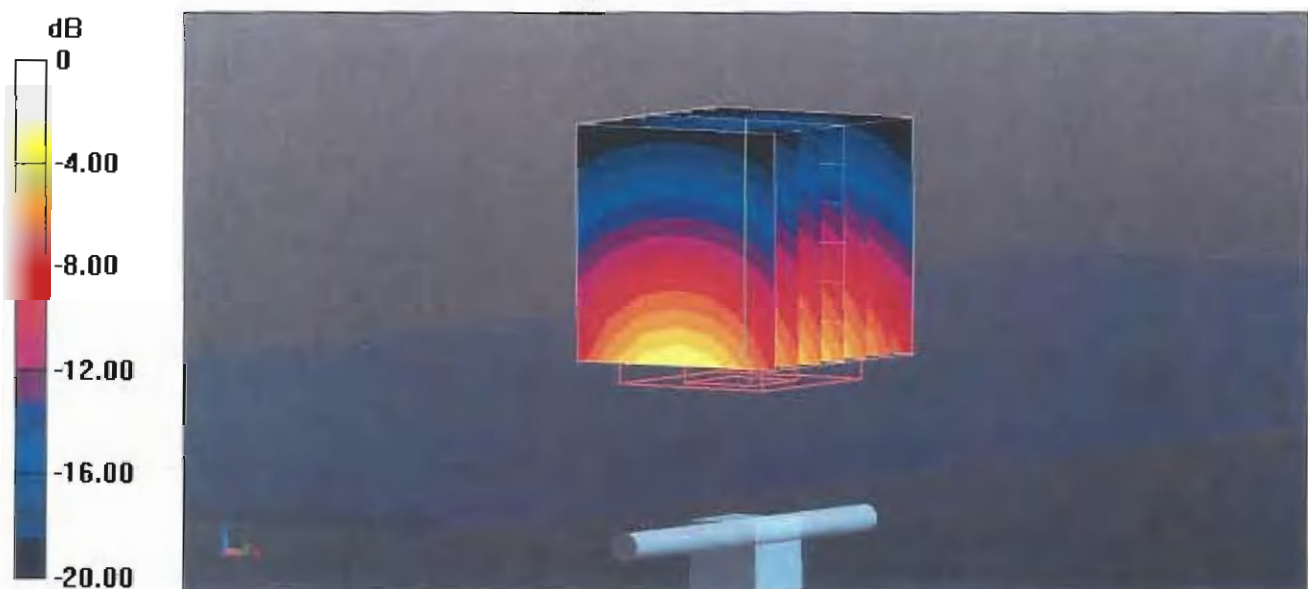



# Impedance Measurement Plot for Head TSL

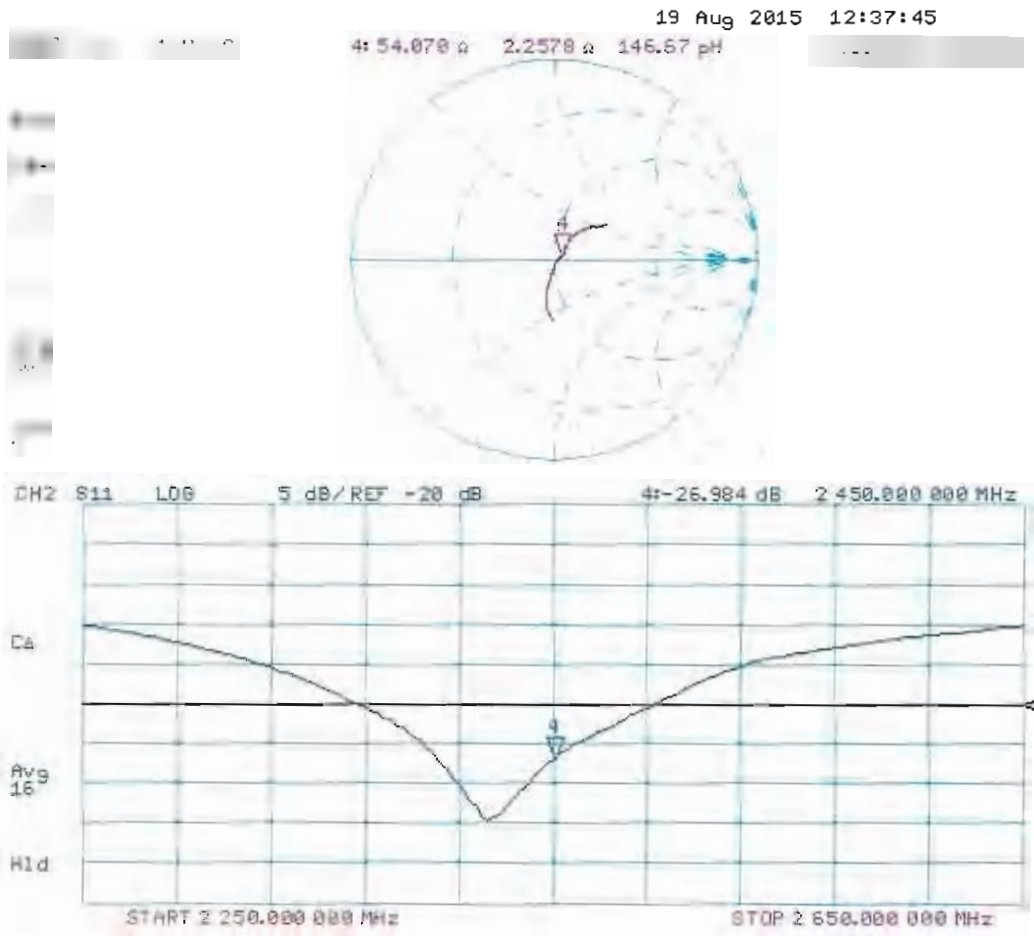

## DASY5 Validation Report for Body TSL

Date: 19.08.2015

Test Laboratory: SPEAG, Zurich, Switzerland

**DUT: Dipole 2450 MHz; Type: D2450V2; Serial: D2450V2 - SN: 736**

Communication System: UID 0 - CW; Frequency: 2450 MHz

Medium parameters used:  $f = 2450$  MHz;  $\sigma = 2$  S/m;  $\epsilon_r = 53.2$ ;  $\rho = 1000$  kg/m<sup>3</sup>

Phantom section: Flat Section

Measurement Standard: DASY5 (IEEE/IEC/ANSI C63.19-2011)

DASY52 Configuration:

- Probe: ES3DV3 - SN3205; ConvF(4.32, 4.32, 4.32); Calibrated: 30.12.2014;
- Sensor-Surface: 3mm (Mechanical Surface Detection)
- Electronics: DAE4 Sn601; Calibrated: 17.08.2015
- Phantom: Flat Phantom 5.0 (back); Type: QD000P50AA; Serial: 1002
- DASY52 52.8.8(1222); SEMCAD X 14.6.10(7331)

### Dipole Calibration for Body Tissue/ $P_{in}=250$ mW, $d=10$ mm/Zoom Scan (7x7x7)/Cube 0:

Measurement grid:  $dx=5$ mm,  $dy=5$ mm,  $dz=5$ mm

Reference Value = 95.81 V/m; Power Drift = 0.00 dB

Peak SAR (extrapolated) = 26.8 W/kg

**SAR(1 g) = 13.1 W/kg; SAR(10 g) = 6.08 W/kg**

Maximum value of SAR (measured) = 17.3 W/kg

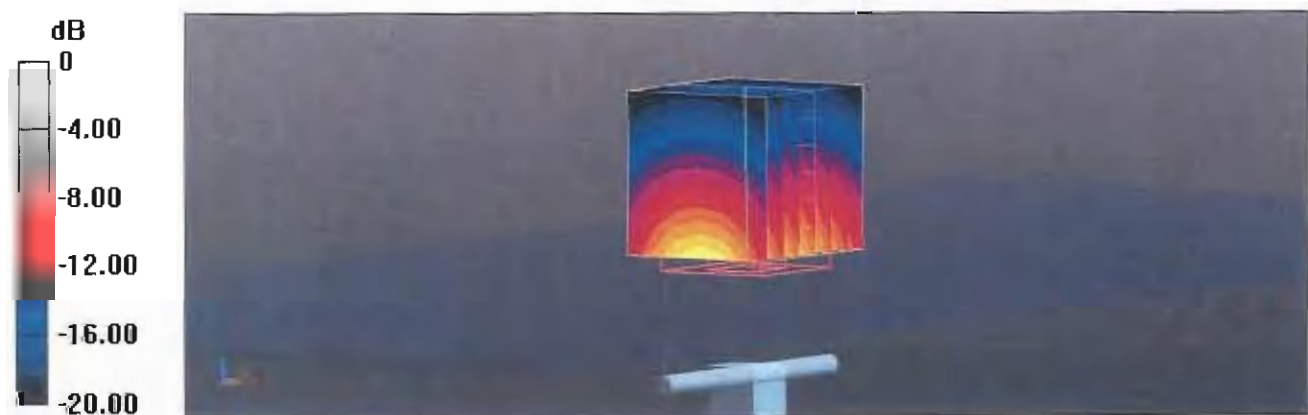

# Impedance Measurement Plot for Body TSL

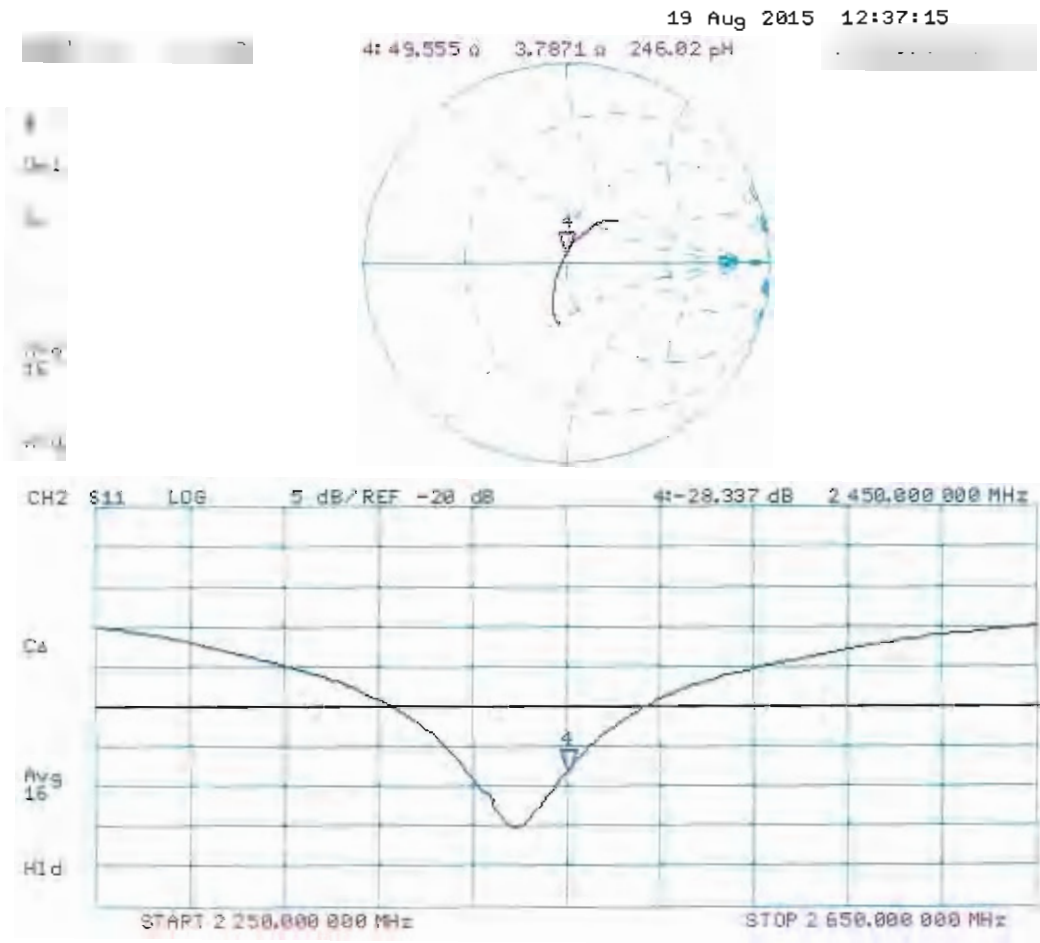



Accredited by the Swiss Accreditation Service (SAS)  
The Swiss Accreditation Service is one of the signatories to the EA  
Multilateral Agreement for the recognition of calibration certificates

Accreditation No.: **SCS 0108**

Client **Sporton-TW (Auden)**

Certificate No: **D5GHzV2-1128\_Jul15**

## CALIBRATION CERTIFICATE

Object **D5GHzV2 - SN: 1128**

Calibration procedure(s) **QA CAL-22.v2  
Calibration procedure for dipole validation kits between 3-6 GHz**

Calibration date: **July 20, 2015**

This calibration certificate documents the traceability to national standards, which realize the physical units of measurements (SI).  
The measurements and the uncertainties with confidence probability are given on the following pages and are part of the certificate.

All calibrations have been conducted in the closed laboratory facility: environment temperature ( $22 \pm 3$ )°C and humidity < 70%.

Calibration Equipment used (M&TE critical for calibration)

Primary Standards	ID #	Cal Date (Certificate No.)	Scheduled Calibration
Power meter EPM-442A	GB37480704	07-Oct-14 (No. 217-02020)	Oct-15
Power sensor HP 8481A	US37292783	07-Oct-14 (No. 217-02020)	Oct-15
Power sensor HP 8481A	MY41092317	07-Oct-14 (No. 217-02021)	Oct-15
Reference 20 dB Attenuator	SN: 5058 (20k)	01-Apr-15 (No. 217-02131)	Mar-16
Type-N mismatch combination	SN: 5047.2 / 06327	01-Apr-15 (No. 217-02134)	Mar-16
Reference Probe EX3DV4	SN: 3503	30-Dec-14 (No. EX3-3503_Dec14)	Dec-15
DAE4	SN: 601	18-Aug-14 (No. DAE4-601_Aug14)	Aug-15

Secondary Standards	ID #	Check Date (in house)	Scheduled Check
RF generator R&S SMT-06	100005	04-Aug-99 (in house check Oct-13)	In house check: Oct-16
Network Analyzer HP 8753E	US37390585 S4206	18-Oct-01 (in house check Oct-14)	In house check: Oct-15

Calibrated by: **Michael Weber**      Function: **Laboratory Technician**

Signature

Approved by: **Katja Pokovic**      Technical Manager

Issued: July 21, 2015

This calibration certificate shall not be reproduced except in full without written approval of the laboratory.



Accredited by the Swiss Accreditation Service (SAS)

The Swiss Accreditation Service is one of the signatories to the EA Multilateral Agreement for the recognition of calibration certificates

Accreditation No.: **SCS 0108**

### Glossary:

TSL	tissue simulating liquid
ConvF	sensitivity in TSL / NORM x,y,z
N/A	not applicable or not measured

### Calibration is Performed According to the Following Standards:

- IEEE Std 1528-2013, "IEEE Recommended Practice for Determining the Peak Spatial-Averaged Specific Absorption Rate (SAR) in the Human Head from Wireless Communications Devices: Measurement Techniques", June 2013
- IEC 62209-2, "Procedure to determine the Specific Absorption Rate (SAR) for wireless communication devices used in close proximity to the human body (frequency range of 30 MHz to 6 GHz)", March 2010
- KDB 865664, "SAR Measurement Requirements for 100 MHz to 6 GHz"

### Additional Documentation:

- DASY4/5 System Handbook

### Methods Applied and Interpretation of Parameters:

- Measurement Conditions:** Further details are available from the Validation Report at the end of the certificate. All figures stated in the certificate are valid at the frequency indicated.
- Antenna Parameters with TSL:** The dipole is mounted with the spacer to position its feed point exactly below the center marking of the flat phantom section, with the arms oriented parallel to the body axis.
- Feed Point Impedance and Return Loss:** These parameters are measured with the dipole positioned under the liquid filled phantom. The impedance stated is transformed from the measurement at the SMA connector to the feed point. The Return Loss ensures low reflected power. No uncertainty required.
- Electrical Delay:** One-way delay between the SMA connector and the antenna feed point. No uncertainty required.
- SAR measured:** SAR measured at the stated antenna input power.
- SAR normalized:** SAR as measured, normalized to an input power of 1 W at the antenna connector.
- SAR for nominal TSL parameters:** The measured TSL parameters are used to calculate the nominal SAR result.

The reported uncertainty of measurement is stated as the standard uncertainty of measurement multiplied by the coverage factor  $k=2$ , which for a normal distribution corresponds to a coverage probability of approximately 95%.

## Measurement Conditions

DASY system configuration, as far as not given on page 1.

<b>DASY Version</b>	DASY5	V52.8.8
<b>Extrapolation</b>	Advanced Extrapolation	
<b>Phantom</b>	Modular Flat Phantom V5.0	
<b>Distance Dipole Center - TSL</b>	10 mm	with Spacer
<b>Zoom Scan Resolution</b>	dx, dy = 4.0 mm, dz = 1.4 mm	Graded Ratio = 1.4 (Z direction)
<b>Frequency</b>	5250 MHz ± 1 MHz 5600 MHz ± 1 MHz 5750 MHz ± 1 MHz	

## Head TSL parameters at 5250 MHz

The following parameters and calculations were applied.

	Temperature	Permittivity	Conductivity
<b>Nominal Head TSL parameters</b>	22.0 °C	35.9	4.71 mho/m
<b>Measured Head TSL parameters</b>	(22.0 ± 0.2) °C	34.4 ± 6 %	4.55 mho/m ± 6 %
<b>Head TSL temperature change during test</b>	< 0.5 °C	----	----

## SAR result with Head TSL at 5250 MHz

<b>SAR averaged over 1 cm<sup>3</sup> (1 g) of Head TSL</b>	Condition	
SAR measured	100 mW input power	8.16 W/kg
SAR for nominal Head TSL parameters	normalized to 1W	<b>80.8 W/kg ± 19.9 % (k=2)</b>

<b>SAR averaged over 10 cm<sup>3</sup> (10 g) of Head TSL</b>	condition	
SAR measured	100 mW input power	2.35 W/kg
SAR for nominal Head TSL parameters	normalized to 1W	<b>23.2 W/kg ± 19.5 % (k=2)</b>

### Head TSL parameters at 5600 MHz

The following parameters and calculations were applied.

	Temperature	Permittivity	Conductivity
Nominal Head TSL parameters	22.0 °C	35.5	5.07 mho/m
Measured Head TSL parameters	(22.0 ± 0.2) °C	33.9 ± 6 %	4.89 mho/m ± 6 %
Head TSL temperature change during test	< 0.5 °C	----	----

### SAR result with Head TSL at 5600 MHz

SAR averaged over 1 cm <sup>3</sup> (1 g) of Head TSL	Condition	
SAR measured	100 mW input power	8.29 W/kg
SAR for nominal Head TSL parameters	normalized to 1W	<b>82.0 W / kg ± 19.9 % (k=2)</b>

SAR averaged over 10 cm <sup>3</sup> (10 g) of Head TSL	condition	
SAR measured	100 mW input power	2.37 W/kg
SAR for nominal Head TSL parameters	normalized to 1W	<b>23.4 W/kg ± 19.5 % (k=2)</b>

### Head TSL parameters at 5750 MHz

The following parameters and calculations were applied.

	Temperature	Permittivity	Conductivity
Nominal Head TSL parameters	22.0 °C	35.4	5.22 mho/m
Measured Head TSL parameters	(22.0 ± 0.2) °C	33.7 ± 6 %	5.04 mho/m ± 6 %
Head TSL temperature change during test	< 0.5 °C	----	----

### SAR result with Head TSL at 5750 MHz

SAR averaged over 1 cm <sup>3</sup> (1 g) of Head TSL	Condition	
SAR measured	100 mW input power	8.06 W/kg
SAR for nominal Head TSL parameters	normalized to 1W	<b>79.7 W/kg ± 19.9 % (k=2)</b>

SAR averaged over 10 cm <sup>3</sup> (10 g) of Head TSL	condition	
SAR measured	100 mW input power	2.30 W/kg
SAR for nominal Head TSL parameters	normalized to 1W	<b>22.7 W/kg ± 19.5 % (k=2)</b>



### Body TSL parameters at 5250 MHz

The following parameters and calculations were applied.

	Temperature	Permittivity	Conductivity
Nominal Body TSL parameters	22.0 °C	48.9	5.36 mho/m
Measured Body TSL parameters	(22.0 ± 0.2) °C	47.0 ± 6 %	5.53 mho/m ± 6 %
Body TSL temperature change during test	< 0.5 °C	----	----

### SAR result with Body TSL at 5250 MHz

SAR averaged over 1 cm <sup>3</sup> (1 g) of Body TSL	Condition	
SAR measured	100 mW input power	7.68 W/kg
SAR for nominal Body TSL parameters	normalized to 1W	<b>76.2 W/kg ± 19.9 % (k=2)</b>

SAR averaged over 10 cm <sup>3</sup> (10 g) of Body TSL	condition	
SAR measured	100 mW input power	2.16 W/kg
SAR for nominal Body TSL parameters	normalized to 1W	<b>21.4 W/kg ± 19.5 % (k=2)</b>

### Body TSL parameters at 5600 MHz

The following parameters and calculations were applied.

	Temperature	Permittivity	Conductivity
Nominal Body TSL parameters	22.0 °C	48.5	5.77 mho/m
Measured Body TSL parameters	(22.0 ± 0.2) °C	46.3 ± 6 %	6.00 mho/m ± 6 %
Body TSL temperature change during test	< 0.5 °C	----	----

### SAR result with Body TSL at 5600 MHz

SAR averaged over 1 cm <sup>3</sup> (1 g) of Body TSL	Condition	
SAR measured	100 mW input power	7.99 W/kg
SAR for nominal Body TSL parameters	normalized to 1W	<b>79.3 W/kg ± 19.9 % (k=2)</b>

SAR averaged over 10 cm <sup>3</sup> (10 g) of Body TSL	condition	
SAR measured	100 mW input power	2.23 W/kg
SAR for nominal Body TSL parameters	normalized to 1W	<b>22.1 W/kg ± 19.5 % (k=2)</b>



### Body TSL parameters at 5750 MHz

The following parameters and calculations were applied.

	Temperature	Permittivity	Conductivity
Nominal Body TSL parameters	22.0 °C	48.3	5.94 mho/m
Measured Body TSL parameters	(22.0 ± 0.2) °C	46.1 ± 6 %	6.22 mho/m ± 6 %
Body TSL temperature change during test	< 0.5 °C	----	----

### SAR result with Body TSL at 5750 MHz

SAR averaged over 1 cm <sup>3</sup> (1 g) of Body TSL	Condition	
SAR measured	100 mW input power	7.65 W/kg
SAR for nominal Body TSL parameters	normalized to 1W	<b>75.9 W/kg ± 19.9 % (k=2)</b>

SAR averaged over 10 cm <sup>3</sup> (10 g) of Body TSL	condition	
SAR measured	100 mW input power	2.14 W/kg
SAR for nominal Body TSL parameters	normalized to 1W	<b>21.2 W/kg ± 19.5 % (k=2)</b>

## Appendix (Additional assessments outside the scope of SCS 0108)

### Antenna Parameters with Head TSL at 5250 MHz

Impedance, transformed to feed point	51.0 $\Omega$ - 2.7 j $\Omega$
Return Loss	- 30.8 dB

### Antenna Parameters with Head TSL at 5600 MHz

Impedance, transformed to feed point	56.2 $\Omega$ + 0.6 j $\Omega$
Return Loss	- 24.6 dB

### Antenna Parameters with Head TSL at 5750 MHz

Impedance, transformed to feed point	54.6 $\Omega$ + 2.7 j $\Omega$
Return Loss	- 25.9 dB

### Antenna Parameters with Body TSL at 5250 MHz

Impedance, transformed to feed point	51.7 $\Omega$ - 1.6 j $\Omega$
Return Loss	- 32.7 dB

### Antenna Parameters with Body TSL at 5600 MHz

Impedance, transformed to feed point	55.9 $\Omega$ + 1.0 j $\Omega$
Return Loss	- 25.0 dB

### Antenna Parameters with Body TSL at 5750 MHz

Impedance, transformed to feed point	55.9 $\Omega$ + 4.3 j $\Omega$
Return Loss	- 23.2 dB

## General Antenna Parameters and Design

Electrical Delay (one direction)	1.209 ns
----------------------------------	----------

After long term use with 100W radiated power, only a slight warming of the dipole near the feedpoint can be measured.

The dipole is made of standard semirigid coaxial cable. The center conductor of the feeding line is directly connected to the second arm of the dipole. The antenna is therefore short-circuited for DC-signals. On some of the dipoles, small end caps are added to the dipole arms in order to improve matching when loaded according to the position as explained in the "Measurement Conditions" paragraph. The SAR data are not affected by this change. The overall dipole length is still according to the Standard.

No excessive force must be applied to the dipole arms, because they might bend or the soldered connections near the feedpoint may be damaged.

## Additional EUT Data

Manufactured by	SPEAG
Manufactured on	September 08, 2011

## DASY5 Validation Report for Head TSL

Date: 20.07.2015

Test Laboratory: SPEAG, Zurich, Switzerland

### DUT: Dipole 5GHz; Type: D5GHzV2; Serial: D5GHzV2 - SN: 1128

Communication System: UID 0 - CW; Frequency: 5250 MHz, Frequency: 5600 MHz, Frequency: 5750 MHz  
Medium parameters used:  $f = 5250$  MHz;  $\sigma = 4.55$  S/m;  $\epsilon_r = 34.4$ ;  $\rho = 1000$  kg/m<sup>3</sup>, Medium parameters used:  
used:  $f = 5600$  MHz;  $\sigma = 4.89$  S/m;  $\epsilon_r = 33.9$ ;  $\rho = 1000$  kg/m<sup>3</sup>, Medium parameters used:  $f = 5750$  MHz;  $\sigma =$   
 $5.04$  S/m;  $\epsilon_r = 33.7$ ;  $\rho = 1000$  kg/m<sup>3</sup>

Phantom section: Flat Section

Measurement Standard: DASY5 (IEEE/IEC/ANSI C63.19-2011)

### DASY52 Configuration:

- Probe: EX3DV4 - SN3503; ConvF(5.45, 5.45, 5.45); Calibrated: 30.12.2014, ConvF(4.92, 4.92, 4.92); Calibrated: 30.12.2014, ConvF(4.91, 4.91, 4.91); Calibrated: 30.12.2014;
- Sensor-Surface: 1.4mm (Mechanical Surface Detection)
- Electronics: DAE4 Sn601; Calibrated: 18.08.2014
- Phantom: Flat Phantom 5.0 (front); Type: QD000P50AA; Serial: 1001
- DASY52 52.8.8(1222); SEMCAD X 14.6.10(7331)

### Dipole Calibration for Head Tissue/Pin=100mW, dist=10mm, f=5250 MHz/Zoom Scan,

**dist=1.4mm (8x8x7)/Cube 0:** Measurement grid: dx=4mm, dy=4mm, dz=1.4mm

Reference Value = 66.31 V/m; Power Drift = 0.02 dB

Peak SAR (extrapolated) = 29.2 W/kg

**SAR(1 g) = 8.16 W/kg; SAR(10 g) = 2.35 W/kg**

Maximum value of SAR (measured) = 18.5 W/kg

### Dipole Calibration for Head Tissue/Pin=100mW, dist=10mm, f=5600 MHz/Zoom Scan,

**dist=1.4mm (8x8x7)/Cube 0:** Measurement grid: dx=4mm, dy=4mm, dz=1.4mm

Reference Value = 65.08 V/m; Power Drift = 0.03 dB

Peak SAR (extrapolated) = 32.2 W/kg

**SAR(1 g) = 8.29 W/kg; SAR(10 g) = 2.37 W/kg**

Maximum value of SAR (measured) = 19.5 W/kg

### Dipole Calibration for Head Tissue/Pin=100mW, dist=10mm, f=5750 MHz/Zoom Scan,

**dist=1.4mm (8x8x7)/Cube 0:** Measurement grid: dx=4mm, dy=4mm, dz=1.4mm

Reference Value = 63.40 V/m; Power Drift = 0.02 dB

Peak SAR (extrapolated) = 32.4 W/kg

**SAR(1 g) = 8.06 W/kg; SAR(10 g) = 2.3 W/kg**

Maximum value of SAR (measured) = 19.0 W/kg

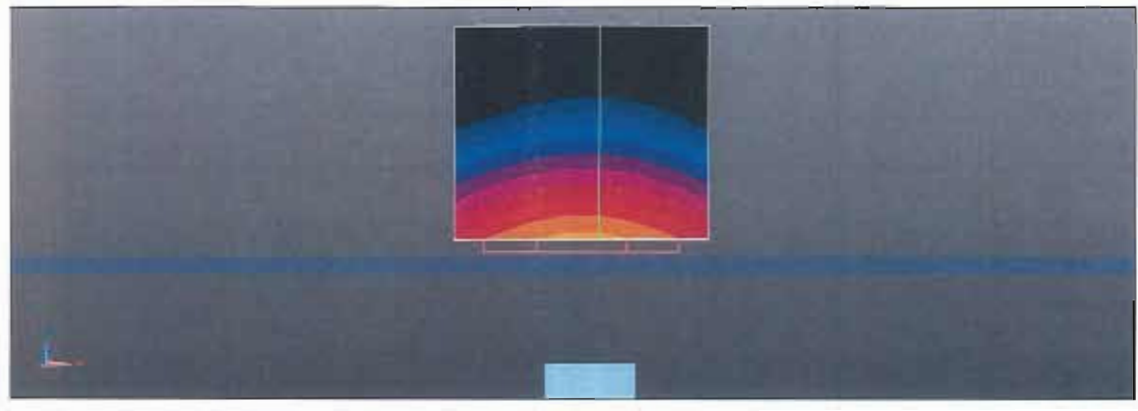
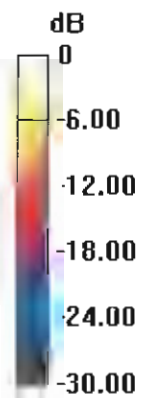

0 dB = 19.0 W/kg = 12.79 dBW/kg

# Impedance Measurement Plot for Head TSL

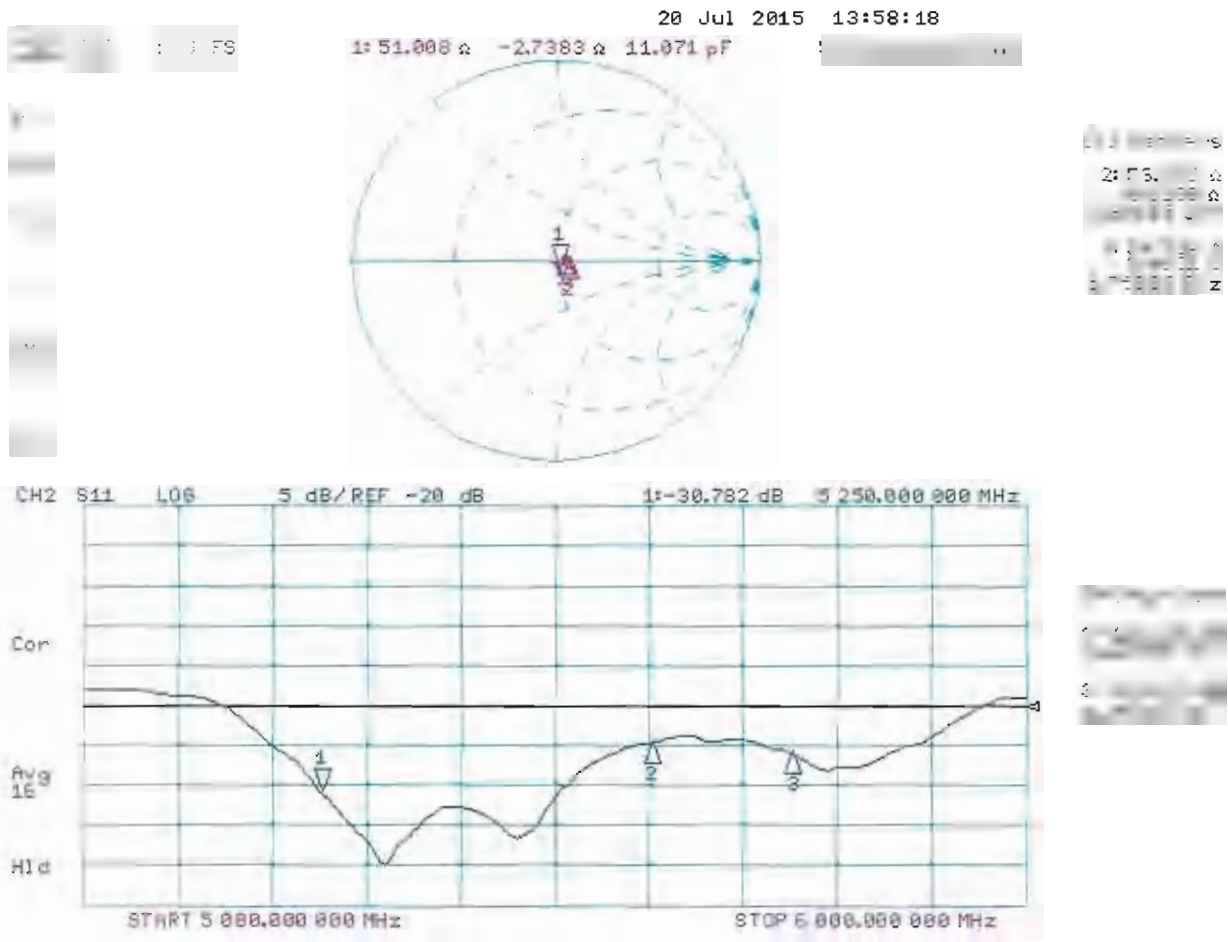

# DASY5 Validation Report for Body TSL

Date: 17.07.2015

Test Laboratory: SPEAG, Zurich, Switzerland

**DUT: Dipole 5GHz; Type: D5GHzV2; Serial: D5GHzV2 - SN: 1128**

Communication System: UID 0 - CW; Frequency: 5250 MHz, Frequency: 5600 MHz, Frequency: 5750 MHz  
Medium parameters used:  $f = 5250$  MHz;  $\sigma = 5.53$  S/m;  $\epsilon_r = 47$ ;  $\rho = 1000$  kg/m<sup>3</sup>, Medium parameters used:  $f = 5600$  MHz;  $\sigma = 6$  S/m;  $\epsilon_r = 46.3$ ;  $\rho = 1000$  kg/m<sup>3</sup>, Medium parameters used:  $f = 5750$  MHz;  $\sigma = 6.22$  S/m;  $\epsilon_r = 46.1$ ;  $\rho = 1000$  kg/m<sup>3</sup>

Phantom section: Flat Section

Measurement Standard: DASY5 (IEEE/IEC/ANSI C63.19-2011)

DASY52 Configuration:

- Probe: EX3DV4 - SN3503; ConvF(4.9, 4.9, 4.9); Calibrated: 30.12.2014, ConvF(4.35, 4.35, 4.35); Calibrated: 30.12.2014; ConvF(4.35, 4.35, 4.35); Calibrated: 30.12.2014
- Sensor-Surface: 1.4mm (Mechanical Surface Detection)
- Electronics: DAE4 Sn601; Calibrated: 18.08.2014
- Phantom: Flat Phantom 5.0 (back); Type: QD000P50AA; Serial: 1002
- DASY52 52.8.8(1222); SEMCAD X 14.6.10(7331)

## **Dipole Calibration for Body Tissue/Pin=100mW, dist=10mm, f=5250 MHz/Zoom Scan,**

**dist=1.4mm (8x8x7)/Cube 0:** Measurement grid: dx=4mm, dy=4mm, dz=1.4mm

Reference Value = 59.26 V/m; Power Drift = 0.01 dB

Peak SAR (extrapolated) = 30.2 W/kg

**SAR(1 g) = 7.68 W/kg; SAR(10 g) = 2.16 W/kg**

Maximum value of SAR (measured) = 17.7 W/kg

## **Dipole Calibration for Body Tissue/Pin=100mW, dist=10mm, f=5600 MHz/Zoom Scan,**

**dist=1.4mm (8x8x7)/Cube 0:** Measurement grid: dx=4mm, dy=4mm, dz=1.4mm

Reference Value = 58.23 V/m; Power Drift = 0.01 dB

Peak SAR (extrapolated) = 34.5 W/kg

**SAR(1 g) = 7.99 W/kg; SAR(10 g) = 2.23 W/kg**

Maximum value of SAR (measured) = 19.1 W/kg

## **Dipole Calibration for Body Tissue/Pin=100mW, dist=10mm, f=5750 MHz/Zoom Scan,**

**dist=1.4mm (8x8x7)/Cube 0:** Measurement grid: dx=4mm, dy=4mm, dz=1.4mm

Reference Value = 56.02 V/m; Power Drift = -0.00 dB

Peak SAR (extrapolated) = 34.5 W/kg

**SAR(1 g) = 7.65 W/kg; SAR(10 g) = 2.14 W/kg**

Maximum value of SAR (measured) = 18.5 W/kg

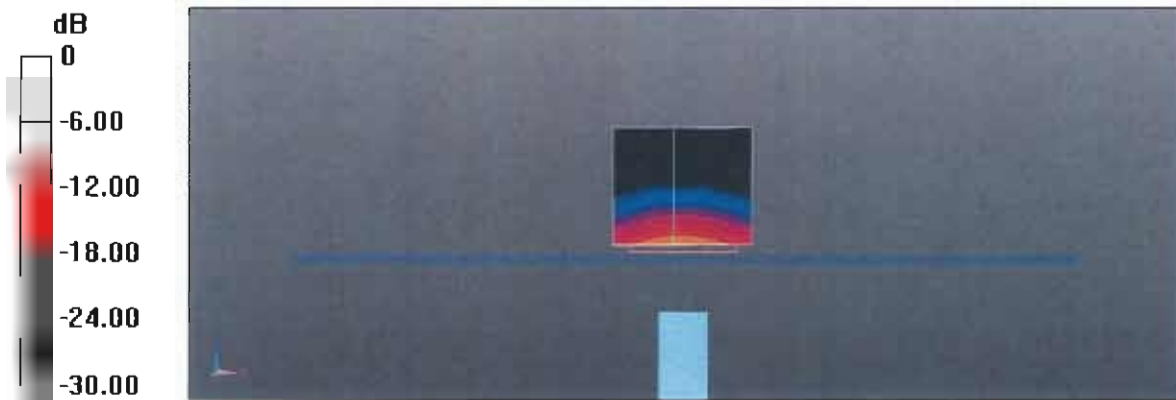

0 dB = 17.7 W/kg = 12.48 dBW/kg

# Impedance Measurement Plot for Body TSL

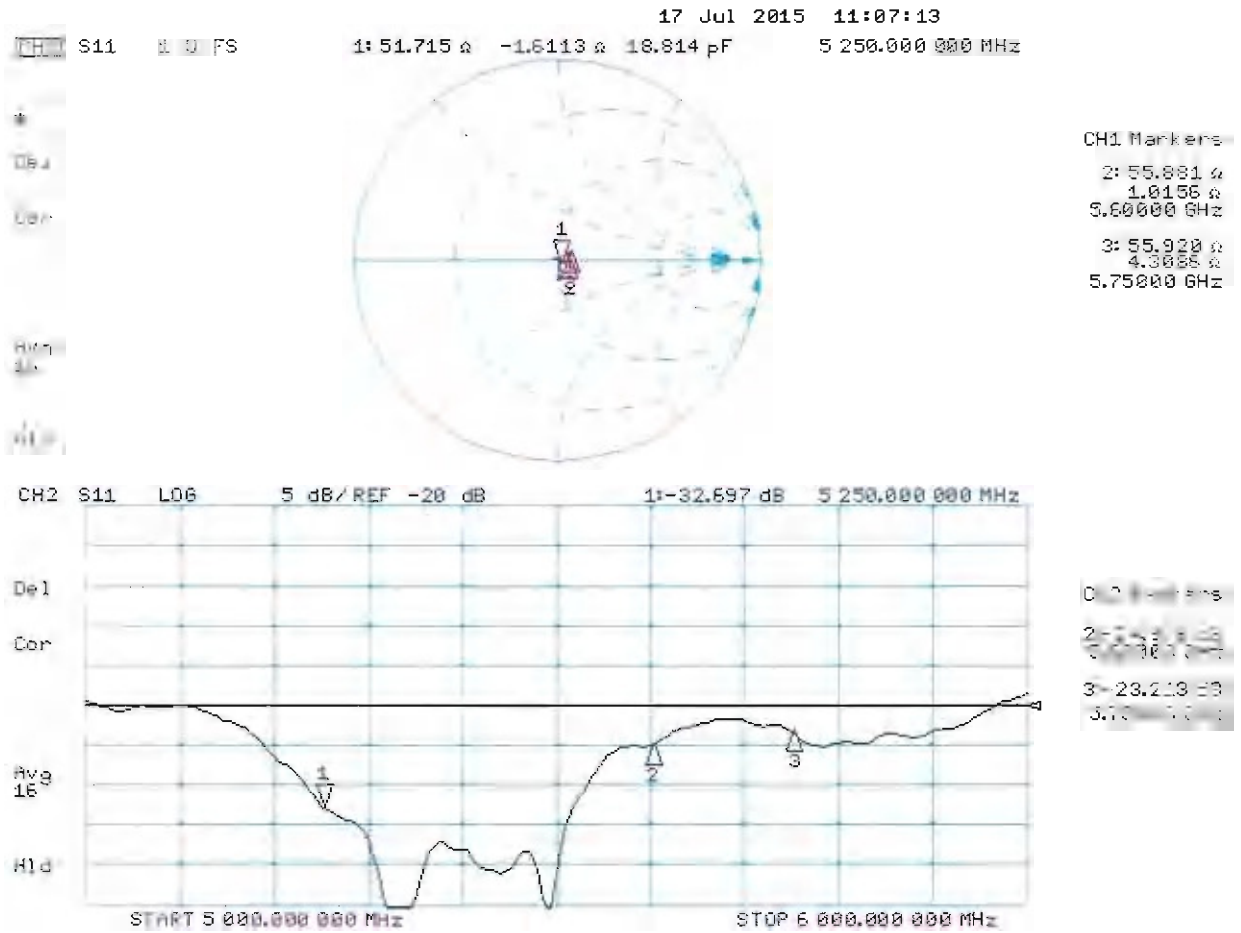





Accredited by the Swiss Accreditation Service (SAS)  
The Swiss Accreditation Service is one of the signatories to the EA  
Multilateral Agreement for the recognition of calibration certificates

Accreditation No.: **SCS 0108**

Client **Sporton-TW (Auden)**

Certificate No: **DAE4-1399\_Nov15**

## CALIBRATION CERTIFICATE

Object **DAE4 - SD 000 D04 BM - SN: 1399**

Calibration procedure(s) **QA CAL-06.v29**  
**Calibration procedure for the data acquisition electronics (DAE)**

Calibration date: **November 23, 2015**

This calibration certificate documents the traceability to national standards, which realize the physical units of measurements (SI).  
The measurements and the uncertainties with confidence probability are given on the following pages and are part of the certificate.

All calibrations have been conducted in the closed laboratory facility: environment temperature  $(22 \pm 3)^\circ\text{C}$  and humidity  $< 70\%$ .

Calibration Equipment used (M&TE critical for calibration)

Primary Standards	ID #	Cal Date (Certificate No.)	Scheduled Calibration
Keithley Multimeter Type 2001	SN: 0810278	09-Sep-15 (No:17153)	Sep-16
Secondary Standards	ID #	Check Date (in house)	Scheduled Check
Auto DAE Calibration Unit	SE UWS 053 AA 1001	06-Jan-15 (in house check)	In house check: Jan-16
Calibrator Box V2.1	SE UMS 006 AA 1002	06-Jan-15 (in house check)	In house check: Jan-16

Calibrated by:	Name Dominique Steffen	Function Technician	Signature 
Approved by:	Fin Bomholt	Deputy Technical Manager	

Issued: November 23, 2015

This calibration certificate shall not be reproduced except in full without written approval of the laboratory.



Accredited by the Swiss Accreditation Service (SAS)  
The Swiss Accreditation Service is one of the signatories to the EA  
Multilateral Agreement for the recognition of calibration certificates

Accreditation No.: **SCS 0108**

## Glossary

DAE data acquisition electronics  
Connector angle information used in DASY system to align probe sensor X to the robot coordinate system.

## Methods Applied and Interpretation of Parameters

- *DC Voltage Measurement:* Calibration Factor assessed for use in DASY system by comparison with a calibrated instrument traceable to national standards. The figure given corresponds to the full scale range of the voltmeter in the respective range.
- *Connector angle:* The angle of the connector is assessed measuring the angle mechanically by a tool inserted. Uncertainty is not required.
- The following parameters as documented in the Appendix contain technical information as a result from the performance test and require no uncertainty.
  - *DC Voltage Measurement Linearity:* Verification of the Linearity at +10% and -10% of the nominal calibration voltage. Influence of offset voltage is included in this measurement.
  - *Common mode sensitivity:* Influence of a positive or negative common mode voltage on the differential measurement.
  - *Channel separation:* Influence of a voltage on the neighbor channels not subject to an input voltage.
  - *AD Converter Values with inputs shorted:* Values on the internal AD converter corresponding to zero input voltage
  - *Input Offset Measurement:* Output voltage and statistical results over a large number of zero voltage measurements.
  - *Input Offset Current:* Typical value for information; Maximum channel input offset current, not considering the input resistance.
  - *Input resistance:* Typical value for information: DAE input resistance at the connector, during internal auto-zeroing and during measurement.
  - *Low Battery Alarm Voltage:* Typical value for information. Below this voltage, a battery alarm signal is generated.
  - *Power consumption:* Typical value for information. Supply currents in various operating modes.

## DC Voltage Measurement

A/D - Converter Resolution nominal

High Range: 1LSB = 6.1 $\mu$ V, full range = -100...+300 mV

Low Range: 1LSB = 61nV, full range = -1.....+3mV

DASY measurement parameters: Auto Zero Time: 3 sec; Measuring time: 3 sec

Calibration Factors	X	Y	Z
High Range	403.569 $\pm$ 0.02% (k=2)	403.830 $\pm$ 0.02% (k=2)	403.686 $\pm$ 0.02% (k=2)
Low Range	3.98186 $\pm$ 1.50% (k=2)	3.99005 $\pm$ 1.50% (k=2)	3.98036 $\pm$ 1.50% (k=2)

## Connector Angle

Connector Angle to be used in DASY system	303.0 $^{\circ}$ $\pm$ 1 $^{\circ}$
---	-------------------------------------

## Appendix (Additional assessments outside the scope of SCS0108)

### 1. DC Voltage Linearity

High Range		Reading ( $\mu\text{V}$ )	Difference ( $\mu\text{V}$ )	Error (%)
Channel X	+ Input	200034.20	-1.95	-0.00
Channel X	+ Input	20004.24	-0.55	-0.00
Channel X	- Input	-20004.68	0.95	-0.00
Channel Y	+ Input	200034.75	-2.81	-0.00
Channel Y	+ Input	20002.71	-1.97	-0.01
Channel Y	- Input	-20006.72	-0.91	0.00
Channel Z	+ Input	200034.35	-2.72	-0.00
Channel Z	+ Input	20002.74	-1.91	-0.01
Channel Z	- Input	-20007.13	-1.44	0.01

Low Range		Reading ( $\mu\text{V}$ )	Difference ( $\mu\text{V}$ )	Error (%)
Channel X	+ Input	2000.90	-0.02	-0.00
Channel X	+ Input	201.19	0.32	0.16
Channel X	- Input	-198.77	0.20	-0.10
Channel Y	+ Input	2000.69	-0.23	-0.01
Channel Y	+ Input	200.19	-0.57	-0.29
Channel Y	- Input	-199.64	-0.59	0.29
Channel Z	+ Input	2000.76	-0.09	-0.00
Channel Z	+ Input	199.54	-1.29	-0.64
Channel Z	- Input	-200.88	-1.78	0.90

### 2. Common mode sensitivity

DASY measurement parameters: Auto Zero Time: 3 sec; Measuring time: 3 sec

	Common mode Input Voltage (mV)	High Range Average Reading ( $\mu\text{V}$ )	Low Range Average Reading ( $\mu\text{V}$ )
Channel X	200	-5.42	-6.82
	- 200	8.31	6.25
Channel Y	200	-5.59	-5.99
	- 200	4.78	4.49
Channel Z	200	-7.36	-7.21
	- 200	4.34	4.37

### 3. Channel separation

DASY measurement parameters: Auto Zero Time: 3 sec; Measuring time: 3 sec

	Input Voltage (mV)	Channel X ( $\mu\text{V}$ )	Channel Y ( $\mu\text{V}$ )	Channel Z ( $\mu\text{V}$ )
Channel X	200	-	5.03	-1.50
Channel Y	200	9.40	-	5.92
Channel Z	200	8.43	7.65	-

#### 4. AD-Converter Values with inputs shorted

DASY measurement parameters: Auto Zero Time: 3 sec; Measuring time: 3 sec

	High Range (LSB)	Low Range (LSB)
Channel X	15830	16396
Channel Y	16113	15933
Channel Z	15887	15858

#### 5. Input Offset Measurement

DASY measurement parameters: Auto Zero Time: 3 sec; Measuring time: 3 sec

Input 10M $\Omega$

	Average ( $\mu$ V)	min. Offset ( $\mu$ V)	max. Offset ( $\mu$ V)	Std. Deviation ( $\mu$ V)
Channel X	0.38	-0.36	1.37	0.35
Channel Y	0.35	-0.44	1.17	0.34
Channel Z	-2.61	-3.42	-1.45	0.39

#### 6. Input Offset Current

Nominal input circuitry offset current on all channels: <25fA

#### 7. Input Resistance (Typical values for information)

	Zeroing (kOhm)	Measuring (MOhm)
Channel X	200	200
Channel Y	200	200
Channel Z	200	200

#### 8. Low Battery Alarm Voltage (Typical values for information)

Typical values	Alarm Level (VDC)
Supply (+ Vcc)	+7.9
Supply (- Vcc)	-7.6

#### 9. Power Consumption (Typical values for information)

Typical values	Switched off (mA)	Stand by (mA)	Transmitting (mA)
Supply (+ Vcc)	+0.01	+6	+14
Supply (- Vcc)	-0.01	-8	-9



Accredited by the Swiss Accreditation Service (SAS)  
The Swiss Accreditation Service is one of the signatories to the EA  
Multilateral Agreement for the recognition of calibration certificates

Accreditation No.: **SCS 0108**

Client **Sporton-TW (Auden)**

Certificate No: **ES3-3270\_Sep15**

## CALIBRATION CERTIFICATE

Object **ES3DV3 - SN:3270**

Calibration procedure(s) **QA CAL-01.v9, QA CAL-23.v5, QA CAL-25.v6  
Calibration procedure for dosimetric E-field probes**

Calibration date: **September 28, 2015**

This calibration certificate documents the traceability to national standards, which realize the physical units of measurements (SI).  
The measurements and the uncertainties with confidence probability are given on the following pages and are part of the certificate.

All calibrations have been conducted in the closed laboratory facility: environment temperature (22 ± 3)°C and humidity < 70%.

Calibration Equipment used (M&TE critical for calibration)

Primary Standards	ID	Cal Date (Certificate No.)	Scheduled Calibration
Power meter E4419B	GB41293874	01-Apr-15 (No. 217-02128)	Mar-16
Power sensor E4412A	MY41498087	01-Apr-15 (No. 217-02128)	Mar-16
Reference 3 dB Attenuator	SN: S5054 (3c)	01-Apr-15 (No. 217-02129)	Mar-16
Reference 20 dB Attenuator	SN: S5277 (20x)	01-Apr-15 (No. 217-02132)	Mar-16
Reference 30 dB Attenuator	SN: S5129 (30b)	01-Apr-15 (No. 217-02133)	Mar-16
Reference Probe ES3DV2	SN: 3013	30-Dec-14 (No. ES3-3013_Dec14)	Dec-15
DAE4	SN: 660	14-Jan-15 (No. DAE4-660_Jan15)	Jan-16
Secondary Standards	ID	Check Date (in house)	Scheduled Check
RF generator HP 8648C	US3642U01700	4-Aug-99 (in house check Apr-13)	In house check: Apr-16
Network Analyzer HP 8753E	US37390585	18-Oct-01 (in house check Oct-14)	In house check: Oct-15

	Name	Function	Signature
Calibrated by:	Israe Elnaouq	Laboratory Technician	
Approved by:	Katja Pokovic	Technical Manager	
			Issued: September 30, 2015
This calibration certificate shall not be reproduced except in full without written approval of the laboratory.			



Accredited by the Swiss Accreditation Service (SAS)

Accreditation No.: **SCS 0108**

The Swiss Accreditation Service is one of the signatories to the EA Multilateral Agreement for the recognition of calibration certificates

### Glossary:

TSL	tissue simulating liquid
NORM <sub>x,y,z</sub>	sensitivity in free space
ConvF	sensitivity in TSL / NORM <sub>x,y,z</sub>
DCP	diode compression point
CF	crest factor (1/duty_cycle) of the RF signal
A, B, C, D	modulation dependent linearization parameters
Polarization $\varphi$	$\varphi$ rotation around probe axis
Polarization $\vartheta$	$\vartheta$ rotation around an axis that is in the plane normal to probe axis (at measurement center), i.e., $\vartheta = 0$ is normal to probe axis
Connector Angle	information used in DASY system to align probe sensor X to the robot coordinate system

### Calibration is Performed According to the Following Standards:

- IEEE Std 1528-2013, "IEEE Recommended Practice for Determining the Peak Spatial-Averaged Specific Absorption Rate (SAR) in the Human Head from Wireless Communications Devices: Measurement Techniques", June 2013
- IEC 62209-1, "Procedure to measure the Specific Absorption Rate (SAR) for hand-held devices used in close proximity to the ear (frequency range of 300 MHz to 3 GHz)", February 2005
- IEC 62209-2, "Procedure to determine the Specific Absorption Rate (SAR) for wireless communication devices used in close proximity to the human body (frequency range of 30 MHz to 6 GHz)", March 2010
- KDB 865664, "SAR Measurement Requirements for 100 MHz to 6 GHz"

### Methods Applied and Interpretation of Parameters:

- NORM<sub>x,y,z</sub>**: Assessed for E-field polarization  $\vartheta = 0$  ( $f \leq 900$  MHz in TEM-cell;  $f > 1800$  MHz: R22 waveguide). NORM<sub>x,y,z</sub> are only intermediate values, i.e., the uncertainties of NORM<sub>x,y,z</sub> does not affect the E<sup>2</sup>-field uncertainty inside TSL (see below ConvF).
- NORM(f)<sub>x,y,z</sub>** = NORM<sub>x,y,z</sub> \* frequency\_response (see Frequency Response Chart). This linearization is implemented in DASY4 software versions later than 4.2. The uncertainty of the frequency response is included in the stated uncertainty of ConvF.
- DCP<sub>x,y,z</sub>**: DCP are numerical linearization parameters assessed based on the data of power sweep with CW signal (no uncertainty required). DCP does not depend on frequency nor media.
- PAR**: PAR is the Peak to Average Ratio that is not calibrated but determined based on the signal characteristics
- A<sub>x,y,z</sub>; B<sub>x,y,z</sub>; C<sub>x,y,z</sub>; D<sub>x,y,z</sub>; VR<sub>x,y,z</sub>**: A, B, C, D are numerical linearization parameters assessed based on the data of power sweep for specific modulation signal. The parameters do not depend on frequency nor media. VR is the maximum calibration range expressed in RMS voltage across the diode.
- ConvF and Boundary Effect Parameters**: Assessed in flat phantom using E-field (or Temperature Transfer Standard for  $f \leq 800$  MHz) and inside waveguide using analytical field distributions based on power measurements for  $f > 800$  MHz. The same setups are used for assessment of the parameters applied for boundary compensation (alpha, depth) of which typical uncertainty values are given. These parameters are used in DASY4 software to improve probe accuracy close to the boundary. The sensitivity in TSL corresponds to NORM<sub>x,y,z</sub> \* ConvF whereby the uncertainty corresponds to that given for ConvF. A frequency dependent ConvF is used in DASY version 4.4 and higher which allows extending the validity from  $\pm 50$  MHz to  $\pm 100$  MHz.
- Spherical isotropy (3D deviation from isotropy)**: in a field of low gradients realized using a flat phantom exposed by a patch antenna.
- Sensor Offset**: The sensor offset corresponds to the offset of virtual measurement center from the probe tip (on probe axis). No tolerance required.
- Connector Angle**: The angle is assessed using the information gained by determining the NORM<sub>x</sub> (no uncertainty required).

Probe ES3DV3

SN:3270

Manufactured: February 25, 2010  
Calibrated: September 28, 2015

Calibrated for DASYS/EASY Systems  
(Note: non-compatible with DASYS2 system!)



## DASY/EASY - Parameters of Probe: ES3DV3 - SN:3270

### Basic Calibration Parameters

	Sensor X	Sensor Y	Sensor Z	Unc (k=2)
Norm ( $\mu\text{V}/(\text{V}/\text{m})^2$ ) <sup>A</sup>	1.10	1.19	1.21	$\pm 10.1 \%$
DCP (mV) <sup>B</sup>	102.9	106.4	103.6	

### Modulation Calibration Parameters

UID	Communication System Name		A dB	B dB $\sqrt{\mu\text{V}}$	C	D dB	VR mV	Unc <sup>E</sup> (k=2)
0	CW	X	0.0	0.0	1.0	0.00	193.7	$\pm 3.0 \%$
		Y	0.0	0.0	1.0		212.5	
		Z	0.0	0.0	1.0		204.6	

The reported uncertainty of measurement is stated as the standard uncertainty of measurement multiplied by the coverage factor  $k=2$ , which for a normal distribution corresponds to a coverage probability of approximately 95%.

<sup>A</sup> The uncertainties of Norm X,Y,Z do not affect the  $E^2$ -field uncertainty inside TSL (see Pages 5 and 6).

<sup>B</sup> Numerical linearization parameter: uncertainty not required.

<sup>E</sup> Uncertainty is determined using the max. deviation from linear response applying rectangular distribution and is expressed for the square of the field value.

## DASY/EASY - Parameters of Probe: ES3DV3 - SN:3270

### Calibration Parameter Determined in Head Tissue Simulating Media

f (MHz) <sup>C</sup>	Relative Permittivity <sup>F</sup>	Conductivity (S/m) <sup>F</sup>	ConvF X	ConvF Y	ConvF Z	Alpha <sup>G</sup>	Depth <sup>G</sup> (mm)	Unc (k=2)
750	41.9	0.89	6.50	6.50	6.50	0.32	1.98	± 12.0 %
835	41.5	0.90	6.32	6.32	6.32	0.52	1.47	± 12.0 %
900	41.5	0.97	6.16	6.16	6.16	0.47	1.53	± 12.0 %
1750	40.1	1.37	5.32	5.32	5.32	0.71	1.25	± 12.0 %
1900	40.0	1.40	5.12	5.12	5.12	0.80	1.20	± 12.0 %
2000	40.0	1.40	5.12	5.12	5.12	0.60	1.38	± 12.0 %
2450	39.2	1.80	4.59	4.59	4.59	0.70	1.39	± 12.0 %
2600	39.0	1.96	4.44	4.44	4.44	0.73	1.37	± 12.0 %

<sup>C</sup> Frequency validity above 300 MHz of ± 100 MHz only applies for DASY v4.4 and higher (see Page 2), else it is restricted to ± 50 MHz. The uncertainty is the RSS of the ConvF uncertainty at calibration frequency and the uncertainty for the indicated frequency band. Frequency validity below 300 MHz is ± 10, 25, 40, 50 and 70 MHz for ConvF assessments at 30, 64, 128, 150 and 220 MHz respectively. Above 5 GHz frequency validity can be extended to ± 110 MHz.

<sup>F</sup> At frequencies below 3 GHz, the validity of tissue parameters ( $\epsilon$  and  $\sigma$ ) can be relaxed to ± 10% if liquid compensation formula is applied to measured SAR values. At frequencies above 3 GHz, the validity of tissue parameters ( $\epsilon$  and  $\sigma$ ) is restricted to ± 5%. The uncertainty is the RSS of the ConvF uncertainty for indicated target tissue parameters.

<sup>G</sup> Alpha/Depth are determined during calibration. SPEAG warrants that the remaining deviation due to the boundary effect after compensation is always less than ± 1% for frequencies below 3 GHz and below ± 2% for frequencies between 3-6 GHz at any distance larger than half the probe tip diameter from the boundary.

## DASY/EASY - Parameters of Probe: ES3DV3 - SN:3270

### Calibration Parameter Determined in Body Tissue Simulating Media

f (MHz) <sup>C</sup>	Relative Permittivity <sup>F</sup>	Conductivity (S/m) <sup>F</sup>	ConvF X	ConvF Y	ConvF Z	Alpha <sup>G</sup>	Depth <sup>G</sup> (mm)	Unc (k=2)
750	55.5	0.96	6.30	6.30	6.30	0.43	1.61	± 12.0 %
835	55.2	0.97	6.24	6.24	6.24	0.30	2.13	± 12.0 %
1750	53.4	1.49	4.95	4.95	4.95	0.64	1.38	± 12.0 %
1900	53.3	1.52	4.78	4.78	4.78	0.64	1.43	± 12.0 %
2450	52.7	1.95	4.37	4.37	4.37	0.80	1.24	± 12.0 %
2600	52.5	2.16	4.27	4.27	4.27	0.80	1.20	± 12.0 %

<sup>C</sup> Frequency validity above 300 MHz of ± 100 MHz only applies for DASY v4.4 and higher (see Page 2), else it is restricted to ± 50 MHz. The uncertainty is the RSS of the ConvF uncertainty at calibration frequency and the uncertainty for the indicated frequency band. Frequency validity below 300 MHz is ± 10, 25, 40, 50 and 70 MHz for ConvF assessments at 30, 64, 128, 150 and 220 MHz respectively. Above 5 GHz frequency validity can be extended to ± 110 MHz.

<sup>F</sup> At frequencies below 3 GHz, the validity of tissue parameters ( $\epsilon$  and  $\sigma$ ) can be relaxed to ± 10% if liquid compensation formula is applied to measured SAR values. At frequencies above 3 GHz, the validity of tissue parameters ( $\epsilon$  and  $\sigma$ ) is restricted to ± 5%. The uncertainty is the RSS of the ConvF uncertainty for indicated target tissue parameters.

<sup>G</sup> Alpha/Depth are determined during calibration. SPEAG warrants that the remaining deviation due to the boundary effect after compensation is always less than ± 1% for frequencies below 3 GHz and below ± 2% for frequencies between 3-6 GHz at any distance larger than half the probe tip diameter from the boundary.

## Frequency Response of E-Field (TEM-Cell:ifi110 EXX, Waveguide: R22)

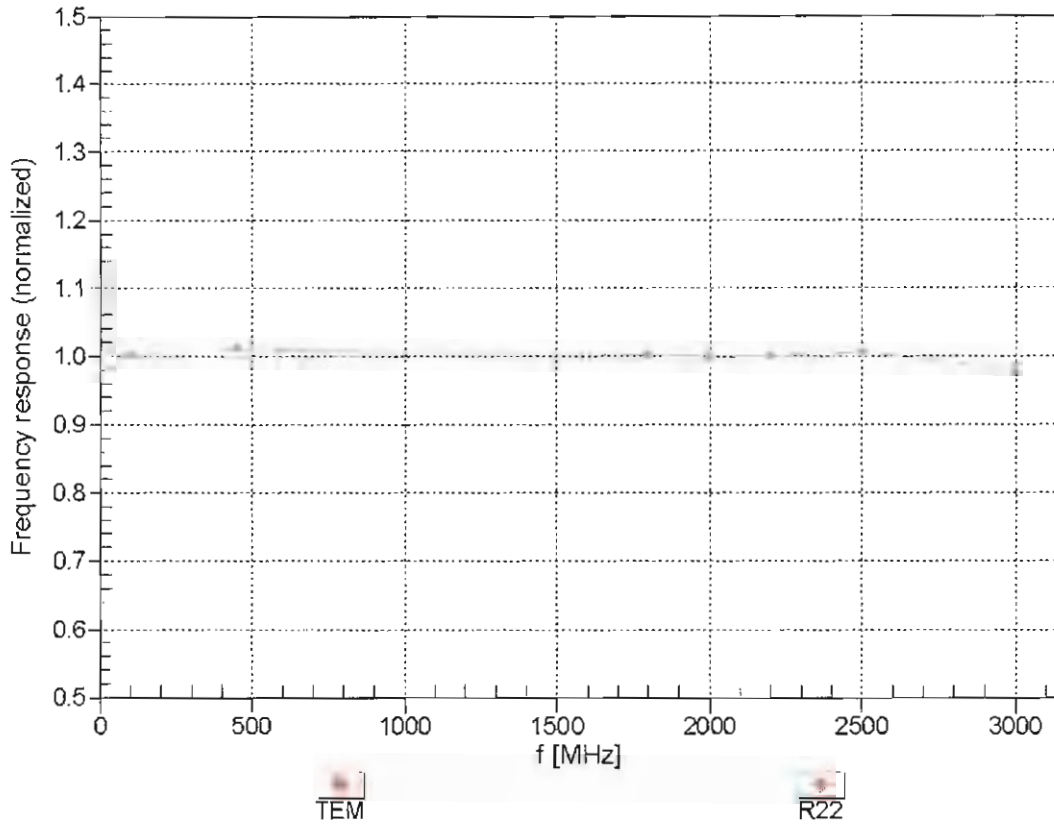

Uncertainty of Frequency Response of E-field:  $\pm 6.3\%$  (k=2)

### Receiving Pattern ( $\phi$ ), $\theta = 0^\circ$

f=600 MHz, TEM

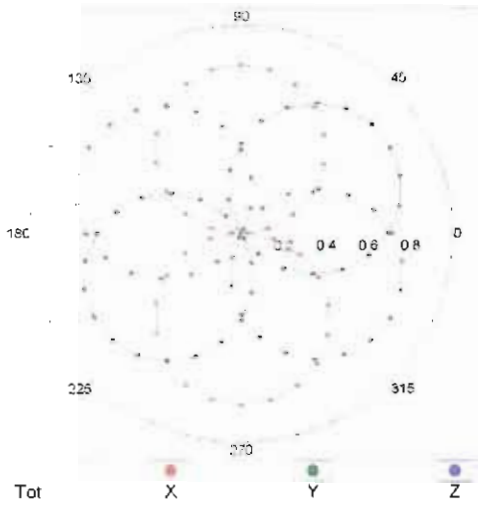

f=1800 MHz, R22

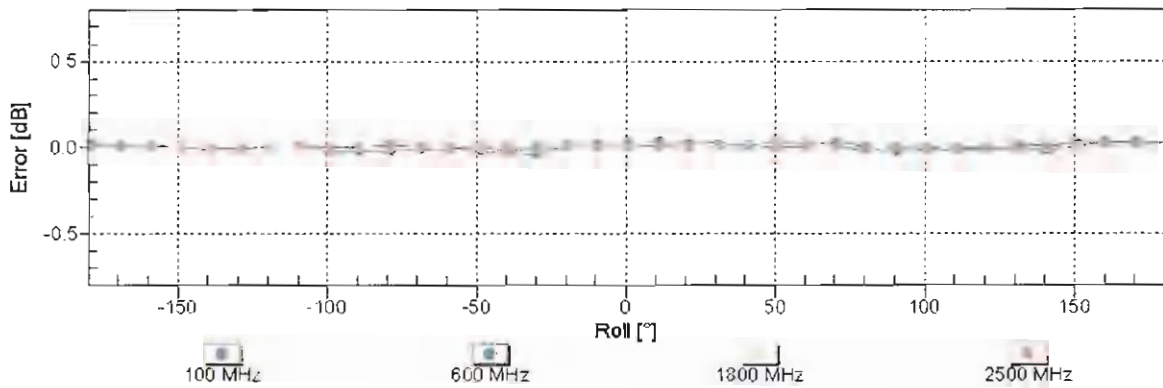
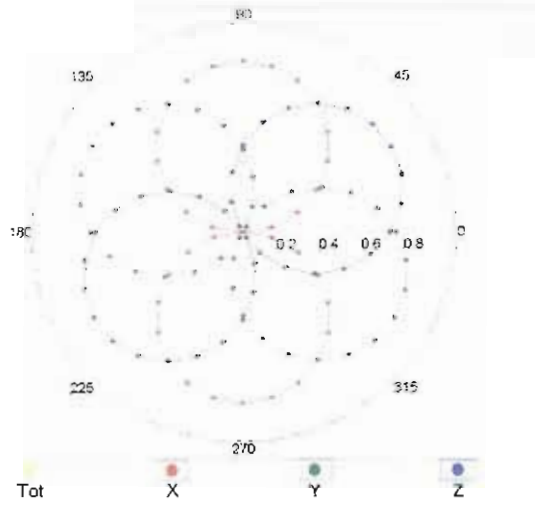

Uncertainty of Axial Isotropy Assessment:  $\pm 0.5\%$  (k=2)

### Dynamic Range $\Gamma$ ( $SAR_{head}$ ) (TEM cell , $f_{eval}= 1900$ MHz)

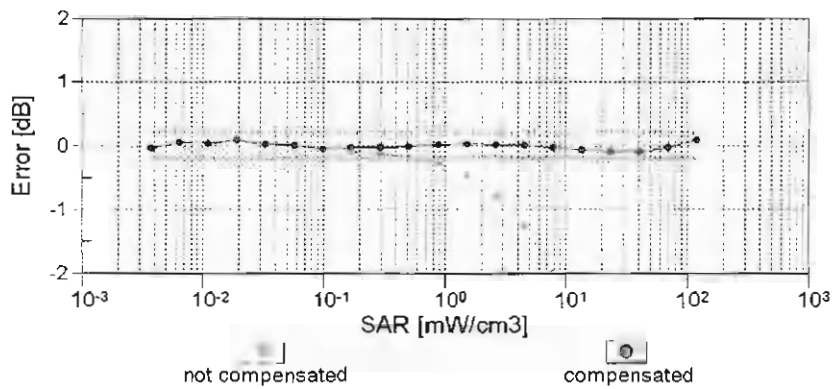
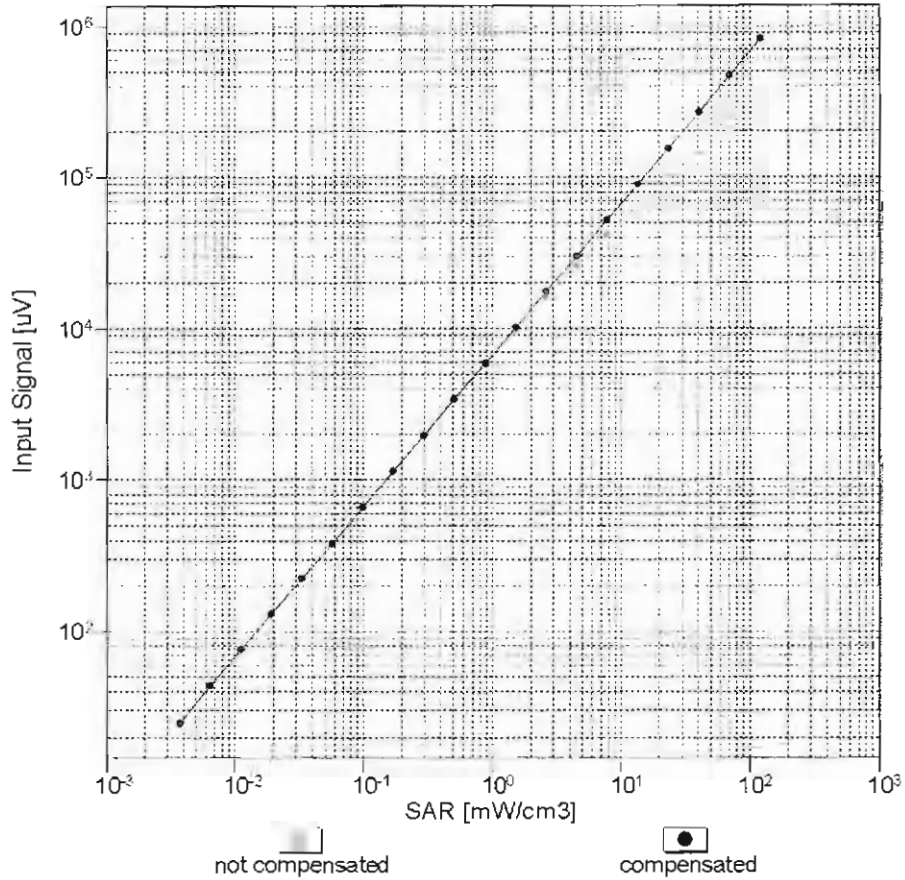

Uncertainty of Linearity Assessment:  $\pm 0.6\%$  ( $k=2$ )

# Conversion Factor Assessment

f = 900 MHz, WGLS R9 (H\_convF)

f = 1750 MHz, WGLS R22 (H\_convF)

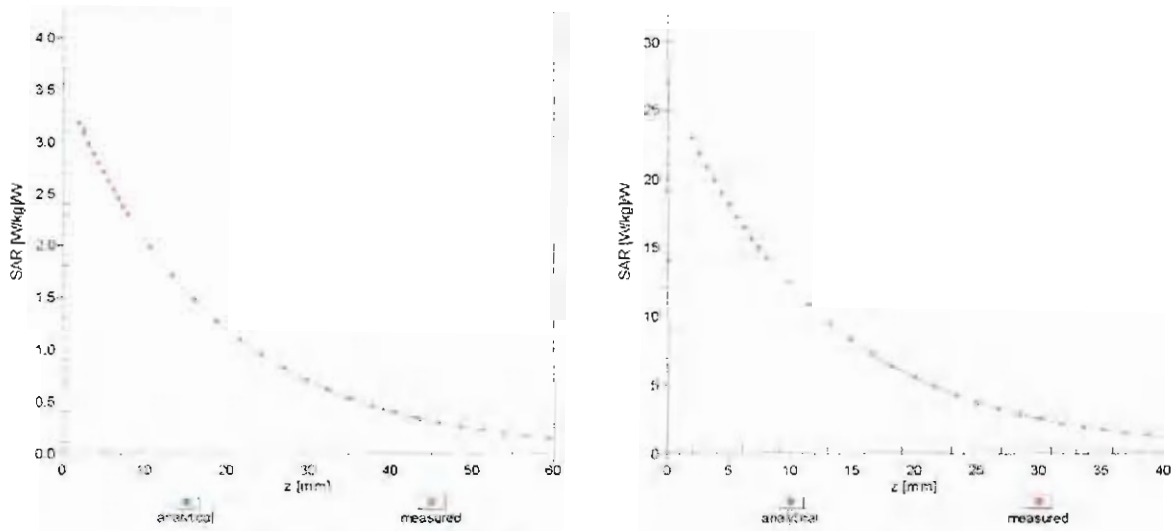

## Deviation from Isotropy in Liquid

Error ( $\phi, \theta$ ), f = 900 MHz

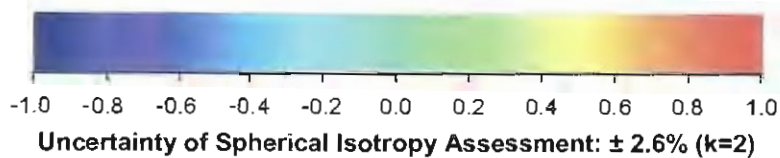
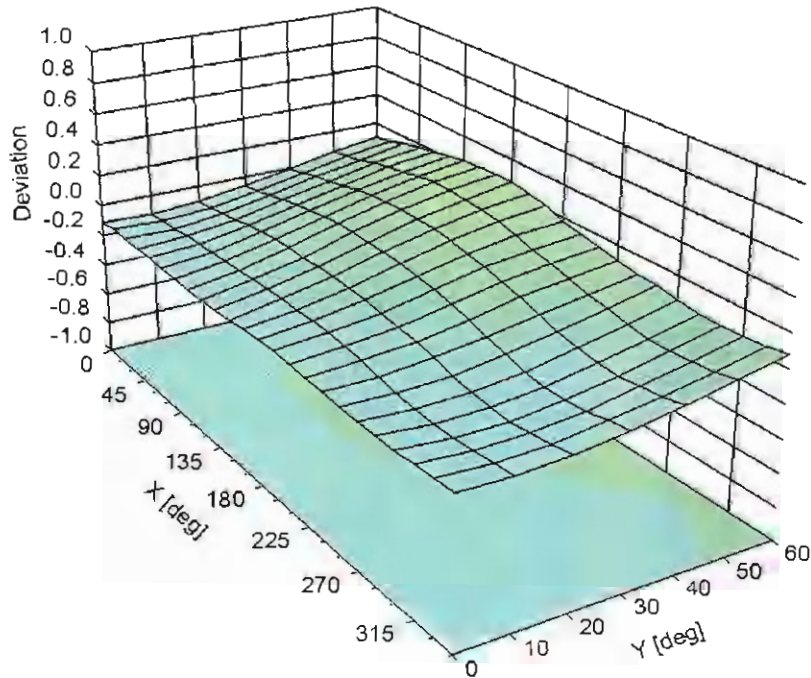

**DASY/EASY - Parameters of Probe: ES3DV3 - SN:3270****Other Probe Parameters**

Sensor Arrangement	Triangular
Connector Angle (°)	-18.7
Mechanical Surface Detection Mode	enabled
Optical Surface Detection Mode	disabled
Probe Overall Length	337 mm
Probe Body Diameter	10 mm
Tip Length	10 mm
Tip Diameter	4 mm
Probe Tip to Sensor X Calibration Point	2 mm
Probe Tip to Sensor Y Calibration Point	2 mm
Probe Tip to Sensor Z Calibration Point	2 mm
Recommended Measurement Distance from Surface	3 mm





Accreditation No.: **SCS 0108**

Accredited by the Swiss Accreditation Service (SAS)  
The Swiss Accreditation Service is one of the signatories to the EA  
Multilateral Agreement for the recognition of calibration certificates

Client **Sporton-TW (Auden)**

Certificate No: **EX3-3955\_Nov15**

## CALIBRATION CERTIFICATE

Object **EX3DV4 - SN:3955**

Calibration procedure(s) **QA CAL-01.v9, QA CAL-14.v4, QA CAL-23.v5, QA CAL-25.v6  
Calibration procedure for dosimetric E-field probes**

Calibration date: **November 24, 2015**

This calibration certificate documents the traceability to national standards, which realize the physical units of measurements (SI).  
The measurements and the uncertainties with confidence probability are given on the following pages and are part of the certificate.

All calibrations have been conducted in the closed laboratory facility: environment temperature (22 ± 3)°C and humidity < 70%.

Calibration Equipment used (M&TE critical for calibration)

Primary Standards	ID	Cal Date (Certificate No.)	Scheduled Calibration
Power meter E4419B	GB41293874	01-Apr-15 (No. 217-02128)	Mar-16
Power sensor E4412A	MY41498087	01-Apr-15 (No. 217-02128)	Mar-16
Reference 3 dB Attenuator	SN: S5054 (3c)	01-Apr-15 (No. 217-02129)	Mar-16
Reference 20 dB Attenuator	SN: S5277 (20x)	01-Apr-15 (No. 217-02132)	Mar-16
Reference 30 dB Attenuator	SN: S5129 (30b)	01-Apr-15 (No. 217-02133)	Mar-16
Reference Probe ES3DV2	SN: 3013	30-Dec-14 (No. ES3-3013_Dec14)	Dec-15
DAE4	SN: 660	14-Jan-15 (No. DAE4-660_Jan15)	Jan-16
Secondary Standards	ID	Check Date (in house)	Scheduled Check
RF generator HP 8648C	US3642U01700	4-Aug-99 (in house check Apr-13)	In house check: Apr-16
Network Analyzer HP 8753E	US37390585	18-Oct-01 (in house check Oct-15)	In house check: Oct-16

Calibrated by:	Name <b>Claudio Leubler</b>	Function Laboratory Technician	Signature 
Approved by:	Name <b>Katja Pokovic</b>	Function Technical Manager	Signature 

Issued: November 26, 2015

This calibration certificate shall not be reproduced except in full without written approval of the laboratory.



Accredited by the Swiss Accreditation Service (SAS)

Accreditation No.: **SCS 0108**

The Swiss Accreditation Service is one of the signatories to the EA  
Multilateral Agreement for the recognition of calibration certificates

### Glossary:

TSL	tissue simulating liquid
NORM <sub>x,y,z</sub>	sensitivity in free space
ConvF	sensitivity in TSL / NORM <sub>x,y,z</sub>
DCP	diode compression point
CF	crest factor (1/duty_cycle) of the RF signal
A, B, C, D	modulation dependent linearization parameters
Polarization $\varphi$	$\varphi$ rotation around probe axis
Polarization $\vartheta$	$\vartheta$ rotation around an axis that is in the plane normal to probe axis (at measurement center), i.e., $\vartheta = 0$ is normal to probe axis
Connector Angle	information used in DASY system to align probe sensor X to the robot coordinate system

### Calibration is Performed According to the Following Standards:

- IEEE Std 1528-2013, "IEEE Recommended Practice for Determining the Peak Spatial-Averaged Specific Absorption Rate (SAR) in the Human Head from Wireless Communications Devices: Measurement Techniques", June 2013
- IEC 62209-1, "Procedure to measure the Specific Absorption Rate (SAR) for hand-held devices used in close proximity to the ear (frequency range of 300 MHz to 3 GHz)", February 2005
- IEC 62209-2, "Procedure to determine the Specific Absorption Rate (SAR) for wireless communication devices used in close proximity to the human body (frequency range of 30 MHz to 6 GHz)", March 2010
- KDB 865664, "SAR Measurement Requirements for 100 MHz to 6 GHz"

### Methods Applied and Interpretation of Parameters:

- NORM<sub>x,y,z</sub>**: Assessed for E-field polarization  $\vartheta = 0$  ( $f \leq 900$  MHz in TEM-cell;  $f > 1800$  MHz: R22 waveguide). NORM<sub>x,y,z</sub> are only intermediate values, i.e., the uncertainties of NORM<sub>x,y,z</sub> does not affect the E<sup>2</sup>-field uncertainty inside TSL (see below ConvF).
- NORM(f)<sub>x,y,z</sub> = NORM<sub>x,y,z</sub> \* frequency\_response** (see Frequency Response Chart). This linearization is implemented in DASY4 software versions later than 4.2. The uncertainty of the frequency response is included in the stated uncertainty of ConvF.
- DCP<sub>x,y,z</sub>**: DCP are numerical linearization parameters assessed based on the data of power sweep with CW signal (no uncertainty required). DCP does not depend on frequency nor media.
- PAR**: PAR is the Peak to Average Ratio that is not calibrated but determined based on the signal characteristics
- A<sub>x,y,z</sub>; B<sub>x,y,z</sub>; C<sub>x,y,z</sub>; D<sub>x,y,z</sub>; VR<sub>x,y,z</sub>; A, B, C, D** are numerical linearization parameters assessed based on the data of power sweep for specific modulation signal. The parameters do not depend on frequency nor media. VR is the maximum calibration range expressed in RMS voltage across the diode.
- ConvF and Boundary Effect Parameters**: Assessed in flat phantom using E-field (or Temperature Transfer Standard for  $f \leq 800$  MHz) and inside waveguide using analytical field distributions based on power measurements for  $f > 800$  MHz. The same setups are used for assessment of the parameters applied for boundary compensation (alpha, depth) of which typical uncertainty values are given. These parameters are used in DASY4 software to improve probe accuracy close to the boundary. The sensitivity in TSL corresponds to NORM<sub>x,y,z</sub> \* ConvF whereby the uncertainty corresponds to that given for ConvF. A frequency dependent ConvF is used in DASY version 4.4 and higher which allows extending the validity from  $\pm 50$  MHz to  $\pm 100$  MHz.
- Spherical isotropy (3D deviation from isotropy)**: in a field of low gradients realized using a flat phantom exposed by a patch antenna.
- Sensor Offset**: The sensor offset corresponds to the offset of virtual measurement center from the probe tip (on probe axis). No tolerance required.
- Connector Angle**: The angle is assessed using the information gained by determining the NORM<sub>x</sub> (no uncertainty required).

Probe EX3DV4

SN:3955

Manufactured: August 6, 2013  
Calibrated: November 24, 2015

Calibrated for DASY/EASY Systems  
(Note: non-compatible with DASY2 system!)

## DASY/EASY - Parameters of Probe: EX3DV4 - SN:3955

### Basic Calibration Parameters

	Sensor X	Sensor Y	Sensor Z	Unc (k=2)
Norm ( $\mu\text{V}/(\text{V}/\text{m})^2$ ) <sup>A</sup>	0.35	0.41	0.31	$\pm 10.1\%$
DCP (mV) <sup>B</sup>	103.2	104.2	98.2	

### Modulation Calibration Parameters

UID	Communication System Name		A dB	B dB $\sqrt{\mu\text{V}}$	C	D dB	VR mV	Unc <sup>E</sup> (k=2)
0	CW	X	0.0	0.0	1.0	0.00	130.3	$\pm 3.3\%$
		Y	0.0	0.0	1.0		120.0	
		Z	0.0	0.0	1.0		132.8	

The reported uncertainty of measurement is stated as the standard uncertainty of measurement multiplied by the coverage factor  $k=2$ , which for a normal distribution corresponds to a coverage probability of approximately 95%.

<sup>A</sup> The uncertainties of Norm X,Y,Z do not affect the  $E^2$ -field uncertainty inside TSL (see Pages 5 and 6).

<sup>B</sup> Numerical linearization parameter: uncertainty not required.

<sup>E</sup> Uncertainty is determined using the max. deviation from linear response applying rectangular distribution and is expressed for the square of the field value.

## DASYEASY - Parameters of Probe: EX3DV4 - SN:3955

### Calibration Parameter Determined in Head Tissue Simulating Media

f (MHz) <sup>C</sup>	Relative Permittivity <sup>F</sup>	Conductivity (S/m) <sup>F</sup>	ConvF X	ConvF Y	ConvF Z	Alpha <sup>G</sup>	Depth <sup>G</sup> (mm)	Unc (k=2)
750	41.9	0.89	10.31	10.31	10.31	0.19	1.73	± 12.0 %
835	41.5	0.90	9.96	9.96	9.96	0.18	1.78	± 12.0 %
900	41.5	0.97	9.73	9.73	9.73	0.18	1.89	± 12.0 %
1750	40.1	1.37	8.69	8.69	8.69	0.26	0.85	± 12.0 %
1900	40.0	1.40	8.32	8.32	8.32	0.32	0.88	± 12.0 %
2000	40.0	1.40	8.24	8.24	8.24	0.25	1.01	± 12.0 %
2450	39.2	1.80	7.36	7.36	7.36	0.29	0.98	± 12.0 %
2600	39.0	1.96	7.20	7.20	7.20	0.29	0.99	± 12.0 %
5250	35.9	4.71	5.08	5.08	5.08	0.35	1.80	± 14.0 %
5600	35.5	5.07	4.39	4.39	4.39	0.50	1.80	± 14.0 %
5750	35.4	5.22	4.41	4.41	4.41	0.50	1.80	± 14.0 %

<sup>C</sup> Frequency validity above 300 MHz of ± 100 MHz only applies for DASY v4.4 and higher (see Page 2), else it is restricted to ± 50 MHz. The uncertainty is the RSS of the ConvF uncertainty at calibration frequency and the uncertainty for the indicated frequency band. Frequency validity below 300 MHz is ± 10, 25, 40, 50 and 70 MHz for ConvF assessments at 30, 64, 128, 150 and 220 MHz respectively. Above 5 GHz frequency validity can be extended to ± 110 MHz.

<sup>F</sup> At frequencies up to 6 GHz, the validity of tissue parameters ( $\epsilon$  and  $\sigma$ ) can be relaxed to ± 10% if liquid compensation formula is applied to measured SAR values. The uncertainty is the RSS of the ConvF uncertainty for indicated target tissue parameters.

<sup>G</sup> Alpha/Depth are determined during calibration. SPEAG warrants that the remaining deviation due to the boundary effect after compensation is always less than ± 1% for frequencies below 3 GHz and below ± 2% for frequencies between 3-6 GHz at any distance larger than half the probe tip diameter from the boundary.

## DASY EASY - Parameters of Probe: EX3DV4 - SN:3955

### Calibration Parameter Determined in Body Tissue Simulating Media

f (MHz) <sup>C</sup>	Relative Permittivity <sup>F</sup>	Conductivity (S/m) <sup>F</sup>	ConvF X	ConvF Y	ConvF Z	Alpha <sup>G</sup>	Depth <sup>G</sup> (mm)	Unc (k=2)
750	55.5	0.96	10.36	10.36	10.36	0.25	1.29	± 12.0 %
835	55.2	0.97	10.08	10.08	10.08	0.24	1.39	± 12.0 %
1750	53.4	1.49	8.25	8.25	8.25	0.42	0.80	± 12.0 %
1900	53.3	1.52	7.89	7.89	7.89	0.38	0.89	± 12.0 %
2450	52.7	1.95	7.53	7.53	7.53	0.60	0.70	± 12.0 %
2600	52.5	2.16	7.23	7.23	7.23	0.27	0.99	± 12.0 %
5250	48.9	5.36	4.42	4.42	4.42	0.50	1.90	± 14.0 %
5600	48.5	5.77	3.81	3.81	3.81	0.60	1.90	± 14.0 %
5750	48.3	5.94	3.92	3.92	3.92	0.60	1.90	± 14.0 %

<sup>C</sup> Frequency validity above 300 MHz of ± 100 MHz only applies for DASY v4.4 and higher (see Page 2), else it is restricted to ± 50 MHz. The uncertainty is the RSS of the ConvF uncertainty at calibration frequency and the uncertainty for the indicated frequency band. Frequency validity below 300 MHz is ± 10, 25, 40, 50 and 70 MHz for ConvF assessments at 30, 64, 128, 150 and 220 MHz respectively. Above 5 GHz frequency validity can be extended to ± 110 MHz.

<sup>F</sup> At frequencies up to 6 GHz, the validity of tissue parameters ( $\epsilon$  and  $\sigma$ ) can be relaxed to ± 10% if liquid compensation formula is applied to measured SAR values. The uncertainty is the RSS of the ConvF uncertainty for indicated target tissue parameters.

<sup>G</sup> Alpha/Depth are determined during calibration. SPEAG warrants that the remaining deviation due to the boundary effect after compensation is always less than ± 1% for frequencies below 3 GHz and below ± 2% for frequencies between 3-6 GHz at any distance larger than half the probe tip diameter from the boundary.

# Frequency Response of E-Field

(TEM-Cell:ifi110 EXX, Waveguide: R22)

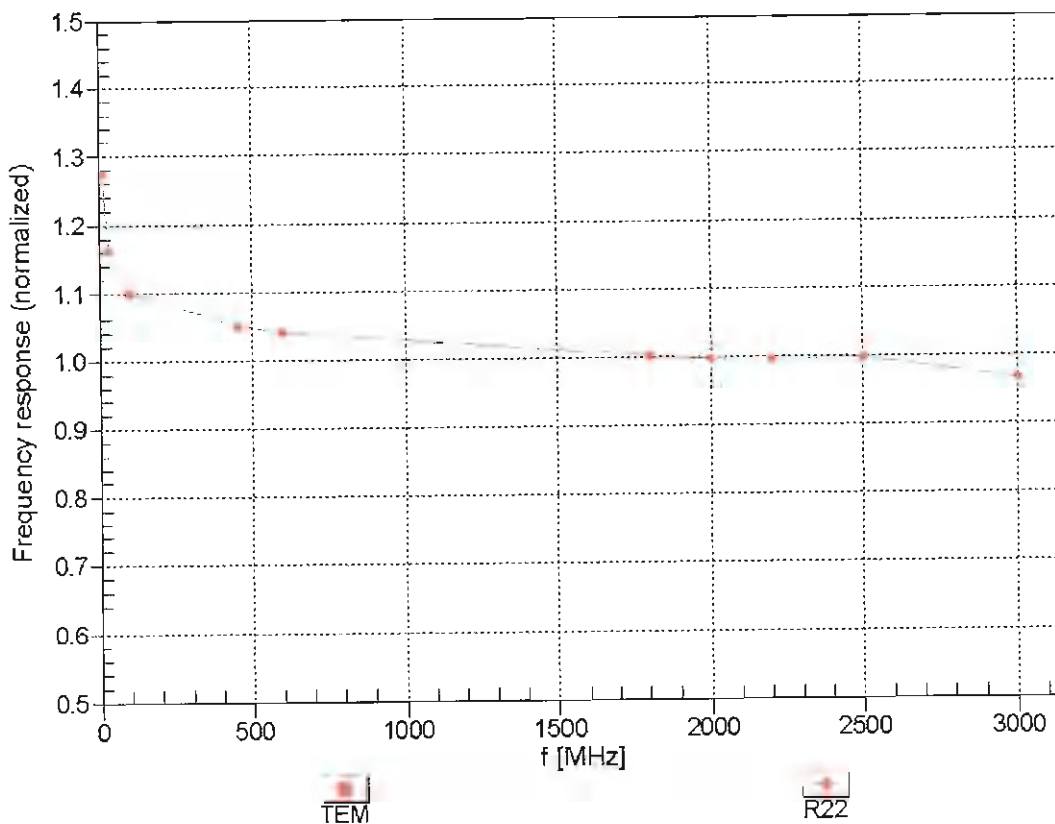

Uncertainty of Frequency Response of E-field:  $\pm 6.3\%$  ( $k=2$ )

# Receiving Pattern $(\phi), \theta = 0^\circ$

f=600 MHz,TEM

f=1800 MHz,R22

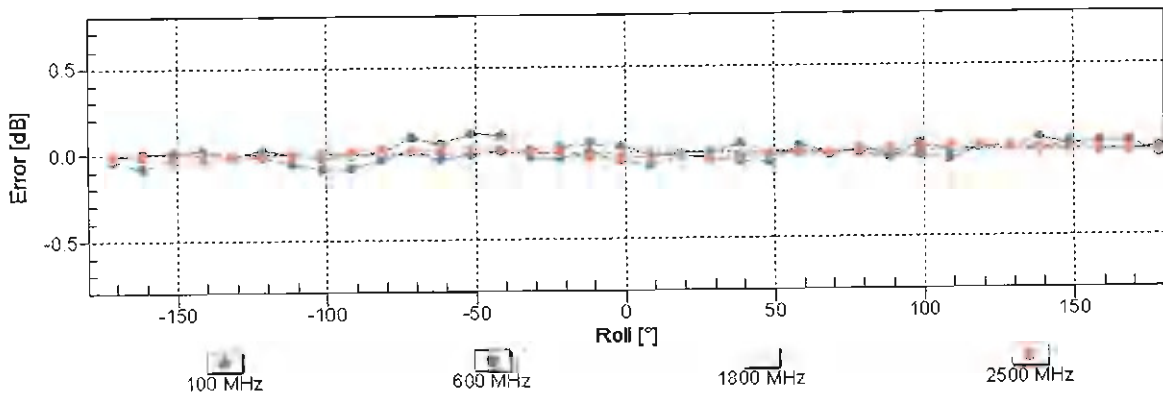
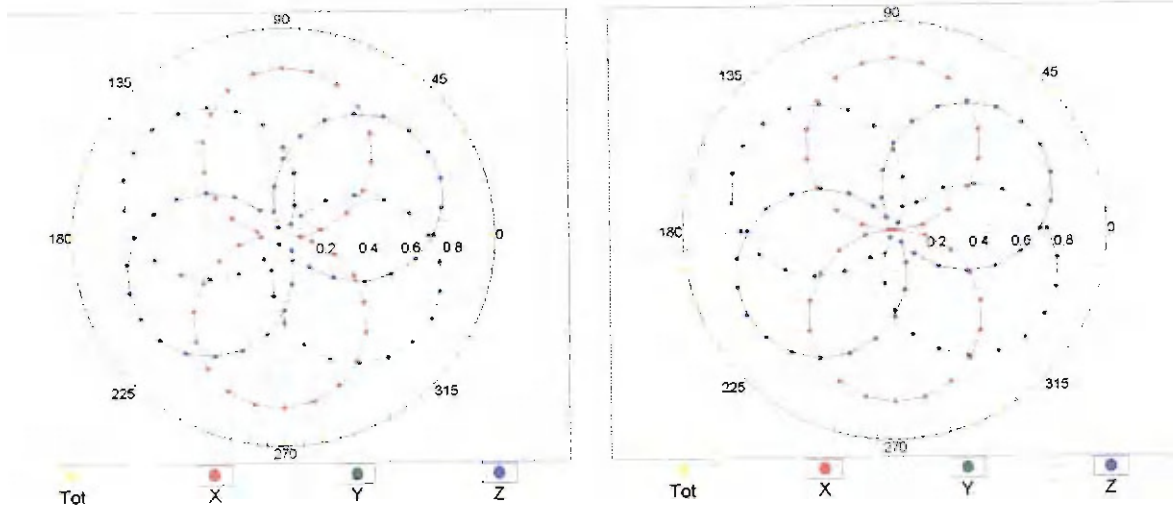

Uncertainty of Axial Isotropy Assessment:  $\pm 0.5\%$  (k=2)



### Dynamic Range f(SAR<sub>head</sub>) (TEM cell , f<sub>eval</sub>= 1900 MHz)

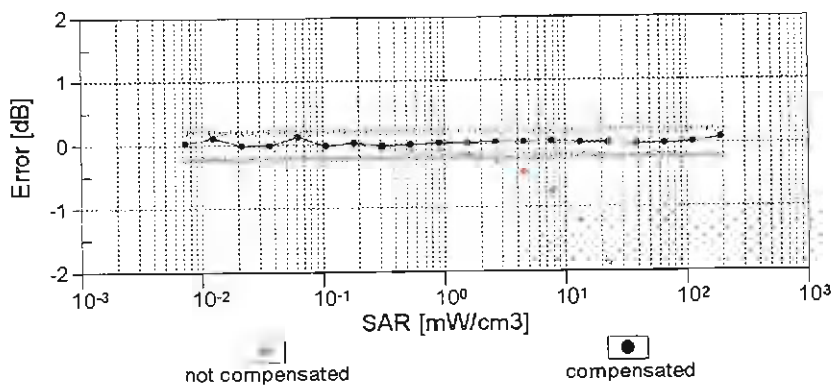
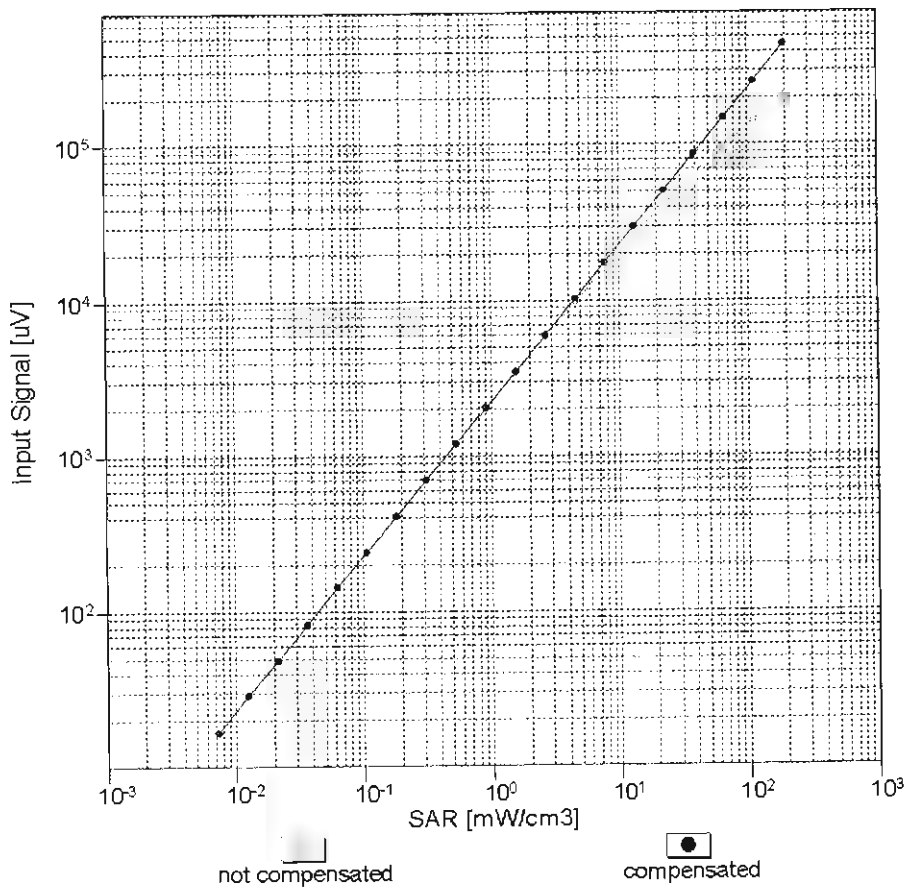

Uncertainty of Linearity Assessment: ± 0.6% (k=2)

# Conversion Factor Assessment

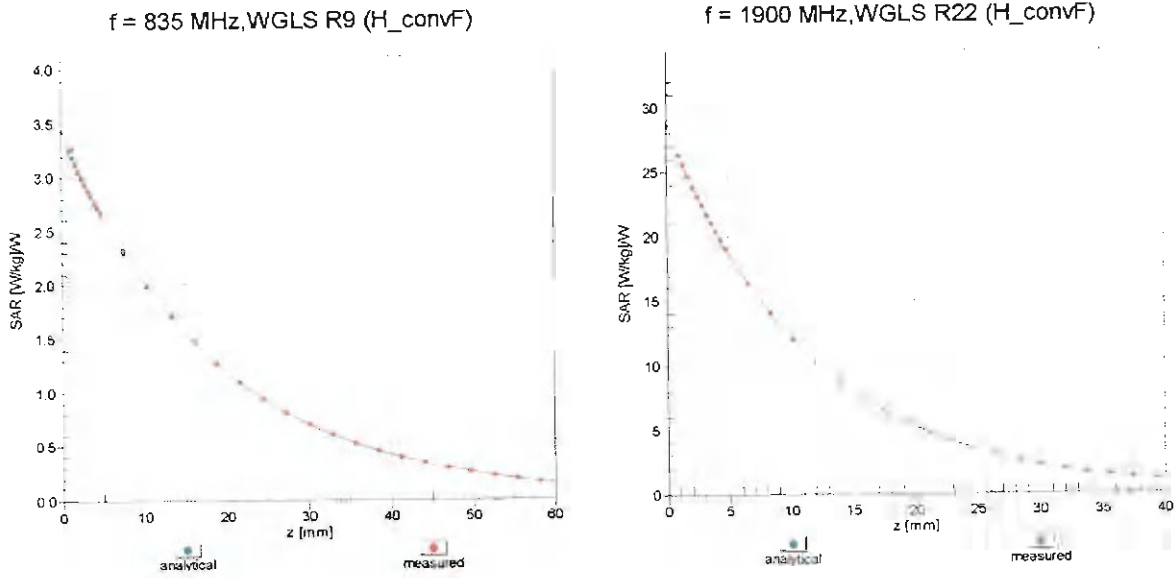

## Deviation from Isotropy in Liquid Error ( $\phi, \theta$ ), f = 900 MHz

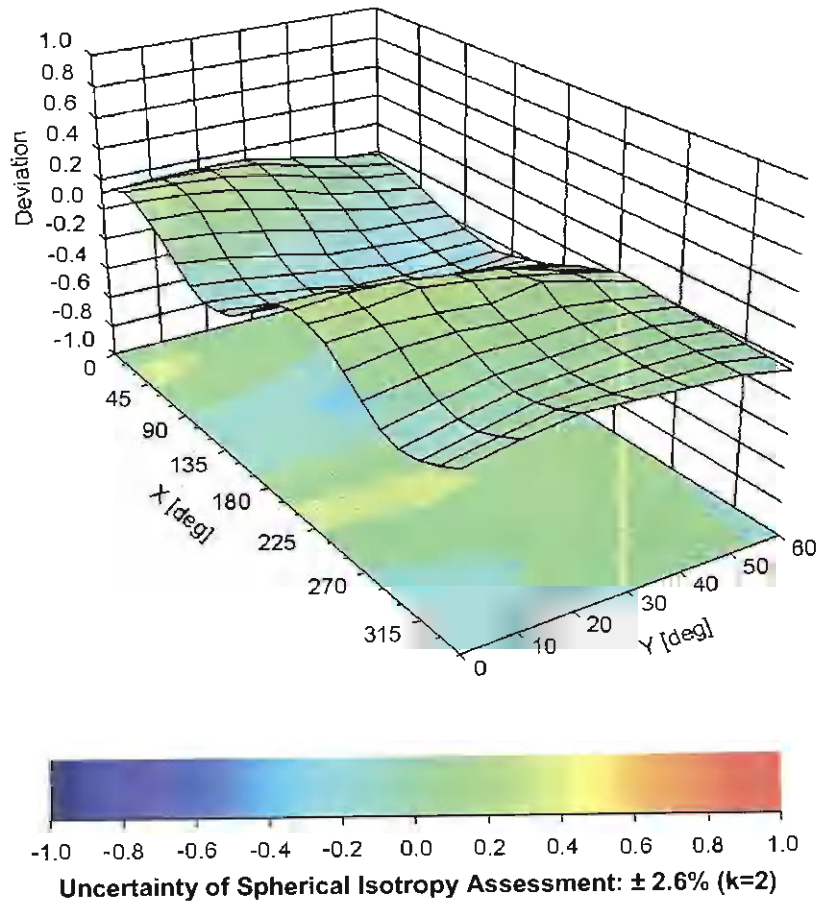

**DASY - ASY - Parameters of Probe: EX3DV4 - SN:3955****Other Probe Parameters**

Sensor Arrangement	Triangular
Connector Angle (°)	128.5
Mechanical Surface Detection Mode	enabled
Optical Surface Detection Mode	disabled
Probe Overall Length	337 mm
Probe Body Diameter	10 mm
Tip Length	9 mm
Tip Diameter	2.5 mm
Probe Tip to Sensor X Calibration Point	1 mm
Probe Tip to Sensor Y Calibration Point	1 mm
Probe Tip to Sensor Z Calibration Point	1 mm
Recommended Measurement Distance from Surface	1.4 mm