



FCC RF Test Report

APPLICANT : Zebra Technologies Corporation
EQUIPMENT : Enterprise Tablet
BRAND NAME : Zebra
MODEL NAME : ET55BT
FCC ID : UZ7ET55BT
STANDARD : FCC Part 15 Subpart E §15.407
CLASSIFICATION : (NII) Unlicensed National Information Infrastructure

The product was received on May 03, 2016 and testing was completed on Jul. 21, 2016. We, SPORTON INTERNATIONAL INC., would like to declare that the tested sample has been evaluated in accordance with the test procedures and has been in compliance with the applicable technical standards.

The test results in this report apply exclusively to the tested model / sample. Without written approval of SPORTON INTERNATIONAL INC., the test report shall not be reproduced except in full.

Reviewed by: Joseph Lin / Supervisor

Approved by: Jones Tsai / Manager



Testing Laboratory
1190

SPORTON INTERNATIONAL INC.

No. 52, Hwa Ya 1st Rd., Hwa Ya Technology Park, Kwei-Shan District, Tao Yuan City, Taiwan, R.O.C.



TABLE OF CONTENTS

REVISION HISTORY 3

SUMMARY OF TEST RESULT 4

1 GENERAL DESCRIPTION 5

 1.1 Applicant 5

 1.2 Manufacturer 5

 1.3 Product Feature of Equipment Under Test 5

 1.4 Product Specification of Equipment Under Test 6

 1.5 Modification of EUT 7

 1.6 Testing Location 7

 1.7 Applicable Standards 8

2 TEST CONFIGURATION OF EQUIPMENT UNDER TEST 9

 2.1 Carrier Frequency and Channel 9

 2.2 Pre-Scanned RF Power 10

 2.3 Test Mode 14

 2.4 Connection Diagram of Test System 15

 2.5 Support Unit used in test configuration and system 16

 2.6 EUT Operation Test Setup 17

 2.7 Measurement Results Explanation Example 17

3 TEST RESULT 18

 3.1 6dB and 26dB and 99% Occupied Bandwidth Measurement 18

 3.2 Maximum Conducted Output Power Measurement 23

 3.3 Power Spectral Density Measurement 25

 3.4 Unwanted Emissions Measurement 29

 3.5 AC Conducted Emission Measurement 35

 3.6 Frequency Stability Measurement 39

 3.7 Automatically Discontinue Transmission 40

 3.8 Antenna Requirements 41

4 LIST OF MEASURING EQUIPMENT 44

5 UNCERTAINTY OF EVALUATION 45

APPENDIX A. CONDUCTED TEST RESULTS

APPENDIX B. RADIATED SPURIOUS EMISSION

APPENDIX C. RADIATED SPURIOUS EMISSION PLOTS

APPENDIX D. DUTY CYCLE PLOTS

APPENDIX E. SETUP PHOTOGRAPHS



SUMMARY OF TEST RESULT

Report Section	FCC Rule	Description	Limit	Result	Remark
3.1	15.403(i)	6dB, 26dB and 99% Occupied Bandwidth	> 500kHz	Pass	-
3.2	15.407(a)	Maximum Conducted Output Power	≤ 30 dBm	Pass	-
3.3	15.407(a)	Power Spectral Density	≤ 30 dBm/500kHz	Pass	-
3.4	15.407(b)	Unwanted Emissions	15.407(b)(4)(i) & 15.209(a)	Pass	Under limit 4.81 dB at 780.200 MHz
3.5	15.207	AC Conducted Emission	15.207(a)	Pass	Under limit 16.70 dB at 0.206 MHz
3.6	15.407(g)	Frequency Stability	Within Operation Band	Pass	-
3.7	15.407(c)	Automatically Discontinue Transmission	Discontinue Transmission	Pass	-
3.8	15.203 & 15.407(a)	Antenna Requirement	N/A	Pass	-



1 General Description

1.1 Applicant

Zebra Technologies Corporation
1 Zebra Plaza, Holtsville, NY 11742

1.2 Manufacturer

Zebra Technologies Corporation
1 Zebra Plaza, Holtsville, NY 11742

1.3 Product Feature of Equipment Under Test

Product Feature	
Equipment	Enterprise Tablet
Brand Name	Zebra
Model Name	ET55BT
FCC ID	UZ7ET55BT
EUT supports Radios application	CDMA/EV-DO/GSM/EGPRS/WCDMA/HSPA/LTE/NFC WLAN 11a/b/g/n HT20/HT40 WLAN 11ac VHT20/VHT40/VHT80 Bluetooth v4.0 EDR/LE
HW Version	DV1
SW Version	5.1.1
FW Version	7.35.205.4
MFD	31-Mar-16
EUT Stage	Identical Prototype

Remark: The above EUT's information was declared by manufacturer. Please refer to the specifications or user's manual for more detailed description.



1.4 Product Specification of Equipment Under Test

Standards-related Product Specification	
Tx/Rx Channel Frequency Range	5745 MHz ~ 5825 MHz
Maximum Output Power <CDD Modes>	<p>SISO <Ant. 1> 802.11a : 11.36 dBm / 0.0137 W 802.11n HT20 : 11.43 dBm / 0.0139 W 802.11n HT40 : 11.31 dBm / 0.0135 W 802.11ac VHT20: 11.49 dBm / 0.0141 W 802.11ac VHT40: 11.49 dBm / 0.0141 W 802.11ac VHT80: 10.98 dBm / 0.0125 W</p> <p>SISO <Ant. 2> 802.11a : 12.99 dBm / 0.0199 W 802.11n HT20 : 12.85 dBm / 0.0193 W 802.11n HT40 : 12.77 dBm / 0.0189 W 802.11ac VHT20: 12.90 dBm / 0.0195 W 802.11ac VHT40: 12.79 dBm / 0.0190 W 802.11ac VHT80: 12.37 dBm / 0.0173 W</p> <p>MIMO <Ant. 1 + 2> 802.11a : 14.46 dBm / 0.0279 W 802.11n HT20 : 14.24 dBm / 0.0265 W 802.11n HT40 : 14.48 dBm / 0.0281 W 802.11ac VHT20: 14.31 dBm / 0.0270 W 802.11ac VHT40: 14.49 dBm / 0.0281 W 802.11ac VHT80: 13.98 dBm / 0.0250 W</p>
Maximum Output Power <TXBF Modes>	<p>MIMO <Ant. 1 + 2> 802.11a : 14.30 dBm / 0.0269 W 802.11n HT20 : 14.23 dBm / 0.0265 W 802.11n HT40 : 14.37 dBm / 0.0274 W 802.11ac VHT20: 14.41 dBm / 0.0276 W 802.11ac VHT40: 14.47 dBm / 0.0280 W 802.11ac VHT80: 14.41 dBm / 0.0276 W</p>
99% Occupied Bandwidth <CDD Modes>	802.11a : 18.45 MHz 802.11n HT20 : 19.15 MHz 802.11n HT40 : 41.58 MHz 802.11ac VHT20 : 19.15 MHz 802.11ac VHT40 : 36.80 MHz 802.11ac VHT80 : 75.96 MHz
99% Occupied Bandwidth <TXBF Modes>	802.11a : 18.00 MHz 802.11n HT20 : 18.85 MHz 802.11n HT40 : 36.90 MHz 802.11ac VHT20 : 19.10 MHz 802.11ac VHT40 : 36.80 MHz 802.11ac VHT80 : 76.20 MHz
Type of Modulation	802.11a/n : OFDM (BPSK / QPSK / 16QAM / 64QAM) 802.11ac : OFDM (BPSK / QPSK / 16QAM / 64QAM / 256QAM)
Antenna Type	Main Antenna : Ceramic Chip Antenna Aux. Antenna : Ceramic Chip Antenna
Antenna Gain	Main Antenna : 0.60 dBi Aux. Antenna : 1.10 dBi

Standards-related Product Specification			
Antenna Function Description		Ant. 1	Ant. 2
	802.11 a/n/ac SISO	V	V
	802.11 a/n/ac MIMO	V	V

1.5 Modification of EUT

No modifications are made to the EUT during all test items.

1.6 Testing Location

Sporton Lab is accredited to ISO 17025 by Taiwan Accreditation Foundation (TAF code : 1190) and the FCC designation No. TW1022 under the FCC 2.948(e) by Mutual Recognition Agreement (MRA) in FCC Test.

Test Site	SPORTON INTERNATIONAL INC.		
Test Site Location	No. 52, Hwa Ya 1 st Rd., Hwa Ya Technology Park, Kwei-Shan District, Tao Yuan City, Taiwan, R.O.C. TEL: +886-3-327-3456 FAX: +886-3-328-4978		
Test Site No.	Sporton Site No.		
	TH05-HY	CO05-HY	03CH07-HY

Note: The test site complies with ANSI C63.4 2014 requirement.



1.7 Applicable Standards

According to the specifications of the manufacturer, the EUT must comply with the requirements of the following standards:

- ♦ FCC Part 15 Subpart E
- ♦ FCC KDB 789033 D02 General UNII Test Procedures New Rules v01r02
- ♦ FCC KDB 662911 D01 Multiple Transmitter Output v02r01.
- ♦ FCC KDB 644545 D03 Guidance for IEEE 802 11ac New Rules v01
- ♦ ANSI C63.10-2013

Remark:

1. All test items were verified and recorded according to the standards and without any deviation during the test.
2. This EUT has also been tested and complied with the requirements of FCC Part 15, Subpart B, recorded in a separate test report.



2 Test Configuration of Equipment Under Test

The EUT has been associated with peripherals and configuration operated in a manner tended to maximize its emission characteristics in a typical application. Frequency range investigated: conducted emission (150 kHz to 30 MHz) and radiated emission (9 kHz to the 10th harmonic of the highest fundamental frequency or to 40 GHz, whichever is lower). For radiated measurement, pre-scanned in three orthogonal panels, X, Y, Z. The worst cases (Y plane for Ant. 1 in CDD Modes; X plane for Ant. 1+2 in CDD Modes and TXBF Modes) were recorded in this report.

2.1 Carrier Frequency and Channel

Frequency Band	Channel	Freq. (MHz)	Channel	Freq. (MHz)
5725-5850 MHz Band 4 (U-NII-3)	149	5745	157	5785
	151	5755	159	5795
	153	5765	161	5805
	155	5775	165	5825

Note: The above Frequency and Channel in boldface were 802.11n HT40.



2.2 Pre-Scanned RF Power

Preliminary tests were performed in different data rate and data rate associated with the highest power were chosen for full test in the following tables.

<CDD Modes>

SISO <Ant. 1>

5GHz 802.11a mode								
Data Rate (MHz)	6M bps	9M bps	12M bps	18M bps	24M bps	36M bps	48M bps	54M bps
Average Power (dBm)	11.36	11.24	11.35	11.33	9.58	9.50	9.63	9.59

5GHz 802.11n HT20 mode								
Data Rate (MHz)	MCS0	MCS1	MCS2	MCS3	MCS4	MCS5	MCS6	MCS7
Average Power (dBm)	11.43	11.39	11.42	9.80	9.86	9.98	10.04	9.20

5GHz 802.11n HT40 mode								
Data Rate (MHz)	MCS0	MCS1	MCS2	MCS3	MCS4	MCS5	MCS6	MCS7
Average Power (dBm)	11.31	11.29	11.30	10.14	10.18	10.21	9.97	9.18

5GHz 802.11ac VHT20 mode									
Data Rate (MHz)	MCS 0	MCS 1	MCS 2	MCS 3	MCS 4	MCS 5	MCS 6	MCS 7	MCS 8
Average Power (dBm)	11.49	11.48	11.45	10.23	10.43	10.20	10.18	9.22	9.28

5GHz 802.11ac VHT40 mode										
Data Rate (MHz)	MCS 0	MCS 1	MCS 2	MCS 3	MCS 4	MCS 5	MCS 6	MCS 7	MCS 8	MCS 9
Average Power (dBm)	11.49	11.46	11.48	10.36	10.34	10.44	10.18	9.13	8.73	8.27

5GHz 802.11ac VHT80 mode										
Data Rate (MHz)	MCS 0	MCS 1	MCS 2	MCS 3	MCS 4	MCS 5	MCS 6	MCS 7	MCS 8	MCS 9
Average Power (dBm)	10.98	10.96	10.94	10.92	10.97	10.93	10.90	10.42	8.88	8.56



SISO <Ant. 2>

5GHz 802.11a mode								
Data Rate (MHz)	6M bps	9M bps	12M bps	18M bps	24M bps	36M bps	48M bps	54M bps
Average Power (dBm)	12.99	12.95	12.96	12.98	11.57	11.40	11.52	11.58

5GHz 802.11n HT20 mode								
Data Rate (MHz)	MCS0	MCS1	MCS2	MCS3	MCS4	MCS5	MCS6	MCS7
Average Power (dBm)	12.85	12.83	12.84	11.54	11.81	11.66	11.67	10.77

5GHz 802.11n HT40 mode								
Data Rate (MHz)	MCS0	MCS1	MCS2	MCS3	MCS4	MCS5	MCS6	MCS7
Average Power (dBm)	12.77	12.75	12.73	11.95	11.83	11.94	11.98	10.88

5GHz 802.11ac VHT20 mode									
Data Rate (MHz)	MCS 0	MCS 1	MCS 2	MCS 3	MCS 4	MCS 5	MCS 6	MCS 7	MCS 8
Average Power (dBm)	12.90	12.88	12.86	11.62	11.76	11.76	11.76	10.79	10.87

5GHz 802.11ac VHT40 mode										
Data Rate (MHz)	MCS 0	MCS 1	MCS 2	MCS 3	MCS 4	MCS 5	MCS 6	MCS 7	MCS 8	MCS 9
Average Power (dBm)	12.79	12.77	12.78	11.89	11.85	11.93	11.84	10.98	10.24	9.79

5GHz 802.11ac VHT80 mode										
Data Rate (MHz)	MCS 0	MCS 1	MCS 2	MCS 3	MCS 4	MCS 5	MCS 6	MCS 7	MCS 8	MCS 9
Average Power (dBm)	12.37	12.35	12.34	12.36	12.32	12.31	12.30	11.54	9.80	9.60



MIMO <Ant. 1+2>

5GHz 802.11a mode								
Data Rate (MHz)	6M bps	9M bps	12M bps	18M bps	24M bps	36M bps	48M bps	54M bps
Average Power (dBm)	14.46	14.44	14.43	14.45	12.84	12.88	13.08	12.92

5GHz 802.11n HT20 mode								
Data Rate (MHz)	MCS 0	MCS 1	MCS 2	MCS 3	MCS 4	MCS 5	MCS 6	MCS 7
Average Power (dBm)	14.24	14.21	14.20	12.69	12.84	12.83	12.68	11.74

5GHz 802.11n HT40 mode								
Data Rate (MHz)	MCS 0	MCS 1	MCS 2	MCS 3	MCS 4	MCS 5	MCS 6	MCS 7
Average Power (dBm)	14.48	14.43	14.44	13.26	13.41	13.33	13.35	12.38

5GHz 802.11ac VHT20 mode									
Data Rate (MHz)	MCS 0	MCS 1	MCS 2	MCS 3	MCS 4	MCS 5	MCS 6	MCS 7	MCS 8
Average Power (dBm)	14.31	14.28	14.29	12.79	12.62	12.61	12.73	11.87	11.81

5GHz 802.11ac VHT40 mode										
Data Rate (MHz)	MCS 0	MCS 1	MCS 2	MCS 3	MCS 4	MCS 5	MCS 6	MCS 7	MCS 8	MCS 9
Average Power (dBm)	14.49	14.46	14.47	13.28	13.40	13.39	13.40	12.46	11.93	11.39

5GHz 802.11ac VHT80 mode										
Data Rate (MHz)	MCS 0	MCS 1	MCS 2	MCS 3	MCS 4	MCS 5	MCS 6	MCS 7	MCS 8	MCS 9
Average Power (dBm)	13.98	13.97	13.93	13.89	13.96	13.94	13.91	12.97	11.51	11.60

Note: MIMO Ant. 1+2 is a calculated result from sum of the power MIMO Ant. 1 and MIMO Ant. 2.



<TXBF Modes>

MIMO <Ant. 1+2>

5GHz 802.11a mode								
Data Rate (MHz)	6M bps	9M bps	12M bps	18M bps	24M bps	36M bps	48M bps	54M bps
Average Power (dBm)	14.30	14.20	14.20	14.10	14.10	14.15	14.14	14.20

5GHz 802.11n HT20 mode								
Data Rate (MHz)	MCS 0	MCS 1	MCS 2	MCS 3	MCS 4	MCS 5	MCS 6	MCS 7
Average Power (dBm)	14.23	14.13	14.13	14.03	14.03	14.03	14.13	14.13

5GHz 802.11n HT40 mode								
Data Rate (MHz)	MCS 0	MCS 1	MCS 2	MCS 3	MCS 4	MCS 5	MCS 6	MCS 7
Average Power (dBm)	14.37	14.27	14.27	14.17	14.17	14.12	14.17	14.27

5GHz 802.11ac VHT20 mode									
Data Rate (MHz)	MCS 0	MCS 1	MCS 2	MCS 3	MCS 4	MCS 5	MCS 6	MCS 7	MCS 8
Average Power (dBm)	14.41	14.31	14.31	14.26	14.21	14.17	14.16	14.26	14.31

5GHz 802.11ac VHT40 mode										
Data Rate (MHz)	MCS 0	MCS 1	MCS 2	MCS 3	MCS 4	MCS 5	MCS 6	MCS 7	MCS 8	MCS 9
Average Power (dBm)	14.47	14.37	14.37	14.32	14.37	14.37	14.32	14.27	14.27	14.37

5GHz 802.11ac VHT80 mode										
Data Rate (MHz)	MCS 0	MCS 1	MCS 2	MCS 3	MCS 4	MCS 5	MCS 6	MCS 7	MCS 8	MCS 9
Average Power (dBm)	14.41	14.31	14.31	14.27	14.21	14.21	14.26	14.31	14.21	14.31

Note: MIMO Ant. 1+2 is a calculated result from sum of the power MIMO Ant. 1 and MIMO Ant. 2.



2.3 Test Mode

Final test mode of conducted test items and radiated spurious emissions are considering the modulation and worse data rates from the power table described in section 2.2.

Modulation	Data Rate
802.11a	6 Mbps
802.11n HT20	MCS0
802.11n HT40	MCS0
802.11ac VHT20	MCS0
802.11ac VHT40	MCS0
802.11ac VHT80	MCS0

AC Conducted Emission	Mode 1 : Bluetooth Link + WLAN (5GHz) Link + USB Cable (Charging from Adapter) + Earphone + Battery
------------------------------	---

Ch. #		Band IV : 5725-5850 MHz		
		802.11a	802.11n HT20	802.11n HT40
L	Low	149	149	151
M	Middle	157	157	-
H	High	165	165	159

Ch. #		Band IV : 5725-5850 MHz		
		802.11ac VHT20	802.11ac VHT40	802.11ac VHT80
L	Low	149	151	-
M	Middle	157	-	155
H	High	165	159	-

2.4 Connection Diagram of Test System

<WLAN Tx Non-TXBF Mode>

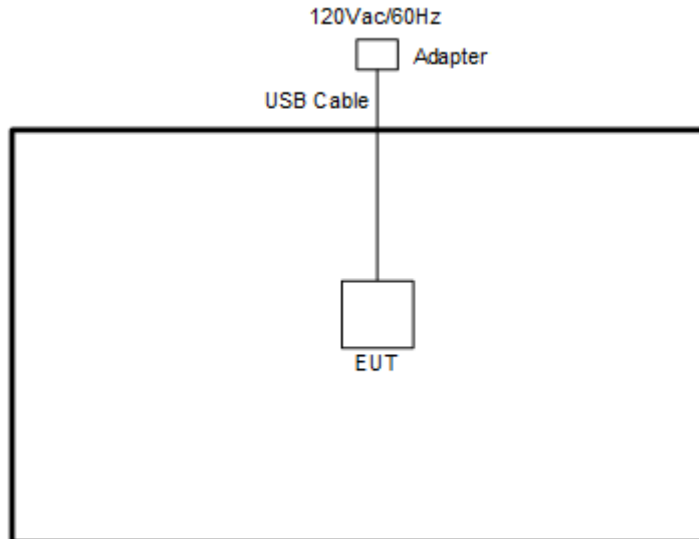

<WLAN Tx TXBF Mode>

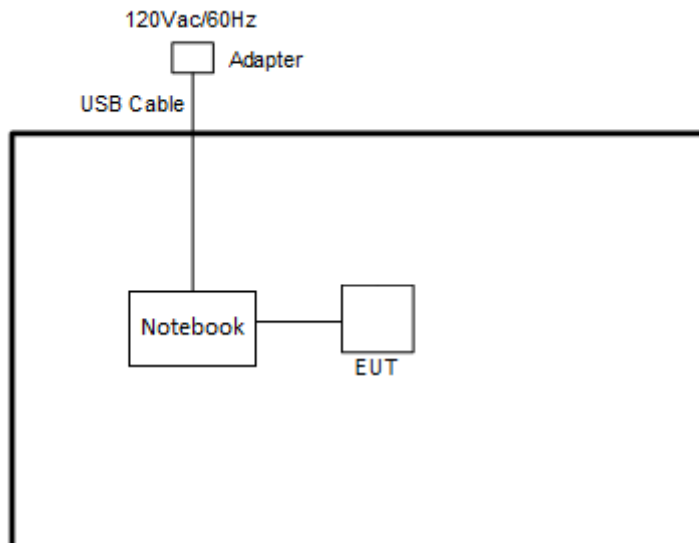

<AC Conducted Emission Mode>

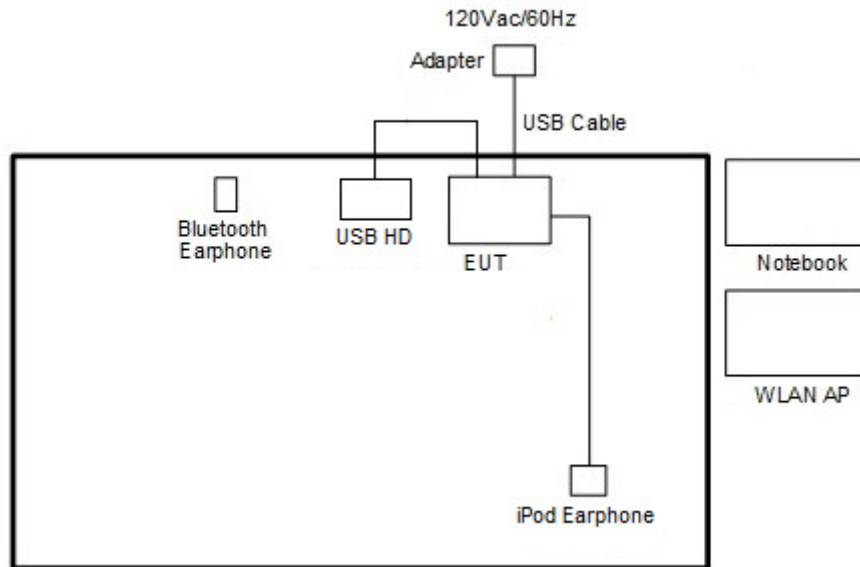

2.5 Support Unit used in test configuration and system

Item	Equipment	Trade Name	Model Name	FCC ID	Data Cable	Power Cord
1.	Bluetooth Earphone	Sony Ericsson	MW600	PY7DDA-2029	N/A	N/A
2.	WLAN AP	D-Link	DIR-865L	KA2IR865LA1	N/A	Unshielded, 1.8 m
3.	Notebook	DELL	Latitude E6320	FCC DoC/ Contains FCC ID: QDS-BRCM1054	N/A	AC I/P: Unshielded, 1.2 m DC O/P: Shielded, 1.8 m
4.	USB2.0 HD	WD	WDBAAR3200 ABK-PESN	FCC DoC	Unshielded, 0.5 m	N/A
5.	iPod Earphone	Apple	N/A	Verification	Unshielded, 1.0 m	N/A
6.	Adapter	Delta Electronics	ADP-10BWC	FCC DoC	N/A	N/A
7.	SD Card	SanDisk	MicroSD HC	FCC DoC	N/A	N/A



2.6 EUT Operation Test Setup

For Non-TXBF modes programmed RF utility is installed in EUT to provide channel selection, power level, data rate and the application type. RF Utility can send transmitting signal for all testing. The RF output power selection is for the setting of RF output power expected by the customer and is going to be fixed on the firmware of the final end product.

For WLAN MIMO TXBF modes, the EUT was tested under normal operation and link to another EUT with power, modulation modes and data rates controlled by engineer mode command lines. The iperf software tool was used to make EUT continuous transmitting signals.

2.7 Measurement Results Explanation Example

For all conducted test items:

The offset level is set in the spectrum analyzer to compensate the RF cable loss and attenuator factor between EUT conducted output port and spectrum analyzer. With the offset compensation, the spectrum analyzer reading level is exactly the EUT RF output level.

Example :

The spectrum analyzer offset is derived from RF cable loss and attenuator factor.

Offset = RF cable loss + attenuator factor.

Following shows an offset computation example with cable loss 4.2 dB and 10dB attenuator.

$$\begin{aligned} \text{Offset(dB)} &= \text{RF cable loss(dB)} + \text{attenuator factor(dB)}. \\ &= 4.2 + 10 = 14.2 \text{ (dB)} \end{aligned}$$

3 Test Result

3.1 6dB and 26dB and 99% Occupied Bandwidth Measurement

3.1.1 Description of 6dB and 26dB and 99% Occupied Bandwidth

The minimum 6 dB bandwidth shall be at least 500 kHz.

26dB and 99% Occupied bandwidth are reporting only.

3.1.2 Measuring Instruments

The measuring equipment is listed in the section 4 of this test report.

3.1.3 Test Procedures

1. The testing follows FCC KDB 789033 D02 General UNII Test Procedures New Rules v01r02. Section C) Emission bandwidth for the band 5.725-5.85GHz
2. Set RBW = 100kHz.
3. Set the VBW $\geq 3 \times$ RBW.
4. Detector = Peak.
5. Trace mode = max hold
6. Measure the maximum width of the emission that is 6 dB down from the peak of the emission.
7. Measure and record the results in the test report.

3.1.4 Test Setup

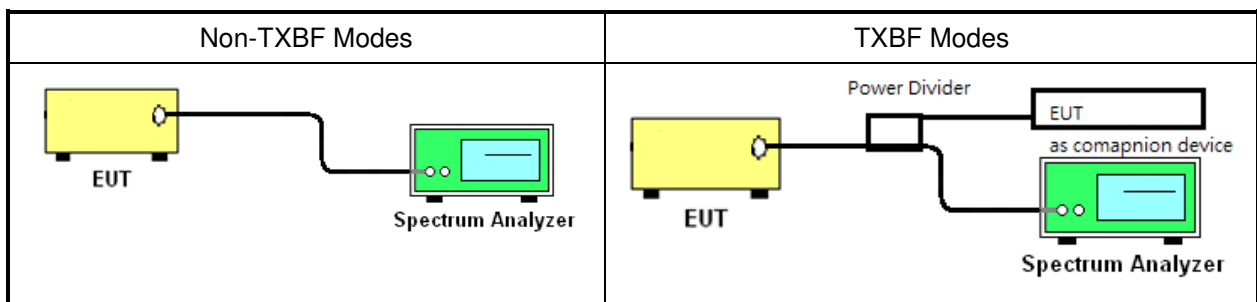

3.1.5 Test Result of 6dB Bandwidth

Please refer to Appendix A.



<CDD Mode>

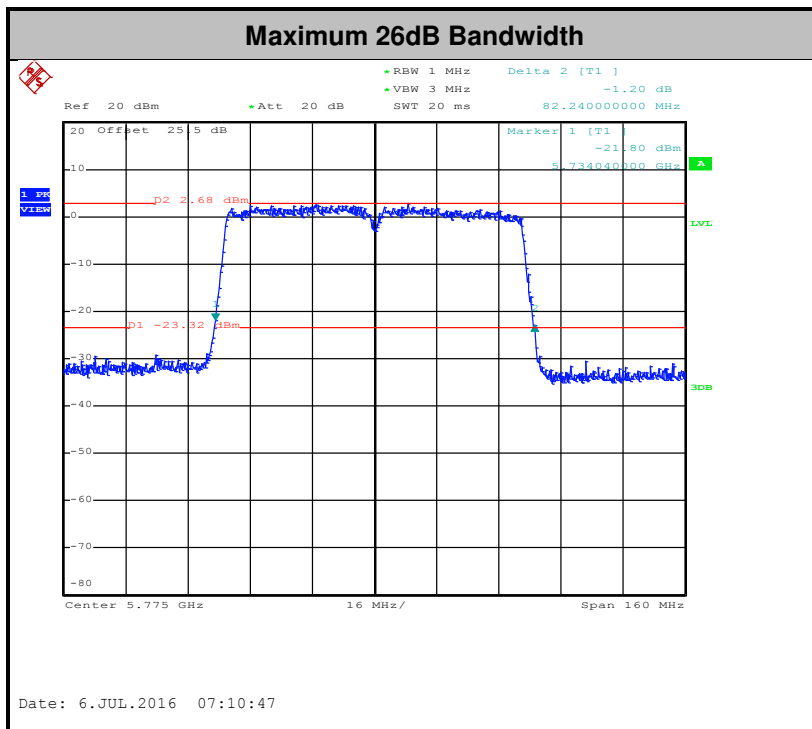
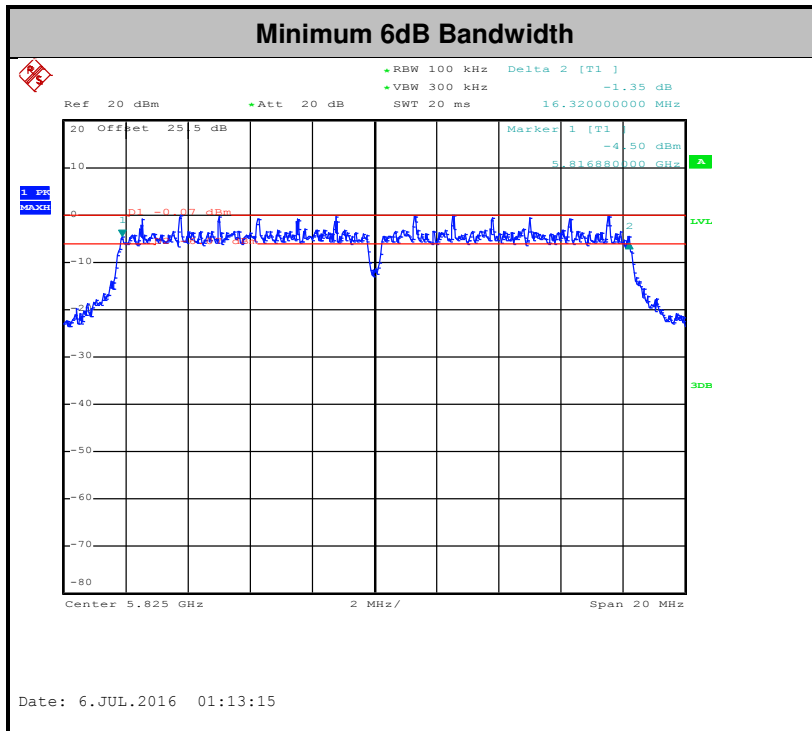

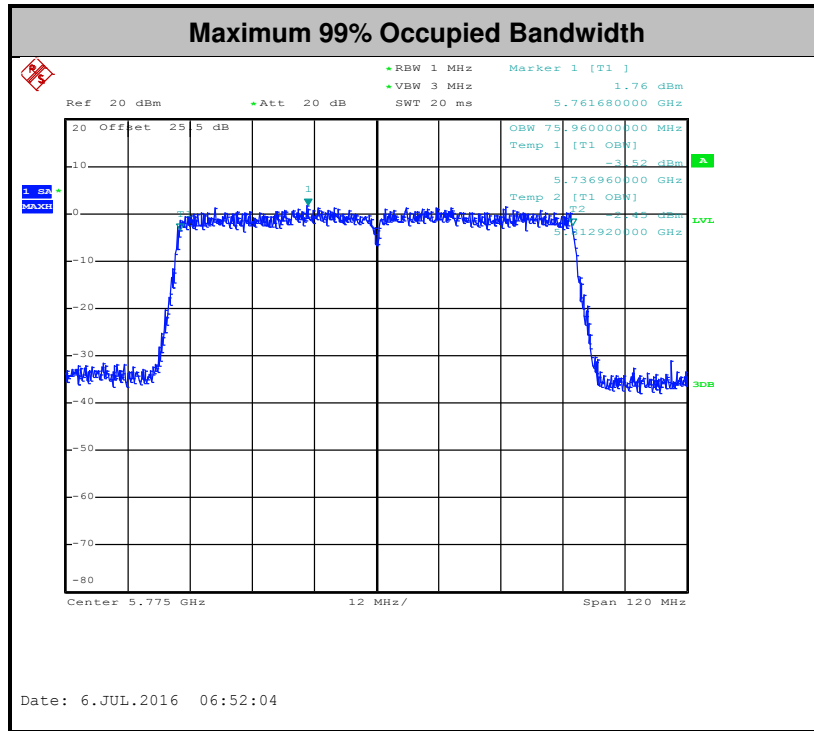

Note: The occupied channel bandwidth is maintained within the band of operation for all of the modulations.



<TXBF Mode>

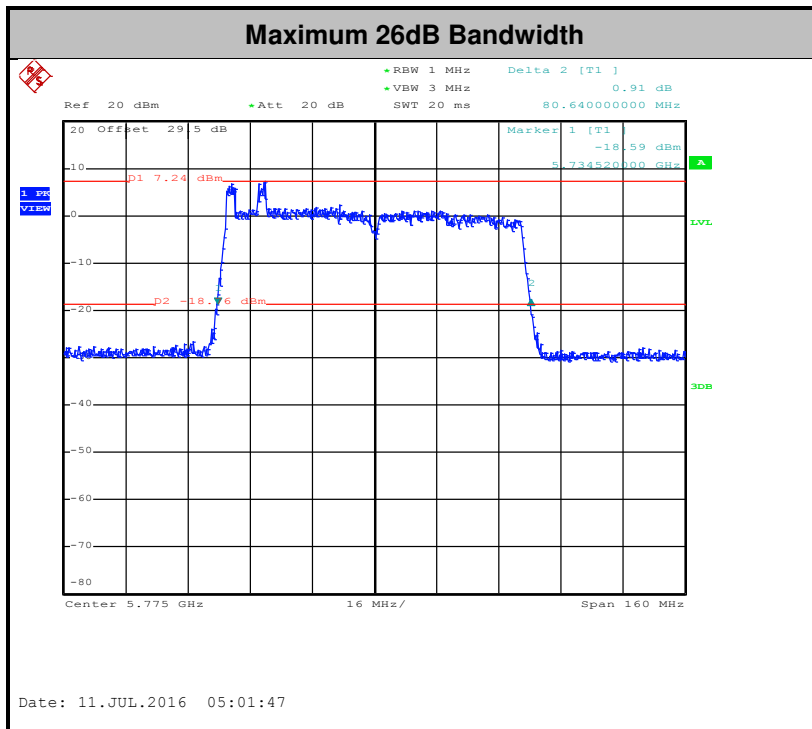
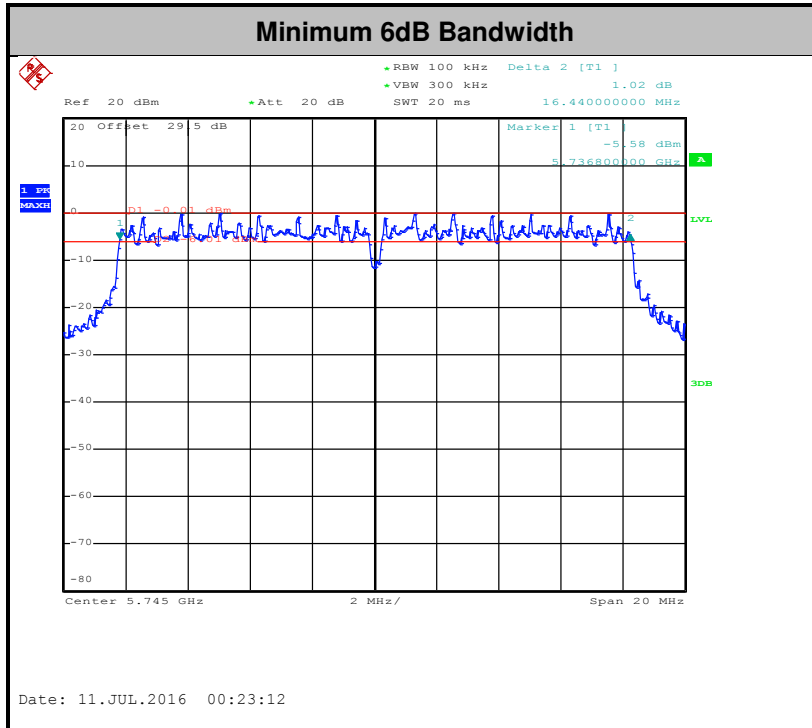

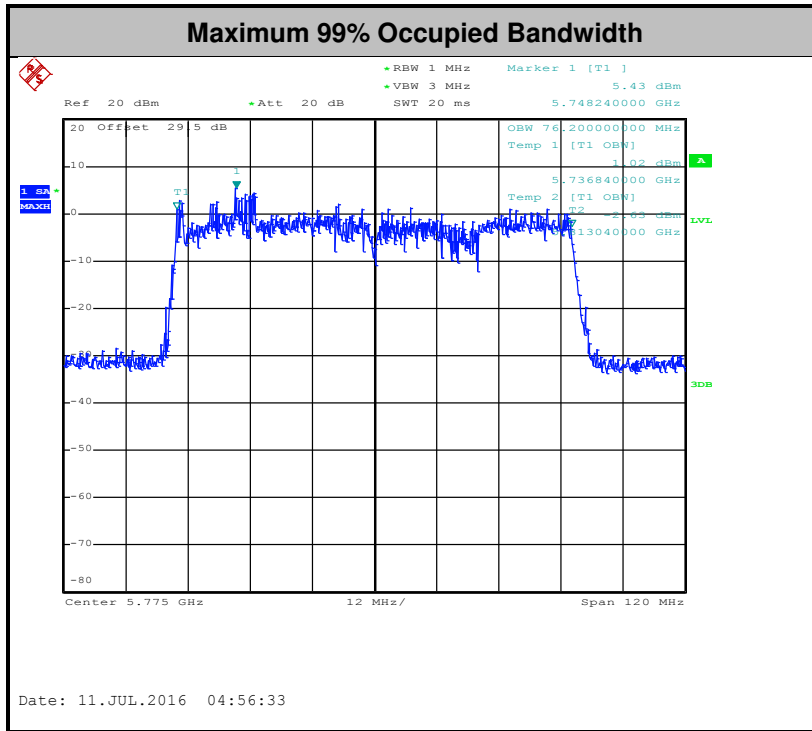

Note: The occupied channel bandwidth is maintained within the band of operation for all of the modulations.



3.2 Maximum Conducted Output Power Measurement

3.2.1 Limit of Maximum Conducted Output Power

For the band 5.725–5.85 GHz, the maximum conducted output power over the frequency band of operation shall not exceed 1 W.

If transmitting antennas of directional gain greater than 6 dBi are used, the peak output power shall be reduced by the amount in dB that the directional gain of the antenna exceeds 6 dBi.

3.2.2 Measuring Instruments

The measuring equipment is listed in the section 4 of this test report.

3.2.3 Test Procedures

CDD modes

The testing follows Method PM of FCC KDB 789033 D02 General UNII Test Procedures New Rules v01r02.

Method PM (Measurement using an RF average power meter):

1. Measurement is performed using a wideband RF power meter.
2. The EUT is configured to transmit continuously with a consistent duty cycle at its maximum power control level.
3. Measure the average power of the transmitter, and the average power is corrected with duty factor, $10 \log(1/x)$, where x is the duty cycle.

TXBF modes

The testing follows Method PM-G of FCC KDB 789033 D02 General UNII Test Procedures New Rules v01r02 for TXBF modes.

Method PM-G (Measurement using a gated RF average power meter):

1. Measurement is performed using a wideband RF power meter.
2. The EUT is configured to transmit at its maximum power control level.
3. Measure the average power of the transmitter
4. Since the measurement is made only during the ON time of the transmitter, no duty cycle correction factor is required.

3.2.4 Test Setup

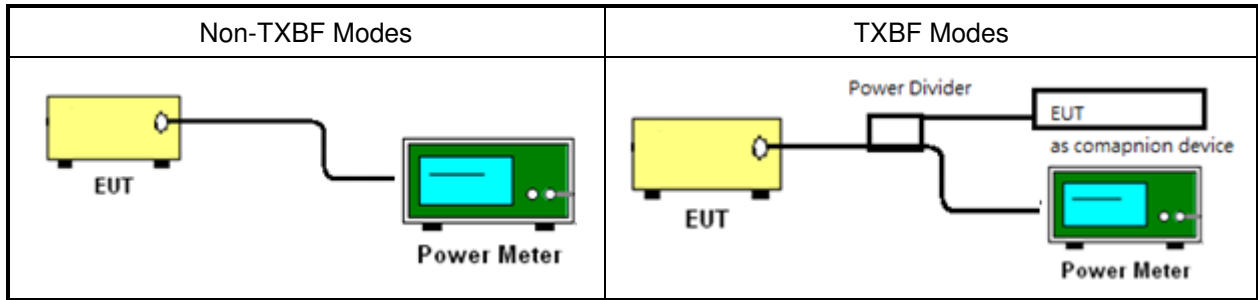

3.2.5 Test Result of Maximum Conducted Output Power

Please refer to Appendix A.



3.3 Power Spectral Density Measurement

3.3.1 Limit of Power Spectral Density

For the band 5.725–5.85 GHz, the maximum power spectral density shall not exceed 30 dBm in any 500-kHz band.

If transmitting antennas of directional gain greater than 6 dBi are used, the peak output power shall be reduced by the amount in dB that the directional gain of the antenna exceeds 6 dBi.

3.3.2 Measuring Instruments

The measuring equipment is listed in the section 4 of this test report.

3.3.3 Test Procedures

The testing follows FCC KDB 789033 D02 General UNII Test Procedures New Rules v01r02. Section F) Maximum power spectral density.

CDD modes

Method SA-2

(trace averaging across on and off times of the EUT transmissions, followed by duty cycle correction).

- Measure the duty cycle.
- Set span to encompass the entire emission bandwidth (EBW) of the signal.
- Set RBW = 300 kHz.
- Set VBW \geq 1 MHz.
- Number of points in sweep \geq 2 Span / RBW.
- Sweep time = auto.
- Detector = RMS
- Trace average at least 100 traces in power averaging mode.
- Add $10 \log(500\text{kHz}/\text{RBW})$ to the test result.
- Add $10 \log(1/x)$, where x is the duty cycle, to the measured power in order to compute the average power during the actual transmission times. For example, add $10 \log(1/0.25) = 6$ dB if the duty cycle is 25 percent.

TXBF modes**# Method SA-3 #**

(power averaging (rms) detection with max hold):

- Set span to encompass the entire emission bandwidth (EBW) of the signal.
 - Set RBW = 300 kHz.
 - Set VBW \geq 1 MHz.
 - Number of points in sweep \geq 2 Span / RBW.
 - Sweep time \leq (number of points in sweep) \times T, when duty cycle is less than 98 percent where T is the minimum transmission duration over which the transmitter is on and is transmitting at its maximum power control level for the tested mode of operation.
 - Detector = power averaging (rms).
 - Trace mode = max hold.
 - Allow max hold to run for at least 60 seconds, or longer as needed to allow the trace to stabilize.
1. The RF output of EUT was connected to the spectrum analyzer by a low loss cable.
 2. Each plot has already offset with cable loss, and attenuator loss. Measure the PPSD and record it.
 3. For MIMO mode, calculation method follows FCC KDB 662911 D01 Multiple Transmitter Output v02r01.

Method (c): Measure and add $10 \log(N_{ANT})$ dB.

With this technique, spectrum measurements are performed at each output of the device, but rather than summing the spectra or the spectral peaks across the outputs, the quantity $10 \log(N_{ANT})$ dB is added to each spectrum value before comparing to the emission limit. The addition of $10 \log(N_{ANT})$ dB serves to apportion the emission limit among the N_{ANT} outputs so that each output is permitted to contribute no more than $1/N_{ANT}^{th}$ of the PSD limit.

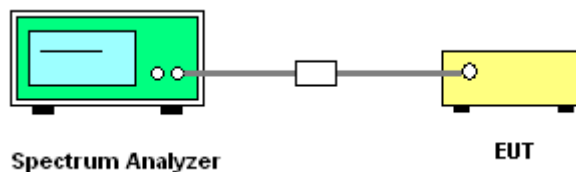
3.3.4 Test Setup



3.3.5 Test Result of Power Spectral Density

Please refer to Appendix A.

<CDD Modes>

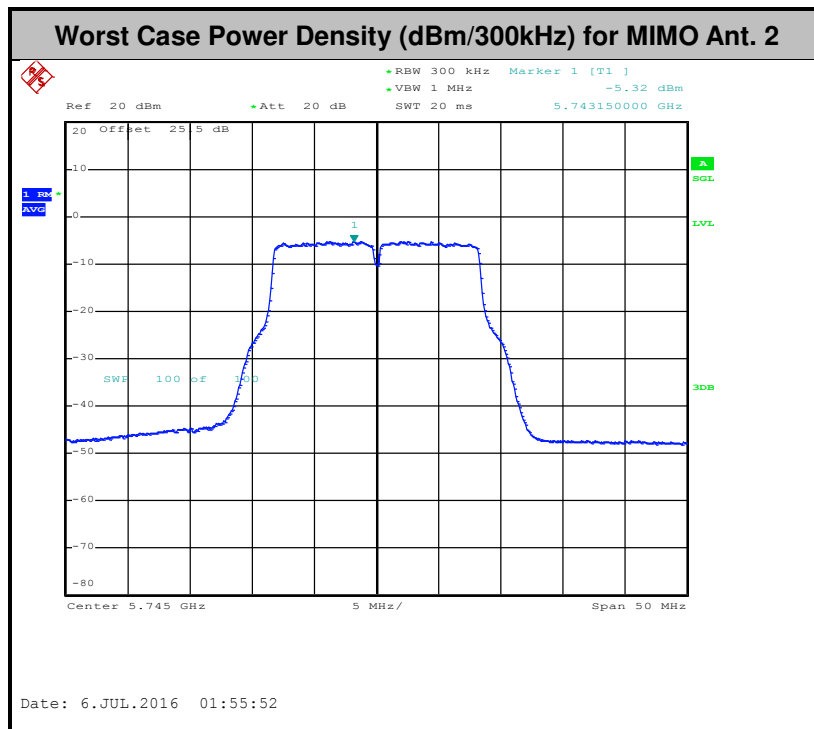
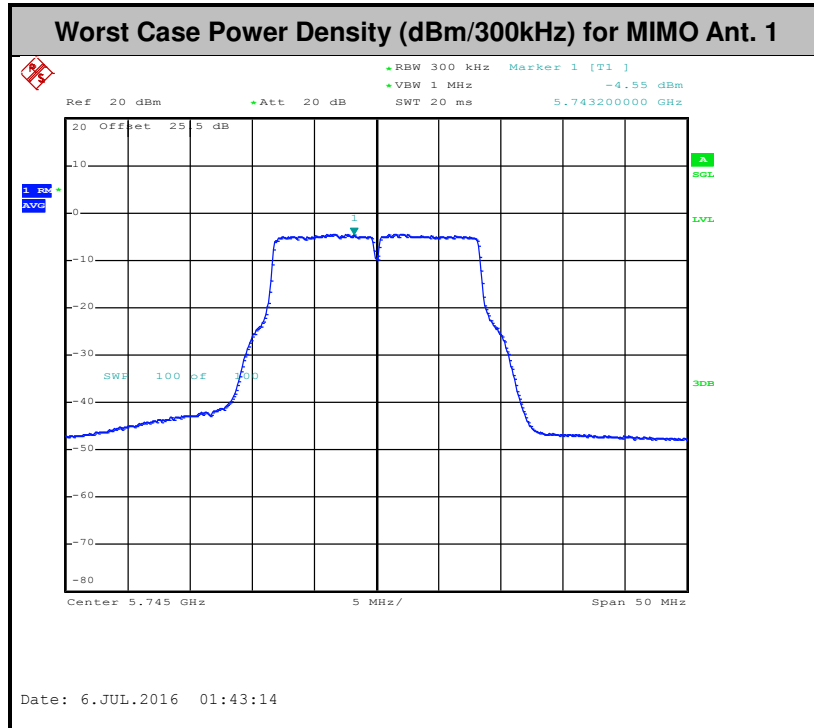



<TXBF Modes>

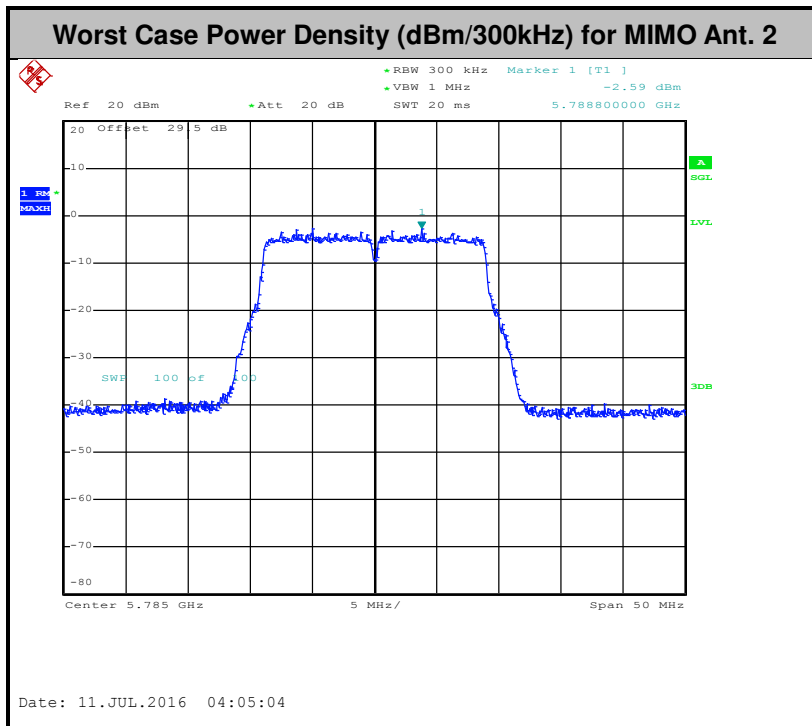
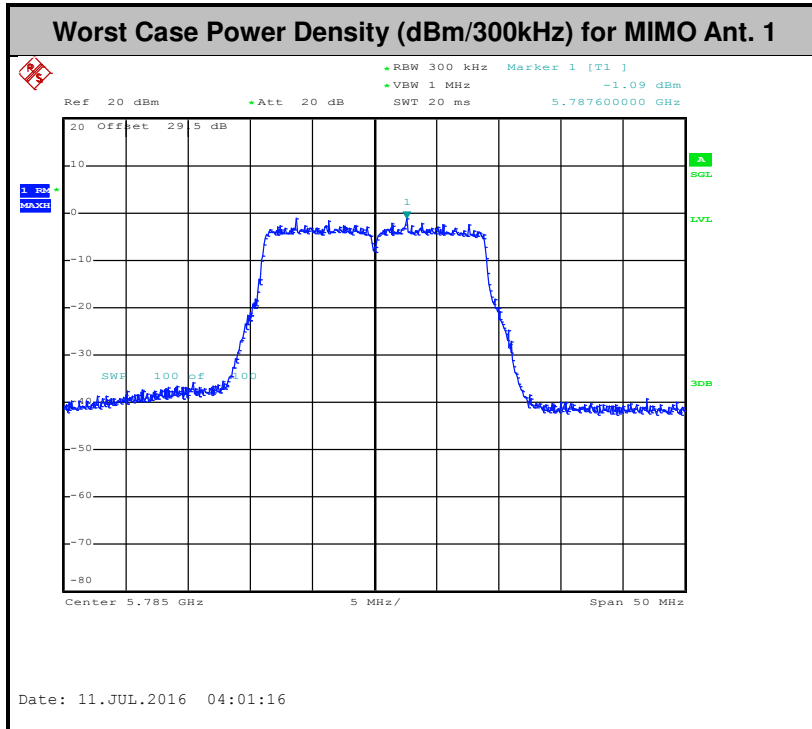



3.4 Unwanted Emissions Measurement

This section as specified in FCC Part 15.407(b) is to measure unwanted emissions through radiated measurement for band edge spurious emissions and out of band emissions measurement. The unwanted emissions shall comply with 15.407(b)(1) to (6), and restricted bands per FCC Part15.205.

3.4.1 Limit of Unwanted Emissions

- (1) For transmitters operating in the 5.725-5.85 GHz band:
15.407(b)(4)(i) All emissions shall be limited to a level of -27 dBm/MHz at 75 MHz or more above or below the band edge increasing linearly to 10 dBm/MHz at 25 MHz above or below the band edge, and from 25 MHz above or below the band edge increasing linearly to a level of 15.6 dBm/MHz at 5 MHz above or below the band edge, and from 5 MHz above or below the band edge increasing linearly to a level of 27 dBm/MHz at the band edge.
- (2) For transmitters operating in the 5725-5850 MHz band:
all emissions within the frequency range from the band edge to 10 MHz above or below the band edge shall not exceed an EIRP of -17 dBm/MHz (78.3dBµV/m); for frequencies 10 MHz or greater above or below the band edge, emissions shall not exceed an EIRP of -27 dBm/MHz (68.3dBµV/m).
- (3) Unwanted spurious emissions fallen in restricted bands per FCC Part15.205 shall comply with the general field strength limits set forth in § 15.209 as below table,

Frequency (MHz)	Field Strength (microvolts/meter)	Measurement Distance (meters)
0.009 – 0.490	2400/F(kHz)	300
0.490 – 1.705	24000/F(kHz)	30
1.705 – 30.0	30	30
30 – 88	100	3
88 – 216	150	3
216 - 960	200	3
Above 960	500	3

Note: The following formula is used to convert the EIRP to field strength.

$$E = \frac{1000000\sqrt{30P}}{3} \mu\text{V/m, where P is the eirp (Watts)}$$

EIRP (dBm)	Field Strength at 3m (dBµV/m)
-17	78.3
- 27	68.3



- (4) KDB 789033 D02 General UNII Test Procedures New Rules v01r02 G)2)c) As specified in 15.407(b), emissions above 1000 MHz that are outside of the restricted bands are subject to a peak emission limit of -27 dBm/MHz (or -17 dBm/MHz as specified in 15.407(b)(4)). However, an out-of-band emission that complies with both the average and peak limits of 15.209 is not required to satisfy the -27 dBm/MHz or -17 dBm/MHz peak emission limit.

3.4.2 Measuring Instruments

The measuring equipment is listed in the section 4 of this test report.

3.4.3 Test Procedures

1. The testing follows FCC KDB 789033 D02 General UNII Test Procedures New Rules v01r02. Section G) Unwanted emissions measurement.
 - (1) Procedure for Unwanted Emissions Measurements Below 1000MHz
 - RBW = 120 kHz
 - VBW = 300 kHz
 - Detector = Peak
 - Trace mode = max hold
 - (2) Procedure for Peak Unwanted Emissions Measurements Above 1000 MHz
 - RBW = 1 MHz
 - VBW \geq 3 MHz
 - Detector = Peak
 - Sweep time = auto
 - Trace mode = max hold
 - (3) Procedures for Average Unwanted Emissions Measurements Above 1000MHz
 - RBW = 1 MHz
 - VBW = 10 Hz, when duty cycle is no less than 98 percent.
 - VBW \geq 1/T, when duty cycle is less than 98 percent where T is the minimum transmission duration over which the transmitter is on and is transmitting at its maximum power control level for the tested mode of operation.
2. The EUT was placed on a turntable with 0.8 meter for frequency below 1GHz and 1.5 meter for frequency above 1GHz respectively above ground.
3. The EUT was set 3 meters from the interference receiving antenna which was mounted on the top of a variable height antenna tower.
4. The antenna is a broadband antenna and its height is adjusted between one meter and four meters above ground to find the maximum value of the field strength for both horizontal

polarization and vertical polarization of the antenna.

5. For each suspected emission, the EUT was arranged to its worst case and then adjust the antenna tower (from 1 m to 4 m) and turntable (from 0 degree to 360 degrees) to find the maximum reading.
6. For testing below 1GHz, if the emission level of the EUT in peak mode was 3 dB lower than the limit specified, then peak values of EUT will be reported, otherwise, the emissions will be repeated one by one using the CISPR quasi-peak method and reported.
7. For testing above 1GHz, the emission level of the EUT in peak mode was 20dB lower than average limit (that means the emission level in average mode also complies with the limit in average mode), then peak values of EUT will be reported, otherwise, the emissions will be measured in average mode again and reported.

3.4.4 Test Setup

For radiated emissions below 30MHz

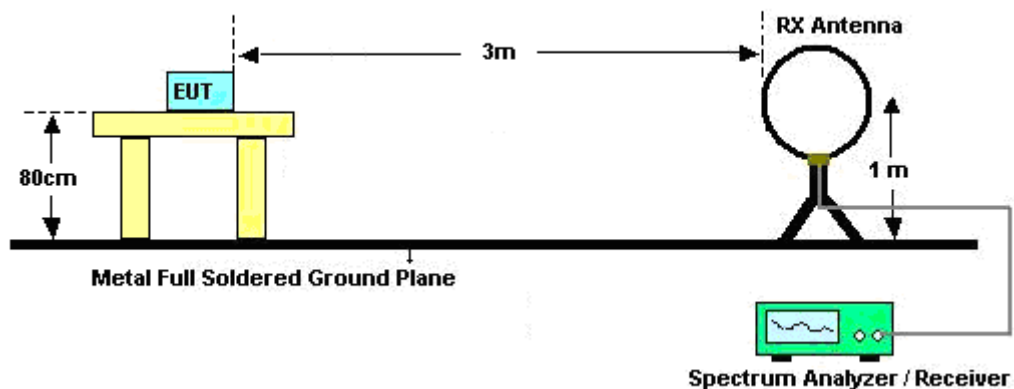

For radiated emissions from 30MHz to 1GHz

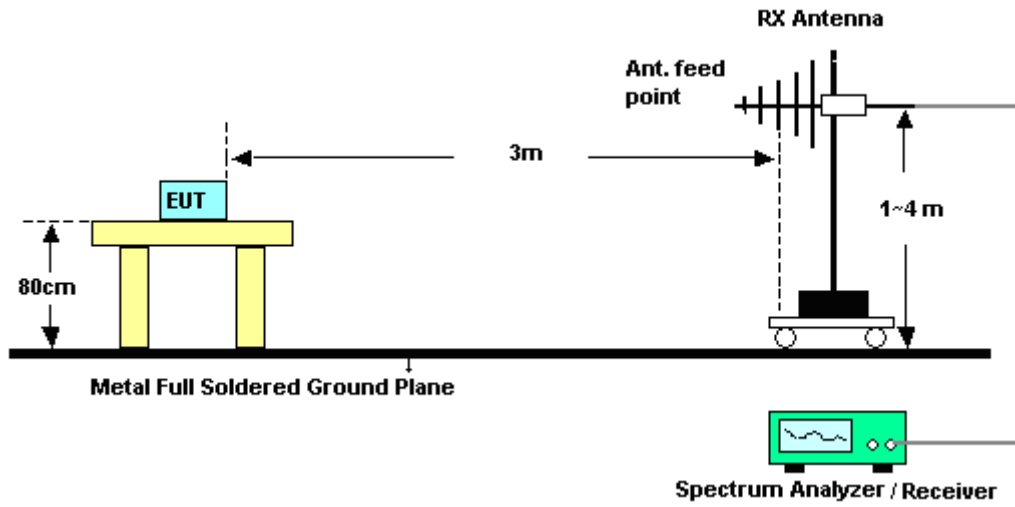

For radiated emissions above 1GHz

<CDD Modes>

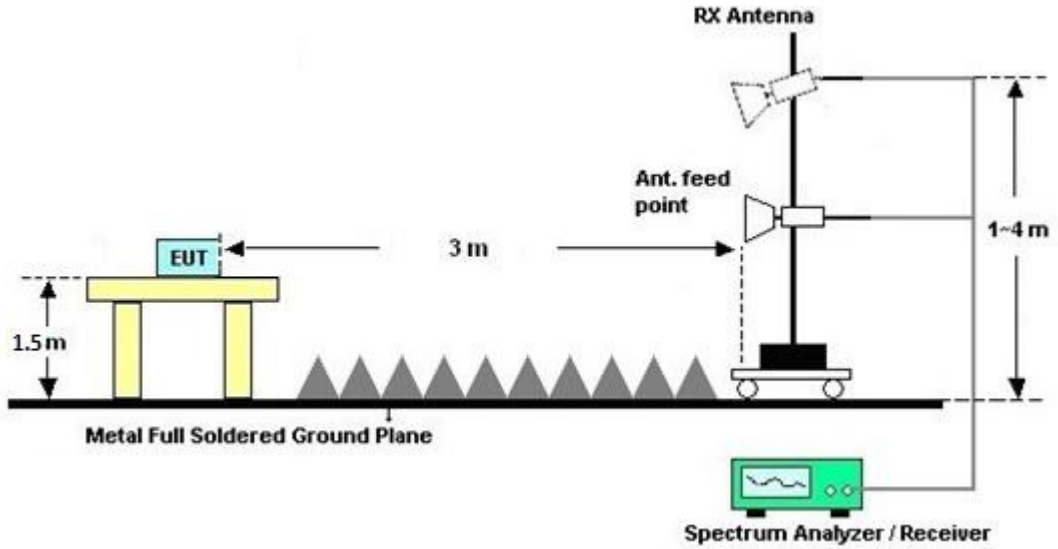

<TXBF Modes>

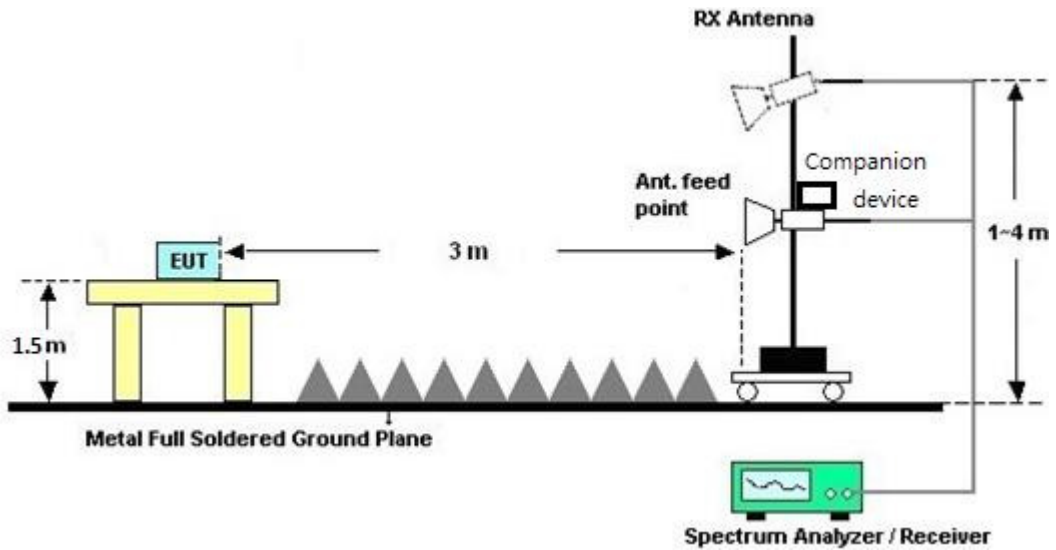

3.4.5 Test Results of Radiated Emissions (9 kHz ~ 30 MHz)

The low frequency, which started from 9 kHz to 30MHz, was pre-scanned and the result which was 20dB lower than the limit line per 15.31(o) was not reported.



3.4.6 Test Result of Radiated Band Edges

Please refer to Appendix B and C.

3.4.7 Duty Cycle

Please refer to Appendix D.

3.4.8 Test Result of Unwanted Radiated Emission (30MHz ~ 10th Harmonic)

Please refer to Appendix B and C.



3.5 AC Conducted Emission Measurement

3.5.1 Limit of AC Conducted Emission

For equipment that is designed to be connected to the public utility (AC) power line, the radio frequency voltage that is conducted back onto the AC power line on any frequency or frequencies within the band 150 kHz to 30 MHz shall not exceed the limits in the following table.

Frequency of emission (MHz)	Conducted limit (dB μ V)	
	Quasi-peak	Average
0.15-0.5	66 to 56*	56 to 46*
0.5-5	56	46
5-30	60	50

*Decreases with the logarithm of the frequency.

3.5.2 Measuring Instruments

The measuring equipment is listed in the section 4 of this test report.

3.5.3 Test Procedures

1. The EUT was placed 0.4 meter from the conducting wall of the shielding room was kept at least 80 centimeters from any other grounded conducting surface.
2. Connect EUT to the power mains through a line impedance stabilization network (LISN).
3. All the support units are connecting to the other LISN.
4. The LISN provides 50 ohm coupling impedance for the measuring instrument.
5. The FCC states that a 50 ohm, 50 microhenry LISN should be used.
6. Both sides of AC line were checked for maximum conducted interference.
7. The frequency range from 150 kHz to 30 MHz was searched.
8. Set the test-receiver system to Peak Detect Function and specified bandwidth with Maximum Hold Mode.

3.5.4 Test Setup

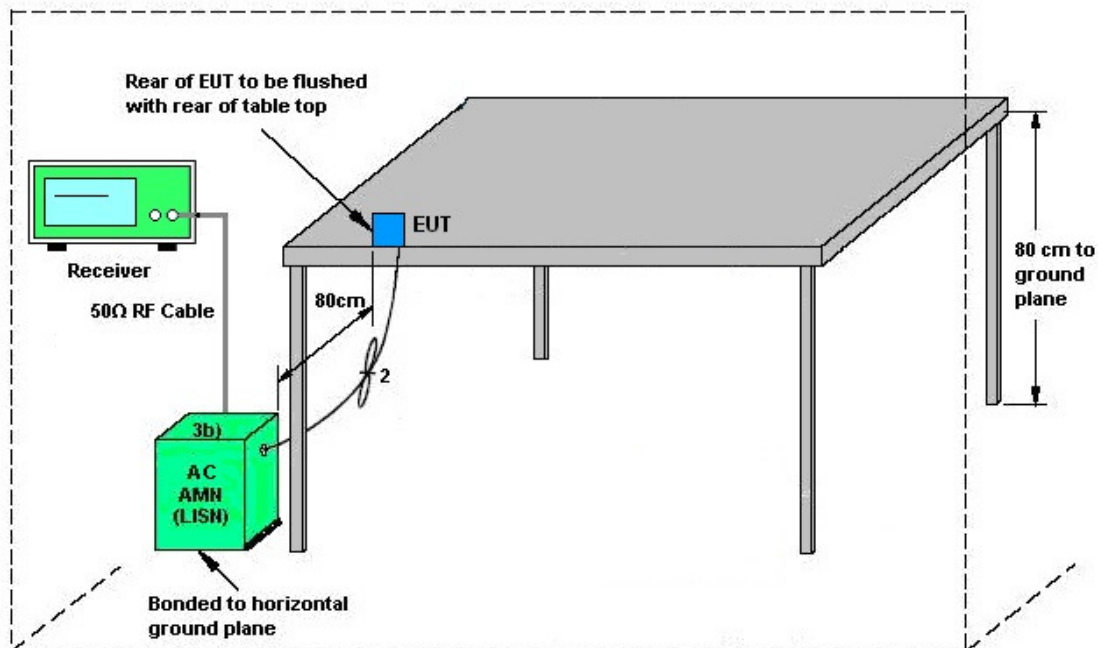

AMN = Artificial mains network (LISN)
AE = Associated equipment
EUT = Equipment under test
ISN = Impedance stabilization network



3.5.5 Test Result of AC Conducted Emission

Test Mode :	Mode 1	Temperature :	25~26°C
Test Engineer :	Arthur Hsieh	Relative Humidity :	54~55%
Test Voltage :	120Vac / 60Hz	Phase :	Line
Function Type :	Bluetooth Link + WLAN (5GHz) Link + USB Cable (Charging from Adapter) + Earphone + Battery		

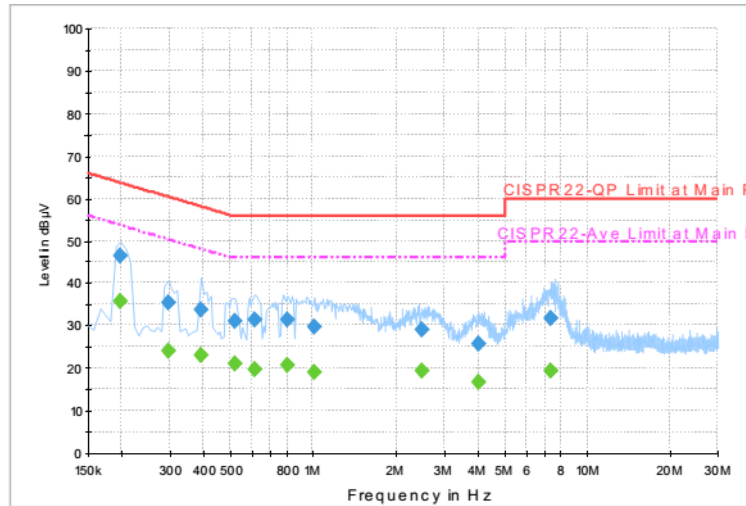

Final Result : QuasiPeak

Frequency (MHz)	QuasiPeak (dBµV)	Filter	Line	Corr. (dB)	Margin (dB)	Limit (dBµV)
0.198000	46.6	Off	L1	19.6	17.1	63.7
0.294000	35.4	Off	L1	19.6	25.0	60.4
0.390000	33.6	Off	L1	19.6	24.5	58.1
0.518000	31.2	Off	L1	19.6	24.8	56.0
0.614000	31.5	Off	L1	19.6	24.5	56.0
0.806000	31.6	Off	L1	19.6	24.4	56.0
1.006000	29.7	Off	L1	19.7	26.3	56.0
2.478000	29.1	Off	L1	19.7	26.9	56.0
4.030000	25.9	Off	L1	19.8	30.1	56.0
7.390000	31.8	Off	L1	20.0	28.2	60.0

Final Result : Average

Frequency (MHz)	Average (dBµV)	Filter	Line	Corr. (dB)	Margin (dB)	Limit (dBµV)
0.198000	35.9	Off	L1	19.6	17.8	53.7
0.294000	24.0	Off	L1	19.6	26.4	50.4
0.390000	23.1	Off	L1	19.6	25.0	48.1
0.518000	20.9	Off	L1	19.6	25.1	46.0
0.614000	19.7	Off	L1	19.6	26.3	46.0
0.806000	20.8	Off	L1	19.6	25.2	46.0
1.006000	19.2	Off	L1	19.7	26.8	46.0
2.478000	19.5	Off	L1	19.7	26.5	46.0
4.030000	16.6	Off	L1	19.8	29.4	46.0
7.390000	19.5	Off	L1	20.0	30.5	50.0



Test Mode :	Mode 1	Temperature :	25~26°C
Test Engineer :	Arthur Hsieh	Relative Humidity :	54~55%
Test Voltage :	120Vac / 60Hz	Phase :	Neutral
Function Type :	Bluetooth Link + WLAN (5GHz) Link + USB Cable (Charging from Adapter) + Earphone + Battery		

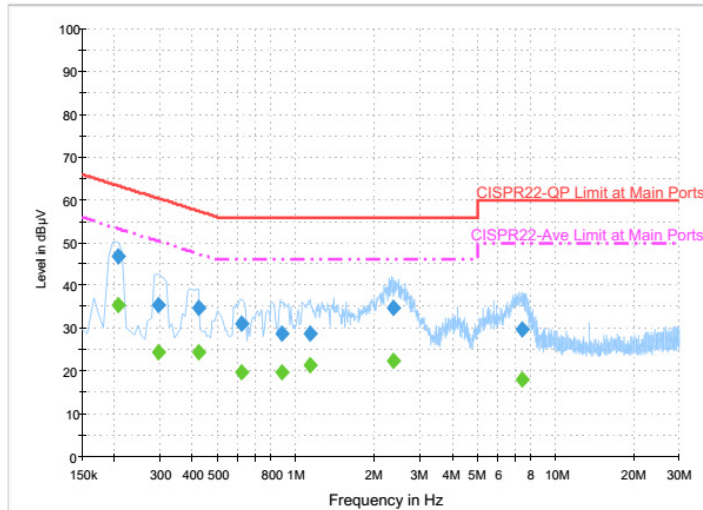

Final Result : QuasiPeak

Frequency (MHz)	QuasiPeak (dBµV)	Filter	Line	Corr. (dB)	Margin (dB)	Limit (dBµV)
0.206000	46.7	Off	N	19.6	16.7	63.4
0.294000	35.6	Off	N	19.6	24.8	60.4
0.422000	34.8	Off	N	19.6	22.6	57.4
0.622000	31.0	Off	N	19.6	25.0	56.0
0.886000	28.6	Off	N	19.6	27.4	56.0
1.142000	28.7	Off	N	19.6	27.3	56.0
2.374000	34.8	Off	N	19.6	21.2	56.0
7.406000	29.8	Off	N	19.9	30.2	60.0

Final Result : Average

Frequency (MHz)	Average (dBµV)	Filter	Line	Corr. (dB)	Margin (dB)	Limit (dBµV)
0.206000	35.3	Off	N	19.6	18.1	53.4
0.294000	24.5	Off	N	19.6	25.9	50.4
0.422000	24.4	Off	N	19.6	23.0	47.4
0.622000	19.6	Off	N	19.6	26.4	46.0
0.886000	19.9	Off	N	19.6	26.1	46.0
1.142000	21.3	Off	N	19.6	24.7	46.0
2.374000	22.3	Off	N	19.6	23.7	46.0
7.406000	18.1	Off	N	19.9	31.9	50.0

3.6 Frequency Stability Measurement

3.6.1 Limit of Frequency Stability

Manufacturers of U-NII devices are responsible for ensuring frequency stability such that an emission is maintained within the band of operation under all conditions of normal operation as specified in the user's manual.

3.6.2 Measuring Instruments

The measuring equipment is listed in the section 4 of this test report.

3.6.3 Test Procedures

1. To ensure emission at the band edge is maintained within the authorized band, those values shall be measured by radiation emissions at upper and lower frequency points, and finally compensated by frequency deviation as procedures below.
2. The EUT was operated at the maximum output power, and connected to the spectrum analyzer, which is set to maximum hold function and peak detector. The peak value of the power envelope was measured and noted. The upper and lower frequency points were respectively measured relatively 10dB lower than the measured peak value.
3. The frequency deviation was calculated by adding the upper frequency point and the lower frequency point divided by two. Those detailed values of frequency deviation are provided in table below.

3.6.4 Test Setup

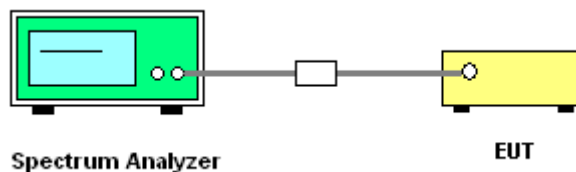

3.6.5 Test Result of Frequency Stability

Please refer to Appendix A.



3.7 Automatically Discontinue Transmission

3.7.1 Limit of Automatically Discontinue Transmission

The device shall automatically discontinue transmission in case of either absence of information to transmit or operational failure. These provisions are not intended to preclude the transmission of control or signaling information or the use of repetitive codes used by certain digital technologies to complete frame or burst intervals. Applicants shall include in their application for equipment authorization to describe how this requirement is met.

3.7.2 Measuring Instruments

The measuring equipment is listed in the section 4 of this test report.

3.7.3 Test Result of Automatically Discontinue Transmission

While the EUT is not transmitting any information, the EUT can automatically discontinue transmission and become standby mode for power saving. The EUT can detect the controlling signal of ACK message transmitting from remote device and verify whether it shall resend or discontinue transmission.



3.8 Antenna Requirements

3.8.1 Standard Applicable

According to FCC 47 CFR Section 15.407(a)(1)(2), if transmitting antenna directional gain is greater than 6 dBi, both the peak transmit power and the peak power spectral density shall be reduced by the amount in dB that the directional gain of the antenna exceeds 6 dBi.

3.8.2 Antenna Anti-Replacement Construction

An embedded-in antenna design is used.



3.8.3 Antenna Gain

CDD modes

FCC KDB 662911 D01 Multiple Transmitter Output v02r01

For CDD transmissions, directional gain is calculated as

Directional gain = G_{ANT} + Array Gain, where Array Gain is as follows.

For power spectral density (PSD) measurements on all devices,

Array Gain = $10 \log(N_{ANT}/N_{SS}=1)$ dB.

For power measurements on IEEE 802.11 devices,

Array Gain = 0 dB (i.e., no array gain) for $N_{ANT} \leq 4$.

Directional gain may be calculated by using the formulas applicable to equal gain antennas with G_{ANT} set equal to the gain of the antenna having the highest gain;

The EUT supports CDD mode.

For power, the directional gain G_{ANT} is set equal to the antenna having the highest gain, i.e., F)2)f)i).

For PSD, the directional gain calculation is following F)2)f)ii) of KDB 662911 D01 v02r01.

The power and PSD limit should be modified if the directional gain of EUT is over 6 dBi,

The directional gain "DG" is calculated as following table.

			DG for Power (dBi)	DG for PSD (dBi)	Power Limit Reduction (dB)	PSD Limit Reduction (dB)
	Ant 1 (dBi)	Ant 2 (dBi)				
Band IV	0.60	1.10	1.10	3.86	0.00	0.00

Power limit reduction = Composite gain – 6dBi, (min = 0)

PSD limit reduction = Composite gain + PSD Array gain – 6dBi, (min = 0)

TXBF modes

FCC KDB 662911 D01 Multiple Transmitter Output v02r01

For CDD transmissions, directional gain is calculated as

$$DirectionalGain = 10 \cdot \log \left[\frac{\sum_{j=1}^{N_{SS}} \left\{ \sum_{k=1}^{N_{ANT}} g_{j,k} \right\}^2}{N_{ANT}} \right]$$

where

Each antenna is driven by no more than one spatial stream;

N_{SS} = the number of independent spatial streams of data;

N_{ANT} = the total number of antennas

$g_{j,k} = 10^{G_k / 20}$ if the k th antenna is being fed by spatial stream j , or zero if it is not;
 G_k is the gain in dBi of the k th antenna.

The EUT supports beamforming for 802.11ac modes.

The directional gain calculation is following F)2)e)ii) of KDB 662911 D01 v02r01.

The power and PSD limit should be modified if the directional gain of EUT is over 6 dBi,

The directional gain "DG" is calculated as following table.

			DG	DG	Power	PSD
			for	for	Limit	Limit
	Ant 1	Ant 2	Power	PSD	Reduction	Reduction
	(dBi)	(dBi)	(dBi)	(dBi)	(dB)	(dB)
Band IV	0.60	1.10	3.86	3.86	0.00	0.00

$Power\ Limit\ Reduction = DG(Power) - 6dBi, (min = 0)$

$PSD\ Limit\ Reduction = DG(PSD) - 6dBi, (min = 0)$



4 List of Measuring Equipment

Instrument	Manufacturer	Model No.	Serial No.	Characteristics	Calibration Date	Test Date	Due Date	Remark
Power Sensor	DARE	RadiPower	15I00041SN O09	10MHz~6GHz	May 03, 2016	Jun. 20, 2016 ~ Jul. 21, 2016	May 02, 2017	Conducted (TH05-HY)
Power Meter	Anritsu	ML2495A	1132003	300MHz~40GHz	Aug. 12, 2015	Jun. 20, 2016 ~ Jul. 21, 2016	Aug. 11, 2016	Conducted (TH05-HY)
Power Sensor	DARE	RadiPower	15I00041SN O10	10MHz~6GHz	May 03, 2016	Jun. 20, 2016 ~ Jul. 21, 2016	May 02, 2017	Conducted (TH05-HY)
Power Sensor	Anritsu	MA2411B	1126017	300MHz~40GHz	Aug. 12, 2015	Jun. 20, 2016 ~ Jul. 21, 2016	Aug. 11, 2016	Conducted (TH05-HY)
Spectrum Analyzer	Rohde & Schwarz	FSP40	100057	9kHz-40GHz	Nov. 23, 2015	Jun. 20, 2016 ~ Jul. 21, 2016	Nov. 22, 2016	Conducted (TH05-HY)
Temperature Chamber	ESPEC	SU-241	92003713	-30℃ ~95℃	Jun. 06, 2016	Jun. 20, 2016 ~ Jul. 21, 2016	Jun. 05, 2017	Conducted (TH05-HY)
AC Power Source	ChainTek	APC-1000W	N/A	N/A	N/A	Jun. 13, 2016	N/A	Conduction (CO05-HY)
EMI Test Receiver	Rohde & Schwarz	ESCI 7	100724	9kHz~7GHz	Aug. 26, 2015	Jun. 13, 2016	Aug. 25, 2016	Conduction (CO05-HY)
LISN	Rohde & Schwarz	ENV216	100080	9kHz~30MHz	Dec. 02, 2015	Jun. 13, 2016	Dec. 01, 2016	Conduction (CO05-HY)
Bilog Antenna	TESEQ	CBL 6111D	35419	30MHz to 1GHz	Jan. 13, 2016	Jun. 22, 2016 ~ Jul. 17, 2016	Jan. 12, 2017	Radiation (03CH07-HY)
Double Ridge Horn Antenna	ESCO	3117	00075962	1GHz ~ 18GHz	Aug. 21, 2015	Jun. 22, 2016 ~ Jul. 17, 2016	Aug. 20, 2016	Radiation (03CH07-HY)
EMI Test Receiver	Keysight	N9038A(MXE)	MY54130085	20Hz ~ 8.4GHz	Nov. 04, 2015	Jun. 22, 2016 ~ Jul. 17, 2016	Nov. 03, 2016	Radiation (03CH07-HY)
Loop Antenna	Rohde & Schwarz	HFH2-Z2	100315	9 kHz~30 MHz	Sep. 02, 2015	Jun. 22, 2016 ~ Jul. 17, 2016	Sep. 01, 2016	Radiation (03CH07-HY)
Preamplifier	MITEQ	AMF-7D-0010 1800-30-10P	1590075	1GHz ~ 18GHz	Apr. 15, 2016	Jun. 22, 2016 ~ Jul. 17, 2016	Apr. 14, 2017	Radiation (03CH07-HY)
Preamplifier	COM-POWER	PA-103A	161241	10MHz-1GHz	Mar. 18, 2016	Jun. 22, 2016 ~ Jul. 17, 2016	Mar. 17, 2017	Radiation (03CH07-HY)
Preamplifier	Agilent	8449B	3008A02362	1GHz~ 26.5GHz	Oct. 19, 2015	Jun. 22, 2016 ~ Jul. 17, 2016	Oct. 18, 2016	Radiation (03CH07-HY)
Spectrum Analyzer	Agilent	N9010A	MY53470118	10Hz~44GHz	Feb. 27, 2016	Jun. 22, 2016 ~ Jul. 17, 2016	Feb. 26, 2017	Radiation (03CH07-HY)
Antenna Mast	Max-Full	MFA520BS	N/A	1m~4m	N/A	Jun. 22, 2016 ~ Jul. 17, 2016	N/A	Radiation (03CH07-HY)
Turn Table	ChainTek	Chaintek 3000	N/A	0~360 Degree	N/A	Jun. 22, 2016 ~ Jul. 17, 2016	N/A	Radiation (03CH07-HY)
Loop Cable	Rohde & Schwarz	N/A	N/A	9KHz~30MHz	Dec. 03, 2015	Jun. 22, 2016 ~ Jul. 17, 2016	Dec. 02, 2016	Radiation (03CH07-HY)
Preamplifier	MITEQ	TTA0204	1872107	2GHz~40GHz	Feb. 15, 2015	Jun. 22, 2016 ~ Jul. 17, 2016	Feb. 14, 2017	Radiation (03CH07-HY)
SHF-EHF Horn Antenna	SCHWARZBE CK	BBHA 9170	BBHA917058 4	18GHz- 40GHz	Nov. 02, 2015	Jun. 22, 2016 ~ Jul. 17, 2016	Nov. 01, 2016	Radiation (03CH07-HY)



5 Uncertainty of Evaluation

Uncertainty of Conducted Emission Measurement (150kHz ~ 30MHz)

Measuring Uncertainty for a Level of Confidence of 95% ($U = 2Uc(y)$)	2.26
---	------

Uncertainty of Radiated Emission Measurement (30 MHz ~ 1000 MHz)

Measuring Uncertainty for a Level of Confidence of 95% ($U = 2Uc(y)$)	5.6
---	-----



Appendix A. Conducted Test Results

<CDD Modes>

Test Engineer:	Luffy Lin, Tommy Lee, and An Wu	Temperature:	21~25	°C
Test Date:	2016/06/20 ~ 2016/07/21	Relative Humidity:	51~54	%

TEST RESULTS DATA
6dB and 26dB EBW and 99% OBW

Band IV													
Mod.	Data Rate	NTX	CH.	Freq. (MHz)	99% Bandwidth (MHz)		26dB Bandwidth (MHz)		6 dB Bandwidth (MHz)		6 dB Bandwidth Min. Limit (MHz)		Pass/Fail
					Ant 1	Ant 2	Ant 1	Ant 2	Ant 1	Ant 2	Ant 1	Ant 2	
11a	6Mbps	1	149	5745	18.45	18.25	23.00	23.00	16.36	16.36	0.5	0.4	Pass
11a	6Mbps	1	157	5785	18.20	18.15	22.90	23.10	16.36	16.32	0.5	0.4	Pass
11a	6Mbps	1	165	5825	18.25	18.35	22.90	22.90	16.32	16.32	0.5	0.4	Pass
HT20	MCS0	1	149	5745	18.90	19.05	23.20	23.30	17.56	17.60	0.5	0.4	Pass
HT20	MCS0	1	157	5785	18.90	19.00	23.30	23.30	17.60	17.60	0.5	0.4	Pass
HT20	MCS0	1	165	5825	19.05	19.15	23.50	23.30	17.60	17.60	0.5	0.4	Pass
HT40	MCS0	1	151	5755	41.40	36.80	41.40	41.58	36.32	36.40	0.5	0.4	Pass
HT40	MCS0	1	159	5795	41.58	36.70	41.58	41.76	36.40	36.40	0.5	0.4	Pass
VHT20	MCS0	1	149	5745	19.00	19.00	23.30	23.40	17.64	17.64	0.5	0.4	Pass
VHT20	MCS0	1	157	5785	19.15	19.00	23.20	23.30	17.60	17.64	0.5	0.4	Pass
VHT20	MCS0	1	165	5825	19.10	19.15	23.30	23.30	17.60	17.56	0.5	0.4	Pass
VHT40	MCS0	1	151	5755	36.70	36.80	41.40	41.58	36.32	36.40	0.5	0.4	Pass
VHT40	MCS0	1	159	5795	36.80	36.70	41.58	41.76	36.40	36.40	0.5	0.4	Pass
VHT80	MCS0	1	155	5775	75.96	75.84	82.24	81.92	76.16	75.68	0.5	0.4	Pass
11a	6Mbps	2	149	5745	18.20	18.15	22.80	23.00	16.36	16.32	0.5		Pass
11a	6Mbps	2	157	5785	18.30	18.00	23.00	22.90	16.36	16.36	0.5		Pass
11a	6Mbps	2	165	5825	18.35	18.10	23.00	23.00	16.32	16.36	0.5		Pass
HT20	MCS0	2	149	5745	19.10	18.90	23.30	22.90	17.60	17.64	0.5		Pass
HT20	MCS0	2	157	5785	19.00	18.80	23.50	23.20	17.60	17.64	0.5		Pass
HT20	MCS0	2	165	5825	19.10	19.00	23.20	23.20	17.64	17.64	0.5		Pass
HT40	MCS0	2	151	5755	36.80	36.80	41.40	41.22	36.40	36.40	0.5		Pass
HT40	MCS0	2	159	5795	36.70	36.90	41.58	41.22	36.32	36.32	0.5		Pass
VHT20	MCS0	2	149	5745	19.00	18.90	23.30	23.30	17.60	17.64	0.5		Pass
VHT20	MCS0	2	157	5785	19.10	18.80	23.20	23.20	17.60	17.64	0.5		Pass
VHT20	MCS0	2	165	5825	19.00	19.00	23.40	23.00	17.60	17.64	0.5		Pass
VHT40	MCS0	2	151	5755	36.80	36.80	41.40	41.22	36.40	36.40	0.5		Pass
VHT40	MCS0	2	159	5795	36.70	36.90	41.58	41.22	36.32	36.32	0.5		Pass
VHT80	MCS0	2	155	5775	75.84	75.84	82.24	82.24	75.52	76.00	0.5		Pass

TEST RESULTS DATA
Average Power Table

Band IV														
Mod.	Data Rate	NTX	CH.	Freq. (MHz)	Duty Factor (dB)		Average Conducted Power (dBm)			FCC Conducted Power Limit (dBm)		DG (dBi)		Pass/Fail
					Ant 1	Ant 2	Ant 1	Ant 2	SUM	Ant 1	Ant 2	Ant 1	Ant 2	
11a	6Mbps	1	149	5745	0.33	0.33	11.34	12.99		30.00	30.00	0.60	1.10	Pass
11a	6Mbps	1	157	5785	0.33	0.33	11.30	12.98		30.00	30.00	0.60	1.10	Pass
11a	6Mbps	1	165	5825	0.33	0.33	11.36	12.80		30.00	30.00	0.60	1.10	Pass
HT20	MCS0	1	149	5745	0.31	0.31	11.43	12.85		30.00	30.00	0.60	1.10	Pass
HT20	MCS0	1	157	5785	0.31	0.31	11.35	12.84		30.00	30.00	0.60	1.10	Pass
HT20	MCS0	1	165	5825	0.31	0.31	11.23	12.70		30.00	30.00	0.60	1.10	Pass
HT40	MCS0	1	151	5755	0.61	0.61	11.21	12.77		30.00	30.00	0.60	1.10	Pass
HT40	MCS0	1	159	5795	0.61	0.61	11.31	12.61		30.00	30.00	0.60	1.10	Pass
VHT20	MCS0	1	149	5745	0.31	0.31	11.49	12.86		30.00	30.00	0.60	1.10	Pass
VHT20	MCS0	1	157	5785	0.31	0.31	11.37	12.90		30.00	30.00	0.60	1.10	Pass
VHT20	MCS0	1	165	5825	0.31	0.31	11.36	12.88		30.00	30.00	0.60	1.10	Pass
VHT40	MCS0	1	151	5755	0.66	0.63	11.49	12.79		30.00	30.00	0.60	1.10	Pass
VHT40	MCS0	1	159	5795	0.66	0.63	11.47	12.76		30.00	30.00	0.60	1.10	Pass
VHT80	MCS0	1	155	5775	1.14	1.16	10.98	12.37		30.00	30.00	0.60	1.10	Pass
11a	6Mbps	2	149	5745	0.33	0.33	11.60	11.29	14.46	30.00		0.5		Pass
11a	6Mbps	2	157	5785	0.33	0.33	11.58	11.27	14.44	30.00		0.5		Pass
11a	6Mbps	2	165	5825	0.33	0.33	11.54	11.17	14.37	30.00		0.5		Pass
HT20	MCS0	2	149	5745	0.31	0.35	11.43	11.02	14.24	30.00		0.5		Pass
HT20	MCS0	2	157	5785	0.31	0.35	11.25	11.01	14.14	30.00		0.5		Pass
HT20	MCS0	2	165	5825	0.31	0.35	11.44	11.00	14.23	30.00		0.5		Pass
HT40	MCS0	2	151	5755	0.68	0.64	11.57	11.37	14.48	30.00		0.5		Pass
HT40	MCS0	2	159	5795	0.68	0.64	11.48	11.22	14.36	30.00		0.5		Pass
VHT20	MCS0	2	149	5745	0.35	0.35	11.45	11.14	14.31	30.00		0.5		Pass
VHT20	MCS0	2	157	5785	0.35	0.35	11.24	11.16	14.21	30.00		0.5		Pass
VHT20	MCS0	2	165	5825	0.35	0.35	11.53	10.98	14.27	30.00		0.5		Pass
VHT40	MCS0	2	151	5755	0.63	0.63	11.59	11.36	14.49	30.00		0.5		Pass
VHT40	MCS0	2	159	5795	0.63	0.63	11.55	11.15	14.37	30.00		0.5		Pass
VHT80	MCS0	2	155	5775	1.20	1.14	11.10	10.84	13.98	30.00		0.5		Pass

TEST RESULTS DATA
Power Spectral Density

Band IV																
Mod.	Data Rate	NTX	CH.	Freq. (MHz)	Duty Factor (dB)		10log (500kHz /RBW) Factor (dB)		Average Power Density (dBm/500kHz)			Average PSD Limit (dBm/500kHz)		DG (dBi)		Pass /Fail
					Ant 1	Ant 2	Ant 1	Ant 2	Ant 1	Ant 2	SUM	Ant 1	Ant 2	Ant 1	Ant 2	
11a	6Mbps	1	149	5745	0.33	0.33	2.22	2.22	-2.39	-1.01		30.00	30.00	0.60	1.10	Pass
11a	6Mbps	1	157	5785	0.33	0.33	2.22	2.22	-2.67	-1.31		30.00	30.00	0.60	1.10	Pass
11a	6Mbps	1	165	5825	0.33	0.33	2.22	2.22	-2.39	-1.61		30.00	30.00	0.60	1.10	Pass
HT20	MCS0	1	149	5745	0.31	0.31	2.22	2.22	-2.66	-1.34		30.00	30.00	0.60	1.10	Pass
HT20	MCS0	1	157	5785	0.31	0.31	2.22	2.22	-2.52	-1.50		30.00	30.00	0.60	1.10	Pass
HT20	MCS0	1	165	5825	0.31	0.31	2.22	2.22	-2.68	-1.73		30.00	30.00	0.60	1.10	Pass
HT40	MCS0	1	151	5755	0.61	0.61	2.22	2.22	-5.70	-4.21		30.00	30.00	0.60	1.10	Pass
HT40	MCS0	1	159	5795	0.61	0.61	2.22	2.22	-5.89	-4.68		30.00	30.00	0.60	1.10	Pass
VHT20	MCS0	1	149	5745	0.31	0.31	2.22	2.22	-2.23	-1.43		30.00	30.00	0.60	1.10	Pass
VHT20	MCS0	1	157	5785	0.31	0.31	2.22	2.22	-2.74	-1.29		30.00	30.00	0.60	1.10	Pass
VHT20	MCS0	1	165	5825	0.31	0.31	2.22	2.22	-2.73	-1.64		30.00	30.00	0.60	1.10	Pass
VHT40	MCS0	1	151	5755	0.66	0.63	2.22	2.22	-5.36	-4.00		30.00	30.00	0.60	1.10	Pass
VHT40	MCS0	1	159	5795	0.66	0.63	2.22	2.22	-5.80	-4.54		30.00	30.00	0.60	1.10	Pass
VHT80	MCS0	1	155	5775	1.14	1.16	2.22	2.22	-8.70	-7.24		30.00	30.00	0.60	1.10	Pass
11a	6Mbps	2	149	5745	0.33	0.33	2.22				1.01	30.00		3.86		Pass
11a	6Mbps	2	157	5785	0.33	0.33	2.22				0.60	30.00		3.86		Pass
11a	6Mbps	2	165	5825	0.33	0.33	2.22				0.65	30.00		3.86		Pass
HT20	MCS0	2	149	5745	0.31	0.35	2.22				0.39	30.00		3.86		Pass
HT20	MCS0	2	157	5785	0.31	0.35	2.22				0.19	30.00		3.86		Pass
HT20	MCS0	2	165	5825	0.31	0.35	2.22				0.25	30.00		3.86		Pass
HT40	MCS0	2	151	5755	0.68	0.64	2.22				-2.13	30.00		3.86		Pass
HT40	MCS0	2	159	5795	0.68	0.64	2.22				-2.50	30.00		3.86		Pass
VHT20	MCS0	2	149	5745	0.35	0.35	2.22				0.47	30.00		3.86		Pass
VHT20	MCS0	2	157	5785	0.35	0.35	2.22				-0.06	30.00		3.86		Pass
VHT20	MCS0	2	165	5825	0.35	0.35	2.22				0.05	30.00		3.86		Pass
VHT40	MCS0	2	151	5755	0.63	0.63	2.22				-2.18	30.00		3.86		Pass
VHT40	MCS0	2	159	5795	0.63	0.63	2.22				-2.70	30.00		3.86		Pass
VHT80	MCS0	2	155	5775	1.20	1.14	2.22				-5.36	30.00		3.86		Pass

TEST RESULTS DATA
Frequency Stability

Band IV										
Mod.	Data Rate	NTX	CH.	Freq. (MHz)	Center Frequency (MHz)	Frequency Deviation (MHz)	Frequency Stability (ppm)	Temperature (°C)	Voltage (V)	Note
11a	6Mbps	1	149	5745	5745.000	0.000	0.00	20	3.5	
11a	6Mbps	1	149	5745	5745.050	0.050	8.70	20	4.35	
11a	6Mbps	1	149	5745	5745.000	0.000	0.00	20	3.8	
11a	6Mbps	1	149	5745	5745.000	0.000	0.00	-30	3.8	
11a	6Mbps	1	149	5745	5745.000	0.000	0.00	50	3.8	



<TXBF Modes>

Test Engineer:	Luffy Lin, Tommy Lee, and An Wu	Temperature:	21~25	°C
Test Date:	2016/06/20 ~ 2016/07/21	Relative Humidity:	51~54	%

TEST RESULTS DATA
6dB and 26dB EBW and 99% OBW

Band IV													
Mod.	Data Rate	NTX	CH.	Freq. (MHz)	99% Bandwidth (MHz)		26dB Bandwidth (MHz)		6 dB Bandwidth (MHz)		6 dB Bandwidth Min. Limit (MHz)		Pass/Fail
					Ant 1	Ant 2	Ant 1	Ant 2	Ant 1	Ant 2	Ant 1	Ant 2	
11a	6Mbps	2	149	5745	17.80	17.60	22.40	24.90	16.44	16.48	0.5		Pass
11a	6Mbps	2	157	5785	17.90	17.90	23.80	26.40	16.48	16.48	0.5		Pass
11a	6Mbps	2	165	5825	17.65	18.00	26.50	25.20	16.44	16.44	0.5		Pass
HT20	MCS0	2	149	5745	18.80	18.85	22.80	22.70	17.64	17.68	0.5		Pass
HT20	MCS0	2	157	5785	18.75	18.80	23.00	23.00	17.64	17.60	0.5		Pass
HT20	MCS0	2	165	5825	18.80	18.75	23.20	22.90	17.64	17.64	0.5		Pass
HT40	MCS0	2	151	5755	36.80	36.70	41.04	40.50	35.12	31.36	0.5		Pass
HT40	MCS0	2	159	5795	36.90	36.90	40.50	39.96	35.76	35.68	0.5		Pass
VHT20	MCS0	2	149	5745	18.90	19.00	23.50	23.00	17.60	17.58	0.5		Pass
VHT20	MCS0	2	157	5785	19.05	18.90	23.40	23.40	17.60	17.60	0.5		Pass
VHT20	MCS0	2	165	5825	19.10	19.10	23.20	23.50	17.56	17.54	0.5		Pass
VHT40	MCS0	2	151	5755	36.70	36.80	40.68	41.40	35.84	35.76	0.5		Pass
VHT40	MCS0	2	159	5795	36.70	36.70	40.68	40.50	35.44	35.68	0.5		Pass
VHT80	MCS0	2	155	5775	76.20	76.08	79.68	80.64	73.76	75.52	0.5		Pass

TEST RESULTS DATA
Average Power Table

Band IV												
Mod.	Data Rate	NTX	CH.	Freq. (MHz)	Average Conducted Power (dBm)			FCC Conducted Power Limit (dBm)		DG (dBi)		Pass/Fail
					Ant 1	Ant 2	SUM	Ant 1	Ant 2	Ant 1	Ant 2	
11a	6Mbps	2	149	5745	11.80	10.70	14.30	30.00		3.86	Pass	
11a	6Mbps	2	157	5785	11.70	10.60	14.20	30.00		3.86	Pass	
11a	6Mbps	2	165	5825	11.70	10.70	14.24	30.00		3.86	Pass	
HT20	MCS0	2	149	5745	11.40	10.90	14.17	30.00		3.86	Pass	
HT20	MCS0	2	157	5785	11.50	10.70	14.13	30.00		3.86	Pass	
HT20	MCS0	2	165	5825	11.60	10.80	14.23	30.00		3.86	Pass	
HT40	MCS0	2	151	5755	11.70	11.00	14.37	30.00		3.86	Pass	
HT40	MCS0	2	159	5795	11.60	10.60	14.14	30.00		3.86	Pass	
VHT20	MCS0	2	149	5745	11.60	11.20	14.41	30.00		3.86	Pass	
VHT20	MCS0	2	157	5785	11.80	10.90	14.38	30.00		3.86	Pass	
VHT20	MCS0	2	165	5825	11.60	10.90	14.27	30.00		3.86	Pass	
VHT40	MCS0	2	151	5755	11.80	11.10	14.47	30.00		3.86	Pass	
VHT40	MCS0	2	159	5795	11.90	10.90	14.44	30.00		3.86	Pass	
VHT80	MCS0	2	155	5775	11.60	11.20	14.41	30.00		3.86	Pass	

TEST RESULTS DATA
Power Spectral Density

Band IV														
Mod.	Data Rate	NTX	CH.	Freq. (MHz)	10log (500kHz /RBW) Factor (dB)		Average Power Density (dBm/500kHz)			Average PSD Limit (dBm/500kHz)		DG (dBi)		Pass /Fail
					Ant 1	Ant 2	Ant 1	Ant 2	SUM	Ant 1	Ant 2	Ant 1	Ant 2	
11a	6Mbps	2	149	5745	2.22					3.17	30.00	3.86		Pass
11a	6Mbps	2	157	5785	2.22					4.07	30.00	3.86		Pass
11a	6Mbps	2	165	5825	2.22					3.27	30.00	3.86		Pass
HT20	MCS0	2	149	5745	2.22					3.32	30.00	3.86		Pass
HT20	MCS0	2	157	5785	2.22					2.77	30.00	3.86		Pass
HT20	MCS0	2	165	5825	2.22					3.42	30.00	3.86		Pass
HT40	MCS0	2	151	5755	2.22					1.64	30.00	3.86		Pass
HT40	MCS0	2	159	5795	2.22					0.90	30.00	3.86		Pass
VHT20	MCS0	2	149	5745	2.22					3.07	30.00	3.86		Pass
VHT20	MCS0	2	157	5785	2.22					4.14	30.00	3.86		Pass
VHT20	MCS0	2	165	5825	2.22					2.84	30.00	3.86		Pass
VHT40	MCS0	2	151	5755	2.22					2.09	30.00	3.86		Pass
VHT40	MCS0	2	159	5795	2.22					2.00	30.00	3.86		Pass
VHT80	MCS0	2	155	5775	2.22					2.70	30.00	3.86		Pass



Appendix B. Radiated Spurious Emission

Test Engineer :	Jesse Wang, James Chiu, Derek Hsu, and Luke Chang	Temperature :	21~24°C
		Relative Humidity :	54~55%

<CDD Mode>

Band 4 - 5725~5850MHz

WIFI 802.11a (Band Edge @ 3m)

WIFI Ant. 2	Note	Frequency (MHz)	Level (dBμV/m)	Over Limit (dB)	Limit Line (dBμV/m)	Read Level (dBμV)	Antenna Factor (dB/m)	Cable Loss (dB)	Preamp Factor (dB)	Ant Pos (cm)	Table Pos (deg)	Peak Avg. (P/A)	Pol. (H/V)	
802.11a CH 149 5745MHz		5615	50.15	-18.15	68.3	38	35.52	11.89	35.26	100	188	P	H	
		5667.4	50.53	-30.68	81.21	38.27	35.53	12	35.27	100	188	P	H	
		5719.6	50.09	-60.7	110.79	37.77	35.54	12.06	35.28	100	188	P	H	
		5724.2	50.72	-69.76	120.48	38.4	35.54	12.06	35.28	100	188	P	H	
	*	5745	95.71	-	-	83.34	35.55	12.11	35.29	100	188	P	H	
	*	5745	88.68	-	-	76.31	35.55	12.11	35.29	100	188	A	H	
														H
														H
			5601.6	51.07	-17.23	68.3	38.92	35.52	11.89	35.26	187	207	P	V
			5696.2	51.41	-51.09	102.5	39.15	35.54	12	35.28	187	207	P	V
			5718.6	56.19	-54.32	110.51	43.87	35.54	12.06	35.28	187	207	P	V
			5725	58.49	-63.81	122.3	46.17	35.54	12.06	35.28	187	207	P	V
	*		5745	104.5	-	-	92.13	35.55	12.11	35.29	187	207	P	V
	*		5745	97.21	-	-	84.84	35.55	12.11	35.29	187	207	A	V
														V
														V



WIFI	Note	Frequency	Level	Over	Limit	Read	Antenna	Cable	Preamp	Ant	Table	Peak	Pol.
Ant.				Limit	Line	Level	Factor	Loss	Factor	Pos	Pos	Avg.	
2		(MHz)	(dBμV/m)	(dB)	(dBμV/m)	(dBμV)	(dB/m)	(dB)	(dB)	(cm)	(deg)	(P/A)	(H/V)
		5637.4	50.43	-17.87	68.3	38.22	35.53	11.95	35.27	144	200	P	H
		5699.6	50.91	-54.1	105.01	38.65	35.54	12	35.28	144	200	P	H
		5715	50.58	-58.92	109.5	38.26	35.54	12.06	35.28	144	200	P	H
		5721.6	49.59	-64.96	114.55	37.27	35.54	12.06	35.28	144	200	P	H
	*	5785	97.33	-	-	84.9	35.56	12.17	35.3	144	200	P	H
	*	5785	89.94	-	-	77.51	35.56	12.17	35.3	144	200	A	H
		5852.4	49.72	-67.11	116.83	37.18	35.57	12.28	35.31	144	200	P	H
		5862.2	50.03	-58.85	108.88	37.38	35.57	12.39	35.31	144	200	P	H
		5920.6	50.94	-20.6	71.54	38.17	35.58	12.51	35.32	144	200	P	H
		5929.2	50.75	-17.55	68.3	37.98	35.59	12.51	35.33	144	200	P	H
													H
													H
802.11a													
CH 157													
5785MHz		5633	50.52	-17.78	68.3	38.31	35.53	11.95	35.27	195	211	P	V
		5669	51.7	-30.7	82.4	39.44	35.53	12	35.27	195	211	P	V
		5717.4	51.2	-58.97	110.17	38.88	35.54	12.06	35.28	195	211	P	V
		5720	50.04	-60.86	110.9	37.72	35.54	12.06	35.28	195	211	P	V
	*	5785	104.84	-	-	92.41	35.56	12.17	35.3	195	211	P	V
	*	5785	97.65	-	-	85.22	35.56	12.17	35.3	195	211	A	V
		5851.4	50.73	-68.38	119.11	38.19	35.57	12.28	35.31	195	211	P	V
		5868.4	52.27	-54.88	107.15	39.62	35.57	12.39	35.31	195	211	P	V
		5894	51.01	-40.19	91.2	38.36	35.58	12.39	35.32	195	211	P	V
		5929.8	51.39	-16.91	68.3	38.62	35.59	12.51	35.33	195	211	P	V
													V
													V



WIFI	Note	Frequency	Level	Over	Limit	Read	Antenna	Cable	Preamp	Ant	Table	Peak	Pol.	
Ant.				Limit	Line	Level	Factor	Loss	Factor	Pos	Pos	Avg.		
2		(MHz)	(dB μ V/m)	(dB)	(dB μ V/m)	(dB μ V)	(dB/m)	(dB)	(dB)	(cm)	(deg)	(P/A)	(H/V)	
802.11a CH 165 5825MHz	*	5825	97.72	-	-	85.18	35.57	12.28	35.31	114	201	P	H	
	*	5825	91.1	-	-	78.56	35.57	12.28	35.31	114	201	A	H	
		5853.6	49.95	-64.14	114.09	37.41	35.57	12.28	35.31	114	201	P	H	
		5857	51.76	-58.58	110.34	39.22	35.57	12.28	35.31	114	201	P	H	
		5915.8	51.48	-23.6	75.08	38.71	35.58	12.51	35.32	114	201	P	H	
		5933	50.64	-17.66	68.3	37.87	35.59	12.51	35.33	114	201	P	H	
														H
														H
	*	5825	104.98	-	-	92.44	35.57	12.28	35.31	192	214	P	V	
	*	5825	98.31	-	-	85.77	35.57	12.28	35.31	192	214	A	V	
		5852	53.71	-64.03	117.74	41.17	35.57	12.28	35.31	192	214	P	V	
		5857.4	52.49	-57.74	110.23	39.95	35.57	12.28	35.31	192	214	P	V	
		5902.2	52.17	-32.96	85.13	39.4	35.58	12.51	35.32	192	214	P	V	
		5943.6	51.52	-16.78	68.3	38.64	35.59	12.62	35.33	192	214	P	V	
														V
														V
													V	
Remark	1. No other spurious found. 2. All results are PASS against Peak and Average limit line.													



Band 4 5725~5850MHz
WIFI 802.11a (Harmonic @ 3m)

WIFI	Note	Frequency	Level	Over	Limit	Read	Antenna	Cable	Preamp	Ant	Table	Peak	Pol.	
Ant.				Limit	Line	Level	Factor	Loss	Factor	Pos	Pos	Avg.		
2		(MHz)	(dBμV/m)	(dB)	(dBμV/m)	(dBμV)	(dB/m)	(dB)	(dB)	(cm)	(deg)	(P/A)	(H/V)	
802.11a CH 149 5745MHz		11490	41.74	-32.26	74	43.54	38.38	17.16	57.34	100	0	P	H	
		17232	44.39	-23.91	68.3	37.46	42.06	20.76	55.89	100	0	P	H	
													H	
													H	
		11490	40.97	-33.03	74	42.77	38.38	17.16	57.34	100	0	P	V	
		17232	44.78	-23.52	68.3	37.85	42.06	20.76	55.89	100	0	P	V	
														V
														V
802.11a CH 157 5785MHz		11570	40.73	-33.27	74	42.29	38.47	17.16	57.19	100	0	P	H	
		17352	46.29	-22.01	68.3	39.4	41.99	20.84	55.94	100	0	P	H	
													H	
													H	
		11570	41.48	-32.52	74	43.04	38.47	17.16	57.19	100	0	P	V	
		17352	44.99	-23.31	68.3	38.1	41.99	20.84	55.94	100	0	P	V	
														V
														V
802.11a CH 165 5825MHz		11650	41.17	-32.83	74	42.55	38.54	17.16	57.08	100	0	P	H	
		17475	44.25	-24.05	68.3	37.39	41.92	20.93	55.99	100	0	P	H	
													H	
													H	
		11650	41.2	-32.8	74	42.58	38.54	17.16	57.08	100	0	P	V	
		17475	45.01	-23.29	68.3	38.15	41.92	20.93	55.99	100	0	P	V	
														V
														V
Remark	1. No other spurious found. 2. All results are PASS against Peak and Average limit line.													



WIFI	Note	Frequency	Level	Over	Limit	Read	Antenna	Cable	Preamp	Ant	Table	Peak	Pol.
Ant.				Limit	Line	Level	Factor	Loss	Factor	Pos	Pos	Avg.	
2		(MHz)	(dBμV/m)	(dB)	(dBμV/m)	(dBμV)	(dB/m)	(dB)	(dB)	(cm)	(deg)	(P/A)	(H/V)
		5644.4	50.03	-18.27	68.3	37.82	35.53	11.95	35.27	100	111	P	H
		5683	49.69	-43.07	92.76	37.44	35.53	12	35.28	100	111	P	H
		5716.2	49.79	-60.05	109.84	37.47	35.54	12.06	35.28	100	111	P	H
		5720.6	50.4	-61.87	112.27	38.08	35.54	12.06	35.28	100	111	P	H
	*	5785	96.33	-	-	83.9	35.56	12.17	35.3	100	111	P	H
	*	5785	89.1	-	-	76.67	35.56	12.17	35.3	100	111	A	H
		5850.4	49.73	-71.66	121.39	37.19	35.57	12.28	35.31	100	111	P	H
		5866.2	51.32	-56.44	107.76	38.67	35.57	12.39	35.31	100	111	P	H
		5903.8	50.99	-32.96	83.95	38.22	35.58	12.51	35.32	100	111	P	H
		5934.8	51.62	-16.68	68.3	38.85	35.59	12.51	35.33	100	111	P	H
													H
													H
802.11ac													
VHT20													
CH 157		5640.6	50.69	-17.61	68.3	38.48	35.53	11.95	35.27	268	217	P	V
5785MHz		5691.8	51.02	-48.23	99.25	38.76	35.54	12	35.28	268	217	P	V
		5717.2	50.98	-59.14	110.12	38.66	35.54	12.06	35.28	268	217	P	V
		5724.2	50.7	-69.78	120.48	38.38	35.54	12.06	35.28	268	217	P	V
	*	5785	103.43	-	-	91	35.56	12.17	35.3	268	217	P	V
	*	5785	97.38	-	-	84.95	35.56	12.17	35.3	268	217	A	V
		5853.2	50.26	-64.74	115	37.72	35.57	12.28	35.31	268	217	P	V
		5872.2	50.53	-55.55	106.08	37.87	35.58	12.39	35.31	268	217	P	V
		5896.8	51.13	-38	89.13	38.48	35.58	12.39	35.32	268	217	P	V
		5946.2	51.02	-17.28	68.3	38.14	35.59	12.62	35.33	268	217	P	V
													V
													V



WIFI	Note	Frequency	Level	Over	Limit	Read	Antenna	Cable	Preamp	Ant	Table	Peak	Pol.	
Ant.				Limit	Line	Level	Factor	Loss	Factor	Pos	Pos	Avg.		
2		(MHz)	(dBμV/m)	(dB)	(dBμV/m)	(dBμV)	(dB/m)	(dB)	(dB)	(cm)	(deg)	(P/A)	(H/V)	
802.11ac VHT20 CH 165 5825MHz	*	5825	97.4	-	-	84.86	35.57	12.28	35.31	117	201	P	H	
	*	5825	90.79	-	-	78.25	35.57	12.28	35.31	117	201	A	H	
		5850.8	51.34	-69.14	120.48	38.8	35.57	12.28	35.31	117	201	P	H	
		5859.6	51.19	-58.42	109.61	38.65	35.57	12.28	35.31	117	201	P	H	
		5886.4	51.8	-45.04	96.84	39.15	35.58	12.39	35.32	117	201	P	H	
		5942.6	50.43	-17.87	68.3	37.55	35.59	12.62	35.33	117	201	P	H	
														H
														H
														H
														H
														H
														H
														H
														H
		*	5825	104.95	-	-	92.41	35.57	12.28	35.31	200	220	P	V
		*	5825	98.1	-	-	85.56	35.57	12.28	35.31	200	220	A	V
			5850.2	55.05	-66.79	121.84	42.51	35.57	12.28	35.31	200	220	P	V
			5855	54.29	-56.61	110.9	41.75	35.57	12.28	35.31	200	220	P	V
			5900.2	51.86	-34.75	86.61	39.09	35.58	12.51	35.32	200	220	P	V
			5928.6	50.1	-18.2	68.3	37.33	35.59	12.51	35.33	200	220	P	V
													V	
													V	
													V	
													V	
													V	
													V	
Remark	1. No other spurious found. 2. All results are PASS against Peak and Average limit line.													



Band 4 5725~5850MHz
WIFI 802.11ac VHT20 (Harmonic @ 3m)

WIFI	Note	Frequency	Level	Over	Limit	Read	Antenna	Cable	Preamp	Ant	Table	Peak	Pol.
Ant.				Limit	Line	Level	Factor	Loss	Factor	Pos	Pos	Avg.	
2		(MHz)	(dBμV/m)	(dB)	(dBμV/m)	(dBμV)	(dB/m)	(dB)	(dB)	(cm)	(deg)	(P/A)	(H/V)
802.11ac VHT20 CH 149 5745MHz		11490	41.19	-32.81	74	42.99	38.38	17.16	57.34	100	0	P	H
		17235	44.1	-24.2	68.3	37.17	42.06	20.76	55.89	100	0	P	H
													H
													H
		11490	41.85	-32.15	74	43.65	38.38	17.16	57.34	100	0	P	V
		17235	44.8	-23.5	68.3	37.87	42.06	20.76	55.89	100	0	P	V
802.11ac VHT20 CH 157 5785MHz		11570	41.25	-32.75	74	42.81	38.47	17.16	57.19	100	0	P	H
		17355	45.29	-23.01	68.3	38.4	41.99	20.84	55.94	100	0	P	H
													H
													H
		11570	41.15	-32.85	74	42.71	38.47	17.16	57.19	100	0	P	V
		17355	44.32	-23.98	68.3	37.43	41.99	20.84	55.94	100	0	P	V
802.11ac VHT20 CH 165 5825MHz		11650	41.49	-32.51	74	42.87	38.54	17.16	57.08	100	0	P	H
		17475	45.24	-23.06	68.3	38.38	41.92	20.93	55.99	100	0	P	H
													H
													H
		11650	41.38	-32.62	74	42.76	38.54	17.16	57.08	100	0	P	V
		17475	46.96	-21.34	68.3	40.1	41.92	20.93	55.99	100	0	P	V
Remark	1. No other spurious found.												
	2. All results are PASS against Peak and Average limit line.												



Band 4 5725~5850MHz
WIFI 802.11ac VHT40 (Band Edge @ 3m)

WIFI	Note	Frequency	Level	Over	Limit	Read	Antenna	Cable	Preamp	Ant	Table	Peak	Pol.
Ant.				Limit	Line	Level	Factor	Loss	Factor	Pos	Pos	Avg.	
2		(MHz)	(dBμV/m)	(dB)	(dBμV/m)	(dBμV)	(dB/m)	(dB)	(dB)	(cm)	(deg)	(P/A)	(H/V)
		5642.8	50.85	-17.45	68.3	38.64	35.53	11.95	35.27	100	203	P	H
		5696.4	52.31	-50.34	102.65	40.05	35.54	12	35.28	100	203	P	H
		5712.6	58.97	-49.86	108.83	46.65	35.54	12.06	35.28	100	203	P	H
		5720.4	57.06	-54.75	111.81	44.74	35.54	12.06	35.28	100	203	P	H
	*	5755	92.96	-	-	80.59	35.55	12.11	35.29	100	203	P	H
	*	5755	86.48	-	-	74.11	35.55	12.11	35.29	100	203	A	H
		5852.4	51.3	-65.53	116.83	38.76	35.57	12.28	35.31	100	203	P	H
		5870.8	50.25	-56.22	106.47	37.59	35.58	12.39	35.31	100	203	P	H
		5918.2	51.59	-21.72	73.31	38.82	35.58	12.51	35.32	100	203	P	H
		5947	51.79	-16.51	68.3	38.91	35.59	12.62	35.33	100	203	P	H
													H
													H
802.11ac													
VHT40													
CH 151		5640.2	50.78	-17.52	68.3	38.57	35.53	11.95	35.27	196	207	P	V
5755MHz		5698	57.59	-46.24	103.83	45.33	35.54	12	35.28	196	207	P	V
		5706.8	68.55	-38.66	107.21	56.23	35.54	12.06	35.28	196	207	P	V
		5723.8	67.3	-52.26	119.56	54.98	35.54	12.06	35.28	196	207	P	V
	*	5755	101.29	-	-	88.92	35.55	12.11	35.29	196	207	P	V
	*	5755	94.89	-	-	82.52	35.55	12.11	35.29	196	207	A	V
		5854.4	49.99	-62.28	112.27	37.45	35.57	12.28	35.31	196	207	P	V
		5867.2	51.56	-55.92	107.48	38.91	35.57	12.39	35.31	196	207	P	V
		5898	51.12	-37.12	88.24	38.47	35.58	12.39	35.32	196	207	P	V
		5930.6	50.79	-17.51	68.3	38.02	35.59	12.51	35.33	196	207	P	V
													V
													V



WIFI	Note	Frequency	Level	Over	Limit	Read	Antenna	Cable	Preamp	Ant	Table	Peak	Pol.
Ant.				Limit	Line	Level	Factor	Loss	Factor	Pos	Pos	Avg.	
2		(MHz)	(dBμV/m)	(dB)	(dBμV/m)	(dBμV)	(dB/m)	(dB)	(dB)	(cm)	(deg)	(P/A)	(H/V)
		5626.8	49.89	-18.41	68.3	37.69	35.52	11.95	35.27	100	108	P	H
		5659.6	50.72	-24.71	75.43	38.51	35.53	11.95	35.27	100	108	P	H
		5716.6	50.33	-59.62	109.95	38.01	35.54	12.06	35.28	100	108	P	H
		5724.4	49.91	-71.02	120.93	37.59	35.54	12.06	35.28	100	108	P	H
	*	5795	93.92	-	-	81.49	35.56	12.17	35.3	100	108	P	H
	*	5795	86.7	-	-	74.27	35.56	12.17	35.3	100	108	A	H
		5853.8	50.42	-63.22	113.64	37.88	35.57	12.28	35.31	100	108	P	H
		5866	50.16	-57.66	107.82	37.51	35.57	12.39	35.31	100	108	P	H
		5901.8	51.75	-33.68	85.43	38.98	35.58	12.51	35.32	100	108	P	H
		5940.2	49.49	-18.81	68.3	36.61	35.59	12.62	35.33	100	108	P	H
802.11ac													H
VHT40													H
CH 159		5643.2	51.2	-17.1	68.3	38.99	35.53	11.95	35.27	195	205	P	V
5795MHz		5689.8	51.36	-46.42	97.78	39.1	35.54	12	35.28	195	205	P	V
		5718.6	55.15	-55.36	110.51	42.83	35.54	12.06	35.28	195	205	P	V
		5725	53.87	-68.43	122.3	41.55	35.54	12.06	35.28	195	205	P	V
	*	5795	101.57	-	-	89.14	35.56	12.17	35.3	195	205	P	V
	*	5795	94.95	-	-	82.52	35.56	12.17	35.3	195	205	A	V
		5851.4	54.7	-64.41	119.11	42.16	35.57	12.28	35.31	195	205	P	V
		5866.8	53.98	-53.61	107.59	41.33	35.57	12.39	35.31	195	205	P	V
		5876.6	51.66	-52.45	104.11	39.01	35.58	12.39	35.32	195	205	P	V
		5927.6	51.04	-17.26	68.3	38.27	35.59	12.51	35.33	195	205	P	V
													V
													V
Remark	1. No other spurious found. 2. All results are PASS against Peak and Average limit line.												



Band 4 5725~5850MHz
WIFI 802.11ac VHT40 (Harmonic @ 3m)

WIFI	Note	Frequency	Level	Over	Limit	Read	Antenna	Cable	Preamp	Ant	Table	Peak	Pol.
Ant.				Limit	Line	Level	Factor	Loss	Factor	Pos	Pos	Avg.	
2		(MHz)	(dBμV/m)	(dB)	(dBμV/m)	(dBμV)	(dB/m)	(dB)	(dB)	(cm)	(deg)	(P/A)	(H/V)
802.11ac VHT40 CH 151 5755MHz		11510	41.66	-32.34	74	43.4	38.4	17.16	57.3	100	0	P	H
		17268	45.39	-22.91	68.3	38.47	42.04	20.79	55.91	100	0	P	H
													H
													H
		11510	41.79	-32.21	74	43.53	38.4	17.16	57.3	100	0	P	V
		17268	44.85	-23.45	68.3	37.93	42.04	20.79	55.91	100	0	P	V
802.11ac VHT40 CH 159 5795MHz		11590	41.19	-32.81	74	42.7	38.49	17.16	57.16	100	0	P	H
		17385	44.7	-23.6	68.3	37.81	41.97	20.87	55.95	100	0	P	H
													H
													H
		11590	41.73	-32.27	74	43.24	38.49	17.16	57.16	100	0	P	V
		17385	43.71	-24.59	68.3	36.82	41.97	20.87	55.95	100	0	P	V
Remark	1. No other spurious found.												
	2. All results are PASS against Peak and Average limit line.												



Band 4 5725~5850MHz
WIFI 802.11ac VHT80 (Band Edge @ 3m)

WIFI	Note	Frequency	Level	Over	Limit	Read	Antenna	Cable	Preamp	Ant	Table	Peak	Pol.	
Ant.				Limit	Line	Level	Factor	Loss	Factor	Pos	Pos	Avg.		
2		(MHz)	(dBμV/m)	(dB)	(dBμV/m)	(dBμV)	(dB/m)	(dB)	(dB)	(cm)	(deg)	(P/A)	(H/V)	
802.11ac VHT80 CH 155 5775MHz		5647.4	50.49	-17.81	68.3	38.28	35.53	11.95	35.27	100	203	P	H	
		5699	54.2	-50.36	104.56	41.94	35.54	12	35.28	100	203	P	H	
		5719.8	55.07	-55.77	110.84	42.75	35.54	12.06	35.28	100	203	P	H	
		5721	52.36	-60.82	113.18	40.04	35.54	12.06	35.28	100	203	P	H	
	*	5775	89.92	-	-	77.55	35.56	12.11	35.3	100	203	P	H	
	*	5775	83.17	-	-	70.8	35.56	12.11	35.3	100	203	A	H	
		5852.4	51.28	-65.55	116.83	38.74	35.57	12.28	35.31	100	203	P	H	
		5868.4	51.36	-55.79	107.15	38.71	35.57	12.39	35.31	100	203	P	H	
		5885.2	51.31	-46.42	97.73	38.66	35.58	12.39	35.32	100	203	P	H	
		5936.4	50.17	-18.13	68.3	37.4	35.59	12.51	35.33	100	203	P	H	
														H
														H
			5640.2	54.55	-13.75	68.3	42.34	35.53	11.95	35.27	206	212	P	V
			5696	59.58	-42.77	102.35	47.32	35.54	12	35.28	206	212	P	V
			5712.2	63.55	-45.17	108.72	51.23	35.54	12.06	35.28	206	212	P	V
			5723.4	62.5	-56.15	118.65	50.18	35.54	12.06	35.28	206	212	P	V
	*		5775	97.97	-	-	85.6	35.56	12.11	35.3	206	212	P	V
	*		5775	90.99	-	-	78.62	35.56	12.11	35.3	206	212	A	V
			5850.2	55.94	-65.9	121.84	43.4	35.57	12.28	35.31	206	212	P	V
			5856.2	56.6	-53.96	110.56	44.06	35.57	12.28	35.31	206	212	P	V
		5875.8	54.23	-50.48	104.71	41.58	35.58	12.39	35.32	206	212	P	V	
		5944	50.16	-18.14	68.3	37.28	35.59	12.62	35.33	206	212	P	V	
													V	
													V	
Remark	1. No other spurious found. 2. All results are PASS against Peak and Average limit line.													



Band 4 5725~5850MHz
WIFI 802.11ac VHT80 (Harmonic @ 3m)

WIFI	Note	Frequency	Level	Over	Limit	Read	Antenna	Cable	Preamp	Ant	Table	Peak	Pol.
Ant.				Limit	Line	Level	Factor	Loss	Factor	Pos	Pos	Avg.	
2		(MHz)	(dBμV/m)	(dB)	(dBμV/m)	(dBμV)	(dB/m)	(dB)	(dB)	(cm)	(deg)	(P/A)	(H/V)
802.11ac VHT80 CH 155 5775MHz		11550	41.99	-32.01	74	43.6	38.45	17.16	57.22	100	0	P	H
		17325	44.25	-24.05	68.3	37.36	42.01	20.81	55.93	100	0	P	H
													H
													H
		11550	41.02	-32.98	74	42.63	38.45	17.16	57.22	100	0	P	V
		17325	44.71	-23.59	68.3	37.82	42.01	20.81	55.93	100	0	P	V
													V
													V
Remark	1. No other spurious found. 2. All results are PASS against Peak and Average limit line.												



Emission below 1GHz
5GHz WIFI 802.11a (LF @ 3m)

WIFI Ant. 2	Note	Frequency (MHz)	Level (dBμV/m)	Over Limit (dB)	Limit Line (dBμV/m)	Read Level (dBμV)	Antenna Factor (dB/m)	Cable Loss (dB)	Preamp Factor (dB)	Ant Pos (cm)	Table Pos (deg)	Peak Avg. (P/A)	Pol. (H/V)
		30	27.57	-12.43	40	31.85	26	1.07	31.35	-	-	P	H
		100.74	33.08	-10.42	43.5	46.56	16.49	1.55	31.52	-	-	P	H
		240.06	32.54	-13.46	46	43.78	18.09	2.07	31.4	-	-	P	H
		479.9	30.24	-15.76	46	34.49	23.76	3.04	31.05	-	-	P	H
		659.8	38.66	-7.34	46	39.85	26	3.57	30.76	100	0	P	H
		981.8	34.33	-19.67	54	30.61	30.26	3.98	30.52	-	-	P	H
													H
													H
													H
													H
													H
													H
5GHz													H
802.11a													H
LF		35.13	26.02	-13.98	40	33.06	23.3	1.07	31.41	-	-	P	V
		100.74	31.54	-11.96	43.5	45.02	16.49	1.55	31.52	-	-	P	V
		240.06	29.54	-16.46	46	40.78	18.09	2.07	31.4	-	-	P	V
		500.9	26.72	-19.28	46	30.4	24.2	3.14	31.02	-	-	P	V
		780.2	34.67	-11.33	46	33.89	27.5	3.9	30.62	100	0	P	V
		975.5	34.26	-19.74	54	30.46	30.25	4.07	30.52	-	-	P	V
													V
													V
													V
													V
													V
													V
													V
													V
Remark	1. No other spurious found. 2. All results are PASS against limit line.												



Emission below 1GHz

5GHz WIFI 802.11ac VHT20 (LF @ 3m)

WIFI Ant. 2	Note	Frequency (MHz)	Level (dBµV/m)	Over Limit (dB)	Limit Line (dBµV/m)	Read Level (dBµV)	Antenna Factor (dB/m)	Cable Loss (dB)	Preamp Factor (dB)	Ant Pos (cm)	Table Pos (deg)	Peak Avg. (P/A)	Pol. (H/V)	
5GHz 802.11ac VHT20 LF		30	28.12	-11.88	40	32.4	26	1.07	31.35	-	-	P	H	
		100.47	34.27	-9.23	43.5	47.75	16.49	1.55	31.52	-	-	P	H	
		240.06	33.69	-12.31	46	44.93	18.09	2.07	31.4	-	-	P	H	
		360.2	29.01	-16.99	46	36.28	21.44	2.5	31.21	-	-	P	H	
		659.8	39.48	-6.52	46	40.67	26	3.57	30.76	-	-	P	H	
		780.2	40.86	-5.14	46	40.08	27.5	3.9	30.62	100	0	P	H	
														H
														H
														H
														H
														H
														H
			33.78	33.64	-6.36	40	40.13	23.84	1.07	31.4	100	0	P	V
			99.12	30.48	-13.02	43.5	44.45	16.27	1.28	31.52	-	-	P	V
			240.06	30.91	-15.09	46	42.15	18.09	2.07	31.4	-	-	P	V
			540.1	31.33	-14.67	46	34.51	24.52	3.24	30.94	-	-	P	V
			780.2	35.32	-10.68	46	34.54	27.5	3.9	30.62	-	-	P	V
			977.6	35.24	-18.76	54	31.43	30.26	4.07	30.52	-	-	P	V
													V	
													V	
													V	
													V	
													V	
													V	
Remark	1. No other spurious found. 2. All results are PASS against limit line.													



Emission below 1GHz

5GHz WIFI 802.11ac VHT40 (LF @ 3m)

WIFI Ant. 2	Note	Frequency (MHz)	Level (dBµV/m)	Over Limit (dB)	Limit Line (dBµV/m)	Read Level (dBµV)	Antenna Factor (dB/m)	Cable Loss (dB)	Preamp Factor (dB)	Ant Pos (cm)	Table Pos (deg)	Peak Avg. (P/A)	Pol. (H/V)	
5GHz 802.11ac VHT40 LF		30	28.93	-11.07	40	33.21	26	1.07	31.35	-	-	P	H	
		88.59	31.16	-12.34	43.5	46.56	14.86	1.28	31.54	-	-	P	H	
		240.06	34.09	-11.91	46	45.33	18.09	2.07	31.4	-	-	P	H	
		360.2	27.9	-18.1	46	35.17	21.44	2.5	31.21	-	-	P	H	
		540.1	34.95	-11.05	46	38.13	24.52	3.24	30.94	-	-	P	H	
		780.2	40.19	-5.81	46	39.41	27.5	3.9	30.62	100	0	P	H	
														H
														H
														H
														H
														H
														H
			36.48	26.72	-13.28	40	34.95	22.14	1.07	31.44	-	-	P	V
			98.85	31.15	-12.35	43.5	45.12	16.27	1.28	31.52	-	-	P	V
			240.06	30.44	-15.56	46	41.68	18.09	2.07	31.4	-	-	P	V
			488.3	28.24	-17.76	46	32.31	23.93	3.04	31.04	-	-	P	V
			659.8	34.79	-11.21	46	35.98	26	3.57	30.76	-	-	P	V
			780.2	34.91	-11.09	46	34.13	27.5	3.9	30.62	100	0	P	V
													V	
													V	
													V	
													V	
													V	
													V	
Remark	1. No other spurious found. 2. All results are PASS against limit line.													



Emission below 1GHz

5GHz WIFI 802.11ac VHT80 (LF @ 3m)

WIFI Ant. 2	Note	Frequency (MHz)	Level (dBµV/m)	Over Limit (dB)	Limit Line (dBµV/m)	Read Level (dBµV)	Antenna Factor (dB/m)	Cable Loss (dB)	Preamp Factor (dB)	Ant Pos (cm)	Table Pos (deg)	Peak Avg. (P/A)	Pol. (H/V)	
5GHz 802.11ac VHT80 LF		30	28.2	-11.8	40	32.48	26	1.07	31.35	-	-	P	H	
		101.01	34.03	-9.47	43.5	47.51	16.49	1.55	31.52	-	-	P	H	
		240.06	33.56	-12.44	46	44.8	18.09	2.07	31.4	-	-	P	H	
		419.7	27.86	-18.14	46	33.65	22.68	2.67	31.14	-	-	P	H	
		659.8	39.14	-6.86	46	40.33	26	3.57	30.76	100	0	P	H	
		780.2	39.12	-6.88	46	38.34	27.5	3.9	30.62	-	-	P	H	
														H
														H
														H
														H
														H
														H
			35.13	28.6	-11.4	40	35.64	23.3	1.07	31.41	-	-	P	V
			101.28	31.68	-11.82	43.5	45.16	16.49	1.55	31.52	-	-	P	V
			240.06	31.1	-14.9	46	42.34	18.09	2.07	31.4	-	-	P	V
			474.3	26.67	-19.33	46	31.06	23.63	3.04	31.06	-	-	P	V
			780.2	34.64	-11.36	46	33.86	27.5	3.9	30.62	100	0	P	V
			956.6	34.21	-11.79	46	30.46	30.21	4.07	30.53	-	-	P	V
													V	
													V	
													V	
													V	
													V	
Remark	3. No other spurious found. 4. All results are PASS against limit line.													



Note symbol

*	Fundamental Frequency which can be ignored. However, the level of any unwanted emissions shall not exceed the level of the fundamental frequency.
!	Test result is over limit line.
P/A	Peak or Average
H/V	Horizontal or Vertical



A calculation example for radiated spurious emission is shown as below:

WIFI Ant. 2	Note	Frequency (MHz)	Level (dBμV/m)	Over Limit (dB)	Limit Line (dBμV/m)	Read Level (dBμV)	Antenna Factor (dB/m)	Cable Loss (dB)	Preamp Factor (dB)	Ant Pos (cm)	Table Pos (deg)	Peak Avg. (P/A)	Pol. (H/V)
802.11b CH 01 2412MHz		2390	55.45	-18.55	74	54.51	32.22	4.58	35.86	103	308	P	H
		2390	43.54	-10.46	54	42.6	32.22	4.58	35.86	103	308	A	H

- Level(dBμV/m) =
Antenna Factor(dB/m) + Cable Loss(dB) + Read Level(dBμV) - Preamp Factor(dB)
- Over Limit(dB) = Level(dBμV/m) – Limit Line(dBμV/m)

For Peak Limit @ 2390MHz:

- Level(dBμV/m)
= Antenna Factor(dB/m) + Cable Loss(dB) + Read Level(dBμV) - Preamp Factor(dB)
= 32.22(dB/m) + 4.58(dB) + 54.51(dBμV) – 35.86 (dB)
= 55.45 (dBμV/m)
- Over Limit(dB)
= Level(dBμV/m) – Limit Line(dBμV/m)
= 55.45(dBμV/m) – 74(dBμV/m)
= -18.55(dB)

For Average Limit @ 2390MHz:

- Level(dBμV/m)
= Antenna Factor(dB/m) + Cable Loss(dB) + Read Level(dBμV) - Preamp Factor(dB)
= 32.22(dB/m) + 4.58(dB) + 42.6(dBμV) – 35.86 (dB)
= 43.54 (dBμV/m)
- Over Limit(dB)
= Level(dBμV/m) – Limit Line(dBμV/m)
= 43.54(dBμV/m) – 54(dBμV/m)
= -10.46(dB)

Both peak and average measured complies with the limit line, so test result is “PASS”.



<CDD Mode>

Band 4 - 5725~5850MHz

WIFI 802.11a (Band Edge @ 3m)

WIFI Ant. 1+2	Note	Frequency (MHz)	Level (dBμV/m)	Over Limit (dB)	Limit Line (dBμV/m)	Read Level (dBμV)	Antenna Factor (dB/m)	Cable Loss (dB)	Preamp Factor (dB)	Ant Pos (cm)	Table Pos (deg)	Peak Avg. (P/A)	Pol. (H/V)	
802.11a CH 149 5745MHz		5637.8	51.78	-16.52	68.3	39.57	35.53	11.95	35.27	374	284	P	H	
		5691.8	51.67	-47.58	99.25	39.41	35.54	12	35.28	374	284	P	H	
		5718.6	53.17	-57.34	110.51	40.85	35.54	12.06	35.28	374	284	P	H	
		5723.4	61.49	-57.16	118.65	49.17	35.54	12.06	35.28	374	284	P	H	
	*	5745	107.27	-	-	94.9	35.55	12.11	35.29	374	284	P	H	
	*	5745	99.9	-	-	87.53	35.55	12.11	35.29	374	284	A	H	
														H
														H
			5632.8	50.18	-18.12	68.3	37.97	35.53	11.95	35.27	369	168	P	V
			5689.6	50.33	-47.3	97.63	38.07	35.54	12	35.28	369	168	P	V
			5719.6	52.81	-57.98	110.79	40.49	35.54	12.06	35.28	369	168	P	V
			5724.8	56.91	-64.93	121.84	44.59	35.54	12.06	35.28	369	168	P	V
	*		5745	102.55	-	-	90.18	35.55	12.11	35.29	369	168	P	V
	*		5745	96.29	-	-	83.92	35.55	12.11	35.29	369	168	A	V
														V
													V	



WIFI	Note	Frequency	Level	Over	Limit	Read	Antenna	Cable	Preamp	Ant	Table	Peak	Pol.	
Ant.				Limit	Line	Level	Factor	Loss	Factor	Pos	Pos	Avg.		
1+2		(MHz)	(dBμV/m)	(dB)	(dBμV/m)	(dBμV)	(dB/m)	(dB)	(dB)	(cm)	(deg)	(P/A)	(H/V)	
802.11a CH 157 5785MHz		5629.8	51.57	-16.73	68.3	39.37	35.52	11.95	35.27	368	283	P	H	
		5664.8	51.43	-27.86	79.29	39.17	35.53	12	35.27	368	283	P	H	
		5719.8	50.9	-59.94	110.84	38.58	35.54	12.06	35.28	368	283	P	H	
		5720	50.37	-60.53	110.9	38.05	35.54	12.06	35.28	368	283	P	H	
	*	5785	106.46	-	-	94.03	35.56	12.17	35.3	368	283	P	H	
	*	5785	99.65	-	-	87.22	35.56	12.17	35.3	368	283	A	H	
		5853.4	51.57	-62.98	114.55	39.03	35.57	12.28	35.31	368	283	P	H	
		5872.4	50.86	-55.17	106.03	38.2	35.58	12.39	35.31	368	283	P	H	
		5889.4	50.9	-43.71	94.61	38.25	35.58	12.39	35.32	368	283	P	H	
		5926.8	50.84	-17.46	68.3	38.07	35.59	12.51	35.33	368	283	P	H	
														H
														H
			5625.4	51.21	-17.09	68.3	39.01	35.52	11.95	35.27	313	164	P	V
			5692.4	51.33	-48.37	99.7	39.07	35.54	12	35.28	313	164	P	V
			5718.6	50.57	-59.94	110.51	38.25	35.54	12.06	35.28	313	164	P	V
			5722.4	50.08	-66.29	116.37	37.76	35.54	12.06	35.28	313	164	P	V
	*		5785	103.62	-	-	91.19	35.56	12.17	35.3	313	164	P	V
	*		5785	96.91	-	-	84.48	35.56	12.17	35.3	313	164	A	V
			5854.6	50.5	-61.31	111.81	37.96	35.57	12.28	35.31	313	164	P	V
			5864	52.49	-55.89	108.38	39.84	35.57	12.39	35.31	313	164	P	V
		5902.6	50.87	-33.97	84.84	38.1	35.58	12.51	35.32	313	164	P	V	
		5938.6	51.05	-17.25	68.3	38.28	35.59	12.51	35.33	313	164	P	V	
													V	
													V	



WIFI	Note	Frequency	Level	Over	Limit	Read	Antenna	Cable	Preamp	Ant	Table	Peak	Pol.	
Ant.				Limit	Line	Level	Factor	Loss	Factor	Pos	Pos	Avg.		
1+2		(MHz)	(dBμV/m)	(dB)	(dBμV/m)	(dBμV)	(dB/m)	(dB)	(dB)	(cm)	(deg)	(P/A)	(H/V)	
802.11a CH 165 5825MHz	*	5825	105.94	-	-	93.4	35.57	12.28	35.31	242	278	P	H	
	*	5825	100.17	-	-	87.63	35.57	12.28	35.31	242	278	A	H	
		5851.4	51.31	-67.8	119.11	38.77	35.57	12.28	35.31	242	278	P	H	
		5872	51.72	-54.42	106.14	39.06	35.58	12.39	35.31	242	278	P	H	
		5916.6	51.41	-23.08	74.49	38.64	35.58	12.51	35.32	242	278	P	H	
		5937.2	51.99	-16.31	68.3	39.22	35.59	12.51	35.33	242	278	P	H	
														H
														H
	*	5825	104.45	-	-	91.91	35.57	12.28	35.31	282	167	P	V	
	*	5825	97.3	-	-	84.76	35.57	12.28	35.31	282	167	A	V	
		5851	53.01	-67.01	120.02	40.47	35.57	12.28	35.31	282	167	P	V	
		5860	51.3	-58.2	109.5	38.76	35.57	12.28	35.31	282	167	P	V	
		5878	51.77	-51.3	103.07	39.12	35.58	12.39	35.32	282	167	P	V	
		5943.4	50.88	-17.42	68.3	38	35.59	12.62	35.33	282	167	P	V	
														V
														V
													V	
Remark	1. No other spurious found. 2. All results are PASS against Peak and Average limit line.													



Band 4 5725~5850MHz
WIFI 802.11a (Harmonic @ 3m)

WIFI	Note	Frequency	Level	Over	Limit	Read	Antenna	Cable	Preamp	Ant	Table	Peak	Pol.
Ant.				Limit	Line	Level	Factor	Loss	Factor	Pos	Pos	Avg.	
1+2		(MHz)	(dBμV/m)	(dB)	(dBμV/m)	(dBμV)	(dB/m)	(dB)	(dB)	(cm)	(deg)	(P/A)	(H/V)
802.11a CH 149 5745MHz		11490	41.25	-32.75	74	43.05	38.38	17.16	57.34	100	0	P	H
		17235	44.57	-23.73	68.3	37.64	42.06	20.76	55.89	100	0	P	H
													H
													H
		11490	41.34	-32.66	74	43.14	38.38	17.16	57.34	100	0	P	V
		17235	44.85	-23.45	68.3	37.92	42.06	20.76	55.89	100	0	P	V
													V
													V
802.11a CH 157 5785MHz		11570	41.06	-32.94	74	42.62	38.47	17.16	57.19	100	0	P	H
		17355	45.02	-23.28	68.3	38.13	41.99	20.84	55.94	100	0	P	H
													H
													H
		11570	42.34	-31.66	74	43.9	38.47	17.16	57.19	100	0	P	V
		17355	44.74	-23.56	68.3	37.85	41.99	20.84	55.94	100	0	P	V
													V
													V
802.11a CH 165 5825MHz		11650	40.79	-33.21	74	42.17	38.54	17.16	57.08	100	0	P	H
		17472	45.38	-22.92	68.3	38.52	41.92	20.93	55.99	100	0	P	H
													H
													H
		11650	42.26	-31.74	74	43.64	38.54	17.16	57.08	100	0	P	V
		17472	44.99	-23.31	68.3	38.13	41.92	20.93	55.99	100	0	P	V
													V
													V
Remark	1. No other spurious found. 2. All results are PASS against Peak and Average limit line.												



Band 4 5725~5850MHz
WIFI 802.11ac VHT20 (Band Edge @ 3m)

WIFI	Note	Frequency	Level	Over	Limit	Read	Antenna	Cable	Preamp	Ant	Table	Peak	Pol.	
Ant.				Limit	Line	Level	Factor	Loss	Factor	Pos	Pos	Avg.		
1+2		(MHz)	(dBμV/m)	(dB)	(dBμV/m)	(dBμV)	(dB/m)	(dB)	(dB)	(cm)	(deg)	(P/A)	(H/V)	
802.11ac VHT20 CH 149 5745MHz		5633.8	52.21	-16.09	68.3	40	35.53	11.95	35.27	100	301	P	H	
		5659.8	51.53	-24.05	75.58	39.32	35.53	11.95	35.27	100	301	P	H	
		5719.8	55.95	-54.89	110.84	43.63	35.54	12.06	35.28	100	301	P	H	
		5724.2	62.16	-58.32	120.48	49.84	35.54	12.06	35.28	100	301	P	H	
	*	5745	107.08	-	-	94.71	35.55	12.11	35.29	100	301	P	H	
	*	5745	99.01	-	-	86.64	35.55	12.11	35.29	100	301	A	H	
														H
														H
														H
														H
														H
														H
														H
														H
														H
														H
			5631.6	50.52	-17.78	68.3	38.32	35.52	11.95	35.27	267	184	P	V
			5694.8	52.75	-48.72	101.47	40.49	35.54	12	35.28	267	184	P	V
		5719.4	51.94	-58.79	110.73	39.62	35.54	12.06	35.28	267	184	P	V	
		5725	57.97	-64.33	122.3	45.65	35.54	12.06	35.28	267	184	P	V	
*		5745	103.11	-	-	90.74	35.55	12.11	35.29	267	184	P	V	
*		5745	95.14	-	-	82.77	35.55	12.11	35.29	267	184	A	V	
													V	
													V	
													V	
													V	
													V	
													V	
													V	



WIFI	Note	Frequency	Level	Over	Limit	Read	Antenna	Cable	Preamp	Ant	Table	Peak	Pol.	
Ant.				Limit	Line	Level	Factor	Loss	Factor	Pos	Pos	Avg.		
1+2		(MHz)	(dBµV/m)	(dB)	(dBµV/m)	(dBµV)	(dB/m)	(dB)	(dB)	(cm)	(deg)	(P/A)	(H/V)	
802.11ac VHT20 CH 157 5785MHz		5613.6	50.01	-18.29	68.3	37.86	35.52	11.89	35.26	100	298	P	H	
		5695.4	53.3	-48.61	101.91	41.04	35.54	12	35.28	100	298	P	H	
		5719.2	51.62	-59.06	110.68	39.3	35.54	12.06	35.28	100	298	P	H	
		5722.4	51.09	-65.28	116.37	38.77	35.54	12.06	35.28	100	298	P	H	
	*	5785	107.24	-	-	94.81	35.56	12.17	35.3	100	298	P	H	
	*	5785	97.52	-	-	85.09	35.56	12.17	35.3	100	298	A	H	
		5850.6	50.84	-70.09	120.93	38.3	35.57	12.28	35.31	100	298	P	H	
		5868.4	52.57	-54.58	107.15	39.92	35.57	12.39	35.31	100	298	P	H	
		5888.6	52.66	-42.54	95.2	40.01	35.58	12.39	35.32	100	298	P	H	
		5926	50.63	-17.67	68.3	37.86	35.59	12.51	35.33	100	298	P	H	
														H
														H
			5617.4	51.97	-16.33	68.3	39.82	35.52	11.89	35.26	265	186	P	V
			5668.6	50.22	-31.88	82.1	37.96	35.53	12	35.27	265	186	P	V
			5705.2	51.07	-55.69	106.76	38.75	35.54	12.06	35.28	265	186	P	V
			5724.8	48.85	-72.99	121.84	36.53	35.54	12.06	35.28	265	186	P	V
	*		5785	103.73	-	-	91.3	35.56	12.17	35.3	265	186	P	V
	*		5785	95.62	-	-	83.19	35.56	12.17	35.3	265	186	A	V
			5851.8	49.98	-68.22	118.2	37.44	35.57	12.28	35.31	265	186	P	V
			5867.6	50.71	-56.66	107.37	38.06	35.57	12.39	35.31	265	186	P	V
		5880	52.07	-49.52	101.59	39.42	35.58	12.39	35.32	265	186	P	V	
		5925.8	50.98	-17.32	68.3	38.21	35.59	12.51	35.33	265	186	P	V	
													V	
													V	



WIFI	Note	Frequency	Level	Over	Limit	Read	Antenna	Cable	Preamp	Ant	Table	Peak	Pol.	
Ant.				Limit	Line	Level	Factor	Loss	Factor	Pos	Pos	Avg.		
1+2		(MHz)	(dBμV/m)	(dB)	(dBμV/m)	(dBμV)	(dB/m)	(dB)	(dB)	(cm)	(deg)	(P/A)	(H/V)	
802.11ac VHT20 CH 165 5825MHz	*	5825	107.25	-	-	94.71	35.57	12.28	35.31	100	300	P	H	
	*	5825	98.44	-	-	85.9	35.57	12.28	35.31	100	300	A	H	
		5850.2	55.21	-66.63	121.84	42.67	35.57	12.28	35.31	100	300	P	H	
		5857.8	54.9	-55.21	110.11	42.36	35.57	12.28	35.31	100	300	P	H	
		5884.4	53.28	-45.04	98.32	40.63	35.58	12.39	35.32	100	300	P	H	
		5943.2	50.95	-17.35	68.3	38.07	35.59	12.62	35.33	100	300	P	H	
														H
														H
														H
														H
														H
														H
	*	5825	103.29	-	-	90.75	35.57	12.28	35.31	264	187	P	V	
	*	5825	94.56	-	-	82.02	35.57	12.28	35.31	264	187	A	V	
		5850.2	52.48	-69.36	121.84	39.94	35.57	12.28	35.31	264	187	P	V	
		5858.4	52.46	-57.49	109.95	39.92	35.57	12.28	35.31	264	187	P	V	
		5902.4	51.71	-33.28	84.99	38.94	35.58	12.51	35.32	264	187	P	V	
		5929	50.46	-17.84	68.3	37.69	35.59	12.51	35.33	264	187	P	V	
													V	
													V	
													V	
													V	
													V	
													V	
Remark	1. No other spurious found. 2. All results are PASS against Peak and Average limit line.													



Band 4 5725~5850MHz
WIFI 802.11ac VHT20 (Harmonic @ 3m)

WIFI	Note	Frequency	Level	Over	Limit	Read	Antenna	Cable	Preamp	Ant	Table	Peak	Pol.
Ant.				Limit	Line	Level	Factor	Loss	Factor	Pos	Pos	Avg.	
1+2		(MHz)	(dBμV/m)	(dB)	(dBμV/m)	(dBμV)	(dB/m)	(dB)	(dB)	(cm)	(deg)	(P/A)	(H/V)
802.11ac VHT20 CH 149 5745MHz		11490	41.69	-32.31	74	43.49	38.38	17.16	57.34	100	0	P	H
		17235	44.11	-24.19	68.3	37.18	42.06	20.76	55.89	100	0	P	H
													H
													H
		11490	41.55	-32.45	74	43.35	38.38	17.16	57.34	100	0	P	V
		17235	44.55	-23.75	68.3	37.62	42.06	20.76	55.89	100	0	P	V
													V
802.11ac VHT20 CH 157 5785MHz		11570	40.98	-33.02	74	42.54	38.47	17.16	57.19	100	0	P	H
		17352	44.08	-24.22	68.3	37.19	41.99	20.84	55.94	100	0	P	H
													H
													H
		11570	41.34	-32.66	74	42.9	38.47	17.16	57.19	100	0	P	V
		17352	44.67	-23.63	68.3	37.78	41.99	20.84	55.94	100	0	P	V
													V
802.11ac VHT20 CH 165 5825MHz		11650	42.09	-31.91	74	43.47	38.54	17.16	57.08	100	0	P	H
		17472	45.59	-22.71	68.3	38.73	41.92	20.93	55.99	100	0	P	H
													H
													H
		11650	41.39	-32.61	74	42.77	38.54	17.16	57.08	100	0	P	V
		17472	44.62	-23.68	68.3	37.76	41.92	20.93	55.99	100	0	P	V
													V
Remark	1. No other spurious found.												
	2. All results are PASS against Peak and Average limit line.												



Band 4 5725~5850MHz
WIFI 802.11ac VHT40 (Band Edge @ 3m)

WIFI	Note	Frequency	Level	Over	Limit	Read	Antenna	Cable	Preamp	Ant	Table	Peak	Pol.	
Ant.				Limit	Line	Level	Factor	Loss	Factor	Pos	Pos	Avg.		
1+2		(MHz)	(dBμV/m)	(dB)	(dBμV/m)	(dBμV)	(dB/m)	(dB)	(dB)	(cm)	(deg)	(P/A)	(H/V)	
802.11ac VHT40 CH 151 5755MHz		5648.2	52.12	-16.18	68.3	39.91	35.53	11.95	35.27	100	298	P	H	
		5693	57.59	-42.55	100.14	45.33	35.54	12	35.28	100	298	P	H	
		5720	65.03	-45.87	110.9	52.71	35.54	12.06	35.28	100	298	P	H	
		5722.4	65.79	-50.58	116.37	53.47	35.54	12.06	35.28	100	298	P	H	
	*	5755	105.8	-	-	93.43	35.55	12.11	35.29	100	298	P	H	
	*	5755	97.27	-	-	84.9	35.55	12.11	35.29	100	298	A	H	
		5853.8	51.44	-62.2	113.64	38.9	35.57	12.28	35.31	100	298	P	H	
		5855.6	51.75	-58.98	110.73	39.21	35.57	12.28	35.31	100	298	P	H	
		5893.4	51.9	-39.75	91.65	39.25	35.58	12.39	35.32	100	298	P	H	
		5929.8	52.04	-16.26	68.3	39.27	35.59	12.51	35.33	100	298	P	H	
														H
														H
			5631	51.63	-16.67	68.3	39.43	35.52	11.95	35.27	280	186	P	V
			5695.8	53.88	-48.32	102.2	41.62	35.54	12	35.28	280	186	P	V
			5719.6	61.26	-49.53	110.79	48.94	35.54	12.06	35.28	280	186	P	V
			5724.6	62.02	-59.37	121.39	49.7	35.54	12.06	35.28	280	186	P	V
	*		5755	101.33	-	-	88.96	35.55	12.11	35.29	280	186	P	V
	*		5755	93.44	-	-	81.07	35.55	12.11	35.29	280	186	A	V
			5854.8	51.81	-59.55	111.36	39.27	35.57	12.28	35.31	280	186	P	V
			5871.2	51.29	-55.07	106.36	38.63	35.58	12.39	35.31	280	186	P	V
		5921	51.68	-19.57	71.25	38.91	35.58	12.51	35.32	280	186	P	V	
		5932.6	50.71	-17.59	68.3	37.94	35.59	12.51	35.33	280	186	P	V	
													V	
													V	



WIFI	Note	Frequency	Level	Over	Limit	Read	Antenna	Cable	Preamp	Ant	Table	Peak	Pol.	
Ant.				Limit	Line	Level	Factor	Loss	Factor	Pos	Pos	Avg.		
1+2		(MHz)	(dBμV/m)	(dB)	(dBμV/m)	(dBμV)	(dB/m)	(dB)	(dB)	(cm)	(deg)	(P/A)	(H/V)	
802.11ac VHT40 CH 159 5795MHz		5642.4	51.15	-17.15	68.3	38.94	35.53	11.95	35.27	100	301	P	H	
		5672.6	51.05	-34.01	85.06	38.79	35.53	12	35.27	100	301	P	H	
		5719.2	52.77	-57.91	110.68	40.45	35.54	12.06	35.28	100	301	P	H	
		5720.8	52.01	-60.71	112.72	39.69	35.54	12.06	35.28	100	301	P	H	
	*	5795	104.92	-	-	92.49	35.56	12.17	35.3	100	301	P	H	
	*	5795	96.32	-	-	83.89	35.56	12.17	35.3	100	301	A	H	
		5851	54.07	-65.95	120.02	41.53	35.57	12.28	35.31	100	301	P	H	
		5857	54.14	-56.2	110.34	41.6	35.57	12.28	35.31	100	301	P	H	
		5876.2	51.49	-52.92	104.41	38.84	35.58	12.39	35.32	100	301	P	H	
		5931.4	52.37	-15.93	68.3	39.6	35.59	12.51	35.33	100	301	P	H	
														H
														H
			5612.6	50.79	-17.51	68.3	38.64	35.52	11.89	35.26	278	187	P	V
			5686	50.86	-44.11	94.97	38.6	35.54	12	35.28	278	187	P	V
			5715.6	52.1	-57.57	109.67	39.78	35.54	12.06	35.28	278	187	P	V
			5722.6	51.73	-65.1	116.83	39.41	35.54	12.06	35.28	278	187	P	V
	*		5795	101.7	-	-	89.27	35.56	12.17	35.3	278	187	P	V
	*		5795	92.91	-	-	80.48	35.56	12.17	35.3	278	187	A	V
			5853.4	52.39	-62.16	114.55	39.85	35.57	12.28	35.31	278	187	P	V
			5856.4	51.74	-58.77	110.51	39.2	35.57	12.28	35.31	278	187	P	V
		5905.8	51.38	-31.09	82.47	38.61	35.58	12.51	35.32	278	187	P	V	
		5944.8	52.05	-16.25	68.3	39.17	35.59	12.62	35.33	278	187	P	V	
													V	
													V	
Remark	1. No other spurious found. 2. All results are PASS against Peak and Average limit line.													



Band 4 5725~5850MHz
WIFI 802.11ac VHT40 (Harmonic @ 3m)

WIFI	Note	Frequency	Level	Over	Limit	Read	Antenna	Cable	Preamp	Ant	Table	Peak	Pol.
Ant.				Limit	Line	Level	Factor	Loss	Factor	Pos	Pos	Avg.	
1+2		(MHz)	(dBμV/m)	(dB)	(dBμV/m)	(dBμV)	(dB/m)	(dB)	(dB)	(cm)	(deg)	(P/A)	(H/V)
802.11ac VHT40 CH 151 5755MHz		11510	40.99	-33.01	74	42.73	38.4	17.16	57.3	100	0	P	H
		17268	44.9	-23.4	68.3	37.98	42.04	20.79	55.91	100	0	P	H
													H
													H
		11510	41.54	-32.46	74	43.28	38.4	17.16	57.3	100	0	P	V
		17268	46.22	-22.08	68.3	39.3	42.04	20.79	55.91	100	0	P	V
802.11ac VHT40 CH 159 5795MHz		11590	41.53	-32.47	74	43.04	38.49	17.16	57.16	100	0	P	H
		17388	44.31	-23.99	68.3	37.42	41.97	20.87	55.95	100	0	P	H
													H
													H
		11590	41.64	-32.36	74	43.15	38.49	17.16	57.16	100	0	P	V
		17388	44.36	-23.94	68.3	37.47	41.97	20.87	55.95	100	0	P	V
Remark	1. No other spurious found.												
	2. All results are PASS against Peak and Average limit line.												



Band 4 5725~5850MHz
WIFI 802.11ac VHT80 (Band Edge @ 3m)

WIFI	Note	Frequency	Level	Over	Limit	Read	Antenna	Cable	Preamp	Ant	Table	Peak	Pol.	
Ant.				Limit	Line	Level	Factor	Loss	Factor	Pos	Pos	Avg.		
1+2		(MHz)	(dBμV/m)	(dB)	(dBμV/m)	(dBμV)	(dB/m)	(dB)	(dB)	(cm)	(deg)	(P/A)	(H/V)	
802.11ac VHT80 CH 155 5775MHz		5649.2	55.03	-13.27	68.3	42.82	35.53	11.95	35.27	100	300	P	H	
		5693.6	63.31	-37.27	100.58	51.05	35.54	12	35.28	100	300	P	H	
		5719.8	65.4	-45.44	110.84	53.08	35.54	12.06	35.28	100	300	P	H	
		5720.4	63.48	-48.33	111.81	51.16	35.54	12.06	35.28	100	300	P	H	
	*	5775	102.98	-	-	90.61	35.56	12.11	35.3	100	300	P	H	
	*	5775	94.49	-	-	82.12	35.56	12.11	35.3	100	300	A	H	
		5855	57.13	-53.77	110.9	44.59	35.57	12.28	35.31	100	300	P	H	
		5872.6	58.92	-47.05	105.97	46.26	35.58	12.39	35.31	100	300	P	H	
		5875.2	56.44	-48.71	105.15	43.79	35.58	12.39	35.32	100	300	P	H	
		5933.2	52.43	-15.87	68.3	39.66	35.59	12.51	35.33	100	300	P	H	
														H
														H
			5648	53.49	-14.81	68.3	41.28	35.53	11.95	35.27	266	186	P	V
			5687.8	59.69	-36.61	96.3	47.43	35.54	12	35.28	266	186	P	V
			5718.4	60.94	-49.51	110.45	48.62	35.54	12.06	35.28	266	186	P	V
			5722	61.02	-54.44	115.46	48.7	35.54	12.06	35.28	266	186	P	V
	*		5775	99.77	-	-	87.4	35.56	12.11	35.3	266	186	P	V
	*		5775	91.49	-	-	79.12	35.56	12.11	35.3	266	186	A	V
			5851.4	54.49	-64.62	119.11	41.95	35.57	12.28	35.31	266	186	P	V
			5871.4	56.39	-49.92	106.31	43.73	35.58	12.39	35.31	266	186	P	V
		5877	54.96	-48.85	103.81	42.31	35.58	12.39	35.32	266	186	P	V	
		5949.4	52.34	-15.96	68.3	39.46	35.59	12.62	35.33	266	186	P	V	
													V	
													V	
Remark	1. No other spurious found. 2. All results are PASS against Peak and Average limit line.													



Band 4 5725~5850MHz
WIFI 802.11ac VHT80 (Harmonic @ 3m)

WIFI	Note	Frequency	Level	Over	Limit	Read	Antenna	Cable	Preamp	Ant	Table	Peak	Pol.
Ant.				Limit	Line	Level	Factor	Loss	Factor	Pos	Pos	Avg.	
1+2		(MHz)	(dBμV/m)	(dB)	(dBμV/m)	(dBμV)	(dB/m)	(dB)	(dB)	(cm)	(deg)	(P/A)	(H/V)
802.11ac VHT80 CH 155 5775MHz		11550	40.74	-33.26	74	42.35	38.45	17.16	57.22	100	0	P	H
		17328	45.96	-22.34	68.3	39.07	42.01	20.81	55.93	100	0	P	H
													H
													H
		11550	41.23	-32.77	74	42.84	38.45	17.16	57.22	100	0	P	V
		17328	45.1	-23.2	68.3	38.21	42.01	20.81	55.93	100	0	P	V
													V
													V
Remark	1. No other spurious found. 2. All results are PASS against Peak and Average limit line.												



Emission below 1GHz
5GHz WIFI 802.11a (LF @ 3m)

WIFI Ant. 1+2	Note	Frequency (MHz)	Level (dBμV/m)	Over Limit (dB)	Limit Line (dBμV/m)	Read Level (dBμV)	Antenna Factor (dB/m)	Cable Loss (dB)	Preamp Factor (dB)	Ant Pos (cm)	Table Pos (deg)	Peak Avg. (P/A)	Pol. (H/V)	
5GHz 802.11a LF		30.54	27.84	-12.16	40	32.67	25.46	1.07	31.36	-	-	P	H	
		106.95	33.45	-10.05	43.5	46.39	17.03	1.55	31.52	-	-	P	H	
		240.06	37.97	-8.03	46	49.21	18.09	2.07	31.4	100	0	P	H	
		320.3	27.95	-18.05	46	36.42	20.37	2.41	31.25	-	-	P	H	
		659.8	36.69	-9.31	46	37.88	26	3.57	30.76	-	-	P	H	
		780.2	37.67	-8.33	46	36.89	27.5	3.9	30.62	-	-	P	H	
														H
														H
														H
														H
														H
														H
														H
			34.59	33.32	-6.68	40	40.36	23.3	1.07	31.41	100	0	P	V
			105.06	30.61	-12.89	43.5	43.73	16.85	1.55	31.52	-	-	P	V
			240.06	29.41	-16.59	46	40.65	18.09	2.07	31.4	-	-	P	V
			426.7	25.76	-20.24	46	31.22	22.78	2.89	31.13	-	-	P	V
			659.8	35.95	-10.05	46	37.14	26	3.57	30.76	-	-	P	V
			955.9	34.18	-11.82	46	30.43	30.21	4.07	30.53	-	-	P	V
														V
													V	
													V	
													V	
													V	
													V	
Remark	1. No other spurious found. 2. All results are PASS against limit line.													



Emission below 1GHz

5GHz WIFI 802.11ac VHT20 (LF @ 3m)

WIFI Ant. 1+2	Note	Frequency (MHz)	Level (dBμV/m)	Over Limit (dB)	Limit Line (dBμV/m)	Read Level (dBμV)	Antenna Factor (dB/m)	Cable Loss (dB)	Preamp Factor (dB)	Ant Pos (cm)	Table Pos (deg)	Peak Avg. (P/A)	Pol. (H/V)	
5GHz 802.11ac VHT20 LF		30	27.63	-12.37	40	31.91	26	1.07	31.35	-	-	P	H	
		102.63	33.08	-10.42	43.5	46.38	16.67	1.55	31.52	-	-	P	H	
		240.06	37.96	-8.04	46	49.2	18.09	2.07	31.4	100	0	P	H	
		300	28.77	-17.23	46	37.92	19.8	2.32	31.27	-	-	P	H	
		659.8	36.52	-9.48	46	37.71	26	3.57	30.76	-	-	P	H	
		899.9	33.89	-12.11	46	31.26	29	4.17	30.54	-	-	P	H	
														H
														H
														H
														H
														H
														H
			35.13	34.51	-5.49	40	41.55	23.3	1.07	31.41	100	0	P	V
			100.74	33.64	-9.86	43.5	47.12	16.49	1.55	31.52	-	-	P	V
			240.06	29.41	-16.59	46	40.65	18.09	2.07	31.4	-	-	P	V
			451.2	26.39	-19.61	46	31.47	23.12	2.89	31.09	-	-	P	V
			659.8	35.14	-10.86	46	36.33	26	3.57	30.76	-	-	P	V
			941.9	33.88	-12.12	46	30.33	30.01	4.07	30.53	-	-	P	V
													V	
													V	
													V	
													V	
													V	
													V	
Remark	1. No other spurious found. 2. All results are PASS against limit line.													



Emission below 1GHz

5GHz WIFI 802.11ac VHT80 (LF @ 3m)

WIFI Ant. 1+2	Note	Frequency (MHz)	Level (dBµV/m)	Over Limit (dB)	Limit Line (dBµV/m)	Read Level (dBµV)	Antenna Factor (dB/m)	Cable Loss (dB)	Preamp Factor (dB)	Ant Pos (cm)	Table Pos (deg)	Peak Avg. (P/A)	Pol. (H/V)	
5GHz 802.11ac VHT80 LF		30	27.75	-12.25	40	32.03	26	1.07	31.35	-	-	P	H	
		104.79	34.67	-8.83	43.5	47.79	16.85	1.55	31.52	-	-	P	H	
		240.06	37.65	-8.35	46	48.89	18.09	2.07	31.4	-	-	P	H	
		360.2	27.9	-18.1	46	35.17	21.44	2.5	31.21	-	-	P	H	
		659.8	38.65	-7.35	46	39.84	26	3.57	30.76	-	-	P	H	
		780.2	40.04	-5.96	46	39.26	27.5	3.9	30.62	100	0	P	H	
														H
														H
														H
														H
														H
														H
														H
														H
														H
			39.45	31.74	-8.26	40	41.75	20.4	1.07	31.48	100	0	P	V
			99.39	30.94	-12.56	43.5	44.78	16.4	1.28	31.52	-	-	P	V
			240.06	29.46	-16.54	46	40.7	18.09	2.07	31.4	-	-	P	V
		509.3	26.92	-19.08	46	30.51	24.27	3.14	31	-	-	P	V	
		659.8	36.12	-9.88	46	37.31	26	3.57	30.76	-	-	P	V	
		780.2	35.64	-10.36	46	34.86	27.5	3.9	30.62	-	-	P	V	
													V	
													V	
													V	
													V	
													V	
													V	
													V	
Remark	3. No other spurious found. 4. All results are PASS against limit line.													



Note symbol

*	Fundamental Frequency which can be ignored. However, the level of any unwanted emissions shall not exceed the level of the fundamental frequency.
!	Test result is over limit line.
P/A	Peak or Average
H/V	Horizontal or Vertical



A calculation example for radiated spurious emission is shown as below:

WIFI Ant. 1+2	Note	Frequency (MHz)	Level (dBμV/m)	Over Limit (dB)	Limit Line (dBμV/m)	Read Level (dBμV)	Antenna Factor (dB/m)	Cable Loss (dB)	Preamp Factor (dB)	Ant Pos (cm)	Table Pos (deg)	Peak Avg. (P/A)	Pol. (H/V)
802.11b CH 01 2412MHz		2390	55.45	-18.55	74	54.51	32.22	4.58	35.86	103	308	P	H
		2390	43.54	-10.46	54	42.6	32.22	4.58	35.86	103	308	A	H

- Level(dBμV/m) =
Antenna Factor(dB/m) + Cable Loss(dB) + Read Level(dBμV) - Preamp Factor(dB)
- Over Limit(dB) = Level(dBμV/m) – Limit Line(dBμV/m)

For Peak Limit @ 2390MHz:

- Level(dBμV/m)
= Antenna Factor(dB/m) + Cable Loss(dB) + Read Level(dBμV) - Preamp Factor(dB)
= 32.22(dB/m) + 4.58(dB) + 54.51(dBμV) – 35.86 (dB)
= 55.45 (dBμV/m)
- Over Limit(dB)
= Level(dBμV/m) – Limit Line(dBμV/m)
= 55.45(dBμV/m) – 74(dBμV/m)
= -18.55(dB)

For Average Limit @ 2390MHz:

- Level(dBμV/m)
= Antenna Factor(dB/m) + Cable Loss(dB) + Read Level(dBμV) - Preamp Factor(dB)
= 32.22(dB/m) + 4.58(dB) + 42.6(dBμV) – 35.86 (dB)
= 43.54 (dBμV/m)
- Over Limit(dB)
= Level(dBμV/m) – Limit Line(dBμV/m)
= 43.54(dBμV/m) – 54(dBμV/m)
= -10.46(dB)

Both peak and average measured complies with the limit line, so test result is “PASS”.



<TXBF Mode>

Band 4 - 5725~5850MHz

WIFI 802.11a (Band Edge @ 3m)

WIFI	Note	Frequency	Level	Over	Limit	Read	Antenna	Cable	Preamp	Ant	Table	Peak	Pol.	
Ant.				Limit	Line	Level	Factor	Loss	Factor	Pos	Pos	Avg.		
1+2		(MHz)	(dBμV/m)	(dB)	(dBμV/m)	(dBμV)	(dB/m)	(dB)	(dB)	(cm)	(deg)	(P/A)	(H/V)	
802.11a CH 149 5745MHz		5648.8	49.55	-18.75	68.3	37.34	35.53	11.95	35.27	114	269	P	H	
		5689.2	51.19	-46.15	97.34	38.93	35.54	12	35.28	114	269	P	H	
		5714.2	53.15	-56.13	109.28	40.83	35.54	12.06	35.28	114	269	P	H	
		5723	57.92	-59.82	117.74	45.6	35.54	12.06	35.28	114	269	P	H	
	*	5745	107.64	-	-	95.27	35.55	12.11	35.29	114	269	P	H	
	*	5745	100.44	-	-	88.07	35.55	12.11	35.29	114	269	A	H	
														H
														H
			5624.2	50.46	-17.84	68.3	38.25	35.52	11.95	35.26	300	173	P	V
			5676.8	49.6	-38.57	88.17	37.35	35.53	12	35.28	300	173	P	V
			5717.6	50.21	-60.02	110.23	37.89	35.54	12.06	35.28	300	173	P	V
			5723.6	56.51	-62.6	119.11	44.19	35.54	12.06	35.28	300	173	P	V
	*		5745	104.31	-	-	91.94	35.55	12.11	35.29	300	173	P	V
	*		5745	96.95	-	-	84.58	35.55	12.11	35.29	300	173	A	V
													V	
													V	



WIFI	Note	Frequency	Level	Over	Limit	Read	Antenna	Cable	Preamp	Ant	Table	Peak	Pol.	
Ant.				Limit	Line	Level	Factor	Loss	Factor	Pos	Pos	Avg.		
1+2		(MHz)	(dBμV/m)	(dB)	(dBμV/m)	(dBμV)	(dB/m)	(dB)	(dB)	(cm)	(deg)	(P/A)	(H/V)	
802.11a CH 157 5785MHz		5612.6	50.57	-17.73	68.3	38.42	35.52	11.89	35.26	114	268	P	H	
		5652	49.61	-20.18	69.79	37.4	35.53	11.95	35.27	114	268	P	H	
		5713.4	49.36	-59.69	109.05	37.04	35.54	12.06	35.28	114	268	P	H	
		5722.6	50.03	-66.8	116.83	37.71	35.54	12.06	35.28	114	268	P	H	
	*	5785	106.81	-	-	94.38	35.56	12.17	35.3	114	268	P	H	
	*	5785	99.76	-	-	87.33	35.56	12.17	35.3	114	268	A	H	
		5850.8	49.69	-70.79	120.48	37.15	35.57	12.28	35.31	114	268	P	H	
		5872.2	50.61	-55.47	106.08	37.95	35.58	12.39	35.31	114	268	P	H	
		5900.6	52.25	-34.07	86.32	39.48	35.58	12.51	35.32	114	268	P	H	
		5939	52.14	-16.16	68.3	39.37	35.59	12.51	35.33	114	268	P	H	
														H
														H
			5611.2	49.67	-18.63	68.3	37.52	35.52	11.89	35.26	300	178	P	V
			5692.4	50.12	-49.58	99.7	37.86	35.54	12	35.28	300	178	P	V
			5710.6	49.75	-58.52	108.27	37.43	35.54	12.06	35.28	300	178	P	V
			5721.6	48.62	-65.93	114.55	36.3	35.54	12.06	35.28	300	178	P	V
	*		5785	103.02	-	-	90.59	35.56	12.17	35.3	300	178	P	V
	*		5785	95.96	-	-	83.53	35.56	12.17	35.3	300	178	A	V
			5854.2	50.82	-61.9	112.72	38.28	35.57	12.28	35.31	300	178	P	V
			5860.2	50.61	-58.83	109.44	37.96	35.57	12.39	35.31	300	178	P	V
		5906	51.73	-30.59	82.32	38.96	35.58	12.51	35.32	300	178	P	V	
		5931.6	50.73	-17.57	68.3	37.96	35.59	12.51	35.33	300	178	P	V	
													V	
													V	



WIFI	Note	Frequency	Level	Over	Limit	Read	Antenna	Cable	Preamp	Ant	Table	Peak	Pol.	
Ant.				Limit	Line	Level	Factor	Loss	Factor	Pos	Pos	Avg.		
1+2		(MHz)	(dBµV/m)	(dB)	(dBµV/m)	(dBµV)	(dB/m)	(dB)	(dB)	(cm)	(deg)	(P/A)	(H/V)	
802.11a CH 165 5825MHz	*	5825	107.58	-	-	95.04	35.57	12.28	35.31	123	269	P	H	
	*	5825	100.45	-	-	87.91	35.57	12.28	35.31	123	269	A	H	
		5853.2	52.37	-62.63	115	39.83	35.57	12.28	35.31	123	269	P	H	
		5864.4	51.3	-56.97	108.27	38.65	35.57	12.39	35.31	123	269	P	H	
		5878.4	52.75	-50.02	102.77	40.1	35.58	12.39	35.32	123	269	P	H	
		5925.6	51.19	-17.11	68.3	38.42	35.59	12.51	35.33	123	269	P	H	
														H
														H
	*	5825	104.15	-	-	91.61	35.57	12.28	35.31	268	167	P	V	
	*	5825	97	-	-	84.46	35.57	12.28	35.31	268	167	A	V	
		5850.6	49.64	-71.29	120.93	37.1	35.57	12.28	35.31	268	167	P	V	
		5860.4	50.62	-58.77	109.39	37.97	35.57	12.39	35.31	268	167	P	V	
		5907.8	51.21	-29.78	80.99	38.44	35.58	12.51	35.32	268	167	P	V	
		5934.6	50.58	-17.72	68.3	37.81	35.59	12.51	35.33	268	167	P	V	
														V
														V
													V	
Remark	1. No other spurious found. 2. All results are PASS against Peak and Average limit line.													



Band 4 5725~5850MHz
WIFI 802.11a (Harmonic @ 3m)

WIFI	Note	Frequency	Level	Over	Limit	Read	Antenna	Cable	Preamp	Ant	Table	Peak	Pol.
Ant.				Limit	Line	Level	Factor	Loss	Factor	Pos	Pos	Avg.	
1+2		(MHz)	(dBμV/m)	(dB)	(dBμV/m)	(dBμV)	(dB/m)	(dB)	(dB)	(cm)	(deg)	(P/A)	(H/V)
802.11a CH 149 5745MHz		11490	41.58	-32.42	74	43.38	38.38	17.16	57.34	100	0	P	H
		17232	45.37	-22.93	68.3	38.44	42.06	20.76	55.89	100	0	P	H
													H
													H
		11490	41.68	-32.32	74	43.48	38.38	17.16	57.34	100	0	P	V
		17232	44.67	-23.63	68.3	37.74	42.06	20.76	55.89	100	0	P	V
													V
													V
802.11a CH 157 5785MHz		11570	41.42	-32.58	74	42.98	38.47	17.16	57.19	100	0	P	H
		17352	44.66	-23.64	68.3	37.77	41.99	20.84	55.94	100	0	P	H
													H
													H
		11570	41.11	-32.89	74	42.67	38.47	17.16	57.19	100	0	P	V
		17352	45.43	-22.87	68.3	38.54	41.99	20.84	55.94	100	0	P	V
													V
													V
802.11a CH 165 5825MHz		11650	40.8	-33.2	74	42.18	38.54	17.16	57.08	100	0	P	H
		17472	45.16	-23.14	68.3	38.3	41.92	20.93	55.99	100	0	P	H
													H
													H
		11650	41.26	-32.74	74	42.64	38.54	17.16	57.08	100	0	P	V
		17472	45.39	-22.91	68.3	38.53	41.92	20.93	55.99	100	0	P	V
													V
													V
Remark	1. No other spurious found. 2. All results are PASS against Peak and Average limit line.												



WIFI	Note	Frequency	Level	Over	Limit	Read	Antenna	Cable	Preamp	Ant	Table	Peak	Pol.	
Ant.				Limit	Line	Level	Factor	Loss	Factor	Pos	Pos	Avg.		
1+2		(MHz)	(dBµV/m)	(dB)	(dBµV/m)	(dBµV)	(dB/m)	(dB)	(dB)	(cm)	(deg)	(P/A)	(H/V)	
802.11ac		5620.6	49.9	-18.4	68.3	37.69	35.52	11.95	35.26	114	271	P	H	
		5665.8	49.4	-30.63	80.03	37.14	35.53	12	35.27	114	271	P	H	
		5702.6	50.41	-55.62	106.03	38.09	35.54	12.06	35.28	114	271	P	H	
		5721.2	49.53	-64.11	113.64	37.21	35.54	12.06	35.28	114	271	P	H	
	*	5785	107.7	-	-	95.27	35.56	12.17	35.3	114	271	P	H	
	*	5785	100.38	-	-	87.95	35.56	12.17	35.3	114	271	A	H	
		5850.6	51.55	-69.38	120.93	39.01	35.57	12.28	35.31	114	271	P	H	
		5856	51.86	-58.76	110.62	39.32	35.57	12.28	35.31	114	271	P	H	
		5891.2	51.25	-42.03	93.28	38.6	35.58	12.39	35.32	114	271	P	H	
		5939.2	50.78	-17.52	68.3	38.01	35.59	12.51	35.33	114	271	P	H	
														H
	VHT20													H
	CH 157		5618.6	50.03	-18.27	68.3	37.88	35.52	11.89	35.26	316	161	P	V
	5785MHz		5673	50.03	-35.33	85.36	37.77	35.53	12	35.27	316	161	P	V
			5711.2	50.32	-58.12	108.44	38	35.54	12.06	35.28	316	161	P	V
			5720	49.21	-61.69	110.9	36.89	35.54	12.06	35.28	316	161	P	V
		*	5785	105.16	-	-	92.73	35.56	12.17	35.3	316	161	P	V
		*	5785	98.34	-	-	85.91	35.56	12.17	35.3	316	161	A	V
			5850.2	49.7	-72.14	121.84	37.16	35.57	12.28	35.31	316	161	P	V
			5866	50	-57.82	107.82	37.35	35.57	12.39	35.31	316	161	P	V
		5911.4	50.74	-27.59	78.33	37.97	35.58	12.51	35.32	316	161	P	V	
		5928.4	50.65	-17.65	68.3	37.88	35.59	12.51	35.33	316	161	P	V	
														V
														V



WIFI	Note	Frequency	Level	Over	Limit	Read	Antenna	Cable	Preamp	Ant	Table	Peak	Pol.	
Ant.				Limit	Line	Level	Factor	Loss	Factor	Pos	Pos	Avg.		
1+2		(MHz)	(dBμV/m)	(dB)	(dBμV/m)	(dBμV)	(dB/m)	(dB)	(dB)	(cm)	(deg)	(P/A)	(H/V)	
802.11ac VHT20 CH 165 5825MHz	*	5825	107.86	-	-	95.32	35.57	12.28	35.31	114	272	P	H	
	*	5825	100.67	-	-	88.13	35.57	12.28	35.31	114	272	A	H	
		5850.2	51.44	-70.4	121.84	38.9	35.57	12.28	35.31	114	272	P	H	
		5868.4	51.86	-55.29	107.15	39.21	35.57	12.39	35.31	114	272	P	H	
		5882.4	52.04	-47.76	99.8	39.39	35.58	12.39	35.32	114	272	P	H	
		5945	50.55	-17.75	68.3	37.67	35.59	12.62	35.33	114	272	P	H	
														H
														H
														H
														H
														H
														H
	*	5825	104.39	-	-	91.85	35.57	12.28	35.31	316	164	P	V	
	*	5825	98.01	-	-	85.47	35.57	12.28	35.31	316	164	A	V	
		5853.6	50.67	-63.42	114.09	38.13	35.57	12.28	35.31	316	164	P	V	
		5858	52.13	-57.93	110.06	39.59	35.57	12.28	35.31	316	164	P	V	
		5920.2	50.98	-20.86	71.84	38.21	35.58	12.51	35.32	316	164	P	V	
		5947	51.2	-17.1	68.3	38.32	35.59	12.62	35.33	316	164	P	V	
													V	
													V	
													V	
													V	
													V	
													V	
Remark	1. No other spurious found. 2. All results are PASS against Peak and Average limit line.													



Band 4 5725~5850MHz
WIFI 802.11ac VHT20 (Harmonic @ 3m)

WIFI	Note	Frequency	Level	Over	Limit	Read	Antenna	Cable	Preamp	Ant	Table	Peak	Pol.
Ant.				Limit	Line	Level	Factor	Loss	Factor	Pos	Pos	Avg.	
1+2		(MHz)	(dBμV/m)	(dB)	(dBμV/m)	(dBμV)	(dB/m)	(dB)	(dB)	(cm)	(deg)	(P/A)	(H/V)
802.11ac VHT20 CH 149 5745MHz		11490	42.03	-31.97	74	43.83	38.38	17.16	57.34	100	0	P	H
		17232	44.73	-23.57	68.3	37.8	42.06	20.76	55.89	100	0	P	H
													H
													H
		11490	41.85	-32.15	74	43.65	38.38	17.16	57.34	100	0	P	V
		17232	44.85	-23.45	68.3	37.92	42.06	20.76	55.89	100	0	P	V
													V
802.11ac VHT20 CH 157 5785MHz		11570	40.94	-33.06	74	42.5	38.47	17.16	57.19	100	0	P	H
		17352	45.97	-22.33	68.3	39.08	41.99	20.84	55.94	100	0	P	H
													H
													H
		11570	41.53	-32.47	74	43.09	38.47	17.16	57.19	100	0	P	V
		17352	44.54	-23.76	68.3	37.65	41.99	20.84	55.94	100	0	P	V
													V
802.11ac VHT20 CH 165 5825MHz		11650	42.07	-31.93	74	43.45	38.54	17.16	57.08	100	0	P	H
		17472	45.41	-22.89	68.3	38.55	41.92	20.93	55.99	100	0	P	H
													H
													H
		11650	41.93	-32.07	74	43.31	38.54	17.16	57.08	100	0	P	V
		17472	45.88	-22.42	68.3	39.02	41.92	20.93	55.99	100	0	P	V
													V
Remark	1. No other spurious found.												
	2. All results are PASS against Peak and Average limit line.												



Band 4 5725~5850MHz
WIFI 802.11ac VHT40 (Band Edge @ 3m)

WIFI	Note	Frequency	Level	Over	Limit	Read	Antenna	Cable	Preamp	Ant	Table	Peak	Pol.	
Ant.				Limit	Line	Level	Factor	Loss	Factor	Pos	Pos	Avg.		
1+2		(MHz)	(dBμV/m)	(dB)	(dBμV/m)	(dBμV)	(dB/m)	(dB)	(dB)	(cm)	(deg)	(P/A)	(H/V)	
802.11ac VHT40 CH 151 5755MHz		5623.8	51.02	-17.28	68.3	38.81	35.52	11.95	35.26	115	270	P	H	
		5697	52.75	-50.34	103.09	40.49	35.54	12	35.28	115	270	P	H	
		5714.6	61.64	-47.75	109.39	49.32	35.54	12.06	35.28	115	270	P	H	
		5721.6	60.54	-54.01	114.55	48.22	35.54	12.06	35.28	115	270	P	H	
	*	5755	104.18	-	-	91.81	35.55	12.11	35.29	115	270	P	H	
	*	5755	97.59	-	-	85.22	35.55	12.11	35.29	115	270	A	H	
		5854.4	50.09	-62.18	112.27	37.55	35.57	12.28	35.31	115	270	P	H	
		5865.2	51.49	-56.55	108.04	38.84	35.57	12.39	35.31	115	270	P	H	
		5895.8	50.86	-39.01	89.87	38.21	35.58	12.39	35.32	115	270	P	H	
		5928	50.7	-17.6	68.3	37.93	35.59	12.51	35.33	115	270	P	H	
														H
														H
			5605.8	49.85	-18.45	68.3	37.7	35.52	11.89	35.26	321	164	P	V
			5685.4	49.88	-44.65	94.53	37.62	35.54	12	35.28	321	164	P	V
			5718.2	56.26	-54.14	110.4	43.94	35.54	12.06	35.28	321	164	P	V
			5721.6	55.21	-59.34	114.55	42.89	35.54	12.06	35.28	321	164	P	V
	*		5755	101.41	-	-	89.04	35.55	12.11	35.29	321	164	P	V
	*		5755	94.25	-	-	81.88	35.55	12.11	35.29	321	164	A	V
			5850.2	50.14	-71.7	121.84	37.6	35.57	12.28	35.31	321	164	P	V
			5866.2	50.34	-57.42	107.76	37.69	35.57	12.39	35.31	321	164	P	V
		5876.8	51.99	-51.97	103.96	39.34	35.58	12.39	35.32	321	164	P	V	
		5933.8	50.54	-17.76	68.3	37.77	35.59	12.51	35.33	321	164	P	V	
													V	
													V	



WIFI	Note	Frequency	Level	Over	Limit	Read	Antenna	Cable	Preamp	Ant	Table	Peak	Pol.	
Ant.				Limit	Line	Level	Factor	Loss	Factor	Pos	Pos	Avg.		
1+2		(MHz)	(dBμV/m)	(dB)	(dBμV/m)	(dBμV)	(dB/m)	(dB)	(dB)	(cm)	(deg)	(P/A)	(H/V)	
802.11ac VHT40 CH 159 5795MHz		5624	49.5	-18.8	68.3	37.29	35.52	11.95	35.26	115	270	P	H	
		5680.6	49.45	-41.53	90.98	37.2	35.53	12	35.28	115	270	P	H	
		5712.6	49.27	-59.56	108.83	36.95	35.54	12.06	35.28	115	270	P	H	
		5720.4	48.29	-63.52	111.81	35.97	35.54	12.06	35.28	115	270	P	H	
	*	5795	104.76	-	-	92.33	35.56	12.17	35.3	115	270	P	H	
	*	5795	102.08	-	-	89.65	35.56	12.17	35.3	115	270	A	H	
		5851.2	53.57	-65.99	119.56	41.03	35.57	12.28	35.31	115	270	P	H	
		5862.2	52.34	-56.54	108.88	39.69	35.57	12.39	35.31	115	270	P	H	
		5879.2	52.31	-49.87	102.18	39.66	35.58	12.39	35.32	115	270	P	H	
		5949.4	50.91	-17.39	68.3	38.03	35.59	12.62	35.33	115	270	P	H	
														H
														H
			5632.4	49.04	-19.26	68.3	36.84	35.52	11.95	35.27	321	185	P	V
			5697.2	49.91	-53.33	103.24	37.65	35.54	12	35.28	321	185	P	V
			5714.6	50.06	-59.33	109.39	37.74	35.54	12.06	35.28	321	185	P	V
			5725	48.69	-73.61	122.3	36.37	35.54	12.06	35.28	321	185	P	V
	*		5795	100.73	-	-	88.3	35.56	12.17	35.3	321	185	P	V
	*		5795	94.59	-	-	82.16	35.56	12.17	35.3	321	185	A	V
			5853.6	50.76	-63.33	114.09	38.22	35.57	12.28	35.31	321	185	P	V
			5866.6	50.45	-57.2	107.65	37.8	35.57	12.39	35.31	321	185	P	V
		5905.4	51.49	-31.28	82.77	38.72	35.58	12.51	35.32	321	185	P	V	
		5935.6	52.46	-15.84	68.3	39.69	35.59	12.51	35.33	321	185	P	V	
													V	
													V	
Remark	1. No other spurious found. 2. All results are PASS against Peak and Average limit line.													



Band 4 5725~5850MHz
WIFI 802.11ac VHT40 (Harmonic @ 3m)

WIFI	Note	Frequency	Level	Over	Limit	Read	Antenna	Cable	Preamp	Ant	Table	Peak	Pol.
Ant.				Limit	Line	Level	Factor	Loss	Factor	Pos	Pos	Avg.	
1+2		(MHz)	(dBμV/m)	(dB)	(dBμV/m)	(dBμV)	(dB/m)	(dB)	(dB)	(cm)	(deg)	(P/A)	(H/V)
802.11ac VHT40 CH 151 5755MHz		11510	41.49	-32.51	74	43.23	38.4	17.16	57.3	100	0	P	H
		17268	45.14	-23.16	68.3	38.22	42.04	20.79	55.91	100	0	P	H
													H
													H
		11510	41.47	-32.53	74	43.21	38.4	17.16	57.3	100	0	P	V
		17268	45.31	-22.99	68.3	38.39	42.04	20.79	55.91	100	0	P	V
													V
802.11ac VHT40 CH 159 5795MHz		11590	41.14	-32.86	74	42.65	38.49	17.16	57.16	100	0	P	H
		17388	45.29	-23.01	68.3	38.4	41.97	20.87	55.95	100	0	P	H
													H
													H
		11590	41.77	-32.23	74	43.28	38.49	17.16	57.16	100	0	P	V
		17388	45.1	-23.2	68.3	38.21	41.97	20.87	55.95	100	0	P	V
													V
Remark	1. No other spurious found.												
	2. All results are PASS against Peak and Average limit line.												



Band 4 5725~5850MHz
WIFI 802.11ac VHT80 (Band Edge @ 3m)

WIFI	Note	Frequency	Level	Over	Limit	Read	Antenna	Cable	Preamp	Ant	Table	Peak	Pol.	
Ant.				Limit	Line	Level	Factor	Loss	Factor	Pos	Pos	Avg.		
1+2		(MHz)	(dBμV/m)	(dB)	(dBμV/m)	(dBμV)	(dB/m)	(dB)	(dB)	(cm)	(deg)	(P/A)	(H/V)	
802.11ac VHT80 CH 155 5775MHz		5628.2	51.17	-17.13	68.3	38.97	35.52	11.95	35.27	115	270	P	H	
		5682.6	58.77	-33.69	92.46	46.52	35.53	12	35.28	115	270	P	H	
		5716.2	58.56	-51.28	109.84	46.24	35.54	12.06	35.28	115	270	P	H	
		5722.4	60.39	-55.98	116.37	48.07	35.54	12.06	35.28	115	270	P	H	
	*	5775	100.39	-	-	88.02	35.56	12.11	35.3	115	270	P	H	
	*	5775	96.23	-	-	83.86	35.56	12.11	35.3	115	270	A	H	
		5855	56.89	-54.01	110.9	44.35	35.57	12.28	35.31	115	270	P	H	
		5855	56.89	-54.01	110.9	44.35	35.57	12.28	35.31	115	270	P	H	
		5879.4	53.78	-48.25	102.03	41.13	35.58	12.39	35.32	115	270	P	H	
		5935.6	51.08	-17.22	68.3	38.31	35.59	12.51	35.33	115	270	P	H	
														H
														H
			5636.4	50.32	-17.98	68.3	38.11	35.53	11.95	35.27	321	183	P	V
			5688.6	55.53	-41.36	96.89	43.27	35.54	12	35.28	321	183	P	V
			5717.8	54.37	-55.91	110.28	42.05	35.54	12.06	35.28	321	183	P	V
			5723.4	54.91	-63.74	118.65	42.59	35.54	12.06	35.28	321	183	P	V
	*		5775	98.48	-	-	86.11	35.56	12.11	35.3	321	183	P	V
	*		5775	93.43	-	-	81.06	35.56	12.11	35.3	321	183	A	V
			5852.2	51.95	-65.33	117.28	39.41	35.57	12.28	35.31	321	183	P	V
			5871	54.45	-51.97	106.42	41.79	35.58	12.39	35.31	321	183	P	V
		5881.6	51.64	-48.76	100.4	38.99	35.58	12.39	35.32	321	183	P	V	
		5937.4	51.1	-17.2	68.3	38.33	35.59	12.51	35.33	321	183	P	V	
													V	
													V	
Remark	1. No other spurious found. 2. All results are PASS against Peak and Average limit line.													



Band 4 5725~5850MHz
WIFI 802.11ac VHT80 (Harmonic @ 3m)

WIFI	Note	Frequency	Level	Over	Limit	Read	Antenna	Cable	Preamp	Ant	Table	Peak	Pol.
Ant.				Limit	Line	Level	Factor	Loss	Factor	Pos	Pos	Avg.	
1+2		(MHz)	(dBμV/m)	(dB)	(dBμV/m)	(dBμV)	(dB/m)	(dB)	(dB)	(cm)	(deg)	(P/A)	(H/V)
802.11ac VHT80 CH 155 5775MHz		11550	41.87	-32.13	74	43.48	38.45	17.16	57.22	100	0	P	H
		17328	45.5	-22.8	68.3	38.61	42.01	20.81	55.93	100	0	P	H
													H
													H
		11550	42.21	-31.79	74	43.82	38.45	17.16	57.22	100	0	P	V
		17328	46.23	-22.07	68.3	39.34	42.01	20.81	55.93	100	0	P	V
													V
													V
Remark	1. No other spurious found. 2. All results are PASS against Peak and Average limit line.												



Emission below 1GHz
5GHz WIFI 802.11a (LF @ 3m)

WIFI Ant. 1+2	Note	Frequency (MHz)	Level (dBμV/m)	Over Limit (dB)	Limit Line (dBμV/m)	Read Level (dBμV)	Antenna Factor (dB/m)	Cable Loss (dB)	Preamp Factor (dB)	Ant Pos (cm)	Table Pos (deg)	Peak Avg. (P/A)	Pol. (H/V)	
5GHz 802.11a LF		30	27.48	-12.52	40	31.76	26	1.07	31.35	-	-	P	H	
		88.59	31.08	-12.42	43.5	46.48	14.86	1.28	31.54	-	-	P	H	
		240.06	32.6	-13.4	46	43.84	18.09	2.07	31.4	-	-	P	H	
		479.9	31.33	-14.67	46	35.58	23.76	3.04	31.05	-	-	P	H	
		780.2	39.04	-6.96	46	38.26	27.5	3.9	30.62	100	0	P	H	
		942.6	34.23	-11.77	46	30.65	30.04	4.07	30.53	-	-	P	H	
														H
														H
														H
														H
														H
														H
														H
			33.78	25.97	-14.03	40	32.46	23.84	1.07	31.4	-	-	P	V
			99.93	30.68	-12.82	43.5	44.52	16.4	1.28	31.52	-	-	P	V
			240.06	30.72	-15.28	46	41.96	18.09	2.07	31.4	-	-	P	V
			477.1	26.57	-19.43	46	30.89	23.69	3.04	31.05	-	-	P	V
			780.2	34.95	-11.05	46	34.17	27.5	3.9	30.62	100	0	P	V
			993	34.27	-19.73	54	30.52	30.29	3.98	30.52	-	-	P	V
														V
													V	
													V	
													V	
													V	
													V	
Remark	1. No other spurious found. 2. All results are PASS against limit line.													



Emission below 1GHz

5GHz WIFI 802.11ac VHT40 (LF @ 3m)

WIFI Ant. 1+2	Note	Frequency (MHz)	Level (dBμV/m)	Over Limit (dB)	Limit Line (dBμV/m)	Read Level (dBμV)	Antenna Factor (dB/m)	Cable Loss (dB)	Preamp Factor (dB)	Ant Pos (cm)	Table Pos (deg)	Peak Avg. (P/A)	Pol. (H/V)	
5GHz 802.11ac VHT40 LF		30	27.6	-12.4	40	31.88	26	1.07	31.35	-	-	P	H	
		105.87	33.06	-10.44	43.5	46.09	16.94	1.55	31.52	-	-	P	H	
		240.06	32.37	-13.63	46	43.61	18.09	2.07	31.4	-	-	P	H	
		479.9	30.51	-15.49	46	34.76	23.76	3.04	31.05	-	-	P	H	
		659.8	38.8	-7.2	46	39.99	26	3.57	30.76	-	-	P	H	
		780.2	39.47	-6.53	46	38.69	27.5	3.9	30.62	100	0	P	H	
														H
														H
														H
														H
														H
														H
			35.4	33.24	-6.76	40	40.88	22.72	1.07	31.43	100	0	P	V
			105.33	29.24	-14.26	43.5	42.27	16.94	1.55	31.52	-	-	P	V
			240.06	29.26	-16.74	46	40.5	18.09	2.07	31.4	-	-	P	V
			540.1	31.97	-14.03	46	35.15	24.52	3.24	30.94	-	-	P	V
			780.2	35.03	-10.97	46	34.25	27.5	3.9	30.62	-	-	P	V
			906.9	34.21	-11.79	46	31.47	29.16	4.12	30.54	-	-	P	V
													V	
													V	
													V	
													V	
													V	
													V	
Remark	3. No other spurious found. 4. All results are PASS against limit line.													



Emission below 1GHz

5GHz WIFI 802.11ac VHT80 (LF @ 3m)

WIFI Ant. 1+2	Note	Frequency (MHz)	Level (dBμV/m)	Over Limit (dB)	Limit Line (dBμV/m)	Read Level (dBμV)	Antenna Factor (dB/m)	Cable Loss (dB)	Preamp Factor (dB)	Ant Pos (cm)	Table Pos (deg)	Peak Avg. (P/A)	Pol. (H/V)	
5GHz 802.11ac VHT80 LF		88.05	30.89	-12.61	43.5	46.29	14.86	1.28	31.54	-	-	P	H	
		104.79	32.22	-11.28	43.5	45.34	16.85	1.55	31.52	-	-	P	H	
		240.06	31.94	-14.06	46	43.18	18.09	2.07	31.4	-	-	P	H	
		479.9	30.85	-15.15	46	35.1	23.76	3.04	31.05	-	-	P	H	
		659.8	39.32	-6.68	46	40.51	26	3.57	30.76	-	-	P	H	
		780.2	39.36	-6.64	46	38.58	27.5	3.9	30.62	100	0	P	H	
														H
														H
														H
														H
														H
														H
														H
														H
														H
			35.13	27.82	-12.18	40	34.86	23.3	1.07	31.41	-	-	P	V
			99.66	33	-10.5	43.5	46.84	16.4	1.28	31.52	-	-	P	V
			240.06	29.64	-16.36	46	40.88	18.09	2.07	31.4	-	-	P	V
		540.1	31.95	-14.05	46	35.13	24.52	3.24	30.94	-	-	P	V	
		659.8	34.94	-11.06	46	36.13	26	3.57	30.76	-	-	P	V	
		780.2	35.6	-10.4	46	34.82	27.5	3.9	30.62	100	0	P	V	
													V	
													V	
													V	
													V	
													V	
													V	

Remark
 5. No other spurious found.
 6. All results are PASS against limit line.



Note symbol

*	Fundamental Frequency which can be ignored. However, the level of any unwanted emissions shall not exceed the level of the fundamental frequency.
!	Test result is over limit line.
P/A	Peak or Average
H/V	Horizontal or Vertical



A calculation example for radiated spurious emission is shown as below:

WIFI Ant. 1+2	Note	Frequency (MHz)	Level (dBμV/m)	Over Limit (dB)	Limit Line (dBμV/m)	Read Level (dBμV)	Antenna Factor (dB/m)	Cable Loss (dB)	Preamp Factor (dB)	Ant Pos (cm)	Table Pos (deg)	Peak Avg. (P/A)	Pol. (H/V)
802.11b		2390	55.45	-18.55	74	54.51	32.22	4.58	35.86	103	308	P	H
CH 01		2390	43.54	-10.46	54	42.6	32.22	4.58	35.86	103	308	A	H
2412MHz													

- 1. Level(dBμV/m) =
Antenna Factor(dB/m) + Cable Loss(dB) + Read Level(dBμV) - Preamp Factor(dB)
- 2. Over Limit(dB) = Level(dBμV/m) – Limit Line(dBμV/m)

For Peak Limit @ 2390MHz:

- 1. Level(dBμV/m)
= Antenna Factor(dB/m) + Cable Loss(dB) + Read Level(dBμV) - Preamp Factor(dB)
= 32.22(dB/m) + 4.58(dB) + 54.51(dBμV) – 35.86 (dB)
= 55.45 (dBμV/m)
- 2. Over Limit(dB)
= Level(dBμV/m) – Limit Line(dBμV/m)
= 55.45(dBμV/m) – 74(dBμV/m)
= -18.55(dB)

For Average Limit @ 2390MHz:

- 1. Level(dBμV/m)
= Antenna Factor(dB/m) + Cable Loss(dB) + Read Level(dBμV) - Preamp Factor(dB)
= 32.22(dB/m) + 4.58(dB) + 42.6(dBμV) – 35.86 (dB)
= 43.54 (dBμV/m)
- 2. Over Limit(dB)
= Level(dBμV/m) – Limit Line(dBμV/m)
= 43.54(dBμV/m) – 54(dBμV/m)
= -10.46(dB)

Both peak and average measured complies with the limit line, so test result is “PASS”.



Appendix C. Radiated Spurious Emission Plots

Test Engineer :	Jesse Wang, James Chiu, Derek Hsu, and Luke Chang	Temperature :	21~24°C
		Relative Humidity :	54~55%

<CDD Mode>

Band 4 - 5725~5850MHz

WIFI 802.11a (Band Edge @ 3m)

WIFI	Band 4 5725~5850MHz Band Edge @ 3m	
ANT	802.11a CH149 5745MHz	
2	Horizontal	Fundamental
Peak	<p>Date: 2016.07.07</p> <p>Site : 03CH07-HY Condition : FCC PART 15E_BAND4_N 3m HF-ANT_130829 HORIZONTAL RBW: 1000.000kHz VBW: 3000.000kHz SWT: Auto Detector : Peak Project : 660115 Mode : 115</p>	<p>Date: 2016.07.07</p> <p>Site : 03CH07-HY Condition : FCC PART 15E_BAND4_N 3m HF-ANT_130829 HORIZONTAL RBW: 1000.000kHz VBW: 3000.000kHz SWT: Auto Detector : Peak Project : 660115 Mode : 115</p>

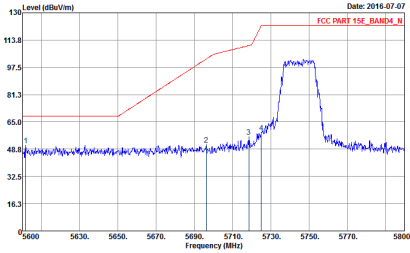
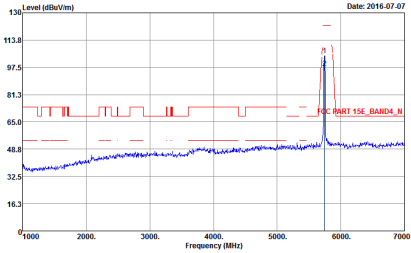

WIFI	Band 4 5725~5850MHz Band Edge @ 3m	
ANT	802.11a CH149 5745MHz	
2	Vertical	Fundamental
Peak	 <p style="font-size: small;">Date: 2016-07-07 FCC PART 15E_BAND4_N</p> <p style="font-size: x-small;">Site : 03CH07-HY Condition : FCC PART 15E_BAND4_N 3m HF-ANT_130829 VERTICAL Detector : Peak Project : 660115 Mode : 119</p>	 <p style="font-size: small;">Date: 2016-07-07 FCC PART 15E_BAND4_N</p> <p style="font-size: x-small;">Site : 03CH07-HY Condition : FCC PART 15E_BAND4_N 3m HF-ANT_130829 VERTICAL Detector : Peak Project : 660115 Mode : 119</p>

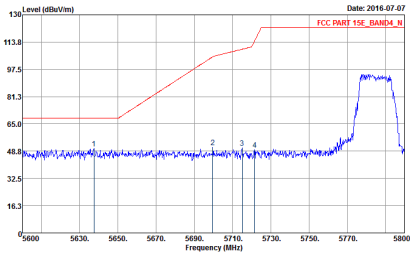
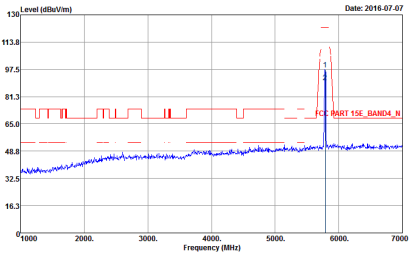
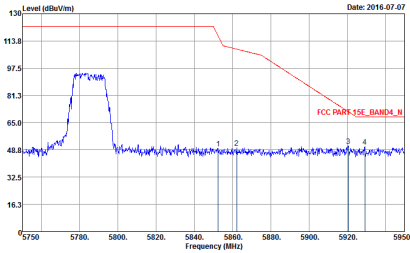

WIFI	Band 4 5725~5850MHz Band Edge @ 3m	
ANT	802.11a CH157 5785MHz	
<p style="text-align: center;">2</p>	<p style="text-align: center;">Horizontal</p>  <p style="font-size: small;">Date: 2016-07-07 FCC PART 15E_BAND4_N</p> <p style="font-size: x-small;">Site : 03CH07-HY Condition : FCC PART 15E_BAND4_N 3m HF-ANT_130829 HORIZONTAL RBW: 1000.000kHz VBW: 3000.000kHz SWT: Auto Detector : Peak Project : 660115 Mode : 120</p>	<p style="text-align: center;">Fundamental</p>  <p style="font-size: small;">Date: 2016-07-07 FCC PART 15E_BAND4_N</p> <p style="font-size: x-small;">Site : 03CH07-HY Condition : FCC PART 15E_BAND4_N 3m HF-ANT_130829 HORIZONTAL RBW: 1000.000kHz VBW: 3000.000kHz SWT: Auto Detector : Peak Project : 660115 Mode : 120</p>
<p style="text-align: center;">Peak</p>	 <p style="font-size: small;">Date: 2016-07-07 FCC PART 15E_BAND4_N</p> <p style="font-size: x-small;">Site : 03CH07-HY Condition : FCC PART 15E_BAND4_N 3m HF-ANT_130829 HORIZONTAL RBW: 1000.000kHz VBW: 3000.000kHz SWT: Auto Detector : Peak Project : 660115 Mode : 120</p>	<p style="text-align: center;">Left blank</p>



WIFI	Band 4 5725~5850MHz Band Edge @ 3m	
ANT	802.11a CH157 5785MHz	
2	Vertical	Fundamental
Peak	<p>Site : 03CH07-HY Condition : FCC PART 15E_BAND4_N 3m HF-ANT_130829 VERTICAL RBW:1000 000kHz VBW:3000 000kHz SVWT:Auto Detector : Peak Project : 660115 Mode : 120</p>	<p>Site : 03CH07-HY Condition : FCC PART 15E_BAND4_N 3m HF-ANT_130829 VERTICAL RBW:1000 000kHz VBW:3000 000kHz SVWT:Auto Detector : Peak Project : 660115 Mode : 120</p>
Peak	<p>Site : 03CH07-HY Condition : FCC PART 15E_BAND4_N 3m HF-ANT_130829 VERTICAL RBW:1000 000kHz VBW:3000 000kHz SVWT:Auto Detector : Peak Project : 660115 Mode : 120</p>	Left blank

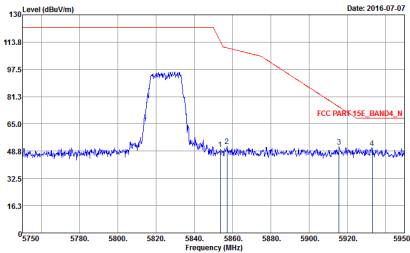
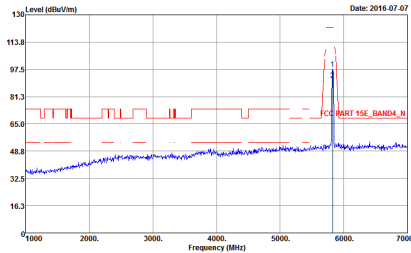

WIFI	Band 4 5725~5850MHz Band Edge @ 3m	
ANT	802.11a CH165 5825MHz	
2	Horizontal	Fundamental
Peak	 <p>Date: 2016-07-07</p> <p>Site : 03CH07-HY Condition : FCC PART 15E_BAND4_N 3m HF-ANT_130829 HORIZONTAL : RBW:1000 000KHz VBW:3000 000KHz SVWT:Auto Detector : Peak Project : 660115 Mode : 121</p>	 <p>Date: 2016-07-07</p> <p>Site : 03CH07-HY Condition : FCC PART 15E_BAND4_N 3m HF-ANT_130829 HORIZONTAL : RBW:1000 000KHz VBW:3000 000KHz SVWT:Auto Detector : Peak Project : 660115 Mode : 121</p>



WIFI	Band 4 5725~5850MHz Band Edge @ 3m	
ANT	802.11a CH165 5825MHz	
2	Vertical	Fundamental
Peak	<p style="font-size: small;">Date: 2016-07-07</p> <p style="font-size: x-small;">Site : 03CH07-HY Condition : FCC PART 15E_BAND4_N 3m HF-ANT_130829 VERTICAL Detector : Peak Project : 660115 Mode : 121</p>	<p style="font-size: small;">Date: 2016-07-07</p> <p style="font-size: x-small;">Site : 03CH07-HY Condition : FCC PART 15E_BAND4_N 3m HF-ANT_130829 VERTICAL Detector : Peak Project : 660115 Mode : 121</p>

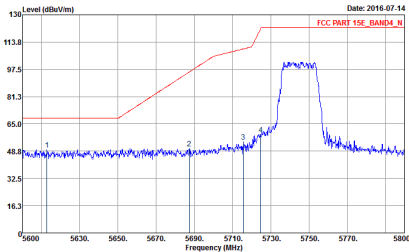
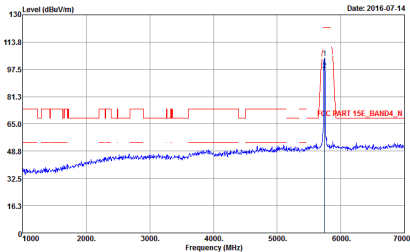

Band 4 5725~5850MHz
WIFI 802.11ac VHT20 (Band Edge @ 3m)

WIFI	Band 4 5725~5850MHz Band Edge @ 3m	
ANT	802.11ac VHT20 CH149 5745MHz	
2	Horizontal	Fundamental
Peak	 <p>Date: 2016.07.14 FCC PART 15E_BAND4_N</p> <p>Site : 03CH07-HY Condition : FCC PART 15E_BAND4_N 3m HF-ANT_130829 HORIZONTAL RBW: 1000.000kHz VBW: 3000.000kHz SWT: Auto Detector : Peak Project : 660115 Mode : 122</p>	 <p>Date: 2016.07.14 FCC PART 15E_BAND4_N</p> <p>Site : 03CH07-HY Condition : FCC PART 15E_BAND4_N 3m HF-ANT_130829 HORIZONTAL RBW: 1000.000kHz VBW: 3000.000kHz SWT: Auto Detector : Peak Project : 660115 Mode : 122</p>



WIFI	Band 4 5725~5850MHz Band Edge @ 3m	
ANT	802.11ac VHT20 CH149 5745MHz	
2	Vertical	Fundamental
Peak Avg.	<p>Site : 03CH07-HY Condition : FCC PART 15E, BAND4, N 3m HF-ANT, 130829 VERTICAL Detector : Peak Project : 660115 Mode : 122</p>	<p>Site : 03CH07-HY Condition : FCC PART 15E, BAND4, N 3m HF-ANT, 130829 VERTICAL Detector : Peak Project : 660115 Mode : 122</p>



WIFI	Band 4 5725~5850MHz Band Edge @ 3m	
ANT	802.11ac VHT20 CH157 5785MHz	
2	Horizontal	Fundamental
Peak	<p>Date: 2016-07-07</p> <p>FCC PART 15E_BAND4_N</p> <p>Site : 03CH07-HY Condition : FCC PART 15E_BAND4_N 3m HF-ANT_130829 HORIZONTAL RBW:1000.000kHz VBW:3000.000kHz SVWT:Auto Detector : Peak Project : 660115 Mode : 123</p>	<p>Date: 2016-07-07</p> <p>FCC PART 15E_BAND4_N</p> <p>Site : 03CH07-HY Condition : FCC PART 15E_BAND4_N 3m HF-ANT_130829 HORIZONTAL RBW:1000.000kHz VBW:3000.000kHz SVWT:Auto Detector : Peak Project : 660115 Mode : 123</p>
Peak	<p>Date: 2016-07-07</p> <p>FCC PART 15E_BAND4_N</p> <p>Site : 03CH07-HY Condition : FCC PART 15E_BAND4_N 3m HF-ANT_130829 HORIZONTAL RBW:1000.000kHz VBW:3000.000kHz SVWT:Auto Detector : Peak Project : 660115 Mode : 123</p>	Left blank



WIFI	Band 4 5725~5850MHz Band Edge @ 3m	
ANT	802.11ac VHT20 CH157 5785MHz	
2	Vertical	Fundamental
Peak	<p>Date: 2016-07-07</p> <p>Site : 03CH07-HY Condition : FCC PART 15E_BAND4_N 3m HF-ANT_130829 VERTICAL Detector : Peak Project : 660115 Mode : 123</p>	<p>Date: 2016-07-07</p> <p>Site : 03CH07-HY Condition : FCC PART 15E_BAND4_N 3m HF-ANT_130829 VERTICAL Detector : Peak Project : 660115 Mode : 123</p>
Peak	<p>Date: 2016-07-07</p> <p>Site : 03CH07-HY Condition : FCC PART 15E_BAND4_N 3m HF-ANT_130829 VERTICAL Detector : Peak Project : 660115 Mode : 123</p>	Left blank

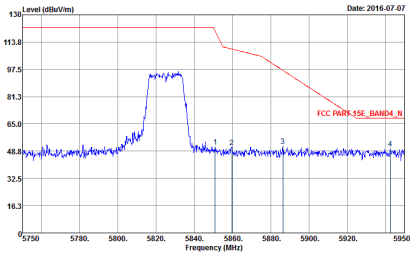
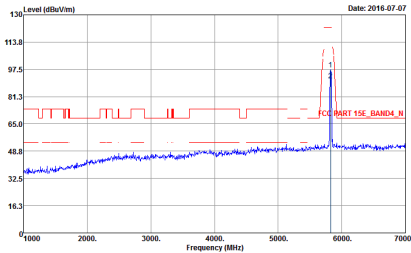

WIFI	Band 4 5725~5850MHz Band Edge @ 3m	
ANT	802.11ac VHT20 CH165 5825MHz	
2	Horizontal	Fundamental
Peak	 <p style="font-size: small;">Date: 2016-07-07</p> <p style="font-size: x-small;">Site : 03CH07-HY Condition : FCC PART 15E_BAND4_N 3m HF-ANT_130829 HORIZONTAL Detector : Peak Project : 660115 Mode : 124</p>	 <p style="font-size: small;">Date: 2016-07-07</p> <p style="font-size: x-small;">Site : 03CH07-HY Condition : FCC PART 15E_BAND4_N 3m HF-ANT_130829 HORIZONTAL Detector : Peak Project : 660115 Mode : 124</p>

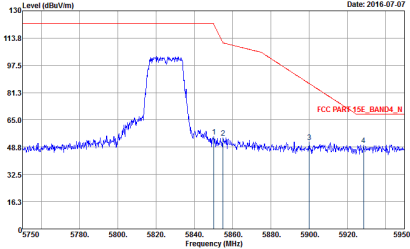
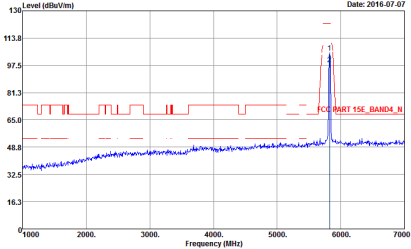

WIFI	Band 4 5725~5850MHz Band Edge @ 3m	
ANT	802.11ac VHT20 CH165 5825MHz	
2	Vertical	Fundamental
Peak Avg.	 <p>Site : 03CH07-HY Condition : FCC PART 15E_BAND4_N 3m HF-ANT_130829 VERTICAL Detector : Peak Project : 660115 Mode : 124</p>	 <p>Site : 03CH07-HY Condition : FCC PART 15E_BAND4_N 3m HF-ANT_130829 VERTICAL Detector : Peak Project : 660115 Mode : 124</p>



Band 4 5725~5850MHz
WIFI 802.11ac VHT40 (Band Edge @ 3m)

WIFI	Band 4 5725~5850MHz Band Edge @ 3m	
ANT	802.11ac VHT40 CH151 5755MHz	
2	Horizontal	Fundamental
Peak	<p>Date: 2016-07-07</p> <p>Site : 03CH07-HY Condition : FCC PART 15E_BAND4_N 3m HF-ANT_130829 HORIZONTAL RBW: 1000.000kHz VBW: 3000.000kHz SWT: Auto Detector : Peak Project : 660115 Mode : 125</p>	<p>Date: 2016-07-07</p> <p>Site : 03CH07-HY Condition : FCC PART 15E_BAND4_N 3m HF-ANT_130829 HORIZONTAL RBW: 1000.000kHz VBW: 3000.000kHz SWT: Auto Detector : Peak Project : 660115 Mode : 125</p>
Peak	<p>Date: 2016-07-07</p> <p>Site : 03CH07-HY Condition : FCC PART 15E_BAND4_N 3m HF-ANT_130829 HORIZONTAL RBW: 1000.000kHz VBW: 3000.000kHz SWT: Auto Detector : Peak Project : 660115 Mode : 125</p>	Left blank



WIFI	Band 4 5725~5850MHz Band Edge @ 3m	
ANT	802.11ac VHT40 CH151 5755MHz	
2	Vertical	Fundamental
Peak	<p>Date: 2016-07-07</p> <p>Site : 03CH07-HY Condition : FCC PART 15E_BAND4_N 3m HF-ANT_130829 VERTICAL RBW:1000.000KHz VBW:3000.000KHz SVT:Auto Detector : Peak Project : 660115 Mode : 125</p>	<p>Date: 2016-07-07</p> <p>Site : 03CH07-HY Condition : FCC PART 15E_BAND4_N 3m HF-ANT_130829 VERTICAL RBW:1000.000KHz VBW:3000.000KHz SVT:Auto Detector : Peak Project : 660115 Mode : 125</p>
Peak	<p>Date: 2016-07-07</p> <p>Site : 03CH07-HY Condition : FCC PART 15E_BAND4_N 3m HF-ANT_130829 VERTICAL RBW:1000.000KHz VBW:3000.000KHz SVT:Auto Detector : Peak Project : 660115 Mode : 125</p>	Left blank



WIFI	Band 4 5725~5850MHz Band Edge @ 3m	
ANT	802.11ac VHT40 CH159 5795MHz	
2	Horizontal	Fundamental
Peak	<p>Date: 2016-07-07</p> <p>Site : 03CH07-HY Condition : FCC PART 15E_BAND4_N 3m HF-ANT_130829 HORIZONTAL RBW:1000.000KHz VBW:3000.000KHz SVWT:Auto Detector : Peak Project : 660115 Mode : 126</p>	<p>Date: 2016-07-07</p> <p>Site : 03CH07-HY Condition : FCC PART 15E_BAND4_N 3m HF-ANT_130829 HORIZONTAL RBW:1000.000KHz VBW:3000.000KHz SVWT:Auto Detector : Peak Project : 660115 Mode : 126</p>
Peak	<p>Date: 2016-07-07</p> <p>Site : 03CH07-HY Condition : FCC PART 15E_BAND4_N 3m HF-ANT_130829 HORIZONTAL RBW:1000.000KHz VBW:3000.000KHz SVWT:Auto Detector : Peak Project : 660115 Mode : 126</p>	Left blank



WIFI	Band 4 5725~5850MHz Band Edge @ 3m	
ANT	802.11ac VHT40 CH159 5795MHz	
2	Vertical	Fundamental
Peak	<p>Date: 2016-07-07</p> <p>Site : 03CH07-HY Condition : FCC PART 15E_BAND4_N 3m HF-ANT_130829 VERTICAL RBW:1000 000KHz VBW:3000 000KHz SVWT:Auto Detector : Peak Project : 660115 Mode : 126</p>	<p>Date: 2016-07-07</p> <p>Site : 03CH07-HY Condition : FCC PART 15E_BAND4_N 3m HF-ANT_130829 VERTICAL RBW:1000 000KHz VBW:3000 000KHz SVWT:Auto Detector : Peak Project : 660115 Mode : 126</p>
Peak	<p>Date: 2016-07-07</p> <p>Site : 03CH07-HY Condition : FCC PART 15E_BAND4_N 3m HF-ANT_130829 VERTICAL RBW:1000 000KHz VBW:3000 000KHz SVWT:Auto Detector : Peak Project : 660115 Mode : 126</p>	Left blank



Band 4 5725~5850MHz
WIFI 802.11ac VHT80 (Band Edge @ 3m)

WIFI	Band 4 5725~5850MHz Band Edge @ 3m	
ANT	802.11ac VHT80 CH155 5775MHz	
2	Horizontal	Fundamental
Peak	<p>Date: 2016-07-07</p> <p>Site : 03CH07.HY Condition : FCC PART 15E_BAND4_N 3m HF-ANT_130829 HORIZONTAL Resolution : RBW:1000.000kHz VBW:3000.000kHz SWT:Auto Detector : Peak Project : 660115 Mode : 127</p>	<p>Date: 2016-07-07</p> <p>Site : 03CH07.HY Condition : FCC PART 15E_BAND4_N 3m HF-ANT_130829 HORIZONTAL Resolution : RBW:1000.000kHz VBW:3000.000kHz SWT:Auto Detector : Peak Project : 660115 Mode : 127</p>
Peak	<p>Date: 2016-07-07</p> <p>Site : 03CH07.HY Condition : FCC PART 15E_BAND4_N 3m HF-ANT_130829 HORIZONTAL Resolution : RBW:1000.000kHz VBW:3000.000kHz SWT:Auto Detector : Peak Project : 660115 Mode : 127</p>	Left blank



WIFI	Band 4 5725~5850MHz Band Edge @ 3m	
ANT	802.11ac VHT80 CH155 5775MHz	
2	Vertical	Fundamental
Peak	<p>Date: 2016-07-07</p> <p>Site : 03CH07-HY Condition : FCC PART 15E_BAND4_N 3m HF-ANT_130829 VERTICAL RBW:1000 000KHz VBW:3000 000KHz SVWT:Auto Detector : Peak Project : 660115 Mode : 127</p>	<p>Date: 2016-07-07</p> <p>Site : 03CH07-HY Condition : FCC PART 15E_BAND4_N 3m HF-ANT_130829 VERTICAL RBW:1000 000KHz VBW:3000 000KHz SVWT:Auto Detector : Peak Project : 660115 Mode : 127</p>
Peak	<p>Date: 2016-07-07</p> <p>Site : 03CH07-HY Condition : FCC PART 15E_BAND4_N 3m HF-ANT_130829 VERTICAL RBW:1000 000KHz VBW:3000 000KHz SVWT:Auto Detector : Peak Project : 660115 Mode : 127</p>	Left blank



Band 4 - 5725~5850MHz
WIFI 802.11a (Harmonic @ 3m)

Table with 2 columns: Horizontal and Vertical. It contains two spectral plots showing Level (dBuV/m) vs Frequency (MHz) for Peak and Avg. measurements. Includes site and condition details for each plot.



WIFI	Band 4 5725~5850MHz Harmonic @ 3m	
ANT	802.11a CH157 5785MHz	
2	Horizontal	Vertical
Peak Avg.		

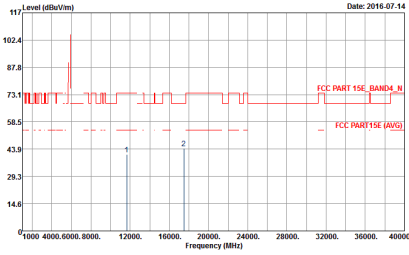
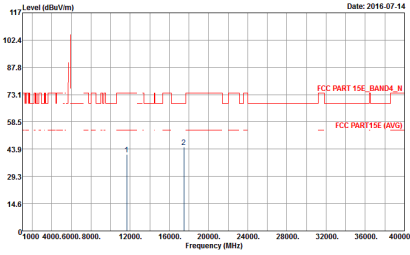

WIFI	Band 4 5725~5850MHz Harmonic @ 3m	
ANT	802.11a CH165 5825MHz	
2	Horizontal	Vertical
Peak Avg.	 <p> Date: 2016-07-14 Site : 03CH07-HY Condition : FCC PART 15E_BAND4_N 3m SHF-EHF_131029 HORIZONTAL Detector : Peak Project : 660115 Mode : 121 </p>	 <p> Date: 2016-07-14 Site : 03CH07-HY Condition : FCC PART 15E_BAND4_N 3m SHF-EHF_131029 VERTICAL Detector : Peak Project : 660115 Mode : 121 </p>



**Band 4 5725~5850MHz
WIFI 802.11ac VHT20 (Harmonic @ 3m)**

WIFI	Band 4 5725~5850MHz Harmonic @ 3m	
ANT	802.11ac VHT20 CH149 5745MHz	
2	Horizontal	Vertical
<p>Peak</p> <p>Avg.</p>	<p>Date: 2016-07-14</p> <p>Site : 03CH07.HY Condition : FCC PART 15E_BAND4_N 3m SHF-EHF_131029 HORIZONTAL Detector : Peak Project : 660115 Mode : 122</p>	<p>Date: 2016-07-14</p> <p>Site : 03CH07.HY Condition : FCC PART 15E_BAND4_N 3m SHF-EHF_131029 VERTICAL Detector : Peak Project : 660115 Mode : 122</p>

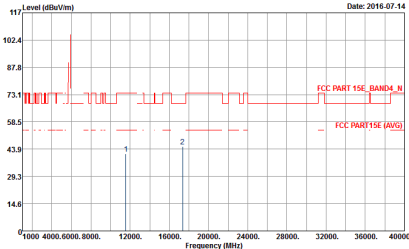
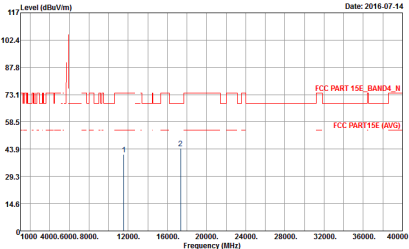

WIFI	Band 4 5725~5850MHz Harmonic @ 3m	
ANT	802.11ac VHT20 CH157 5785MHz	
2	Horizontal	Vertical
<p>Peak</p> <p>Avg.</p>	 <p>Site : 03CH07-HY Condition : FCC PART 15E_BAND4_N 3m SHF-EHF_131029 HORIZONTAL Detector : Peak Project : 660115 Mode : 123</p>	 <p>Site : 03CH07-HY Condition : FCC PART 15E_BAND4_N 3m SHF-EHF_131029 VERTICAL Detector : Peak Project : 660115 Mode : 123</p>

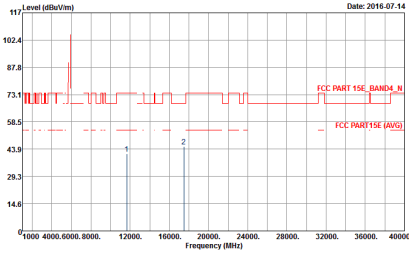
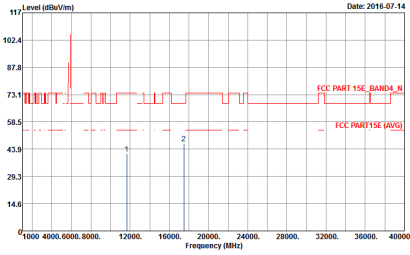

WIFI	Band 4 5725~5850MHz Harmonic @ 3m	
ANT	802.11ac VHT20 CH165 5825MHz	
2	Horizontal	Vertical
Peak Avg.	 <p>Site : 03CH07-HY Condition : FCC PART 15E_BAND4_N 3m SHF-EHF_131029 HORIZONTAL Detector : Peak Project : 660115 Mode : 124</p>	 <p>Site : 03CH07-HY Condition : FCC PART 15E_BAND4_N 3m SHF-EHF_131029 VERTICAL Detector : Peak Project : 660115 Mode : 124</p>



Band 4 5725~5850MHz
WIFI 802.11ac VHT40 (Harmonic @ 3m)

WIFI	Band 4 5725~5850MHz Harmonic @ 3m	
ANT	802.11ac VHT40 CH151 5755MHz	
2	Horizontal	Vertical
<p>Peak</p> <p>Avg.</p>	<p>Site : 03CH07.HY Condition : FCC PART 15E_BAND4_N 3m SHF-EHF_131029 HORIZONTAL Detector : Peak Project : 660115 Mode : 125</p>	<p>Site : 03CH07.HY Condition : FCC PART 15E_BAND4_N 3m SHF-EHF_131029 VERTICAL Detector : Peak Project : 660115 Mode : 125</p>