



FCC RADIO TEST REPORT

FCC ID : UZ7ET45CB
Equipment : Tablet
Brand Name : Zebra
Model Name : ET45CB
Applicant : Zebra Technologies Corporation
1 Zebra Plaza, Holtsville, NY 11742
Manufacturer : Zebra Technologies Corporation
1 Zebra Plaza, Holtsville, NY 11742
Standard : FCC Part 15 Subpart C §15.247

The product was received on Jun. 01, 2022 and testing was performed from Jun. 09, 2022 to Jul. 21, 2022. We, Sporton International Inc. Wensan Laboratory, would like to declare that the tested sample has been evaluated in accordance with the test procedures and has been in compliance with the applicable technical standards.

The test results in this report apply exclusively to the tested model / sample. Without written approval from Sporton International Inc. Wensan Laboratory, the test report shall not be reproduced except in full.

Approved by: Louis Wu

Sporton International Inc. Wensan Laboratory

No.58, Aly. 75, Ln. 564, Wenhua 3rd, Rd., Guishan Dist., Taoyuan City 333010, Taiwan (R.O.C.)



Table of Contents

History of this test report.....	3
Summary of Test Result.....	4
1 General Description	5
1.1 Product Feature of Equipment Under Test.....	5
1.2 Product Specification of Equipment Under Test.....	6
1.3 Modification of EUT	6
1.4 Testing Location	7
1.5 Applicable Standards.....	7
2 Test Configuration of Equipment Under Test	8
2.1 Carrier Frequency and Channel	8
2.2 Test Mode.....	9
2.3 Connection Diagram of Test System.....	12
2.4 Support Unit used in test configuration and system	13
2.5 EUT Operation Test Setup	13
2.6 Measurement Results Explanation Example.....	14
3 Test Result	15
3.1 6dB and 99% Bandwidth Measurement	15
3.2 Output Power Measurement.....	20
3.3 Power Spectral Density Measurement	23
3.4 Conducted Band Edges and Spurious Emission Measurement	27
3.5 Radiated Band Edges and Spurious Emission Measurement	52
3.6 AC Conducted Emission Measurement.....	58
3.7 Antenna Requirements	60
4 List of Measuring Equipment.....	63
5 Uncertainty of Evaluation	65
Appendix A. AC Conducted Emission Test Result	
Appendix B. Radiated Spurious Emission	
Appendix C. Radiated Spurious Emission Plots	
Appendix D. Duty Cycle Plots	
Appendix E. Setup Photographs	



History of this test report

Report No.	Version	Description	Issue Date
FR1N2539C	01	Initial issue of report	Aug. 09, 2022
FR1N2539C	02	Revise Product Feature	Aug. 16, 2022



Summary of Test Result

Report Clause	Ref Std. Clause	Test Items	Result (PASS/FAIL)	Remark
3.1	15.247(a)(2)	6dB Bandwidth	Pass	-
3.1	2.1049	99% Occupied Bandwidth	Reporting only	-
3.2	15.247(b)	Power Output Measurement	Pass	-
3.3	15.247(e)	Power Spectral Density	Pass	-
3.4	15.247(d)	Conducted Band Edges	Pass	-
		Conducted Spurious Emission	Pass	-
3.5	15.247(d)	Radiated Band Edges and Radiated Spurious Emission	Pass	1.20 dB under the limit at 2390.000 MHz
3.6	15.207	AC Conducted Emission	Pass	16.85 dB under the limit at 0.178 MHz
3.7	15.203 & 15.247(b)	Antenna Requirement	Pass	-

Declaration of Conformity:

1. The test results (PASS/FAIL) with all measurement uncertainty excluded are presented in accordance with the regulation limits or requirements declared by manufacturers. It's means measurement values may risk exceeding the limit of regulation standards, if measurement uncertainty is include in test results.
2. The measurement uncertainty please refer to this report "Uncertainty of Evaluation".

Comments and Explanations:

The product specifications of the EUT presented in the report are declared by the manufacturer who shall take full responsibility for the authenticity.

Reviewed by: Keven Cheng

Report Producer: Michelle Chen



1 General Description

1.1 Product Feature of Equipment Under Test

Product Feature	
Equipment	Tablet
Brand Name	Zebra
Model Name	ET45CB
FCC ID	UZ7ET45CB
EUT supports Radios application	GSM/EGPRS/WCDMA/HSPA/LTE/5G NR/NFC/GNSS WLAN 11a/b/g/n HT20/HT40 WLAN 11ac VHT20/VHT40/VHT80 WLAN 11ax HE20/HE40/HE80 Bluetooth BR/EDR/LE Note: 2.4G doesn't support BW 40/80.
HW Version	EV2-2
SW Version	ET45-userdebug 11 11-10-12.00-RG-U00-PRD-GSE MXJ release-keys
MFD	30APR22
EUT Stage	Identical Prototype

Remark: The above EUT's information was declared by manufacturer.

Specification of Accessories				
Battery	Brand Name	Zebra	Model Name	BT-000456

Supported Unit Used in Test Configuration and System				
AC Adapter	Brand Name	Zebra	Part Number	PWR-WUA5V12W0US
Earphone 1	Brand Name	Zebra	Part Number	HDST-35MM-PTVP-01
Earphone 2	Brand Name	Zebra	Part Number	HDST-USBC-PTT1-01
USB Cable (Type C to Type A)	Brand Name	Zebra	Part Number	CBL-TC5X-USBC2A-01
Type C-Audio Cable (Type C to 3.5mm)	Brand Name	Zebra	Part Number	ADP-USBC-35MM1-01



1.2 Product Specification of Equipment Under Test

Product Specification is subject to this standard										
Tx/Rx Channel Frequency Range	2412 MHz ~ 2462 MHz									
Maximum Output Power to Antenna <CDD Modes>	MIMO <Ant. 6+7> 802.11b : 23.86 dBm / 0.2432 W 802.11g : 22.98 dBm / 0.1986 W 802.11n HT20 : 21.32 dBm / 0.1355 W 802.11ac VHT20: 21.32 dBm / 0.1355 W 802.11ax HE20: 21.42 dBm / 0.1387 W									
Maximum Output Power <TXBF Modes>	MIMO <Ant. 6+7> 802.11ax HE20: 21.66 dBm / 0.1466 W									
99% Occupied Bandwidth <CDD Mode>	MIMO <Ant. 6> 802.11b : 11.59 MHz 802.11g : 19.48 MHz 802.11ax HE20 : 19.58 MHz MIMO <Ant. 7> 802.11b : 12.19 MHz 802.11g : 19.88 MHz 802.11ax HE20 : 19.63 MHz									
99% Occupied Bandwidth <TXBF Mode>	MIMO <Ant. 6> 802.11ax HE20 : 19.83 MHz MIMO <Ant. 7> 802.11ax HE20 : 19.93 MHz									
Antenna Type / Gain	<Ant. 6> : IFA Antenna with gain 1.20 dBi <Ant. 7> : IFA Antenna with gain 1.50 dBi									
Type of Modulation	802.11b: DSSS (DBPSK/DQPSK/CCK) 802.11g/n: OFDM (BPSK/QPSK/16QAM/64QAM) 802.11ac: OFDM (BPSK/QPSK/16QAM/64QAM/256QAM) 802.11ax: OFDMA (BPSK/QPSK/16QAM/64QAM/256QAM/1024QAM)									
Antenna Function Description	<table border="1"> <thead> <tr> <th></th> <th>Ant. 6</th> <th>Ant. 7</th> </tr> </thead> <tbody> <tr> <td>802.11 b/g/n/ac/ax MIMO</td> <td>V</td> <td>V</td> </tr> <tr> <td>802.11ax TXBF</td> <td>V</td> <td>V</td> </tr> </tbody> </table>		Ant. 6	Ant. 7	802.11 b/g/n/ac/ax MIMO	V	V	802.11ax TXBF	V	V
	Ant. 6	Ant. 7								
802.11 b/g/n/ac/ax MIMO	V	V								
802.11ax TXBF	V	V								

Note:

1. MIMO Ant. 6+7 Directional Gain is a calculated result from MIMO Ant. 6 and MIMO Ant. 7. The formula used in calculation is documented in section 3.7.
2. Power of MIMO Ant. 6 + Ant. 7 is a calculated result from sum of the power MIMO Ant. 6 and MIMO Ant. 7.
3. The above EUT's information was declared by manufacturer. Please refer to Comments and Explanations in report summary.

1.3 Modification of EUT

No modifications made to the EUT during the testing.



1.4 Testing Location

Test Site	Sporton International Inc. Wensan Laboratory
Test Site Location	No.58, Aly. 75, Ln. 564, Wenhua 3rd, Rd., Guishan Dist., Taoyuan City 333010, Taiwan (R.O.C.) TEL: +886-3-327-0868 FAX: +886-3-327-0855
Test Site No.	Sporton Site No. TH05-HY, CO07-HY, 03CH13-HY

Note: The test site complies with ANSI C63.4 2014 requirement.

FCC designation No.: TW3786

1.5 Applicable Standards

According to the specifications declared by the manufacturer, the EUT must comply with the requirements of the following standards:

- ♦ FCC Part 15 Subpart C §15.247
- ♦ FCC KDB Publication No. 558074 D01 DTS Meas. Guidance v05r02
- ♦ FCC KDB 414788 D01 Radiated Test Site v01r01.
- ♦ FCC KDB 662911 D01 Multiple Transmitter Output v02r01.
- ♦ ANSI C63.10-2013

Remark:

1. All the test items were validated and recorded in accordance with the standards without any modification during the testing.
2. The TAF code is not including all the FCC KDB listed without accreditation.
3. This EUT has also been tested and complied with the requirements of FCC Part 15, Subpart B, recorded in a separate test report.



2 Test Configuration of Equipment Under Test

- a. The EUT has been associated with peripherals and configuration operated in a manner tended to maximize its emission characteristics in a typical application. Frequency range investigated: conduction emission (150 kHz to 30 MHz), radiation emission (9 kHz to the 10th harmonic of the highest fundamental frequency or to 40 GHz, whichever is lower). For radiated measurement, the measured emission level of the EUT was maximized by rotating the EUT on a turntable, adjusting the orientation of the EUT and EUT antenna in three orthogonal axis (X: flat, Y: portrait, Z: landscape), and adjusting the measurement antenna orientation, following C63.10 exploratory test procedures and find X plane as worst plane.
- b. AC power line Conducted Emission was tested under maximum output power.

2.1 Carrier Frequency and Channel

Frequency Band	Channel	Freq. (MHz)	Channel	Freq. (MHz)
2400-2483.5 MHz	1	2412	7	2442
	2	2417	8	2447
	3	2422	9	2452
	4	2427	10	2457
	5	2432	11	2462
	6	2437		



2.2 Test Mode

The 802.11ax mode is investigated among different tones, full resource units (RU), partial resource units. The partial RU has no higher power than full RU's, thus the full RU is chosen as main test configuration.

The CDD mode is chosen as worst case configuration for all test cases due to higher power than SISO mode.

The 802.11n/ac mode has no higher power and PSD than 802.11ax mode, thus the 802.11ax mode is chosen as main test configuration, and the 802.11n/ac mode is verified the power.

The final test modes consider the modulation and the worst data rates as shown in the table below.

MIMO Mode

Modulation	Data Rate
802.11b	1 Mbps
802.11g	6 Mbps
802.11n HT20 (Covered by HE20)	MCS0
802.11ac VHT20 (Covered by HE20)	MCS0
802.11ax HE20	MCS0

Remark: The conducted power level of each chain in MIMO mode is equal or higher than SISO mode.

TXBF Mode

Modulation	Data Rate
802.11ax HE20	MCS0

Remark: The conducted power level of each chain in MIMO mode is equal or higher than SISO mode.

Test Cases	
AC Conducted Emission	Mode 1 :WLAN (2.4GHz) Link + Bluetooth Link + USB Cable (Charging from Adapter)



<CDD Mode>

Ch. #	2400-2483.5 MHz				
	802.11b	802.11g			802.11ax HE20
Low	01	01	02	01	
Middle	06	06			06
High	11	9	10	11	11

<TXBF Mode>

Ch. #	2400-2483.5 MHz		
	802.11ax HE20		
Low	01		
Middle	06		
High	9	10	11

Remark: For radiation spurious emission, the modulation and the data rate picked for testing are determined by the Max. RF conducted power.

<CDD Mode>

802.11b RF Avg Output Power (dBm)						
Power vs. Channel			Power vs Data Rate			
Channel	Frequency (MHz)	Data Rate (bps)	Channel	Data Rate (bps)		
		1M		2M	5.5M	11M
CH 01	2412	23.86	CH 01	23.76	23.71	23.66
CH 06	2437	23.25				
CH 11	2462	22.47				

802.11g RF Avg Output Power (dBm)										
Power vs. Channel			Power vs Data Rate							
Channel	Frequency (MHz)	Data Rate (bps)	Channel	Data Rate (bps)						
		6M		9M	12M	18M	24M	36M	48M	54M
CH 01	2412	19.11	CH 06	22.88	22.88	22.88	22.67	22.67	22.62	22.61
CH 02	2417	21.36								
CH 06	2437	22.98								
CH 09	2452	21.03								
CH 10	2457	17.87								
CH 11	2462	15.82								



802.11n HT20 RF Avg Output Power (dBm)										
Power vs. Channel			Power vs Data Rate							
Channel	Frequency (MHz)	MCS Index	Channel	MCS Index						
		MCS0		MCS1	MCS2	MCS3	MCS4	MCS5	MCS6	MCS7
CH 01	2412	18.06	CH 06	21.02	21.01	21.11	21.06	21.01	21.01	21.01
CH 06	2437	21.32								
CH 10	2457	17.86								
CH 11	2462	15.65								

802.11ac VHT20 RF Avg Output Power (dBm)											
Power vs. Channel			Power vs Data Rate								
Channel	Frequency (MHz)	MCS Index	Channel	MCS Index							
		MCS0		MCS1	MCS2	MCS3	MCS4	MCS5	MCS6	MCS7	MCS8
CH 01	2412	18.06	CH 06	21.02	21.01	21.11	21.06	21.01	21.01	21.01	21.01
CH 06	2437	21.32									
CH 10	2457	17.86									
CH 11	2462	15.65									

802.11ax HE20 RF Output Power (dBm)															
Power vs. Channel				Power vs Data Rate											
Channel	Frequency (MHz)	RU Config.	MCS Index	Channel	MCS Index										
			MCS0		MCS1	MCS2	MCS3	MCS4	MCS5	MCS6	MCS7	MCS8	MCS9	MCS 10	MCS 11
CH 01	2412	Full	18.16	CH 06	21.02	21.01	21.11	21.06	21.06	21.01	21.06	21.01	21.01		
CH 01	2412	26/0	11.02												
CH 01	2412	52/37	14.21												
CH 01	2412	106/53	17.07												
CH 06	2437	Full	21.42												
CH 06	2437	26/4	14.81												
CH 06	2437	52/39	17.87												
CH 06	2437	106/53	19.33												
CH 10	2457	Full	17.96												
CH 11	2462	Full	15.75												
CH 11	2462	26/8	9.27												
CH 11	2462	52/40	11.87												
CH 11	2462	106/54	14.36												

<TXBF Mode>

802.11ax HE20 RF Output Power (dBm)															
Power vs. Channel				Power vs Data Rate											
Channel	Frequency (MHz)	RU Config.	MCS Index	Channel	MCS Index										
			MCS0		MCS1	MCS2	MCS3	MCS4	MCS5	MCS6	MCS7	MCS8	MCS9	MCS 10	MCS 11
CH 01	2412	Full	19.16	CH 06											
CH 06	2437	Full	21.66		21.56	21.56	21.56	21.56	21.56	21.56	21.56	21.56	21.56	21.56	21.56
CH 09	2452	Full	21.31												
CH 10	2457	Full	18.46												
CH 11	2462	Full	15.87												

2.3 Connection Diagram of Test System

<CDD Mode>

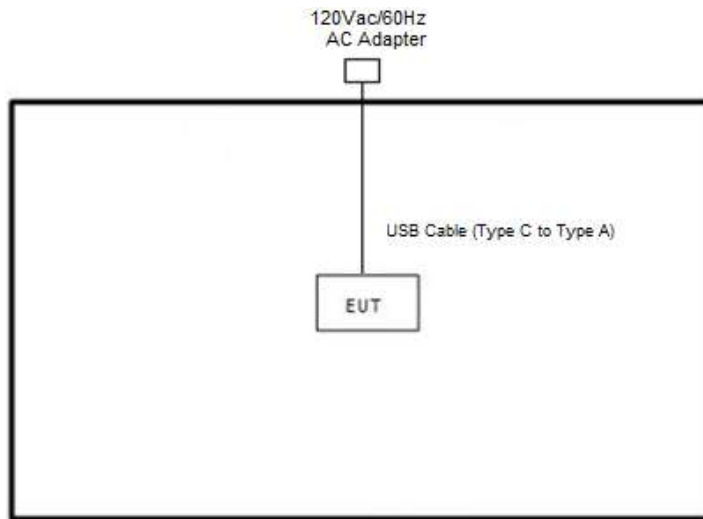

<TXBF Mode>

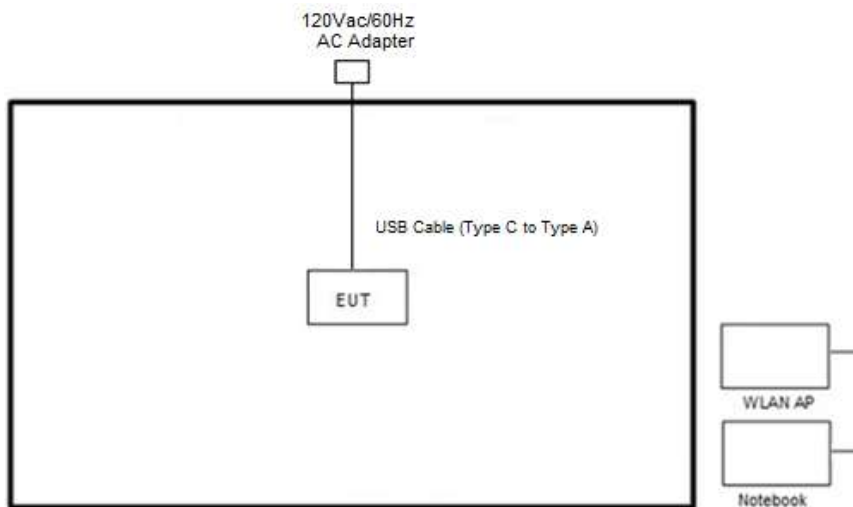

<AC Conducted Emission Mode>

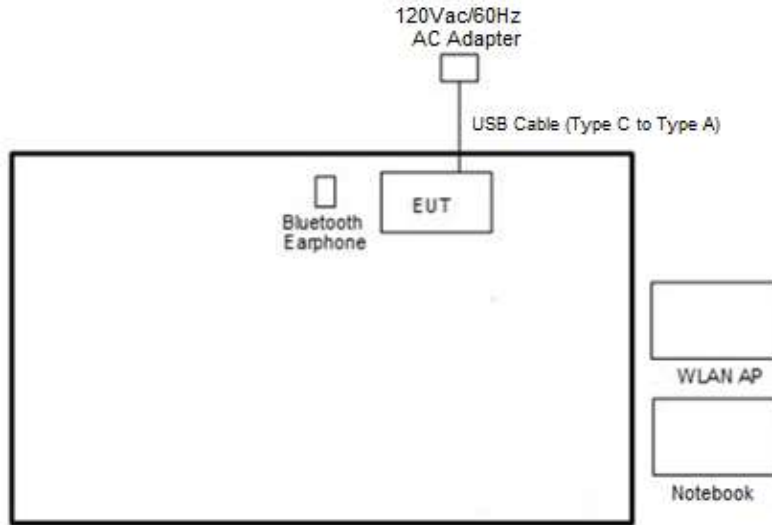

2.4 Support Unit used in test configuration and system

Item	Equipment	Brand Name	Model Name	FCC ID	Data Cable	Power Cord
1.	Bluetooth Earphone	Kinyo	BTE-3622	N/A	N/A	N/A
2.	WLAN AP	ASUS	RT-AC58	N/A	N/A	Unshielded, 1.8 m
3.	WLAN AP	ASUS	RT-AX88U	LCITHP000236	N/A	Unshielded, 1.8 m
4.	Notebook	Dell	P79G	FCC DoC	N/A	AC I/P: Unshielded, 1.2 m DC O/P: Shielded, 1.8 m
5.	Notebook	Acer	N18Q13	PD9AX201NG	N/A	AC I/P: Unshielded, 1.2 m DC O/P: Shielded, 1.8 m

2.5 EUT Operation Test Setup

The RF test items, utility “cmd.exe (10.0.17763.1577)” was installed in Notebook which was programmed in order to make the EUT get into the engineering modes to provide channel selection, power level, data rate and the application type and for continuous transmitting signals.

For TXBF mode, the modulation modes and data rates manipulated by the command lines in the engineering program made the EUT link to another EUT by power under the normal operation. The “Cmd version 1.0.39” software tool was used to enable the EUT to transmit signals continuously.



2.6 Measurement Results Explanation Example

For all conducted test items:

The offset level is set in the spectrum analyzer to compensate the RF cable loss and attenuator factor between EUT conducted output port and spectrum analyzer. With the offset compensation, the spectrum analyzer reading level is exactly the EUT RF output level.

Example:

The spectrum analyzer offset is derived from RF cable loss and attenuator factor.

Offset = RF cable loss + attenuator factor.

Following shows an offset computation example with cable loss 4.2 dB and 10 dB attenuator.

$$\begin{aligned} \text{Offset(dB)} &= \text{RF cable loss(dB)} + \text{attenuator factor(dB)}. \\ &= 4.2 + 10 = 14.2 \text{ (dB)} \end{aligned}$$

3 Test Result

3.1 6dB and 99% Bandwidth Measurement

3.1.1 Limit of 6dB and 99% Bandwidth

The minimum 6 dB bandwidth shall be at least 500 kHz.

3.1.2 Measuring Instruments

Please refer to the measuring equipment list in this test report.

3.1.3 Test Procedures

1. The testing follows the ANSI C63.10 Section 6.9.3 (OBW) and 11.8.1 (6dB BW).
2. The RF output of EUT is connected to the spectrum analyzer by RF cable and attenuator. The path loss is compensated to the results for each measurement.
3. Set the maximum power setting and enable the EUT to transmit continuously.
4. Make the measurement with the spectrum analyzer's resolution bandwidth (RBW) = 100 kHz. Set the Video bandwidth (VBW) = 300 kHz. In order to make an accurate measurement. The 6 dB bandwidth must be greater than 500 kHz.
5. For 99% Bandwidth Measurement, the spectrum analyzer's resolution bandwidth (RBW) is set 1-5% of the emission bandwidth and set the Video bandwidth (VBW) $\geq 3 * RBW$.
6. Measure and record the results in the test report.

3.1.4 Test Setup

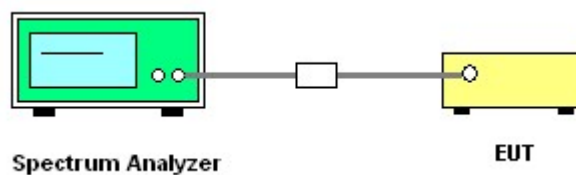



3.1.5 Test Result of 6dB and 99% Occupied Bandwidth

Test Engineer :	Eason Huang	Temperature :	21~25°C
		Relative Humidity :	51~54%

<CDD Mode>

2.4GHz Band MIMO										
Mod.	Data Rate	NTX	CH.	Freq. (MHz)	99% Occupied BW (MHz)		6dB BW (MHz)		6dB BW Limit (MHz)	Pass/Fail
					Ant. 6	Ant. 7	Ant. 6	Ant. 7		
11b	1Mbps	2	1	2412	11.44	12.19	8.06	7.58	0.50	Pass
11b	1Mbps	2	6	2437	11.59	11.44	7.60	7.08	0.50	Pass
11b	1Mbps	2	11	2462	11.34	12.14	7.10	8.08	0.50	Pass
11g	6Mbps	2	1	2412	18.43	17.63	16.37	15.49	0.50	Pass
11g	6Mbps	2	2	2417	18.63	18.23	16.37	15.77	0.50	Pass
11g	6Mbps	2	6	2437	19.13	19.88	16.37	16.35	0.50	Pass
11g	6Mbps	2	9	2452	19.48	19.13	16.11	16.37	0.50	Pass
11g	6Mbps	2	10	2457	18.43	17.88	16.09	16.37	0.50	Pass
11g	6Mbps	2	11	2462	18.03	18.28	15.97	16.39	0.50	Pass

2.4GHz Band MIMO											
Mod.	Data Rate	NTX	CH.	Freq. (MHz)	RU Config.	99% Occupied BW (MHz)		6dB BW (MHz)		6dB BW Limit (MHz)	Pass/Fail
						Ant. 6	Ant. 7	Ant. 6	Ant. 7		
HE20	MCS0	2	1	2412	Full	19.43	19.08	18.42	15.39	0.50	Pass
HE20	MCS0	2	6	2437	Full	19.58	19.63	18.67	17.62	0.50	Pass
HE20	MCS0	2	11	2462	Full	19.13	19.58	16.42	18.84	0.50	Pass



<802.11b>

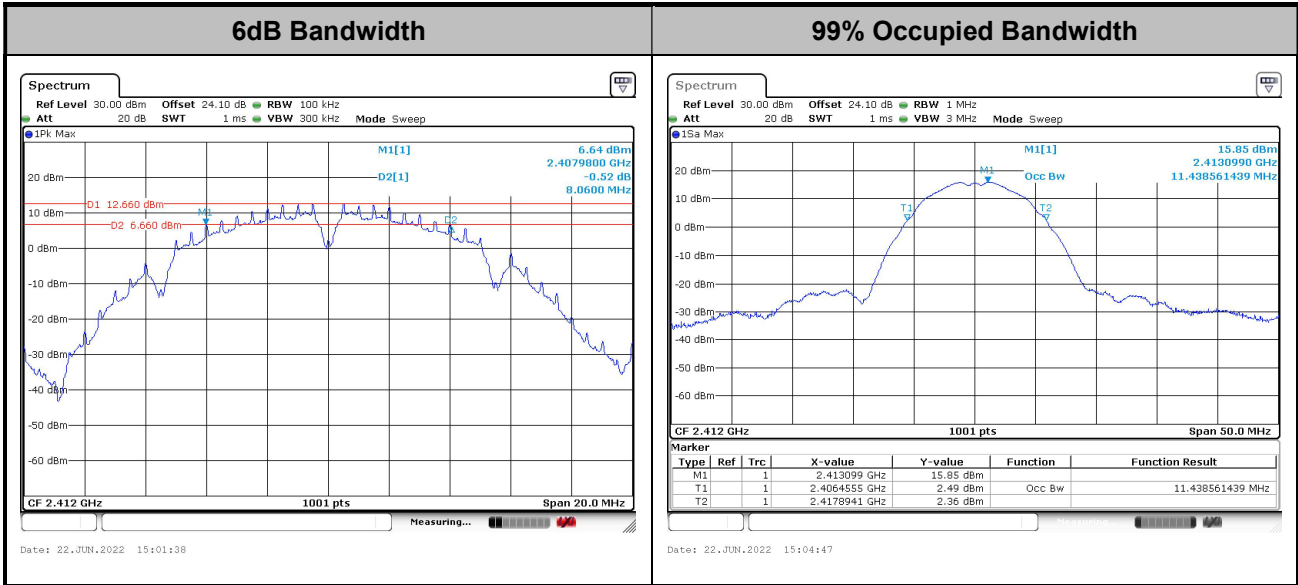

Note: The occupied channel bandwidth is maintained within the band of operation for all of the modulations.

<802.11g>

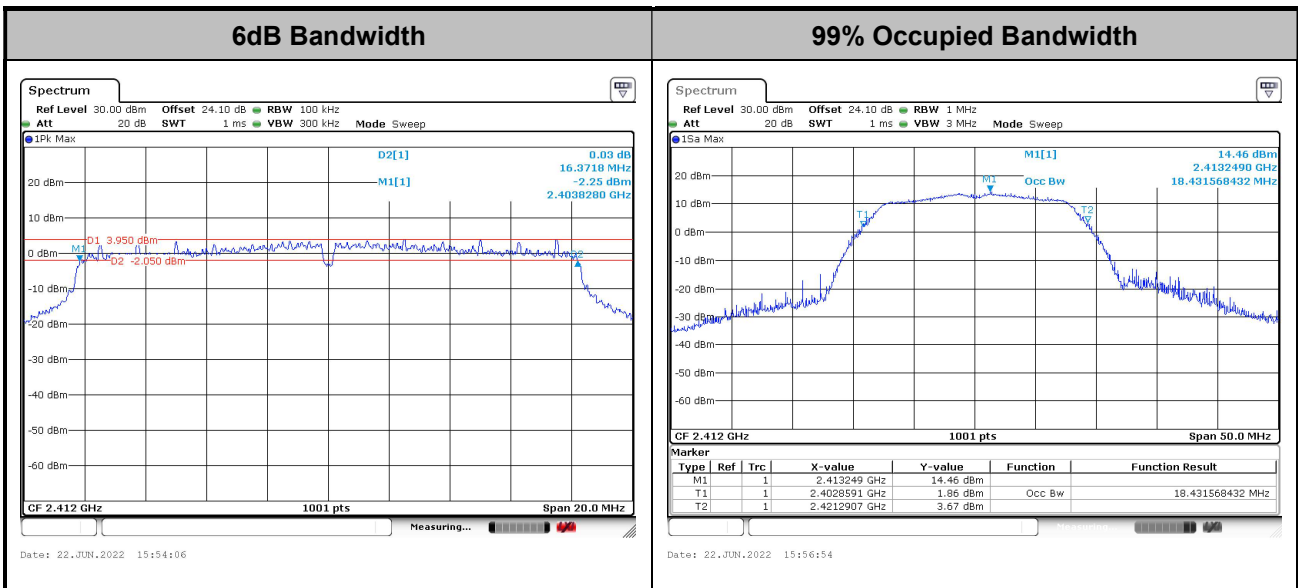

Note: The occupied channel bandwidth is maintained within the band of operation for all of the modulations.



<802.11ax HE20>

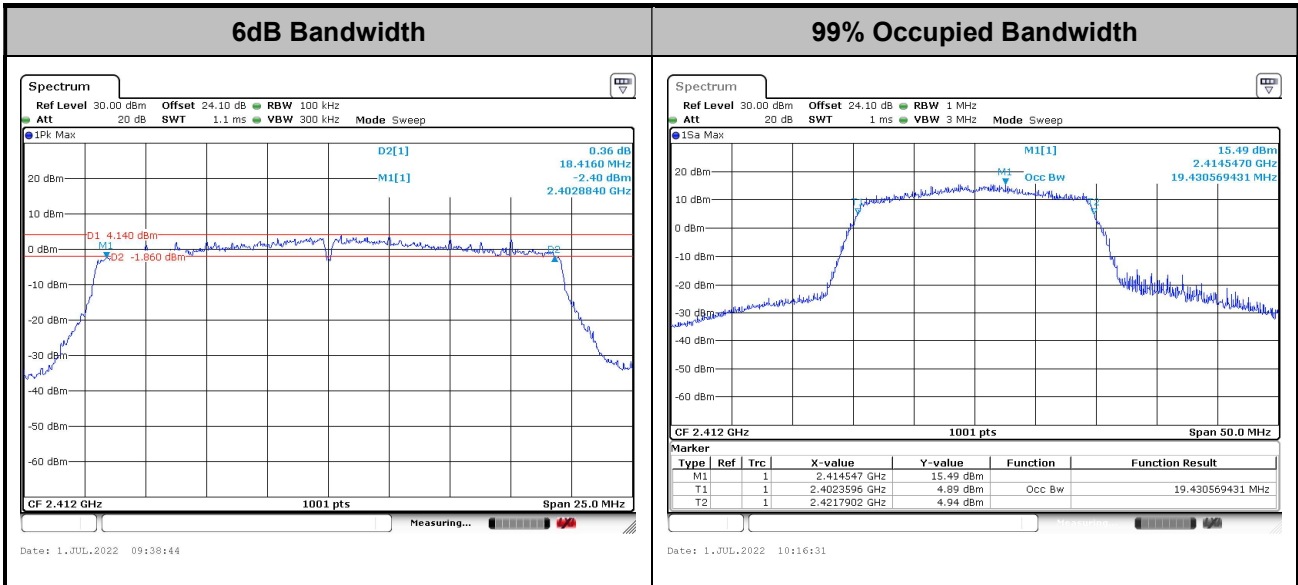

Note: The occupied channel bandwidth is maintained within the band of operation for all of the modulations.



<TXBF Modes>

2.4GHz Band MIMO											
Mod.	Data Rate	NTX	CH.	Freq. (MHz)	RU Config.	99% Occupied BW (MHz)		6dB BW (MHz)		6dB BW Limit (MHz)	Pass/Fail
						Ant. 6	Ant. 7	Ant. 6	Ant. 7		
HE20	MCS0	2	1	2412	Full	19.68	19.43	19.15	18.95	0.50	Pass
HE20	MCS0	2	6	2437	Full	19.83	19.93	19.15	19.10	0.50	Pass
HE20	MCS0	2	11	2462	Full	19.28	19.88	18.13	19.15	0.50	Pass

<802.11ax HE20>

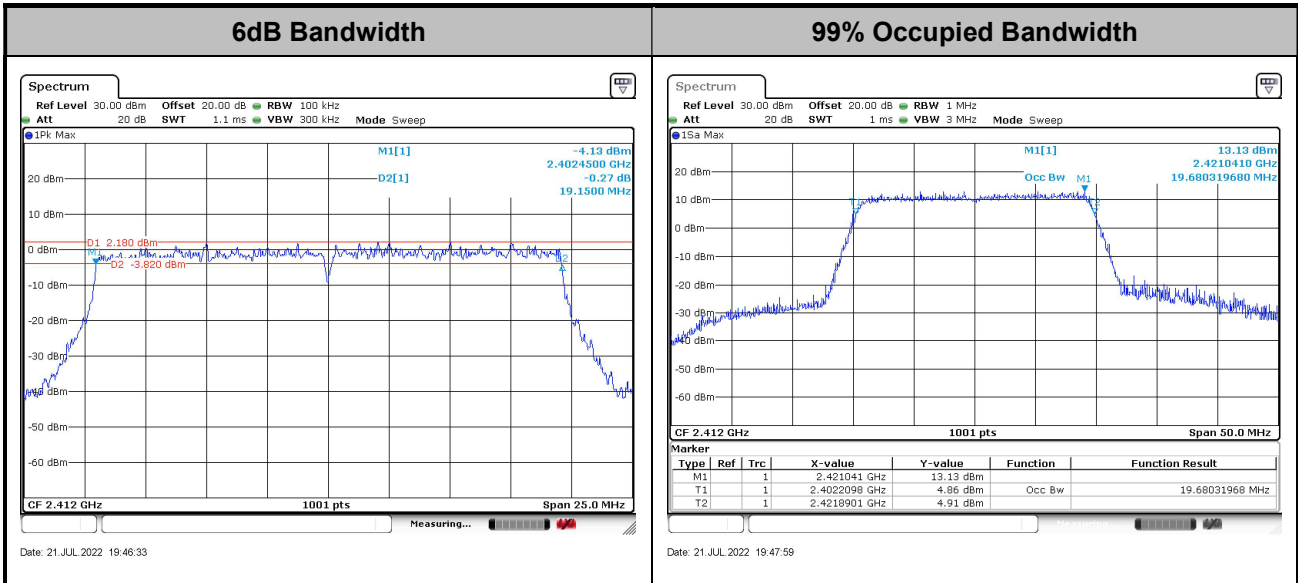

Note: The occupied channel bandwidth is maintained within the band of operation for all of the modulations.

3.2 Output Power Measurement

3.2.1 Limit of Output Power

For systems using digital modulation in the 2400-2483.5 MHz, the limit for output power is 30 dBm. If transmitting antenna with directional gain greater than 6 dBi is used, the peak output power from the intentional radiator shall be reduced below the above stated value by the amount in dB that the directional gain of the antenna exceeds 6 dBi. In case of point-to-point operation, the limit has to be reduced by 1 dB for every 3 dB that the directional gain of the antenna exceeds 6 dBi.

3.2.2 Measuring Instruments

Please refer to the measuring equipment list in this test report.

3.2.3 Test Procedures

1. For Average Power, the testing follows ANSI C63.10 Section 11.9.2.3.2 Method AVGPM-G
2. The RF output of EUT is connected to the power meter by RF cable and attenuator. The path loss is compensated to the results for each measurement.
3. Set the maximum power setting and enable the EUT to transmit continuously.
4. Measure the conducted output power and record the results in the test report.
5. For MIMO mode, calculation method follows FCC KDB 662911 D01 Multiple Transmitter Output v02r01.

3.2.4 Test Setup

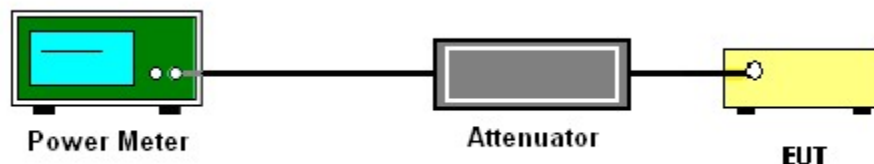



3.2.5 Test Result of Average Output Power

Test Engineer :	Eason Huang	Temperature :	21~25°C
		Relative Humidity :	51~54%

<CDD Mode>

2.4GHz Band MIMO																
Mod.	Data Rate	NTX	CH.	Freq. (MHz)	Average Conducted Power (dBm)			Conducted Power Limit (dBm)		DG (dBi)		EIRP Power (dBm)		EIRP Power Limit (dBm)		Pass /Fail
					Ant. 6	Ant. 7	SUM	Ant. 6	Ant. 7	Ant. 6	Ant. 7	Ant. 6	Ant. 7	Ant. 6	Ant. 7	
11b	1Mbps	2	1	2412	20.90	20.80	23.86	30.00		1.50		25.36		36.00	Pass	
11b	1Mbps	2	6	2437	20.80	19.60	23.25	30.00		1.50		24.75		36.00	Pass	
11b	1Mbps	2	11	2462	19.70	19.20	22.47	30.00		1.50		23.97		36.00	Pass	
11g	6Mbps	2	1	2412	16.30	15.90	19.11	30.00		1.50		20.61		36.00	Pass	
11g	6Mbps	2	2	2417	18.50	18.20	21.36	30.00		1.50		22.86		36.00	Pass	
11g	6Mbps	2	6	2437	20.40	19.50	22.98	30.00		1.50		24.48		36.00	Pass	
11g	6Mbps	2	9	2452	17.60	18.40	21.03	30.00		1.50		22.53		36.00	Pass	
11g	6Mbps	2	10	2457	14.50	15.20	17.87	30.00		1.50		19.37		36.00	Pass	
11g	6Mbps	2	11	2462	12.50	13.10	15.82	30.00		1.50		17.32		36.00	Pass	
HT20	MCS0	2	1	2412	15.20	14.90	18.06	30.00		1.50		19.56		36.00	Pass	
HT20	MCS0	2	6	2437	18.60	18.00	21.32	30.00		1.50		22.82		36.00	Pass	
HT20	MCS0	2	10	2457	14.70	15.00	17.86	30.00		1.50		19.36		36.00	Pass	
HT20	MCS0	2	11	2462	12.00	13.20	15.65	30.00		1.50		17.15		36.00	Pass	
VHT20	MCS0	2	1	2412	15.20	14.90	18.06	30.00		1.50		19.56		36.00	Pass	
VHT20	MCS0	2	6	2437	18.60	18.00	21.32	30.00		1.50		22.82		36.00	Pass	
VHT20	MCS0	2	10	2457	14.70	15.00	17.86	30.00		1.50		19.36		36.00	Pass	
VHT20	MCS0	2	11	2462	12.00	13.20	15.65	30.00		1.50		17.15		36.00	Pass	



<CDD Mode>

2.4GHz Band MIMO																	
Mod.	Data Rate	NTX	CH.	Freq. (MHz)	RU Config.	Average Conducted Power (dBm)			Conducted Power Limit (dBm)		DG (dBi)		EIRP Power (dBm)		EIRP Power Limit (dBm)		Pass /Fail
						Ant. 6	Ant. 7	SUM	Ant. 6	Ant. 7	Ant. 6	Ant. 7	Ant. 6	Ant. 7	Ant. 6	Ant. 7	
HE20	MCS0	2	1	2412	Full	15.30	15.00	18.16	30.00		1.50		19.66		36.00	Pass	
HE20	MCS0	2	1	2412	26/0	8.70	7.20	11.02	30.00		1.50		12.52		36.00	Pass	
HE20	MCS0	2	1	2412	52/37	11.20	11.20	14.21	30.00		1.50		15.71		36.00	Pass	
HE20	MCS0	2	1	2412	106/53	14.30	13.80	17.07	30.00		1.50		18.57		36.00	Pass	
HE20	MCS0	2	6	2437	Full	18.70	18.10	21.42	30.00		1.50		22.92		36.00	Pass	
HE20	MCS0	2	6	2437	26/4	11.70	11.90	14.81	30.00		1.50		16.31		36.00	Pass	
HE20	MCS0	2	6	2437	52/39	13.50	15.90	17.87	30.00		1.50		19.37		36.00	Pass	
HE20	MCS0	2	6	2437	106/53	16.70	15.90	19.33	30.00		1.50		20.83		36.00	Pass	
HE20	MCS0	2	10	2457	Full	14.80	15.10	17.96	30.00		1.50		19.46		36.00	Pass	
HE20	MCS0	2	11	2462	Full	12.10	13.30	15.75	30.00		1.50		17.25		36.00	Pass	
HE20	MCS0	2	11	2462	26/8	5.50	6.90	9.27	30.00		1.50		10.77		36.00	Pass	
HE20	MCS0	2	11	2462	52/40	8.60	9.10	11.87	30.00		1.50		13.37		36.00	Pass	
HE20	MCS0	2	11	2462	106/54	11.40	11.30	14.36	30.00		1.50		15.86		36.00	Pass	

<TXBF Mode>

2.4GHz Band MIMO																	
Mod.	Data Rate	NTX	CH.	Freq. (MHz)	RU Config.	Average Conducted Power (dBm)			Conducted Power Limit (dBm)		DG (dBi)		EIRP Power (dBm)		EIRP Power Limit (dBm)		Pass /Fail
						Ant. 6	Ant. 7	SUM	Ant. 6	Ant. 7	Ant. 6	Ant. 7	Ant. 6	Ant. 7	Ant. 6	Ant. 7	
HE20	MCS0	2	1	2412	Full	16.10	16.20	19.16	30.00		4.36		23.52		36.00	Pass	
HE20	MCS0	2	6	2437	Full	18.80	18.50	21.66	30.00		4.36		26.02		36.00	Pass	
HE20	MCS0	2	9	2452	Full	18.50	18.10	21.31	30.00		4.36		25.68		36.00	Pass	
HE20	MCS0	2	10	2457	Full	15.50	15.40	18.46	30.00		4.36		22.82		36.00	Pass	
HE20	MCS0	2	11	2462	Full	12.50	13.20	15.87	30.00		4.36		20.24		36.00	Pass	

3.3 Power Spectral Density Measurement

3.3.1 Limit of Power Spectral Density

The peak power spectral density shall not be greater than 8 dBm in any 3 kHz band at any time interval of continuous transmission.

3.3.2 Measuring Instruments

Please refer to the measuring equipment list in this test report.

3.3.3 Test Procedures

1. The testing follows the ANSI C63.10 Section 11.10.2 Method PKPSD.
2. The RF output of EUT is connected to the spectrum analyzer by RF cable and attenuator. The path loss is compensated to the results for each measurement.
3. Set the maximum power setting and enable the EUT to transmit continuously.
4. Make the measurement with the spectrum analyzer's resolution bandwidth (RBW) = 3 kHz. Video bandwidth VBW = 10 kHz In order to make an accurate measurement, set the span to 1.5 times DTS Channel Bandwidth. (6dB BW)
5. Detector = peak, Sweep time = auto couple, Trace mode = max hold, Allow trace to fully stabilize. Use the peak marker function to determine the maximum power level.
6. Measure and record the results in the test report.
7. For MIMO mode, calculation method follows FCC KDB 662911 D01 Multiple Transmitter Output v02r01.

If measurements performed using method (2) plus $10 \log(N)$ exceeds the emission limit, the test should choose method (1) before declaring that the device fails the emission limit.

Method (1): Measure and sum the spectra across the outputs.

The total final Power Spectral Density is from a device with 2 transmitter outputs. The spectrum measurements of the individual outputs are all performed with the same span and number of points, the spectrum value in the first spectral bin of output 1 is summed with that in the first spectral bin of output 2 to obtain the value for the first frequency bin of the summed spectrum.

Method (2): Measure and add $10 \log(N)$ dB, where N is the number of outputs. (N=2)

3.3.4 Test Setup

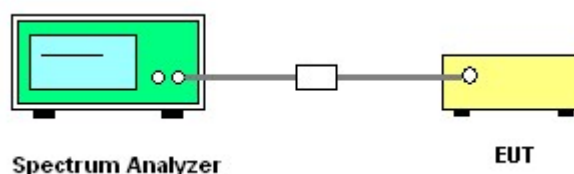



3.3.5 Test Result of Power Spectral Density

Test Engineer :	Eason Huang	Temperature :	21~25°C
		Relative Humidity :	51~54%

<CDD Mode>

2.4GHz Band MIMO												
Mod.	Data Rate	NTX	CH.	Freq. (MHz)	Peak PSD (dBm/3kHz)			DG (dBi)		Peak PSD Limit (dBm/3kHz)		Pass/Fail
					Ant. 6	Ant. 7	Worse + 3.01	Ant. 6	Ant. 7	Ant. 6	Ant. 7	
11b	1Mbps	2	1	2412	-0.50	-1.32	2.51	4.36		8.00	8.00	Pass
11b	1Mbps	2	6	2437	-0.89	-1.38	2.12	4.36		8.00	8.00	Pass
11b	1Mbps	2	11	2462	-1.56	-2.35	1.45	4.36		8.00	8.00	Pass
11g	6Mbps	2	1	2412	-7.94	-8.08	-4.93	4.36		8.00	8.00	Pass
11g	6Mbps	2	2	2417	-6.30	-6.44	-3.29	4.36		8.00	8.00	Pass
11g	6Mbps	2	6	2437	-4.39	-4.49	-1.38	4.36		8.00	8.00	Pass
11g	6Mbps	2	9	2452	-6.85	-5.33	-2.32	4.36		8.00	8.00	Pass
11g	6Mbps	2	10	2457	-10.39	-9.39	-6.38	4.36		8.00	8.00	Pass
11g	6Mbps	2	11	2462	-11.79	-11.49	-8.48	4.36		8.00	8.00	Pass

<802.11b>

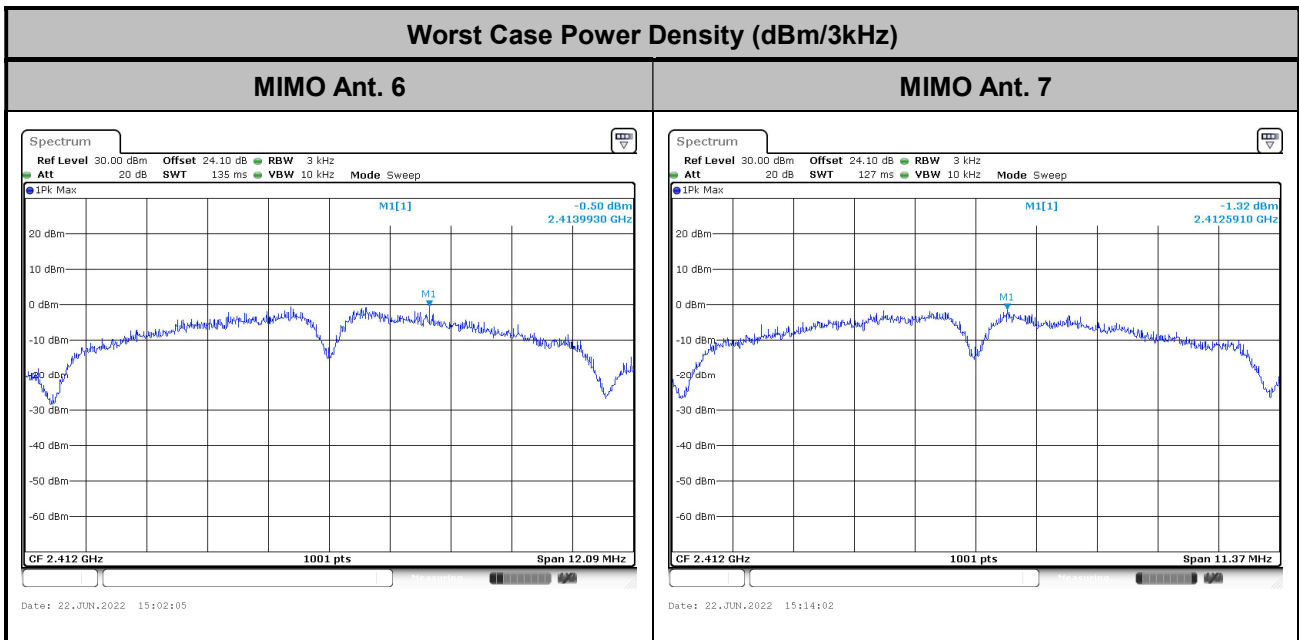



<802.11ax Mode>

2.4GHz Band MIMO													
Mod.	Data Rate	NTX	CH.	Freq. (MHz)	RU Config.	Peak PSD (dBm/3kHz)			DG (dBi)		Peak PSD Limit (dBm/3kHz)		Pass/Fail
						Ant. 6	Ant. 7	Worse + 3.01	Ant. 6	Ant. 7	Ant. 6	Ant. 7	
HE20	MCS0	2	1	2412	Full	-9.13	-8.63	-5.62	4.36		8.00		Pass
HE20	MCS0	2	1	2412	26/0	-9.17	-8.85	-5.84	4.36		8.00		Pass
HE20	MCS0	2	1	2412	52/37	-9.15	-8.66	-5.65	4.36		8.00		Pass
HE20	MCS0	2	1	2412	106/53	-9.21	-8.83	-5.82	4.36		8.00		Pass
HE20	MCS0	2	6	2437	Full	-6.03	-6.58	-3.02	4.36		8.00		Pass
HE20	MCS0	2	6	2437	26/4	-6.40	-6.67	-3.39	4.36		8.00		Pass
HE20	MCS0	2	6	2437	52/39	-6.12	-6.96	-3.11	4.36		8.00		Pass
HE20	MCS0	2	6	2437	106/53	-6.26	-6.76	-3.25	4.36		8.00		Pass
HE20	MCS0	2	10	2457	Full	-8.46	-7.77	-4.76	4.36		8.00		Pass
HE20	MCS0	2	11	2462	Full	-11.64	-11.66	-8.63	4.36		8.00		Pass
HE20	MCS0	2	11	2462	26/8	-11.80	-11.82	-8.79	4.36		8.00		Pass
HE20	MCS0	2	11	2462	52/40	-11.80	-11.83	-8.79	4.36		8.00		Pass
HE20	MCS0	2	11	2462	106/54	-11.90	-11.76	-8.75	4.36		8.00		Pass

<802.11ax HE20>

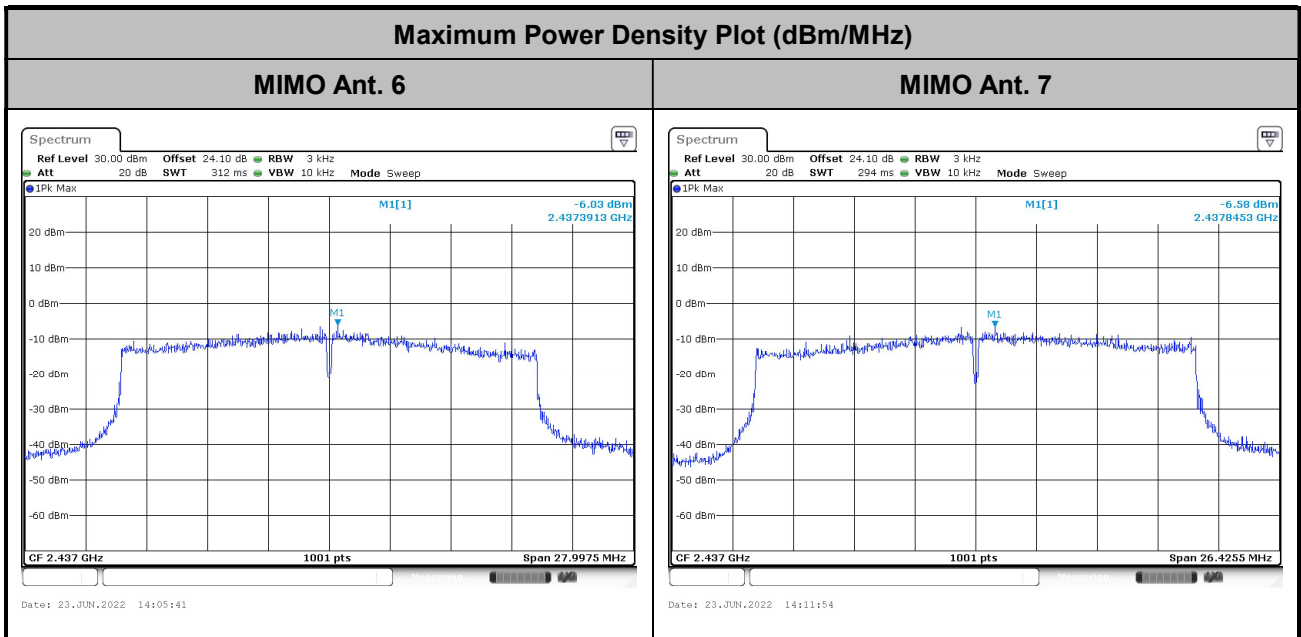



<TXBF Modes>

2.4GHz Band MIMO													
Mod.	Data Rate	NTX	CH.	Freq. (MHz)	RU Config.	Peak PSD (dBm/3kHz)			DG (dBi)		Peak PSD Limit (dBm/3kHz)		Pass/Fail
						Ant. 6	Ant. 7	Worse + 3.01	Ant. 6	Ant. 7	Ant. 6	Ant. 7	
HE20	MCS0	2	1	2412	Full	-11.67	-11.47	-8.46	4.36		8.00		Pass
HE20	MCS0	2	6	2437	Full	-9.10	-8.80	-5.79	4.36		8.00		Pass
HE20	MCS0	2	9	2452	Full	-7.28	-9.29	-4.27	4.36		8.00		Pass
HE20	MCS0	2	10	2457	Full	-11.89	-11.79	-8.78	4.36		8.00		Pass
HE20	MCS0	2	11	2462	Full	-13.50	-13.39	-10.38	4.36		8.00		Pass

Worst Case Power Density (dBm/3kHz)

MIMO Ant. 6

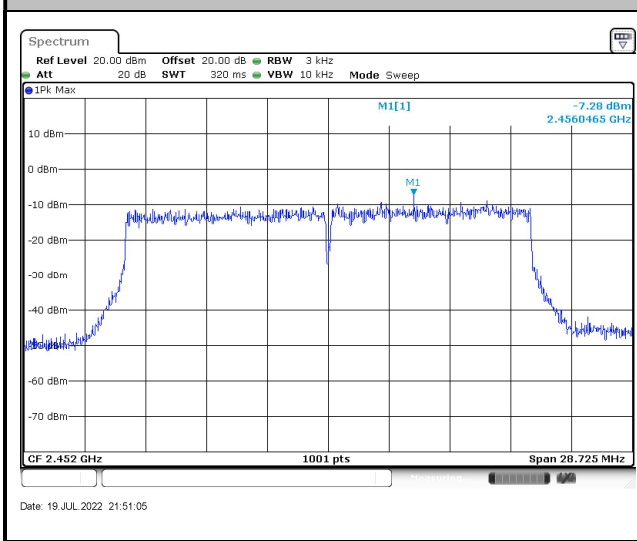

MIMO Ant. 7

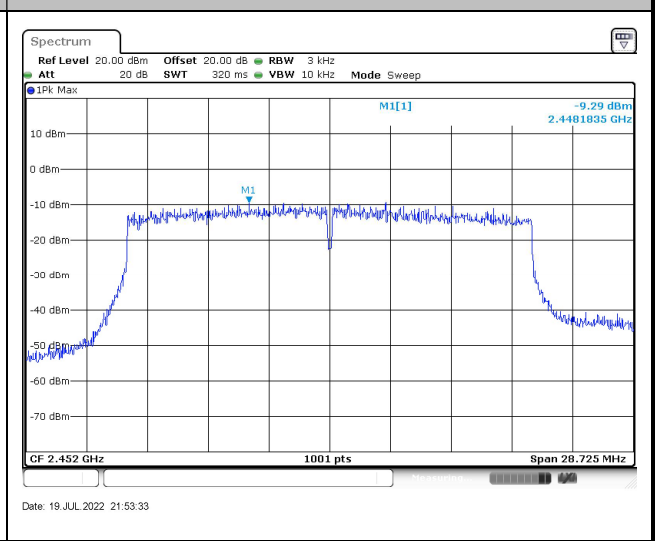

3.4 Conducted Band Edges and Spurious Emission Measurement

3.4.1 Limit of Conducted Band Edges and Spurious Emission Measurement

In any 100 kHz bandwidth outside of the authorized frequency band, the emissions which fall in the non-restricted bands shall be attenuated at least 20 dB / 30dB relative to the maximum PSD level in 100 kHz by RF conducted measurement.

3.4.2 Measuring Instruments

Please refer to the measuring equipment list in this test report.

3.4.3 Test Procedures

1. The testing follows the ANSI C63.10 Section 11.11.3 Emission level measurement.
2. The RF output of EUT is connected to the spectrum analyzer by RF cable and attenuator. The path loss is compensated to the results for each measurement.
3. Set the maximum power setting and enable the EUT to transmit continuously.
4. Set RBW = 100 kHz, VBW=300 kHz, Peak Detector. Unwanted Emissions measured in any 100 kHz bandwidth outside of the authorized frequency band shall be attenuated by at least 20 dB relative to the maximum in-band peak PSD level in 100 kHz when maximum peak conducted output power procedure is used. If the transmitter complies with the conducted power limits based on the use of RMS averaging over a time interval, the attenuation required under this paragraph shall be 30 dB instead of 20 dB per 15.247(d).
5. Measure and record the results in the test report.
6. The RF fundamental frequency should be excluded against the limit line in the operating frequency band.

3.4.4 Test Setup

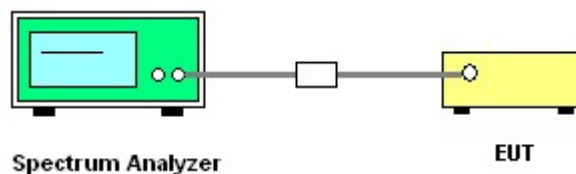



3.4.5 Test Result of Conducted Band Edges and Spurious Emission

<CDD Modes>

Number of TX = 2, Ant. 6 (Measured)

Test Mode :	802.11b	Test Channel :	01
-------------	---------	----------------	----

100kHz PSD reference Level	Channel Plot
-----------------------------------	---------------------

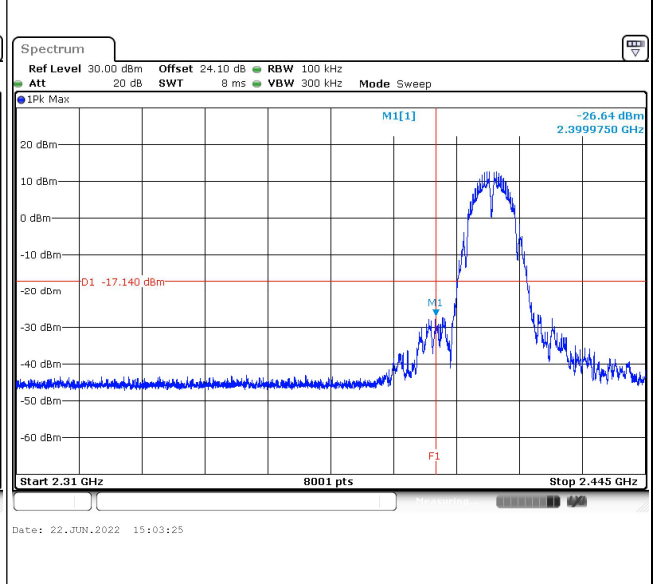
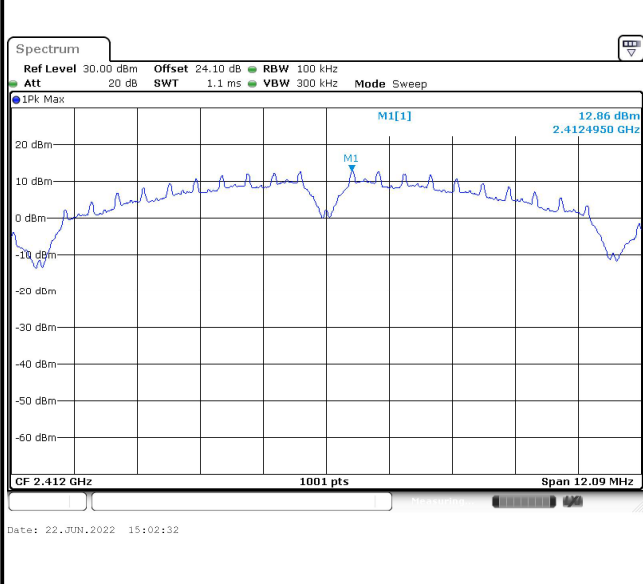

Spurious Emission 30MHz~3GHz	Spurious Emission 2GHz~25GHz
-------------------------------------	-------------------------------------

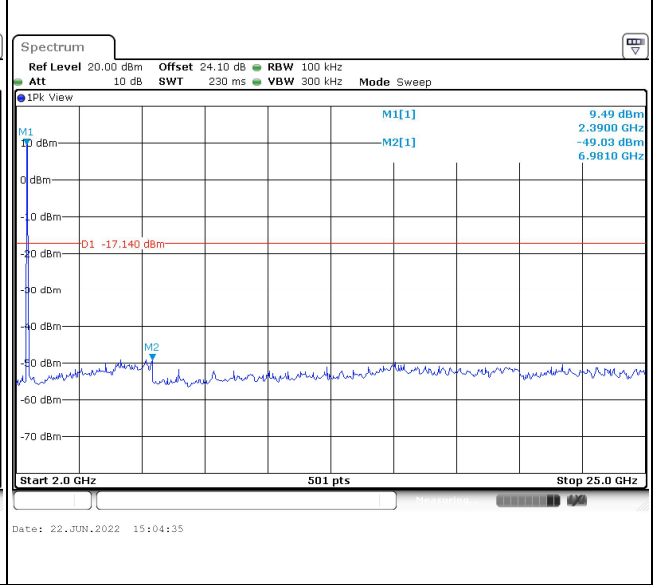
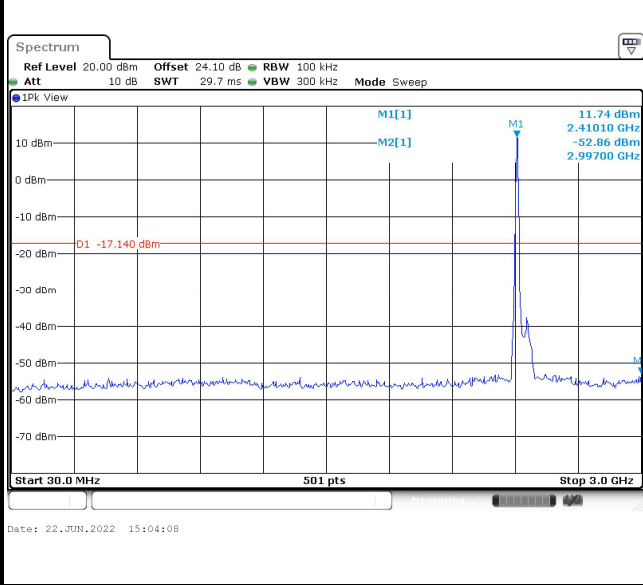



Test Mode :	802.11b	Test Channel :	06
-------------	---------	----------------	----

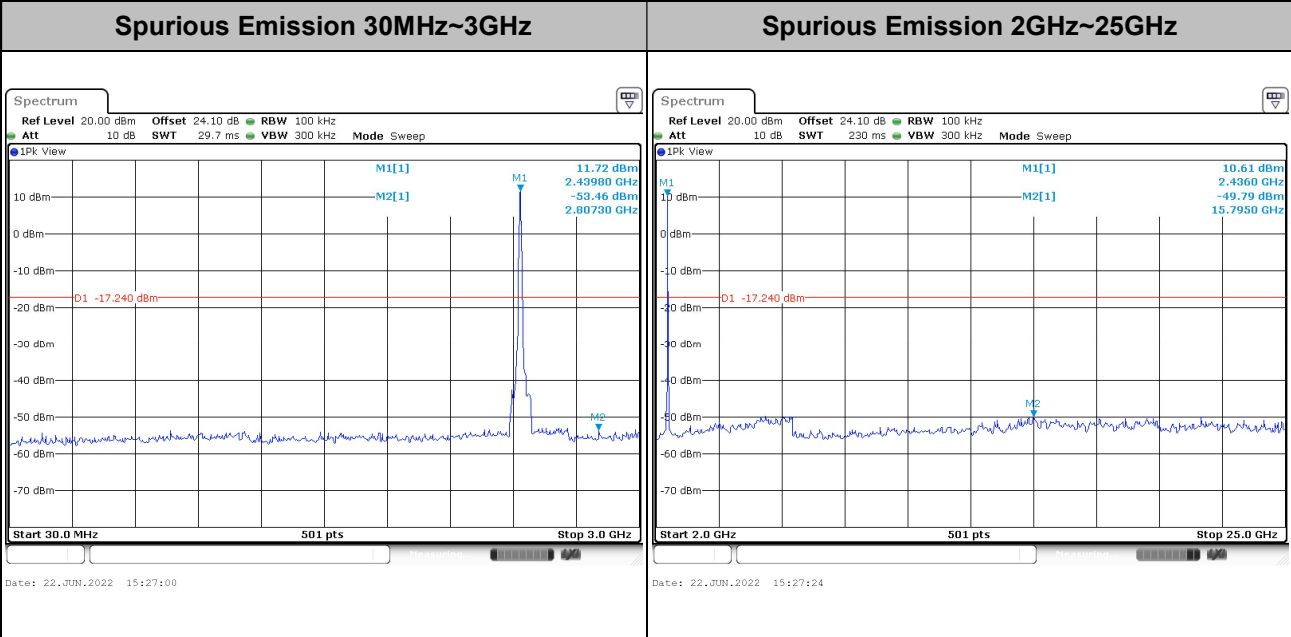
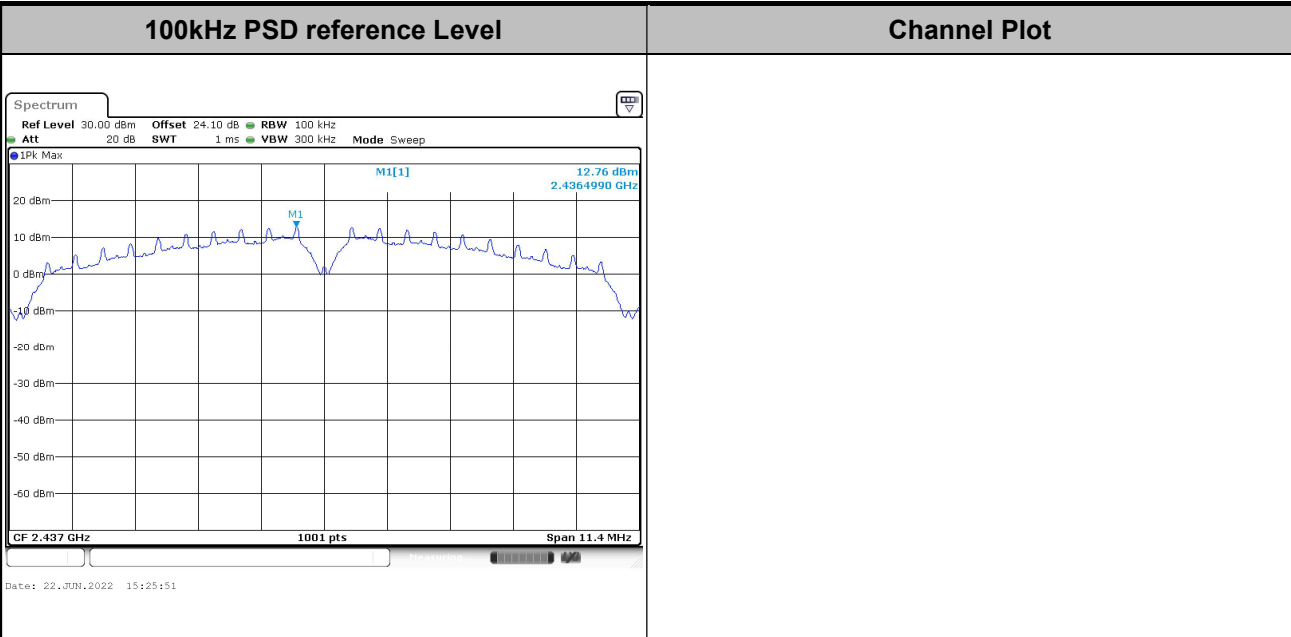



Test Mode : 802.11b Test Channel : 11

100kHz PSD reference Level

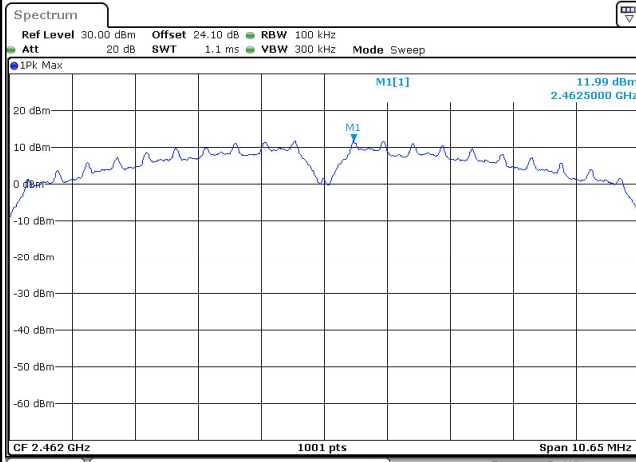

Date: 22 JUN 2022 15:37:08

Channel Plot

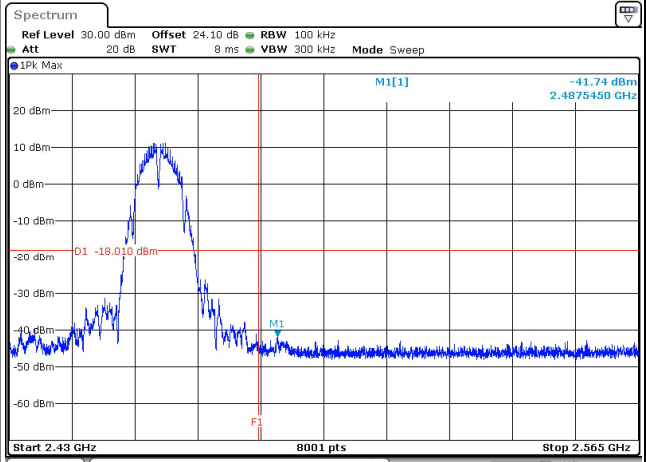

Date: 22 JUN 2022 15:37:20

Spurious Emission 30MHz~3GHz

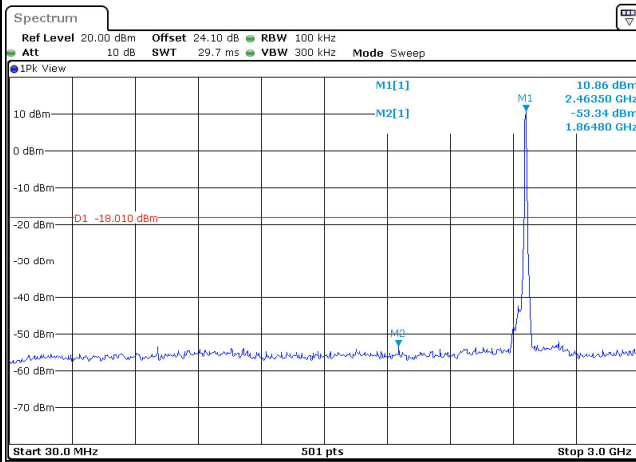

Date: 22 JUN 2022 15:39:08

Spurious Emission 2GHz~25GHz

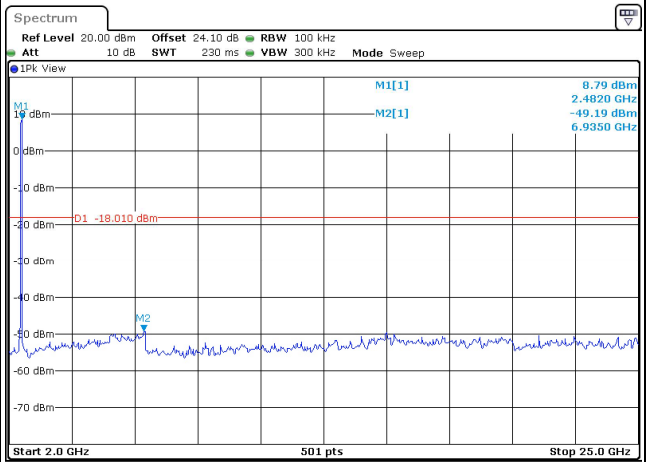

Date: 22 JUN 2022 15:39:20