



FCC CO-LOCATION RADIO TEST REPORT

FCC ID : UZ7ET45CB
Equipment : Tablet
Brand Name : Zebra
Model Name : ET45CB
Applicant : Zebra Technologies Corporation
1 Zebra Plaza, Holtsville, NY 11742
Manufacturer : Zebra Technologies Corporation
1 Zebra Plaza, Holtsville, NY 11742
Standard : FCC Part 15 Subpart E §15.407

The product was received on Jun. 01, 2022 and testing was performed from Jun. 17, 2022 to Jun. 30, 2022. We, Sporton International Inc. Wensan Laboratory, would like to declare that the tested sample has been evaluated in accordance with the test procedures and has been in compliance with the applicable technical standards.

The test results in this report apply exclusively to the tested model / sample. Without written approval of Sporton International Inc. Wensan Laboratory, the test report shall not be reproduced except in full.

Approved by: Louis Wu

Sporton International Inc. Wensan Laboratory

No. 58, Aly. 75, Ln. 564, Wenhua 3rd, Rd., Guishan Dist., Taoyuan City 333010, Taiwan (R.O.C.)



Table of Contents

History of this test report.....	3
Summary of Test Result.....	4
1 General Description	5
1.1 Product Feature of Equipment Under Test.....	5
1.2 Product Specification of Equipment Under Test.....	6
1.3 Modification of EUT	6
1.4 Testing Location	6
1.5 Applicable Standards.....	7
2 Test Configuration of Equipment Under Test	8
2.1 Carrier Frequency and Channel	8
2.2 Test Mode.....	8
2.3 Connection Diagram of Test System.....	9
2.4 Support Unit used in test configuration and system	9
2.5 EUT Operation Test Setup	9
3 Test Result	10
3.1 Unwanted Emissions Measurement.....	10
3.2 Antenna Requirements	15
4 List of Measuring Equipment.....	16
5 Uncertainty of Evaluation	17
Appendix A. Radiated Spurious Emission	
Appendix B. Radiated Spurious Emission Plots	
Appendix C. Duty Cycle Plots	
Appendix D. Setup Photographs	



History of this test report

Report No.	Version	Description	Issued Date
FR1N2539G	01	Initial issue of report	Aug. 09, 2022
FR1N2539G	02	Revise Product Feature of Equipment Under Test	Aug. 16, 2022



Summary of Test Result

Report Clause	Ref Std. Clause	Test Items	Result (PASS/FAIL)	Remark
3.1	15.407(b)	Unwanted Emissions	Pass	1.22 dB under the limit at 5149.240 MHz
3.2	15.203 15.407(a)	Antenna Requirement	Pass	-

Declaration of Conformity:

1. The test results (PASS/FAIL) with all measurement uncertainty excluded are presented in accordance with the regulation limits or requirements declared by manufacturers. It's means measurement values may risk exceeding the limit of regulation standards, if measurement uncertainty is include in test results.
2. The measurement uncertainty please refer to this report "Uncertainty of Evaluation".

Comments and Explanations:

The product specifications of the EUT presented in the report are declared by the manufacturer who shall take full responsibility for the authenticity.

Reviewed by: Keven Cheng

Report Producer: Cindy Liu



1 General Description

1.1 Product Feature of Equipment Under Test

Product Feature	
Equipment	Tablet
Brand Name	Zebra
Model Name	ET45CB
FCC ID	UZ7ET45CB
EUT supports Radios application	GSM/EGPRS/WCDMA/HSPA/LTE/5G NR/NFC/GNSS WLAN 11a/b/g/n HT20/HT40 WLAN 11ac VHT20/VHT40/VHT80 WLAN 11ax HE20/HE40/HE80 Bluetooth BR/EDR/LE Note: 2.4G doesn't support BW 40/80.
HW Version	EV2-2
SW Version	ET45-userdebug 11 11-10-12.00-RG-U00-PRD-GSE MXJ release-keys
MFD	30APR22
EUT Stage	Identical Prototype

Remark: The above EUT's information was declared by manufacturer.

Specification of Accessories				
Battery	Brand Name	Zebra	Model Name	BT-000456

Supported Unit Used in Test Configuration and System				
AC Adapter	Brand Name	Zebra	Part Number	PWR-WUA5V12W0US
Earphone 1	Brand Name	Zebra	Part Number	HDST-35MM-PTVP-01
Earphone 2	Brand Name	Zebra	Part Number	HDST-USBC-PTT1-01
USB Cable (Type C to Type A)	Brand Name	Zebra	Part Number	CBL-TC5X-USBC2A-01
Type C-Audio Cable (Type C to 3.5mm)	Brand Name	Zebra	Part Number	ADP-USBC-35MM1-01

1.2 Product Specification of Equipment Under Test

Product Specification is subject to this standard			
Tx/Rx Frequency Range	2402 MHz ~ 2480 MHz 5180 MHz ~ 5240 MHz		
Antenna Type / Gain	Bluetooth-LE: IFA Antenna type with gain 1.20 dBi WLAN <5180 MHz ~ 5240 MHz> Ant. 6 : IFA Antenna with gain 1.80 dBi Ant. 7 : IFA Antenna with gain 1.50 dBi		
Type of Modulation	Bluetooth LE : GFSK 802.11ax : OFDMA (BPSK/QPSK/16QAM/64QAM/256QAM/1024QAM)		
Antenna Function for Transmitter		Ant. 6	Ant. 7
	Bluetooth-LE	√	-
	802.11 ax MIMO	√	√

Remark:

1. MIMO Ant. 6+7 is a calculated result from sum of the power MIMO Ant. 6 and MIMO Ant. 7.
2. The above EUT's information was declared by manufacturer. Please refer to Comments and Explanations in report summary.

1.3 Modification of EUT

No modifications are made to the EUT during all test items.

1.4 Testing Location

Test Site	Sporton International Inc. Wensan Laboratory
Test Site Location	No.58, Aly. 75, Ln. 564, Wenhua 3rd, Rd., Guishan Dist., Taoyuan City 333010, Taiwan (R.O.C.) TEL: +886-3-327-0868 FAX: +886-3-327-0855
Test Site No.	Sporton Site No. 03CH13-HY

Note: The test site complies with ANSI C63.4 2014 requirement.

FCC designation No.: TW3786



1.5 Applicable Standards

According to the specifications of the manufacturer, the EUT must comply with the requirements of the following standards:

- ♦ FCC Part 15 Subpart E
- ♦ FCC Part 15 Subpart C §15.247
- ♦ FCC KDB Publication No. 558074 D01 DTS Meas. Guidance v05r02
- ♦ FCC KDB 789033 D02 General UNII Test Procedures New Rules v02r01.
- ♦ FCC KDB 414788 D01 Radiated Test Site v01r01.
- ♦ FCC KDB 662911 D01 Multiple Transmitter Output v02r01.
- ♦ ANSI C63.10-2013

Remark:

1. All the test items were validated and recorded in accordance with the standards without any modification during the testing.
2. The TAF code is not including all the FCC KDB listed without accreditation.



2 Test Configuration of Equipment Under Test

The EUT has been associated with peripherals and configuration operated in a manner tended to maximize its emission characteristics in a typical application. Frequency range investigated: radiation emission (9 kHz to the 10th harmonic of the highest fundamental frequency or to 40 GHz, whichever is lower). For radiated measurement, the measured emission level of the EUT was maximized by rotating the EUT on a turntable, adjusting the orientation of the EUT and EUT antenna in three orthogonal axis (X: flat, Y: portrait, Z: landscape), and adjusting the measurement antenna orientation, following C63.10 exploratory test procedures and find X plane as worst plane.

2.1 Carrier Frequency and Channel

<Ant. 6>

2402-2480 MHz	
Bluetooth - LE for 2Mbps	
Channel	Freq. (MHz)
39	2480

MIMO <Ant. 6+7>

5180-5240MHz	
802.11ax HE80	
Channel	Freq. (MHz)
42	5210

2.2 Test Mode

Final test modes are considering the modulation and worse data rates as below table.

<Co-Location>

Test Mode	Modulation	Data Rate
Mode 1	Bluetooth-LE for Ant. 6 + WLAN 5GHz 802.11ax HE80 for MIMO <Ant. 6+7> + LTE Band 7	2Mbps + MCS0 + QPSK

2.3 Connection Diagram of Test System

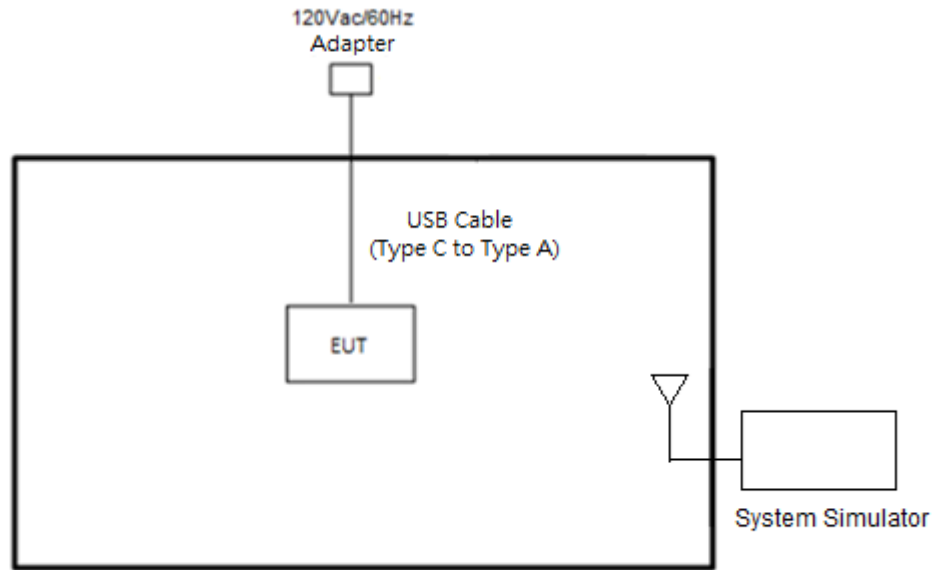

2.4 Support Unit used in test configuration and system

Item	Equipment	Brand Name	Model Name	FCC ID	Data Cable	Power Cord
1.	System Simulator	Anritsu	MT8820C	N/A	N/A	Unshielded, 1.8 m

2.5 EUT Operation Test Setup

The RF test items, utility “cmd.exe (10.0.17763.1577)” was installed in Notebook which was programmed in order to make the EUT get into the engineering modes to provide channel selection, power level, data rate and the application type and for continuous transmitting signals.



3 Test Result

3.1 Unwanted Emissions Measurement

This section is to measure unwanted emissions through radiated measurement for band edge spurious emissions and out of band emissions measurement.

3.1.1 Limit of Unwanted Emissions

- (1) For transmitters operating in the 5150-5250 MHz band: all emissions outside of the 5150-5350 MHz band shall not exceed an EIRP of -27dBm/MHz.
- (2) Unwanted spurious emissions fallen in restricted bands shall comply with the general field strength limits as below table:

Frequency (MHz)	Field Strength (microvolts/meter)	Measurement Distance (meters)
0.009 – 0.490	2400/F(kHz)	300
0.490 – 1.705	24000/F(kHz)	30
1.705 – 30.0	30	30
30 – 88	100	3
88 – 216	150	3
216 - 960	200	3
Above 960	500	3

Note: The following formula is used to convert the EIRP to field strength.

$$E = \frac{1000000\sqrt{30P}}{3} \mu\text{V/m, where P is the eirp (Watts)}$$

EIRP (dBm)	Field Strength at 3m (dBμV/m)
- 27	68.3

- (3) KDB789033 D02 v02r01 G)2)c)
 - (i) Sections 15.407(b)(1-3) specifies the unwanted emissions limit for the U-NII-1 and U-NII-2 bands. As specified, emissions above 1000 MHz that are outside of the restricted bands are subject to a peak emission limit of -27 dBm/MHz.
 - (ii) Section 15.407(b)(4) specifies the unwanted emissions limit for the U-NII-3 band. A band emissions mask is specified in Section 15.407(b)(4)(i). The emission limits are based on the use of a peak detector.



3.1.2 Measuring Instruments

Please refer to the measuring equipment list in this test report.

3.1.3 Test Procedures

1. The testing follows FCC KDB 789033 D02 General UNII Test Procedures New Rules v02r01. Section G) Unwanted emissions measurement.
 - (1) Procedure for Unwanted Emissions Measurements Below 1000MHz
 - RBW = 120 kHz
 - VBW = 300 kHz
 - Detector = Peak
 - Trace mode = max hold
 - (2) Procedure for Peak Unwanted Emissions Measurements Above 1000 MHz
 - RBW = 1 MHz
 - VBW \geq 3 MHz
 - Detector = Peak
 - Sweep time = auto
 - Trace mode = max hold
 - (3) Procedures for Average Unwanted Emissions Measurements Above 1000MHz
 - RBW = 1 MHz
 - VBW = 10 Hz, when duty cycle is no less than 98 percent.
 - VBW \geq 1/T, when duty cycle is less than 98 percent where T is the minimum transmission duration over which the transmitter is on and is transmitting at its maximum power control level for the tested mode of operation.
2. The EUT is placed on a turntable with 0.8 meter for frequency below 1 GHz and 1.5 meter for frequency above 1 GHz respectively above ground.
3. The EUT is set 3 meters away from the receiving antenna which is mounted on the top of a variable height antenna tower.
4. The antenna is a broadband antenna and its height is adjusted between one meter and four meters above ground to find the maximum value of the field strength for both horizontal polarization and vertical polarization of the antenna.
5. For each suspected emission, the EUT is arranged to its worst case and then adjust the antenna tower (from 1 m to 4 m) and turntable (from 0 degree to 360 degrees) to find the maximum reading.

6. Radiated testing below 1 GHz is performed by adjusting the antenna tower from 1 m to 4 m and by rotating the turn table from 0 degree to 360 degrees to find the peak maximum hold reading. When there is no suspected emission found and the emission level is with at least 6 dB margin against QP limit line, the position is marked as “-”.
7. Radiated testing above 1 GHz is performed by adjusting the antenna tower from 1 m to 4 m and by rotating the turn table from 0 degree to 360 degrees to find the peak maximum hold reading for scanning all frequencies. When there is no suspected emission found and the harmonic emission level is with at least 6 dB margin against average limit line, the position is marked as “-”.

3.1.4 Test Setup

For radiated emissions below 30MHz

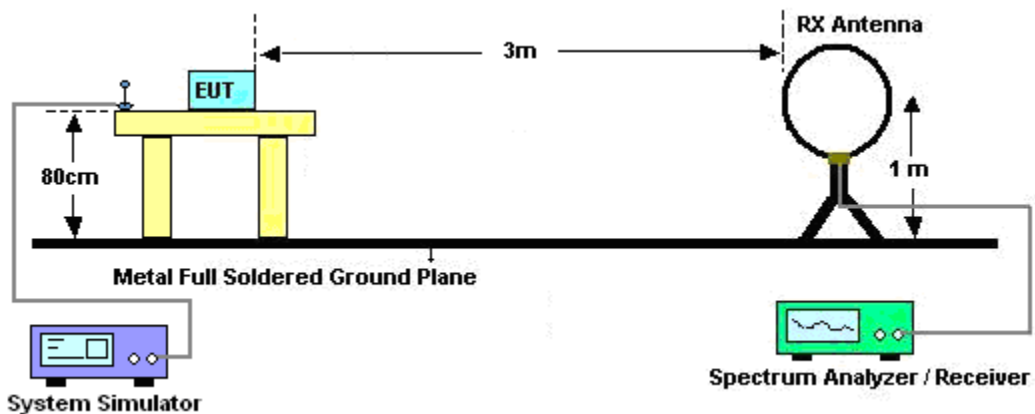

For radiated emissions from 30MHz to 1GHz

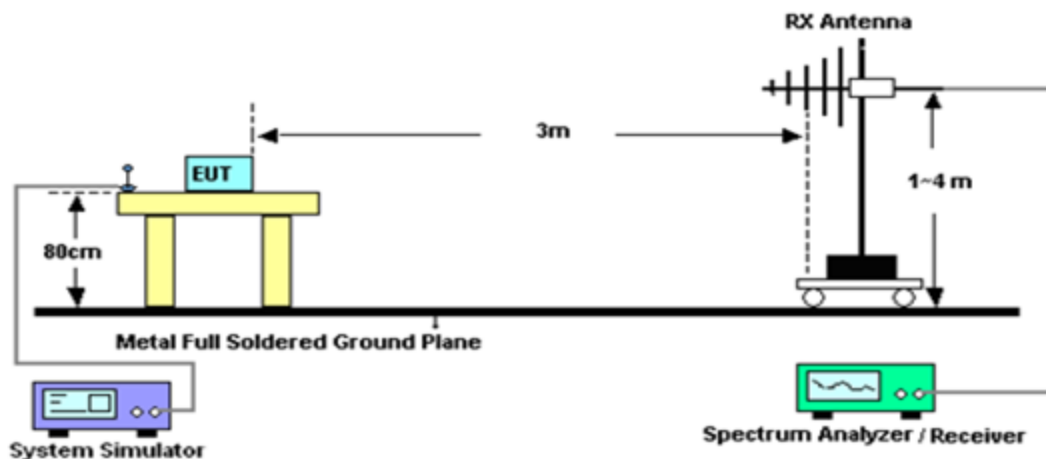

For radiated test from 1GHz to 18GHz

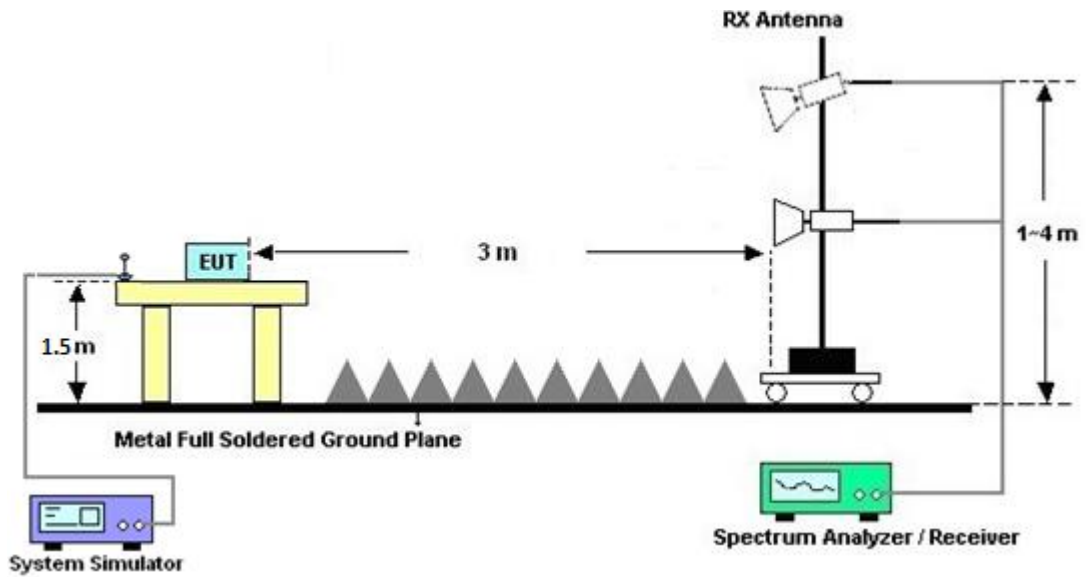

For radiated test above 18GHz

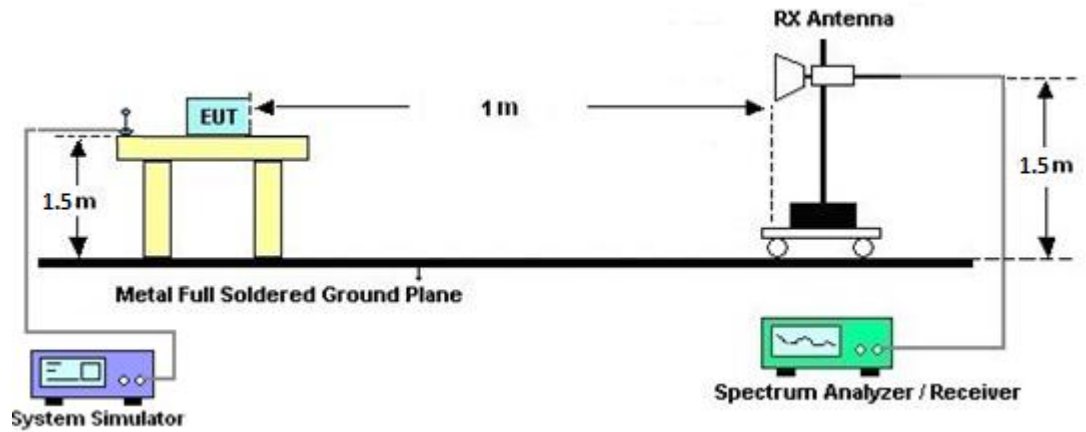



3.1.5 Test Results of Radiated Spurious Emissions (9 kHz ~ 30 MHz)

The low frequency, which started from 9 kHz to 30MHz, was pre-scanned and the result which was 20dB lower than the limit line was not reported.

There is adequate comparison measurement of both open-field test site and alternative test site - semi-Anechoic chamber according to 414788 D01 Radiated Test Site v01r01, and the result came out very similar.

3.1.6 Test Result of Radiated Spurious at Band Edges

Please refer to Appendix A and B.

3.1.7 Duty Cycle

Please refer to Appendix C.

3.1.8 Test Result of Radiated Spurious Emissions (30MHz ~ 10th Harmonic)

Please refer to Appendix A and B.



3.2 Antenna Requirements

3.2.1 Standard Applicable

If directional gain of transmitting antennas is greater than 6dBi, the power and the peak power spectral density shall be reduced by the same level in dB comparing to gain minus 6dBi. The use of a permanently attached antenna or of an antenna that uses a unique coupling to the intentional radiator shall be considered sufficient to comply with the rule.

3.2.2 Antenna Anti-Replacement Construction

An embedded-in antenna design is used.



4 List of Measuring Equipment

Instrument	Brand Name	Model No.	Serial No.	Characteristics	Calibration Date	Test Date	Due Date	Remark
Loop Antenna	Rohde & Schwarz	HFH2-Z2	100488	9kHz~30MHz	Sep. 07, 2021	Jun. 17, 2022~ Jun. 30, 2022	Sep. 06, 2022	Radiation (03CH13-HY)
Bilog Antenna	TESEQ	CBL 6111D & 00800N1D01N -06	40103 & 07	30MHz~1GHz	Apr. 24, 2022	Jun. 17, 2022~ Jun. 30, 2022	Apr. 23, 2023	Radiation (03CH13-HY)
Horn Antenna	SCHWARZBE CK	BBHA 9120 D	9120D-1241	1GHz~18GHz	Jul. 13, 2021	Jun. 17, 2022~ Jun. 30, 2022	Jul. 12, 2022	Radiation (03CH13-HY)
SHF-EHF Horn Antenna	SCHWARZBE CK	BBHA 9170	00994	18GHz~40GHz	Nov. 04, 2021	Jun. 17, 2022~ Jun. 30, 2022	Nov. 03, 2022	Radiation (03CH13-HY)
Amplifier	Sonoma-Instru ment	310 N	187282	9kHz~1GHz	Dec. 15, 2021	Jun. 17, 2022~ Jun. 30, 2022	Dec. 14, 2022	Radiation (03CH13-HY)
Preamplifier	MITEQ	AMF-7D-0010 1800-30-10P	1590074	1GHz~18GHz	May 17, 2022	Jun. 17, 2022~ Jun. 30, 2022	May 16, 2023	Radiation (03CH13-HY)
Preamplifier	Keysight	83017A	MY53270147	1GHz~26.5GHz	Oct. 26, 2021	Jun. 17, 2022~ Jun. 30, 2022	Oct. 25, 2022	Radiation (03CH13-HY)
Preamplifier	EMEC	EM18G40G	060715	18GHz~40GHz	Dec. 24, 2021	Jun. 17, 2022~ Jun. 30, 2022	Dec. 23, 2022	Radiation (03CH13-HY)
Spectrum Analyzer	Keysight	N9010A	MY55370526	10Hz~44GHz	Mar. 18, 2022	Jun. 17, 2022~ Jun. 30, 2022	Mar. 17, 2023	Radiation (03CH13-HY)
Hygrometer	TECPEL	DTM-303B	TP200889	N/A	Sep. 30, 2021	Jun. 17, 2022~ Jun. 30, 2022	Sep. 29, 2022	Radiation (03CH13-HY)
Antenna Mast	EMEC	AM-BS-4500-B	N/A	1m~4m	N/A	Jun. 17, 2022~ Jun. 30, 2022	N/A	Radiation (03CH13-HY)
Turn Table	EMEC	TT2000	N/A	0~360 Degree	N/A	Jun. 17, 2022~ Jun. 30, 2022	N/A	Radiation (03CH13-HY)
Software	Audix	E3 6.2009-8-24	RK-000992	N/A	N/A	Jun. 17, 2022~ Jun. 30, 2022	N/A	Radiation (03CH13-HY)
RF Cable	HUBER + SUHNER	SUCOFLEX 126E	0030/126E	30MHz~18GHz	Feb. 09, 2022	Jun. 17, 2022~ Jun. 30, 2022	Feb. 08, 2023	Radiation (03CH13-HY)
RF Cable	HUBER + SUHNER	SUCOFLEX 104	804793/4	30MHz~18GHz	Feb. 09, 2022	Jun. 17, 2022~ Jun. 30, 2022	Feb. 08, 2023	Radiation (03CH13-HY)
RF Cable	HUBER + SUHNER	SUCOFLEX 104	MY24961/4	30MHz~18GHz	Feb. 09, 2022	Jun. 17, 2022~ Jun. 30, 2022	Feb. 08, 2023	Radiation (03CH13-HY)
RF Cable	HUBER + SUHNER	SUCOFLEX 102	804011/2, 804012/2	18GHz~40GHz	Jan. 04, 2022	Jun. 17, 2022~ Jun. 30, 2022	Jan. 03, 2023	Radiation (03CH13-HY)
RF Cable	HUBER + SUHNER	SUCOFLEX 104	MY9837/4PE	9kHz~30MHz	Mar. 10, 2022	Jun. 17, 2022~ Jun. 30, 2022	Mar. 09, 2023	Radiation (03CH13-HY)
Filter	Wainwright	WLK4-1000-15 30-8000-40SS	SN12	1.53GHz Low Pass Filter	Sep. 14, 2021	Jun. 17, 2022~ Jun. 30, 2022	Sep. 13, 2022	Radiation (03CH13-HY)
Filter	Wainwright	WHKX8-5872. 5-6750-18000- 40ST	SN5	6.75GHz High Pass Filter	Mar. 10, 2022	Jun. 17, 2022~ Jun. 30, 2022	Mar. 09, 2023	Radiation (03CH13-HY)
Filter	Wainwright	WHKX12-2700 -3000-18000-6 0SS	SN2	3GHz High Pass Filter	Jul. 12, 2021	Jun. 17, 2022~ Jun. 30, 2022	Jul. 11, 2022	Radiation (03CH13-HY)



5 Uncertainty of Evaluation

Uncertainty of Radiated Emission Measurement (30 MHz ~ 1000 MHz)

Measuring Uncertainty for a Level of Confidence of 95% ($U = 2Uc(y)$)	6.0 dB
---	--------

Uncertainty of Radiated Emission Measurement (1000 MHz ~ 18000 MHz)

Measuring Uncertainty for a Level of Confidence of 95% ($U = 2Uc(y)$)	5.2 dB
---	--------

Uncertainty of Radiated Emission Measurement (18000 MHz ~ 40000 MHz)

Measuring Uncertainty for a Level of Confidence of 95% ($U = 2Uc(y)$)	5.9 dB
---	--------



Appendix A. Radiated Spurious Emission

Test Engineer :	Mancy Chou, Jacky Hong and Rain Lee	Temperature :	20~25°C
		Relative Humidity :	50~60%

BLE (2Mbps)_Tx_CH39 + Ant. 6+7_802.11ax HE80_Tx_CH42 + LTE B7 CH21100 Link

(Band Edge @ 3m)

BLE	Note	Frequency	Level	Over Limit	Limit Line	Read Level	Antenna Factor	Path Loss	Preamp Factor	Ant Pos	Table Pos	Peak Avg.	Pol.
		(MHz)	(dBμV/m)	(dB)	(dBμV/m)	(dBμV)	(dB/m)	(dB)	(dB)	(cm)	(deg)	(P/A)	(H/V)
BLE CH 39 2480MHz	*	2480	100.12	-	-	85.36	27.66	14.14	27.04	100	171	P	H
	*	2480	98.72	-	-	83.96	27.66	14.14	27.04	100	171	A	H
		2497.56	55.56	-18.44	74	40.73	27.7	14.16	27.03	100	171	P	H
		2487.64	47.55	-6.45	54	32.75	27.68	14.15	27.03	100	171	A	H
													H
													H
	*	2480	98.03	-	-	83.27	27.66	14.14	27.04	294	211	P	V
	*	2480	96.57	-	-	81.81	27.66	14.14	27.04	294	211	A	V
		2484.68	55.47	-18.53	74	40.68	27.67	14.15	27.03	294	211	P	V
		2488.44	47.8	-6.2	54	33	27.68	14.15	27.03	294	211	A	V
													V
													V
Remark	1. No other spurious found. 2. All results are PASS against Peak and Average limit line.												



WIFI	Note	Frequency	Level	Over	Limit	Read	Antenna	Path	Preamp	Ant	Table	Peak	Pol.
Ant.				Limit	Line	Level	Factor	Loss	Factor	Pos	Pos	Avg.	
6+7		(MHz)	(dBμV/m)	(dB)	(dBμV/m)	(dBμV)	(dB/m)	(dB)	(dB)	(cm)	(deg)	(P/A)	(H/V)
802.11ax HE80 CH42 5210MHz		5141.18	61.22	-12.78	74	49.34	32.18	6.21	26.51	100	18	P	H
		5148.46	51.48	-2.52	54	39.58	32.2	6.21	26.51	100	18	A	H
	*	5210	106.21	-	-	94.5	31.96	6.27	26.52	100	18	P	H
	*	5210	96.33	-	-	84.62	31.96	6.27	26.52	100	18	A	H
		5376.28	55.77	-18.23	74	44.23	31.76	6.32	26.54	100	18	P	H
		5386.36	47.47	-6.53	54	35.86	31.82	6.33	26.54	100	18	A	H
		5042.38	59.66	-14.34	74	48.01	32.05	6.1	26.5	381	221	P	V
		5149.24	52.78	-1.22	54	40.88	32.2	6.21	26.51	381	221	A	V
	*	5210	105.09	-	-	93.38	31.96	6.27	26.52	381	221	P	V
	*	5210	95.21	-	-	83.5	31.96	6.27	26.52	381	221	A	V
		5389.16	55.88	-18.12	74	44.26	31.83	6.33	26.54	381	221	P	V
		5353.32	46.79	-7.21	54	35.39	31.62	6.32	26.54	381	221	A	V
Remark	1. No other spurious found. 2. All results are PASS against Peak and Average limit line.												



BLE (2Mbps)_Tx_CH39 + Ant. 6+7_802.11ax HE80_Tx_CH42 + LTE B7 CH21100 Link

(Harmonic @ 3m)

BLE+WIFI	Note	Frequency	Level	Over	Limit	Read	Antenna	Path	Preamp	Ant	Table	Peak	Pol.	
Ant.				Limit	Line	Level	Factor	Loss	Factor	Pos	Pos	Avg.		
Simultaneously		(MHz)	(dBμV/m)	(dB)	(dBμV/m)	(dBμV)	(dB/m)	(dB)	(dB)	(cm)	(deg)	(P/A)	(H/V)	
BLE CH 39 2480MHz + 802.11ax HE80 CH42 5210MHz		4960	54.4	-19.6	74	43.23	31.72	5.95	26.5	128	65	P	H	
		4960	43.28	-10.72	54	32.11	31.72	5.95	26.5	128	65	A	H	
		7440	44.89	-29.11	74	56.66	37.02	8.73	57.52	-	-	P	H	
		10420	46.06	-22.14	68.2	52.59	40.16	9.81	56.5	-	-	P	H	
		15630	44.87	-29.13	74	50.18	39.05	12.05	56.41	-	-	P	H	
														H
														H
														H
														H
														H
														H
			4960	56.16	-17.84	74	44.99	31.72	5.95	26.5	102	122	P	V
			4960	44.4	-9.6	54	33.23	31.72	5.95	26.5	102	122	A	V
			7440	43.94	-30.06	74	55.71	37.02	8.73	57.52	-	-	P	V
			10420	45.7	-22.5	68.2	52.23	40.16	9.81	56.5	-	-	P	V
			15630	45.24	-28.76	74	50.55	39.05	12.05	56.41	-	-	P	V
														V
														V
													V	
													V	
													V	
													V	
Remark	<ol style="list-style-type: none"> No other spurious found. All results are PASS against Peak and Average limit line. The emission position marked as "-" means no suspected emission found with sufficient margin against limit line or noise floor only. 													



Emission below 1GHz

BLE (2Mbps)_Tx_CH39 + Ant. 6+7_802.11ax HE80_Tx_CH42 + LTE B7 CH21100 Link (LF)

BLE+WIFI	Note	Frequency	Level	Over	Limit	Read	Antenna	Path	Preamp	Ant	Table	Peak	Pol.	
Ant.				Limit	Line	Level	Factor	Loss	Factor	Pos	Pos	Avg.		
Simultaneously		(MHz)	(dBμV/m)	(dB)	(dBμV/m)	(dBμV)	(dB/m)	(dB)	(dB)	(cm)	(deg)	(P/A)	(H/V)	
BLE CH 39 2480MHz + 802.11ax (HE80) CH 42 5210MHz		30	21.7	-18.3	40	28.79	24.53	0.72	32.34	-	-	P	H	
		66.86	19.45	-20.55	40	38.69	12.15	0.91	32.3	-	-	P	H	
		136.7	18.95	-24.55	43.5	32.68	17.4	1.16	32.29	-	-	P	H	
		260.86	19.33	-26.67	46	30	20.05	1.5	32.22	-	-	P	H	
		765.26	31.58	-14.42	46	33.27	28.07	2.35	32.11	-	-	P	H	
		896.21	33.05	-12.95	46	33.09	28.97	2.54	31.55	-	-	P	H	
														H
														H
														H
														H
														H
														H
														H
														H
														H
														H
														H
														H
														H
			30	23.11	-16.89	40	30.2	24.53	0.72	32.34	-	-	P	V
		113.42	21.65	-21.85	43.5	35.75	17.1	1.11	32.31	-	-	P	V	
		258.92	18.86	-27.14	46	29.72	19.87	1.5	32.23	-	-	P	V	
		578.05	27.5	-18.5	46	31.74	25.88	2.14	32.26	-	-	P	V	
		737.13	30.13	-15.87	46	32.25	27.71	2.33	32.16	-	-	P	V	
		839.95	30.71	-15.29	46	31.17	28.81	2.56	31.83	-	-	P	V	
													V	
													V	
													V	
													V	
													V	
													V	
													V	
													V	
													V	
Remark	1. No other spurious found. 2. All results are PASS against limit line. 3. The emission position marked as "-" means no suspected emission found and emission level has at least 6dB margin against limit or emission is noise floor only.													



Note symbol

*	Fundamental Frequency which can be ignored. However, the level of any unwanted emissions shall not exceed the level of the fundamental frequency.
!	Test result is over limit line.
P/A	Peak or Average
H/V	Horizontal or Vertical



A calculation example for radiated spurious emission is shown as below:

WIFI	Note	Frequency	Level	Over	Limit	Read	Antenna	Path	Preamp	Ant	Table	Peak	Pol.
Ant.				Limit	Line	Level	Factor	Loss	Factor	Pos	Pos	Avg.	
Simultaneously		(MHz)	(dBμV/m)	(dB)	(dBμV/m)	(dBμV)	(dB/m)	(dB)	(dB)	(cm)	(deg)	(P/A)	(H/V)
802.11b CH 01		2390	55.45	-18.55	74	54.51	32.22	4.58	35.86	103	308	P	H
2412MHz		2390	43.54	-10.46	54	42.6	32.22	4.58	35.86	103	308	A	H

1. Path Loss(dB) = Cable loss(dB) + Filter loss(dB) + Attenuator loss(dB)
2. Level(dBμV/m) =
Antenna Factor(dB/m) + Path Loss(dB) + Read Level(dBμV) - Preamp Factor(dB)
3. Over Limit(dB) = Level(dBμV/m) – Limit Line(dBμV/m)

For Peak Limit @ 2390MHz:

1. Level(dBμV/m)
= Antenna Factor(dB/m) + Path Loss(dB) + Read Level(dBμV) - Preamp Factor(dB)
= 32.22(dB/m) + 4.58(dB) + 54.51(dBμV) – 35.86 (dB)
= 55.45 (dBμV/m)
2. Over Limit(dB)
= Level(dBμV/m) – Limit Line(dBμV/m)
= 55.45(dBμV/m) – 74(dBμV/m)
= -18.55(dB)

For Average Limit @ 2390MHz:

1. Level(dBμV/m)
= Antenna Factor(dB/m) + Path Loss(dB) + Read Level(dBμV) - Preamp Factor(dB)
= 32.22(dB/m) + 4.58(dB) + 42.6(dBμV) – 35.86 (dB)
= 43.54 (dBμV/m)
2. Over Limit(dB)
= Level(dBμV/m) – Limit Line(dBμV/m)
= 43.54(dBμV/m) – 54(dBμV/m)
= -10.46(dB)

Both peak and average measured complies with the limit line, so test result is “PASS”.



Appendix B. Radiated Spurious Emission Plots

Test Engineer :	Mancy Chou, Jacky Hong and Rain Lee	Temperature :	20~25°C
		Relative Humidity :	50~60%

Note symbol

-L	Low channel location
-R	High channel location



BLE (2Mbps)_Tx_CH39 + Ant. 6+7_802.11ax HE80_Tx_CH42 + LTE B7 CH21100 Link

(Band Edge @ 3m)

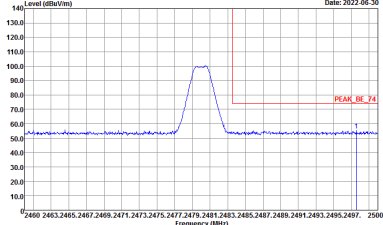
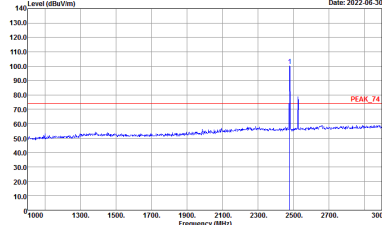
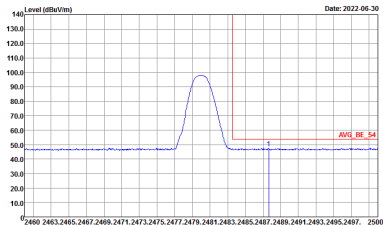
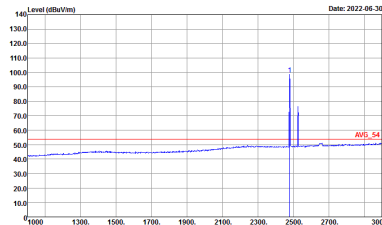
BLE	2.4GHz 2400~2483.5MHz Band Edge @ 3m	
BLE_CH39 2480MHz		
	Horizontal	Fundamental
Peak	 <p>Site : 03CH13-HY Condition : PEAK_BE_74 3m HORN_91200_1241 HORIZONTAL : RBW:1000.000KHz VBW:3000.000KHz SWT:Auto</p>	 <p>Site : 03CH13-HY Condition : PEAK_74 3m HORN_91200_1241 HORIZONTAL : RBW:1000.000KHz VBW:3000.000KHz SWT:Auto</p>
Avg.	 <p>Site : 03CH13-HY Condition : AVG_BE_54 3m HORN_91200_1241 HORIZONTAL : RBW:1000.000KHz VBW:10.000KHz SWT:Auto</p>	 <p>Site : 03CH13-HY Condition : AVG_54 3m HORN_91200_1241 HORIZONTAL : RBW:1000.000KHz VBW:10.000KHz SWT:Auto</p>

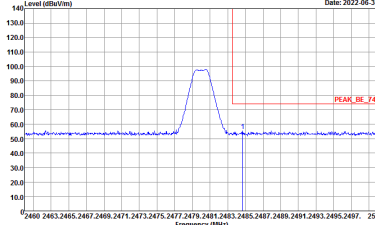
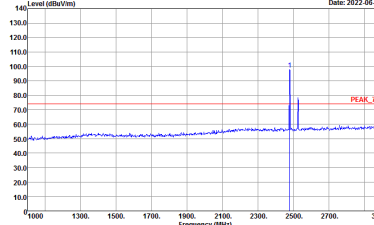
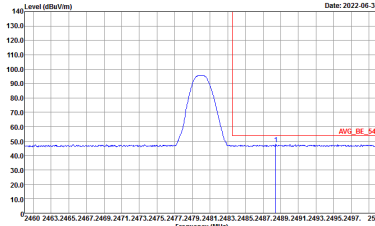
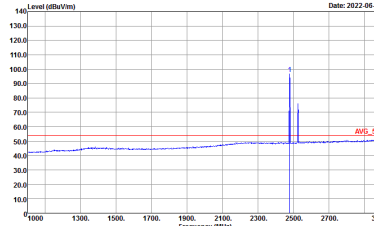

BLE	2.4GHz 2400~2483.5MHz Band Edge @ 3m	
BLE_CH39 2480MHz		
	Vertical	Fundamental
Peak	 <p>Level (dBm/Vm) vs Frequency (MHz) plot showing a peak at 2480 MHz. The peak level is approximately 100 dBm/Vm. A red line indicates the peak level, labeled 'PEAK_BE_74'.</p> <p>Site : 03CH13-HY Condition : PEAK_BE_74 3m HORN_9120D_1241 VERTICAL : RBW:1000.000KHz VBW:3000.000KHz SWT:Auto</p>	 <p>Level (dBm/Vm) vs Frequency (MHz) plot showing a peak at 2480 MHz. The peak level is approximately 100 dBm/Vm. A red line indicates the peak level, labeled 'PEAK_74'.</p> <p>Site : 03CH13-HY Condition : PEAK_74 3m HORN_9120D_1241 VERTICAL : RBW:1000.000KHz VBW:3000.000KHz SWT:Auto</p>
Avg.	 <p>Level (dBm/Vm) vs Frequency (MHz) plot showing an average level at 2480 MHz. The average level is approximately 90 dBm/Vm. A red line indicates the average level, labeled 'AVG_BE_54'.</p> <p>Site : 03CH13-HY Condition : AVG_BE_54 3m HORN_9120D_1241 VERTICAL : RBW:1000.000KHz VBW:3000.000KHz SWT:Auto</p>	 <p>Level (dBm/Vm) vs Frequency (MHz) plot showing an average level at 2480 MHz. The average level is approximately 90 dBm/Vm. A red line indicates the average level, labeled 'AVG_54'.</p> <p>Site : 03CH13-HY Condition : AVG_54 3m HORN_9120D_1241 VERTICAL : RBW:1000.000KHz VBW:3000.000KHz SWT:Auto</p>

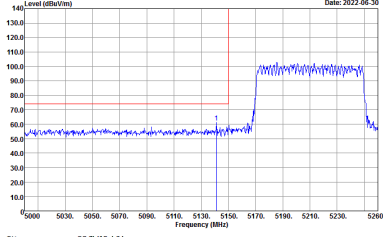
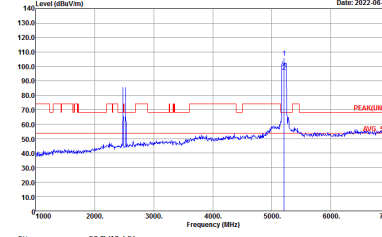
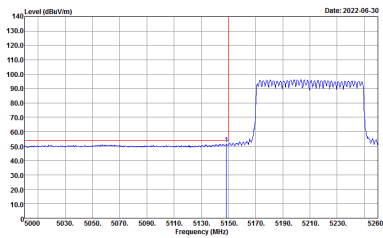

WIFI	Band 1 5150~5250MHz Band Edge @ 3m	
ANT	802.11ax HE80 Full CH42 5210MHz - R	
6+7	Horizontal	Fundamental
Peak	 <p>Site : 03CH13-HY Condition : PEAK_BE_74 3m HORN_9120D_1241 HORIZONTAL : RBW:1000.000KHz VBW:3000.000KHz SWT:Auto</p>	 <p>Site : 03CH13-HY Condition : PEAK(LINE) 3m HORN_9120D_1241 HORIZONTAL : RBW:1000.000KHz VBW:3000.000KHz SWT:Auto</p>
Avg.	 <p>Site : 03CH13-HY Condition : AVG_BE_54 3m HORN_9120D_1241 HORIZONTAL : RBW:1000.000KHz VBW:3.000KHz SWT:Auto</p>	Left blank

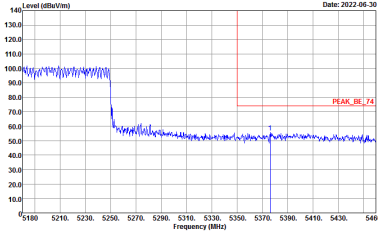
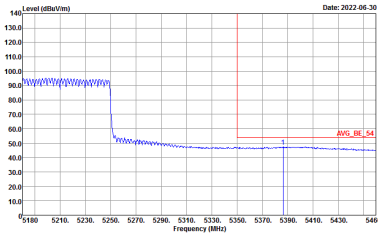

WIFI	Band 1 5150~5250MHz Band Edge @ 3m	
ANT	802.11ax HE80 Full CH42 5210MHz - R	
6+7	Horizontal	Fundamental
Peak	 <p>Site : 03CH13-HY Condition : PEAK_BE_74 3m HORN_9120D_1241 HORIZONTAL : RBW:1000.000KHz VBW:3000.000KHz SWT:Auto</p>	Left blank
Avg.	 <p>Site : 03CH13-HY Condition : AVG_BE_54 3m HORN_9120D_1241 HORIZONTAL : RBW:1000.000KHz VBW:3.000KHz SWT:Auto</p>	Left blank

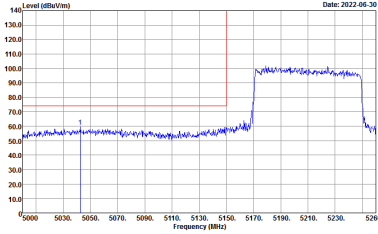
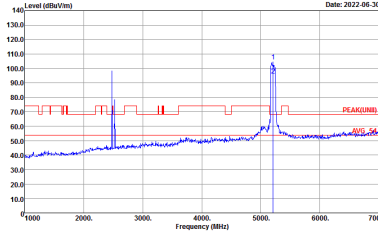
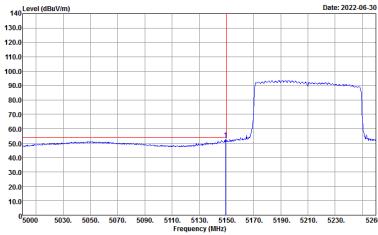

WIFI	Band 1 5150~5250MHz Band Edge @ 3m	
ANT	802.11ax HE80 Full CH42 5210MHz - L	
6+7	Vertical	Fundamental
Peak	 <p>Site : 03CH13-HY Condition : PEAK_BE_74 3m HORN_9120D_1241 VERTICAL : RBW:1000.000KHz VBW:3000.000KHz SWT:Auto</p>	 <p>Site : 03CH13-HY Condition : PEAK(FUN1) 3m HORN_9120D_1241 VERTICAL : RBW:1000.000KHz VBW:3000.000KHz SWT:Auto</p>
Avg.	 <p>Site : 03CH13-HY Condition : AVG_BE_54 3m HORN_9120D_1241 VERTICAL : RBW:1000.000KHz VBW:3.000KHz SWT:Auto</p>	Left blank

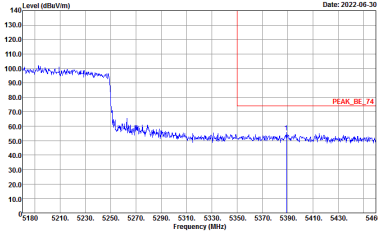
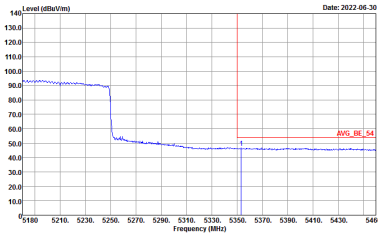

WIFI	Band 1 5150~5250MHz Band Edge @ 3m	
ANT	802.11ax HE80 Full CH42 5210MHz - R	
6+7	Vertical	Fundamental
Peak	 <p>Site : 03CH13-HY Condition : PEAK_BE_74 3m HORN_9120D_1241 VERTICAL : RBW:1000.000KHz VBW:3000.000KHz SWT:Auto</p>	Left blank
Avg.	 <p>Site : 03CH13-HY Condition : AVG_BE_54 3m HORN_9120D_1241 VERTICAL : RBW:1000.000KHz VBW:3.000KHz SWT:Auto</p>	Left blank



**BLE (2Mbps)_Tx_CH39 + Ant. 6+7_802.11ax HE80_Tx_CH42 + LTE B7 CH21100 Link
(Harmonic @ 3m)**

BLE+WIFI	2.4GHz 2400~2483.5MHz + Band 1 5150~5250MHz Harmonic @ 3m	
ANT	BLE_Tx_Ch39 + 802.11ax HE80 Full CH42	
Simultaneously	Horizontal	Vertical
Peak Avg.	<p>Site : 03CH13-HY Condition : PEAK(UNII) 3m HORN_9120D_1241 HORIZONTAL Detector : Peak</p>	<p>Site : 03CH13-HY Condition : PEAK(UNII) 3m HORN_9120D_1241 VERTICAL Detector : Peak</p>



Emission below 1GHz

BLE (2Mbps)_Tx_CH39 + Ant. 6+7_802.11ax HE80_Tx_CH42 + LTE B7 CH21100 Link (LF)

BLE+WIFI	2.4GHz 2400~2483.5MHz + Band 1 5150~5250MHz	
ANT	BLE_Tx_Ch39 + 802.11ax HE80 Full CH42	
Simultaneously	Horizontal	Vertical
QP / Peak	<p>Site : 03CH13-HY Condition : QP 3m BIL06_40103 HORIZONTAL Detector : Peak</p>	<p>Site : 03CH13-HY Condition : QP 3m BIL06_40103 VERTICAL Detector : Peak</p>



Appendix C. Duty Cycle Plots

Antenna	Band	Duty Cycle(%)	T(us)	1/T(kHz)	VBW Setting
6	Bluetooth –LE for 2Mbps	30.65	190	5.26	10kHz
6+7	5GHz 802.11ax HE80 Full RU	90.74	980	1.02	3kHz

<Ant. 6>

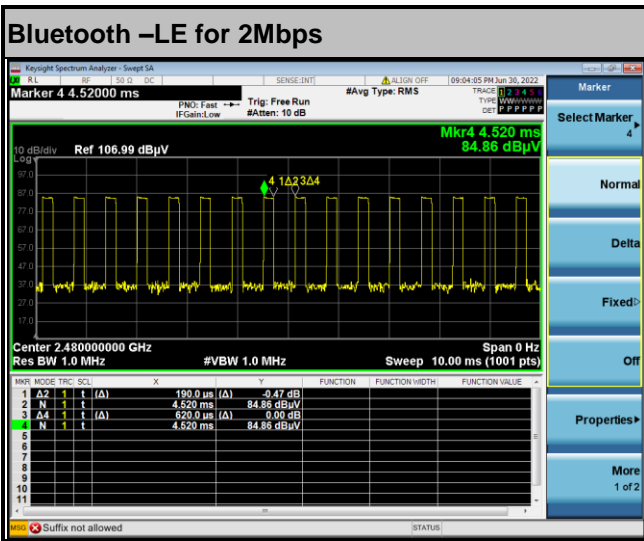

MIMO <Ant. 6+7>

