



FCC RADIO TEST REPORT

FCC ID : UZ7ET45CB
Equipment : Tablet
Brand Name : Zebra
Model Name : ET45CB
Applicant : Zebra Technologies Corporation
1 Zebra Plaza, Holtsville, NY 11742
Manufacturer : Zebra Technologies Corporation
1 Zebra Plaza, Holtsville, NY 11742
Standard : FCC Part 15 Subpart E §15.407

The product was received on Jun. 01, 2022 and testing was performed from Jun. 10, 2022 to Jul. 16, 2022. We, Sporton International Inc. Wensan Laboratory, would like to declare that the tested sample has been evaluated in accordance with the test procedures and has been in compliance with the applicable technical standards.

The test results in this report apply exclusively to the tested model / sample. Without written approval from Sporton International Inc. Wensan Laboratory, the test report shall not be reproduced except in full.

Louis Wu

Approved by: Louis Wu

Sporton International Inc. Wensan Laboratory

No. 58, Aly. 75, Ln. 564, Wenhua 3rd, Rd., Guishan Dist., Taoyuan City 333010, Taiwan (R.O.C.)



Table of Contents

History of this test report..... 3

Summary of Test Result..... 4

1 General Description 5

 1.1 Product Feature of Equipment Under Test..... 5

 1.2 Product Specification of Equipment Under Test..... 6

 1.3 Modification of EUT 7

 1.4 Testing Location 7

 1.5 Applicable Standards..... 8

2 Test Configuration of Equipment Under Test 9

 2.1 Carrier Frequency and Channel 9

 2.2 Test Mode..... 10

 2.3 Connection Diagram of Test System..... 16

 2.4 Support Unit used in test configuration and system 17

 2.5 EUT Operation Test Setup 18

 2.6 Measurement Results Explanation Example..... 18

3 Test Result 19

 3.1 6dB and 26dB and 99% Occupied Bandwidth Measurement 19

 3.2 Maximum Conducted Output Power Measurement 29

 3.3 Power Spectral Density Measurement 33

 3.4 Unwanted Emissions Measurement 38

 3.5 AC Conducted Emission Measurement..... 44

 3.6 Antenna Requirements 46

4 List of Measuring Equipment..... 49

5 Uncertainty of Evaluation 51

Appendix A. AC Conducted Emission Test Result

Appendix B. Radiated Spurious Emission

Appendix C. Radiated Spurious Emission Plots

Appendix D. Duty Cycle Plots

Appendix E. Setup Photographs



History of this test report

Report No.	Version	Description	Issue Date
FR1N2539F	01	Initial issue of report	Aug. 09, 2022
FR1N2539F	02	Revise Product Feature of Equipment Under Test	Aug. 16, 2022



Summary of Test Result

Report Clause	Ref Std. Clause	Test Items	Result (PASS/FAIL)	Remark
3.1	15.403(i)	6dB & 26dB Bandwidth	Pass	-
3.1	2.1049	99% Occupied Bandwidth	Reporting only	-
3.2	15.407(a)	Maximum Conducted Output Power	Pass	-
3.3	15.407(a)	Power Spectral Density	Pass	-
3.4	15.407(b)	Unwanted Emissions	Pass	2.61 dB under the limit at 5649.600 MHz
3.5	15.207	AC Conducted Emission	Pass	19.62 dB under the limit at 0.170 MHz
3.6	15.203 15.407(a)	Antenna Requirement	Pass	-

Declaration of Conformity:

1. The test results (PASS/FAIL) with all measurement uncertainty excluded are presented in accordance with the regulation limits or requirements declared by manufacturers.
It's means measurement values may risk exceeding the limit of regulation standards, if measurement uncertainty is include in test results.
2. The measurement uncertainty please refer to report "Uncertainty of Evaluation".

Comments and Explanations:

The product specifications of the EUT presented in the report are declared by the manufacturer who shall take full responsibility for the authenticity.

Reviewed by: Keven Cheng

Report Producer: Vivian Hsu



1 General Description

1.1 Product Feature of Equipment Under Test

Product Feature	
Equipment	Tablet
Brand Name	Zebra
Model Name	ET45CB
FCC ID	UZ7ET45CB
EUT supports Radios application	GSM/EGPRS/WCDMA/HSPA/LTE/5G NR/NFC/GNSS WLAN 11a/b/g/n HT20/HT40 WLAN 11ac VHT20/VHT40/VHT80 WLAN 11ax HE20/HE40/HE80 Bluetooth BR/EDR/LE Note: 2.4G doesn't support BW 40/80.
HW Version	EV2-2
SW Version	ET45-userdebug 11 11-10-12.00-RG-U00-PRD-GSE MXJ release-keys
MFD	30APR22
EUT Stage	Identical Prototype

Remark: The above EUT's information was declared by manufacturer.

Specification of Accessories				
Battery	Brand Name	Zebra	Model Name	BT-000456

Supported Unit Used in Test Configuration and System				
AC Adapter	Brand Name	Zebra	Part Number	PWR-WUA5V12W0US
Earphone 1	Brand Name	Zebra	Part Number	HDST-35MM-PTVP-01
Earphone 2	Brand Name	Zebra	Part Number	HDST-USBC-PTT1-01
USB Cable (Type C to Type A)	Brand Name	Zebra	Part Number	CBL-TC5X-USBC2A-01
Type C-Audio Cable (Type C to 3.5mm)	Brand Name	Zebra	Part Number	ADP-USBC-35MM1-01



1.2 Product Specification of Equipment Under Test

Product Specification is subject to this standard	
Tx/Rx Frequency Range	5745 MHz ~ 5825 MHz
Maximum Output Power to Antenna <CDD Mode>	MIMO <Ant. 6+7> 802.11a: 24.41 dBm / 0.2761 W 802.11n HT20: 24.41 dBm / 0.2761 W 802.11n HT40: 23.31 dBm / 0.2143 W 802.11ac VHT20: 24.41 dBm / 0.2761 W 802.11ac VHT40: 23.31 dBm / 0.2143 W 802.11ac VHT80: 23.26 dBm / 0.2118 W 802.11ax HE20: 24.51 dBm / 0.2825 W 802.11ax HE40: 23.41 dBm / 0.2193 W 802.11ax HE80: 23.36 dBm / 0.2168 W
Maximum Output Power to Antenna <TXBF Mode>	MIMO <Ant. 6+7> 802.11n HT20: 24.21 dBm / 0.2636 W 802.11n HT40: 23.26 dBm / 0.2118 W 802.11ax HE20: 24.31 dBm / 0.2698 W 802.11ax HE40: 23.36 dBm / 0.2168 W 802.11ax HE80: 23.31 dBm / 0.2143 W
99% Occupied Bandwidth <CDD Mode>	MIMO <Ant. 6> 802.11a: 18.53 MHz 802.11ax HE20: 19.33 MHz 802.11ax HE40: 38.56 MHz 802.11ax HE80: 77.68 MHz MIMO <Ant. 7> 802.11a: 18.53 MHz 802.11ax HE20: 19.48 MHz 802.11ax HE40: 39.66 MHz 802.11ax HE80: 77.68 MHz
99% Occupied Bandwidth <TXBF Mode>	MIMO <Ant. 6> 802.11ax HE20: 19.23 MHz 802.11ax HE40: 38.16 MHz 802.11ax HE80: 77.44 MHz MIMO <Ant. 7> 802.11ax HE20: 19.28 MHz 802.11ax HE40: 38.36 MHz 802.11ax HE80: 77.44 MHz
Antenna Type / Gain	TX Beamforming Gain (Y) : 0 dBi <Ant. 6> : IFA Antenna with gain 2.0 dBi <Ant. 7> : IFA Antenna with gain -0.7 dBi



Product Specification is subject to this standard			
Type of Modulation	802.11a/n: OFDM (BPSK/QPSK/16QAM/64QAM)		
	802.11ac: OFDM (BPSK/QPSK/16QAM/64QAM/256QAM)		
Antenna Function Description	802.11ax: OFDMA		
	(BPSK/QPSK/16QAM/64QAM/256QAM/ 1024QAM)		
		Ant. 6	Ant. 7
	802.11 a/n/ac/ax MIMO	V	V
	802.11 n/ax TXBF	V	V

Remark:

1. MIMO Ant. 6+7 Directional Gain is a calculated result from MIMO Ant. 6 and MIMO Ant. 7. The formula used in calculation is documented in section 3.6.
2. MIMO Ant. 6+7 is a calculated result from sum of the power MIMO Ant. 6 and MIMO Ant. 7.
3. The EUT's information above is declared by manufacturer. Please refer to Comments and Explanations in report summary.

1.3 Modification of EUT

No modifications made to the EUT during the testing.

1.4 Testing Location

Test Site	Sporton International Inc. Wensan Laboratory
Test Site Location	No.58, Aly. 75, Ln. 564, Wenhua 3rd, Rd., Guishan Dist., Taoyuan City 333010, Taiwan (R.O.C.) TEL: +886-3-327-0868 FAX: +886-3-327-0855
Test Site No.	Sporton Site No. TH05-HY, CO07-HY, 03CH13-HY

Note: The test site complies with ANSI C63.4 2014 requirement.

FCC designation No.: TW3786



1.5 Applicable Standards

According to the specifications declared by the manufacturer, the EUT must comply with the requirements of the following standards:

- ♦ FCC Part 15 Subpart E
- ♦ FCC KDB 789033 D02 General UNII Test Procedures New Rules v02r01.
- ♦ FCC KDB 414788 D01 Radiated Test Site v01r01.
- ♦ FCC KDB 662911 D01 Multiple Transmitter Output v02r01.
- ♦ ANSI C63.10-2013

Remark:

1. All the test items were validated and recorded in accordance with the standards without any modification during the testing.
2. The TAF code is not including all the FCC KDB listed without accreditation.
3. This EUT has also been tested and complied with the requirements of FCC Part 15, Subpart B, recorded in a separate test report.



2 Test Configuration of Equipment Under Test

- a. The EUT has been associated with peripherals and configuration operated in a manner tended to maximize its emission characteristics in a typical application. Frequency range investigated: conduction emission (150 kHz to 30 MHz), radiation emission (9 kHz to the 10th harmonic of the highest fundamental frequency or to 40 GHz, whichever is lower). For radiated measurement, the measured emission level of the EUT was maximized by rotating the EUT on a turntable, adjusting the orientation of the EUT and EUT antenna in three orthogonal axis (X: flat, Y: portrait, Z: landscape), and adjusting the measurement antenna orientation, following C63.10 exploratory test procedures and find X plane as worst plane.
- b. AC power line Conducted Emission was tested under maximum output power.

2.1 Carrier Frequency and Channel

Frequency Band	Channel	Freq. (MHz)	Channel	Freq. (MHz)
5725-5850 MHz Band 4 (U-NII-3)	149	5745	157	5785
	151*	5755	159*	5795
	153	5765	161	5805
	155#	5775	165	5825

Note:

1. The above Frequency and Channel with "*" are 802.11n HT40 and 802.11ac VHT40 and 802.11ax HE40.
2. The above Frequency and Channel with "#" are 802.11ac VHT80 and 802.11ax HE80.



2.2 Test Mode

The 802.11ax mode is investigated among different tones, full resource units (RU), partial resource units. The partial RU has no higher power than full RU's, thus the full RU is chosen as main test configuration.

The CDD mode is chosen as worst case configuration for all test cases due to higher power than SISO mode.

The 802.11n/ac mode has no higher power and PSD than 802.11ax mode, thus the 802.11ax mode is chosen as main test configuration, and the 802.11n/ac mode is verified the power.

The final test modes consider the modulation and the worst data rates as shown in the table below.

CDD Mode

Modulation	Data Rate
802.11a	6 Mbps
802.11n HT20 (Covered by HE20)	MCS0
802.11n HT40 (Covered by HE40)	MCS0
802.11ac VHT20 (Covered by HE20)	MCS0
802.11ac VHT40 (Covered by HE40)	MCS0
802.11ac VHT80 (Covered by HE80)	MCS0
802.11ax HE20	MCS0
802.11ax HE40	MCS0
802.11ax HE80	MCS0

Remark: The conducted power level of each chain in MIMO mode is equal or higher than SISO mode.

TXBF Mode

Modulation	Data Rate
802.11n HT20 (Covered by HE20)	MCS0
802.11n HT40 (Covered by HE40)	MCS0
802.11ax HE20	MCS0
802.11ax HE40	MCS0
802.11ax HE80	MCS0

Remark: The conducted power level of each chain in MIMO mode is equal or higher than SISO mode.



Test Cases	
AC Conducted Emission	Mode 1 : WLAN (5GHz) Link + Bluetooth Link + USB Cable (Type C to Type A) (Charging from AC Adapter)

Ch. #		Band IV : 5725-5850 MHz			
		802.11a	802.11ax HE20	802.11ax HE40	802.11ax HE80
L	Low	149	149	151	-
M	Middle	157	157	-	155
H	High	165	165	159	-

Remark: For radiation spurious emission, the modulation and the data rate picked for testing are determined by the Max. RF conducted power.

<CDD Mode>

MIMO <Ant. 6+7>

802.11a RF Output Power (dBm)										
Power vs. Channel			Power vs Data Rate							
Channel	Frequency (MHz)	Data Rate (bps)	Channel	Data Rate (bps)						
		6M		9M	12M	18M	24M	36M	48M	54M
Duty Cycle (%)										
CH 149	5745	24.31	CH 165	24.31	24.31	24.26	24.16	24.21	24.16	24.16
CH 157	5785	24.36								
CH 165	5825	24.41								

802.11n HT20 RF Output Power (dBm)										
Power vs. Channel			Power vs Data Rate							
Channel	Frequency (MHz)	MCS Index	Channel	MCS Index						
		MCS0		MCS1	MCS2	MCS3	MCS4	MCS5	MCS6	MCS7
Duty Cycle (%)										
CH 149	5745	24.31	CH 165	24.31	24.31	24.31	24.31	24.31	24.31	24.31
CH 157	5785	24.31								
CH 165	5825	24.41								



802.11n HT40 RF Output Power (dBm)											
Power vs. Channel			Power vs Data Rate								
Channel	Frequency (MHz)	MCS Index	Channel	MCS Index							
		MCS0		MCS1	MCS2	MCS3	MCS4	MCS5	MCS6	MCS7	
Duty Cycle (%)											
CH 151	5755	23.21	CH 159	23.21	23.21	23.21	23.21	23.21	23.21	23.21	23.21
CH 159	5795	23.31									

802.11ac VHT20 RF Output Power (dBm)												
Power vs. Channel			Power vs Data Rate									
Channel	Frequency (MHz)	MCS Index	Channel	MCS Index								
		MCS0		MCS1	MCS2	MCS3	MCS4	MCS5	MCS6	MCS7	MCS8	
Duty Cycle (%)												
CH 149	5745	24.31	CH 165									
CH 157	5785	24.31		24.31	24.31	24.31	24.31	24.31	24.31	24.31	24.31	24.21
CH 165	5825	24.41										

802.11ac VHT40 RF Output Power (dBm)												
Power vs. Channel			Power vs Data Rate									
Channel	Frequency (MHz)	MCS Index	Channel	MCS Index								
		MCS0		MCS1	MCS2	MCS3	MCS4	MCS5	MCS6	MCS7	MCS8	MCS9
Duty Cycle (%)												
CH 151	5755	23.21	CH 159	23.21	23.21	23.21	23.21	23.21	23.21	23.21	23.11	23.11
CH 159	5795	23.31										

802.11ac VHT80 RF Output Power (dBm)												
Power vs. Channel			Power vs Data Rate									
Channel	Frequency (MHz)	MCS Index	Channel	MCS Index								
		MCS0		MCS1	MCS2	MCS3	MCS4	MCS5	MCS6	MCS7	MCS8	MCS9
Duty Cycle (%)												
CH 155	5775	23.26	CH 155	23.16	23.06	23.06	23.06	23.16	23.06	23.06	23.11	23.06



802.11ax HE20 RF Output Power (dBm)															
Power vs. Channel				Power vs Data Rate											
Channel	Frequency (MHz)	RU Config.	MCS Index	Channel	MCS Index										
			MCS0		MCS1	MCS2	MCS3	MCS4	MCS5	MCS6	MCS7	MCS8	MCS9	MCS10	MCS11
Duty Cycle (%)															
CH 149	5745	Full	24.41	CH 157	24.41	24.41	24.31	24.36	24.31	24.31	24.31	24.31	24.31	24.31	24.31
CH 149	5745	26/0	16.67												
CH 149	5745	52/37	19.37												
CH 149	5745	106/53	22.01												
CH 157	5785	Full	24.41												
CH 157	5785	26/4	17.06												
CH 157	5785	52/38	19.82												
CH 157	5785	106/53	22.56												
CH 157	5785	Full	24.51												
CH 157	5785	26/8	16.46												
CH 157	5785	52/40	19.37												
CH 165	5825	106/54	22.46												

802.11ax HE40 RF Output Power (dBm)															
Power vs. Channel				Power vs Data Rate											
Channel	Frequency (MHz)	RU Config.	MCS Index	Channel	MCS Index										
			MCS0		MCS1	MCS2	MCS3	MCS4	MCS5	MCS6	MCS7	MCS8	MCS9	MCS10	MCS11
Duty Cycle (%)															
CH 151	5755	Full	23.31	CH 159	23.31	23.31	23.21	23.21	23.26	23.31	23.26	23.21	23.21	23.21	23.21
CH 151	5755	242/61	21.36												
CH 159	5795	Full	23.41												
CH 159	5795	242/62	21.47												



802.11ax HE80 RF Output Power (dBm)															
Power vs. Channel				Power vs Data Rate											
Channel	Frequency (MHz)	RU Config.	MCS Index	Channel	MCS Index										
			MCS0		MCS1	MCS2	MCS3	MCS4	MCS5	MCS6	MCS7	MCS8	MCS9	MCS10	MCS11
Duty Cycle (%)															
CH 155	5775	Full	23.36												
CH 155	5775	484/65	21.61	CH 155	23.26	23.26	23.16	23.21	23.26	23.16	23.16	23.21	23.21	23.21	23.21
CH 155	5775	484/66	21.41												

<TXBF Mode>

MIMO <Ant. 6+7>

802.11n HT20 RF Output Power (dBm)										
Power vs. Channel				Power vs Data Rate						
Channel	Frequency (MHz)	MCS Index	Channel	MCS Index						
		MCS0		MCS1	MCS2	MCS3	MCS4	MCS5	MCS6	MCS7
Duty Cycle (%)										
CH 149	5745	24.21								
CH 157	5785	24.21	CH 149	24.11	24.11	24.11	24.01	24.01	24.01	24.01
CH 165	5825	24.16								

802.11n HT40 RF Output Power (dBm)										
Power vs. Channel				Power vs Data Rate						
Channel	Frequency (MHz)	MCS Index	Channel	MCS Index						
		MCS0		MCS1	MCS2	MCS3	MCS4	MCS5	MCS6	MCS7
Duty Cycle (%)										
CH 151	5755	23.26								
CH 159	5795	23.26	CH 151	23.16	23.16	23.16	23.06	23.06	23.06	23.06



802.11ax HE20 RF Output Power (dBm)															
Power vs. Channel				Power vs Data Rate											
Channel	Frequency (MHz)	RU Config.	MCS Index	Channel	MCS Index										
			MCS0		MCS1	MCS2	MCS3	MCS4	MCS5	MCS6	MCS7	MCS8	MCS9	MCS10	MCS11
Duty Cycle (%)															
CH 149	5745	Full	24.31	CH 149											
CH 157	5785	Full	24.31		24.21	24.21	24.21	24.11	24.11	24.11	24.11	24.11	24.11	24.11	24.01
CH 165	5825	Full	24.26												

802.11ax HE40 RF Output Power (dBm)															
Power vs. Channel				Power vs Data Rate											
Channel	Frequency (MHz)	RU Config.	MCS Index	Channel	MCS Index										
			MCS0		MCS1	MCS2	MCS3	MCS4	MCS5	MCS6	MCS7	MCS8	MCS9	MCS10	MCS11
Duty Cycle (%)															
CH 151	5755	Full	23.36	CH 151											
CH 159	5795	Full	23.36		23.26	23.26	23.26	23.16	23.16	23.16	23.16	23.16	23.16	23.16	23.06

802.11ax HE80 RF Output Power (dBm)															
Power vs. Channel				Power vs Data Rate											
Channel	Frequency (MHz)	RU Config.	MCS Index	Channel	MCS Index										
			MCS0		MCS1	MCS2	MCS3	MCS4	MCS5	MCS6	MCS7	MCS8	MCS9	MCS10	MCS11
Duty Cycle (%)															
CH 155	5775	Full	23.31	CH 155	23.21	23.21	23.21	23.11	23.11	23.11	23.11	23.11	23.11	23.11	23.01

2.3 Connection Diagram of Test System

<AC Conducted Emission Mode>

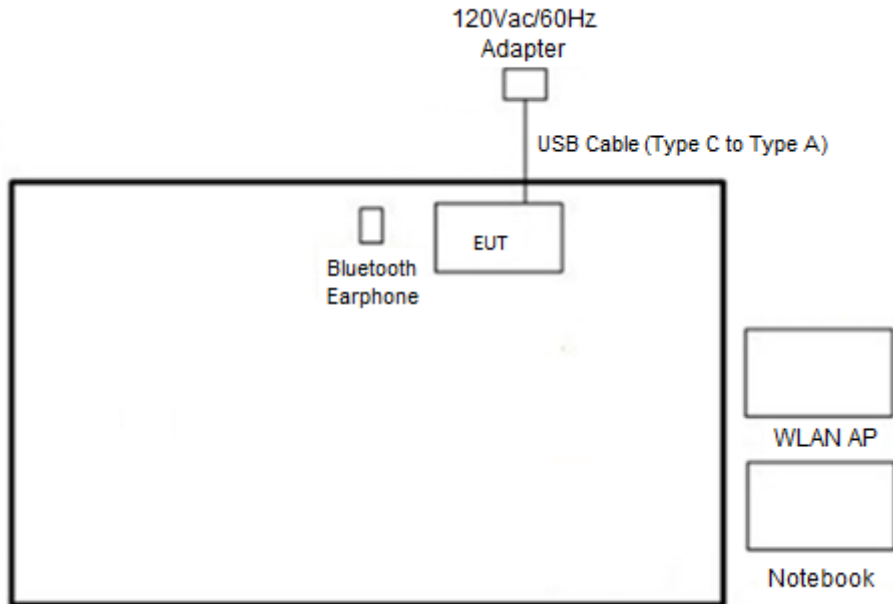

<WLAN Tx Mode>

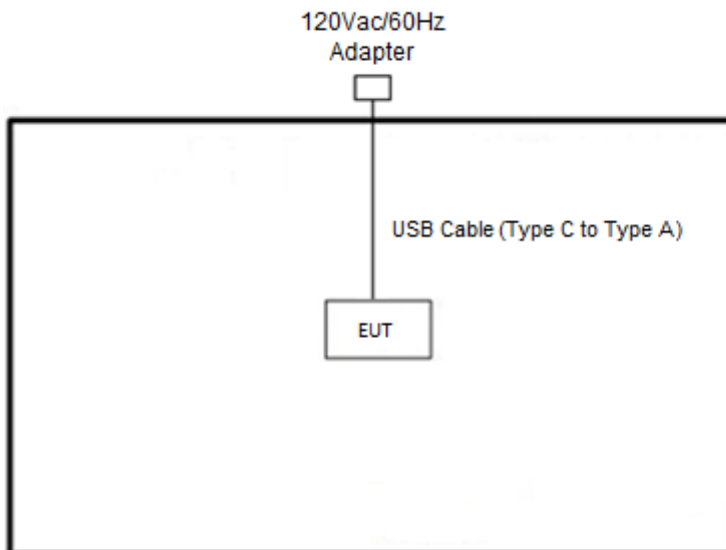

<WLAN TXBF Mode>

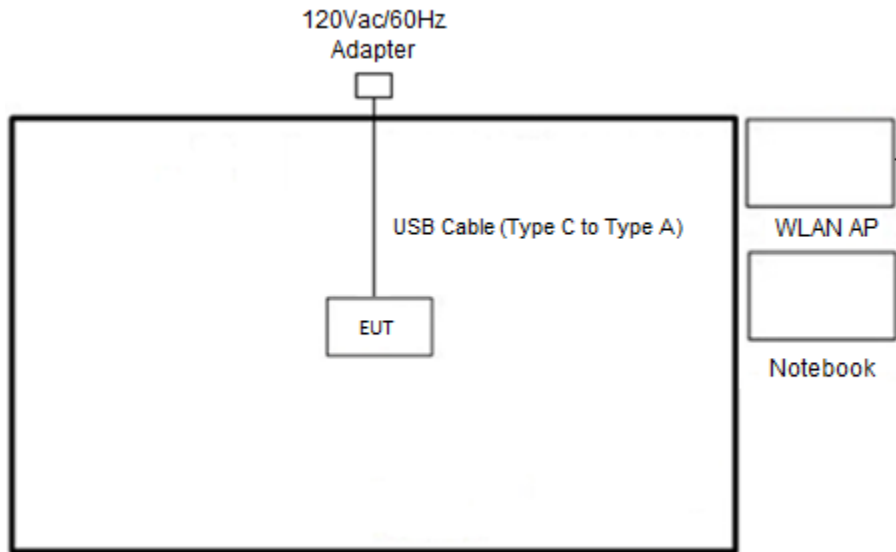

2.4 Support Unit used in test configuration and system

Item	Equipment	Brand Name	Model Name	FCC ID	Data Cable	Power Cord
1.	Bluetooth Earphone	Kinyo	BTE-3622	N/A	N/A	N/A
2.	WLAN AP	ASUS	RT-AC58	N/A	N/A	Unshielded, 1.8m
3.	WLAN AP	ASUS	RT-AX88U	LCITHP000236	N/A	Unshielded, 1.8m
4.	Notebook	Dell	P79G	FCC DoC	N/A	AC I/P : Unshielded, 1.2m DC O/P : Shielded, 1.8m
5.	Notebook	Acer	N18Q13	PD9AX201NG	N/A	AC I/P : Unshielded, 1.2m DC O/P : Shielded, 1.8m



2.5 EUT Operation Test Setup

The RF test items, utility “cmd.exe version 10.0.17763.1577” was installed in Notebook which was programmed in order to make the EUT get into the engineering modes to provide channel selection, power level, data rate and the application type and for continuous transmitting signals.

For TXBF mode, the modulation modes and data rates manipulated by the command lines in the engineering program made the EUT link to another EUT by power under the normal operation. The “Cmd version 1.0.39” software tool was used to enable the EUT to transmit signals continuously.

2.6 Measurement Results Explanation Example

For all conducted test items:

The offset level is set in the spectrum analyzer to compensate the RF cable loss and attenuator factor between EUT conducted output port and spectrum analyzer. With the offset compensation, the spectrum analyzer reading level is exactly the EUT RF output level.

Example :

The spectrum analyzer offset is derived from RF cable loss and attenuator factor.

Offset = RF cable loss + attenuator factor.

Following shows an offset computation example with cable loss 4.2 dB and 10 dB attenuator.

$$\begin{aligned} \text{Offset(dB)} &= \text{RF cable loss(dB)} + \text{attenuator factor(dB)}. \\ &= 4.2 + 10 = 14.2 \text{ (dB)} \end{aligned}$$

3 Test Result

3.1 6dB and 26dB and 99% Occupied Bandwidth Measurement

3.1.1 Description of 6dB and 26dB and 99% Occupied Bandwidth

The minimum 6 dB bandwidth shall be at least 500 kHz.

26dB and 99% Occupied bandwidth are reporting only.

3.1.2 Measuring Instruments

Please refer to the measuring equipment list in this test report.

3.1.3 Test Procedures

1. The testing follows FCC KDB 789033 D02 General UNII Test Procedures New Rules v02r01. Section C) Emission bandwidth for the band 5.725-5.85 GHz
2. Set RBW = 100 kHz.
3. Set the VBW $\geq 3 \times$ RBW.
4. Detector = Peak.
5. Trace mode = max hold
6. Measure the maximum width of the emission that is 6 dB down from the peak of the emission.
7. Measure and record the results in the test report.

3.1.4 Test Setup





3.1.5 Test Result of 6dB and 26dB and 99% Occupied Bandwidth

Test Engineer :	Eason Huang and Hank Hsu	Temperature :	21~25°C
		Relative Humidity :	51~54%

<CDD Modes>

Band IV MIMO												
Mod.	Data Rate	NTX	CH.	Freq. (MHz)	99% Bandwidth (MHz)		26dB Bandwidth (MHz)		6 dB Bandwidth (MHz)		6 dB Bandwidth Min. Limit (MHz)	Pass/Fail
					Ant 6	Ant 7	Ant 6	Ant 7	Ant 6	Ant 7		
11a	6Mbps	2	149	5745	17.73	18.48	26.25	30.10	16.39	16.44	0.5	Pass
11a	6Mbps	2	157	5785	18.33	18.53	28.60	31.45	16.39	16.39	0.5	Pass
11a	6Mbps	2	165	5825	18.53	18.53	32.00	32.90	16.39	16.39	0.5	Pass

<802.11ax Mode>

Band IV MIMO													
Mod.	Data Rate	NTX	CH.	Freq. (MHz)	RU Config.	99% Bandwidth (MHz)		26dB Bandwidth (MHz)		6 dB Bandwidth (MHz)		6 dB Bandwidth Min. Limit (MHz)	Pass/Fail
						Ant 6	Ant 7	Ant 6	Ant 7	Ant 6	Ant 7		
HE20	MCS0	2	149	5745	Full	19.18	19.48	25.40	33.40	18.84	18.34	0.5	Pass
HE20	MCS0	2	157	5785	Full	19.33	19.38	30.75	31.55	18.34	18.79	0.5	Pass
HE20	MCS0	2	165	5825	Full	19.33	19.43	31.70	31.90	18.54	18.58	0.5	Pass
HE40	MCS0	2	151	5755	Full	38.56	39.66	72.18	76.14	38.05	37.96	0.5	Pass
HE40	MCS0	2	159	5795	Full	38.56	39.06	65.70	75.96	37.87	37.78	0.5	Pass
HE80	MCS0	2	155	5775	Full	77.68	77.68	123.68	132.98	78.20	77.88	0.5	Pass



<802.11a>

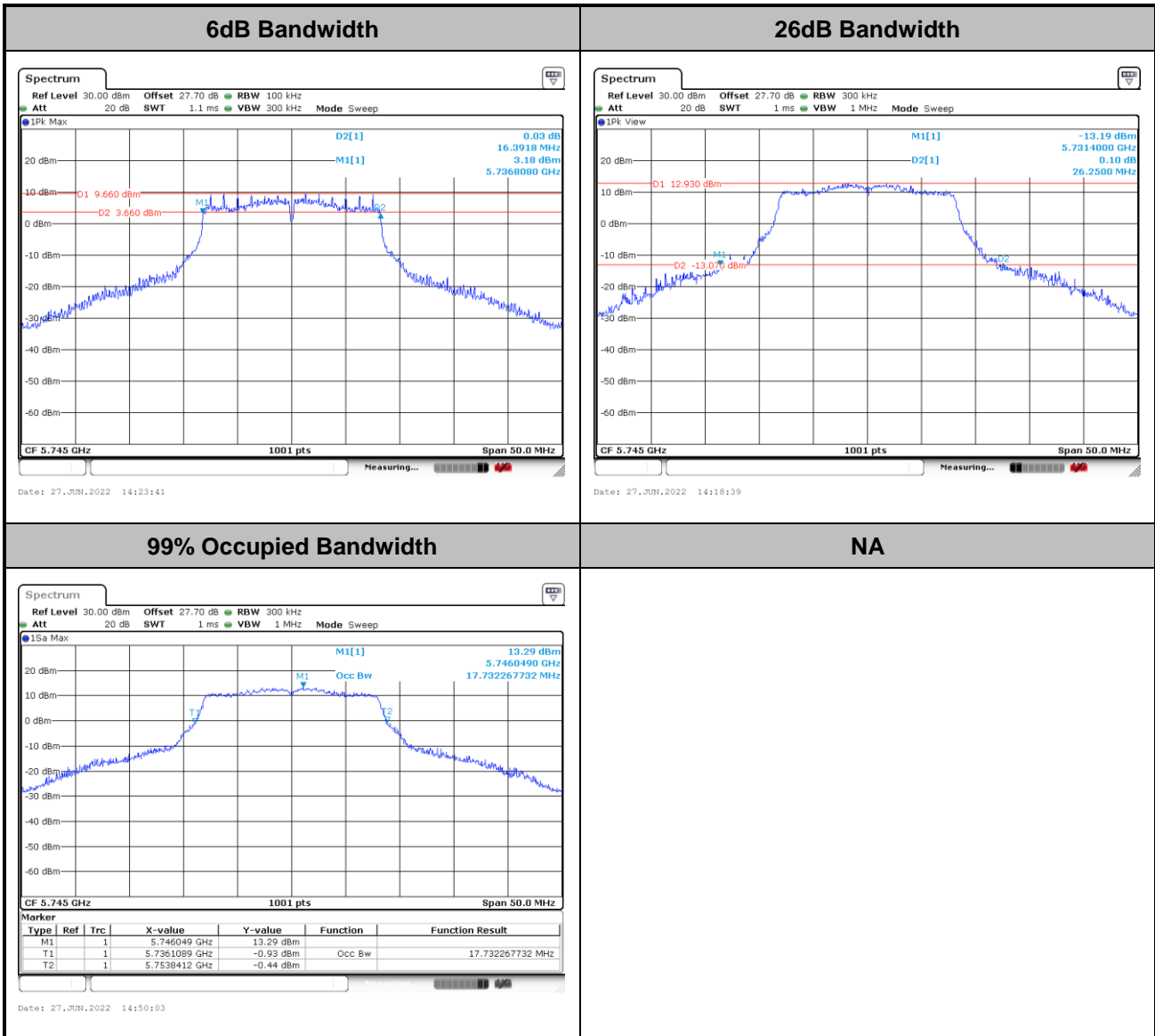

Note: The occupied channel bandwidth is maintained within the band of operation for all of the modulations.



<802.11ax HE20>

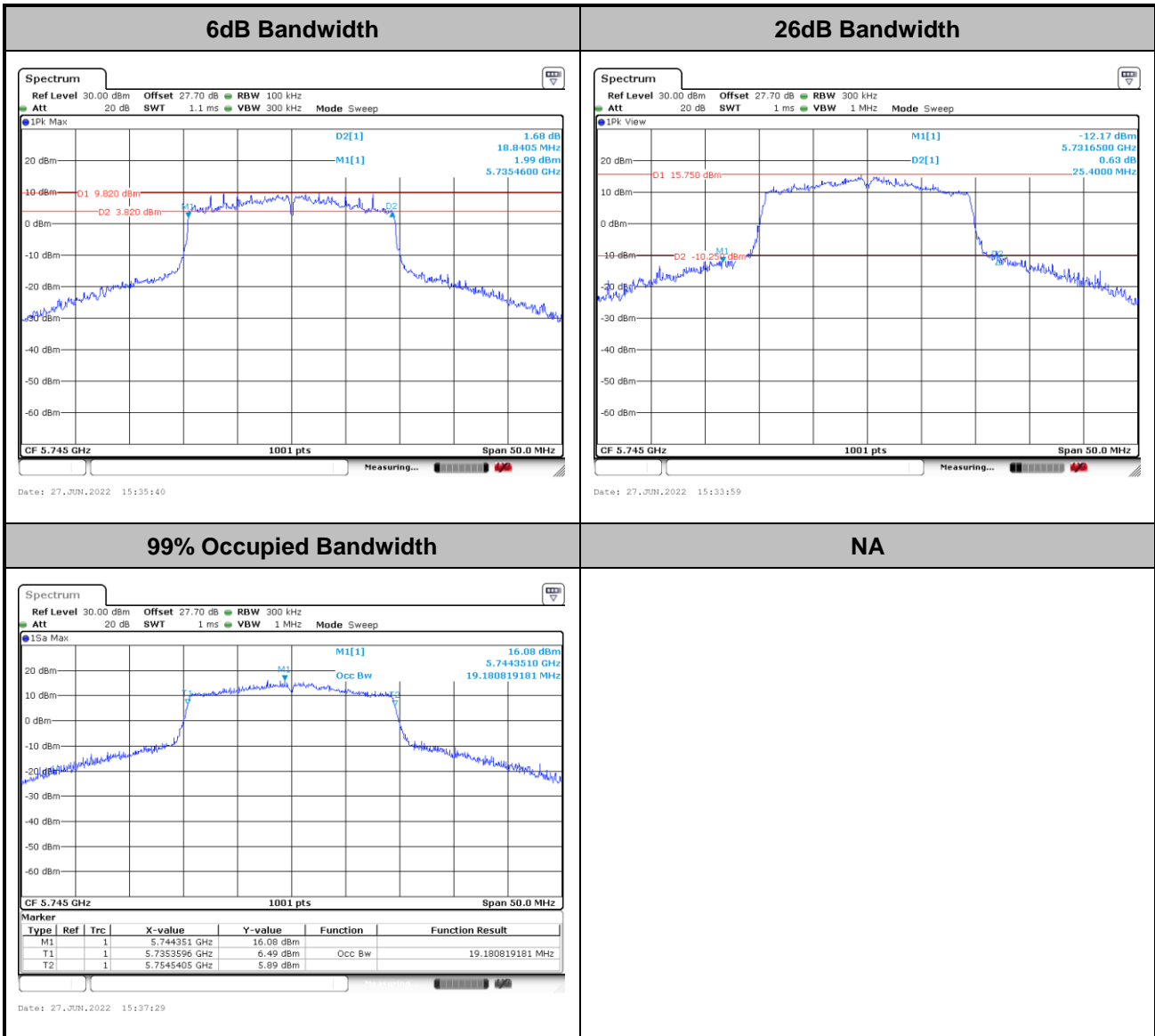

Note: The occupied channel bandwidth is maintained within the band of operation for all of the modulations.



<802.11ax HE40>

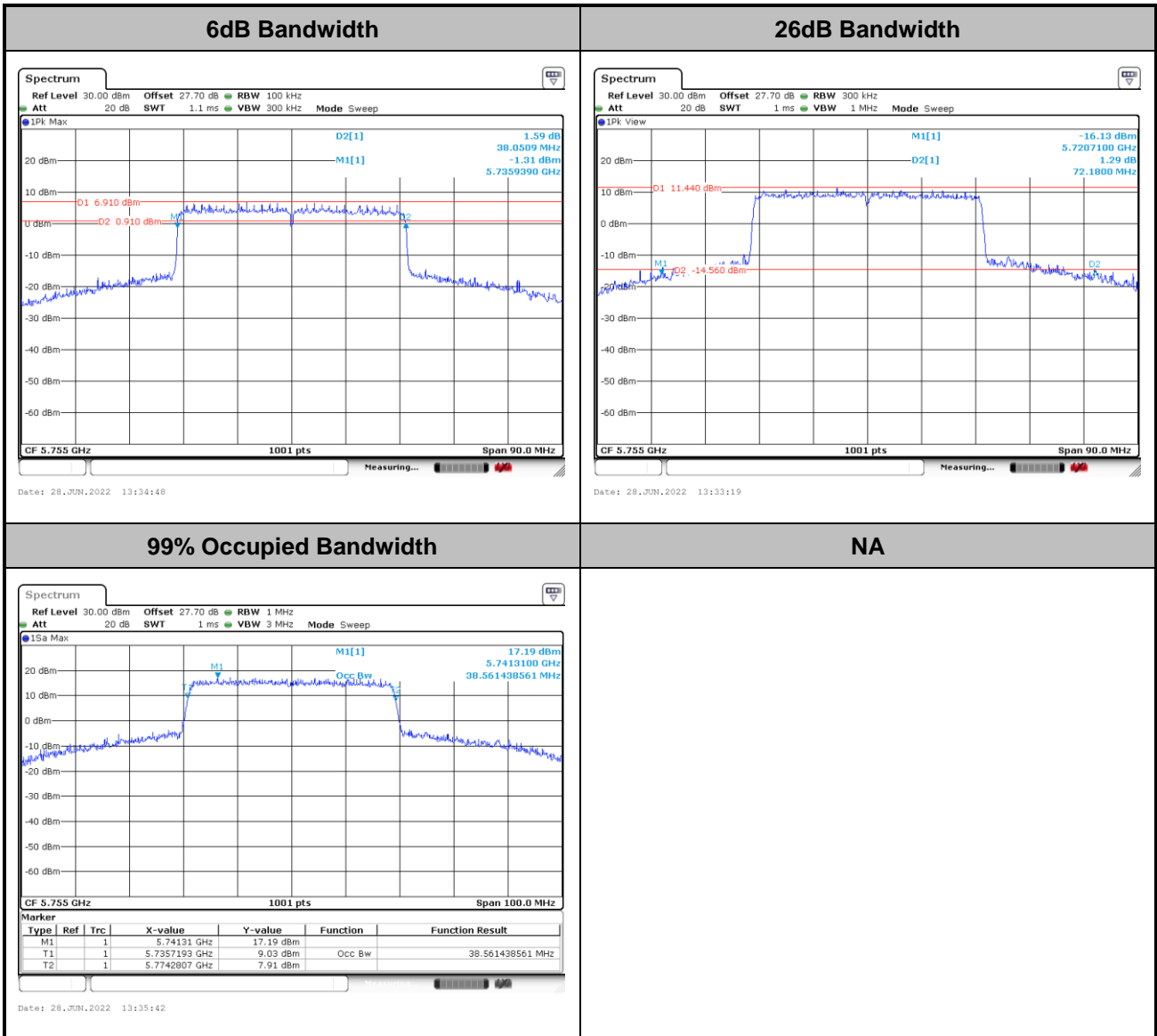

Note: The occupied channel bandwidth is maintained within the band of operation for all of the modulations.



<802.11ax HE80>

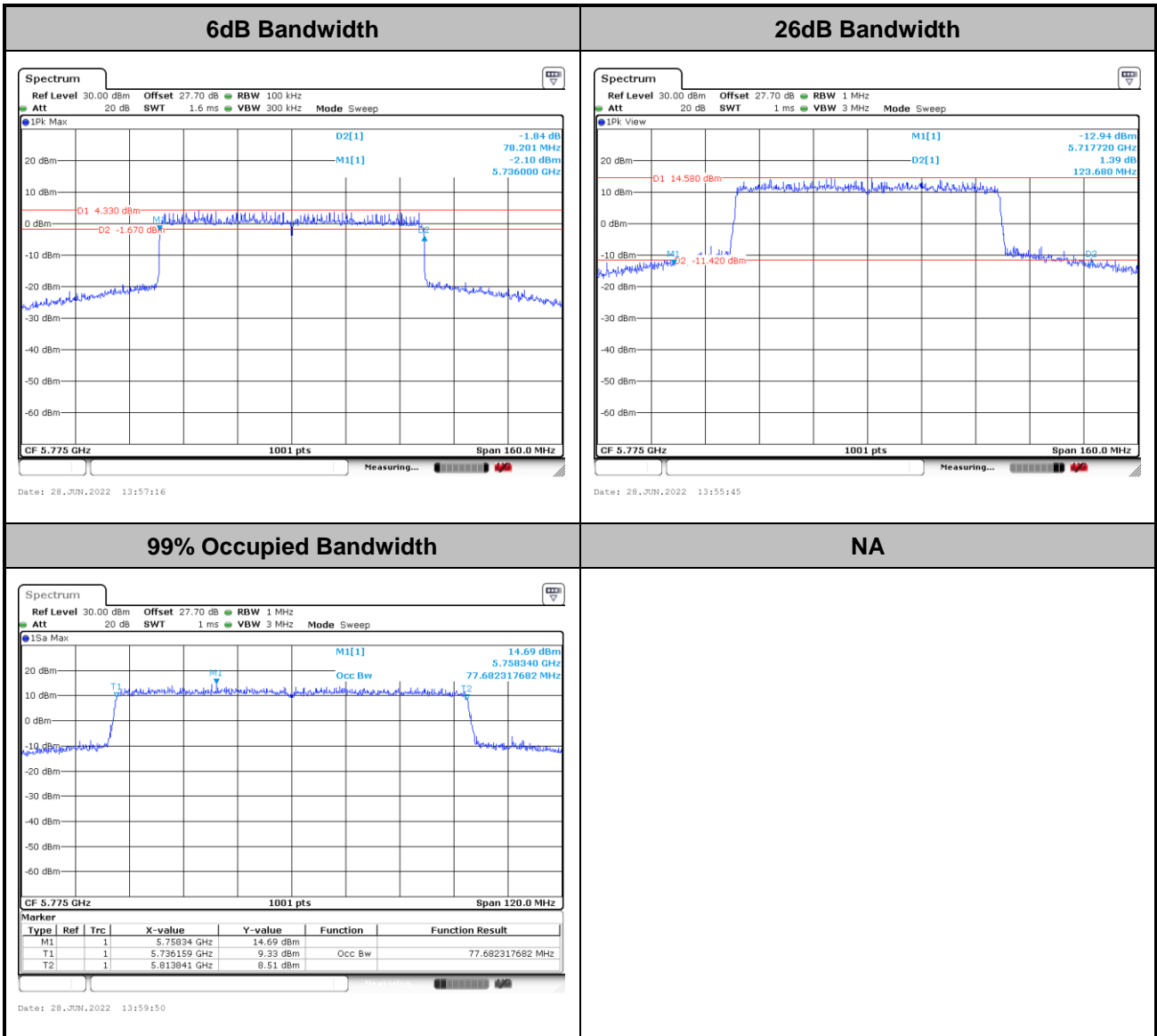

Note: The occupied channel bandwidth is maintained within the band of operation for all of the modulations.



<TXBF Modes>

Band IV MIMO													
Mod.	Data Rate	NTX	CH.	Freq. (MHz)	RU Config.	99% Bandwidth (MHz)		26dB Bandwidth (MHz)		6 dB Bandwidth (MHz)		6 dB Bandwidth Min. Limit (MHz)	Pass/Fail
						Ant 6	Ant 7	Ant 6	Ant 7	Ant 6	Ant 7		
HE20	MCS0	2	149	5745	Full	19.18	19.18	26.40	29.30	18.50	17.70	0.5	Pass
HE20	MCS0	2	157	5785	Full	19.23	19.28	28.80	31.35	18.10	18.25	0.5	Pass
HE20	MCS0	2	165	5825	Full	19.13	19.23	27.70	30.85	18.55	16.80	0.5	Pass
HE40	MCS0	2	151	5755	Full	38.16	38.36	58.32	56.34	37.89	37.80	0.5	Pass
HE40	MCS0	2	159	5795	Full	37.96	38.16	45.54	53.73	37.80	37.80	0.5	Pass
HE80	MCS0	2	155	5775	Full	77.44	77.44	113.54	107.47	77.44	74.24	0.5	Pass



<802.11ax HE20>

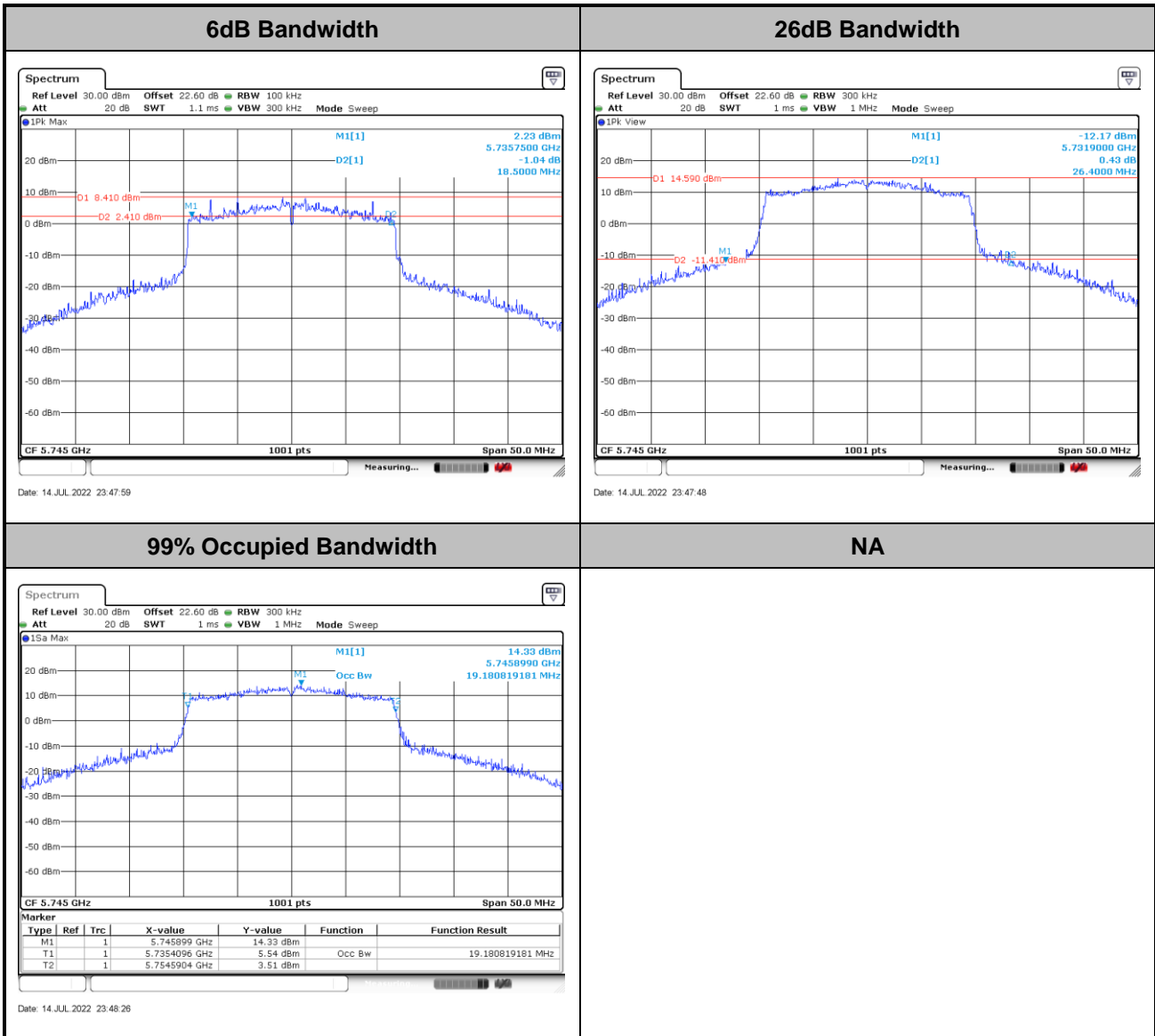

Note: The occupied channel bandwidth is maintained within the band of operation for all of the modulations.



<802.11ax HE40>

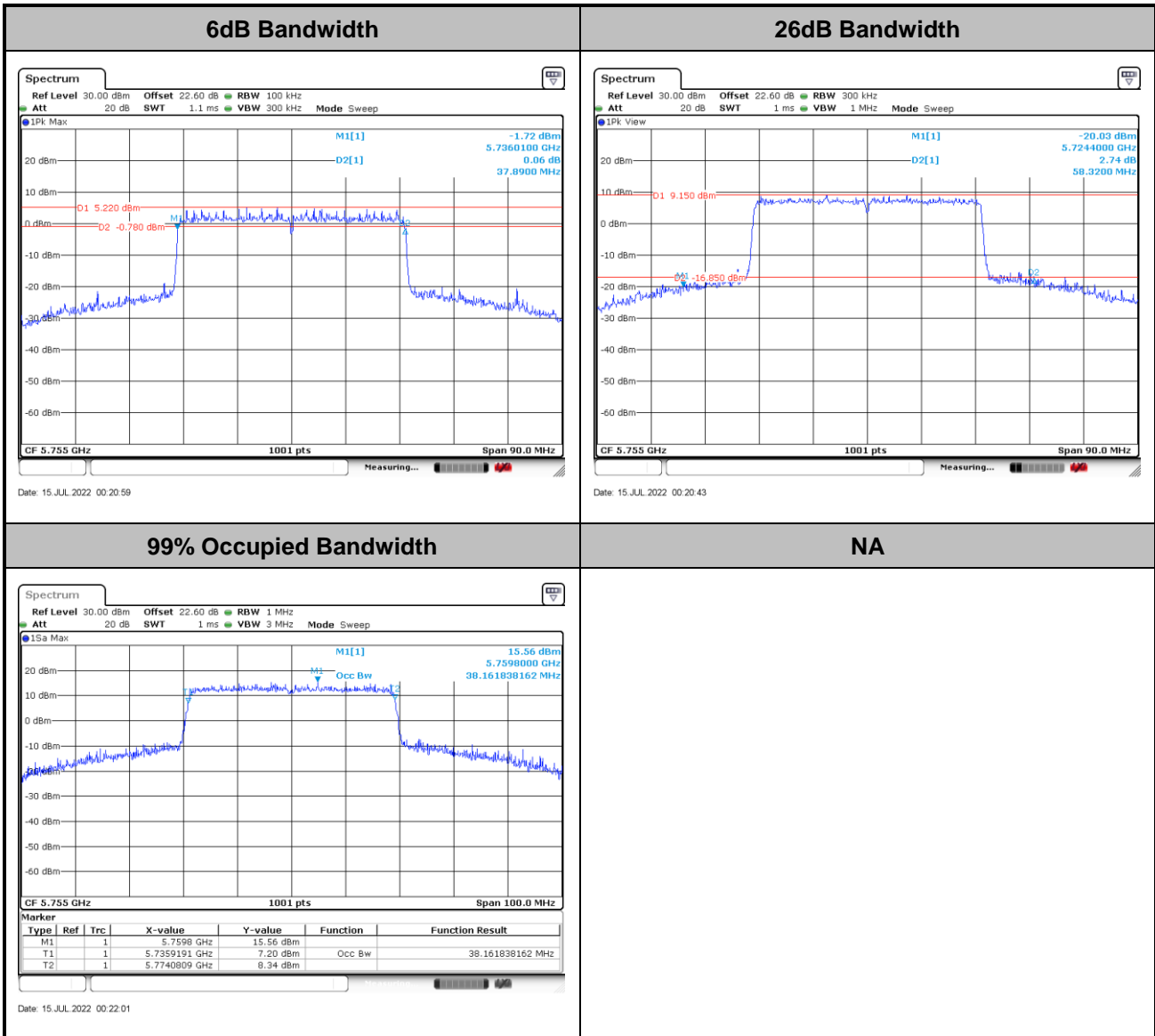

Note: The occupied channel bandwidth is maintained within the band of operation for all of the modulations.



<802.11ax HE80>

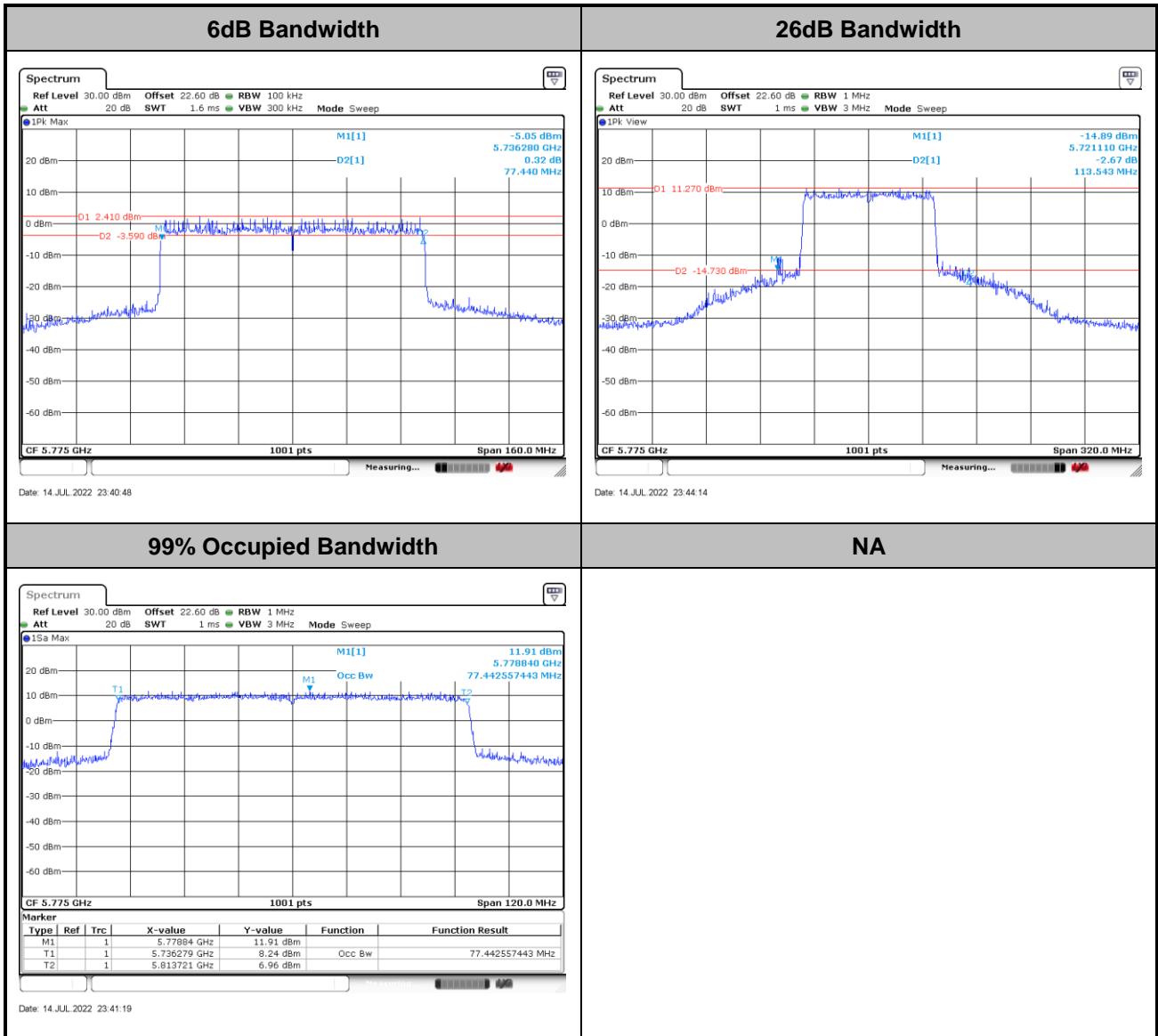

Note: The occupied channel bandwidth is maintained within the band of operation for all of the modulations.

3.2 Maximum Conducted Output Power Measurement

3.2.1 Limit of Maximum Conducted Output Power

For the band 5.725–5.85 GHz, the maximum conducted output power over the frequency band of operation shall not exceed 1 W.

If transmitting antennas of directional gain greater than 6 dBi are used, the peak output power shall be reduced by the amount in dB that the directional gain of the antenna exceeds 6 dBi.

3.2.2 Measuring Instruments

Please refer to the measuring equipment list in this test report.

3.2.3 Test Procedures

The testing follows Method PM-G of FCC KDB 789033 D02 General UNII Test Procedures New Rules v02r01.

Method PM-G (Measurement using a gated RF average power meter):

1. Measurement is performed using a wideband RF power meter.
2. The EUT is configured to transmit at its maximum power control level.
3. Measure the average power of the transmitter.
4. Since the measurement is made only during the ON time of the transmitter, no duty cycle correction factor is required.
5. For MIMO mode, calculation method follows FCC KDB 662911 D01 Multiple Transmitter Output v02r01

3.2.4 Test Setup

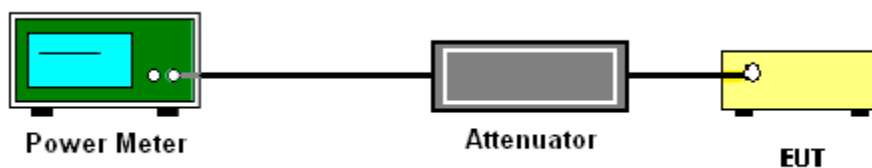



3.2.5 Test Result of Maximum Conducted Output Power

Test Engineer :	Eason Huang and Hank Hsu	Temperature :	21~25°C
		Relative Humidity :	51~54%

<CDD Mode>

Band IV MIMO												
Mod.	Data Rate	NTX	CH.	Freq. (MHz)	Average Conducted Power (dBm)			FCC Conducted Power Limit (dBm)		DG (dBi)		Pass/Fail
					Ant 6	Ant 7	SUM	Ant 6	Ant 7	Ant 6	Ant 7	
11a	6Mbps	2	149	5745	21.20	21.40	24.31	30.00		2.00	Pass	
11a	6Mbps	2	157	5785	21.20	21.50	24.36	30.00		2.00	Pass	
11a	6Mbps	2	165	5825	21.40	21.40	24.41	30.00		2.00	Pass	
HT20	MCS0	2	149	5745	21.20	21.40	24.31	30.00		2.00	Pass	
HT20	MCS0	2	157	5785	21.20	21.40	24.31	30.00		2.00	Pass	
HT20	MCS0	2	165	5825	21.40	21.40	24.41	30.00		2.00	Pass	
HT40	MCS0	2	151	5755	20.10	20.30	23.21	30.00		2.00	Pass	
HT40	MCS0	2	159	5795	20.20	20.40	23.31	30.00		2.00	Pass	
VHT20	MCS0	2	149	5745	21.20	21.40	24.31	30.00		2.00	Pass	
VHT20	MCS0	2	157	5785	21.20	21.40	24.31	30.00		2.00	Pass	
VHT20	MCS0	2	165	5825	21.40	21.40	24.41	30.00		2.00	Pass	
VHT40	MCS0	2	151	5755	20.10	20.30	23.21	30.00		2.00	Pass	
VHT40	MCS0	2	159	5795	20.20	20.40	23.31	30.00		2.00	Pass	
VHT80	MCS0	2	155	5775	20.30	20.20	23.26	30.00		2.00	Pass	



<802.11ax Mode>

Band IV MIMO													
Mod.	Data Rate	NTX	CH.	Freq. (MHz)	RU Config.	Average Conducted Power (dBm)			FCC Conducted Power Limit (dBm)		DG (dBi)		Pass/Fail
						Ant 6	Ant 7	SUM	Ant 6	Ant 7	Ant 6	Ant 7	
HE20	MCS0	2	149	5745	Full	21.30	21.50	24.41	30.00		2.00		Pass
HE20	MCS0	2	149	5745	26/0	13.30	14.00	16.67	30.00		2.00		Pass
HE20	MCS0	2	149	5745	52/37	16.00	16.70	19.37	30.00		2.00		Pass
HE20	MCS0	2	149	5745	106/53	18.80	19.20	22.01	30.00		2.00		Pass
HE20	MCS0	2	157	5785	Full	21.30	21.50	24.41	30.00		2.00		Pass
HE20	MCS0	2	157	5785	26/4	13.90	14.20	17.06	30.00		2.00		Pass
HE20	MCS0	2	157	5785	52/38	16.50	17.10	19.82	30.00		2.00		Pass
HE20	MCS0	2	157	5785	106/53	19.40	19.70	22.56	30.00		2.00		Pass
HE20	MCS0	2	165	5825	Full	21.50	21.50	24.51	30.00		2.00		Pass
HE20	MCS0	2	165	5825	26/8	13.30	13.60	16.46	30.00		2.00		Pass
HE20	MCS0	2	165	5825	52/40	16.10	16.60	19.37	30.00		2.00		Pass
HE20	MCS0	2	165	5825	106/54	19.30	19.60	22.46	30.00		2.00		Pass
HE40	MCS0	2	151	5755	Full	20.20	20.40	23.31	30.00		2.00		Pass
HE40	MCS0	2	151	5755	242/61	18.20	18.50	21.36	30.00		2.00		Pass
HE40	MCS0	2	159	5795	Full	20.30	20.50	23.41	30.00		2.00		Pass
HE40	MCS0	2	159	5795	242/62	18.20	18.70	21.47	30.00		2.00		Pass
HE80	MCS0	2	155	5775	Full	20.40	20.30	23.36	30.00		2.00		Pass
HE80	MCS0	2	155	5775	484/65	18.40	18.80	21.61	30.00		2.00		Pass
HE80	MCS0	2	155	5775	484/66	18.30	18.50	21.41	30.00		2.00		Pass



<TXBF Mode>

Band IV MIMO												
Mod.	Data Rate	NTX	CH.	Freq. (MHz)	Average Conducted Power (dBm)			FCC Conducted Power Limit (dBm)		DG (dBi)		Pass/Fail
					Ant 6	Ant 7	SUM	Ant 6	Ant 7	Ant 6	Ant 7	
HT20	MCS0	2	149	5745	21.10	21.30	24.21	30.00		3.76		Pass
HT20	MCS0	2	157	5785	21.10	21.30	24.21	30.00		3.76		Pass
HT20	MCS0	2	165	5825	21.00	21.30	24.16	30.00		3.76		Pass
HT40	MCS0	2	151	5755	20.10	20.40	23.26	30.00		3.76		Pass
HT40	MCS0	2	159	5795	20.10	20.40	23.26	30.00		3.76		Pass

Band IV MIMO													
Mod.	Data Rate	NTX	CH.	Freq. (MHz)	RU Config.	Average Conducted Power (dBm)			FCC Conducted Power Limit (dBm)		DG (dBi)		Pass/Fail
						Ant 6	Ant 7	SUM	Ant 6	Ant 7	Ant 6	Ant 7	
HE20	MCS0	2	149	5745	Full	21.20	21.40	24.31	30.00		3.76		Pass
HE20	MCS0	2	157	5785	Full	21.20	21.40	24.31	30.00		3.76		Pass
HE20	MCS0	2	165	5825	Full	21.10	21.40	24.26	30.00		3.76		Pass
HE40	MCS0	2	151	5755	Full	20.20	20.50	23.36	30.00		3.76		Pass
HE40	MCS0	2	159	5795	Full	20.20	20.50	23.36	30.00		3.76		Pass
HE80	MCS0	2	155	5775	Full	20.20	20.40	23.31	30.00		3.76		Pass



3.3 Power Spectral Density Measurement

3.3.1 Limit of Power Spectral Density

For the band 5.725–5.85 GHz, the maximum power spectral density shall not exceed 30 dBm in any 500-kHz band.

If transmitting antennas of directional gain greater than 6 dBi are used, the peak output power shall be reduced by the amount in dB that the directional gain of the antenna exceeds 6 dBi.

3.3.2 Measuring Instruments

Please refer to the measuring equipment list in this test report.

3.3.3 Test Procedures

The testing follows FCC KDB 789033 D02 General UNII Test Procedures New Rules v02r01. Section F) Maximum power spectral density.

Method SA-3

(power averaging (rms) detection with max hold):

- Set span to encompass the entire emission bandwidth (EBW) of the signal.
 - Set RBW = 300 kHz.
 - Set VBW \geq 1 MHz.
 - Number of points in sweep \geq 2 Span / RBW.
 - Add $10 \log(500 \text{ kHz/RBW})$ to the measured result, whereas RBW (<500 kHz) is the reduced resolution bandwidth of the spectrum analyzer set during measurement
 - Sweep time \leq (number of points in sweep) \times T, when duty cycle is less than 98 percent where T is the minimum transmission duration over which the transmitter is on and is transmitting at its maximum power control level for the tested mode of operation.
Detector = power averaging (rms).
 - Trace mode = max hold.
 - Allow max hold to run for at least 60 seconds, or longer as needed to allow the trace to stabilize.
1. The RF output of EUT is connected to the spectrum analyzer by a low loss cable.
 2. Each plot has already offset with cable loss, and attenuator loss. Measure the PPSD and record it.
 3. For MIMO mode, calculation method follows FCC KDB 662911 D01 Multiple Transmitter Output v02r01.

Method (c): Measure and add $10 \log(N_{\text{ANT}})$ dB.

With this technique, spectrum measurements are performed at each output of the device, but rather than summing the spectra or the spectral peaks across the outputs, the quantity $10 \log(N_{\text{ANT}})$ dB is added to each spectrum value before comparing to the emission limit. The addition of $10 \log(N_{\text{ANT}})$ dB serves to apportion the emission limit among the N_{ANT} outputs so that each output is permitted to contribute no more than $1/N_{\text{ANT}}^{\text{th}}$ of the PSD limit.

3.3.4 Test Setup

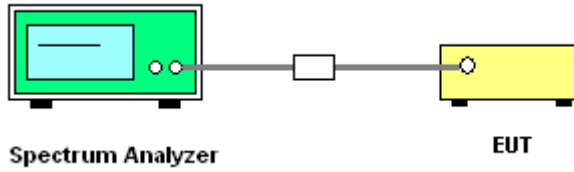

3.3.5 Test Result of Power Spectral Density

Test Engineer :	Eason Huang and Hank Hsu	Temperature :	21~25°C
		Relative Humidity :	51~54%

<CDD Modes>

Band IV MIMO														
Mod.	Data Rate	NTX	CH.	Freq. (MHz)	10log (500kHz /RBW) Factor (dB)		Average Power Density (dBm/500kHz)			Average PSD Limit (dBm/500kHz)		DG (dBi)		Pass /Fail
					Ant 6	Ant 7	Ant 6	Ant 7	SUM	Ant 6	Ant 7	Ant 6	Ant 7	
11a	6Mbps	2	149	5745	2.22	10.21	11.12	14.13	30.00	3.76	3.76	Pass		
11a	6Mbps	2	157	5785	2.22	10.82	10.85	13.86	30.00	3.76	3.76	Pass		
11a	6Mbps	2	165	5825	2.22	10.17	11.34	14.35	30.00	3.76	3.76	Pass		

Note: PSD Sum = Max PSD(Ant. 6, Ant. 7) + 10 log (n)

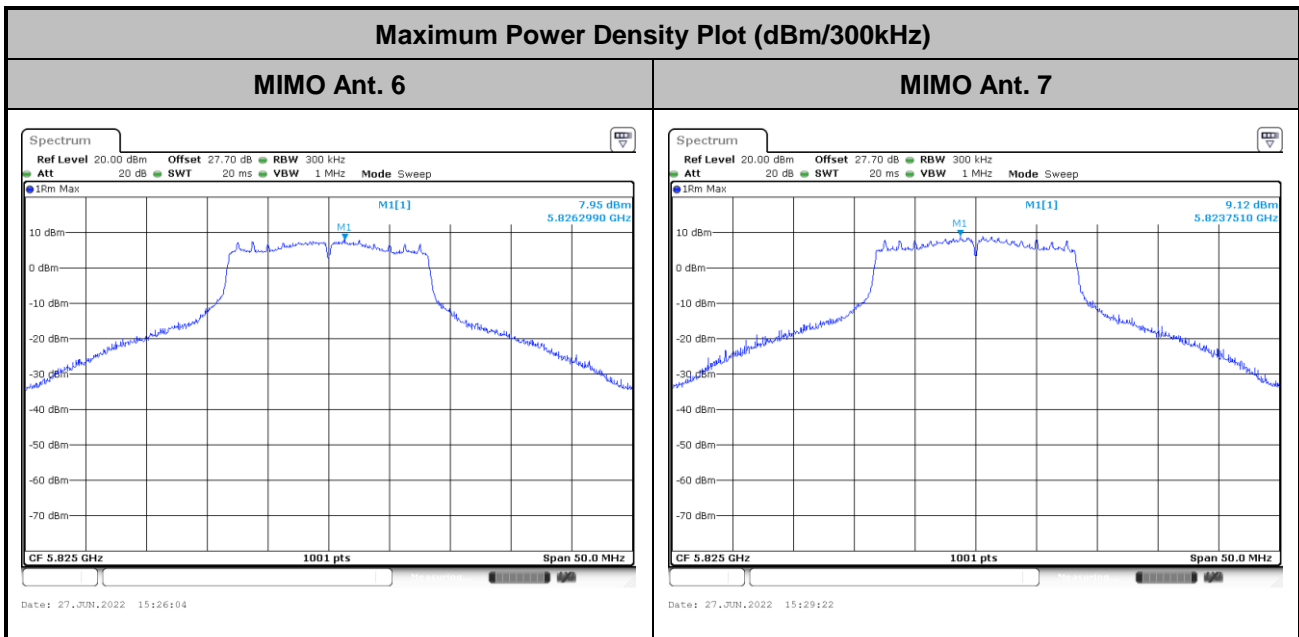



<802.11ax Mode>

Band IV MIMO															
Mod.	Data Rate	NTX	CH.	Freq. (MHz)	RU Config.	10log (500kHz /RBW) Factor (dB)		Average Power Density (dBm/500kHz)			Average PSD Limit (dBm/500kHz)		DG (dBi)		Pass /Fail
						Ant 6	Ant 7	Ant 6	Ant 7	SUM	Ant 6	Ant 7	Ant 6	Ant 7	
						HE20	MCS0	2	149	5745	Full	2.22	10.45	11.42	
HE20	MCS0	2	149	5745	26/0	2.22	10.19	11.29	14.30	30.00	3.76	Pass			
HE20	MCS0	2	149	5745	52/37	2.22	10.24	11.05	14.06	30.00	3.76	Pass			
HE20	MCS0	2	149	5745	106/53	2.22	10.20	11.04	14.05	30.00	3.76	Pass			
HE20	MCS0	2	157	5785	Full	2.22	10.83	11.24	14.25	30.00	3.76	Pass			
HE20	MCS0	2	157	5785	26/4	2.22	10.59	10.95	13.96	30.00	3.76	Pass			
HE20	MCS0	2	157	5785	52/38	2.22	10.70	11.15	14.16	30.00	3.76	Pass			
HE20	MCS0	2	157	5785	106/53	2.22	10.66	11.02	14.03	30.00	3.76	Pass			
HE20	MCS0	2	165	5825	Full	2.22	10.54	11.11	14.12	30.00	3.76	Pass			
HE20	MCS0	2	165	5825	26/8	2.22	10.27	11.02	14.03	30.00	3.76	Pass			
HE20	MCS0	2	165	5825	52/40	2.22	10.26	10.69	13.70	30.00	3.76	Pass			
HE20	MCS0	2	165	5825	106/54	2.22	10.38	11.07	14.08	30.00	3.76	Pass			
HE40	MCS0	2	151	5755	Full	2.22	6.85	7.18	10.19	30.00	3.76	Pass			
HE40	MCS0	2	151	5755	242/61	2.22	6.42	6.93	9.94	30.00	3.76	Pass			
HE40	MCS0	2	159	5795	Full	2.22	6.85	7.49	10.50	30.00	3.76	Pass			
HE40	MCS0	2	159	5795	242/62	2.22	6.82	7.17	10.18	30.00	3.76	Pass			
HE80	MCS0	2	155	5775	Full	2.22	4.22	4.35	7.36	30.00	3.76	Pass			
HE80	MCS0	2	155	5775	484/65	2.22	3.77	4.31	7.32	30.00	3.76	Pass			
HE80	MCS0	2	155	5775	484/66	2.22	4.00	3.96	7.01	30.00	3.76	Pass			

Note: PSD Sum = Max PSD(Ant. 6, Ant. 7) + 10 log (n)



Maximum Power Density Plot (dBm/300kHz)

MIMO Ant. 6

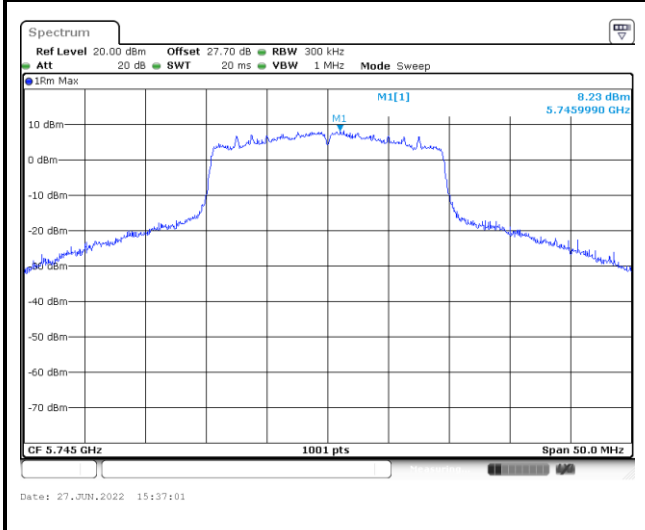

MIMO Ant. 7

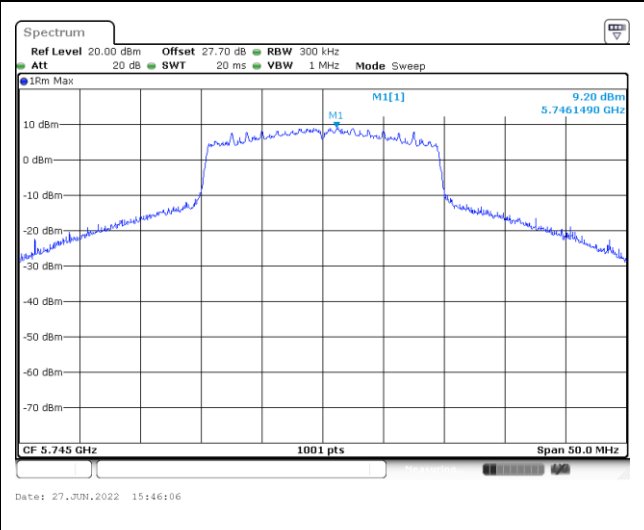



<TXBF Modes>

Band IV MIMO															
Mod.	Data Rate	NTX	CH.	Freq. (MHz)	RU Config.	10log (500kHz /RBW) Factor (dB)		Average Power Density (dBm/500kHz)			Average PSD Limit (dBm/500kHz)		DG (dBi)		Pass /Fail
						Ant 6	Ant 7	Ant 6	Ant 7	SUM	Ant 6	Ant 7	Ant 6	Ant 7	
HE20	MCS0	2	149	5745	Full	2.22	9.55	9.75	12.76	30.00	3.76	Pass			
HE20	MCS0	2	157	5785	Full	2.22	9.92	9.96	12.97	30.00	3.76	Pass			
HE20	MCS0	2	165	5825	Full	2.22	9.77	9.75	12.78	30.00	3.76	Pass			
HE40	MCS0	2	151	5755	Full	2.22	4.88	5.01	8.02	30.00	3.76	Pass			
HE40	MCS0	2	159	5795	Full	2.22	4.97	5.20	8.21	30.00	3.76	Pass			
HE80	MCS0	2	155	5775	Full	2.22	5.89	6.64	9.65	30.00	3.76	Pass			

Note: PSD Sum = Max PSD(Ant. 6, Ant. 7) + 10 log (n).

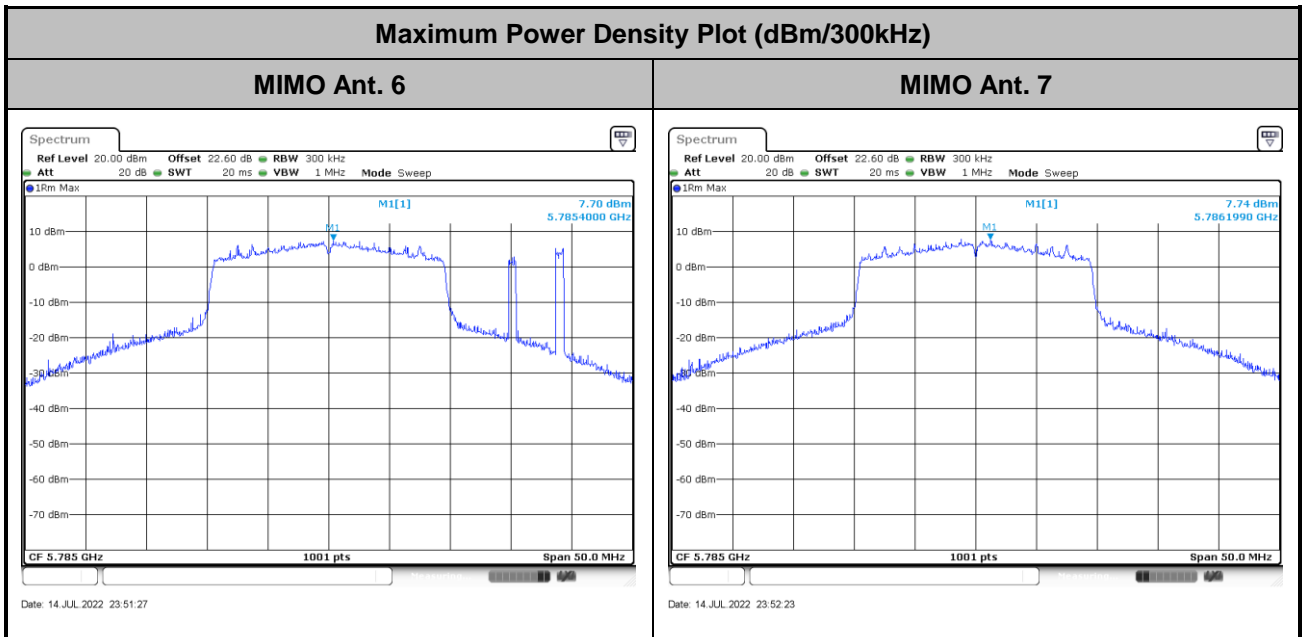



3.4 Unwanted Emissions Measurement

This section is to measure unwanted emissions through radiated measurement for band edge spurious emissions and out of band emissions measurement.

3.4.1 Limit of Unwanted Emissions

(1) For transmitters operating in the 5.725-5.85 GHz band:

15.407(b)(4)(i) All emissions shall be limited to a level of -27 dBm/MHz at 75 MHz or more above or below the band edge increasing linearly to 10 dBm/MHz at 25 MHz above or below the band edge, and from 25 MHz above or below the band edge increasing linearly to a level of 15.6 dBm/MHz at 5 MHz above or below the band edge, and from 5 MHz above or below the band edge increasing linearly to a level of 27 dBm/MHz at the band edge.

(2) Unwanted spurious emissions falls in restricted bands shall comply with the general field strength limits as below table,

Frequency (MHz)	Field Strength (microvolts/meter)	Measurement Distance (meters)
0.009 – 0.490	2400/F(kHz)	300
0.490 – 1.705	24000/F(kHz)	30
1.705 – 30.0	30	30
30 – 88	100	3
88 – 216	150	3
216 - 960	200	3
Above 960	500	3

Note: The following formula is used to convert the EIRP to field strength.

$$E = \frac{1000000\sqrt{30P}}{3} \mu\text{V/m, where P is the eirp (Watts)}$$

EIRP (dBm)	Field Strength at 3m (dBμV/m)
- 27	68.3

(3) KDB789033 D02 v02r01 G)2)c)

(i) Sections 15.407(b)(1-3) specifies the unwanted emissions limit for the U-NII-1 and U-NII-2 bands. As specified, emissions above 1000 MHz that are outside of the restricted bands are subject to a peak emission limit of -27 dBm/MHz.

(ii) Section 15.407(b)(4) specifies the unwanted emissions limit for the U-NII-3 band. A band emissions mask is specified in Section 15.407(b)(4)(i). The emission limits are based on the use of a peak detector.



3.4.2 Measuring Instruments

Please refer to the measuring equipment list in this test report.

3.4.3 Test Procedures

1. The testing follows FCC KDB 789033 D02 General UNII Test Procedures New Rules v02r01. Section G) Unwanted emissions measurement.
 - (1) Procedure for Unwanted Emissions Measurements Below 1000 MHz
 - RBW = 120 kHz
 - VBW = 300 kHz
 - Detector = Peak
 - Trace mode = max hold
 - (2) Procedure for Peak Unwanted Emissions Measurements Above 1000 MHz
 - RBW = 1 MHz
 - VBW \geq 3 MHz
 - Detector = Peak
 - Sweep time = auto
 - Trace mode = max hold
 - (3) Procedures for Average Unwanted Emissions Measurements Above 1000 MHz
 - RBW = 1 MHz
 - VBW = 10 Hz, when duty cycle is no less than 98 percent.
 - VBW \geq 1/T, when duty cycle is less than 98 percent where T is the minimum transmission duration over which the transmitter is on and is transmitting at its maximum power control level for the tested mode of operation.
2. The EUT is placed on a turntable with 0.8 meter for frequency below 1 GHz and 1.5 meter for frequency above 1 GHz respectively above ground.
3. The EUT is set 3 meters away from the receiving antenna which is mounted on the top of a variable height antenna tower.
4. The antenna is a broadband antenna and its height is adjusted between one meter and four meters above ground to find the maximum value of the field strength for both horizontal polarization and vertical polarization of the antenna.
5. For each suspected emission, the EUT is arranged to its worst case and then adjust the antenna tower (from 1 m to 4 m) and turntable (from 0 degree to 360 degrees) to find the maximum reading.

6. Radiated testing below 1 GHz is performed by adjusting the antenna tower from 1 m to 4 m and by rotating the turn table from 0 degree to 360 degrees to find the peak maximum hold reading. When there is no suspected emission found and the emission level is with at least 6 dB margin against QP limit line, the position is marked as “-“.
7. Radiated testing above 1 GHz is performed by adjusting the antenna tower from 1 m to 4 m and by rotating the turn table from 0 degree to 360 degrees to find the peak maximum hold reading for scanning all frequencies. When there is no suspected emission found and the harmonic emission level is with at least 6 dB margin against average limit line, the position is marked as “-“.

3.4.4 Test Setup

For radiated emissions below 30MHz

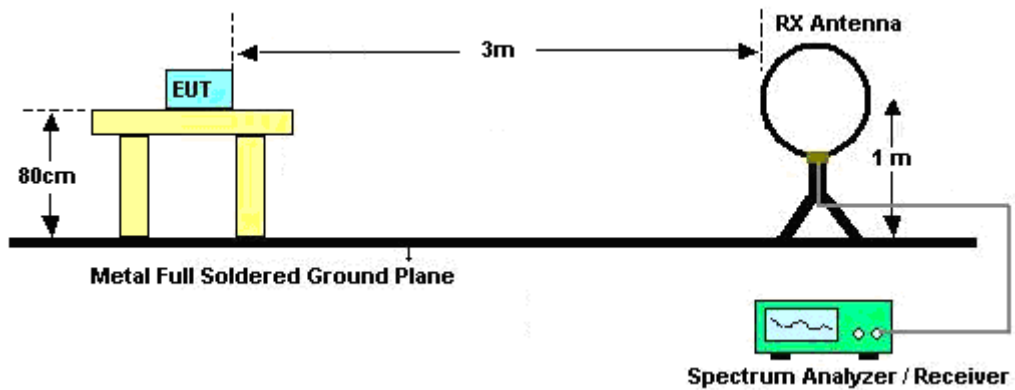

For radiated emissions from 30MHz to 1GHz

<CDD Mode>

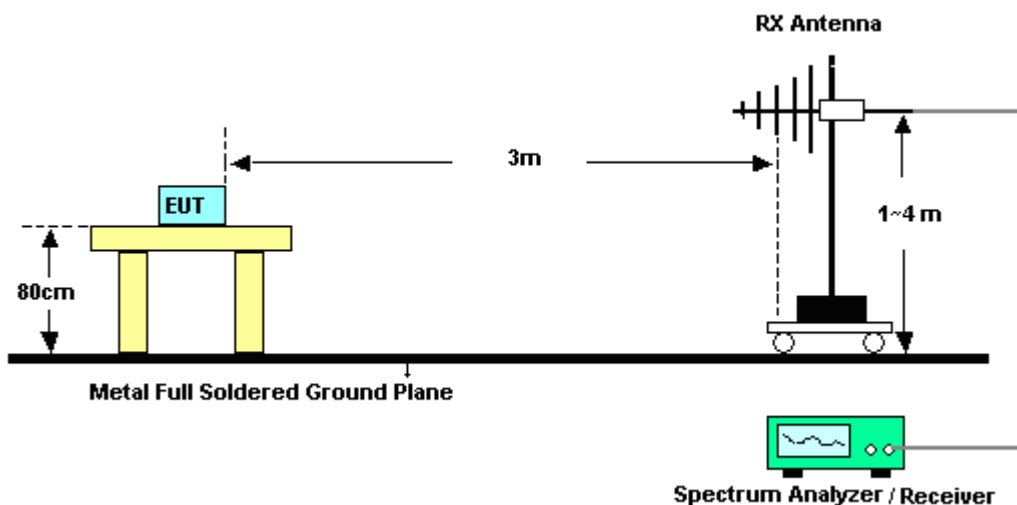

<TXBF Modes>

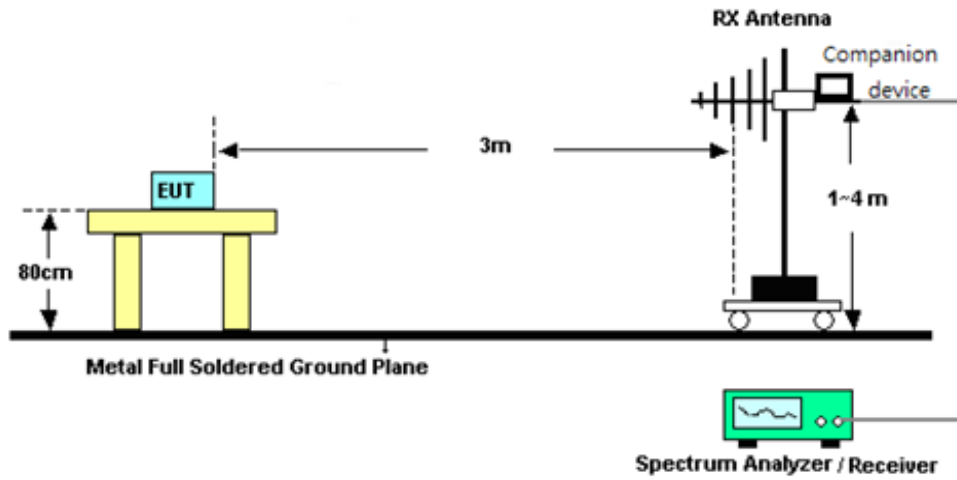

For radiated test from 1GHz to 18GHz

<CDD Mode>

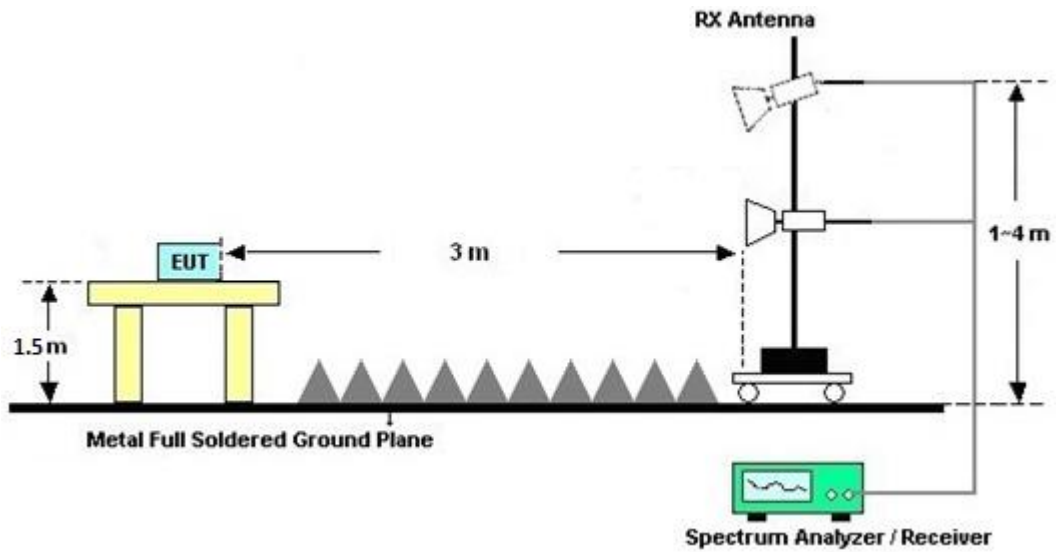

<TXBF Modes>

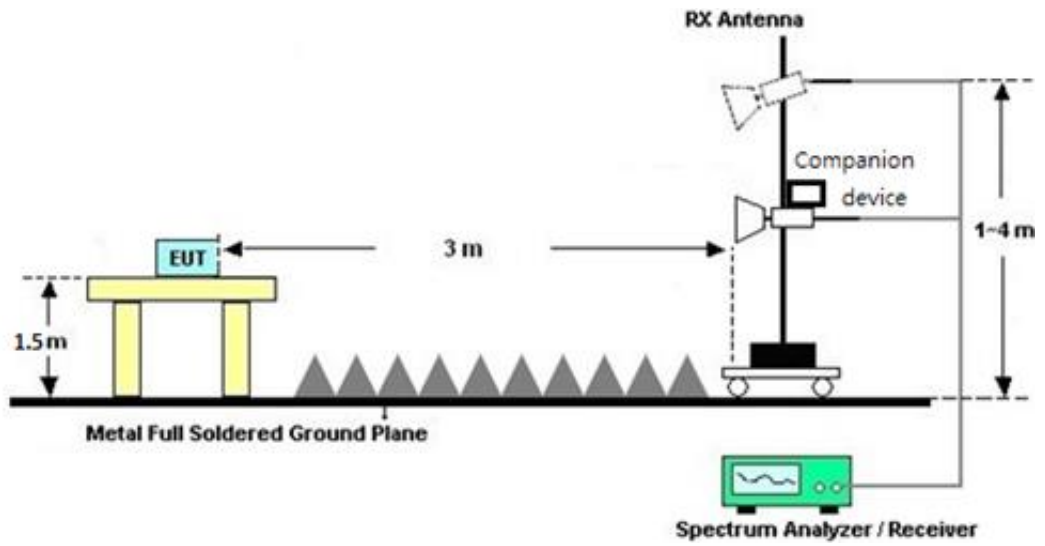

For radiated test above 18GHz

<CDD Mode>

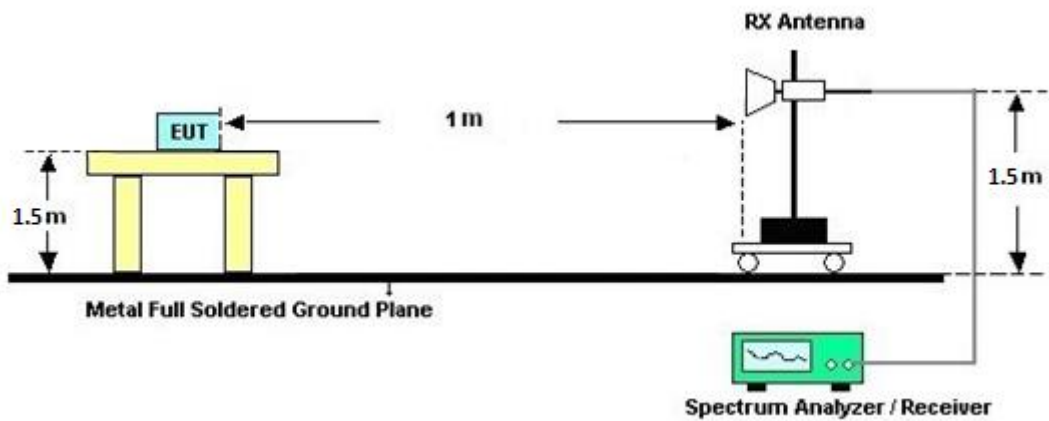

<TXBF Modes>

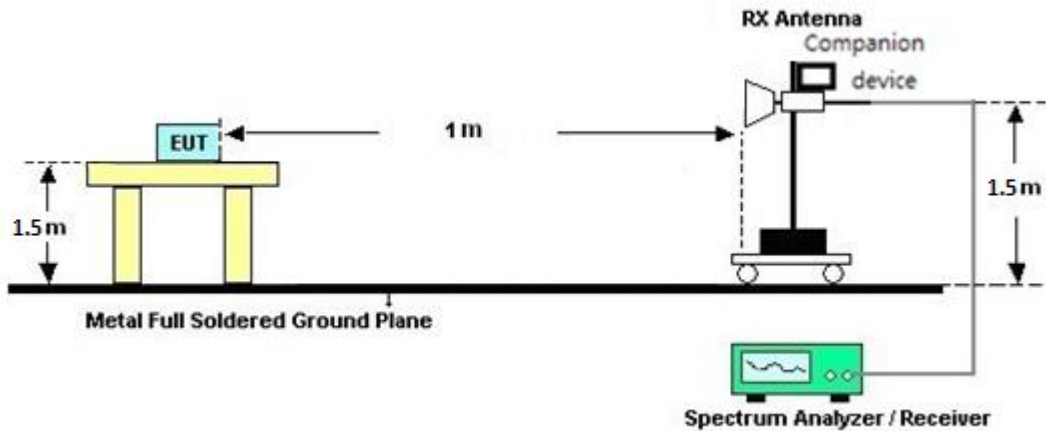

3.4.5 Test Results of Radiated Emissions (9 kHz ~ 30 MHz)

The low frequency, which starts from 9 kHz to 30 MHz, is pre-scanned and the result which is 20 dB lower than the limit line is not reported.

There is adequate comparison measurement of both open-field test site and alternative test site - semi-Anechoic chamber according to 414788 D01 Radiated Test Site v01r01, and the result came out very similar.

3.4.6 Test Result of Radiated Band Edges

Please refer to Appendix B and C.

3.4.7 Duty Cycle

Please refer to Appendix D.

3.4.8 Test Result of Unwanted Radiated Emission (30MHz ~ 10th Harmonic)

Please refer to Appendix B and C.



3.5 AC Conducted Emission Measurement

3.5.1 Limit of AC Conducted Emission

For equipment that is designed to be connected to the public utility (AC) power line, the radio frequency voltage that is conducted back onto the AC power line on any frequency or frequencies within the band 150 kHz to 30 MHz shall not exceed the limits in the following table.

Frequency of emission (MHz)	Conducted limit (dB μ V)	
	Quasi-peak	Average
0.15-0.5	66 to 56*	56 to 46*
0.5-5	56	46
5-30	60	50

*Decreases with the logarithm of the frequency.

3.5.2 Measuring Instruments

Please refer to the measuring equipment list in this test report.

3.5.3 Test Procedures

1. The EUT is placed 0.4 meter away from the conducting wall of the shielding room, and is kept at least 80 centimeters from any other grounded conducting surface.
2. Connect EUT to the power mains through a line impedance stabilization network (LISN).
3. All the support units are connecting to the other LISN.
4. The LISN provides 50 ohm coupling impedance for the measuring instrument.
5. The FCC states that a 50 ohm, 50 microhenry LISN shall be used.
6. Both Line and Neutral shall be tested in order to find out the maximum conducted emission.
7. The frequency range from 150 kHz to 30 MHz is scanned.
8. Set the test-receiver system to Peak Detect Function and specified bandwidth with Maximum Hold Mode.

3.5.4 Test Setup

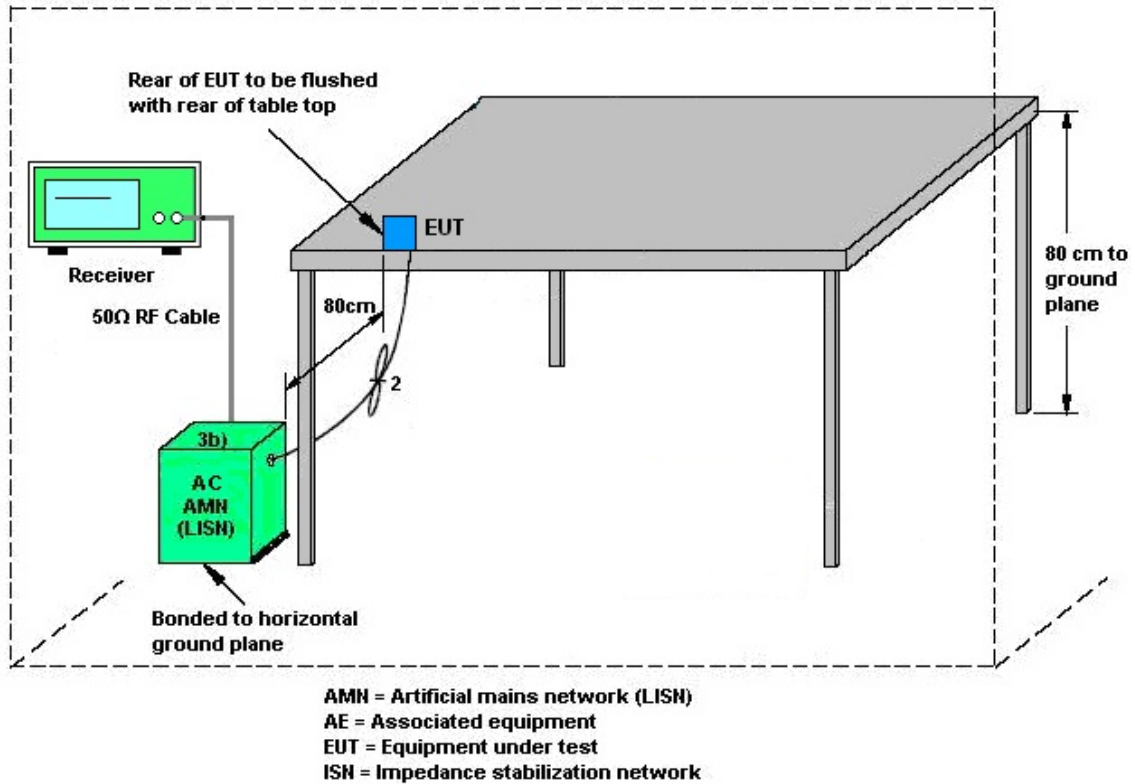

3.5.5 Test Result of AC Conducted Emission

Please refer to Appendix A.

3.6 Antenna Requirements

3.6.1 Standard Applicable

If transmitting antenna directional gain is greater than 6 dBi, both the peak transmit power and the peak power spectral density shall be reduced by the amount in dB that the directional gain of the antenna exceeds 6 dBi.

3.6.2 Antenna Anti-Replacement Construction

An embedded-in antenna design is used.

3.6.3 Antenna Gain

<CDD Modes >

FCC KDB 662911 D01 Multiple Transmitter Output v02r01

For power measurements on IEEE 802.11 devices,

Directional gain = G_{ANT} + Array Gain, where Array Gain is as follows:

Array Gain = 0 dB (i.e., no array gain) for $N_{ANT} \leq 4$.

G_{ANT} is set equal to the gain of the antenna having the highest gain.

For PSD measurements, the directional gain calculation follows F)2)f)ii) of KDB 662911 D01 v02r01.

$$DirectionalGain = 10 \cdot \log \left[\frac{\sum_{j=1}^{N_{SS}} \left\{ \sum_{k=1}^{N_{ANT}} g_{j,k} \right\}^2}{N_{ANT}} \right]$$

where

Each antenna is driven by no more than one spatial stream;

N_{SS} = the number of independent spatial streams of data;

N_{ANT} = the total number of antennas

$g_{j,k} = 10^{G_k/20}$ if the k th antenna is being fed by spatial stream j , or zero if it is not;
 G_k is the gain in dBi of the k th antenna.

As minimum $N_{SS}=1$ is supported by EUT, the formula can be simplified as:

Directional gain = $10 \cdot \log[(10^{G_1/20} + 10^{G_2/20} + \dots + 10^{G_N/20})^2 / N_{ANT}]$ dBi

Where G_1, G_2, \dots, G_N denote single antenna gain.

For example: If a device has two antenna, $G_{ANT1}= 3.6$ dBi; $G_{ANT2}=4.2$ dBi

Directional gain of power measurement = $\max(3.6, 4.2) + 0 = 4.2$ dBi

Directional gain of PSD measurement = $10 \cdot \log[(10^{3.6/20} + 10^{4.2/20})^2 / 2] = 6.92$ dBi



The directional gain "DG" is calculated as following table.

<CDD Modes>						
			DG	DG	Power	PSD
			for	for	Limit	Limit
	Ant. 6	Ant. 7	Power	PSD	Reduction	Reduction
	(dBi)	(dBi)	(dBi)	(dBi)	(dB)	(dB)
Band IV	2.00	-0.70	2.00	3.76	0.00	0.00

$$Power\ Limit\ Reduction = DG(Power) - 6dBi, (min = 0)$$

$$PSD\ Limit\ Reduction = DG(PSD) - 6dBi, (min = 0)$$

Calculation example:

The DG for PSD is derived from formula is

$$10 \times \log \left\{ \left[10^{(2.0\text{ dBi} / 20)} + 10^{(-0.7\text{ dBi} / 20)} \right]^2 / 2 \right\}$$

$$= 3.76\text{ dBi}$$

TXBF modes

FCC KDB 662911 D01 Multiple Transmitter Output v02r01

For CDD transmissions, directional gain is calculated as

$$DirectionalGain = 10 \cdot \log \left[\frac{\sum_{j=1}^{N_{SS}} \left\{ \sum_{k=1}^{N_{ANT}} g_{j,k} \right\}^2}{N_{ANT}} \right]$$

where

Each antenna is driven by no more than one spatial stream;

N_{SS} = the number of independent spatial streams of data;

N_{ANT} = the total number of antennas

$g_{j,k} = 10^{G_k / 20}$ if the k th antenna is being fed by spatial stream j , or zero if it is not;
 G_k is the gain in dBi of the k th antenna.

The EUT supports beamforming modes.

The directional gain calculation is following F)2)e)ii) of KDB 662911 D01 v02r01.

The power and PSD limit should be modified if the directional gain of EUT is over 6 dBi,

The directional gain “DG” is calculated as following table.

			DG	DG	Power	PSD
			for	for	Limit	Limit
	Ant. 6	Ant. 7	Power	PSD	Reduction	Reduction
	(dBi)	(dBi)	(dBi)	(dBi)	(dB)	(dB)
Band IV	2.00	-0.70	3.76	3.76	0.00	0.00

$$Power\ Limit\ Reduction = DG(Power) - 6dBi, (min = 0)$$

$$PSD\ Limit\ Reduction = DG(PSD) - 6dBi, (min = 0)$$

Calculation example:

For the Band IV, the DG for PSD is derived from formula is

$$10 \times \log \left\{ \left[10^{(2.0\text{ dBi} / 20)} + 10^{(-0.7\text{ dBi} / 20)} \right]^2 / 2 \right\}$$

$$= 3.76\text{ dBi}$$



4 List of Measuring Equipment

Instrument	Brand Name	Model No.	Serial No.	Characteristics	Calibration Date	Test Date	Due Date	Remark
Loop Antenna	Rohde & Schwarz	HFH2-Z2	100488	9kHz~30MHz	Sep. 07, 2021	Jun. 17, 2022~ Jun. 30, 2022	Sep. 06, 2022	Radiation (03CH13-HY)
Bilog Antenna	TESEQ	CBL 6111D & 00800N1D01N -06	40103 & 07	30MHz~1GHz	Apr. 24, 2022	Jun. 17, 2022~ Jun. 30, 2022	Apr. 23, 2023	Radiation (03CH13-HY)
Horn Antenna	SCHWARZBE CK	BBHA 9120 D	9120D-1241	1GHz~18GHz	Jul. 13, 2021	Jun. 17, 2022~ Jun. 30, 2022	Jul. 12, 2022	Radiation (03CH13-HY)
SHF-EHF Horn Antenna	SCHWARZBE CK	BBHA 9170	00994	18GHz~40GHz	Nov. 04, 2021	Jun. 17, 2022~ Jun. 30, 2022	Nov. 03, 2022	Radiation (03CH13-HY)
Amplifier	Sonoma-Instru ment	310 N	187282	9kHz~1GHz	Dec. 15, 2021	Jun. 17, 2022~ Jun. 30, 2022	Dec. 14, 2022	Radiation (03CH13-HY)
Preamplifier	MITEQ	AMF-7D-0010 1800-30-10P	1590074	1GHz~18GHz	May 17, 2022	Jun. 17, 2022~ Jun. 30, 2022	May 16, 2023	Radiation (03CH13-HY)
Preamplifier	Keysight	83017A	MY53270147	1GHz~26.5GHz	Oct. 26, 2021	Jun. 17, 2022~ Jun. 30, 2022	Oct. 25, 2022	Radiation (03CH13-HY)
Preamplifier	EMEC	EM18G40G	060715	18GHz~40GHz	Dec. 24, 2021	Jun. 17, 2022~ Jun. 30, 2022	Dec. 23, 2022	Radiation (03CH13-HY)
Spectrum Analyzer	Keysight	N9010A	MY55370526	10Hz~44GHz	Mar. 18, 2022	Jun. 17, 2022~ Jun. 30, 2022	Mar. 17, 2023	Radiation (03CH13-HY)
Hygrometer	TECPEL	DTM-303B	TP200889	N/A	Sep. 30, 2021	Jun. 17, 2022~ Jun. 30, 2022	Sep. 29, 2022	Radiation (03CH13-HY)
Antenna Mast	EMEC	AM-BS-4500-B	N/A	1m~4m	N/A	Jun. 17, 2022~ Jun. 30, 2022	N/A	Radiation (03CH13-HY)
Turn Table	EMEC	TT2000	N/A	0~360 Degree	N/A	Jun. 17, 2022~ Jun. 30, 2022	N/A	Radiation (03CH13-HY)
Software	Audix	E3 6.2009-8-24	RK-000992	N/A	N/A	Jun. 17, 2022~ Jun. 30, 2022	N/A	Radiation (03CH13-HY)
RF Cable	HUBER + SUHNER	SUCOFLEX 126E	0030/126E	30MHz~18GHz	Feb. 09, 2022	Jun. 17, 2022~ Jun. 30, 2022	Feb. 08, 2023	Radiation (03CH13-HY)
RF Cable	HUBER + SUHNER	SUCOFLEX 104	804793/4	30MHz~18GHz	Feb. 09, 2022	Jun. 17, 2022~ Jun. 30, 2022	Feb. 08, 2023	Radiation (03CH13-HY)
RF Cable	HUBER + SUHNER	SUCOFLEX 104	MY24961/4	30MHz~18GHz	Feb. 09, 2022	Jun. 17, 2022~ Jun. 30, 2022	Feb. 08, 2023	Radiation (03CH13-HY)
RF Cable	HUBER + SUHNER	SUCOFLEX 102	804011/2, 804012/2	18GHz~40GHz	Jan. 04, 2022	Jun. 17, 2022~ Jun. 30, 2022	Jan. 03, 2023	Radiation (03CH13-HY)
RF Cable	HUBER + SUHNER	SUCOFLEX 104	MY9837/4PE	9kHz~30MHz	Mar. 10, 2022	Jun. 17, 2022~ Jun. 30, 2022	Mar. 09, 2023	Radiation (03CH13-HY)
Filter	Wainwright	WLK4-1000-15 30-8000-40SS	SN12	1.53GHz Low Pass Filter	Sep. 14, 2021	Jun. 17, 2022~ Jun. 30, 2022	Sep. 13, 2022	Radiation (03CH13-HY)
Filter	Wainwright	WHKX8-5872. 5-6750-18000- 40ST	SN5	6.75GHz High Pass Filter	Mar. 10, 2022	Jun. 17, 2022~ Jun. 30, 2022	Mar. 09, 2023	Radiation (03CH13-HY)
Filter	Wainwright	WHKX12-2700 -3000-18000-6 0SS	SN2	3GHz High Pass Filter	Jul. 12, 2021	Jun. 17, 2022~ Jun. 30, 2022	Jul. 11, 2022	Radiation (03CH13-HY)
Hygrometer	TECPEL	DTM-303A	TP201996	N/A	Nov. 16, 2021	Jun. 10, 2022~ Jul. 16, 2022	Nov. 15, 2022	Conducted (TH05-HY)
Power Sensor	DARE	RPR3006W	16I00054SNO 12 (NO:113)	10MHz~6GHz	Dec. 16, 2021	Jun. 10, 2022~ Jul. 16, 2022	Dec. 15, 2022	Conducted (TH05-HY)
Signal Analyzer	Rohde & Schwarz	FSV40	101566	10Hz~40GHz	Aug. 30, 2021	Jun. 10, 2022~ Jul. 16, 2022	Aug. 29, 2022	Conducted (TH05-HY)
Switch Control Mainframe	E-IUSTRUME NT	ETF-1405-0	EC1900067 (BOX7)	N/A	Aug. 12, 2021	Jun. 10, 2022~ Jul. 16, 2022	Aug. 11, 2022	Conducted (TH05-HY)



Instrument	Brand Name	Model No.	Serial No.	Characteristics	Calibration Date	Test Date	Due Date	Remark
AC Power Source	ACPOWER	AFC-11003G	F317040033	N/A	N/A	Jul. 05, 2022	N/A	Conduction (CO07-HY)
Software	Rohde & Schwarz	EMC32 V10.30	N/A	N/A	N/A	Jul. 05, 2022	N/A	Conduction (CO07-HY)
Pulse Limiter	SCHWARZBECK	VTSD 9561-F N	9561-F N00373	9kHz-200MHz	Oct. 29, 2021	Jul. 05, 2022	Oct. 28, 2022	Conduction (CO07-HY)
RF Cable	HUBER + SUHNER	RG 214/U	1358175	9kHz~30MHz	Mar. 16, 2022	Jul. 05, 2022	Mar. 15, 2023	Conduction (CO07-HY)
Two-Line V-Network	TESEQ	NNB 51	45051	N/A	Feb. 16, 2022	Jul. 05, 2022	Feb. 15, 2023	Conduction (CO07-HY)
EMI Test Receiver	Rohde & Schwarz	ESCI7	100724	9kHz~7GHz	Feb. 24, 2022	Jul. 05, 2022	Feb. 23, 2023	Conduction (CO07-HY)



5 Uncertainty of Evaluation

Uncertainty of Conducted Emission Measurement (150kHz ~ 30MHz)

Measuring Uncertainty for a Level of Confidence of 95% ($U = 2Uc(y)$)	2.3 dB
---	--------

Uncertainty of Radiated Emission Measurement (30 MHz ~ 1000 MHz)

Measuring Uncertainty for a Level of Confidence of 95% ($U = 2Uc(y)$)	6.0 dB
---	--------

Uncertainty of Radiated Emission Measurement (1000 MHz ~ 18000 MHz)

Measuring Uncertainty for a Level of Confidence of 95% ($U = 2Uc(y)$)	5.2 dB
---	--------

Uncertainty of Radiated Emission Measurement (18000 MHz ~ 40000 MHz)

Measuring Uncertainty for a Level of Confidence of 95% ($U = 2Uc(y)$)	5.9 dB
---	--------



Appendix A. AC Conducted Emission Test Results

Test Engineer :	Louis Chung	Temperature :	23.7~26.1°C
		Relative Humidity :	50.2~55.6%

EUT Information

Report NO : 1N2539
 Test Mode : Mode 1
 Test Voltage : 120Vac/60Hz
 Phase : Line

Full Spectrum

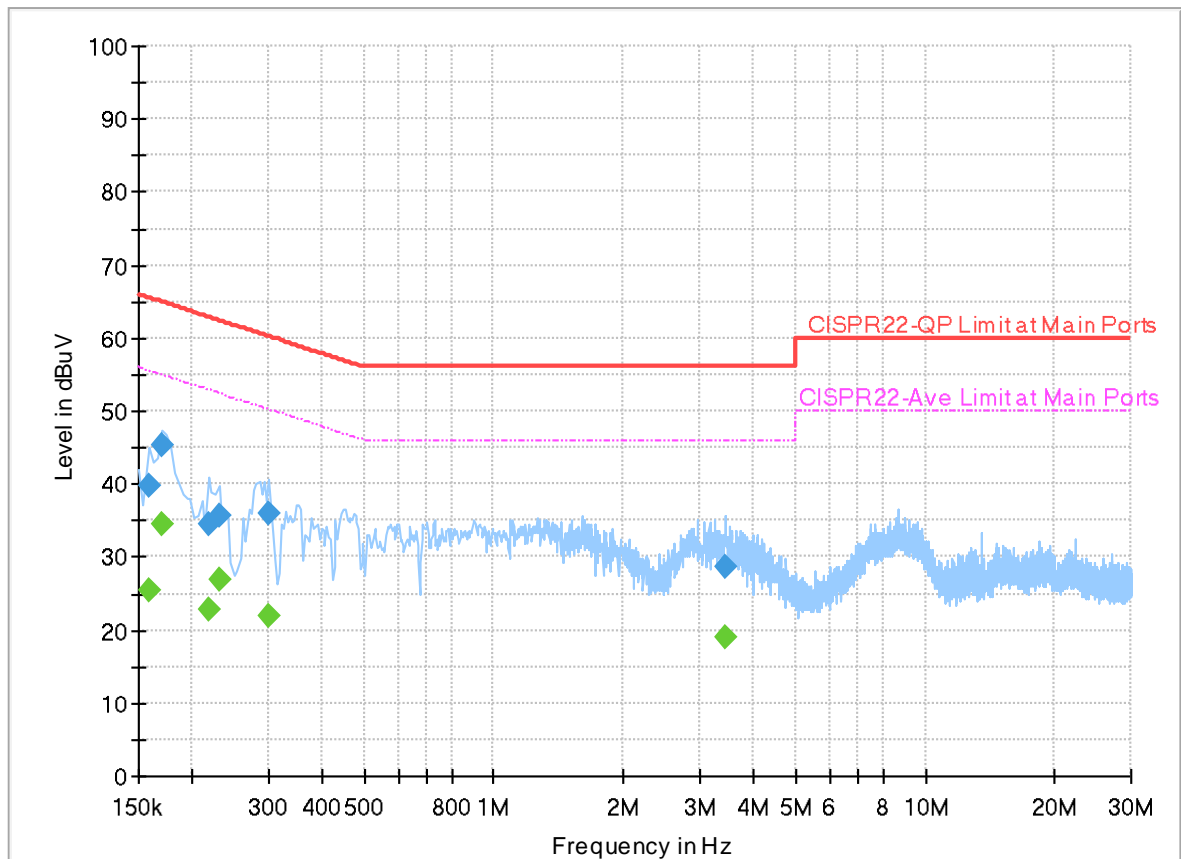

Final_Result

Frequency (MHz)	QuasiPeak (dBuV)	CAverage (dBuV)	Limit (dBuV)	Margin (dB)	Line	Filter	Corr. (dB)
0.158000	---	25.58	55.57	29.99	L1	OFF	20.0
0.158000	39.77	---	65.57	25.80	L1	OFF	20.0
0.170000	---	34.50	54.96	20.46	L1	OFF	20.0
0.170000	45.34	---	64.96	19.62	L1	OFF	20.0
0.218000	---	22.81	52.90	30.09	L1	OFF	20.0
0.218000	34.38	---	62.90	28.52	L1	OFF	20.0
0.230000	---	26.90	52.45	25.55	L1	OFF	20.0
0.230000	35.53	---	62.45	26.92	L1	OFF	20.0
0.302000	---	21.79	50.19	28.40	L1	OFF	20.0
0.302000	35.86	---	60.19	24.33	L1	OFF	20.0
3.438000	---	19.07	46.00	26.93	L1	OFF	20.0
3.438000	28.60	---	56.00	27.40	L1	OFF	20.0

EUT Information

Report NO : 1N2539
 Test Mode : Mode 1
 Test Voltage : 120Vac/60Hz
 Phase : Neutral

Full Spectrum

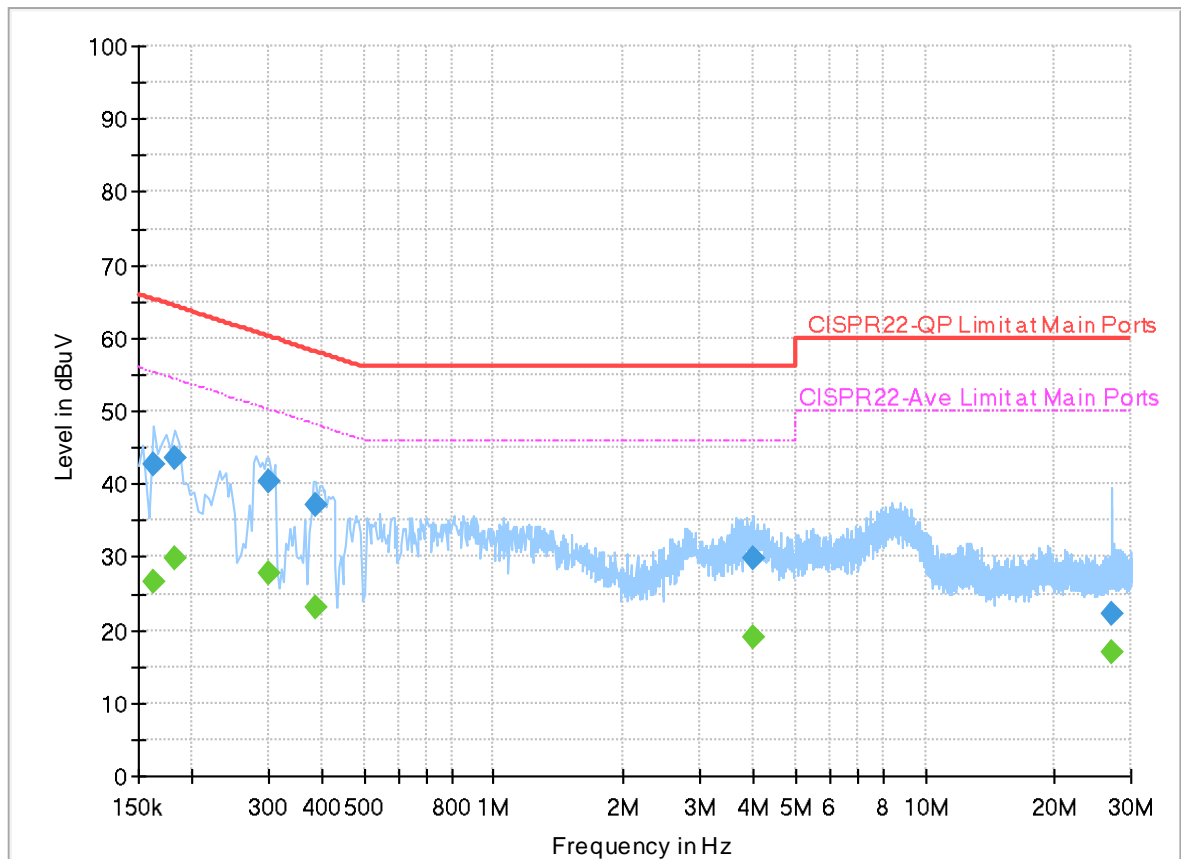

Final_Result

Frequency (MHz)	QuasiPeak (dBuV)	CAverage (dBuV)	Limit (dBuV)	Margin (dB)	Line	Filter	Corr. (dB)
0.162000	---	26.57	55.36	28.79	N	OFF	20.0
0.162000	42.59	---	65.36	22.77	N	OFF	20.0
0.182000	---	29.92	54.39	24.47	N	OFF	20.0
0.182000	43.51	---	64.39	20.88	N	OFF	20.0
0.302000	---	27.85	50.19	22.34	N	OFF	20.0
0.302000	40.37	---	60.19	19.82	N	OFF	20.0
0.386000	---	23.18	48.15	24.97	N	OFF	20.0
0.386000	37.01	---	58.15	21.14	N	OFF	20.0
4.002000	---	18.91	46.00	27.09	N	OFF	20.1
4.002000	29.90	---	56.00	26.10	N	OFF	20.1
27.058000	---	16.90	50.00	33.10	N	OFF	20.3
27.058000	22.09	---	60.00	37.91	N	OFF	20.3



Appendix B. Radiated Spurious Emission

Test Engineer :	Mancy Chou, Jacky Hong and Rain Lee	Temperature :	20~25°C
		Relative Humidity :	40~60%

<CDD Mode>

Band 4 - 5725~5850MHz
WIFI 802.11a (Band Edge @ 3m)

WIFI Ant.	Note	Frequency	Level	Margin	Limit Line	Read Level	Antenna Factor	Path Loss	Preamp Factor	Ant Pos	Table Pos	Peak Avg.	Pol.	
6+7		(MHz)	(dBμV/m)	(dB)	(dBμV/m)	(dBμV)	(dB/m)	(dB)	(dB)	(cm)	(deg)	(P/A)	(H/V)	
802.11a CH 149 5745MHz		5627	58.72	-9.48	68.2	46.92	31.95	6.46	26.61	100	354	P	H	
		5690	62.53	-35.3	97.83	50.51	32.14	6.52	26.64	100	354	P	H	
		5717.8	74.87	-35.31	110.18	62.71	32.27	6.54	26.65	100	354	P	H	
		5723	84.13	-33.51	117.64	71.95	32.29	6.54	26.65	100	354	P	H	
	*	5745	117.52	-	-	105.24	32.38	6.56	26.66	100	354	P	H	
	*	5745	110.06	-	-	97.78	32.38	6.56	26.66	100	354	A	H	
														H
														H
			5646.8	56.36	-11.84	68.2	44.59	31.91	6.48	26.62	249	199	P	V
			5697	61.45	-41.54	102.99	49.39	32.18	6.52	26.64	249	199	P	V
			5718.8	73.33	-37.13	110.46	61.16	32.28	6.54	26.65	249	199	P	V
			5725	84.72	-37.48	122.2	72.52	32.3	6.55	26.65	249	199	P	V
	*		5745	116.07	-	-	103.79	32.38	6.56	26.66	249	199	P	V
	*		5745	108.39	-	-	96.11	32.38	6.56	26.66	249	199	A	V
														V
													V	



WIFI Ant. 6+7	Note	Frequency (MHz)	Level (dBμV/m)	Margin (dB)	Limit Line (dBμV/m)	Read Level (dBμV)	Antenna Factor (dB/m)	Path Loss (dB)	Preamp Factor (dB)	Ant Pos (cm)	Table Pos (deg)	Peak Avg. (P/A)	Pol. (H/V)
		5618.8	55.73	-12.47	68.2	43.92	31.96	6.46	26.61	118	358	P	H
		5689	57.75	-39.34	97.09	45.74	32.13	6.52	26.64	118	358	P	H
		5717.4	59.75	-50.32	110.07	47.59	32.27	6.54	26.65	118	358	P	H
		5722.6	59.4	-57.33	116.73	47.22	32.29	6.54	26.65	118	358	P	H
	*	5785	118.06	-	-	105.73	32.4	6.6	26.67	118	358	P	H
	*	5785	110.32	-	-	97.99	32.4	6.6	26.67	118	358	A	H
		5852.2	57.98	-59.2	117.18	45.53	32.51	6.64	26.7	118	358	P	H
		5855.6	58.24	-52.39	110.63	45.77	32.52	6.65	26.7	118	358	P	H
		5876.8	56.39	-47.47	103.86	43.83	32.61	6.66	26.71	118	358	P	H
		5943.4	54.56	-13.64	68.2	41.81	32.79	6.7	26.74	118	358	P	H
													H
													H
802.11a													
CH 157													
5785MHz		5608.2	55.99	-12.21	68.2	44.16	31.98	6.45	26.6	274	196	P	V
		5690.2	56.67	-41.3	97.97	44.65	32.14	6.52	26.64	274	196	P	V
		5705	57.24	-49.36	106.6	45.13	32.22	6.53	26.64	274	196	P	V
		5720.4	58.58	-53.13	111.71	46.41	32.28	6.54	26.65	274	196	P	V
	*	5785	116.2	-	-	103.87	32.4	6.6	26.67	274	196	P	V
	*	5785	108.43	-	-	96.1	32.4	6.6	26.67	274	196	A	V
		5854	55.9	-57.18	113.08	43.43	32.52	6.65	26.7	274	196	P	V
		5863.4	56.82	-51.63	108.45	44.33	32.55	6.65	26.71	274	196	P	V
		5883.4	55.96	-43	98.96	43.38	32.63	6.66	26.71	274	196	P	V
		5937.2	54.65	-13.55	68.2	41.91	32.77	6.7	26.73	274	196	P	V
													V
													V



WiFi Ant. 6+7	Note	Frequency (MHz)	Level (dBµV/m)	Margin (dB)	Limit Line (dBµV/m)	Read Level (dBµV)	Antenna Factor (dB/m)	Path Loss (dB)	Preamp Factor (dB)	Ant Pos (cm)	Table Pos (deg)	Peak Avg. (P/A)	Pol. (H/V)	
802.11a CH 165 5825MHz	*	5825	117.82	-	-	105.43	32.45	6.63	26.69	100	356	P	H	
	*	5825	110.46	-	-	98.07	32.45	6.63	26.69	100	356	A	H	
		5850	73.37	-48.83	122.2	60.93	32.5	6.64	26.7	100	356	P	H	
		5858.6	69.55	-40.24	109.79	57.07	32.53	6.65	26.7	100	356	P	H	
		5877.2	61.37	-42.2	103.57	48.81	32.61	6.66	26.71	100	356	P	H	
		5938.2	55.62	-12.58	68.2	42.88	32.78	6.7	26.74	100	356	P	H	
														H
														H
	*	5825	115.81	-	-	103.42	32.45	6.63	26.69	300	204	P	V	
	*	5825	108.54	-	-	96.15	32.45	6.63	26.69	300	204	A	V	
		5852	75.03	-42.61	117.64	62.58	32.51	6.64	26.7	300	204	P	V	
		5858	72.22	-37.74	109.96	59.74	32.53	6.65	26.7	300	204	P	V	
		5876.4	58.81	-45.35	104.16	46.25	32.61	6.66	26.71	300	204	P	V	
		5942	54.94	-13.26	68.2	42.2	32.78	6.7	26.74	300	204	P	V	
														V
														V
													V	
Remark	1. No other spurious found. 2. All results are PASS against Peak and Average limit line.													



Band 4 5725~5850MHz

WIFI 802.11a (Harmonic @ 3m)

WIFI Ant. 6+7	Note	Frequency (MHz)	Level (dBμV/m)	Margin (dB)	Limit Line (dBμV/m)	Read Level (dBμV)	Antenna Factor (dB/m)	Path Loss (dB)	Preamp Factor (dB)	Ant Pos (cm)	Table Pos (deg)	Peak Avg. (P/A)	Pol. (H/V)	
802.11a CH 149 5745MHz		11490	45.76	-28.24	74	51.29	40.17	10.38	56.08	-	-	P	H	
		17235	48.18	-20.02	68.2	51.32	40.57	12.86	56.57	-	-	P	H	
													H	
													H	
													H	
													H	
													H	
													H	
													H	
													H	
													H	
													H	
			11490	45.63	-28.37	74	51.16	40.17	10.38	56.08	-	-	P	V
			17235	48.35	-19.85	68.2	51.49	40.57	12.86	56.57	-	-	P	V
														V
														V
														V
														V
													V	
													V	
													V	



WIFI Ant. 6+7	Note	Frequency (MHz)	Level (dBμV/m)	Margin (dB)	Limit Line (dBμV/m)	Read Level (dBμV)	Antenna Factor (dB/m)	Path Loss (dB)	Preamp Factor (dB)	Ant Pos (cm)	Table Pos (deg)	Peak Avg. (P/A)	Pol. (H/V)
802.11a CH 157 5785MHz		11570	46.05	-27.95	74	51.65	40.06	10.41	56.07	-	-	P	H
		17355	50.4	-17.8	68.2	53.17	41.03	12.99	56.79	-	-	P	H
													H
													H
													H
													H
													H
													H
													H
													H
													H
													H
													H
													H
													H
													H
													H
													H
													H
			11570	45.48	-28.52	74	51.08	40.06	10.41	56.07	-	-	P
		17355	48.84	-19.36	68.2	51.61	41.03	12.99	56.79	-	-	P	V
													V
													V
													V
													V
													V
													V
													V
													V
													V
													V
													V
													V
													V
													V
													V



WiFi Ant. 6+7	Note	Frequency (MHz)	Level (dBµV/m)	Margin (dB)	Limit Line (dBµV/m)	Read Level (dBµV)	Antenna Factor (dB/m)	Path Loss (dB)	Preamp Factor (dB)	Ant Pos (cm)	Table Pos (deg)	Peak Avg. (P/A)	Pol. (H/V)
802.11a CH 165 5825MHz		11650	46	-28	74	51.87	39.75	10.45	56.07	-	-	P	H
		17475	49.75	-18.45	68.2	52.12	41.52	13.12	57.01	-	-	P	H
													H
													H
													H
													H
													H
													H
													H
													H
													H
													H
													H
													H
													H
													H
													H
													H
													H
			11650	46.35	-27.65	74	52.22	39.75	10.45	56.07	-	-	P
		17475	48.71	-19.49	68.2	51.08	41.52	13.12	57.01	-	-	P	V
													V
													V
													V
													V
													V
													V
													V
													V
													V
													V
													V
													V
Remark	<ol style="list-style-type: none"> No other spurious found. All results are PASS against Peak and Average limit line. The emission position marked as "-" means no suspected emission found with sufficient margin against limit line or noise floor only. 												



Band 4 5725~5850MHz
WIFI 802.11ax HE20_Full (Band Edge @ 3m)

WIFI Ant. 6+7	Note	Frequency (MHz)	Level (dBμV/m)	Margin (dB)	Limit Line (dBμV/m)	Read Level (dBμV)	Antenna Factor (dB/m)	Path Loss (dB)	Preamp Factor (dB)	Ant Pos (cm)	Table Pos (deg)	Peak Avg. (P/A)	Pol. (H/V)	
802.11ax HE20 Full CH 149 5745MHz		5623.8	60.19	-8.01	68.2	48.39	31.95	6.46	26.61	100	3	P	H	
		5698.6	64.43	-39.74	104.17	52.36	32.19	6.52	26.64	100	3	P	H	
		5718	76.57	-33.67	110.24	64.41	32.27	6.54	26.65	100	3	P	H	
		5725	86.66	-35.54	122.2	74.46	32.3	6.55	26.65	100	3	P	H	
	*	5745	118.47	-	-	106.19	32.38	6.56	26.66	100	3	P	H	
	*	5745	109.62	-	-	97.34	32.38	6.56	26.66	100	3	A	H	
														H
														H
			5606.2	57.83	-10.37	68.2	45.99	31.99	6.45	26.6	265	196	P	V
			5691.6	62.08	-36.93	99.01	50.05	32.15	6.52	26.64	265	196	P	V
			5719.4	79.52	-31.11	110.63	67.35	32.28	6.54	26.65	265	196	P	V
			5725	85.07	-37.13	122.2	72.87	32.3	6.55	26.65	265	196	P	V
	*		5745	116.51	-	-	104.23	32.38	6.56	26.66	265	196	P	V
	*		5745	108.33	-	-	96.05	32.38	6.56	26.66	265	196	A	V
													V	
													V	



WiFi Ant. 6+7	Note	Frequency (MHz)	Level (dBµV/m)	Margin (dB)	Limit Line (dBµV/m)	Read Level (dBµV)	Antenna Factor (dB/m)	Path Loss (dB)	Preamp Factor (dB)	Ant Pos (cm)	Table Pos (deg)	Peak Avg. (P/A)	Pol. (H/V)
		5610.4	57.69	-10.51	68.2	45.86	31.98	6.45	26.6	100	3	P	H
		5692.2	58.63	-40.82	99.45	46.6	32.15	6.52	26.64	100	3	P	H
		5719.2	60.17	-50.41	110.58	48	32.28	6.54	26.65	100	3	P	H
		5725	60.34	-61.86	122.2	48.14	32.3	6.55	26.65	100	3	P	H
	*	5785	118.04	-	-	105.71	32.4	6.6	26.67	100	3	P	H
	*	5785	109.93	-	-	97.6	32.4	6.6	26.67	100	3	A	H
		5853	58.28	-57.08	115.36	45.83	32.51	6.64	26.7	100	3	P	H
		5874.2	57.95	-47.47	105.42	45.4	32.6	6.66	26.71	100	3	P	H
		5875.2	57.38	-47.67	105.05	44.83	32.6	6.66	26.71	100	3	P	H
		5944.8	54.8	-13.4	68.2	42.05	32.79	6.7	26.74	100	3	P	H
802.11ax													H
HE20 Full													H
CH 157		5642.2	57.05	-11.15	68.2	45.27	31.92	6.48	26.62	400	207	P	V
5785MHz		5666.2	57.08	-23.14	80.22	45.21	32	6.5	26.63	400	207	P	V
		5717.4	58	-52.07	110.07	45.84	32.27	6.54	26.65	400	207	P	V
		5724.4	57.76	-63.07	120.83	45.56	32.3	6.55	26.65	400	207	P	V
	*	5785	118.93	-	-	106.6	32.4	6.6	26.67	400	207	P	V
	*	5785	108.49	-	-	96.16	32.4	6.6	26.67	400	207	A	V
		5852.6	56.07	-60.2	116.27	43.62	32.51	6.64	26.7	400	207	P	V
		5856.8	56.71	-53.59	110.3	44.23	32.53	6.65	26.7	400	207	P	V
		5904	57.1	-26.6	83.7	44.43	32.71	6.68	26.72	400	207	P	V
		5927.2	54.71	-13.49	68.2	42	32.75	6.69	26.73	400	207	P	V
													V
													V



WiFi Ant. 6+7	Note	Frequency (MHz)	Level (dBμV/m)	Margin (dB)	Limit Line (dBμV/m)	Read Level (dBμV)	Antenna Factor (dB/m)	Path Loss (dB)	Preamp Factor (dB)	Ant Pos (cm)	Table Pos (deg)	Peak Avg. (P/A)	Pol. (H/V)	
802.11ax HE20 Full CH 165 5825MHz	*	5825	118.21	-	-	105.82	32.45	6.63	26.69	100	355	P	H	
	*	5825	109.86	-	-	97.47	32.45	6.63	26.69	100	355	A	H	
		5851	80.45	-39.47	119.92	68.01	32.5	6.64	26.7	100	355	P	H	
		5856.2	72.19	-38.27	110.46	59.72	32.52	6.65	26.7	100	355	P	H	
		5875.8	65.12	-39.49	104.61	52.57	32.6	6.66	26.71	100	355	P	H	
		5946.4	56.23	-11.97	68.2	43.47	32.79	6.71	26.74	100	355	P	H	
														H
														H
	*	5825	117.97	-	-	105.58	32.45	6.63	26.69	393	203	P	V	
	*	5825	108.65	-	-	96.26	32.45	6.63	26.69	393	203	A	V	
		5850.4	80.16	-41.13	121.29	67.72	32.5	6.64	26.7	393	203	P	V	
		5855.8	73.54	-37.04	110.58	61.07	32.52	6.65	26.7	393	203	P	V	
		5878.4	60.48	-42.19	102.67	47.92	32.61	6.66	26.71	393	203	P	V	
		5933	55.9	-12.3	68.2	43.16	32.77	6.7	26.73	393	203	P	V	
													V	
													V	
Remark	1. No other spurious found. 2. All results are PASS against Peak and Average limit line.													



Band 4 5725~5850MHz

WIFI 802.11ax HE20 Full (Harmonic @ 3m)

WIFI Ant. 6+7	Note	Frequency (MHz)	Level (dBμV/m)	Margin (dB)	Limit Line (dBμV/m)	Read Level (dBμV)	Antenna Factor (dB/m)	Path Loss (dB)	Preamp Factor (dB)	Ant Pos (cm)	Table Pos (deg)	Peak Avg. (P/A)	Pol. (H/V)
802.11ax HE20 Full CH 149 5745MHz		11490	45.54	-28.46	74	51.07	40.17	10.38	56.08	-	-	P	H
		17235	48.86	-19.34	68.2	52	40.57	12.86	56.57	-	-	P	H
													H
													H
													H
													H
													H
													H
													H
													H
													H
													H
													H
													H
													H
													H
													H
			11490	46.79	-27.21	74	52.32	40.17	10.38	56.08	-	-	P
		17235	47.77	-20.43	68.2	50.91	40.57	12.86	56.57	-	-	P	V
													V
													V
													V
													V
													V
													V
													V
													V
													V
													V



WIFI Ant. 6+7	Note	Frequency (MHz)	Level (dBμV/m)	Margin (dB)	Limit Line (dBμV/m)	Read Level (dBμV)	Antenna Factor (dB/m)	Path Loss (dB)	Preamp Factor (dB)	Ant Pos (cm)	Table Pos (deg)	Peak Avg. (P/A)	Pol. (H/V)	
802.11ax HE20 Full CH 157 5785MHz		11570	45.21	-28.79	74	50.81	40.06	10.41	56.07	-	-	P	H	
		17355	50.14	-18.06	68.2	52.91	41.03	12.99	56.79	-	-	P	H	
													H	
													H	
													H	
													H	
													H	
													H	
													H	
													H	
													H	
													H	
													H	
													H	
													H	
													H	
													H	
			11570	45.13	-28.87	74	50.73	40.06	10.41	56.07	-	-	P	V
			17355	49.88	-18.32	68.2	52.65	41.03	12.99	56.79	-	-	P	V
													V	
													V	
													V	
													V	
													V	
													V	
													V	
													V	
													V	
													V	
													V	
													V	
													V	



WiFi Ant. 6+7	Note	Frequency (MHz)	Level (dBμV/m)	Margin (dB)	Limit Line (dBμV/m)	Read Level (dBμV)	Antenna Factor (dB/m)	Path Loss (dB)	Preamp Factor (dB)	Ant Pos (cm)	Table Pos (deg)	Peak Avg. (P/A)	Pol. (H/V)
802.11ax HE20 Full CH 165 5825MHz		11650	46.02	-27.98	74	51.89	39.75	10.45	56.07	-	-	P	H
		17475	49.52	-18.68	68.2	51.89	41.52	13.12	57.01	-	-	P	H
													H
													H
													H
													H
													H
													H
													H
													H
													H
													H
													H
													H
													H
													H
													H
													H
													H
	Remark	1. No other spurious found. 2. All results are PASS against Peak and Average limit line. 3. The emission position marked as "-" means no suspected emission found with sufficient margin against limit line or noise floor only.											



Band 4 5725~5850MHz
WIFI 802.11ax HE20_Partial 106 (Band Edge @ 3m)

WIFI Ant. 6+7	Note	Frequency (MHz)	Level (dBμV/m)	Margin (dB)	Limit Line (dBμV/m)	Read Level (dBμV)	Antenna Factor (dB/m)	Path Loss (dB)	Preamp Factor (dB)	Ant Pos (cm)	Table Pos (deg)	Peak Avg. (P/A)	Pol. (H/V)	
802.11ax HE20 Partial 106/53 CH 149 5745MHz		5643.6	59.81	-8.39	68.2	48.04	31.91	6.48	26.62	100	5	P	H	
		5697.4	62.03	-41.25	103.28	49.97	32.18	6.52	26.64	100	5	P	H	
		5719	71.67	-38.85	110.52	59.5	32.28	6.54	26.65	100	5	P	H	
		5722.6	81.9	-34.83	116.73	69.72	32.29	6.54	26.65	100	5	P	H	
	*	5745	119.55	-	-	107.27	32.38	6.56	26.66	100	5	P	H	
	*	5745	110.46	-	-	98.18	32.38	6.56	26.66	100	5	A	H	
														H
														H
			5636.2	58.49	-9.71	68.2	46.7	31.93	6.47	26.61	361	211	P	V
			5693.4	61.15	-39.18	100.33	49.11	32.16	6.52	26.64	361	211	P	V
			5718.6	73.18	-37.23	110.41	61.02	32.27	6.54	26.65	361	211	P	V
			5723.6	78.41	-40.6	119.01	66.22	32.29	6.55	26.65	361	211	P	V
	*		5745	118.91	-	-	106.63	32.38	6.56	26.66	361	211	P	V
	*		5745	110.02	-	-	97.74	32.38	6.56	26.66	361	211	A	V
														V
													V	



WiFi Ant. 6+7	Note	Frequency (MHz)	Level (dBμV/m)	Margin (dB)	Limit Line (dBμV/m)	Read Level (dBμV)	Antenna Factor (dB/m)	Path Loss (dB)	Preamp Factor (dB)	Ant Pos (cm)	Table Pos (deg)	Peak Avg. (P/A)	Pol. (H/V)	
802.11ax HE20 Partial 106/54 CH 165 5825MHz	*	5825	118.94	-	-	106.55	32.45	6.63	26.69	100	4	P	H	
	*	5825	109.67	-	-	97.28	32.45	6.63	26.69	100	4	A	H	
		5851.2	70.99	-48.47	119.46	58.55	32.5	6.64	26.7	100	4	P	H	
		5855.4	64.29	-46.4	110.69	51.82	32.52	6.65	26.7	100	4	P	H	
		5875.4	59.93	-44.97	104.9	47.38	32.6	6.66	26.71	100	4	P	H	
		5944.6	55.65	-12.55	68.2	42.9	32.79	6.7	26.74	100	4	P	H	
														H
														H
	*	5825	118.24	-	-	105.85	32.45	6.63	26.69	372	199	P	V	
	*	5825	109.36	-	-	96.97	32.45	6.63	26.69	372	199	A	V	
		5854.4	73.43	-38.74	112.17	60.96	32.52	6.65	26.7	372	199	P	V	
		5857.2	71.57	-38.61	110.18	59.09	32.53	6.65	26.7	372	199	P	V	
		5876	59.94	-44.52	104.46	47.39	32.6	6.66	26.71	372	199	P	V	
		5928.2	55.52	-12.68	68.2	42.8	32.76	6.69	26.73	372	199	P	V	
														V
													V	
Remark	1. No other spurious found. 2. All results are PASS against Peak and Average limit line.													



Band 4 5725~5850MHz
WIFI 802.11ax HE40_Full (Band Edge @ 3m)

WIFI Ant. 6+7	Note	Frequency (MHz)	Level (dBμV/m)	Margin (dB)	Limit Line (dBμV/m)	Read Level (dBμV)	Antenna Factor (dB/m)	Path Loss (dB)	Preamp Factor (dB)	Ant Pos (cm)	Table Pos (deg)	Peak Avg. (P/A)	Pol. (H/V)
		5627.8	60.74	-7.46	68.2	48.95	31.94	6.46	26.61	100	355	P	H
		5699	68.74	-35.72	104.46	56.67	32.19	6.52	26.64	100	355	P	H
		5719.2	85	-25.58	110.58	72.83	32.28	6.54	26.65	100	355	P	H
		5723.6	88.79	-30.22	119.01	76.6	32.29	6.55	26.65	100	355	P	H
	*	5755	114.29	-	-	101.98	32.4	6.57	26.66	100	355	P	H
	*	5755	104.58	-	-	92.27	32.4	6.57	26.66	100	355	A	H
		5851.2	60.21	-59.25	119.46	47.77	32.5	6.64	26.7	100	355	P	H
		5861.4	60.22	-48.79	109.01	47.72	32.55	6.65	26.7	100	355	P	H
		5876.4	59.74	-44.42	104.16	47.18	32.61	6.66	26.71	100	355	P	H
		5939	57.91	-10.29	68.2	45.17	32.78	6.7	26.74	100	355	P	H
802.11ax													H
HE40 Full													H
CH 151		5624.4	61.86	-6.34	68.2	50.06	31.95	6.46	26.61	384	209	P	V
5755MHz		5699	69.86	-34.6	104.46	57.79	32.19	6.52	26.64	384	209	P	V
		5716.6	84.11	-25.74	109.85	71.95	32.27	6.54	26.65	384	209	P	V
		5721	86.11	-26.97	113.08	73.94	32.28	6.54	26.65	384	209	P	V
	*	5755	113.83	-	-	101.52	32.4	6.57	26.66	384	209	P	V
	*	5755	103.35	-	-	91.04	32.4	6.57	26.66	384	209	A	V
		5854.2	59.73	-52.89	112.62	47.26	32.52	6.65	26.7	384	209	P	V
		5856	60.48	-50.04	110.52	48.01	32.52	6.65	26.7	384	209	P	V
		5875.6	59.18	-45.57	104.75	46.63	32.6	6.66	26.71	384	209	P	V
		5925.2	58.21	-9.99	68.2	45.5	32.75	6.69	26.73	384	209	P	V
													V
													V



WIFI Ant. 6+7	Note	Frequency (MHz)	Level (dBμV/m)	Margin (dB)	Limit Line (dBμV/m)	Read Level (dBμV)	Antenna Factor (dB/m)	Path Loss (dB)	Preamp Factor (dB)	Ant Pos (cm)	Table Pos (deg)	Peak Avg. (P/A)	Pol. (H/V)
		5647.8	55.78	-12.42	68.2	44.02	31.9	6.48	26.62	100	355	P	H
		5698	58.43	-45.3	103.73	46.36	32.19	6.52	26.64	100	355	P	H
		5720	63.35	-47.45	110.8	51.18	32.28	6.54	26.65	100	355	P	H
		5723.2	63.91	-54.19	118.1	51.73	32.29	6.54	26.65	100	355	P	H
	*	5795	113.19	-	-	100.86	32.4	6.61	26.68	100	355	P	H
	*	5795	104.38	-	-	92.05	32.4	6.61	26.68	100	355	A	H
		5851	67.62	-52.3	119.92	55.18	32.5	6.64	26.7	100	355	P	H
		5856.4	66.17	-44.24	110.41	53.69	32.53	6.65	26.7	100	355	P	H
		5879	62.17	-40.06	102.23	49.6	32.62	6.66	26.71	100	355	P	H
		5928.6	55.47	-12.73	68.2	42.75	32.76	6.69	26.73	100	355	P	H
802.11ax													H
HE40 Full													H
CH 159		5641.4	56.83	-11.37	68.2	45.05	31.92	6.48	26.62	400	203	P	V
5795MHz		5695.4	57.3	-44.51	101.81	45.25	32.17	6.52	26.64	400	203	P	V
		5719.6	60.59	-50.1	110.69	48.42	32.28	6.54	26.65	400	203	P	V
		5722.4	61.23	-55.04	116.27	49.05	32.29	6.54	26.65	400	203	P	V
	*	5795	112.47	-	-	100.14	32.4	6.61	26.68	400	203	P	V
	*	5795	103.29	-	-	90.96	32.4	6.61	26.68	400	203	A	V
		5850.8	67.38	-53	120.38	54.94	32.5	6.64	26.7	400	203	P	V
		5860.6	65.61	-43.62	109.23	53.12	32.54	6.65	26.7	400	203	P	V
		5875.4	61.49	-43.41	104.9	48.94	32.6	6.66	26.71	400	203	P	V
		5939.6	56	-12.2	68.2	43.26	32.78	6.7	26.74	400	203	P	V
													V
													V
Remark	1. No other spurious found. 2. All results are PASS against Peak and Average limit line.												



Band 4 5725~5850MHz

WIFI 802.11ax HE40_Full (Harmonic @ 3m)

WIFI Ant. 6+7	Note	Frequency (MHz)	Level (dBμV/m)	Margin (dB)	Limit Line (dBμV/m)	Read Level (dBμV)	Antenna Factor (dB/m)	Path Loss (dB)	Preamp Factor (dB)	Ant Pos (cm)	Table Pos (deg)	Peak Avg. (P/A)	Pol. (H/V)	
802.11ax HE40 Full CH 151 5755MHz		11510	45.76	-28.24	74	51.27	40.18	10.38	56.07	-	-	P	H	
		17265	47.45	-20.75	68.2	50.56	40.63	12.89	56.63	-	-	P	H	
													H	
													H	
													H	
													H	
													H	
													H	
													H	
													H	
													H	
													H	
													H	
													H	
													H	
													H	
													H	
			11510	46.49	-27.51	74	52	40.18	10.38	56.07	-	-	P	V
			17265	47.75	-20.45	68.2	50.86	40.63	12.89	56.63	-	-	P	V
													V	
													V	
													V	
													V	
													V	
													V	
													V	
													V	
													V	
													V	
													V	
													V	
													V	



WiFi Ant. 6+7	Note	Frequency (MHz)	Level (dBμV/m)	Margin (dB)	Limit Line (dBμV/m)	Read Level (dBμV)	Antenna Factor (dB/m)	Path Loss (dB)	Preamp Factor (dB)	Ant Pos (cm)	Table Pos (deg)	Peak Avg. (P/A)	Pol. (H/V)	
802.11ax HE40 Full CH 159 5795MHz		11590	45.57	-28.43	74	51.2	40.02	10.42	56.07	-	-	P	H	
		17385	48.77	-19.43	68.2	51.39	41.21	13.02	56.85	-	-	P	H	
													H	
													H	
													H	
													H	
													H	
													H	
													H	
													H	
													H	
													H	
													H	
													H	
													H	
													H	
													H	
													H	
			11590	46.02	-27.98	74	51.65	40.02	10.42	56.07	-	-	P	V
			17385	50.12	-18.08	68.2	52.74	41.21	13.02	56.85	-	-	P	V
													V	
													V	
													V	
													V	
													V	
													V	
													V	
													V	
													V	
													V	
													V	
													V	
Remark	<ol style="list-style-type: none"> No other spurious found. All results are PASS against Peak and Average limit line. The emission position marked as "-" means no suspected emission found with sufficient margin against limit line or noise floor only. 													



Band 4 5725~5850MHz
WIFI 802.11ax HE80_Full (Band Edge @ 3m)

WIFI Ant. 6+7	Note	Frequency (MHz)	Level (dBμV/m)	Margin (dB)	Limit Line (dBμV/m)	Read Level (dBμV)	Antenna Factor (dB/m)	Path Loss (dB)	Preamp Factor (dB)	Ant Pos (cm)	Table Pos (deg)	Peak Avg. (P/A)	Pol. (H/V)
		5642.4	64.45	-3.75	68.2	52.67	31.92	6.48	26.62	100	359	P	H
		5650.2	65.67	-2.68	68.35	53.91	31.9	6.48	26.62	100	359	P	H
		5715.2	82.75	-26.71	109.46	70.6	32.26	6.54	26.65	100	359	P	H
		5722.4	85.29	-30.98	116.27	73.11	32.29	6.54	26.65	100	359	P	H
	*	5775	110.06	-	-	97.74	32.4	6.59	26.67	100	359	P	H
	*	5775	101.38	-	-	89.06	32.4	6.59	26.67	100	359	A	H
		5854.6	78.7	-33.01	111.71	66.23	32.52	6.65	26.7	100	359	P	H
		5857	78.26	-31.98	110.24	65.78	32.53	6.65	26.7	100	359	P	H
		5875.2	72.06	-32.99	105.05	59.51	32.6	6.66	26.71	100	359	P	H
		5947.4	61.83	-6.37	68.2	49.07	32.79	6.71	26.74	100	359	P	H
802.11ax													H
HE80 Full													H
CH 155		5649.6	65.59	-2.61	68.2	53.83	31.9	6.48	26.62	400	203	P	V
5775MHz		5665.4	73.18	-6.45	79.63	61.32	31.99	6.5	26.63	400	203	P	V
		5718.6	82.54	-27.87	110.41	70.38	32.27	6.54	26.65	400	203	P	V
		5725	80.93	-41.27	122.2	68.73	32.3	6.55	26.65	400	203	P	V
	*	5775	109.07	-	-	96.75	32.4	6.59	26.67	400	203	P	V
	*	5775	100.52	-	-	88.2	32.4	6.59	26.67	400	203	A	V
		5852.4	78.11	-38.62	116.73	65.66	32.51	6.64	26.7	400	203	P	V
		5855.8	78.86	-31.72	110.58	66.39	32.52	6.65	26.7	400	203	P	V
		5875.6	73.45	-31.3	104.75	60.9	32.6	6.66	26.71	400	203	P	V
		5929.4	63	-5.2	68.2	50.28	32.76	6.69	26.73	400	203	P	V
													V
													V
Remark	1. No other spurious found. 2. All results are PASS against Peak and Average limit line.												



Band 4 5725~5850MHz

WIFI 802.11ax HE80_Full (Harmonic @ 3m)

WIFI Ant. 6+7	Note	Frequency (MHz)	Level (dBμV/m)	Margin (dB)	Limit Line (dBμV/m)	Read Level (dBμV)	Antenna Factor (dB/m)	Path Loss (dB)	Preamp Factor (dB)	Ant Pos (cm)	Table Pos (deg)	Peak Avg. (P/A)	Pol. (H/V)	
802.11ax HE80 Full CH 155 5775MHz		11550	46.83	-27.17	74	52.4	40.1	10.4	56.07	-	-	P	H	
		17325	47.85	-20.35	68.2	50.79	40.85	12.95	56.74	-	-	P	H	
													H	
													H	
													H	
													H	
													H	
													H	
													H	
													H	
													H	
													H	
													H	
													H	
													H	
													H	
													H	
													H	
			11550	46.88	-27.12	74	52.45	40.1	10.4	56.07	-	-	P	V
			17325	47.89	-20.31	68.2	50.83	40.85	12.95	56.74	-	-	P	V
													V	
													V	
													V	
													V	
													V	
													V	
													V	
													V	
													V	
													V	
													V	
													V	
Remark	<ol style="list-style-type: none"> No other spurious found. All results are PASS against Peak and Average limit line. The emission position marked as "-" means no suspected emission found with sufficient margin against limit line or noise floor only. 													



Emission below 1GHz

5GHz WIFI 802.11ax HE80 Full (LF @ 3m)

WIFI	Note	Frequency	Level	Margin	Limit	Read	Antenna	Path	Preamp	Ant	Table	Peak	Pol.	
Ant.					Line	Level	Factor	Loss	Factor	Pos	Pos	Avg.		
6+7		(MHz)	(dBμV/m)	(dB)	(dBμV/m)	(dBμV)	(dB/m)	(dB)	(dB)	(cm)	(deg)	(P/A)	(H/V)	
802.11ax HE80 Full LF		30.97	22.27	-17.73	40	29.66	24.24	0.72	32.35	-	-	P	H	
		134.76	18.5	-25	43.5	32.22	17.42	1.15	32.29	-	-	P	H	
		297.72	19.26	-26.74	46	30.45	19.39	1.59	32.17	-	-	P	H	
		426.73	23.48	-22.52	46	30.75	23	1.91	32.18	-	-	P	H	
		765.26	32.19	-13.81	46	33.88	28.07	2.35	32.11	-	-	P	H	
		860.32	31.59	-14.41	46	31.54	29.19	2.59	31.73	-	-	P	H	
														H
														H
														H
														H
														H
														H
														H
			30	22.19	-17.81	40	29.28	24.53	0.72	32.34	-	-	P	V
			66.86	16.94	-23.06	40	36.18	12.15	0.91	32.3	-	-	P	V
			113.42	20.87	-22.63	43.5	34.97	17.1	1.11	32.31	-	-	P	V
			260.86	18.5	-27.5	46	29.17	20.05	1.5	32.22	-	-	P	V
			745.86	30.23	-15.77	46	32.14	27.93	2.32	32.16	-	-	P	V
			896.21	31.64	-14.36	46	31.68	28.97	2.54	31.55	-	-	P	V
														V
													V	
													V	
													V	
													V	
													V	

Remark

- No other spurious found.
- All results are PASS against limit line.
- The emission position marked as "-" means no suspected emission found and emission level has at least 6dB margin against limit or emission is noise floor only.



<TXBF Mode>

Band 4 - 5725~5850MHz

WIFI 802.11ax HE20_Full (Band Edge @ 3m)

WIFI Ant.	Note	Frequency	Level	Margin	Limit Line	Read Level	Antenna Factor	Path Loss	Preamp Factor	Ant Pos	Table Pos	Peak Avg.	Pol.	
6+7		(MHz)	(dBμV/m)	(dB)	(dBμV/m)	(dBμV)	(dB/m)	(dB)	(dB)	(cm)	(deg)	(P/A)	(H/V)	
802.11ax HE20 Full CH 149 5745MHz		5633.2	59.91	-8.29	68.2	48.12	31.93	6.47	26.61	100	353	P	H	
		5696.2	64.7	-37.7	102.4	52.64	32.18	6.52	26.64	100	353	P	H	
		5719.4	78.24	-32.39	110.63	66.07	32.28	6.54	26.65	100	353	P	H	
		5724.8	85.98	-35.76	121.74	73.78	32.3	6.55	26.65	100	353	P	H	
	*	5745	118.48	-	-	106.2	32.38	6.56	26.66	100	353	P	H	
	*	5745	108.83	-	-	96.55	32.38	6.56	26.66	100	353	A	H	
														H
														H
			5646	56.82	-11.38	68.2	45.05	31.91	6.48	26.62	250	194	P	V
			5693.6	61.05	-39.43	100.48	49.01	32.16	6.52	26.64	250	194	P	V
			5718.8	77.86	-32.6	110.46	65.69	32.28	6.54	26.65	250	194	P	V
			5724.8	86.21	-35.53	121.74	74.01	32.3	6.55	26.65	250	194	P	V
		*	5745	116.99	-	-	104.71	32.38	6.56	26.66	250	194	P	V
		*	5745	107.94	-	-	95.66	32.38	6.56	26.66	250	194	A	V
													V	
													V	



WIFI Ant. 6+7	Note	Frequency (MHz)	Level (dBμV/m)	Margin (dB)	Limit Line (dBμV/m)	Read Level (dBμV)	Antenna Factor (dB/m)	Path Loss (dB)	Preamp Factor (dB)	Ant Pos (cm)	Table Pos (deg)	Peak Avg. (P/A)	Pol. (H/V)
		5634.6	56.93	-11.27	68.2	45.14	31.93	6.47	26.61	100	353	P	H
		5686.4	57.7	-37.47	95.17	45.7	32.12	6.51	26.63	100	353	P	H
		5717.4	58.95	-51.12	110.07	46.79	32.27	6.54	26.65	100	353	P	H
		5721.2	59.03	-54.51	113.54	46.86	32.28	6.54	26.65	100	353	P	H
	*	5785	118.1	-	-	105.77	32.4	6.6	26.67	100	353	P	H
	*	5785	109	-	-	96.67	32.4	6.6	26.67	100	353	A	H
		5850	57.75	-64.45	122.2	45.31	32.5	6.64	26.7	100	353	P	H
		5872	57.86	-48.18	106.04	45.32	32.59	6.66	26.71	100	353	P	H
		5876.6	55.35	-48.66	104.01	42.79	32.61	6.66	26.71	100	353	P	H
		5929.4	53.93	-14.27	68.2	41.21	32.76	6.69	26.73	100	353	P	H
802.11ax													H
HE20 Full													H
CH 157		5649.6	54.81	-13.39	68.2	43.05	31.9	6.48	26.62	265	194	P	V
5785MHz		5691.2	57.15	-41.56	98.71	45.12	32.15	6.52	26.64	265	194	P	V
		5717.6	58.41	-51.72	110.13	46.25	32.27	6.54	26.65	265	194	P	V
		5721.6	59.43	-55.02	114.45	47.25	32.29	6.54	26.65	265	194	P	V
	*	5785	116.71	-	-	104.38	32.4	6.6	26.67	265	194	P	V
	*	5785	107.64	-	-	95.31	32.4	6.6	26.67	265	194	A	V
		5855	55.43	-55.37	110.8	42.96	32.52	6.65	26.7	265	194	P	V
		5856.2	55.7	-54.76	110.46	43.23	32.52	6.65	26.7	265	194	P	V
		5892.8	55.41	-36.58	91.99	42.79	32.67	6.67	26.72	265	194	P	V
		5936.4	54.13	-14.07	68.2	41.39	32.77	6.7	26.73	265	194	P	V
													V
													V



WiFi Ant. 6+7	Note	Frequency (MHz)	Level (dBμV/m)	Margin (dB)	Limit Line (dBμV/m)	Read Level (dBμV)	Antenna Factor (dB/m)	Path Loss (dB)	Preamp Factor (dB)	Ant Pos (cm)	Table Pos (deg)	Peak Avg. (P/A)	Pol. (H/V)	
802.11ax HE20 Full CH 165 5825MHz	*	5825	118.38	-	-	105.99	32.45	6.63	26.69	100	353	P	H	
	*	5825	109.14	-	-	96.75	32.45	6.63	26.69	100	353	A	H	
		5851.4	73.93	-45.08	119.01	61.48	32.51	6.64	26.7	100	353	P	H	
		5856.6	70.57	-39.78	110.35	58.09	32.53	6.65	26.7	100	353	P	H	
		5876.4	59.21	-44.95	104.16	46.65	32.61	6.66	26.71	100	353	P	H	
		5925.8	56	-12.2	68.2	43.29	32.75	6.69	26.73	100	353	P	H	
														H
														H
	*	5825	115.02	-	-	102.63	32.45	6.63	26.69	244	194	P	V	
	*	5825	107.09	-	-	94.7	32.45	6.63	26.69	244	194	A	V	
		5850	74.89	-47.31	122.2	62.45	32.5	6.64	26.7	244	194	P	V	
		5855.2	70.47	-40.27	110.74	58	32.52	6.65	26.7	244	194	P	V	
		5875.8	57.93	-46.68	104.61	45.38	32.6	6.66	26.71	244	194	P	V	
		5937	54.46	-13.74	68.2	41.72	32.77	6.7	26.73	244	194	P	V	
													V	
													V	
Remark	1. No other spurious found. 2. All results are PASS against Peak and Average limit line.													



Band 4 5725~5850MHz

WIFI 802.11ax HE20 Full (Harmonic @ 3m)

WIFI Ant. 6+7	Note	Frequency (MHz)	Level (dBμV/m)	Margin (dB)	Limit Line (dBμV/m)	Read Level (dBμV)	Antenna Factor (dB/m)	Path Loss (dB)	Preamp Factor (dB)	Ant Pos (cm)	Table Pos (deg)	Peak Avg. (P/A)	Pol. (H/V)	
802.11ax HE20 Full CH 149 5745MHz		11490	46.65	-27.35	74	52.18	40.17	10.38	56.08	-	-	P	H	
		17235	47.32	-20.88	68.2	50.46	40.57	12.86	56.57	-	-	P	H	
													H	
													H	
													H	
													H	
													H	
													H	
													H	
													H	
													H	
													H	
													H	
													H	
													H	
													H	
			11490	45.81	-28.19	74	51.34	40.17	10.38	56.08	-	-	P	V
			17235	48.55	-19.65	68.2	51.69	40.57	12.86	56.57	-	-	P	V
													V	
													V	
													V	
													V	
													V	
													V	
													V	
													V	
													V	



WIFI Ant. 6+7	Note	Frequency (MHz)	Level (dBμV/m)	Margin (dB)	Limit Line (dBμV/m)	Read Level (dBμV)	Antenna Factor (dB/m)	Path Loss (dB)	Preamp Factor (dB)	Ant Pos (cm)	Table Pos (deg)	Peak Avg. (P/A)	Pol. (H/V)
802.11ax HE20 Full CH 157 5785MHz		11570	46.03	-27.97	74	51.63	40.06	10.41	56.07	-	-	P	H
		17355	47.85	-20.35	68.2	50.62	41.03	12.99	56.79	-	-	P	H
													H
													H
													H
													H
													H
													H
													H
													H
													H
													H
													H
													H
													H
													H
													H
													H
													H
			11570	46.21	-27.79	74	51.81	40.06	10.41	56.07	-	-	P
		17355	49.18	-19.02	68.2	51.95	41.03	12.99	56.79	-	-	P	V
													V
													V
													V
													V
													V
													V
													V
													V
													V
													V
													V
													V
													V
													V
													V



WiFi Ant. 6+7	Note	Frequency (MHz)	Level (dBμV/m)	Margin (dB)	Limit Line (dBμV/m)	Read Level (dBμV)	Antenna Factor (dB/m)	Path Loss (dB)	Preamp Factor (dB)	Ant Pos (cm)	Table Pos (deg)	Peak Avg. (P/A)	Pol. (H/V)
802.11ax HE20 Full CH 165 5825MHz		11650	46.64	-27.36	74	52.51	39.75	10.45	56.07	-	-	P	H
		17475	49.81	-18.39	68.2	52.18	41.52	13.12	57.01	-	-	P	H
													H
													H
													H
													H
													H
													H
													H
													H
													H
													H
													H
													H
													H
													H
													H
													H
													H
	Remark	1. No other spurious found. 2. All results are PASS against Peak and Average limit line. 3. The emission position marked as "-" means no suspected emission found with sufficient margin against limit line or noise floor only.											



Band 4 5725~5850MHz
WIFI 802.11ax HE40_Full (Band Edge @ 3m)

WIFI Ant. 6+7	Note	Frequency (MHz)	Level (dBμV/m)	Margin (dB)	Limit Line (dBμV/m)	Read Level (dBμV)	Antenna Factor (dB/m)	Path Loss (dB)	Preamp Factor (dB)	Ant Pos (cm)	Table Pos (deg)	Peak Avg. (P/A)	Pol. (H/V)
		5631.8	59.19	-9.01	68.2	47.39	31.94	6.47	26.61	100	354	P	H
		5697.4	68.4	-34.88	103.28	56.34	32.18	6.52	26.64	100	354	P	H
		5707.4	79.62	-27.65	107.27	67.5	32.23	6.53	26.64	100	354	P	H
		5720	83.83	-26.97	110.8	71.66	32.28	6.54	26.65	100	354	P	H
	*	5755	114.7	-	-	102.39	32.4	6.57	26.66	100	354	P	H
	*	5755	103.65	-	-	91.34	32.4	6.57	26.66	100	354	A	H
		5851.6	58.39	-60.16	118.55	45.94	32.51	6.64	26.7	100	354	P	H
		5867	59.18	-48.26	107.44	46.67	32.57	6.65	26.71	100	354	P	H
		5878.2	57.91	-44.91	102.82	45.35	32.61	6.66	26.71	100	354	P	H
		5927.6	56.56	-11.64	68.2	43.84	32.76	6.69	26.73	100	354	P	H
802.11ax													H
HE40 Full													H
CH 151		5606.2	59.22	-8.98	68.2	47.38	31.99	6.45	26.6	253	196	P	V
5755MHz		5691.6	66.35	-32.66	99.01	54.32	32.15	6.52	26.64	253	196	P	V
		5718.4	82.31	-28.04	110.35	70.15	32.27	6.54	26.65	253	196	P	V
		5723.2	85.77	-32.33	118.1	73.59	32.29	6.54	26.65	253	196	P	V
	*	5755	111.86	-	-	99.55	32.4	6.57	26.66	253	196	P	V
	*	5755	102.41	-	-	90.1	32.4	6.57	26.66	253	196	A	V
		5855	60.34	-50.46	110.8	47.87	32.52	6.65	26.7	253	196	P	V
		5867.6	57.54	-49.73	107.27	45.03	32.57	6.65	26.71	253	196	P	V
		5912.2	57.6	-20.04	77.64	44.92	32.72	6.68	26.72	253	196	P	V
		5927.2	56.69	-11.51	68.2	43.98	32.75	6.69	26.73	253	196	P	V
													V
													V



WIFI Ant. 6+7	Note	Frequency (MHz)	Level (dBµV/m)	Margin (dB)	Limit Line (dBµV/m)	Read Level (dBµV)	Antenna Factor (dB/m)	Path Loss (dB)	Preamp Factor (dB)	Ant Pos (cm)	Table Pos (deg)	Peak Avg. (P/A)	Pol. (H/V)
		5629	54.23	-13.97	68.2	42.44	31.94	6.46	26.61	106	354	P	H
		5699.2	58.27	-46.34	104.61	46.19	32.2	6.52	26.64	106	354	P	H
		5719.6	61.98	-48.71	110.69	49.81	32.28	6.54	26.65	106	354	P	H
		5725	61.57	-60.63	122.2	49.37	32.3	6.55	26.65	106	354	P	H
	*	5795	113.74	-	-	101.41	32.4	6.61	26.68	106	354	P	H
	*	5795	103.38	-	-	91.05	32.4	6.61	26.68	106	354	A	H
		5851.6	66.44	-52.11	118.55	53.99	32.51	6.64	26.7	106	354	P	H
		5855	65.03	-45.77	110.8	52.56	32.52	6.65	26.7	106	354	P	H
		5877	60.18	-43.53	103.71	47.62	32.61	6.66	26.71	106	354	P	H
		5932.4	53.3	-14.9	68.2	40.57	32.76	6.7	26.73	106	354	P	H
802.11ax													H
HE40 Full													H
CH 159		5605.8	54.71	-13.49	68.2	42.88	31.99	6.44	26.6	259	192	P	V
5795MHz		5687.6	57.15	-38.9	96.05	45.15	32.13	6.51	26.64	259	192	P	V
		5705.2	59.17	-47.49	106.66	47.06	32.22	6.53	26.64	259	192	P	V
		5720.8	61.16	-51.46	112.62	48.99	32.28	6.54	26.65	259	192	P	V
	*	5795	111.96	-	-	99.63	32.4	6.61	26.68	259	192	P	V
	*	5795	102.27	-	-	89.94	32.4	6.61	26.68	259	192	A	V
		5854	64.58	-48.5	113.08	52.11	32.52	6.65	26.7	259	192	P	V
		5856	65.18	-45.34	110.52	52.71	32.52	6.65	26.7	259	192	P	V
		5876.6	59.92	-44.09	104.01	47.36	32.61	6.66	26.71	259	192	P	V
		5932.4	53.96	-14.24	68.2	41.23	32.76	6.7	26.73	259	192	P	V
													V
													V
Remark	1. No other spurious found. 2. All results are PASS against Peak and Average limit line.												



Band 4 5725~5850MHz
WIFI 802.11ax HE40_Full (Harmonic @ 3m)

WIFI Ant. 6+7	Note	Frequency (MHz)	Level (dBμV/m)	Margin (dB)	Limit Line (dBμV/m)	Read Level (dBμV)	Antenna Factor (dB/m)	Path Loss (dB)	Preamp Factor (dB)	Ant Pos (cm)	Table Pos (deg)	Peak Avg. (P/A)	Pol. (H/V)
802.11ax HE40 Full CH 151 5755MHz		11510	47.2	-26.8	74	52.71	40.18	10.38	56.07	-	-	P	H
		17265	48.51	-19.69	68.2	51.62	40.63	12.89	56.63	-	-	P	H
													H
													H
													H
													H
													H
													H
													H
													H
													H
													H
													H
													H
													H
													H
													H
													H
													H
			11510	46.94	-27.06	74	52.45	40.18	10.38	56.07	-	-	P
		17265	48.11	-20.09	68.2	51.22	40.63	12.89	56.63	-	-	P	V
													V
													V
													V
													V
													V
													V
													V
													V
													V
													V
													V
													V
													V
													V



WiFi Ant. 6+7	Note	Frequency (MHz)	Level (dBμV/m)	Margin (dB)	Limit Line (dBμV/m)	Read Level (dBμV)	Antenna Factor (dB/m)	Path Loss (dB)	Preamp Factor (dB)	Ant Pos (cm)	Table Pos (deg)	Peak Avg. (P/A)	Pol. (H/V)	
802.11ax HE40 Full CH 159 5795MHz		11590	46.07	-27.93	74	51.7	40.02	10.42	56.07	-	-	P	H	
		17385	49.27	-18.93	68.2	51.89	41.21	13.02	56.85	-	-	P	H	
													H	
													H	
													H	
													H	
													H	
													H	
													H	
													H	
													H	
													H	
													H	
													H	
													H	
													H	
													H	
													H	
	Remark	1. No other spurious found. 2. All results are PASS against Peak and Average limit line. 3. The emission position marked as "-" means no suspected emission found with sufficient margin against limit line or noise floor only.												



Band 4 5725~5850MHz
WIFI 802.11ax HE80_Full (Band Edge @ 3m)

WIFI Ant. 6+7	Note	Frequency (MHz)	Level (dBμV/m)	Margin (dB)	Limit Line (dBμV/m)	Read Level (dBμV)	Antenna Factor (dB/m)	Path Loss (dB)	Preamp Factor (dB)	Ant Pos (cm)	Table Pos (deg)	Peak Avg. (P/A)	Pol. (H/V)
		5642.2	64.98	-3.22	68.2	53.2	31.92	6.48	26.62	100	359	P	H
		5695	79.28	-22.23	101.51	67.23	32.17	6.52	26.64	100	359	P	H
		5713.2	81.56	-27.34	108.9	69.42	32.25	6.54	26.65	100	359	P	H
		5720.6	83.21	-28.96	112.17	71.04	32.28	6.54	26.65	100	359	P	H
	*	5775	110.11	-	-	97.79	32.4	6.59	26.67	100	359	P	H
	*	5775	101.16	-	-	88.84	32.4	6.59	26.67	100	359	A	H
		5850.2	79.97	-41.77	121.74	67.53	32.5	6.64	26.7	100	359	P	H
		5855.2	77.09	-33.65	110.74	64.62	32.52	6.65	26.7	100	359	P	H
		5877.6	70.63	-32.64	103.27	58.07	32.61	6.66	26.71	100	359	P	H
		5925.2	60.69	-7.51	68.2	47.98	32.75	6.69	26.73	100	359	P	H
802.11ax													H
HE80 Full													H
CH 155		5630.6	63.76	-4.44	68.2	51.96	31.94	6.47	26.61	267	185	P	V
5775MHz		5695	78.73	-22.78	101.51	66.68	32.17	6.52	26.64	267	185	P	V
		5719.8	81.99	-28.75	110.74	69.82	32.28	6.54	26.65	267	185	P	V
		5720.4	80.99	-30.72	111.71	68.82	32.28	6.54	26.65	267	185	P	V
	*	5775	109.15	-	-	96.83	32.4	6.59	26.67	267	185	P	V
	*	5775	99.14	-	-	86.82	32.4	6.59	26.67	267	185	A	V
		5852.4	79.13	-37.6	116.73	66.68	32.51	6.64	26.7	267	185	P	V
		5857	76.8	-33.44	110.24	64.32	32.53	6.65	26.7	267	185	P	V
		5876.8	69.46	-34.4	103.86	56.9	32.61	6.66	26.71	267	185	P	V
		5949	60.04	-8.16	68.2	47.27	32.8	6.71	26.74	267	185	P	V
													V
													V
Remark	1. No other spurious found. 2. All results are PASS against Peak and Average limit line.												



Band 4 5725~5850MHz

WIFI 802.11ax HE80_Full (Harmonic @ 3m)

WIFI Ant. 6+7	Note	Frequency (MHz)	Level (dBμV/m)	Margin (dB)	Limit Line (dBμV/m)	Read Level (dBμV)	Antenna Factor (dB/m)	Path Loss (dB)	Preamp Factor (dB)	Ant Pos (cm)	Table Pos (deg)	Peak Avg. (P/A)	Pol. (H/V)	
802.11ax HE80 Full CH 155 5775MHz		11550	46.51	-27.49	74	52.08	40.1	10.4	56.07	-	-	P	H	
		17325	48.74	-19.46	68.2	51.68	40.85	12.95	56.74	-	-	P	H	
													H	
													H	
													H	
													H	
													H	
													H	
													H	
													H	
													H	
													H	
													H	
													H	
													H	
													H	
													H	
													H	
			11550	46.44	-27.56	74	52.01	40.1	10.4	56.07	-	-	P	V
			17325	48.68	-19.52	68.2	51.62	40.85	12.95	56.74	-	-	P	V
													V	
													V	
													V	
													V	
													V	
													V	
													V	
													V	
													V	
													V	
													V	
													V	
Remark	1. No other spurious found.													
	2. All results are PASS against Peak and Average limit line.													
	3. The emission position marked as "-" means no suspected emission found with sufficient margin against limit line or noise floor only.													



Note symbol

*	Fundamental Frequency which can be ignored. However, the level of any unwanted emissions shall not exceed the level of the fundamental frequency.
!	Test result is over limit line.
P/A	Peak or Average
H/V	Horizontal or Vertical



A calculation example for radiated spurious emission is shown as below:

WIFI	Note	Frequency	Level	Over	Limit	Read	Antenna	Path	Preamp	Ant	Table	Peak	Pol.
Ant.				Limit	Line	Level	Factor	Loss	Factor	Pos	Pos	Avg.	
6+7		(MHz)	(dBμV/m)	(dB)	(dBμV/m)	(dBμV)	(dB/m)	(dB)	(dB)	(cm)	(deg)	(P/A)	(H/V)
802.11a		5650	55.45	-18.55	74	54.51	32.22	4.58	35.86	103	308	P	H
CH 149		5650	43.54	-10.46	54	42.6	32.22	4.58	35.86	103	308	A	H
5745MHz													

1. Path Loss(dB) = Cable loss(dB) + Filter loss(dB) + Attenuator loss(dB)
2. Level(dBμV/m) = Antenna Factor(dB/m) + Path Loss(dB) + Read Level(dBμV) - Preamp Factor(dB)
3. Over Limit(dB) = Level(dBμV/m) – Limit Line(dBμV/m)

For Peak Limit @ 5650MHz:

1. Level(dBμV/m)
= Antenna Factor(dB/m) + Path Loss(dB) + Read Level(dBμV) - Preamp Factor(dB)
= 32.22(dB/m) + 4.58(dB) + 54.51(dBμV) – 35.86 (dB)
= 55.45 (dBμV/m)
2. Over Limit(dB)
= Level(dBμV/m) – Limit Line(dBμV/m)
= 55.45(dBμV/m) – 74(dBμV/m)
= -18.55(dB)

For Average Limit @ 5650MHz:

1. Level(dBμV/m)
= Antenna Factor(dB/m) + Path Loss(dB) + Read Level(dBμV) - Preamp Factor(dB)
= 32.22(dB/m) + 4.58(dB) + 42.6(dBμV) – 35.86 (dB)
= 43.54 (dBμV/m)
2. Over Limit(dB) = Level(dBμV/m) – Limit Line(dBμV/m)
= 43.54(dBμV/m) – 54(dBμV/m)
= -10.46(dB)

Both peak and average measured complies with the limit line, so test result is “PASS”.



Appendix C. Radiated Spurious Emission Plots

Test Engineer :	Mancy Chou, Jacky Hong and Rain Lee	Temperature :	20~25°C
		Relative Humidity :	40~60%

<CDD Mode>

Band 4 - 5725~5850MHz
WIFI 802.11a (Band Edge @ 3m)

WIFI	Band 4 5725~5850MHz Band Edge @ 3m	
ANT	802.11a CH149 5745MHz	
6+7	Horizontal	Fundamental
Peak	<p>Site : 03CH13-HY Condition : PEAK_BE(B4)_16-24 3m HORN_91200_1241 HORIZONTAL -REW:1000.000KHz VSW:3000.000KHz SWT:Auto</p>	<p>Site : 03CH13-HY Condition : PEAK(UNIT) 3m HORN_91200_1241 HORIZONTAL -REW:1000.000KHz VSW:3000.000KHz SWT:Auto</p>



WIFI	Band 4 5725~5850MHz Band Edge @ 3m	
ANT	802.11a CH149 5745MHz	
6+7	Vertical	Fundamental
Peak	<p>Site : 03CH13-HY Condition : PEAK_BE(B4)_16-24 3m HORN_91200_1241 VERTICAL : RBW:1000.000KHz VBW:3000.000KHz SWT:Auto</p>	<p>Site : 03CH13-HY Condition : PEAK(LINE) 3m HORN_91200_1241 VERTICAL : RBW:1000.000KHz VBW:3000.000KHz SWT:Auto</p>

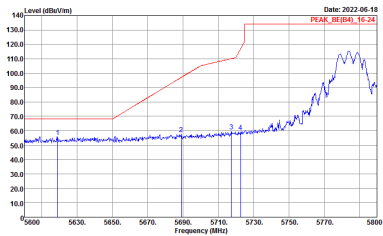
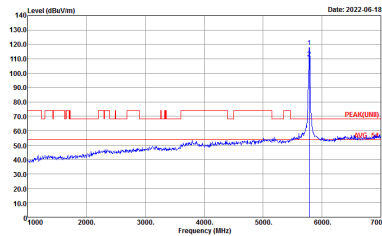
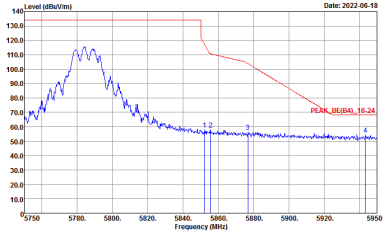

WIFI	Band 4 5725~5850MHz Band Edge @ 3m	
ANT	802.11a CH157 5785MHz	
6+7	Horizontal	Fundamental
Peak	 <p>Date: 2022-06-18 PEAK_BE(B4)_16-24</p> <p>Site : 03CH13-HY Condition : PEAK_BE(B4)_16-24 3m HORN_91200_1241 HORIZONTAL : RBW:1000.000KHz VBW:3000.000KHz SWT:Auto</p>	 <p>Date: 2022-06-18 PEAK(LINE)</p> <p>Site : 03CH13-HY Condition : PEAK(LINE) 3m HORN_91200_1241 HORIZONTAL : RBW:1000.000KHz VBW:3000.000KHz SWT:Auto</p>
Peak	 <p>Date: 2022-06-18 PEAK_BE(B4)_16-24</p> <p>Site : 03CH13-HY Condition : PEAK_BE(B4)_16-24 3m HORN_91200_1241 HORIZONTAL : RBW:1000.000KHz VBW:3000.000KHz SWT:Auto</p>	Left blank

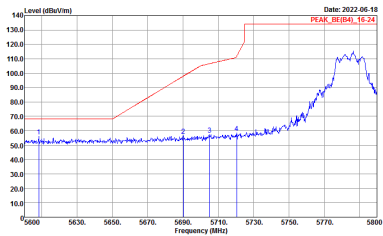
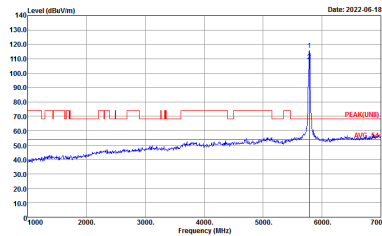
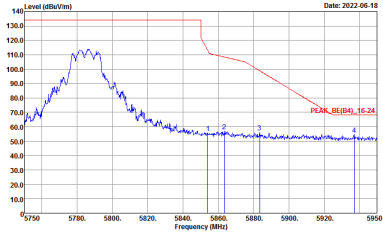

WIFI	Band 4 5725~5850MHz Band Edge @ 3m	
ANT	802.11a CH157 5785MHz	
6+7	Vertical	Fundamental
Peak	 <p>Site : 03CH13-HY Condition : PEAK_BE(B4)_16-24 3m HORN_91200_1241 VERTICAL : RBW:1000.000KHz VBW:3000.000KHz SWT:Auto</p>	 <p>Site : 03CH13-HY Condition : PEAK(LINE) 3m HORN_91200_1241 VERTICAL : RBW:1000.000KHz VBW:3000.000KHz SWT:Auto</p>
Peak	 <p>Site : 03CH13-HY Condition : PEAK_BE(B4)_16-24 3m HORN_91200_1241 VERTICAL : RBW:1000.000KHz VBW:3000.000KHz SWT:Auto</p>	Left blank

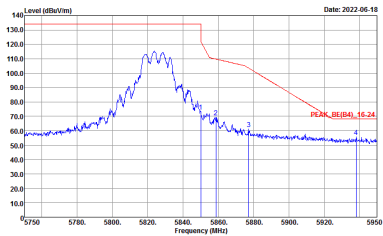
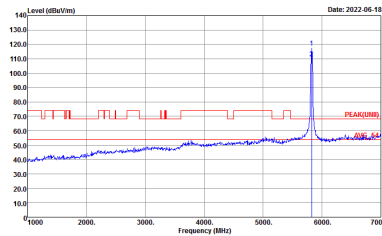

WIFI	Band 4 5725~5850MHz Band Edge @ 3m	
ANT	802.11a CH165 5825MHz	
6+7	Horizontal	Fundamental
Peak	 <p>Date: 2022-06-18</p> <p>Site : 03CH13-HY Condition : PEAK_SE[94]_16-24 3m HORN_91200_1241 HORIZONTAL : RBW:1000.000KHz VBW:3000.000KHz SWT:Auto</p>	 <p>Date: 2022-06-18</p> <p>Site : 03CH13-HY Condition : PEAK[LINE] 3m HORN_91200_1241 HORIZONTAL : RBW:1000.000KHz VBW:3000.000KHz SWT:Auto</p>

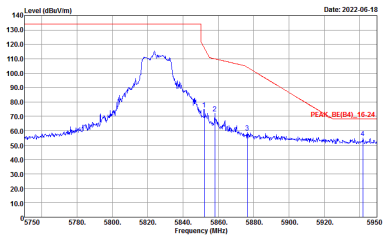
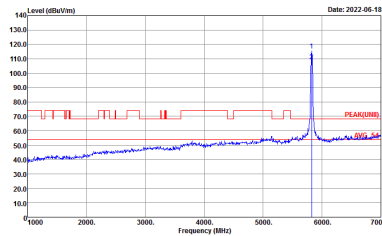

WIFI	Band 4 5725~5850MHz Band Edge @ 3m	
ANT	802.11a CH165 5825MHz	
6+7	Vertical	Fundamental
Peak	 <p>Site : 03CH13-HY Condition : PEAK_B4(84)_16-24 3m HORN_91200_1241 VERTICAL : RBW:1000.000KHz VBW:3000.000KHz SWT:Auto</p>	 <p>Site : 03CH13-HY Condition : PEAK(LINE) 3m HORN_91200_1241 VERTICAL : RBW:1000.000KHz VBW:3000.000KHz SWT:Auto</p>



Band 4 5725~5850MHz
WIFI 802.11ax HE20 Full (Band Edge @ 3m)

WIFI	Band 4 5725~5850MHz Band Edge @ 3m	
ANT	802.11ax HE20 Full CH149 5745MHz	
6+7	Horizontal	Fundamental
Peak	<p>Site : 03CH13-HY Condition : PEAK_BE(84)_16-24 3m HORN_91200_1241 HORIZONTAL : RBW:1000.000KHz VBW:3000.000KHz SWT:Auto</p>	<p>Site : 03CH13-HY Condition : PEAK(UNB) 3m HORN_91200_1241 HORIZONTAL : RBW:1000.000KHz VBW:3000.000KHz SWT:Auto</p>



WIFI	Band 4 5725~5850MHz Band Edge @ 3m	
ANT	802.11ax HE20 Full CH149 5745MHz	
6+7	Vertical	Fundamental
Peak	<p>Site : 03CH13-HY Condition : PEAK_BE(B4)_16-24 3m HORN_91200_1241 VERTICAL : RBW:1000.000KHz VBW:3000.000KHz SWT:Auto</p>	<p>Site : 03CH13-HY Condition : PEAK(LINE) 3m HORN_91200_1241 VERTICAL : RBW:1000.000KHz VBW:3000.000KHz SWT:Auto</p>



WIFI	Band 4 5725~5850MHz Band Edge @ 3m	
ANT	802.11ax HE20 Full CH157 5785MHz	
6+7	Horizontal	Fundamental
Peak		
Peak		Left blank

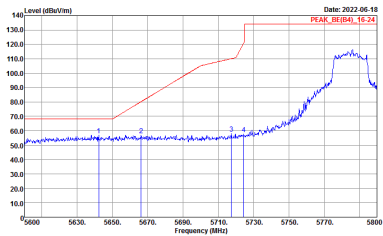
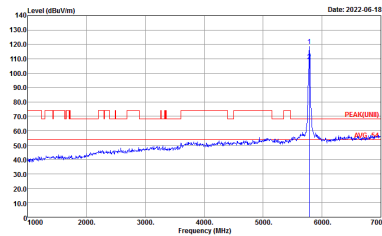
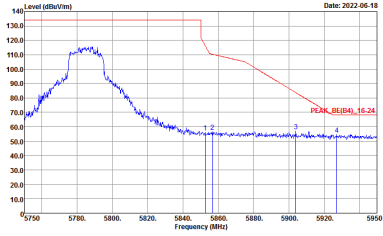

WIFI	Band 4 5725~5850MHz Band Edge @ 3m	
ANT	802.11ax HE20 Full CH157 5785MHz	
6+7	Vertical	Fundamental
Peak	 <p>Site : 03CH13-HY Condition : PEAK_BE(B4)_16-24 3m HORN_91200_1241 VERTICAL : RBW:1000.000KHz VBW:3000.000KHz SWT:Auto</p>	 <p>Site : 03CH13-HY Condition : PEAK(LINE) 3m HORN_91200_1241 VERTICAL : RBW:1000.000KHz VBW:3000.000KHz SWT:Auto</p>
Peak	 <p>Site : 03CH13-HY Condition : PEAK_BE(B4)_16-24 3m HORN_91200_1241 VERTICAL : RBW:1000.000KHz VBW:3000.000KHz SWT:Auto</p>	Left blank



WIFI	Band 4 5725~5850MHz Band Edge @ 3m	
ANT	802.11ax HE20 Full CH165 5825MHz	
6+7	Horizontal	Fundamental
Peak	<p>Site : 03CH13-HY Condition : PEAK_SE[94]_16-24 3m HORN_91200_1241 HORIZONTAL : RBW:1000.000KHz VBW:3000.000KHz SWT:Auto</p>	<p>Site : 03CH13-HY Condition : PEAK[LINE] 3m HORN_91200_1241 HORIZONTAL : RBW:1000.000KHz VBW:3000.000KHz SWT:Auto</p>

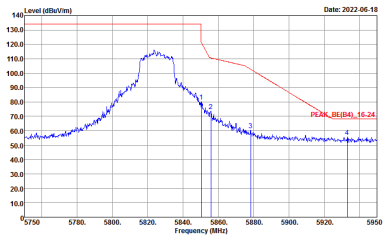
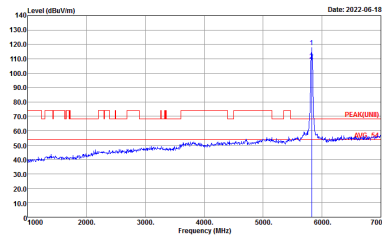

WIFI	Band 4 5725~5850MHz Band Edge @ 3m	
ANT	802.11ax HE20 Full CH165 5825MHz	
6+7	Vertical	Fundamental
Peak	 <p>Site : 03CH13-HY Condition : PEAK_B4(B4)_16-24 3m HORN_91200_1241 VERTICAL : RBW:1000.000KHz VBW:3000.000KHz SWT:Auto</p>	 <p>Site : 03CH13-HY Condition : PEAK(LINE) 3m HORN_91200_1241 VERTICAL : RBW:1000.000KHz VBW:3000.000KHz SWT:Auto</p>



Band 4 5725~5850MHz
WIFI 802.11ax HE20 Partial 106 (Band Edge @ 3m)

Table with 3 columns: WIFI, ANT, 6+7. It contains two spectral plots: 'Horizontal' and 'Fundamental'. The 'Horizontal' plot shows a peak at approximately 5730 MHz. The 'Fundamental' plot shows a peak at approximately 5730 MHz. Both plots include site and condition details.



WIFI	Band 4 5725~5850MHz Band Edge @ 3m	
ANT	802.11ax HE20 Partial 106/53 CH149 5745MHz	
6+7	Vertical	Fundamental
Peak	<p>Site : 03CH13-HY Condition : PEAK_BE(B4)_16-24 3m HORN_91200_1241 VERTICAL : RBW:1000.000KHz VBW:3000.000KHz SWT:Auto</p>	<p>Site : 03CH13-HY Condition : PEAK(LINE) 3m HORN_91200_1241 VERTICAL : RBW:1000.000KHz VBW:3000.000KHz SWT:Auto</p>

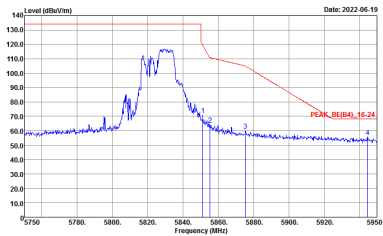
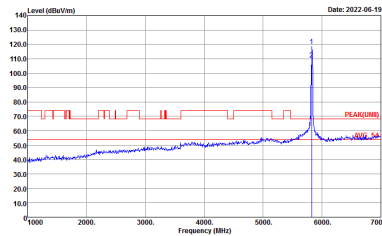

WIFI	Band 4 5725~5850MHz Band Edge @ 3m	
ANT	802.11ax HE20 Partial 106/54 CH165 5825MHz	
6+7	Horizontal	Fundamental
Peak	 <p>Date: 2022-06-19</p> <p>Site : 03CH13-HY Condition : PEAK_SE[94]_16-24 3m HORN_91200_1241 HORIZONTAL : RBW:1000.000KHz VBW:3000.000KHz SWT:Auto</p>	 <p>Date: 2022-06-19</p> <p>Site : 03CH13-HY Condition : PEAK[LINE] 3m HORN_91200_1241 HORIZONTAL : RBW:1000.000KHz VBW:3000.000KHz SWT:Auto</p>

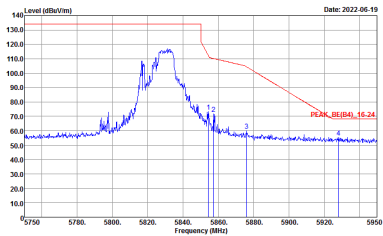
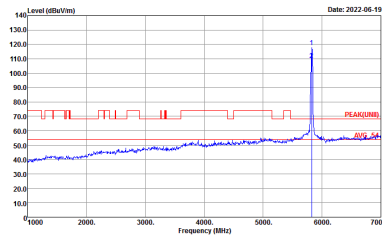

WIFI	Band 4 5725~5850MHz Band Edge @ 3m	
ANT	802.11ax HE20 Partial 106/54 CH165 5825MHz	
6+7	Vertical	Fundamental
Peak	 <p>Site : 03CH13-HY Condition : PEAK_B4(B4)_16-24 3m HORN_91200_1241 VERTICAL : RBW:1000.000KHz VBW:3000.000KHz SWT:Auto</p>	 <p>Site : 03CH13-HY Condition : PEAK(LINE) 3m HORN_91200_1241 VERTICAL : RBW:1000.000KHz VBW:3000.000KHz SWT:Auto</p>



Band 4 5725~5850MHz
WIFI 802.11ax HE40 Full (Band Edge @ 3m)

WIFI	Band 4 5725~5850MHz Band Edge @ 3m	
ANT	802.11ax HE40 Full CH151 5755MHz	
6+7	Horizontal	Fundamental
Peak	<p>Site : 03CH13-HY Condition : PEAK_BE(84)_16-24 3m HORN_91200_1241 HORIZONTAL : RBW:1000.000KHz VBW:3000.000KHz SWT:Auto</p>	<p>Site : 03CH13-HY Condition : PEAK(UNII) 3m HORN_91200_1241 HORIZONTAL : RBW:1000.000KHz VBW:3000.000KHz SWT:Auto</p>
Peak	<p>Site : 03CH13-HY Condition : PEAK_BE(84)_16-24 3m HORN_91200_1241 HORIZONTAL : RBW:1000.000KHz VBW:3000.000KHz SWT:Auto</p>	Left blank

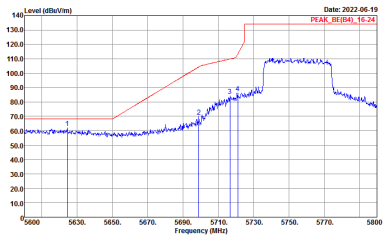
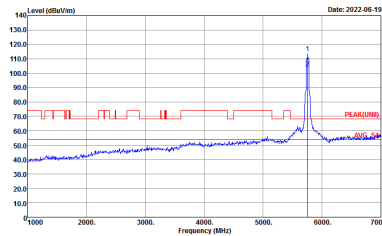
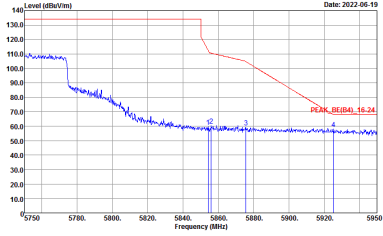

WIFI	Band 4 5725~5850MHz Band Edge @ 3m	
ANT	802.11ax HE40 Full CH151 5755MHz	
6+7	Vertical	Fundamental
Peak	 <p>Site : 03CH13-HY Condition : PEAK_BE(B4)_16-24 3m HORN_91200_1241 VERTICAL : RBW:1000.000KHz VBW:3000.000KHz SWT:Auto</p>	 <p>Site : 03CH13-HY Condition : PEAK(LINE) 3m HORN_91200_1241 VERTICAL : RBW:1000.000KHz VBW:3000.000KHz SWT:Auto</p>
Peak	 <p>Site : 03CH13-HY Condition : PEAK_BE(B4)_16-24 3m HORN_91200_1241 VERTICAL : RBW:1000.000KHz VBW:3000.000KHz SWT:Auto</p>	Left blank

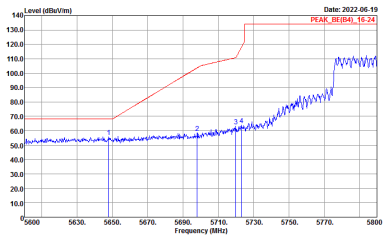
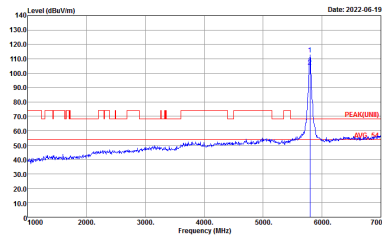
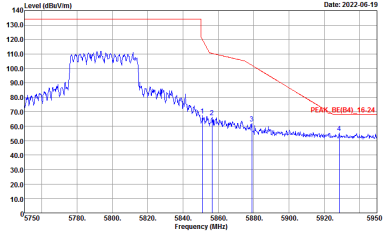

WIFI	Band 4 5725~5850MHz Band Edge @ 3m	
ANT	802.11ax HE40 Full HT40 CH159 5795MHz	
6+7	Horizontal	Fundamental
Peak	 <p>Date: 2022-06-19 PEAK_BE(B4)_16-24</p> <p>Site : 03CH13-HY Condition : PEAK_BE(B4)_16-24 3m HORN_91200_1241 HORIZONTAL : RBW:1000.000KHz VBW:3000.000KHz SWT:Auto</p>	 <p>Date: 2022-06-19 PEAK(LINE)</p> <p>Site : 03CH13-HY Condition : PEAK(LINE) 3m HORN_91200_1241 HORIZONTAL : RBW:1000.000KHz VBW:3000.000KHz SWT:Auto</p>
Peak	 <p>Date: 2022-06-19 PEAK_BE(B4)_16-24</p> <p>Site : 03CH13-HY Condition : PEAK_BE(B4)_16-24 3m HORN_91200_1241 HORIZONTAL : RBW:1000.000KHz VBW:3000.000KHz SWT:Auto</p>	Left blank

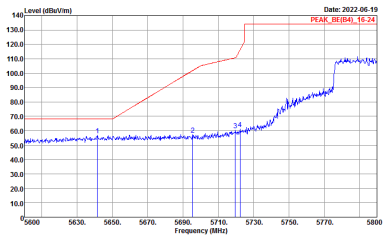
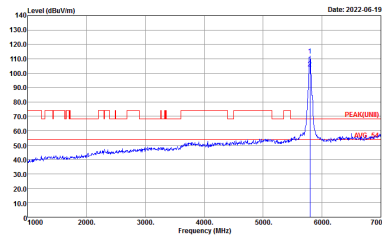
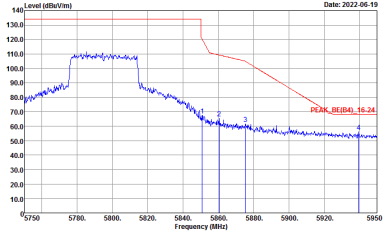

WIFI	Band 4 5725~5850MHz Band Edge @ 3m	
ANT	802.11ax HE40 Full CH159 5795MHz	
6+7	Vertical	Fundamental
Peak	 <p>Date: 2022-06-19 PEAK_BE(B4)_16-24</p> <p>Site : 03CH13-HY Condition : PEAK_BE(B4)_16-24 3m HORN_91200_1241 VERTICAL : RBW:1000.000KHz VBW:3000.000KHz SWT:Auto</p>	 <p>Date: 2022-06-19 PEAK(LINE)</p> <p>Site : 03CH13-HY Condition : PEAK(LINE) 3m HORN_91200_1241 VERTICAL : RBW:1000.000KHz VBW:3000.000KHz SWT:Auto</p>
Peak	 <p>Date: 2022-06-19 PEAK_BE(B4)_16-24</p> <p>Site : 03CH13-HY Condition : PEAK_BE(B4)_16-24 3m HORN_91200_1241 VERTICAL : RBW:1000.000KHz VBW:3000.000KHz SWT:Auto</p>	Left blank



Band 4 5725~5850MHz
WIFI 802.11ax HE80 Full (Band Edge @ 3m)

WIFI	Band 4 5725~5850MHz Band Edge @ 3m	
ANT	802.11ax HE80 Full CH155 5775MHz	
6+7	Horizontal	Fundamental
Peak	<p>Site : 03CH13-HY Condition : PEAK_BE(B4)_16-24 3m HORN_91200_1241 HORIZONTAL : RBW:1000.000KHz VBW:3000.000KHz SWT:Auto</p>	<p>Site : 03CH13-HY Condition : PEAK(UNB) 3m HORN_91200_1241 HORIZONTAL : RBW:1000.000KHz VBW:3000.000KHz SWT:Auto</p>
Peak	<p>Site : 03CH13-HY Condition : PEAK_BE(B4)_16-24 3m HORN_91200_1241 HORIZONTAL : RBW:1000.000KHz VBW:3000.000KHz SWT:Auto</p>	Left blank

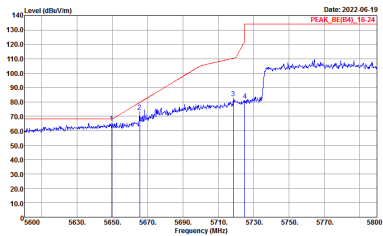
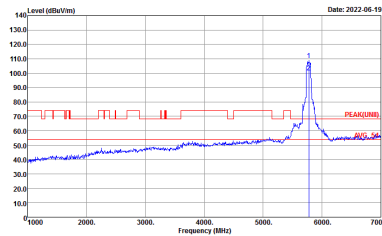
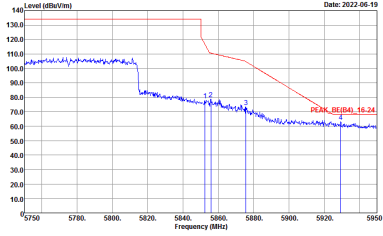

WIFI	Band 4 5725~5850MHz Band Edge @ 3m	
ANT	802.11ax HE80 Full CH155 5775MHz	
6+7	Vertical	Fundamental
Peak	 <p>Site : 03CH13-HY Condition : PEAK_BE(B4)_16-24 3m HORN_91200_1241 VERTICAL : RBW:1000.000KHz VBW:3000.000KHz SWT:Auto</p>	 <p>Site : 03CH13-HY Condition : PEAK(LINE) 3m HORN_91200_1241 VERTICAL : RBW:1000.000KHz VBW:3000.000KHz SWT:Auto</p>
Peak	 <p>Site : 03CH13-HY Condition : PEAK_BE(B4)_16-24 3m HORN_91200_1241 VERTICAL : RBW:1000.000KHz VBW:3000.000KHz SWT:Auto</p>	Left blank



Band 4 - 5725~5850MHz
WIFI 802.11a (Harmonic @ 3m)

WIFI	Band 4 5725~5850MHz Harmonic @ 3m	
ANT	802.11a CH149 5745MHz	
6+7	Horizontal	Vertical
Peak Avg.	<p>Site : 03CH13-HY Condition : PEAK(UNII) 3m HORN_9120D_1241 HORIZONTAL</p>	<p>Site : 03CH13-HY Condition : PEAK(UNII) 3m HORN_9120D_1241 VERTICAL</p>

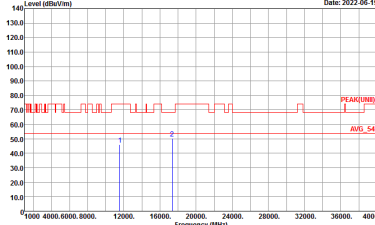
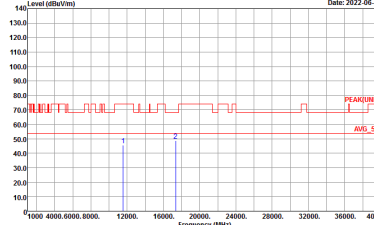

WIFI	Band 4 5725~5850MHz Harmonic @ 3m	
ANT	802.11a CH157 5785MHz	
6+7	Horizontal	Vertical
Peak Avg.	 <p>Site : 03CH13-HY Condition : PEAK(UNII) 3m HORN_91200_1241 HORIZONTAL</p>	 <p>Site : 03CH13-HY Condition : PEAK(UNII) 3m HORN_91200_1241 VERTICAL</p>

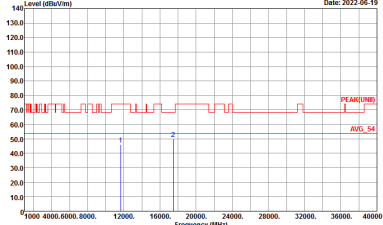
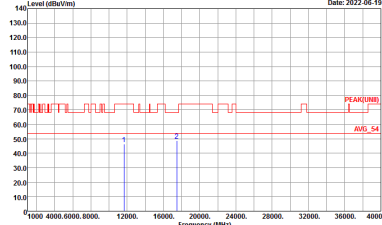

WIFI	Band 4 5725~5850MHz Harmonic @ 3m	
ANT	802.11a CH165 5825MHz	
6+7	Horizontal	Vertical
<p>Peak Avg.</p>	 <p>Site : 03CH13-HY Condition : PEAK(UNII) 3m HORN_91200_1241 HORIZONTAL</p>	 <p>Site : 03CH13-HY Condition : PEAK(UNII) 3m HORN_91200_1241 VERTICAL</p>



Band 4 5725~5850MHz
WIFI 802.11ax HE20 Full (Harmonic @ 3m)

WIFI	Band 4 5725~5850MHz Harmonic @ 3m	
ANT	802.11ax HE20 Full CH149 5745MHz	
6+7	Horizontal	Vertical
Peak Avg.	<p>Site : 03CH13-14Y Condition : PEAK(UNII) 3m HORN_91200_1241 HORIZONTAL</p>	<p>Site : 03CH13-14Y Condition : PEAK(UNII) 3m HORN_91200_1241 VERTICAL</p>



WIFI	Band 4 5725~5850MHz Harmonic @ 3m	
ANT	802.11ax HE20 Full CH157 5785MHz	
6+7	Horizontal	Vertical
Peak Avg.	<p>Site : 03CH13-HY Condition : PEAK(UNII) 3m HORN_9120D_1241 HORIZONTAL</p>	<p>Site : 03CH13-HY Condition : PEAK(UNII) 3m HORN_9120D_1241 VERTICAL</p>

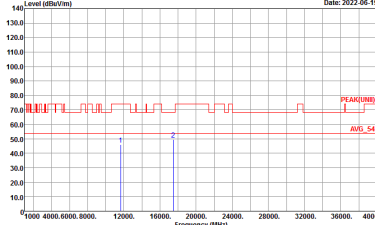
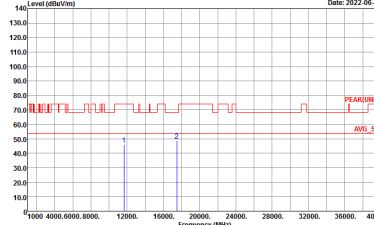

WIFI	Band 4 5725~5850MHz Harmonic @ 3m	
ANT	802.11ax HE20 Full CH165 5825MHz	
6+7	Horizontal	Vertical
Peak Avg.	 <p>Site : 03CH13-HY Condition : PEAK(UNII) 3m HORN_91200_1241 HORIZONTAL</p>	 <p>Site : 03CH13-HY Condition : PEAK(UNII) 3m HORN_91200_1241 VERTICAL</p>



Band 4 5725~5850MHz
WIFI 802.11ax HE40 Full (Harmonic @ 3m)

WIFI	Band 4 5725~5850MHz Harmonic @ 3m	
ANT	802.11ax HE40 Full CH151 5755MHz	
6+7	Horizontal	Vertical
Peak Avg.	<p>Site : 03CH13-14Y Condition : PEAK(UNII) 3m HORN_91200_1241 HORIZONTAL</p>	<p>Site : 03CH13-14Y Condition : PEAK(UNII) 3m HORN_91200_1241 VERTICAL</p>



WIFI	Band 4 5725~5850MHz Harmonic @ 3m	
ANT	802.11ax HE40 Full CH159 5795MHz	
6+7	Horizontal	Vertical
Peak Avg.	<p>Site : 03CH13-HY Condition : PEAK(UNII) 3m HORN_91200_1241 HORIZONTAL</p>	<p>Site : 03CH13-HY Condition : PEAK(UNII) 3m HORN_91200_1241 VERTICAL</p>



Band 4 5725~5850MHz
WIFI 802.11ax HE80 Full (Harmonic @ 3m)

WIFI	Band 4 5725~5850MHz Harmonic @ 3m	
ANT	802.11ax HE80 Full CH155 5775MHz	
6+7	Horizontal	Vertical
Peak Avg.	<p>Site : 03CH13-4F Condition : PEAK(UNII) 3m HORN_91200_1241 HORIZONTAL</p>	<p>Site : 03CH13-4F Condition : PEAK(UNII) 3m HORN_91200_1241 VERTICAL</p>



Emission below 1GHz
5GHz WIFI 802.11ax HE80 Full (LF @ 3m)

WIFI	5GHz WIFI	
ANT	802.11ax HE80 Full LF	
6+7	Horizontal	Vertical
QP / Peak	<p>Site Condition : 03CH13-HY : QP 3m BIL06_40103 HORIZONTAL</p>	<p>Site Condition : 03CH13-HY : QP 3m BIL06_40103 VERTICAL</p>



<TXBF Mode>

Band 4 - 5725~5850MHz
WIFI 802.11ax HE20 Full (Band Edge @ 3m)

WIFI	Band 4 5725~5850MHz Band Edge @ 3m	
ANT	802.11ax HE20 Full CH149 5745MHz	
6+7	Horizontal	Fundamental
Peak	<p>Site : 03CH13-IHY Condition : PEAK_BE(84)_16-24 3m HORN_91200_1241 HORIZONTAL : RBW:1000.000KHz VBW:3000.000KHz SWT:Auto</p>	<p>Site : 03CH13-IHY Condition : PEAK(UNII) 3m HORN_91200_1241 HORIZONTAL : RBW:1000.000KHz VBW:3000.000KHz SWT:Auto</p>

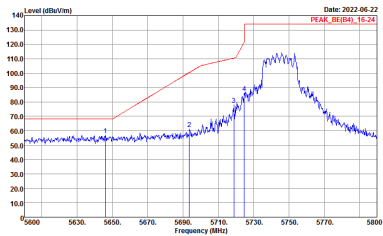
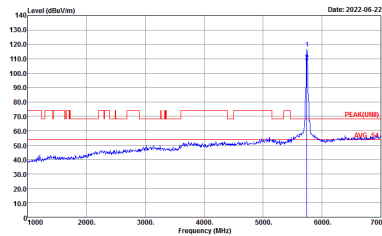

WIFI	Band 4 5725~5850MHz Band Edge @ 3m	
ANT	802.11ax HE20 Full CH149 5745MHz	
6+7	Vertical	Fundamental
Peak	 <p>Date: 2022-06-22 PEAK_BE(B4)_15.24</p> <p>Site : 03CH13-HY Condition : PEAK_BE(B4)_16-24 3m HORN_91200_1241 VERTICAL : RBW:1000.000KHz VBW:3000.000KHz SWT:Auto</p>	 <p>Date: 2022-06-22 PEAK(LINE)</p> <p>Site : 03CH13-HY Condition : PEAK(LINE) 3m HORN_91200_1241 VERTICAL : RBW:1000.000KHz VBW:3000.000KHz SWT:Auto</p>

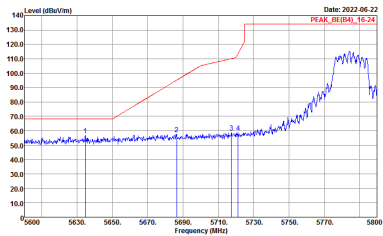
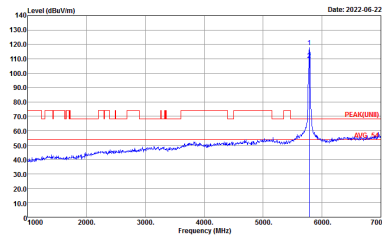
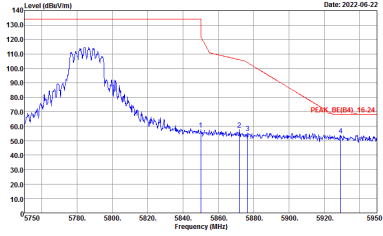

WIFI	Band 4 5725~5850MHz Band Edge @ 3m	
ANT	802.11ax HE20 Full CH157 5785MHz	
6+7	Horizontal	Fundamental
Peak	 <p>Site : 03CH13-HY Condition : PEAK_BE(B4)_16-24 3m HORN_91200_1241 HORIZONTAL : RBW:1000.000KHz VBW:3000.000KHz SWT:Auto</p>	 <p>Site : 03CH13-HY Condition : PEAK(LINE) 3m HORN_91200_1241 HORIZONTAL : RBW:1000.000KHz VBW:3000.000KHz SWT:Auto</p>
Peak	 <p>Site : 03CH13-HY Condition : PEAK_BE(B4)_16-24 3m HORN_91200_1241 HORIZONTAL : RBW:1000.000KHz VBW:3000.000KHz SWT:Auto</p>	Left blank



WIFI	Band 4 5725~5850MHz Band Edge @ 3m	
ANT	802.11ax HE20 Full CH157 5785MHz	
6+7	Vertical	Fundamental
Peak	<p>Date: 2022-06-22 PEAK_BE(B4)_16-24</p> <p>Site : 03CH13-HY Condition : PEAK_BE(B4)_16-24 3m HORN_91200_1241 VERTICAL : RBW:1000.000KHz VBW:3000.000KHz SWT:Auto</p>	<p>Date: 2022-06-22 PEAK(LINE)</p> <p>Site : 03CH13-HY Condition : PEAK(LINE) 3m HORN_91200_1241 VERTICAL : RBW:1000.000KHz VBW:3000.000KHz SWT:Auto</p>
Peak	<p>Date: 2022-06-22 PEAK_BE(B4)_16-24</p> <p>Site : 03CH13-HY Condition : PEAK_BE(B4)_16-24 3m HORN_91200_1241 VERTICAL : RBW:1000.000KHz VBW:3000.000KHz SWT:Auto</p>	Left blank

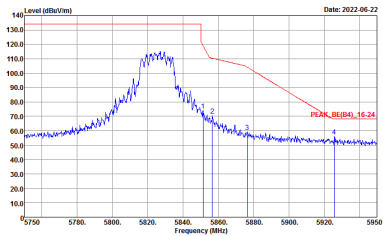
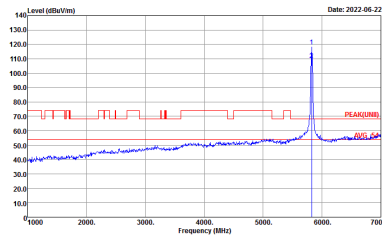

WIFI	Band 4 5725~5850MHz Band Edge @ 3m	
ANT	802.11ax HE20 Full CH165 5825MHz	
6+7	Horizontal	Fundamental
Peak	 <p>Date: 2022-06-22</p> <p>Site : 03CH13-HY Condition : PEAK_B4(B4)_16-24 3m HORN_91200_1241 HORIZONTAL : RBW:1000.000KHz VBW:3000.000KHz SWT:Auto</p>	 <p>Date: 2022-06-22</p> <p>Site : 03CH13-HY Condition : PEAK(LINE) 3m HORN_91200_1241 HORIZONTAL : RBW:1000.000KHz VBW:3000.000KHz SWT:Auto</p>



WIFI	Band 4 5725~5850MHz Band Edge @ 3m	
ANT	802.11ax HE20 Full CH165 5825MHz	
6+7	Vertical	Fundamental
Peak	<p>Site : 03CH13-HY Condition : PEAK_B4(B4)_16-24 3m HORN_91200_1241 VERTICAL : RBW:1000.000KHz VBW:3000.000KHz SWT:Auto</p>	<p>Site : 03CH13-HY Condition : PEAK(FUN) 3m HORN_91200_1241 VERTICAL : RBW:1000.000KHz VBW:3000.000KHz SWT:Auto</p>



Band 4 5725~5850MHz
WIFI 802.11ax HE40 Full (Band Edge @ 3m)

WIFI	Band 4 5725~5850MHz Band Edge @ 3m	
ANT	802.11ax HE40 Full CH151 5755MHz	
6+7	Horizontal	Fundamental
Peak	<p>Site : 03CH13-HY Condition : PEAK_BE(B4)_16-24 3m HORN_91200_1241 HORIZONTAL : RBW:1000.000KHz VBW:3000.000KHz SWT:Auto</p>	<p>Site : 03CH13-HY Condition : PEAK(UIN) 3m HORN_91200_1241 HORIZONTAL : RBW:1000.000KHz VBW:3000.000KHz SWT:Auto</p>
Peak	<p>Site : 03CH13-HY Condition : PEAK_BE(B4)_16-24 3m HORN_91200_1241 HORIZONTAL : RBW:1000.000KHz VBW:3000.000KHz SWT:Auto</p>	Left blank

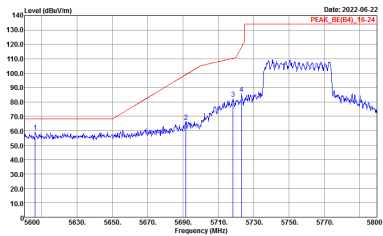
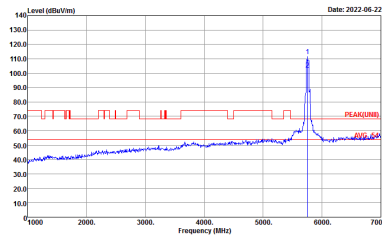
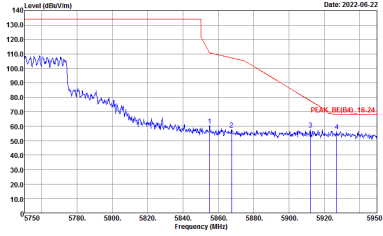

WIFI	Band 4 5725~5850MHz Band Edge @ 3m	
ANT	802.11ax HE40 Full CH151 5755MHz	
6+7	Vertical	Fundamental
Peak	 <p>Site : 03CH13-HY Condition : PEAK_BE(B4)_16-24 3m HORN_91200_1241 VERTICAL : RBW:1000.000KHz VBW:3000.000KHz SWT:Auto</p>	 <p>Site : 03CH13-HY Condition : PEAK(LINE) 3m HORN_91200_1241 VERTICAL : RBW:1000.000KHz VBW:3000.000KHz SWT:Auto</p>
Peak	 <p>Site : 03CH13-HY Condition : PEAK_BE(B4)_16-24 3m HORN_91200_1241 VERTICAL : RBW:1000.000KHz VBW:3000.000KHz SWT:Auto</p>	Left blank

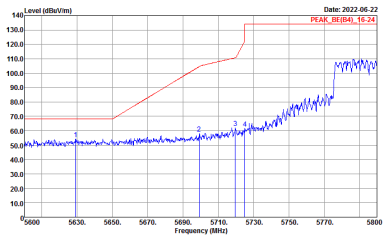
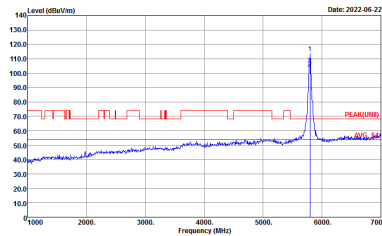
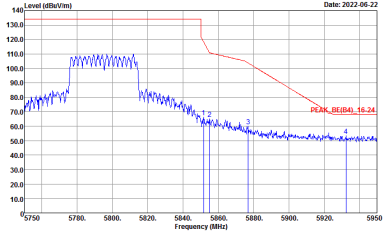

WIFI	Band 4 5725~5850MHz Band Edge @ 3m	
ANT	802.11ax HE40 Full HT40 CH159 5795MHz	
6+7	Horizontal	Fundamental
Peak	 <p>Site : 03CH13-HY Condition : PEAK_BE(B4)_16-24 3m HORN_91200_1241 HORIZONTAL : RBW:1000.000KHz VBW:3000.000KHz SWT:Auto</p>	 <p>Site : 03CH13-HY Condition : PEAK(LINE) 3m HORN_91200_1241 HORIZONTAL : RBW:1000.000KHz VBW:3000.000KHz SWT:Auto</p>
Peak	 <p>Site : 03CH13-HY Condition : PEAK_BE(B4)_16-24 3m HORN_91200_1241 HORIZONTAL : RBW:1000.000KHz VBW:3000.000KHz SWT:Auto</p>	Left blank

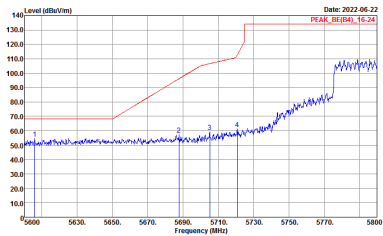
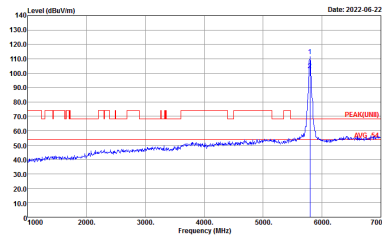
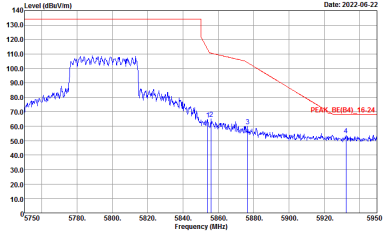

WIFI	Band 4 5725~5850MHz Band Edge @ 3m	
ANT	802.11ax HE40 Full CH159 5795MHz	
6+7	Vertical	Fundamental
Peak	 <p>Site : 03CH13-HY Condition : PEAK_BE(B4)_16-24 3m HORN_91200_1241 VERTICAL : RBW:1000.000KHz VBW:3000.000KHz SWT:Auto</p>	 <p>Site : 03CH13-HY Condition : PEAK(LINE) 3m HORN_91200_1241 VERTICAL : RBW:1000.000KHz VBW:3000.000KHz SWT:Auto</p>
Peak	 <p>Site : 03CH13-HY Condition : PEAK_BE(B4)_16-24 3m HORN_91200_1241 VERTICAL : RBW:1000.000KHz VBW:3000.000KHz SWT:Auto</p>	Left blank



Band 4 5725~5850MHz
WIFI 802.11ax HE80 Full (Band Edge @ 3m)

WIFI	Band 4 5725~5850MHz Band Edge @ 3m	
ANT	802.11ax HE80 Full CH155 5775MHz	
6+7	Horizontal	Fundamental
Peak	<p>Site : 03CH13-HY Condition : PEAK_BE(B4)_16-24 3m HORN_91200_1241 HORIZONTAL : RBW:1000.000KHz VBW:3000.000KHz SWT:Auto</p>	<p>Site : 03CH13-HY Condition : PEAK(UNII) 3m HORN_91200_1241 HORIZONTAL : RBW:1000.000KHz VBW:3000.000KHz SWT:Auto</p>
Peak	<p>Site : 03CH13-HY Condition : PEAK_BE(B4)_16-24 3m HORN_91200_1241 HORIZONTAL : RBW:1000.000KHz VBW:3000.000KHz SWT:Auto</p>	Left blank

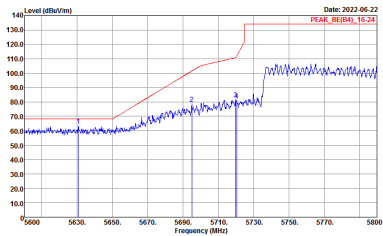
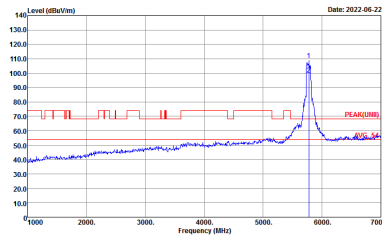
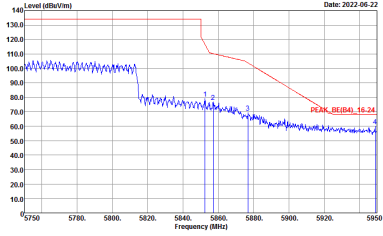

WIFI	Band 4 5725~5850MHz Band Edge @ 3m	
ANT	802.11ax HE80 Full CH155 5775MHz	
6+7	Vertical	Fundamental
Peak	 <p>Date: 2022-06-22 PEAK_BE(B4)_16-24</p> <p>Site : 03CH13-HY Condition : PEAK_BE(B4)_16-24 3m HORN_91200_1241 VERTICAL : RBW:1000.000KHz VBW:3000.000KHz SWT:Auto</p>	 <p>Date: 2022-06-22 PEAK(LINE) AOL 24</p> <p>Site : 03CH13-HY Condition : PEAK(LINE) 3m HORN_91200_1241 VERTICAL : RBW:1000.000KHz VBW:3000.000KHz SWT:Auto</p>
Peak	 <p>Date: 2022-06-22 PEAK_BE(B4)_16-24</p> <p>Site : 03CH13-HY Condition : PEAK_BE(B4)_16-24 3m HORN_91200_1241 VERTICAL : RBW:1000.000KHz VBW:3000.000KHz SWT:Auto</p>	Left blank



Band 4 - 5725~5850MHz
WIFI 802.11ax HE20 Full (Harmonic @ 3m)

Table with 3 columns: WIFI, ANT, 6+7. It contains two spectral plots: Horizontal and Vertical. Each plot shows Level (dBm/10m) vs Frequency (MHz) with peak and average markers. Includes site and condition details for each plot.



WIFI	Band 4 5725~5850MHz Harmonic @ 3m	
ANT	802.11ax HE20 Full CH157 5785MHz	
6+7	Horizontal	Vertical
Peak Avg.	<p>Site : 03CH13-HY Condition : PEAK(UNII) 3m HORN_91200_1241 HORIZONTAL</p>	<p>Site : 03CH13-HY Condition : PEAK(UNII) 3m HORN_91200_1241 VERTICAL</p>



WIFI	Band 4 5725~5850MHz Harmonic @ 3m	
ANT	802.11ax HE20 Full CH165 5825MHz	
6+7	Horizontal	Vertical
Peak Avg.	<p>Site : 03CH13-HY Condition : PEAK(UNII) 3m HORN_91200_1241 HORIZONTAL</p>	<p>Site : 03CH13-HY Condition : PEAK(UNII) 3m HORN_91200_1241 VERTICAL</p>



Band 4 5725~5850MHz
WIFI 802.11ax HE40 Full (Harmonic @ 3m)

Table with 3 columns: WIFI, ANT, 6+7. It contains two spectral plots: Horizontal and Vertical. Each plot shows Level (dBuV/m) vs Frequency (MHz) with peak and average values indicated.



WIFI	Band 4 5725~5850MHz Harmonic @ 3m	
ANT	802.11ax HE40 Full CH159 5795MHz	
6+7	Horizontal	Vertical
Peak Avg.	<p>Site : 03CH13-HY Condition : PEAK(UNII) 3m HORN_91200_1241 HORIZONTAL</p>	<p>Site : 03CH13-HY Condition : PEAK(UNII) 3m HORN_91200_1241 VERTICAL</p>



Band 4 5725~5850MHz
WIFI 802.11ax HE80 Full (Harmonic @ 3m)

WIFI	Band 4 5725~5850MHz Harmonic @ 3m	
ANT	802.11ax HE80 Full CH155 5775MHz	
6+7	Horizontal	Vertical
Peak Avg.	<p>Site : 03CH13-4F Condition : PEAK(UNII) 3m HORN_91200_1241 HORIZONTAL</p>	<p>Site : 03CH13-4F Condition : PEAK(UNII) 3m HORN_91200_1241 VERTICAL</p>



Appendix D. Duty Cycle Plots

<CDD Mode>

Antenna	Band	Duty Cycle(%)	T(us)	1/T(kHz)	VBW Setting
6+7	802.11a	93.44	1425	0.70	1kHz
6+7	5GHz 802.11ax HE20 Full RU	97.50	3900	0.26	300Hz
6+7	5GHz 802.11ax HE20 106 RU	99.56	-	-	10Hz
6+7	5GHz 802.11ax HE40 Full RU	95.17	1970	0.51	1kHz
6+7	5GHz 802.11ax HE80 Full RU	90.78	975	1.03	3kHz



MIMO <Ant. 6+7>

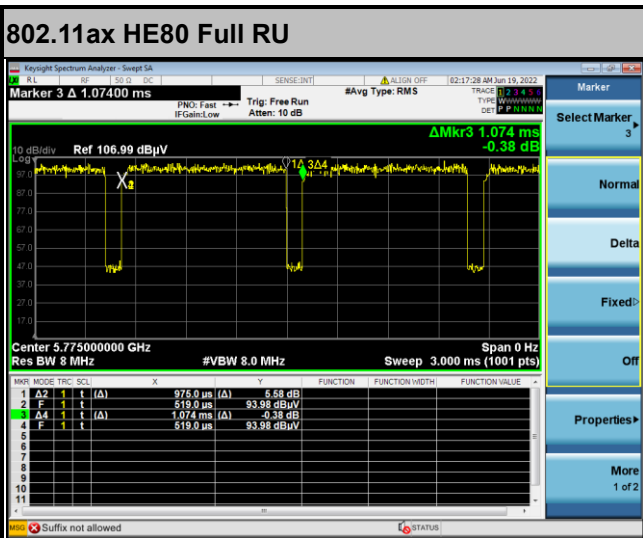
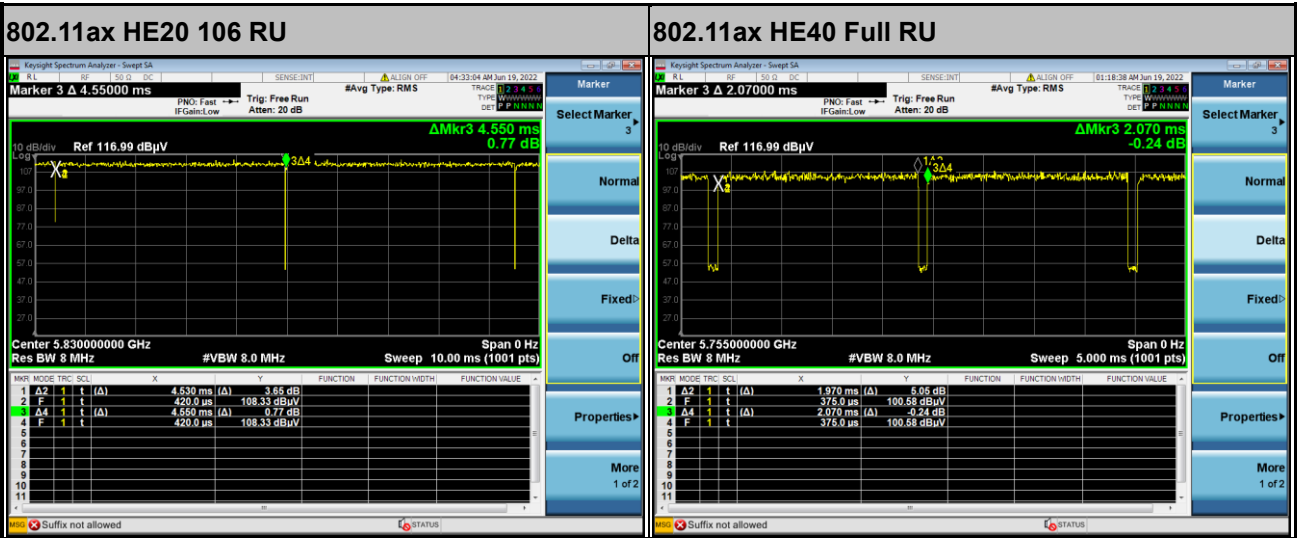
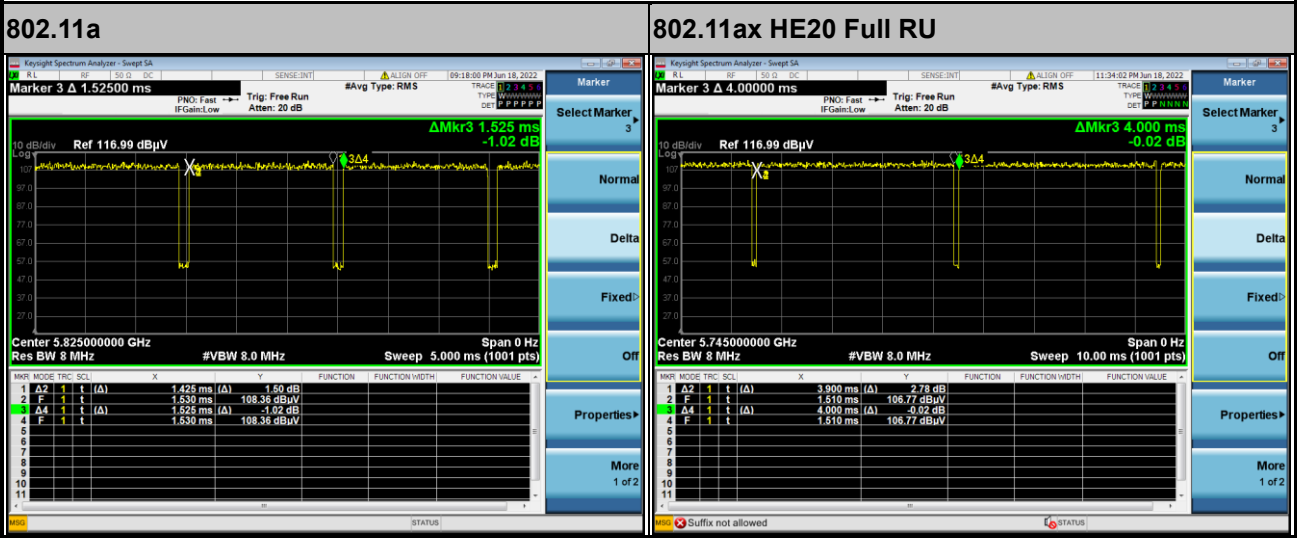



<TXBF Mode>

Antenna	Band	Duty Cycle(%)	T(us)	1/T(kHz)	VBW Setting
6+7	5GHz 802.11ax HE20 Full RU	94.52	5175	0.19	300Hz
6+7	5GHz 802.11ax HE40 Full RU	91.53	4050	0.25	300Hz
6+7	5GHz 802.11ax HE80 Full RU	93.54	5430	0.18	300Hz

MIMO <Ant. 6+7>

