



FCC RADIO TEST REPORT

FCC ID : UZ7ET45CB
Equipment : Tablet
Brand Name : Zebra
Model Name : ET45CB
Applicant : Zebra Technologies Corporation
1 Zebra Plaza, Holtsville, NY 11742
Manufacturer : Zebra Technologies Corporation
1 Zebra Plaza, Holtsville, NY 11742
Standard : FCC Part 15 Subpart E §15.407

The product was received on Jun. 01, 2022 and testing was performed from Jun. 10, 2022 to Jul. 16, 2022. We, Sporton International Inc. Wensan Laboratory, would like to declare that the tested sample has been evaluated in accordance with the test procedures and has been in compliance with the applicable technical standards.

The test results in this report apply exclusively to the tested model / sample. Without written approval from Sporton International Inc. Wensan Laboratory, the test report shall not be reproduced except in full.

Approved by: Louis Wu

Sporton International Inc. Wensan Laboratory

No.58, Aly. 75, Ln. 564, Wenhua 3rd, Rd., Guishan Dist., Taoyuan City 333010, Taiwan (R.O.C.)



Table of Contents

History of this test report..... 3

Summary of Test Result..... 4

1 General Description 5

 1.1 Product Feature of Equipment Under Test..... 5

 1.2 Product Specification of Equipment Under Test..... 6

 1.3 Modification of EUT 8

 1.4 Testing Location 9

 1.5 Applicable Standards..... 9

2 Test Configuration of Equipment Under Test 10

 2.1 Carrier Frequency and Channel 10

 2.2 Test Mode 12

 2.3 Connection Diagram of Test System 21

 2.4 Support Unit used in test configuration and system 22

 2.5 EUT Operation Test Setup 23

 2.6 Measurement Results Explanation Example..... 23

3 Test Result 24

 3.1 26dB & 99% Occupied Bandwidth Measurement 24

 3.2 Maximum Conducted Output Power Measurement 35

 3.3 Power Spectral Density Measurement 46

 3.4 Unwanted Emissions Measurement..... 58

 3.5 AC Conducted Emission Measurement..... 65

 3.6 Antenna Requirements..... 67

4 List of Measuring Equipment..... 69

5 Uncertainty of Evaluation 70

Appendix A. AC Conducted Emission Test Result

Appendix B. Radiated Spurious Emission

Appendix C. Radiated Spurious Emission Plots

Appendix D. Duty Cycle Plots

Appendix E. Setup Photographs



Summary of Test Result

Report Clause	Ref Std. Clause	Test Items	Result (PASS/FAIL)	Remark
3.1	15.403(i)	26dB Bandwidth	Pass	-
3.1	2.1049	99% Occupied Bandwidth	Reporting only	-
3.2	15.407(a)	Maximum Conducted Output Power	Pass	-
3.3	15.407(a)	Power Spectral Density	Pass	-
3.4	15.407(b)	Unwanted Emissions	Pass	1.14 dB under the limit at 5146.380 MHz
3.5	15.207	AC Conducted Emission	Pass	19.62 dB under the limit at 0.170 MHz
3.6	15.203 15.407(a)	Antenna Requirement	Pass	-

Declaration of Conformity:

1. The test results (PASS/FAIL) with all measurement uncertainty excluded are presented in accordance with the regulation limits or requirements declared by manufacturers. It's means measurement values may risk exceeding the limit of regulation standards, if measurement uncertainty is include in test results.
2. The measurement uncertainty please refer to this report "Uncertainty of Evaluation".

Comments and Explanations:

The product specifications of the EUT presented in the report are declared by the manufacturer who shall take full responsibility for the authenticity.

Reviewed by: Keven Cheng

Report Producer: Ming Chen



1 General Description

1.1 Product Feature of Equipment Under Test

Product Feature	
Equipment	Tablet
Brand Name	Zebra
Model Name	ET45CB
FCC ID	UZ7ET45CB
EUT supports Radios application	GSM/EGPRS/WCDMA/HSPA/LTE/5G NR/NFC/GNSS WLAN 11a/b/g/n HT20/HT40 WLAN 11ac VHT20/VHT40/VHT80 WLAN 11ax HE20/HE40/HE80 Bluetooth BR/EDR/LE Note: 2.4G doesn't support BW 40/80.
HW Version	EV2-2
SW Version	ET45-userdebug 11 11-10-12.00-RG-U00-PRD-GSE MXJ release-keys
MFD	30APR22
EUT Stage	Identical Prototype

Remark: The EUT's information above is declared by manufacturer.

Specification of Accessories				
Battery	Brand Name	Zebra	Model Name	BT-000456

Supported Unit Used in Test Configuration and System				
AC Adapter	Brand Name	Zebra	Part Number	PWR-WUA5V12W0US
Earphone 1	Brand Name	Zebra	Part Number	HDST-35MM-PTVP-01
Earphone 2	Brand Name	Zebra	Part Number	HDST-USBC-PTT1-01
USB Cable (Type C to Type A)	Brand Name	Zebra	Part Number	CBL-TC5X-USBC2A-01
Type C-Audio Cable (Type C to 3.5mm)	Brand Name	Zebra	Part Number	ADP-USBC-35MM1-01



1.2 Product Specification of Equipment Under Test

Product Specification is subject to this standard	
Tx/Rx Frequency Range	5180 MHz ~ 5240 MHz 5260 MHz ~ 5320 MHz 5500 MHz ~ 5720 MHz
Maximum Output Power to Antenna <CDD Mode>	<p><5180 MHz ~ 5240 MHz> MIMO <Ant. 6+7> 802.11a: 20.72 dBm / 0.1180 W 802.11n HT20: 20.77 dBm / 0.1194 W 802.11n HT40: 23.16 dBm / 0.2070 W 802.11ac VHT20: 20.77 dBm / 0.1194 W 802.11ac VHT40: 23.16 dBm / 0.2070 W 802.11ac VHT80: 19.86 dBm / 0.0968 W 802.11ax HE20: 20.87 dBm / 0.1222 W 802.11ax HE40: 23.26 dBm / 0.2118 W 802.11ax HE80: 19.96 dBm / 0.0991 W</p> <p><5260 MHz ~ 5320 MHz> MIMO <Ant. 6+7> 802.11a: 20.56 dBm / 0.1138 W 802.11n HT20: 20.61 dBm / 0.1151 W 802.11n HT40: 23.16 dBm / 0.2070 W 802.11ac VHT20: 20.61 dBm / 0.1151 W 802.11ac VHT40: 23.16 dBm / 0.2070 W 802.11ac VHT80: 19.26 dBm / 0.0843 W 802.11ax HE20: 20.71 dBm / 0.1178 W 802.11ax HE40: 23.26 dBm / 0.2118 W 802.11ax HE80: 19.36 dBm / 0.0863 W</p> <p><5500 MHz ~ 5720 MHz> MIMO <Ant. 6+7> 802.11a: 20.93 dBm / 0.1239 W 802.11n HT20: 20.74 dBm / 0.1186 W 802.11n HT40: 23.31 dBm / 0.2143 W 802.11ac VHT20: 20.74 dBm / 0.1186 W 802.11ac VHT40: 23.31 dBm / 0.2143 W 802.11ac VHT80: 23.01 dBm / 0.2000 W 802.11ax HE20: 20.84 dBm / 0.1213 W 802.11ax HE40: 23.41 dBm / 0.2193 W 802.11ax HE80: 23.11 dBm / 0.2046 W</p>



Product Specification is subject to this standard	
<p>Maximum Output Power to Antenna <TXBF Mode></p>	<p><5180 MHz ~ 5240 MHz> MIMO <Ant. 6+7> 802.11n HT20: 21.06 dBm / 0.1276 W 802.11n HT40: 23.21 dBm / 0.2094 W 802.11ax HE20: 21.16 dBm / 0.1306 W 802.11ax HE40: 23.31 dBm / 0.2143 W 802.11ax HE80: 18.66 dBm / 0.0735 W <5260 MHz ~ 5320 MHz> MIMO <Ant. 6+7> 802.11n HT20: 21.16 dBm / 0.1306 W 802.11n HT40: 23.31 dBm / 0.2143 W 802.11ax HE20: 21.26 dBm / 0.1337 W 802.11ax HE40: 23.41 dBm / 0.2193 W 802.11ax HE80: 17.31 dBm / 0.0538 W <5500 MHz ~ 5720 MHz> MIMO <Ant. 6+7> 802.11n HT20: 21.61 dBm / 0.1194 W 802.11n HT40: 23.26 dBm / 0.2118 W 802.11ax HE20: 20.71 dBm / 0.1222 W 802.11ax HE40: 23.36 dBm / 0.2168 W 802.11ax HE80: 23.31 dBm / 0.2143 W</p>
<p>99% Occupied Bandwidth <CDD Mode></p>	<p>MIMO <Ant. 6> 802.11a: 17.03 MHz 802.11ax HE20: 19.03 MHz 802.11ax HE40: 38.36 MHz 802.11ax HE80: 77.44 MHz MIMO <Ant. 7> 802.11a: 16.93 MHz 802.11ax HE20: 18.98 MHz 802.11ax HE40: 39.86 MHz 802.11ax HE80: 77.56 MHz</p>
<p>99% Occupied Bandwidth <TXBF Mode></p>	<p>MIMO <Ant. 6> 802.11ax HE20: 18.98 MHz 802.11ax HE40: 37.96 MHz 802.11ax HE80: 77.20 MHz MIMO <Ant. 7> 802.11ax HE20: 18.98 MHz 802.11ax HE40: 38.16 MHz 802.11ax HE80: 77.32 MHz</p>



Product Specification is subject to this standard			
Antenna Type	Ant. 6: IFIA Antenna Ant. 7: IFIA Antenna		
Antenna Gain	<5180 MHz ~ 5240 MHz>		
	Ant. 6: 1.80 dBi Ant. 7: 1.50 dBi		
	<5260 MHz ~ 5320 MHz>		
Antenna Gain	Ant. 6: 2.40 dBi Ant. 7: 1.20 dBi		
	<5500 MHz ~ 5720 MHz>		
	Ant. 6: 2.00 dBi Ant. 7: -0.20 dBi		
Type of Modulation	802.11a/n: OFDM (BPSK/QPSK/16QAM/64QAM) 802.11ac: OFDM (BPSK/QPSK/16QAM/64QAM/256QAM) 802.11ax: OFDMA (BPSK/QPSK/16QAM/64QAM/256QAM/1024QAM)		
Antenna Function Description		Ant. 6	Ant. 7
	802.11 a/n/ac/ax MIMO	V	V
	802.11 n/ax TXBF	V	V

Remark:

1. MIMO Ant. 6+7 Directional Gain is a calculated result from MIMO Ant. 6 and MIMO Ant. 7. The formula used in calculation is documented in section 3.6.
2. MIMO Ant. 6+7 is a calculated result from sum of the power MIMO Ant. 6 and MIMO Ant. 7.
3. The EUT's information above is declared by manufacturer. Please refer to Comments and Explanations in report summary.

1.3 Modification of EUT

No modifications made to the EUT during the testing.



1.4 Testing Location

Test Site	Sporton International Inc. Wensan Laboratory
Test Site Location	No.58, Aly. 75, Ln. 564, Wenhua 3rd, Rd., Guishan Dist., Taoyuan City 333010, Taiwan (R.O.C.) TEL: +886-3-327-0868 FAX: +886-3-327-0855
Test Site No.	Sporton Site No. TH05-HY, CO07-HY, 03CH16-HY

Note: The test site complies with ANSI C63.4 2014 requirement.

FCC designation No.: TW3786

1.5 Applicable Standards

According to the specifications declared by the manufacturer, the EUT must comply with the requirements of the following standards:

- ♦ FCC Part 15 Subpart E
- ♦ FCC KDB 789033 D02 General UNII Test Procedures New Rules v02r01.
- ♦ FCC KDB 414788 D01 Radiated Test Site v01r01.
- ♦ FCC KDB 662911 D01 Multiple Transmitter Output v02r01.
- ♦ ANSI C63.10-2013

Remark:

1. All the test items were validated and recorded in accordance with the standards without any modification during the testing.
2. The TAF code is not including all the FCC KDB listed without accreditation.
3. This EUT has also been tested and complied with the requirements of FCC Part 15, Subpart B, recorded in a separate test report.



2 Test Configuration of Equipment Under Test

- a. The EUT has been associated with peripherals and configuration operated in a manner tended to maximize its emission characteristics in a typical application. Frequency range investigated: conduction emission (150 kHz to 30 MHz), radiation emission (9 kHz to the 10th harmonic of the highest fundamental frequency or to 40 GHz, whichever is lower). For radiated measurement, the measured emission level of the EUT was maximized by rotating the EUT on a turntable, adjusting the orientation of the EUT and EUT antenna in three orthogonal axis (X: flat, Y: portrait, Z: landscape), and adjusting the measurement antenna orientation, following C63.10 exploratory test procedures and find X plane as worst plane.
- b. AC power line Conducted Emission was tested under maximum output power.

2.1 Carrier Frequency and Channel

Frequency Band	Channel	Freq. (MHz)	Channel	Freq. (MHz)
5150-5250 MHz Band 1 (U-NII-1)	36	5180	44	5220
	38*	5190	46*	5230
	40	5200	48	5240
	42#	5210		

Frequency Band	Channel	Freq. (MHz)	Channel	Freq. (MHz)
5250-5350 MHz Band 2 (U-NII-2A)	52	5260	60	5300
	54*	5270	62*	5310
	56	5280	64	5320
	58#	5290		

Frequency Band	Channel	Freq. (MHz)	Channel	Freq. (MHz)
5470-5725 MHz Band 3 (U-NII-2C)	100	5500	112	5560
	102*	5510	116	5580
	104	5520	132	5660
	106#	5530	134*	5670
	108	5540	136	5680
	110*	5550	140	5700



Frequency Band	Channel	Freq. (MHz)	Channel	Freq. (MHz)
TDWR Channel	118*	5590	124	5620
	120	5600	126*	5630
	122#	5610	128	5640

Frequency Band	Channel	Freq. (MHz)	Channel	Freq. (MHz)
Straddle Channel	138#	5690	144	5720
	142*	5710		

Note:

1. The above Frequency and Channel with "*" are 802.11n HT40 and 802.11ac VHT40 and 802.11ax HE40.
2. The above Frequency and Channel with "#" are 802.11ac VHT80 and 802.11ax HE80.



2.2 Test Mode

The 802.11ax mode is investigated among different tones, full resource units (RU), partial resource units. The partial RU has no higher power than full RU's, thus the full RU is chosen as main test configuration.

The CDD mode is chosen as worst case configuration for all test cases due to higher power than SISO mode.

The 802.11n/ac mode has no higher power and PSD than 802.11ax mode, thus the 802.11ax mode is chosen as main test configuration, and the 802.11n/ac mode is verified the power.

The final test modes consider the modulation and the worst data rates as shown in the table below.

CDD Mode

Modulation	Data Rate
802.11a	6 Mbps
802.11n HT20 (Covered by HE20)	MCS0
802.11n HT40 (Covered by HE40)	MCS0
802.11ac VHT20 (Covered by HE20)	MCS0
802.11ac VHT40 (Covered by HE40)	MCS0
802.11ac VHT80 (Covered by HE80)	MCS0
802.11ax HE20	MCS0
802.11ax HE40	MCS0
802.11ax HE80	MCS0

Remark: The conducted power level of each chain in MIMO mode is equal or higher than SISO mode.

TXBF Mode

Modulation	Data Rate
802.11n HT20 (Covered by HE20)	MCS0
802.11n HT40 (Covered by HE40)	MCS0
802.11ax HE20	MCS0
802.11ax HE40	MCS0
802.11ax HE80	MCS0

Remark: The conducted power level of each chain in MIMO mode is equal or higher than SISO mode.



Test Cases	
AC Conducted Emission	Mode 1 : WLAN (5GHz) Link + Bluetooth Link + USB Cable (Type C to Type A) (Charging from Adapter)

Ch. #		Band I : 5150-5250 MHz	Band II : 5250-5350 MHz	Band III : 5470-5725MHz
		802.11a	802.11a	802.11a
L	Low	36	52	100
M	Middle	44	60	116
H	High	48	64	140
Straddle		-	-	144

Ch. #		Band I : 5150-5250 MHz	Band II : 5250-5350 MHz	Band III : 5470-5725MHz
		802.11ax HE20	802.11ax HE20	802.11ax HE20
L	Low	36	52	100
M	Middle	44	60	116
H	High	48	64	140
Straddle		-	-	144

Ch. #		Band I : 5150-5250 MHz	Band II : 5250-5350 MHz	Band III : 5470-5725MHz
		802.11ax HE40	802.11ax HE40	802.11ax HE40
L	Low	38	54	102
M	Middle	-	-	110
H	High	46	62	134
Straddle		-	-	142

Ch. #		Band I : 5150-5250 MHz	Band II : 5250-5350 MHz	Band III : 5470-5725MHz
		802.11ax HE80	802.11ax HE80	802.11ax HE80
L	Low	-	-	106
M	Middle	42	58	-
H	High	-	-	122
Straddle		-	-	138

Remark: For radiation spurious emission, the modulation and the data rate picked for testing are determined by the Max. RF conducted power.



<CDD Mode>

MIMO <Ant. 6+7>

802.11a RF Output Power (dBm)										
Power vs. Channel			Power vs Data Rate							
Channel	Frequency (MHz)	Data Rate (bps)	Channel	Data Rate (bps)						
		6M		9M	12M	18M	24M	36M	48M	54M
Duty Cycle (%)										
CH 036	5180	20.72	CH 036	20.62	20.62	20.62	20.62	20.62	20.52	20.52
CH 044	5220	20.37								
CH 048	5240	20.56								
CH 052	5260	20.47	CH 060	20.41	20.41	20.41	20.46	20.41	20.41	20.36
CH 060	5300	20.56								
CH 064	5320	20.51								
CH 100	5500	20.51	CH 140	20.83	20.77	20.73	20.77	20.83	20.72	20.77
CH 116	5580	20.46								
CH 140	5700	20.93								
CH 144*	5720	20.93								

Note: The above Frequency and Channel in "*" were straddle Channel.

802.11n HT20 RF Output Power (dBm)										
Power vs. Channel			Power vs Data Rate							
Channel	Frequency (MHz)	MCS Index	Channel	MCS Index						
		MCS0		MCS1	MCS2	MCS3	MCS4	MCS5	MCS6	MCS7
Duty Cycle (%)										
CH 036	5180	20.57	CH 048	20.67	20.67	20.67	20.47	20.52	20.51	20.51
CH 044	5220	20.61								
CH 048	5240	20.77								
CH 052	5260	20.61	CH 052	20.51	20.51	20.51	20.31	20.31	20.21	20.31
CH 060	5300	20.26								
CH 064	5320	20.51								
CH 100	5500	20.46	CH 140	20.64	20.64	20.64	20.50	20.50	20.48	20.54
CH 116	5580	20.41								
CH 140	5700	20.74								
CH 144*	5720	20.64								

Note: The above Frequency and Channel in "*" were straddle Channel.



802.11n HT40 RF Output Power (dBm)										
Power vs. Channel			Power vs Data Rate							
Channel	Frequency (MHz)	MCS Index	Channel	MCS Index						
		MCS0		MCS1	MCS2	MCS3	MCS4	MCS5	MCS6	MCS7
Duty Cycle (%)										
CH 038	5190	20.76	CH 046	23.06	23.06	23.01	23.06	23.06	22.96	23.06
CH 046	5230	23.16								
CH 054	5270	23.16	CH 054	23.06	23.06	22.96	22.96	23.01	23.01	22.96
CH 062	5310	20.71								
CH 102	5510	21.26	CH 110	23.21	23.21	23.11	23.16	23.21	23.11	23.11
CH 110	5550	23.31								
CH 134	5670	22.31								
CH 142*	5710	23.21								

Note: The above Frequency and Channel in "*" were straddle Channel.

802.11ac VHT20 RF Output Power (dBm)											
Power vs. Channel			Power vs Data Rate								
Channel	Frequency (MHz)	MCS Index	Channel	MCS Index							
		MCS0		MCS1	MCS2	MCS3	MCS4	MCS5	MCS6	MCS7	MCS8
Duty Cycle (%)											
CH 036	5180	20.57	CH 048	20.67	20.67	20.67	20.47	20.52	20.51	20.51	20.51
CH 044	5220	20.61									
CH 048	5240	20.77									
CH 052	5260	20.61	CH 052	20.51	20.51	20.51	20.31	20.31	20.21	20.31	20.31
CH 060	5300	20.26									
CH 064	5320	20.51									
CH 100	5500	20.46	CH 140	20.64	20.64	20.64	20.50	20.50	20.48	20.54	20.54
CH 116	5580	20.41									
CH 140	5700	20.74									
CH 144*	5720	20.64									

Note: The above Frequency and Channel in "*" were straddle Channel.



802.11ac VHT40 RF Output Power (dBm)												
Power vs. Channel			Power vs Data Rate									
Channel	Frequency (MHz)	MCS Index	Channel	MCS Index								
		MCS0		MCS1	MCS2	MCS3	MCS4	MCS5	MCS6	MCS7	MCS8	MCS9
Duty Cycle (%)												
CH 038	5190	20.76										
CH 046	5230	23.16	CH 046	23.06	23.06	23.01	23.06	23.06	22.96	23.06	23.06	23.06
CH 054	5270	23.16										
CH 062	5310	20.71	CH 054	23.06	23.06	22.96	22.96	23.01	23.01	22.96	22.96	22.96
CH 102	5510	21.26										
CH 110	5550	23.31										
CH 134	5670	22.31	CH 110	23.21	23.21	23.11	23.16	23.21	23.11	23.11	23.11	23.11
CH 142*	5710	23.21										

Note: The above Frequency and Channel in "*" were straddle Channel.

802.11ac VHT80 RF Output Power (dBm)												
Power vs. Channel			Power vs Data Rate									
Channel	Frequency (MHz)	MCS Index	Channel	MCS Index								
		MCS0		MCS1	MCS2	MCS3	MCS4	MCS5	MCS6	MCS7	MCS8	MCS9
Duty Cycle (%)												
CH 042	5210	19.86	CH 042	19.76	19.76	19.71	19.66	19.71	19.71	19.71	19.76	19.71
CH 058	5290	19.26	CH 058	-	-	-	-	-	-	-	-	-
CH 106	5530	19.91										
CH 122	5610	23.01	CH 122	22.91	22.86	22.91	22.86	22.81	22.86	22.91	22.86	22.81
CH 138*	5690	22.37										

Note: The above Frequency and Channel in "*" were straddle Channel.



802.11ax HE20 RF Output Power (dBm)															
Power vs. Channel				Power vs Data Rate											
Channel	Frequency (MHz)	RU Config.	MCS Index	Channel	MCS Index										
			MCS0		MCS1	MCS2	MCS3	MCS4	MCS5	MCS6	MCS7	MCS8	MCS9	MCS10	MCS11
Duty Cycle (%)															
CH 036	5180	Full	20.67	CH 048	20.77	20.77	20.57	20.57	20.56	20.56	20.61	20.57	20.56	20.61	20.56
CH 036	5180	26/0	12.27												
CH 036	5180	52/37	15.26												
CH 036	5180	106/53	18.51												
CH 044	5220	Full	20.71												
CH 044	5220	26/4	13.21												
CH 044	5220	52/39	15.26												
CH 044	5220	106/53	18.31												
CH 048	5240	Full	20.87												
CH 048	5240	26/8	12.01												
CH 048	5240	52/40	15.21												
CH 048	5240	106/54	18.41												
CH 052	5260	Full	20.71	CH 052	20.61	20.61	20.36	20.37	20.37	20.37	20.41	20.46	20.36	20.41	20.41
CH 052	5260	26/0	12.06												
CH 052	5260	52/37	15.06												
CH 052	5260	106/53	18.26												
CH 060	5300	Full	20.36												
CH 060	5300	26/4	12.91												
CH 060	5300	52/39	14.96												
CH 060	5300	106/54	18.26												
CH 064	5320	Full	20.61												
CH 064	5320	26/8	12.46												
CH 064	5320	52/40	15.06												
CH 064	5320	106/54	18.16												
CH 100	5500	Full	20.56	CH 140	20.74	20.74	20.54	20.50	20.50	20.48	20.44	20.54	20.54	20.54	20.54
CH 100	5500	26/0	12.46												
CH 100	5500	52/37	15.41												
CH 100	5500	106/53	18.66												
CH 116	5580	Full	20.51												
CH 116	5580	26/4	12.96												
CH 116	5580	52/38	15.31												
CH 116	5580	106/53	18.31												
CH 140	5700	Full	20.84												
CH 140	5700	26/8	12.63												
CH 140	5700	52/40	15.43												
CH 140	5700	106/54	18.68												
CH 144*	5720	Full	20.74												
CH 144*	5720	26/8	12.67												
CH 144*	5720	52/40	15.42												
CH 144*	5720	106/54	18.77												

Note: The above Frequency and Channel in "*" were straddle Channel.



802.11ax HE40 RF Output Power (dBm)															
Power vs. Channel				Power vs Data Rate											
Channel	Frequency (MHz)	RU Config.	MCS Index	Channel	MCS Index										
			MCS0		MCS1	MCS2	MCS3	MCS4	MCS5	MCS6	MCS7	MCS8	MCS9	MCS10	MCS11
Duty Cycle (%)															
CH 038	5190	Full	20.86	CH 046	23.16	23.16	23.11	23.11	23.16	23.16	23.11	23.06	23.16	23.11	23.11
CH 038	5190	242/61	18.61												
CH 046	5230	Full	23.26												
CH 046	5230	242/62	21.86												
CH 054	5270	Full	23.26	CH 054	23.16	23.16	23.16	23.06	23.01	23.11	23.11	23.06	23.06	23.06	23.11
CH 054	5270	242/61	21.86												
CH 062	5310	Full	20.81												
CH 062	5310	242/62	18.06												
CH 102	5510	Full	21.36	CH 110	23.31	23.31	23.31	23.26	23.31	23.31	23.26	23.26	23.21	23.26	23.26
CH 102	5510	242/61	18.71												
CH 110	5550	Full	23.41												
CH 110	5550	242/61	22.06												
CH 134	5670	Full	22.41												
CH 134	5670	242/62	19.70												
CH 142*	5710	Full	23.31												
CH 142*	5710	242/62	21.63												

Note: The above Frequency and Channel in "*" were straddle Channel.

802.11ax HE80 RF Output Power (dBm)															
Power vs. Channel				Power vs Data Rate											
Channel	Frequency (MHz)	RU Config.	MCS Index	Channel	MCS Index										
			MCS0		MCS1	MCS2	MCS3	MCS4	MCS5	MCS6	MCS7	MCS8	MCS9	MCS10	MCS11
Duty Cycle (%)															
CH 042	5210	Full	19.96	CH 042	19.86	19.81	19.81	19.76	19.86	19.86	19.86	19.86	19.86	19.81	19.81
CH 042	5210	484/65	17.31												
CH 058	5290	Full	19.36	CH 058	19.26	19.26	19.21	19.21	19.21	19.26	19.21	19.21	19.21	19.16	19.16
CH 058	5290	484/66	16.31												
CH 106	5530	Full	20.01	CH 122	23.01	23.01	22.96	22.96	22.96	22.96	23.01	23.01	22.96	22.96	22.96
CH 106	5530	484/65	16.86												
CH 122	5610	Full	23.11												
CH 122	5610	484/66	21.31												
CH 138*	5690	Full	22.47												
CH 138*	5690	484/66	20.97												

Note: The above Frequency and Channel in "*" were straddle Channel.



<TXBF Mode>

MIMO <Ant. 6+7>

802.11n HT20 RF Output Power (dBm)										
Power vs. Channel			Power vs Data Rate							
Channel	Frequency (MHz)	MCS Index	Channel	MCS Index						
		MCS0		MCS1	MCS2	MCS3	MCS4	MCS5	MCS6	MCS7
Duty Cycle (%)										
CH 036	5180	20.66	CH 044	20.96	20.96	20.96	20.96	20.96	20.96	20.96
CH 044	5220	21.06								
CH 048	5240	20.66								
CH 052	5260	21.16	CH 052	21.06	21.06	21.06	21.06	21.06	21.06	21.06
CH 060	5300	20.91								
CH 064	5320	20.66								
CH 100	5500	19.11	CH 144*	21.51	21.51	21.51	21.51	21.51	21.51	21.51
CH 116	5580	20.71								
CH 140	5700	20.77								
CH 144*	5720	21.61								

Note: The above Frequency and Channel in "*" were straddle Channel.

802.11n HT40 RF Output Power (dBm)										
Power vs. Channel			Power vs Data Rate							
Channel	Frequency (MHz)	MCS Index	Channel	MCS Index						
		MCS0		MCS1	MCS2	MCS3	MCS4	MCS5	MCS6	MCS7
Duty Cycle (%)										
CH 038	5190	18.46	CH 046	23.11	23.11	23.11	23.01	23.01	23.01	23.01
CH 046	5230	23.21								
CH 054	5270	23.31	CH 054	23.21	23.21	23.21	23.11	23.11	23.11	23.11
CH 062	5310	17.71								
CH 102	5510	19.11	CH 110	23.16	23.16	23.16	23.06	23.06	23.06	23.06
CH 110	5550	23.26								
CH 134	5670	21.71								
CH 142*	5710	23.07								

Note: The above Frequency and Channel in "*" were straddle Channel.



802.11ax HE20 RF Output Power (dBm)															
Power vs. Channel				Power vs Data Rate											
Channel	Frequency (MHz)	RU Config.	MCS Index	Channel	MCS Index										
			MCS0		MCS1	MCS2	MCS3	MCS4	MCS5	MCS6	MCS7	MCS8	MCS9	MCS10	MCS11
Duty Cycle (%)															
CH 036	5180	Full	20.76												
CH 044	5220	Full	21.16	CH 044	21.06	21.06	21.06	21.06	21.06	21.06	21.06	21.06	21.06	20.96	20.96
CH 048	5240	Full	20.76												
CH 052	5260	Full	21.26												
CH 060	5300	Full	21.01	CH 052	21.16	21.16	21.16	21.16	21.16	21.16	21.16	21.16	21.16	21.06	21.06
CH 064	5320	Full	20.76												
CH 100	5500	Full	19.21												
CH 116	5580	Full	20.81												
CH 140	5700	Full	20.87	CH 144*	21.61	21.61	21.61	21.61	21.61	21.61	21.61	21.61	21.61	21.51	21.51
CH 144*	5720	Full	21.71												

Note: The above Frequency and Channel in "*" were straddle Channel.

802.11ax HE40 RF Output Power (dBm)															
Power vs. Channel				Power vs Data Rate											
Channel	Frequency (MHz)	RU Config.	MCS Index	Channel	MCS Index										
			MCS0		MCS1	MCS2	MCS3	MCS4	MCS5	MCS6	MCS7	MCS8	MCS9	MCS10	MCS11
Duty Cycle (%)															
CH 038	5190	Full	18.56												
CH 046	5230	Full	23.31	CH 046	23.21	23.21	23.21	23.11	23.11	23.11	23.11	23.11	23.11	23.11	23.01
CH 054	5270	Full	23.41												
CH 062	5310	Full	17.81	CH 054	23.31	23.31	23.31	23.21	23.21	23.21	23.21	23.21	23.21	23.21	23.11
CH 102	5510	Full	19.21												
CH 110	5550	Full	23.36	CH 110	23.26	23.26	23.26	23.16	23.16	23.16	23.16	23.16	23.16	23.16	23.06
CH 134	5670	Full	21.81												
CH 142*	5710	Full	23.17												

Note: The above Frequency and Channel in "*" were straddle Channel.

802.11ax HE80 RF Output Power (dBm)															
Power vs. Channel				Power vs Data Rate											
Channel	Frequency (MHz)	RU Config.	MCS Index	Channel	MCS Index										
			MCS0		MCS1	MCS2	MCS3	MCS4	MCS5	MCS6	MCS7	MCS8	MCS9	MCS10	MCS11
Duty Cycle (%)															
CH 042	5210	Full	18.66	CH 042	18.56	18.56	18.56	18.46	18.46	18.46	18.46	18.46	18.46	18.46	18.36
CH 058	5290	Full	17.31	CH 058	17.21	17.21	17.21	17.11	17.11	17.11	17.11	17.11	17.11	17.11	17.01
CH 106	5530	Full	18.61												
CH 122	5610	Full	23.31	CH 122	23.21	23.21	23.21	23.11	23.11	23.11	23.11	23.11	23.11	23.11	23.01
CH 138*	5690	Full	23.21												

Note: The above Frequency and Channel in "*" were straddle Channel.

2.3 Connection Diagram of Test System

<AC Conducted Emission Mode>

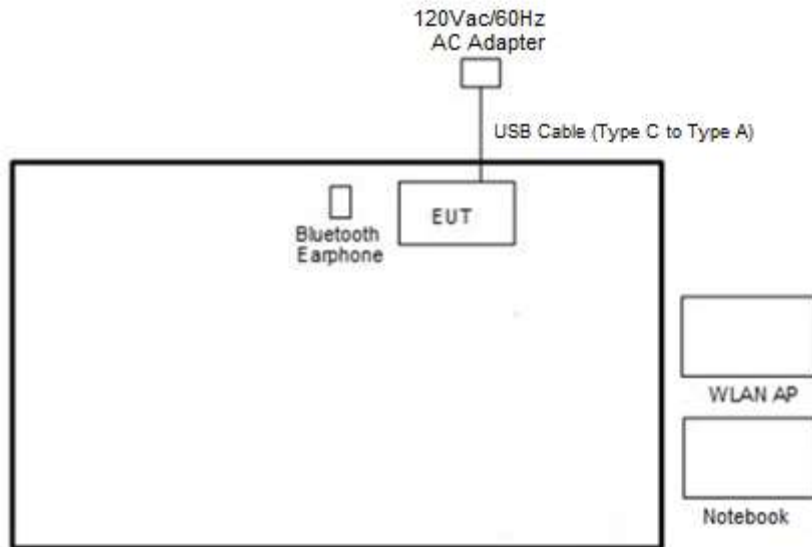

<WLAN Tx Mode>

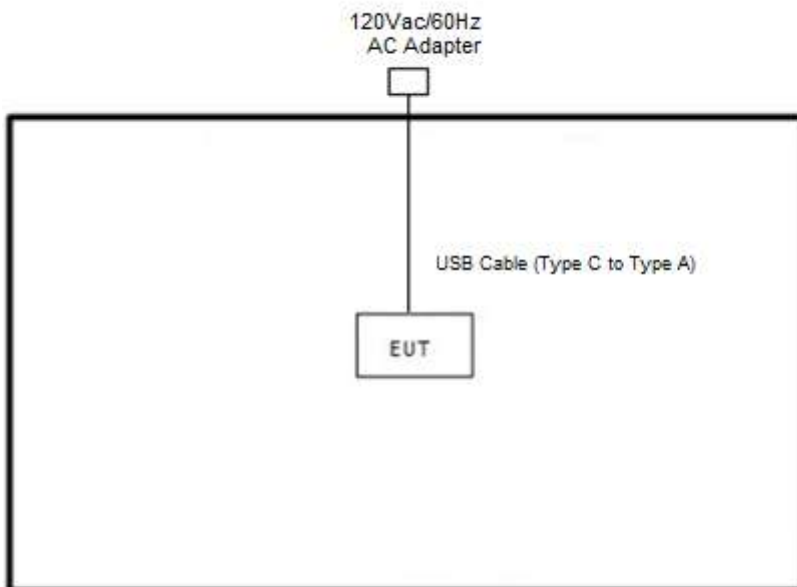

<WLAN TXBF Mode>

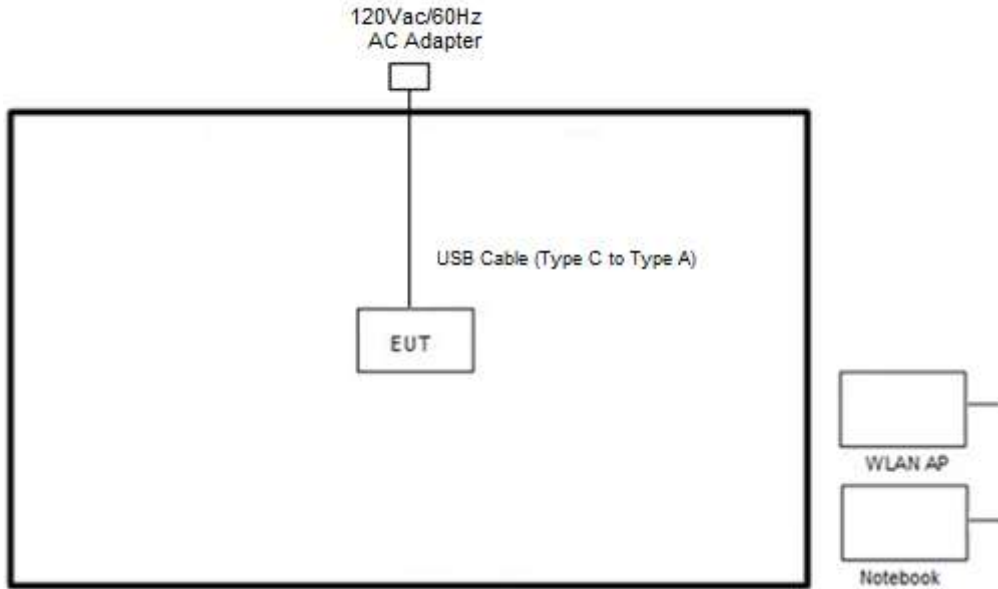

2.4 Support Unit used in test configuration and system

Item	Equipment	Brand Name	Model Name	FCC ID	Data Cable	Power Cord
1.	Bluetooth Earphone	Kinyo	BTE-3622	N/A	N/A	N/A
2.	WLAN AP	ASUS	RT-AC58	N/A	N/A	Unshielded, 1.8m
3.	WLAN AP	ASUS	RT-AX88U	LCITHP000236	N/A	Unshielded, 1.8m
4.	Notebook	Dell	P79G	FCC DoC	N/A	AC I/P : Unshielded, 1.2m DC O/P : Shielded, 1.8m
5.	Notebook	Lenovo	L570	N/A	N/A	AC I/P : Unshielded, 1.2m DC O/P : Shielded, 1.8m



2.5 EUT Operation Test Setup

The RF test items, utility “cmd.exe version 10.0.17763.1577” was installed in Notebook which was programmed in order to make the EUT get into the engineering modes to provide channel selection, power level, data rate and the application type and for continuous transmitting signals.

For TXBF mode, the modulation modes and data rates manipulated by the command lines in the engineering program made the EUT link to another EUT by power under the normal operation. The “Cmd version 1.0.39” software tool was used to enable the EUT to transmit signals continuously.

2.6 Measurement Results Explanation Example

For all conducted test items:

The offset level is set in the spectrum analyzer to compensate the RF cable loss and attenuator factor between EUT conducted output port and spectrum analyzer. With the offset compensation, the spectrum analyzer reading level is exactly the EUT RF output level.

Example :

The spectrum analyzer offset is derived from RF cable loss and attenuator factor.

Offset = RF cable loss + attenuator factor.

Following shows an offset computation example with cable loss 4.2 dB and 10 dB attenuator.

$$\begin{aligned} \text{Offset(dB)} &= \text{RF cable loss(dB)} + \text{attenuator factor(dB)}. \\ &= 4.2 + 10 = 14.2 \text{ (dB)} \end{aligned}$$

3 Test Result

3.1 26dB & 99% Occupied Bandwidth Measurement

3.1.1 Description of 26dB & 99% Occupied Bandwidth

This section is for reporting purpose only.

There is no restriction limits for bandwidth.

For Straddle Channel, according to KDB 789033 D02 General UNII Test Procedures New Rules v02r01, if the power and PSD of the devices are uniform and comply with the lower limits specified for the U-NII-2 bands, a single measurement over the entire emission bandwidth can be performed to show compliance.

3.1.2 Measuring Instruments

Please refer to the measuring equipment list in this test report.

3.1.3 Test Procedures

1. The testing follows FCC KDB 789033 D02 General UNII Test Procedures New Rules v02r01. Section C) Emission bandwidth
2. Set RBW = approximately 1% of the emission bandwidth.
3. Set the VBW > RBW.
4. Detector = Peak.
5. Trace mode = max hold
6. Measure the maximum width of the emission that is 26 dB down from the peak of the emission. Compare this with the RBW setting of the analyzer. Readjust RBW and repeat measurement as needed until the RBW/EBW ratio is approximately 1%.
7. For 99% Bandwidth Measurement, the spectrum analyzer's resolution bandwidth (RBW) is set 1-5% of the emission bandwidth and set the Video bandwidth (VBW) $\geq 3 * RBW$.
8. Measure and record the results in the test report.

3.1.4 Test Setup

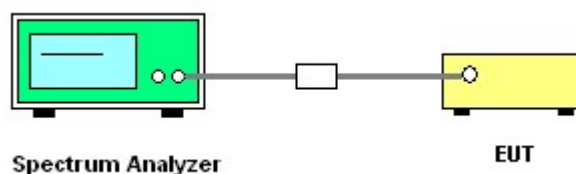



3.1.5 Test Result of 26dB & 99% Occupied Bandwidth

Test Engineer :	Eason Huang	Temperature :	21~25°C
		Relative Humidity :	51~54%

<CDD Mode>

Band I MIMO														
Mod.	Data Rate	NTX	CH.	Freq. (MHz)	99% Bandwidth (MHz)		26 dB Bandwidth (MHz)		IC 99% Bandwidth Power Limit (dBm)		IC 99% Bandwidth EIRP Limit (dBm)		-	Note
					Ant 6	Ant 7	Ant 6	Ant 7	Ant 6	Ant 7	Ant 6	Ant 7		
11a	6Mbps	2	36	5180	16.98	16.83	21.60	21.45	-	-	22.26	-	-	
11a	6Mbps	2	44	5220	16.98	16.88	21.80	21.35	-	-	22.27	-	-	
11a	6Mbps	2	48	5240	16.98	16.83	21.45	21.55	-	-	22.26	-	-	

Band II MIMO															
Mod.	Data Rate	NTX	CH.	Freq. (MHz)	99% Bandwidth (MHz)		26 dB Bandwidth (MHz)		IC 99% Bandwidth Power Limit (dBm)		IC 99% Bandwidth EIRP Limit (dBm)		FCC 26dB Bandwidth Power Limit (dBm)		Note
					Ant 6	Ant 7	Ant 6	Ant 7	Ant 6	Ant 7	Ant 6	Ant 7	Ant 6	Ant 7	
11a	6Mbps	2	52	5260	16.98	16.83	21.70	21.30	23.26	23.26	29.26	29.26	23.98	-	
11a	6Mbps	2	60	5300	16.98	16.83	21.80	21.80	23.26	23.26	29.26	29.26	23.98	-	
11a	6Mbps	2	64	5320	17.03	16.78	21.60	21.40	23.25	23.25	29.25	29.25	23.98	-	



Band III MIMO																
Mod.	Data Rate	NTX	CH.	Freq. (MHz)	99% Bandwidth In U-NII 2C (MHz)		26 dB Bandwidth In U-NII 2C (MHz)		IC 99% Bandwidth Power Limit (dBm)		IC 99% Bandwidth EIRP Limit (dBm)		FCC 26dB Bandwidth Power Limit (dBm)		6 dB Bandwidth for Straddle Channel (MHz)	
					Ant 6	Ant 7	Ant 6	Ant 7	Ant 6	Ant 7	Ant 6	Ant 7	Ant 6	Ant 7	Ant 6	Ant 7
11a	6Mbps	2	100	5500	17.03	16.93	21.70	21.45	23.29	29.29	23.98	23.98	---	---		
11a	6Mbps	2	116	5580	17.03	16.88	21.70	21.40	23.27	29.27	23.98	23.98	---	---		
11a	6Mbps	2	140	5700	17.03	16.88	21.75	21.70	23.27	29.27	23.98	23.98	---	---		

Band III straddle channel MIMO																
Mod.	Data Rate	NTX	CH.	Freq. (MHz)	99% Bandwidth In U-NII 2C (MHz)		26 dB Bandwidth In U-NII 2C (MHz)		IC 99% Bandwidth Power Limit (dBm)		IC 99% Bandwidth EIRP Limit (dBm)		FCC 26dB Bandwidth Power Limit (dBm)		6 dB Bandwidth for Straddle Channel (MHz)	
					Ant 6	Ant 7	Ant 6	Ant 7	Ant 6	Ant 7	Ant 6	Ant 7	Ant 6	Ant 7	Ant 6	Ant 7
11a	6Mbps	2	144	5720	13.54	13.44	15.95	15.80	22.28	28.28	22.99	22.99	3.2	3.2		

<802.11a>

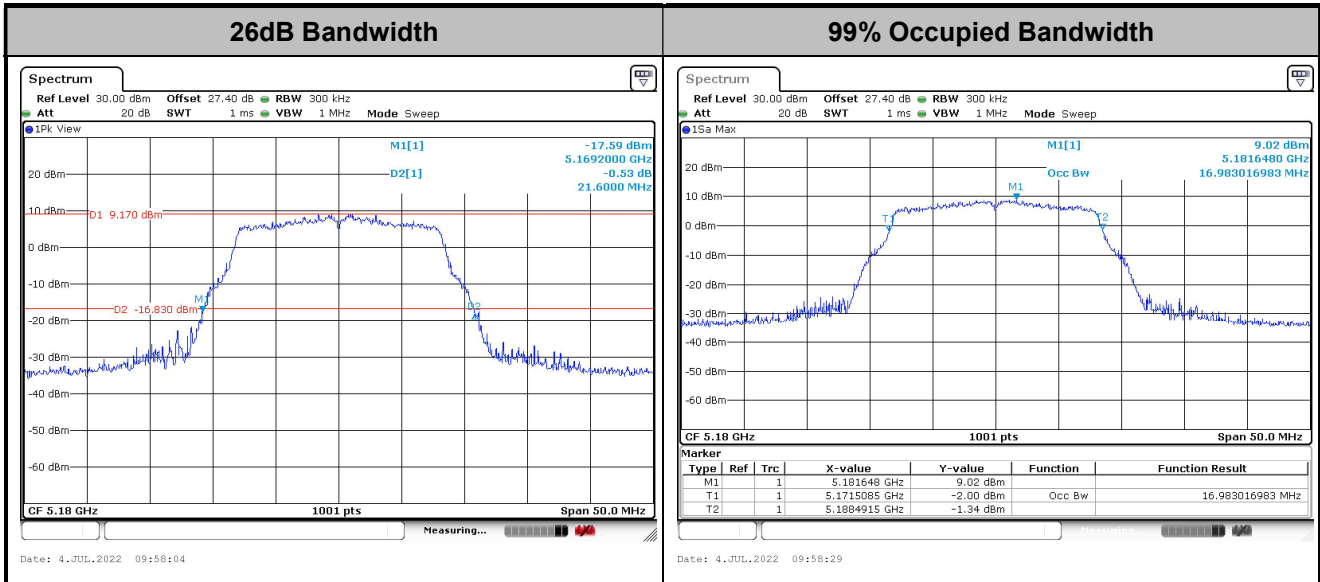

Note: The occupied channel bandwidth is maintained within the band of operation for all of the modulations.



<802.11ax Mode>

Band I MIMO															
Mod.	Data Rate	NTX	CH.	Freq. (MHz)	RU Config.	99% Bandwidth (MHz)		26 dB Bandwidth (MHz)		IC 99% Bandwidth Power Limit (dBm)		IC 99% Bandwidth EIRP Limit (dBm)		-	Note
						Ant 6	Ant 7	Ant 6	Ant 7	Ant 6	Ant 7	Ant 6	Ant 7		
HE20	MCS0	2	36	5180	Full	18.98	18.98	21.60	21.60	-	-	22.78	-	-	
HE20	MCS0	2	44	5220	Full	18.93	18.98	21.55	21.70	-	-	22.77	-	-	
HE20	MCS0	2	48	5240	Full	18.88	18.98	21.65	21.35	-	-	22.76	-	-	
HE40	MCS0	2	38	5190	Full	37.86	37.86	39.96	39.87	-	-	23.01	-	-	
HE40	MCS0	2	46	5230	Full	38.16	38.36	50.13	59.22	-	-	23.01	-	-	
HE80	MCS0	2	42	5210	Full	77.20	77.08	82.24	81.76	-	-	23.01	-	-	

Band II MIMO															
Mod.	Data Rate	NTX	CH.	Freq. (MHz)	RU Config.	99% Bandwidth (MHz)		26 dB Bandwidth (MHz)		IC 99% Bandwidth Power Limit (dBm)		IC 99% Bandwidth EIRP Limit (dBm)		FCC 26dB Bandwidth Power Limit (dBm)	Note
						Ant 6	Ant 7	Ant 6	Ant 7	Ant 6	Ant 7	Ant 6	Ant 7	Ant 6	
HE20	MCS0	2	52	5260	Full	18.93	18.98	21.75	21.40	23.77	23.77	29.77	23.98	-	
HE20	MCS0	2	60	5300	Full	18.98	18.98	21.55	21.20	23.78	23.78	29.78	23.98	-	
HE20	MCS0	2	64	5320	Full	18.93	18.98	21.45	21.60	23.77	23.77	29.77	23.98	-	
HE40	MCS0	2	54	5270	Full	38.26	38.46	49.95	62.01	23.98	23.98	30.00	23.98	-	
HE40	MCS0	2	62	5310	Full	37.86	37.96	39.87	39.87	23.98	23.98	30.00	23.98	-	
HE80	MCS0	2	58	5290	Full	77.08	77.20	82.08	82.08	23.98	23.98	30.00	23.98	-	



Band III MIMO																	
Mod.	Data Rate	NTX	CH.	Freq. (MHz)	RU Config.	99% Bandwidth In U-NII 2C (MHz)		26 dB Bandwidth In U-NII 2C (MHz)		IC 99% Bandwidth Power Limit (dBm)		IC 99% Bandwidth EIRP Limit (dBm)		FCC 26dB Bandwidth Power Limit (dBm)		6 dB Bandwidth for Straddle Channel (MHz)	
						Ant 6	Ant 7	Ant 6	Ant 7	Ant 6	Ant 7	Ant 6	Ant 7	Ant 6	Ant 7	Ant 6	Ant 7
HE20	MCS0	2	100	5500	Full	18.93	18.98	21.65	21.30	23.77	29.77	23.98	---	---			
HE20	MCS0	2	116	5580	Full	19.03	18.98	21.60	21.35	23.78	29.78	23.98	---	---			
HE20	MCS0	2	140	5700	Full	18.98	18.98	21.45	21.30	23.78	29.78	23.98	---	---			
HE40	MCS0	2	102	5510	Full	37.96	37.96	40.05	39.96	23.98	30.00	23.98	---	---			
HE40	MCS0	2	110	5550	Full	38.36	39.86	55.26	75.33	23.98	30.00	23.98	---	---			
HE40	MCS0	2	134	5670	Full	38.16	38.36	43.74	61.20	23.98	30.00	23.98	---	---			
HE80	MCS0	2	106	5530	Full	77.08	77.20	82.72	81.76	23.98	30.00	23.98	---	---			
HE80	MCS0	2	122	5610	Full	77.44	77.56	93.76	126.72	23.98	30.00	23.98	---	---			

Band III straddle channel MIMO																	
Mod.	Data Rate	NTX	CH.	Freq. (MHz)	RU Config.	99% Bandwidth In U-NII 2C (MHz)		26 dB Bandwidth In U-NII 2C (MHz)		IC 99% Bandwidth Power Limit (dBm)		IC 99% Bandwidth EIRP Limit (dBm)		FCC 26dB Bandwidth Power Limit (dBm)		6 dB Bandwidth for Straddle Channel (MHz)	
						Ant 6	Ant 7	Ant 6	Ant 7	Ant 6	Ant 7	Ant 6	Ant 7	Ant 6	Ant 7	Ant 6	Ant 7
HE20	MCS0	2	144	5720	Full	14.49	14.49	15.75	15.70	22.61	28.61	22.96	4.35	4.5			
HE40	MCS0	2	142	5710	Full	34.18	34.58	46.86	51.90	23.98	30.00	23.98	4.08	3.9			
HE80	MCS0	2	138	5690	Full	73.72	73.72	78.04	92.92	23.98	30.00	23.98	4.201	3.881			



<802.11ax HE20>

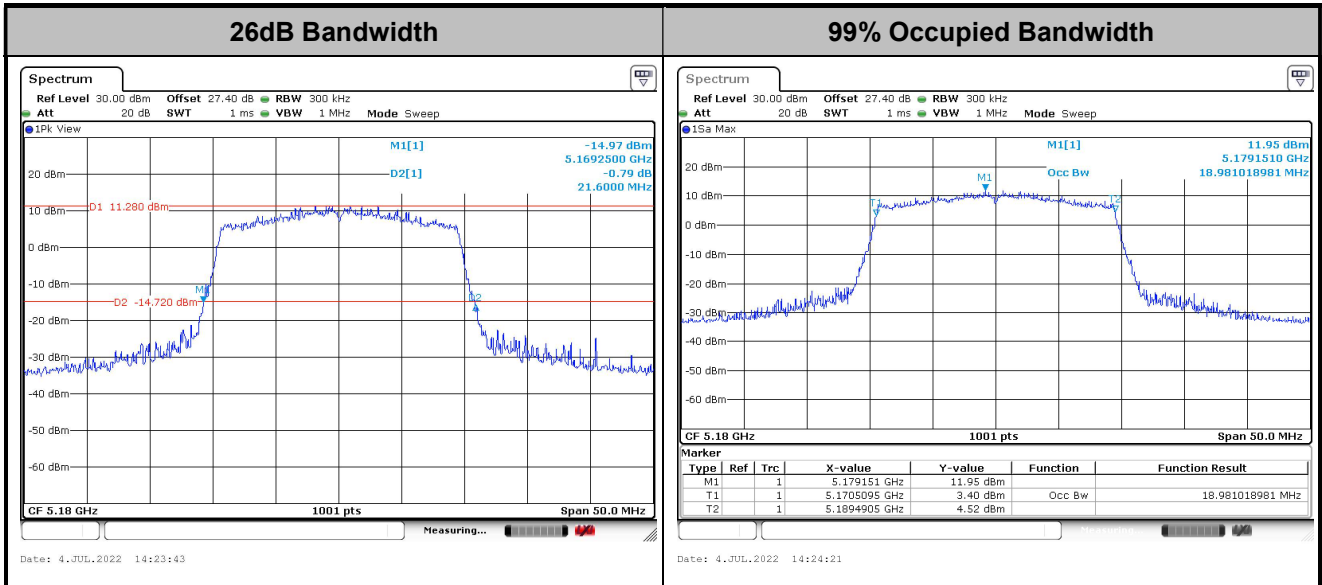

Note: The occupied channel bandwidth is maintained within the band of operation for all of the modulations.

<802.11ax HE40>

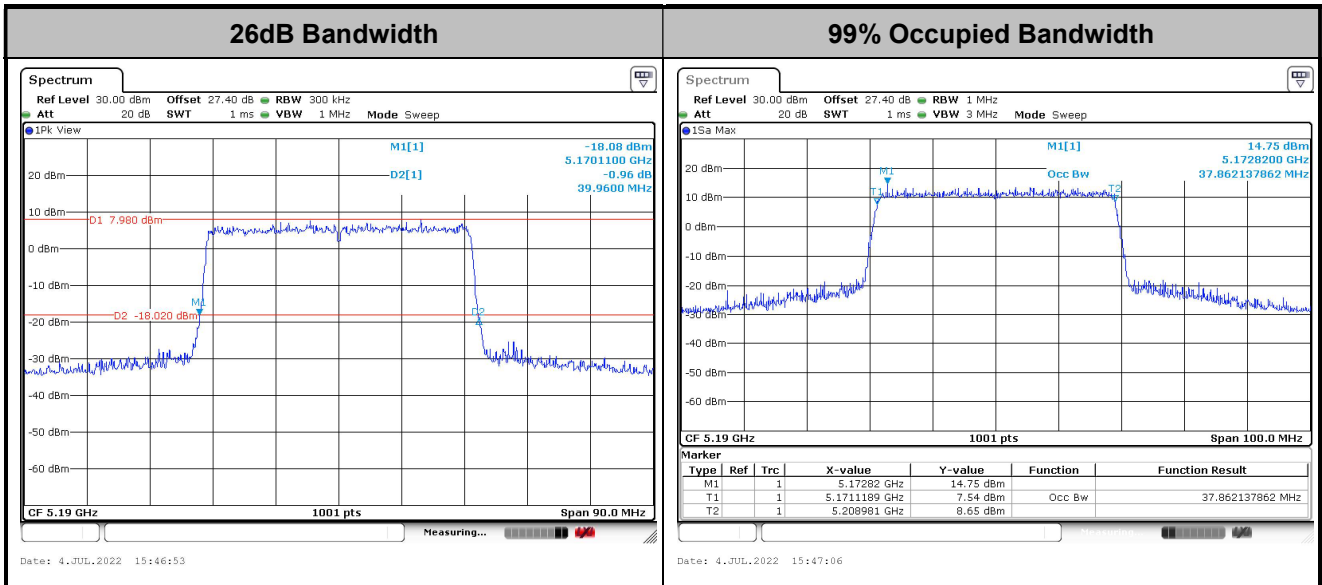

Note: The occupied channel bandwidth is maintained within the band of operation for all of the modulations.



<802.11ax HE80>

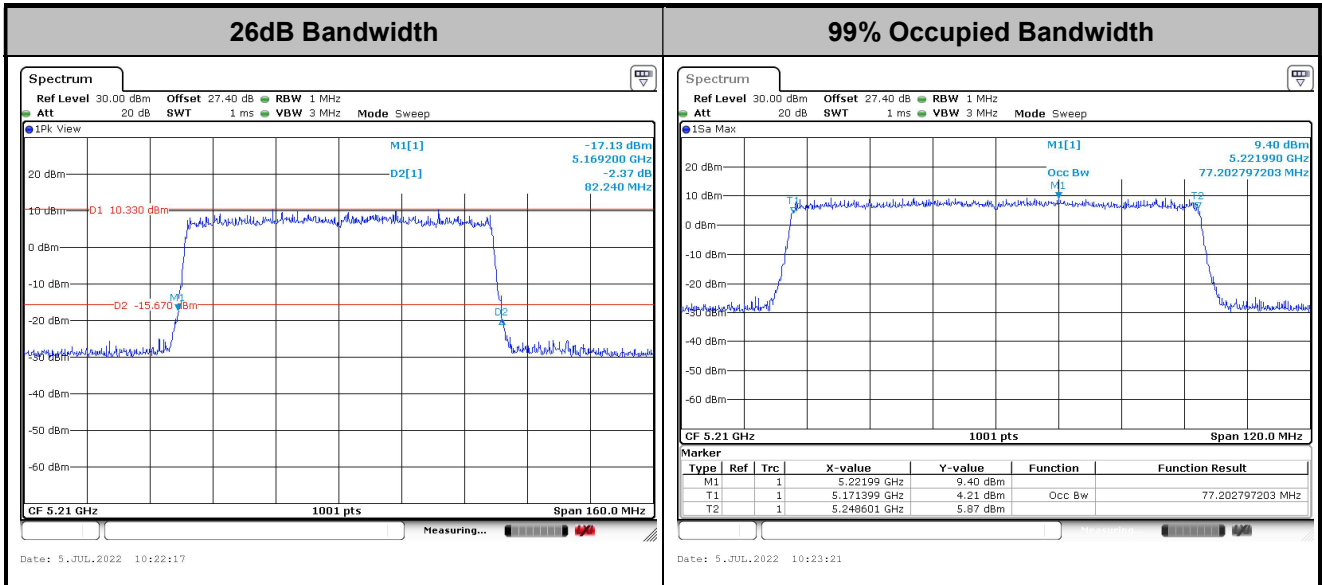

Note: The occupied channel bandwidth is maintained within the band of operation for all of the modulations.



Test Engineer :	Eason Huang , Hank Hsu	Temperature :	21~25°C
		Relative Humidity :	51~54%

<TXBF Modes>

Band I MIMO															
Mod.	Data Rate	NTX	CH.	Freq. (MHz)	RU Config.	99% Bandwidth (MHz)		26 dB Bandwidth (MHz)		IC 99% Bandwidth Power Limit (dBm)		IC 99% Bandwidth EIRP Limit (dBm)		-	Note
						Ant 6	Ant 7	Ant 6	Ant 7	Ant 6	Ant 7	Ant 6	Ant 7		
HE20	MCS2	2	36	5180	Full	18.93	18.93	21.35	21.45	-	-	22.77	-	-	
HE20	MCS2	2	44	5220	Full	18.93	18.98	21.60	21.25	-	-	22.77	-	-	
HE20	MCS2	2	48	5240	Full	18.88	18.93	21.55	21.15	-	-	22.76	-	-	
HE40	MCS0	2	38	5190	Full	37.76	37.86	40.05	39.87	-	-	23.01	-	-	
HE40	MCS0	2	46	5230	Full	37.96	38.06	40.14	41.85	-	-	23.01	-	-	
HE80	MCS0	2	42	5210	Full	77.20	77.08	81.76	81.92	-	-	23.01	-	-	

Band II MIMO															
Mod.	Data Rate	NTX	CH.	Freq. (MHz)	RU Config.	99% Bandwidth (MHz)		26 dB Bandwidth (MHz)		IC 99% Bandwidth Power Limit (dBm)		IC 99% Bandwidth EIRP Limit (dBm)		FCC 26dB Bandwidth Power Limit (dBm)	Note
						Ant 6	Ant 7	Ant 6	Ant 7	Ant 6	Ant 7	Ant 6	Ant 7	Ant 6	
HE20	MCS2	2	52	5260	Full	18.93	18.93	21.40	21.60	23.77	23.77	29.77	23.98	-	
HE20	MCS2	2	60	5300	Full	18.93	18.98	21.60	21.55	23.77	23.77	29.77	23.98	-	
HE20	MCS2	2	64	5320	Full	18.93	18.93	21.40	21.50	23.77	23.77	29.77	23.98	-	
HE40	MCS0	2	54	5270	Full	37.96	37.96	40.05	46.26	23.98	23.98	30.00	23.98	-	
HE40	MCS0	2	62	5310	Full	37.76	37.86	40.05	39.87	23.98	23.98	30.00	23.98	-	
HE80	MCS0	2	58	5290	Full	77.20	77.08	82.40	81.76	23.98	23.98	30.00	23.98	-	



Band III MIMO																	
Mod.	Data Rate	NTX	CH.	Freq. (MHz)	RU Config.	99% Bandwidth In U-NII 2C (MHz)		26 dB Bandwidth In U-NII 2C (MHz)		IC 99% Bandwidth Power Limit (dBm)		IC 99% Bandwidth EIRP Limit (dBm)		FCC 26dB Bandwidth Power Limit (dBm)		6 dB Bandwidth for Straddle Channel (MHz)	
						Ant 6	Ant 7	Ant 6	Ant 7	Ant 6	Ant 7	Ant 6	Ant 7	Ant 6	Ant 7	Ant 6	Ant 7
HE20	MCS2	2	100	5500	Full	18.93	18.93	21.50	21.45	23.77	29.77	29.77	23.98	----	----		
HE20	MCS2	2	116	5580	Full	18.98	18.98	21.60	21.50	23.78	29.78	29.78	23.98	----	----		
HE20	MCS2	2	140	5700	Full	18.93	18.98	21.50	21.50	23.77	29.77	29.77	23.98	----	----		
HE40	MCS0	2	102	5510	Full	37.96	37.76	40.14	39.96	23.98	30.00	30.00	23.98	----	----		
HE40	MCS0	2	110	5550	Full	37.96	38.16	40.14	55.62	23.98	30.00	30.00	23.98	----	----		
HE40	MCS0	2	134	5670	Full	37.86	37.96	40.05	40.05	23.98	30.00	30.00	23.98	----	----		
HE80	MCS0	2	106	5530	Full	77.08	77.08	82.24	81.76	23.98	30.00	30.00	23.98	----	----		
HE80	MCS0	2	122	5610	Full	77.20	77.32	85.76	117.28	23.98	30.00	30.00	23.98	----	----		

Band III straddle channel MIMO																	
Mod.	Data Rate	NTX	CH.	Freq. (MHz)	RU Config.	99% Bandwidth In U-NII 2C (MHz)		26 dB Bandwidth In U-NII 2C (MHz)		IC 99% Bandwidth Power Limit (dBm)		IC 99% Bandwidth EIRP Limit (dBm)		FCC 26dB Bandwidth Power Limit (dBm)		6 dB Bandwidth for Straddle Channel (MHz)	
						Ant 6	Ant 7	Ant 6	Ant 7	Ant 6	Ant 7	Ant 6	Ant 7	Ant 6	Ant 7	Ant 6	Ant 7
HE20	MCS2	2	144	5720	Full	14.49	14.49	15.70	15.80	22.61	28.61	28.61	22.96	4.25	2.6		
HE40	MCS0	2	142	5710	Full	33.98	34.08	35.16	41.91	23.98	30.00	30.00	23.98	3.99	3.99		
HE80	MCS0	2	138	5690	Full	73.84	73.84	75.64	87.74	23.98	30.00	30.00	23.98	4.04	2.92		



<802.11ax HE20>

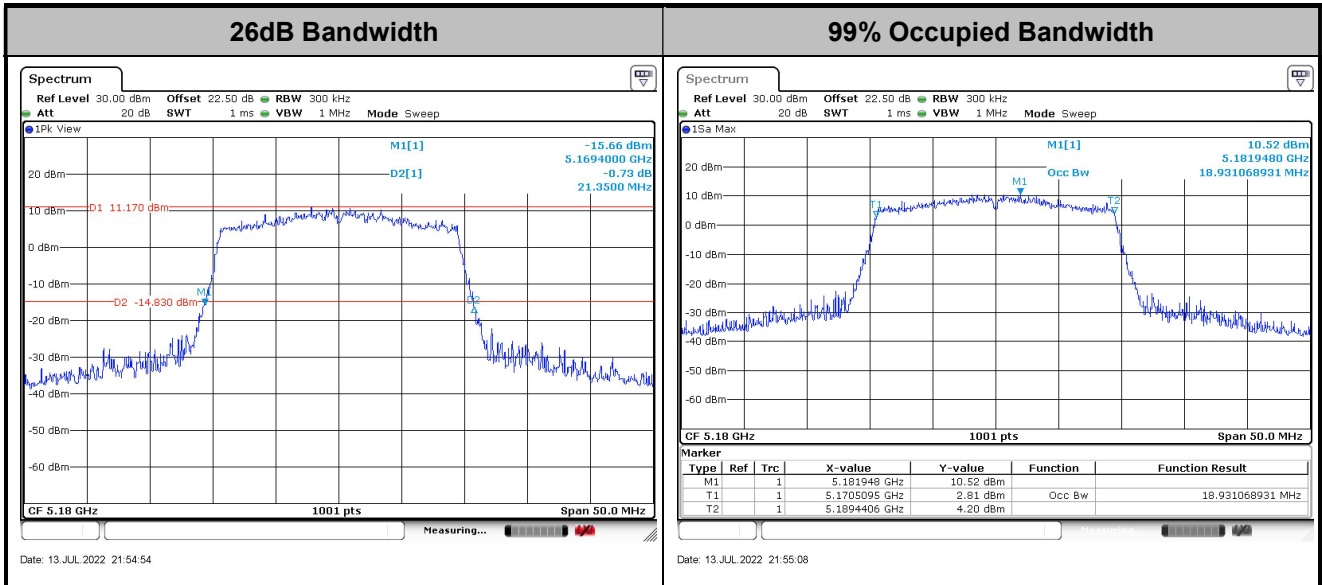

Note: The occupied channel bandwidth is maintained within the band of operation for all of the modulations.

<802.11ax HE40>

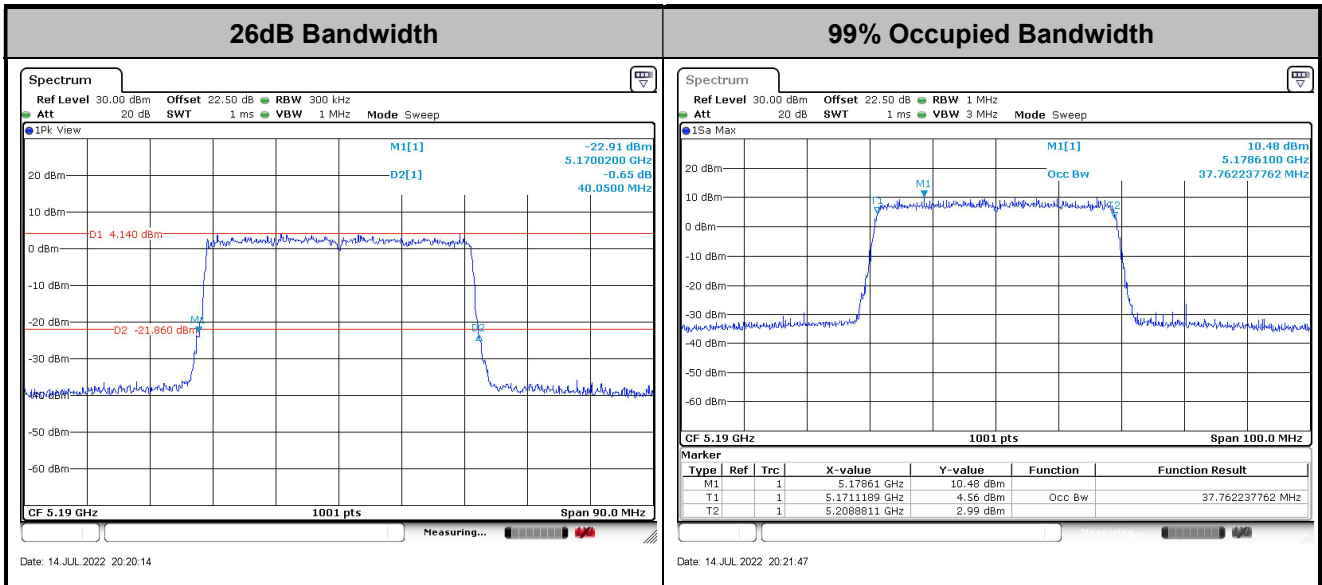

Note: The occupied channel bandwidth is maintained within the band of operation for all of the modulations.



<802.11ax HE80>

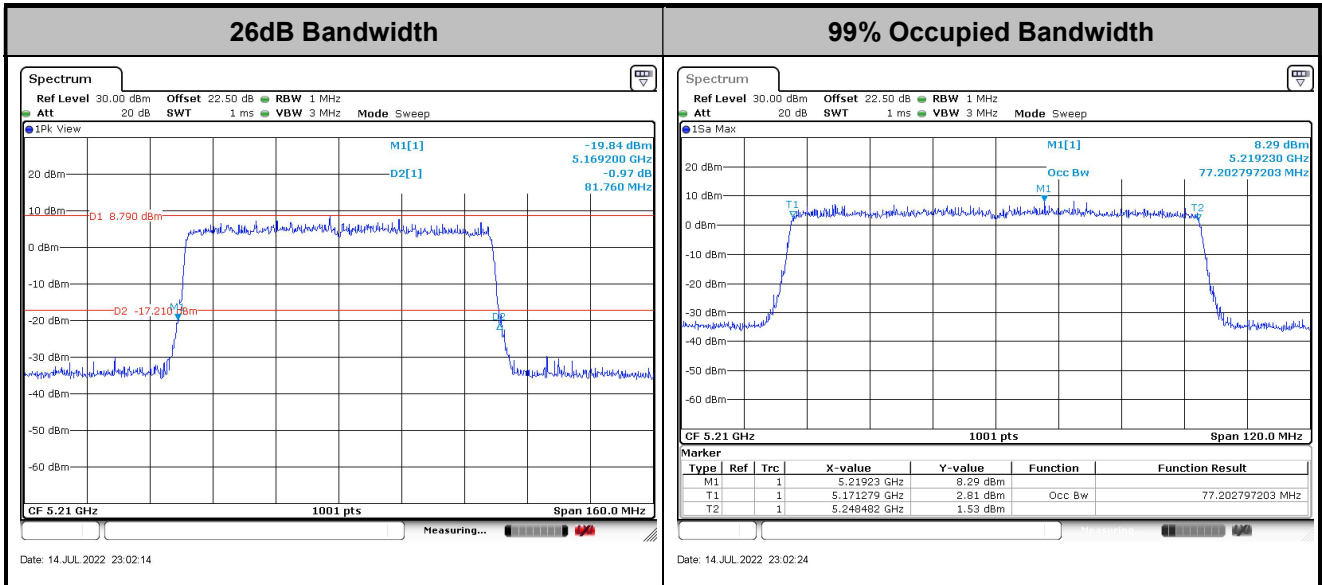

Note: The occupied channel bandwidth is maintained within the band of operation for all of the modulations.



3.2 Maximum Conducted Output Power Measurement

3.2.1 Limit of Maximum Conducted Output Power

<FCC 14-30 CFR 15.407>

For the 5.15–5.25 GHz bands:

■ For mobile and portable client devices in the 5.15–5.25 GHz band, the maximum conducted output power over the frequency band of operation shall not exceed 250 mW. For an indoor access point operating in the band 5.15-5.25 GHz, the maximum conducted output power over the frequency band of operation shall not exceed 1 W.

For the 5.25–5.725 GHz bands:

■ The maximum conducted output power over the frequency bands of operation shall not exceed the lesser of 250 mW or 11 dBm 10 log B, where B is the 26 dB emission bandwidth in megahertz.

For Straddle Channel, according to KDB 789033 D02 General UNII Test Procedures New Rules v02r01, if the power and PSD of the devices are uniform and comply with the lower limits specified for the U-NII-2 bands, a single measurement over the entire emission bandwidth can be performed to show compliance.

If transmitting antennas of directional gain greater than 6 dBi are used, the peak output power shall be reduced by the amount in dB that the directional gain of the antenna exceeds 6 dBi.

Note that U-NII-2 band, devices with a maximum e.i.r.p. greater than 500 mW shall implement TPC in order to have the capability to operate at least 6 dB below the maximum permitted e.i.r.p. of 1 W.

3.2.2 Measuring Instruments

Please refer to the measuring equipment list in this test report.

3.2.3 Test Procedures

<CDD Modes>

The testing follows Method PM-G of FCC KDB 789033 D02 General UNII Test Procedures New Rules v02r01.

Method PM-G (Measurement using a gated RF average power meter):

1. Measurement is performed using a wideband RF power meter.
2. The EUT is configured to transmit at its maximum power control level.
3. Measure the average power of the transmitter.
4. Since the measurement is made only during the ON time of the transmitter, no duty cycle correction factor is required.
5. For MIMO mode, calculation method follows FCC KDB 662911 D01 Multiple Transmitter Output v02r01

<TXBF Modes>

The testing follows Method PM-G of FCC KDB 789033 D02 General UNII Test Procedures New Rules v02r01.

Method PM-G (Measurement using a gated RF average power meter):

1. Measurement is performed using a wideband RF power meter.
2. The EUT is configured to transmit at its maximum power control level.
3. Measure the average power of the transmitter
4. Since the measurement is made only during the ON time of the transmitter, no duty cycle correction factor is required.
5. For MIMO mode, calculation method follows FCC KDB 662911 D01 Multiple Transmitter Output v02r01.

For Straddle Channel, according to KDB 789033 D02 General UNII Test Procedures New Rules v02r01, if the power and PSD of the devices are uniform and comply with the lower limits specified for the U-NII-2 bands, a single measurement over the entire emission bandwidth can be performed to show compliance.

3.2.4 Test Setup

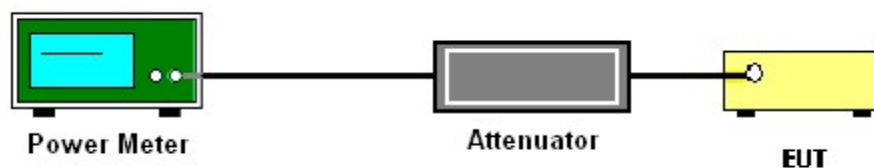



3.2.5 Test Result of Maximum Conducted Output Power

Test Engineer :	Eason Huang	Temperature :	21~25°C
		Relative Humidity :	51~54%

<CDD Mode>

FCC Band I MIMO												
Mod.	Data Rate	NTX	CH.	Freq. (MHz)	Average Conducted Power (dBm)			FCC Conducted Power Limit (dBm)		DG (dBi)		Pass/Fail
					Ant 6	Ant 7	SUM	Ant 6	Ant 7	Ant 6	Ant 7	
11a	6Mbps	2	36	5180	17.40	18.00	20.72	24.00	1.80		Pass	
11a	6Mbps	2	44	5220	17.10	17.60	20.37	24.00	1.80		Pass	
11a	6Mbps	2	48	5240	17.40	17.70	20.56	24.00	1.80		Pass	
HT20	MCS0	2	36	5180	17.20	17.90	20.57	24.00	1.80		Pass	
HT20	MCS0	2	44	5220	17.40	17.80	20.61	24.00	1.80		Pass	
HT20	MCS0	2	48	5240	17.50	18.00	20.77	24.00	1.80		Pass	
HT40	MCS0	2	38	5190	17.70	17.80	20.76	24.00	1.80		Pass	
HT40	MCS0	2	46	5230	20.10	20.20	23.16	24.00	1.80		Pass	
VHT20	MCS0	2	36	5180	17.20	17.90	20.57	24.00	1.80		Pass	
VHT20	MCS0	2	44	5220	17.40	17.80	20.61	24.00	1.80		Pass	
VHT20	MCS0	2	48	5240	17.50	18.00	20.77	24.00	1.80		Pass	
VHT40	MCS0	2	38	5190	17.70	17.80	20.76	24.00	1.80		Pass	
VHT40	MCS0	2	46	5230	20.10	20.20	23.16	24.00	1.80		Pass	
VHT80	MCS0	2	42	5210	16.80	16.90	19.86	24.00	1.80		Pass	



FCC Band II MIMO													
Mod.	Data Rate	NTX	CH.	Freq. (MHz)	Average Conducted Power (dBm)			FCC Conducted Power Limit (dBm)		DG (dBi)		EIRP Power Limit (dBm)	Pass/Fail
					Ant 6	Ant 7	SUM	Ant 6	Ant 7	Ant 6	Ant 7		
11a	6Mbps	2	52	5260	17.20	17.70	20.47	23.98		2.40		30	Pass
11a	6Mbps	2	60	5300	17.40	17.70	20.56	23.98		2.40		30	Pass
11a	6Mbps	2	64	5320	17.40	17.60	20.51	23.98		2.40		30	Pass
HT20	MCS0	2	52	5260	17.40	17.80	20.61	23.98		2.40		30	Pass
HT20	MCS0	2	60	5300	17.10	17.40	20.26	23.98		2.40		30	Pass
HT20	MCS0	2	64	5320	17.30	17.70	20.51	23.98		2.40		30	Pass
HT40	MCS0	2	54	5270	20.30	20.00	23.16	23.98		2.40		30	Pass
HT40	MCS0	2	62	5310	17.70	17.70	20.71	23.98		2.40		30	Pass
VHT20	MCS0	2	52	5260	17.40	17.80	20.61	23.98		2.40		30	Pass
VHT20	MCS0	2	60	5300	17.10	17.40	20.26	23.98		2.40		30	Pass
VHT20	MCS0	2	64	5320	17.30	17.70	20.51	23.98		2.40		30	Pass
VHT40	MCS0	2	54	5270	20.30	20.00	23.16	23.98		2.40		30	Pass
VHT40	MCS0	2	62	5310	17.70	17.70	20.71	23.98		2.40		30	Pass
VHT80	MCS0	2	58	5290	16.20	16.30	19.26	23.98		2.40		30	Pass



FCC Band III MIMO													
Mod.	Data Rate	NTX	CH.	Freq. (MHz)	Average Conducted Power (dBm)			FCC Conducted Power Limit (dBm)		DG (dBi)		EIRP Power Limit (dBm)	Pass/Fail
					Ant 6	Ant 7	SUM	Ant 6	Ant 7	Ant 6	Ant 7		
11a	6Mbps	2	100	5500	17.50	17.50	20.51	23.98		2.00		30	Pass
11a	6Mbps	2	116	5580	17.30	17.60	20.46	23.98		2.00		30	Pass
11a	6Mbps	2	140	5700	17.50	18.30	20.93	23.98		2.00		30	Pass
HT20	MCS0	2	100	5500	17.40	17.50	20.46	23.98		2.00		30	Pass
HT20	MCS0	2	116	5580	17.30	17.50	20.41	23.98		2.00		30	Pass
HT20	MCS0	2	140	5700	17.20	18.20	20.74	23.98		2.00		30	Pass
HT40	MCS0	2	102	5510	18.20	18.30	21.26	23.98		2.00		30	Pass
HT40	MCS0	2	110	5550	20.40	20.20	23.31	23.98		2.00		30	Pass
HT40	MCS0	2	134	5670	19.10	19.50	22.31	23.98		2.00		30	Pass
VHT20	MCS0	2	100	5500	17.40	17.50	20.46	23.98		2.00		30	Pass
VHT20	MCS0	2	116	5580	17.30	17.50	20.41	23.98		2.00		30	Pass
VHT20	MCS0	2	140	5700	17.20	18.20	20.74	23.98		2.00		30	Pass
VHT40	MCS0	2	102	5510	18.20	18.30	21.26	23.98		2.00		30	Pass
VHT40	MCS0	2	110	5550	20.40	20.20	23.31	23.98		2.00		30	Pass
VHT40	MCS0	2	134	5670	19.10	19.50	22.31	23.98		2.00		30	Pass
VHT80	MCS0	2	106	5530	17.00	16.80	19.91	23.98		2.00		30	Pass
VHT80	MCS0	2	122	5610	20.00	20.00	23.01	23.98		2.00		30	Pass

FCC Band III straddle channel MIMO													
Mod.	Data Rate	NTX	CH.	Freq. (MHz)	Average Conducted Power (dBm)			FCC Conducted Power Limit (dBm)		DG (dBi)		EIRP Power Limit (dBm)	Pass/Fail
					Ant 6	Ant 7	SUM	Ant 6	Ant 7	Ant 6	Ant 7		
11a	6Mbps	2	144	5720	17.50	18.30	20.93	22.99		2.00		30	Pass
HT20	MCS0	2	144	5720	17.10	18.10	20.64	23.98		2.00		30	Pass
HT40	MCS0	2	142	5710	20.00	20.40	23.21	23.98		2.00		30	Pass
VHT20	MCS0	2	144	5720	17.10	18.10	20.64	23.98		2.00		30	Pass
VHT40	MCS0	2	142	5710	20.00	20.40	23.21	23.98		2.00		30	Pass
VHT80	MCS0	2	138	5690	19.00	19.70	22.37	23.98		2.00		30	Pass



<802.11ax Mode>

FCC Band I MIMO													
Mod.	Data Rate	NTX	CH.	Freq. (MHz)	RU Config.	Average Conducted Power (dBm)			FCC Conducted Power Limit (dBm)		DG (dBi)		Pass/Fail
						Ant 6	Ant 7	SUM	Ant 6	Ant 7	Ant 6	Ant 7	
HE20	MCS0	2	36	5180	Full	17.30	18.00	20.67	24.00	24.00	1.80	1.80	Pass
HE20	MCS0	2	36	5180	26/0	9.00	9.50	12.27	24.00	24.00	1.80	1.80	Pass
HE20	MCS0	2	36	5180	52/37	12.10	12.40	15.26	24.00	24.00	1.80	1.80	Pass
HE20	MCS0	2	36	5180	106/53	15.30	15.70	18.51	24.00	24.00	1.80	1.80	Pass
HE20	MCS0	2	44	5220	Full	17.50	17.90	20.71	24.00	24.00	1.80	1.80	Pass
HE20	MCS0	2	44	5220	26/4	10.20	10.20	13.21	24.00	24.00	1.80	1.80	Pass
HE20	MCS0	2	44	5220	52/39	12.20	12.30	15.26	24.00	24.00	1.80	1.80	Pass
HE20	MCS0	2	44	5220	106/53	15.30	15.30	18.31	24.00	24.00	1.80	1.80	Pass
HE20	MCS0	2	48	5240	Full	17.60	18.10	20.87	24.00	24.00	1.80	1.80	Pass
HE20	MCS0	2	48	5240	26/8	8.80	9.20	12.01	24.00	24.00	1.80	1.80	Pass
HE20	MCS0	2	48	5240	52/40	12.20	12.20	15.21	24.00	24.00	1.80	1.80	Pass
HE20	MCS0	2	48	5240	106/54	15.30	15.50	18.41	24.00	24.00	1.80	1.80	Pass
HE40	MCS0	2	38	5190	Full	17.80	17.90	20.86	24.00	24.00	1.80	1.80	Pass
HE40	MCS0	2	38	5190	242/61	15.40	15.80	18.61	24.00	24.00	1.80	1.80	Pass
HE40	MCS0	2	46	5230	Full	20.20	20.30	23.26	24.00	24.00	1.80	1.80	Pass
HE40	MCS0	2	46	5230	242/62	18.80	18.90	21.86	24.00	24.00	1.80	1.80	Pass
HE80	MCS0	2	42	5210	Full	16.90	17.00	19.96	24.00	24.00	1.80	1.80	Pass
HE80	MCS0	2	42	5210	484/65	14.20	14.40	17.31	24.00	24.00	1.80	1.80	Pass



FCC Band II MIMO														
Mod.	Data Rate	NTX	CH.	Freq. (MHz)	RU Config.	Average Conducted Power (dBm)			FCC Conducted Power Limit (dBm)		DG (dBi)		EIRP Power Limit (dBm)	Pass/Fail
						Ant 6	Ant 7	SUM	Ant 6	Ant 7	Ant 6	Ant 7		
HE20	MCS0	2	52	5260	Full	17.50	17.90	20.71	23.98		2.40		30	Pass
HE20	MCS0	2	52	5260	26/0	9.00	9.10	12.06	23.98		2.40		30	Pass
HE20	MCS0	2	52	5260	52/37	12.00	12.10	15.06	23.98		2.40		30	Pass
HE20	MCS0	2	52	5260	106/53	15.10	15.40	18.26	23.98		2.40		30	Pass
HE20	MCS0	2	60	5300	Full	17.20	17.50	20.36	23.98		2.40		30	Pass
HE20	MCS0	2	60	5300	26/4	9.90	9.90	12.91	23.98		2.40		30	Pass
HE20	MCS0	2	60	5300	52/39	12.00	11.90	14.96	23.98		2.40		30	Pass
HE20	MCS0	2	60	5300	106/54	15.20	15.30	18.26	23.98		2.40		30	Pass
HE20	MCS0	2	64	5320	Full	17.40	17.80	20.61	23.98		2.40		30	Pass
HE20	MCS0	2	64	5320	26/8	9.50	9.40	12.46	23.98		2.40		30	Pass
HE20	MCS0	2	64	5320	52/40	12.10	12.00	15.06	23.98		2.40		30	Pass
HE20	MCS0	2	64	5320	106/54	15.10	15.20	18.16	23.98		2.40		30	Pass
HE40	MCS0	2	54	5270	Full	20.40	20.10	23.26	23.98		2.40		30	Pass
HE40	MCS0	2	54	5270	242/61	18.70	19.00	21.86	23.98		2.40		30	Pass
HE40	MCS0	2	62	5310	Full	17.80	17.80	20.81	23.98		2.40		30	Pass
HE40	MCS0	2	62	5310	242/62	15.00	15.10	18.06	23.98		2.40		30	Pass
HE80	MCS0	2	58	5290	Full	16.30	16.40	19.36	23.98		2.40		30	Pass
HE80	MCS0	2	58	5290	484/66	13.20	13.40	16.31	23.98		2.40		30	Pass



FCC Band III MIMO														
Mod.	Data Rate	NTX	CH.	Freq. (MHz)	RU Config.	Average Conducted Power (dBm)			FCC Conducted Power Limit (dBm)		DG (dBi)		EIRP Power Limit (dBm)	Pass/Fail
						Ant 6	Ant 7	SUM	Ant 6	Ant 7	Ant 6	Ant 7		
HE20	MCS0	2	100	5500	Full	17.50	17.60	20.56	23.98	2.00	30	Pass		
HE20	MCS0	2	100	5500	26/0	9.30	9.60	12.46	23.98	2.00	30	Pass		
HE20	MCS0	2	100	5500	52/37	12.40	12.40	15.41	23.98	2.00	30	Pass		
HE20	MCS0	2	100	5500	106/53	15.70	15.60	18.66	23.98	2.00	30	Pass		
HE20	MCS0	2	116	5580	Full	17.40	17.60	20.51	23.98	2.00	30	Pass		
HE20	MCS0	2	116	5580	26/4	9.80	10.10	12.96	23.98	2.00	30	Pass		
HE20	MCS0	2	116	5580	52/38	12.30	12.30	15.31	23.98	2.00	30	Pass		
HE20	MCS0	2	116	5580	106/53	15.10	15.50	18.31	23.98	2.00	30	Pass		
HE20	MCS0	2	140	5700	Full	17.30	18.30	20.84	23.98	2.00	30	Pass		
HE20	MCS0	2	140	5700	26/8	9.20	10.00	12.63	23.98	2.00	30	Pass		
HE20	MCS0	2	140	5700	52/40	12.00	12.80	15.43	23.98	2.00	30	Pass		
HE20	MCS0	2	140	5700	106/54	15.20	16.10	18.68	23.98	2.00	30	Pass		
HE40	MCS0	2	102	5510	Full	18.30	18.40	21.36	23.98	2.00	30	Pass		
HE40	MCS0	2	102	5510	242/61	15.70	15.70	18.71	23.98	2.00	30	Pass		
HE40	MCS0	2	110	5550	Full	20.50	20.30	23.41	23.98	2.00	30	Pass		
HE40	MCS0	2	110	5550	242/61	19.00	19.10	22.06	23.98	2.00	30	Pass		
HE40	MCS0	2	134	5670	Full	19.20	19.60	22.41	23.98	2.00	30	Pass		
HE40	MCS0	2	134	5670	242/62	16.10	17.20	19.70	23.98	2.00	30	Pass		
HE80	MCS0	2	106	5530	Full	17.10	16.90	20.01	23.98	2.00	30	Pass		
HE80	MCS0	2	106	5530	484/65	13.80	13.90	16.86	23.98	2.00	30	Pass		
HE80	MCS0	2	122	5610	Full	20.10	20.10	23.11	23.98	2.00	30	Pass		
HE80	MCS0	2	122	5610	484/66	18.10	18.50	21.31	23.98	2.00	30	Pass		

FCC Band III straddle channel MIMO														
Mod.	Data Rate	NTX	CH.	Freq. (MHz)	RU Config.	Average Conducted Power (dBm)			FCC Conducted Power Limit (dBm)		DG (dBi)		EIRP Power Limit (dBm)	Pass/Fail
						Ant 6	Ant 7	SUM	Ant 6	Ant 7	Ant 6	Ant 7		
HE20	MCS0	2	144	5720	Full	17.20	18.20	20.74	22.96	2.00	30	Pass		
HE20	MCS0	2	144	5720	26/8	9.30	10.00	12.67	22.96	2.00	30	Pass		
HE20	MCS0	2	144	5720	52/40	12.10	12.70	15.42	22.96	2.00	30	Pass		
HE20	MCS0	2	144	5720	106/54	15.40	16.10	18.77	22.96	2.00	30	Pass		
HE40	MCS0	2	142	5710	Full	20.10	20.50	23.31	23.98	2.00	30	Pass		
HE40	MCS0	2	142	5710	242/62	18.20	19.00	21.63	23.98	2.00	30	Pass		
HE80	MCS0	2	138	5690	Full	19.10	19.80	22.47	23.98	2.00	30	Pass		
HE80	MCS0	2	138	5690	484/66	17.60	18.30	20.97	23.98	2.00	30	Pass		



Test Engineer :	Eason Huang , Hank Hsu	Temperature :	21~25°C
		Relative Humidity :	51~54%

<TXBF Modes>

FCC Band I MIMO												
Mod.	Data Rate	NTX	CH.	Freq. (MHz)	Average Conducted Power (dBm)			FCC Conducted Power Limit (dBm)		DG (dBi)		Pass/Fail
					Ant 6	Ant 7	SUM	Ant 6	Ant 7	Ant 6	Ant 7	
HT20	MCS2	2	36	5180	17.60	17.70	20.66	24.00		4.66		Pass
HT20	MCS2	2	44	5220	18.20	17.90	21.06	24.00		4.66		Pass
HT20	MCS2	2	48	5240	17.80	17.50	20.66	24.00		4.66		Pass
HT40	MCS0	2	38	5190	15.50	15.40	18.46	24.00		4.66		Pass
HT40	MCS0	2	46	5230	20.00	20.40	23.21	24.00		4.66		Pass

FCC Band II MIMO													
Mod.	Data Rate	NTX	CH.	Freq. (MHz)	Average Conducted Power (dBm)			FCC Conducted Power Limit (dBm)		DG (dBi)		EIRP Power Limit (dBm)	Pass/Fail
					Ant 6	Ant 7	SUM	Ant 6	Ant 7	Ant 6	Ant 7		
HT20	MCS2	2	52	5260	18.30	18.00	21.16	23.98		4.83		30	Pass
HT20	MCS2	2	60	5300	18.00	17.80	20.91	23.98		4.83		30	Pass
HT20	MCS2	2	64	5320	17.80	17.50	20.66	23.98		4.83		30	Pass
HT40	MCS0	2	54	5270	20.30	20.30	23.31	23.98		4.83		30	Pass
HT40	MCS0	2	62	5310	14.90	14.50	17.71	23.98		4.83		30	Pass



FCC Band III MIMO													
Mod.	Data Rate	NTX	CH.	Freq. (MHz)	Average Conducted Power (dBm)			FCC Conducted Power Limit (dBm)		DG (dBi)		EIRP Power Limit (dBm)	Pass/Fail
					Ant 6	Ant 7	SUM	Ant 6	Ant 7	Ant 6	Ant 7		
HT20	MCS2	2	100	5500	16.10	16.10	19.11	23.98		3.98		30	Pass
HT20	MCS2	2	116	5580	17.60	17.80	20.71	23.98		3.98		30	Pass
HT20	MCS2	2	140	5700	17.40	18.10	20.77	23.98		3.98		30	Pass
HT40	MCS0	2	102	5510	16.10	16.10	19.11	23.98		3.98		30	Pass
HT40	MCS0	2	110	5550	20.30	20.20	23.26	23.98		3.98		30	Pass
HT40	MCS0	2	134	5670	18.50	18.90	21.71	23.98		3.98		30	Pass

FCC Band III straddle channel MIMO													
Mod.	Data Rate	NTX	CH.	Freq. (MHz)	Average Conducted Power (dBm)			FCC Conducted Power Limit (dBm)		DG (dBi)		EIRP Power Limit (dBm)	Pass/Fail
					Ant 6	Ant 7	SUM	Ant 6	Ant 7	Ant 6	Ant 7		
HT20	MCS2	2	144	5720	18.40	18.80	21.61	23.98		3.98		30	Pass
HT40	MCS0	2	142	5710	19.80	20.30	23.07	23.98		3.98		30	Pass

<802.11ax Mode>

FCC Band I MIMO													
Mod.	Data Rate	NTX	CH.	Freq. (MHz)	RU Config.	Average Conducted Power (dBm)			FCC Conducted Power Limit (dBm)		DG (dBi)		Pass/Fail
						Ant 6	Ant 7	SUM	Ant 6	Ant 7	Ant 6	Ant 7	
HE20	MCS2	2	36	5180	Full	17.70	17.80	20.76	24.00		4.66		Pass
HE20	MCS2	2	44	5220	Full	18.30	18.00	21.16	24.00		4.66		Pass
HE20	MCS2	2	48	5240	Full	17.90	17.60	20.76	24.00		4.66		Pass
HE40	MCS0	2	38	5190	Full	15.60	15.50	18.56	24.00		4.66		Pass
HE40	MCS0	2	46	5230	Full	20.10	20.50	23.31	24.00		4.66		Pass
HE80	MCS0	2	42	5210	Full	15.80	15.50	18.66	24.00		4.66		Pass



FCC Band II MIMO														
Mod.	Data Rate	NTX	CH.	Freq. (MHz)	RU Config.	Average Conducted Power (dBm)			FCC Conducted Power Limit (dBm)		DG (dBi)		EIRP Power Limit (dBm)	Pass/Fail
						Ant 6	Ant 7	SUM	Ant 6	Ant 7	Ant 6	Ant 7		
HE20	MCS2	2	52	5260	Full	18.40	18.10	21.26	23.98	23.98	4.83	4.83	30	Pass
HE20	MCS2	2	60	5300	Full	18.10	17.90	21.01	23.98	23.98	4.83	4.83	30	Pass
HE20	MCS2	2	64	5320	Full	17.90	17.60	20.76	23.98	23.98	4.83	4.83	30	Pass
HE40	MCS0	2	54	5270	Full	20.40	20.40	23.41	23.98	23.98	4.83	4.83	30	Pass
HE40	MCS0	2	62	5310	Full	15.00	14.60	17.81	23.98	23.98	4.83	4.83	30	Pass
HE80	MCS0	2	58	5290	Full	14.50	14.10	17.31	23.98	23.98	4.83	4.83	30	Pass

FCC Band III MIMO														
Mod.	Data Rate	NTX	CH.	Freq. (MHz)	RU Config.	Average Conducted Power (dBm)			FCC Conducted Power Limit (dBm)		DG (dBi)		EIRP Power Limit (dBm)	Pass/Fail
						Ant 6	Ant 7	SUM	Ant 6	Ant 7	Ant 6	Ant 7		
HE20	MCS2	2	100	5500	Full	16.20	16.20	19.21	23.98	23.98	3.98	3.98	30	Pass
HE20	MCS2	2	116	5580	Full	17.70	17.90	20.81	23.98	23.98	3.98	3.98	30	Pass
HE20	MCS2	2	140	5700	Full	17.50	18.20	20.87	23.98	23.98	3.98	3.98	30	Pass
HE40	MCS0	2	102	5510	Full	16.20	16.20	19.21	23.98	23.98	3.98	3.98	30	Pass
HE40	MCS0	2	110	5550	Full	20.40	20.30	23.36	23.98	23.98	3.98	3.98	30	Pass
HE40	MCS0	2	134	5670	Full	18.60	19.00	21.81	23.98	23.98	3.98	3.98	30	Pass
HE80	MCS0	2	106	5530	Full	15.60	15.60	18.61	23.98	23.98	3.98	3.98	30	Pass
HE80	MCS0	2	122	5610	Full	20.20	20.40	23.31	23.98	23.98	3.98	3.98	30	Pass

FCC Band III straddle channel MIMO														
Mod.	Data Rate	NTX	CH.	Freq. (MHz)	RU Config.	Average Conducted Power (dBm)			FCC Conducted Power Limit (dBm)		DG (dBi)		EIRP Power Limit (dBm)	Pass/Fail
						Ant 6	Ant 7	SUM	Ant 6	Ant 7	Ant 6	Ant 7		
HE20	MCS2	2	144	5720	Full	18.50	18.90	21.71	22.96	22.96	3.98	3.98	30	Pass
HE40	MCS0	2	142	5710	Full	19.90	20.40	23.17	23.98	23.98	3.98	3.98	30	Pass
HE80	MCS0	2	138	5690	Full	20.00	20.40	23.21	23.98	23.98	3.98	3.98	30	Pass



3.3 Power Spectral Density Measurement

3.3.1 Limit of Power Spectral Density

<FCC 14-30 CFR 15.407>

For the 5.15–5.25 GHz bands:

For mobile and portable client devices in the 5.15–5.25 GHz band, the maximum power spectral density shall not exceed 11 dBm in any 1.0 MHz band. For an indoor access point operating in the band 5.15-5.25 GHz, the maximum power spectral density shall not exceed 17 dBm in any 1.0 MHz band.

For the 5.25–5.725 GHz bands:

The maximum power spectral density shall not exceed 11 dBm in any 1.0 MHz band.

For Straddle Channel, according to KDB 789033 D02 General UNII Test Procedures New Rules v02r01, if the power and PSD of the devices are uniform and comply with the lower limits specified for the U-NII-2 bands, a single measurement over the entire emission bandwidth can be performed to show compliance.

If transmitting antennas of directional gain greater than 6 dBi are used, the peak output power shall be reduced by the amount in dB that the directional gain of the antenna exceeds 6 dBi.

3.3.2 Measuring Instruments

Please refer to the measuring equipment list in this test report.



3.3.3 Test Procedures

The testing follows FCC KDB 789033 D02 General UNII Test Procedures New Rules v02r01.

Section F) Maximum power spectral density.

<CDD Modes>

Method SA-3

(power averaging (rms) detection with max hold):

- Set span to encompass the entire emission bandwidth (EBW) of the signal.
- Set RBW = 1 MHz.
- Set VBW \geq 3 MHz.
- Number of points in sweep \geq 2 Span / RBW.
- Sweep time \leq (number of points in sweep) \times T, when duty cycle is less than 98 percent where T is the minimum transmission duration over which the transmitter is on and is transmitting at its maximum power control level for the tested mode of operation.
Detector = power averaging (rms).
- Trace mode = max hold.
- Allow max hold to run for at least 60 seconds, or longer as needed to allow the trace to stabilize.

<TXBF Modes>

Method SA-3

(power averaging (rms) detection with max hold):

- Set span to encompass the entire emission bandwidth (EBW) of the signal.
- Set RBW = 300 kHz.
- Set VBW \geq 1 MHz.
- Number of points in sweep \geq 2 Span / RBW.
- Sweep time \leq (number of points in sweep) \times T, when duty cycle is less than 98 percent where T is the minimum transmission duration over which the transmitter is on and is transmitting at its maximum power control level for the tested mode of operation.
- Detector = power averaging (rms).
- Trace mode = max hold.
- Allow max hold to run for at least 60 seconds, or longer as needed to allow the trace to stabilize.



Band II MIMO												
Mod.	Data Rate	NTX	CH.	Freq. (MHz)	Average Power Densit (dBm/MHz)			Average PSD Limit (dBm/MHz)		DG (dBi)		Pass /Fail
					Ant 6	Ant 7	SUM	Ant 6	Ant 7	Ant 6	Ant 7	
11a	6Mbps	2	52	5260	-		10.90	11.00	4.83		-	Pass
11a	6Mbps	2	60	5300			10.95	11.00	4.83		-	Pass
11a	6Mbps	2	64	5320			10.80	11.00	4.83		-	Pass

Band III MIMO												
Mod.	Data Rate	NTX	CH.	Freq. (MHz)	Average Power Densit (dBm/MHz)			Average PSD Limit (dBm/MHz)		DG (dBi)		Pass /Fail
					Ant 6	Ant 7	SUM	Ant 6	Ant 7	Ant 6	Ant 7	
11a	6Mbps	2	100	5500	-		10.87	11.00	3.98		-	Pass
11a	6Mbps	2	116	5580			10.73	11.00	3.98		-	Pass
11a	6Mbps	2	140	5700			10.80	11.00	3.98		-	Pass

Band III straddle channel MIMO												
Mod.	Data Rate	NTX	CH.	Freq. (MHz)	Average Power Density (dBm/MHz)			Average PSD Limit (dBm/MHz)		DG (dBi)		Pass /Fail
					Ant 6	Ant 7	SUM	Ant 6	Ant 7	Ant 6	Ant 7	
11a	6Mbps	2	144	5720	-		10.99	11.00	3.98		-	Pass

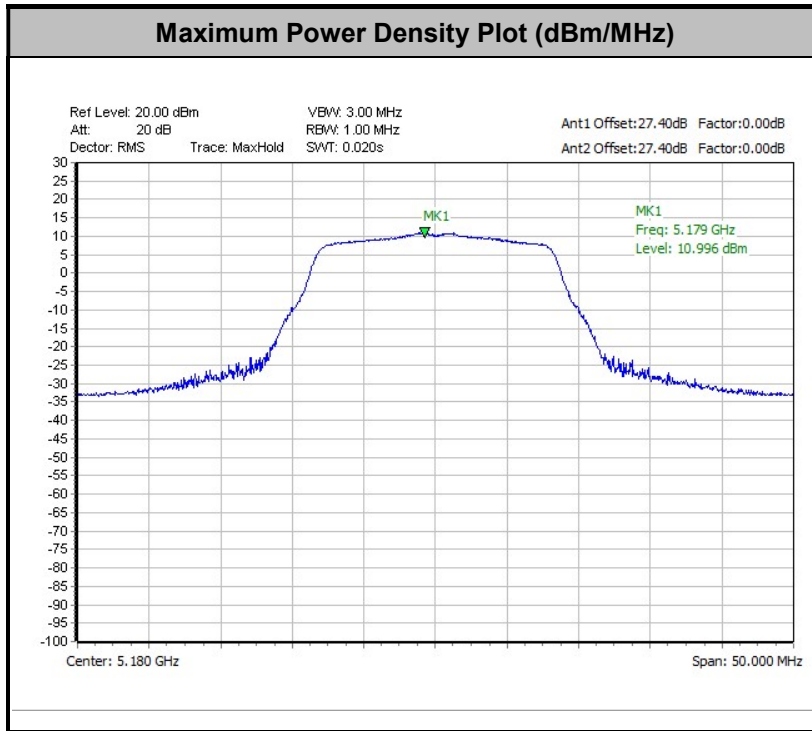

Remark: The test plot is showing a bin by bin combined result mathematically adds two traces.

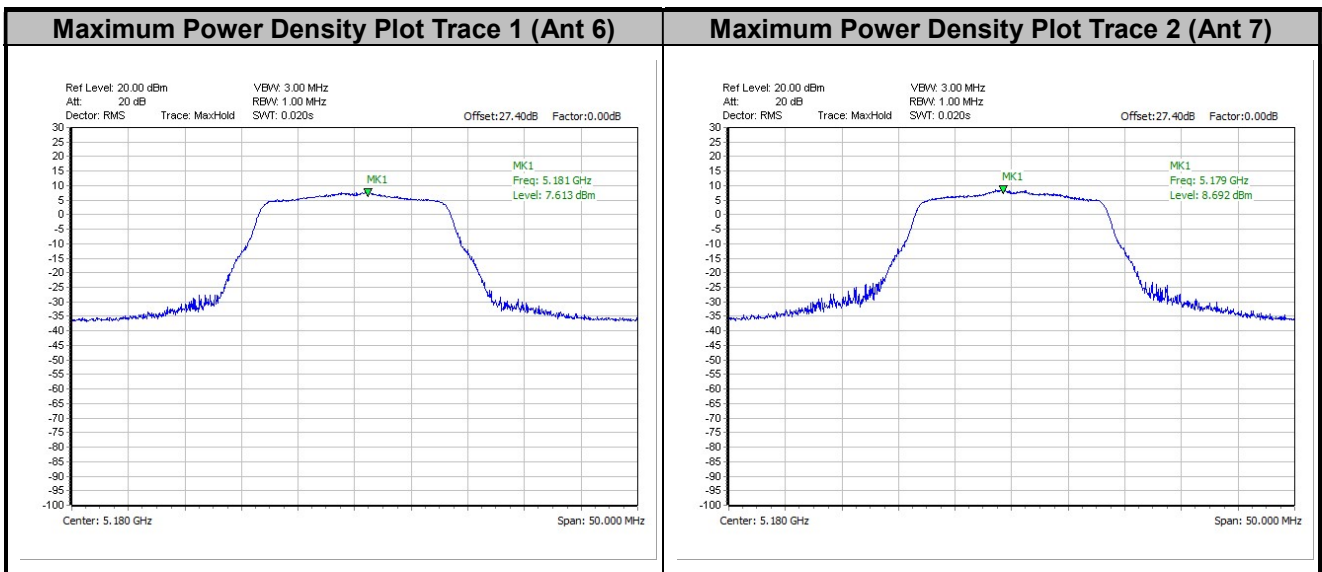



<802.11ax Mode>

FCC Band I MIMO													
Mod.	Data Rate	NTX	CH.	Freq. (MHz)	RU Config.	Average Power Densit (dBm/MHz)			Average PSD Limit (dBm/MHz)		DG (dBi)		Pass /Fail
						Ant 6	Ant 7	SUM	Ant 6	Ant 7	Ant 6	Ant 7	
HE20	MCS0	2	36	5180	Full			10.92	11.00	4.66		Pass	
HE20	MCS0	2	36	5180	26/0			10.76	11.00	4.66		Pass	
HE20	MCS0	2	36	5180	52/37			10.81	11.00	4.66		Pass	
HE20	MCS0	2	36	5180	106/53			10.74	11.00	4.66		Pass	
HE20	MCS0	2	44	5220	Full			10.87	11.00	4.66		Pass	
HE20	MCS0	2	44	5220	26/4			10.73	11.00	4.66		Pass	
HE20	MCS0	2	44	5220	52/39			10.71	11.00	4.66		Pass	
HE20	MCS0	2	44	5220	106/53			10.83	11.00	4.66		Pass	
HE20	MCS0	2	48	5240	Full			10.91	11.00	4.66		Pass	
HE20	MCS0	2	48	5240	26/8			10.82	11.00	4.66		Pass	
HE20	MCS0	2	48	5240	52/40			10.89	11.00	4.66		Pass	
HE20	MCS0	2	48	5240	106/54			10.80	11.00	4.66		Pass	
HE40	MCS0	2	38	5190	Full			7.36	11.00	4.66		Pass	
HE40	MCS0	2	38	5190	242/61			7.09	11.00	4.66		Pass	
HE40	MCS0	2	46	5230	Full			9.85	11.00	4.66		Pass	
HE40	MCS0	2	46	5230	242/62			9.62	11.00	4.66		Pass	
HE80	MCS0	2	42	5210	Full			3.46	11.00	4.66		Pass	
HE80	MCS0	2	42	5210	484/65			3.36	11.00	4.66		Pass	



Band II MIMO													
Mod.	Data Rate	NTX	CH.	Freq. (MHz)	RU Config.	Average Power Densit (dBm/MHz)			Average PSD Limit (dBm/MHz)		DG (dBi)		Pass /Fail
						Ant 6	Ant 7	SUM	Ant 6	Ant 7	Ant 6	Ant 7	
HE20	MCS0	2	52	5260	Full			10.90	11.00	4.83		Pass	
HE20	MCS0	2	52	5260	26/0			10.76	11.00	4.83		Pass	
HE20	MCS0	2	52	5260	52/37			10.72	11.00	4.83		Pass	
HE20	MCS0	2	52	5260	106/53			10.66	11.00	4.83		Pass	
HE20	MCS0	2	60	5300	Full			10.72	11.00	4.83		Pass	
HE20	MCS0	2	60	5300	26/4			10.57	11.00	4.83		Pass	
HE20	MCS0	2	60	5300	52/39			10.51	11.00	4.83		Pass	
HE20	MCS0	2	60	5300	106/54			10.55	11.00	4.83		Pass	
HE20	MCS0	2	64	5320	Full			10.91	11.00	4.83		Pass	
HE20	MCS0	2	64	5320	26/8			10.79	11.00	4.83		Pass	
HE20	MCS0	2	64	5320	52/40			10.89	11.00	4.83		Pass	
HE20	MCS0	2	64	5320	106/54			10.61	11.00	4.83		Pass	
HE40	MCS0	2	54	5270	Full			9.57	11.00	4.83		Pass	
HE40	MCS0	2	54	5270	242/61			9.36	11.00	4.83		Pass	
HE40	MCS0	2	62	5310	Full			6.77	11.00	4.83		Pass	
HE40	MCS0	2	62	5310	242/62			6.74	11.00	4.83		Pass	
HE80	MCS0	2	58	5290	Full			2.67	11.00	4.83		Pass	
HE80	MCS0	2	58	5290	484/66			2.48	11.00	4.83		Pass	



Band III MIMO													
Mod.	Data Rate	NTX	CH.	Freq. (MHz)	RU Config.	Average Power Densit (dBm/MHz)			Average PSD Limit (dBm/MHz)		DG (dBi)		Pass /Fail
						Ant 6	Ant 7	SUM	Ant 6	Ant 7	Ant 6	Ant 7	
HE20	MCS0	2	100	5500	Full			10.85	11.00	3.98		Pass	
HE20	MCS0	2	100	5500	26/0			10.71	11.00	3.98		Pass	
HE20	MCS0	2	100	5500	52/37			10.72	11.00	3.98		Pass	
HE20	MCS0	2	100	5500	106/53			10.83	11.00	3.98		Pass	
HE20	MCS0	2	116	5580	Full			10.97	11.00	3.98		Pass	
HE20	MCS0	2	116	5580	26/4			10.63	11.00	3.98		Pass	
HE20	MCS0	2	116	5580	52/38			10.63	11.00	3.98		Pass	
HE20	MCS0	2	116	5580	106/53			10.70	11.00	3.98		Pass	
HE20	MCS0	2	140	5700	Full			10.94	11.00	3.98		Pass	
HE20	MCS0	2	140	5700	26/8			10.85	11.00	3.98		Pass	
HE20	MCS0	2	140	5700	52/40			10.73	11.00	3.98		Pass	
HE20	MCS0	2	140	5700	106/54			10.76	11.00	3.98		Pass	
HE40	MCS0	2	102	5510	Full			7.62	11.00	3.98		Pass	
HE40	MCS0	2	102	5510	242/61			7.24	11.00	3.98		Pass	
HE40	MCS0	2	110	5550	Full			9.64	11.00	3.98		Pass	
HE40	MCS0	2	110	5550	242/61			9.58	11.00	3.98		Pass	
HE40	MCS0	2	134	5670	Full			8.71	11.00	3.98		Pass	
HE40	MCS0	2	134	5670	242/62			8.54	11.00	3.98		Pass	
HE80	MCS0	2	106	5530	Full			3.37	11.00	3.98		Pass	
HE80	MCS0	2	106	5530	484/65			3.19	11.00	3.98		Pass	
HE80	MCS0	2	122	5610	Full			6.35	11.00	3.98		Pass	
HE80	MCS0	2	122	5610	484/66			6.19	11.00	3.98		Pass	

Band III straddle channel MIMO													
Mod.	Data Rate	NTX	CH.	Freq. (MHz)	RU Config.	Average Power Density (dBm/MHz)			Average PSD Limit (dBm/MHz)		DG (dBi)		Pass /Fail
						Ant 6	Ant 7	SUM	Ant 6	Ant 7	Ant 6	Ant 7	
HE20	MCS0	2	144	5720	Full			10.89	11.00	3.98		Pass	
HE40	MCS0	2	144	5720	26/8			10.87	11.00	3.98		Pass	
HE40	MCS0	2	144	5720	52/40			10.87	11.00	3.98		Pass	
HE40	MCS0	2	144	5720	106/54			10.75	11.00	3.98		Pass	
HE40	MCS0	2	142	5710	Full			9.32	11.00	3.98		Pass	
HE40	MCS0	2	142	5710	242/62			9.18	11.00	3.98		Pass	
HE80	MCS0	2	138	5690	Full			6.01	11.00	3.98		Pass	
HE80	MCS0	2	138	5690	484/66			5.89	11.00	3.98		Pass	

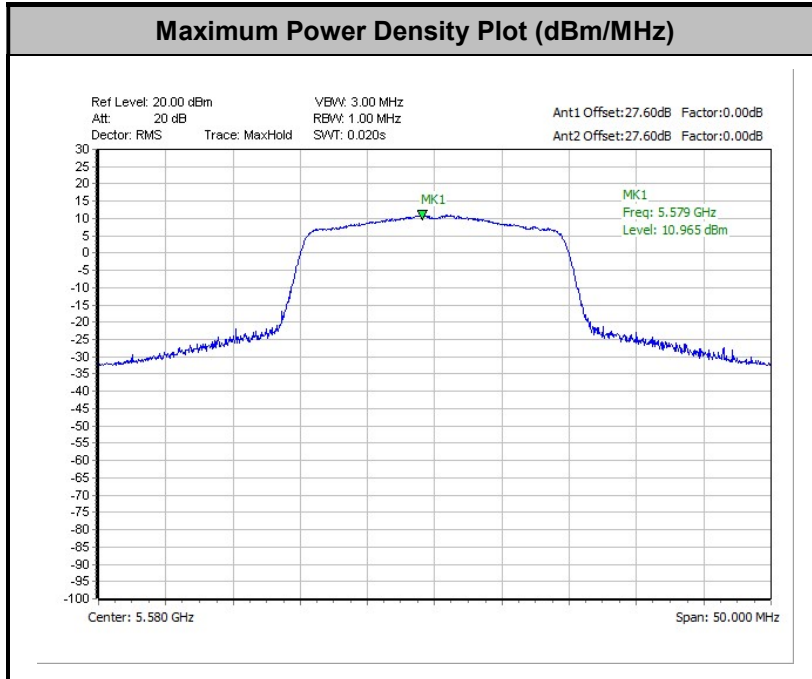

Remark: The test plot is showing a bin by bin combined result mathematically adds two traces.

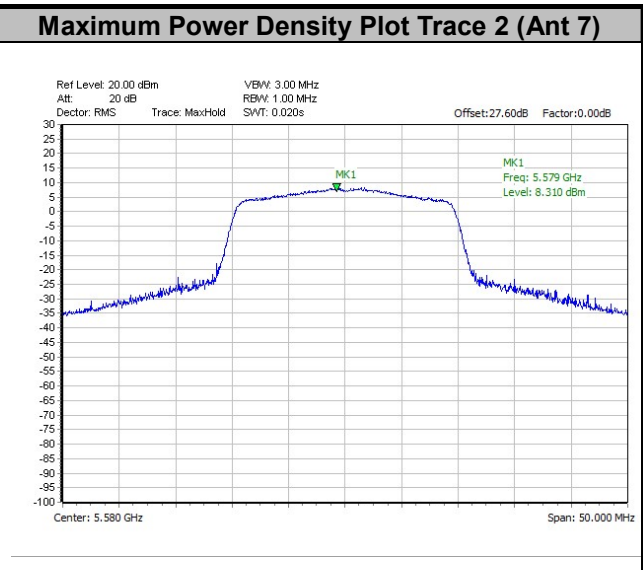
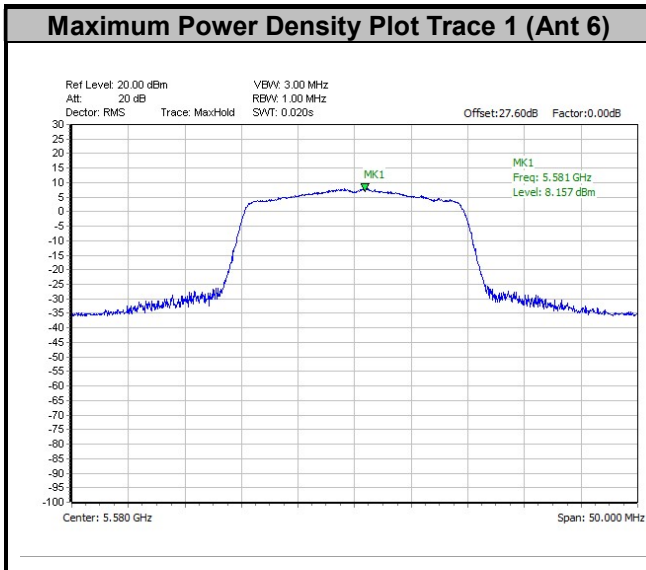



Test Engineer :	Eason Huang , Hank Hsu	Temperature :	21~25°C
		Relative Humidity :	51~54%

<TXBF Modes>

FCC Band I MIMO													
Mod.	Data Rate	NTX	CH.	Freq. (MHz)	RU Config.	Average Power Density (dBm/MHz)			Average PSD Limit (dBm/MHz)		DG (dBi)		Pass /Fail
						Ant 6	Ant 7	SUM	Ant 6	Ant 7	Ant 6	Ant 7	
HE20	MCS2	2	36	5180	Full			10.90	11.00	4.66		Pass	
HE20	MCS2	2	44	5220	Full			10.70	11.00	4.66		Pass	
HE20	MCS2	2	48	5240	Full			10.57	11.00	4.66		Pass	
HE40	MCS0	2	38	5190	Full			6.21	11.00	4.66		Pass	
HE40	MCS0	2	46	5230	Full			7.70	11.00	4.66		Pass	
HE80	MCS0	2	42	5210	Full			5.14	11.00	4.66		Pass	

Band II MIMO													
Mod.	Data Rate	NTX	CH.	Freq. (MHz)	RU Config.	Average Power Density (dBm/MHz)			Average PSD Limit (dBm/MHz)		DG (dBi)		Pass /Fail
						Ant 6	Ant 7	SUM	Ant 6	Ant 7	Ant 6	Ant 7	
HE20	MCS2	2	52	5260	Full			10.97	11.00	4.83		Pass	
HE20	MCS2	2	60	5300	Full			10.61	11.00	4.83		Pass	
HE20	MCS2	2	64	5320	Full			10.71	11.00	4.83		Pass	
HE40	MCS0	2	54	5270	Full			10.35	11.00	4.83		Pass	
HE40	MCS0	2	62	5310	Full			4.60	11.00	4.83		Pass	
HE80	MCS0	2	58	5290	Full			2.77	11.00	4.83		Pass	



Band III MIMO													
Mod.	Data Rate	NTX	CH.	Freq. (MHz)	RU Config.	Average Power Density (dBm/MHz)			Average PSD Limit (dBm/MHz)		DG (dBi)		Pass /Fail
						Ant 6	Ant 7	SUM	Ant 6	Ant 7	Ant 6	Ant 7	
HE20	MCS2	2	100	5500	Full	-			9.14	11.00	3.98		Pass
HE20	MCS2	2	116	5580	Full				10.69	11.00	3.98		Pass
HE20	MCS2	2	140	5700	Full				10.56	11.00	3.98		Pass
HE40	MCS0	2	102	5510	Full				5.94	11.00	3.98		Pass
HE40	MCS0	2	110	5550	Full				8.92	11.00	3.98		Pass
HE40	MCS0	2	134	5670	Full				8.21	11.00	3.98		Pass
HE80	MCS0	2	106	5530	Full				4.79	11.00	3.98		Pass
HE80	MCS0	2	122	5610	Full				10.56	11.00	3.98		Pass

Band III straddle channel MIMO													
Mod.	Data Rate	NTX	CH.	Freq. (MHz)	RU Config.	Average Power Density (dBm/MHz)			Average PSD Limit (dBm/MHz)		DG (dBi)		Pass /Fail
						Ant 6	Ant 7	SUM	Ant 6	Ant 7	Ant 6	Ant 7	
HE20	MCS2	2	144	5720	Full	-			10.90	11.00	3.98		Pass
HE40	MCS0	2	142	5710	Full				9.57	11.00	3.98		Pass
HE80	MCS0	2	138	5690	Full				10.76	11.00	3.98		Pass

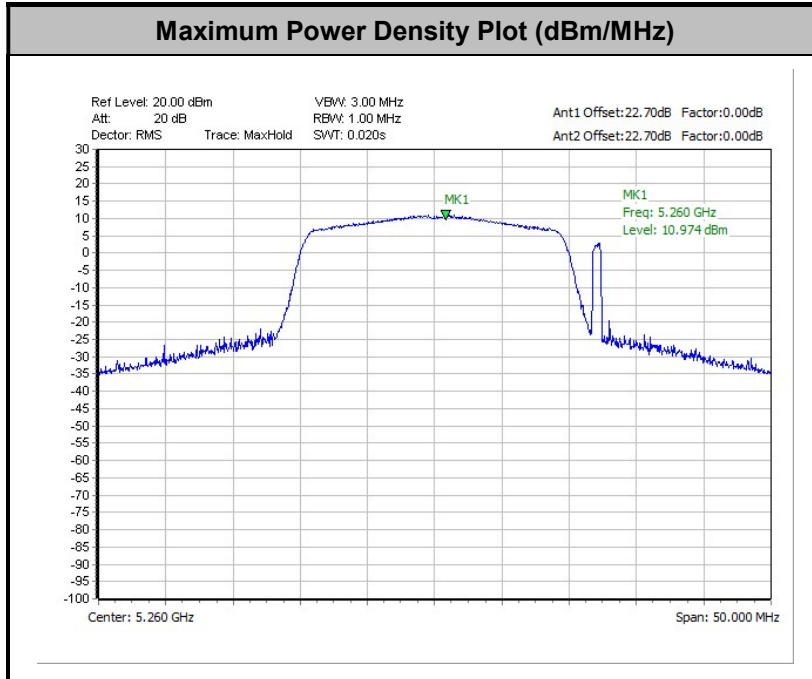

Remark: The test plot is showing a bin by bin combined result mathematically adds two traces.

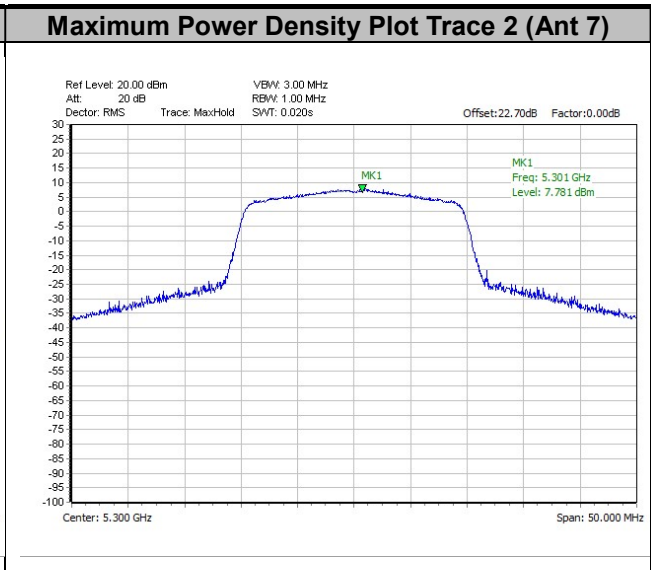
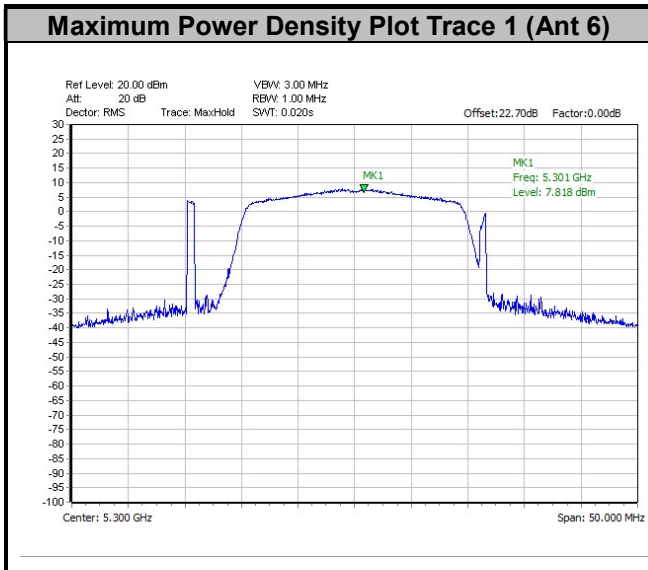



3.4 Unwanted Emissions Measurement

This section is to measure unwanted emissions through radiated measurement for band edge spurious emissions and out of band emissions measurement.

3.4.1 Limit of Unwanted Emissions

(1) For transmitters operating in the 5150-5250 MHz band: all emissions outside of the 5150-5350 MHz band shall not exceed an EIRP of -27dBm/MHz.

For transmitters operating in the 5250-5350 MHz band: all emissions outside of the 5150-5350 MHz band shall not exceed an EIRP of -27 dBm/MHz. Devices operating in the 5250-5350 MHz band that generate emissions in the 5150-5250 MHz band must meet all applicable technical requirements for operation in the 5150-5250 MHz band (including indoor use) or alternatively meet an out-of-band emission EIRP limit of -27 dBm/MHz in the 5150-5250 MHz band.

For transmitters operating in the 5470-5600 MHz and 5650-5725MHz band: all emissions outside of the 5470-5600 MHz and 5650-5725MHz band shall not exceed an EIRP of -27 dBm/MHz.

(2) Unwanted spurious emissions falls in restricted bands shall comply with the general field strength limits as below table:

Frequency (MHz)	Field Strength (microvolts/meter)	Measurement Distance (meters)
0.009 – 0.490	2400/F(kHz)	300
0.490 – 1.705	24000/F(kHz)	30
1.705 – 30.0	30	30
30 – 88	100	3
88 – 216	150	3
216 - 960	200	3
Above 960	500	3

Note: The following formula is used to convert the EIRP to field strength.

$$E = \frac{1000000\sqrt{30P}}{3} \mu\text{V/m, where P is the eirp (Watts)}$$



EIRP (dBm)	Field Strength at 3m (dBμV/m)
- 27	68.3

(3) KDB789033 D02 v02r01 G)2)c)

(i) Sections 15.407(b)(1-3) specifies the unwanted emissions limit for the U-NII-1 and U-NII-2 bands. As specified, emissions above 1000 MHz that are outside of the restricted bands are subject to a peak emission limit of -27 dBm/MHz.

(ii) Section 15.407(b)(4) specifies the unwanted emissions limit for the U-NII-3 band. A band emissions mask is specified in Section 15.407(b)(4)(i). The emission limits are based on the use of a peak detector.

3.4.2 Measuring Instruments

Please refer to the measuring equipment list in this test report.

3.4.3 Test Procedures

1. The testing follows FCC KDB 789033 D02 General UNII Test Procedures New Rules v02r01.

Section G) Unwanted emissions measurement.

(1) Procedure for Unwanted Emissions Measurements Below 1000 MHz

- RBW = 120 kHz
- VBW = 300 kHz
- Detector = Peak
- Trace mode = max hold

(2) Procedure for Peak Unwanted Emissions Measurements Above 1000 MHz

- RBW = 1 MHz
- VBW ≥ 3 MHz
- Detector = Peak
- Sweep time = auto
- Trace mode = max hold

(3) Procedures for Average Unwanted Emissions Measurements Above 1000 MHz

- RBW = 1 MHz
- VBW = 10 Hz, when duty cycle is no less than 98 percent.
- $VBW \geq 1/T$, when duty cycle is less than 98 percent where T is the minimum transmission duration over which the transmitter is on and is transmitting at its maximum power control level for the tested mode of operation.

2. The EUT is placed on a turntable with 0.8 meter for frequency below 1 GHz and 1.5 meter for frequency above 1 GHz respectively above ground.
3. The EUT is set 3 meters away from the receiving antenna which is mounted on the top of a variable height antenna tower.
4. The antenna is a broadband antenna and its height is adjusted between one meter and four meters above ground to find the maximum value of the field strength for both horizontal polarization and vertical polarization of the antenna.
5. For each suspected emission, the EUT is arranged to its worst case and then adjust the antenna tower (from 1 m to 4 m) and turntable (from 0 degree to 360 degrees) to find the maximum reading.
6. Radiated testing below 1 GHz is performed by adjusting the antenna tower from 1 m to 4 m and by rotating the turn table from 0 degree to 360 degrees to find the peak maximum hold reading. When there is no suspected emission found and the emission level is with at least 6 dB margin against QP limit line, the position is marked as “-“.
7. Radiated testing above 1 GHz is performed by adjusting the antenna tower from 1 m to 4 m and by rotating the turn table from 0 degree to 360 degrees to find the peak maximum hold reading for scanning all frequencies. When there is no suspected emission found and the harmonic emission level is with at least 6 dB margin against average limit line, the position is marked as “-“.

3.4.4 Test Setup

For radiated emissions below 30MHz

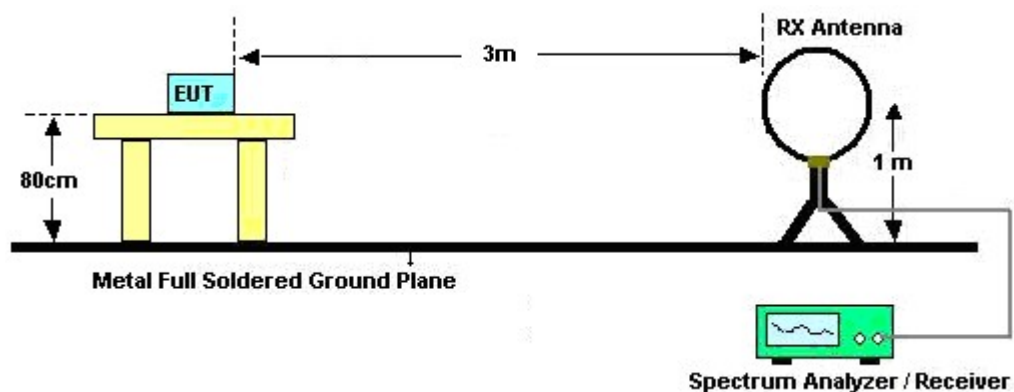

For radiated emissions from 30MHz to 1GHz

<CDD Mode>

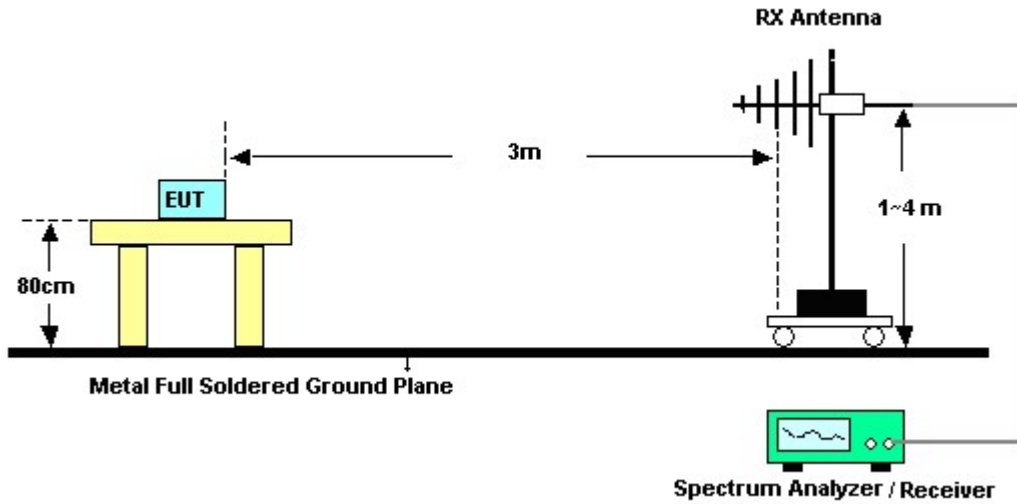

<TXBF Modes>

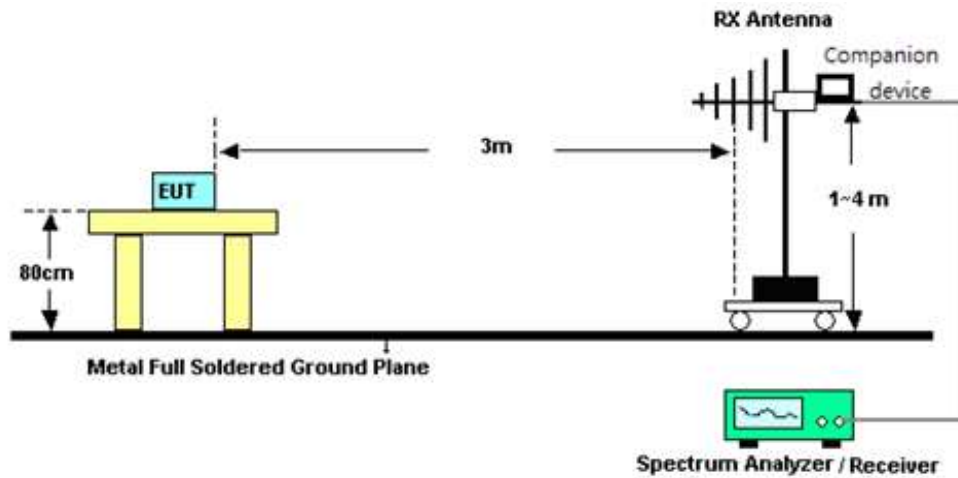

For radiated test from 1GHz to 18GHz

<CDD Mode>

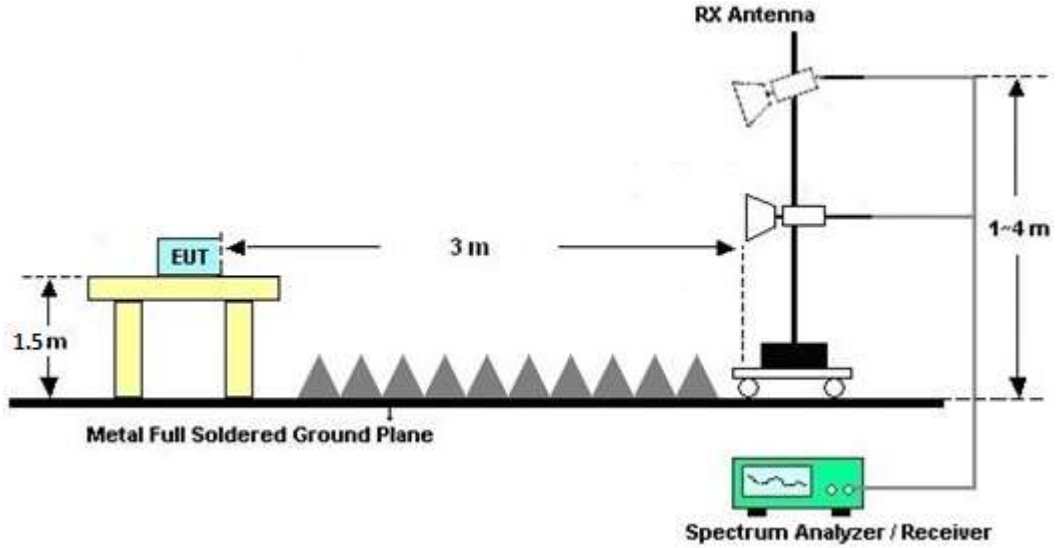

<TXBF Modes>

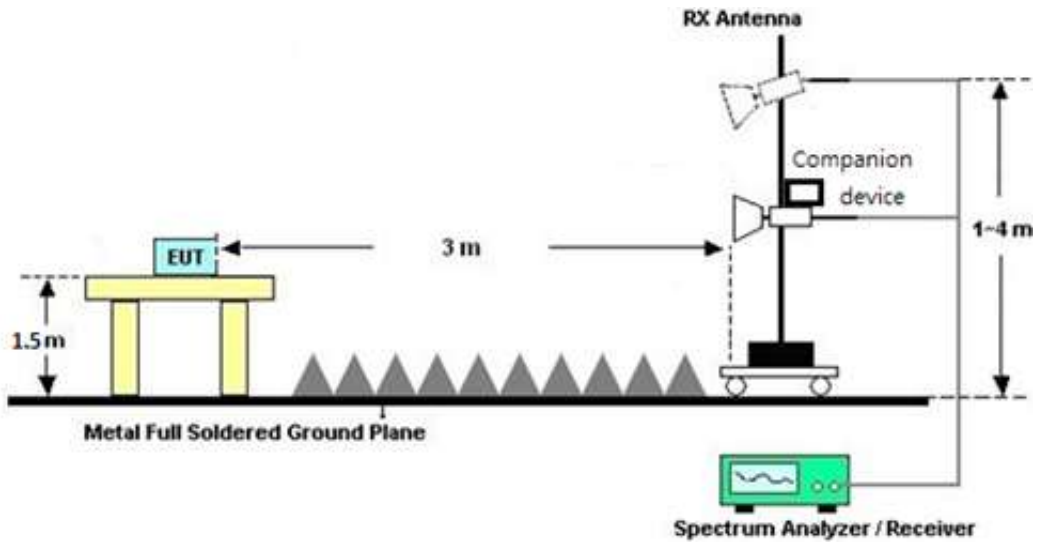

For radiated test above 18GHz

<CDD Mode>

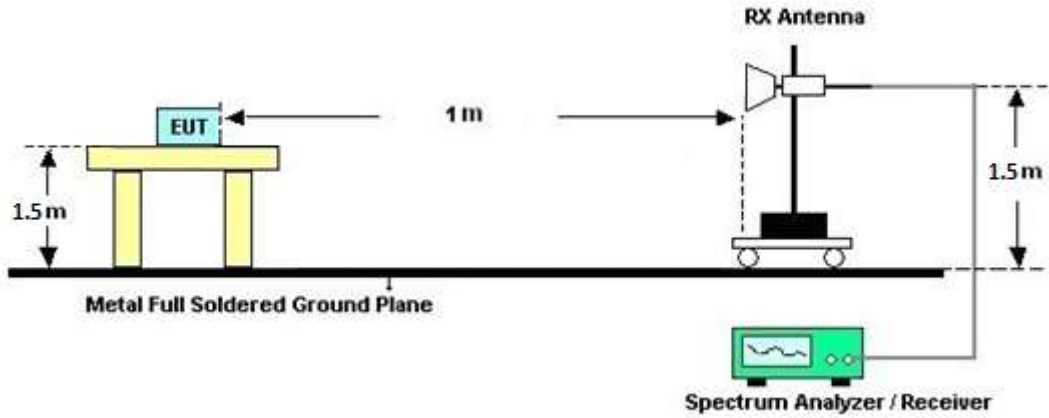

<TXBF Modes>

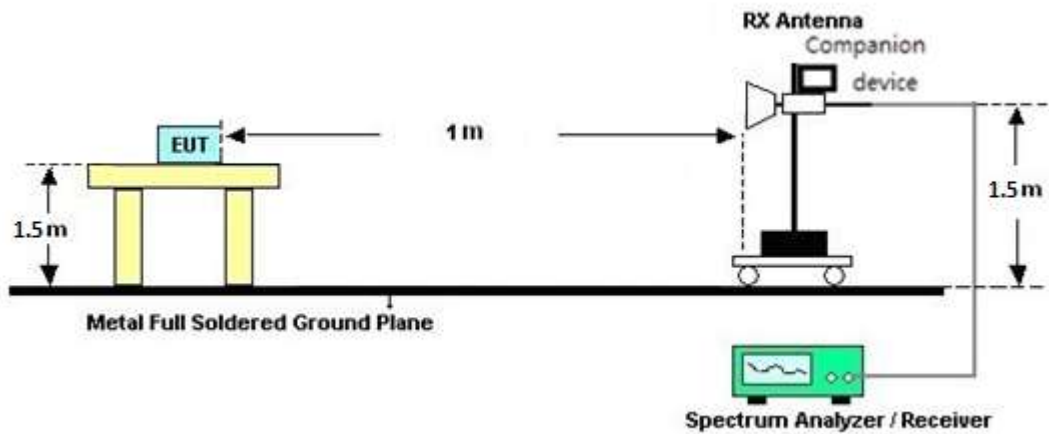



3.4.5 Test Results of Radiated Spurious Emissions (9 kHz ~ 30 MHz)

The low frequency, which starts from 9 kHz to 30 MHz, is pre-scanned and the result which is 20 dB lower than the limit line is not reported.

There is adequate comparison measurement of both open-field test site and alternative test site - semi-Anechoic chamber according to 414788 D01 Radiated Test Site v01r01, and the result came out very similar.

3.4.6 Test Result of Radiated Spurious at Band Edges

Please refer to Appendix B and C.

3.4.7 Duty Cycle

Please refer to Appendix D.

3.4.8 Test Result of Radiated Spurious Emissions (30MHz ~ 10th Harmonic)

Please refer to Appendix B and C.



3.5 AC Conducted Emission Measurement

3.5.1 Limit of AC Conducted Emission

For equipment that is designed to be connected to the public utility (AC) power line, the radio frequency voltage that is conducted back onto the AC power line on any frequency or frequencies within the band 150 kHz to 30 MHz shall not exceed the limits in the following table.

Frequency of emission (MHz)	Conducted limit (dB μ V)	
	Quasi-peak	Average
0.15-0.5	66 to 56*	56 to 46*
0.5-5	56	46
5-30	60	50

*Decreases with the logarithm of the frequency.

3.5.2 Measuring Instruments

Please refer to the measuring equipment list in this test report.

3.5.3 Test Procedures

1. The EUT is placed 0.4 meter away from the conducting wall of the shielding room, and is kept at least 80 centimeters from any other grounded conducting surface.
2. Connect EUT to the power mains through a line impedance stabilization network (LISN).
3. All the support units are connecting to the other LISN.
4. The LISN provides 50 ohm coupling impedance for the measuring instrument.
5. The FCC states that a 50 ohm, 50 microhenry LISN shall be used.
6. Both Line and Neutral shall be tested in order to find out the maximum conducted emission.
7. The frequency range from 150 kHz to 30 MHz is scanned.
8. Set the test-receiver system to Peak Detect Function and specified bandwidth with Maximum Hold Mode.

3.5.4 Test Setup

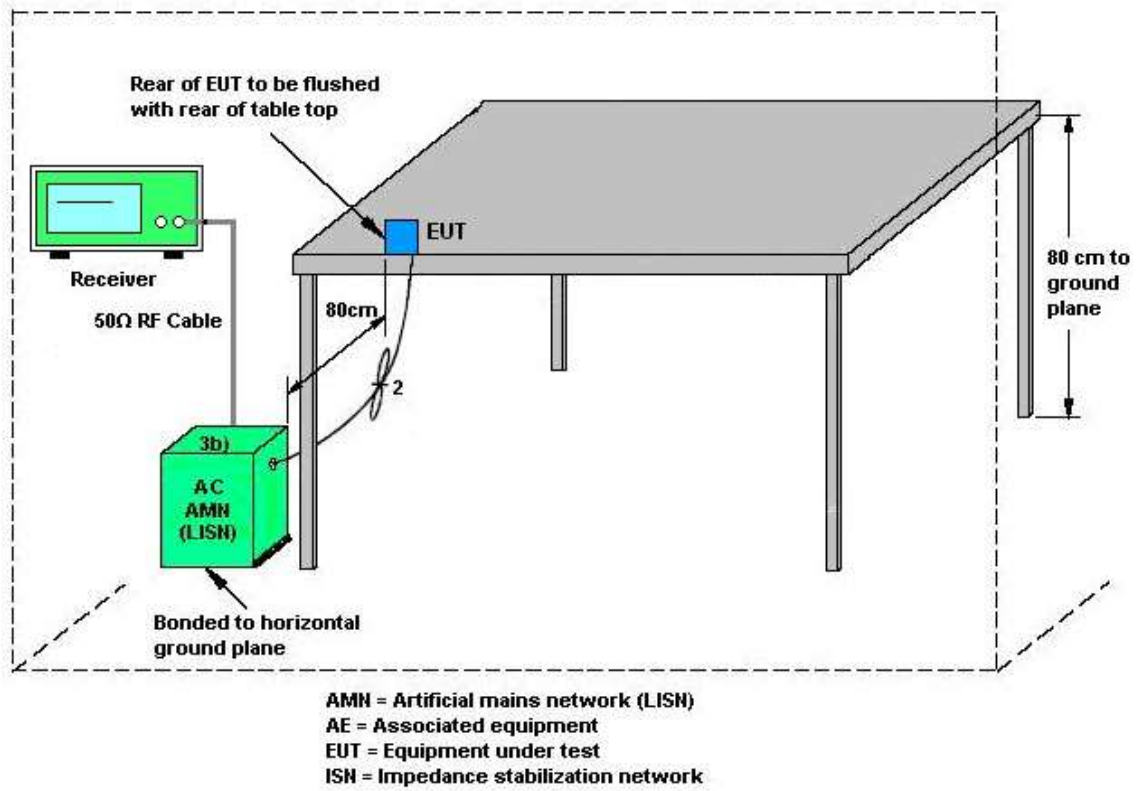

3.5.5 Test Result of AC Conducted Emission

Please refer to Appendix A.



3.6 Antenna Requirements

3.6.1 Standard Applicable

If transmitting antenna directional gain is greater than 6 dBi, both the peak transmit power and the peak power spectral density shall be reduced by the amount in dB that the directional gain of the antenna exceeds 6 dBi.

3.6.2 Antenna Anti-Replacement Construction

An embedded-in antenna design is used.

3.6.3 Antenna Gain

<CDD Modes >

FCC KDB 662911 D01 Multiple Transmitter Output v02r01

For CDD transmissions, directional gain is calculated as

Directional gain = G_{ANT} + Array Gain, where Array Gain is as follows.

For power spectral density (PSD) measurements on all devices,

Array Gain = $10 \log(N_{ANT}/N_{SS}=1)$ dB.

For power measurements on IEEE 802.11 devices,

Array Gain = 0 dB (i.e., no array gain) for $N_{ANT} \leq 4$.

Directional gain may be calculated by using the formulas applicable to equal gain antennas with G_{ANT} set equal to the gain of the antenna having the highest gain;

The EUT supports CDD mode.

For power, the directional gain G_{ANT} is set equal to the antenna having the highest gain, i.e., F)2)f)i).

For PSD, the directional gain calculation is following F)2)f)ii) of KDB 662911 D01 v02r01.

The power and PSD limit should be modified if the directional gain of EUT is over 6 dBi,

The directional gain "DG" is calculated as following table.

<CDD Modes>						
			DG	DG	Power	PSD
			for	for	Limit	Limit
	Ant. 6	Ant. 7	Power	PSD	Reduction	Reduction
	(dBi)	(dBi)	(dBi)	(dBi)	(dB)	(dB)
Band I	1.80	1.50	1.80	4.66	0.00	0.00
Band II	2.40	1.20	2.40	4.83	0.00	0.00
Band III	2.00	-0.20	2.00	3.98	0.00	0.00

Power limit reduction = Composite gain – 6dBi, (min = 0)

PSD limit reduction = Composite gain + PSD Array gain – 6dBi, (min = 0)

TXBF modes

FCC KDB 662911 D01 Multiple Transmitter Output v02r01

For CDD transmissions, directional gain is calculated as

$$DirectionalGain = 10 \cdot \log \left[\frac{\sum_{j=1}^{N_{SS}} \left\{ \sum_{k=1}^{N_{ANT}} g_{j,k} \right\}^2}{N_{ANT}} \right]$$

where

Each antenna is driven by no more than one spatial stream;

N_{SS} = the number of independent spatial streams of data;

N_{ANT} = the total number of antennas

$g_{j,k} = 10^{G_k / 20}$ if the k th antenna is being fed by spatial stream j , or zero if it is not;
 G_k is the gain in dBi of the k th antenna.

The EUT supports beamforming for 802.11ac modes.

The directional gain calculation is following F)2)e)ii) of KDB 662911 D01 v02r01.

The power and PSD limit should be modified if the directional gain of EUT is over 6 dBi,

The directional gain “DG” is calculated as following table.

			DG	DG	Power	PSD
			for	for	Limit	Limit
	Ant 6	Ant 7	Power	PSD	Reduction	Reduction
	(dBi)	(dBi)	(dBi)	(dBi)	(dB)	(dB)
Band I	1.80	1.50	4.66	4.66	0.00	0.00
Band II	2.40	1.20	4.83	4.83	0.00	0.00
Band III	2.00	1.80	4.91	4.91	0.00	0.00

Power Limit Reduction = DG(Power) – 6dBi, (min = 0)

PSD Limit Reduction = DG(PSD) – 6dBi, (min = 0)



4 List of Measuring Equipment

Instrument	Brand Name	Model No.	Serial No.	Characteristics	Calibration Date	Test Date	Due Date	Remark
Loop Antenna	Rohde & Schwarz	HFH2-Z2	100488	9 kHz~30 MHz	May 13, 2022	Jun. 21, 2022~ Jun. 30, 2022	May 12, 2023	Radiation (03CH16-HY)
Bilog Antenna	TESEQ	CBL 6111D & 00802N1D01N -06	47020 & 06	30MHz to 1GHz	Oct. 09, 2021	Jun. 21, 2022~ Jun. 30, 2022	Oct. 08, 2022	Radiation (03CH16-HY)
Horn Antenna	SCHWARZBE CK	BBHA 9120 D	9120D-1522	1G~18GHz	Mar. 10, 2022	Jun. 21, 2022~ Jun. 30, 2022	Mar. 09, 2023	Radiation (03CH16-HY)
SHF-EHF Horn Antenna	SCHWARZBE CK	BBHA 9170	00993	18GHz ~40GHz	Nov. 30, 2021	Jun. 21, 2022~ Jun. 30, 2022	Nov. 29, 2022	Radiation (03CH16-HY)
Amplifier	SONOMA	310N	371607	9kHz~1G	Jul. 05, 2021	Jun. 21, 2022~ Jun. 30, 2022	Jul. 04, 2022	Radiation (03CH16-HY)
Preamplifier	EMEC	EM18G40G	060812	18GHz~40GHz	Dec. 27, 2021	Jun. 21, 2022~ Jun. 30, 2022	Dec. 26, 2022	Radiation (03CH16-HY)
Preamplifier	Keysight	83017A	MY53270264	1GHz~26.5GHz	Dec. 09, 2021	Jun. 21, 2022~ Jun. 30, 2022	Dec. 08, 2022	Radiation (03CH16-HY)
EMI Test Receiver	Keysight	N9038A(MXE)	MY57290111	3Hz~26.5GHz	Dec. 15, 2021	Jun. 21, 2022~ Jun. 30, 2022	Dec. 14, 2022	Radiation (03CH16-HY)
RF Cable	HUBER + SUHNER	SUCOFLEX 104	MY11680/4P E	NA	Aug. 28, 2021	Jun. 21, 2022~ Jun. 30, 2022	Aug. 27, 2022	Radiation (03CH16-HY)
RF Cable	HUBER + SUHNER	SUCOFLEX 104	MY11688/4P E	NA	Aug. 28, 2021	Jun. 21, 2022~ Jun. 30, 2022	Aug. 27, 2022	Radiation (03CH16-HY)
RF Cable	HUBER + SUHNER	SUCOFLEX 102	EC-A5-300-5 757	NA	Aug. 28, 2021	Jun. 21, 2022~ Jun. 30, 2022	Aug. 27, 2022	Radiation (03CH16-HY)
Software	Audix	E3 6.2009-8-24	RK-001136	N/A	N/A	Jun. 21, 2022~ Jun. 30, 2022	N/A	Radiation (03CH16-HY)
Controller	ChainTek	3000-1	N/A	Control Turn table & Ant Mast	N/A	Jun. 21, 2022~ Jun. 30, 2022	N/A	Radiation (03CH16-HY)
Antenna Mast	ChainTek	MBS-520-1	N/A	1m~4m	N/A	Jun. 21, 2022~ Jun. 30, 2022	N/A	Radiation (03CH16-HY)
Turn Table	ChainTek	T-200-S-1	N/A	0~360 Degree	N/A	Jun. 21, 2022~ Jun. 30, 2022	N/A	Radiation (03CH16-HY)
AC Power Source	ACPOWER	AFC-11003G	F317040033	N/A	N/A	Jul. 05, 2022	N/A	Conduction (CO07-HY)
Software	Rohde & Schwarz	EMC32 V10.30	N/A	N/A	N/A	Jul. 05, 2022	N/A	Conduction (CO07-HY)
Pulse Limiter	SCHWARZBE CK	VTSD 9561-F N	9561-F N00373	9kHz-200MHz	Oct. 29, 2021	Jul. 05, 2022	Oct. 28, 2022	Conduction (CO07-HY)
RF Cable	HUBER + SUHNER	RG 214/U	1358175	9kHz~30MHz	Mar. 16, 2022	Jul. 05, 2022	Mar. 15, 2023	Conduction (CO07-HY)
Two-Line V-Network	TESEQ	NNB 51	45051	N/A	Feb. 16, 2022	Jul. 05, 2022	Feb. 15, 2023	Conduction (CO07-HY)
EMI Test Receiver	Rohde & Schwarz	ESC17	100724	9kHz~7GHz	Feb. 24, 2022	Jul. 05, 2022	Feb. 23, 2023	Conduction (CO07-HY)
Hygrometer	TECPEL	DTM-303A	TP201996	N/A	Nov. 16, 2021	Jun. 10, 2022~ Jul. 16, 2022	Nov. 15, 2022	Conducted (TH05-HY)
Power Sensor	DARE	RPR3006W	16I00054SNO 12 (NO:113)	10MHz~6GHz	Dec. 16, 2021	Jun. 10, 2022~ Jul. 16, 2022	Dec. 15, 2022	Conducted (TH05-HY)
Signal Analyzer	Rohde & Schwarz	FSV40	101566	10Hz~40GHz	Aug. 30, 2021	Jun. 10, 2022~ Jul. 16, 2022	Aug. 29, 2022	Conducted (TH05-HY)
Switch Control Mainframe	E-IUSTRUME NT	ETF-1405-0	EC1900067 (BOX7)	N/A	Aug. 12, 2021	Jun. 10, 2022~ Jul. 16, 2022	Aug. 11, 2022	Conducted (TH05-HY)



5 Uncertainty of Evaluation

Uncertainty of Conducted Emission Measurement (150kHz ~ 30MHz)

Measuring Uncertainty for a Level of Confidence of 95% ($U = 2Uc(y)$)	2.3 dB
---	--------

Uncertainty of Radiated Emission Measurement (30 MHz ~ 1000 MHz)

Measuring Uncertainty for a Level of Confidence of 95% ($U = 2Uc(y)$)	5.8 dB
---	--------

Uncertainty of Radiated Emission Measurement (1000 MHz ~ 18000 MHz)

Measuring Uncertainty for a Level of Confidence of 95% ($U = 2Uc(y)$)	5.2 dB
---	--------

Uncertainty of Radiated Emission Measurement (18000 MHz ~ 40000 MHz)

Measuring Uncertainty for a Level of Confidence of 95% ($U = 2Uc(y)$)	5.8 dB
---	--------



Appendix A. AC Conducted Emission Test Results

Test Engineer :	Louis Chung	Temperature :	23.7~26.1°C
		Relative Humidity :	50.2~55.6%

EUT Information

Report NO : 1N2539
 Test Mode : Mode 1
 Test Voltage : 120Vac/60Hz
 Phase : Line

Full Spectrum

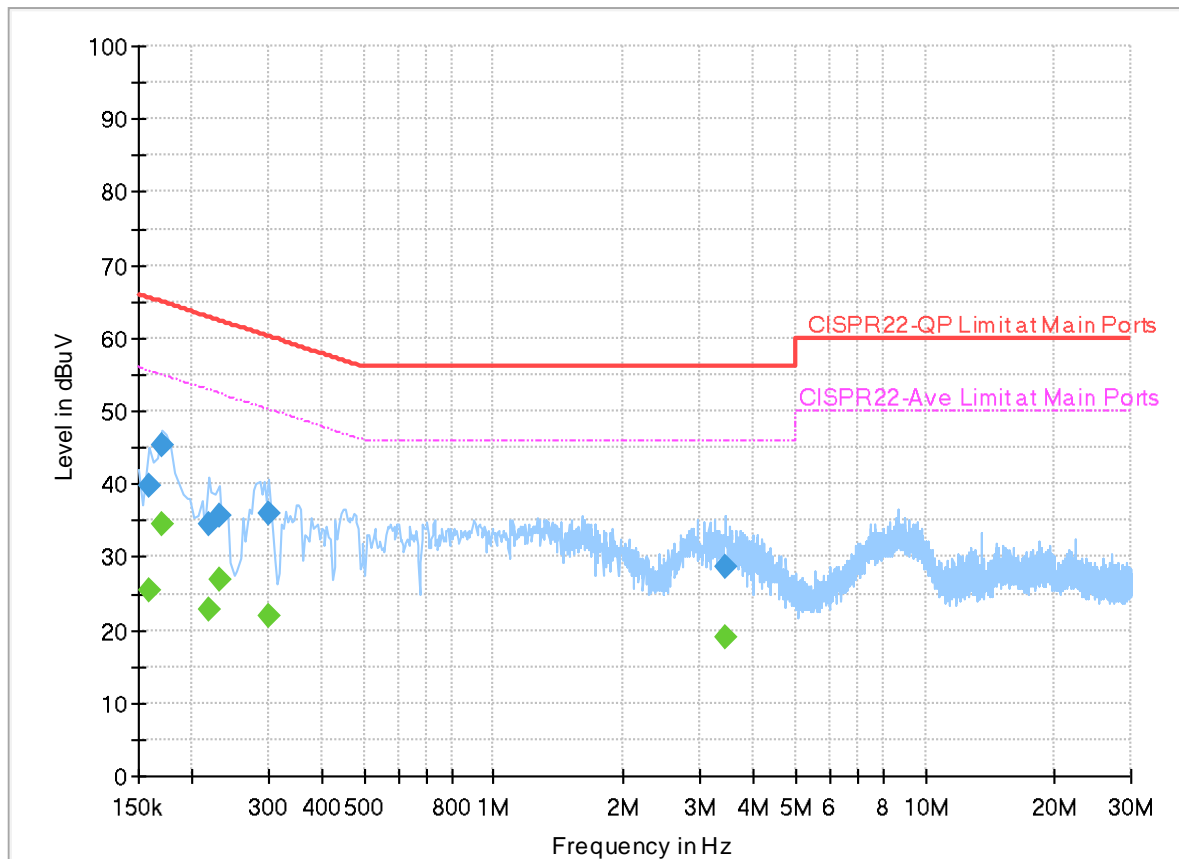

Final_Result

Frequency (MHz)	QuasiPeak (dBuV)	CAverage (dBuV)	Limit (dBuV)	Margin (dB)	Line	Filter	Corr. (dB)
0.158000	---	25.58	55.57	29.99	L1	OFF	20.0
0.158000	39.77	---	65.57	25.80	L1	OFF	20.0
0.170000	---	34.50	54.96	20.46	L1	OFF	20.0
0.170000	45.34	---	64.96	19.62	L1	OFF	20.0
0.218000	---	22.81	52.90	30.09	L1	OFF	20.0
0.218000	34.38	---	62.90	28.52	L1	OFF	20.0
0.230000	---	26.90	52.45	25.55	L1	OFF	20.0
0.230000	35.53	---	62.45	26.92	L1	OFF	20.0
0.302000	---	21.79	50.19	28.40	L1	OFF	20.0
0.302000	35.86	---	60.19	24.33	L1	OFF	20.0
3.438000	---	19.07	46.00	26.93	L1	OFF	20.0
3.438000	28.60	---	56.00	27.40	L1	OFF	20.0

EUT Information

Report NO : 1N2539
 Test Mode : Mode 1
 Test Voltage : 120Vac/60Hz
 Phase : Neutral

Full Spectrum

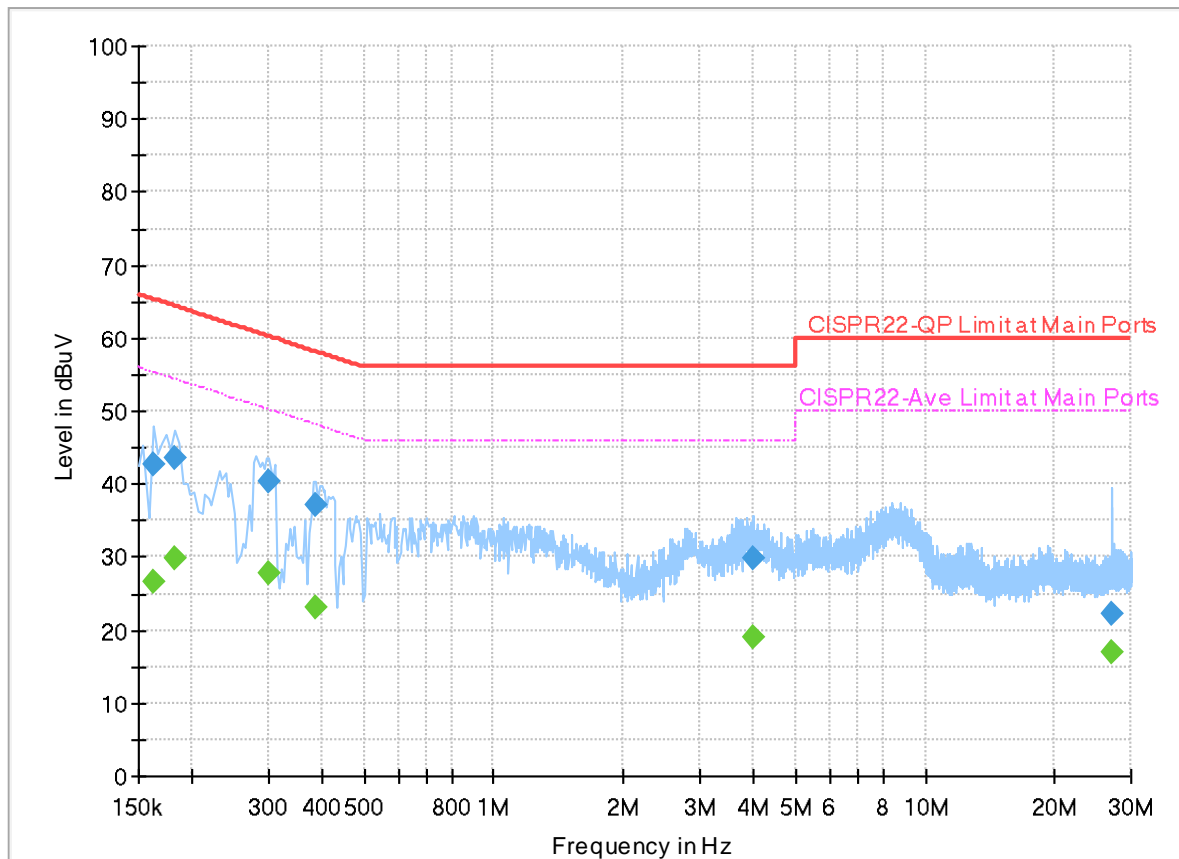

Final_Result

Frequency (MHz)	QuasiPeak (dBuV)	CAverage (dBuV)	Limit (dBuV)	Margin (dB)	Line	Filter	Corr. (dB)
0.162000	---	26.57	55.36	28.79	N	OFF	20.0
0.162000	42.59	---	65.36	22.77	N	OFF	20.0
0.182000	---	29.92	54.39	24.47	N	OFF	20.0
0.182000	43.51	---	64.39	20.88	N	OFF	20.0
0.302000	---	27.85	50.19	22.34	N	OFF	20.0
0.302000	40.37	---	60.19	19.82	N	OFF	20.0
0.386000	---	23.18	48.15	24.97	N	OFF	20.0
0.386000	37.01	---	58.15	21.14	N	OFF	20.0
4.002000	---	18.91	46.00	27.09	N	OFF	20.1
4.002000	29.90	---	56.00	26.10	N	OFF	20.1
27.058000	---	16.90	50.00	33.10	N	OFF	20.3
27.058000	22.09	---	60.00	37.91	N	OFF	20.3



Appendix B. Radiated Spurious Emission

Test Engineer :	Andy Yang , Karl Hou and Steven Wu	Temperature :	20~25°C
		Relative Humidity :	50~60%

<CDD Mode>

Band 1 - 5150~5250MHz

WIFI 802.11a (Band Edge @ 3m)

WIFI	Note	Frequency	Level	Over	Limit	Read	Antenna	Path	Preamp	Ant	Table	Peak	Pol.	
Ant. 6+7		(MHz)	(dBμV/m)	(dB)	Line (dBμV/m)	Level (dBμV)	Factor (dB/m)	Loss (dB)	Factor (dB)	Pos (cm)	Pos (deg)	Avg. (P/A)	(H/V)	
802.11a CH 36 5180MHz		5150	64.15	-9.85	74	48.58	33	12.03	29.46	100	235	P	H	
		5149.76	52.39	-1.61	54	36.82	33	12.03	29.46	100	235	A	H	
	*	5180	115.39	-	-	99.72	33.06	12.08	29.47	100	359	P	H	
	*	5180	107.22	-	-	91.55	33.06	12.08	29.47	100	359	A	H	
													H	
														H
			5147.42	60.13	-13.87	74	44.56	33	12.03	29.46	380	179	P	V
			5150	51.11	-2.89	54	35.54	33	12.03	29.46	380	179	A	V
	*		5180	113.93	-	-	98.26	33.06	12.08	29.47	380	179	P	V
	*		5180	105.3	-	-	89.63	33.06	12.08	29.47	380	179	A	V
														V
														V
802.11a CH 44 5220MHz		5145.6	58.9	-15.1	74	43.33	33	12.03	29.46	106	8	P	H	
		5145.86	49.17	-4.83	54	33.6	33	12.03	29.46	106	8	A	H	
	*	5220	115.65	-	-	99.89	33.06	12.18	29.48	106	8	P	H	
	*	5220	109.06	-	-	93.3	33.06	12.18	29.48	106	8	A	H	
			5350.24	55.74	-18.26	74	39.84	32.8	12.62	29.52	106	8	P	H
			5352.76	45.48	-8.52	54	29.56	32.81	12.63	29.52	106	8	A	H
			5147.16	56.7	-17.3	74	41.13	33	12.03	29.46	379	229	P	V
			5149.76	46.59	-7.41	54	31.02	33	12.03	29.46	379	229	A	V
	*		5220	112.51	-	-	96.75	33.06	12.18	29.48	379	229	P	V
	*		5220	104.9	-	-	89.14	33.06	12.18	29.48	379	229	A	V
			5399.8	56.15	-17.85	74	40	32.9	12.79	29.54	379	229	P	V
			5355.84	45.75	-8.25	54	29.82	32.81	12.64	29.52	379	229	A	V



802.11a CH 48 5240MHz		5091.26	57.11	-16.89	74	41.58	33.03	11.94	29.44	100	236	P	H
		5149.76	47.75	-6.25	54	32.18	33	12.03	29.46	100	236	A	H
	*	5240	114.94	-	-	99.16	33.02	12.25	29.49	100	236	P	H
	*	5240	106.37	-	-	90.59	33.02	12.25	29.49	100	236	A	H
		5392.8	55.62	-18.38	74	39.5	32.89	12.77	29.54	100	236	P	H
		5350	46.5	-7.5	54	30.6	32.8	12.62	29.52	100	236	A	H
		5143	56.22	-17.78	74	40.66	33	12.02	29.46	286	213	P	V
		5148.98	46.57	-7.43	54	31	33	12.03	29.46	286	213	A	V
	*	5240	113.79	-	-	98.01	33.02	12.25	29.49	286	213	P	V
	*	5240	106.25	-	-	90.47	33.02	12.25	29.49	286	213	A	V
		5365.08	55.17	-18.83	74	39.2	32.83	12.67	29.53	286	213	P	V
		5353.32	45.91	-8.09	54	29.99	32.81	12.63	29.52	286	213	A	V
Remark	1. No other spurious found. 2. All results are PASS against Peak and Average limit line.												



Band 1 5150~5250MHz

WIFI 802.11a (Harmonic @ 3m)

WIFI Ant. 6+7	Note	Frequency (MHz)	Level (dBμV/m)	Over Limit (dB)	Limit Line (dBμV/m)	Read Level (dBμV)	Antenna Factor (dB/m)	Path Loss (dB)	Preamp Factor (dB)	Ant Pos (cm)	Table Pos (deg)	Peak Avg. (P/A)	Pol. (H/V)	
802.11a CH 36 5180MHz		10360	48.38	-19.82	68.2	57.28	38.92	18.9	66.72	-	-	P	H	
		15540	47.93	-26.07	74	53.49	37.92	22.65	66.13	-	-	P	H	
													H	
													H	
													H	
													H	
													H	
													H	
													H	
													H	
													H	
													H	
			10360	48.84	-19.36	68.2	57.74	38.92	18.9	66.72	-	-	P	V
			15540	47.89	-26.11	74	53.45	37.92	22.65	66.13	-	-	P	V
														V
														V
														V
														V
														V
													V	
													V	
													V	



WIFI Ant. 6+7	Note	Frequency (MHz)	Level (dBμV/m)	Over Limit (dB)	Limit Line (dBμV/m)	Read Level (dBμV)	Antenna Factor (dB/m)	Path Loss (dB)	Preamp Factor (dB)	Ant Pos (cm)	Table Pos (deg)	Peak Avg. (P/A)	Pol. (H/V)	
802.11a CH 44 5220MHz		10440	47.95	-20.25	68.2	56.86	38.92	18.91	66.74	-	-	P	H	
		15660	47.47	-26.53	74	53.57	37.44	22.74	66.28	-	-	P	H	
													H	
													H	
													H	
													H	
													H	
													H	
													H	
													H	
													H	
			10440	47.95	-20.25	68.2	56.86	38.92	18.91	66.74	-	-	P	V
			15660	51.65	-22.35	74	57.75	37.44	22.74	66.28	110	234	P	V
			15660	40.63	-13.37	54	46.73	37.44	22.74	66.28	110	234	A	V
														V
														V
														V
														V
														V
														V
													V	



WiFi Ant. 6+7	Note	Frequency (MHz)	Level (dBμV/m)	Over Limit (dB)	Limit Line (dBμV/m)	Read Level (dBμV)	Antenna Factor (dB/m)	Path Loss (dB)	Preamp Factor (dB)	Ant Pos (cm)	Table Pos (deg)	Peak Avg. (P/A)	Pol. (H/V)	
802.11a CH 48 5240MHz		10480	48.75	-19.45	68.2	57.74	38.84	18.92	66.75	-	-	P	H	
		15720	48.07	-25.93	74	54.43	37.22	22.78	66.36	300	0	P	H	
		15720	41.09	-12.91	54	47.45	37.22	22.78	66.36	300	0	A	H	
													H	
													H	
													H	
													H	
													H	
													H	
													H	
													H	
			10480	49.14	-19.06	68.2	58.13	38.84	18.92	66.75	-	-	P	V
			15720	49.87	-24.13	74	56.23	37.22	22.78	66.36	100	283	P	V
			15720	39.44	-14.56	54	45.8	37.22	22.78	66.36	100	283	A	V
														V
														V
														V
														V
														V
														V
													V	
Remark	<ol style="list-style-type: none"> No other spurious found. All results are PASS against Peak and Average limit line. The emission position marked as "-" means no suspected emission found with sufficient margin against limit line or noise floor only. 													



Band 1 5150~5250MHz

WIFI 802.11ax HE20 Full (Band Edge @ 3m)

WIFI Ant. 6+7	Note	Frequency (MHz)	Level (dBμV/m)	Over Limit (dB)	Limit Line (dBμV/m)	Read Level (dBμV)	Antenna Factor (dB/m)	Path Loss (dB)	Preamp Factor (dB)	Ant Pos (cm)	Table Pos (deg)	Peak Avg. (P/A)	Pol. (H/V)	
802.11ax HE20 Full CH 36 5180MHz		5145.6	62.73	-11.27	74	47.16	33	12.03	29.46	100	235	P	H	
		5150	52.17	-1.83	54	36.6	33	12.03	29.46	100	235	A	H	
	*	5180	114.76	-	-	99.09	33.06	12.08	29.47	100	235	P	H	
	*	5180	104.34	-	-	88.67	33.06	12.08	29.47	100	235	A	H	
													H	
														H
			5150	60.73	-13.27	74	45.16	33	12.03	29.46	298	188	P	V
			5150	51.08	-2.92	54	35.51	33	12.03	29.46	298	188	A	V
		*	5180	115.1	-	-	99.43	33.06	12.08	29.47	298	188	P	V
		*	5180	104.47	-	-	88.8	33.06	12.08	29.47	298	188	A	V
													V	
													V	
802.11ax HE20 Full CH 44 5220MHz		5145.86	56.34	-17.66	74	40.77	33	12.03	29.46	112	21	P	H	
		5148.46	46.69	-7.31	54	31.12	33	12.03	29.46	112	21	A	H	
		* 5220	116	-	-	100.24	33.06	12.18	29.48	112	21	P	H	
		* 5220	106.66	-	-	90.9	33.06	12.18	29.48	112	21	A	H	
			5402.32	55.38	-18.62	74	39.23	32.9	12.79	29.54	112	21	P	H
			5399.8	45.05	-8.95	54	28.9	32.9	12.79	29.54	112	21	A	H
			5148.98	56.11	-17.89	74	40.54	33	12.03	29.46	400	217	P	V
			5148.72	45.9	-8.1	54	30.33	33	12.03	29.46	400	217	A	V
		*	5220	113.35	-	-	97.59	33.06	12.18	29.48	400	217	P	V
		*	5220	104.71	-	-	88.95	33.06	12.18	29.48	400	217	A	V
		5370.4	56.48	-17.52	74	40.48	32.84	12.69	29.53	400	217	P	V	
		5364.8	45.71	-8.29	54	29.74	32.83	12.67	29.53	400	217	A	V	



802.11ax HE20 Full CH 48 5240MHz		5119.08	56.43	-17.57	74	40.9	33	11.98	29.45	101	4	P	H
		5149.5	47.2	-6.8	54	31.63	33	12.03	29.46	101	4	A	H
	*	5240	116.64	-	-	100.86	33.02	12.25	29.49	101	4	P	H
	*	5240	107.31	-	-	91.53	33.02	12.25	29.49	101	4	A	H
		5384.4	56.31	-17.69	74	40.23	32.87	12.74	29.53	101	4	P	H
		5350.24	46.81	-7.19	54	30.91	32.8	12.62	29.52	101	4	A	H
		5111.28	56.63	-17.37	74	41.11	33	11.97	29.45	400	215	P	V
		5131.56	46.61	-7.39	54	31.06	33	12	29.45	400	215	A	V
	*	5240	114.7	-	-	98.92	33.02	12.25	29.49	400	215	P	V
	*	5240	106.02	-	-	90.24	33.02	12.25	29.49	400	215	A	V
		5368.44	56.55	-17.45	74	40.56	32.84	12.68	29.53	400	215	P	V
		5350.8	47.14	-6.86	54	31.24	32.8	12.62	29.52	400	215	A	V
Remark	1. No other spurious found. 2. All results are PASS against Peak and Average limit line.												



WIFI Ant. 6+7	Note	Frequency (MHz)	Level (dBμV/m)	Over Limit (dB)	Limit Line (dBμV/m)	Read Level (dBμV)	Antenna Factor (dB/m)	Path Loss (dB)	Preamp Factor (dB)	Ant Pos (cm)	Table Pos (deg)	Peak Avg. (P/A)	Pol. (H/V)
802.11ax HE20 Full CH 44 5220MHz		10440	48.32	-19.88	68.2	57.23	38.92	18.91	66.74	-	-	P	H
		15660	47.38	-26.62	74	53.48	37.44	22.74	66.28	-	-	P	H
													H
													H
													H
													H
													H
													H
													H
													H
													H
													H
													H
													H
													H
													H
													H
													H
													H
			10440	47.6	-20.6	68.2	56.51	38.92	18.91	66.74	-	-	P
		15660	47.05	-26.95	74	53.15	37.44	22.74	66.28	-	-	P	V
													V
													V
													V
													V
													V
													V
													V
													V
													V
													V
													V
													V
													V
													V
													V



WiFi Ant. 6+7	Note	Frequency (MHz)	Level (dBμV/m)	Over Limit (dB)	Limit Line (dBμV/m)	Read Level (dBμV)	Antenna Factor (dB/m)	Path Loss (dB)	Preamp Factor (dB)	Ant Pos (cm)	Table Pos (deg)	Peak Avg. (P/A)	Pol. (H/V)	
802.11ax HE20 Full CH 48 5240MHz		10480	48.24	-19.96	68.2	57.23	38.84	18.92	66.75	-	-	P	H	
		15720	48.92	-25.08	74	55.28	37.22	22.78	66.36	300	0	P	H	
		15720	39.1	-14.9	54	45.46	37.22	22.78	66.36	300	0	A	H	
													H	
													H	
													H	
													H	
													H	
													H	
													H	
													H	
													H	
													H	
													H	
			10480	48.83	-19.37	68.2	57.82	38.84	18.92	66.75	-	-	P	V
			15720	47.91	-26.09	74	54.27	37.22	22.78	66.36	-	-	P	V
														V
														V
														V
														V
													V	
													V	
													V	
													V	
Remark	<ol style="list-style-type: none"> No other spurious found. All results are PASS against Peak and Average limit line. The emission position marked as "-" means no suspected emission found with sufficient margin against limit line or noise floor only. 													



Band 1 5150~5250MHz

WIFI 802.11ax HE20 Partial 106 (Band Edge @ 3m)

WIFI Ant. 6+7	Note	Frequency (MHz)	Level (dBμV/m)	Over Limit (dB)	Limit Line (dBμV/m)	Read Level (dBμV)	Antenna Factor (dB/m)	Path Loss (dB)	Preamp Factor (dB)	Ant Pos (cm)	Table Pos (deg)	Peak Avg. (P/A)	Pol. (H/V)	
802.11ax HE20 Partial 106/53 CH 36 5180MHz		5149.5	65.64	-8.36	74	50.07	33	12.03	29.46	100	236	P	H	
		5150	52.07	-1.93	54	36.5	33	12.03	29.46	100	236	A	H	
	*	5180	117.22	-	-	101.55	33.06	12.08	29.47	100	236	P	H	
	*	5180	107.99	-	-	92.32	33.06	12.08	29.47	100	236	A	H	
													H	
													H	
			5149.76	60.82	-13.18	74	45.25	33	12.03	29.46	301	184	P	V
			5150	51.21	-2.79	54	35.64	33	12.03	29.46	301	184	A	V
	*		5180	116.19	-	-	100.52	33.06	12.08	29.47	301	184	P	V
	*		5180	107.17	-	-	91.5	33.06	12.08	29.47	301	184	A	V
													V	
													V	
Remark	1. No other spurious found. 2. All results are PASS against Peak and Average limit line.													



Band 1 5150~5250MHz

WIFI 802.11ax HE40 Full (Band Edge @ 3m)

WIFI Ant. 6+7	Note	Frequency (MHz)	Level (dBμV/m)	Over Limit (dB)	Limit Line (dBμV/m)	Read Level (dBμV)	Antenna Factor (dB/m)	Path Loss (dB)	Preamp Factor (dB)	Ant Pos (cm)	Table Pos (deg)	Peak Avg. (P/A)	Pol. (H/V)
802.11ax HE40 Full CH 38 5190MHz		5145.86	65.21	-8.79	74	49.64	33	12.03	29.46	100	234	P	H
		5149.76	52.66	-1.34	54	37.09	33	12.03	29.46	100	234	A	H
	*	5190	108.55	-	-	92.85	33.08	12.09	29.47	100	234	P	H
	*	5190	97.3	-	-	81.6	33.08	12.09	29.47	100	234	A	H
		5426.68	56.36	-17.64	74	40.26	32.85	12.8	29.55	100	234	P	H
		5369	46.42	-7.58	54	30.43	32.84	12.68	29.53	100	234	A	H
		5149.76	63.12	-10.88	74	47.55	33	12.03	29.46	316	186	P	V
		5150	51.2	-2.8	54	35.63	33	12.03	29.46	316	186	A	V
	*	5190	107.23	-	-	91.53	33.08	12.09	29.47	316	186	P	V
	*	5190	97.41	-	-	81.71	33.08	12.09	29.47	316	186	A	V
		5458.6	55.35	-18.65	74	39.27	32.82	12.82	29.56	316	186	P	V
		5358.64	45.83	-8.17	54	29.88	32.82	12.65	29.52	316	186	A	V
802.11ax HE40 Full CH 46 5230MHz		5147.68	60.09	-13.91	74	44.52	33	12.03	29.46	100	15	P	H
		5148.98	49.35	-4.65	54	33.78	33	12.03	29.46	100	15	A	H
	*	5230	111.77	-	-	96	33.04	12.21	29.48	100	15	P	H
	*	5230	102.41	-	-	86.64	33.04	12.21	29.48	100	15	A	H
		5385.8	58.01	-15.99	74	41.93	32.87	12.74	29.53	100	15	P	H
		5398.4	48.04	-5.96	54	31.9	32.9	12.78	29.54	100	15	A	H
		5148.98	59.75	-14.25	74	44.18	33	12.03	29.46	400	214	P	V
		5128.96	47.64	-6.36	54	32.09	33	12	29.45	400	214	A	V
	*	5230	109.84	-	-	94.07	33.04	12.21	29.48	400	214	P	V
	*	5230	101.06	-	-	85.29	33.04	12.21	29.48	400	214	A	V
	5409.88	56.19	-17.81	74	40.06	32.88	12.79	29.54	400	214	P	V	
	5393.36	47.42	-6.58	54	31.3	32.89	12.77	29.54	400	214	A	V	
Remark	1. No other spurious found. 2. All results are PASS against Peak and Average limit line.												



Band 1 5150~5250MHz

WIFI 802.11ax HE40 Full (Harmonic @ 3m)

WIFI Ant. 6+7	Note	Frequency (MHz)	Level (dBμV/m)	Over Limit (dB)	Limit Line (dBμV/m)	Read Level (dBμV)	Antenna Factor (dB/m)	Path Loss (dB)	Preamp Factor (dB)	Ant Pos (cm)	Table Pos (deg)	Peak Avg. (P/A)	Pol. (H/V)	
802.11ax HE40 Full CH 38 5190MHz		10380	48.55	-19.65	68.2	57.42	38.96	18.9	66.73	-	-	P	H	
		15570	47.98	-26.02	74	53.61	37.86	22.68	66.17	-	-	P	H	
													H	
													H	
													H	
													H	
													H	
													H	
													H	
													H	
													H	
													H	
			10380	48.72	-19.48	68.2	57.59	38.96	18.9	66.73	-	-	P	V
			15570	47.81	-26.19	74	53.44	37.86	22.68	66.17	-	-	P	V
														V
														V
														V
														V
														V
													V	
													V	
													V	
													V	



WIFI Ant. 6+7	Note	Frequency (MHz)	Level (dBμV/m)	Over Limit (dB)	Limit Line (dBμV/m)	Read Level (dBμV)	Antenna Factor (dB/m)	Path Loss (dB)	Preamp Factor (dB)	Ant Pos (cm)	Table Pos (deg)	Peak Avg. (P/A)	Pol. (H/V)
802.11ax HE40 Full CH 46 5230MHz		10460	49.57	-18.63	68.2	58.52	38.88	18.91	66.74	-	-	P	H
		15690	47.99	-26.01	74	54.29	37.26	22.76	66.32	-	-	P	H
													H
													H
													H
													H
													H
													H
													H
													H
													H
													H
													H
													H
													H
													H
													H
													H
													H
			10460	49.02	-19.18	68.2	57.97	38.88	18.91	66.74	-	-	P
		15690	49.29	-24.71	74	55.59	37.26	22.76	66.32	100	259	P	V
		15690	39.99	-14.01	54	46.29	37.26	22.76	66.32	100	259	A	V
													V
													V
													V
													V
													V
													V
													V
													V
													V
													V
													V
													V
Remark	1. No other spurious found. 2. All results are PASS against Peak and Average limit line.												



Band 1 5150~5250MHz

WIFI 802.11ax HE80 Full (Band Edge @ 3m)

WIFI Ant. 6+7	Note	Frequency (MHz)	Level (dBμV/m)	Over Limit (dB)	Limit Line (dBμV/m)	Read Level (dBμV)	Antenna Factor (dB/m)	Path Loss (dB)	Preamp Factor (dB)	Ant Pos (cm)	Table Pos (deg)	Peak Avg. (P/A)	Pol. (H/V)
802.11ax HE80 Full CH 42 5210MHz		5139.1	63.41	-10.59	74	47.84	33	12.02	29.45	100	235	P	H
		5146.38	52.86	-1.14	54	37.29	33	12.03	29.46	100	235	A	H
	*	5210	104.63	-	-	88.89	33.08	12.14	29.48	100	235	P	H
	*	5210	94.24	-	-	78.5	33.08	12.14	29.48	100	235	A	H
		5372.92	57.2	-16.8	74	41.18	32.85	12.7	29.53	100	235	P	H
		5413.52	48.86	-5.14	54	32.73	32.87	12.8	29.54	100	235	A	H
		5142.22	59.4	-14.6	74	43.84	33	12.02	29.46	315	188	P	V
		5149.76	50.53	-3.47	54	34.96	33	12.03	29.46	315	188	A	V
	*	5210	103.56	-	-	87.82	33.08	12.14	29.48	315	188	P	V
	*	5210	94.73	-	-	78.99	33.08	12.14	29.48	315	188	A	V
	5355.84	56.74	-17.26	74	40.81	32.81	12.64	29.52	315	188	P	V	
	5377.12	48.28	-5.72	54	32.25	32.85	12.71	29.53	315	188	A	V	
Remark	1. No other spurious found. 2. All results are PASS against Peak and Average limit line.												



Band 1 5150~5250MHz

WIFI 802.11ax HE80 Full (Harmonic @ 3m)

WIFI Ant. 6+7	Note	Frequency (MHz)	Level (dBμV/m)	Over Limit (dB)	Limit Line (dBμV/m)	Read Level (dBμV)	Antenna Factor (dB/m)	Path Loss (dB)	Preamp Factor (dB)	Ant Pos (cm)	Table Pos (deg)	Peak Avg. (P/A)	Pol. (H/V)	
802.11ax HE80 Full CH 42 5210MHz		10420	48.47	-19.73	68.2	57.34	38.96	18.91	66.74	-	-	P	H	
		15630	47.73	-26.27	74	53.63	37.62	22.72	66.24	-	-	P	H	
													H	
													H	
													H	
													H	
													H	
													H	
													H	
													H	
													H	
													H	
													H	
													H	
													H	
													H	
													H	
													H	
			10420	49	-19.2	68.2	57.87	38.96	18.91	66.74	-	-	P	V
			15630	47.91	-26.09	74	53.81	37.62	22.72	66.24	-	-	P	V
													V	
													V	
													V	
													V	
													V	
													V	
													V	
													V	
													V	
													V	
													V	
Remark	<ol style="list-style-type: none"> No other spurious found. All results are PASS against Peak and Average limit line. The emission position marked as "-" means no suspected emission found with sufficient margin against limit line or noise floor only. 													



Band 2 - 5250~5350MHz

WIFI 802.11a (Band Edge @ 3m)

WIFI Ant. 6+7	Note	Frequency (MHz)	Level (dBμV/m)	Over Limit (dB)	Limit Line (dBμV/m)	Read Level (dBμV)	Antenna Factor (dB/m)	Path Loss (dB)	Preamp Factor (dB)	Ant Pos (cm)	Table Pos (deg)	Peak Avg. (P/A)	Pol. (H/V)
802.11a CH 52 5260MHz		5140.76	55.22	-18.78	74	39.66	33	12.02	29.46	326	235	P	H
		5149.26	45.85	-8.15	54	30.28	33	12.03	29.46	326	235	A	H
	*	5260	114.17	-	-	98.37	32.98	12.31	29.49	326	235	P	H
	*	5260	105.98	-	-	90.18	32.98	12.31	29.49	326	235	A	H
		5350.08	57.08	-16.92	74	41.18	32.8	12.62	29.52	326	235	P	H
		5352.24	47.36	-6.64	54	31.45	32.8	12.63	29.52	326	235	A	H
		5093.84	55.79	-18.21	74	40.26	33.02	11.95	29.44	400	205	P	V
		5149.94	46.69	-7.31	54	31.12	33	12.03	29.46	400	205	A	V
	*	5260	114.38	-	-	98.58	32.98	12.31	29.49	400	205	P	V
	*	5260	106.13	-	-	90.33	32.98	12.31	29.49	400	205	A	V
		5421.36	57.31	-16.69	74	41.19	32.86	12.8	29.54	400	205	P	V
		5350.08	46.8	-7.2	54	30.9	32.8	12.62	29.52	400	205	A	V
802.11a CH 60 5300MHz		5148.58	55.53	-18.47	74	39.96	33	12.03	29.46	282	27	P	H
		5149.6	45.45	-8.55	54	29.88	33	12.03	29.46	282	27	A	H
	*	5300	115.63	-	-	99.79	32.9	12.45	29.51	282	27	P	H
	*	5300	108.71	-	-	92.87	32.9	12.45	29.51	282	27	A	H
		5354.4	59.21	-14.79	74	43.29	32.81	12.63	29.52	282	27	P	H
		5350.8	50.11	-3.89	54	34.21	32.8	12.62	29.52	282	27	A	H
		5118.32	53.83	-20.17	74	38.3	33	11.98	29.45	376	188	P	V
		5145.52	45	-9	54	29.43	33	12.03	29.46	376	188	A	V
	*	5300	115.18	-	-	99.34	32.9	12.45	29.51	376	188	P	V
	*	5300	106.95	-	-	91.11	32.9	12.45	29.51	376	188	A	V
		5357.52	57.52	-16.48	74	41.57	32.82	12.65	29.52	376	188	P	V
		5350.08	48.93	-5.07	54	33.03	32.8	12.62	29.52	376	188	A	V



802.11a CH 64 5320MHz	*	5320	115.07	-	-	99.2	32.86	12.52	29.51	100	233	P	H
	*	5320	105.93	-	-	90.06	32.86	12.52	29.51	100	233	A	H
		5355.68	62.81	-11.19	74	46.88	32.81	12.64	29.52	100	233	P	H
		5350.4	52.61	-1.39	54	36.71	32.8	12.62	29.52	100	233	A	H
												P	H
												A	H
	*	5320	113.9	-	-	98.03	32.86	12.52	29.51	298	193	P	V
	*	5320	106.2	-	-	90.33	32.86	12.52	29.51	298	193	A	V
		5350.72	62.84	-11.16	74	46.94	32.8	12.62	29.52	298	193	P	V
		5350.88	52.19	-1.81	54	36.29	32.8	12.62	29.52	298	193	A	V
												P	V
												A	V
Remark	1. No other spurious found. 2. All results are PASS against Peak and Average limit line.												



Band 2 5250~5350MHz

WIFI 802.11a (Harmonic @ 3m)

WIFI Ant. 6+7	Note	Frequency (MHz)	Level (dBμV/m)	Over Limit (dB)	Limit Line (dBμV/m)	Read Level (dBμV)	Antenna Factor (dB/m)	Path Loss (dB)	Preamp Factor (dB)	Ant Pos (cm)	Table Pos (deg)	Peak Avg. (P/A)	Pol. (H/V)
802.11a CH 52 5260MHz		10520	48.12	-20.08	68.2	57.03	38.88	18.93	66.72	-	-	P	H
		15780	47.79	-26.21	74	54.11	37.28	22.83	66.43	-	-	P	H
													H
													H
													H
													H
													H
													H
													H
													H
													H
													H
													H
													H
													H
													H
													H
													H
													H
			10520	47.83	-20.37	68.2	56.74	38.88	18.93	66.72	-	-	P
		15780	53.01	-20.99	74	59.33	37.28	22.83	66.43	100	245	P	V
		15780	41.76	-12.24	54	48.08	37.28	22.83	66.43	100	245	A	V
													V
													V
													V
													V
													V
													V
													V
													V
													V
													V
													V
													V
													V



WiFi Ant. 6+7	Note	Frequency (MHz)	Level (dBμV/m)	Over Limit (dB)	Limit Line (dBμV/m)	Read Level (dBμV)	Antenna Factor (dB/m)	Path Loss (dB)	Preamp Factor (dB)	Ant Pos (cm)	Table Pos (deg)	Peak Avg. (P/A)	Pol. (H/V)	
802.11a CH 64 5320MHz		10640	47.99	-26.01	74	56.41	39.2	18.95	66.57	-	-	P	H	
		15960	47.41	-26.59	74	53.98	37.14	22.95	66.66	-	-	P	H	
													H	
													H	
													H	
													H	
													H	
													H	
													H	
													H	
													H	
			10640	47.9	-26.1	74	56.32	39.2	18.95	66.57	-	-	P	V
			15960	47.44	-26.56	74	54.01	37.14	22.95	66.66	-	-	P	V
														V
														V
														V
														V
														V
														V
														V
													V	
Remark	<ol style="list-style-type: none"> No other spurious found. All results are PASS against Peak and Average limit line. The emission position marked as "-" means no suspected emission found with sufficient margin against limit line or noise floor only. 													



Band 2 5250~5350MHz

WIFI 802.11ax HE20 Full (Band Edge @ 3m)

WIFI Ant. 6+7	Note	Frequency (MHz)	Level (dBµV/m)	Over Limit (dB)	Limit Line (dBµV/m)	Read Level (dBµV)	Antenna Factor (dB/m)	Path Loss (dB)	Preamp Factor (dB)	Ant Pos (cm)	Table Pos (deg)	Peak Avg. (P/A)	Pol. (H/V)
802.11ax HE20 Full CH 52 5260MHz		5125.46	56.31	-17.69	74	40.77	33	11.99	29.45	100	6	P	H
		5146.88	46.98	-7.02	54	31.41	33	12.03	29.46	100	6	A	H
	*	5260	116.14	-	-	100.34	32.98	12.31	29.49	100	6	P	H
	*	5260	107.61	-	-	91.81	32.98	12.31	29.49	100	6	A	H
		5352.48	56.24	-17.76	74	40.33	32.8	12.63	29.52	100	6	P	H
		5350.08	47.19	-6.81	54	31.29	32.8	12.62	29.52	100	6	A	H
		5079.22	55.92	-18.08	74	40.36	33.08	11.92	29.44	301	211	P	V
		5148.92	45.93	-8.07	54	30.36	33	12.03	29.46	301	211	A	V
	*	5260	115.39	-	-	99.59	32.98	12.31	29.49	301	211	P	V
	*	5260	105.68	-	-	89.88	32.98	12.31	29.49	301	211	A	V
		5357.76	57.35	-16.65	74	41.4	32.82	12.65	29.52	301	211	P	V
		5350.08	46.84	-7.16	54	30.94	32.8	12.62	29.52	301	211	A	V
802.11ax HE20 Full CH 60 5300MHz		5137.36	55.61	-18.39	74	40.05	33	12.01	29.45	101	28	P	H
		5147.9	46.07	-7.93	54	30.5	33	12.03	29.46	101	28	A	H
	*	5300	117.55	-	-	101.71	32.9	12.45	29.51	101	28	P	H
	*	5300	107.97	-	-	92.13	32.9	12.45	29.51	101	28	A	H
		5363.76	59.99	-14.01	74	44.02	32.83	12.67	29.53	101	28	P	H
		5351.28	49.87	-4.13	54	33.97	32.8	12.62	29.52	101	28	A	H
		5141.1	56	-18	74	40.44	33	12.02	29.46	356	190	P	V
		5147.9	46.56	-7.44	54	30.99	33	12.03	29.46	356	190	A	V
	*	5300	116.66	-	-	100.82	32.9	12.45	29.51	356	190	P	V
	*	5300	107.35	-	-	91.51	32.9	12.45	29.51	356	190	A	V
	5402.4	58.61	-15.39	74	42.46	32.9	12.79	29.54	356	190	P	V	
	5350.56	49.14	-4.86	54	33.24	32.8	12.62	29.52	356	190	A	V	



802.11ax HE20 Full CH 64 5320MHz	*	5320	115.58	-	-	99.71	32.86	12.52	29.51	100	234	P	H
	*	5320	105.16	-	-	89.29	32.86	12.52	29.51	100	234	A	H
		5350.08	64.77	-9.23	74	48.87	32.8	12.62	29.52	100	234	P	H
		5350.08	52.17	-1.83	54	36.27	32.8	12.62	29.52	100	234	A	H
													H
													H
	*	5320	115.38	-	-	99.51	32.86	12.52	29.51	320	190	P	V
	*	5320	105.35	-	-	89.48	32.86	12.52	29.51	320	190	A	V
		5350.4	64.41	-9.59	74	48.51	32.8	12.62	29.52	320	190	P	V
		5350.88	51.03	-2.97	54	35.13	32.8	12.62	29.52	320	190	A	V
												V	
												V	
Remark	1. No other spurious found. 2. All results are PASS against Peak and Average limit line.												



Band 2 5250~5350MHz

WIFI 802.11ax HE20 Full (Harmonic @ 3m)

WIFI Ant. 6+7	Note	Frequency (MHz)	Level (dBμV/m)	Over Limit (dB)	Limit Line (dBμV/m)	Read Level (dBμV)	Antenna Factor (dB/m)	Path Loss (dB)	Preamp Factor (dB)	Ant Pos (cm)	Table Pos (deg)	Peak Avg. (P/A)	Pol. (H/V)
802.11ax HE20 Full CH 52 5260MHz		10520	48.13	-20.07	68.2	57.04	38.88	18.93	66.72	-	-	P	H
		15780	47.35	-26.65	74	53.67	37.28	22.83	66.43	-	-	P	H
													H
													H
													H
													H
													H
													H
													H
													H
													H
													H
													H
													H
													H
													H
													H
													H
													H
			10520	48.45	-19.75	68.2	57.36	38.88	18.93	66.72	-	-	P
		15780	47.97	-26.03	74	54.29	37.28	22.83	66.43	-	-	P	V
													V
													V
													V
													V
													V
													V
													V
													V
													V
													V
													V
													V
													V
													V



WIFI Ant. 6+7	Note	Frequency (MHz)	Level (dBμV/m)	Over Limit (dB)	Limit Line (dBμV/m)	Read Level (dBμV)	Antenna Factor (dB/m)	Path Loss (dB)	Preamp Factor (dB)	Ant Pos (cm)	Table Pos (deg)	Peak Avg. (P/A)	Pol. (H/V)	
802.11ax HE20 Full CH 60 5300MHz		10600	47.86	-26.14	74	56.33	39.2	18.95	66.62	-	-	P	H	
		15900	47.98	-26.02	74	54.46	37.2	22.9	66.58	-	-	P	H	
													H	
													H	
													H	
													H	
													H	
													H	
													H	
													H	
													H	
													H	
													H	
													H	
													H	
													H	
													H	
													H	
			10600	47.96	-26.04	74	56.43	39.2	18.95	66.62	-	-	P	V
			15900	47.52	-26.48	74	54	37.2	22.9	66.58	-	-	P	V
													V	
													V	
													V	
													V	
													V	
													V	
													V	
													V	
													V	
													V	
													V	
													V	
													V	



WIFI Ant. 6+7	Note	Frequency (MHz)	Level (dBμV/m)	Over Limit (dB)	Limit Line (dBμV/m)	Read Level (dBμV)	Antenna Factor (dB/m)	Path Loss (dB)	Preamp Factor (dB)	Ant Pos (cm)	Table Pos (deg)	Peak Avg. (P/A)	Pol. (H/V)	
802.11ax HE20 Full CH 64 5320MHz		10640	47.97	-26.03	74	56.39	39.2	18.95	66.57	-	-	P	H	
		15960	47.76	-26.24	74	54.33	37.14	22.95	66.66	-	-	P	H	
													H	
													H	
													H	
													H	
													H	
													H	
													H	
													H	
													H	
													H	
													H	
													H	
													H	
													H	
													H	
													H	
	Remark	1. No other spurious found. 2. All results are PASS against Peak and Average limit line. 3. The emission position marked as "-" means no suspected emission found with sufficient margin against limit line or noise floor only.												



Band 2 5250~5350MHz

WIFI 802.11ax HE20 Partial 106 (Band Edge @ 3m)

WIFI Ant. 6+7	Note	Frequency (MHz)	Level (dBμV/m)	Over Limit (dB)	Limit Line (dBμV/m)	Read Level (dBμV)	Antenna Factor (dB/m)	Path Loss (dB)	Preamp Factor (dB)	Ant Pos (cm)	Table Pos (deg)	Peak Avg. (P/A)	Pol. (H/V)
802.11ax HE20 Partial 106/54 CH 64 5320MHz	*	5320	118.66	-	-	102.79	32.86	12.52	29.51	100	239	P	H
	*	5320	108.52	-	-	92.65	32.86	12.52	29.51	100	239	A	H
		5351.2	64.93	-9.07	74	49.03	32.8	12.62	29.52	100	239	P	H
		5350.08	52.5	-1.5	54	36.6	32.8	12.62	29.52	100	239	A	H
													H
													H
	*	5320	118.28	-	-	102.41	32.86	12.52	29.51	298	190	P	V
	*	5320	107.79	-	-	91.92	32.86	12.52	29.51	298	190	A	V
		5350.24	61.55	-12.45	74	45.65	32.8	12.62	29.52	298	190	P	V
		5350.08	52.25	-1.75	54	36.35	32.8	12.62	29.52	298	190	A	V
												V	
												V	
Remark	1. No other spurious found. 2. All results are PASS against Peak and Average limit line.												



Band 2 5250~5350MHz

WIFI 802.11ax HE40 Full (Band Edge @ 3m)

WIFI Ant. 6+7	Note	Frequency (MHz)	Level (dBμV/m)	Over Limit (dB)	Limit Line (dBμV/m)	Read Level (dBμV)	Antenna Factor (dB/m)	Path Loss (dB)	Preamp Factor (dB)	Ant Pos (cm)	Table Pos (deg)	Peak Avg. (P/A)	Pol. (H/V)
802.11ax HE40 Full CH 54 5270MHz		5091.8	58.69	-15.31	74	43.16	33.03	11.94	29.44	100	11	P	H
		5103.7	49.8	-4.2	54	34.28	33	11.96	29.44	100	11	A	H
	*	5270	112.86	-	-	97.05	32.96	12.35	29.5	100	11	P	H
	*	5270	103.14	-	-	87.33	32.96	12.35	29.5	100	11	A	H
		5361.12	60.4	-13.6	74	44.45	32.82	12.66	29.53	100	11	P	H
		5350.08	50.2	-3.8	54	34.3	32.8	12.62	29.52	100	11	A	H
		5073.78	56.77	-17.23	74	41.19	33.1	11.91	29.43	337	196	P	V
		5129.54	47.78	-6.22	54	32.23	33	12	29.45	337	196	A	V
	*	5270	110.99	-	-	95.18	32.96	12.35	29.5	337	196	P	V
	*	5270	101.52	-	-	85.71	32.96	12.35	29.5	337	196	A	V
		5350.56	59.89	-14.11	74	43.99	32.8	12.62	29.52	337	196	P	V
		5350.08	48.49	-5.51	54	32.59	32.8	12.62	29.52	337	196	A	V
802.11ax HE40 Full CH 62 5310MHz		5122.4	57.5	-16.5	74	41.96	33	11.99	29.45	100	234	P	H
		5126.82	48.08	-5.92	54	32.53	33	12	29.45	100	234	A	H
	*	5310	108.36	-	-	92.51	32.88	12.48	29.51	100	234	P	H
	*	5310	98.56	-	-	82.71	32.88	12.48	29.51	100	234	A	H
		5353.68	66.37	-7.63	74	50.45	32.81	12.63	29.52	100	234	P	H
		5351.04	52.49	-1.51	54	36.59	32.8	12.62	29.52	100	234	A	H
		5147.22	56.09	-17.91	74	40.52	33	12.03	29.46	288	191	P	V
		5126.82	46.65	-7.35	54	31.1	33	12	29.45	288	191	A	V
	*	5310	108.71	-	-	92.86	32.88	12.48	29.51	288	191	P	V
	*	5310	98.67	-	-	82.82	32.88	12.48	29.51	288	191	A	V
	5350.8	65.25	-8.75	74	49.35	32.8	12.62	29.52	288	191	P	V	
	5350.8	51.89	-2.11	54	35.99	32.8	12.62	29.52	288	191	A	V	
Remark	1. No other spurious found. 2. All results are PASS against Peak and Average limit line.												



WIFI Ant. 6+7	Note	Frequency (MHz)	Level (dBμV/m)	Over Limit (dB)	Limit Line (dBμV/m)	Read Level (dBμV)	Antenna Factor (dB/m)	Path Loss (dB)	Preamp Factor (dB)	Ant Pos (cm)	Table Pos (deg)	Peak Avg. (P/A)	Pol. (H/V)	
802.11ax HE40 Full CH 62 5310MHz		10620	47.55	-26.45	74	55.99	39.2	18.95	66.59	-	-	P	H	
		15930	47.29	-26.71	74	53.81	37.17	22.93	66.62	-	-	P	H	
													H	
													H	
													H	
													H	
													H	
													H	
													H	
													H	
													H	
													H	
													H	
													H	
													H	
													H	
													H	
													H	
			10620	47.86	-26.14	74	56.3	39.2	18.95	66.59	-	-	P	V
			15930	47.12	-26.88	74	53.64	37.17	22.93	66.62	-	-	P	V
													V	
													V	
													V	
													V	
													V	
													V	
													V	
													V	
													V	
													V	
													V	
													V	
Remark	<ol style="list-style-type: none"> No other spurious found. All results are PASS against Peak and Average limit line. The emission position marked as "-" means no suspected emission found with sufficient margin against limit line or noise floor only. 													



Band 2 5250~5350MHz

WIFI 802.11ax HE80 Full (Band Edge @ 3m)

WIFI Ant. 6+7	Note	Frequency (MHz)	Level (dBμV/m)	Over Limit (dB)	Limit Line (dBμV/m)	Read Level (dBμV)	Antenna Factor (dB/m)	Path Loss (dB)	Preamp Factor (dB)	Ant Pos (cm)	Table Pos (deg)	Peak Avg. (P/A)	Pol. (H/V)
802.11ax HE80 Full CH 58 5290MHz		5130.22	58.08	-15.92	74	42.53	33	12	29.45	100	236	P	H
		5092.48	49.48	-4.52	54	33.95	33.03	11.94	29.44	100	236	A	H
	*	5290	104.68	-	-	88.84	32.92	12.42	29.5	100	236	P	H
	*	5290	94.32	-	-	78.48	32.92	12.42	29.5	100	236	A	H
		5353.68	61.37	-12.63	74	45.45	32.81	12.63	29.52	100	236	P	H
		5351.52	52.2	-1.8	54	36.29	32.8	12.63	29.52	100	236	A	H
		5063.92	56.68	-17.32	74	41.07	33.14	11.9	29.43	290	191	P	V
		5076.84	48.16	-5.84	54	32.58	33.09	11.92	29.43	290	191	A	V
	*	5290	104.34	-	-	88.5	32.92	12.42	29.5	290	191	P	V
	*	5290	94.9	-	-	79.06	32.92	12.42	29.5	290	191	A	V
		5350.56	59.07	-14.93	74	43.17	32.8	12.62	29.52	290	191	P	V
	5350.32	51.17	-2.83	54	35.27	32.8	12.62	29.52	290	191	A	V	
Remark	1. No other spurious found. 2. All results are PASS against Peak and Average limit line.												



Band 2 5250~5350MHz

WIFI 802.11ax HE80 Full (Harmonic @ 3m)

WIFI Ant. 6+7	Note	Frequency (MHz)	Level (dBμV/m)	Over Limit (dB)	Limit Line (dBμV/m)	Read Level (dBμV)	Antenna Factor (dB/m)	Path Loss (dB)	Preamp Factor (dB)	Ant Pos (cm)	Table Pos (deg)	Peak Avg. (P/A)	Pol. (H/V)	
802.11ax HE80 Full CH 58 5290MHz		10580	48.51	-19.69	68.2	57.1	39.12	18.94	66.65	-	-	P	H	
		15870	47.57	-26.43	74	54	37.23	22.89	66.55	-	-	P	H	
													H	
													H	
													H	
													H	
													H	
													H	
													H	
													H	
													H	
													H	
													H	
													H	
													H	
													H	
													H	
													H	
	Remark	1. No other spurious found. 2. All results are PASS against Peak and Average limit line. 3. The emission position marked as "-" means no suspected emission found with sufficient margin against limit line or noise floor only.												



Band 3 - 5470~5725MHz

WIFI 802.11a (Band Edge @ 3m)

WIFI Ant. 6+7	Note	Frequency (MHz)	Level (dBμV/m)	Over Limit (dB)	Limit Line (dBμV/m)	Read Level (dBμV)	Antenna Factor (dB/m)	Path Loss (dB)	Preamp Factor (dB)	Ant Pos (cm)	Table Pos (deg)	Peak Avg. (P/A)	Pol. (H/V)	
802.11a CH 100 5500MHz		5459.12	61.55	-12.45	74	45.47	32.82	12.82	29.56	100	235	P	H	
		5469.2	66.15	-2.05	68.2	50.05	32.84	12.82	29.56	100	235	P	H	
		5459.76	52.83	-1.17	54	36.75	32.82	12.82	29.56	100	235	A	H	
	*	5500	115.94	-	-	99.77	32.9	12.84	29.57	100	235	P	H	
	*	5500	107.37	-	-	91.2	32.9	12.84	29.57	100	235	A	H	
														H
			5459.76	59.9	-14.1	74	43.82	32.82	12.82	29.56	283	192	P	V
			5465.84	63.28	-4.92	68.2	47.19	32.83	12.82	29.56	283	192	P	V
			5460	50.59	-3.41	54	34.51	32.82	12.82	29.56	283	192	A	V
	*		5500	114.39	-	-	98.22	32.9	12.84	29.57	283	192	P	V
	*		5500	106.56	-	-	90.39	32.9	12.84	29.57	283	192	A	V
														V
802.11a CH 116 5580MHz		5455.6	54.93	-19.07	74	38.86	32.81	12.82	29.56	108	14	P	H	
		5469.76	54.74	-13.46	68.2	38.64	32.84	12.82	29.56	108	14	P	H	
		5452.24	45.38	-8.62	54	29.32	32.8	12.81	29.55	108	14	A	H	
	*	5580	115.28	-	-	98.97	33.02	12.87	29.58	108	14	P	H	
	*	5580	107.98	-	-	91.67	33.02	12.87	29.58	108	14	A	H	
			5762.48	54.86	-13.34	68.2	37.84	33.67	12.97	29.62	108	14	P	H
			5427.76	56.16	-17.84	74	40.07	32.84	12.8	29.55	324	190	P	V
			5464.96	54.92	-13.28	68.2	38.83	32.83	12.82	29.56	324	190	P	V
			5454.4	45.49	-8.51	54	29.43	32.81	12.81	29.56	324	190	A	V
	*		5580	113.34	-	-	97.03	33.02	12.87	29.58	324	190	P	V
	*		5580	106.43	-	-	90.12	33.02	12.87	29.58	324	190	A	V
			5756.81	55.32	-12.88	68.2	38.33	33.64	12.97	29.62	324	190	P	V