

FCC RF Test Report

FCC ID : UZ7ET45CB
EQUIPMENT : Tablet
BRAND NAME : Zebra
MODEL NAME : ET45CB
Applicant : Zebra Technologies Corporation
1 Zebra Plaza, Holtsville, NY 11742
Manufacturer : Zebra Technologies Corporation
1 Zebra Plaza, Holtsville, NY 11742
STANDARD : 47 CFR Part 2, 27 Subpart Q
CLASSIFICATION : PCS Licensed Transmitter (PCB)
TEST DATE(S) : Jun. 29, 2022 ~ Jul. 13, 2022

We, Sporton International Inc. (Kunshan), would like to declare that the tested sample has been evaluated in accordance with the procedures given in ANSI C63.26-2015 and shown compliance with the applicable technical standards.

The test results in this report apply exclusively to the tested model / sample. Without written approval of Sporton International Inc. (Kunshan), the test report shall not be reproduced except in full.

Jason Jia

Approved by: Jason Jia



Sporton International Inc. (Kunshan)

**No. 1098, Pengxi North Road, Kunshan Economic Development Zone Jiangsu Province 215300
People's Republic of China**



TABLE OF CONTENTS

REVISION HISTORY... 3
SUMMARY OF TEST RESULT ... 4
1. GENERAL DESCRIPTION ... 5
1.1 Product Feature of Equipment Under Test... 5
1.2 Product Specification of Equipment Under Test... 6
1.3 Modification of EUT ... 6
1.4 Maximum EIRP and Emission Designator ... 7
1.5 Testing Site ... 8
1.6 Test Software... 8
1.7 Applied Standards ... 9
2. TEST CONFIGURATION OF EQUIPMENT UNDER TEST ... 10
2.1 Test Mode ... 10
2.2 Connection Diagram of Test System ... 11
2.3 Support Unit used in test configuration and system ... 11
2.4 Measurement Results Explanation Example ... 11
2.5 Frequency List of Low/Middle/High Channels ... 12
3. CONDUCTED TEST ITEMS ... 14
3.1 Measuring Instruments ... 14
3.2 Test Setup ... 14
3.3 Test Result of Conducted Test ... 14
3.4 Conducted Output Power Measurement ... 15
3.5 Peak-to-Average Ratio ... 16
3.6 EIRP ... 17
3.7 Occupied Bandwidth ... 18
3.8 Conducted Band Edge Measurement ... 19
3.9 Conducted Spurious Emission Measurement ... 20
3.10 Frequency Stability Measurement ... 21
4. RADIATED TEST ITEMS ... 22
4.1 Measuring Instruments ... 22
4.2 Test Setup ... 22
4.3 Test Result of Radiated Test ... 23
4.4 Radiated Spurious Emission Measurement ... 24
5. LIST OF MEASURING EQUIPMENT ... 25
6. UNCERTAINTY OF EVALUATION ... 26
APPENDIX A. TEST RESULTS OF CONDUCTED TEST
APPENDIX B. TEST RESULTS OF RADIATED TEST
APPENDIX C. TEST SETUP PHOTOGRAPHS



REVISION HISTORY

REPORT NO.	VERSION	DESCRIPTION	ISSUED DATE
FG230406G	Rev. 01	Initial issue of report	Aug. 12, 2022

SUMMARY OF TEST RESULT

Report Section	FCC Rule	Description	Limit	Result	Remark
3.4	§2.1046	Conducted Output Power	—	Report Only	-
3.5	§27.50 (k)(4)	Peak-to-Average Ratio	<13dB	PASS	
3.6	§27.50 (k)(3)	EIRP	EIRP < 1W (30dBm)	PASS	-
3.7	§2.1049	Occupied Bandwidth	—	Report Only	-
3.8	§2.1051 §27.53 (n)(2)	Conducted Band Edge Measurement	-13dBm/MHz	PASS	-
3.9	§2.1051 §27.53 (n)(2)	Conducted Spurious Emission	-13dBm/MHz	PASS	-
3.10	§2.1055 §27.54	Frequency Stability Temperature & Voltage	Within the band	PASS	-
4.4	§2.1053 §27.53 (n)(2)	Radiated Spurious Emission	-13dBm/MHz	PASS	Under limit 34.22 dB at 6900.00 MHz

Declaration of Conformity:
The test results with all measurement uncertainty excluded are presented in accordance with the regulation limits or requirements declared by manufacturers.
Comments and Explanations:
The declared of product specification for EUT presented in the report are provided by the manufacturer, and the manufacturer takes all the responsibilities for the accuracy of product specification.

1. General Description

1.1 Product Feature of Equipment Under Test

Product Feature	
Equipment	Tablet
Brand Name	Zebra
Model Name	ET45CB
FCC ID	UZ7ET45CB
HW Version	EV2-2
SW Version	ET45-userdebug 11 11-10-12.00-RG-U00-PRD-GSE MXJ release-keys
MFD	30APR22
EUT Stage	Identical Prototype

Specification of Accessory				
Battery	Brand Name	Zebra	Model Number	BT-000456

Supported Unit Used in Test Configuration and System				
AC Adapter	Brand Name	Zebra	Part Number	PWR-WUA5V12W0US
Earphone 1	Brand Name	Zebra	Part Number	HDST-35MM-PTVP-01
Earphone 2	Brand Name	Zebra	Part Number	HDST-USBC-PTT1-01
USB Cable (Type C to Type A)	Brand Name	Zebra	Part Number	CBL-TC5X-USBC2A-01
Type C-Audio Cable (Type C to 3.5mm)	Brand Name	Zebra	Part Number	ADP-USBC-35MM1-01

1.2 Product Specification of Equipment Under Test

Product Feature	
Tx/Rx Frequency	5G NR n77: 3450 MHz ~ 3550 MHz 5G NR n78: 3450 MHz ~ 3550 MHz
SCS	30kHz
Bandwidth	n77: 20 / 30 / 40 / 60 / 80 / 100MHz n78: 20 / 30 / 40 / 50 / 60 / 70 / 80 / 90 / 100MHz
Antenna Type	IFA Antenna
Antenna Gain	Ant. 1: 5G NR n77: -1.1 dBi 5G NR n78: -1.2 dBi Ant. 3: 5G NR n77: 0.3 dBi 5G NR n78: 0.3 dBi Ant. 4: 5G NR n77: -1.7 dBi 5G NR n78: -2.2 dBi Ant. 5: 5G NR n77: -1.1 dBi 5G NR n78: -1.1 dBi
Type of Modulation	CP-OFDM: QPSK / 16QAM / 64QAM / 256QAM DFT-s-OFDM: PI/2 BPSK / QPSK / 16QAM / 64QAM / 256QAM

Remark:

1. The device supports n77/n78(1T4R) SRS resources on Ant.1/4/5, only the test data of worst Ant.3 is showed in the report according to the maximum power.
2. 5G NR n77/n78 support SA and NSA mode. The whole testing has assessed SA mode for n78 by referring to the higher conducted power for conducted test items.
3. 5G NR n77/n78 support HPUE mode.
4. The EN-DC combinations declared by the manufacturer are as follows: DC_7A_n77A, DC_2A_n78A, DC_5A_n78A, DC_7A_n78A, DC_38A_n78A.
5. For NSA mode of RSE testing, we only choose the combination of the maximum power among all NSA combinations to test.

1.3 Modification of EUT

No modifications are made to the EUT during all test items.

1.4 Maximum EIRP and Emission Designator

5G NR n77		PI/2 BPSK / QPSK		16QAM/64QAM/256QAM	
BW (MHz)	Frequency Range (MHz)	Maximum EIRP(W)	Emission Designator (99%OBW)	Maximum EIRP(W)	Emission Designator (99%OBW)
20	3460.02 ~ 3540.00	0.4742	18M2G7D	0.3908	18M2W7D
30	3465.00 ~ 3534.99	0.4764	27M8G7D	0.3963	27M8W7D
40	3470.01 ~ 3529.98	0.4742	37M8G7D	0.4036	37M8W7D
60	3480.00 ~ 3519.99	0.4581	57M9G7D	0.3828	57M8W7D
80	3490.02 ~ 3510.00	0.4446	77M4G7D	0.3631	77M6W7D
100	3500.01 ~ 3500.01	0.4797	97M4G7D	0.3622	97M5W7D

5G NR n78		PI/2 BPSK / QPSK		16QAM/64QAM/256QAM	
BW (MHz)	Frequency Range (MHz)	Maximum EIRP(W)	Emission Designator (99%OBW)	Maximum EIRP(W)	Emission Designator (99%OBW)
20	3460.02 ~ 3540.00	0.4519	18M2G7D	0.3776	18M2W7D
30	3465.00 ~ 3534.99	0.4732	27M8G7D	0.3936	27M8W7D
40	3470.01 ~ 3529.98	0.4786	37M8G7D	0.3917	37M8W7D
50	3475.02 ~ 3525.00	0.4325	47M4G7D	0.3622	47M5W7D
60	3480.00 ~ 3519.99	0.4395	57M9G7D	0.3784	57M8W7D
70	3485.01 ~ 3514.98	0.4395	67M4G7D	0.3639	67M5W7D
80	3490.02 ~ 3510.00	0.4305	77M4G7D	0.3606	77M6W7D
90	3495.00 ~ 3504.99	0.4236	87M4G7D	0.3524	87M6W7D
100	3500.01 ~ 3500.01	0.4819	97M4G7D	0.3908	97M5W7D

Note:

- 5G NR Band n78 overlaps the entire frequency range of Band n77, and n78 power > n77 power, therefore the conducted test results of n78 provided in this report cover n77.
- All modulations have been tested, and only the worst test results of PSK & QAM are shown in the report.

1.5 Testing Site

Sporton International Inc. (Kunshan) is accredited to ISO/IEC 17025:2017 by American Association for Laboratory Accreditation with Certificate Number 5145.02.

Test Firm	Sporton International Inc. (Kunshan)		
Test Site Location	No. 1098, Pengxi North Road, Kunshan Economic Development Zone Jiangsu Province 215300 People's Republic of China TEL : +86-512-57900158 FAX : +86-512-57900958		
Test Site No.	Sporton Site No.	FCC Designation No.	FCC Test Firm Registration No.
	03CH04-KS	CN1257	314309

Sporton International Inc. (Shenzhen) is accredited to ISO/IEC 17025:2017 by American Association for Laboratory Accreditation with Certificate Number 5145.01.

Test Firm	Sporton International Inc. (Shenzhen)		
Test Site Location	1/F, 2/F, Bldg 5, Shiling Industrial Zone, Xinwei Village, Xili, Nanshan, Shenzhen, 518055 People's Republic of China TEL: +86-755-86379589 FAX: +86-755-86379595		
Test Site No.	Sporton Site No.	FCC Designation No.	FCC Test Firm Registration No.
	TH01-SZ	CN1256	421272

Test data subcontracted: Conducted test case in section 3 of this report.

1.6 Test Software

Item	Site	Manufacturer	Name	Version
1.	03CH04-KS	AUDIX	E3	6.2009-8-24a

1.7 Applied Standards

According to the specifications of the manufacturer, the EUT must comply with the requirements of the following standards:

- ♦ 47 CFR Part 2, 27Q
- ♦ ANSI C63.26-2015
- ♦ FCC KDB 971168 Power Meas License Digital Systems D01 v03r01
- ♦ FCC KDB 412172 D01 Determining ERP and EIRP v01r01
- ♦

Remark:

1. All test items were verified and recorded according to the standards and without any deviation during the test.
2. This EUT has also been tested and complied with the requirements of FCC Part 15, Subpart B, recorded in a separate test report.

2. Test Configuration of Equipment Under Test

2.1 Test Mode

Antenna port conducted and radiated test items listed below are performed according to KDB 971168 D01 Power Meas. License Digital Systems v03r01 with maximum output power.

For radiated measurement, pre-scanned in three orthogonal panels, X, Y, Z. The worst cases were recorded in this report.(Y-Plane)

Test Items	5G NR	Bandwidth (MHz)									Modulation					RB #		Test Channel		
		20	30	40	50	60	70	80	90	100	PI/2 BPSK	QPSK	16QAM	64QAM	256 QAM	1	Full	L	M	H
Max. Output Power	n77	v	v	v	-	v	-	v	-	v	v	v	v	v	v	v	v	v	v	v
	n78	v	v	v	v	v	v	v	v	v	v	v	v	v	v	v	v	v	v	v
Peak-to-Average Ratio	n78	v									v	v				v	v	v	v	
26dB and 99% Bandwidth	n78	v	v	v	v	v	v	v	v	v	v	v	v	v	v		v		v	
Conducted Band Edge	n78	v				v				v	v	v				v	v	v	v	
Conducted Spurious Emission	n78	v				v				v	v	v				v		v	v	
Frequency Stability	n78	v									v					v		v		
E.R.P / E.I.R.P	n77	v	v	v	-	v	-	v	-	v	v	v	v	v	v	v	v	v	v	
	n78	v	v	v	v	v	v	v	v	v	v	v	v	v	v	v	v	v	v	
Radiated Spurious Emission	n78	Worst Case																		v
Note	1. The mark "v " means that this configuration is chosen for testing 2. The mark "-" means that this bandwidth is not supported. 3. The device is investigated from 30MHz to 10 times of fundamental signal for radiated spurious emission test under different RB size/offset and modulations in exploratory test. Subsequently, only the worst case emissions are reported. 4. Normal Voltage: 3.87Vdc, Extreme Voltage: 3.55Vdc ~4.45Vdc																			

2.2 Connection Diagram of Test System

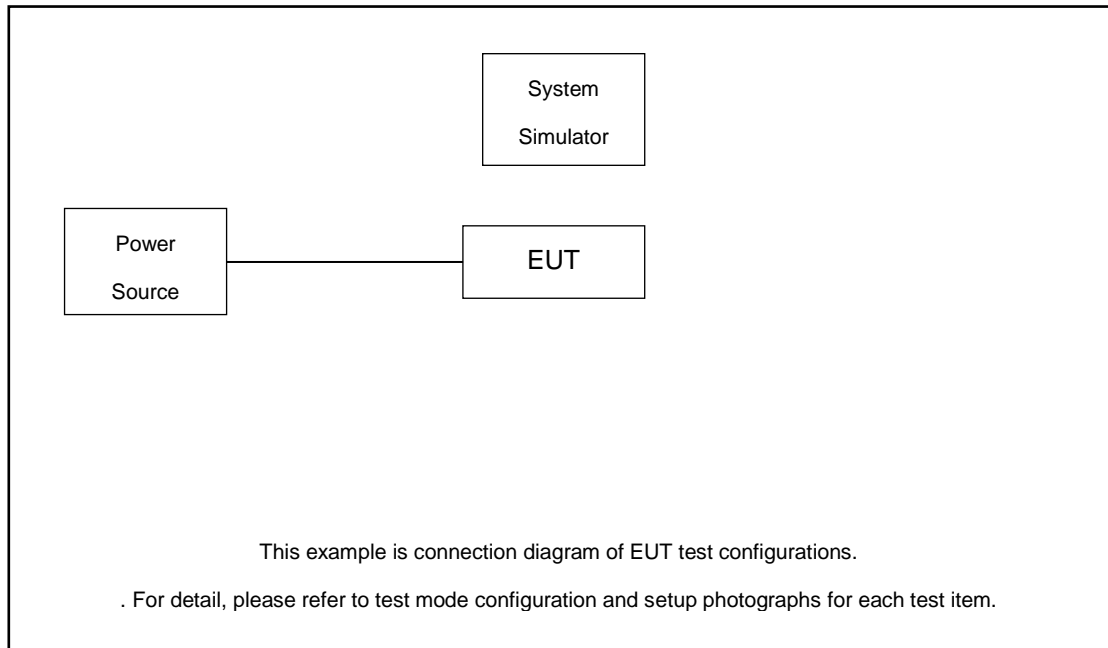

2.3 Support Unit used in test configuration and system

Item	Equipment	Trade Name	Model No.	FCC ID	Data Cable	Power Cord
1.	Power Supply	GWINSTEK	PSS-2002	N/A	N/A	Unshielded, 1.8 m
2.	LTE Base Station	Anritsu	MT8821C	N/A	N/A	Unshielded, 1.8 m
3.	NR Base Station	Anritsu	MT8000A	N/A	N/A	Unshielded, 1.8 m

2.4 Measurement Results Explanation Example

For all conducted test items:

The offset level is set in the spectrum analyzer to compensate the RF cable loss between EUT conducted output port and spectrum analyzer. With the offset compensation, the spectrum analyzer reading level is exactly the EUT RF output level.

The spectrum analyzer offset is derived from RF cable loss.

$Offset = RF\ cable\ loss.$

Following shows an offset computation example with cable loss 8.6 dB.

Example :

$Offset(dB) = RF\ cable\ loss(dB).$

$= 8.6\ (dB)$

2.5 Frequency List of Low/Middle/High Channels

5G n77 Channel and Frequency List				
BW [MHz]	Channel/Frequency(MHz)	Lowest	Middle	Highest
100	Channel	-	633334	-
	Frequency	-	3500.01	-
80	Channel	632668	633334	634000
	Frequency	3490.02	3500.01	3510
60	Channel	632000	633334	634666
	Frequency	3480	3500.01	3519.99
40	Channel	631334	633334	635332
	Frequency	3470.01	3500.01	3529.98
30	Channel	631000	633334	635666
	Frequency	3465	3500.01	3534.99
20	Channel	630668	633334	636000
	Frequency	3460.02	3500.01	3540

5G n78 Channel and Frequency List				
BW [MHz]	Channel/Frequency(MHz)	Lowest	Middle	Highest
100	Channel	-	633334	-
	Frequency	-	3500.01	-
90	Channel	633000	633334	633666
	Frequency	3495	3500.01	3504.99
80	Channel	632668	633334	634000
	Frequency	3490.02	3500.01	3510
70	Channel	632334	633334	634332
	Frequency	3485.01	3500.01	3514.98
60	Channel	632000	633334	634666
	Frequency	3480	3500.01	3519.99
50	Channel	631668	633334	635000
	Frequency	3475.02	3500.01	3525
40	Channel	631334	633334	635332
	Frequency	3470.01	3500.01	3529.98
30	Channel	631000	633334	635666
	Frequency	3465	3500.01	3534.99
20	Channel	630668	633334	636000
	Frequency	3460.02	3500.01	3540

3. Conducted Test Items

3.1 Measuring Instruments

See list of measuring instruments of this test report.

3.2 Test Setup

3.2.1 Conducted Output Power

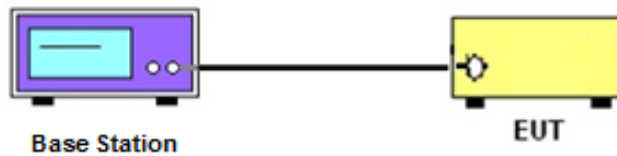

3.2.2 Peak-to-Average Ratio, Occupied / 26dB Bandwidth ,Band-Edge and Conducted Spurious Emission

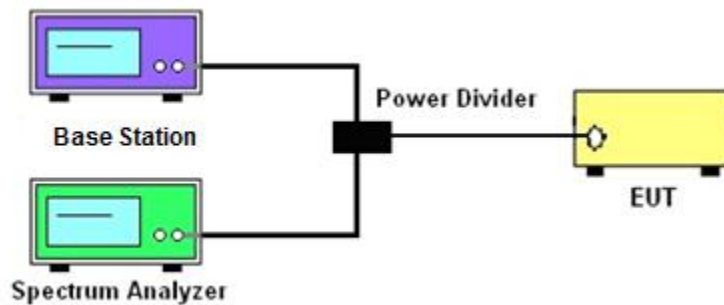

3.2.3 Frequency Stability

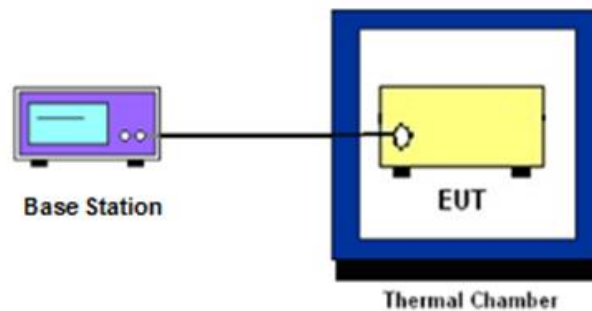

3.3 Test Result of Conducted Test

Please refer to Appendix A.



3.4 Conducted Output Power Measurement

3.4.1 Description of the Conducted Output Power Measurement

A base station simulator was used to establish communication with the EUT. Its parameters were set to transmit the maximum power on the EUT. The measured power in the radio frequency on the transmitter output terminals shall be reported.

3.4.2 Test Procedures

1. The testing follows ANSI C63.26 Section 5.2
2. The transmitter output port was connected to the system simulator.
3. Set EUT at maximum power through the system simulator.
4. Select lowest, middle, and highest channels for each band and different modulation.
5. Measure and record the power level from the system simulator.

3.5 Peak-to-Average Ratio

3.5.1 Description of the PAR Measurement

Power Complementary Cumulative Distribution Function (CCDF) curves provide a means for characterizing the power peaks of a digitally modulated signal on a statistical basis. A CCDF curve depicts the probability of the peak signal amplitude exceeding the average power level. Most contemporary measurement instrumentation include the capability to produce CCDF curves for an input signal provided that the instrument's resolution bandwidth can be set wide enough to accommodate the entire input signal bandwidth. In measuring transmissions in this band using an average power technique, the peak-to-average ratio (PAR) of the transmission may not exceed 13 dB.

3.5.2 Test Procedures

1. The testing follows ANSI C63.26 Section 5.2.3.4 (CCDF).
2. The EUT was connected to spectrum and system simulator via a power divider.
3. Set the CCDF (Complementary Cumulative Distribution Function) option in spectrum analyzer.
4. The highest RF powers were measured and recorded the maximum PAPR level associated with a probability of 0.1 %.
5. Record the deviation as Peak to Average Ratio.

3.6 EIRP

3.6.1 Description of EIRP Limit

§ 27.50 (k)(3)

Mobile devices are limited to 1Watt (30 dBm) EIRP. Mobile devices operating in these bands must employ a means for limiting power to the minimum necessary for successful communications

3.6.2 Test Procedures

1. According to KDB 412172 D01 Power Approach,
2. $EIRP = P_T + G_T - L_C$, $ERP = EIRP - 2.15$, where
 P_T = transmitter output power in dBm
 G_T = gain of the transmitting antenna in dBi
 L_C = signal attenuation in the connecting cable between the transmitter and antenna in dB

3.7 Occupied Bandwidth

3.7.1 Description of Occupied Bandwidth Measurement

The occupied bandwidth is the width of a frequency band such that, below the lower and above the upper frequency limits, the mean powers emitted are each equal to a specified percentage 0.5% of the total mean transmitted power.

The 26 dB emission bandwidth is defined as the frequency range between two points, one above and one below the carrier frequency, at which the spectral density of the emission is attenuated 26 dB below the maximum in-band spectral density of the modulated signal. Spectral density (power per unit bandwidth) is to be measured with a detector of resolution bandwidth equal to approximately 1.0% of the emission bandwidth.

3.7.2 Test Procedures

1. The testing follows ANSI C63.26 Section 5.4
2. The EUT was connected to spectrum analyzer and system simulator via a power divider.
3. The spectrum analyzer center frequency is set to the nominal EUT channel center frequency. The span range for the spectrum analyzer shall be between two and five times the anticipated OBW.
4. The nominal resolution bandwidth (RBW) shall be in the range of 1 to 5 % of the anticipated OBW, and the VBW shall be at least 3 times the RBW.
5. Set the detection mode to peak, and the trace mode to max hold.
6. Determine the reference value: Set the EUT to transmit a modulated signal. Allow the trace to stabilize. Set the spectrum analyzer marker to the highest level of the displayed trace.
(this is the reference value)
7. Determine the “-26 dB down amplitude” as equal to (Reference Value – X).
8. Place two markers, one at the lowest and the other at the highest frequency of the envelope of the spectral display such that each marker is at or slightly below the “-X dB down amplitude” determined in step 6. If a marker is below this “-X dB down amplitude” value it shall be placed as close as possible to this value. The OBW is the positive frequency difference between the two markers.
9. Use the 99 % power bandwidth function of the spectrum analyzer and report the measured bandwidth.

3.8 Conducted Band Edge Measurement

3.8.1 Description of Conducted Band Edge Measurement

§ 27.53 (n)(2)

For mobile operations in the 3450-3550 MHz band, the conducted power of any emission outside the licensee's authorized bandwidth shall not exceed -13 dBm/MHz.

Compliance with this paragraph is based on the use of measurement instrumentation employing a resolution bandwidth of 1 megahertz or greater. However, in the 1 megahertz bands immediately outside and adjacent to the licensee's frequency block, a resolution bandwidth of at least one percent of the emission bandwidth of the fundamental emission of the transmitter may be employed, but limited to a maximum of 200 kHz. In the bands between 1 and 5 MHz removed from the licensee's frequency block, the minimum resolution bandwidth for the measurement shall be 500 kHz.

3.8.2 Test Procedures

1. The testing follows ANSI C63.26 section 5.7
2. The EUT was connected to spectrum analyzer and system simulator via a power divider.
3. The band edges of low and high channels for the highest RF powers were measured.
4. Set RBW $\geq 1\%$ EBW but limited to a maximum of 200 kHz in the 1MHz band immediately outside and adjacent to the band edge.
5. Beyond the 1 MHz and 5 MHz removed from the band edge, set RBW ≥ 500 KHz.
6. Beyond the 5 MHz removed from the band edge, set RBW = 1MHz.
7. Offset has included the duty factor for Band n77/n78. Duty factor = $10 \log (1/x)$, where x is the measured duty cycle
8. Set spectrum analyzer with RMS detector.
9. The RF fundamental frequency should be excluded against the limit line in the operating frequency band.
10. Checked that all the results comply with the emission limit line.
11. When using the integration method, the starting frequency of the integration shall be centered at one-half of the RBW away from the band edge.

3.9 Conducted Spurious Emission Measurement

3.9.1 Description of Conducted Spurious Emission Measurement

The power of any emission outside of the authorized operating frequency ranges shall not exceed -13 dBm/MHz.

It is measured by means of a calibrated spectrum analyzer and scanned from 9 kHz up to a frequency including its 10th harmonic.

3.9.2 Test Procedures

1. The testing follows ANSI C63.26 section 5.7
2. The EUT was connected to spectrum analyzer and system simulator via a power divider.
3. The RF output of EUT was connected to the spectrum analyzer by RF cable and attenuator. The path loss was compensated to the results for each measurement.
4. The middle channel for the highest RF power within the transmitting frequency was measured.
5. The conducted spurious emission for the whole frequency range was taken.
6. Make the measurement with the spectrum analyzer's RBW = 1MHz, VBW = 3MHz.
7. Set spectrum analyzer with RMS detector.
8. Offset has included the duty factor for Band n77/n78. Duty factor = $10 \log(1/x)$, where x is the measured duty cycle
9. Taking the record of maximum spurious emission.
10. The RF fundamental frequency should be excluded against the limit line in the operating frequency band.
11. Checked that all the results comply with the emission limit line.

3.10 Frequency Stability Measurement

3.10.1 Description of Frequency Stability Measurement

The frequency stability shall be measured by variation of ambient temperature and variation of primary supply voltage to ensure that the fundamental emission stays within the authorized frequency block.

3.10.2 Test Procedures for Temperature Variation

1. The testing follows ANSI C63.26 section 5.6.4
2. The EUT was set up in the thermal chamber and connected with the system simulator.
3. With power OFF, the temperature was decreased to -30°C and the EUT was stabilized before testing. Power was applied and the maximum change in frequency was recorded within one minute.
4. With power OFF, the temperature was raised in 10°C step up to 50°C . The EUT was stabilized at each step for at least half an hour. Power was applied and the maximum frequency change was recorded within one minute.

3.10.3 Test Procedures for Voltage Variation

1. The testing follows ANSI C63.26 section 5.6.5.
2. The EUT was placed in a temperature chamber at $20\pm 5^{\circ}\text{C}$ and connected with the system simulator.
3. The power supply voltage to the EUT was varied from 85% to 115% of the nominal value for other than hand carried battery equipment.
4. For hand carried, battery powered equipment, reduce the primary ac or dc supply voltage to the battery operating end point, which shall be specified by the manufacturer.
5. The variation in frequency was measured for the worst case.

4. Radiated Test Items

4.1 Measuring Instruments

See list of measuring instruments of this test report.

4.2 Test Setup

4.2.1 For radiated test below 30MHz

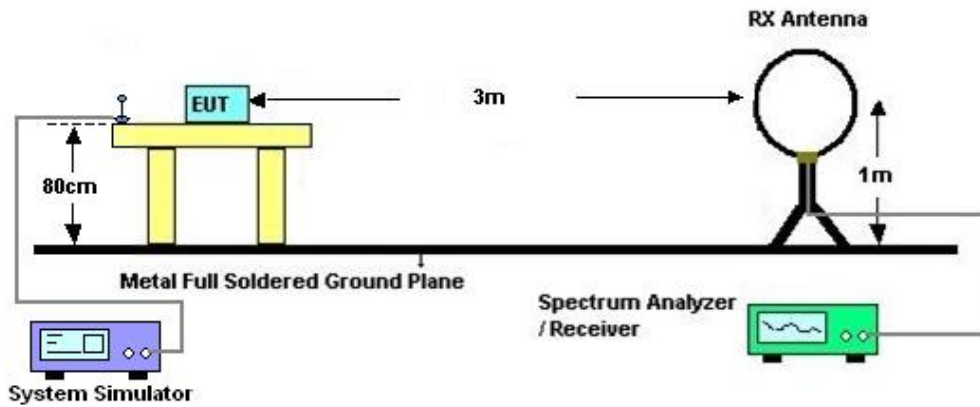

4.2.2 For radiated test from 30MHz to 1GHz

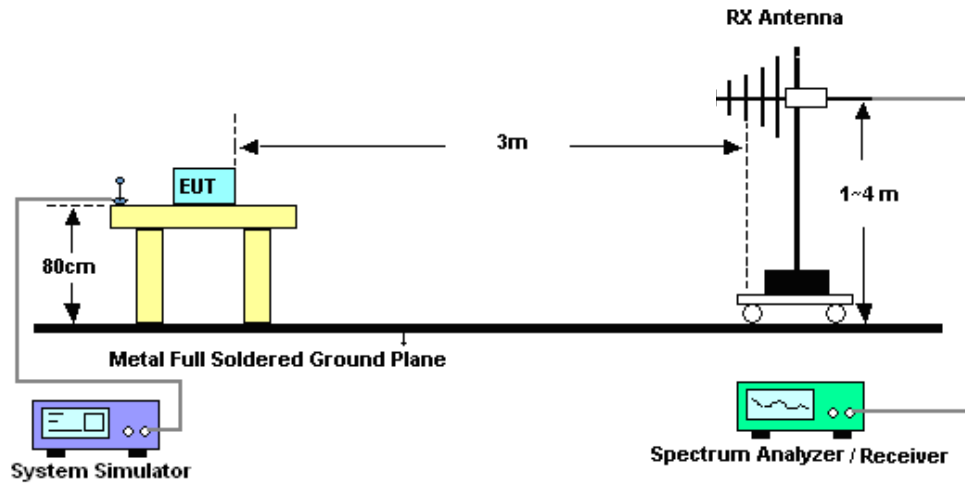

4.2.3 For radiated test above 1GHz

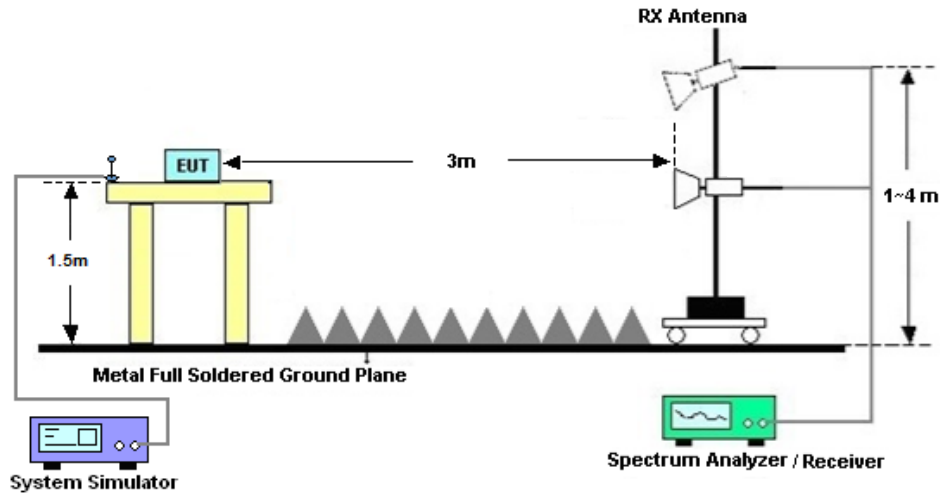

4.3 Test Result of Radiated Test

The low frequency, which started from 9 kHz to 30MHz, was pre-scanned and the result which was 20dB lower than the limit line was not reported.

Please refer to Appendix B.

4.4 Radiated Spurious Emission Measurement

4.4.1 Description of Radiated Spurious Emission

The radiated spurious emission was measured by substitution method according to ANSI/TIA-603-E. The power of any emission outside of the authorized operating frequency ranges shall not exceed -13 dBm/MHz.

The spectrum is scanned from 30 MHz up to a frequency including its 10th harmonic.

4.4.2 Test Procedures

1. The testing follows ANSI C63.26 Section 5.5
2. The EUT was placed on a turntable with 0.8 meter height for frequency below 1GHz and 1.5 meter height for frequency above 1GHz respectively above ground.
3. The EUT was set 3 meters from the receiving antenna mounted on the antenna tower.
4. The table was rotated 360 degrees to determine the position of the highest spurious emission.
5. The height of the receiving antenna is varied between 1m to 4m to search the maximum spurious emission for both horizontal and vertical polarizations.
6. During the measurement, the system simulator parameters were set to force the EUT transmitting at maximum output power.
7. Make the measurement with the spectrum analyzer's RBW = 1MHz, VBW = 3MHz, taking the record of maximum spurious emission.
8. A horn antenna was substituted in place of the EUT and was driven by a signal generator.
9. Tune the output power of signal generator to the same emission level with EUT maximum spurious emission.
$$\text{EIRP (dBm)} = \text{S.G. Power} - \text{Tx Cable Loss} + \text{Tx Antenna Gain}$$
$$\text{ERP (dBm)} = \text{EIRP} - 2.15$$
10. The RF fundamental frequency should be excluded against the limit line in the operating frequency band.



5. List of Measuring Equipment

Instrument	Manufacturer	Model No.	Serial No.	Characteristics	Calibration Date	Test Date	Due Date	Remark
EMI Test Receiver&SA	Agilent	N9038A	MY52260185	20Hz~26.5GHz	Dec. 27, 2021	Jul. 06, 2022~ Jul. 13, 2022	Dec. 26, 2022	Conducted (TH01-SZ)
Power Divider	TOJOIN	PS-2SM-04 265	60.06.020.007 7	0.4GHz~26.5GHz	Dec. 25, 2021	Jul. 06, 2022~ Jul. 13, 2022	Dec. 24, 2022	Conducted (TH01-SZ)
Thermal Chamber	Ten Billion Hongzhangroup	LP-150U	H2014081803	-40~+150°C	Jul. 14, 2021	Jul. 06, 2022~ Jul. 13, 2022	Jul. 13, 2022	Conducted (TH01-SZ)
EXA Spectrum Analyzer	Keysight	N9010B	MY57541079	10Hz-44G,MAX 30dB	Oct. 14, 2021	Jun. 29, 2022	Oct. 13, 2022	Radiation (03CH04-KS)
Loop Antenna	R&S	HFH2-Z2	100321	9kHz~30MHz	Oct. 30, 2021	Jun. 29, 2022	Oct. 29, 2022	Radiation (03CH04-KS)
Bilog Antenna	TeseQ	CBL6111D	49922	30MHz-1GHz	May 30, 2022	Jun. 29, 2022	May 29, 2023	Radiation (03CH04-KS)
Horn Antenna	Schwarzbeck	BBHA9120D	1284	1GHz~18GHz	Oct. 18, 2021	Jun. 29, 2022	Oct. 17, 2022	Radiation (03CH04-KS)
SHF-EHF Horn	Com-power	AH-840	101070	18GHz~40GHz	Jan. 05, 2022	Jun. 29, 2022	Jan. 04, 2023	Radiation (03CH04-KS)
Amplifier	SONOMA	310N	187289	9KHz-1GHz	Jan. 05, 2022	Jun. 29, 2022	Jan. 04, 2023	Radiation (03CH04-KS)
Amplifier	MITEQ	EM18G40G GA	060728	18~40GHz	Jan. 05, 2022	Jun. 29, 2022	Jan. 04, 2023	Radiation (03CH04-KS)
high gain Amplifier	MITEQ	AMF-7D-00 101800-30-1 0P	2025788	1Ghz-18Ghz	Jul. 30, 2021	Jun. 29, 2022	Jul. 29, 2022	Radiation (03CH04-KS)
Amplifier	Keysight	83017A	MY57280106	500MHz~26.5GHz	Oct. 13, 2021	Jun. 29, 2022	Oct. 12, 2022	Radiation (03CH04-KS)
AC Power Source	Chroma	61601	F104090004	N/A	NCR	Jun. 29, 2022	NCR	Radiation (03CH04-KS)
Turn Table	ChamPro	EM 1000-T	060762-T	0~360 degree	NCR	Jun. 29, 2022	NCR	Radiation (03CH04-KS)
Antenna Mast	ChamPro	EM 1000-A	060762-A	1 m~4 m	NCR	Jun. 29, 2022	NCR	Radiation (03CH04-KS)

NCR: No Calibration Required

6. Uncertainty of Evaluation

The measurement uncertainties shown below were calculated in accordance with the requirements of ANSI 63.26-2015. All the measurement uncertainty value were shown with a coverage $K=2$ to indicate 95% level of confidence. The measurement data show herein meets or exceeds the CISPR measurement uncertainty values specified in CISPR 16-4-2 and can be compared directly to specified limit to determine compliance.

Uncertainty of Radiated Emission Measurement (30 MHz ~ 1000 MHz)

Measuring Uncertainty for a Level of Confidence of 95% ($U = 2Uc(y)$)	3.3 dB
---	--------

Uncertainty of Radiated Emission Measurement (1 GHz ~ 18 GHz)

Measuring Uncertainty for a Level of Confidence of 95% ($U = 2Uc(y)$)	2.8 dB
---	--------

Uncertainty of Radiated Emission Measurement (18 GHz ~ 40 GHz)

Measuring Uncertainty for a Level of Confidence of 95% ($U = 2Uc(y)$)	2.8 dB
---	--------



Appendix A. Test Results of Conducted Test

Test Engineer :	Jung Kuo	Temperature :	22~23°C
		Relative Humidity :	45~51%

FR1 N77(ANT3)

Conducted Output Power and EIRP (gain=0.3dBi)

NR Band	SCS (kHz)	Bandwidth (MHz)	Arfcn	Freq (MHz)	Modulation	RB	Conducted Power (dBm)	EIRP (dBm)	EIRP (W)
77	30	20	630668	3460.02	DFT-s-OFDM QPSK	1@1	26.46	26.76	0.4742
77	30	20	630668	3460.02	DFT-s-OFDM 16 QAM	1@1	25.61	25.91	0.3899
77	30	20	633334	3500.01	DFT-s-OFDM QPSK	1@1	26.38	26.68	0.4656
77	30	20	633334	3500.01	DFT-s-OFDM 16 QAM	1@1	25.62	25.92	0.3908
77	30	20	636000	3540	DFT-s-OFDM QPSK	1@1	26.29	26.59	0.4560
77	30	20	636000	3540	DFT-s-OFDM 16 QAM	1@1	25.44	25.74	0.3750
77	30	30	631000	3465	DFT-s-OFDM QPSK	1@1	26.46	26.76	0.4742
77	30	30	631000	3465	DFT-s-OFDM 16 QAM	1@1	25.68	25.98	0.3963
77	30	30	633334	3500.01	DFT-s-OFDM QPSK	1@1	26.48	26.78	0.4764
77	30	30	633334	3500.01	DFT-s-OFDM 16 QAM	1@1	25.6	25.9	0.3890
77	30	30	635666	3534.99	DFT-s-OFDM QPSK	1@1	26.46	26.76	0.4742
77	30	30	635666	3534.99	DFT-s-OFDM 16 QAM	1@1	25.59	25.89	0.3882
77	30	40	631334	3470.01	DFT-s-OFDM QPSK	1@1	26.39	26.69	0.4667
77	30	40	631334	3470.01	DFT-s-OFDM 16 QAM	1@1	25.76	26.06	0.4036
77	30	40	633334	3500.01	DFT-s-OFDM QPSK	1@1	26.43	26.73	0.4710
77	30	40	633334	3500.01	DFT-s-OFDM 16 QAM	1@1	25.69	25.99	0.3972
77	30	40	635332	3529.98	DFT-s-OFDM QPSK	1@1	26.46	26.76	0.4742
77	30	40	635332	3529.98	DFT-s-OFDM 16 QAM	1@1	25.61	25.91	0.3899
77	30	60	632000	3480	DFT-s-OFDM QPSK	1@1	26.27	26.57	0.4539
77	30	60	632000	3480	DFT-s-OFDM 16 QAM	1@1	25.53	25.83	0.3828
77	30	60	633334	3500.01	DFT-s-OFDM QPSK	1@1	26.16	26.46	0.4426
77	30	60	633334	3500.01	DFT-s-OFDM 16 QAM	1@1	25.42	25.72	0.3733
77	30	60	634666	3519.99	DFT-s-OFDM QPSK	1@1	26.31	26.61	0.4581
77	30	60	634666	3519.99	DFT-s-OFDM 16 QAM	1@1	25.4	25.7	0.3715
77	30	80	632668	3490.02	DFT-s-OFDM QPSK	1@1	26.18	26.48	0.4446
77	30	80	632668	3490.02	DFT-s-OFDM 16 QAM	1@1	25.29	25.59	0.3622
77	30	80	633334	3500.01	DFT-s-OFDM QPSK	1@1	26.11	26.41	0.4375
77	30	80	633334	3500.01	DFT-s-OFDM	1@1	25.3	25.6	0.3631

					16 QAM				
77	30	80	634000	3510	DFT-s-OFDM QPSK	1@1	26.14	26.44	0.4406
77	30	80	634000	3510	DFT-s-OFDM 16 QAM	1@1	25.29	25.59	0.3622
77	30	100	633334	3500.01	DFT-s-OFDM PI/2 BPSK	135@67	26.08	26.38	0.4345
77	30	100	633334	3500.01	DFT-s-OFDM PI/2 BPSK	1@1	26.05	26.35	0.4315
77	30	100	633334	3500.01	DFT-s-OFDM PI/2 BPSK	1@271	25.96	26.26	0.4227
77	30	100	633334	3500.01	DFT-s-OFDM QPSK	135@67	26	26.3	0.4266
77	30	100	633334	3500.01	DFT-s-OFDM QPSK	1@1	26.51	26.81	0.4797
77	30	100	633334	3500.01	DFT-s-OFDM QPSK	1@271	26.06	26.36	0.4325
77	30	100	633334	3500.01	DFT-s-OFDM 16 QAM	135@67	24.99	25.29	0.3381
77	30	100	633334	3500.01	DFT-s-OFDM 16 QAM	1@1	25.29	25.59	0.3622
77	30	100	633334	3500.01	DFT-s-OFDM 16 QAM	1@271	25.23	25.53	0.3573
77	30	100	633334	3500.01	DFT-s-OFDM 64 QAM	135@67	23.56	23.86	0.2432
77	30	100	633334	3500.01	DFT-s-OFDM 64 QAM	1@1	23.48	23.78	0.2388
77	30	100	633334	3500.01	DFT-s-OFDM 64 QAM	1@271	23.21	23.51	0.2244
77	30	100	633334	3500.01	DFT-s-OFDM 256 QAM	135@67	21.5	21.8	0.1514
77	30	100	633334	3500.01	DFT-s-OFDM 256 QAM	1@1	21.45	21.75	0.1496
77	30	100	633334	3500.01	DFT-s-OFDM 256 QAM	1@271	21.33	21.63	0.1455
77	30	100	633334	3500.01	CP-OFDM QPSK	137@68	24.46	24.76	0.2992
77	30	100	633334	3500.01	CP-OFDM QPSK	1@1	24.5	24.8	0.3020
77	30	100	633334	3500.01	CP-OFDM QPSK	1@271	24.39	24.69	0.2944

FR1 N78(ANT3)

Conducted Output Power and EIRP (gain=0.3dBi)

NR Band	SCS (kHz)	Bandwidth (MHz)	Arfcn	Freq (MHz)	Modulation	RB	Conducted Power (dBm)	EIRP (dBm)	EIRP (W)
78	30	20	630668	3460.02	DFT-s-OFDM QPSK	1@1	26.25	26.55	0.4519
78	30	20	630668	3460.02	DFT-s-OFDM 16 QAM	1@1	25.47	25.77	0.3776
78	30	20	633334	3500.01	DFT-s-OFDM QPSK	1@1	26.12	26.42	0.4385
78	30	20	633334	3500.01	DFT-s-OFDM 16 QAM	1@1	25.35	25.65	0.3673
78	30	20	636000	3540	DFT-s-OFDM QPSK	1@1	26.24	26.54	0.4508
78	30	20	636000	3540	DFT-s-OFDM 16 QAM	1@1	25.39	25.69	0.3707
78	30	30	631000	3465	DFT-s-OFDM QPSK	1@1	26.43	26.73	0.4710
78	30	30	631000	3465	DFT-s-OFDM 16 QAM	1@1	25.65	25.95	0.3936
78	30	30	633334	3500.01	DFT-s-OFDM QPSK	1@1	26.32	26.62	0.4592
78	30	30	633334	3500.01	DFT-s-OFDM 16 QAM	1@1	25.55	25.85	0.3846
78	30	30	635666	3534.99	DFT-s-OFDM QPSK	1@1	26.45	26.75	0.4732
78	30	30	635666	3534.99	DFT-s-OFDM 16 QAM	1@1	25.62	25.92	0.3908
78	30	40	631334	3470.01	DFT-s-OFDM QPSK	1@1	26.34	26.64	0.4613
78	30	40	631334	3470.01	DFT-s-OFDM 16 QAM	1@1	25.53	25.83	0.3828
78	30	40	633334	3500.01	DFT-s-OFDM QPSK	1@1	26.45	26.75	0.4732
78	30	40	633334	3500.01	DFT-s-OFDM 16 QAM	1@1	25.63	25.93	0.3917
78	30	40	635332	3529.98	DFT-s-OFDM QPSK	1@1	26.5	26.8	0.4786
78	30	40	635332	3529.98	DFT-s-OFDM 16 QAM	1@1	25.56	25.86	0.3855
78	30	50	631668	3475.02	DFT-s-OFDM QPSK	1@1	26.06	26.36	0.4325
78	30	50	631668	3475.02	DFT-s-OFDM 16 QAM	1@1	25.22	25.52	0.3565
78	30	50	633334	3500.01	DFT-s-OFDM QPSK	1@1	26.01	26.31	0.4276
78	30	50	633334	3500.01	DFT-s-OFDM 16 QAM	1@1	25.29	25.59	0.3622
78	30	50	635000	3525	DFT-s-OFDM QPSK	1@1	26.01	26.31	0.4276
78	30	50	635000	3525	DFT-s-OFDM 16 QAM	1@1	25.25	25.55	0.3589
78	30	60	632000	3480	DFT-s-OFDM QPSK	1@1	26.09	26.39	0.4355
78	30	60	632000	3480	DFT-s-OFDM 16 QAM	1@1	25.37	25.67	0.3690
78	30	60	633334	3500.01	DFT-s-OFDM QPSK	1@1	26.11	26.41	0.4375
78	30	60	633334	3500.01	DFT-s-OFDM	1@1	25.28	25.58	0.3614

					16 QAM				
78	30	60	634666	3519.99	DFT-s-OFDM QPSK	1@1	26.13	26.43	0.4395
78	30	60	634666	3519.99	DFT-s-OFDM 16 QAM	1@1	25.48	25.78	0.3784
78	30	70	632334	3485.01	DFT-s-OFDM QPSK	1@1	26.04	26.34	0.4305
78	30	70	632334	3485.01	DFT-s-OFDM 16 QAM	1@1	25.2	25.5	0.3548
78	30	70	633334	3500.01	DFT-s-OFDM QPSK	1@1	25.98	26.28	0.4246
78	30	70	633334	3500.01	DFT-s-OFDM 16 QAM	1@1	25.24	25.54	0.3581
78	30	70	634332	3514.98	DFT-s-OFDM QPSK	1@1	26.13	26.43	0.4395
78	30	70	634332	3514.98	DFT-s-OFDM 16 QAM	1@1	25.31	25.61	0.3639
78	30	80	632668	3490.02	DFT-s-OFDM QPSK	1@1	26	26.3	0.4266
78	30	80	632668	3490.02	DFT-s-OFDM 16 QAM	1@1	25.21	25.51	0.3556
78	30	80	633334	3500.01	DFT-s-OFDM QPSK	1@1	25.95	26.25	0.4217
78	30	80	633334	3500.01	DFT-s-OFDM 16 QAM	1@1	25.09	25.39	0.3459
78	30	80	634000	3510	DFT-s-OFDM QPSK	1@1	26.04	26.34	0.4305
78	30	80	634000	3510	DFT-s-OFDM 16 QAM	1@1	25.27	25.57	0.3606
78	30	90	633000	3495	DFT-s-OFDM QPSK	1@1	25.95	26.25	0.4217
78	30	90	633000	3495	DFT-s-OFDM 16 QAM	1@1	24.95	25.25	0.3350
78	30	90	633334	3500.01	DFT-s-OFDM QPSK	1@1	25.97	26.27	0.4236
78	30	90	633334	3500.01	DFT-s-OFDM 16 QAM	1@1	24.96	25.26	0.3357
78	30	90	633666	3504.99	DFT-s-OFDM QPSK	1@1	25.92	26.22	0.4188
78	30	90	633666	3504.99	DFT-s-OFDM 16 QAM	1@1	25.17	25.47	0.3524
78	30	100	633334	3500.01	DFT-s-OFDM PI/2 BPSK	135@67	26.46	26.76	0.4742
78	30	100	633334	3500.01	DFT-s-OFDM PI/2 BPSK	1@1	26.46	26.76	0.4742
78	30	100	633334	3500.01	DFT-s-OFDM PI/2 BPSK	1@271	26.35	26.65	0.4624
78	30	100	633334	3500.01	DFT-s-OFDM QPSK	135@67	26.46	26.76	0.4742
78	30	100	633334	3500.01	DFT-s-OFDM QPSK	1@1	26.53	26.83	0.4819
78	30	100	633334	3500.01	DFT-s-OFDM QPSK	1@271	26.4	26.7	0.4677
78	30	100	633334	3500.01	DFT-s-OFDM 16 QAM	135@67	25.41	25.71	0.3724
78	30	100	633334	3500.01	DFT-s-OFDM 16 QAM	1@1	25.62	25.92	0.3908
78	30	100	633334	3500.01	DFT-s-OFDM 16 QAM	1@271	25.3	25.6	0.3631
78	30	100	633334	3500.01	DFT-s-OFDM 64 QAM	135@67	24.05	24.35	0.2723
78	30	100	633334	3500.01	DFT-s-OFDM 64 QAM	1@1	23.89	24.19	0.2624
78	30	100	633334	3500.01	DFT-s-OFDM 64 QAM	1@271	23.4	23.7	0.2344
78	30	100	633334	3500.01	DFT-s-OFDM 256 QAM	135@67	21.76	22.06	0.1607

78	30	100	633334	3500.01	DFT-s-OFDM 256 QAM	1@1	21.85	22.15	0.1641
78	30	100	633334	3500.01	DFT-s-OFDM 256 QAM	1@271	21.67	21.97	0.1574
78	30	100	633334	3500.01	CP-OFDM QPSK	137@68	24.94	25.24	0.3342
78	30	100	633334	3500.01	CP-OFDM QPSK	1@1	24.97	25.27	0.3365
78	30	100	633334	3500.01	CP-OFDM QPSK	1@271	24.75	25.05	0.3199

Frequency Stability

NR Band	SCS (kHz)	Bandwidth (MHz)	Arfcn	Freq (MHz)	Modulation	RB	Deviation (ppm)	Verdict	Environment
78	30	20	633334	3500.01	DFT-s-OFDM QPSK	50@0	0.00368	PASS	NV
78	30	20	633334	3500.01	DFT-s-OFDM QPSK	50@0	0.00216	PASS	LV
78	30	20	633334	3500.01	DFT-s-OFDM QPSK	50@0	0.00152	PASS	HV
78	30	20	633334	3500.01	DFT-s-OFDM QPSK	50@0	0.00331	PASS	-30°C
78	30	20	633334	3500.01	DFT-s-OFDM QPSK	50@0	0.00556	PASS	-20°C
78	30	20	633334	3500.01	DFT-s-OFDM QPSK	50@0	0.00319	PASS	-10°C
78	30	20	633334	3500.01	DFT-s-OFDM QPSK	50@0	0.00534	PASS	0°C
78	30	20	633334	3500.01	DFT-s-OFDM QPSK	50@0	0.00442	PASS	10°C
78	30	20	633334	3500.01	DFT-s-OFDM QPSK	50@0	0.00435	PASS	20°C
78	30	20	633334	3500.01	DFT-s-OFDM QPSK	50@0	0.00216	PASS	30°C
78	30	20	633334	3500.01	DFT-s-OFDM QPSK	50@0	0.00112	PASS	40°C
78	30	20	633334	3500.01	DFT-s-OFDM QPSK	50@0	0.00146	PASS	50°C

Peak to Average Ratio

NR Band	SCS (kHz)	Bandwidth (MHz)	Arfcn	Freq (MHz)	Modulation	RB	Result (dB)	Limit (dB)	Verdict
78	30	20	630668	3460.02	DFT-s-OFDM PI/2 BPSK	50@0	6.78	13	PASS
78	30	20	630668	3460.02	DFT-s-OFDM PI/2 BPSK	1@0	6.96	13	PASS
78	30	20	630668	3460.02	DFT-s-OFDM QPSK	50@0	7.3	13	PASS
78	30	20	630668	3460.02	DFT-s-OFDM QPSK	1@0	7.25	13	PASS
78	30	20	633334	3500.01	DFT-s-OFDM PI/2 BPSK	50@0	6.71	13	PASS
78	30	20	633334	3500.01	DFT-s-OFDM PI/2 BPSK	1@0	6.95	13	PASS
78	30	20	633334	3500.01	DFT-s-OFDM QPSK	50@0	7.44	13	PASS
78	30	20	633334	3500.01	DFT-s-OFDM QPSK	1@0	7.27	13	PASS
78	30	20	636000	3540.0	DFT-s-OFDM PI/2 BPSK	50@0	6.81	13	PASS
78	30	20	636000	3540.0	DFT-s-OFDM PI/2 BPSK	1@0	6.87	13	PASS
78	30	20	636000	3540.0	DFT-s-OFDM QPSK	50@0	7.64	13	PASS
78	30	20	636000	3540.0	DFT-s-OFDM QPSK	1@0	6.99	13	PASS

N78(20M)_DFT-s-OFDM_PI_2-BPSK_Outer_Full_Low_CH

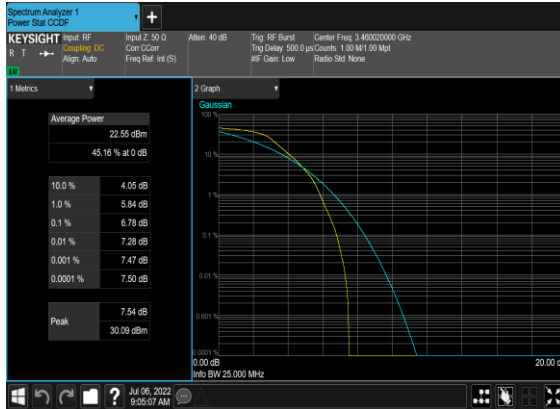

N78(20M)_DFT-s-OFDM_PI_2-BPSK_Edge_1RB_Left_Low_CH



N78(20M)_DFT-s-OFDM_QPSK_Outer_Full_Low_CH

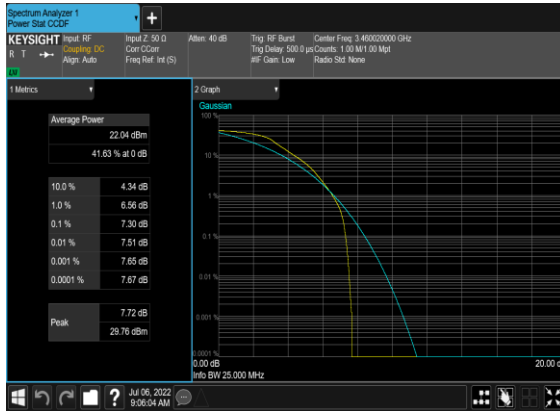

N78(20M)_DFT-s-OFDM_QPSK_Edge_1RB_Left_Low_CH

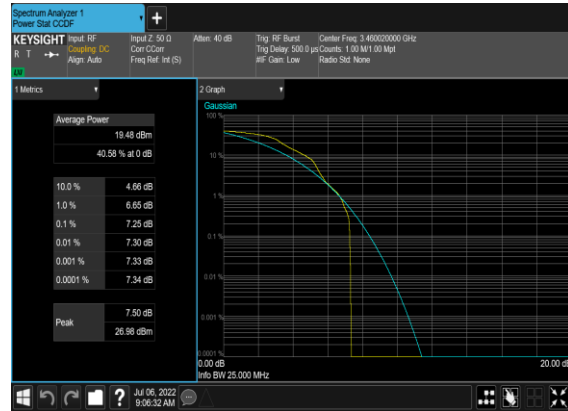

N78(20M)_DFT-s-OFDM_PI_2-BPSK_Outer_Full_Mid_CH

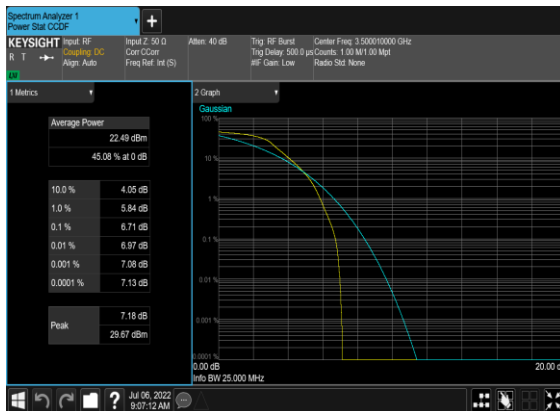

N78(20M)_DFT-s-OFDM_PI_2-BPSK_Edge_1RB_Left_Mid_CH



N78(20M)_DFT-s-OFDM_QPSK_Outer_Full_Mid_CH

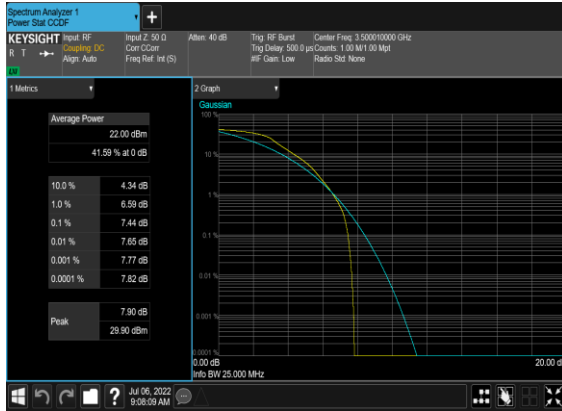

N78(20M)_DFT-s-OFDM_QPSK_Edge_1RB_Left_Mid_CH



N78(20M)_DFT-s-OFDM_PI_2-BPSK_Outer_Full_High_CH



N78(20M)_DFT-s-OFDM_PI_2-BPSK_Edge_1RB_Left_High_CH

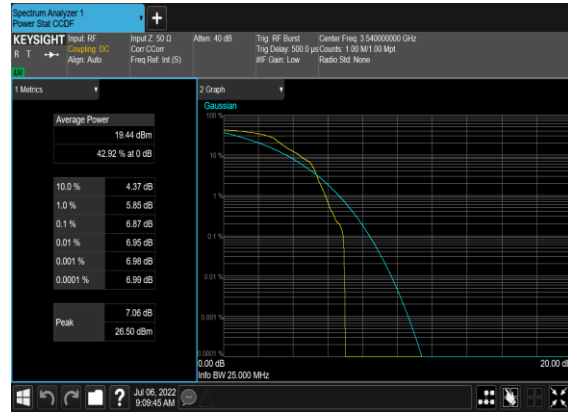

N78(20M)_DFT-s-OFDM_QPSK_Outer_Full_High_CH

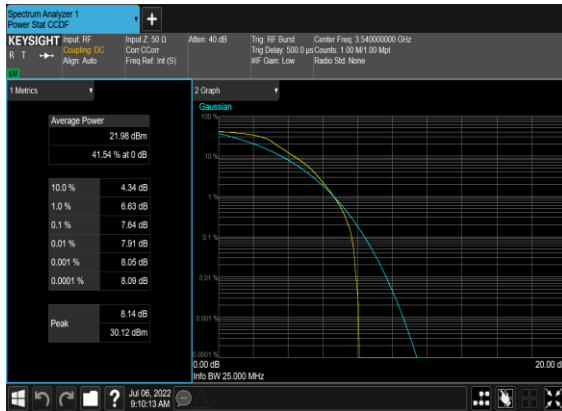

N78(20M)_DFT-s-OFDM_QPSK_Edge_1RB_Left_High_CH

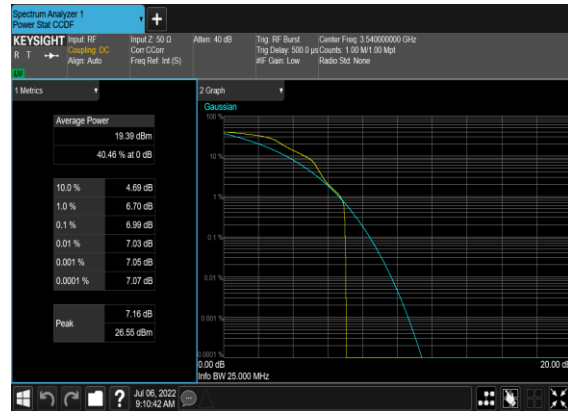

Occupied Bandwidth

NR Band	SCS (kHz)	Bandwidth (MHz)	Arfcn	Freq (MHz)	Modulation	RB	OBW (MHz)	26dB OBW (MHz)
78	30	20	633334	3500.01	DFT-s-OFDM PI/2 BPSK	50@0	17.788	18.94
78	30	20	633334	3500.01	DFT-s-OFDM QPSK	50@0	17.853	18.99
78	30	20	633334	3500.01	CP-OFDM QPSK	51@0	18.189	19.46
78	30	20	633334	3500.01	CP-OFDM 16 QAM	51@0	18.235	19.42
78	30	20	633334	3500.01	CP-OFDM 64 QAM	51@0	18.215	19.39
78	30	20	633334	3500.01	CP-OFDM 256 QAM	51@0	18.201	19.45
78	30	30	633334	3500.01	DFT-s-OFDM PI/2 BPSK	75@0	26.733	28.12
78	30	30	633334	3500.01	DFT-s-OFDM QPSK	75@0	26.69	28.09
78	30	30	633334	3500.01	CP-OFDM QPSK	78@0	27.833	29.19
78	30	30	633334	3500.01	CP-OFDM 16 QAM	78@0	27.836	29.33
78	30	30	633334	3500.01	CP-OFDM 64 QAM	78@0	27.798	29.12
78	30	30	633334	3500.01	CP-OFDM 256 QAM	78@0	27.826	29.34
78	30	40	633334	3500.01	DFT-s-OFDM PI/2 BPSK	100@0	35.739	36.94
78	30	40	633334	3500.01	DFT-s-OFDM QPSK	100@0	35.739	37.28
78	30	40	633334	3500.01	CP-OFDM QPSK	106@0	37.802	39.71
78	30	40	633334	3500.01	CP-OFDM 16 QAM	106@0	37.825	39.38
78	30	40	633334	3500.01	CP-OFDM 64 QAM	106@0	37.796	39.48
78	30	40	633334	3500.01	CP-OFDM 256 QAM	106@0	37.809	39.39
78	30	50	633334	3500.01	DFT-s-OFDM PI/2 BPSK	128@0	45.753	47.34
78	30	50	633334	3500.01	DFT-s-OFDM QPSK	128@0	45.809	47.39
78	30	50	633334	3500.01	CP-OFDM QPSK	133@0	47.428	49.25
78	30	50	633334	3500.01	CP-OFDM 16 QAM	133@0	47.459	49.23
78	30	50	633334	3500.01	CP-OFDM 64 QAM	133@0	47.489	49.3
78	30	50	633334	3500.01	CP-OFDM 256 QAM	133@0	47.451	49.33
78	30	60	633334	3500.01	DFT-s-OFDM PI/2 BPSK	162@0	57.83	59.99

78	30	60	633334	3500.01	DFT-s-OFDM QPSK	162@0	57.864	60.0
78	30	60	633334	3500.01	CP-OFDM QPSK	162@0	57.723	59.95
78	30	60	633334	3500.01	CP-OFDM 16 QAM	162@0	57.777	59.94
78	30	60	633334	3500.01	CP-OFDM 64 QAM	162@0	57.815	60.04
78	30	60	633334	3500.01	CP-OFDM 256 QAM	162@0	57.733	59.87
78	30	70	633334	3500.01	DFT-s-OFDM PI/2 BPSK	180@0	64.304	66.44
78	30	70	633334	3500.01	DFT-s-OFDM QPSK	180@0	64.211	66.45
78	30	70	633334	3500.01	CP-OFDM QPSK	189@0	67.444	69.73
78	30	70	633334	3500.01	CP-OFDM 16 QAM	189@0	67.375	69.81
78	30	70	633334	3500.01	CP-OFDM 64 QAM	189@0	67.506	69.64
78	30	70	633334	3500.01	CP-OFDM 256 QAM	189@0	67.412	69.86
78	30	80	633334	3500.01	DFT-s-OFDM PI/2 BPSK	216@0	77.178	79.78
78	30	80	633334	3500.01	DFT-s-OFDM QPSK	216@0	77.169	79.81
78	30	80	633334	3500.01	CP-OFDM QPSK	217@0	77.416	79.93
78	30	80	633334	3500.01	CP-OFDM 16 QAM	217@0	77.592	79.99
78	30	80	633334	3500.01	CP-OFDM 64 QAM	217@0	77.516	80.04
78	30	80	633334	3500.01	CP-OFDM 256 QAM	217@0	77.366	79.95
78	30	90	633334	3500.01	DFT-s-OFDM PI/2 BPSK	240@0	85.622	88.46
78	30	90	633334	3500.01	DFT-s-OFDM QPSK	240@0	85.679	88.49
78	30	90	633334	3500.01	CP-OFDM QPSK	245@0	87.391	90.35
78	30	90	633334	3500.01	CP-OFDM 16 QAM	245@0	87.343	90.27
78	30	90	633334	3500.01	CP-OFDM 64 QAM	245@0	87.347	90.26
78	30	90	633334	3500.01	CP-OFDM 256 QAM	245@0	87.593	90.29
78	30	100	633334	3500.01	DFT-s-OFDM PI/2 BPSK	270@0	96.29	99.46
78	30	100	633334	3500.01	DFT-s-OFDM QPSK	270@0	96.418	99.39
78	30	100	633334	3500.01	CP-OFDM QPSK	273@0	97.392	100.7
78	30	100	633334	3500.01	CP-OFDM 16 QAM	273@0	97.486	100.5

78	30	100	633334	3500.01	CP-OFDM 64 QAM	273@0	97.273	100.5
78	30	100	633334	3500.01	CP-OFDM 256 QAM	273@0	97.365	100.6

N78(20M)_DFT-s-OFDM_PI_2-BPSK_Outer_Full_Mid_CH

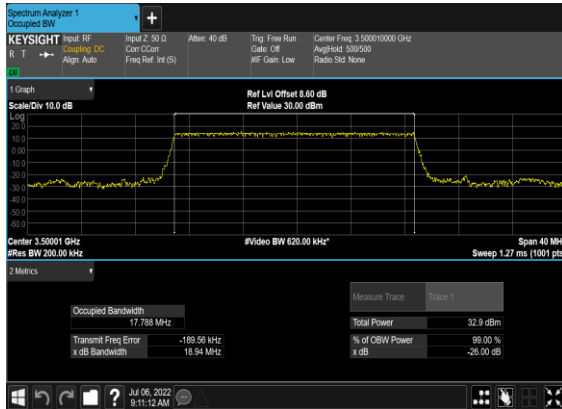

N78(20M)_DFT-s-OFDM_QPSK_Outer_Full_Mid_CH

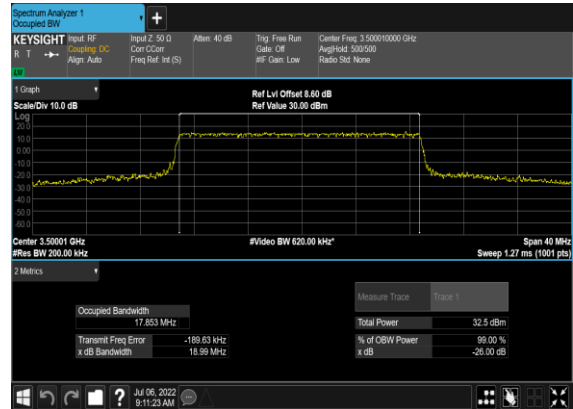

N78(20M)_CP-OFDM_QPSK_Outer_Full_Mid_CH

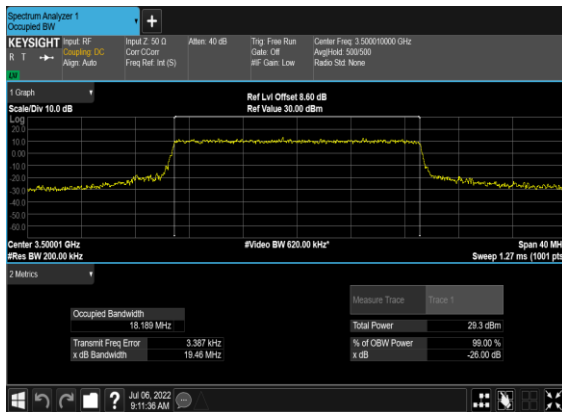

N78(20M)_CP-OFDM_16 QAM_Outer_Full_Mid_CH

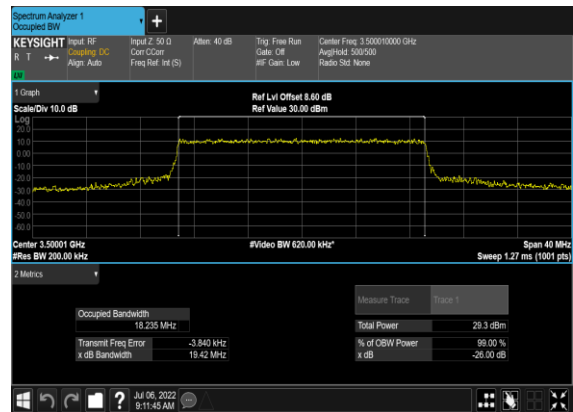

N78(20M)_CP-OFDM_64 QAM_Outer_Full_Mid_CH

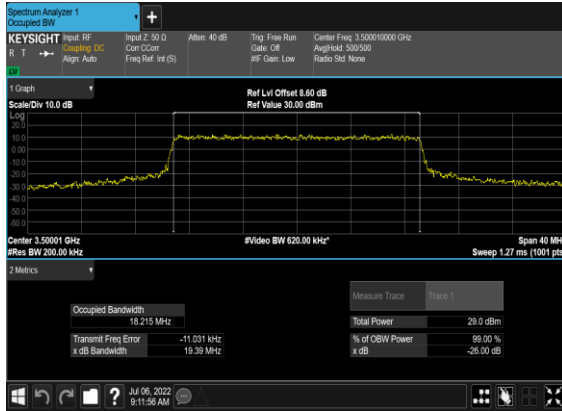

N78(20M)_CP-OFDM_256 QAM_Outer_Full_Mid_CH

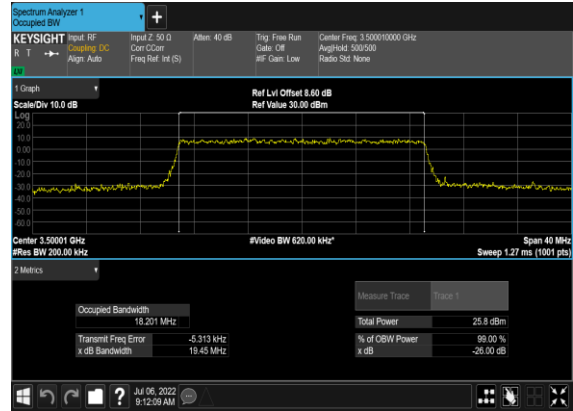

N78(30M)_DFT-s-OFDM_PI_2- BPSK_Outer_Full_Mid_CH



N78(30M)_DFT-s- OFDM_QPSK_Outer_Full_Mid_CH



N78(30M)_CP- OFDM_QPSK_Outer_Full_Mid_CH

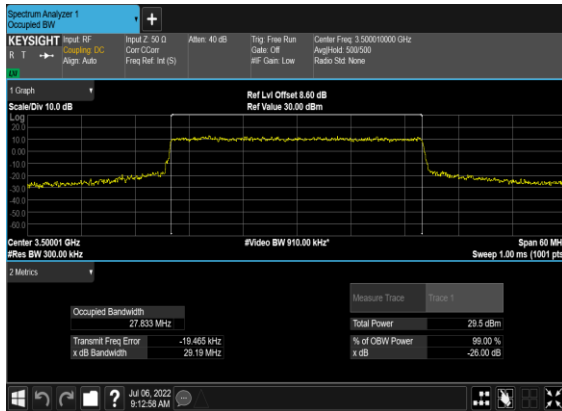

N78(30M)_CP-OFDM_16 QAM_Outer_Full_Mid_CH

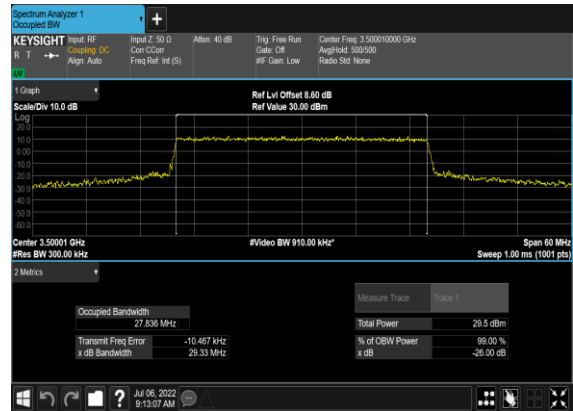

N78(30M)_CP-OFDM_64
QAM_Outer_Full_Mid_CH



N78(30M)_CP-OFDM_256
QAM_Outer_Full_Mid_CH

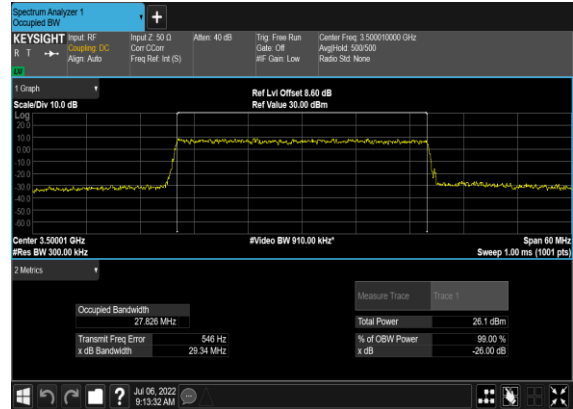

N78(40M)_DFT-s-OFDM_PI_2-
BPSK_Outer_Full_Mid_CH

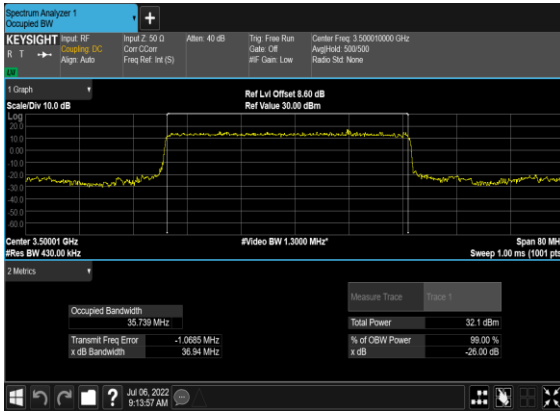

N78(40M)_DFT-s-
OFDM_QPSK_Outer_Full_Mid_CH

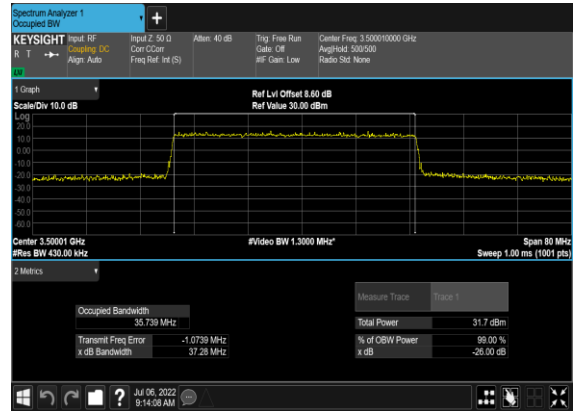

N78(40M)_CP-
OFDM_QPSK_Outer_Full_Mid_CH

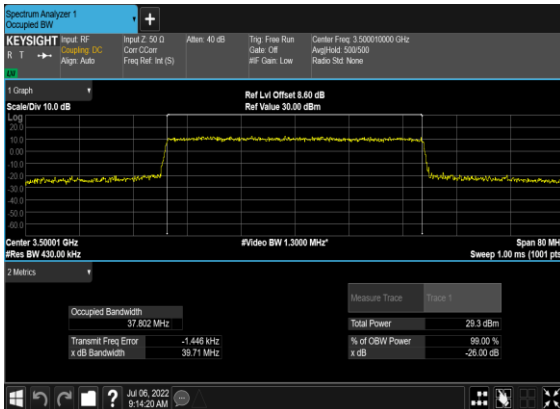

N78(40M)_CP-OFDM_16
QAM_Outer_Full_Mid_CH

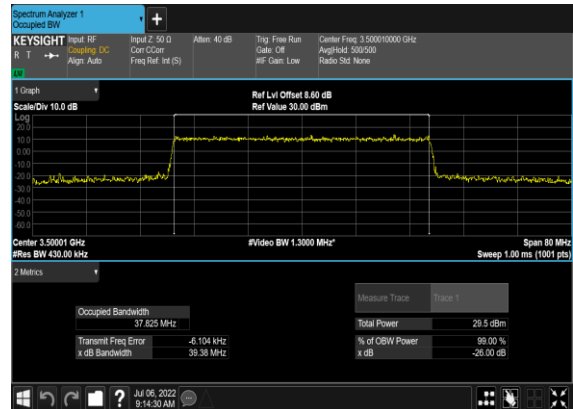

N78(40M)_CP-OFDM_64 QAM_Outer_Full_Mid_CH

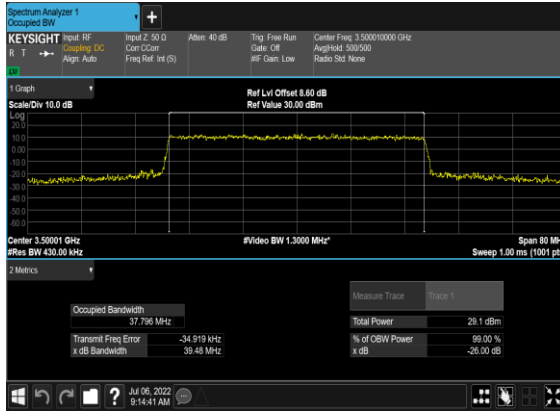

N78(40M)_CP-OFDM_256 QAM_Outer_Full_Mid_CH

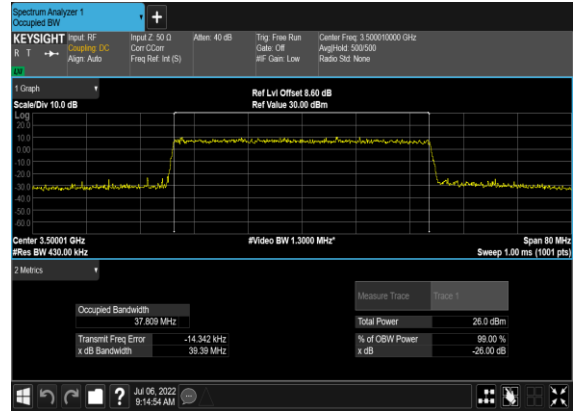

N78(50M)_DFT-s-OFDM_PI_2- BPSK_Outer_Full_Mid_CH

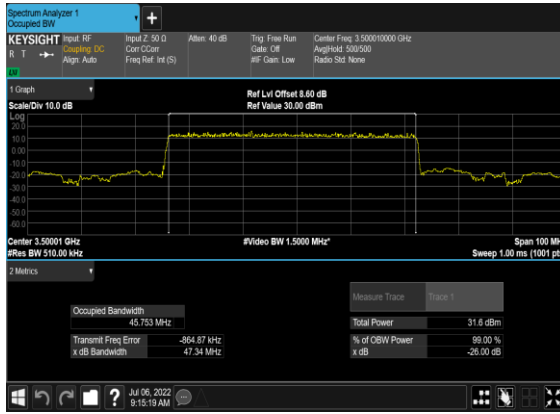

N78(50M)_DFT-s- OFDM_QPSK_Outer_Full_Mid_CH

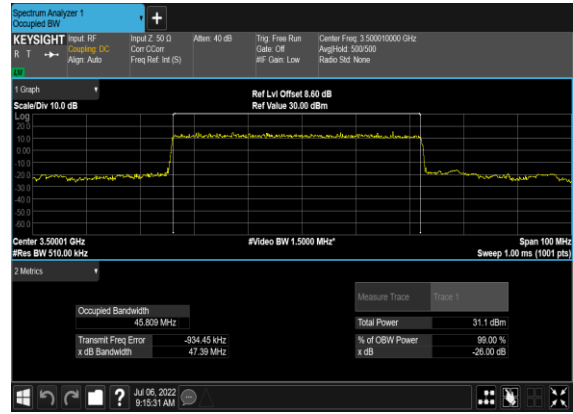

N78(50M)_CP- OFDM_QPSK_Outer_Full_Mid_CH

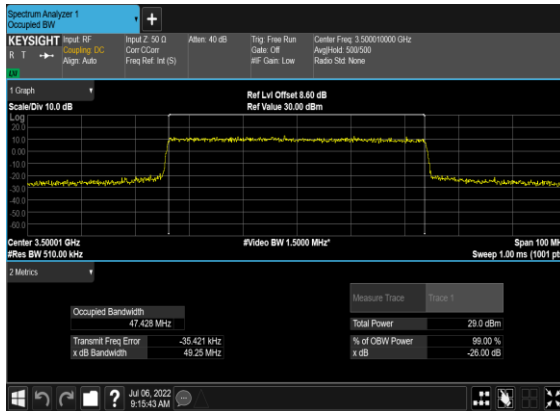

N78(50M)_CP-OFDM_16 QAM_Outer_Full_Mid_CH

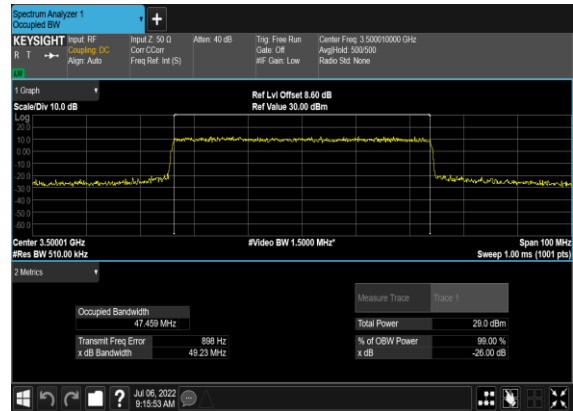

N78(50M)_CP-OFDM_64 QAM_Outer_Full_Mid_CH

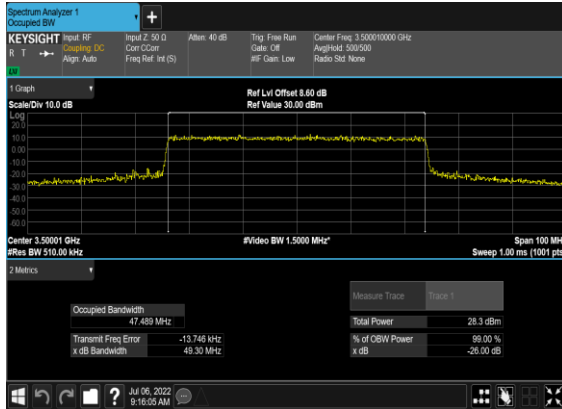

N78(50M)_CP-OFDM_256 QAM_Outer_Full_Mid_CH

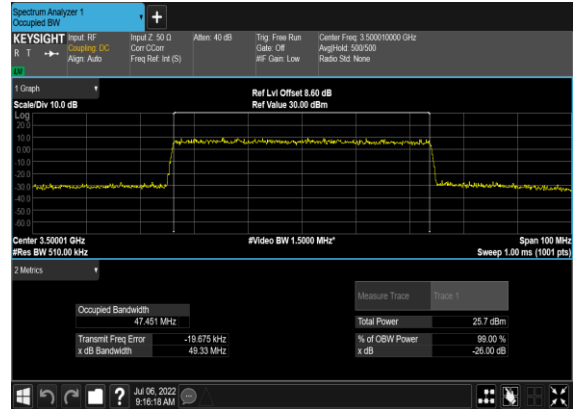

N78(60M)_DFT-s-OFDM_PI_2- BPSK_Outer_Full_Mid_CH



N78(60M)_DFT-s- OFDM_QPSK_Outer_Full_Mid_CH

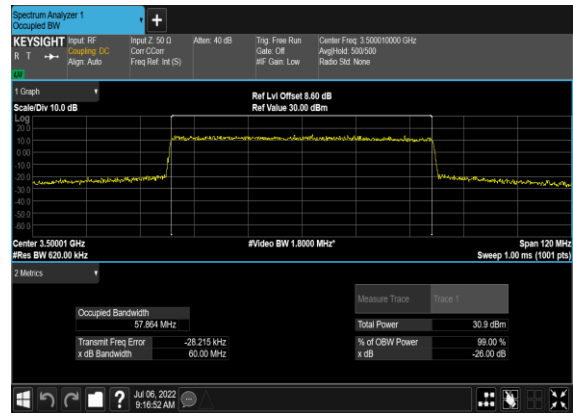

N78(60M)_CP- OFDM_QPSK_Outer_Full_Mid_CH

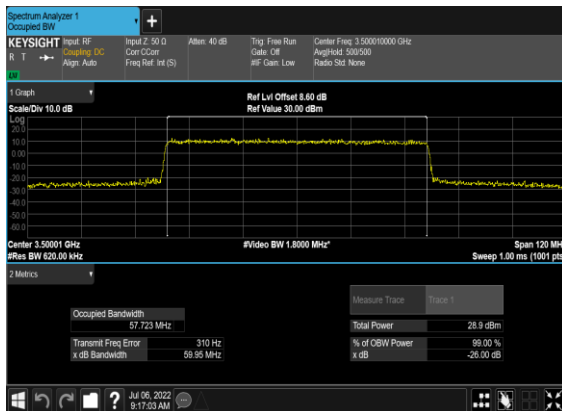

N78(60M)_CP-OFDM_16 QAM_Outer_Full_Mid_CH

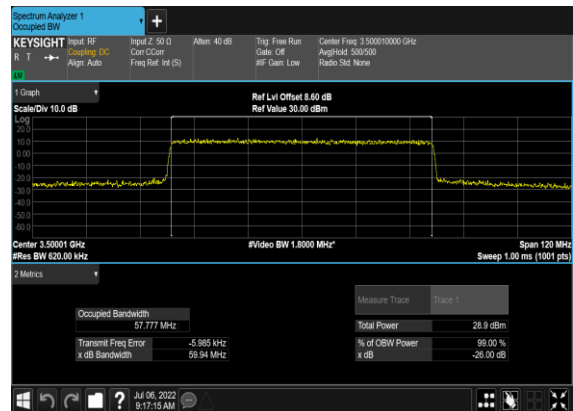

N78(60M)_CP-OFDM_64
QAM_Outer_Full_Mid_CH

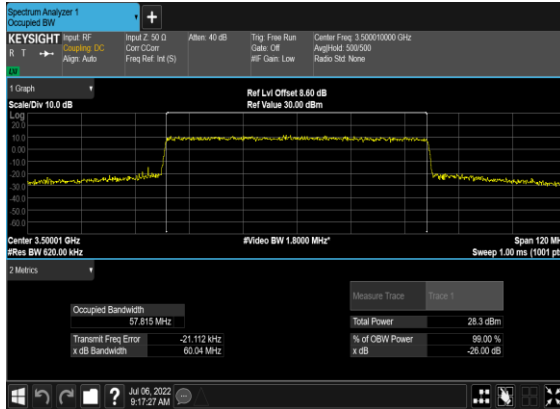

N78(60M)_CP-OFDM_256
QAM_Outer_Full_Mid_CH

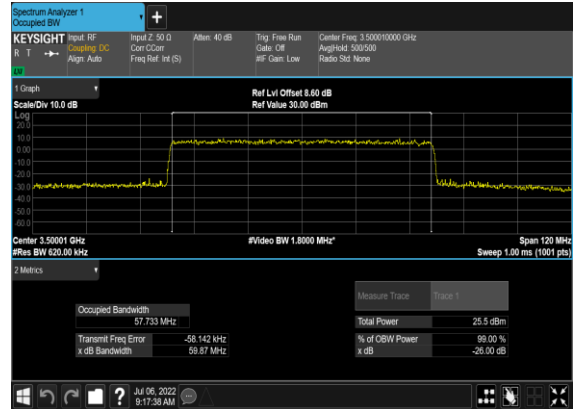

N78(70M)_DFT-s-OFDM_PI_2-
BPSK_Outer_Full_Mid_CH

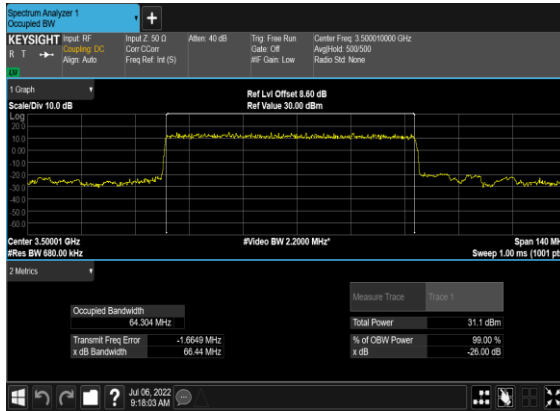

N78(70M)_DFT-s-
OFDM_QPSK_Outer_Full_Mid_CH

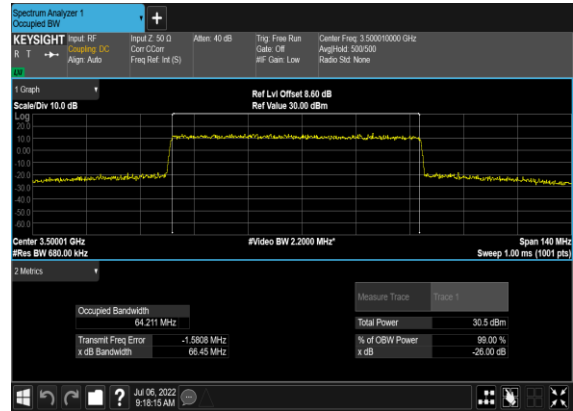

N78(70M)_CP-
OFDM_QPSK_Outer_Full_Mid_CH

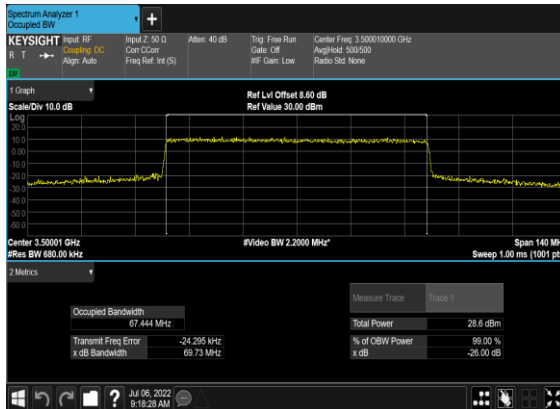

N78(70M)_CP-OFDM_16
QAM_Outer_Full_Mid_CH

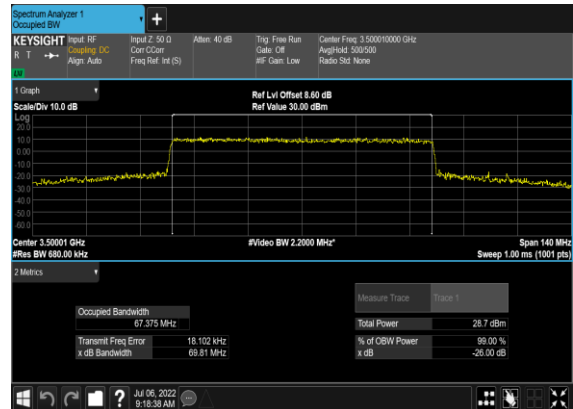

N78(70M)_CP-OFDM_64 QAM_Outer_Full_Mid_CH

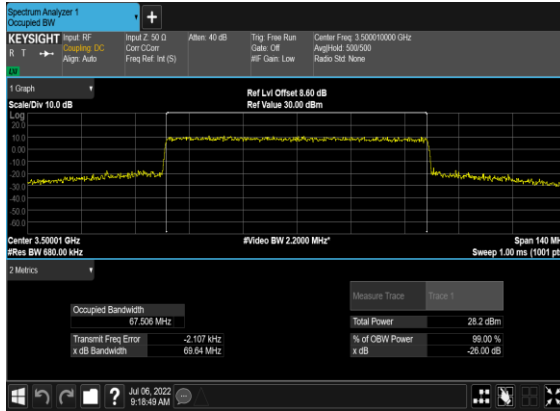

N78(70M)_CP-OFDM_256 QAM_Outer_Full_Mid_CH

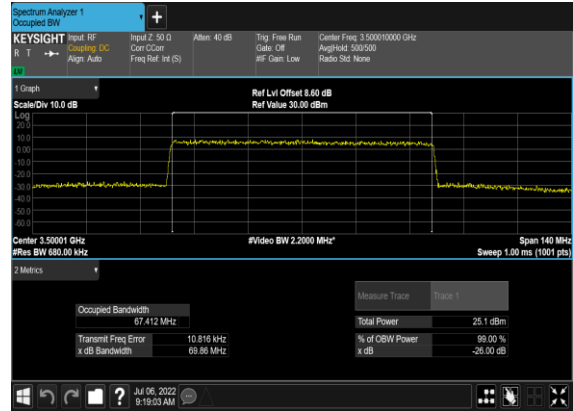

N78(80M)_DFT-s-OFDM_PI_2- BPSK_Outer_Full_Mid_CH

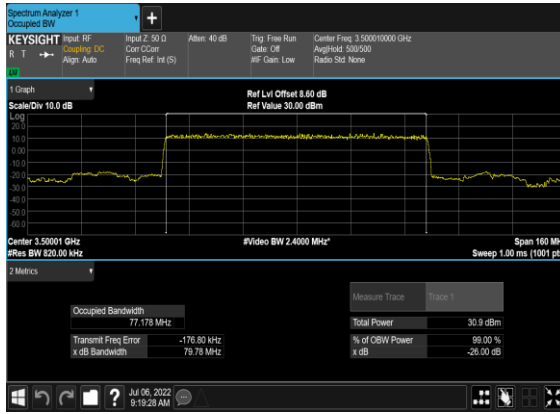

N78(80M)_DFT-s- OFDM_QPSK_Outer_Full_Mid_CH

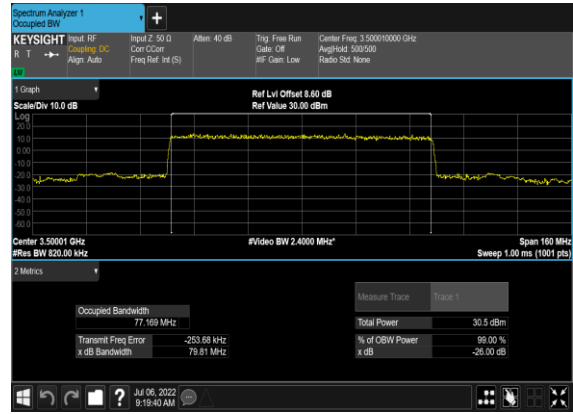

N78(80M)_CP- OFDM_QPSK_Outer_Full_Mid_CH

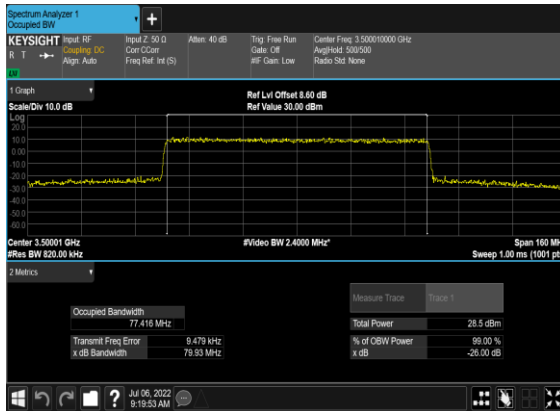

N78(80M)_CP-OFDM_16 QAM_Outer_Full_Mid_CH

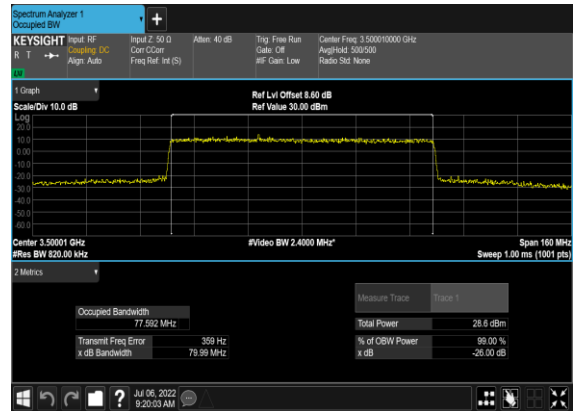

N78(80M)_CP-OFDM_64 QAM_Outer_Full_Mid_CH

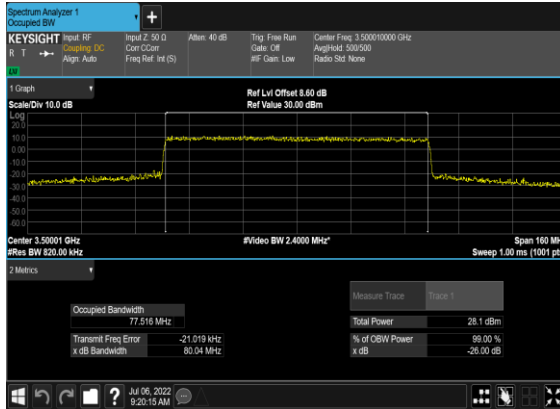

N78(80M)_CP-OFDM_256 QAM_Outer_Full_Mid_CH

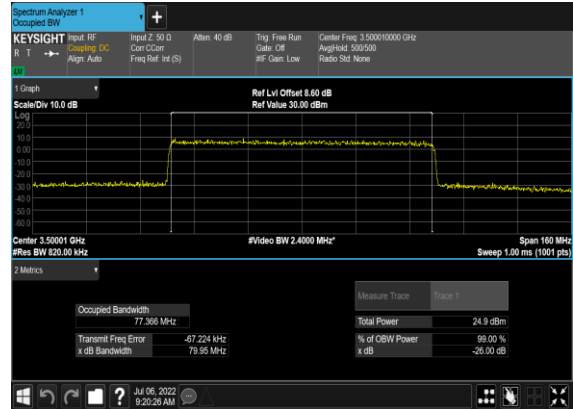

N78(90M)_DFT-s-OFDM_PI_2- BPSK_Outer_Full_Mid_CH

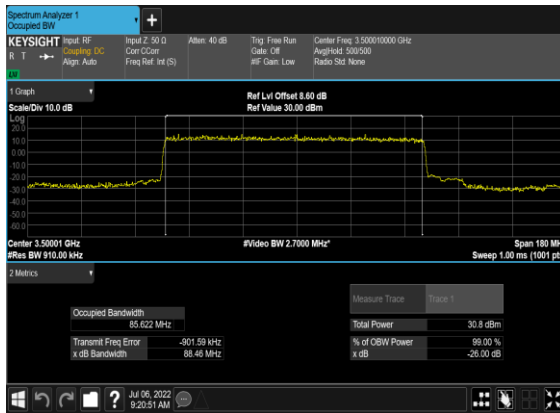

N78(90M)_DFT-s- OFDM_QPSK_Outer_Full_Mid_CH

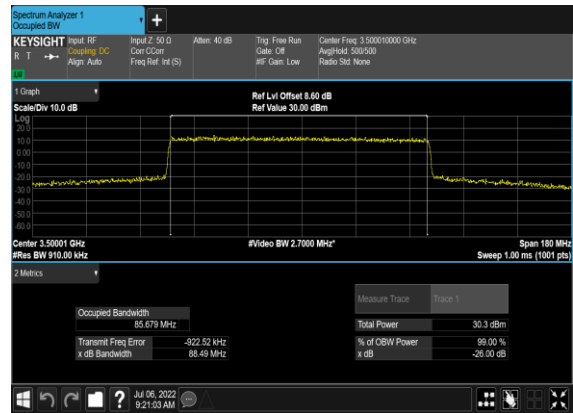

N78(90M)_CP- OFDM_QPSK_Outer_Full_Mid_CH

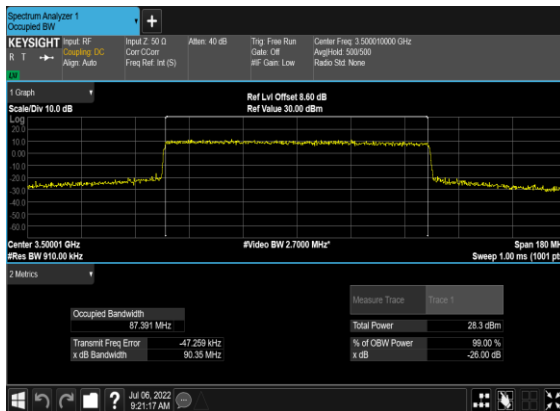

N78(90M)_CP-OFDM_16 QAM_Outer_Full_Mid_CH

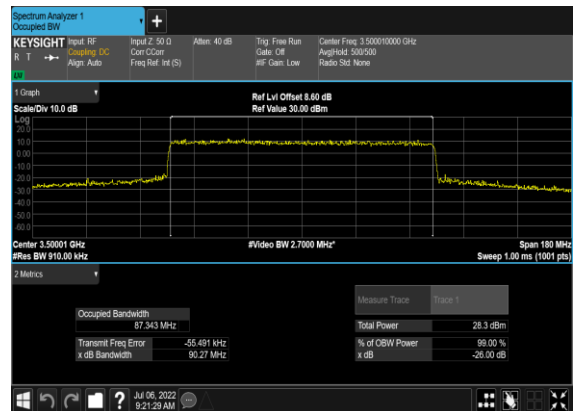

N78(90M)_CP-OFDM_64
QAM_Outer_Full_Mid_CH

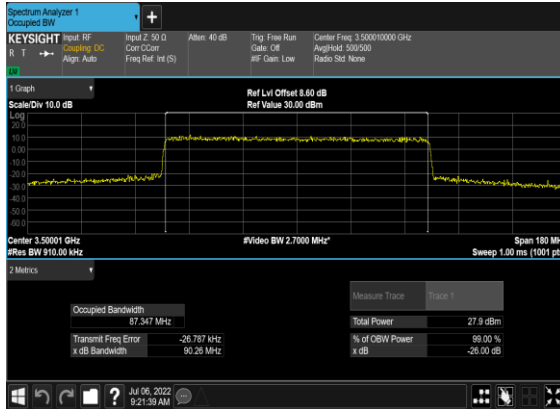

N78(90M)_CP-OFDM_256
QAM_Outer_Full_Mid_CH

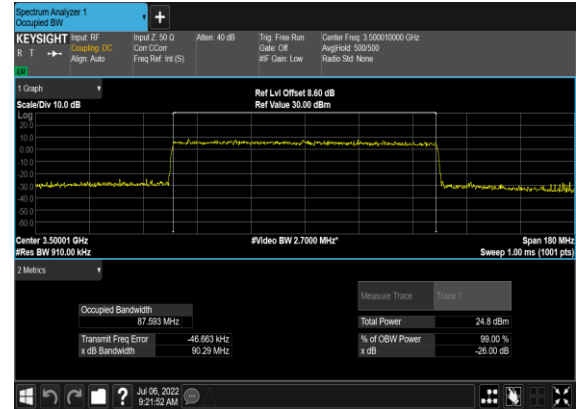

N78(100M)_DFT-s-OFDM_PI_2-
BPSK_Outer_Full_Mid_CH

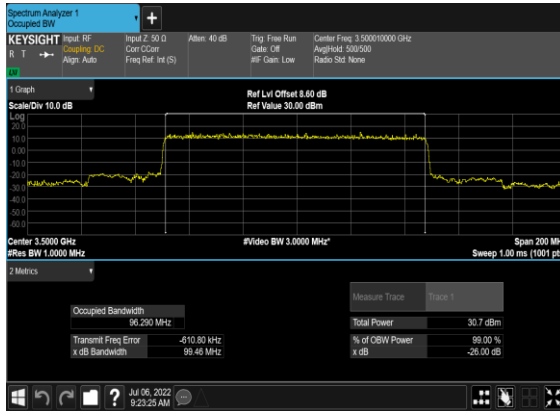

N78(100M)_DFT-s-
OFDM_QPSK_Outer_Full_Mid_CH

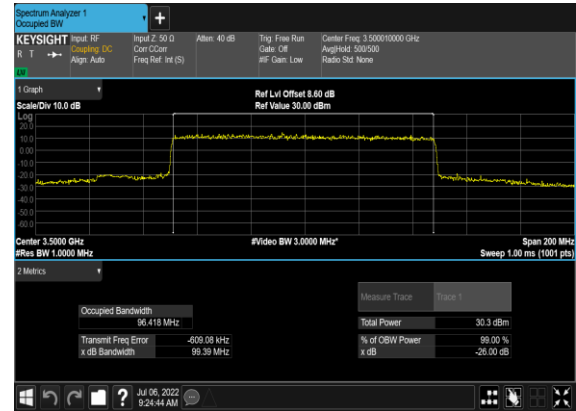

N78(100M)_CP-
OFDM_QPSK_Outer_Full_Mid_CH

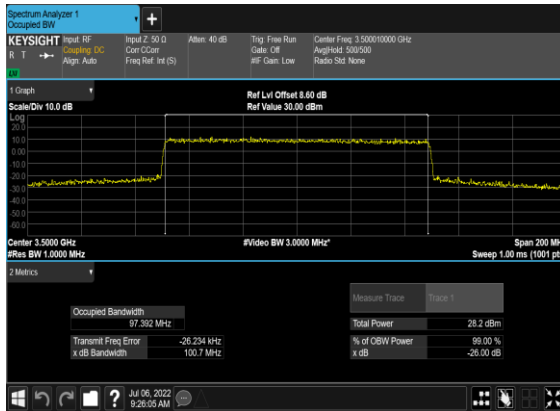

N78(100M)_CP-OFDM_16
QAM_Outer_Full_Mid_CH

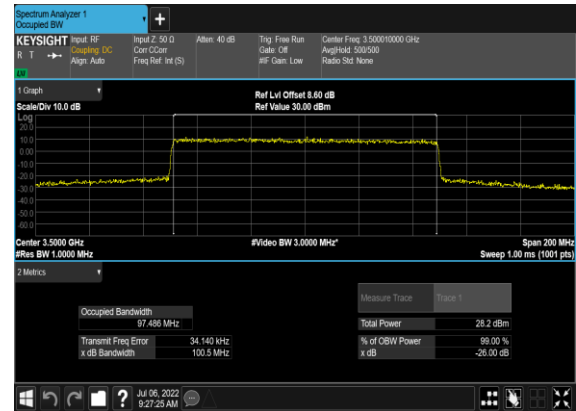

N78(100M)_CP-OFDM_64 QAM_Outer_Full_Mid_CH

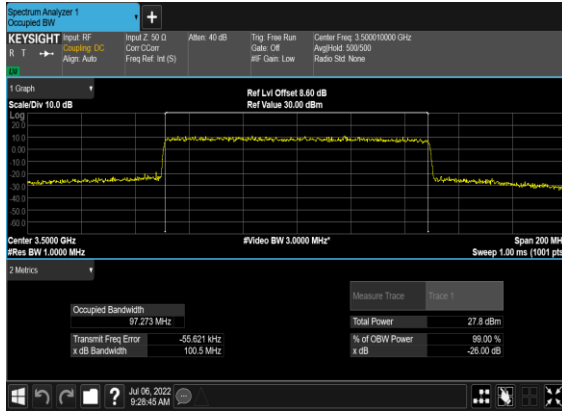

N78(100M)_CP-OFDM_256 QAM_Outer_Full_Mid_CH

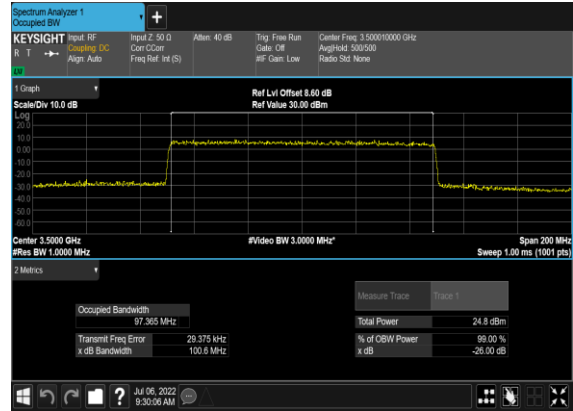

Conducted Spurious Emissions

NR Band	SCS (kHz)	Bandwidth (MHz)	Arfcn	Freq (MHz)	Modulation	RB	Result	Verdict
78	30	20	630668	3460.02	DFT-s-OFDM BPSK	1@0	see graph	---
78	30	20	630668	3460.02	DFT-s-OFDM BPSK	1@0	see graph	PASS
78	30	20	630668	3460.02	DFT-s-OFDM BPSK	1@0	see graph	PASS
78	30	20	630668	3460.02	DFT-s-OFDM QPSK	1@0	see graph	---
78	30	20	630668	3460.02	DFT-s-OFDM QPSK	1@0	see graph	PASS
78	30	20	630668	3460.02	DFT-s-OFDM QPSK	1@0	see graph	PASS
78	30	20	633334	3500.01	DFT-s-OFDM BPSK	1@0	see graph	---
78	30	20	633334	3500.01	DFT-s-OFDM BPSK	1@0	see graph	PASS
78	30	20	633334	3500.01	DFT-s-OFDM BPSK	1@0	see graph	PASS
78	30	20	633334	3500.01	DFT-s-OFDM QPSK	1@0	see graph	---
78	30	20	633334	3500.01	DFT-s-OFDM QPSK	1@0	see graph	PASS
78	30	20	633334	3500.01	DFT-s-OFDM QPSK	1@0	see graph	PASS
78	30	20	636000	3540.0	DFT-s-OFDM BPSK	1@0	see graph	---
78	30	20	636000	3540.0	DFT-s-OFDM BPSK	1@0	see graph	PASS
78	30	20	636000	3540.0	DFT-s-OFDM BPSK	1@0	see graph	PASS
78	30	20	636000	3540.0	DFT-s-OFDM QPSK	1@0	see graph	---
78	30	20	636000	3540.0	DFT-s-OFDM QPSK	1@0	see graph	PASS
78	30	20	636000	3540.0	DFT-s-OFDM QPSK	1@0	see graph	PASS
78	30	60	632000	3480.0	DFT-s-OFDM BPSK	1@0	see graph	---
78	30	60	632000	3480.0	DFT-s-OFDM BPSK	1@0	see graph	PASS
78	30	60	632000	3480.0	DFT-s-OFDM BPSK	1@0	see graph	PASS
78	30	60	632000	3480.0	DFT-s-OFDM QPSK	1@0	see graph	---

78	30	60	632000	3480.0	DFT-s-OFDM QPSK	1@0	see graph	PASS
78	30	60	632000	3480.0	DFT-s-OFDM QPSK	1@0	see graph	PASS
78	30	60	633334	3500.01	DFT-s-OFDM BPSK	1@0	see graph	---
78	30	60	633334	3500.01	DFT-s-OFDM BPSK	1@0	see graph	PASS
78	30	60	633334	3500.01	DFT-s-OFDM BPSK	1@0	see graph	PASS
78	30	60	633334	3500.01	DFT-s-OFDM QPSK	1@0	see graph	---
78	30	60	633334	3500.01	DFT-s-OFDM QPSK	1@0	see graph	PASS
78	30	60	633334	3500.01	DFT-s-OFDM QPSK	1@0	see graph	PASS
78	30	60	634666	3519.99	DFT-s-OFDM BPSK	1@0	see graph	---
78	30	60	634666	3519.99	DFT-s-OFDM BPSK	1@0	see graph	PASS
78	30	60	634666	3519.99	DFT-s-OFDM BPSK	1@0	see graph	PASS
78	30	60	634666	3519.99	DFT-s-OFDM QPSK	1@0	see graph	---
78	30	60	634666	3519.99	DFT-s-OFDM QPSK	1@0	see graph	PASS
78	30	60	634666	3519.99	DFT-s-OFDM QPSK	1@0	see graph	PASS
78	30	100	633334	3500.01	DFT-s-OFDM BPSK	1@0	see graph	---
78	30	100	633334	3500.01	DFT-s-OFDM BPSK	1@0	see graph	PASS
78	30	100	633334	3500.01	DFT-s-OFDM BPSK	1@0	see graph	PASS
78	30	100	633334	3500.01	DFT-s-OFDM QPSK	1@0	see graph	---
78	30	100	633334	3500.01	DFT-s-OFDM QPSK	1@0	see graph	PASS
78	30	100	633334	3500.01	DFT-s-OFDM QPSK	1@0	see graph	PASS

N78(20M)_DFT-s-OFDM_BPSK_Edge_1RB_Left_Low_CH

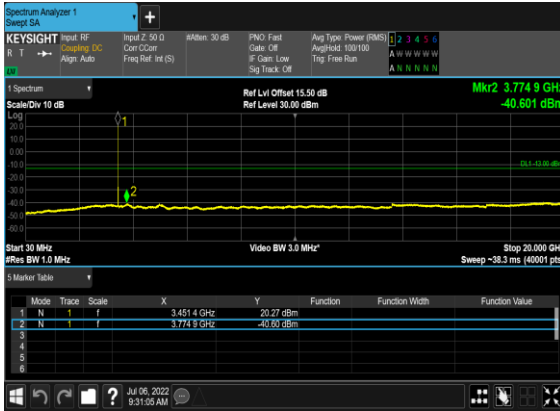

N78(20M)_DFT-s-OFDM_BPSK_Edge_1RB_Left_Low_CH

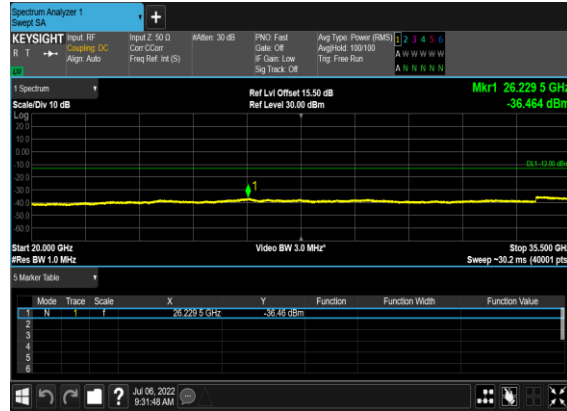

N78(20M)_DFT-s-OFDM_QPSK_Edge_1RB_Left_Low_CH



N78(20M)_DFT-s-OFDM_QPSK_Edge_1RB_Left_Low_CH



N78(20M)_DFT-s-OFDM_BPSK_Edge_1RB_Left_Mid_CH

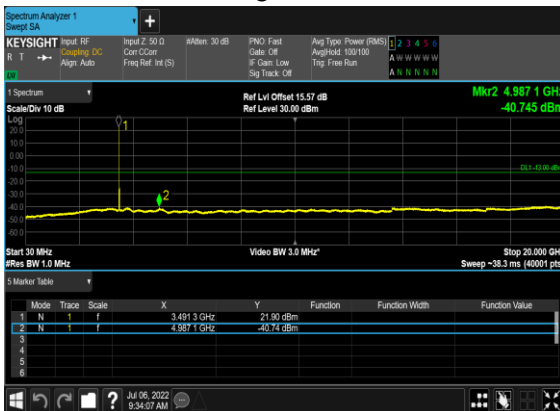

N78(20M)_DFT-s-OFDM_BPSK_Edge_1RB_Left_Mid_CH

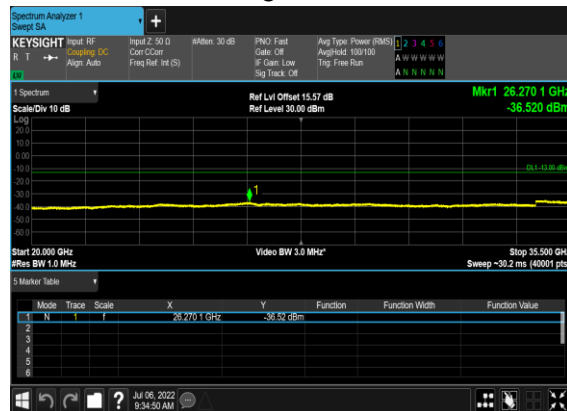

N78(20M)_DFT-s-OFDM_QPSK_Edge_1RB_Left_Mid_CH

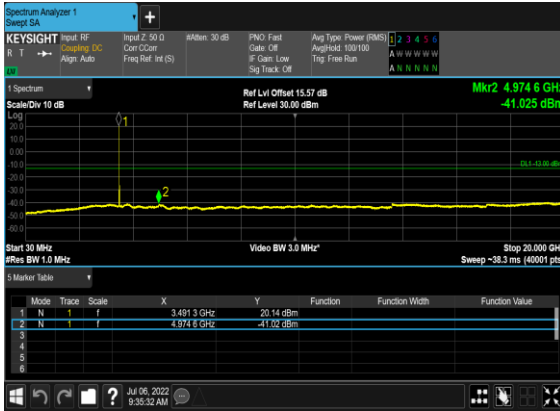

N78(20M)_DFT-s-OFDM_QPSK_Edge_1RB_Left_Mid_CH

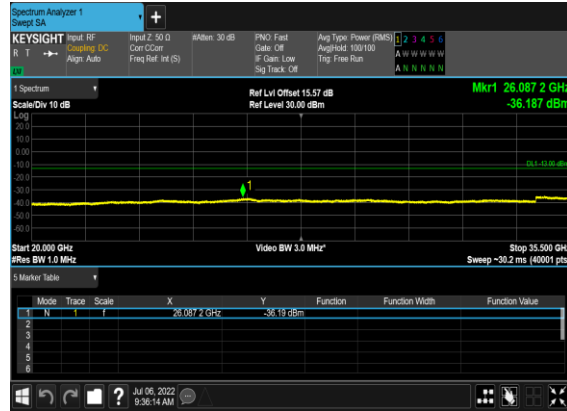

N78(20M)_DFT-s-OFDM_BPSK_Edge_1RB_Left_High_CH

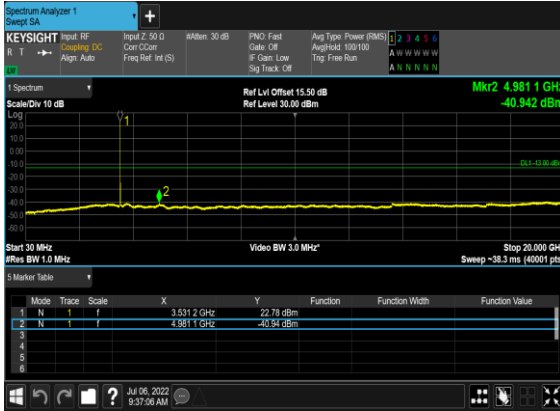

N78(20M)_DFT-s-OFDM_BPSK_Edge_1RB_Left_High_CH

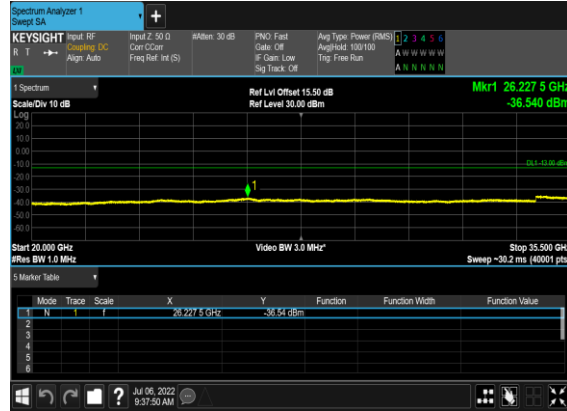

N78(20M)_DFT-s-OFDM_QPSK_Edge_1RB_Left_High_CH

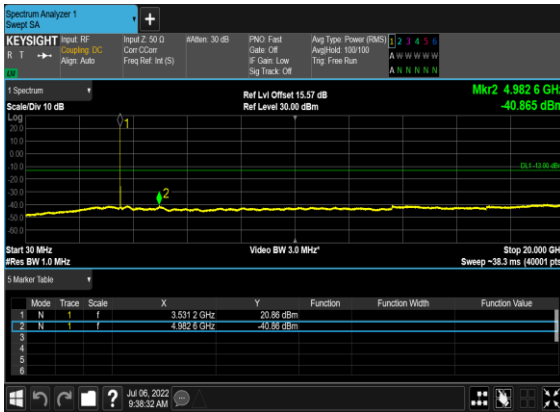

N78(20M)_DFT-s-OFDM_QPSK_Edge_1RB_Left_High_CH

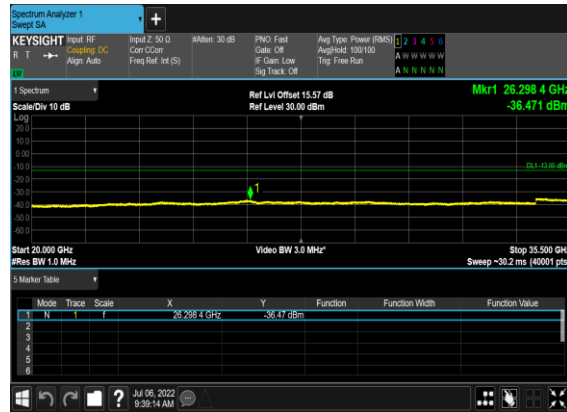

N78(60M)_DFT-s-OFDM_BPSK_Edge_1RB_Left_Low_CH

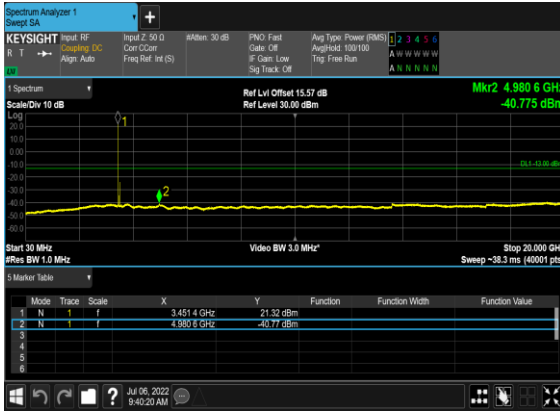

N78(60M)_DFT-s-OFDM_BPSK_Edge_1RB_Left_Low_CH

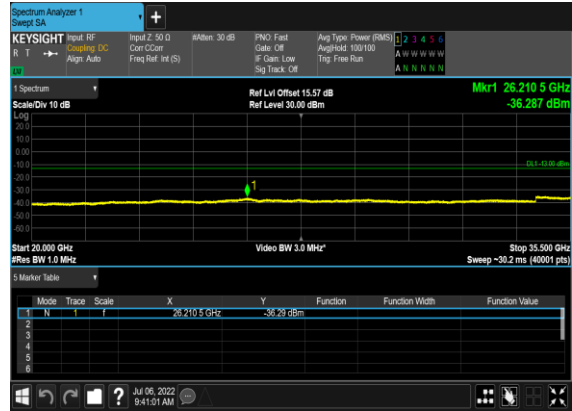

N78(60M)_DFT-s-OFDM_QPSK_Edge_1RB_Left_Low_CH



N78(60M)_DFT-s-OFDM_QPSK_Edge_1RB_Left_Low_CH



N78(60M)_DFT-s-OFDM_BPSK_Edge_1RB_Left_Mid_CH

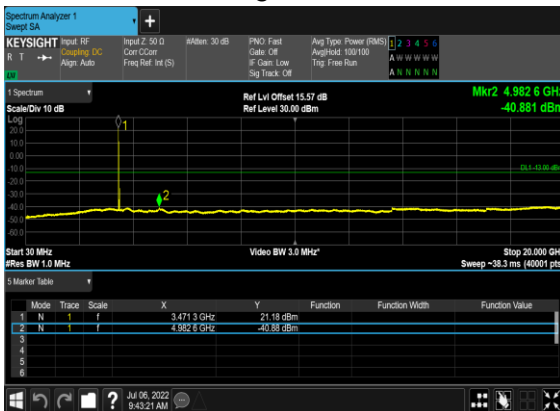

N78(60M)_DFT-s-OFDM_BPSK_Edge_1RB_Left_Mid_CH

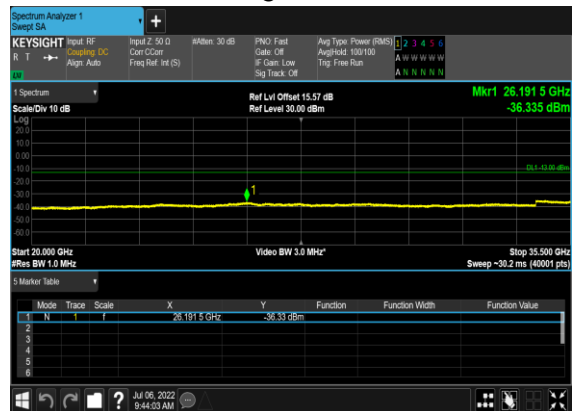

N78(60M)_DFT-s-OFDM_QPSK_Edge_1RB_Left_Mid_CH



N78(60M)_DFT-s-OFDM_QPSK_Edge_1RB_Left_Mid_CH

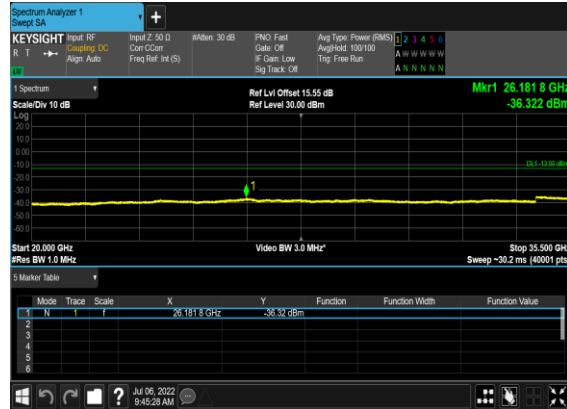

N78(60M)_DFT-s-OFDM_BPSK_Edge_1RB_Left_High_CH



N78(60M)_DFT-s-OFDM_BPSK_Edge_1RB_Left_High_CH

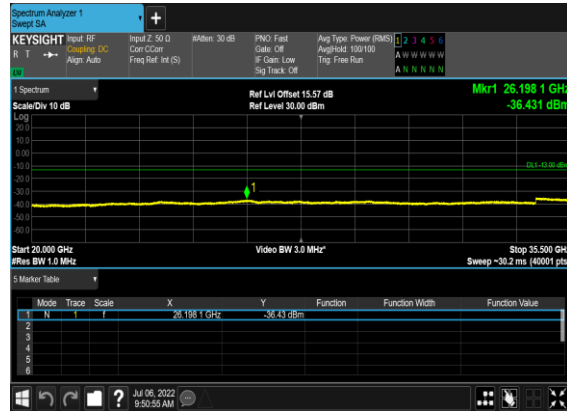

N78(60M)_DFT-s-OFDM_QPSK_Edge_1RB_Left_High_CH

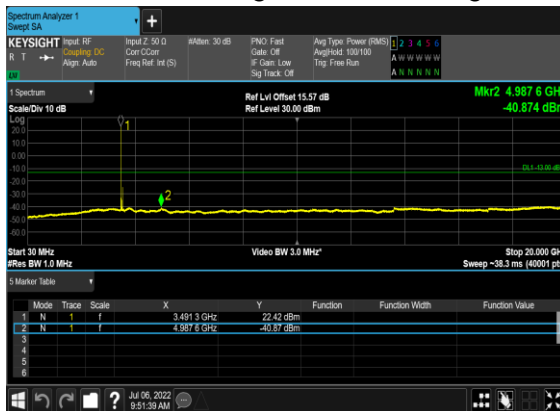

N78(60M)_DFT-s-OFDM_QPSK_Edge_1RB_Left_High_CH

