



FCC RF Test Report

FCC ID : UZ7ET45BB
EQUIPMENT : Tablet
BRAND NAME : Zebra
MODEL NAME : ET45BB
APPLICANT : Zebra Technologies Corporation
1 Zebra Plaza, Holtsville, NY 11742
MANUFACTURER : Zebra Technologies Corporation
1 Zebra Plaza, Holtsville, NY 11742
STANDARD : 47 CFR Part 2, 96
CLASSIFICATION : Citizens Band End User Devices (CBE)
EQUIPMENT TYPE : End User Equipment
TEST DATE(S) : Jun. 22, 2022 ~ Jul. 20, 2022

We, Sporton International Inc. (Kunshan), would like to declare that the tested sample has been evaluated in accordance with the procedures given in ANSI C63.26 and shown compliance with the applicable technical standards.

The test results in this report apply exclusively to the tested model / sample. Without written approval of Sporton International Inc. (Kunshan), the test report shall not be reproduced except in full.

Jason Jia



Approved by: Jason Jia

Sporton International Inc. (Kunshan)

No. 1098, Pengxi North Road, Kunshan Economic Development Zone Jiangsu Province 215300
People's Republic of China



Table of Contents

History of this test report..... 3

Summary of Test Result..... 4

1 General Description 5

 1.1 Feature of Equipment Under Test..... 5

 1.2 Maximum EIRP Power and Emission Designator 6

 1.3 Testing Site..... 6

 1.4 Test Software 6

 1.5 Applied Standards 7

2 Test Configuration of Equipment Under Test 8

 2.1 Test Mode..... 8

 2.2 Connection Diagram of Test System 9

 2.3 Support Unit used in test configuration 9

 2.4 Measurement Results Explanation Example 9

 2.5 Frequency List of Low/Middle/High Channels..... 10

3 Conducted Test Items 11

 3.1 Measuring Instruments..... 11

 3.2 Conducted Output Power 12

 3.3 EIRP 13

 3.4 Occupied Bandwidth 14

 3.5 Conducted Band Edge 15

 3.6 Conducted Spurious Emission 16

 3.7 Frequency Stability..... 17

4 Radiated Test Items 18

 4.1 Measuring Instruments..... 18

 4.2 Test Setup 18

 4.3 Test Result of Radiated Test..... 19

 4.4 Radiated Spurious Emission 20

5 List of Measuring Equipment..... 21

6 Uncertainty of Evaluation 22

Appendix A. Test Results of Conducted Test

Appendix B. Test Results of EIRP and Radiated Test

Appendix C. Test Setup Photographs



Summary of Test Result

Report Clause	Ref Std. Clause	Test Items	Result (PASS/FAIL)	Remark
3.2	§2.1046	Conducted Output Power	Reporting only	-
-	§96.41	Peak-to-Average Ratio	Not applicable	Not applicable for End User Devices
3.3	§96.41	Maximum E.I.R.P	Pass	-
		Maximum Power Spectral Density	Not applicable	Not applicable for End User Devices
3.4	§2.1049 §96.41	Occupied Bandwidth	Reporting only	-
3.5	§2.1051 §96.41	Conducted Band Edge Measurement Adjacent Channel Leakage Ratio	Pass	-
3.6	§2.1051 §96.41	Conducted Spurious Emission	Pass	
3.7	§2.1055	Frequency Stability for Temperature & Voltage	Pass	-
4.4	§2.1051 §96.41	Radiated Spurious Emission	Pass	Under limit 3.38 dB at 17760.000 MHz

Declaration of Conformity:

The test results with all measurement uncertainty excluded are presented in accordance with the regulation limits or requirements declared by manufacturers.

Comments and Explanations:

The declared of product specification for EUT presented in the report are provided by the manufacturer, and the manufacturer takes all the responsibilities for the accuracy of product specification.



1 General Description

1.1 Feature of Equipment Under Test

Product Feature	
Equipment	Tablet
Brand Name	Zebra
Model Name	ET45BB
FCC ID	UZ7ET45BB
Tx Frequency	5G NR n48: 3550 MHz ~ 3700 MHz
Rx Frequency	5G NR n48: 3550 MHz ~ 3700 MHz
SCS	30kHz
Bandwidth	10MHz / 20MHz / 40MHz
Antenna Type	IFA Antenna
Antenna Gain	<Ant. 3> Lowest Channel: -1.4 dBi Middle Channel: -1.6 dBi Highest Channel: -2.2 dBi
Type of Modulation	CP-OFDM: QPSK / 16QAM / 64QAM / 256QAM DFT-s-OFDM: PI/2 BPSK / QPSK / 16QAM / 64QAM / 256QAM
HW Version	EV2-2
SW Version	ET45USERDEBUG 11 11-10-12.00-RG-U00-PRD-GSE MXJ release-keys
MFD	07MAY22
EUT Stage	Identical Prototype

Remark:

1. The above EUT's information was declared by manufacturer. Please refer to the specifications or user's manual for more detailed description.
2. 5G NR n48 support SA and NSA mode. The whole testing has assessed SA mode by referring to the higher conducted power for conducted test items.
3. The EN-DC mode combination could be referred to the product spec.
4. For NSA mode of RSE testing, we only choose the combination of the maximum power among all NSA combinations to test.

Specification of Accessory				
Battery	Brand Name	Zebra	Model Number	BT-000456

Supported Unit used in test configuration and system				
AC Adapter	Brand Name	Zebra	Part Number	PWR-WUA5V12W0US
Earphone 1	Brand Name	Zebra	Part Number	HDST-35MM-PTVP-01
Earphone 2	Brand Name	Zebra	Part Number	HDST-USBC-PTT1-01
USB Cable (Type C to Type A)	Brand Name	Zebra	Part Number	CBL-TC5X-USBC2A-01
Type C-Audio Cable (Type C to 3.5mm)	Brand Name	Zebra	Part Number	ADP-USBC-35MM1-01

1.2 Maximum EIRP Power and Emission Designator

5G NR n48		PI/2 BPSK / QPSK		16QAM/64QAM/256QAM	
BW (MHz)	Frequency Range (MHz)	Maximum EIRP(W)	Emission Designator (99%OBW)	Maximum EIRP(W)	Emission Designator (99%OBW)
10	3555.00~3694.98	0.1419	8M73G7D	0.1091	8M77W7D
20	3560.01~3690.00	0.1384	18M7G7D	0.1119	18M7W7D
40	3570.00~3679.98	0.1439	38M0G7D	0.1143	38M0W7D

Note: All modulations have been tested, and only the worst test results of PSK & QAM are shown in the report.

1.3 Testing Site

Sporton International (Kunshan) Inc. is accredited to ISO/IEC 17025:2017 by American Association for Laboratory Accreditation with Certificate Number 5145.02.

Test Firm	Sporton International (Kunshan) Inc.		
Test Site Location	No. 1098, Pengxi North Road, Kunshan Economic Development Zone Jiangsu Province 215300 People's Republic of China TEL : +86-512-57900158 FAX : +86-512-57900958		
Test Site No.	Sporton Site No.	FCC Designation No.	FCC Test Firm Registration No.
	03CH04-KS TH01-KS	CN1257	314309

1.4 Test Software

Item	Site	Manufacturer	Name	Version
1.	03CH04-KS	AUDIX	E3	6.2009-8-24a



1.5 Applied Standards

According to the specifications of the manufacturer, the EUT must comply with the requirements of the following standards:

- ♦ ANSI C63.26-2015
- ♦ ANSI / TIA-603-E
- ♦ 47 CFR Part 2, 96
- ♦ FCC KDB 971168 D01 Power Meas. License Digital Systems v03r01
- ♦ FCC KDB 940660 D01 Part 96 CBRS v03
- ♦ FCC KDB 412172 D01 Determining ERP and EIRP v01r01

Remark:

1. All test items were verified and recorded according to the standards and without any deviation during the test.
2. This EUT has also been tested and complied with the requirements of FCC Part 15, Subpart B, recorded in a separate test report.



2 Test Configuration of Equipment Under Test

2.1 Test Mode

Antenna port conducted and radiated test items listed below are performed according to KDB 971168 D01 Power Meas. License Digital Systems v03r01 with maximum output power.

For radiated measurement, pre-scanned in three orthogonal panels, X, Y, Z. The worst cases (Y plane) were recorded in this report.

Test Items	Band	Bandwidth (MHz)						Modulation					RB #		Test Channel			
		5	10	15	20	30	40	PI/2 BPSK	QPSK	16QAM	64QAM	256 QAM	1	Full	L	M	H	
Max. Output Power	n48	-	v	-	v	-	v	v	v	v	v	v	v	v	v	v	v	v
26dB and 99% Bandwidth	n48	-	v	-	v	-	v		v	v	v	v		v			v	
Adjacent Channel Leakage Ratio	n48	-	v	-	v	-	v	v	v	v	v	v	v	v	v	v	v	v
Conducted Band Edge	n48	-	v	-	v	-	v	v	v					v	v	v	v	v
Conducted Spurious Emission	n48	-	v	-	v	-	v	v	v					v			v	v
E.I.R.P	n48	-	v	-	v	-	v	v	v	v	v	v	v	v	v	v	v	v
Frequency Stability	n48	-	v	-		-			v						v			v
Radiated Spurious Emission	n48	Worst Case													v	v	v	
Remark	<ol style="list-style-type: none"> The mark "v" means that this configuration is chosen for testing The mark "-" means that this bandwidth is not supported. The device is investigated from 30MHz to 10 times of fundamental signal for radiated spurious emission test under different RB size/offset and modulations in exploratory test. Subsequently, only the worst case emissions are reported. All test items are based on engineering evaluation. 																	

2.2 Connection Diagram of Test System

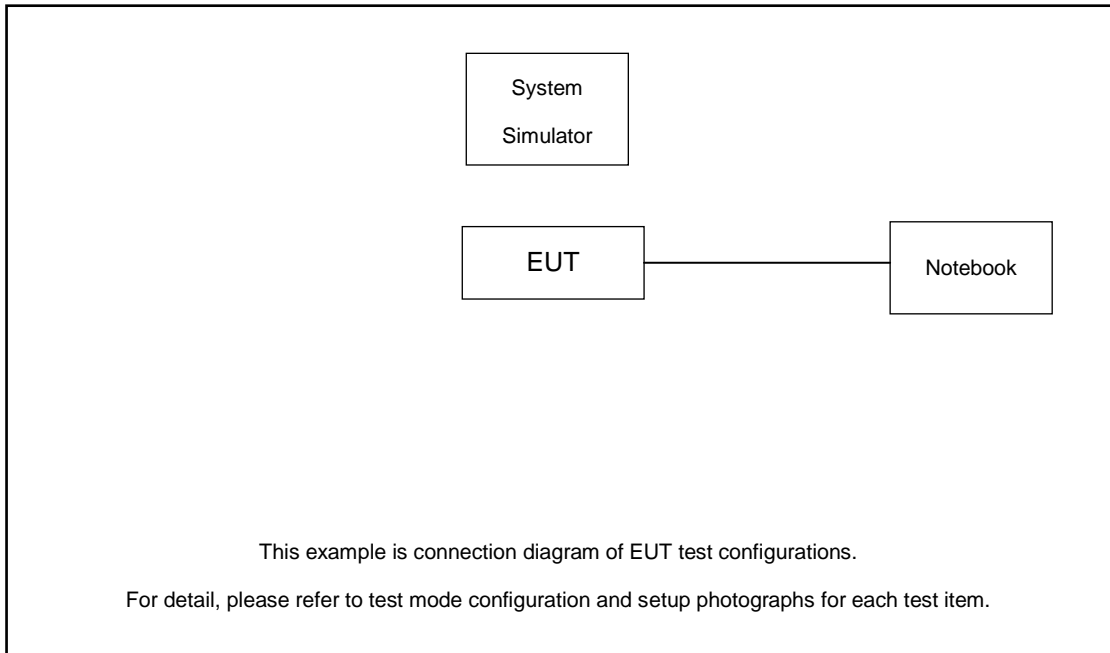

2.3 Support Unit used in test configuration

Item	Equipment	Trade Name	Model No.	FCC ID	Data Cable	Power Cord
1.	Power Supply	GWINSTEK	PSS-2002	N/A	N/A	Unshielded, 1.8 m
2.	LTE Base Station	Anritsu	MT8820/8821	N/A	N/A	Unshielded,1.8m

2.4 Measurement Results Explanation Example

For all conducted test items:

The offset level is set in the spectrum analyzer to compensate the RF cable loss and attenuator factor between EUT conducted output port and spectrum analyzer. With the offset compensation, the spectrum analyzer reading level is exactly the EUT RF output level.

The spectrum analyzer offset is derived from RF cable loss and attenuator factor.

Offset = RF cable loss + attenuator factor.

Following shows an offset computation example with cable loss 3.49 dB and 10dB attenuator.

Example :

$$\begin{aligned} \text{Offset(dB)} &= \text{RF cable loss(dB)} + \text{attenuator factor(dB)} \\ &= 3.49 + 10 = 13.49 \text{ (dB)} \end{aligned}$$



2.5 Frequency List of Low/Middle/High Channels

5G NR n48 Channel and Frequency List				
BW [MHz]	Channel/Frequency(MHz)	Lowest	Middle	Highest
40	Channel	638000	641666	645332
	Frequency	3570	3624.99	3679.98
20	Channel	637334	641666	646000
	Frequency	3560.01	3624.99	3690
10	Channel	637000	641666	646332
	Frequency	3555	3624.99	3694.98

3 Conducted Test Items

3.1 Measuring Instruments

See list of measuring instruments of this test report.

3.1.1 Test Setup

3.1.2 Conducted Output Power

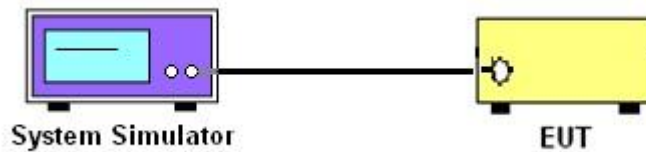

3.1.3 PSD, Peak-to-Average Ratio, Occupied Bandwidth, Conducted Band-Edge and Conducted Spurious Emission

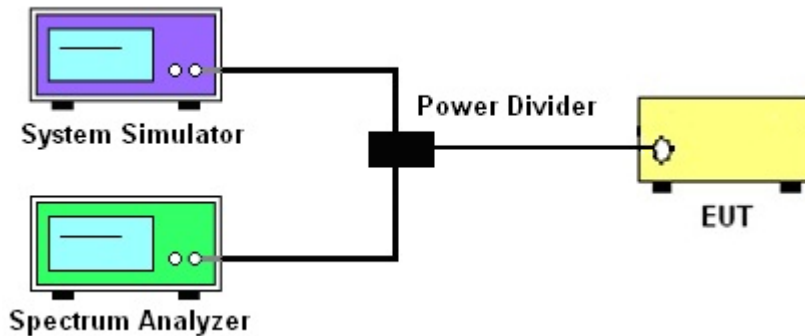

3.1.4 Frequency Stability

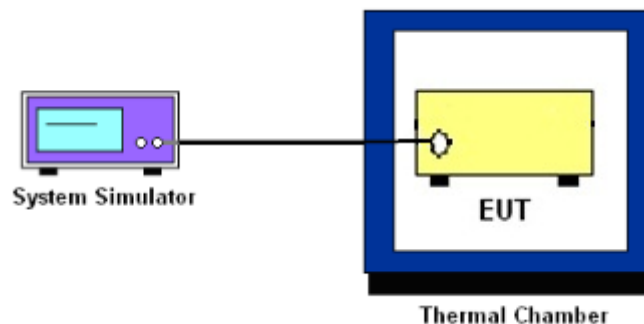

3.1.5 Test Result of Conducted Test

Please refer to Appendix A.



3.2 Conducted Output Power

3.2.1 Description of the Conducted Output Power Measurement

A system simulator was used to establish communication with the EUT. Its parameters were set to force the EUT transmitting at maximum output power. The measured power in the radio frequency on the transmitter output terminals shall be reported.

3.2.2 Test Procedures

1. The transmitter output port was connected to the system simulator.
2. Set EUT at maximum power through the system simulator.
3. Select lowest, middle, and highest channels for each band and different modulation.
4. Measure and record the power level from the system simulator.

3.3 EIRP

3.3.1 Description of the EIRP Measurement

EIRP and PSD limits for CBRS equipment as below table:

Device		Maximum EIRP (dBm/10 MHz)	Maximum PSD (dBm/MHz)
Applied	End User Device	23	n/a
<input type="checkbox"/>	Category A CBSD	30	20
<input type="checkbox"/>	Category B CBSD	47	37

Remark: The worst case EIRP shown in this section is found with LTE operating only using 1RB. As such, the EIRP/10MHz and full channel EIRP values will be identical since 1RB is fully contained within all available channel bandwidths for LTE Band 48 (i.e. 5, 10, 15, 20MHz)

3.3.2 Test Procedures for EIRP

1. Establishing a communications link with the call box (Base station) to measure the Maximum conducted power, the parameters were set to force the EUT transmitting at maximum output power level. Use the average power measurement function to measure total channel power of each channel bandwidth (per ANSI C63.26-2015 Section 5.2.1)
2. Determining ERP and/or EIRP from conducted RF output power measurements (Per ANSI C63.26-2015 Section 5.2.5.5)
 - EIRP = $P_T + G_T - L_C$, ERP = EIRP - 2.15, where
 - P_T = transmitter output power in dBm
 - G_T = gain of the transmitting antenna in dBi
 - L_C = signal attenuation in the connecting cable between the transmitter and antenna in dB



3.4 Occupied Bandwidth

3.4.1 Description of Occupied Bandwidth Measurement

The occupied bandwidth is the width of a frequency band such that, below the lower and above the upper frequency limits, the mean powers emitted are each equal to a specified percentage 0.5% of the total mean transmitted power.

The 26 dB emission bandwidth is defined as the frequency range between two points, one above and one below the carrier frequency, at which the spectral density of the emission is attenuated 26 dB below the maximum in-band spectral density of the modulated signal. Spectral density (power per unit bandwidth) is to be measured with a detector of resolution bandwidth equal to approximately 1.0% of the emission bandwidth.

3.4.2 Test Procedures

The testing follows ANSI C63.26-2015 Section 5.4.3 (26dB) and Section 5.4.4 (99OB)

1. The EUT was connected to spectrum analyzer and system simulator via a power divider.
2. The spectrum analyzer center frequency is set to the nominal EUT channel center frequency. The span range for the spectrum analyzer shall be between two and five times the anticipated OBW.
3. The nominal resolution bandwidth (RBW) shall be in the range of 1 to 5 % of the anticipated OBW, and the VBW shall be at least 3 times the RBW.
4. Set the detection mode to peak, and the trace mode to max hold.
5. Determine the reference value: Set the EUT to transmit a modulated signal. Allow the trace to stabilize. Set the spectrum analyzer marker to the highest level of the displayed trace.
(this is the reference value)
6. Determine the “-26 dB down amplitude” as equal to (Reference Value – X).
7. Place two markers, one at the lowest and the other at the highest frequency of the envelope of the spectral display such that each marker is at or slightly below the “-X dB down amplitude” determined in step 6. If a marker is below this “-X dB down amplitude” value it shall be placed as close as possible to this value. The OBW is the positive frequency difference between the two markers.
8. Use the 99 % power bandwidth function of the spectrum analyzer and report the measured bandwidth.



3.5 Conducted Band Edge

3.5.1 Description of Conducted Band Edge Measurement

Part 96.41 (e) (1) (i)

For CBSD the emission limits outside the fundamental are as follows:

Within 0 MHz to 10 MHz above and below the assigned channel ≤ -13 dBm/MHz

Greater than 10 MHz above and below the assigned channel ≤ -25 dBm/MHz

Part 96.41 (e) (1) (ii)

For End User Devices the emission limits outside the fundamental are as follows:

Within 0 MHz to B MHz above and below the assigned channel ≤ -13 dBm/MHz

Greater than B MHz above and below the assigned channel ≤ -25 dBm/MHz

where B is the bandwidth in megahertz of the assigned channel or multiple contiguous channels of the End User Device.

Notwithstanding the emission limits in this paragraph, the Adjacent Channel Leakage Ratio for End User Devices shall be at least 30 dB.

Part 96.41 (e) (2)

For CBSDs and End User Devices, the conducted power of emissions below 3540 MHz or above 3710 MHz shall not exceed -25 dBm/MHz, and the conducted power of emissions below 3530 MHz or above 3720 MHz shall not exceed -40 dBm/MHz

3.5.2 Test Procedures

The testing follows FCC KDB 971168 D01 v03r01 Section 6.1.

1. The EUT was connected to spectrum analyzer and system simulator via a power divider.
2. The band edges of low and high channels for the highest RF powers were measured.
3. Set RBW $\geq 1\%$ EBW in the 1MHz band immediately outside and adjacent to the band edge.
4. Beyond the 1 MHz band from the band edge, RBW=1MHz was used
5. Offset has included the duty factor for LTE Band 48. Duty factor $=10 \log (1/x)$, where x is the measured duty cycle.
6. Set spectrum analyzer with RMS detector.
7. The RF fundamental frequency should be excluded against the limit line in the operating frequency band.
8. When using the integration method, the starting frequency of the integration shall be centered at one-half of the RBW away from the band edge.



3.6 Conducted Spurious Emission

3.6.1 Description of Conducted Spurious Emission Measurement

96.41 (e)(2)

The conducted power of any emissions below 3530 MHz or above 3720 MHz shall not exceed -40dBm/MHz.

3.6.2 Test Procedures

The testing follows FCC KDB 971168 D01 v03r01 Section 6.1.

1. The EUT was connected to spectrum analyzer and system simulator via a power divider.
2. The RF output of EUT was connected to the spectrum analyzer by RF cable and attenuator. The path loss was compensated to the results for each measurement.
3. The middle channel for the highest RF power within the transmitting frequency was measured.
4. The conducted spurious emission for the whole frequency range was taken.
5. Make the measurement with the spectrum analyzer's RBW = 1MHz, VBW = 3MHz.
6. Set spectrum analyzer with RMS detector.
7. Taking the record of maximum spurious emission.
8. The RF fundamental frequency should be excluded against the limit line in the operating frequency band.
9. The limit line is -40dBm/MHz.



3.7 Frequency Stability

3.7.1 Description of Frequency Stability Measurement

The frequency stability shall be measured by variation of ambient temperature and variation of primary supply voltage to ensure that the fundamental emission stays within the authorized frequency block. The frequency stability of the transmitter shall be maintained within $\pm 0.00025\%$ ($\pm 2.5\text{ppm}$) of the center frequency

3.7.2 Test Procedures for Temperature Variation

The testing follows FCC KDB 971168 D01 v03r01 Section 9.0.

1. The EUT was set up in the thermal chamber and connected with the system simulator.
2. With power OFF, the temperature was decreased to -30°C and the EUT was stabilized before testing. Power was applied and the maximum change in frequency was recorded within one minute.
3. With power OFF, the temperature was raised in 10°C step up to 50°C . The EUT was stabilized at each step for at least half an hour. Power was applied and the maximum frequency change was recorded within one minute.

3.7.3 Test Procedures for Voltage Variation

The testing follows FCC KDB 971168 D01 v03r01 Section 9.0.

1. The EUT was placed in a temperature chamber at $25\pm 5^{\circ}\text{C}$ and connected with the system simulator.
2. The power supply voltage to the EUT was varied from 85% to 115% of the nominal value measured at the input to the EUT.
3. The variation in frequency was measured for the worst case.

4 Radiated Test Items

4.1 Measuring Instruments

See list of measuring instruments of this test report.

4.2 Test Setup

4.2.1 For radiated test below 30MHz

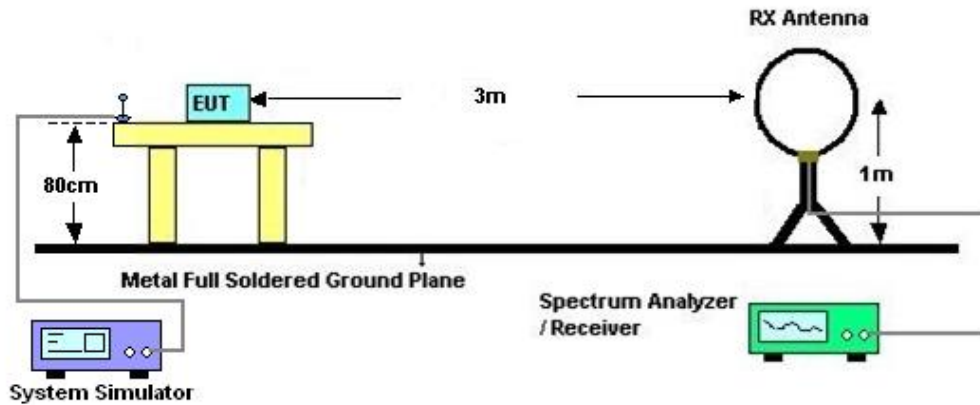

4.2.2 For radiated test from 30MHz to 1GHz

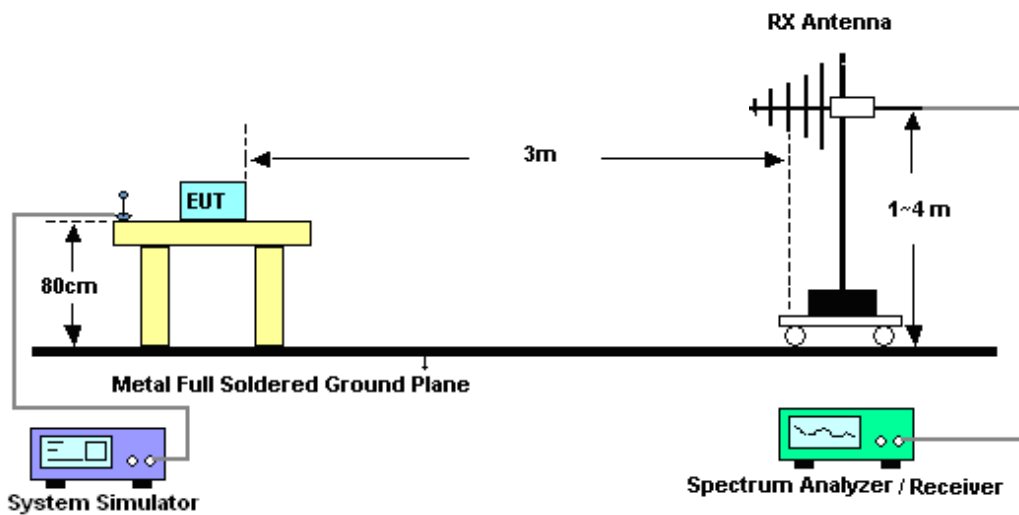

4.2.3 For radiated test above 1GHz

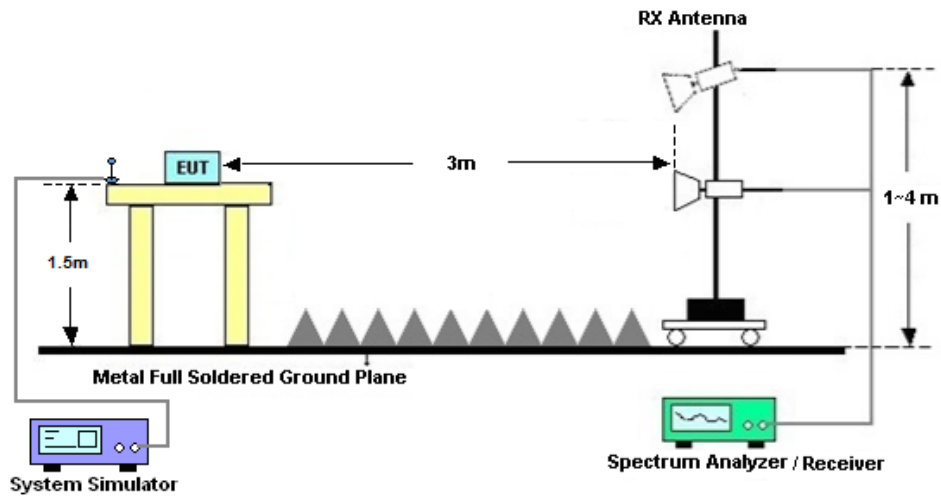

4.3 Test Result of Radiated Test

The low frequency, which started from 9 kHz to 30MHz, was pre-scanned and the result which was 20dB lower than the limit line was not reported.

Please refer to Appendix B.



4.4 Radiated Spurious Emission

4.4.1 Description of Radiated Spurious Emission Measurement

The radiated spurious emission was measured by substitution method according to ANSI / TIA-603-E. The power of any emission outside of the authorized operating frequency ranges must be attenuated below the transmitter power (P) by a factor of at least -40dBm / MHz. The spectrum is scanned from 30 MHz up to a frequency including its 10th harmonic.

4.4.2 Test Procedures

1. The EUT was placed on a turntable with 0.8 meter height for frequency below 1GHz and 1.5 meter height for frequency above 1GHz respectively above ground.
2. The EUT was set 3 meters from the receiving antenna mounted on the antenna tower.
3. The table was rotated 360 degrees to determine the position of the highest spurious emission.
4. The height of the receiving antenna is varied between 1m to 4m to search the maximum spurious emission for both horizontal and vertical polarizations.
5. During the measurement, the system simulator parameters were set to force the EUT transmitting at maximum output power.
6. Make the measurement with the spectrum analyzer's RBW = 1MHz, VBW = 3MHz, taking the record of maximum spurious emission.
7. A horn antenna was substituted in place of the EUT and was driven by a signal generator. Tune the output power of signal generator to the same emission level with EUT maximum spurious emission.
$$\text{EIRP (dBm)} = \text{S.G. Power} - \text{Tx Cable Loss} + \text{Tx Antenna Gain}$$
$$\text{ERP (dBm)} = \text{EIRP} - 2.15$$
8. The RF fundamental frequency should be excluded against the limit line in the operating frequency band.
The limit line is -40dBm/MHz



5 List of Measuring Equipment

Instrument	Manufacturer	Model No.	Serial No.	Characteristics	Calibration Date	Test Date	Due Date	Remark
Spectrum Analyzer	R&S	FSV40	101040	10Hz~40GHz	Oct. 14, 2021	Jun. 22, 2022~ Jun. 30, 2022	Oct. 13, 2022	Conducted (TH01-KS)
Power divider	STI	STI08-0055	-	0.5~40GHz	Aug. 26, 2021	Jun. 22, 2022~ Jun. 30, 2022	Aug. 25, 2022	Conducted (TH01-KS)
Temperature & humidity chamber	Hongzhan	LP-150U	H2014011 440	-40~+150°C 20%~95%RH	Jul. 12, 2021	Jun. 22, 2022~ Jun. 30, 2022	Jul. 11, 2022	Conducted (TH01-KS)
EXA Spectrum Analyzer	Keysight	N9010B	MY575410 79	10Hz-44G,MAX 30dB	Oct. 14, 2022	Jul. 20, 2022	Oct. 13, 2023	Radiation (03CH04-KS)
Loop Antenna	R&S	HFH2-Z2	100321	9kHz~30MHz	Oct. 30, 2021	Jul. 20, 2022	Oct. 29, 2022	Radiation (03CH04-KS)
Bilog Antenna	TeseQ	CBL6111D	49922	30MHz-1GHz	May 24, 2022	Jul. 20, 2022	May 23, 2023	Radiation (03CH04-KS)
Horn Antenna	Schwarzbeck	BBHA9120D	1356	1GHz~18GHz	Apr. 17, 2022	Jul. 20, 2022	Apr. 16, 2023	Radiation (03CH04-KS)
SHF-EHF Horn	Com-power	AH-840	101070	18GHz~40GHz	Jan. 05, 2022	Jul. 20, 2022	Jan. 04, 2023	Radiation (03CH04-KS)
Amplifier	SONOMA	310N	187289	9KHz-1GHz	Jan. 05, 2022	Jul. 20, 2022	Jan. 04, 2023	Radiation (03CH04-KS)
Amplifier	MITEQ	EM18G40GG A	060728	18~40GHz	Jan. 05, 2022	Jul. 20, 2022	Jan. 04, 2023	Radiation (03CH04-KS)
high gain Amplifier	MITEQ	AMF-7D-0010 1800-30-10P	2025788	1Ghz-18Ghz	Jul. 30, 2021	Jul. 20, 2022	Jul. 29, 2022	Radiation (03CH04-KS)
Amplifier	Keysight	83017A	MY572801 06	500MHz~26.5G Hz	Oct. 13, 2021	Jul. 20, 2022	Oct. 12, 2022	Radiation (03CH04-KS)
AC Power Source	Chroma	61601	F1040900 04	N/A	NCR	Jul. 20, 2022	NCR	Radiation (03CH04-KS)
Turn Table	ChamPro	EM 1000-T	060762-T	0~360 degree	NCR	Jul. 20, 2022	NCR	Radiation (03CH04-KS)
Antenna Mast	ChamPro	EM 1000-A	060762-A	1 m~4 m	NCR	Jul. 20, 2022	NCR	Radiation (03CH04-KS)

NCR: No Calibration Required



6 Uncertainty of Evaluation

Uncertainty of Radiated Emission Measurement (30 MHz ~ 1000 MHz)

Measuring Uncertainty for a Level of Confidence of 95% (U = 2Uc(y))	3.3dB
---	-------

Uncertainty of Radiated Emission Measurement (1 GHz ~ 18 GHz)

Measuring Uncertainty for a Level of Confidence of 95% (U = 2Uc(y))	2.8dB
---	-------

Uncertainty of Radiated Emission Measurement (18 GHz ~ 40 GHz)

Measuring Uncertainty for a Level of Confidence of 95% (U = 2Uc(y))	2.8dB
---	-------

----- THE END -----



Appendix A. Test Results of Conducted Test

Test Engineer :	Simle Wang	Temperature :	22~23°C
		Relative Humidity :	40~42%

Conducted Output Power(Average power) and EIRP

5G NR n48

BW [MHz]	Modulation	RB Size	RB Offset	Power Low Ch. / Freq.	Power Middle Ch. / Freq.	Power High Ch. / Freq.	Gain	Gain	Gain	EIRP	EIRP	EIRP
Channel				638000	641666	645332	L	M	H	L	M	H
Frequency (MHz)				3570	3624.99	3679.98						
40	PI/2 BPSK	1	1	22.98	22.89	22.89	-1.40	-1.60	-2.20	0.1439	0.1346	0.1172
40	PI/2 BPSK	1	104	22.91	22.99	22.90	-1.40	-1.60	-2.20	0.1416	0.1377	0.1175
40	PI/2 BPSK	1	105	22.47	22.43	22.47	-1.40	-1.60	-2.20	0.1279	0.1211	0.1064
40	PI/2 BPSK	1	0	22.56	22.49	22.40	-1.40	-1.60	-2.20	0.1306	0.1227	0.1047
40	PI/2 BPSK	100	0	22.50	22.56	22.38	-1.40	-1.60	-2.20	0.1288	0.1247	0.1042
40	QPSK	1	1	22.92	22.84	22.83	-1.40	-1.60	-2.20	0.1419	0.1330	0.1156
40	QPSK	1	104	22.97	22.85	22.96	-1.40	-1.60	-2.20	0.1435	0.1334	0.1191
40	QPSK	1	105	22.08	22.17	21.86	-1.40	-1.60	-2.20	0.1169	0.1140	0.0925
40	QPSK	1	0	22.06	22.04	21.84	-1.40	-1.60	-2.20	0.1164	0.1107	0.0920
40	QPSK	100	0	22.01	22.06	21.98	-1.40	-1.60	-2.20	0.1151	0.1112	0.0951
40	16QAM	1	1	21.98	21.89	21.87	-1.40	-1.60	-2.20	0.1143	0.1069	0.0927
40	64QAM	1	1	19.85	20.54	19.74	-1.40	-1.60	-2.20	0.0700	0.0783	0.0568
40	256QAM	1	1	18.33	18.62	18.11	-1.40	-1.60	-2.20	0.0493	0.0504	0.0390
Channel				637334	641666	646000	Gain	Gain	Gain	EIRP	EIRP	EIRP
Frequency (MHz)				3560.01	3624.99	3690						
20	PI/2 BPSK	1	1	22.81	22.79	22.66	-1.40	-1.60	-2.20	0.1384	0.1315	0.1112
20	QPSK	1	1	22.78	22.75	22.67	-1.40	-1.60	-2.20	0.1374	0.1303	0.1114
20	16QAM	1	1	21.89	21.83	21.74	-1.40	-1.60	-2.20	0.1119	0.1054	0.0899
Channel				637000	641666	646332	Gain	Gain	Gain	EIRP	EIRP	EIRP
Frequency (MHz)				3555	3624.99	3694.98						
10	PI/2 BPSK	1	1	22.92	22.95	22.80	-1.40	-1.60	-2.20	0.1419	0.1365	0.1148
10	QPSK	1	1	22.85	22.75	22.75	-1.40	-1.60	-2.20	0.1396	0.1303	0.1135
10	16QAM	1	1	21.78	21.88	21.75	-1.40	-1.60	-2.20	0.1091	0.1067	0.0902



FR1 Part 96 N48

ACLR

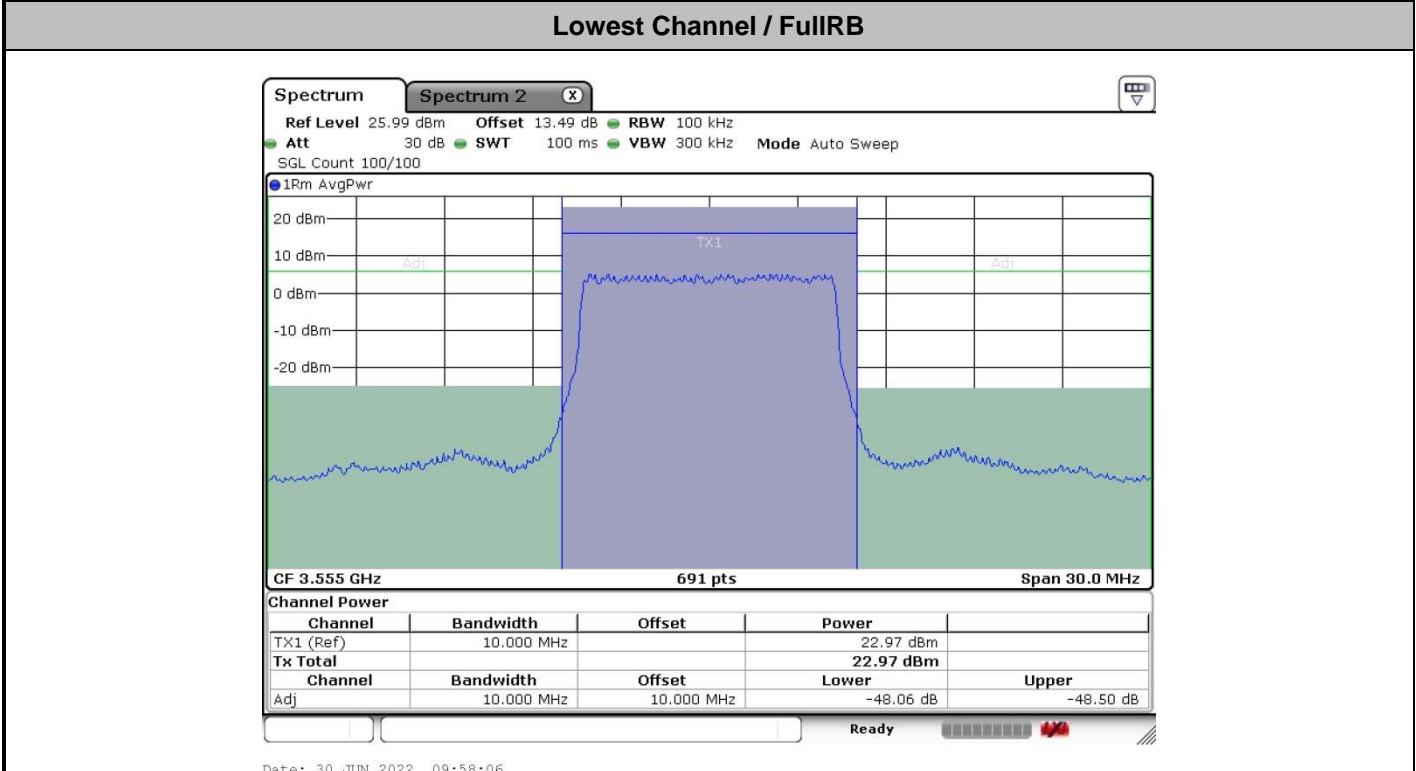
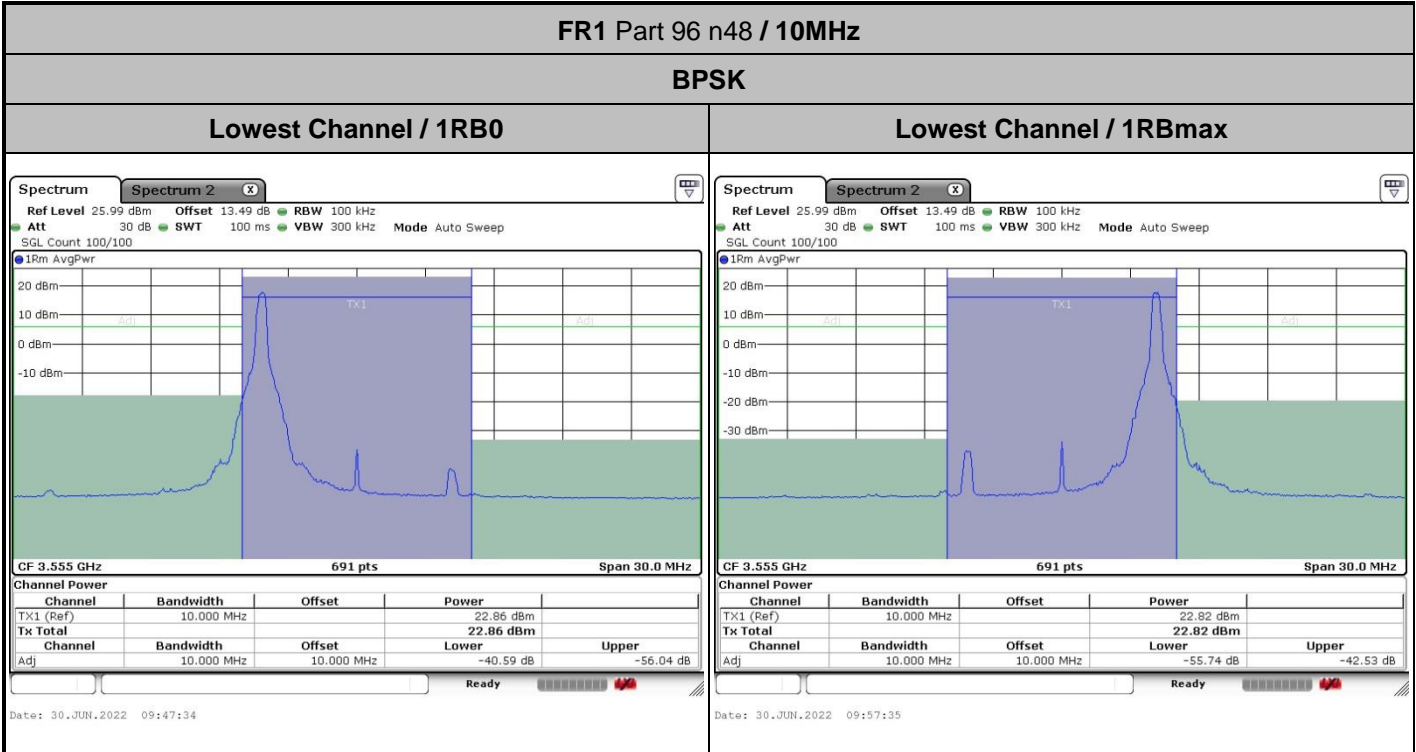



FR1 Part 96 n48 / 10MHz

BPSK

Middle Channel / 1RB0

Middle Channel / 1RBmax

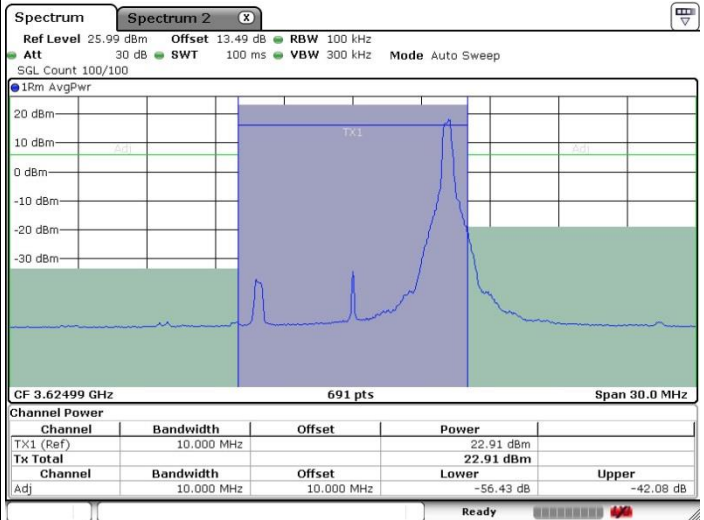
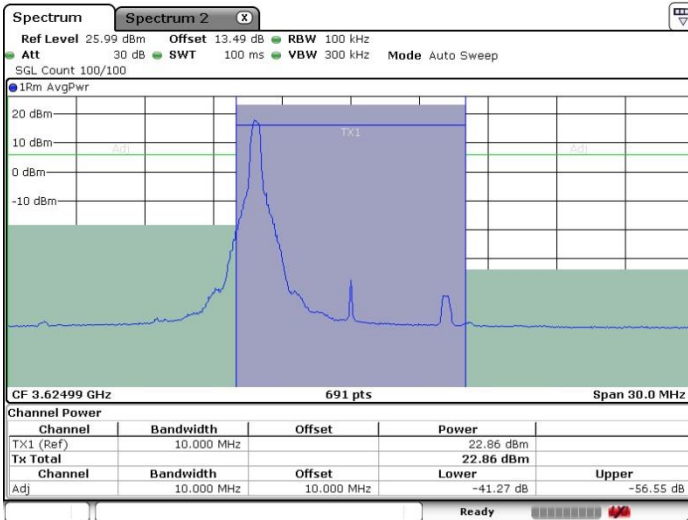

Date: 30.JUN.2022 10:05:00

Date: 30.JUN.2022 10:12:05

Middle Channel / FullIRB

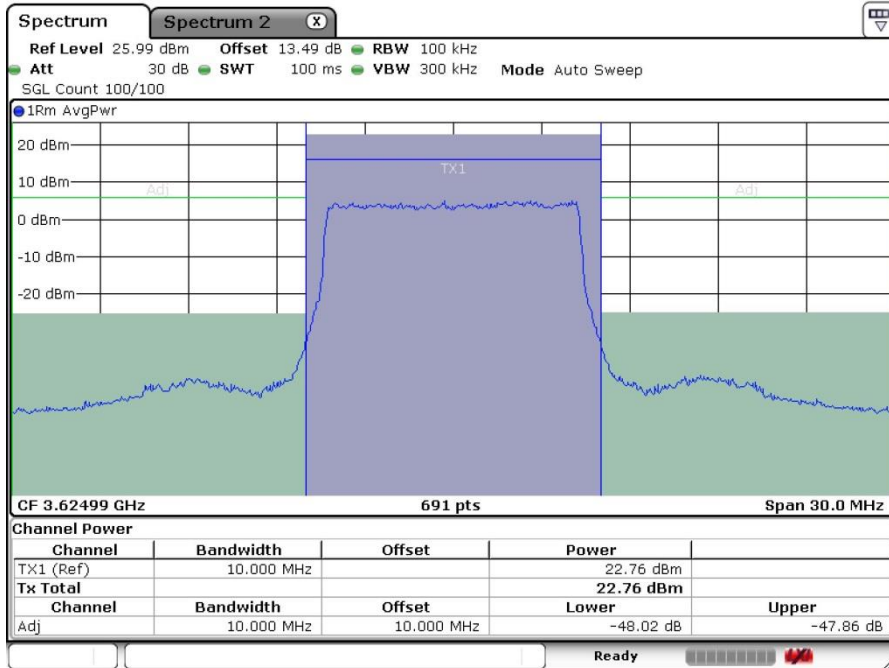

Date: 30.JUN.2022 10:12:34



FR1 Part 96 n48 / 10MHz

BPSK

Highest Channel / 1RB0

Highest Channel / 1RBmax

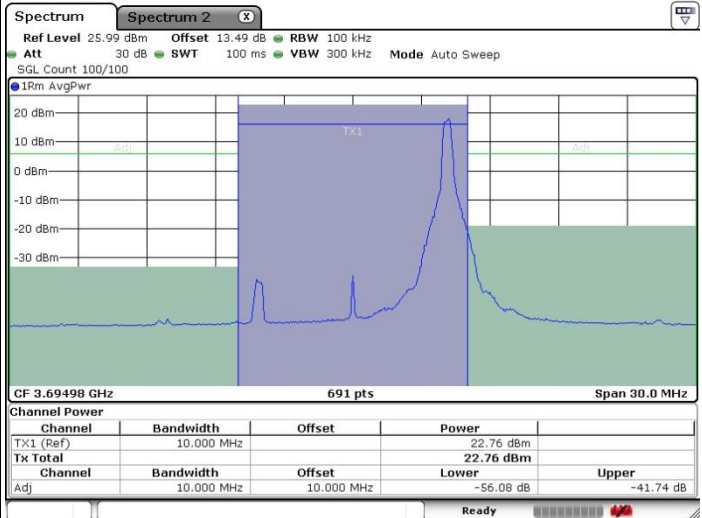
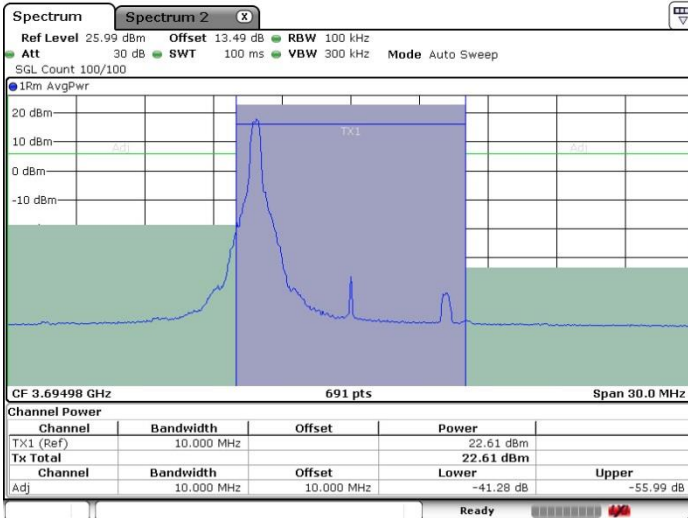

Highest Channel / FullRB

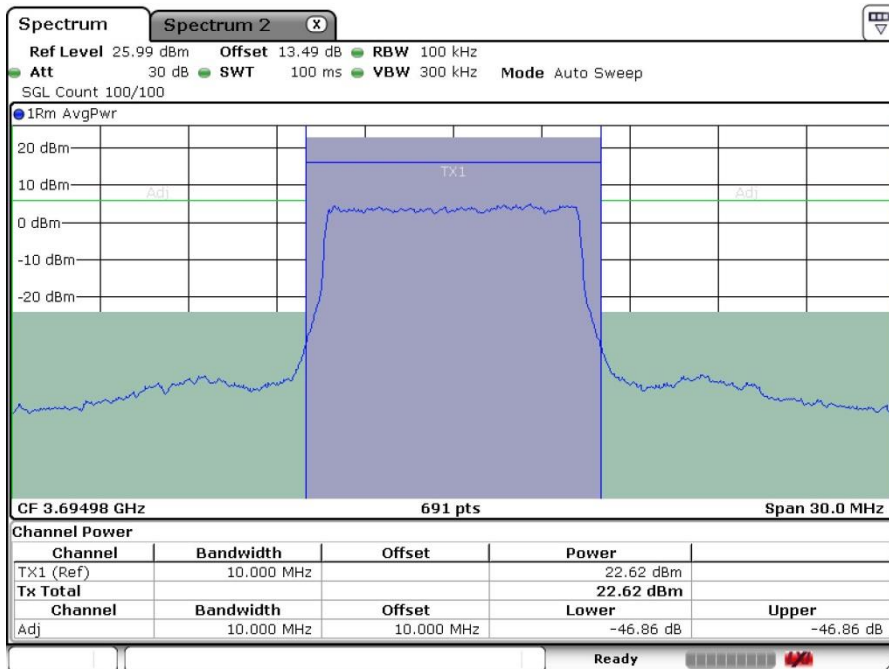



FR1 Part 96 n48 / 10MHz

QPSK

Lowest Channel / 1RB0

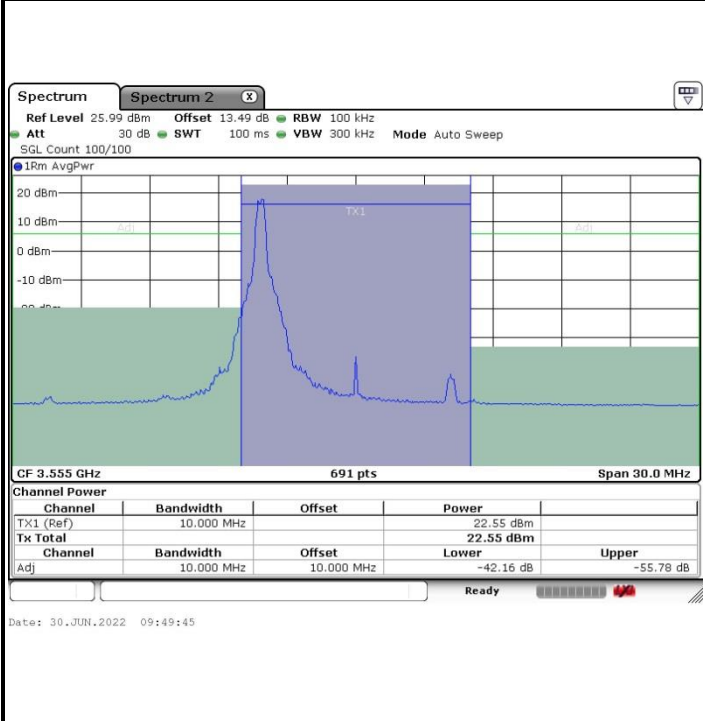

Lowest Channel / 1RBmax

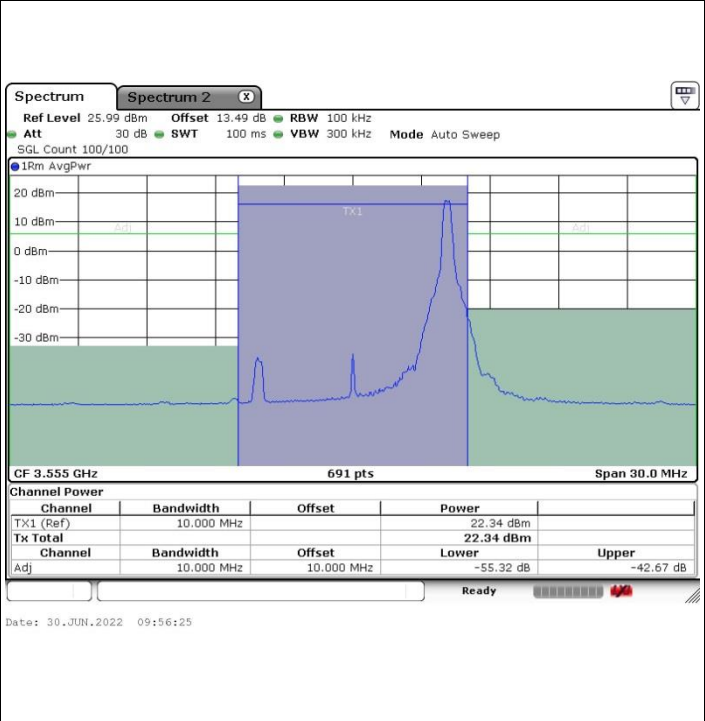

Lowest Channel / FullRB

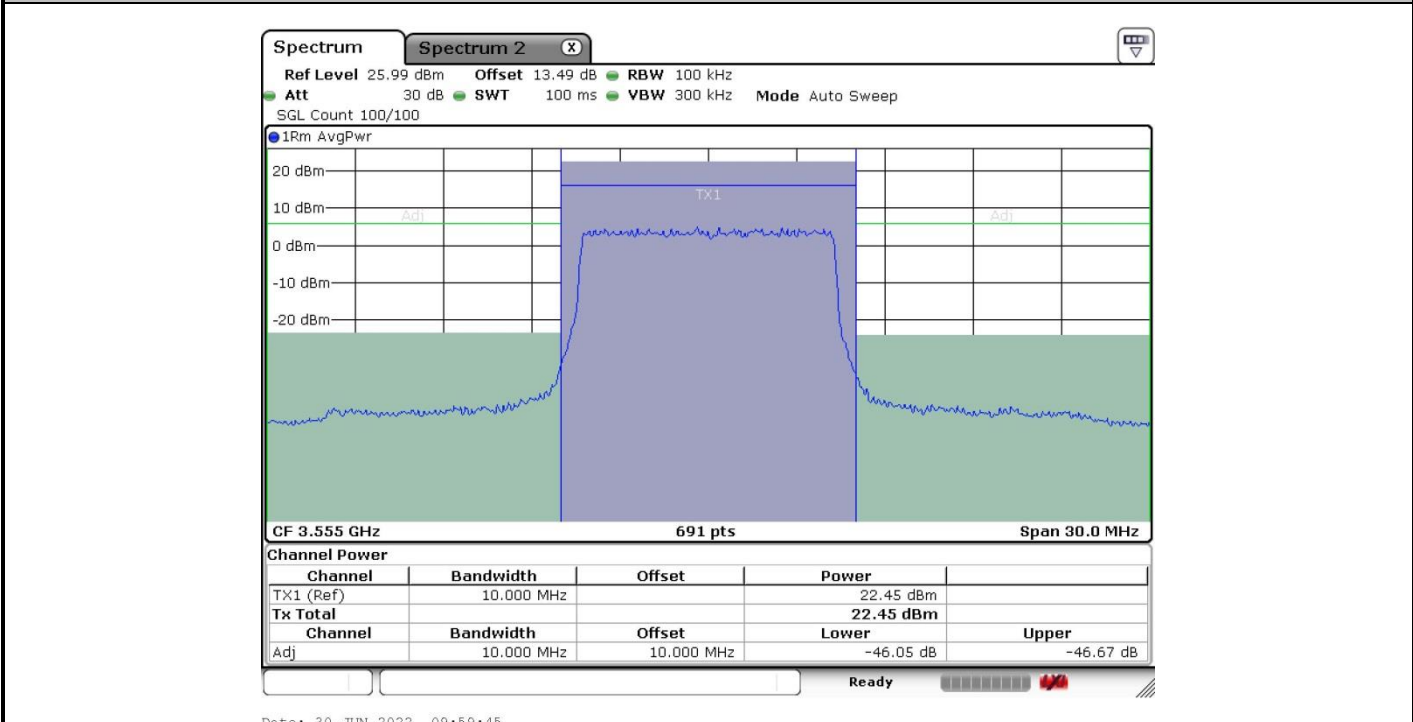



FR1 Part 96 n48 / 10MHz

QPSK

Middle Channel / 1RB0

Middle Channel / 1RBmax

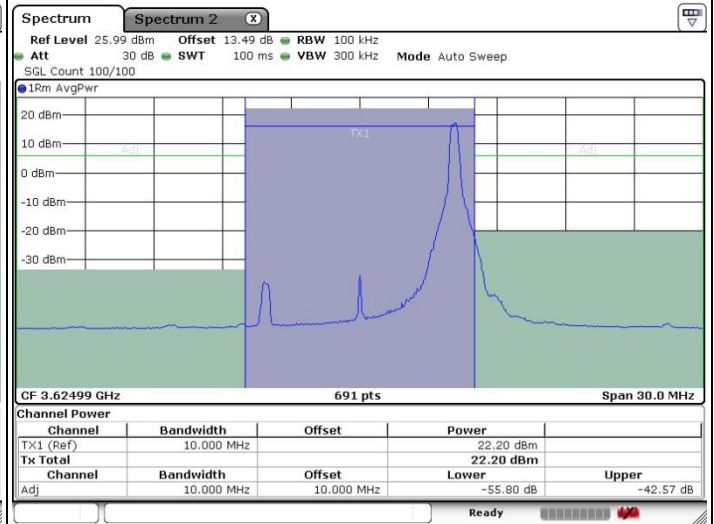
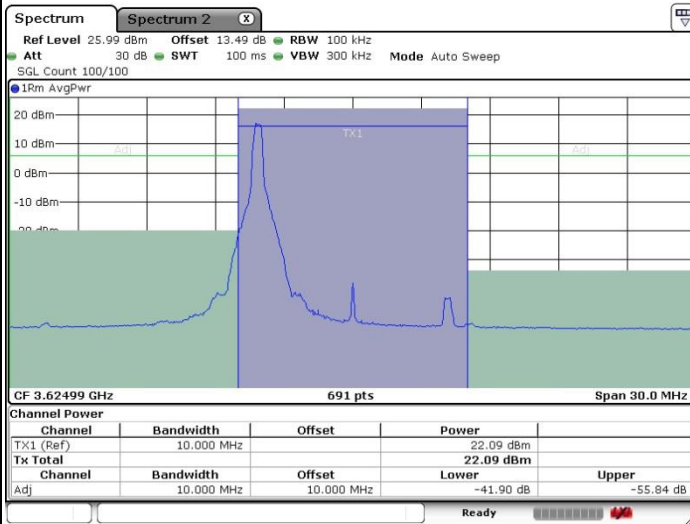

Middle Channel / FullRB

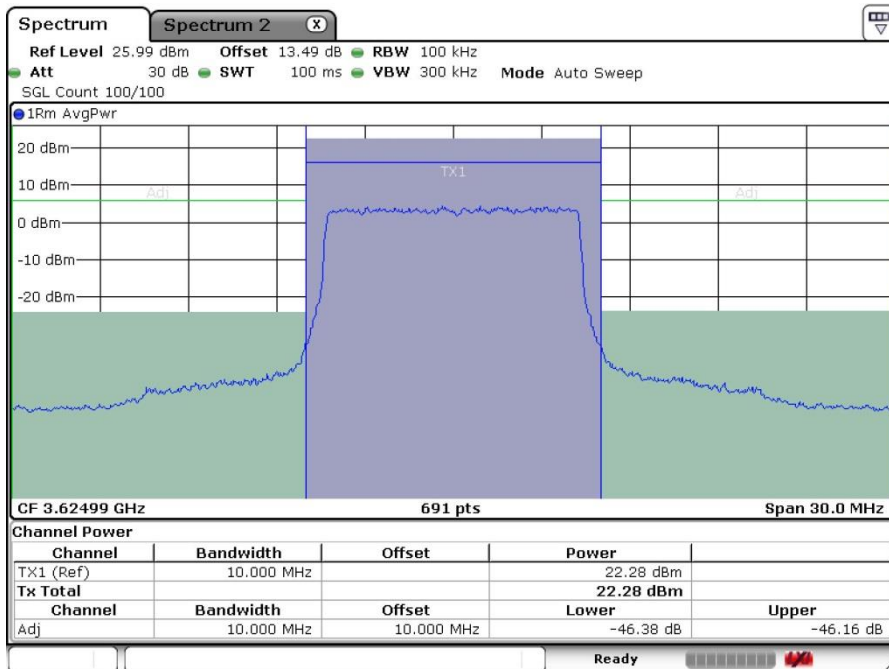



FR1 Part 96 n48 / 10MHz

QPSK

Highest Channel / 1RB0

Highest Channel / 1RBmax

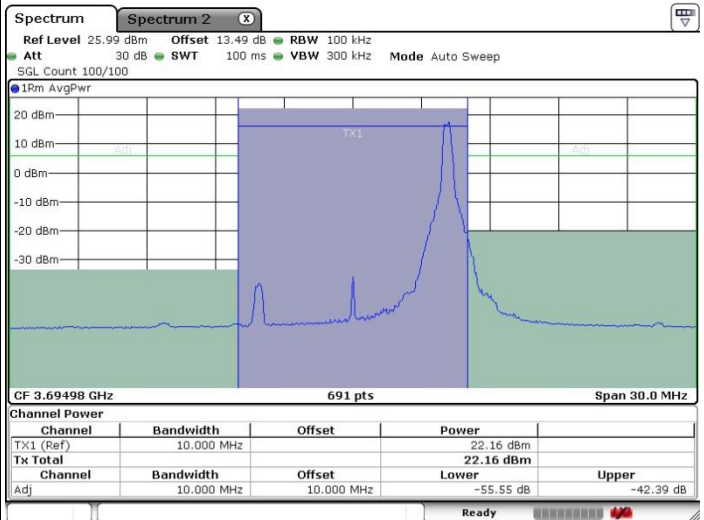
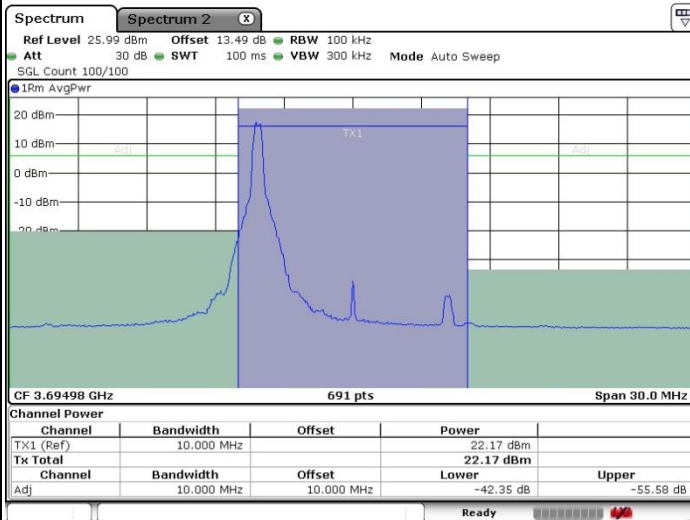

Highest Channel / FullRB

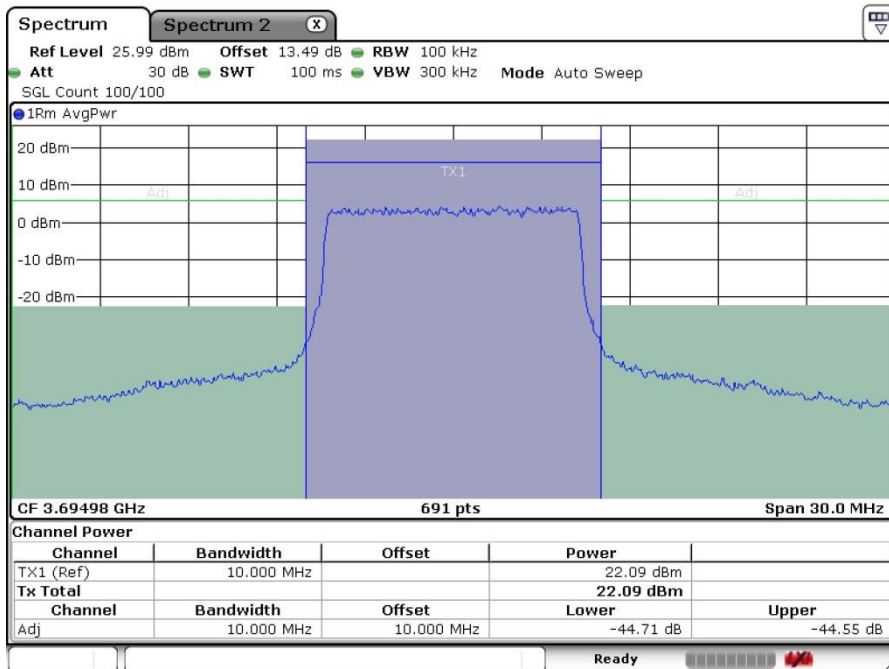



FR1 Part 96 n48 / 10MHz

16QAM

Lowest Channel / 1RB0

Lowest Channel / 1RBmax

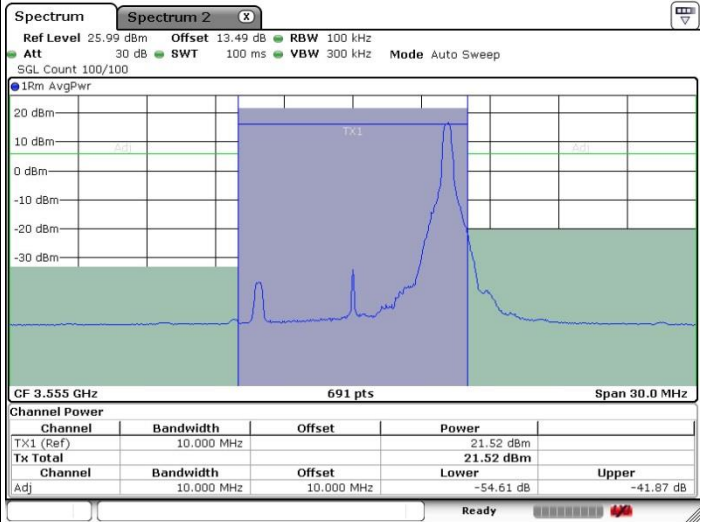
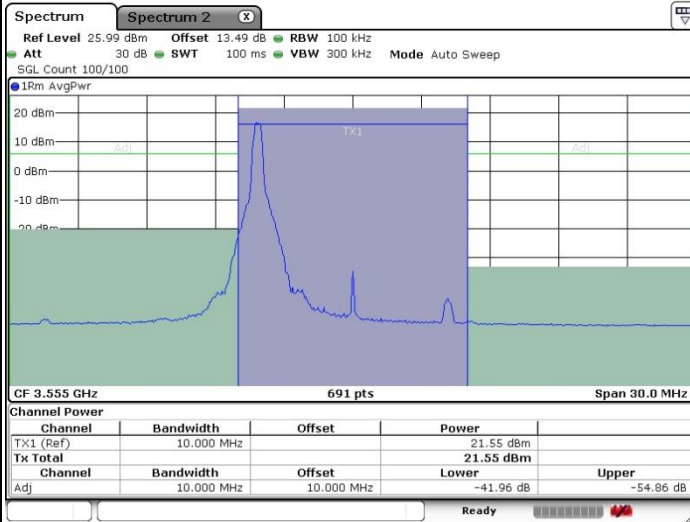

Lowest Channel / FullIRB

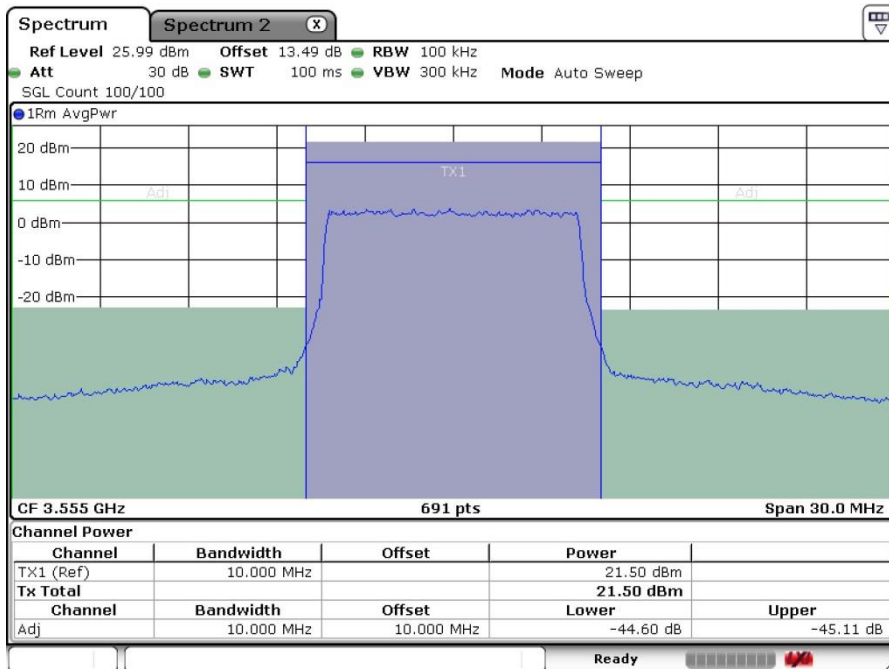



FR1 Part 96 n48 / 10MHz

16QAM

Middle Channel / 1RB0

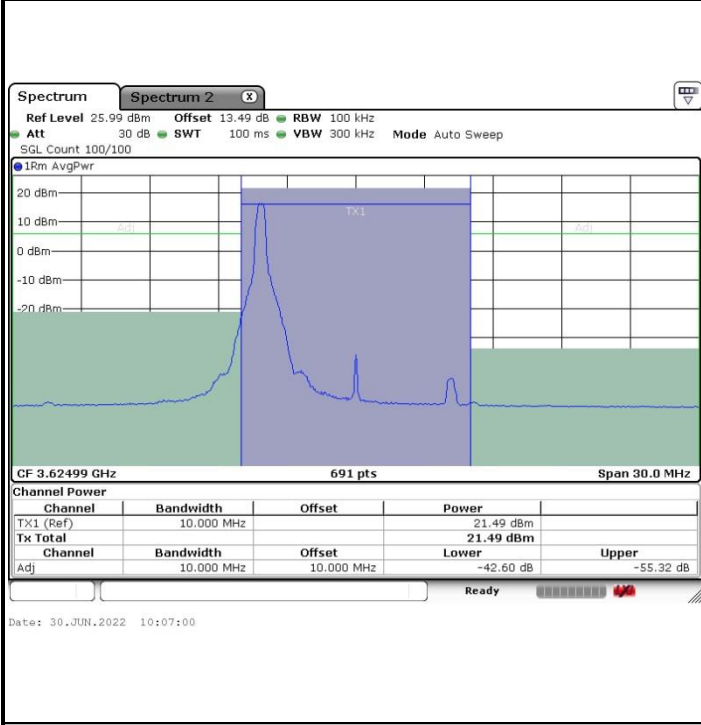

Middle Channel / 1RBmax

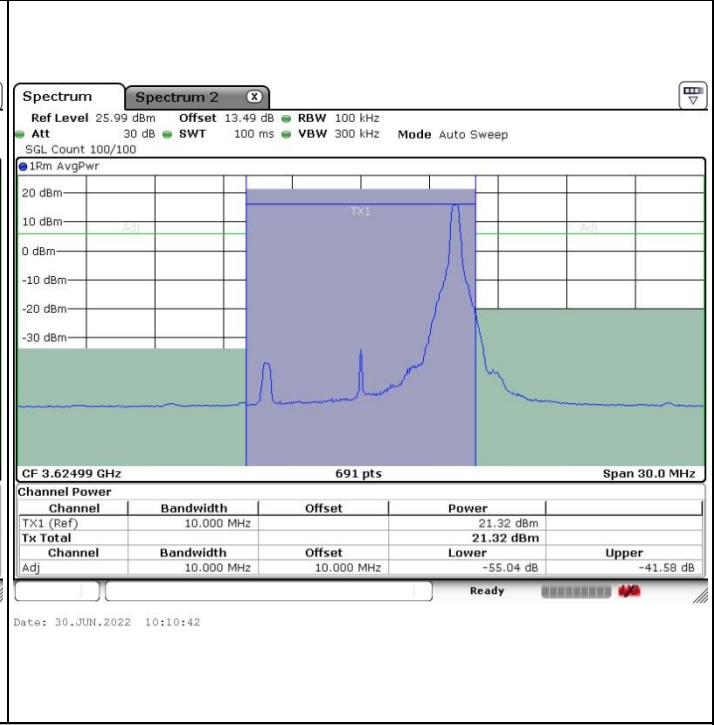

Middle Channel / FullRB

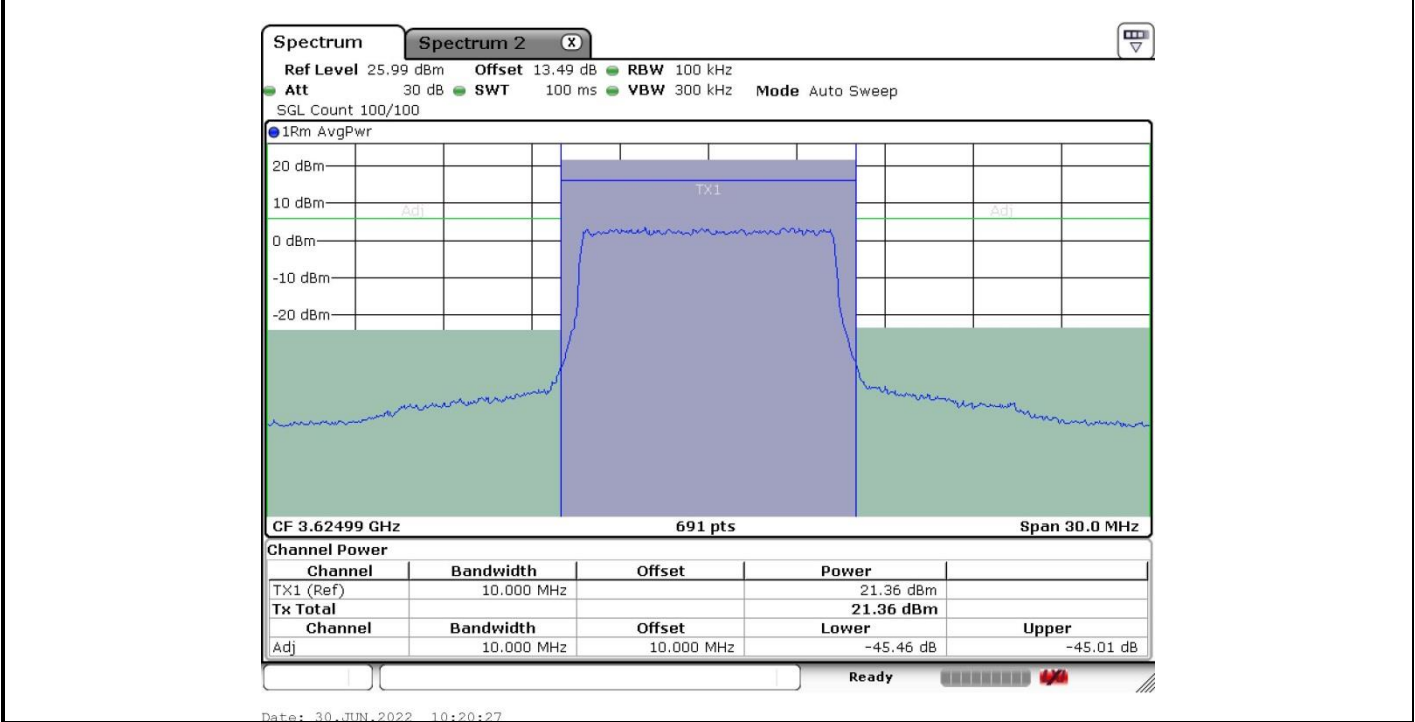



FR1 Part 96 n48 / 10MHz

16QAM

Highest Channel / 1RB0

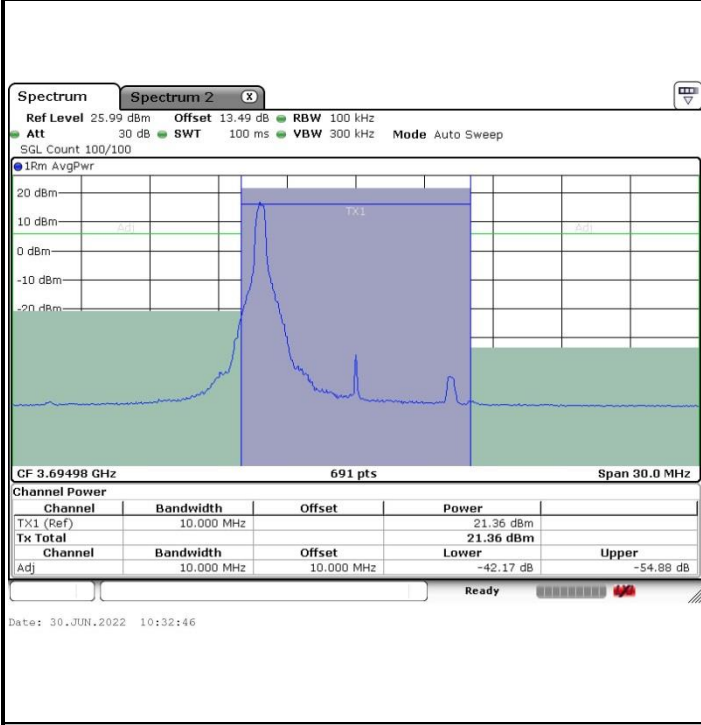

Highest Channel / 1RBmax

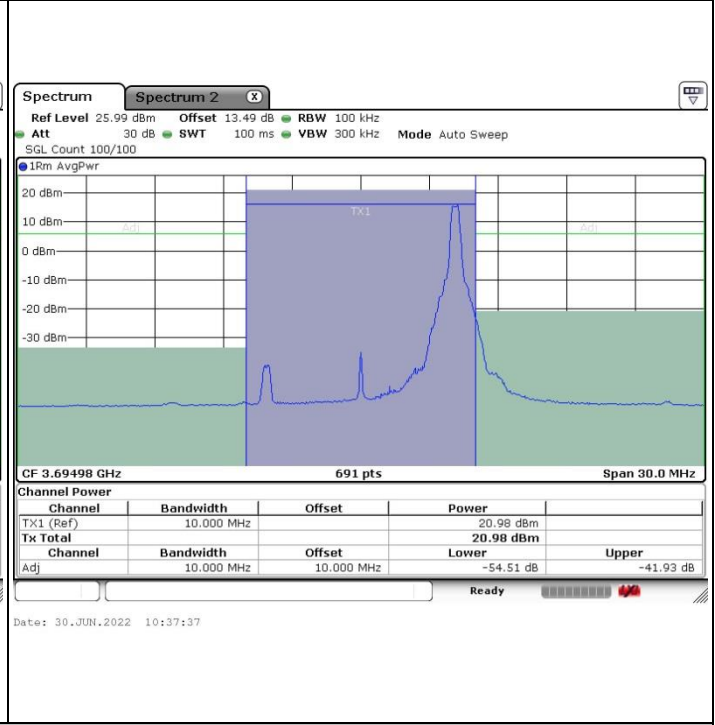

Highest Channel / FullRB

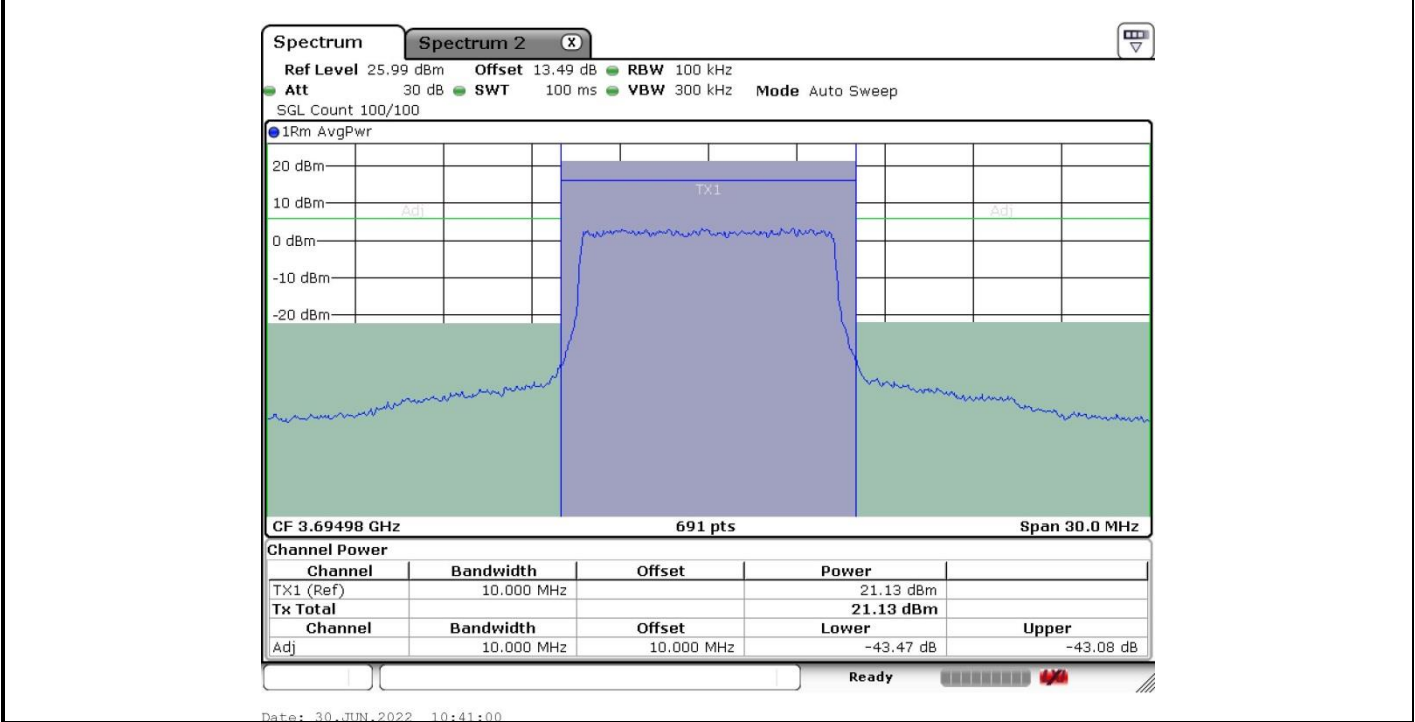



FR1 Part 96 n48 / 10MHz

64QAM

Lowest Channel / 1RB0

Lowest Channel / 1RBmax

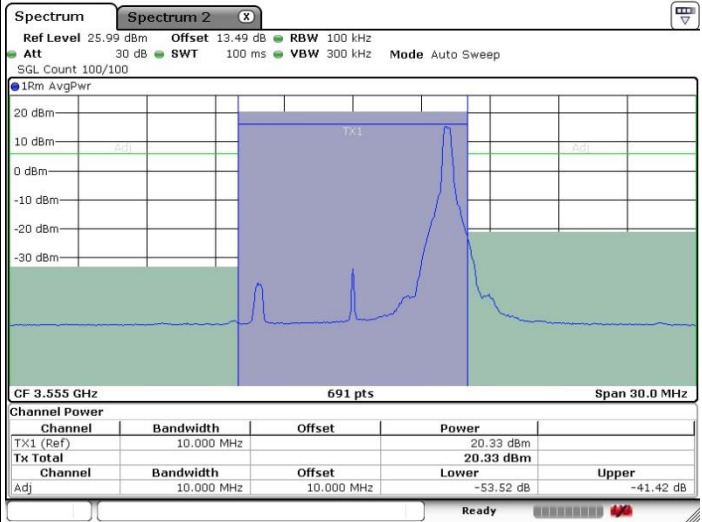
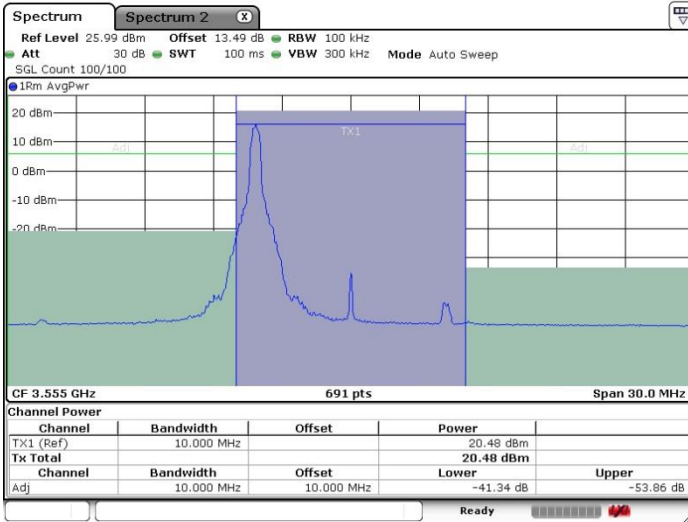

Lowest Channel / FullIRB

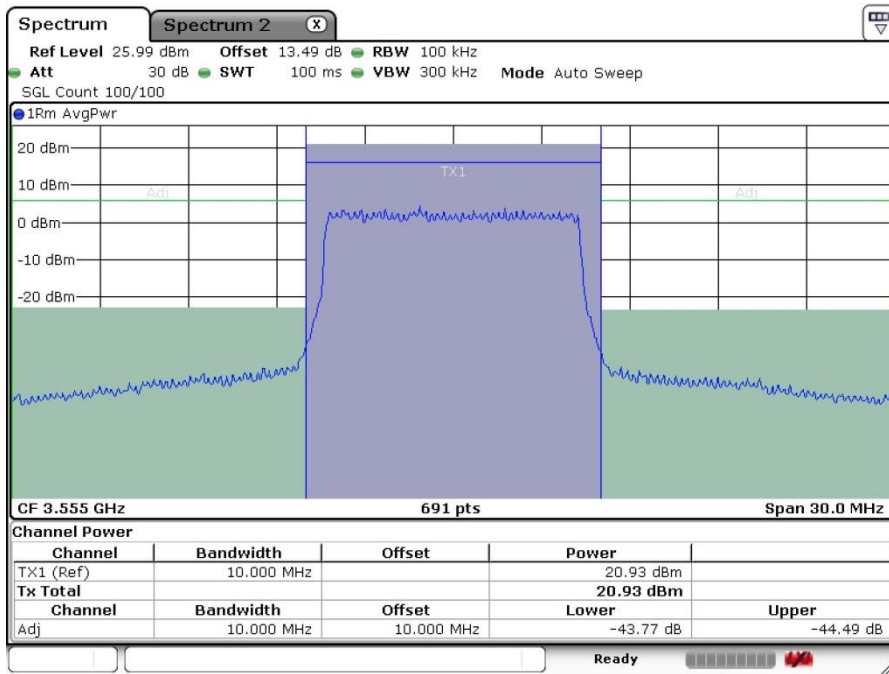



FR1 Part 96 n48 / 10MHz

64QAM

Middle Channel / 1RB0

Middle Channel / 1RBmax

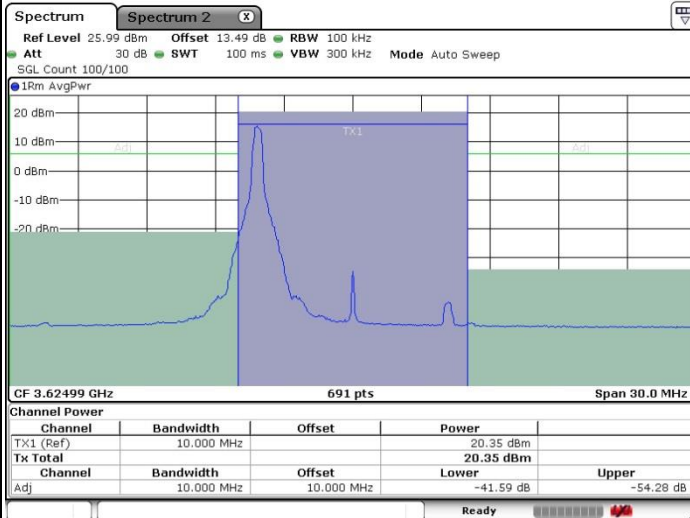

Date: 30.JUN.2022 10:07:48

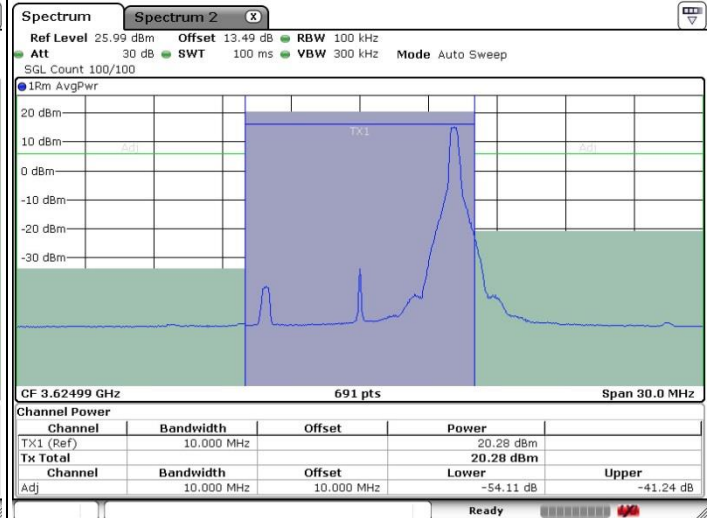

Date: 30.JUN.2022 10:09:47

Middle Channel / FullRB

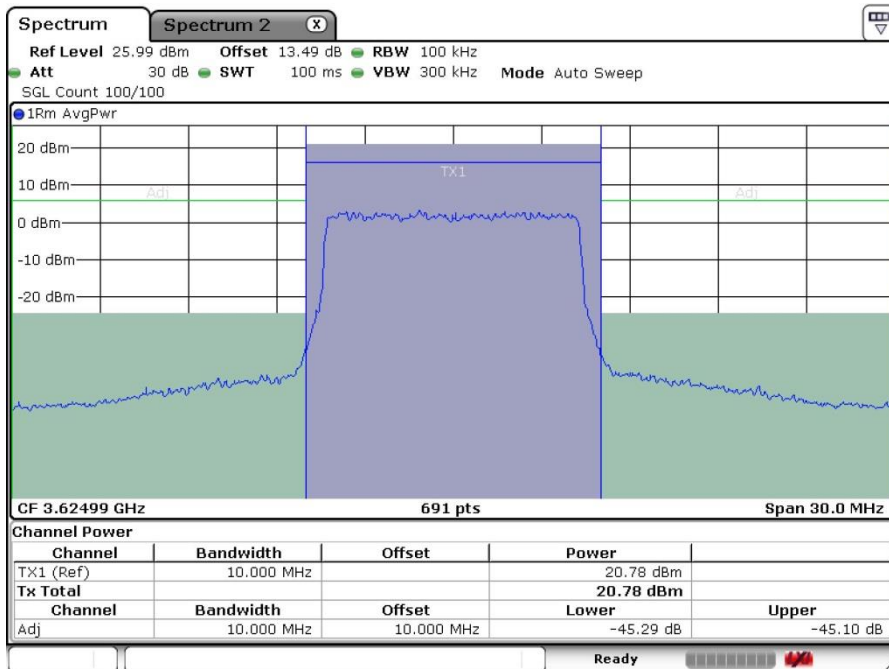

Date: 30.JUN.2022 10:21:07



FR1 Part 96 n48 / 10MHz

64QAM

Highest Channel / 1RB0

Highest Channel / 1RBmax

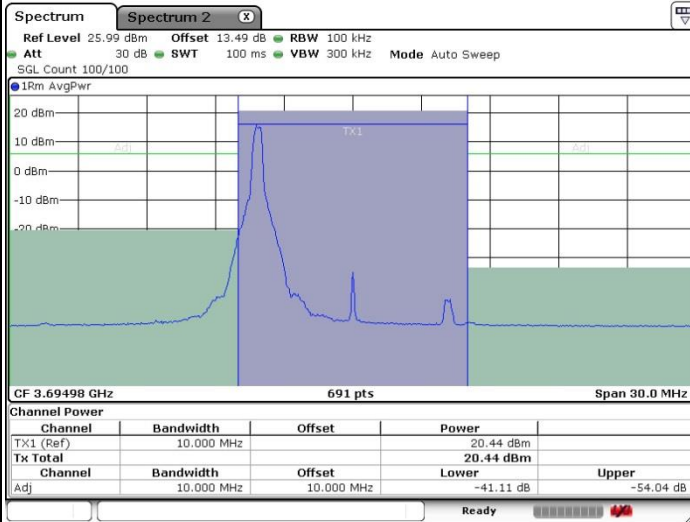

Date: 30.JUN.2022 10:34:12

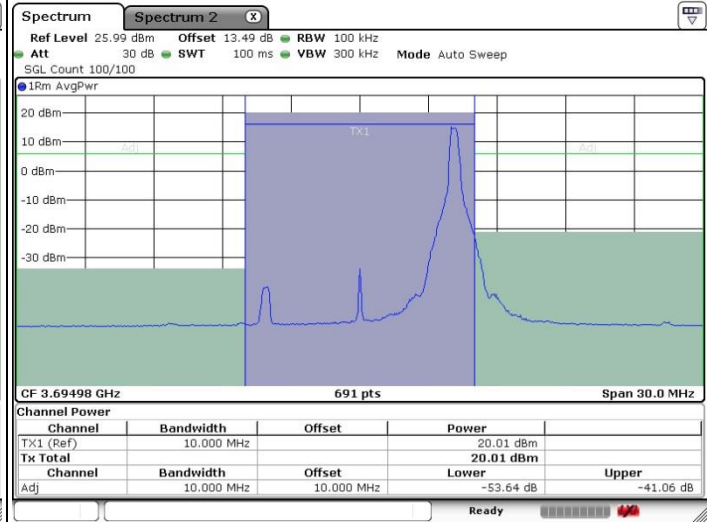

Date: 30.JUN.2022 10:36:36

Highest Channel / FullRB

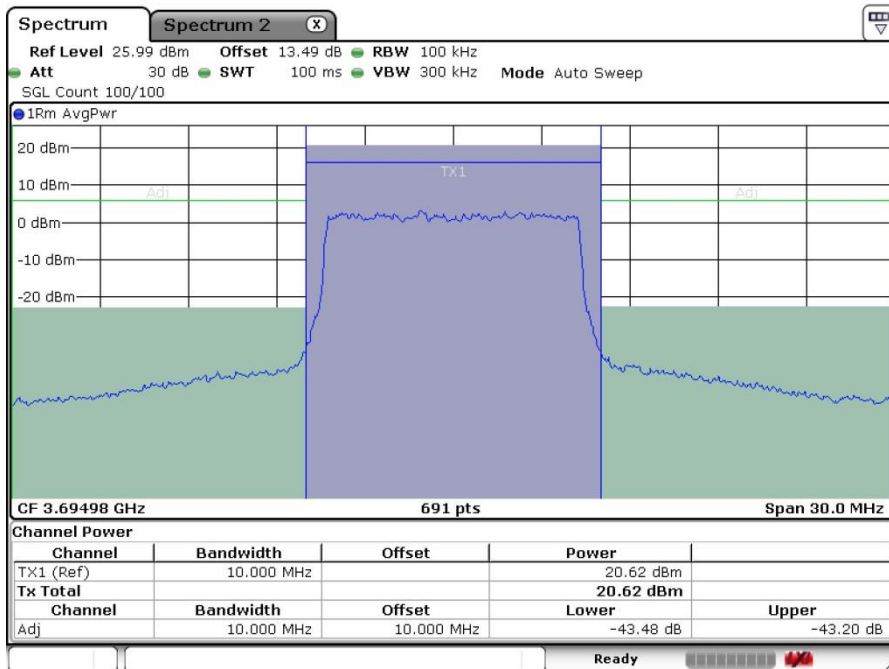

Date: 30.JUN.2022 10:41:53



FR1 Part 96 n48 / 10MHz

256QAM

Lowest Channel / 1RB0

Lowest Channel / 1RBmax

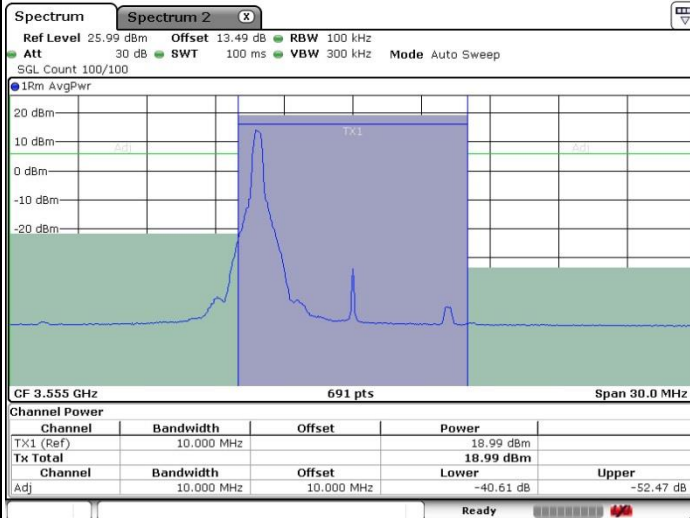

Date: 30.JUN.2022 09:52:27

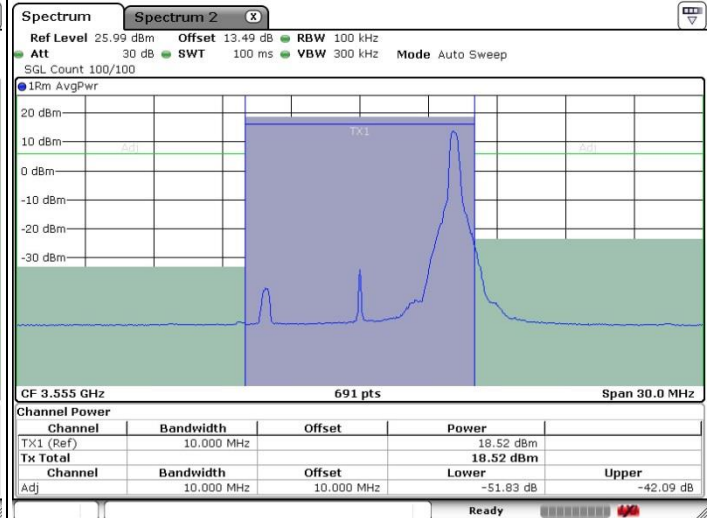

Date: 30.JUN.2022 09:53:59

Lowest Channel / FullIRB

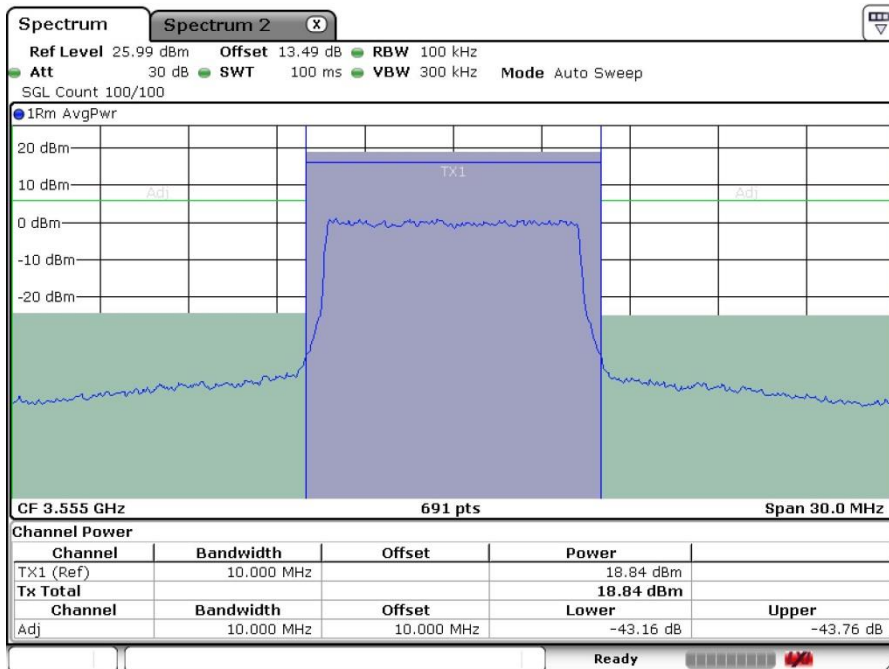

Date: 30.JUN.2022 10:02:01



FR1 Part 96 n48 / 10MHz

256QAM

Middle Channel / 1RB0

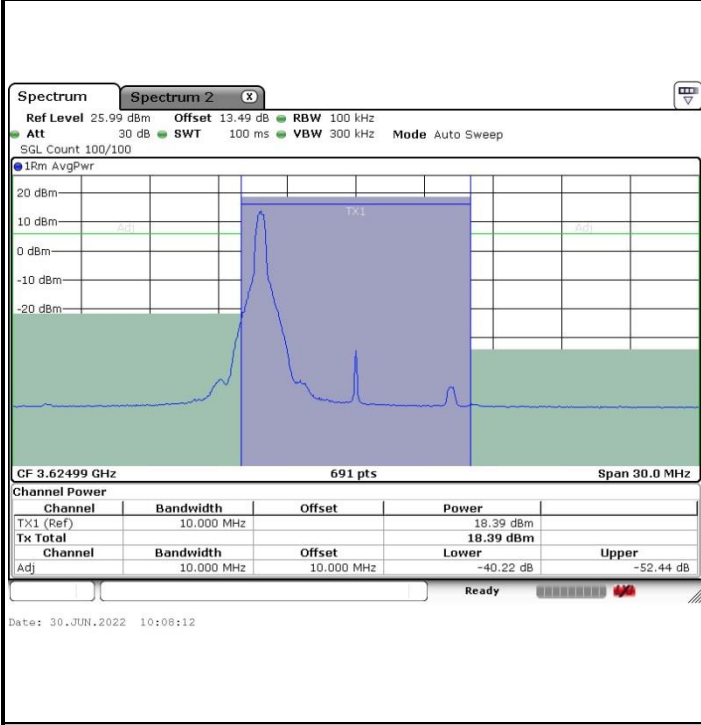

Middle Channel / 1RBmax

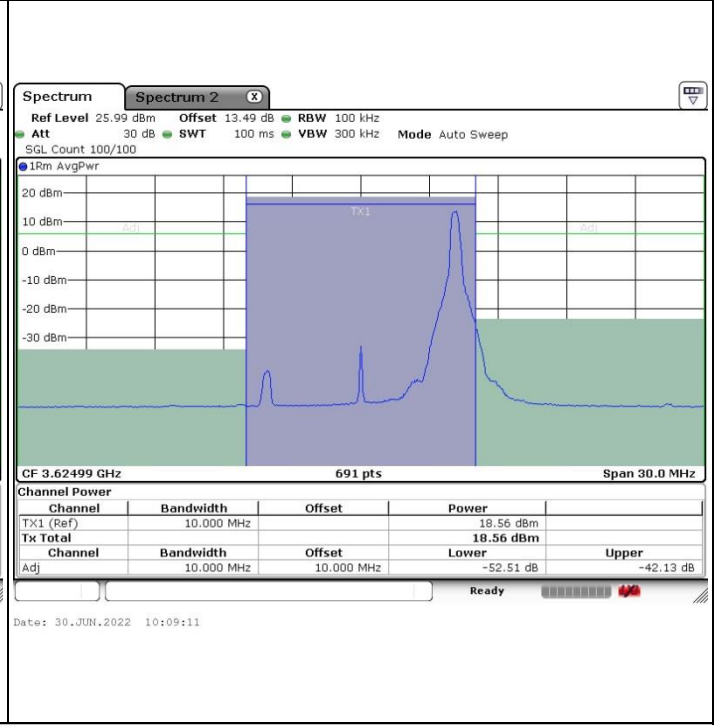

Middle Channel / FullRB

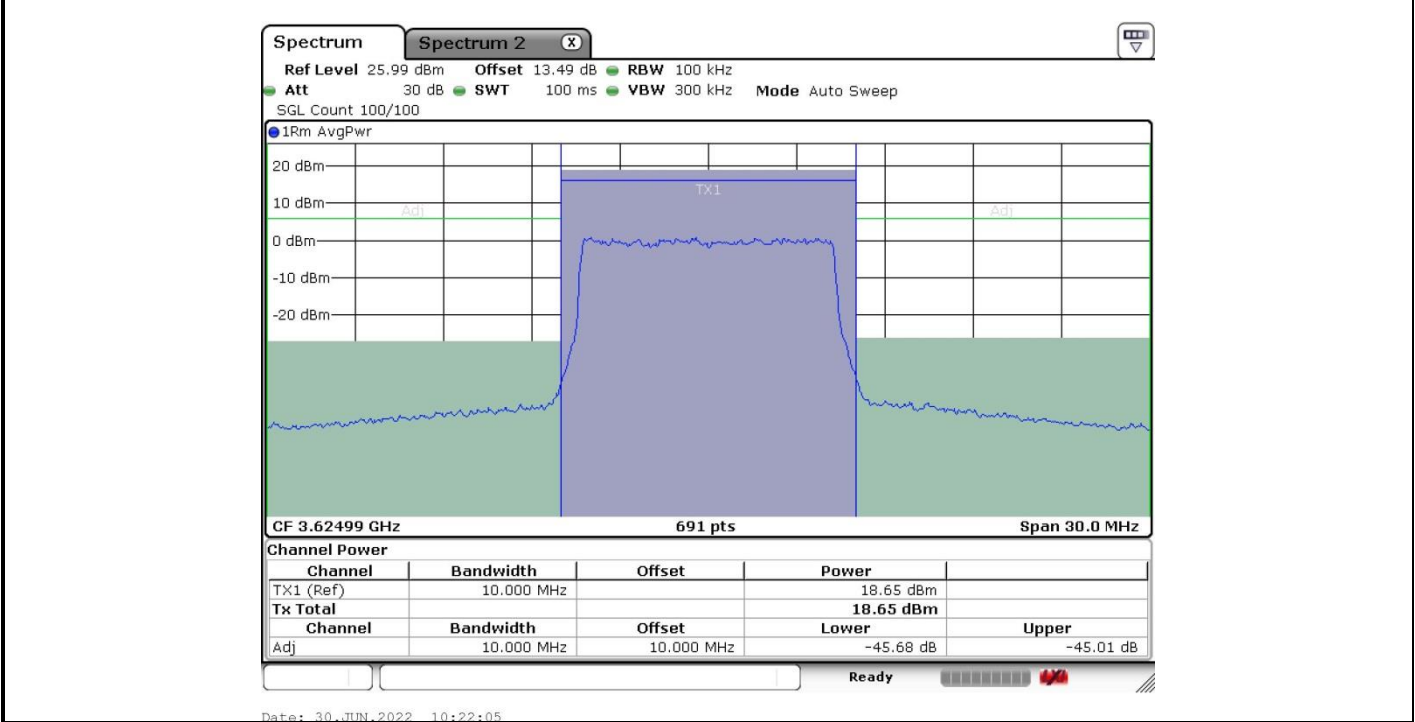



FR1 Part 96 n48 / 10MHz

256QAM

Highest Channel / 1RB0

Highest Channel / 1RBmax

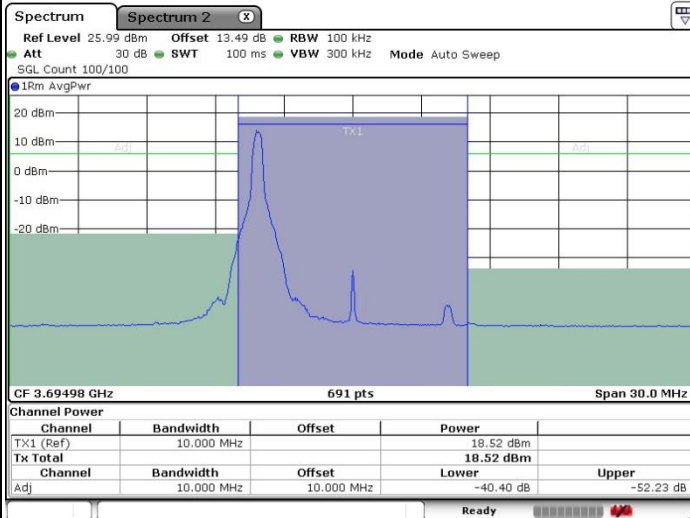

Date: 30.JUN.2022 10:34:45

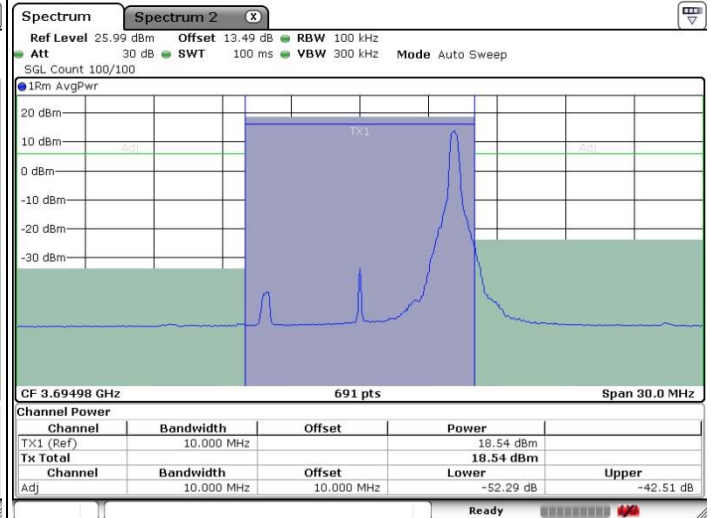

Date: 30.JUN.2022 10:36:03

Highest Channel / FullRB

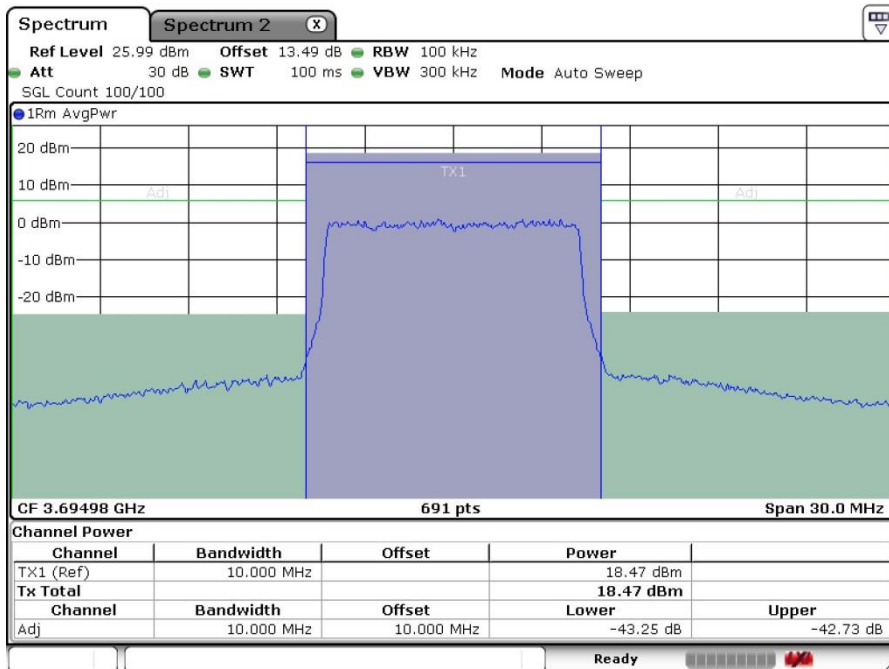

Date: 30.JUN.2022 10:42:20



FR1 Part 96 n48 / 20MHz

BPSK

Lowest Channel / 1RB0

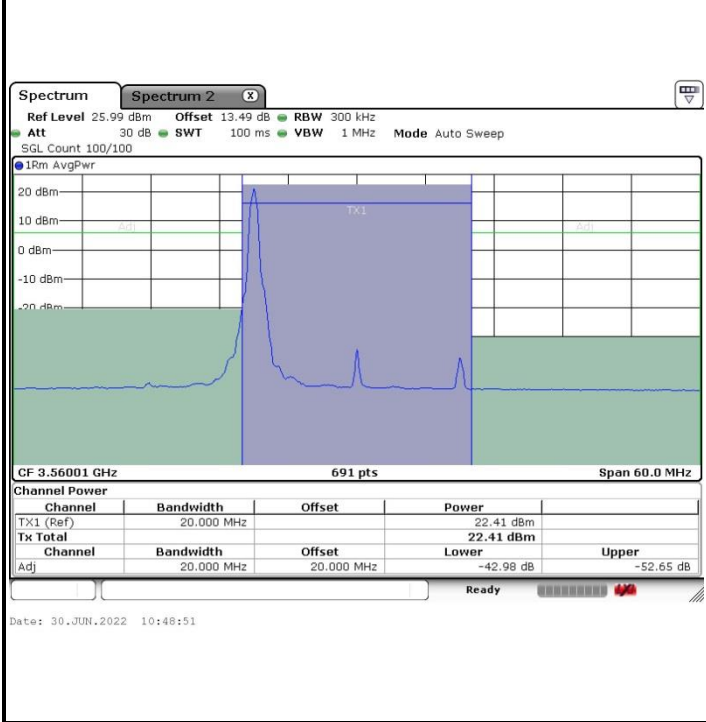

Lowest Channel / 1RBmax

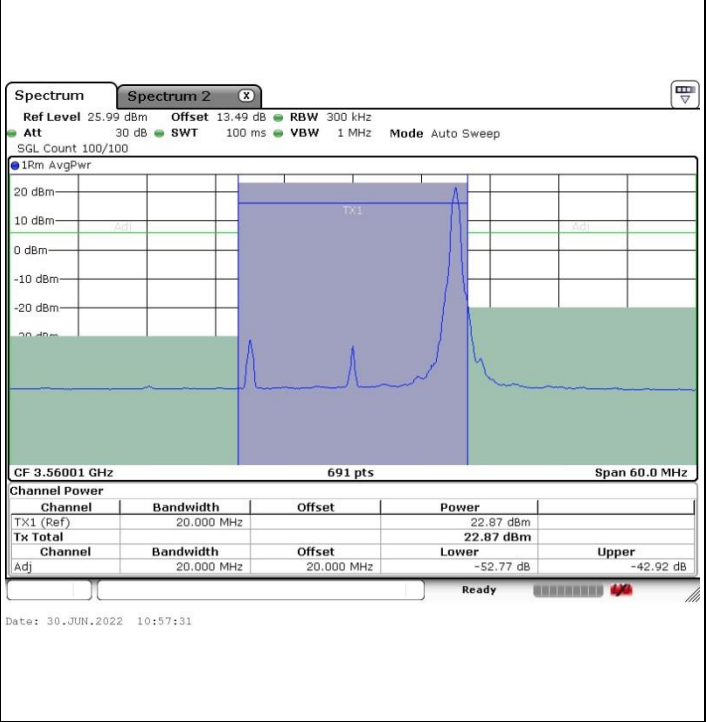

Lowest Channel / FullRB

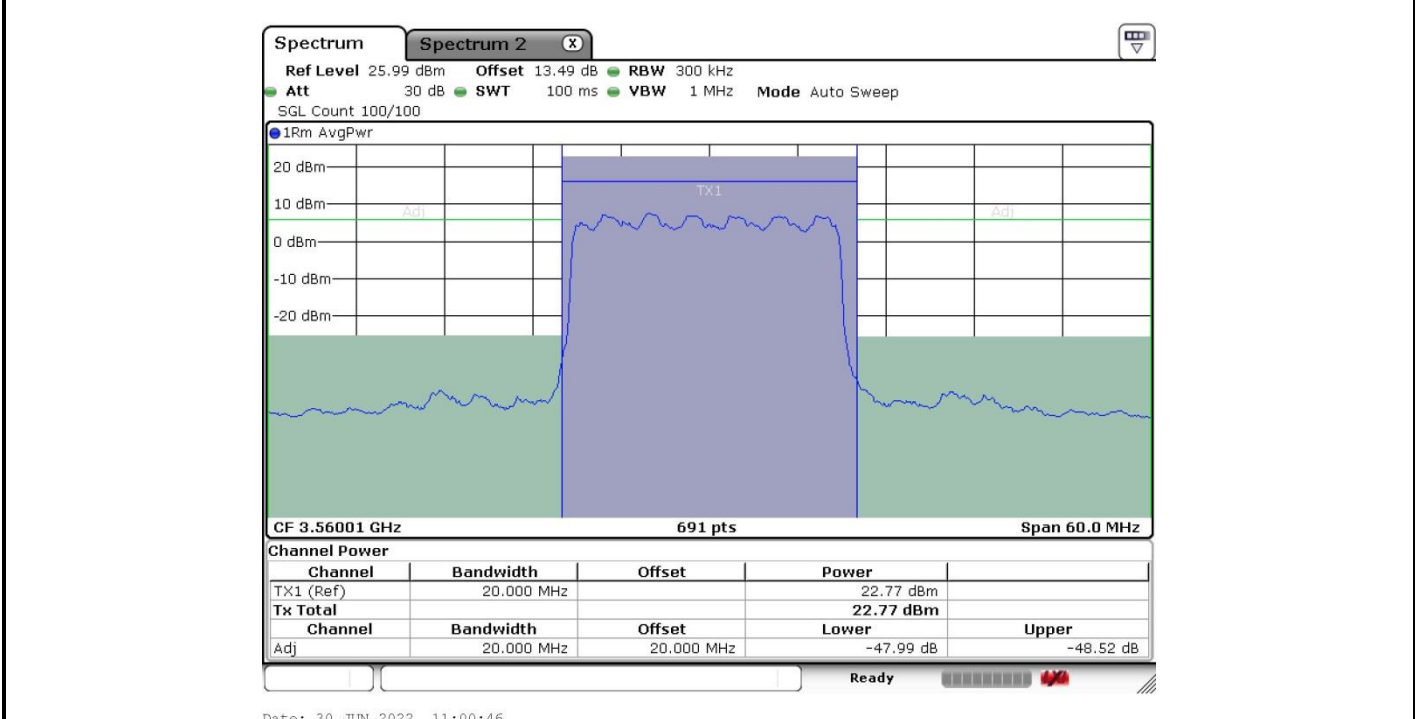



FR1 Part 96 n48 / 20MHz

BPSK

Middle Channel / 1RB0

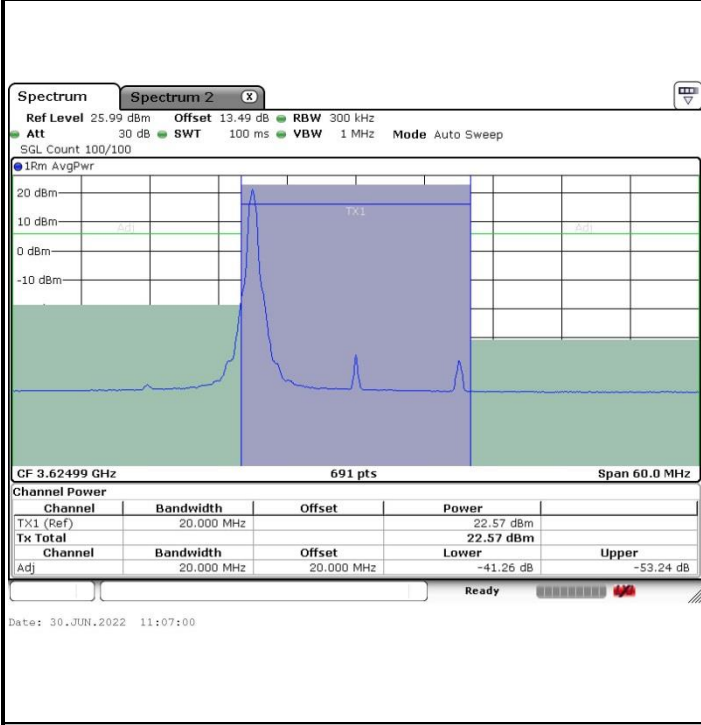

Middle Channel / 1RBmax

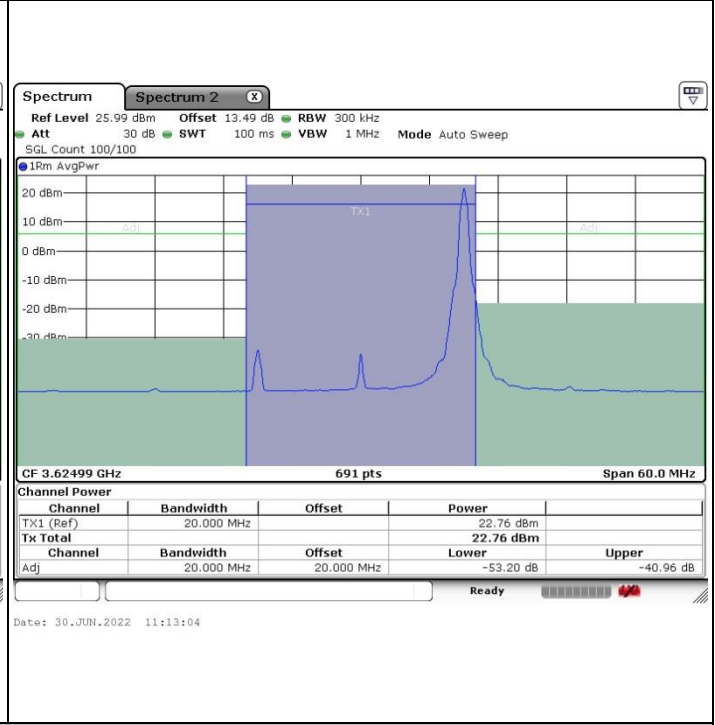

Middle Channel / FullRB

