



# FCC RF Test Report

FCC ID : UZ7ET45BA  
Equipment : Tablet  
Brand Name : Zebra  
Model Name : ET45BA  
Applicant : Zebra Technologies Corporation  
1 Zebra Plaza, Holtsville, NY 11742  
Manufacturer : Zebra Technologies Corporation  
1 Zebra Plaza, Holtsville, NY 11742  
Standard : 47 CFR Part 2, 27  
Classification : PCS Licensed Transmitter (PCB)  
TEST DATE(S) : Jun. 07, 2022 ~ Jul. 21, 2022

We, Sporton International Inc. (Kunshan), would like to declare that the tested sample has been evaluated in accordance with the procedures given in ANSI C63.26-2015 and shown compliance with the applicable technical standards.

The test results in this report apply exclusively to the tested model / sample. Without written approval of Sporton International Inc. (Kunshan), the test report shall not be reproduced except in full.

Jason Jia



Approved by: Jason Jia

**Sporton International Inc. (Kunshan)**

**No. 1098, Pengxi North Road, Kunshan Economic Development Zone Jiangsu Province 215300  
People's Republic of China**



TABLE OF CONTENTS

REVISION HISTORY..... 3
SUMMARY OF TEST RESULT ..... 4
1 GENERAL DESCRIPTION ..... 5
1.1 Product Feature of Equipment Under Test..... 5
1.2 Product Specification of Equipment Under Test..... 6
1.3 Modification of EUT ..... 7
1.4 Maximum ERP/EIRP and Emission Designator ..... 7
1.5 Testing Location ..... 9
1.6 Test Software..... 9
1.7 Applicable Standards..... 9
2 TEST CONFIGURATION OF EQUIPMENT UNDER TEST ..... 10
2.1 Test Mode ..... 10
2.2 Connection Diagram of Test System..... 12
2.3 Support Unit used in test configuration and system ..... 12
2.4 Measurement Results Explanation Example..... 12
2.5 Frequency List of Low/Middle/High Channels ..... 13
3 CONDUCTED TEST ITEMS ..... 15
3.1 Measuring Instruments ..... 15
3.2 Test Setup ..... 15
3.3 Test Result of Conducted Test ..... 15
3.4 Conducted Output Power and ERP/EIRP ..... 16
3.5 Peak-to-Average Ratio ..... 17
3.6 Occupied Bandwidth ..... 18
3.7 Conducted Band Edge ..... 19
3.8 Conducted Spurious Emission ..... 21
3.9 Frequency Stability ..... 22
4 RADIATED TEST ITEMS ..... 23
4.1 Measuring Instruments ..... 23
4.2 Test Setup ..... 23
4.3 Test Result of Radiated Test ..... 24
4.4 Radiated Spurious Emission ..... 25
5 LIST OF MEASURING EQUIPMENT ..... 26
6 UNCERTAINTY OF EVALUATION ..... 27
Appendix A. Test Results of Conducted Test
Appendix B. Test Results of Radiated Test
Appendix C. Test Setup Photographs





## SUMMARY OF TEST RESULT

Report Section	FCC Rule	Description	Limit	Result	Remark
3.4	§2.1046	Conducted Output Power	Reporting Only	PASS	-
	§27.50(h)(2)	Equivalent Isotropic Radiated Power (5G NR n7, n38, n41)	EIRP < 2Watt		
	§27.50(d)(4)	Equivalent Isotropic Radiated Power (5G NR n66)	EIRP < 1Watt		
3.5	§27.50(j)(4)	Peak-to-Average Ratio	<13 dB	PASS	-
3.6	§2.1049	Occupied Bandwidth	Reporting Only	PASS	-
3.7	§2.1051 §27.53(h)	Conducted Band Edge Measurement (5G NR n66)	< 43+10log <sub>10</sub> (P[Watts])	PASS	-
	§27.53(m)(4)	Conducted Band Edge Measurement (5G NR n7, n38, n41)	§27.53(m)(4)		
3.8	§2.1051 §27.53(h)	Conducted Spurious Emission (5G NR n66)	< 43+10log <sub>10</sub> (P[Watts])	PASS	-
	§2.1051 §27.53(m)(4)	Conducted Spurious Emission (5G NR n7, n38, n41)	< 55+10log <sub>10</sub> (P[Watts])		
3.9	§27.54	Frequency Stability Temperature & Voltage	Within Authorized Band	PASS	-
4.4	§2.1053 §27.53(h)	Radiated Spurious Emission (5G NR n66)	< 43+10log <sub>10</sub> (P[Watts])	PASS	Under limit 21.43 dB at 7632.000 MHz
	§2.1053 §27.53(m)(4)	Radiated Spurious Emission (5G NR n7, n38, n41)	< 55+10log <sub>10</sub> (P[Watts])		

**Declaration of Conformity:**

The test results with all measurement uncertainty excluded are presented in accordance with the regulation limits or requirements declared by manufacturers.

**Comments and Explanations:**

The declared of product specification for EUT presented in the report are provided by the manufacturer, and the manufacturer takes all the responsibilities for the accuracy of product specification.



# 1 General Description

## 1.1 Product Feature of Equipment Under Test

Product Feature	
Equipment	Tablet
Brand Name	Zebra
Model Name	ET45BA
FCC ID	UZ7ET45BA
HW Version	EV2-2
SW Version	ET45USERDEBUG 11 11-10-12.00-RG-U00-PRD-GSE MXJ release-keys
MFD	12MAY22
EUT Stage	Identical Prototype

Specification of Accessory				
Battery	Brand Name	Zebra	Model Number	BT-000455

Supported Unit Used in Test Configuration and System				
AC Adapter	Brand Name	Zebra	Part Number	PWR-WUA5V12W0US
Earphone 1	Brand Name	Zebra	Part Number	HDST-35MM-PTVP-01
Earphone 2	Brand Name	Zebra	Part Number	HDST-USBC-PTT1-01
USB Cable (Type C to Type A)	Brand Name	Zebra	Part Number	CBL-TC5X-USBC2A-01
Type C-Audio Cable (Type C to 3.5mm)	Brand Name	Zebra	Part Number	ADP-USBC-35MM1-01

## 1.2 Product Specification of Equipment Under Test

Standards-related Product Specification	
<b>Tx Frequency</b>	5G NR n7 : 2500 MHz ~ 2570 MHz 5G NR n38 : 2570 MHz ~ 2620 MHz 5G NR n41 : 2496 MHz ~ 2690 MHz 5G NR n66 : 1710 MHz ~ 1780 MHz
<b>Rx Frequency</b>	5G NR n7 : 2620 MHz ~ 2690 MHz 5G NR n38: 2570 MHz ~ 2620 MHz 5G NR n41 : 2496 MHz ~ 2690 MHz 5G NR n66 : 2110 MHz~ 2200 MHz
<b>Bandwidth</b>	<b>SA:</b> n7: 5MHz / 10MHz / 15MHz / 20MHz / 25MHz / 30MHz / 40MHz / 50MHz n38 : 20MHz / 30MHz / 40MHz n41 : 20MHz / 30MHz / 40MHz / 50MHz / 60MHz / 70MHz / 80MHz / 90MHz / 100MHz n66: 5MHz / 10MHz / 15MHz / 20MHz <b>NSA:</b> n7: 5MHz / 10MHz / 15MHz / 20MHz n38 : 20MHz / 30MHz / 40MHz n41 : 20MHz / 30MHz / 40MHz / 50MHz / 60MHz / 70MHz / 80MHz / 90MHz / 100MHz n66: 5MHz / 10MHz / 15MHz / 20MHz / 30MHz
<b>SCS</b>	n7, n66: 15kHz n38, n41: 30kHz
<b>Maximum Output Power to Antenna</b>	<b>&lt;Ant. 0&gt;:</b> 5G NR n7 : 23.58 dBm 5G NR 71A-n38 : 22.66 dBm 5G NR n66 : 23.90 dBm <b>&lt;Ant. 2&gt;:</b> 5G NR n41 : 25.07 dBm
<b>Antenna Gain</b>	<b>&lt;Ant. 0&gt;:</b> 5G NR n7: 2.6 dBi 5G NR n38: 2.4 dBi 5G NR n66: -0.9 dBi <b>&lt;Ant. 1&gt;:</b> 5G NR n41: 1.0 dBi <b>&lt;Ant. 2&gt;:</b> 5G NR n7: 2.0 dBi 5G NR n38: 1.0 dBi 5G NR n41: 2.0 dBi 5G NR n66: 1.7 dBi <b>&lt;Ant. 4&gt;:</b> 5G NR n41: -1.4 dBi <b>&lt;Ant. 5&gt;:</b> 5G NR n41: -1.9 dBi
<b>Type of Modulation</b>	CP-OFDM: QPSK / 16QAM / 64QAM / 256QAM DFT-s-OFDM: PI/2 BPSK / QPSK / 16QAM / 64QAM / 256QAM

**Remark:**

1. The maximum EIRP/ERP is calculated from max output power and max antenna gain, only the maximum EIRP/ERP of Antenna 0 for n7/n38/n66, and EIRP of Antenna 2 for n41 is shown in the report.



2. 5G NR n7/n66/n38/n41 support SA mode and NSA mode. According to the maximum power between SA and NSA mode, SA covers NSA mode for n7/n66/n41, and NSA covers SA mode for n38.
3. The EN-DC mode combination could be referred to the product spec.
4. The device supports HPUE mode for 5G NR n41.
5. The device supports n41(1T4R) SRS resources on ant.1/2/4/5, only the test data of worst ant.2 is showed in the report according to the maximum power.
6. The device supports two PAs for 5G NR n7/n38/n66 (main PA for SA mode and other PA for NSA mode), the maximum power of main PA is higher than the other PA for n7/n66 and other PA is higher than the main PA for 71A-n38A, therefore, we chose higher power PA to calculate the EIRP and show in the report.

### 1.3 Modification of EUT

No modifications are made to the EUT during all test items.

### 1.4 Maximum ERP/EIRP and Emission Designator

5G NR n7 SA		PI/2 BPSK / QPSK		16QAM / 64QAM / 256QAM	
BW (MHz)	Frequency Range (MHz)	Maximum EIRP(W)	Emission Designator (99%OBW)	Maximum EIRP(W)	Emission Designator (99%OBW)
5	2502.5 ~ 2567.5	0.3963	4M490G7D	0.3206	4M53W7D
10	2505.0 ~ 2565.0	0.4027	9M41G7D	0.3251	9M41W7D
15	2507.5 ~ 2562.5	0.3846	14M2G7D	0.3097	14M2W7D
20	2510.0 ~ 2560.0	0.3811	19M4G7D	0.3013	19M5W7D
25	2512.5 ~ 2557.5	0.3926	23M8G7D	0.3926	23M8W7D
30	2515.0 ~ 2555.0	0.3917	28M5G7D	0.3170	28M6W7D
40	2520.0 ~ 2550.0	0.4121	38M8G7D	0.3311	38M9W7D
50	2525.0 ~ 2545.0	0.4150	48M2G7D	0.3228	48M5W7D

5G NR n38 NSA (EN DC_71A-n38A)		PI/2 BPSK / QPSK		16QAM / 64QAM / 256QAM	
BW (MHz)	Frequency Range (MHz)	Maximum EIRP(W)	Emission Designator (99%OBW)	Maximum EIRP(W)	Emission Designator (99%OBW)
20	2580.0 ~ 2610.0	0.3097	18M7G7D	0.2323	18M9W7D
30	2585.0 ~ 2605.0	0.3199	27M8G7D	0.2449	27M9W7D
40	2590.0 ~ 2600.0	0.3206	38M0G7D	0.2404	38M4W7D



5G NR n41 SA		PI/2 BPSK / QPSK		16QAM / 64QAM / 256QAM	
BW (MHz)	Frequency Range (MHz)	Maximum EIRP(W)	Emission Designator (99%OBW)	Maximum EIRP(W)	Emission Designator (99%OBW)
20	2506.02 ~ 2679.99	0.5023	18M2G7D	0.4217	18M9W7D
30	2511.00 ~ 2674.98	0.5070	27M8G7D	0.4345	27M9W7D
40	2516.01 ~ 2670.00	0.5082	38M1G7D	0.4217	38M0W7D
50	2521.02 ~ 2664.99	0.5047	47M6G7D	0.4305	47M5W7D
60	2526.00 ~ 2659.98	0.5070	57M8G7D	0.4416	57M9W7D
70	2531.01 ~ 2655.00	0.5035	66M9G7D	0.4355	67M5W7D
80	2536.02 ~ 2649.99	0.4943	77M5G7D	0.4121	77M4W7D
90	2541.00 ~ 2644.98	0.5070	87M6G7D	0.4305	87M8W7D
100	2546.01 ~ 2640.00	0.5093	98M3G7D	0.4159	98M1W7D

5G NR n66 SA		PI/2 BPSK / QPSK		16QAM / 64QAM / 256QAM	
BW (MHz)	Frequency Range (MHz)	Maximum EIRP(W)	Emission Designator (99%OBW)	Maximum EIRP(W)	Emission Designator (99%OBW)
5	1712.5 ~ 1777.5	0.1982	4M47G7D	0.1592	4M49W7D
10	1715.0 ~ 1775.0	0.1986	9M39G7D	0.1633	9M43W7D
15	1717.5 ~ 1772.5	0.1871	14M1G7D	0.1633	14M2W7D
20	1720.0 ~ 1770.0	0.1995	19M5G7D	0.1567	19M6W7D

5G NR n66 NSA (EN DC_12A-n66A)		PI/2 BPSK / QPSK		16QAM / 64QAM / 256QAM	
BW (MHz)	Frequency Range (MHz)	Maximum EIRP(W)	Emission Designator (99%OBW)	Maximum EIRP(W)	Emission Designator (99%OBW)
5	1712.5 ~ 1777.5	0.1730	4M49G7D	0.1560	4M49W7D
10	1715.0 ~ 1775.0	0.1799	9M41G7D	0.1560	9M37W7D
15	1717.5 ~ 1772.5	0.1726	14M1G7D	0.1535	14M2W7D
20	1720.0 ~ 1770.0	0.1722	19M6G7D	0.1538	19M4W7D
30	1725.0 ~ 1765.0	0.1807	28M5G7D	0.1563	28M5W7D

**Note:**

1. All modulations have been tested, and only the worst test results of PSK & QAM are shown in the report.
2. For 5G NR n66, according to the maximum power between SA and NSA mode, SA covers NSA mode.  
And 5G NR n66 NSA supports BW 30MHz, it is tested in the report.





### 1.5 Testing Location

<b>Test Firm</b>	Sporton International Inc. (Kunshan)		
<b>Test Site Location</b>	No. 1098, Pengxi North Road, Kunshan Economic Development Zone Jiangsu Province 215300 People's Republic of China TEL : +86-512-57900158 FAX : +86-512-57900958		
<b>Test Site No.</b>	<b>Sporton Site No.</b>	<b>FCC Designation No.</b>	<b>FCC Test Firm Registration No.</b>
	03CH04-KS TH01-KS	CN1257	314309

### 1.6 Test Software

Item	Site	Manufacturer	Name	Version
1.	03CH04-KS	AUDIX	E3	6.2009-8-24a

### 1.7 Applicable Standards

According to the specifications of the manufacturer, the EUT must comply with the requirements of the following standards:

- ♦ 47 CFR Part 2, 22, 24, 27
- ♦ ANSI C63.26-2015
- ♦ FCC KDB 971168 D01 Power Meas License Digital Systems v03r01
- ♦ FCC KDB 412172 D01 Determining ERP and EIRP v01r01

**Remark:**

All test items were verified and recorded according to the standards and without any deviation during the test.



## 2 Test Configuration of Equipment Under Test

### 2.1 Test Mode

Antenna port conducted and radiated test items are performed according to KDB 971168 D01 Power Meas License Digital Systems v03r01 with maximum output power.

For radiated measurement, pre-scanned in three orthogonal panels, X, Y, Z and accessory configurations. The worst-cases were recorded in this report.

The device is investigated from 30MHz to 10 times of fundamental signal for radiated spurious emission test under different RB size/offset and modulations in exploratory test. Subsequently, only the worst case emissions are reported.

Test Items	5G NR	Bandwidth (MHz)											Modulation					RB #		Test Channel		
		5	10	15	20	25	30	40	50	60	70-90	100	PI/2 BPSK	QPSK	16QAM	64QAM	256 QAM	1	Full	L	M	H
Max. Output Power	n7	v	v	v	v	v	v	v	v	-	-	-	v	v	v	v	v	v	v	v	v	v
	n38	-	-	-	v	-	v	v	-	-	-	-	v	v	v	v	v	v	v	v	v	v
	n41	-	-	-	v	-	v	v	v	v	v	v	v	v	v	v	v	v	v	v	v	v
	n66	v	v	v	v	-	v	-	-	-	-	-	v	v	v	v	v	v	v	v	v	v
Peak-to-Average Ratio	n7				v					-	-	-	v	v				v	v	v	v	v
	n38	-	-	-	v	-				-			v	v				v	v	v	v	v
	n41	-	-	-	v	-							v	v				v	v	v	v	v
	n66				v	-		-	-	-	-	-	v	v				v	v	v	v	v
26dB and 99% Bandwidth	n7	v	v	v	v	v	v	v	v	-	-	-		v	v	v	v		v		v	
	n38	-	-	-	v	-	v	v	-	-	-	-		v	v	v	v		v		v	
	n41	-	-	-	v	-	v	v	v	v	v	v		v	v	v	v		v		v	
	n66	v	v	v	v	-	v	-	-	-	-	-		v	v	v	v		v		v	



Test Items	5G NR	Bandwidth (MHz)											Modulation				RB #		Test Channel			
		5	10	15	20	25	30	40	50	60	70-90	100	PI/2 BPSK	QPSK	16QAM	64QAM	256 QAM	1	Full	L	M	H
Conducted Band Edge	n7	v	v		v				v	-	-	-	v	v				v	v	v		v
	n38	-	-	-	v	-	v	v	-				v	v				v	v	v		v
	n41	-	-	-	v	-				v			v	v				v	v	v		v
	n66	v	v		v	-	v	-	-	-	-	-	v	v				v	v	v		v
Conducted Spurious Emission	n7	v	v		v				v	-	-	-	v	v				v		v	v	v
	n38	-	-	-	v	-	v	v	-				v	v				v		v	v	v
	n41	-	-	-	v	-				v			v	v				v		v	v	v
	n66	v	v		v	-	v	-	-	-	-	-	v	v				v		v	v	v
Frequency Stability	n7				v					-	-	-		v				v		v		
	n38	-	-	-	v	-				-				v				v		v		
	n41	-	-	-	v	-								v				v		v		
	n66				v	-		-	-	-	-	-		v				v		v		
E.R.P / E.I.R.P	n7	v	v	v	v	v	v	v	v	-	-	-	v	v	v	v	v	v	v	v	v	v
	n38	-	-	-	v	-	v	v	-	-	-	-	v	v	v	v	v	v	v	v	v	v
	n41	-	-	-	v	-	v	v	v	v	v	v	v	v	v	v	v	v	v	v	v	v
	n66	v	v	v	v	-	v	-	-	-	-	-	v	v	v	v	v	v	v	v	v	v
Radiated Spurious Emission	n7	Worst Case																	v	v	v	
	n38	Worst Case																	v	v	v	
	n41	Worst Case																	v	v	v	
	n66	Worst Case																	v	v	v	
Note	1. The mark "v" means that this configuration is chosen for testing 2. The mark "-" means that this bandwidth is not supported. 3. The device is investigated from 30MHz to 10 times of fundamental signal for radiated spurious emission test under different RB size/offset and modulations in exploratory test. Subsequently, only the worst case emissions are reported. 4. Based on engineering evaluation, only the worst modulation test results are shown in the report. 5. Frequency Stability : Normal Voltage = 3.87V ; Low Voltage =3.55V. ; High Voltage =4.45V																					

## 2.2 Connection Diagram of Test System

Adapter Mode:

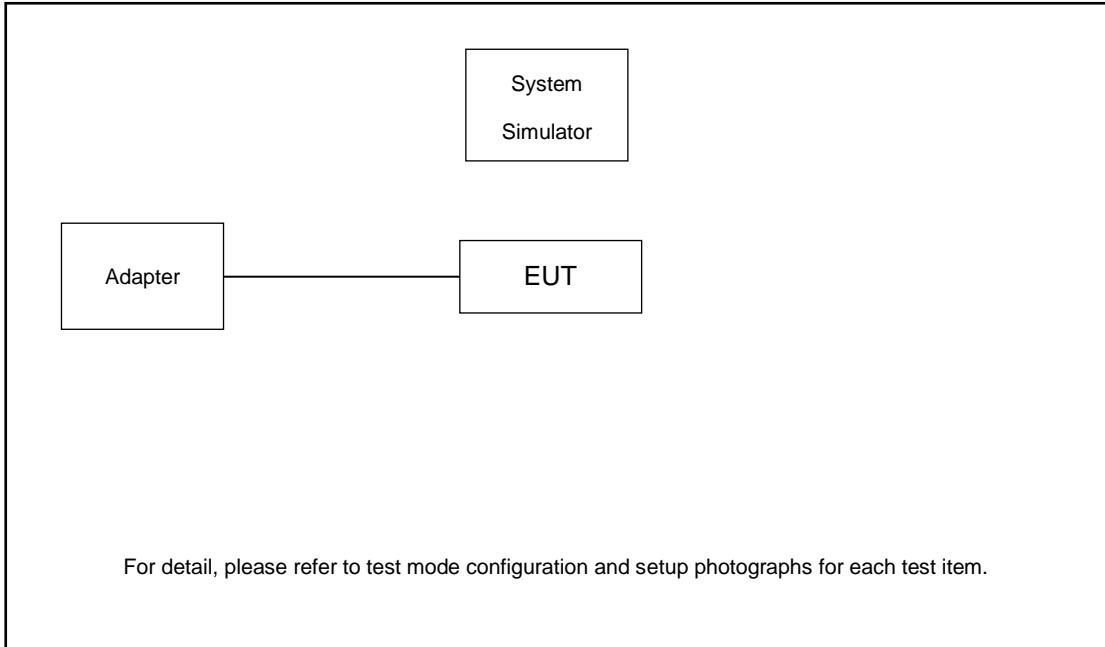

## 2.3 Support Unit used in test configuration and system

Item	Equipment	Trade Name	Model No.	FCC ID	Data Cable	Power Cord
1.	DC Power Supply	GW	GPS-3030D	N/A	N/A	Unshielded, 1.8 m
2.	LTE Base Station	Anritsu	MT8820/8821	N/A	N/A	Unshielded, 1.8 m
3.	NR Base Station	Anritsu	MT8000A	N/A	N/A	Unshielded, 1.8 m

## 2.4 Measurement Results Explanation Example

**For all conducted test items:**

The offset level is set in the spectrum analyzer to compensate the RF cable loss between EUT conducted output port and spectrum analyzer. With the offset compensation, the spectrum analyzer reading level is exactly the EUT RF output level.

The spectrum analyzer offset is derived from RF cable loss.

*Offset = RF cable loss.*

Following shows an offset computation example with cable loss 6.0 dB.

Example :

$$\begin{aligned} \text{Offset(dB)} &= \text{RF cable loss(dB)}. \\ &= 6.0 \text{ (dB)} \end{aligned}$$



### 2.5 Frequency List of Low/Middle/High Channels

5G NR n7 Channel and Frequency List				
BW [MHz]	Channel/Frequency(MHz)	Lowest	Middle	Highest
50	Channel	529000	531000	533000
	Frequency	2525	2535	2545
40	Channel	528000	531000	534000
	Frequency	2520	2535	2550
30	Channel	527000	531000	535000
	Frequency	2515	2535	2555
25	Channel	526500	531000	535500
	Frequency	2512.5	2535	2557.5
20	Channel	526000	531000	536000
	Frequency	2510	2535	2560
15	Channel	525500	531000	536500
	Frequency	2507.5	2535	2562.5
10	Channel	525000	531000	537000
	Frequency	2505	2535	2565
5	Channel	524500	531000	537500
	Frequency	2502.5	2535	2567.5

5G NR n38 Channel and Frequency List				
BW [MHz]	Channel/Frequency(MHz)	Lowest	Middle	Highest
40	Channel	518000	519000	520000
	Frequency	2590	2595	2600
30	Channel	517000	519000	521000
	Frequency	2585	2595	2605
20	Channel	516000	519000	522000
	Frequency	2580	2595	2610



5G NR n41 Channel and Frequency List				
BW [MHz]	Channel/Frequency(MHz)	Lowest	Middle	Highest
100	Channel	509202	518598	528000
	Frequency	2546.01	2592.99	2640
90	Channel	508200	518598	528996
	Frequency	2541	2592.99	2644.98
80	Channel	507204	518598	529998
	Frequency	2536.02	2592.99	2649.99
70	Channel	506202	518598	531000
	Frequency	2531.01	2592.99	2655
60	Channel	505200	518598	531996
	Frequency	2526	2592.99	2659.98
50	Channel	504204	518598	532998
	Frequency	2521.02	2592.99	2664.99
40	Channel	503202	518598	534000
	Frequency	2516.01	2592.99	2670
30	Channel	502200	518598	534996
	Frequency	2511	2592.99	2674.98
20	Channel	501204	518598	535998
	Frequency	2506.02	2592.99	2679.99

5G NR n66 Channel and Frequency List				
BW [MHz]	Channel/Frequency(MHz)	Lowest	Middle	Highest
30	Channel	425000	429000	433000
	Frequency	1725	1745	1765
20	Channel	424000	429000	434000
	Frequency	1720	1745	1770
15	Channel	423500	429000	434500
	Frequency	1717.5	1745	1772.5
10	Channel	423000	429000	435000
	Frequency	1715	1745	1775
5	Channel	422500	429000	435500
	Frequency	1712.5	1745	1777.5

### 3 Conducted Test Items

#### 3.1 Measuring Instruments

See list of measuring instruments of this test report.

#### 3.2 Test Setup

##### 3.2.1 Conducted Output Power

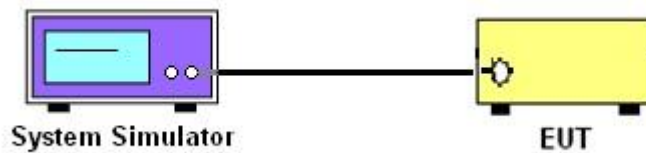

##### 3.2.2 Peak-to-Average Ratio, Occupied Bandwidth, Conducted Band-Edge and Conducted Spurious Emission

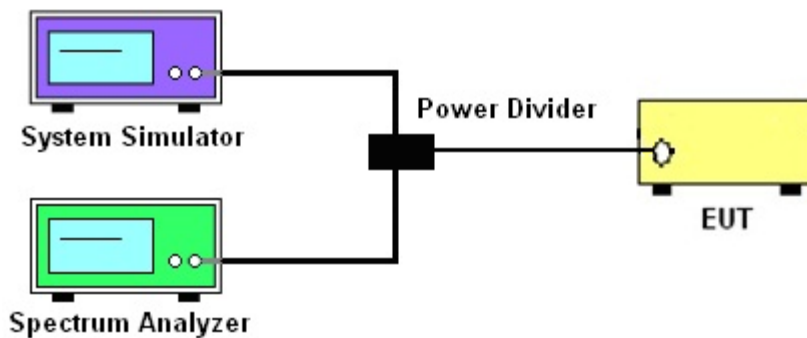

##### 3.2.3 Frequency Stability

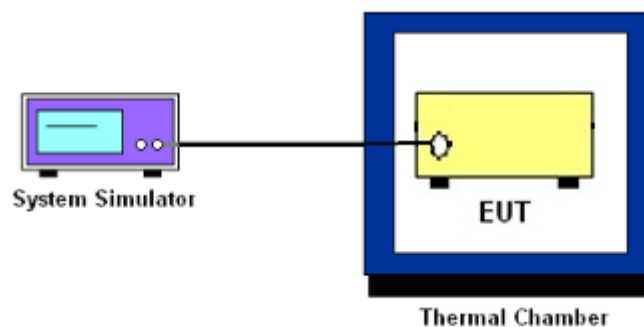

### 3.3 Test Result of Conducted Test

Please refer to Appendix A.



### 3.4 Conducted Output Power and ERP/EIRP

#### 3.4.1 Description of the Conducted Output Power Measurement and ERP/EIRP Measurement

A system simulator was used to establish communication with the EUT. Its parameters were set to force the EUT transmitting at maximum output power. The measured power in the radio frequency on the transmitter output terminals shall be reported.

The EIRP of mobile transmitters must not exceed 2 Watts for 5G NR n7, n38 and n41.

The EIRP of mobile transmitters must not exceed 1 Watts for 5G NR n66.

According to KDB 412172 D01 Power Approach,

$EIRP = P_T + G_T - L_C$ ,  $ERP = EIRP - 2.15$ , where

$P_T$  = transmitter output power in dBm

$G_T$  = gain of the transmitting antenna in dBi

$L_C$  = signal attenuation in the connecting cable between the transmitter and antenna in dB

#### 3.4.2 Test Procedures

1. The testing follows ANSI C63.26 Section 5.2
2. The transmitter output port was connected to the system simulator.
3. Set EUT at maximum power through the system simulator.
4. Select lowest, middle, and highest channels for each band and different modulation.
5. Measure and record the power level from the system simulator.





### 3.5 Peak-to-Average Ratio

#### 3.5.1 Description of the PAR Measurement

Power Complementary Cumulative Distribution Function (CCDF) curves provide a means for characterizing the power peaks of a digitally modulated signal on a statistical basis. A CCDF curve depicts the probability of the peak signal amplitude exceeding the average power level. Most contemporary measurement instrumentation include the capability to produce CCDF curves for an input signal provided that the instrument's resolution bandwidth can be set wide enough to accommodate the entire input signal bandwidth. In measuring transmissions in this band using an average power technique, the peak-to-average ratio (PAR) of the transmission may not exceed 13 dB.

#### 3.5.2 Test Procedures

1. The testing follows ANSI C63.26 Section 5.2.6 (PAPR).
2. The EUT was connected to spectrum and system simulator via a power divider.
3. Set EUT in maximum power output.
4. Set the RBW = 1MHz, VBW = 3MHz, Detector = Peak, Trace mode = max hold, Set span  $\geq 2 \times$  OBW in spectrum analyzer.
5. Set the RBW = 1MHz, VBW = 3MHz, Detector = power averaging, Trace mode = max hold, Set span  $\geq 2 \times$  OBW in spectrum analyzer.
6. Add  $[10 \log (1/\text{duty cycle})]$  to the measured maximum power level to compute the average power during continuous transmission.

7.  $PAPR \text{ (dB)} = P_{Pk} \text{ (dBm)} - P_{Avg} \text{ (dBm)}$

where

PAPR peak-to-average power ratio, in dB

$P_{Pk}$  measured peak power level, in dBm

$P_{Avg}$  measured average power level, in dBm

8. Record the deviation as Peak to Average Ratio.



### 3.6 Occupied Bandwidth

#### 3.6.1 Description of Occupied Bandwidth Measurement

The occupied bandwidth is the width of a frequency band such that, below the lower and above the upper frequency limits, the mean powers emitted are each equal to a specified percentage 0.5% of the total mean transmitted power.

The 26 dB emission bandwidth is defined as the frequency range between two points, one above and one below the carrier frequency, at which the spectral density of the emission is attenuated 26 dB below the maximum in-band spectral density of the modulated signal. Spectral density (power per unit bandwidth) is to be measured with a detector of resolution bandwidth equal to approximately 1.0% of the emission bandwidth.

#### 3.6.2 Test Procedures

1. The testing follows ANSI C63.26 Section 5.4
2. The EUT was connected to spectrum analyzer and system simulator via a power divider.
3. The spectrum analyzer center frequency is set to the nominal EUT channel center frequency. The span range for the spectrum analyzer shall be between two and five times the anticipated OBW.
4. The nominal resolution bandwidth (RBW) shall be in the range of 1 to 5 % of the anticipated OBW, and the VBW shall be at least 3 times the RBW.
5. Set the detection mode to peak, and the trace mode to max hold.
6. Determine the reference value: Set the EUT to transmit a modulated signal. Allow the trace to stabilize. Set the spectrum analyzer marker to the highest level of the displayed trace.  
(this is the reference value)
7. Determine the “-26 dB down amplitude” as equal to (Reference Value – X).
8. Place two markers, one at the lowest and the other at the highest frequency of the envelope of the spectral display such that each marker is at or slightly below the “-X dB down amplitude” determined in step 6. If a marker is below this “-X dB down amplitude” value it shall be placed as close as possible to this value. The OBW is the positive frequency difference between the two markers.
9. Use the 99 % power bandwidth function of the spectrum analyzer and report the measured bandwidth.



## 3.7 Conducted Band Edge

### 3.7.1 Description of Conducted Band Edge Measurement

27.53 (h)

For operations in the 1710 – 1755 MHz band, the FCC limit is  $43 + 10\log_{10}(P[\text{Watts}])$  dB below the transmitter power  $P(\text{Watts})$  in a 1 MHz bandwidth. However, in the 1MHz bands immediately outside and adjacent to the licensee's frequency block, a resolution bandwidth of at least one percent of the emission bandwidth of the fundamental emission of the transmitter may be employed.

27.53(m)(4)

For mobile digital stations, the attenuation factor shall be not less than  $40 + 10 \log (P)$  dB on all frequencies between the channel edge and 5 megahertz from the channel edge,  $43 + 10 \log (P)$  dB on all frequencies between 5 megahertz and X megahertz from the channel edge, and  $55 + 10 \log (P)$  dB on all frequencies more than X megahertz from the channel edge, where X is the greater of 6 megahertz or the actual emission bandwidth as defined in paragraph (m)(6) of this section. In addition, the attenuation factor shall not be less that  $43 + 10 \log (P)$  dB on all frequencies between 2490.5 MHz and 2496 MHz and  $55 + 10 \log (P)$  dB at or below 2490.5 MHz. Mobile Satellite Service licensees operating on frequencies below 2495 MHz may also submit a documented interference complaint against BRS licensees operating on channel BRS Channel 1 on the same terms and conditions as adjacent channel BRS or EBS licensees.



### 3.7.2 Test Procedures

1. The testing follows ANSI C63.26 section 5.7
2. The EUT was connected to spectrum analyzer and system simulator via a power divider.
3. The band edges of low and high channels for the highest RF powers were measured.
4. Set RBW  $\geq$  1% EBW in the 1MHz band immediately outside and adjacent to the band edge.
5. Beyond the 1 MHz band from the band edge, RBW=1MHz was used.
6. Set spectrum analyzer with RMS detector.
7. The RF fundamental frequency should be excluded against the limit line in the operating frequency band.
8. Checked that all the results comply with the emission limit line.

Example:

The limit line is derived from  $43 + 10\log(P)$ dB below the transmitter power P(Watts)  
= P(W)- [43 + 10log(P)] (dB)  
= [30 + 10log(P)] (dBm) - [43 + 10log(P)] (dB) = -13dBm.

9. For 5G NR n7/n38/n41, the other 40 dB, and 55 dB have additionally applied same calculation above.
10. When using the integration method, the starting frequency of the integration shall be centered at one-half of the RBW away from the band edge.



### 3.8 Conducted Spurious Emission

#### 3.8.1 Description of Conducted Spurious Emission Measurement

The power of any emission outside of the authorized operating frequency ranges must be lower than the transmitter power (P) by a factor of at least  $43 + 10 \log (P)$  dB.

For 5G NR n7/n38/n41:

The power of any emission outside of the authorized operating frequency ranges must be lower than the transmitter power (P) by a factor of at least  $55 + 10 \log (P)$  dB.

It is measured by means of a calibrated spectrum analyzer and scanned from 30 MHz up to a frequency including its 10<sup>th</sup> harmonic.

#### 3.8.2 Test Procedures

1. The testing follows ANSI C63.26 section 5.7
2. The EUT was connected to spectrum analyzer and system simulator via a power divider.
3. The RF output of EUT was connected to the spectrum analyzer by RF cable and attenuator. The path loss was compensated to the results for each measurement.
4. The middle channel for the highest RF power within the transmitting frequency was measured.
5. The conducted spurious emission for the whole frequency range was taken.
6. Make the measurement with the spectrum analyzer's RBW = 1MHz, VBW = 3MHz.
7. Set spectrum analyzer with RMS detector.
8. Taking the record of maximum spurious emission.
9. The RF fundamental frequency should be excluded against the limit line in the operating frequency band.
10. The limit line is derived from  $43 + 10\log(P)$ dB below the transmitter power P(Watts)  
 $= P(W) - [43 + 10\log(P)]$  (dB)  
 $= [30 + 10\log(P)]$  (dBm) -  $[43 + 10\log(P)]$  (dB)  
 $= -13$ dBm.
11. For 5G NR n7/n38/n41  
The limit line is derived from  $55 + 10\log(P)$ dB below the transmitter power P(Watts)  
 $= P(W) - [55 + 10\log(P)]$  (dB)  
 $= [30 + 10\log(P)]$  (dBm) -  $[55 + 10\log(P)]$  (dB)  
 $= -25$ dBm.



## 3.9 Frequency Stability

### 3.9.1 Description of Frequency Stability Measurement

The frequency stability shall be measured by variation of ambient temperature and variation of primary supply voltage to ensure that the fundamental emission stays within the authorized frequency block. The frequency stability of the transmitter shall be maintained within  $\pm 0.00025\%$  ( $\pm 2.5\text{ppm}$ ) of the center frequency.

### 3.9.2 Test Procedures for Temperature Variation

1. The testing follows ANSI C63.26 section 5.6.4
2. The EUT was set up in the thermal chamber and connected with the system simulator.
3. With power OFF, the temperature was decreased to  $-30^{\circ}\text{C}$  and the EUT was stabilized before testing. Power was applied and the maximum change in frequency was recorded within one minute.
4. With power OFF, the temperature was raised in  $10^{\circ}\text{C}$  step up to  $50^{\circ}\text{C}$ . The EUT was stabilized at each step for at least half an hour. Power was applied and the maximum frequency change was recorded within one minute.

### 3.9.3 Test Procedures for Voltage Variation

1. The testing follows ANSI C63.26 section 5.6.5
2. The EUT was placed in a temperature chamber at  $20\pm 5^{\circ}\text{C}$  and connected with the system simulator.
3. The power supply voltage to the EUT was varied from 85% to 115% of the nominal value for other than hand carried battery equipment.
4. For hand carried, battery powered equipment, reduce the primary ac or dc supply voltage to the battery operating end point, which shall be specified by the manufacturer.
5. The variation in frequency was measured for the worst case.

## 4 Radiated Test Items

### 4.1 Measuring Instruments

See list of measuring instruments of this test report.

### 4.2 Test Setup

#### 4.2.1 For radiated test below 30MHz

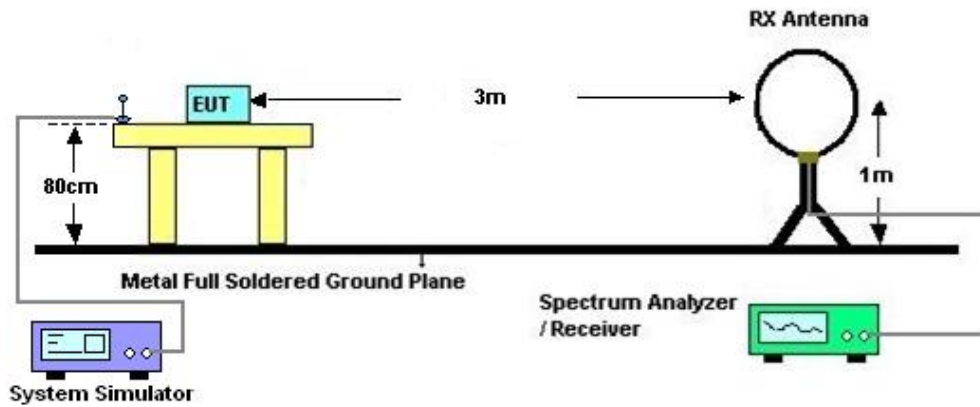

#### 4.2.2 For radiated test from 30MHz to 1GHz

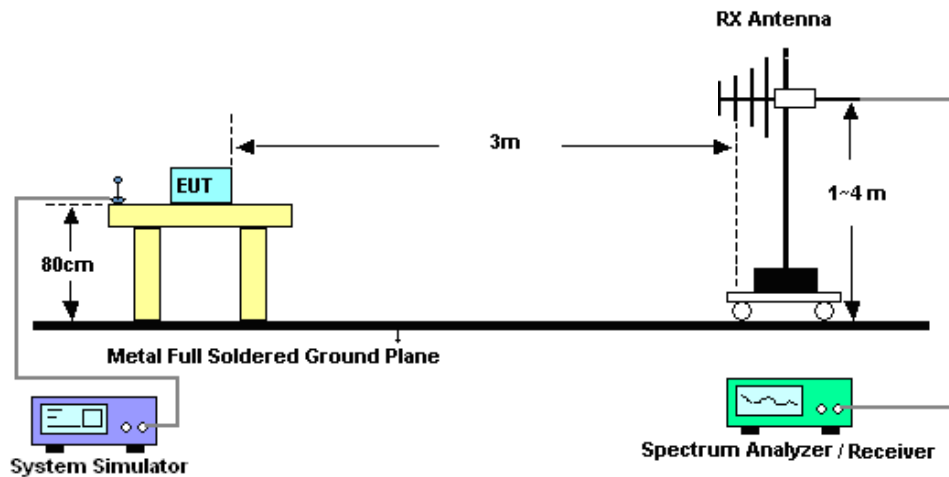

#### 4.2.3 For radiated test above 1GHz

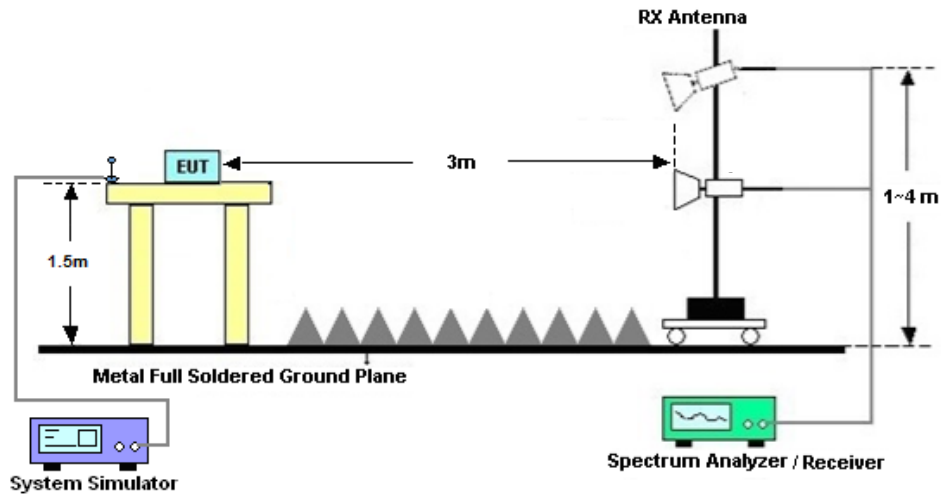

#### 4.3 Test Result of Radiated Test

The low frequency, which started from 9 kHz to 30MHz, was pre-scanned and the result which was 20dB lower than the limit line was not reported.

Please refer to Appendix B.





## 4.4 Radiated Spurious Emission

### 4.4.1 Description of Radiated Spurious Emission

The radiated spurious emission was measured by substitution method according to ANSI C63.26. The power of any emission outside of the authorized operating frequency ranges must be attenuated below the transmitter power (P) by a factor of at least  $43 + 10 \log (P)$  dB.

For 5G NR n7/n38/n41

The power of any emission outside of the authorized operating frequency ranges must be attenuated below the transmitter power (P) by a factor of at least  $55 + 10 \log (P)$  dB.

The spectrum is scanned from 30 MHz up to a frequency including its 10th harmonic.

### 4.4.2 Test Procedures

1. The testing follows ANSI C63.26 Section 5.5
2. The EUT was placed on a turntable with 0.8 meter height for frequency below 1GHz and 1.5 meter height for frequency above 1GHz respectively above ground.
3. The EUT was set 3 meters from the receiving antenna mounted on the antenna tower.
4. The table was rotated 360 degrees to determine the position of the highest spurious emission.
5. The height of the receiving antenna is varied between 1m to 4m to search the maximum spurious emission for both horizontal and vertical polarizations.
6. During the measurement, the system simulator parameters were set to force the EUT transmitting at maximum output power.
7. Make the measurement with the spectrum analyzer's RBW = 1MHz, VBW = 3MHz, taking the record of maximum spurious emission.
8. A horn antenna was substituted in place of the EUT and was driven by a signal generator.
9. Tune the output power of signal generator to the same emission level with EUT maximum spurious emission.
10.  $EIRP (dBm) = S.G. Power - Tx Cable Loss + Tx Antenna Gain$
11.  $ERP (dBm) = EIRP - 2.15$
12. The RF fundamental frequency should be excluded against the limit line in the operating frequency band.

The limit line is derived from  $43 + 10\log(P)$ dB below the transmitter power P(Watts)  
 $= P(W) - [43 + 10\log(P)] (dB)$   
 $= [30 + 10\log(P)] (dBm) - [43 + 10\log(P)] (dB)$   
 $= -13dBm.$

13. For 5G NR n7/n38/n41:

The limit line is derived from  $55 + 10\log(P)$ dB below the transmitter power P(Watts)The limit line is derived from  $55 + 10\log(P)$ dB below the transmitter power P(Watts)



## 5 List of Measuring Equipment

Instrument	Manufacturer	Model No.	Serial No.	Characteristics	Calibration Date	Test Date	Due Date	Remark
Spectrum Analyzer	R&S	FSV40	101040	10Hz~40GHz	Oct. 14, 2021	Jun. 07, 2022~ Jul. 21, 2022	Oct. 13, 2022	Conducted (TH01-KS)
Power divider	STI	STI08-0055	-	0.5~40GHz	Aug. 26, 2021	Jun. 07, 2022~ Jul. 21, 2022	Aug. 25, 2022	Conducted (TH01-KS)
Temperature & humidity chamber	Hongzhan	LP-150U	H2014011440	-40~+150°C 20%~95%RH	Jul. 12, 2021	Jun. 07, 2022~ Jul. 21, 2022	Jul. 11, 2022	Conducted (TH01-KS)
Temperature & humidity chamber	Hongzhan	LP-150U	H2014011440	-40~+150°C 20%~95%RH	Jul. 11, 2022		Jul. 10, 2023	Conducted (TH01-KS)
EXA Spectrum Analyzer	Keysight	N9010B	MY57541079	10Hz-44G,MAX 30dB	Oct. 14, 2021	Jun. 24, 2022	Oct. 13, 2022	Radiation (03CH04-KS)
Loop Antenna	R&S	HFH2-Z2	100321	9kHz~30MHz	Oct. 30, 2021	Jun. 24, 2022	Oct. 29, 2022	Radiation (03CH04-KS)
Bilog Antenna	TeseQ	CBL6111D	49922	30MHz-1GHz	May 30, 2022	Jun. 24, 2022	May 29, 2023	Radiation (03CH04-KS)
Horn Antenna	Schwarzbeck	BBHA9120D	1284	1GHz~18GHz	Oct. 18, 2021	Jun. 24, 2022	Oct. 18, 2022	Radiation (03CH04-KS)
SHF-EHF Horn	Com-power	AH-840	101070	18GHz~40GHz	Jan. 05, 2022	Jun. 24, 2022	Jan. 04, 2023	Radiation (03CH04-KS)
Amplifier	SONOMA	310N	187289	9KHz-1GHz	Jan. 05, 2022	Jun. 24, 2022	Jan. 04, 2023	Radiation (03CH04-KS)
Amplifier	MITEQ	EM18G40G GA	060728	18~40GHz	Jan. 05, 2022	Jun. 24, 2022	Jan. 04, 2023	Radiation (03CH04-KS)
high gain Amplifier	MITEQ	AMF-7D-00 101800-30-1 0P	2025788	1Ghz-18Ghz	Jul. 30, 2021	Jun. 24, 2022	Jul. 29, 2022	Radiation (03CH04-KS)
Amplifier	Keysight	83017A	MY57280106	500MHz~26.5GHz	Oct. 13, 2021	Jun. 24, 2022	Oct. 12, 2022	Radiation (03CH04-KS)
AC Power Source	Chroma	61601	F104090004	N/A	NCR	Jun. 24, 2022	NCR	Radiation (03CH04-KS)
Turn Table	ChamPro	EM 1000-T	060762-T	0~360 degree	NCR	Jun. 24, 2022	NCR	Radiation (03CH04-KS)
Antenna Mast	ChamPro	EM 1000-A	060762-A	1 m~4 m	NCR	Jun. 24, 2022	NCR	Radiation (03CH04-KS)

NCR: No Calibration Required



## 6 Uncertainty of Evaluation

The measurement uncertainties shown below were calculated in accordance with the requirements of ANSI 63.26-2015. All the measurement uncertainty value were shown with a coverage K=2 to indicate 95% level of confidence. The measurement data show herein meets or exceeds the CISPR measurement uncertainty values specified in CISPR 16-4-2 and can be compared directly to specified limit to determine compliance.

### Uncertainty of Radiated Emission Measurement (30 MHz ~ 1000 MHz)

Measuring Uncertainty for a Level of Confidence of 95% (U = 2Uc(y))	3.3dB
---	-------

### Uncertainty of Radiated Emission Measurement (1 GHz ~ 18 GHz)

Measuring Uncertainty for a Level of Confidence of 95% (U = 2Uc(y))	2.8dB
---	-------

### Uncertainty of Radiated Emission Measurement (18 GHz ~ 40 GHz)

Measuring Uncertainty for a Level of Confidence of 95% (U = 2Uc(y))	2.8dB
---	-------

----- THE END -----



## Appendix A. Test Results of Conducted Test

Test Engineer :	Simle Wang	Temperature :	22~23°C
		Relative Humidity :	40~42%

### Conducted Output Power(Average power) and ERP/EIRP

5G NR n7										
BW [MHz]	Modulation	RB Size	RB Offset	Power Low Ch. / Freq.	Power Middle Ch. / Freq.	Power High Ch. / Freq.	Gain	EIRP	EIRP	EIRP
Channel				505000	507000	509000		L	M	H
Frequency (MHz)				2525	2535	2545				
50	PI/2 BPSK	1	1	22.81	23.14	23.17	2.60	0.3475	0.3750	0.3776
50	QPSK	1	1	22.84	23.17	23.23	2.60	0.3499	0.3776	0.3828
50	QPSK	1	108	23.36	23.58	23.30	2.60	0.3945	0.4150	0.3890
50	QPSK	1	214	23.23	23.25	23.34	2.60	0.3828	0.3846	0.3926
50	QPSK	108	0	21.86	22.12	22.16	2.60	0.2793	0.2965	0.2992
50	QPSK	108	54	23.06	23.19	23.28	2.60	0.3681	0.3793	0.3873
50	QPSK	108	108	23.20	23.26	23.23	2.60	0.3802	0.3855	0.3828
50	QPSK	216	0	22.12	22.19	22.30	2.60	0.2965	0.3013	0.3090
50	16QAM	1	1	22.15	22.08	22.49	2.60	0.2985	0.2938	0.3228
50	64QAM	1	1	20.34	20.19	20.69	2.60	0.1968	0.1901	0.2133
50	256QAM	1	1	18.35	18.32	18.45	2.60	0.1245	0.1236	0.1274
Channel				504000	507000	510000	Gain	EIRP	EIRP	EIRP
Frequency (MHz)				2520	2535	2550				
40	QPSK	1	1	23.10	23.11	23.55	2.60	0.3715	0.3724	0.4121
40	16QAM	1	1	22.23	22.19	22.60	2.60	0.3041	0.3013	0.3311
Channel				503000	507000	511000	Gain	EIRP	EIRP	EIRP
Frequency (MHz)				2515	2535	2555				
30	QPSK	1	1	23.02	23.33	23.27	2.60	0.3648	0.3917	0.3864
30	16QAM	1	1	22.10	22.38	22.41	2.60	0.2951	0.3148	0.3170
Channel				502500	507000	511500	Gain	EIRP	EIRP	EIRP
Frequency (MHz)				2512.5	2535	2557.5				
25	QPSK	1	1	23.25	23.29	23.34	2.60	0.3846	0.3882	0.3926



25	16QAM	1	1	22.30	23.34	22.42	2.60	0.3090	0.3926	0.3177
Channel				502000	507000	512000	Gain	EIRP	EIRP	EIRP
Frequency (MHz)				2510	2535	2560				
20	QPSK	1	1	23.08	23.21	23.17	2.60	0.3698	0.3811	0.3776
20	16QAM	1	1	22.07	22.19	22.15	2.60	0.2931	0.3013	0.2985
Channel				501500	507000	512500	Gain	EIRP	EIRP	EIRP
Frequency (MHz)				2507.5	2535	2562.5				
15	QPSK	1	1	22.97	23.25	23.19	2.60	0.3606	0.3846	0.3793
15	16QAM	1	1	22.06	22.30	22.31	2.60	0.2924	0.3090	0.3097
Channel				501000	507000	513000	Gain	EIRP	EIRP	EIRP
Frequency (MHz)				2505	2535	2565				
10	QPSK	1	1	22.93	23.45	23.29	2.60	0.3573	0.4027	0.3882
10	16QAM	1	1	22.05	22.52	22.30	2.60	0.2917	0.3251	0.3090
Channel				500500	507000	513500	Gain	EIRP	EIRP	EIRP
Frequency (MHz)				2502.5	2535	2567.5				
5	QPSK	1	1	23.24	23.38	23.34	2.60	0.3837	0.3963	0.3926
5	16QAM	1	1	22.30	22.46	22.40	2.60	0.3090	0.3206	0.3162



5G NR ENDC 71A_n38										
BW [MHz]	Modulation	RB Size	RB Offset	Power Low Ch. / Freq.	Power Middle Ch. / Freq.	Power High Ch. / Freq.	Gain	EIRP	EIRP	EIRP
Channel				518004	519000	519996		L	M	H
Frequency (MHz)				2590.02	2595	2599.98				
40	PI/2 BPSK	1	1	22.60	22.34	22.61	2.4	0.3162	0.2979	0.3170
40	QPSK	1	1	22.49	22.25	22.57	2.4	0.3083	0.2917	0.3141
40	QPSK	1	53	22.50	22.37	22.46	2.4	0.3090	0.2999	0.3062
40	QPSK	1	104	22.66	22.46	22.63	2.4	0.3206	0.3062	0.3184
40	QPSK	50	0	21.72	21.44	21.60	2.4	0.2582	0.2421	0.2512
40	QPSK	50	28	22.65	22.37	22.54	2.4	0.3199	0.2999	0.3119
40	QPSK	50	56	21.66	21.45	21.66	2.4	0.2547	0.2427	0.2547
40	QPSK	100	0	21.69	21.46	21.60	2.4	0.2564	0.2432	0.2512
40	16QAM	1	1	21.41	21.13	21.35	2.4	0.2404	0.2254	0.2371
40	64QAM	1	1	19.72	19.48	19.71	2.4	0.1629	0.1542	0.1626
40	256QAM	1	1	18.26	17.90	18.06	2.4	0.1164	0.1072	0.1112
Channel				517002	519000	520998	Gain	EIRP	EIRP	EIRP
Frequency (MHz)				2585.01	2595	2604.99				
30	QPSK	1	1	22.32	22.44	22.65	2.4	0.2965	0.3048	0.3199
30	16QAM	1	1	21.05	21.20	21.49	2.4	0.2213	0.2291	0.2449
Channel				516000	519000	522000	Gain	EIRP	EIRP	EIRP
Frequency (MHz)				2580	2595	2610				
20	QPSK	1	1	22.39	22.38	22.51	2.4	0.3013	0.3006	0.3097
20	16QAM	1	1	21.13	21.26	21.17	2.4	0.2254	0.2323	0.2275



5GNR n41										
BW [MHz]	Modulation	RB Size	RB Offset	Power Low Ch. / Freq.	Power Middle Ch. / Freq.	Power High Ch. / Freq.	Gain	EIRP	EIRP	EIRP
Channel				509202	518598	528000		L	M	H
Frequency (MHz)				2546.01	2592.99	2640				
100	PI/2 BPSK	1	1	24.98	25.01	24.91	2.00	0.4989	0.5023	0.4909
100	QPSK	1	1	25.02	24.89	24.78	2.00	0.5035	0.4887	0.4764
100	QPSK	1	137	24.79	24.90	24.74	2.00	0.4775	0.4898	0.4721
100	QPSK	1	271	24.96	24.68	24.93	2.00	0.4966	0.4656	0.4932
100	QPSK	135	0	23.90	24.04	23.97	2.00	0.3890	0.4018	0.3954
100	QPSK	135	69	24.93	25.07	24.91	2.00	0.4932	0.5093	0.4909
100	QPSK	135	138	23.87	23.96	23.95	2.00	0.3864	0.3945	0.3936
100	QPSK	270	0	23.95	24.06	23.98	2.00	0.3936	0.4036	0.3963
100	16QAM	1	1	24.10	24.19	23.81	2.00	0.4074	0.4159	0.3811
100	64QAM	1	1	22.17	22.05	21.95	2.00	0.2612	0.2541	0.2483
100	256QAM	1	1	20.54	20.39	20.23	2.00	0.1795	0.1734	0.1671
Channel				508200	518598	528996	Gain	EIRP	EIRP	EIRP
Frequency (MHz)				2541	2592.99	2644.98				
90	QPSK	1	1	25.05	24.77	24.92	2.00	0.5070	0.4753	0.4920
90	16QAM	1	1	24.28	24.16	24.34	2.00	0.4246	0.4130	0.4305
Channel				507204	518598	529998	Gain	EIRP	EIRP	EIRP
Frequency (MHz)				2536.02	2592.99	2649.99				
80	QPSK	1	1	24.88	24.94	24.77	2.00	0.4875	0.4943	0.4753
80	16QAM	1	1	23.83	24.15	23.89	2.00	0.3828	0.4121	0.3882
Channel				506202	518598	531000	Gain	EIRP	EIRP	EIRP
Frequency (MHz)				2531.01	2592.99	2565				
70	QPSK	1	1	24.97	25.02	24.65	2.00	0.4977	0.5035	0.4624
70	16QAM	1	1	24.34	24.39	23.67	2.00	0.4305	0.4355	0.3690
Channel				505200	518598	531996	Gain	EIRP	EIRP	EIRP
Frequency (MHz)				2526	2592.99	2659.98				
60	QPSK	1	1	25.05	24.98	24.74	2.00	0.5070	0.4989	0.4721
60	16QAM	1	1	24.10	24.45	23.87	2.00	0.4074	0.4416	0.3864
Channel				504204	518598	532998	Gain	EIRP	EIRP	EIRP
Frequency (MHz)				2521.02	2592.99	2664.99				



50	QPSK	1	1	25.03	24.85	24.72	2.00	0.5047	0.4842	0.4699
50	16QAM	1	1	24.34	23.96	23.95	2.00	0.4305	0.3945	0.3936
Channel				503202	518598	534000	Gain	EIRP	EIRP	EIRP
Frequency (MHz)				2516.01	2592.99	2670				
40	QPSK	1	1	25.06	24.97	24.88	2.00	0.5082	0.4977	0.4875
40	16QAM	1	1	24.20	24.25	24.03	2.00	0.4169	0.4217	0.4009
Channel				502200	518598	534996	Gain	EIRP	EIRP	EIRP
Frequency (MHz)				2511	2592.99	2674.98				
30	QPSK	1	1	25.01	25.04	25.05	2.00	0.5023	0.5058	0.5070
30	16QAM	1	1	24.38	24.21	24.23	2.00	0.4345	0.4178	0.4198
Channel				501204	518598	535998	Gain	EIRP	EIRP	EIRP
Frequency (MHz)				2506.02	2592.99	2679.99				
20	QPSK	1	1	25.01	24.92	24.86	2.00	0.5023	0.4920	0.4853
20	16QAM	1	1	24.25	24.21	24.05	2.00	0.4217	0.4178	0.4027





5GNR n66										
BW [MHz]	Modulation	RB Size	RB Offset	Power Low Ch. / Freq.	Power Middle Ch. / Freq.	Power High Ch. / Freq.	Gain	EIRP	EIRP	EIRP
Channel				344000	349000	354000		L	M	H
Frequency (MHz)				1720	1745	1770				
20	PI/2 BPSK	1	1	23.63	23.76	23.66	-0.9	0.1875	0.1932	0.1888
20	QPSK	1	1	23.78	23.42	23.66	-0.9	0.1941	0.1786	0.1888
20	QPSK	1	53	23.67	23.86	23.45	-0.9	0.1891	0.1977	0.1799
20	QPSK	1	104	23.74	23.21	23.57	-0.9	0.1923	0.1702	0.1849
20	QPSK	50	0	22.73	22.83	22.56	-0.9	0.1524	0.1560	0.1466
20	QPSK	50	28	23.68	23.90	23.39	-0.9	0.1897	0.1995	0.1774
20	QPSK	50	56	22.75	22.89	22.87	-0.9	0.1531	0.1581	0.1574
20	QPSK	100	0	22.73	22.84	22.32	-0.9	0.1524	0.1563	0.1387
20	16QAM	1	1	22.85	22.56	22.83	-0.9	0.1567	0.1466	0.1560
20	64QAM	1	1	21.00	20.85	21.00	-0.9	0.1023	0.0989	0.1023
20	256QAM	1	1	19.02	19.22	18.97	-0.9	0.0649	0.0679	0.0641
Channel				343500	349000	354500	Gain	EIRP	EIRP	EIRP
Frequency (MHz)				1717.5	1745	1772.5				
15	QPSK	1	1	23.62	23.56	23.53	-0.9	0.1871	0.1845	0.1832
15	16QAM	1	1	22.66	23.03	22.93	-0.9	0.1500	0.1633	0.1596
Channel				343000	349000	355000	Gain	EIRP	EIRP	EIRP
Frequency (MHz)				1715	1745	1775				
10	QPSK	1	1	23.79	23.88	23.82	-0.9	0.1945	0.1986	0.1959
10	16QAM	1	1	22.74	23.02	23.03	-0.9	0.1528	0.1629	0.1633
Channel				342500	349000	355500	Gain	EIRP	EIRP	EIRP
Frequency (MHz)				1712.5	1745	1777.5				
5	QPSK	1	1	23.87	23.82	23.87	-0.9	0.1982	0.1959	0.1982
5	16QAM	1	1	22.85	22.78	22.92	-0.9	0.1567	0.1542	0.1592



5G NR ENDC 12A_n66										
BW [MHz]	Modulation	RB Size	RB Offset	Power Low Ch. / Freq.	Power Middle Ch. / Freq.	Power High Ch. / Freq.	Gain	EIRP	EIRP	EIRP
Channel				345000	349000	353000		L	M	H
Frequency (MHz)				1725	1745	1765				
30	BPSK	1	1	23.47	23.31	23.42	-0.9	0.1807	0.1742	0.1786
30	BPSK	160	0	23.02	23.04	23.07	-0.9	0.1629	0.1637	0.1648
30	BPSK	1	0	22.96	22.83	22.92	-0.9	0.1607	0.1560	0.1592
30	BPSK	1	159	22.77	22.98	22.81	-0.9	0.1538	0.1614	0.1552
30	QPSK	1	1	23.30	23.18	23.31	-0.9	0.1738	0.1690	0.1742
30	16QAM	1	1	22.84	22.71	22.78	-0.9	0.1563	0.1517	0.1542
30	64QAM	1	1	20.94	20.76	20.83	-0.9	0.1009	0.0968	0.0984
30	256QAM	1	1	18.71	18.54	18.79	-0.9	0.0604	0.0581	0.0615
Channel				344000	349000	354000	Gain	EIRP	EIRP	EIRP
Frequency (MHz)				1720	1745	1770				
20	QPSK	1	1	23.26	23.13	22.76				
20	16QAM	1	1	22.77	22.64	22.47	-0.9	0.1538	0.1493	0.1435
Channel				343500	349000	354500	Gain	EIRP	EIRP	EIRP
Frequency (MHz)				1717.5	1745	1772.5				
15	QPSK	1	1	23.27	23.09	23.11				
15	16QAM	1	1	22.76	22.63	22.54	-0.9	0.1535	0.1489	0.1459
Channel				343000	349000	355000	Gain	EIRP	EIRP	EIRP
Frequency (MHz)				1715	1745	1775				
10	QPSK	1	1	23.29	23.26	23.45				
10	16QAM	1	1	22.77	22.72	22.83	-0.9	0.1538	0.1521	0.1560
Channel				342500	349000	355500	Gain	EIRP	EIRP	EIRP
Frequency (MHz)				1712.5	1745	1777.5				
5	QPSK	1	1	23.21	23.24	23.28				
5	16QAM	1	1	22.70	22.75	22.83	-0.9	0.1514	0.1531	0.1560



# FR1 n7

## Peak-to-Average Ratio

Mode	FR1 n7 / 50MHz / DFT-S OFDM			
Mod.	PI/2 BPSK	QPSK		Limit: 13dB
RB Size	Full RB	Full RB		Result
Middle CH	6.76	7		PASS

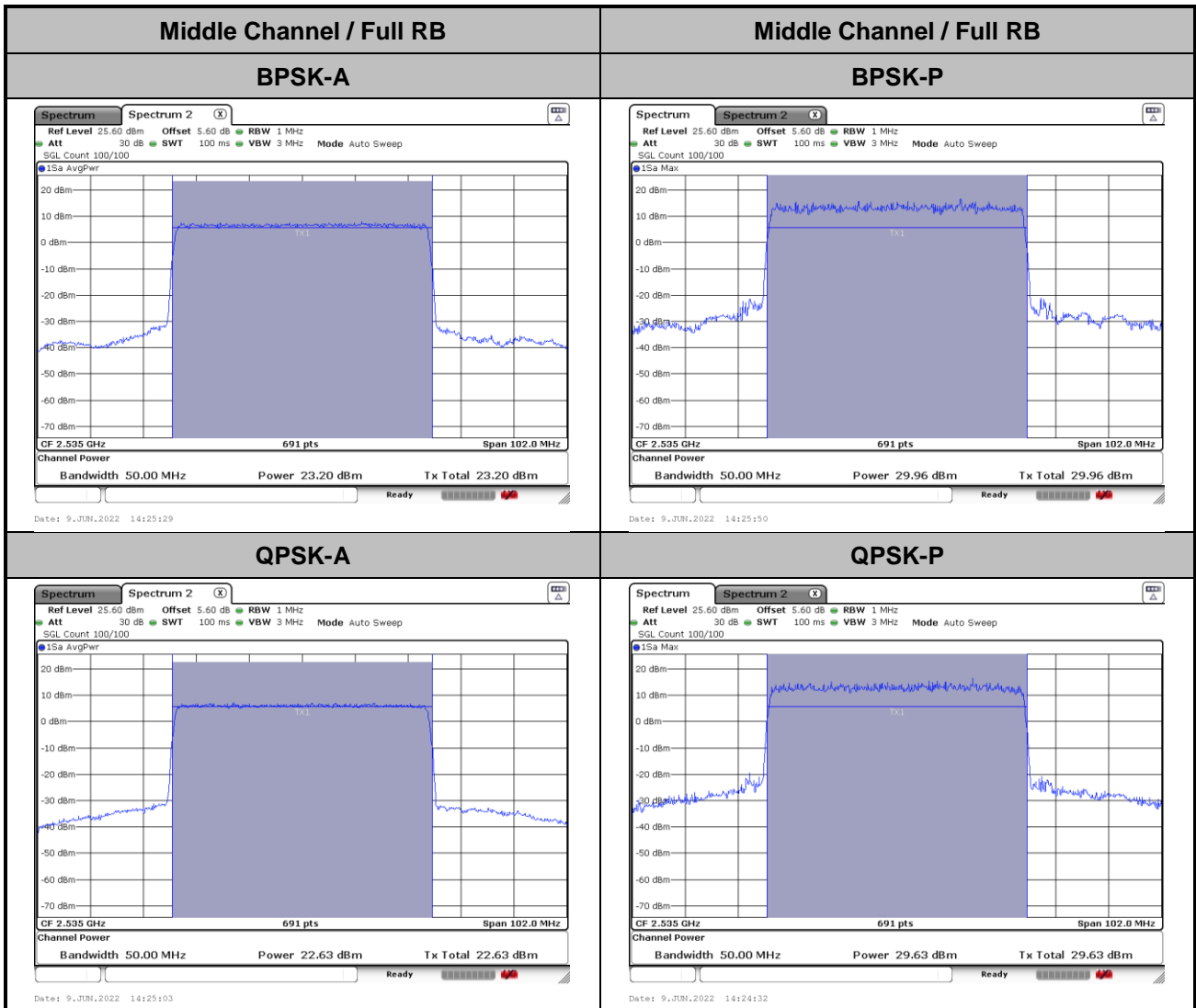



Occupied Bandwidth

Mode	FR1 n7 : OB BW(MHz) / CP-S OFDM				
<b>BW</b>	<b>5M</b>				
<b>Mod.</b>		<b>QPSK</b>	<b>16QAM</b>	<b>64QAM</b>	<b>256QAM</b>
<b>Middle CH</b>		4.49	4.53	4.51	4.51
<b>BW</b>	<b>10M</b>				
<b>Mod.</b>		<b>QPSK</b>	<b>16QAM</b>	<b>64QAM</b>	<b>256QAM</b>
<b>Middle CH</b>		9.41	9.37	9.33	9.41
<b>BW</b>	<b>15M</b>				
<b>Mod.</b>		<b>QPSK</b>	<b>16QAM</b>	<b>64QAM</b>	<b>256QAM</b>
<b>Middle CH</b>		14.15	14.12	14.15	14.09
<b>BW</b>	<b>20M</b>				
<b>Mod.</b>		<b>QPSK</b>	<b>16QAM</b>	<b>64QAM</b>	<b>256QAM</b>
<b>Middle CH</b>		19.38	19.42	19.50	19.50
<b>BW</b>	<b>25M</b>				
<b>Mod.</b>		<b>QPSK</b>	<b>16QAM</b>	<b>64QAM</b>	<b>256QAM</b>
<b>Middle CH</b>		23.78	23.78	23.82	23.74
<b>BW</b>	<b>30M</b>				
<b>Mod.</b>		<b>QPSK</b>	<b>16QAM</b>	<b>64QAM</b>	<b>256QAM</b>
<b>Middle CH</b>		28.49	28.57	28.49	28.53
<b>BW</b>	<b>40M</b>				
<b>Mod.</b>		<b>QPSK</b>	<b>16QAM</b>	<b>64QAM</b>	<b>256QAM</b>
<b>Middle CH</b>		38.76	38.84	38.92	38.76
<b>BW</b>	<b>50M</b>				
<b>Mod.</b>		<b>QPSK</b>	<b>16QAM</b>	<b>64QAM</b>	<b>256QAM</b>
<b>Middle CH</b>		48.15	48.45	48.15	48.05



5M

QPSK

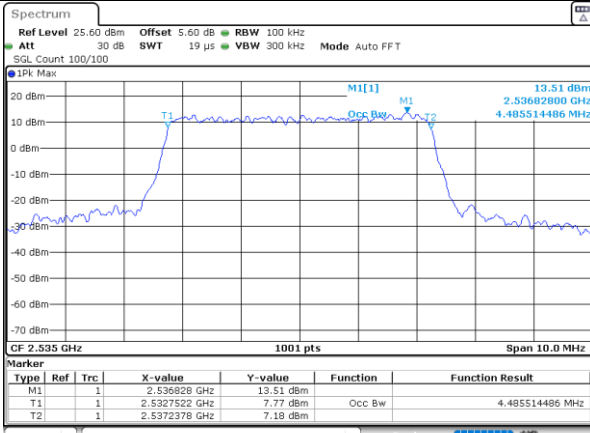

Date: 11..JUN.2022 12:23:42

16QAM

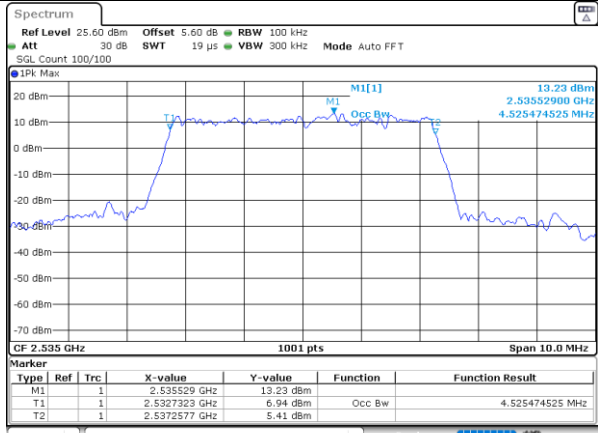

Date: 11..JUN.2022 12:24:01

64QAM

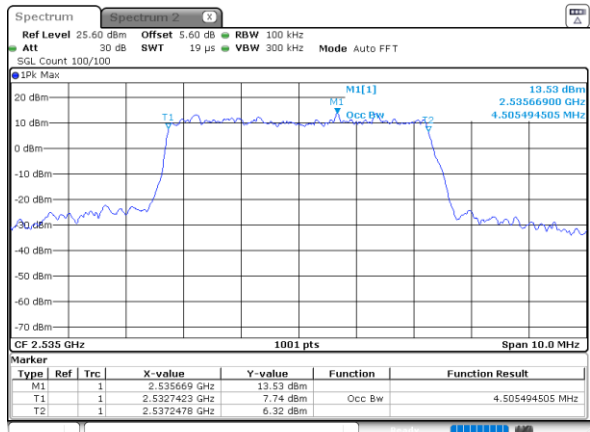

Date: 11..JUN.2022 17:34:44

256QAM

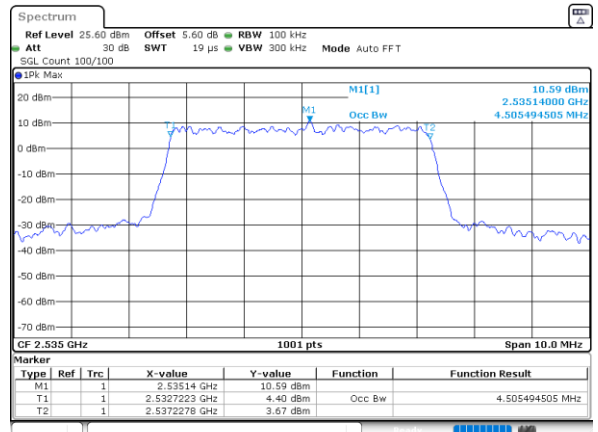

Date: 11..JUN.2022 12:24:18



10M

QPSK

16QAM

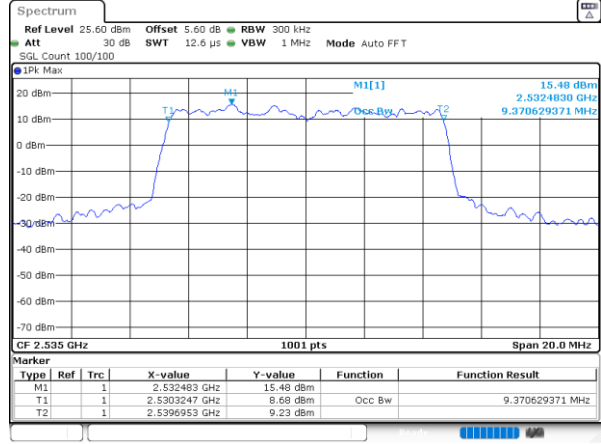
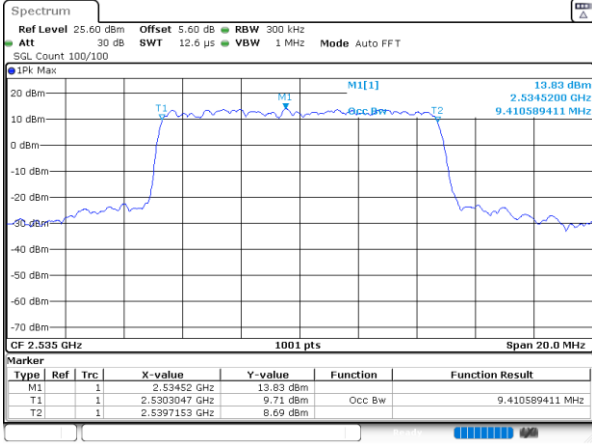

Date: 11..JUN.2022 12:25:17

Date: 11..JUN.2022 12:25:13

64QAM

256QAM

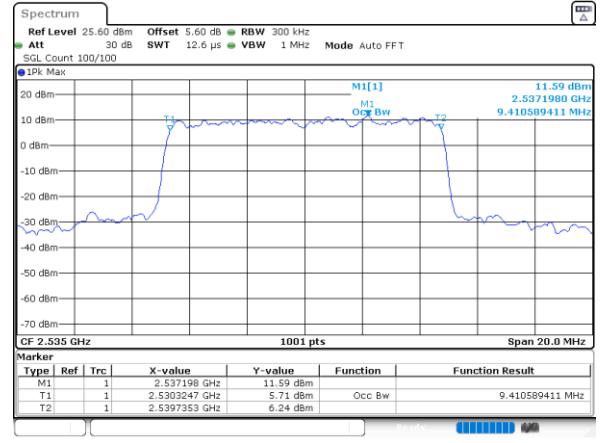
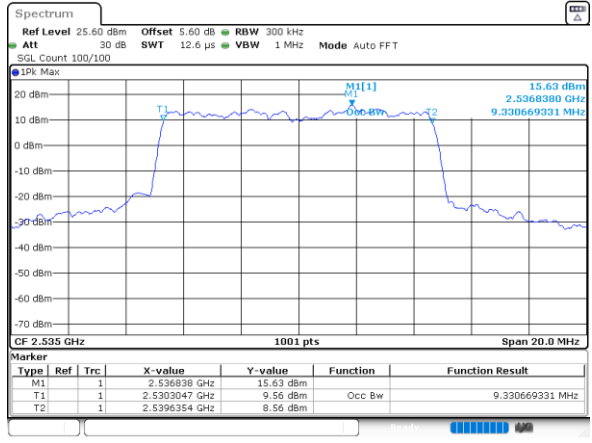

Date: 11..JUN.2022 12:25:15

Date: 11..JUN.2022 12:24:57



15M

QPSK

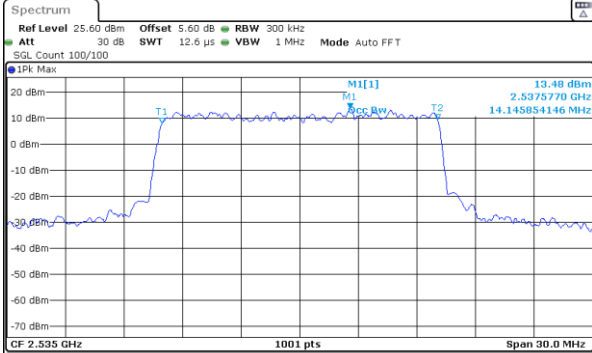

Date: 11 JUN 2022 12:26:48

16QAM

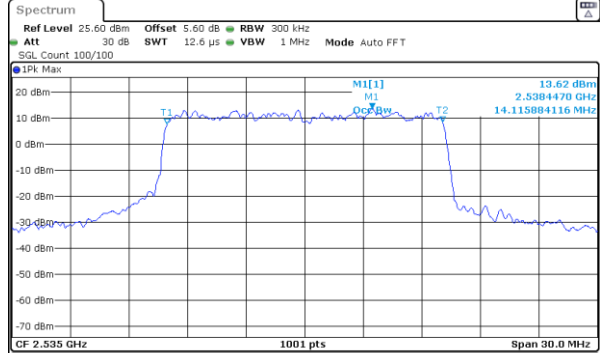

Date: 11 JUN 2022 12:27:05

64QAM

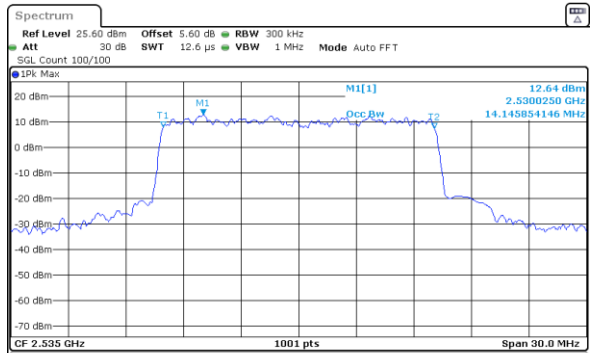

Date: 11 JUN 2022 12:27:33

256QAM

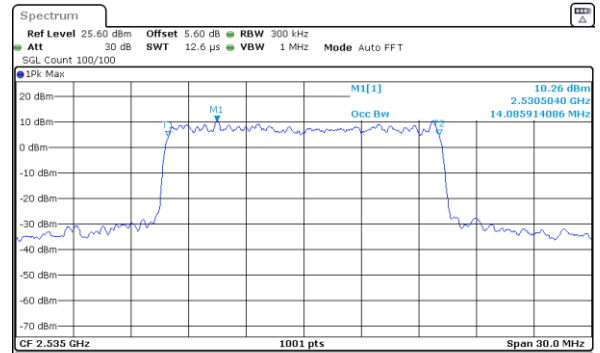

Date: 11 JUN 2022 12:27:48



20M

QPSK

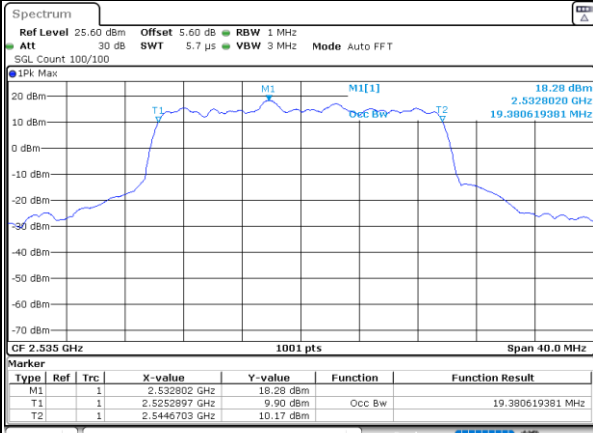

Date: 11..JUN.2022 12:30:42

16QAM

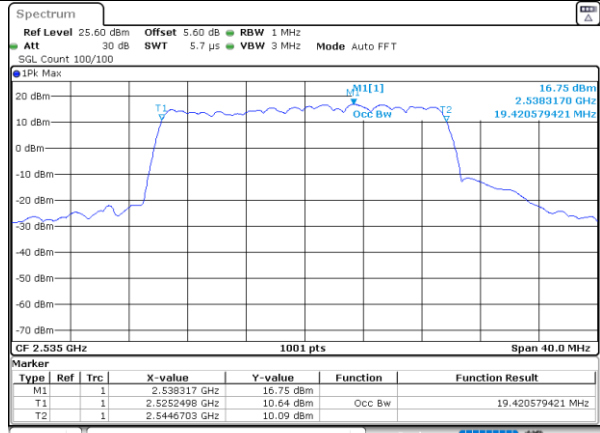

Date: 11..JUN.2022 12:29:57

64QAM

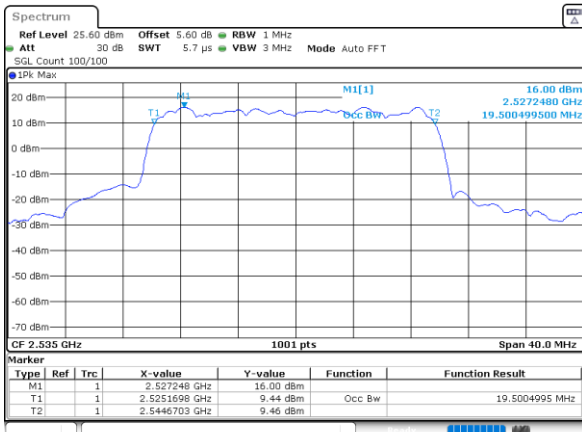

Date: 11..JUN.2022 12:29:26

256QAM

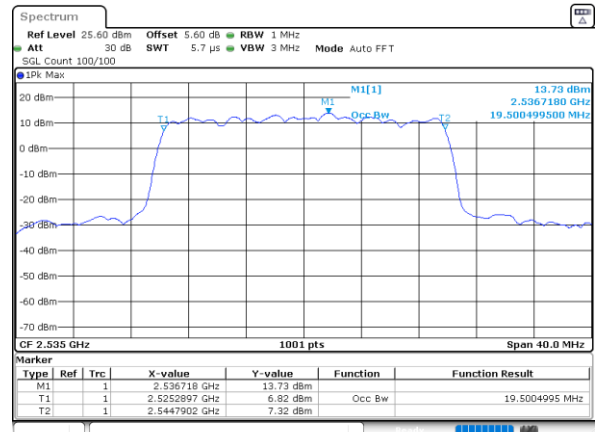

Date: 11..JUN.2022 12:29:20





25M

QPSK

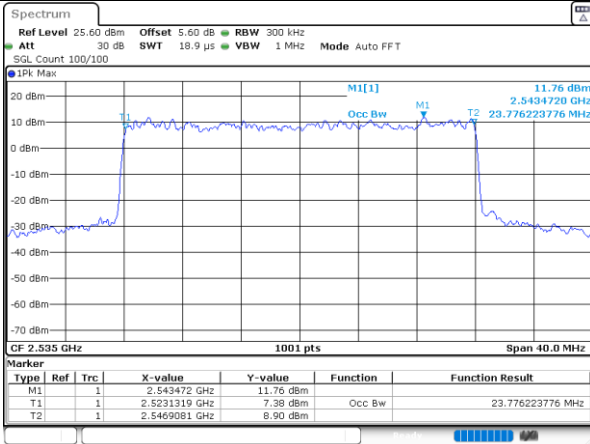

Date: 11..JUN.2022 12:31:31

16QAM

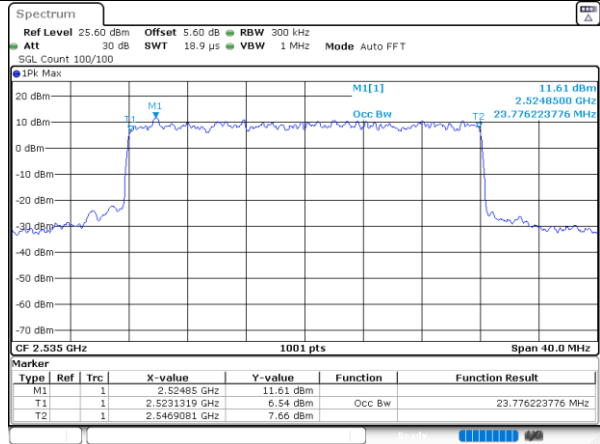

Date: 11..JUN.2022 12:31:48

64QAM

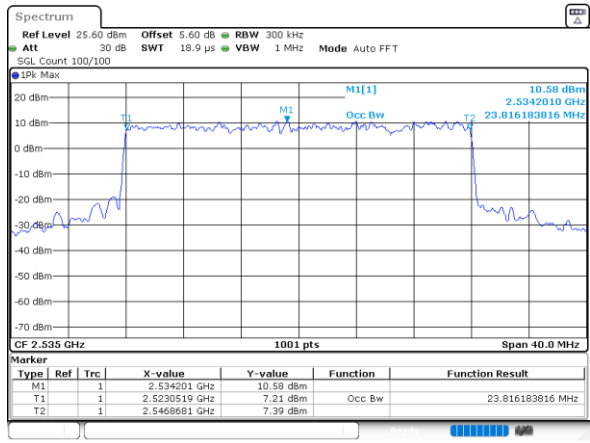

Date: 11..JUN.2022 12:32:14

256QAM

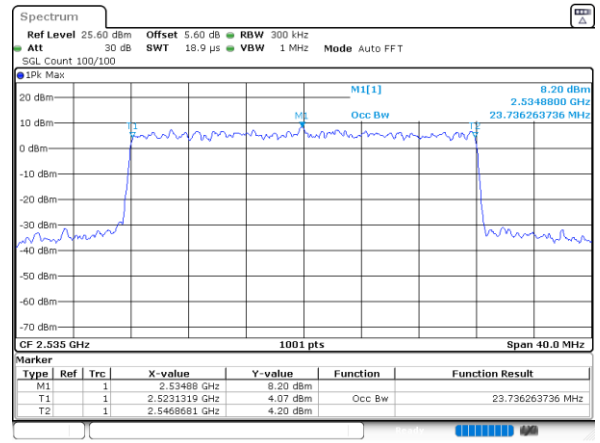

Date: 11..JUN.2022 12:32:54



30M

QPSK

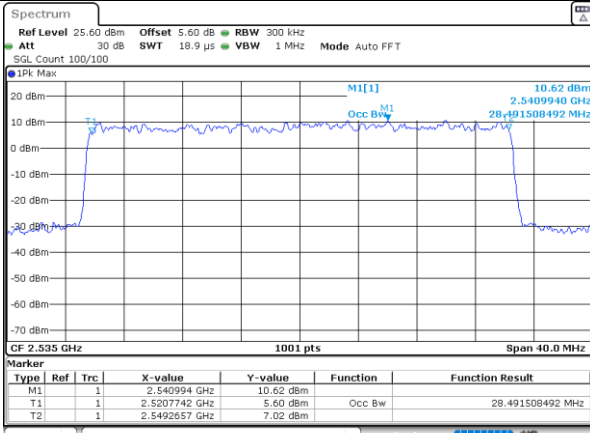

Date: 11..JUN.2022 12:35:14

16QAM

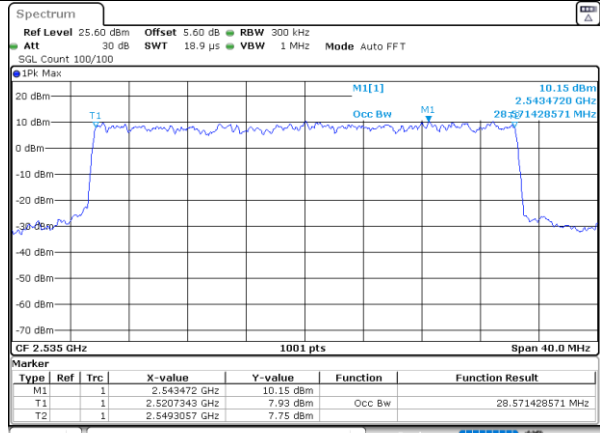

Date: 11..JUN.2022 12:34:52

64QAM

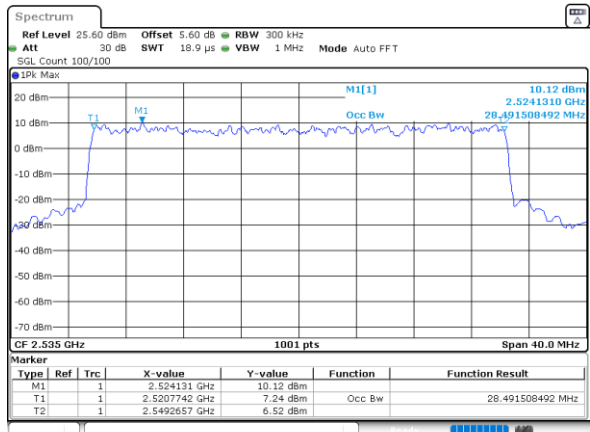

Date: 11..JUN.2022 12:34:25

256QAM

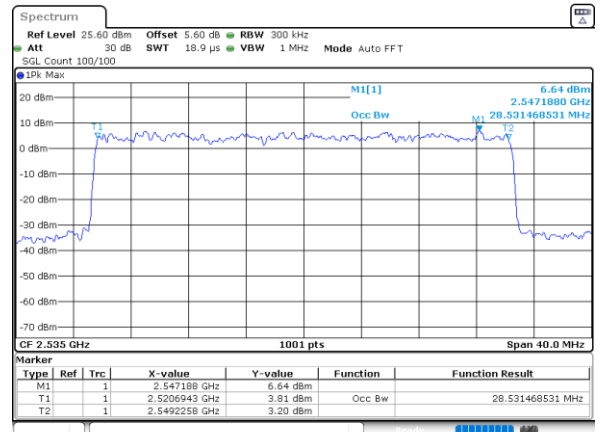

Date: 11..JUN.2022 12:34:06



40M

QPSK

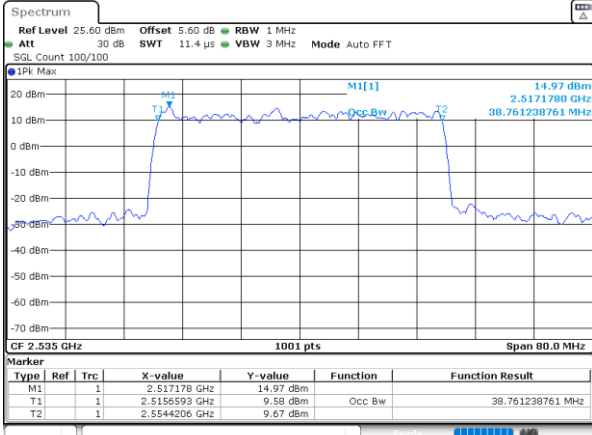

Date: 11..JUN.2022 12:13:6:19

16QAM

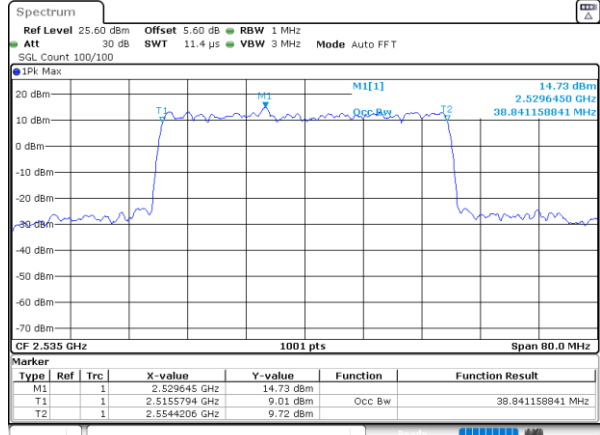

Date: 11..JUN.2022 12:13:7:07

64QAM

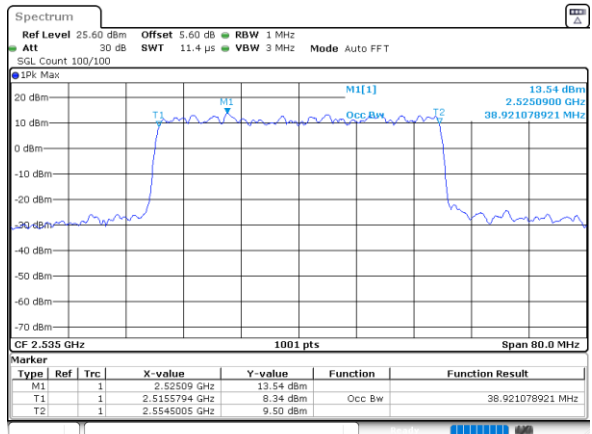

Date: 11..JUN.2022 12:13:7:43

256QAM

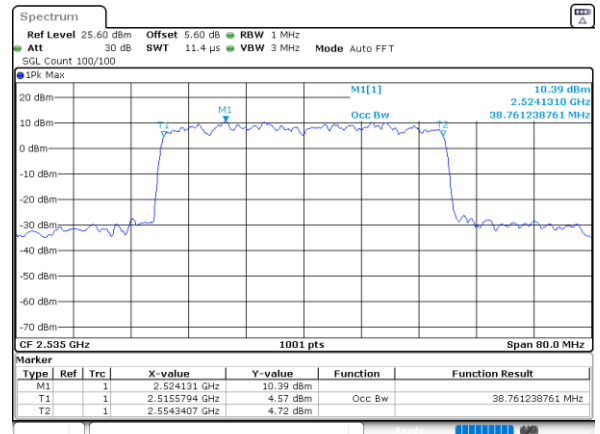

Date: 11..JUN.2022 12:13:8:17

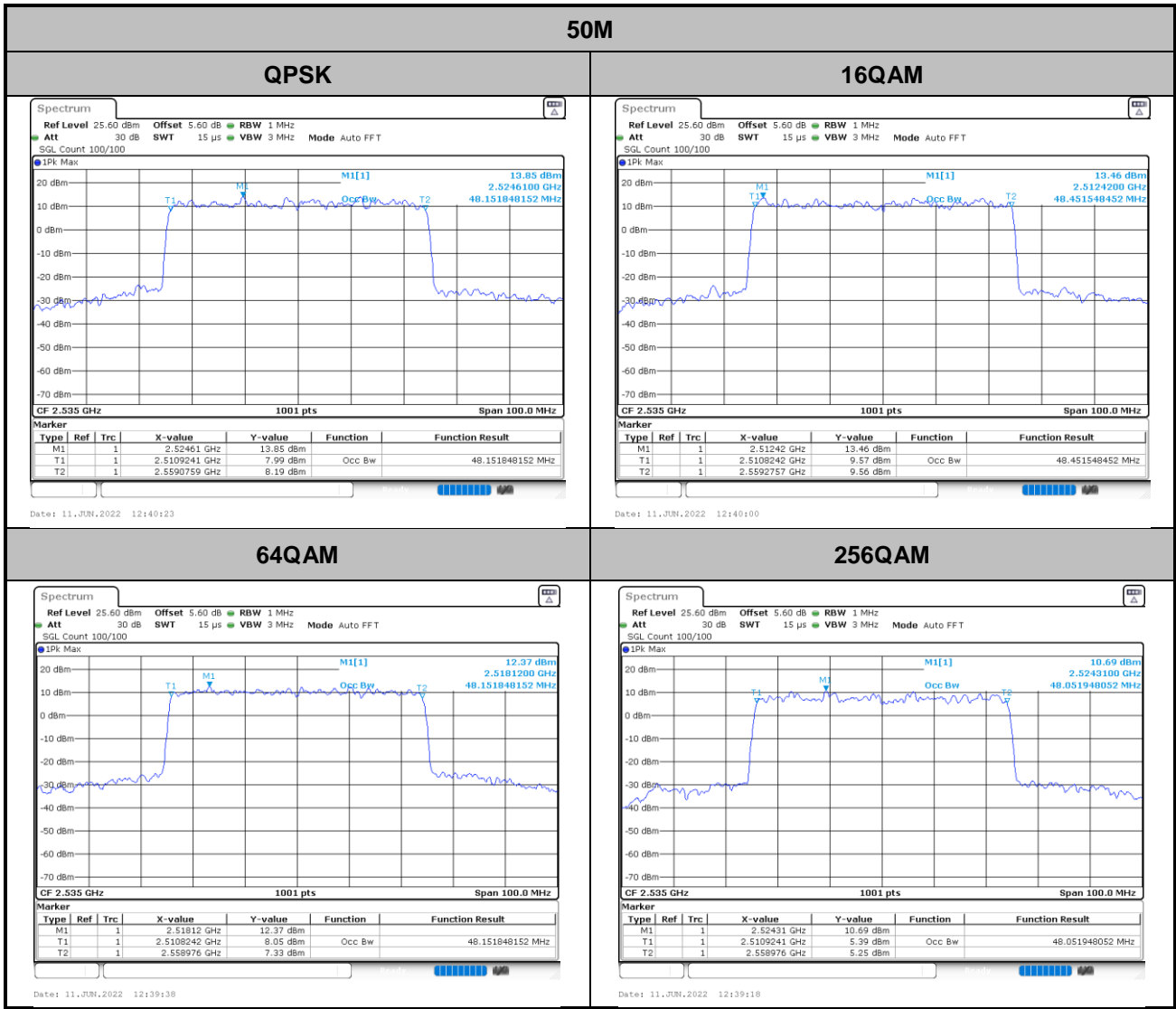



**26dB Bandwidth**

Mode	FR1 n7 : 26dB BW(MHz) / CP-S OFDM				
<b>BW</b>	<b>5M</b>				
<b>Mod.</b>		<b>QPSK</b>	<b>16QAM</b>	<b>64QAM</b>	<b>256QAM</b>
<b>Middle CH</b>		4.93	4.89	4.78	4.98
<b>BW</b>	<b>10M</b>				
<b>Mod.</b>		<b>QPSK</b>	<b>16QAM</b>	<b>64QAM</b>	<b>256QAM</b>
<b>Middle CH</b>		10.07	10.01	10.23	10.15
<b>BW</b>	<b>15M</b>				
<b>Mod.</b>		<b>QPSK</b>	<b>16QAM</b>	<b>64QAM</b>	<b>256QAM</b>
<b>Middle CH</b>		15.05	14.93	14.93	14.84
<b>BW</b>	<b>20M</b>				
<b>Mod.</b>		<b>QPSK</b>	<b>16QAM</b>	<b>64QAM</b>	<b>256QAM</b>
<b>Middle CH</b>		21.30	21.18	21.14	21.18
<b>BW</b>	<b>25M</b>				
<b>Mod.</b>		<b>QPSK</b>	<b>16QAM</b>	<b>64QAM</b>	<b>256QAM</b>
<b>Middle CH</b>		24.66	24.74	24.70	24.66
<b>BW</b>	<b>30M</b>				
<b>Mod.</b>		<b>QPSK</b>	<b>16QAM</b>	<b>64QAM</b>	<b>256QAM</b>
<b>Middle CH</b>		29.53	29.49	29.53	29.49
<b>BW</b>	<b>40M</b>				
<b>Mod.</b>		<b>QPSK</b>	<b>16QAM</b>	<b>64QAM</b>	<b>256QAM</b>
<b>Middle CH</b>		41.00	41.00	41.00	41.08
<b>BW</b>	<b>50M</b>				
<b>Mod.</b>		<b>QPSK</b>	<b>16QAM</b>	<b>64QAM</b>	<b>256QAM</b>
<b>Middle CH</b>		<b>50.65</b>	<b>50.75</b>	<b>50.75</b>	<b>50.75</b>



5M

QPSK

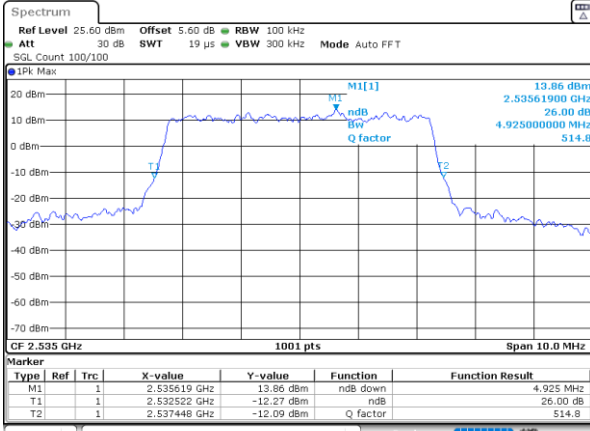

Date: 11..JUN.2022 12:23:49

16QAM

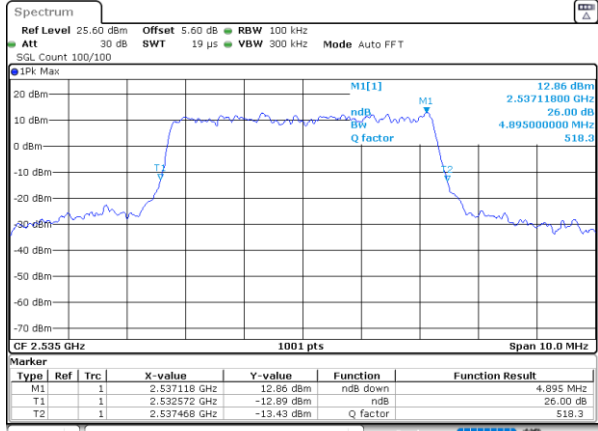

Date: 11..JUN.2022 12:24:08

64QAM

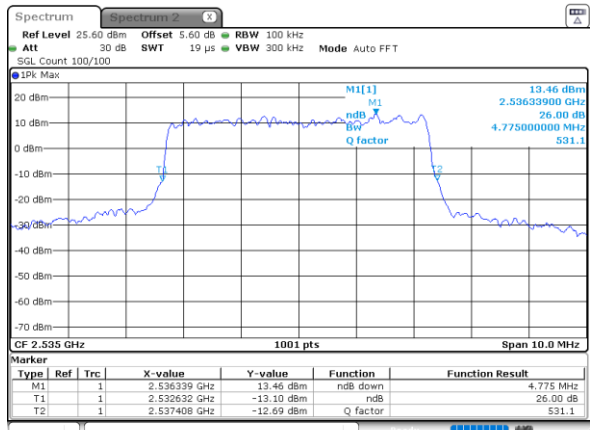

Date: 11..JUN.2022 17:34:53

256QAM

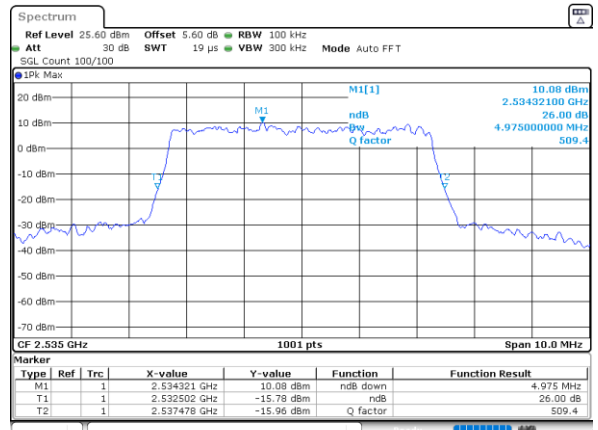

Date: 11..JUN.2022 12:24:24



10M

QPSK

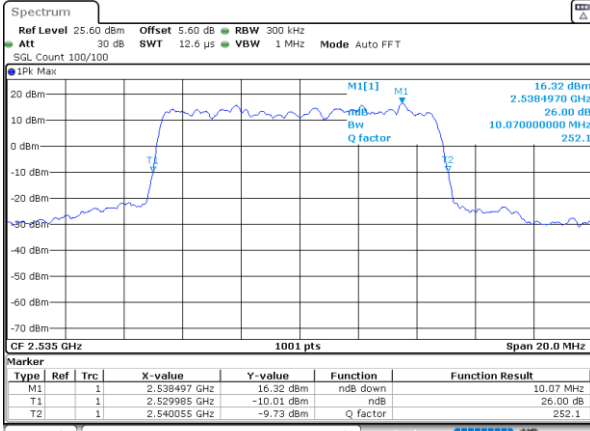

Date: 11..JUN.2022 12:25:53

16QAM

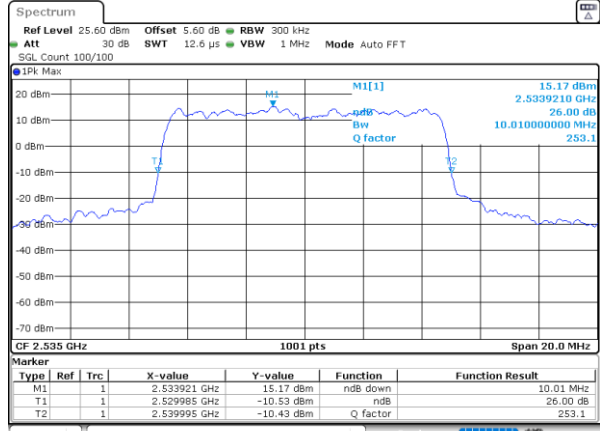

Date: 11..JUN.2022 12:25:39

64QAM

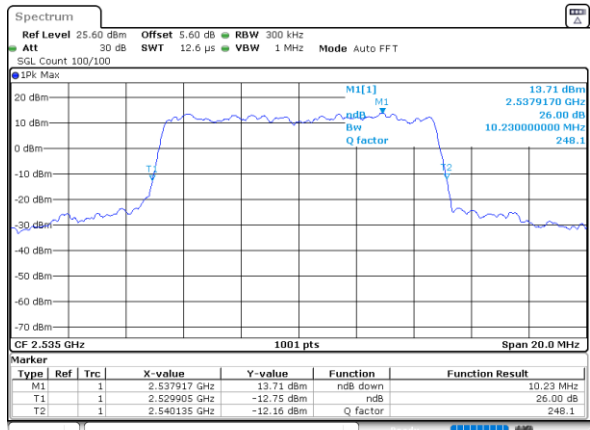

Date: 11..JUN.2022 12:25:22

256QAM

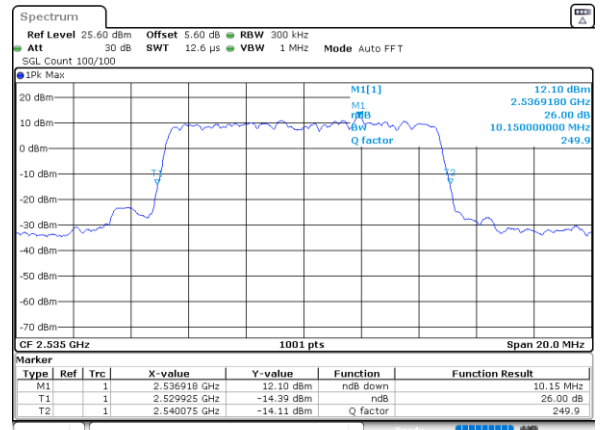

Date: 11..JUN.2022 12:25:05



15M

QPSK

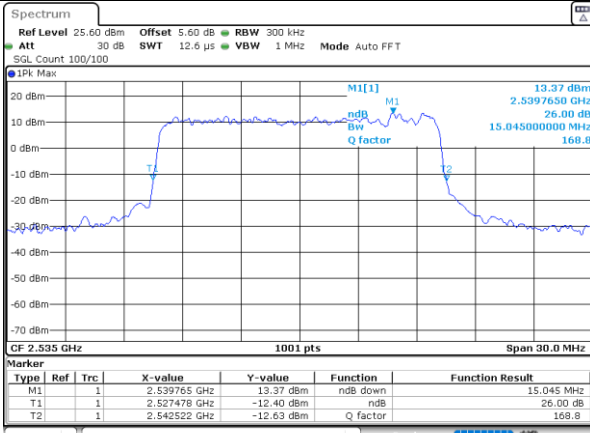

Date: 11..JUN.2022 12:26:55

16QAM

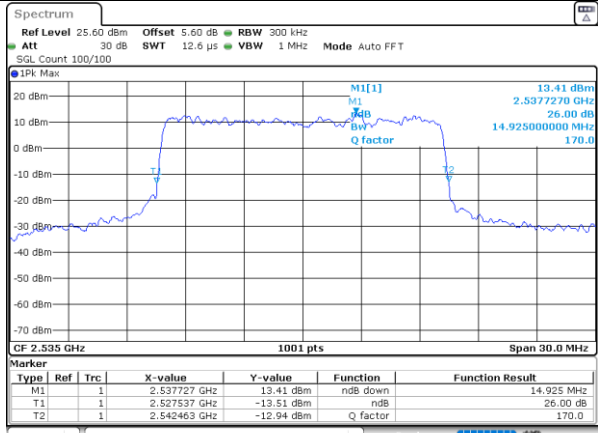

Date: 11..JUN.2022 12:27:11

64QAM

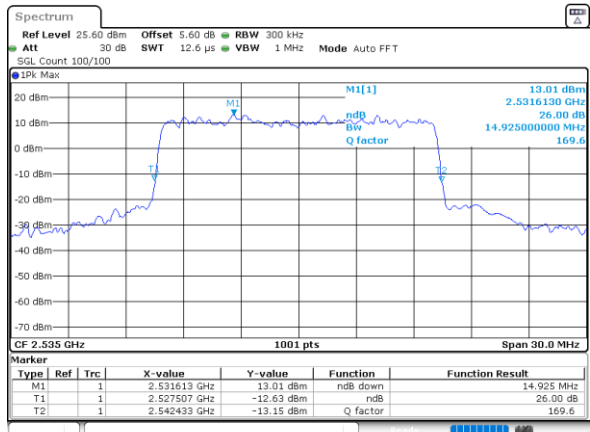

Date: 11..JUN.2022 12:27:39

256QAM

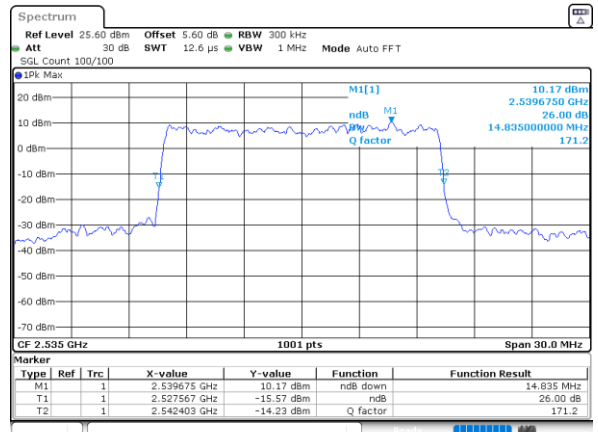

Date: 11..JUN.2022 12:27:57





20M

QPSK

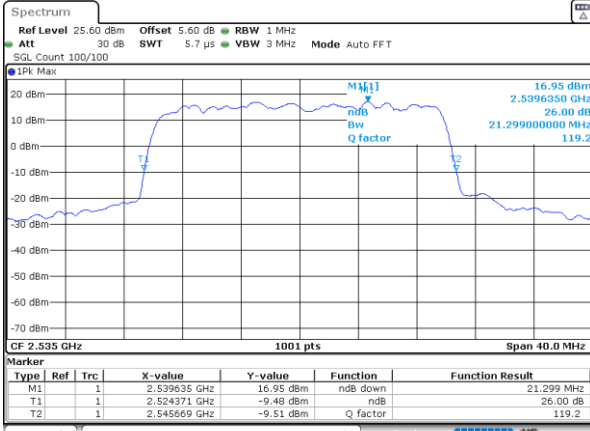

Date: 11..JUN.2022 12:30:48

16QAM

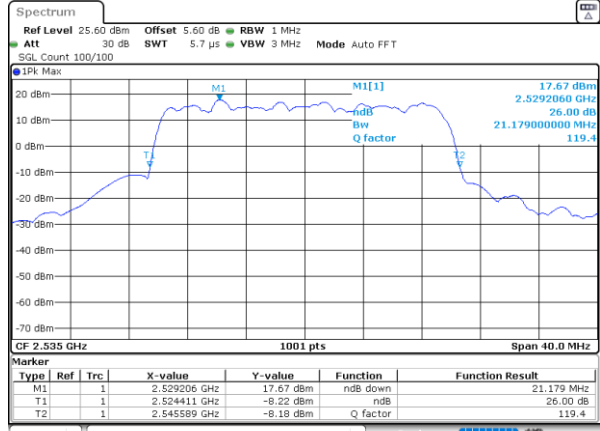

Date: 11..JUN.2022 12:30:30

64QAM

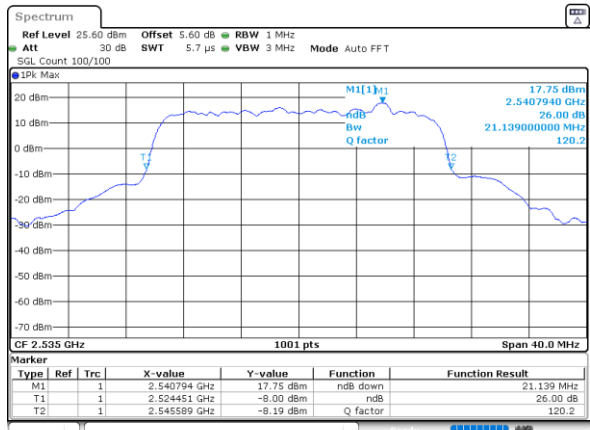

Date: 11..JUN.2022 12:29:46

256QAM

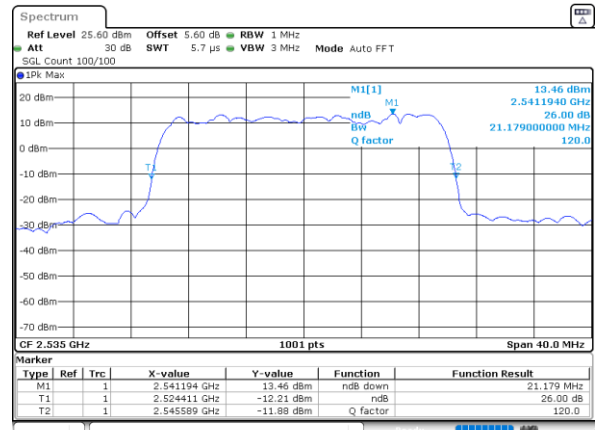

Date: 11..JUN.2022 12:29:27



25M

QPSK

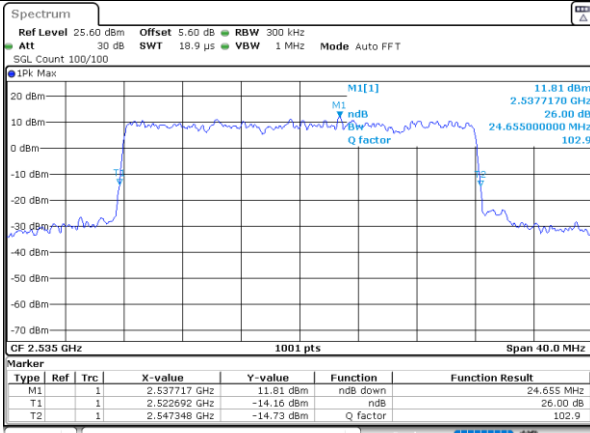

Date: 11..JUN.2022 12:31:38

16QAM

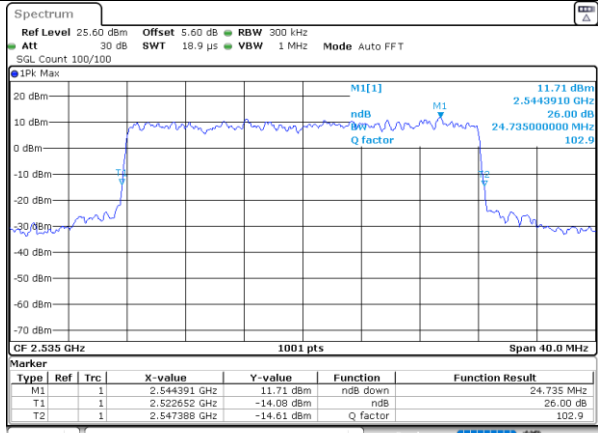

Date: 11..JUN.2022 12:31:58

64QAM

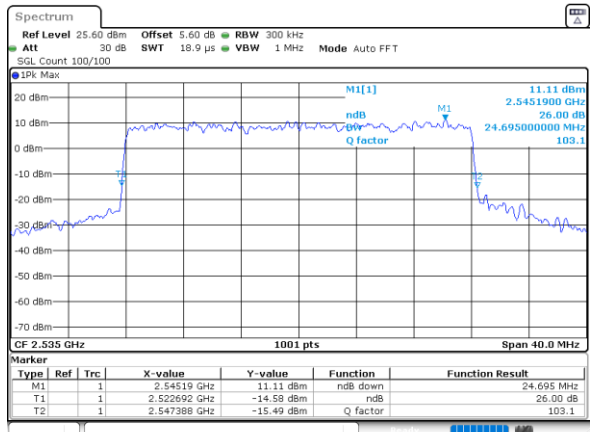

Date: 11..JUN.2022 12:32:20

256QAM



Date: 11..JUN.2022 12:32:59



30M

QPSK

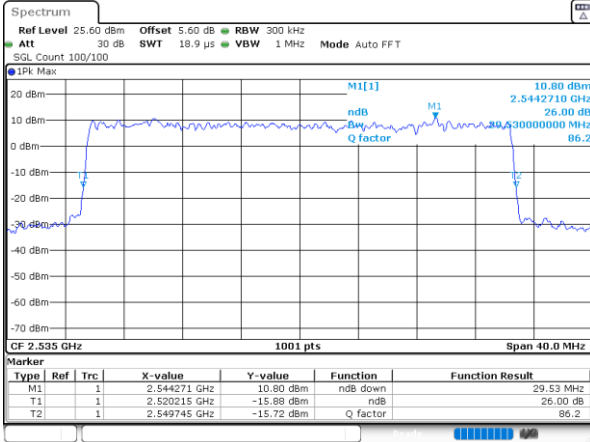

Date: 11..JUN.2022 12:35:26

16QAM

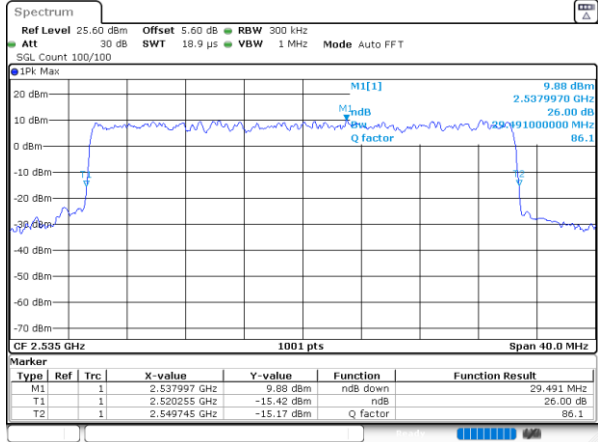

Date: 11..JUN.2022 12:35:05

64QAM

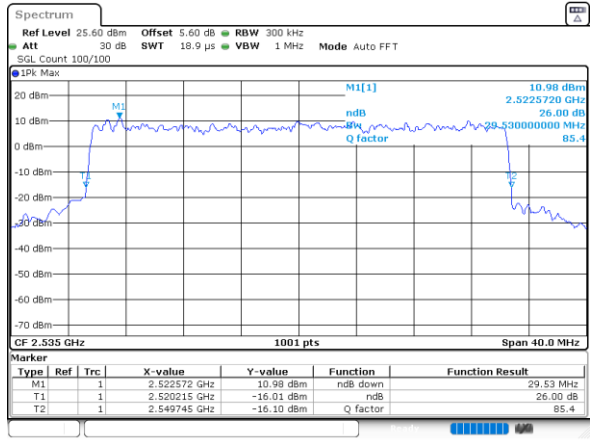

Date: 11..JUN.2022 12:34:33

256QAM

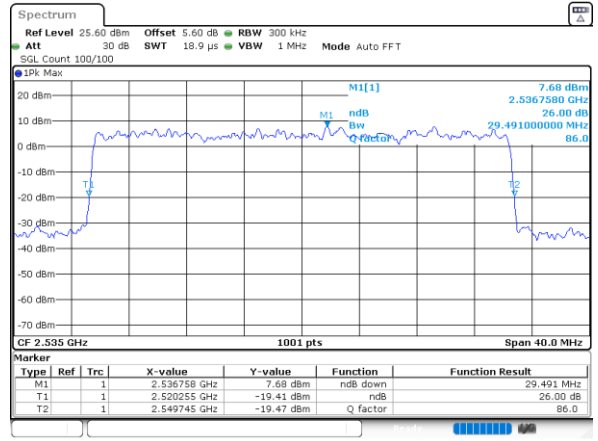

Date: 11..JUN.2022 12:34:15



40M

QPSK

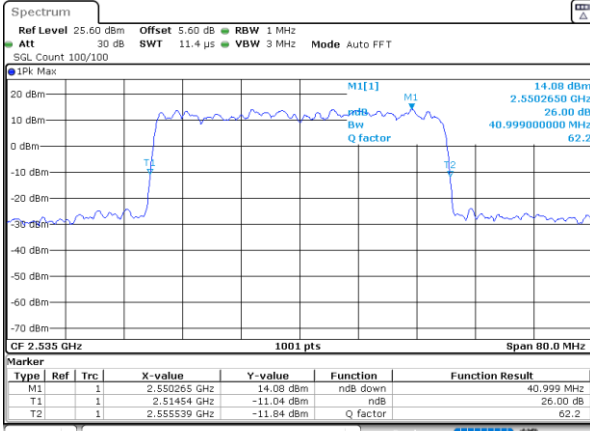

Date: 11..JUN.2022 12:13:11

16QAM

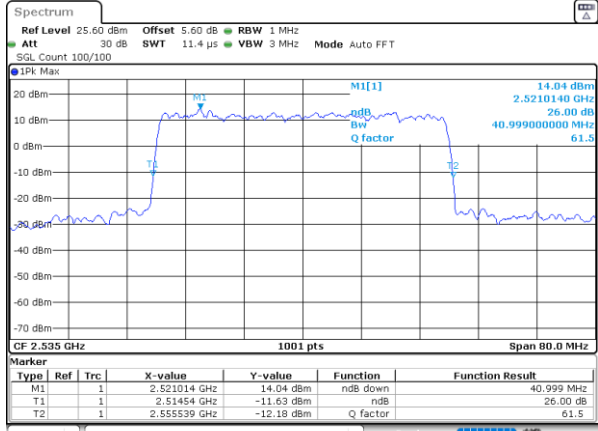

Date: 11..JUN.2022 12:13:22

64QAM

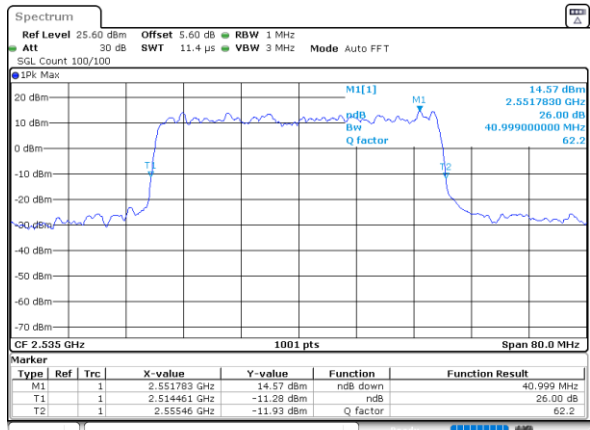

Date: 11..JUN.2022 12:13:04

256QAM

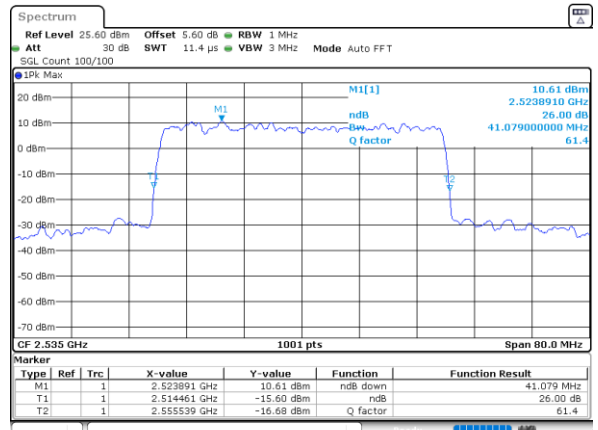

Date: 11..JUN.2022 12:13:25



50M

QPSK

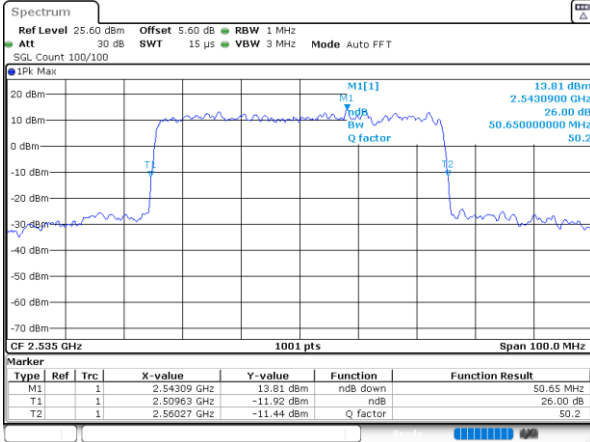

Date: 11..JUN.2022 12:40:29

16QAM

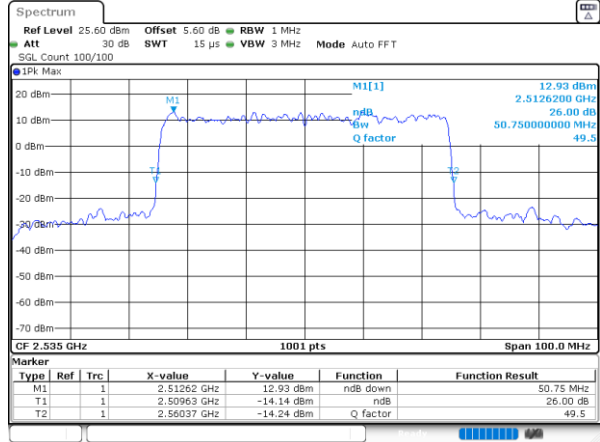

Date: 11..JUN.2022 12:40:07

64QAM

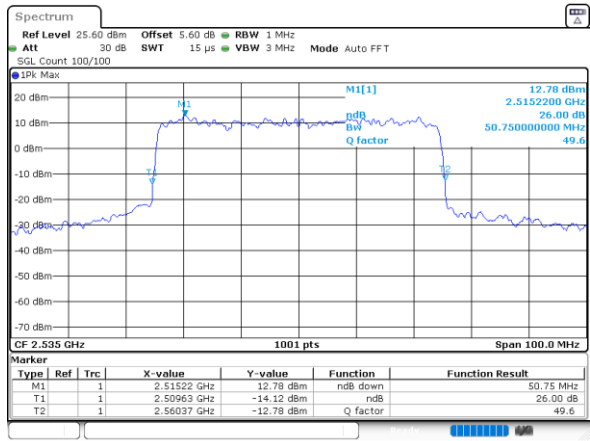

Date: 11..JUN.2022 12:39:48

256QAM

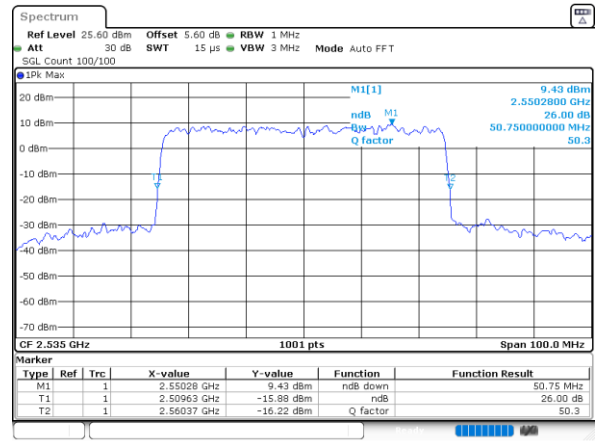

Date: 11..JUN.2022 12:39:27



# Conducted Band Edge

FR1 n7 / 5MHz / DFT-S OFDM / PI/2 BPSK

Lowest Band Edge / 1RB0

Highest Band Edge / 1RBMAX

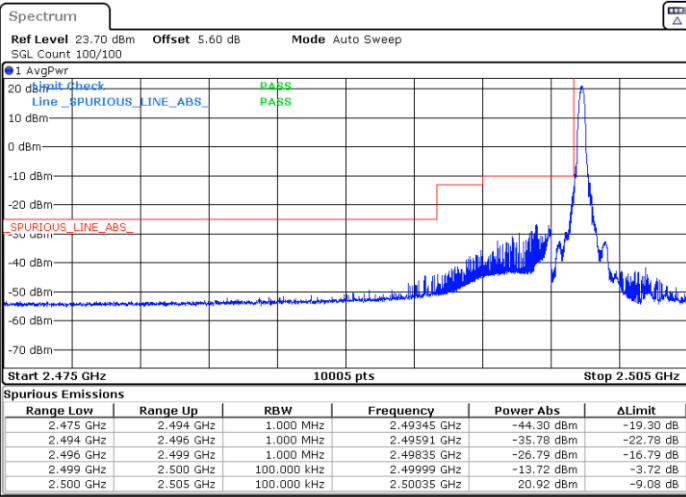

Date: 7 JUN 2022 05:25:58

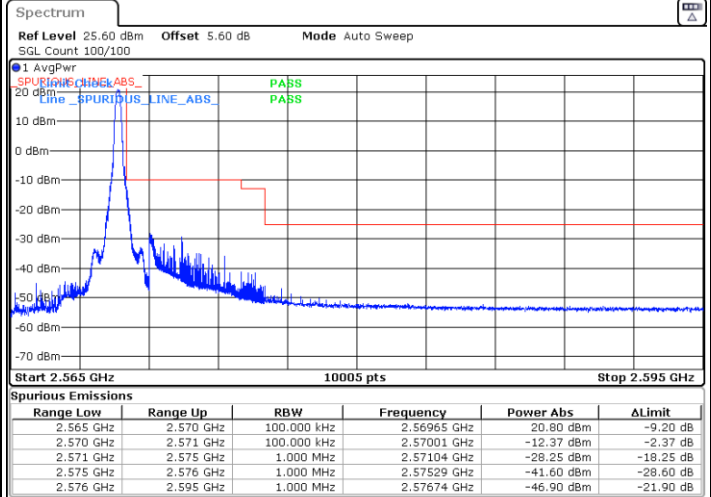

Date: 7 JUN 2022 05:45:34

Lowest Band Edge / Full RB

Highest Band Edge / Full RB

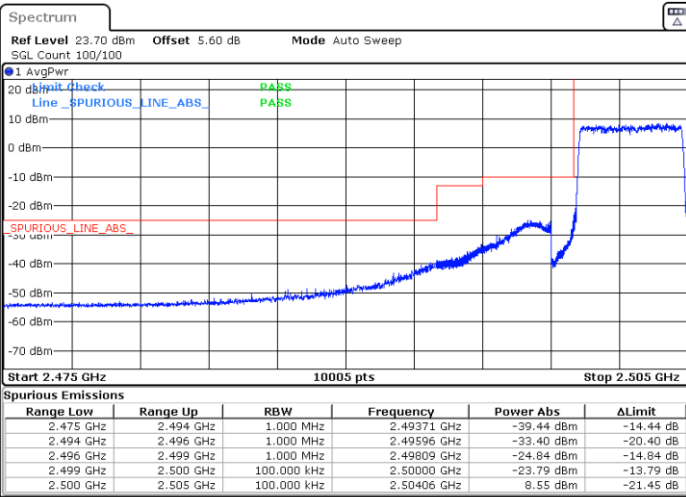

Date: 7 JUN 2022 05:27:18

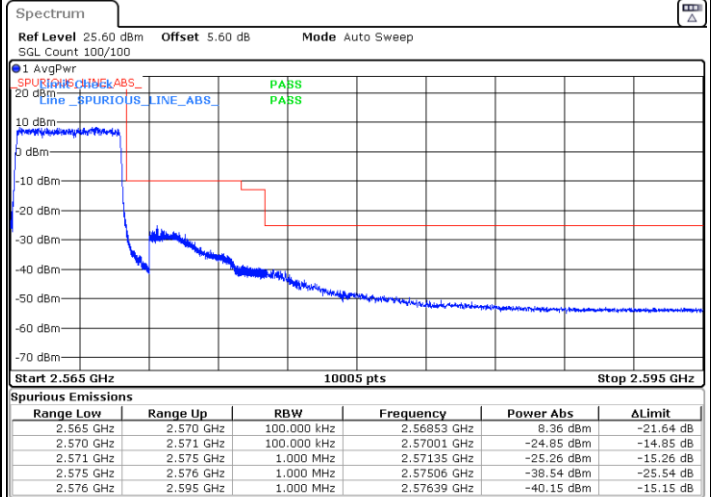

Date: 7 JUN 2022 05:44:00



FR1 n7 / 5MHz / DFT-S OFDM / QPSK

Lowest Band Edge / 1RB0

Highest Band Edge / 1RBMAX

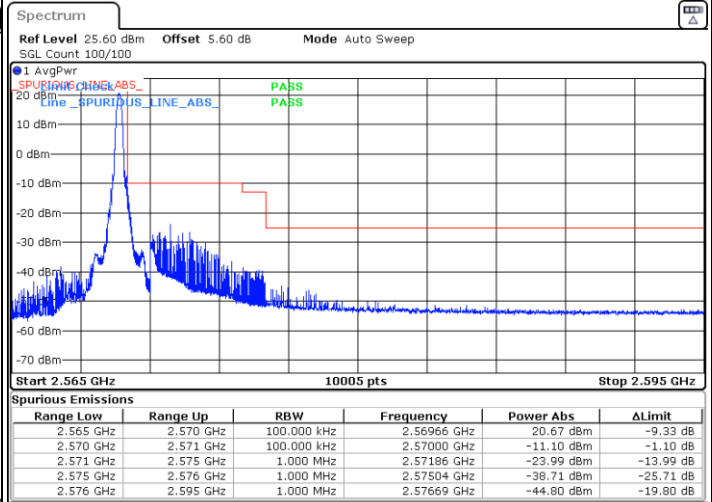
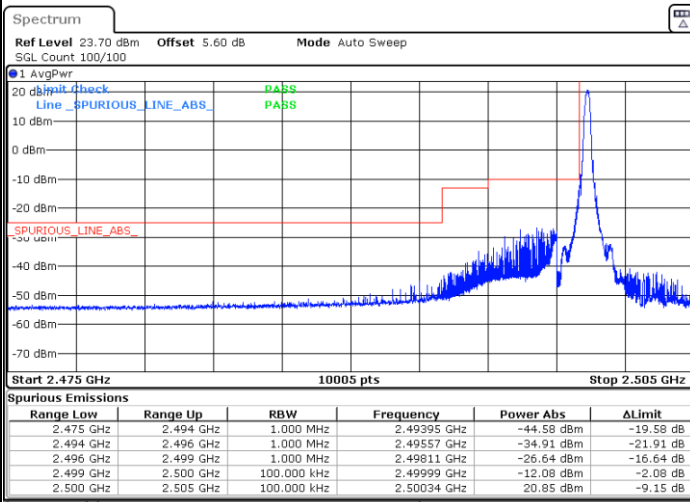

Date: 7 JUN 2022 05:26:33

Date: 7 JUN 2022 05:45:15

Lowest Band Edge / Full RB

Highest Band Edge / Full RB

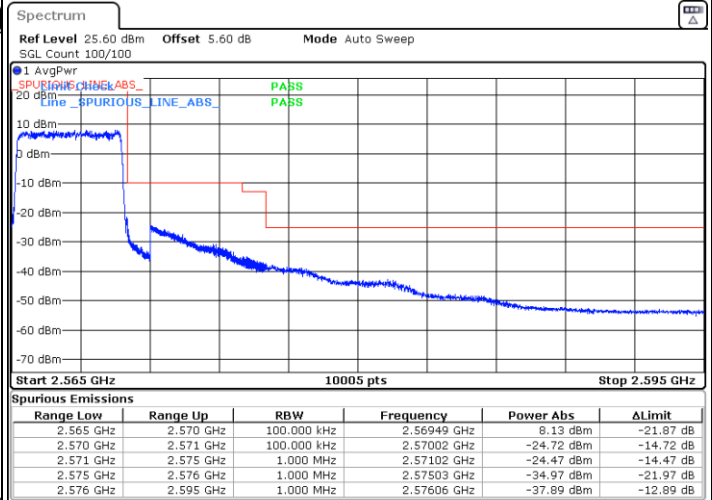
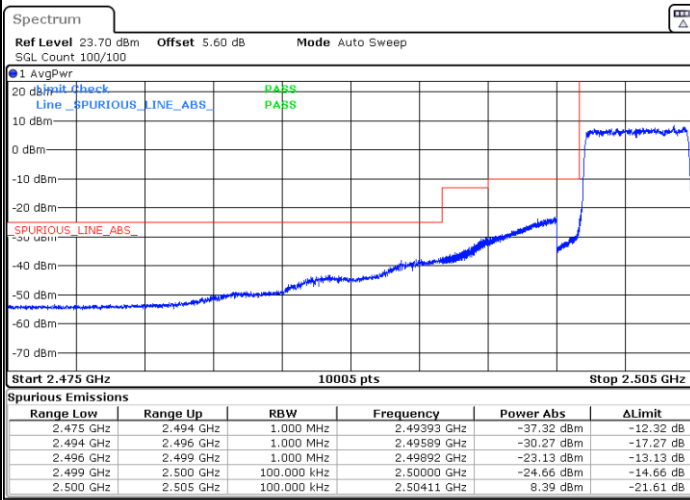

Date: 7 JUN 2022 05:27:01

Date: 7 JUN 2022 05:44:53



FR1 n7 / 20MHz / DFT-s-OFDM / PI/2 BPSK

Lowest Band Edge / 1RB0

Highest Band Edge / 1RBMAX

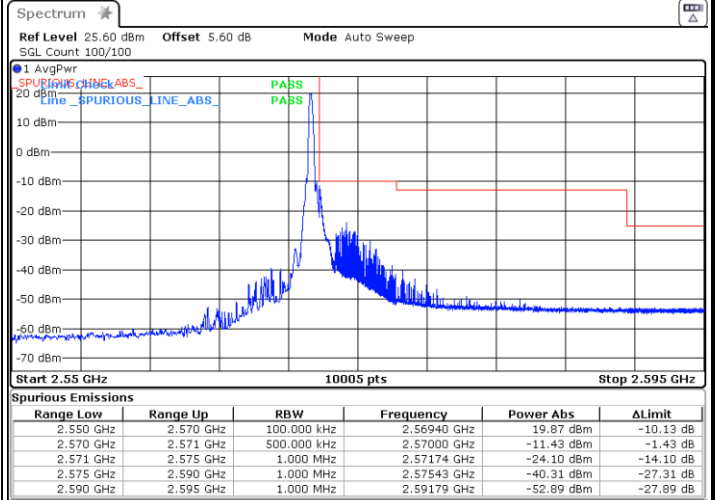
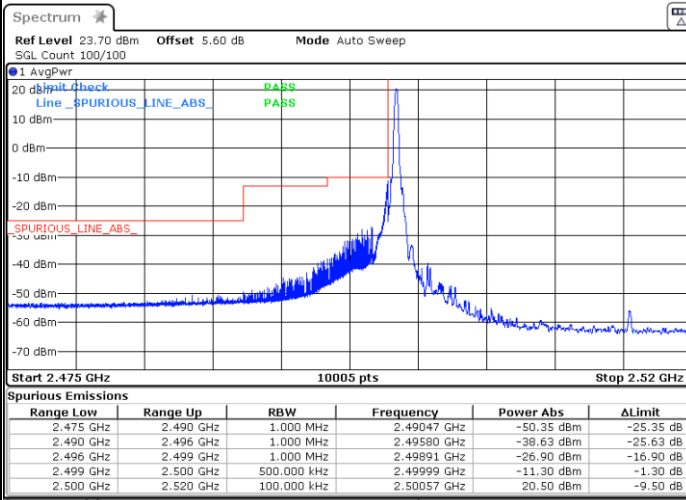

Date: 7 JUN 2022 06:16:56

Date: 7 JUN 2022 06:47:15

Lowest Band Edge / Full RB

Highest Band Edge / Full RB

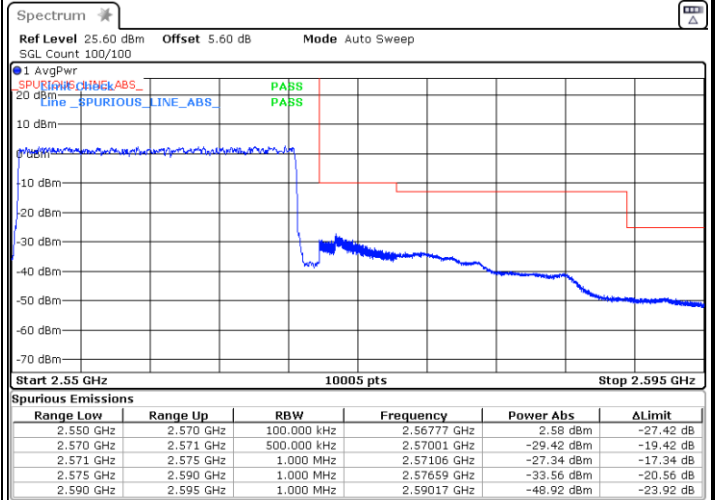
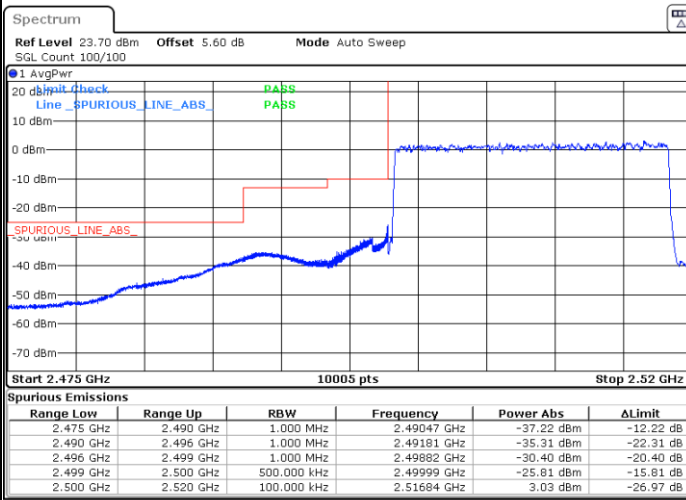

Date: 7 JUN 2022 06:31:55

Date: 7 JUN 2022 06:40:46





FR1 n7 / 25MHz / DFT-s-OFDM / QPSK

Lowest Band Edge / 1RB0

Highest Band Edge / 1RBMAX

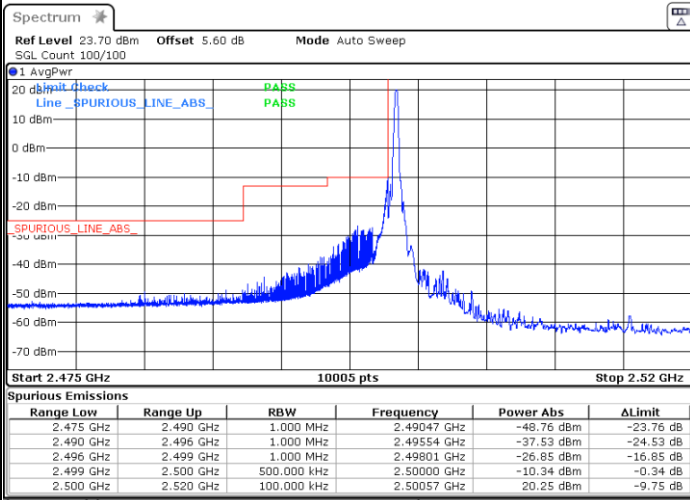

Date: 7 JUN 2022 06:23:32

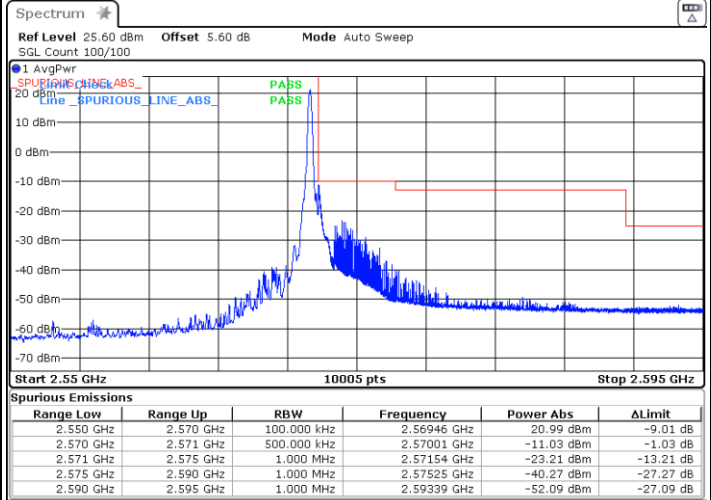

Date: 7 JUN 2022 06:45:39

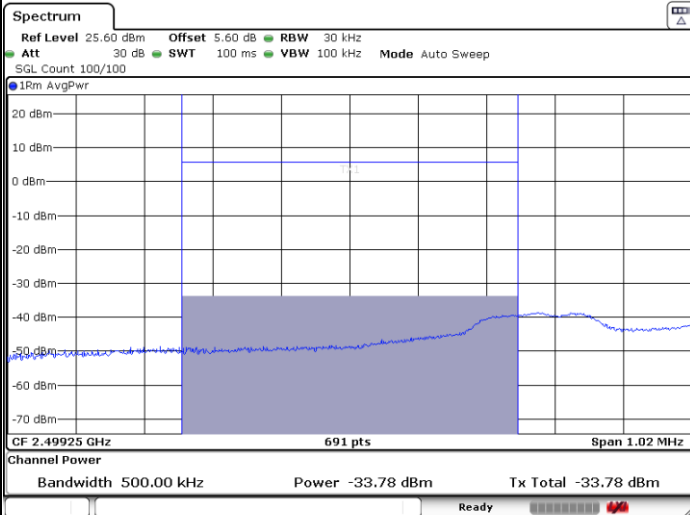

Date: 7 JUN 2022 06:30:50



FR1 n7 / 25MHz / DFT-s-OFDM / QPSK

Lowest Band Edge / Full RB

Highest Band Edge / Full RB

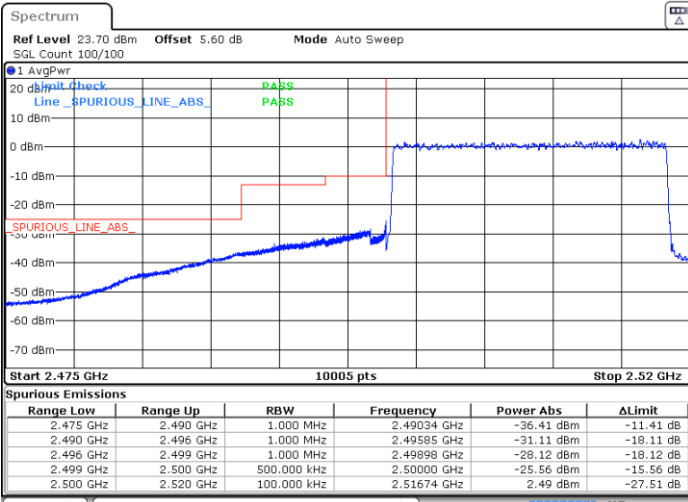

Date: 7 JUN 2022 06:32:13

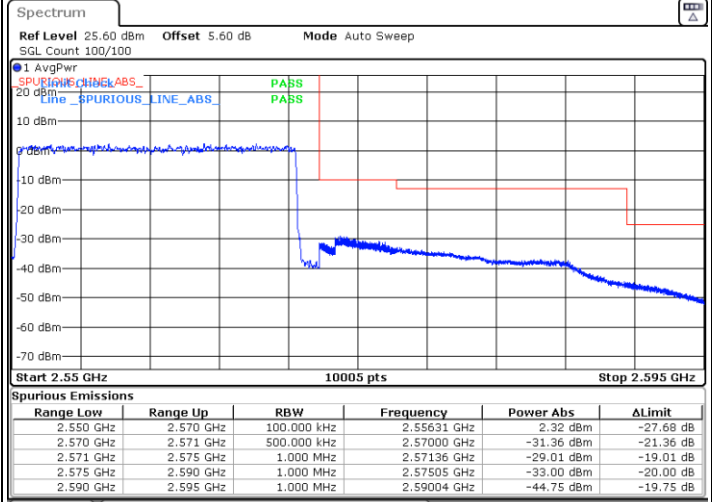

Date: 7 JUN 2022 06:41:44



FR1 n7 / 50MHz / DFT-s-OFDM / PI/2 BPSK

Lowest Band Edge / 1RB0

Highest Band Edge / 1RBMAX

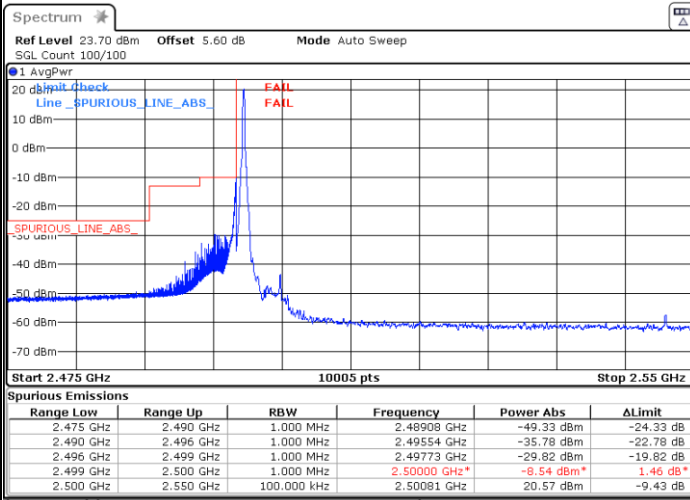

Date: 9 JUN 2022 13:36:09

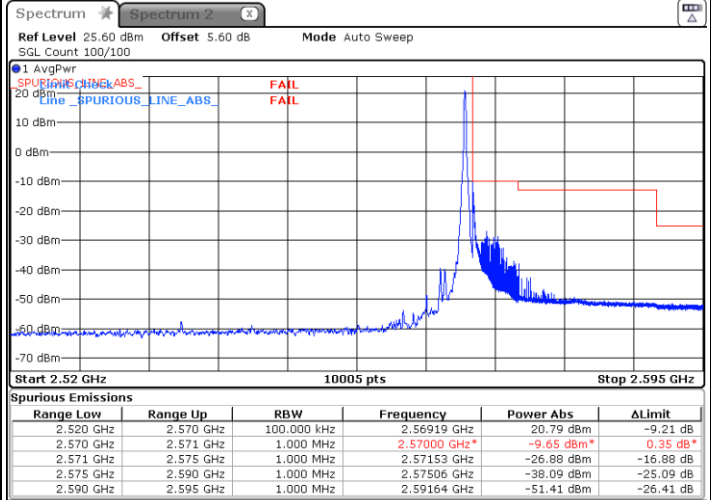

Date: 9 JUN 2022 14:37:56

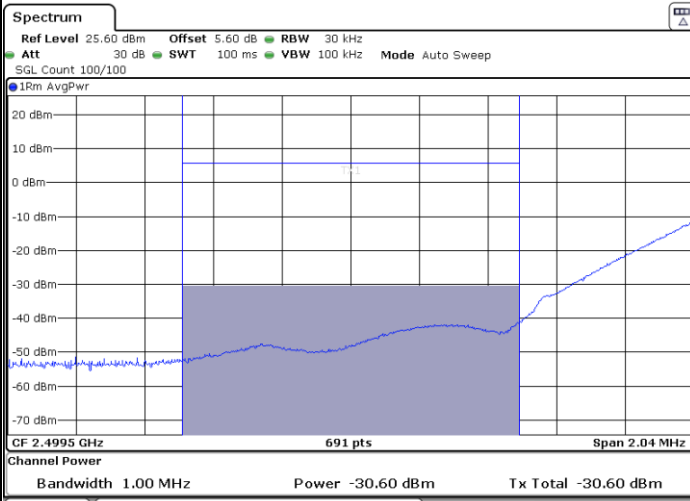

Date: 9 JUN 2022 13:38:39

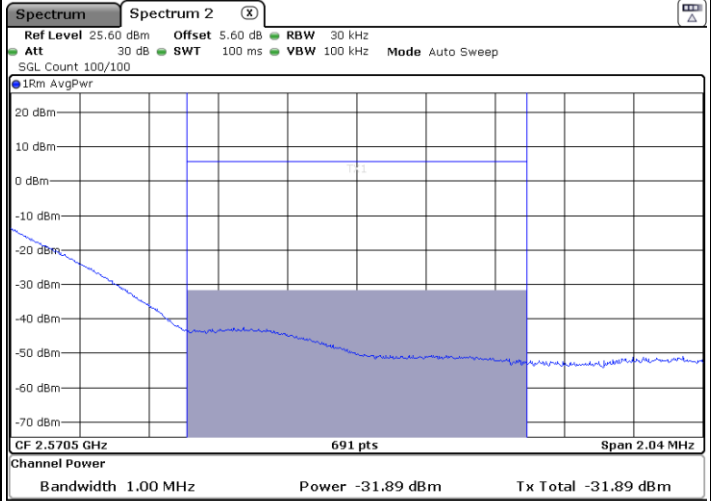

Date: 9 JUN 2022 14:37:07



FR1 n7 / 50MHz / DFT-s-OFDM / PI/2 BPSK

Lowest Band Edge / Full RB

Highest Band Edge / Full RB

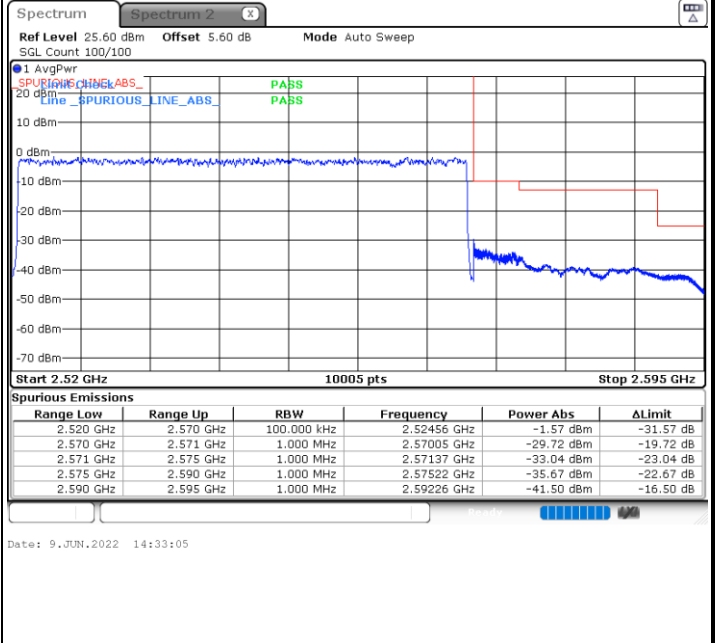
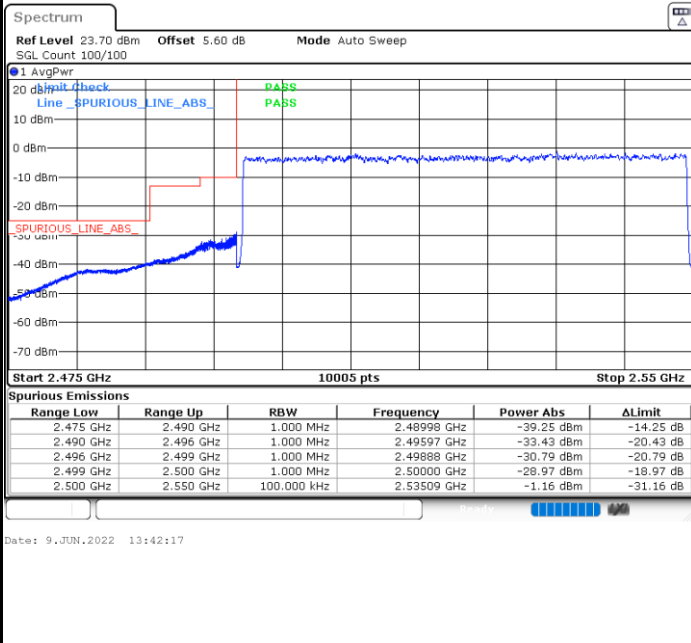



FR1 n7 / 50MHz / DFT-s-OFDM / PI/2 QPSK

Lowest Band Edge / 1RB0

Highest Band Edge / 1RBMAX

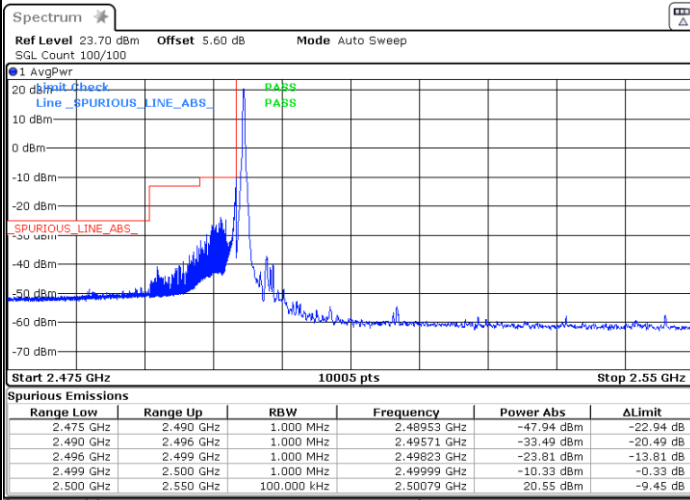

Date: 9 JUN.2022 13:40:48

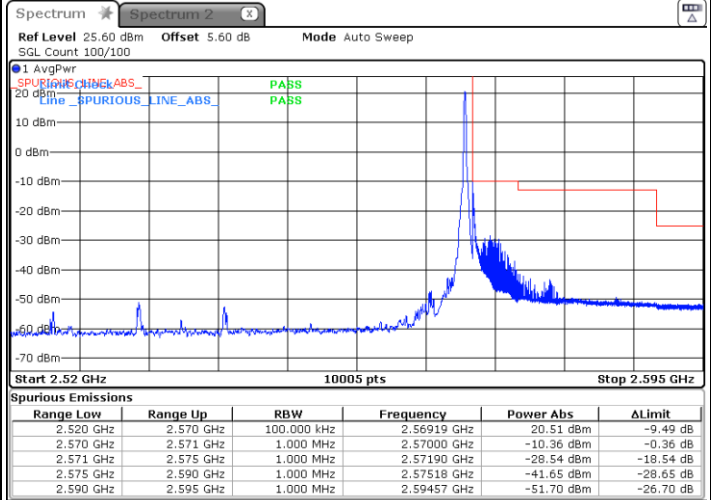

Date: 9 JUN.2022 14:35:09

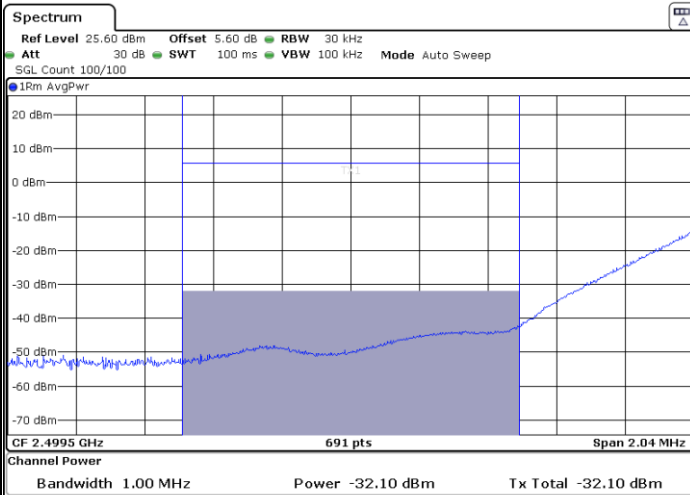

Date: 9 JUN.2022 13:39:34

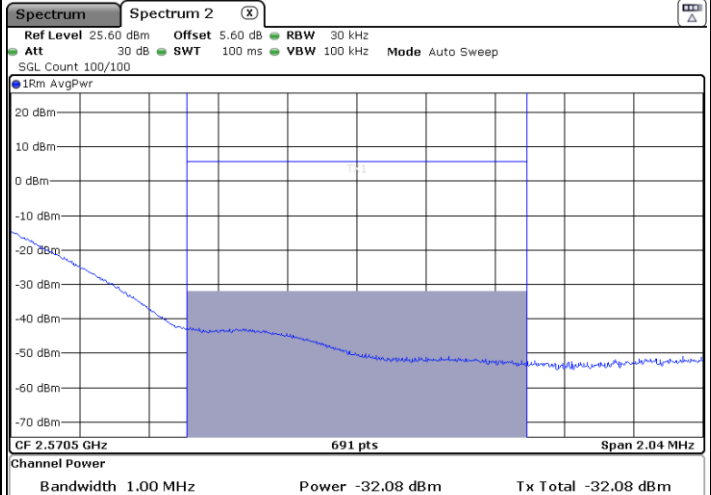

Date: 9 JUN.2022 14:36:21