



# FCC RADIO TEST REPORT

**FCC ID** : UZ7ET40AB  
**Equipment** : Tablet  
**Brand Name** : Zebra  
**Model Name** : ET40AB  
**Applicant** : Zebra Technologies Corporation  
1 Zebra Plaza, Holtsville, NY 11742  
**Manufacturer** : Zebra Technologies Corporation  
1 Zebra Plaza, Holtsville, NY 11742  
**Standard** : FCC Part 15 Subpart E §15.407

The product was received on Mar. 18, 2022 and testing was performed from Mar. 23, 2022 to Apr. 26, 2022. We, Sporton International Inc. Wensan Laboratory, would like to declare that the tested sample has been evaluated in accordance with the test procedures and has been in compliance with the applicable technical standards.

The test results in this report apply exclusively to the tested model / sample. Without written approval from Sporton International Inc. Wensan Laboratory, the test report shall not be reproduced except in full.

Approved by: Louis Wu

**Sporton International Inc. Wensan Laboratory**

No.58, Aly. 75, Ln. 564, Wenhua 3rd, Rd., Guishan Dist., Taoyuan City 333010, Taiwan (R.O.C.)



## Table of Contents

History of this test report.....	3
Summary of Test Result.....	4
<b>1 General Description .....</b>	<b>5</b>
1.1 Product Feature of Equipment Under Test.....	5
1.2 Product Specification of Equipment Under Test.....	6
1.3 Modification of EUT .....	8
1.4 Testing Location .....	9
1.5 Applicable Standards.....	9
<b>2 Test Configuration of Equipment Under Test .....</b>	<b>10</b>
2.1 Carrier Frequency and Channel .....	10
2.2 Test Mode.....	12
2.3 Connection Diagram of Test System.....	20
2.4 Support Unit used in test configuration and system .....	21
2.5 EUT Operation Test Setup .....	22
2.6 Measurement Results Explanation Example.....	22
<b>3 Test Result .....</b>	<b>23</b>
3.1 26dB & 99% Occupied Bandwidth Measurement .....	23
3.2 Maximum Conducted Output Power Measurement .....	32
3.3 Power Spectral Density Measurement .....	42
3.4 Unwanted Emissions Measurement.....	54
3.5 AC Conducted Emission Measurement.....	61
3.6 Antenna Requirements.....	63
<b>4 List of Measuring Equipment.....</b>	<b>65</b>
<b>5 Uncertainty of Evaluation .....</b>	<b>67</b>
<b>Appendix A. AC Conducted Emission Test Result</b>	
<b>Appendix B. Radiated Spurious Emission</b>	
<b>Appendix C. Radiated Spurious Emission Plots</b>	
<b>Appendix D. Duty Cycle Plots</b>	
<b>Appendix E. Setup Photographs</b>	



### History of this test report

Report No.	Version	Description	Issue Date
FR222229D	01	Initial issue of report	May 17, 2022



## Summary of Test Result

Report Clause	Ref Std. Clause	Test Items	Result (PASS/FAIL)	Remark
3.1	15.403(i)	26dB Bandwidth	Pass	-
3.1	2.1049	99% Occupied Bandwidth	Reporting only	-
3.2	15.407(a)	Maximum Conducted Output Power	Pass	-
3.3	15.407(a)	Power Spectral Density	Pass	-
3.4	15.407(b)	Unwanted Emissions	Pass	1.16 dB under the limit at 5350.080 MHz
3.5	15.207	AC Conducted Emission	Pass	16.36 dB under the limit at 0.266 MHz
3.6	15.203 15.407(a)	Antenna Requirement	Pass	-

**Declaration of Conformity:**

1. The test results (PASS/FAIL) with all measurement uncertainty excluded are presented in accordance with the regulation limits or requirements declared by manufacturers.  
It's means measurement values may risk exceeding the limit of regulation standards, if measurement uncertainty is include in test results.
2. The measurement uncertainty please refer to this report "Uncertainty of Evaluation".

**Comments and Explanations:**

The product specifications of the EUT presented in the report are declared by the manufacturer who shall take full responsibility for the authenticity.

**Reviewed by: Keven Cheng**

**Report Producer: Vivian Hsu**



# 1 General Description

## 1.1 Product Feature of Equipment Under Test

Product Feature	
Equipment	Tablet
Brand Name	Zebra
Model Name	ET40AB
FCC ID	UZ7ET40AB
EUT supports Radios application	NFC WLAN 11a/b/g/n HT20/HT40 WLAN 11ac VHT20/VHT40/VHT80 WLAN 11ax HE20/HE40/HE80 Bluetooth BR/EDR/LE
HW Version	EV2-1
SW Version	ET40-userdebug 11 11-07-10.00-RG-U00-PRD-GSE MX3 release-keys
MFD	28JAN22
EUT Stage	Identical Prototype

Remark: The EUT's information above is declared by manufacturer.

Specification of Accessories				
Battery	Brand Name	Zebra	Model Name	BT-000456

Supported Unit Used in Test Configuration and System				
AC Adapter	Brand Name	Zebra	Part Number	PWR-WUA5V12W0US
Earphone 1	Brand Name	Zebra	Part Number	HDST-35MM-PTVP-01
Earphone 2	Brand Name	Zebra	Part Number	HDST-USBC-PTT1-01
USB Cable (Type C to Type A)	Brand Name	Zebra	Part Number	CBL-TC5X-USBC2A-01
Type C-Audio Cable (Type C to 3.5mm)	Brand Name	Zebra	Part Number	ADP-USBC-35MM1-01



### 1.2 Product Specification of Equipment Under Test

Product Specification is subject to this standard	
<b>Tx/Rx Frequency Range</b>	5180 MHz ~ 5240 MHz 5260 MHz ~ 5320 MHz 5500 MHz ~ 5720 MHz
<b>Maximum Output Power to Antenna &lt;CDD Mode&gt;</b>	<p><b>&lt;5180 MHz ~ 5240 MHz&gt;</b>  <b>MIMO &lt;Ant. 6+7&gt;</b>  802.11a: 21.57 dBm / 0.1435 W  802.11n HT20: 21.83 dBm / 0.1524 W  802.11n HT40: 23.17 dBm / 0.2074 W  802.11ac VHT20: 21.83 dBm / 0.1524 W  802.11ac VHT40: 23.17 dBm / 0.2074 W  802.11ac VHT80: 19.87 dBm / 0.0970 W  802.11ax HE20: 21.93 dBm / 0.1559 W  802.11ax HE40: 23.27 dBm / 0.2122 W  802.11ax HE80: 19.97 dBm / 0.0993 W</p> <p><b>&lt;5260 MHz ~ 5320 MHz&gt;</b>  <b>MIMO &lt;Ant. 6+7&gt;</b>  802.11a: 21.76 dBm / 0.1500 W  802.11n HT20: 21.76 dBm / 0.1500 W  802.11n HT40: 23.01 dBm / 0.2002 W  802.11ac VHT20: 21.76 dBm / 0.1500 W  802.11ac VHT40: 23.01 dBm / 0.2002 W  802.11ac VHT80: 19.51 dBm / 0.0894 W  802.11ax HE20: 21.86 dBm / 0.1535 W  802.11ax HE40: 23.11 dBm / 0.2049 W  802.11ax HE80: 19.61 dBm / 0.0914 W</p> <p><b>&lt;5500 MHz ~ 5720 MHz&gt;</b>  <b>MIMO &lt;Ant. 6+7&gt;</b>  802.11a: 22.22 dBm / 0.1667 W  802.11n HT20: 22.17 dBm / 0.1647 W  802.11n HT40: 23.31 dBm / 0.2144 W  802.11ac VHT20: 22.17 dBm / 0.1647 W  802.11ac VHT40: 23.31 dBm / 0.2144 W  802.11ac VHT80: 23.26 dBm / 0.2119 W  802.11ax HE20: 22.27 dBm / 0.1686 W  802.11ax HE40: 23.41 dBm / 0.2194 W  802.11ax HE80: 23.36 dBm / 0.2168 W</p>



Product Specification is subject to this standard	
<p><b>Maximum Output Power to Antenna &lt;TXBF Mode&gt;</b></p>	<p><b>&lt;5180 MHz ~ 5240 MHz&gt;</b>  <b>MIMO &lt;Ant. 6+7&gt;</b>            802.11n HT20: 20.57 dBm / 0.1140 W            802.11n HT40: 22.81 dBm / 0.1912 W            802.11ax HE20: 20.67 dBm / 0.1166 W            802.11ax HE40: 22.91 dBm / 0.1957 W            802.11ax HE80: 19.61 dBm / 0.0915 W</p> <p><b>&lt;5260 MHz ~ 5320 MHz&gt;</b>  <b>MIMO &lt;Ant. 6+7&gt;</b>            802.11n HT20: 20.21 dBm / 0.1050 W            802.11n HT40: 22.96 dBm / 0.1978 W            802.11ax HE20: 20.31 dBm / 0.1074 W            802.11ax HE40: 23.06 dBm / 0.2024 W            802.11ax HE80: 20.31 dBm / 0.1074 W</p> <p><b>&lt;5500 MHz ~ 5720 MHz&gt;</b>  <b>MIMO &lt;Ant. 6+7&gt;</b>            802.11n HT20: 20.46 dBm / 0.1112 W            802.11n HT40: 23.31 dBm / 0.2144 W            802.11ax HE20: 20.56 dBm / 0.1138 W            802.11ax HE40: 23.41 dBm / 0.2194 W            802.11ax HE80: 23.11 dBm / 0.2047 W</p>
<p><b>99% Occupied Bandwidth &lt;CDD Mode&gt;</b></p>	<p><b>MIMO &lt;Ant. 6&gt;</b>            802.11a: 16.98 MHz            802.11ax HE20: 18.98 MHz            802.11ax HE40: 38.06 MHz            802.11ax HE80: 77.32 MHz</p> <p><b>MIMO &lt;Ant. 7&gt;</b>            802.11a: 16.93 MHz            802.11ax HE20: 18.98 MHz            802.11ax HE40: 38.26 MHz            802.11ax HE80: 77.44 MHz</p>
<p><b>99% Occupied Bandwidth &lt;TXBF Mode&gt;</b></p>	<p><b>MIMO &lt;Ant. 6&gt;</b>            802.11ax HE20: 18.98 MHz            802.11ax HE40: 38.06 MHz            802.11ax HE80: 77.32 MHz</p> <p><b>MIMO &lt;Ant. 7&gt;</b>            802.11ax HE20: 18.98 MHz            802.11ax HE40: 38.16 MHz            802.11ax HE80: 77.32 MHz</p>



Product Specification is subject to this standard			
<b>Antenna Type</b>	<b>Ant. 6</b> : IFIA Antenna <b>Ant. 7</b> : IFIA Antenna		
<b>Antenna Gain</b>	<b>&lt;5180 MHz ~ 5240 MHz&gt;</b> Ant. 6 : 2.70 dBi Ant. 7 : 1.30 dBi		
	<b>&lt;5260 MHz ~ 5320 MHz&gt;</b> Ant. 6 : 2.70 dBi Ant. 7 : 2.50 dBi		
	<b>&lt;5500 MHz ~ 5720 MHz&gt;</b> Ant. 6 : 1.70 dBi Ant. 7 : 1.80 dBi		
<b>Type of Modulation</b>	802.11a/n: OFDM (BPSK/QPSK/16QAM/64QAM) 802.11ac: OFDM (BPSK/QPSK/16QAM/64QAM/256QAM) 802.11ax: OFDMA (BPSK/QPSK/16QAM/64QAM/256QAM/1024QAM)		
<b>Antenna Function Description</b>		<b>Ant. 6</b>	<b>Ant. 7</b>
	802.11 a/n/ac/ax MIMO	√	√
	802.11 n/ax TXBF	√	√

**Remark:**

1. MIMO Ant. 6+7 is a calculated result from sum of the power MIMO Ant. 6 and MIMO Ant. 7.
2. The EUT's information above is declared by manufacturer. Please refer to Comments and Explanations in report summary.

### 1.3 Modification of EUT

No modifications made to the EUT during the testing.





### 1.4 Testing Location

<b>Test Site</b>	Sporton International Inc. Wensan Laboratory
<b>Test Site Location</b>	No.58, Aly. 75, Ln. 564, Wenhua 3rd, Rd., Guishan Dist., Taoyuan City 333010, Taiwan (R.O.C.) TEL: +886-3-327-0868 FAX: +886-3-327-0855
<b>Test Site No.</b>	<b>Sporton Site No.</b> TH05-HY, 03CH13-HY, CO07-HY

**Note:** The test site complies with ANSI C63.4 2014 requirement.

FCC designation No.: TW3786

### 1.5 Applicable Standards

According to the specifications declared by the manufacturer, the EUT must comply with the requirements of the following standards:

- ♦ FCC Part 15 Subpart E
- ♦ FCC KDB 789033 D02 General UNII Test Procedures New Rules v02r01.
- ♦ FCC KDB 414788 D01 Radiated Test Site v01r01.
- ♦ FCC KDB 662911 D01 Multiple Transmitter Output v02r01.
- ♦ ANSI C63.10-2013

**Remark:**

1. All the test items were validated and recorded in accordance with the standards without any modification during the testing.
2. The TAF code is not including all the FCC KDB listed without accreditation.
3. This EUT has also been tested and complied with the requirements of FCC Part 15, Subpart B, recorded in a separate test report.



## 2 Test Configuration of Equipment Under Test

- a. The EUT has been associated with peripherals and configuration operated in a manner tended to maximize its emission characteristics in a typical application. Frequency range investigated: conduction emission (150 kHz to 30 MHz), radiation emission (9 kHz to the 10th harmonic of the highest fundamental frequency or to 40 GHz, whichever is lower). For radiated measurement, the measured emission level of the EUT was maximized by rotating the EUT on a turntable, adjusting the orientation of the EUT and EUT antenna in three orthogonal axis (X: flat, Y: portrait, Z: landscape), and adjusting the measurement antenna orientation, following C63.10 exploratory test procedures and find Z plane as worst plane.
- b. AC power line Conducted Emission was tested under maximum output power.

### 2.1 Carrier Frequency and Channel

Frequency Band	Channel	Freq. (MHz)	Channel	Freq. (MHz)
5150-5250 MHz Band 1 (U-NII-1)	36	5180	44	5220
	38*	5190	46*	5230
	40	5200	48	5240
	42 <sup>#</sup>	5210		

Frequency Band	Channel	Freq. (MHz)	Channel	Freq. (MHz)
5250-5350 MHz Band 2 (U-NII-2A)	52	5260	60	5300
	54*	5270	62*	5310
	56	5280	64	5320
	58 <sup>#</sup>	5290		

Frequency Band	Channel	Freq. (MHz)	Channel	Freq. (MHz)
5470-5725 MHz Band 3 (U-NII-2C)	100	5500	112	5560
	102*	5510	116	5580
	104	5520	132	5660
	106 <sup>#</sup>	5530	134*	5670
	108	5540	136	5680
	110*	5550	140	5700



Frequency Band	Channel	Freq. (MHz)	Channel	Freq. (MHz)
TDWR Channel	118*	5590	124	5620
	120	5600	126*	5630
	122 <sup>#</sup>	5610	128	5640

Frequency Band	Channel	Freq. (MHz)	Channel	Freq. (MHz)
Straddle Channel	138 <sup>#</sup>	5690	144	5720
	142*	5710		

**Note:**

1. The above Frequency and Channel with "\*" are 802.11n HT40 and 802.11ac VHT40 and 802.11ax HE40.
2. The above Frequency and Channel with "<sup>#</sup>" are 802.11ac VHT80 and 802.11ax HE80.



## 2.2 Test Mode

The 802.11ax mode is investigated among different tones, full resource units (RU), partial resource units. The partial RU has no higher power than full RU's, thus the full RU is chosen as main test configuration.

The CDD mode is chosen as worst case configuration for all test cases due to higher power than SISO mode.

The 802.11n/ac mode has no higher power and PSD than 802.11ax mode, thus the 802.11ax mode is chosen as main test configuration, and the 802.11n/ac mode is verified the power.

The final test modes consider the modulation and the worst data rates as shown in the table below.

### <CDD Mode>

Modulation	Data Rate
802.11a	6 Mbps
802.11n HT20 (Covered by HE20)	MCS0
802.11n HT40 (Covered by HE40)	MCS0
802.11ac VHT20 (Covered by HE20)	MCS0
802.11ac VHT40 (Covered by HE40)	MCS0
802.11ac VHT80 (Covered by HE80)	MCS0
802.11ax HE20	MCS0
802.11ax HE40	MCS0
802.11ax HE80	MCS0

### <TXBF Mode>

Modulation	Data Rate
802.11n HT20 (Covered by HE20)	MCS0
802.11n HT40 (Covered by HE40)	MCS0
802.11ax HE20	MCS0
802.11ax HE40	MCS0
802.11ax HE80	MCS0



Test Cases	
<b>AC Conducted Emission</b>	Mode 1 : WLAN (5GHz) Link + Bluetooth Link + USB Cable (Charging from Adapter)

Ch. #		Band I : 5150-5250 MHz	Band II : 5250-5350 MHz	Band III : 5470-5725MHz
		802.11a	802.11a	802.11a
L	Low	36	52	100
M	Middle	44	60	116
H	High	48	64	140
Straddle		-	-	144

Ch. #		Band I : 5150-5250 MHz	Band II : 5250-5350 MHz	Band III : 5470-5725MHz
		802.11ax HE20	802.11ax HE20	802.11ax HE20
L	Low	36	52	100
M	Middle	44	60	116
H	High	48	64	140
Straddle		-	-	144

Ch. #		Band I : 5150-5250 MHz	Band II : 5250-5350 MHz	Band III : 5470-5725MHz
		802.11ax HE40	802.11ax HE40	802.11ax HE40
L	Low	38	54	102
M	Middle	-	-	110
H	High	46	62	134
Straddle		-	-	142

Ch. #		Band I : 5150-5250 MHz	Band II : 5250-5350 MHz	Band III : 5470-5725MHz
		802.11ax HE80	802.11ax HE80	802.11ax HE80
L	Low	-	-	106
M	Middle	42	58	-
H	High	-	-	122
Straddle		-	-	138

**Remark:** For radiation spurious emission, the modulation and the data rate picked for testing are determined by the Max. RF conducted power.



MIMO <Ant. 6+7>

<CDD Mode>

Power vs. Channel			Power vs Data Rate							
Channel	Frequency (MHz)	Data Rate (bps)	Channel	Data Rate (bps)						
		6M		9M	12M	18M	24M	36M	48M	54M
CH 036	5180	21.34	CH 044	21.47	21.47	21.47	21.37	21.37	21.37	21.37
CH 044	5220	<b>21.57</b>								
CH 048	5240	21.27								
CH 052	5260	21.41	CH 060	21.66	21.66	21.66	21.56	21.56	21.56	21.56
CH 060	5300	<b>21.76</b>								
CH 064	5320	21.21								
CH 100	5500	21.56	CH 144*	22.12	22.12	22.02	22.02	22.02	21.92	21.92
CH 116	5580	21.46								
CH 140	5700	21.83								
CH 144*	5720	<b>22.22</b>								

Note: The above Frequency and Channel in "\*" were straddle Channel.

802.11n HT20 RF Output Power (dBm)										
Power vs. Channel			Power vs Data Rate							
Channel	Frequency (MHz)	MCS Index	Channel	MCS Index						
		MCS0		MCS1	MCS2	MCS3	MCS4	MCS5	MCS6	MCS7
CH 036	5180	<b>21.83</b>	CH 036	21.73	21.73	21.73	21.63	21.63	21.63	21.53
CH 044	5220	21.67								
CH 048	5240	21.17								
CH 052	5260	21.51	CH 060	21.66	21.66	21.66	21.56	21.56	21.56	21.46
CH 060	5300	<b>21.76</b>								
CH 064	5320	21.46								
CH 100	5500	21.51	CH 144*	22.07	22.07	22.07	21.97	21.97	21.97	21.87
CH 116	5580	21.51								
CH 140	5700	20.77								
CH 144*	5720	<b>22.17</b>								

Note: The above Frequency and Channel in "\*" were straddle Channel.

802.11n HT40 RF Output Power (dBm)										
Power vs. Channel			Power vs Data Rate							
Channel	Frequency (MHz)	MCS Index	Channel	MCS Index						
		MCS0		MCS1	MCS2	MCS3	MCS4	MCS5	MCS6	MCS7
CH 038	5190	21.32	CH 046	23.07	23.07	23.07	22.97	22.97	22.97	22.87
CH 046	5230	<b>23.17</b>								
CH 054	5270	<b>23.01</b>	CH 054	22.91	22.91	22.91	22.81	22.81	22.81	22.71
CH 062	5310	21.51								
CH 102	5510	20.66	CH 110	23.21	23.21	23.21	23.11	23.11	23.11	23.01
CH 110	5550	<b>23.31</b>								
CH 134	5670	23.21								
CH 142*	5710	23.26								

Note: The above Frequency and Channel in "\*" were straddle Channel.



802.11ac VHT20 RF Output Power (dBm)											
Power vs. Channel			Power vs Data Rate								
Channel	Frequency (MHz)	MCS Index	Channel	MCS Index							
		MCS0		MCS1	MCS2	MCS3	MCS4	MCS5	MCS6	MCS7	MCS8
CH 036	5180	21.83	CH 036	21.73	21.73	21.73	21.63	21.63	21.63	21.53	21.53
CH 044	5220	21.67									
CH 048	5240	21.17									
CH 052	5260	21.51	CH 060	21.66	21.66	21.66	21.56	21.56	21.56	21.46	21.46
CH 060	5300	21.76									
CH 064	5320	21.46									
CH 100	5500	21.51	CH 144*	22.07	22.07	22.07	21.97	21.97	21.97	21.87	21.87
CH 116	5580	21.51									
CH 140	5700	20.77									
CH 144*	5720	22.17									

Note: The above Frequency and Channel in "\*" were straddle Channel.

802.11ac VHT40 RF Output Power (dBm)												
Power vs. Channel			Power vs Data Rate									
Channel	Frequency (MHz)	MCS Index	Channel	MCS Index								
		MCS0		MCS1	MCS2	MCS3	MCS4	MCS5	MCS6	MCS7	MCS8	MCS9
CH 038	5190	21.32	CH 046	23.07	23.07	23.07	22.97	22.97	22.97	22.87	22.87	22.87
CH 046	5230	23.17										
CH 054	5270	23.01	CH 054	22.91	22.91	22.91	22.81	22.81	22.81	22.71	22.71	22.71
CH 062	5310	21.51										
CH 102	5510	20.66	CH 110	23.21	23.21	23.21	23.11	23.11	23.11	23.01	23.01	23.01
CH 110	5550	23.31										
CH 134	5670	23.21										
CH 142*	5710	23.26										

Note: The above Frequency and Channel in "\*" were straddle Channel.

802.11ac VHT80 RF Output Power (dBm)												
Power vs. Channel			Power vs Data Rate									
Channel	Frequency (MHz)	MCS Index	Channel	MCS Index								
		MCS0		MCS1	MCS2	MCS3	MCS4	MCS5	MCS6	MCS7	MCS8	MCS9
CH 042	5210	19.87	CH 042	19.77	19.77	19.77	19.67	19.67	19.67	19.57	19.57	19.57
CH 058	5290	19.51	CH 058	19.41	19.41	19.41	19.31	19.31	19.31	19.21	19.21	19.21
CH 106	5530	19.96	CH 122	23.16	23.16	23.16	23.06	23.06	23.06	22.96	22.96	22.96
CH 122	5610	23.26										
CH 138*	5690	22.82										

Note: The above Frequency and Channel in "\*" were straddle Channel.



<802.11ax Mode>

802.11ax HE20 RF Output Power (dBm)															
Power vs. Channel				Power vs Data Rate											
Channel	Frequency (MHz)	RU Config.	MCS Index	Channel	MCS Index										
			MCS0		MCS1	MCS2	MCS3	MCS4	MCS5	MCS6	MCS7	MCS8	MCS9	MCS10	MCS11
CH 036	5180	Full	21.93												
CH 036	5180	26/0	13.04												
CH 036	5180	52/37	16.34												
CH 036	5180	106/53	19.64												
CH 044	5220	Full	21.77												
CH 044	5220	26/4	14.56	CH 036	21.83	21.83	21.83	21.73	21.73	21.73	21.63	21.63	21.53	21.53	21.53
CH 044	5220	52/39	16.11												
CH 044	5220	106/53	19.51												
CH 048	5240	Full	21.27												
CH 048	5240	26/8	12.61												
CH 048	5240	52/40	15.56												
CH 048	5240	106/54	18.81												
CH 052	5260	Full	21.61												
CH 052	5260	26/0	12.66												
CH 052	5260	52/37	15.96												
CH 052	5260	106/53	19.21												
CH 060	5300	Full	21.86												
CH 060	5300	26/4	14.51	CH 060	21.76	21.76	21.76	21.66	21.66	21.66	21.56	21.56	21.46	21.46	21.46
CH 060	5300	52/39	16.56												
CH 060	5300	106/54	19.61												
CH 064	5320	Full	21.56												
CH 064	5320	26/8	13.16												
CH 064	5320	52/40	15.96												
CH 064	5320	106/54	19.31												
CH 100	5500	Full	21.61												
CH 100	5500	26/0	14.16												
CH 100	5500	52/37	17.21												
CH 100	5500	106/53	20.11												
CH 116	5580	Full	21.61												
CH 116	5580	26/4	14.87												
CH 116	5580	52/38	17.12												
CH 116	5580	106/53	20.31	CH 144*	22.17	22.17	22.17	22.07	22.07	22.07	21.97	21.97	21.87	21.87	21.87
CH 140	5700	Full	20.87												
CH 140	5700	26/8	12.88												
CH 140	5700	52/40	15.47												
CH 140	5700	106/54	18.58												
CH 144*	5720	Full	22.27												
CH 144*	5720	26/8	14.53												
CH 144*	5720	52/40	17.57												
CH 144*	5720	106/54	20.92												

Note: The above Frequency and Channel in "\*" were straddle Channel.





802.11ax HE40 RF Output Power (dBm)															
Power vs. Channel				Power vs Data Rate											
Channel	Frequency (MHz)	RU Config.	MCS Index	Channel	MCS Index										
			MCS0		MCS1	MCS2	MCS3	MCS4	MCS5	MCS6	MCS7	MCS8	MCS9	MCS10	MCS11
CH 038	5190	Full	21.42	CH 046	23.17	23.17	23.17	23.07	23.07	23.07	22.97	22.97	22.87	22.87	22.87
CH 038	5190	242/61	19.02												
CH 046	5230	Full	23.27												
CH 046	5230	242/62	20.76												
CH 054	5270	Full	23.11	CH 054	23.01	23.01	23.01	22.91	22.91	22.91	22.81	22.81	22.71	22.71	22.71
CH 054	5270	242/61	20.71												
CH 062	5310	Full	21.61												
CH 062	5310	242/62	19.26												
CH 102	5510	Full	20.76	CH 110	23.31	23.31	23.31	23.21	23.21	23.21	23.11	23.11	23.01	23.01	23.01
CH 102	5510	242/61	18.96												
CH 110	5550	Full	23.41												
CH 110	5550	242/61	21.61												
CH 134	5670	Full	23.31												
CH 134	5670	242/62	21.17												
CH 142*	5710	Full	23.36												
CH 142*	5710	242/62	21.11												

Note: The above Frequency and Channel in "\*" were straddle Channel.

802.11ax HE80 RF Output Power (dBm)															
Power vs. Channel				Power vs Data Rate											
Channel	Frequency (MHz)	RU Config.	MCS Index	Channel	MCS Index										
			MCS0		MCS1	MCS2	MCS3	MCS4	MCS5	MCS6	MCS7	MCS8	MCS9	MCS10	MCS11
CH 042	5210	Full	19.97	CH 042	19.87	19.87	19.87	19.77	19.77	19.77	19.67	19.67	19.67	19.57	19.57
CH 042	5210	484/65	18.08												
CH 058	5290	Full	19.61	CH 058	19.51	19.51	19.51	19.41	19.41	19.41	19.31	19.31	19.31	19.21	19.21
CH 058	5290	484/66	17.01												
CH 106	5530	Full	20.06	CH 122	23.26	23.26	23.26	23.16	23.16	23.16	23.06	23.06	23.06	22.96	22.96
CH 106	5530	484/65	17.56												
CH 122	5610	Full	23.36												
CH 122	5610	484/66	20.86												
CH 138*	5690	Full	22.92												
CH 138*	5690	484/66	20.57												

Note: The above Frequency and Channel in "\*" were straddle Channel.



<TXBF Mode>

802.11n HT20 RF Output Power (dBm)										
Power vs. Channel			Power vs Data Rate							
Channel	Frequency (MHz)	MCS Index	Channel	MCS Index						
		MCS0		MCS1	MCS2	MCS3	MCS4	MCS5	MCS6	MCS7
CH 036	5180	20.33	CH 044	20.57	20.57	20.51	20.47	20.47	20.47	20.47
CH 044	5220	<b>20.57</b>								
CH 048	5240	20.01								
CH 052	5260	19.86	CH 060	20.21	20.21	20.16	20.11	20.11	20.11	20.11
CH 060	5300	<b>20.21</b>								
CH 064	5320	20.01								
CH 100	5500	19.96	CH 144*	20.46	20.46	20.41	20.36	20.36	20.36	20.36
CH 116	5580	20.31								
CH 140	5700	20.32								
CH 144*	5720	<b>20.46</b>								

802.11n HT40 RF Output Power (dBm)										
Power vs. Channel			Power vs Data Rate							
Channel	Frequency (MHz)	MCS Index	Channel	MCS Index						
		MCS0		MCS1	MCS2	MCS3	MCS4	MCS5	MCS6	MCS7
CH 038	5190	19.63	CH 046	22.71	22.71	22.71	22.61	22.61	22.61	22.61
CH 046	5230	<b>22.81</b>								
CH 054	5270	<b>22.96</b>	CH 054	22.86	22.86	22.86	22.76	22.76	22.76	22.76
CH 062	5310	19.81								
CH 102	5510	20.21	CH 110	23.21	23.21	23.21	23.11	23.11	23.11	23.11
CH 110	5550	<b>23.31</b>								
CH 134	5670	22.51								
CH 142*	5710	22.97								



<802.11ax Mode>

802.11ax HE20 RF Output Power (dBm)															
Power vs. Channel				Power vs Data Rate											
Channel	Frequency (MHz)	RU Config.	MCS Index	Channel	MCS Index										
			MCS0		MCS1	MCS2	MCS3	MCS4	MCS5	MCS6	MCS7	MCS8	MCS9	MCS10	MCS11
CH 036	5180	Full	20.43												
CH 044	5220	Full	20.67	CH 044	20.67	20.67	20.61	20.57	20.57	20.57	20.57	20.51	20.47	20.41	20.41
CH 048	5240	Full	20.11												
CH 052	5260	Full	19.96												
CH 060	5300	Full	20.31	CH 060	20.31	20.31	20.26	20.21	20.21	20.21	20.21	20.16	20.11	20.06	20.06
CH 064	5320	Full	20.11												
CH 100	5500	Full	20.06												
CH 116	5580	Full	20.41												
CH 140	5700	Full	20.42												
CH 144*	5720	Full	20.56	CH 144*	20.56	20.56	20.51	20.46	20.46	20.46	20.46	20.41	20.36	20.31	20.31

802.11ax HE40 RF Output Power (dBm)															
Power vs. Channel				Power vs Data Rate											
Channel	Frequency (MHz)	RU Config.	MCS Index	Channel	MCS Index										
			MCS0		MCS1	MCS2	MCS3	MCS4	MCS5	MCS6	MCS7	MCS8	MCS9	MCS10	MCS11
CH 038	5190	Full	19.73												
CH 046	5230	Full	22.91	CH 046	22.81	22.81	22.81	22.71	22.71	22.71	22.71	22.61	22.61	22.61	22.51
CH 054	5270	Full	23.06												
CH 062	5310	Full	19.91	CH 054	22.96	22.96	22.96	22.86	22.86	22.86	22.86	22.76	22.76	22.76	22.66
CH 102	5510	Full	20.31												
CH 110	5550	Full	23.41												
CH 134	5670	Full	22.61												
CH 142*	5710	Full	23.07	CH 110	23.31	23.31	23.31	23.21	23.21	23.21	23.21	23.11	23.11	23.11	23.01

802.11ax HE80 RF Output Power (dBm)															
Power vs. Channel				Power vs Data Rate											
Channel	Frequency (MHz)	RU Config.	MCS Index	Channel	MCS Index										
			MCS0		MCS1	MCS2	MCS3	MCS4	MCS5	MCS6	MCS7	MCS8	MCS9	MCS10	MCS11
CH 042	5210	Full	19.61	CH 042	19.51	19.51	19.51	19.41	19.41	19.41	19.41	19.31	19.31	19.31	19.21
CH 058	5290	Full	20.31	CH 058	20.21	20.21	20.21	20.11	20.11	20.11	20.11	20.01	20.01	20.01	19.91
CH 106	5530	Full	21.26												
CH 122	5610	Full	23.11	CH 122	23.01	23.01	23.01	22.91	22.91	22.91	22.91	22.81	22.81	22.81	22.71
CH 138*	5690	Full	23.06												

## 2.3 Connection Diagram of Test System

<AC Conducted Emission Mode>

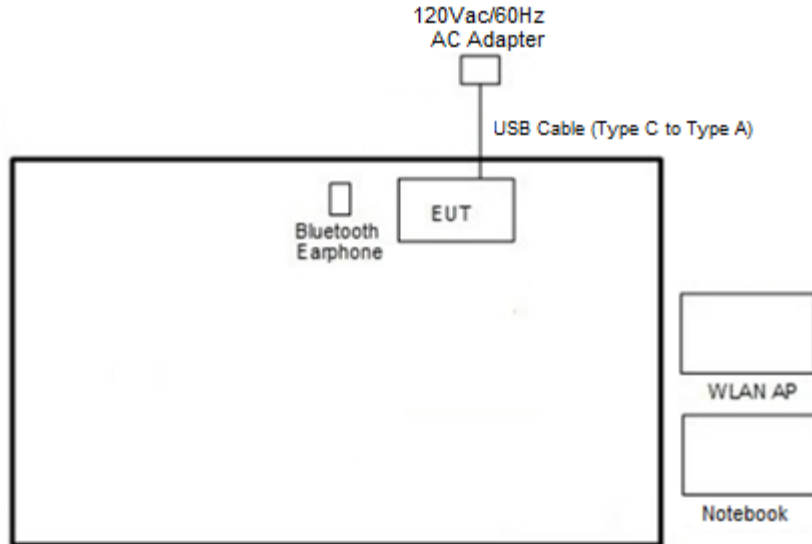

<WLAN Tx Mode>

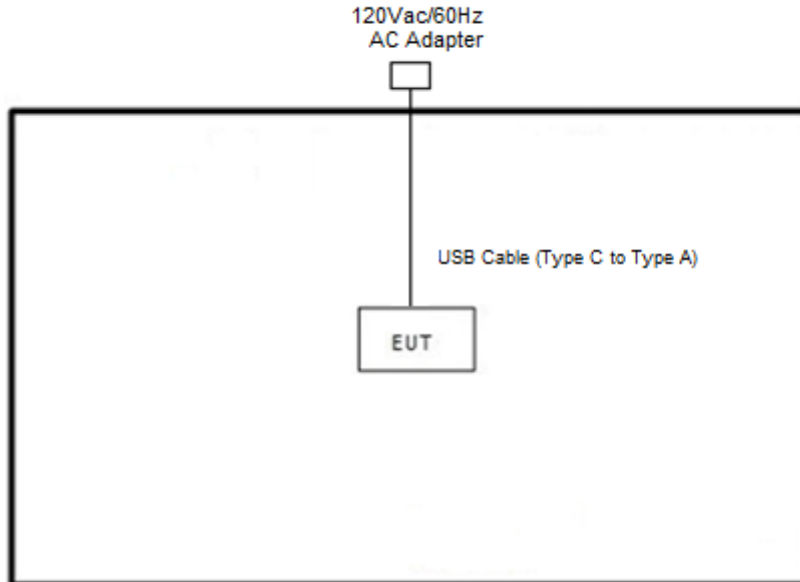

<WLAN TXBF Mode>

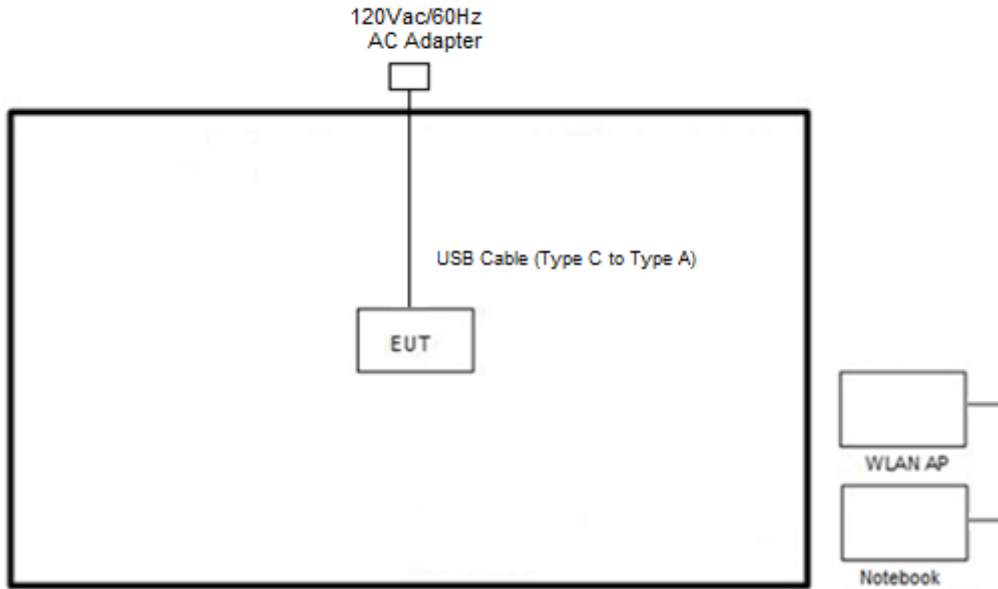

**2.4 Support Unit used in test configuration and system**

Item	Equipment	Brand Name	Model Name	FCC ID	Data Cable	Power Cord
1.	Bluetooth Earphone	Sony	SBH20	PY7-RD0010	N/A	N/A
2.	WLAN AP	ASUS	RT-AC52	MSQ-RTAC66U	N/A	Unshielded, 1.8m
3.	WLAN AP	ASUS	RT-AX88U	LCITHP000236	N/A	Unshielded, 1.8m
4.	Notebook	Dell	P74G	FCC DoC	N/A	AC I/P: Unshielded, 1.2 m DC O/P: Shielded, 1.8 m
5.	Notebook	Acer	N18Q13	PD9AX201NG	N/A	AC I/P: Unshielded, 1.2 m DC O/P: Shielded, 1.8 m



## 2.5 EUT Operation Test Setup

The RF test items, utility “CMD Version 1.0.29” was installed in Notebook which was programmed in order to make the EUT get into the engineering modes to provide channel selection, power level, data rate and the application type and for continuous transmitting signals.

For TXBF mode, the modulation modes and data rates manipulated by the command lines in the engineering program made the EUT link to another EUT by power under the normal operation. The “CMD Version 1.0.29” software tool was used to enable the EUT to transmit signals continuously.

## 2.6 Measurement Results Explanation Example

**For all conducted test items:**

The offset level is set in the spectrum analyzer to compensate the RF cable loss and attenuator factor between EUT conducted output port and spectrum analyzer. With the offset compensation, the spectrum analyzer reading level is exactly the EUT RF output level.

Example :

The spectrum analyzer offset is derived from RF cable loss and attenuator factor.

*Offset = RF cable loss + attenuator factor.*

Following shows an offset computation example with cable loss 4.2 dB and 10 dB attenuator.

$$\begin{aligned} \text{Offset(dB)} &= \text{RF cable loss(dB)} + \text{attenuator factor(dB)}. \\ &= 4.2 + 10 = 14.2 \text{ (dB)} \end{aligned}$$

### 3 Test Result

#### 3.1 26dB & 99% Occupied Bandwidth Measurement

##### 3.1.1 Description of 26dB & 99% Occupied Bandwidth

This section is for reporting purpose only.

There is no restriction limits for bandwidth.

For Straddle Channel, according to KDB 789033 D02 General UNII Test Procedures New Rules v02r01, if the power and PSD of the devices are uniform and comply with the lower limits specified for the U-NII-2 bands, a single measurement over the entire emission bandwidth can be performed to show compliance.

##### 3.1.2 Measuring Instruments

Please refer to the measuring equipment list in this test report.

##### 3.1.3 Test Procedures

1. The testing follows FCC KDB 789033 D02 General UNII Test Procedures New Rules v02r01. Section C) Emission bandwidth
2. Set RBW = approximately 1% of the emission bandwidth.
3. Set the VBW > RBW.
4. Detector = Peak.
5. Trace mode = max hold
6. Measure the maximum width of the emission that is 26 dB down from the peak of the emission. Compare this with the RBW setting of the analyzer. Readjust RBW and repeat measurement as needed until the RBW/EBW ratio is approximately 1%.
7. For 99% Bandwidth Measurement, the spectrum analyzer's resolution bandwidth (RBW) is set 1-5% of the emission bandwidth and set the Video bandwidth (VBW)  $\geq 3 * RBW$ .
8. Measure and record the results in the test report.

##### 3.1.4 Test Setup

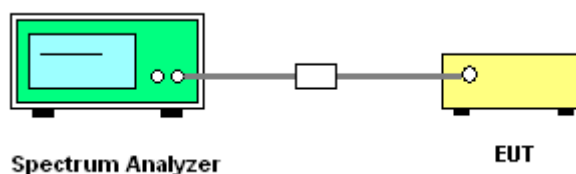



3.1.5 Test Result of 26dB & 99% Occupied Bandwidth

Test Engineer :	Hank Hsu	Temperature :	21~25°C
		Relative Humidity :	51~54%

<CDD Mode>

Band I MIMO														
Mod.	Data Rate	NTX	CH.	Freq. (MHz)	99% Bandwidth (MHz)		26 dB Bandwidth (MHz)		IC 99% Bandwidth Power Limit (dBm)		IC 99% Bandwidth EIRP Limit (dBm)		-	Note
					Ant 6	Ant 7	Ant 6	Ant 7	Ant 6	Ant 7	Ant 6	Ant 7		
11a	6Mbps	2	36	5180	16.93	16.78	21.50	21.35	-	-	22.25	-	-	
11a	6Mbps	2	44	5220	16.93	16.83	21.65	21.60	-	-	22.26	-	-	
11a	6Mbps	2	48	5240	16.98	16.78	21.65	21.50	-	-	22.25	-	-	

Band II MIMO															
Mod.	Data Rate	NTX	CH.	Freq. (MHz)	99% Bandwidth (MHz)		26 dB Bandwidth (MHz)		IC 99% Bandwidth Power Limit (dBm)		IC 99% Bandwidth EIRP Limit (dBm)		FCC 26dB Bandwidth Power Limit (dBm)		Note
					Ant 6	Ant 7	Ant 6	Ant 7	Ant 6	Ant 7	Ant 6	Ant 7	Ant 6	Ant 7	
11a	6Mbps	2	52	5260	16.98	16.88	21.60	21.60	23.27	23.27	29.27	23.98	-		
11a	6Mbps	2	60	5300	16.93	16.83	21.70	21.60	23.26	23.26	29.26	23.98	-		
11a	6Mbps	2	64	5320	16.98	16.78	21.80	21.60	23.25	23.25	29.25	23.98	-		

Band III MIMO																
Mod.	Data Rate	NTX	CH.	Freq. (MHz)	99% Bandwidth In U-NII 2C (MHz)		26 dB Bandwidth In U-NII 2C (MHz)		IC 99% Bandwidth Power Limit (dBm)		IC 99% Bandwidth EIRP Limit (dBm)		FCC 26dB Bandwidth Power Limit (dBm)		6 dB Bandwidth for Straddle Channel (MHz)	
					Ant 6	Ant 7	Ant 6	Ant 7	Ant 6	Ant 7	Ant 6	Ant 7	Ant 6	Ant 7	Ant 6	Ant 7
11a	6Mbps	2	100	5500	16.98	16.83	21.80	21.40	23.26	23.26	29.26	23.98	----	----		
11a	6Mbps	2	116	5580	16.98	16.93	21.55	21.75	23.29	23.29	29.29	23.98	----	----		
11a	6Mbps	2	140	5700	16.98	16.93	21.75	22.10	23.29	23.29	29.29	23.98	----	----		

Band III straddle channel MIMO																
Mod.	Data Rate	NTX	CH.	Freq. (MHz)	99% Bandwidth In U-NII 2C (MHz)		26 dB Bandwidth In U-NII 2C (MHz)		IC 99% Bandwidth Power Limit (dBm)		IC 99% Bandwidth EIRP Limit (dBm)		FCC 26dB Bandwidth Power Limit (dBm)		6 dB Bandwidth for Straddle Channel (MHz)	
					Ant 6	Ant 7	Ant 6	Ant 7	Ant 6	Ant 7	Ant 6	Ant 7	Ant 6	Ant 7	Ant 6	Ant 7
11a	6Mbps	2	144	5720	13.54	13.44	15.75	15.85	22.28	22.28	28.28	22.97	3.2	3.15		





<802.11a>

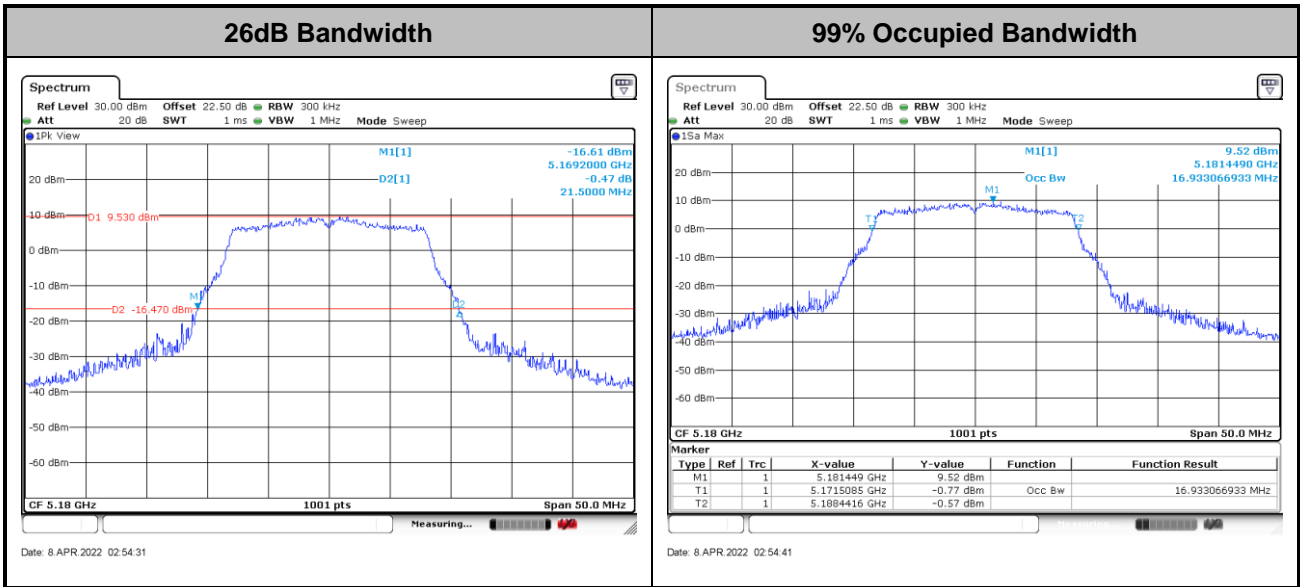

**Note:** The occupied channel bandwidth is maintained within the band of operation for all of the modulations.



<802.11ax Mode>

Band I MIMO															
Mod.	Data Rate	NTX	CH.	Freq. (MHz)	RU Config.	99% Bandwidth (MHz)		26 dB Bandwidth (MHz)		IC 99% Bandwidth Power Limit (dBm)		IC 99% Bandwidth EIRP Limit (dBm)		-	Note
						Ant 6	Ant 7	Ant 6	Ant 7	Ant 6	Ant 7	Ant 6	Ant 7		
HE20	MCS0	2	36	5180	Full	18.93	18.93	21.35	21.20	-	-	22.77	-	-	
HE20	MCS0	2	44	5220	Full	18.93	18.93	21.45	21.60	-	-	22.77	-	-	
HE20	MCS0	2	48	5240	Full	18.93	18.93	21.65	21.75	-	-	22.77	-	-	
HE40	MCS0	2	38	5190	Full	37.86	37.86	39.87	39.96	-	-	23.01	-	-	
HE40	MCS0	2	46	5230	Full	37.96	37.96	39.96	43.74	-	-	23.01	-	-	
HE80	MCS0	2	42	5210	Full	77.08	77.20	82.08	82.40	-	-	23.01	-	-	

Band II MIMO																
Mod.	Data Rate	NTX	CH.	Freq. (MHz)	RU Config.	99% Bandwidth (MHz)		26 dB Bandwidth (MHz)		IC 99% Bandwidth Power Limit (dBm)		IC 99% Bandwidth EIRP Limit (dBm)		FCC 26dB Bandwidth Power Limit (dBm)		Note
						Ant 6	Ant 7	Ant 6	Ant 7	Ant 6	Ant 7	Ant 6	Ant 7	Ant 6	Ant 7	
HE20	MCS0	2	52	5260	Full	18.98	18.93	21.50	21.45	23.77	23.77	29.77	23.98	-		
HE20	MCS0	2	60	5300	Full	18.93	18.93	21.85	21.50	23.77	23.77	29.77	23.98	-		
HE20	MCS0	2	64	5320	Full	18.98	18.93	21.70	21.55	23.77	23.77	29.77	23.98	-		
HE40	MCS0	2	54	5270	Full	37.96	37.96	40.23	40.32	23.98	23.98	30.00	23.98	-		
HE40	MCS0	2	62	5310	Full	37.96	37.96	40.05	40.14	23.98	23.98	30.00	23.98	-		
HE80	MCS0	2	58	5290	Full	77.20	77.20	82.24	82.08	23.98	23.98	30.00	23.98	-		

Band III MIMO																	
Mod.	Data Rate	NTX	CH.	Freq. (MHz)	RU Config.	99% Bandwidth In U-NII 2C (MHz)		26 dB Bandwidth In U-NII 2C (MHz)		IC 99% Bandwidth Power Limit (dBm)		IC 99% Bandwidth EIRP Limit (dBm)		FCC 26dB Bandwidth Power Limit (dBm)		6 dB Bandwidth for Straddle Channel (MHz)	
						Ant 6	Ant 7	Ant 6	Ant 7	Ant 6	Ant 7	Ant 6	Ant 7	Ant 6	Ant 7	Ant 6	Ant 7
HE20	MCS0	2	100	5500	Full	18.98	18.93	21.55	21.65	23.77	23.77	29.77	23.98	----	----		
HE20	MCS0	2	116	5580	Full	18.98	18.98	21.65	21.30	23.78	23.78	29.78	23.98	----	----		
HE20	MCS0	2	140	5700	Full	18.98	18.93	21.60	21.40	23.77	23.77	29.77	23.98	----	----		
HE40	MCS0	2	102	5510	Full	37.86	37.86	39.96	39.96	23.98	23.98	30.00	23.98	----	----		
HE40	MCS0	2	110	5550	Full	38.06	38.26	43.74	51.57	23.98	23.98	30.00	23.98	----	----		
HE40	MCS0	2	134	5670	Full	38.06	38.06	40.23	43.92	23.98	23.98	30.00	23.98	----	----		
HE80	MCS0	2	106	5530	Full	77.20	77.32	81.76	81.92	23.98	23.98	30.00	23.98	----	----		
HE80	MCS0	2	122	5610	Full	77.32	77.44	82.40	102.56	23.98	23.98	30.00	23.98	----	----		



Band III straddle channel MIMO																	
Mod.	Data Rate	NTX	CH.	Freq. (MHz)	RU Config.	99% Bandwidth In U-NII 2C (MHz)		26 dB Bandwidth In U-NII 2C (MHz)		IC 99% Bandwidth Power Limit (dBm)		IC 99% Bandwidth EIRP Limit (dBm)		FCC 26dB Bandwidth Power Limit (dBm)		6 dB Bandwidth for Straddle Channel (MHz)	
						Ant 6	Ant 7	Ant 6	Ant 7	Ant 6	Ant 7	Ant 6	Ant 7	Ant 6	Ant 7	Ant 6	Ant 7
HE20	MCS0	2	144	5720	Full	14.54	14.54	15.75	15.75	22.63	28.63	22.97	-	-	-	-	
HE40	MCS0	2	142	5710	Full	34.08	34.08	35.16	39.21	23.98	30.00	23.98	-	-	-	-	
HE80	MCS0	2	138	5690	Full	73.72	73.72	75.96	80.44	23.98	30.00	23.98	-	-	-	-	

<802.11ax HE20>

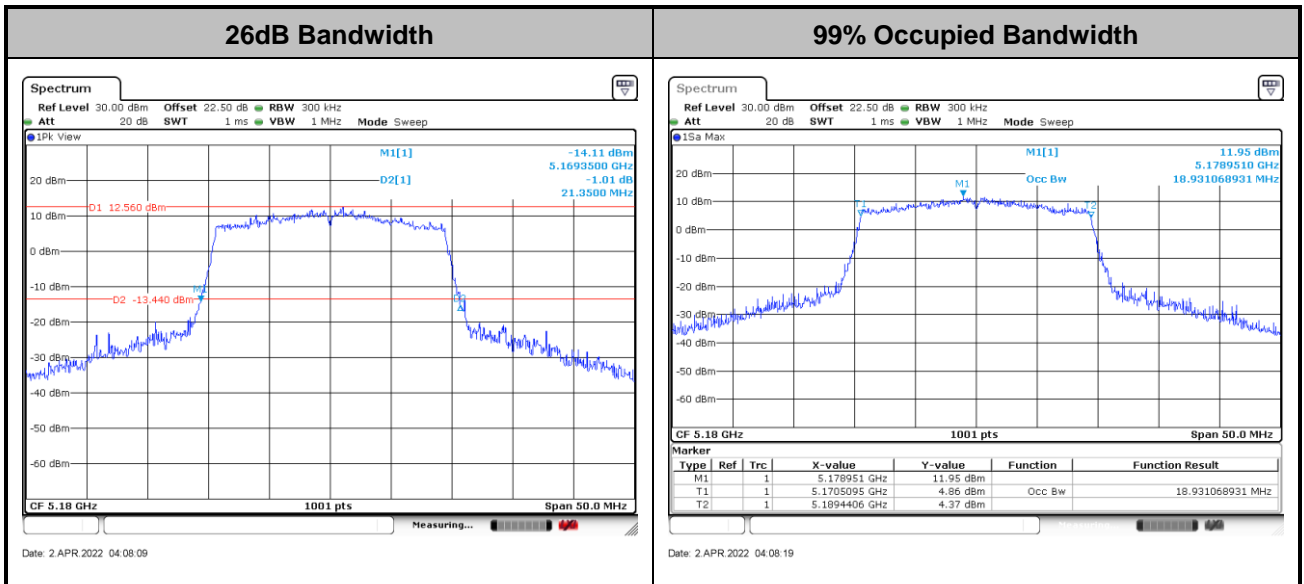

**Note:** The occupied channel bandwidth is maintained within the band of operation for all of the modulations.



<802.11ax HE40>

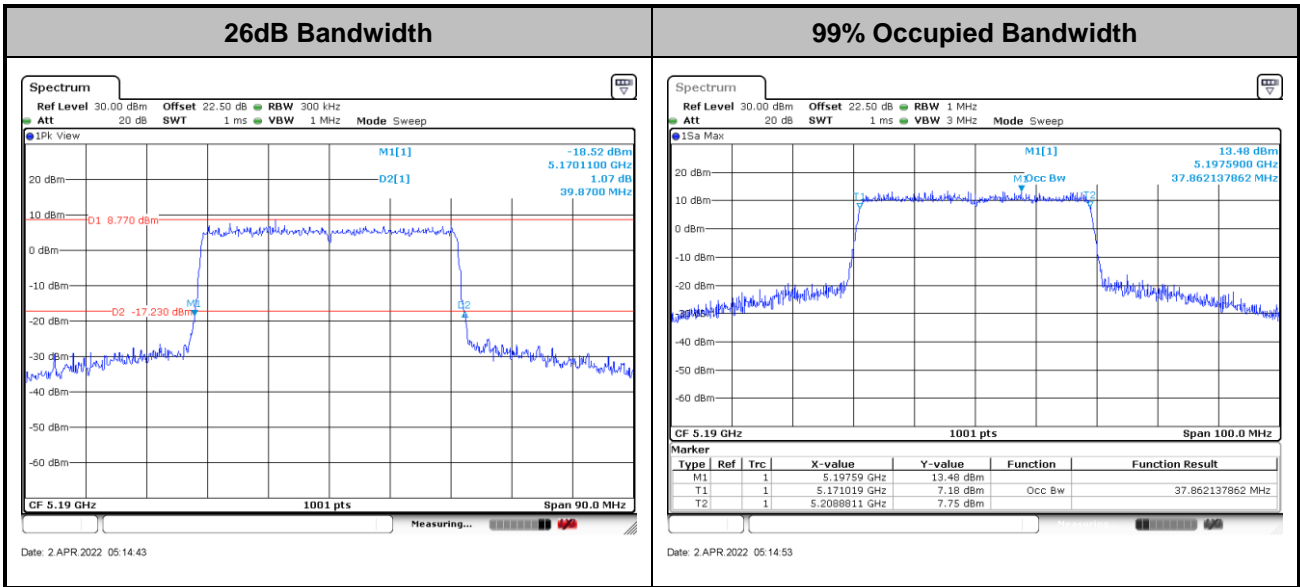

Note: The occupied channel bandwidth is maintained within the band of operation for all of the modulations.

<802.11ax HE80>

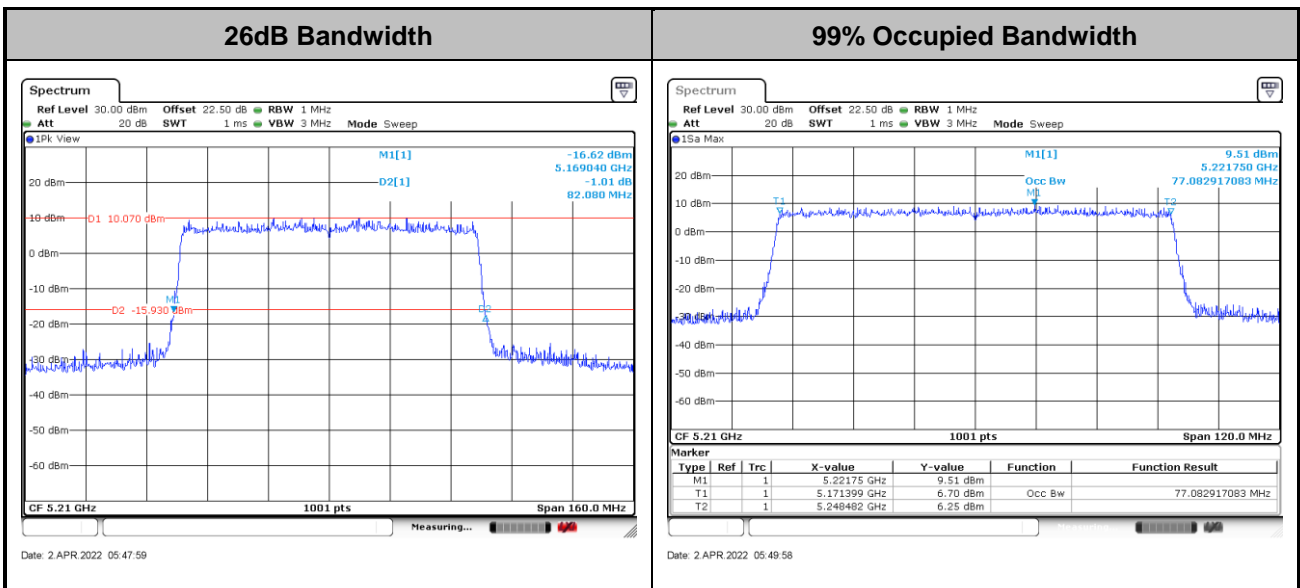

Note: The occupied channel bandwidth is maintained within the band of operation for all of the modulations.



<TXBF Modes>

Band I MIMO															
Mod.	Data Rate	NTX	CH.	Freq. (MHz)	RU Config.	99% Bandwidth (MHz)		26 dB Bandwidth (MHz)		IC 99% Bandwidth Power Limit (dBm)		IC 99% Bandwidth EIRP Limit (dBm)		-	Note
						Ant 6	Ant 7	Ant 6	Ant 7	Ant 6	Ant 7	Ant 6	Ant 7		
HE20	MCS2	2	36	5180	Full	18.98	18.98	21.55	21.40	-	-	22.78	-	-	
HE20	MCS2	2	44	5220	Full	18.93	18.98	21.65	21.30	-	-	22.77	-	-	
HE20	MCS2	2	48	5240	Full	18.93	18.98	21.60	21.50	-	-	22.77	-	-	
HE40	MCS0	2	38	5190	Full	37.86	37.76	39.96	39.78	-	-	23.01	-	-	
HE40	MCS0	2	46	5230	Full	37.96	37.86	40.05	39.78	-	-	23.01	-	-	
HE80	MCS0	2	42	5210	Full	77.08	77.20	81.60	81.28	-	-	23.01	-	-	

Band II MIMO																
Mod.	Data Rate	NTX	CH.	Freq. (MHz)	RU Config.	99% Bandwidth (MHz)		26 dB Bandwidth (MHz)		IC 99% Bandwidth Power Limit (dBm)		IC 99% Bandwidth EIRP Limit (dBm)		FCC 26dB Bandwidth Power Limit (dBm)		Note
						Ant 6	Ant 7	Ant 6	Ant 7	Ant 6	Ant 7	Ant 6	Ant 7	Ant 6	Ant 7	
HE20	MCS2	2	52	5260	Full	18.98	18.93	21.45	21.55	23.77	23.77	29.77	23.98	-		
HE20	MCS2	2	60	5300	Full	18.93	18.93	21.55	21.30	23.77	23.77	29.77	23.98	-		
HE20	MCS2	2	64	5320	Full	18.98	18.93	21.45	21.25	23.77	23.77	29.77	23.98	-		
HE40	MCS0	2	54	5270	Full	37.96	37.96	39.87	40.14	23.98	23.98	30.00	23.98	-		
HE40	MCS0	2	62	5310	Full	37.96	37.76	39.87	39.78	23.98	23.98	30.00	23.98	-		
HE80	MCS0	2	58	5290	Full	77.08	77.08	82.24	81.28	23.98	23.98	30.00	23.98	-		

Band III MIMO																	
Mod.	Data Rate	NTX	CH.	Freq. (MHz)	RU Config.	99% Bandwidth In U-NII 2C (MHz)		26 dB Bandwidth In U-NII 2C (MHz)		IC 99% Bandwidth Power Limit (dBm)		IC 99% Bandwidth EIRP Limit (dBm)		FCC 26dB Bandwidth Power Limit (dBm)		6 dB Bandwidth for Straddle Channel (MHz)	
						Ant 6	Ant 7	Ant 6	Ant 7	Ant 6	Ant 7	Ant 6	Ant 7	Ant 6	Ant 7	Ant 6	Ant 7
HE20	MCS2	2	100	5500	Full	18.98	18.98	21.40	21.25	23.78	23.78	29.78	23.98	----	----		
HE20	MCS2	2	116	5580	Full	18.98	18.98	21.70	21.40	23.78	23.78	29.78	23.98	----	----		
HE20	MCS2	2	140	5700	Full	18.98	18.93	21.40	21.35	23.77	23.77	29.77	23.98	----	----		
HE40	MCS0	2	102	5510	Full	37.86	37.96	39.87	39.96	23.98	23.98	30.00	23.98	----	----		
HE40	MCS0	2	110	5550	Full	37.96	38.16	41.85	55.62	23.98	23.98	30.00	23.98	----	----		
HE40	MCS0	2	134	5670	Full	38.06	38.06	40.23	40.05	23.98	23.98	30.00	23.98	----	----		
HE80	MCS0	2	106	5530	Full	77.32	77.20	81.92	81.60	23.98	23.98	30.00	23.98	----	----		
HE80	MCS0	2	122	5610	Full	77.32	77.32	89.44	109.92	23.98	23.98	30.00	23.98	----	----		



Band III straddle channel MIMO																	
Mod.	Data Rate	NTX	CH.	Freq. (MHz)	RU Config.	99% Bandwidth In U-NII 2C (MHz)		26 dB Bandwidth In U-NII 2C (MHz)		IC 99% Bandwidth Power Limit (dBm)		IC 99% Bandwidth EIRP Limit (dBm)		FCC 26dB Bandwidth Power Limit (dBm)		6 dB Bandwidth for Straddle Channel (MHz)	
						Ant 6	Ant 7	Ant 6	Ant 7	Ant 6	Ant 7	Ant 6	Ant 7	Ant 6	Ant 7	Ant 6	Ant 7
HE20	MCS2	2	144	5720	Full	14.54	14.49	15.85	15.65	22.61	28.61	22.95	4.2	4			
HE40	MCS0	2	142	5710	Full	33.98	34.08	35.16	36.78	23.98	30.00	23.98	3.99	3.9			
HE80	MCS0	2	138	5690	Full	73.72	73.72	76.28	90.68	23.98	30.00	23.98	4.04	3.72			

<802.11ax HE20>

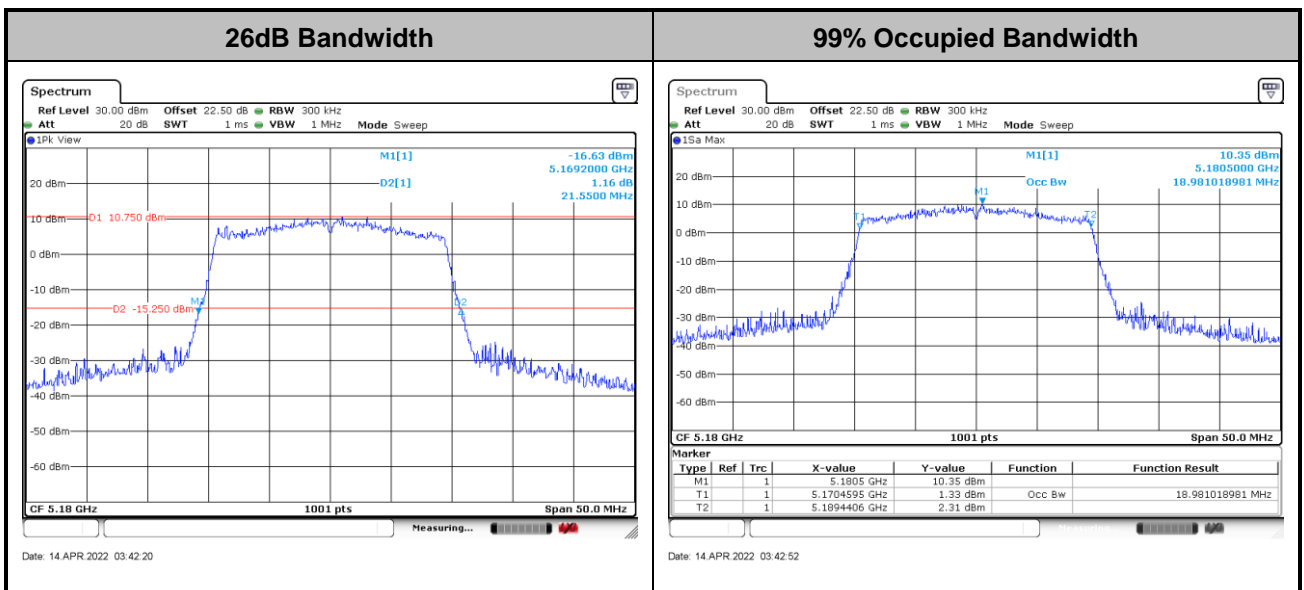

**Note:** The occupied channel bandwidth is maintained within the band of operation for all of the modulations.



<802.11ax HE40>

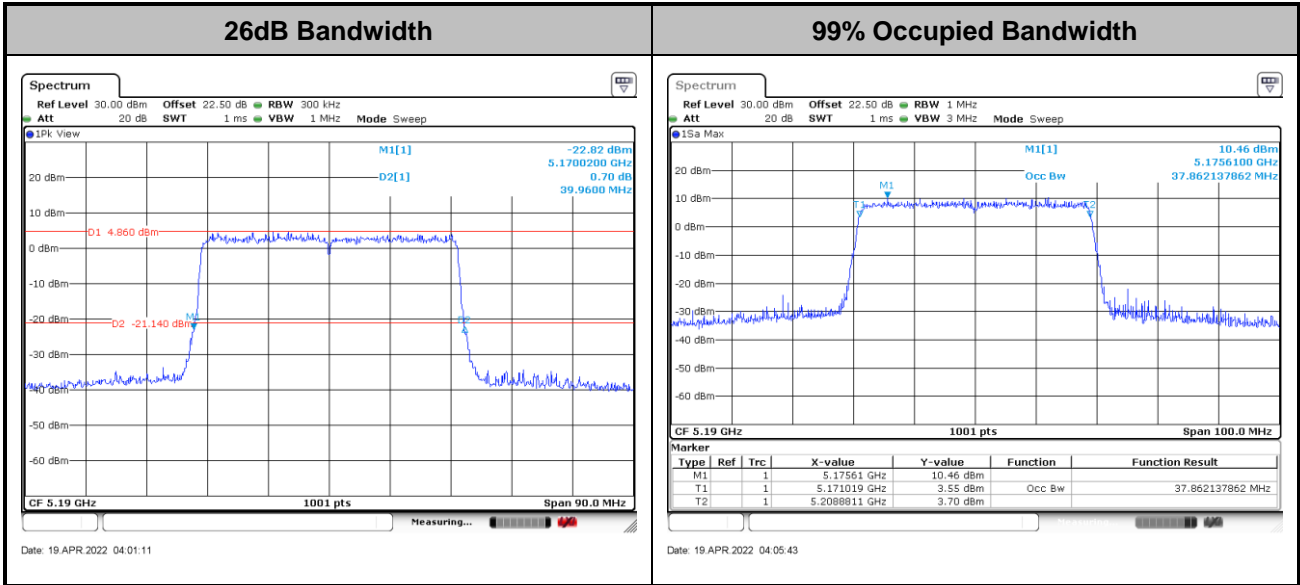

Note: The occupied channel bandwidth is maintained within the band of operation for all of the modulations.

<802.11ax HE80>

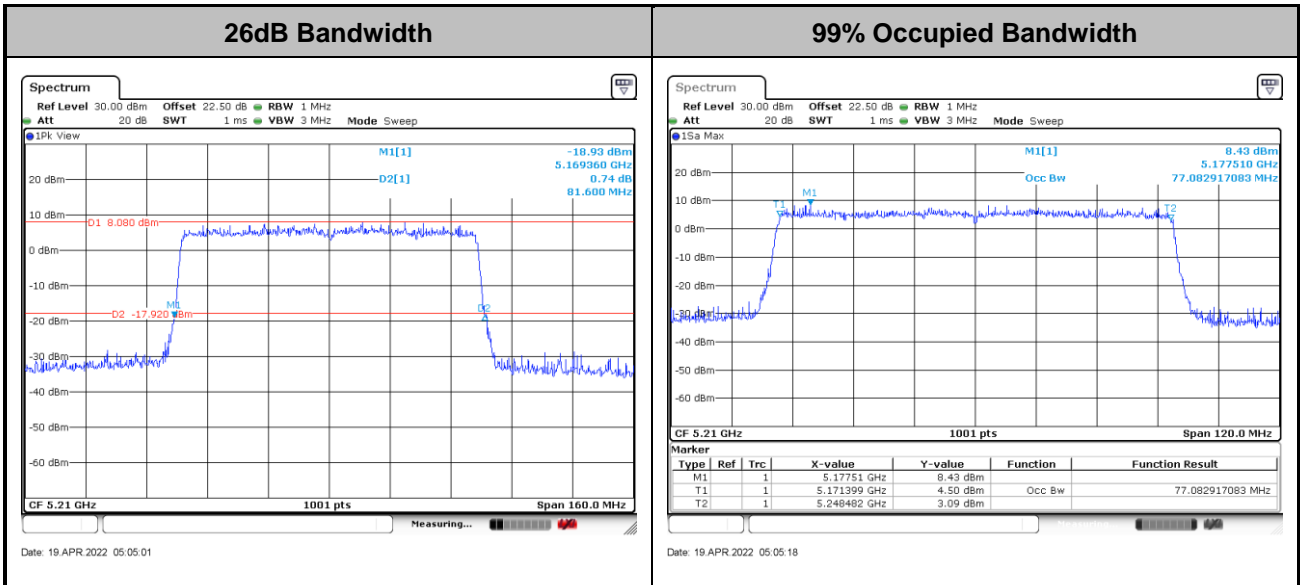

Note: The occupied channel bandwidth is maintained within the band of operation for all of the modulations.



## 3.2 Maximum Conducted Output Power Measurement

### 3.2.1 Limit of Maximum Conducted Output Power

<FCC 14-30 CFR 15.407>

**For the 5.15–5.25 GHz bands:**

■ For mobile and portable client devices in the 5.15–5.25 GHz band, the maximum conducted output power over the frequency band of operation shall not exceed 250 mW. For an indoor access point operating in the band 5.15-5.25 GHz, the maximum conducted output power over the frequency band of operation shall not exceed 1 W.

**For the 5.25–5.725 GHz bands:**

■ The maximum conducted output power over the frequency bands of operation shall not exceed the lesser of 250 mW or 11 dBm 10 log B, where B is the 26 dB emission bandwidth in megahertz.

For Straddle Channel, according to KDB 789033 D02 General UNII Test Procedures New Rules v02r01, if the power and PSD of the devices are uniform and comply with the lower limits specified for the U-NII-2 bands, a single measurement over the entire emission bandwidth can be performed to show compliance.

If transmitting antennas of directional gain greater than 6 dBi are used, the peak output power shall be reduced by the amount in dB that the directional gain of the antenna exceeds 6 dBi.

Note that U-NII-2 band, devices with a maximum e.i.r.p. greater than 500 mW shall implement TPC in order to have the capability to operate at least 6 dB below the maximum permitted e.i.r.p. of 1 W.

### 3.2.2 Measuring Instruments

Please refer to the measuring equipment list in this test report.



### 3.2.3 Test Procedures

#### <CDD Modes>

The testing follows Method PM-G of FCC KDB 789033 D02 General UNII Test Procedures New Rules v02r01.

Method PM-G (Measurement using a gated RF average power meter):

1. Measurement is performed using a wideband RF power meter.
2. The EUT is configured to transmit at its maximum power control level.
3. Measure the average power of the transmitter.
4. Since the measurement is made only during the ON time of the transmitter, no duty cycle correction factor is required.
5. For MIMO mode, calculation method follows FCC KDB 662911 D01 Multiple Transmitter Output v02r01

#### <TXBF Modes>

The testing follows Method PM-G of FCC KDB 789033 D02 General UNII Test Procedures New Rules v02r01.

Method PM-G (Measurement using a gated RF average power meter):

1. Measurement is performed using a wideband RF power meter.
2. The EUT is configured to transmit at its maximum power control level.
3. Measure the average power of the transmitter
4. Since the measurement is made only during the ON time of the transmitter, no duty cycle correction factor is required.
5. For MIMO mode, calculation method follows FCC KDB 662911 D01 Multiple Transmitter Output v02r01.

For Straddle Channel, according to KDB 789033 D02 General UNII Test Procedures New Rules v02r01, if the power and PSD of the devices are uniform and comply with the lower limits specified for the U-NII-2 bands, a single measurement over the entire emission bandwidth can be performed to show compliance.

### 3.2.4 Test Setup

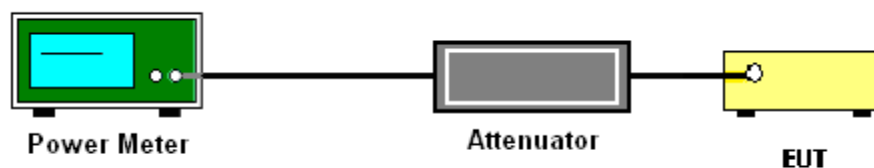



3.2.5 Test Result of Maximum Conducted Output Power

Test Engineer :	Hank Hsu	Temperature :	21~25°C
		Relative Humidity :	51~54%

<CDD Mode>

FCC Band I MIMO												
Mod.	Data Rate	NTX	CH.	Freq. (MHz)	Average Conducted Power (dBm)			FCC Conducted Power Limit (dBm)		DG (dBi)		Pass/Fail
					Ant 6	Ant 7	SUM	Ant 6	Ant 7	Ant 6	Ant 7	
11a	6Mbps	2	36	5180	17.80	18.80	21.34	24.00	2.70		Pass	
11a	6Mbps	2	44	5220	18.30	18.80	21.57	24.00	2.70		Pass	
11a	6Mbps	2	48	5240	18.00	18.50	21.27	24.00	2.70		Pass	
HT20	MCS0	2	36	5180	18.40	19.20	21.83	24.00	2.70		Pass	
HT20	MCS0	2	44	5220	18.30	19.00	21.67	24.00	2.70		Pass	
HT20	MCS0	2	48	5240	17.90	18.40	21.17	24.00	2.70		Pass	
HT40	MCS0	2	38	5190	18.00	18.60	21.32	24.00	2.70		Pass	
HT40	MCS0	2	46	5230	19.90	20.40	23.17	24.00	2.70		Pass	
VHT20	MCS0	2	36	5180	18.40	19.20	21.83	24.00	2.70		Pass	
VHT20	MCS0	2	44	5220	18.30	19.00	21.67	24.00	2.70		Pass	
VHT20	MCS0	2	48	5240	17.90	18.40	21.17	24.00	2.70		Pass	
VHT40	MCS0	2	38	5190	18.00	18.60	21.32	24.00	2.70		Pass	
VHT40	MCS0	2	46	5230	19.90	20.40	23.17	24.00	2.70		Pass	
VHT80	MCS0	2	42	5210	16.60	17.10	19.87	24.00	2.70		Pass	

FCC Band II MIMO													
Mod.	Data Rate	NTX	CH.	Freq. (MHz)	Average Conducted Power (dBm)			FCC Conducted Power Limit (dBm)		DG (dBi)		EIRP Power Limit (dBm)	Pass/Fail
					Ant 6	Ant 7	SUM	Ant 6	Ant 7	Ant 6	Ant 7		
11a	6Mbps	2	52	5260	18.20	18.60	21.41	23.98	2.70	30	Pass		
11a	6Mbps	2	60	5300	18.70	18.80	21.76	23.98	2.70	30	Pass		
11a	6Mbps	2	64	5320	18.20	18.20	21.21	23.98	2.70	30	Pass		
HT20	MCS0	2	52	5260	18.30	18.70	21.51	23.98	2.70	30	Pass		
HT20	MCS0	2	60	5300	18.70	18.80	21.76	23.98	2.70	30	Pass		
HT20	MCS0	2	64	5320	18.30	18.60	21.46	23.98	2.70	30	Pass		
HT40	MCS0	2	54	5270	19.80	20.20	23.01	23.98	2.70	30	Pass		
HT40	MCS0	2	62	5310	18.40	18.60	21.51	23.98	2.70	30	Pass		
VHT20	MCS0	2	52	5260	18.30	18.70	21.51	23.98	2.70	30	Pass		
VHT20	MCS0	2	60	5300	18.70	18.80	21.76	23.98	2.70	30	Pass		
VHT20	MCS0	2	64	5320	18.30	18.60	21.46	23.98	2.70	30	Pass		
VHT40	MCS0	2	54	5270	19.80	20.20	23.01	23.98	2.70	30	Pass		
VHT40	MCS0	2	62	5310	18.40	18.60	21.51	23.98	2.70	30	Pass		
VHT80	MCS0	2	58	5290	16.40	16.60	19.51	23.98	2.70	30	Pass		



FCC Band III MIMO													
Mod.	Data Rate	NTX	CH.	Freq. (MHz)	Average Conducted Power (dBm)			FCC Conducted Power Limit (dBm)		DG (dBi)		EIRP Power Limit (dBm)	Pass/Fail
					Ant 6	Ant 7	SUM	Ant 6	Ant 7	Ant 6	Ant 7		
11a	6Mbps	2	100	5500	18.60	18.50	21.56	23.98		1.80		30	Pass
11a	6Mbps	2	116	5580	18.30	18.60	21.46	23.98		1.80		30	Pass
11a	6Mbps	2	140	5700	18.40	19.20	21.83	23.98		1.80		30	Pass
HT20	MCS0	2	100	5500	18.50	18.50	21.51	23.98		1.80		30	Pass
HT20	MCS0	2	116	5580	18.40	18.60	21.51	23.98		1.80		30	Pass
HT20	MCS0	2	140	5700	17.40	18.20	20.77	23.98		1.80		30	Pass
HT40	MCS0	2	102	5510	17.60	17.70	20.66	23.98		1.80		30	Pass
HT40	MCS0	2	110	5550	20.40	20.20	23.31	23.98		1.80		30	Pass
HT40	MCS0	2	134	5670	20.00	20.40	23.21	23.98		1.80		30	Pass
VHT20	MCS0	2	100	5500	18.50	18.50	21.51	23.98		1.80		30	Pass
VHT20	MCS0	2	116	5580	18.40	18.60	21.51	23.98		1.80		30	Pass
VHT20	MCS0	2	140	5700	17.40	18.20	20.77	23.98		1.80		30	Pass
VHT40	MCS0	2	102	5510	17.60	17.70	20.66	23.98		1.80		30	Pass
VHT40	MCS0	2	110	5550	20.40	20.20	23.31	23.98		1.80		30	Pass
VHT40	MCS0	2	134	5670	20.00	20.40	23.21	23.98		1.80		30	Pass
VHT80	MCS0	2	106	5530	17.00	16.90	19.96	23.98		1.80		30	Pass
VHT80	MCS0	2	122	5610	20.30	20.20	23.26	23.98		1.80		30	Pass

FCC Band III straddle channel MIMO													
Mod.	Data Rate	NTX	CH.	Freq. (MHz)	Average Conducted Power (dBm)			FCC Conducted Power Limit (dBm)		DG (dBi)		EIRP Power Limit (dBm)	Pass/Fail
					Ant 6	Ant 7	SUM	Ant 6	Ant 7	Ant 6	Ant 7		
11a	6Mbps	2	144	5720	18.90	19.50	22.22	22.97		1.80		30	Pass
HT20	MCS0	2	144	5720	18.90	19.40	22.17	23.98		1.80		30	Pass
HT40	MCS0	2	142	5710	20.10	20.40	23.26	23.98		1.80		30	Pass
VHT20	MCS0	2	144	5720	18.90	19.40	22.17	23.98		1.80		30	Pass
VHT40	MCS0	2	142	5710	20.10	20.40	23.26	23.98		1.80		30	Pass
VHT80	MCS0	2	138	5690	19.50	20.10	22.82	23.98		1.80		30	Pass



<802.11ax Mode>

FCC Band I MIMO													
Mod.	Data Rate	NTX	CH.	Freq. (MHz)	RU Config.	Average Conducted Power (dBm)			FCC Conducted Power Limit (dBm)		DG (dBi)		Pass/Fail
						Ant 6	Ant 7	SUM	Ant 6	Ant 7	Ant 6	Ant 7	
HE20	MCS0	2	36	5180	Full	18.50	19.30	21.93	24.00	24.00	2.70	2.70	Pass
HE20	MCS0	2	36	5180	26/0	9.50	10.50	13.04	24.00	24.00	2.70	2.70	Pass
HE20	MCS0	2	36	5180	52/37	12.80	13.80	16.34	24.00	24.00	2.70	2.70	Pass
HE20	MCS0	2	36	5180	106/53	16.10	17.10	19.64	24.00	24.00	2.70	2.70	Pass
HE20	MCS0	2	44	5220	Full	18.40	19.10	21.77	24.00	24.00	2.70	2.70	Pass
HE20	MCS0	2	44	5220	26/4	11.40	11.70	14.56	24.00	24.00	2.70	2.70	Pass
HE20	MCS0	2	44	5220	52/39	12.90	13.30	16.11	24.00	24.00	2.70	2.70	Pass
HE20	MCS0	2	44	5220	106/53	16.50	16.50	19.51	24.00	24.00	2.70	2.70	Pass
HE20	MCS0	2	48	5240	Full	18.00	18.50	21.27	24.00	24.00	2.70	2.70	Pass
HE20	MCS0	2	48	5240	26/8	9.40	9.80	12.61	24.00	24.00	2.70	2.70	Pass
HE20	MCS0	2	48	5240	52/40	12.40	12.70	15.56	24.00	24.00	2.70	2.70	Pass
HE20	MCS0	2	48	5240	106/54	15.80	15.80	18.81	24.00	24.00	2.70	2.70	Pass
HE40	MCS0	2	38	5190	Full	18.10	18.70	21.42	24.00	24.00	2.70	2.70	Pass
HE40	MCS0	2	38	5190	242/61	15.70	16.30	19.02	24.00	24.00	2.70	2.70	Pass
HE40	MCS0	2	46	5230	Full	20.00	20.50	<b>23.27</b>	24.00	24.00	2.70	2.70	Pass
HE40	MCS0	2	46	5230	242/62	17.60	17.90	20.76	24.00	24.00	2.70	2.70	Pass
HE80	MCS0	2	42	5210	Full	16.70	17.20	19.97	24.00	24.00	2.70	2.70	Pass
HE80	MCS0	2	42	5210	484/65	14.60	15.50	18.08	24.00	24.00	2.70	2.70	Pass



FCC Band II MIMO														
Mod.	Data Rate	NTX	CH.	Freq. (MHz)	RU Config.	Average Conducted Power (dBm)			FCC Conducted Power Limit (dBm)		DG (dBi)		EIRP Power Limit (dBm)	Pass/Fail
						Ant 6	Ant 7	SUM	Ant 6	Ant 7	Ant 6	Ant 7		
HE20	MCS0	2	52	5260	Full	18.40	18.80	21.61	23.98		2.70		30	Pass
HE20	MCS0	2	52	5260	26/0	9.50	9.80	12.66	23.98		2.70		30	Pass
HE20	MCS0	2	52	5260	52/37	12.80	13.10	15.96	23.98		2.70		30	Pass
HE20	MCS0	2	52	5260	106/53	16.10	16.30	19.21	23.98		2.70		30	Pass
HE20	MCS0	2	60	5300	Full	18.80	18.90	21.86	23.98		2.70		30	Pass
HE20	MCS0	2	60	5300	26/4	11.50	11.50	14.51	23.98		2.70		30	Pass
HE20	MCS0	2	60	5300	52/39	13.60	13.50	16.56	23.98		2.70		30	Pass
HE20	MCS0	2	60	5300	106/54	16.60	16.60	19.61	23.98		2.70		30	Pass
HE20	MCS0	2	64	5320	Full	18.40	18.70	21.56	23.98		2.70		30	Pass
HE20	MCS0	2	64	5320	26/8	10.20	10.10	13.16	23.98		2.70		30	Pass
HE20	MCS0	2	64	5320	52/40	12.90	13.00	15.96	23.98		2.70		30	Pass
HE20	MCS0	2	64	5320	106/54	16.40	16.20	19.31	23.98		2.70		30	Pass
HE40	MCS0	2	54	5270	Full	19.90	20.30	23.11	23.98		2.70		30	Pass
HE40	MCS0	2	54	5270	242/61	17.50	17.90	20.71	23.98		2.70		30	Pass
HE40	MCS0	2	62	5310	Full	18.50	18.70	21.61	23.98		2.70		30	Pass
HE40	MCS0	2	62	5310	242/62	16.20	16.30	19.26	23.98		2.70		30	Pass
HE80	MCS0	2	58	5290	Full	16.50	16.70	19.61	23.98		2.70		30	Pass
HE80	MCS0	2	58	5290	484/66	13.90	14.10	17.01	23.98		2.70		30	Pass



FCC Band III MIMO														
Mod.	Data Rate	NTX	CH.	Freq. (MHz)	RU Config.	Average Conducted Power (dBm)			FCC Conducted Power Limit (dBm)		DG (dBi)		EIRP Power Limit (dBm)	Pass/Fail
						Ant 6	Ant 7	SUM	Ant 6	Ant 7	Ant 6	Ant 7		
HE20	MCS0	2	100	5500	Full	18.60	18.60	21.61	23.98		1.80		30	Pass
HE20	MCS0	2	100	5500	26/0	11.00	11.30	14.16	23.98		1.80		30	Pass
HE20	MCS0	2	100	5500	52/37	14.20	14.20	17.21	23.98		1.80		30	Pass
HE20	MCS0	2	100	5500	106/53	17.00	17.20	20.11	23.98		1.80		30	Pass
HE20	MCS0	2	116	5580	Full	18.50	18.70	21.61	23.98		1.80		30	Pass
HE20	MCS0	2	116	5580	26/4	11.60	12.10	14.87	23.98		1.80		30	Pass
HE20	MCS0	2	116	5580	52/38	13.80	14.40	17.12	23.98		1.80		30	Pass
HE20	MCS0	2	116	5580	106/53	17.20	17.40	20.31	23.98		1.80		30	Pass
HE20	MCS0	2	140	5700	Full	17.50	18.20	20.87	23.98		1.80		30	Pass
HE20	MCS0	2	140	5700	26/8	9.40	10.30	12.88	23.98		1.80		30	Pass
HE20	MCS0	2	140	5700	52/40	12.10	12.80	15.47	23.98		1.80		30	Pass
HE20	MCS0	2	140	5700	106/54	15.10	16.00	18.58	23.98		1.80		30	Pass
HE40	MCS0	2	102	5510	Full	17.70	17.80	20.76	23.98		1.80		30	Pass
HE40	MCS0	2	102	5510	242/61	16.00	15.90	18.96	23.98		1.80		30	Pass
HE40	MCS0	2	110	5550	Full	20.50	20.30	23.41	23.98		1.80		30	Pass
HE40	MCS0	2	110	5550	242/61	18.60	18.60	21.61	23.98		1.80		30	Pass
HE40	MCS0	2	134	5670	Full	20.50	20.30	23.31	23.98		1.80		30	Pass
HE40	MCS0	2	134	5670	242/62	17.80	18.50	21.17	23.98		1.80		30	Pass
HE80	MCS0	2	106	5530	Full	17.10	17.00	20.06	23.98		1.80		30	Pass
HE80	MCS0	2	106	5530	484/65	14.50	14.60	17.56	23.98		1.80		30	Pass
HE80	MCS0	2	122	5610	Full	20.40	20.30	23.36	23.98		1.80		30	Pass
HE80	MCS0	2	122	5610	484/66	17.70	18.00	20.86	23.98		1.80		30	Pass

FCC Band III straddle channel MIMO														
Mod.	Data Rate	NTX	CH.	Freq. (MHz)	RU Config.	Average Conducted Power (dBm)			FCC Conducted Power Limit (dBm)		DG (dBi)		EIRP Power Limit (dBm)	Pass/Fail
						Ant 6	Ant 7	SUM	Ant 6	Ant 7	Ant 6	Ant 7		
HE20	MCS0	2	144	5720	Full	19.00	19.50	22.27	22.97		1.80		30	Pass
HE20	MCS0	2	144	5720	26/8	11.10	11.90	14.53	22.97		1.80		30	Pass
HE20	MCS0	2	144	5720	52/40	14.20	14.90	17.57	22.97		1.80		30	Pass
HE20	MCS0	2	144	5720	106/54	17.60	18.20	20.92	22.97		1.80		30	Pass
HE40	MCS0	2	142	5710	Full	20.20	20.50	23.36	23.98		1.80		30	Pass
HE40	MCS0	2	142	5710	242/62	17.90	18.30	21.11	23.98		1.80		30	Pass
HE80	MCS0	2	138	5690	Full	19.60	20.20	22.92	23.98		1.80		30	Pass
HE80	MCS0	2	138	5690	484/66	17.30	17.80	20.57	23.98		1.80		30	Pass



<TXBF Modes>

FCC Band I MIMO												
Mod.	Data Rate	NTX	CH.	Freq. (MHz)	Average Conducted Power (dBm)			FCC Conducted Power Limit (dBm)		DG (dBi)		Pass/Fail
					Ant 6	Ant 7	SUM	Ant 6	Ant 7	Ant 6	Ant 7	
HT20	MCS2	2	36	5180	16.90	17.70	20.33	24.00		5.04		Pass
HT20	MCS2	2	44	5220	17.30	17.80	20.57	24.00		5.04		Pass
HT20	MCS2	2	48	5240	16.80	17.20	20.01	24.00		5.04		Pass
HT40	MCS0	2	38	5190	16.20	17.00	19.63	24.00		5.04		Pass
HT40	MCS0	2	46	5230	19.60	20.00	22.81	24.00		5.04		Pass

FCC Band II MIMO													
Mod.	Data Rate	NTX	CH.	Freq. (MHz)	Average Conducted Power (dBm)			FCC Conducted Power Limit (dBm)		DG (dBi)		EIRP Power Limit (dBm)	Pass/Fail
					Ant 6	Ant 7	SUM	Ant 6	Ant 7	Ant 6	Ant 7		
HT20	MCS2	2	52	5260	16.80	16.90	19.86	23.98		5.61		30	Pass
HT20	MCS2	2	60	5300	17.30	17.10	20.21	23.98		5.61		30	Pass
HT20	MCS2	2	64	5320	17.10	16.90	20.01	23.98		5.61		30	Pass
HT40	MCS0	2	54	5270	19.80	20.10	22.96	23.98		5.61		30	Pass
HT40	MCS0	2	62	5310	16.80	16.80	19.81	23.98		5.61		30	Pass

FCC Band III MIMO													
Mod.	Data Rate	NTX	CH.	Freq. (MHz)	Average Conducted Power (dBm)			FCC Conducted Power Limit (dBm)		DG (dBi)		EIRP Power Limit (dBm)	Pass/Fail
					Ant 6	Ant 7	SUM	Ant 6	Ant 7	Ant 6	Ant 7		
HT20	MCS2	2	100	5500	17.10	16.80	19.96	23.98		4.76		30	Pass
HT20	MCS2	2	116	5580	17.20	17.40	20.31	23.98		4.76		30	Pass
HT20	MCS2	2	140	5700	17.00	17.60	20.32	23.98		4.76		30	Pass
HT40	MCS0	2	102	5510	17.20	17.20	20.21	23.98		4.76		30	Pass
HT40	MCS0	2	110	5550	20.40	20.20	23.31	23.98		4.76		30	Pass
HT40	MCS0	2	134	5670	19.30	19.70	22.51	23.98		4.76		30	Pass

FCC Band III straddle channel MIMO													
Mod.	Data Rate	NTX	CH.	Freq. (MHz)	Average Conducted Power (dBm)			FCC Conducted Power Limit (dBm)		DG (dBi)		EIRP Power Limit (dBm)	Pass/Fail
					Ant 6	Ant 7	SUM	Ant 6	Ant 7	Ant 6	Ant 7		
HT20	MCS2	2	144	5720	17.30	17.60	20.46	23.98		4.76		30	Pass
HT40	MCS0	2	142	5710	19.70	20.20	22.97	23.98		4.76		30	Pass



<802.11ax Mode>

FCC Band I MIMO													
Mod.	Data Rate	NTX	CH.	Freq. (MHz)	RU Config.	Average Conducted Power (dBm)			FCC Conducted Power Limit (dBm)		DG (dBi)		Pass/Fail
						Ant 6	Ant 7	SUM	Ant 6	Ant 7	Ant 6	Ant 7	
HE20	MCS2	2	36	5180	Full	17.00	17.80	20.43	24.00		5.04		Pass
HE20	MCS2	2	44	5220	Full	17.40	17.90	20.67	24.00		5.04		Pass
HE20	MCS2	2	48	5240	Full	16.90	17.30	20.11	24.00		5.04		Pass
HE40	MCS0	2	38	5190	Full	16.30	17.10	19.73	24.00		5.04		Pass
HE40	MCS0	2	46	5230	Full	19.70	20.10	22.91	24.00		5.04		Pass
HE80	MCS0	2	42	5210	Full	16.40	16.80	19.61	24.00		5.04		Pass

FCC Band II MIMO														
Mod.	Data Rate	NTX	CH.	Freq. (MHz)	RU Config.	Average Conducted Power (dBm)			FCC Conducted Power Limit (dBm)		DG (dBi)		EIRP Power Limit (dBm)	Pass/Fail
						Ant 6	Ant 7	SUM	Ant 6	Ant 7	Ant 6	Ant 7		
HE20	MCS2	2	52	5260	Full	16.90	17.00	19.96	23.98		5.61		30	Pass
HE20	MCS2	2	60	5300	Full	17.40	17.20	20.31	23.98		5.61		30	Pass
HE20	MCS2	2	64	5320	Full	17.20	17.00	20.11	23.98		5.61		30	Pass
HE40	MCS0	2	54	5270	Full	19.90	20.20	23.06	23.98		5.61		30	Pass
HE40	MCS0	2	62	5310	Full	16.90	16.90	19.91	23.98		5.61		30	Pass
HE80	MCS0	2	58	5290	Full	17.20	17.40	20.31	23.98		5.61		30	Pass





FCC Band III MIMO														
Mod.	Data Rate	NTX	CH.	Freq. (MHz)	RU Config.	Average Conducted Power (dBm)			FCC Conducted Power Limit (dBm)		DG (dBi)		EIRP Power Limit (dBm)	Pass/Fail
						Ant 6	Ant 7	SUM	Ant 6	Ant 7	Ant 6	Ant 7		
HE20	MCS2	2	100	5500	Full	17.20	16.90	20.06	23.98		4.76		30	Pass
HE20	MCS2	2	116	5580	Full	17.30	17.50	20.41	23.98		4.76		30	Pass
HE20	MCS2	2	140	5700	Full	17.10	17.70	20.42	23.98		4.76		30	Pass
HE40	MCS0	2	102	5510	Full	17.30	17.30	20.31	23.98		4.76		30	Pass
HE40	MCS0	2	110	5550	Full	20.50	20.30	23.41	23.98		4.76		30	Pass
HE40	MCS0	2	134	5670	Full	19.40	19.80	22.61	23.98		4.76		30	Pass
HE80	MCS0	2	106	5530	Full	18.40	18.10	21.26	23.98		4.76		30	Pass
HE80	MCS0	2	122	5610	Full	20.00	20.20	23.11	23.98		4.76		30	Pass

FCC Band III straddle channel MIMO														
Mod.	Data Rate	NTX	CH.	Freq. (MHz)	RU Config.	Average Conducted Power (dBm)			FCC Conducted Power Limit (dBm)		DG (dBi)		EIRP Power Limit (dBm)	Pass/Fail
						Ant 6	Ant 7	SUM	Ant 6	Ant 7	Ant 6	Ant 7		
HE20	MCS2	2	144	5720	Full	17.40	17.70	20.56	22.95		4.76		30	Pass
HE40	MCS0	2	142	5710	Full	19.80	20.30	23.07	23.98		4.76		30	Pass
HE80	MCS0	2	138	5690	Full	19.90	20.20	23.06	23.98		4.76		30	Pass



### 3.3 Power Spectral Density Measurement

#### 3.3.1 Limit of Power Spectral Density

<FCC 14-30 CFR 15.407>

**For the 5.15–5.25 GHz bands:**

For mobile and portable client devices in the 5.15–5.25 GHz band, the maximum power spectral density shall not exceed 11 dBm in any 1.0 MHz band. For an indoor access point operating in the band 5.15-5.25 GHz, the maximum power spectral density shall not exceed 17 dBm in any 1.0 MHz band.

**For the 5.25–5.725 GHz bands:**

The maximum power spectral density shall not exceed 11 dBm in any 1.0 MHz band.

For Straddle Channel, according to KDB 789033 D02 General UNII Test Procedures New Rules v02r01, if the power and PSD of the devices are uniform and comply with the lower limits specified for the U-NII-2 bands, a single measurement over the entire emission bandwidth can be performed to show compliance.

If transmitting antennas of directional gain greater than 6 dBi are used, the peak output power shall be reduced by the amount in dB that the directional gain of the antenna exceeds 6 dBi.

#### 3.3.2 Measuring Instruments

Please refer to the measuring equipment list in this test report.



### 3.3.3 Test Procedures

The testing follows FCC KDB 789033 D02 General UNII Test Procedures New Rules v02r01.

Section F) Maximum power spectral density.

#### <CDD Modes>

##### # Method SA-2 #

(trace averaging across on and off times of the EUT transmissions, followed by duty cycle correction).

- Measure the duty cycle.
- Set span to encompass the entire emission bandwidth (EBW) of the signal.
- Set RBW = 1 MHz.
- Set VBW  $\geq$  3 MHz.
- Number of points in sweep  $\geq$  2 Span / RBW.
- Sweep time = auto.
- Detector = RMS
- Trace average at least 100 traces in power averaging mode.
- Add  $10 \log(1/x)$ , where x is the duty cycle, to the measured power in order to compute the average power during the actual transmission times. For example, add  $10 \log(1/0.25) = 6$  dB if the duty cycle is 25 percent.

#### <TXBF Modes>

##### # Method SA-3 #

(power averaging (rms) detection with max hold):

- Set span to encompass the entire emission bandwidth (EBW) of the signal.
- Set RBW = 300 kHz.
- Set VBW  $\geq$  1 MHz.
- Number of points in sweep  $\geq$  2 Span / RBW.
- Sweep time  $\leq$  (number of points in sweep)  $\times$  T, when duty cycle is less than 98 percent where T is the minimum transmission duration over which the transmitter is on and is transmitting at its maximum power control level for the tested mode of operation.
- Detector = power averaging (rms).
- Trace mode = max hold.
- Allow max hold to run for at least 60 seconds, or longer as needed to allow the trace to stabilize.

1. The RF output of EUT is connected to the spectrum analyzer by a low loss cable.
2. Each plot has already offset with cable loss, and attenuator loss. Measure the PPSD and record it.
3. For MIMO mode, calculation method follows FCC KDB 662911 D01 Multiple Transmitter Output v02r01.

Method (a): Measure and sum the spectra across the outputs.

The total final Power Spectral Density is from a device with 2 transmitter outputs. The spectrum measurements of the individual outputs are all performed with the same span and number of points; the spectrum value in the first spectral bin of output 1 is summed with that in the first spectral bin of output 2 to obtain the value for the first frequency bin of the summed spectrum.

### 3.3.4 Test Setup

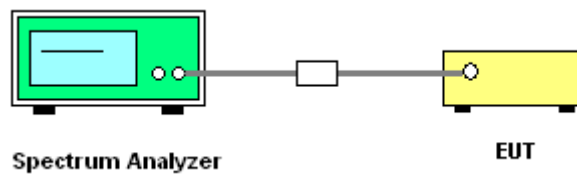



3.3.5 Test Result of Power Spectral Density

Test Engineer :	Hank Hsu	Temperature :	21~25°C
		Relative Humidity :	51~54%

<CDD Mode>

FCC Band I MIMO												
Mod.	Data Rate	NTX	CH.	Freq. (MHz)	Average Power Density with Duty Factor (dBm/MHz)			Average PSD Limit (dBm/MHz)		DG (dBi)		Pass /Fail
					Ant 6	Ant 7	SUM	Ant 6	Ant 7	Ant 6	Ant 7	
11a	6Mbps	2	36	5180	-	-	10.59	11.00	5.04	-	Pass	
11a	6Mbps	2	44	5220	-	-	10.75	11.00	5.04	-	Pass	
11a	6Mbps	2	48	5240	-	-	10.84	11.00	5.04	-	Pass	

Band II MIMO												
Mod.	Data Rate	NTX	CH.	Freq. (MHz)	Average Power Density with Duty Factor (dBm/MHz)			Average PSD Limit (dBm/MHz)		DG (dBi)		Pass /Fail
					Ant 6	Ant 7	SUM	Ant 6	Ant 7	Ant 6	Ant 7	
11a	6Mbps	2	52	5260	-	-	10.77	11.00	5.61	-	Pass	
11a	6Mbps	2	60	5300	-	-	10.99	11.00	5.61	-	Pass	
11a	6Mbps	2	64	5320	-	-	10.52	11.00	5.61	-	Pass	

Band III MIMO												
Mod.	Data Rate	NTX	CH.	Freq. (MHz)	Average Power Density with Duty Factor (dBm/MHz)			Average PSD Limit (dBm/MHz)		DG (dBi)		Pass /Fail
					Ant 6	Ant 7	SUM	Ant 6	Ant 7	Ant 6	Ant 7	
11a	6Mbps	2	100	5500	-	-	10.88	11.00	4.76	-	Pass	
11a	6Mbps	2	116	5580	-	-	10.64	11.00	4.76	-	Pass	
11a	6Mbps	2	140	5700	-	-	10.88	11.00	4.76	-	Pass	

Band III straddle channel MIMO												
Mod.	Data Rate	NTX	CH.	Freq. (MHz)	Average Power Density (dBm/MHz)			Average PSD Limit (dBm/MHz)		DG (dBi)		Pass /Fail
					Ant 6	Ant 7	SUM	Ant 6	Ant 7	Ant 6	Ant 7	
11a	6Mbps	2	144	5720	-	-	10.99	11.00	4.76	-	Pass	

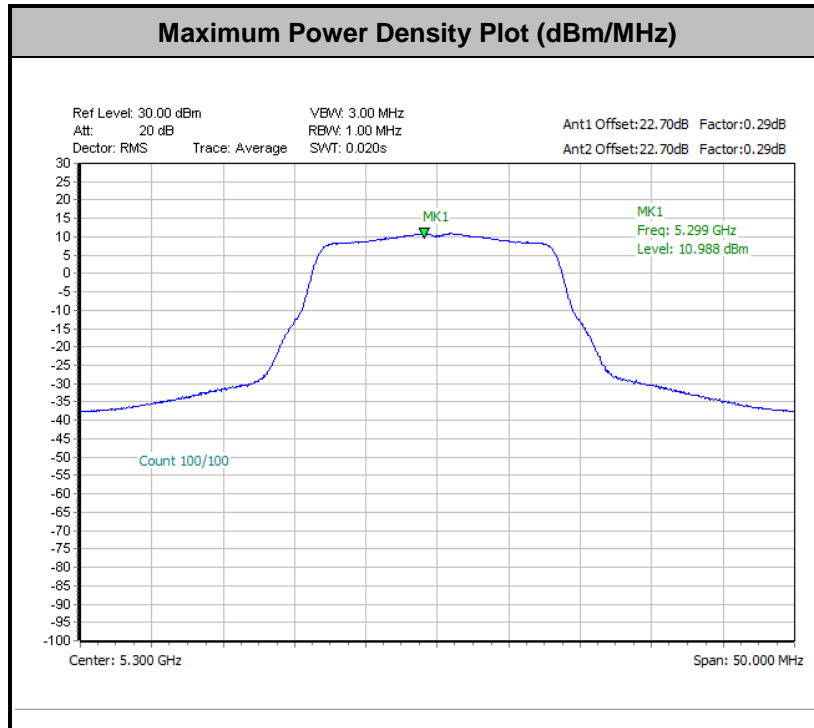

**Remark:** The test plot is showing a bin by bin combined result mathematically adds two traces.

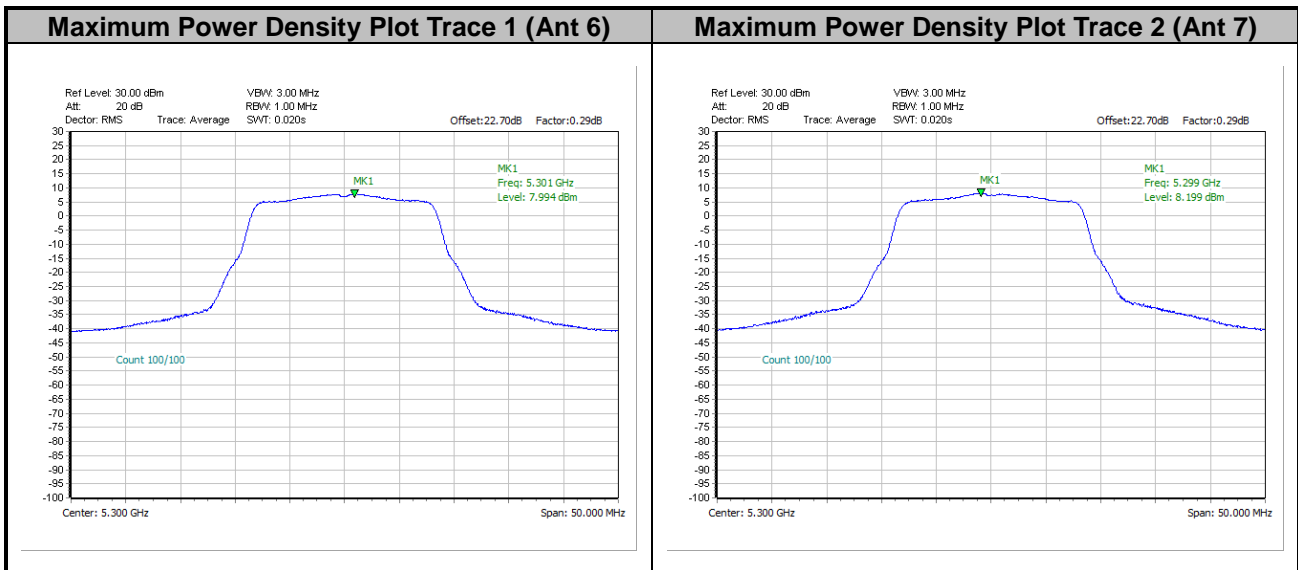



<802.11ax Mode>

FCC Band I MIMO													
Mod.	Data Rate	NTX	CH.	Freq. (MHz)	RU Config.	Average Power Density with Duty Factor (dBm/MHz)			Average PSD Limit (dBm/MHz)		DG (dBi)		Pass /Fail
						Ant 6	Ant 7	SUM	Ant 6	Ant 7	Ant 6	Ant 7	
HE20	MCS0	2	36	5180	Full			10.86	11.00	5.04		Pass	
HE20	MCS0	2	36	5180	26/0			10.28	11.00	5.04		Pass	
HE20	MCS0	2	36	5180	52/37			10.63	11.00	5.04		Pass	
HE20	MCS0	2	36	5180	106/53			10.59	11.00	5.04		Pass	
HE20	MCS0	2	44	5220	Full			10.55	11.00	5.04		Pass	
HE20	MCS0	2	44	5220	26/4			10.45	11.00	5.04		Pass	
HE20	MCS0	2	44	5220	52/39			10.21	11.00	5.04		Pass	
HE20	MCS0	2	44	5220	106/53			10.07	11.00	5.04		Pass	
HE20	MCS0	2	48	5240	Full			10.56	11.00	5.04		Pass	
HE20	MCS0	2	48	5240	26/8			10.13	11.00	5.04		Pass	
HE20	MCS0	2	48	5240	52/40			10.04	11.00	5.04		Pass	
HE20	MCS0	2	48	5240	106/54			10.19	11.00	5.04		Pass	
HE40	MCS0	2	38	5190	Full			6.05	11.00	5.04		Pass	
HE40	MCS0	2	38	5190	242/61			5.70	11.00	5.04		Pass	
HE40	MCS0	2	46	5230	Full			8.23	11.00	5.04		Pass	
HE40	MCS0	2	46	5230	242/62			8.03	11.00	5.04		Pass	
HE80	MCS0	2	42	5210	Full			2.01	11.00	5.04		Pass	
HE80	MCS0	2	42	5210	484/65			1.79	11.00	5.04		Pass	



Band II MIMO													
Mod.	Data Rate	NTX	CH.	Freq. (MHz)	RU Config.	Average Power Density with Duty Factor (dBm/MHz)			Average PSD Limit (dBm/MHz)		DG (dBi)		Pass /Fail
						Ant 6	Ant 7	SUM	Ant 6	Ant 7	Ant 6	Ant 7	
HE20	MCS0	2	52	5260	Full			10.61	11.00	5.61		Pass	
HE20	MCS0	2	52	5260	26/0			10.10	11.00	5.61		Pass	
HE20	MCS0	2	52	5260	52/37			10.39	11.00	5.61		Pass	
HE20	MCS0	2	52	5260	106/53			10.32	11.00	5.61		Pass	
HE20	MCS0	2	60	5300	Full			10.81	11.00	5.61		Pass	
HE20	MCS0	2	60	5300	26/4			10.38	11.00	5.61		Pass	
HE20	MCS0	2	60	5300	52/39			10.54	11.00	5.61		Pass	
HE20	MCS0	2	60	5300	106/54			10.51	11.00	5.61		Pass	
HE20	MCS0	2	64	5320	Full			10.82	11.00	5.61		Pass	
HE20	MCS0	2	64	5320	26/8			10.64	11.00	5.61		Pass	
HE20	MCS0	2	64	5320	52/40			10.48	11.00	5.61		Pass	
HE20	MCS0	2	64	5320	106/54			10.49	11.00	5.61		Pass	
HE40	MCS0	2	54	5270	Full			7.84	11.00	5.61		Pass	
HE40	MCS0	2	54	5270	242/61			7.61	11.00	5.61		Pass	
HE40	MCS0	2	62	5310	Full			6.52	11.00	5.61		Pass	
HE40	MCS0	2	62	5310	242/62			6.39	11.00	5.61		Pass	
HE80	MCS0	2	58	5290	Full			1.59	11.00	5.61		Pass	
HE80	MCS0	2	58	5290	484/66			1.27	11.00	5.61		Pass	





Band III MIMO													
Mod.	Data Rate	NTX	CH.	Freq. (MHz)	RU Config.	Average Power Density with Duty Factor (dBm/MHz)			Average PSD Limit (dBm/MHz)		DG (dBi)		Pass /Fail
						Ant 6	Ant 7	SUM	Ant 6	Ant 7	Ant 6	Ant 7	
HE20	MCS0	2	100	5500	Full			10.75	11.00	4.76		Pass	
HE20	MCS0	2	100	5500	26/0			10.51	11.00	4.76		Pass	
HE20	MCS0	2	100	5500	52/37			10.74	11.00	4.76		Pass	
HE20	MCS0	2	100	5500	106/53			10.27	11.00	4.76		Pass	
HE20	MCS0	2	116	5580	Full			10.50	11.00	4.76		Pass	
HE20	MCS0	2	116	5580	26/4			10.21	11.00	4.76		Pass	
HE20	MCS0	2	116	5580	52/38			10.49	11.00	4.76		Pass	
HE20	MCS0	2	116	5580	106/53			10.45	11.00	4.76		Pass	
HE20	MCS0	2	140	5700	Full			9.50	11.00	4.76		Pass	
HE20	MCS0	2	140	5700	26/8			9.35	11.00	4.76		Pass	
HE20	MCS0	2	140	5700	52/40			9.09	11.00	4.76		Pass	
HE20	MCS0	2	140	5700	106/54			9.07	11.00	4.76		Pass	
HE40	MCS0	2	102	5510	Full			5.65	11.00	4.76		Pass	
HE40	MCS0	2	102	5510	242/61			5.63	11.00	4.76		Pass	
HE40	MCS0	2	110	5550	Full			8.20	11.00	4.76		Pass	
HE40	MCS0	2	110	5550	242/61			8.13	11.00	4.76		Pass	
HE40	MCS0	2	134	5670	Full			8.09	11.00	4.76		Pass	
HE40	MCS0	2	134	5670	242/62			8.02	11.00	4.76		Pass	
HE80	MCS0	2	106	5530	Full			2.00	11.00	4.76		Pass	
HE80	MCS0	2	106	5530	484/65			1.47	11.00	4.76		Pass	
HE80	MCS0	2	122	5610	Full			5.17	11.00	4.76		Pass	
HE80	MCS0	2	122	5610	484/66			4.87	11.00	4.76		Pass	

Band III straddle channel MIMO													
Mod.	Data Rate	NTX	CH.	Freq. (MHz)	RU Config.	Average Power Density (dBm/MHz)			Average PSD Limit (dBm/MHz)		DG (dBi)		Pass /Fail
						Ant 6	Ant 7	SUM	Ant 6	Ant 7	Ant 6	Ant 7	
HE20	MCS0	2	144	5720	Full			10.96	11.00	4.76		Pass	
HE40	MCS0	2	144	5720	26/8			10.65	11.00	4.76		Pass	
HE40	MCS0	2	144	5720	52/40			10.79	11.00	4.76		Pass	
HE40	MCS0	2	144	5720	106/54			10.79	11.00	4.76		Pass	
HE40	MCS0	2	142	5710	Full			7.77	11.00	4.76		Pass	
HE40	MCS0	2	142	5710	242/62			7.39	11.00	4.76		Pass	
HE80	MCS0	2	138	5690	Full			4.77	11.00	4.76		Pass	
HE80	MCS0	2	138	5690	484/66			4.55	11.00	4.76		Pass	

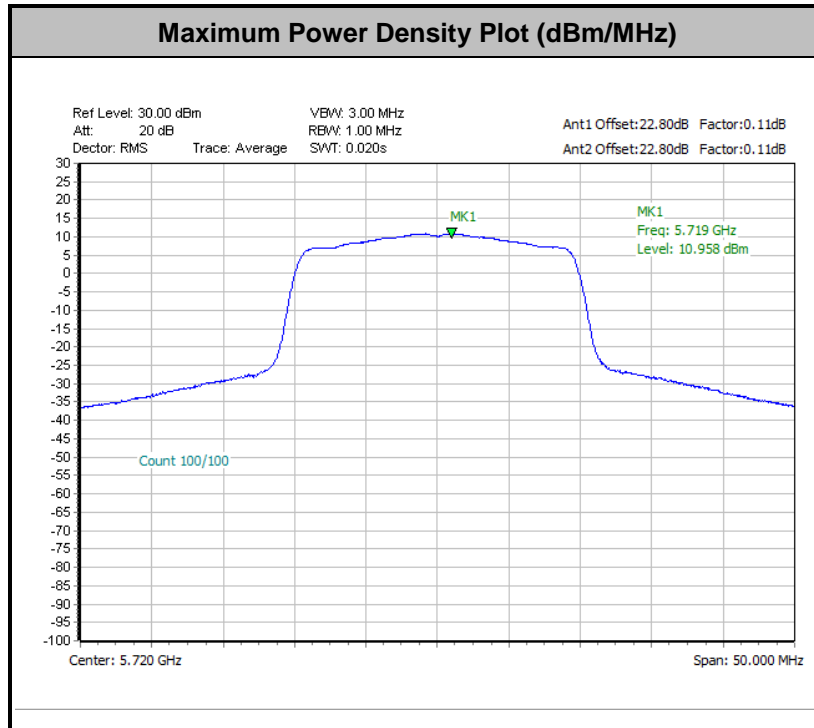

**Remark:** The test plot is showing a bin by bin combined result mathematically adds two traces.

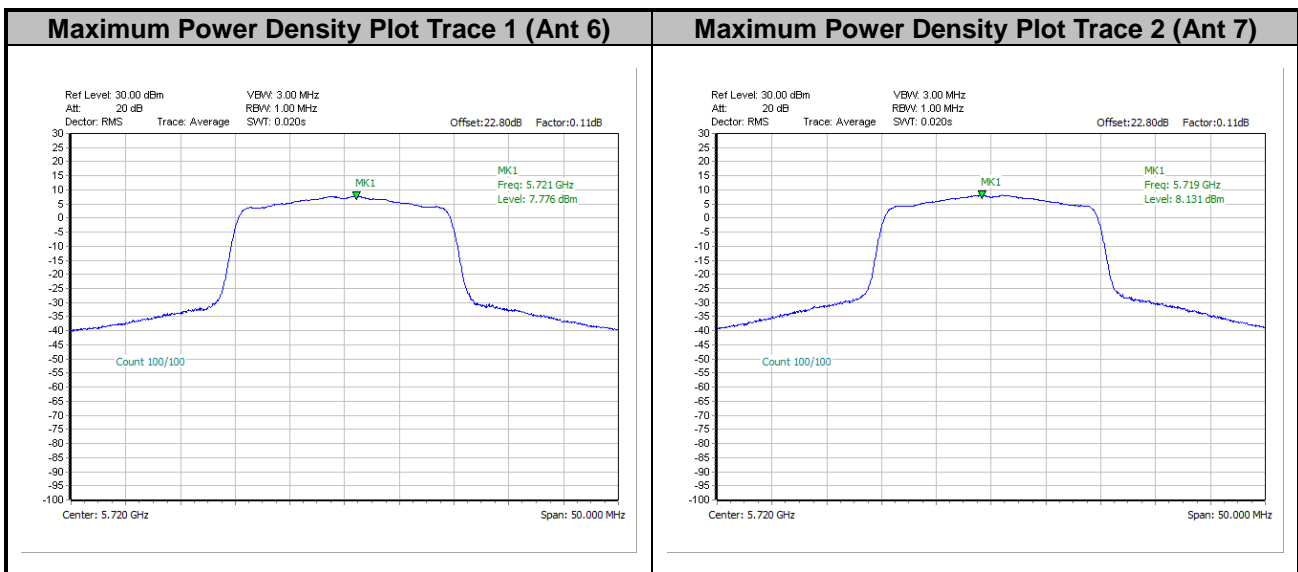



<TXBF Modes>

FCC Band I MIMO													
Mod.	Data Rate	NTX	CH.	Freq. (MHz)	RU Config.	Average Power Density (dBm/MHz)			Average PSD Limit (dBm/MHz)		DG (dBi)		Pass /Fail
						Ant 6	Ant 7	SUM	Ant 6	Ant 7	Ant 6	Ant 7	
HE20	MCS2	2	36	5180	Full	-	-	10.67	11.00	5.04	-	Pass	
HE20	MCS2	2	44	5220	Full	-	-	10.72	11.00	5.04	-	Pass	
HE20	MCS2	2	48	5240	Full	-	-	10.82	11.00	5.04	-	Pass	
HE40	MCS0	2	38	5190	Full	-	-	6.07	11.00	5.04	-	Pass	
HE40	MCS0	2	46	5230	Full	-	-	9.52	11.00	5.04	-	Pass	
HE80	MCS0	2	42	5210	Full	-	-	5.39	11.00	5.04	-	Pass	

Band II MIMO													
Mod.	Data Rate	NTX	CH.	Freq. (MHz)	RU Config.	Average Power Density (dBm/MHz)			Average PSD Limit (dBm/MHz)		DG (dBi)		Pass /Fail
						Ant 6	Ant 7	SUM	Ant 6	Ant 7	Ant 6	Ant 7	
HE20	MCS2	2	52	5260	Full	-	-	10.50	11.00	5.61	-	Pass	
HE20	MCS2	2	60	5300	Full	-	-	10.75	11.00	5.61	-	Pass	
HE20	MCS2	2	64	5320	Full	-	-	10.54	11.00	5.61	-	Pass	
HE40	MCS0	2	54	5270	Full	-	-	8.26	11.00	5.61	-	Pass	
HE40	MCS0	2	62	5310	Full	-	-	5.10	11.00	5.61	-	Pass	
HE80	MCS0	2	58	5290	Full	-	-	6.19	11.00	5.61	-	Pass	



Band III MIMO													
Mod.	Data Rate	NTX	CH.	Freq. (MHz)	RU Config.	Average Power Density (dBm/MHz)			Average PSD Limit (dBm/MHz)		DG (dBi)		Pass /Fail
						Ant 6	Ant 7	SUM	Ant 6	Ant 7	Ant 6	Ant 7	
HE20	MCS2	2	100	5500	Full	-	-	10.69	11.00	4.76	-	Pass	
HE20	MCS2	2	116	5580	Full	-	-	10.72	11.00	4.76	-	Pass	
HE20	MCS2	2	140	5700	Full	-	-	10.62	11.00	4.76	-	Pass	
HE40	MCS0	2	102	5510	Full	-	-	5.80	11.00	4.76	-	Pass	
HE40	MCS0	2	110	5550	Full	-	-	8.58	11.00	4.76	-	Pass	
HE40	MCS0	2	134	5670	Full	-	-	9.30	11.00	4.76	-	Pass	
HE80	MCS0	2	106	5530	Full	-	-	6.62	11.00	4.76	-	Pass	
HE80	MCS0	2	122	5610	Full	-	-	5.37	11.00	4.76	-	Pass	

Band III straddle channel MIMO													
Mod.	Data Rate	NTX	CH.	Freq. (MHz)	RU Config.	Average Power Density (dBm/MHz)			Average PSD Limit (dBm/MHz)		DG (dBi)		Pass /Fail
						Ant 6	Ant 7	SUM	Ant 6	Ant 7	Ant 6	Ant 7	
HE20	MCS2	2	144	5720	Full	-	-	10.51	11.00	4.76	-	Pass	
HE40	MCS0	2	142	5710	Full	-	-	9.52	11.00	4.76	-	Pass	
HE80	MCS0	2	138	5690	Full	-	-	5.49	11.00	4.76	-	Pass	

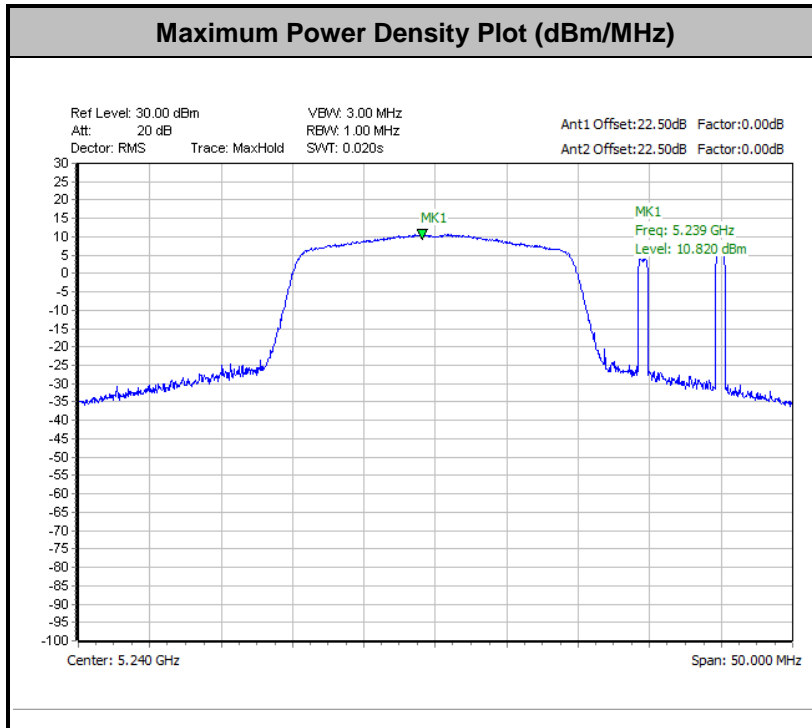

Remark: The test plot is showing a bin by bin combined result mathematically adds two traces.

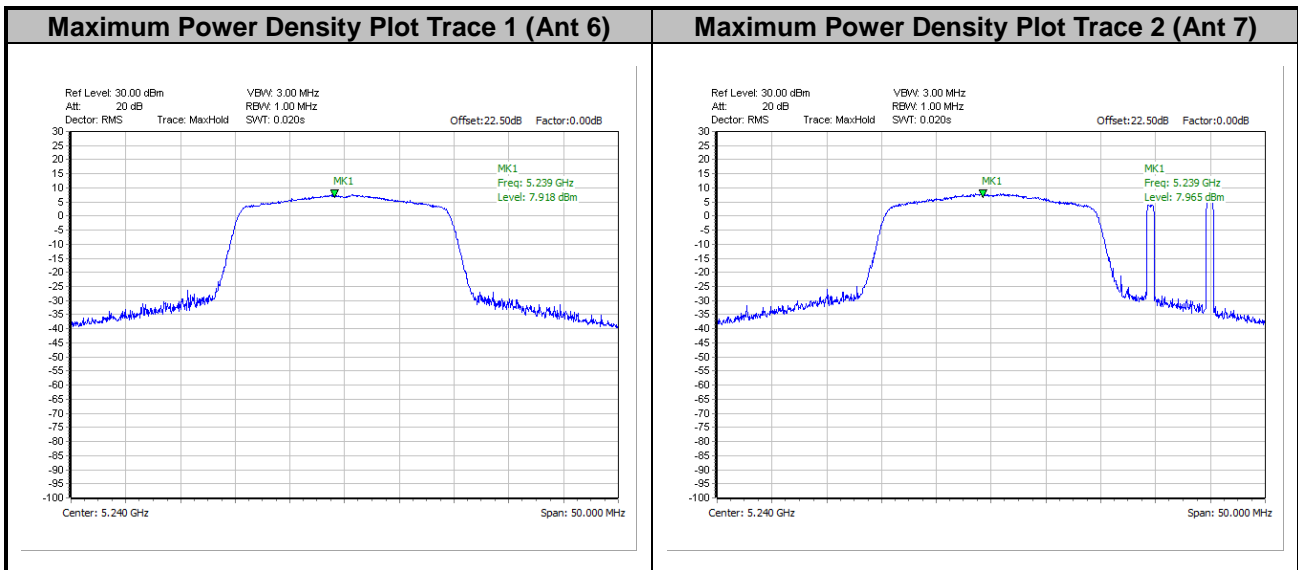



### 3.4 Unwanted Emissions Measurement

This section is to measure unwanted emissions through radiated measurement for band edge spurious emissions and out of band emissions measurement.

#### 3.4.1 Limit of Unwanted Emissions

(1) For transmitters operating in the 5150-5250 MHz band: all emissions outside of the 5150-5350 MHz band shall not exceed an EIRP of -27dBm/MHz.

For transmitters operating in the 5250-5350 MHz band: all emissions outside of the 5150-5350 MHz band shall not exceed an EIRP of -27 dBm/MHz. Devices operating in the 5250-5350 MHz band that generate emissions in the 5150-5250 MHz band must meet all applicable technical requirements for operation in the 5150-5250 MHz band (including indoor use) or alternatively meet an out-of-band emission EIRP limit of -27 dBm/MHz in the 5150-5250 MHz band.

For transmitters operating in the 5470-5600 MHz and 5650-5725MHz band: all emissions outside of the 5470-5600 MHz and 5650-5725MHz band shall not exceed an EIRP of -27 dBm/MHz.

(2) Unwanted spurious emissions falls in restricted bands shall comply with the general field strength limits as below table:

Frequency (MHz)	Field Strength (microvolts/meter)	Measurement Distance (meters)
0.009 – 0.490	2400/F(kHz)	300
0.490 – 1.705	24000/F(kHz)	30
1.705 – 30.0	30	30
30 – 88	100	3
88 – 216	150	3
216 - 960	200	3
Above 960	500	3

**Note:** The following formula is used to convert the EIRP to field strength.

$$E = \frac{1000000\sqrt{30P}}{3} \mu\text{V/m, where P is the eirp (Watts)}$$



EIRP (dBm)	Field Strength at 3m (dBμV/m)
- 27	68.3

(3) KDB789033 D02 v02r01 G)2)c)

(i) Sections 15.407(b)(1-3) specifies the unwanted emissions limit for the U-NII-1 and U-NII-2 bands. As specified, emissions above 1000 MHz that are outside of the restricted bands are subject to a peak emission limit of -27 dBm/MHz.

(ii) Section 15.407(b)(4) specifies the unwanted emissions limit for the U-NII-3 band. A band emissions mask is specified in Section 15.407(b)(4)(i). The emission limits are based on the use of a peak detector.

### 3.4.2 Measuring Instruments

Please refer to the measuring equipment list in this test report.

### 3.4.3 Test Procedures

1. The testing follows FCC KDB 789033 D02 General UNII Test Procedures New Rules v02r01. Section G) Unwanted emissions measurement.

(1) Procedure for Unwanted Emissions Measurements Below 1000 MHz

- RBW = 120 kHz
- VBW = 300 kHz
- Detector = Peak
- Trace mode = max hold

(2) Procedure for Peak Unwanted Emissions Measurements Above 1000 MHz

- RBW = 1 MHz
- VBW ≥ 3 MHz
- Detector = Peak
- Sweep time = auto
- Trace mode = max hold

(3) Procedures for Average Unwanted Emissions Measurements Above 1000 MHz

- RBW = 1 MHz
- VBW = 10 Hz, when duty cycle is no less than 98 percent.
- VBW ≥ 1/T, when duty cycle is less than 98 percent where T is the minimum transmission duration over which the transmitter is on and is transmitting at its maximum power control level for the tested mode of operation.

2. The EUT is placed on a turntable with 0.8 meter for frequency below 1 GHz and 1.5 meter for frequency above 1 GHz respectively above ground.
3. The EUT is set 3 meters away from the receiving antenna which is mounted on the top of a variable height antenna tower.
4. The antenna is a broadband antenna and its height is adjusted between one meter and four meters above ground to find the maximum value of the field strength for both horizontal polarization and vertical polarization of the antenna.
5. For each suspected emission, the EUT is arranged to its worst case and then adjust the antenna tower (from 1 m to 4 m) and turntable (from 0 degree to 360 degrees) to find the maximum reading.
6. Radiated testing below 1 GHz is performed by adjusting the antenna tower from 1 m to 4 m and by rotating the turn table from 0 degree to 360 degrees to find the peak maximum hold reading. When there is no suspected emission found and the emission level is with at least 6 dB margin against QP limit line, the position is marked as “-“.
7. Radiated testing above 1 GHz is performed by adjusting the antenna tower from 1 m to 4 m and by rotating the turn table from 0 degree to 360 degrees to find the peak maximum hold reading for scanning all frequencies. When there is no suspected emission found and the harmonic emission level is with at least 6 dB margin against average limit line, the position is marked as “-“.

### 3.4.4 Test Setup

For radiated emissions below 30MHz

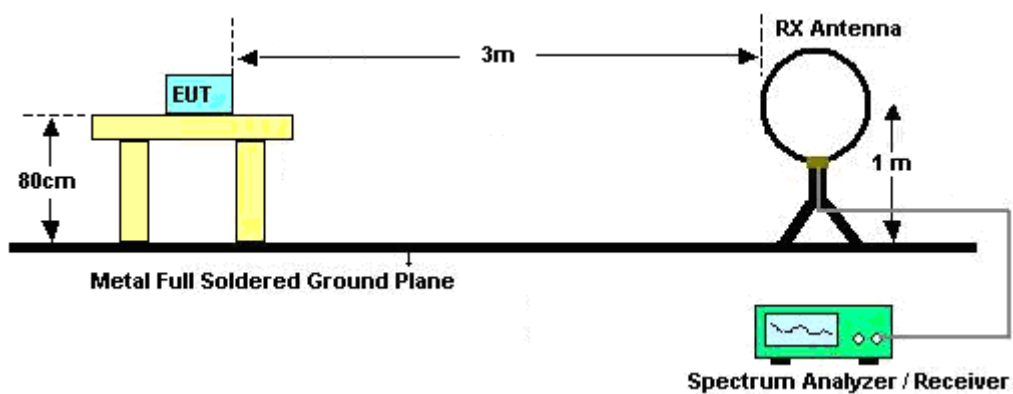



For radiated emissions from 30MHz to 1GHz

<CDD Mode>

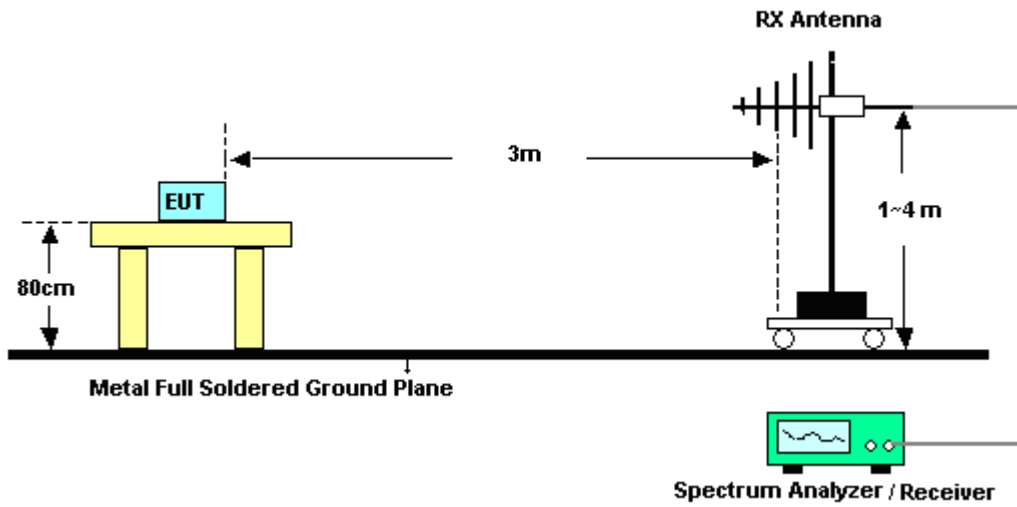

<TXBF Modes>

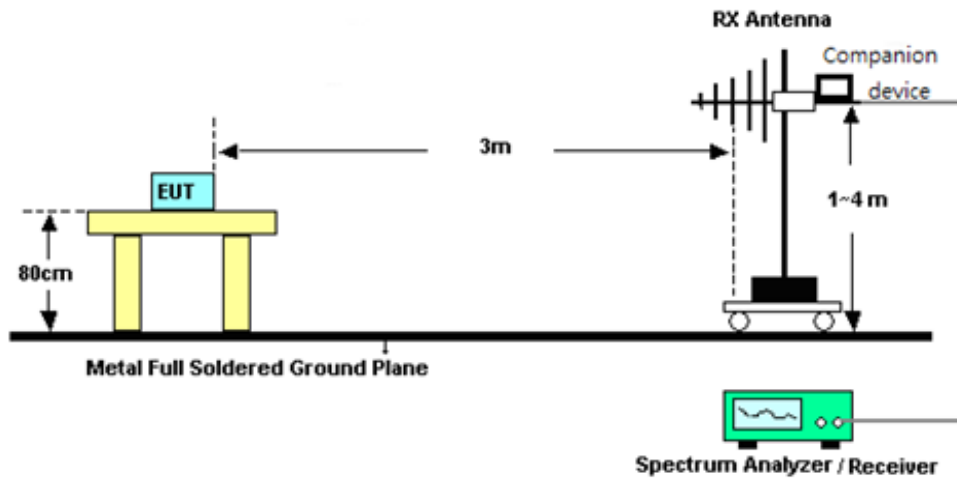

For radiated test from 1GHz to 18GHz

<CDD Mode>

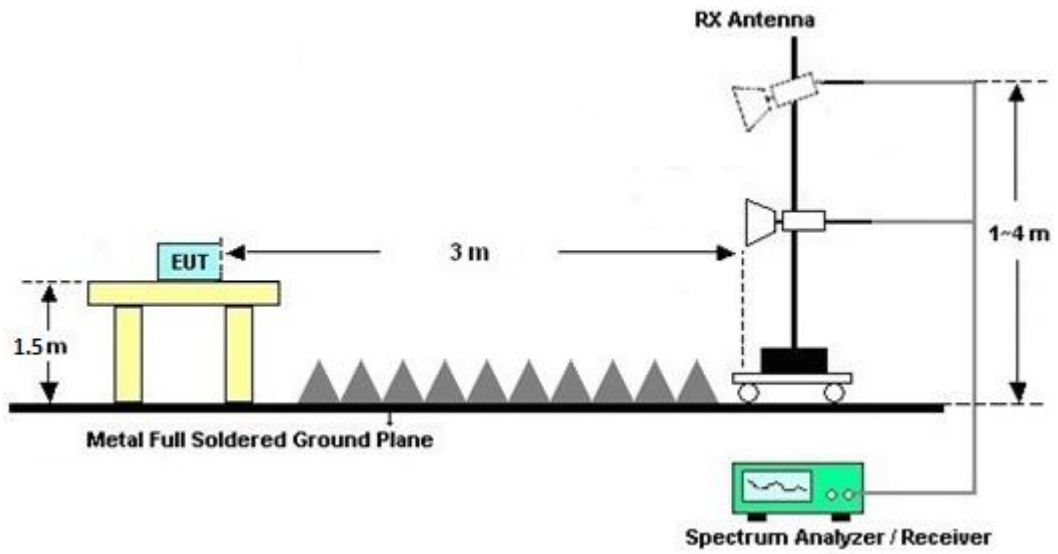

<TXBF Modes>

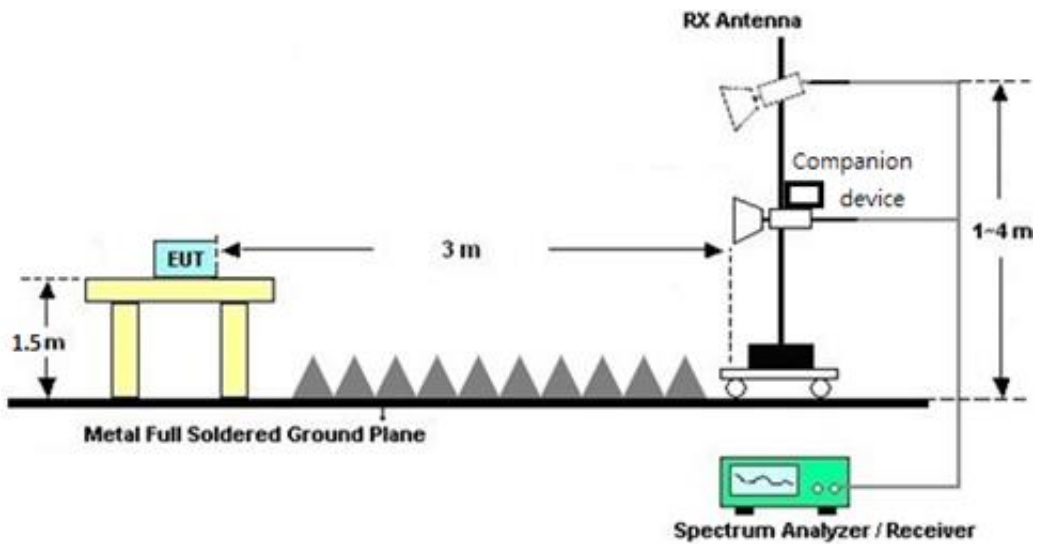

For radiated test above 18GHz

<CDD Mode>

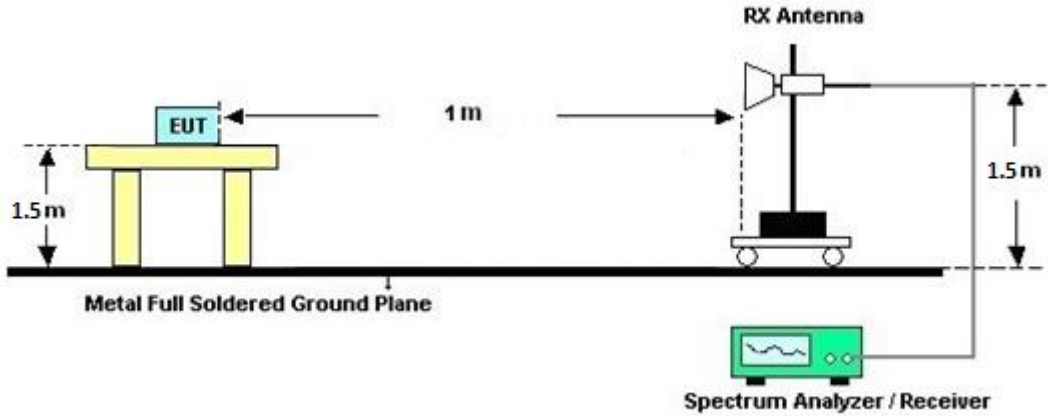

<TXBF Modes>

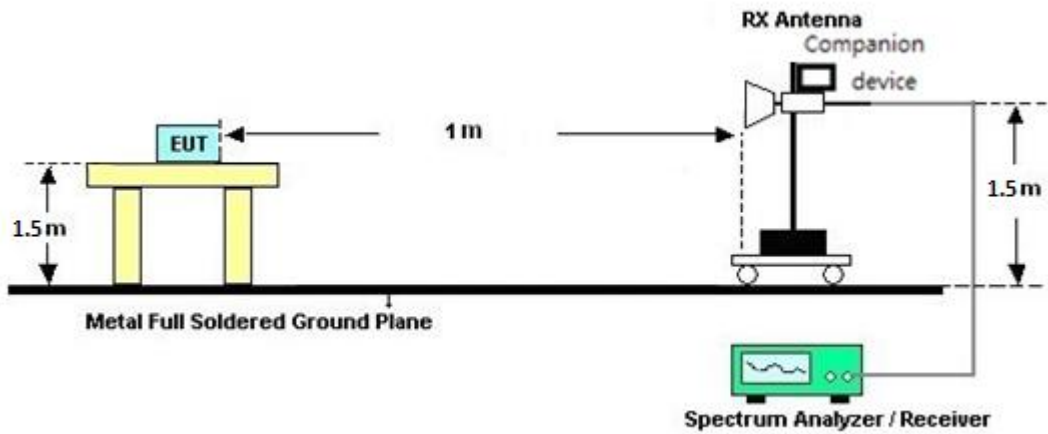



### **3.4.5 Test Results of Radiated Spurious Emissions (9 kHz ~ 30 MHz)**

The low frequency, which starts from 9 kHz to 30 MHz, is pre-scanned and the result which is 20 dB lower than the limit line is not reported.

There is adequate comparison measurement of both open-field test site and alternative test site - semi-Anechoic chamber according to 414788 D01 Radiated Test Site v01r01, and the result came out very similar.

### **3.4.6 Test Result of Radiated Spurious at Band Edges**

Please refer to Appendix B and C.

### **3.4.7 Duty Cycle**

Please refer to Appendix D.

### **3.4.8 Test Result of Radiated Spurious Emissions (30MHz ~ 10th Harmonic)**

Please refer to Appendix B and C.



### 3.5 AC Conducted Emission Measurement

#### 3.5.1 Limit of AC Conducted Emission

For equipment that is designed to be connected to the public utility (AC) power line, the radio frequency voltage that is conducted back onto the AC power line on any frequency or frequencies within the band 150 kHz to 30 MHz shall not exceed the limits in the following table.

Frequency of emission (MHz)	Conducted limit (dB $\mu$ V)	
	Quasi-peak	Average
0.15-0.5	66 to 56*	56 to 46*
0.5-5	56	46
5-30	60	50

\*Decreases with the logarithm of the frequency.

#### 3.5.2 Measuring Instruments

Please refer to the measuring equipment list in this test report.

#### 3.5.3 Test Procedures

1. The EUT is placed 0.4 meter away from the conducting wall of the shielding room, and is kept at least 80 centimeters from any other grounded conducting surface.
2. Connect EUT to the power mains through a line impedance stabilization network (LISN).
3. All the support units are connecting to the other LISN.
4. The LISN provides 50 ohm coupling impedance for the measuring instrument.
5. The FCC states that a 50 ohm, 50 microhenry LISN shall be used.
6. Both Line and Neutral shall be tested in order to find out the maximum conducted emission.
7. The frequency range from 150 kHz to 30 MHz is scanned.
8. Set the test-receiver system to Peak Detect Function and specified bandwidth with Maximum Hold Mode.

### 3.5.4 Test Setup

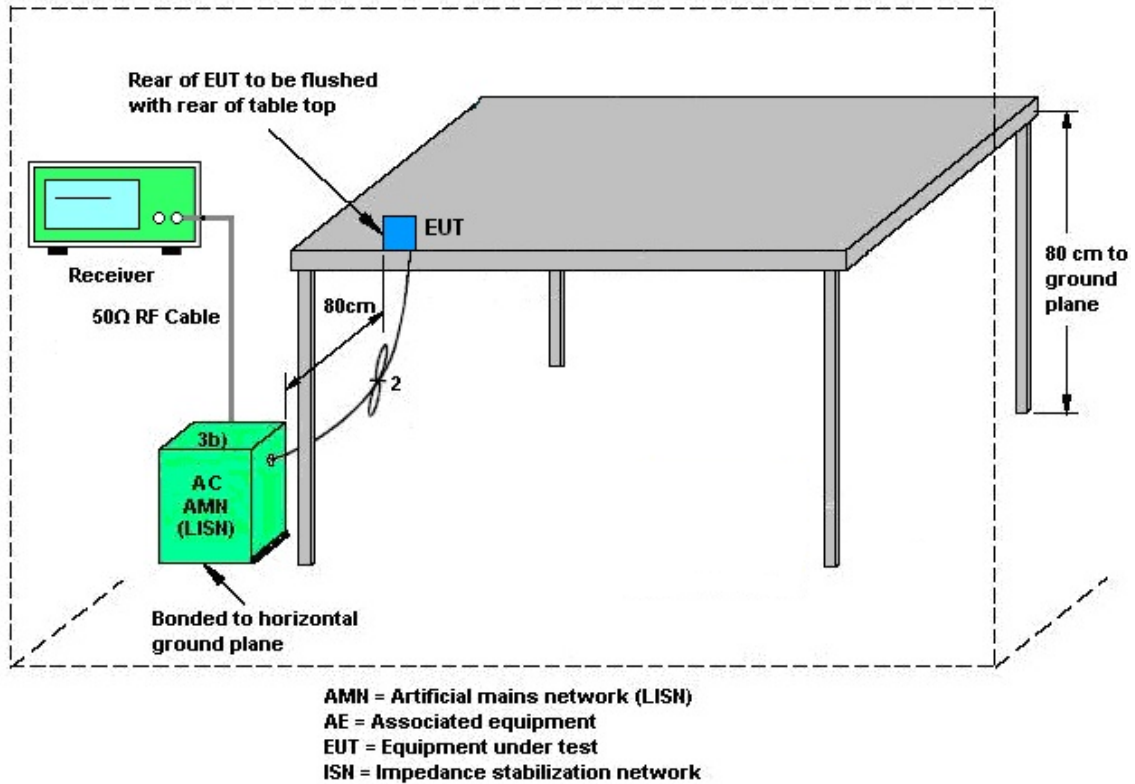

### 3.5.5 Test Result of AC Conducted Emission

Please refer to Appendix A.



### 3.6 Antenna Requirements

#### 3.6.1 Standard Applicable

If transmitting antenna directional gain is greater than 6 dBi, both the peak transmit power and the peak power spectral density shall be reduced by the amount in dB that the directional gain of the antenna exceeds 6 dBi.

#### 3.6.2 Antenna Anti-Replacement Construction

An embedded-in antenna design is used.

#### 3.6.3 Antenna Gain

<CDD Modes >

FCC KDB 662911 D01 Multiple Transmitter Output v02r01

For CDD transmissions, directional gain is calculated as

Directional gain =  $G_{ANT}$  + Array Gain, where Array Gain is as follows.

For power spectral density (PSD) measurements on all devices,

Array Gain =  $10 \log(N_{ANT}/N_{SS}=1)$  dB.

For power measurements on IEEE 802.11 devices,

Array Gain = 0 dB (i.e., no array gain) for  $N_{ANT} \leq 4$ .

Directional gain may be calculated by using the formulas applicable to equal gain antennas with  $G_{ANT}$  set equal to the gain of the antenna having the highest gain;

The EUT supports CDD mode.

For power, the directional gain  $G_{ANT}$  is set equal to the antenna having the highest gain, i.e., F)2)f)i).

For PSD, the directional gain calculation is following F)2)f)ii) of KDB 662911 D01 v02r01.

The power and PSD limit should be modified if the directional gain of EUT is over 6 dBi,

The directional gain "DG" is calculated as following table.

<CDD Modes>						
			DG	DG	Power	PSD
			for	for	Limit	Limit
	Ant. 6	Ant. 7	Power	PSD	Reduction	Reduction
	(dBi)	(dBi)	(dBi)	(dBi)	(dB)	(dB)
Band I	2.70	1.30	2.70	5.04	0.00	0.00
Band II	2.70	2.50	2.70	5.61	0.00	0.00
Band III	1.70	1.80	1.80	4.76	0.00	0.00

Power limit reduction = Composite gain – 6dBi, ( min = 0 )

PSD limit reduction = Composite gain + PSD Array gain – 6dBi, ( min = 0 )

**TXBF modes**

FCC KDB 662911 D01 Multiple Transmitter Output v02r01

For CDD transmissions, directional gain is calculated as

$$DirectionalGain = 10 \cdot \log \left[ \frac{\sum_{j=1}^{N_{SS}} \left\{ \sum_{k=1}^{N_{ANT}} g_{j,k} \right\}^2}{N_{ANT}} \right]$$

where

Each antenna is driven by no more than one spatial stream;

$N_{SS}$  = the number of independent spatial streams of data;

$N_{ANT}$  = the total number of antennas

$g_{j,k} = 10^{G_k / 20}$  if the  $k$ th antenna is being fed by spatial stream  $j$ , or zero if it is not;  
 $G_k$  is the gain in dBi of the  $k$ th antenna.

The EUT supports beamforming for 802.11ac modes.

The directional gain calculation is following F)2)e)ii) of KDB 662911 D01 v02r01.

The power and PSD limit should be modified if the directional gain of EUT is over 6 dBi,

The directional gain “DG” is calculated as following table.

			DG	DG	Power	PSD
			for	for	Limit	Limit
	Ant 6	Ant 7	Power	PSD	Reduction	Reduction
	(dBi)	(dBi)	(dBi)	(dBi)	(dB)	(dB)
<b>Band I</b>	2.70	1.30	5.04	5.04	0.00	0.00
<b>Band II</b>	2.70	2.50	5.61	5.61	0.00	0.00
<b>Band III</b>	1.70	1.80	4.76	4.76	0.00	0.00

$Power\ Limit\ Reduction = DG(Power) - 6dBi, (min = 0)$

$PSD\ Limit\ Reduction = DG(PSD) - 6dBi, (min = 0)$





## 4 List of Measuring Equipment

Instrument	Brand Name	Model No.	Serial No.	Characteristics	Calibration Date	Test Date	Due Date	Remark
Loop Antenna	Rohde & Schwarz	HFH2-Z2	100488	9 kHz~30 MHz	Sep. 07, 2021	Mar. 30, 2022~ Apr. 26, 2022	Sep. 06, 2022	Radiation (03CH13-HY)
Preamplifier	EMEC	EM18G40G	060715	18GHz~40GHz	Dec. 24, 2021	Mar. 30, 2022~ Apr. 26, 2022	Dec. 23, 2022	Radiation (03CH13-HY)
SHF-EHF Horn Antenna	SCHWARZBECK	BBHA9170	00993	18GHz~40GHz	Nov. 30, 2021	Mar. 30, 2022~ Apr. 26, 2022	Nov. 29, 2022	Radiation (03CH13-HY)
Amplifier	SONOMA	310N	187282	9kHz~1GHz	Dec. 15, 2021	Mar. 30, 2022~ Apr. 26, 2022	Dec. 14, 2022	Radiation (03CH13-HY)
Bilog Antenna	TESEQ	CBL 6111D & 00800N1D01N -06	40103 & 07	30MHz~1GHz	Apr. 28, 2021	Mar. 30, 2022~ Apr. 26, 2022	Apr. 27, 2022	Radiation (03CH13-HY)
Horn Antenna	SCHWARZBECK	BBHA 9120 D	9120D-1241	1GHz~18GHz	Jul. 13, 2021	Mar. 30, 2022~ Apr. 26, 2022	Jul. 12, 2022	Radiation (03CH13-HY)
Hygrometer	TECPEL	DTM-303B	TP200889	N/A	Sep. 30, 2021	Mar. 30, 2022~ Apr. 26, 2022	Sep. 29, 2022	Radiation (03CH13-HY)
Preamplifier	MITEQ	AMF-7D-0010 1800-30-10P	1590074	1GHz~18GHz	May 18, 2021	Mar. 30, 2022~ Apr. 26, 2022	May 17, 2022	Radiation (03CH13-HY)
Preamplifier	Keysight	83017A	MY53270147	1GHz~26.5GHz	Oct. 26, 2021	Mar. 30, 2022~ Apr. 26, 2022	Oct. 25, 2022	Radiation (03CH13-HY)
Spectrum Analyzer	Keysight	N9010A	MY55370526	10Hz~44GHz	Mar. 18, 2022	Mar. 30, 2022~ Apr. 26, 2022	Mar. 17, 2023	Radiation (03CH13-HY)
Filter	Wainwright	WLK4-1000-15 30-8000-40SS	SN12	1.53GHz Low Pass Filter	Sep. 14, 2021	Mar. 30, 2022~ Apr. 26, 2022	Sep. 13, 2022	Radiation (03CH13-HY)
Filter	Wainwright	WHKX12-2700 -3000-18000-6 0SS	SN2	3GHz High Pass Filter	Jul. 12, 2021	Mar. 30, 2022~ Apr. 26, 2022	Jul. 11, 2022	Radiation (03CH13-HY)
Filter	Wainwright	WHKX8-5872. 5-6750-18000- 40ST	SN6	6.75GHz High Pass Filter	Jun. 30, 2021	Mar. 30, 2022~ Apr. 26, 2022	Jun. 29, 2022	Radiation (03CH13-HY)
RF Cable	HUBER + SUHNER	SUCOFLEX 126E	0030/126E	30MHz~18GHz	Feb. 09, 2022	Mar. 30, 2022~ Apr. 26, 2022	Feb. 08, 2023	Radiation (03CH13-HY)
RF Cable	HUBER + SUHNER	SUCOFLEX 104	804793/4	30MHz~18GHz	Feb. 09, 2022	Mar. 30, 2022~ Apr. 26, 2022	Feb. 08, 2023	Radiation (03CH13-HY)
RF Cable	HUBER + SUHNER	SUCOFLEX 104	MY24961/4	30MHz~18GHz	Feb. 09, 2022	Mar. 30, 2022~ Apr. 26, 2022	Feb. 08, 2023	Radiation (03CH13-HY)
RF Cable	HUBER + SUHNER	SUCOFLEX 104	MY9837/4PE	9kHz~30MHz	Mar. 10, 2022	Mar. 30, 2022~ Apr. 26, 2022	Mar. 09, 2023	Radiation (03CH13-HY)
Controller	EMEC	EM1000	N/A	Control Turn table & Ant Mast	N/A	Mar. 30, 2022~ Apr. 26, 2022	N/A	Radiation (03CH13-HY)
Antenna Mast	EMEC	AM-BS-4500-B	N/A	1m~4m	N/A	Mar. 30, 2022~ Apr. 26, 2022	N/A	Radiation (03CH13-HY)
Turn Table	EMEC	TT2000	N/A	0~360 Degree	N/A	Mar. 30, 2022~ Apr. 26, 2022	N/A	Radiation (03CH13-HY)



Instrument	Brand Name	Model No.	Serial No.	Characteristics	Calibration Date	Test Date	Due Date	Remark
AC Power Source	ACPOWER	AFC-11003G	F317040033	N/A	N/A	Apr. 23, 2022	N/A	Conduction (CO07-HY)
Software	Rohde & Schwarz	EMC32 V10.30	N/A	N/A	N/A	Apr. 23, 2022	N/A	Conduction (CO07-HY)
Pulse Limiter	SCHWARZBECK	VTSD 9561-FN	9561-FN00373	9kHz-200MHz	Oct. 29, 2021	Apr. 23, 2022	Oct. 28, 2022	Conduction (CO07-HY)
RF Cable	HUBER + SUHNER	RG 214/U	1358175	9kHz~30MHz	Mar. 16, 2022	Apr. 23, 2022	Mar. 15, 2023	Conduction (CO07-HY)
Two-Line V-Network	TESEQ	NNB 51	45051	N/A	Feb. 16, 2022	Apr. 23, 2022	Feb. 15, 2023	Conduction (CO07-HY)
EMI Test Receiver	Rohde & Schwarz	ESC17	100724	9kHz~7GHz	Feb. 24, 2022	Apr. 23, 2022	Feb. 23, 2023	Conduction (CO07-HY)
Hygrometer	TECPEL	DTM-303A	TP201996	N/A	Nov. 16, 2021	Mar. 23, 2022~ Apr. 19, 2022	Nov. 15, 2022	Conducted (TH05-HY)
Power Sensor	DARE	RPR3006W	16I00054SNO12 (NO:113)	10MHz~6GHz	Dec. 16, 2021	Mar. 23, 2022~ Apr. 19, 2022	Dec. 15, 2022	Conducted (TH05-HY)
Signal Analyzer	Rohde & Schwarz	FSV40	101566	10Hz~40GHz	Aug. 30, 2021	Mar. 23, 2022~ Apr. 19, 2022	Aug. 29, 2022	Conducted (TH05-HY)
Switch Control Mainframe	E-IUSTRUMENT	ETF-1405-0	EC1900067 (BOX7)	N/A	Aug. 12, 2021	Mar. 23, 2022~ Apr. 19, 2022	Aug. 11, 2022	Conducted (TH05-HY)



## 5 Uncertainty of Evaluation

### Uncertainty of Conducted Emission Measurement (150kHz ~ 30MHz)

Measuring Uncertainty for a Level of Confidence of 95% ( $U = 2Uc(y)$ )	2.3 dB
---	--------

### Uncertainty of Radiated Emission Measurement (30 MHz ~ 1000 MHz)

Measuring Uncertainty for a Level of Confidence of 95% ( $U = 2Uc(y)$ )	6.0 dB
---	--------

### Uncertainty of Radiated Emission Measurement (1000 MHz ~ 18000 MHz)

Measuring Uncertainty for a Level of Confidence of 95% ( $U = 2Uc(y)$ )	5.2 dB
---	--------

### Uncertainty of Radiated Emission Measurement (18000 MHz ~ 40000 MHz)

Measuring Uncertainty for a Level of Confidence of 95% ( $U = 2Uc(y)$ )	5.9 dB
---	--------



## Appendix A. AC Conducted Emission Test Results

Test Engineer :	Louis Chung	Temperature :	28.6~29.5°C
		Relative Humidity :	43.9~46.7%

# EUT Information

Report NO : 222229  
 Test Mode : Mode 1  
 Test Voltage : 120Vac/60Hz  
 Phase : Line

Full Spectrum

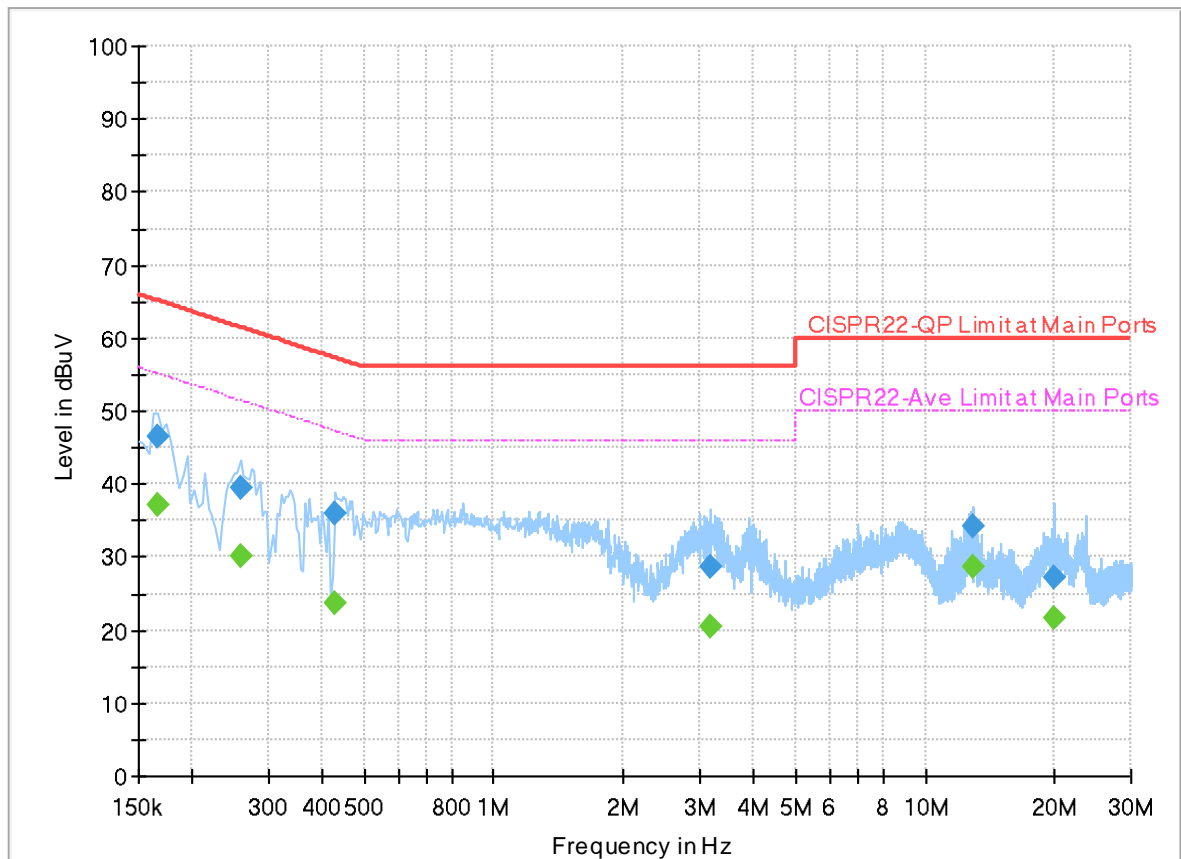

## Final\_Result

Frequency (MHz)	QuasiPeak (dBuV)	CAverage (dBuV)	Limit (dBuV)	Margin (dB)	Line	Filter	Corr. (dB)
0.166000	---	37.07	55.16	18.09	L1	OFF	20.0
0.166000	46.58	---	65.16	18.58	L1	OFF	20.0
0.258000	---	30.10	51.50	21.40	L1	OFF	20.0
0.258000	39.44	---	61.50	22.06	L1	OFF	20.0
0.430000	---	23.79	47.25	23.46	L1	OFF	20.0
0.430000	36.09	---	57.25	21.16	L1	OFF	20.0
3.186000	---	20.33	46.00	25.67	L1	OFF	20.0
3.186000	28.79	---	56.00	27.21	L1	OFF	20.0
12.866000	---	28.52	50.00	21.48	L1	OFF	20.2
12.866000	34.34	---	60.00	25.66	L1	OFF	20.2
20.002000	---	21.77	50.00	28.23	L1	OFF	20.2
20.002000	27.05	---	60.00	32.95	L1	OFF	20.2

# EUT Information

Report NO : 222229  
 Test Mode : Mode 1  
 Test Voltage : 120Vac/60Hz  
 Phase : Neutral

Full Spectrum

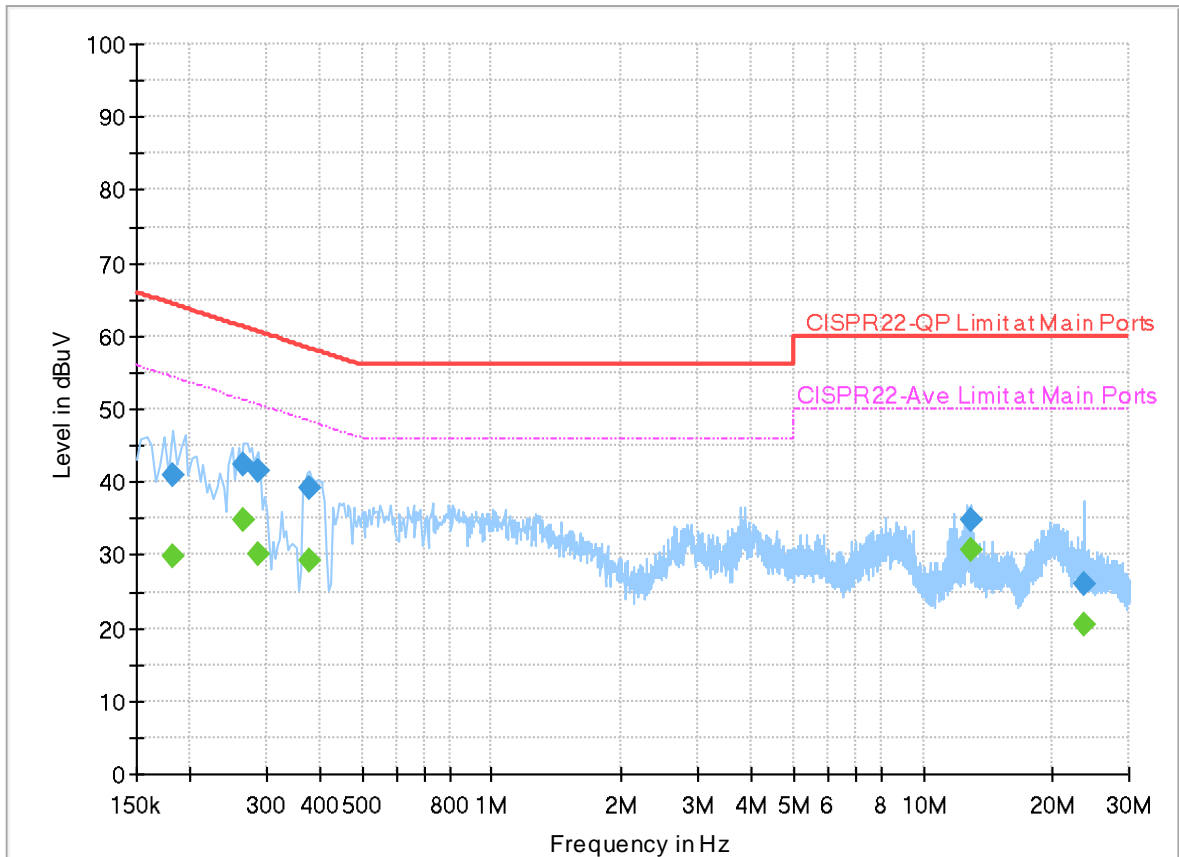

## Final\_Result

Frequency (MHz)	QuasiPeak (dBuV)	CAverage (dBuV)	Limit (dBuV)	Margin (dB)	Line	Filter	Corr. (dB)
0.182000	---	29.89	54.39	24.50	N	OFF	20.0
0.182000	41.01	---	64.39	23.38	N	OFF	20.0
0.266000	---	34.89	51.24	16.35	N	OFF	20.0
0.266000	42.48	---	61.24	18.76	N	OFF	20.0
0.286000	---	30.07	50.64	20.57	N	OFF	20.0
0.286000	41.59	---	60.64	19.05	N	OFF	20.0
0.378000	---	29.31	48.32	19.01	N	OFF	20.0
0.378000	39.17	---	58.32	19.15	N	OFF	20.0
12.870000	---	30.68	50.00	19.32	N	OFF	20.2
12.870000	34.94	---	60.00	25.06	N	OFF	20.2
23.530000	---	20.39	50.00	29.61	N	OFF	20.3
23.530000	26.14	---	60.00	33.86	N	OFF	20.3



## Appendix B. Radiated Spurious Emission

Test Engineer :	Yuan Lee, Jacky Hong, Peter Liao and Rain Lee	Temperature :	20~25°C
		Relative Humidity :	40~60%

<CDD Mode>

**Band 1 - 5150~5250MHz**  
**WIFI 802.11a (Band Edge @ 3m)**

WIFI Ant.	Note	Frequency ( MHz )	Level ( dBμV/m )	Margin ( dB )	Limit Line ( dBμV/m )	Read Level ( dBμV )	Antenna Factor ( dB/m )	Path Loss ( dB )	Preamp Factor ( dB )	Ant Pos ( cm )	Table Pos ( deg )	Peak Avg. ( P/A )	Pol. ( H/V )	
802.11a CH 36 5180MHz		5146.38	58.66	-15.34	74	46.77	32.19	6.21	26.51	100	228	P	H	
		5149.76	50.78	-3.22	54	38.88	32.2	6.21	26.51	100	228	A	H	
	*	5180	113.04	-	-	101.23	32.08	6.25	26.52	100	228	P	H	
	*	5180	105.01	-	-	93.2	32.08	6.25	26.52	100	228	A	H	
													H	
			5137.8	56.86	-17.14	74	44.99	32.18	6.2	26.51	357	226	P	V
			5148.46	49.98	-4.02	54	38.08	32.2	6.21	26.51	357	226	A	V
	*		5180	112.02	-	-	100.21	32.08	6.25	26.52	357	226	P	V
	*		5180	103.02	-	-	91.21	32.08	6.25	26.52	357	226	A	V
														V
802.11a CH 44 5220MHz		5138.84	56.69	-17.31	74	44.82	32.18	6.2	26.51	100	230	P	H	
		5150	48.68	-5.32	54	36.77	32.2	6.22	26.51	100	230	A	H	
	*	5220	113.03	-	-	101.35	31.92	6.28	26.52	100	230	P	H	
	*	5220	106.29	-	-	94.61	31.92	6.28	26.52	100	230	A	H	
			5351.64	52.91	-21.09	74	41.52	31.61	6.32	26.54	100	230	P	H
			5399.8	45.74	-8.26	54	34.06	31.9	6.33	26.55	100	230	A	H
			5142.74	54.98	-19.02	74	43.09	32.19	6.21	26.51	327	223	P	V
			5147.42	46.53	-7.47	54	34.64	32.19	6.21	26.51	327	223	A	V
	*		5220	112.15	-	-	100.47	31.92	6.28	26.52	327	223	P	V
	*		5220	105.04	-	-	93.36	31.92	6.28	26.52	327	223	A	V
			5396.72	53.96	-20.04	74	42.3	31.88	6.33	26.55	327	223	P	V
			5399.8	46.17	-7.83	54	34.49	31.9	6.33	26.55	327	223	A	V



<b>802.11a CH 48 5240MHz</b>		5140.66	57.19	-16.81	74	45.32	32.18	6.2	26.51	100	27	P	H
		5147.16	47.89	-6.11	54	36	32.19	6.21	26.51	100	27	A	H
	*	5240	116.33	-	-	104.73	31.84	6.28	26.52	100	27	P	H
	*	5240	109.54	-	-	97.94	31.84	6.28	26.52	100	27	A	H
		5351.08	55.93	-18.07	74	44.54	31.61	6.32	26.54	100	27	P	H
		5351.64	46.56	-7.44	54	35.17	31.61	6.32	26.54	100	27	A	H
		5109.46	54.18	-19.82	74	42.4	32.12	6.17	26.51	313	201	P	V
		5149.24	46.06	-7.94	54	34.16	32.2	6.21	26.51	313	201	A	V
	*	5240	115.32	-	-	103.72	31.84	6.28	26.52	313	201	P	V
	*	5240	108.15	-	-	96.55	31.84	6.28	26.52	313	201	A	V
		5384.96	53.1	-20.9	74	41.5	31.81	6.33	26.54	313	201	P	V
		5420.52	44.93	-9.07	54	33.24	31.9	6.34	26.55	313	201	A	V
<b>Remark</b>	<ol style="list-style-type: none"> <li>1. No other spurious found.</li> <li>2. All results are PASS against Peak and Average limit line.</li> </ol>												





**Band 1 5150~5250MHz**  
**WIFI 802.11a (Harmonic @ 3m)**

WIFI Ant. 6+7	Note	Frequency ( MHz )	Level ( dBμV/m )	Margin ( dB )	Limit Line ( dBμV/m )	Read Level (dBμV)	Antenna Factor ( dB/m )	Path Loss ( dB )	Preamp Factor ( dB )	Ant Pos ( cm )	Table Pos ( deg )	Peak Avg. (P/A)	Pol. (H/V)
802.11a CH 36 5180MHz		10360	47.66	-20.54	68.2	54.4	39.94	9.78	56.46	-	-	P	H
		15540	45.31	-28.69	74	50	39.44	12.05	56.18	-	-	P	H
													H
													H
													H
													H
													H
													H
													H
													H
													H
													H
													H
													H
													H
													H
													H
													H
													H
			10360	46.94	-21.26	68.2	53.68	39.94	9.78	56.46	-	-	P
		15540	45.19	-28.81	74	49.88	39.44	12.05	56.18	-	-	P	V
													V
													V
													V
													V
													V
													V
													V
													V
													V
													V
													V
													V
													V
													V



WIFI Ant. 6+7	Note	Frequency ( MHz )	Level ( dBμV/m )	Margin ( dB )	Limit Line ( dBμV/m )	Read Level (dBμV)	Antenna Factor ( dB/m )	Path Loss ( dB )	Preamp Factor ( dB )	Ant Pos ( cm )	Table Pos ( deg )	Peak Avg. (P/A)	Pol. (H/V)
802.11a CH 44 5220MHz		10440	46.69	-21.51	68.2	53.11	40.22	9.82	56.46	-	-	P	H
		15660	45.14	-28.86	74	50.13	38.9	12.04	55.93	-	-	P	H
													H
													H
													H
													H
													H
													H
													H
													H
													H
													H
													H
													H
													H
													H
													H
													H
													H
			10440	46.87	-21.33	68.2	53.29	40.22	9.82	56.46	-	-	P
		15660	45.36	-28.64	74	50.35	38.9	12.04	55.93	-	-	P	V
													V
													V
													V
													V
													V
													V
													V
													V
													V
													V
													V
													V
													V
													V
													V
													V



WiFi Ant. 6+7	Note	Frequency ( MHz )	Level ( dBμV/m )	Margin ( dB )	Limit Line ( dBμV/m )	Read Level (dBμV)	Antenna Factor ( dB/m )	Path Loss ( dB )	Preamp Factor ( dB )	Ant Pos ( cm )	Table Pos ( deg )	Peak Avg. (P/A)	Pol. (H/V)
802.11a CH 48 5240MHz		10480	47.21	-20.99	68.2	53.48	40.34	9.85	56.46	-	-	P	H
		15720	45.52	-28.48	74	50.59	38.68	12.05	55.8	-	-	P	H
													H
													H
													H
													H
													H
													H
													H
													H
													H
													H
													H
													H
													H
													H
													H
													H
													H
			10480	47.42	-20.78	68.2	53.69	40.34	9.85	56.46	-	-	P
		15720	45.57	-28.43	74	50.64	38.68	12.05	55.8	-	-	P	V
													V
													V
													V
													V
													V
													V
													V
													V
													V
													V
													V
													V
													V
													V
<b>Remark</b>	<ol style="list-style-type: none"> <li>No other spurious found.</li> <li>All results are PASS against Peak and Average limit line.</li> <li>The emission position marked as "-" means no suspected emission found with sufficient margin against limit line or noise floor only.</li> </ol>												



**Band 1 5150~5250MHz**  
**WIFI 802.11ax HE20 Full (Band Edge @ 3m)**

WIFI Ant. 6+7	Note	Frequency ( MHz )	Level ( dBμV/m )	Margin ( dB )	Limit Line ( dBμV/m )	Read Level ( dBμV )	Antenna Factor ( dB/m )	Path Loss ( dB )	Preamp Factor ( dB )	Ant Pos ( cm )	Table Pos ( deg )	Peak Avg. ( P/A )	Pol. ( H/V )	
802.11ax HE20 Full CH 36 5180MHz		5148.2	60.22	-13.78	74	48.32	32.2	6.21	26.51	100	229	P	H	
		5149.5	50.92	-3.08	54	39.02	32.2	6.21	26.51	100	229	A	H	
	*	5180	115.47	-	-	103.66	32.08	6.25	26.52	100	229	P	H	
	*	5180	104.26	-	-	92.45	32.08	6.25	26.52	100	229	A	H	
													H	
														H
			5148.2	60.32	-13.68	74	48.42	32.2	6.21	26.51	100	117	P	V
			5150	48.06	-5.94	54	36.15	32.2	6.22	26.51	100	117	A	V
		*	5180	112.13	-	-	100.32	32.08	6.25	26.52	100	117	P	V
		*	5180	102.36	-	-	90.55	32.08	6.25	26.52	100	117	A	V
													V	
													V	
802.11ax HE20 Full CH 44 5220MHz		5138.32	56.83	-17.17	74	44.96	32.18	6.2	26.51	100	8	P	H	
		5149.76	48.6	-5.4	54	36.7	32.2	6.21	26.51	100	8	A	H	
		* 5220	116.51	-	-	104.83	31.92	6.28	26.52	100	8	P	H	
		* 5220	107.09	-	-	95.41	31.92	6.28	26.52	100	8	A	H	
			5364.24	55.46	-18.54	74	43.99	31.69	6.32	26.54	100	8	P	H
			5400.08	47.31	-6.69	54	35.63	31.9	6.33	26.55	100	8	A	H
			5076.18	54.25	-19.75	74	42.52	32.1	6.13	26.5	400	208	P	V
			5150	46.09	-7.91	54	34.18	32.2	6.22	26.51	400	208	A	V
		*	5220	115.45	-	-	103.77	31.92	6.28	26.52	400	208	P	V
		*	5220	104.89	-	-	93.21	31.92	6.28	26.52	400	208	A	V
		5394.48	54.08	-19.92	74	42.43	31.87	6.33	26.55	400	208	P	V	
		5350.52	46.02	-7.98	54	34.64	31.6	6.32	26.54	400	208	A	V	



<b>802.11ax</b> <b>HE20 Full</b> <b>CH 48</b> <b>5240MHz</b>		5136.76	55.35	-18.65	74	43.49	32.17	6.2	26.51	111	7	P	H
		5149.76	47.7	-6.3	54	35.8	32.2	6.21	26.51	111	7	A	H
	*	5240	117.58	-	-	105.98	31.84	6.28	26.52	111	7	P	H
	*	5240	107.62	-	-	96.02	31.84	6.28	26.52	111	7	A	H
		5356.68	56.7	-17.3	74	45.28	31.64	6.32	26.54	111	7	P	H
		5358.64	48.07	-5.93	54	36.64	31.65	6.32	26.54	111	7	A	H
		5131.56	54.46	-19.54	74	42.62	32.16	6.19	26.51	297	186	P	V
		5150	45.77	-8.23	54	33.86	32.2	6.22	26.51	297	186	A	V
	*	5240	115.01	-	-	103.41	31.84	6.28	26.52	297	186	P	V
	*	5240	105.9	-	-	94.3	31.84	6.28	26.52	297	186	A	V
		5375.44	52.74	-21.26	74	41.21	31.75	6.32	26.54	297	186	P	V
		5350	45.09	-8.91	54	33.71	31.6	6.32	26.54	297	186	A	V
<b>Remark</b>	1. No other spurious found. 2. All results are PASS against Peak and Average limit line.												



Band 1 5150~5250MHz

WIFI 802.11ax HE20 Full (Harmonic @ 3m)

WIFI Ant. 6+7	Note	Frequency ( MHz )	Level ( dBμV/m )	Margin ( dB )	Limit Line ( dBμV/m )	Read Level (dBμV)	Antenna Factor ( dB/m )	Path Loss ( dB )	Preamp Factor ( dB )	Ant Pos ( cm )	Table Pos ( deg )	Peak Avg. (P/A)	Pol. (H/V)
802.11ax HE20 Full CH 36 5180MHz		10360	47.34	-20.86	68.2	54.08	39.94	9.78	56.46	-	-	P	H
		15540	44.73	-29.27	74	49.42	39.44	12.05	56.18	-	-	P	H
													H
													H
													H
													H
													H
													H
													H
													H
													H
													H
													H
													H
													H
													H
													H
													H
													H
			10360	46.95	-21.25	68.2	53.69	39.94	9.78	56.46	-	-	P
		15540	45.84	-28.16	74	50.53	39.44	12.05	56.18	-	-	P	V
													V
													V
													V
													V
													V
													V
													V
													V
													V
													V
													V
													V
													V
													V



WIFI Ant. 6+7	Note	Frequency ( MHz )	Level ( dBμV/m )	Margin ( dB )	Limit Line ( dBμV/m )	Read Level (dBμV)	Antenna Factor ( dB/m )	Path Loss ( dB )	Preamp Factor ( dB )	Ant Pos ( cm )	Table Pos ( deg )	Peak Avg. (P/A)	Pol. (H/V)	
802.11ax HE20 Full CH 44 5220MHz		10440	48.48	-19.72	68.2	54.9	40.22	9.82	56.46	-	-	P	H	
		15660	44.07	-29.93	74	49.06	38.9	12.04	55.93	-	-	P	H	
													H	
													H	
													H	
													H	
													H	
													H	
													H	
													H	
													H	
													H	
			10440	46.85	-21.35	68.2	53.27	40.22	9.82	56.46	-	-	P	V
			15660	44.57	-29.43	74	49.56	38.9	12.04	55.93	-	-	P	V
														V
														V
														V
														V
														V
													V	
													V	
													V	



WIFI Ant. 6+7	Note	Frequency ( MHz )	Level ( dBμV/m )	Margin ( dB )	Limit Line ( dBμV/m )	Read Level (dBμV)	Antenna Factor ( dB/m )	Path Loss ( dB )	Preamp Factor ( dB )	Ant Pos ( cm )	Table Pos ( deg )	Peak Avg. (P/A)	Pol. (H/V)	
802.11ax HE20 Full CH 48 5240MHz		10480	47.86	-20.34	68.2	54.13	40.34	9.85	56.46	-	-	P	H	
		15720	45.04	-28.96	74	50.11	38.68	12.05	55.8	-	-	P	H	
													H	
													H	
													H	
													H	
													H	
													H	
													H	
													H	
													H	
													H	
													H	
													H	
													H	
													H	
													H	
													H	
	Remark	1. No other spurious found. 2. All results are PASS against Peak and Average limit line. 3. The emission position marked as "-" means no suspected emission found with sufficient margin against limit line or noise floor only.												





**Band 1 5150~5250MHz**  
**WIFI 802.11ax HE20 Partial 106 (Band Edge @ 3m)**

WIFI Ant. 6+7	Note	Frequency ( MHz )	Level ( dBμV/m )	Margin ( dB )	Limit Line ( dBμV/m )	Read Level (dBμV)	Antenna Factor ( dB/m )	Path Loss ( dB )	Preamp Factor ( dB )	Ant Pos ( cm )	Table Pos ( deg )	Peak Avg. (P/A)	Pol. (H/V)	
802.11ax HE20 Partial 106/53 CH 36 5180MHz		5148.2	58.62	-15.38	74	46.72	32.2	6.21	26.51	100	230	P	H	
		5150	48.78	-5.22	54	36.87	32.2	6.22	26.51	100	230	A	H	
	*	5180	114.17	-	-	102.36	32.08	6.25	26.52	100	230	P	H	
	*	5180	103.63	-	-	91.82	32.08	6.25	26.52	100	230	A	H	
													H	
														H
			5147.94	56.47	-17.53	74	44.57	32.2	6.21	26.51	400	220	P	V
			5150	47.14	-6.86	54	35.23	32.2	6.22	26.51	400	220	A	V
	*		5180	113.61	-	-	101.8	32.08	6.25	26.52	400	220	P	V
	*		5180	103	-	-	91.19	32.08	6.25	26.52	400	220	A	V
													V	
													V	
Remark	1. No other spurious found. 2. All results are PASS against Peak and Average limit line.													



**Band 1 5150~5250MHz**  
**WIFI 802.11ax HE40 Full (Band Edge @ 3m)**

WIFI Ant. 6+7	Note	Frequency ( MHz )	Level ( dBμV/m )	Margin ( dB )	Limit Line ( dBμV/m )	Read Level ( dBμV )	Antenna Factor ( dB/m )	Path Loss ( dB )	Preamp Factor ( dB )	Ant Pos ( cm )	Table Pos ( deg )	Peak Avg. ( P/A )	Pol. ( H/V )
802.11ax HE40 Full CH 38 5190MHz		5148.46	62.01	-11.99	74	50.11	32.2	6.21	26.51	100	228	P	H
		5149.76	52.58	-1.42	54	40.68	32.2	6.21	26.51	100	228	A	H
	*	5190	107.82	-	-	96.04	32.04	6.26	26.52	100	228	P	H
	*	5190	98.6	-	-	86.82	32.04	6.26	26.52	100	228	A	H
		5363.96	54.84	-19.16	74	43.38	31.68	6.32	26.54	100	228	P	H
		5360.32	45.51	-8.49	54	34.07	31.66	6.32	26.54	100	228	A	H
		5149.5	61.08	-12.92	74	49.18	32.2	6.21	26.51	400	223	P	V
		5150.02	50.84	-99.16	150	38.93	32.2	6.22	26.51	400	223	A	V
	*	5190	107.22	-	-	95.44	32.04	6.26	26.52	400	223	P	V
	*	5190	97.61	-	-	85.83	32.04	6.26	26.52	400	223	A	V
		5371.24	54.1	-19.9	74	42.59	31.73	6.32	26.54	400	223	P	V
		5351.64	45.08	-8.92	54	33.69	31.61	6.32	26.54	400	223	A	V
	802.11ax HE40 Full CH 46 5230MHz		5149.76	58.73	-15.27	74	46.83	32.2	6.21	26.51	100	226	P
		5150	49.76	-4.24	54	37.85	32.2	6.22	26.51	100	226	A	H
*		5230	110.75	-	-	99.11	31.88	6.28	26.52	100	226	P	H
*		5230	99.87	-	-	88.23	31.88	6.28	26.52	100	226	A	H
		5410.16	57.01	-16.99	74	45.32	31.9	6.34	26.55	100	226	P	H
		5393.36	48.42	-5.58	54	36.78	31.86	6.33	26.55	100	226	A	H
		5119.34	57.72	-16.28	74	45.91	32.14	6.18	26.51	390	219	P	V
		5119.08	48.72	-5.28	54	36.91	32.14	6.18	26.51	390	219	A	V
*		5230	110.19	-	-	98.55	31.88	6.28	26.52	390	219	P	V
*		5230	99.5	-	-	87.86	31.88	6.28	26.52	390	219	A	V
	5381.6	57.83	-16.17	74	46.26	31.79	6.32	26.54	390	219	P	V	
	5386.92	48.43	-5.57	54	36.82	31.82	6.33	26.54	390	219	A	V	
Remark	1. No other spurious found. 2. All results are PASS against Peak and Average limit line.												



Band 1 5150~5250MHz

WIFI 802.11ax HE40 Full (Harmonic @ 3m)

WIFI Ant. 6+7	Note	Frequency ( MHz )	Level ( dBμV/m )	Margin ( dB )	Limit Line ( dBμV/m )	Read Level (dBμV)	Antenna Factor ( dB/m )	Path Loss ( dB )	Preamp Factor ( dB )	Ant Pos ( cm )	Table Pos ( deg )	Peak Avg. (P/A)	Pol. (H/V)
802.11ax HE40 Full CH 38 5190MHz		10380	46.79	-21.41	68.2	53.44	40.02	9.79	56.46	-	-	P	H
		15570	46.09	-27.91	74	50.84	39.32	12.05	56.12	-	-	P	H
													H
													H
													H
													H
													H
													H
													H
													H
													H
													H
													H
													H
													H
													H
													H
													H
			10380	47.99	-20.21	68.2	54.64	40.02	9.79	56.46	-	-	P
		15570	45.65	-28.35	74	50.4	39.32	12.05	56.12	-	-	P	V
													V
													V
													V
													V
													V
													V
													V
													V
													V
													V
													V
													V



WiFi Ant. 6+7	Note	Frequency ( MHz )	Level ( dBµV/m )	Margin ( dB )	Limit Line ( dBµV/m )	Read Level (dBµV)	Antenna Factor ( dB/m )	Path Loss ( dB )	Preamp Factor ( dB )	Ant Pos ( cm )	Table Pos ( deg )	Peak Avg. (P/A)	Pol. (H/V)	
802.11ax HE40 Full CH 46 5230MHz		10460	47.06	-21.14	68.2	53.4	40.28	9.84	56.46	-	-	P	H	
		15690	44.79	-29.21	74	49.86	38.75	12.04	55.86	-	-	P	H	
													H	
													H	
													H	
													H	
													H	
													H	
													H	
													H	
													H	
													H	
													H	
													H	
													H	
													H	
													H	
													H	
	Remark	1. No other spurious found.												
		2. All results are PASS against Peak and Average limit line.												
3. The emission position marked as "-" means no suspected emission found with sufficient margin against limit line or noise floor only.														



**Band 1 5150~5250MHz**  
**WIFI 802.11ax HE80 Full (Band Edge @ 3m)**

WIFI Ant. 6+7	Note	Frequency ( MHz )	Level ( dBμV/m )	Margin ( dB )	Limit Line ( dBμV/m )	Read Level (dBμV)	Antenna Factor ( dB/m )	Path Loss ( dB )	Preamp Factor ( dB )	Ant Pos ( cm )	Table Pos ( deg )	Peak Avg. (P/A)	Pol. (H/V)
<b>802.11ax HE80 Full CH 42 5210MHz</b>		5148.98	60.86	-13.14	74	48.96	32.2	6.21	26.51	312	219	P	H
		5146.38	52.13	-1.87	54	40.24	32.19	6.21	26.51	312	219	A	H
	*	5210	106.09	-	-	94.38	31.96	6.27	26.52	312	219	P	H
	*	5210	96.72	-	-	85.01	31.96	6.27	26.52	312	219	A	H
		5384.4	56.15	-17.85	74	44.55	31.81	6.33	26.54	312	219	P	H
		5371.8	48.97	-5.03	54	37.46	31.73	6.32	26.54	312	219	A	H
		5146.64	58.26	-15.74	74	46.37	32.19	6.21	26.51	113	325	P	V
		5148.98	51.62	-2.38	54	39.72	32.2	6.21	26.51	113	325	A	V
	*	5210	106.12	-	-	94.41	31.96	6.27	26.52	113	325	P	V
	*	5210	97.14	-	-	85.43	31.96	6.27	26.52	113	325	A	V
		5403.72	56.17	-17.83	74	44.49	31.9	6.33	26.55	113	325	P	V
		5383.56	48.6	-5.4	54	37.01	31.8	6.33	26.54	113	325	A	V
<b>Remark</b>	1. No other spurious found. 2. All results are PASS against Peak and Average limit line.												



Band 1 5150~5250MHz

WIFI 802.11ax HE80 Full (Harmonic @ 3m)

WIFI Ant. 6+7	Note	Frequency ( MHz )	Level ( dBμV/m )	Margin ( dB )	Limit Line ( dBμV/m )	Read Level (dBμV)	Antenna Factor ( dB/m )	Path Loss ( dB )	Preamp Factor ( dB )	Ant Pos ( cm )	Table Pos ( deg )	Peak Avg. (P/A)	Pol. (H/V)	
802.11ax HE80 Full CH 42 5210MHz		10420	46.87	-21.33	68.2	53.36	40.16	9.81	56.46	-	-	P	H	
		15630	45.78	-28.22	74	50.67	39.05	12.05	55.99	-	-	P	H	
													H	
													H	
													H	
													H	
													H	
													H	
													H	
													H	
													H	
													H	
													H	
													H	
													H	
													H	
													H	
													H	
	802.11ax HE80 Full CH 42 5210MHz		10420	46.69	-21.51	68.2	53.18	40.16	9.81	56.46	-	-	P	V
			15630	45.64	-28.36	74	50.53	39.05	12.05	55.99	-	-	P	V
													V	
													V	
													V	
													V	
													V	
													V	
													V	
													V	
Remark	<ol style="list-style-type: none"> <li>No other spurious found.</li> <li>All results are PASS against Peak and Average limit line.</li> <li>The emission position marked as "-" means no suspected emission found with sufficient margin against limit line or noise floor only.</li> </ol>													



**Band 2 - 5250~5350MHz**  
**WIFI 802.11a (Band Edge @ 3m)**

WIFI Ant. 6+7	Note	Frequency ( MHz )	Level ( dBμV/m )	Margin ( dB )	Limit Line ( dBμV/m )	Read Level (dBμV)	Antenna Factor ( dB/m )	Path Loss ( dB )	Preamp Factor ( dB )	Ant Pos ( cm )	Table Pos ( deg )	Peak Avg. (P/A)	Pol. (H/V)
<b>802.11a CH 52 5260MHz</b>		5147.56	54.73	-19.27	74	42.83	32.2	6.21	26.51	100	229	P	H
		5148.58	46.51	-7.49	54	34.61	32.2	6.21	26.51	100	229	A	H
	*	5260	115.2	-	-	103.66	31.78	6.29	26.53	100	229	P	H
	*	5260	106.79	-	-	95.25	31.78	6.29	26.53	100	229	A	H
		5351.52	56.45	-17.55	74	45.06	31.61	6.32	26.54	100	229	P	H
		5350.08	46.56	-7.44	54	35.18	31.6	6.32	26.54	100	229	A	H
		5087.72	54.87	-19.13	74	43.12	32.1	6.15	26.5	294	200	P	V
		5078.54	45.12	-8.88	54	33.38	32.1	6.14	26.5	294	200	A	V
	*	5260	114.26	-	-	102.72	31.78	6.29	26.53	294	200	P	V
	*	5260	107.13	-	-	95.59	31.78	6.29	26.53	294	200	A	V
		5358.96	53.81	-20.19	74	42.38	31.65	6.32	26.54	294	200	P	V
		5351.52	45.3	-8.7	54	33.91	31.61	6.32	26.54	294	200	A	V
<b>802.11a CH 60 5300MHz</b>		5049.64	54.98	-19.02	74	43.28	32.1	6.1	26.5	107	355	P	H
		5117.3	45.28	-8.72	54	33.48	32.13	6.18	26.51	107	355	A	H
	*	5300	116.01	-	-	104.54	31.7	6.3	26.53	107	355	P	H
	*	5300	108.58	-	-	97.11	31.7	6.3	26.53	107	355	A	H
		5351.52	60.67	-13.33	74	49.28	31.61	6.32	26.54	107	355	P	H
		5350.32	51.63	-2.37	54	40.25	31.6	6.32	26.54	107	355	A	H
		5078.54	53.91	-20.09	74	42.17	32.1	6.14	26.5	400	200	P	V
		5117.3	45.71	-8.29	54	33.91	32.13	6.18	26.51	400	200	A	V
	*	5300	113.08	-	-	101.61	31.7	6.3	26.53	400	200	P	V
	*	5300	104.21	-	-	92.74	31.7	6.3	26.53	400	200	A	V
		5351.04	59.02	-14.98	74	47.63	31.61	6.32	26.54	400	200	P	V
		5350.32	49.61	-4.39	54	38.23	31.6	6.32	26.54	400	200	A	V



<b>802.11a CH 64 5320MHz</b>	*	5320	114.43	-	-	102.99	31.66	6.31	26.53	107	355	P	H
	*	5320	106.3	-	-	94.86	31.66	6.31	26.53	107	355	A	H
		5350.88	63.59	-10.41	74	52.2	31.61	6.32	26.54	107	355	P	H
		5350.24	52.47	-1.53	54	41.09	31.6	6.32	26.54	107	355	A	H
													H
													H
	*	5320	112.92	-	-	101.48	31.66	6.31	26.53	399	209	P	V
	*	5320	104.3	-	-	92.86	31.66	6.31	26.53	399	209	A	V
		5350.72	61.07	-12.93	74	49.69	31.6	6.32	26.54	399	209	P	V
		5351.04	52.33	-1.67	54	40.94	31.61	6.32	26.54	399	209	A	V
													V
													V
<b>Remark</b>	1. No other spurious found. 2. All results are PASS against Peak and Average limit line.												





**Band 2 5250~5350MHz**  
**WIFI 802.11a (Harmonic @ 3m)**

WIFI Ant. 6+7	Note	Frequency ( MHz )	Level ( dBμV/m )	Margin ( dB )	Limit Line ( dBμV/m )	Read Level (dBμV)	Antenna Factor ( dB/m )	Path Loss ( dB )	Preamp Factor ( dB )	Ant Pos ( cm )	Table Pos ( deg )	Peak Avg. (P/A)	Pol. (H/V)
802.11a CH 52 5260MHz		10520	47.88	-20.32	68.2	54.08	40.36	9.87	56.43	-	-	P	H
		15780	45.52	-28.48	74	50.53	38.62	12.04	55.67	-	-	P	H
													H
													H
													H
													H
													H
													H
													H
													H
													H
													H
													H
													H
													H
													H
													H
													H
													H
			10520	47.75	-20.45	68.2	53.95	40.36	9.87	56.43	-	-	P
		15780	45.31	-28.69	74	50.32	38.62	12.04	55.67	-	-	P	V
													V
													V
													V
													V
													V
													V
													V
													V
													V
													V
													V
													V
													V
													V



WIFI Ant. 6+7	Note	Frequency ( MHz )	Level ( dBμV/m )	Margin ( dB )	Limit Line ( dBμV/m )	Read Level (dBμV)	Antenna Factor ( dB/m )	Path Loss ( dB )	Preamp Factor ( dB )	Ant Pos ( cm )	Table Pos ( deg )	Peak Avg. (P/A)	Pol. (H/V)
i802.11a CH 60 5300MHz		10600	47.14	-26.86	74	53.34	40.2	9.92	56.32	-	-	P	H
		15900	45.16	-28.84	74	49.84	38.7	12.03	55.41	-	-	P	H
													H
													H
													H
													H
													H
													H
													H
													H
													H
													H
													H
													H
													H
													H
													H
													H
													H
			10600	47.09	-26.91	74	53.29	40.2	9.92	56.32	-	-	P
		15900	46.05	-27.95	74	50.73	38.7	12.03	55.41	-	-	P	V
													V
													V
													V
													V
													V
													V
													V
													V
													V
													V
													V
													V
													V
													V
													V
													V
													V



WiFi Ant. 6+7	Note	Frequency ( MHz )	Level ( dBμV/m )	Margin ( dB )	Limit Line ( dBμV/m )	Read Level (dBμV)	Antenna Factor ( dB/m )	Path Loss ( dB )	Preamp Factor ( dB )	Ant Pos ( cm )	Table Pos ( deg )	Peak Avg. (P/A)	Pol. (H/V)
802.11a CH 64 5320MHz		10640	48.04	-25.96	74	54.05	40.32	9.94	56.27	-	-	P	H
		15960	44.78	-29.22	74	49.52	38.52	12.03	55.29	-	-	P	H
													H
													H
													H
													H
													H
													H
													H
													H
													H
													H
													H
													H
													H
													H
													H
													H
													H
			10640	48.2	-25.8	74	54.21	40.32	9.94	56.27	-	-	P
		15960	43.91	-30.09	74	48.65	38.52	12.03	55.29	-	-	P	V
													V
													V
													V
													V
													V
													V
													V
													V
													V
													V
													V
													V
													V
													V
<b>Remark</b>	<ol style="list-style-type: none"> <li>No other spurious found.</li> <li>All results are PASS against Peak and Average limit line.</li> <li>The emission position marked as "-" means no suspected emission found with sufficient margin against limit line or noise floor only.</li> </ol>												



**Band 2 5250~5350MHz**  
**WIFI 802.11ax HE20 Full (Band Edge @ 3m)**

WIFI Ant. 6+7	Note	Frequency ( MHz )	Level ( dBμV/m )	Margin ( dB )	Limit Line ( dBμV/m )	Read Level (dBμV)	Antenna Factor ( dB/m )	Path Loss ( dB )	Preamp Factor ( dB )	Ant Pos ( cm )	Table Pos ( deg )	Peak Avg. (P/A)	Pol. (H/V)
802.11ax HE20 Full CH 52 5260MHz		5130.56	54.77	-19.23	74	42.93	32.16	6.19	26.51	100	6	P	H
		5148.92	46.8	-7.2	54	34.9	32.2	6.21	26.51	100	6	A	H
	*	5260	117	-	-	105.46	31.78	6.29	26.53	100	6	P	H
	*	5260	107.86	-	-	96.32	31.78	6.29	26.53	100	6	A	H
		5354.64	58.38	-15.62	74	46.97	31.63	6.32	26.54	100	6	P	H
		5350.08	48.87	-5.13	54	37.49	31.6	6.32	26.54	100	6	A	H
		5124.1	52.71	-21.29	74	40.88	32.15	6.19	26.51	292	186	P	V
		5078.54	44.03	-9.97	54	32.29	32.1	6.14	26.5	292	186	A	V
	*	5260	109.78	-	-	98.24	31.78	6.29	26.53	292	186	P	V
	*	5260	99.5	-	-	87.96	31.78	6.29	26.53	292	186	A	V
		5364.72	53.03	-20.97	74	41.56	31.69	6.32	26.54	292	186	P	V
		5354.16	43.37	-10.63	54	31.97	31.62	6.32	26.54	292	186	A	V
802.11ax HE20 Full CH 60 5300MHz		5147.56	53.93	-20.07	74	42.03	32.2	6.21	26.51	104	6	P	H
		5117.3	45.66	-8.34	54	33.86	32.13	6.18	26.51	104	6	A	H
	*	5300	117.19	-	-	105.72	31.7	6.3	26.53	104	6	P	H
	*	5300	107.84	-	-	96.37	31.7	6.3	26.53	104	6	A	H
		5356.8	57.74	-16.26	74	46.32	31.64	6.32	26.54	104	6	P	H
		5350.32	49.44	-4.56	54	38.06	31.6	6.32	26.54	104	6	A	H
		5145.18	53.88	-20.12	74	41.99	32.19	6.21	26.51	100	129	P	V
		5117.3	45.38	-8.62	54	33.58	32.13	6.18	26.51	100	129	A	V
	*	5300	115.71	-	-	104.24	31.7	6.3	26.53	100	129	P	V
	*	5300	105.31	-	-	93.84	31.7	6.3	26.53	100	129	A	V
		5392.32	54.98	-19.02	74	43.34	31.85	6.33	26.54	100	129	P	V
		5350.32	47.55	-6.45	54	36.17	31.6	6.32	26.54	100	129	A	V



<b>802.11ax HE20 Full CH 64 5320MHz</b>	*	5320	116.26	-	-	104.82	31.66	6.31	26.53	101	358	P	H
	*	5320	105.97	-	-	94.53	31.66	6.31	26.53	101	358	A	H
		5353.28	64.2	-9.8	74	52.8	31.62	6.32	26.54	101	358	P	H
		5350.56	52.11	-1.89	54	40.73	31.6	6.32	26.54	101	358	A	H
													H
													H
	*	5320	114.11	-	-	102.67	31.66	6.31	26.53	400	208	P	V
	*	5320	103.14	-	-	91.7	31.66	6.31	26.53	400	208	A	V
		5350.08	61.92	-12.08	74	50.54	31.6	6.32	26.54	400	208	P	V
		5350.24	50.14	-3.86	54	38.76	31.6	6.32	26.54	400	208	A	V
												V	
												V	
<b>Remark</b>	1. No other spurious found. 2. All results are PASS against Peak and Average limit line.												



Band 2 5250~5350MHz

WIFI 802.11ax HE20 Full (Harmonic @ 3m)

WIFI Ant. 6+7	Note	Frequency ( MHz )	Level ( dBμV/m )	Margin ( dB )	Limit Line ( dBμV/m )	Read Level (dBμV)	Antenna Factor ( dB/m )	Path Loss ( dB )	Preamp Factor ( dB )	Ant Pos ( cm )	Table Pos ( deg )	Peak Avg. (P/A)	Pol. (H/V)
802.11ax HE20 Full CH 52 5260MHz		10520	47.98	-20.22	68.2	54.18	40.36	9.87	56.43	-	-	P	H
		15780	45.1	-28.9	74	50.11	38.62	12.04	55.67	-	-	P	H
													H
													H
													H
													H
													H
													H
													H
													H
													H
													H
													H
													H
													H
													H
													H
													H
													H
			10520	47.24	-20.96	68.2	53.44	40.36	9.87	56.43	-	-	P
		15780	45.42	-28.58	74	50.43	38.62	12.04	55.67	-	-	P	V
													V
													V
													V
													V
													V
													V
													V
													V
													V
													V
													V
													V
													V
													V
													V



WIFI Ant. 6+7	Note	Frequency ( MHz )	Level ( dBμV/m )	Margin ( dB )	Limit Line ( dBμV/m )	Read Level (dBμV)	Antenna Factor ( dB/m )	Path Loss ( dB )	Preamp Factor ( dB )	Ant Pos ( cm )	Table Pos ( deg )	Peak Avg. (P/A)	Pol. (H/V)
802.11ax HE20 Full CH 60 5300MHz		10600	47.57	-26.43	74	53.77	40.2	9.92	56.32	-	-	P	H
		15900	45.97	-28.03	74	50.65	38.7	12.03	55.41	-	-	P	H
													H
													H
													H
													H
													H
													H
													H
													H
													H
													H
													H
													H
													H
													H
													H
													H
													H
			10600	47.77	-26.23	74	53.97	40.2	9.92	56.32	-	-	P
		15900	45.62	-28.38	74	50.3	38.7	12.03	55.41	-	-	P	V
													V
													V
													V
													V
													V
													V
													V
													V
													V
													V
													V
													V
													V
													V
													V



WIFI Ant. 6+7	Note	Frequency ( MHz )	Level ( dBμV/m )	Margin ( dB )	Limit Line ( dBμV/m )	Read Level (dBμV)	Antenna Factor ( dB/m )	Path Loss ( dB )	Preamp Factor ( dB )	Ant Pos ( cm )	Table Pos ( deg )	Peak Avg. (P/A)	Pol. (H/V)
802.11ax HE20 Full CH 64 5320MHz		10640	48.06	-25.94	74	54.07	40.32	9.94	56.27	-	-	P	H
		15960	44.16	-29.84	74	48.9	38.52	12.03	55.29	-	-	P	H
													H
													H
													H
													H
													H
													H
													H
													H
													H
													H
													H
													H
													H
													H
													H
													H
													H
	Remark	1. No other spurious found.											
2. All results are PASS against Peak and Average limit line.													
	3. The emission position marked as "-" means no suspected emission found with sufficient margin against limit line or noise floor only.												





**Band 2 5250~5350MHz  
WIFI 802.11ax HE20 Partial 106 (Band Edge @ 3m)**

WIFI Ant. 6+7	Note	Frequency ( MHz )	Level ( dBμV/m )	Margin ( dB )	Limit Line ( dBμV/m )	Read Level (dBμV)	Antenna Factor ( dB/m )	Path Loss ( dB )	Preamp Factor ( dB )	Ant Pos ( cm )	Table Pos ( deg )	Peak Avg. (P/A)	Pol. (H/V)
802.11ax HE20 Partial 106/54 CH 64 5320MHz	*	5320	112.1	-	-	100.66	31.66	6.31	26.53	100	227	P	H
	*	5320	101.71	-	-	90.27	31.66	6.31	26.53	100	227	A	H
		5376.96	54.35	-19.65	74	42.81	31.76	6.32	26.54	100	227	P	H
		5350.08	45.41	-8.59	54	34.03	31.6	6.32	26.54	100	227	A	H
													H
													H
	*	5320	111.73	-	-	100.29	31.66	6.31	26.53	356	220	P	V
	*	5320	101.62	-	-	90.18	31.66	6.31	26.53	356	220	A	V
		5370.4	55.27	-18.73	74	43.77	31.72	6.32	26.54	356	220	P	V
		5350.08	45.09	-8.91	54	33.71	31.6	6.32	26.54	356	220	A	V
												V	
												V	
<b>Remark</b>	1. No other spurious found. 2. All results are PASS against Peak and Average limit line.												



**Band 2 5250~5350MHz**  
**WIFI 802.11ax HE40 Full (Band Edge @ 3m)**

WIFI Ant. 6+7	Note	Frequency ( MHz )	Level ( dBμV/m )	Margin ( dB )	Limit Line ( dBμV/m )	Read Level ( dBμV )	Antenna Factor ( dB/m )	Path Loss ( dB )	Preamp Factor ( dB )	Ant Pos ( cm )	Table Pos ( deg )	Peak Avg. ( P/A )	Pol. ( H/V )
802.11ax HE40 Full CH 54 5270MHz		5132.26	58.21	-15.79	74	46.36	32.16	6.2	26.51	100	235	P	H
		5149.26	49.31	-4.69	54	37.41	32.2	6.21	26.51	100	235	A	H
	*	5270	108.49	-	-	96.97	31.76	6.29	26.53	100	235	P	H
	*	5270	98.92	-	-	87.4	31.76	6.29	26.53	100	235	A	H
		5398.56	57.21	-16.79	74	45.54	31.89	6.33	26.55	100	235	P	H
		5359.92	48.76	-5.24	54	37.32	31.66	6.32	26.54	100	235	A	H
		5141.78	57.76	-16.24	74	45.88	32.18	6.21	26.51	386	218	P	V
		5139.4	48.29	-5.71	54	36.42	32.18	6.2	26.51	386	218	A	V
	*	5270	111.03	-	-	99.51	31.76	6.29	26.53	386	218	P	V
	*	5270	99.97	-	-	88.45	31.76	6.29	26.53	386	218	A	V
		5410.08	58	-16	74	46.31	31.9	6.34	26.55	386	218	P	V
		5395.2	48.07	-5.93	54	36.42	31.87	6.33	26.55	386	218	A	V
802.11ax HE40 Full CH 62 5310MHz		5112.2	55.23	-18.77	74	43.45	32.12	6.17	26.51	100	11	P	H
		5145.18	46.85	-7.15	54	34.96	32.19	6.21	26.51	100	11	A	H
	*	5310	106.73	-	-	95.28	31.68	6.3	26.53	100	11	P	H
	*	5310	98.28	-	-	86.83	31.68	6.3	26.53	100	11	A	H
		5354.64	61.99	-12.01	74	50.58	31.63	6.32	26.54	100	11	P	H
		5350.56	51.47	-2.53	54	40.09	31.6	6.32	26.54	100	11	A	H
		5139.74	55.47	-18.53	74	43.6	32.18	6.2	26.51	375	220	P	V
		5146.54	46.48	-7.52	54	34.59	32.19	6.21	26.51	375	220	A	V
	*	5310	107.3	-	-	95.85	31.68	6.3	26.53	375	220	P	V
	*	5310	98.2	-	-	86.75	31.68	6.3	26.53	375	220	A	V
	5352.24	60.59	-13.41	74	49.2	31.61	6.32	26.54	375	220	P	V	
	5350.08	51.17	-2.83	54	39.79	31.6	6.32	26.54	375	220	A	V	
Remark	1. No other spurious found. 2. All results are PASS against Peak and Average limit line.												



Band 2 5250~5350MHz

WIFI 802.11ax HE40 Full (Harmonic @ 3m)

WIFI Ant. 6+7	Note	Frequency ( MHz )	Level ( dBμV/m )	Margin ( dB )	Limit Line ( dBμV/m )	Read Level (dBμV)	Antenna Factor ( dB/m )	Path Loss ( dB )	Preamp Factor ( dB )	Ant Pos ( cm )	Table Pos ( deg )	Peak Avg. (P/A)	Pol. (H/V)	
802.11ax HE40 Full CH 54 5270MHz		10540	46.87	-21.33	68.2	53.07	40.32	9.88	56.4	-	-	P	H	
		15810	44.25	-29.75	74	49.21	38.61	12.04	55.61	-	-	P	H	
													H	
													H	
													H	
													H	
													H	
													H	
													H	
													H	
													H	
													H	
			10540	47.03	-21.17	68.2	53.23	40.32	9.88	56.4	-	-	P	V
			15810	44.78	-29.22	74	49.74	38.61	12.04	55.61	-	-	P	V
														V
														V
														V
														V
														V
													V	
													V	
													V	
													V	



WIFI Ant. 6+7	Note	Frequency ( MHz )	Level ( dBμV/m )	Margin ( dB )	Limit Line ( dBμV/m )	Read Level (dBμV)	Antenna Factor ( dB/m )	Path Loss ( dB )	Preamp Factor ( dB )	Ant Pos ( cm )	Table Pos ( deg )	Peak Avg. (P/A)	Pol. (H/V)	
802.11ax HE40 Full CH 62 5310MHz		10620	47.79	-26.21	74	53.89	40.26	9.93	56.29	-	-	P	H	
		15930	45.93	-28.07	74	50.63	38.61	12.04	55.35	-	-	P	H	
													H	
													H	
													H	
													H	
													H	
													H	
													H	
													H	
													H	
													H	
													H	
													H	
													H	
													H	
													H	
													H	
	Remark	1. No other spurious found. 2. All results are PASS against Peak and Average limit line. 3. The emission position marked as "-" means no suspected emission found with sufficient margin against limit line or noise floor only.												



**Band 2 5250~5350MHz**  
**WIFI 802.11ax HE80 Full (Band Edge @ 3m)**

WIFI Ant. 6+7	Note	Frequency ( MHz )	Level ( dBμV/m )	Margin ( dB )	Limit Line ( dBμV/m )	Read Level (dBμV)	Antenna Factor ( dB/m )	Path Loss ( dB )	Preamp Factor ( dB )	Ant Pos ( cm )	Table Pos ( deg )	Peak Avg. (P/A)	Pol. (H/V)
<b>802.11ax HE80 Full CH 58 5290MHz</b>		5130.56	56.76	-17.24	74	44.92	32.16	6.19	26.51	314	217	P	H
		5146.54	49.33	-4.67	54	37.44	32.19	6.21	26.51	314	217	A	H
	*	5290	105.94	-	-	94.45	31.72	6.3	26.53	314	217	P	H
	*	5290	96.77	-	-	85.28	31.72	6.3	26.53	314	217	A	H
		5361.6	59.15	-14.85	74	47.7	31.67	6.32	26.54	314	217	P	H
		5357.28	52.72	-1.28	54	41.3	31.64	6.32	26.54	314	217	A	H
		5104.38	57.37	-16.63	74	45.6	32.11	6.16	26.5	129	326	P	V
		5112.88	49.42	-4.58	54	37.63	32.13	6.17	26.51	129	326	A	V
	*	5290	106.85	-	-	95.36	31.72	6.3	26.53	129	326	P	V
	*	5290	97.4	-	-	85.91	31.72	6.3	26.53	129	326	A	V
		5351.76	59.19	-14.81	74	47.8	31.61	6.32	26.54	129	326	P	V
	5352.24	51.67	-2.33	54	40.28	31.61	6.32	26.54	129	326	A	V	
<b>Remark</b>	1. No other spurious found. 2. All results are PASS against Peak and Average limit line.												



Band 2 5250~5350MHz

WIFI 802.11ax HE80 Full (Harmonic @ 3m)

WIFI Ant. 6+7	Note	Frequency ( MHz )	Level ( dBμV/m )	Margin ( dB )	Limit Line ( dBμV/m )	Read Level (dBμV)	Antenna Factor ( dB/m )	Path Loss ( dB )	Preamp Factor ( dB )	Ant Pos ( cm )	Table Pos ( deg )	Peak Avg. (P/A)	Pol. (H/V)
802.11ax HE80 Full CH 58 5290MHz		10580	46.98	-21.22	68.2	53.18	40.24	9.91	56.35	-	-	P	H
		15870	45.93	-28.07	74	50.71	38.67	12.03	55.48	-	-	P	H
													H
													H
													H
													H
													H
													H
													H
													H
													H
													H
													H
													H
													H
													H
													H
													H
													H
			10580	47.83	-20.37	68.2	54.03	40.24	9.91	56.35	-	-	P
		15870	45.34	-28.66	74	50.12	38.67	12.03	55.48	-	-	P	V
													V
													V
													V
													V
													V
													V
													V
													V
													V
													V
													V
													V
<b>Remark</b>	<ol style="list-style-type: none"> <li>No other spurious found.</li> <li>All results are PASS against Peak and Average limit line.</li> <li>The emission position marked as "-" means no suspected emission found with sufficient margin against limit line or noise floor only.</li> </ol>												



**Band 3 - 5470~5725MHz**  
**WIFI 802.11a (Band Edge @ 3m)**

WIFI Ant. 6+7	Note	Frequency ( MHz )	Level ( dBμV/m )	Margin ( dB )	Limit Line ( dBμV/m )	Read Level (dBμV)	Antenna Factor ( dB/m )	Path Loss ( dB )	Preamp Factor ( dB )	Ant Pos ( cm )	Table Pos ( deg )	Peak Avg. (P/A)	Pol. (H/V)	
802.11a CH 100 5500MHz		5457.04	60.1	-13.9	74	48.36	31.93	6.36	26.55	100	3	P	H	
		5469.52	63.7	-4.5	68.2	51.91	31.98	6.37	26.56	100	3	P	H	
		5460	52.25	-1.75	54	40.5	31.94	6.36	26.55	100	3	A	H	
	*	5500	116.67	-	-	104.74	32.1	6.39	26.56	100	3	P	H	
	*	5500	109.56	-	-	97.63	32.1	6.39	26.56	100	3	A	H	
														H
			5455.92	56.72	-17.28	74	44.99	31.92	6.36	26.55	398	210	P	V
			5468.88	58.65	-9.55	68.2	46.86	31.98	6.37	26.56	398	210	P	V
			5458.96	48.93	-5.07	54	37.18	31.94	6.36	26.55	398	210	A	V
	*		5500	113	-	-	101.07	32.1	6.39	26.56	398	210	P	V
	*		5500	105.82	-	-	93.89	32.1	6.39	26.56	398	210	A	V
														V
802.11a CH 116 5580MHz		5423.44	54.7	-19.3	74	43.01	31.9	6.34	26.55	109	4	P	H	
		5464.72	54.68	-13.52	68.2	42.91	31.96	6.37	26.56	109	4	P	H	
		5387.44	47.37	-6.63	54	35.76	31.82	6.33	26.54	109	4	A	H	
	*	5580	117.75	-	-	105.91	32	6.43	26.59	109	4	P	H	
	*	5580	110.65	-	-	98.81	32	6.43	26.59	109	4	A	H	
			5737.91	53.94	-14.26	68.2	41.69	32.35	6.56	26.66	109	4	P	H
			5456.32	52.81	-21.19	74	41.07	31.93	6.36	26.55	385	216	P	V
			5461.6	53.9	-14.3	68.2	42.14	31.95	6.36	26.55	385	216	P	V
			5447.92	45.66	-8.34	54	33.95	31.9	6.36	26.55	385	216	A	V
	*		5580	115.11	-	-	103.27	32	6.43	26.59	385	216	P	V
	*		5580	106.26	-	-	94.42	32	6.43	26.59	385	216	A	V
			5730.035	53.42	-14.78	68.2	41.2	32.32	6.55	26.65	385	216	P	V



<b>802.11a</b> <b>CH 140</b> <b>5700MHz</b>	*	5700	115.26	-	-	103.17	32.2	6.53	26.64	101	4	P	H
	*	5700	108.22	-	-	96.13	32.2	6.53	26.64	101	4	A	H
		5726.12	65.39	-2.81	68.2	53.19	32.3	6.55	26.65	101	4	P	H
													H
													H
													H
	*	5700	114.17	-	-	102.08	32.2	6.53	26.64	389	215	P	V
	*	5700	105.39	-	-	93.3	32.2	6.53	26.64	389	215	A	V
		5725.32	64.19	-4.01	68.2	51.99	32.3	6.55	26.65	389	215	P	V
													V
													V
													V
<b>Remark</b>	1. No other spurious found. 2. All results are PASS against Peak and Average limit line.												





**Band 3 - 5470~5725MHz**  
**WIFI 802.11a (Harmonic @ 3m)**

WIFI Ant. 6+7	Note	Frequency ( MHz )	Level ( dBμV/m )	Margin ( dB )	Limit Line ( dBμV/m )	Read Level (dBμV)	Antenna Factor ( dB/m )	Path Loss ( dB )	Preamp Factor ( dB )	Ant Pos ( cm )	Table Pos ( deg )	Peak Avg. (P/A)	Pol. (H/V)
802.11a CH 100 5500MHz		11000	48.39	-25.61	74	53.3	40.7	10.16	55.77	-	-	P	H
		16500	45.29	-22.91	68.2	48.39	39.9	12.31	55.31	-	-	P	H
													H
													H
													H
													H
													H
													H
													H
													H
													H
													H
													H
													H
													H
													H
													H
													H
													H
			11000	47.9	-26.1	74	52.81	40.7	10.16	55.77	-	-	P
		16500	45.62	-22.58	68.2	48.72	39.9	12.31	55.31	-	-	P	V
													V
													V
													V
													V
													V
													V
													V
													V
													V
													V
													V
													V
													V
													V



WIFI Ant. 6+7	Note	Frequency ( MHz )	Level ( dBμV/m )	Margin ( dB )	Limit Line ( dBμV/m )	Read Level (dBμV)	Antenna Factor ( dB/m )	Path Loss ( dB )	Preamp Factor ( dB )	Ant Pos ( cm )	Table Pos ( deg )	Peak Avg. (P/A)	Pol. (H/V)
802.11a CH 116 5580MHz		11160	47.8	-26.2	74	53.39	39.96	10.22	55.77	-	-	P	H
		16740	46.04	-22.16	68.2	48.86	40.26	12.45	55.53	-	-	P	H
													H
													H
													H
													H
													H
													H
													H
													H
													H
													H
													H
													H
													H
													H
													H
													H
													H
			11160	47.62	-26.38	74	53.21	39.96	10.22	55.77	-	-	P
		16740	47.64	-20.56	68.2	50.46	40.26	12.45	55.53	-	-	P	V
													V
													V
													V
													V
													V
													V
													V
													V
													V
													V
													V
													V
													V
													V
													V



WiFi Ant. 6+7	Note	Frequency ( MHz )	Level ( dBμV/m )	Margin ( dB )	Limit Line ( dBμV/m )	Read Level (dBμV)	Antenna Factor ( dB/m )	Path Loss ( dB )	Preamp Factor ( dB )	Ant Pos ( cm )	Table Pos ( deg )	Peak Avg. (P/A)	Pol. (H/V)
802.11a CH 140 5700MHz		11400	47.9	-26.1	74	53.45	39.9	10.33	55.78	-	-	P	H
		17100	46.74	-21.46	68.2	49.58	40.4	12.71	55.95	-	-	P	H
													H
													H
													H
													H
													H
													H
													H
													H
													H
													H
													H
													H
													H
													H
													H
													H
													H
			11400	48	-26	74	53.55	39.9	10.33	55.78	-	-	P
		17100	46.31	-21.89	68.2	49.15	40.4	12.71	55.95	-	-	P	V
													V
													V
													V
													V
													V
													V
													V
													V
													V
													V
													V
													V
													V
<b>Remark</b>	<ol style="list-style-type: none"> <li>No other spurious found.</li> <li>All results are PASS against Peak and Average limit line.</li> <li>The emission position marked as "-" means no suspected emission found with sufficient margin against limit line or noise floor only.</li> </ol>												



**Band 3 - 5470~5725MHz**  
**WIFI 802.11ax HE20 Full (Band Edge @ 3m)**

WIFI Ant. 6+7	Note	Frequency ( MHz )	Level ( dBμV/m )	Margin ( dB )	Limit Line ( dBμV/m )	Read Level (dBμV)	Antenna Factor ( dB/m )	Path Loss ( dB )	Preamp Factor ( dB )	Ant Pos ( cm )	Table Pos ( deg )	Peak Avg. (P/A)	Pol. (H/V)
802.11ax HE20 Full CH 100 5500MHz		5459.12	59.69	-14.31	74	47.94	31.94	6.36	26.55	100	2	P	H
		5466.8	63.4	-4.8	68.2	51.62	31.97	6.37	26.56	100	2	P	H
		5458.8	50.42	-3.58	54	38.67	31.94	6.36	26.55	100	2	A	H
	*	5500	117.88	-	-	105.95	32.1	6.39	26.56	100	2	P	H
	*	5500	108.82	-	-	96.89	32.1	6.39	26.56	100	2	A	H
		5454.96	56.62	-17.38	74	44.89	31.92	6.36	26.55	398	215	P	V
		5468.56	61.5	-6.7	68.2	49.72	31.97	6.37	26.56	398	215	P	V
		5459.76	48.56	-5.44	54	36.81	31.94	6.36	26.55	398	215	A	V
	*	5500	116.42	-	-	104.49	32.1	6.39	26.56	398	215	P	V
	*	5500	105.39	-	-	93.46	32.1	6.39	26.56	398	215	A	V
												V	
												V	
802.11ax HE20 Full CH 116 5580MHz		5443.6	55.21	-18.79	74	43.51	31.9	6.35	26.55	102	3	P	H
		5466.16	55.01	-13.19	68.2	43.24	31.96	6.37	26.56	102	3	P	H
		5458.72	47.04	-6.96	54	35.3	31.93	6.36	26.55	102	3	A	H
	*	5580	119.68	-	-	107.84	32	6.43	26.59	102	3	P	H
	*	5580	109.42	-	-	97.58	32	6.43	26.59	102	3	A	H
		5739.8	55.61	-12.59	68.2	43.35	32.36	6.56	26.66	102	3	P	H
		5457.04	54.29	-19.71	74	42.55	31.93	6.36	26.55	386	214	P	V
		5464.48	54.94	-13.26	68.2	43.17	31.96	6.37	26.56	386	214	P	V
		5451.76	46.33	-7.67	54	34.61	31.91	6.36	26.55	386	214	A	V
	*	5580	114	-	-	102.16	32	6.43	26.59	386	214	P	V
*	5580	105.28	-	-	93.44	32	6.43	26.59	386	214	A	V	
	5725	53.91	-14.29	68.2	41.71	32.3	6.55	26.65	386	214	P	V	



<b>802.11ax HE20 Full CH 140 5700MHz</b>	*	5700	115.54	-	-	103.45	32.2	6.53	26.64	102	1	P	H
	*	5700	106.5	-	-	94.41	32.2	6.53	26.64	102	1	A	H
		5725.16	66.57	-1.63	68.2	54.37	32.3	6.55	26.65	102	1	P	H
													H
													H
													H
	*	5700	113.53	-	-	101.44	32.2	6.53	26.64	389	214	P	V
	*	5700	103.24	-	-	91.15	32.2	6.53	26.64	389	214	A	V
		5725.24	61.74	-6.46	68.2	49.54	32.3	6.55	26.65	389	214	P	V
													V
												V	
												V	
<b>Remark</b>	1. No other spurious found. 2. All results are PASS against Peak and Average limit line.												



Band 3 5470~5725MHz

WIFI 802.11ax HE20 (Harmonic @ 3m)

WIFI Ant. 6+7	Note	Frequency ( MHz )	Level ( dBμV/m )	Margin ( dB )	Limit Line ( dBμV/m )	Read Level (dBμV)	Antenna Factor ( dB/m )	Path Loss ( dB )	Preamp Factor ( dB )	Ant Pos ( cm )	Table Pos ( deg )	Peak Avg. (P/A)	Pol. (H/V)
802.11ax HE20 Full CH 100 5500MHz		11000	47.66	-26.34	74	52.57	40.7	10.16	55.77	-	-	P	H
		16500	45.4	-22.8	68.2	48.5	39.9	12.31	55.31	-	-	P	H
													H
													H
													H
													H
													H
													H
													H
													H
													H
													H
													H
													H
													H
													H
													H
													H
			11000	48.68	-25.32	74	53.59	40.7	10.16	55.77	-	-	P
		16500	45.12	-23.08	68.2	48.22	39.9	12.31	55.31	-	-	P	V
													V
													V
													V
													V
													V
													V
													V
													V
													V
													V
													V
													V



WIFI Ant. 6+7	Note	Frequency ( MHz )	Level ( dB $\mu$ V/m )	Margin ( dB )	Limit Line ( dB $\mu$ V/m )	Read Level ( dB $\mu$ V )	Antenna Factor ( dB/m )	Path Loss ( dB )	Preamp Factor ( dB )	Ant Pos ( cm )	Table Pos ( deg )	Peak Avg. (P/A)	Pol. (H/V)	
802.11ax HE20 Full CH 116 5580MHz		11160	47.88	-26.12	74	53.47	39.96	10.22	55.77	-	-	P	H	
		16740	46.62	-21.58	68.2	49.44	40.26	12.45	55.53	-	-	P	H	
													H	
													H	
													H	
													H	
													H	
													H	
													H	
													H	
													H	
													H	
													H	
													H	
													H	
													H	
													H	
													H	
			11160	46.88	-27.12	74	52.47	39.96	10.22	55.77	-	-	P	V
			16740	45.93	-22.27	68.2	48.75	40.26	12.45	55.53	-	-	P	V
													V	
													V	
													V	
													V	
													V	
													V	
													V	
													V	
													V	
													V	
													V	
													V	
													V	
													V	
													V	



WiFi Ant. 6+7	Note	Frequency ( MHz )	Level ( dBμV/m )	Margin ( dB )	Limit Line ( dBμV/m )	Read Level ( dBμV )	Antenna Factor ( dB/m )	Path Loss ( dB )	Preamp Factor ( dB )	Ant Pos ( cm )	Table Pos ( deg )	Peak Avg. ( P/A )	Pol. ( H/V )	
802.11ax HE20 Full CH 140 5700MHz		11400	47.14	-26.86	74	52.69	39.9	10.33	55.78	-	-	P	H	
		17100	46.66	-21.54	68.2	49.5	40.4	12.71	55.95	-	-	P	H	
													H	
													H	
													H	
													H	
													H	
													H	
													H	
													H	
													H	
													H	
													H	
													H	
													H	
													H	
													H	
													H	
	Remark	1. No other spurious found. 2. All results are PASS against Peak and Average limit line. 3. The emission position marked as "-" means no suspected emission found with sufficient margin against limit line or noise floor only.												





**Band 3 5470~5725MHz**  
**WIFI 802.11ax HE20 Partial 106 (Band Edge @ 3m)**

WIFI Ant. 6+7	Note	Frequency ( MHz )	Level ( dBμV/m )	Margin ( dB )	Limit Line ( dBμV/m )	Read Level (dBμV)	Antenna Factor ( dB/m )	Path Loss ( dB )	Preamp Factor ( dB )	Ant Pos ( cm )	Table Pos ( deg )	Peak Avg. (P/A)	Pol. (H/V)	
802.11ax HE20 Partial 106/53 CH 100 5500MHz		5452.4	54.53	-19.47	74	42.81	31.91	6.36	26.55	100	353	P	H	
		5460.56	55.59	-12.61	68.2	43.84	31.94	6.36	26.55	100	353	P	H	
		5460	45.82	-8.18	54	34.07	31.94	6.36	26.55	100	353	A	H	
	*	5500	113.78	-	-	101.85	32.1	6.39	26.56	100	353	P	H	
	*	5500	103.92	-	-	91.99	32.1	6.39	26.56	100	353	A	H	
														H
			5444.72	55.41	-18.59	74	43.71	31.9	6.35	26.55	400	207	P	V
			5465.52	55.21	-12.99	68.2	43.44	31.96	6.37	26.56	400	207	P	V
			5459.92	45.54	-8.46	54	33.79	31.94	6.36	26.55	400	207	A	V
		*	5500	113.59	-	-	101.66	32.1	6.39	26.56	400	207	P	V
	*	5500	102.52	-	-	90.59	32.1	6.39	26.56	400	207	A	V	
													V	
802.11ax HE20 Partial 106/54 CH 140 5700MHz	*	5700	113.62	-	-	101.53	32.2	6.53	26.64	100	360	P	H	
	*	5700	104.27	-	-	92.18	32.2	6.53	26.64	100	360	A	H	
			5728.76	58.11	-10.09	68.2	45.89	32.32	6.55	26.65	100	360	P	H
														H
														H
		*	5700	111.93	-	-	99.84	32.2	6.53	26.64	392	213	P	V
		*	5700	101.56	-	-	89.47	32.2	6.53	26.64	392	213	A	V
			5727.32	55.88	-12.32	68.2	43.67	32.31	6.55	26.65	392	213	P	V
													V	
													V	
													V	
<b>Remark</b>	1. No other spurious found. 2. All results are PASS against Peak and Average limit line.													



**Band 3 5470~5725MHz**  
**WIFI 802.11ax HE40 Full (Band Edge @ 3m)**

WIFI Ant. 6+7	Note	Frequency ( MHz )	Level ( dBμV/m )	Margin ( dB )	Limit Line ( dBμV/m )	Read Level ( dBμV )	Antenna Factor ( dB/m )	Path Loss ( dB )	Preamp Factor ( dB )	Ant Pos ( cm )	Table Pos ( deg )	Peak Avg. ( P/A )	Pol. ( H/V )
802.11ax HE40 Full CH 102 5510MHz		5455.6	58.79	-15.21	74	47.06	31.92	6.36	26.55	101	4	P	H
		5469.28	65.23	-2.97	68.2	53.44	31.98	6.37	26.56	101	4	P	H
		5458.72	49.79	-4.21	54	38.05	31.93	6.36	26.55	101	4	A	H
	*	5510	110.22	-	-	98.31	32.08	6.39	26.56	101	4	P	H
	*	5510	99.84	-	-	87.93	32.08	6.39	26.56	101	4	A	H
		5730.665	57.11	-11.09	68.2	44.89	32.32	6.55	26.65	101	4	P	H
		5459.2	55.96	-18.04	74	44.21	31.94	6.36	26.55	100	144	P	V
		5466.4	61.86	-6.34	68.2	50.08	31.97	6.37	26.56	100	144	P	V
		5458.72	47.15	-6.85	54	35.41	31.93	6.36	26.55	100	144	A	V
	*	5510	106.01	-	-	94.1	32.08	6.39	26.56	100	144	P	V
	*	5510	95.09	-	-	83.18	32.08	6.39	26.56	100	144	A	V
		5732.87	54.04	-14.16	68.2	41.81	32.33	6.55	26.65	100	144	P	V
802.11ax HE40 Full CH 110 5550MHz		5424.88	57.67	-16.33	74	45.98	31.9	6.34	26.55	108	4	P	H
		5468.08	58.67	-9.53	68.2	46.89	31.97	6.37	26.56	108	4	P	H
		5448.16	49.7	-4.3	54	37.99	31.9	6.36	26.55	108	4	A	H
	*	5550	112.54	-	-	100.71	32	6.41	26.58	108	4	P	H
	*	5550	103.61	-	-	91.78	32	6.41	26.58	108	4	A	H
		5746.73	56.5	-11.7	68.2	44.21	32.39	6.56	26.66	108	4	P	H
		5400.4	55.83	-18.17	74	44.15	31.9	6.33	26.55	370	214	P	V
		5463.28	54.15	-14.05	68.2	42.39	31.95	6.36	26.55	370	214	P	V
		5399.92	47.01	-6.99	54	35.33	31.9	6.33	26.55	370	214	A	V
	*	5550	110.29	-	-	98.46	32	6.41	26.58	370	214	P	V
	*	5550	99.61	-	-	87.78	32	6.41	26.58	370	214	A	V
		5745.47	55.04	-13.16	68.2	42.76	32.38	6.56	26.66	370	214	P	V



<b>802.11ax</b> <b>HE40 Full</b> <b>CH 134</b> <b>5670MHz</b>		5454.3	54.96	-19.04	74	43.23	31.92	6.36	26.55	100	11	P	H
		5466.9	55.29	-12.91	68.2	43.51	31.97	6.37	26.56	100	11	P	H
		5451.15	46.34	-7.66	54	34.63	31.9	6.36	26.55	100	11	A	H
	*	5670	112.52	-	-	100.63	32.02	6.5	26.63	100	11	P	H
	*	5670	102.88	-	-	90.99	32.02	6.5	26.63	100	11	A	H
		5725	64.83	-3.37	68.2	52.63	32.3	6.55	26.65	100	11	P	H
		5451.85	55.69	-18.31	74	43.97	31.91	6.36	26.55	386	210	P	V
		5461.65	55.17	-13.03	68.2	43.41	31.95	6.36	26.55	386	210	P	V
		5451.5	46.59	-7.41	54	34.87	31.91	6.36	26.55	386	210	A	V
	*	5670	109.6	-	-	97.71	32.02	6.5	26.63	386	210	P	V
	*	5670	99.04	-	-	87.15	32.02	6.5	26.63	386	210	A	V
		5727.83	59.25	-8.95	68.2	47.04	32.31	6.55	26.65	386	210	P	V
<b>Remark</b>	1. No other spurious found. 2. All results are PASS against Peak and Average limit line.												



**Band 3 5470~5725MHz**

**WIFI 802.11ax HE40 Full (Harmonic @ 3m)**

WIFI Ant. 6+7	Note	Frequency ( MHz )	Level ( dBμV/m )	Margin ( dB )	Limit Line ( dBμV/m )	Read Level ( dBμV )	Antenna Factor ( dB/m )	Path Loss ( dB )	Preamp Factor ( dB )	Ant Pos ( cm )	Table Pos ( deg )	Peak Avg. ( P/A )	Pol. ( H/V )	
802.11ax HE40 Full CH 102 5510MHz		11020	47.74	-26.26	74	52.75	40.6	10.16	55.77	-	-	P	H	
		16530	45.8	-22.4	68.2	48.94	39.87	12.33	55.34	-	-	P	H	
													H	
													H	
													H	
													H	
													H	
													H	
													H	
													H	
													H	
													H	
			11020	47.72	-26.28	74	52.73	40.6	10.16	55.77	-	-	P	V
			16530	45.41	-22.79	68.2	48.55	39.87	12.33	55.34	-	-	P	V
														V
														V
														V
														V
													V	
													V	
													V	
													V	
													V	



WIFI Ant. 6+7	Note	Frequency ( MHz )	Level ( dBμV/m )	Margin ( dB )	Limit Line ( dBμV/m )	Read Level ( dBμV )	Antenna Factor ( dB/m )	Path Loss ( dB )	Preamp Factor ( dB )	Ant Pos ( cm )	Table Pos ( deg )	Peak Avg. (P/A)	Pol. (H/V)	
802.11ax HE40 Full CH 110 5550MHz		11100	47.11	-26.89	74	52.48	40.2	10.2	55.77	-	-	P	H	
		16650	46.48	-21.72	68.2	49.58	39.95	12.4	55.45	-	-	P	H	
													H	
													H	
													H	
													H	
													H	
													H	
													H	
													H	
													H	
													H	
													H	
													H	
													H	
													H	
													H	
													H	
			11100	47.41	-26.59	74	52.78	40.2	10.2	55.77	-	-	P	V
			16650	46.05	-22.15	68.2	49.15	39.95	12.4	55.45	-	-	P	V
													V	
													V	
													V	
													V	
													V	
													V	
													V	
													V	
													V	
													V	
													V	
													V	
													V	



WIFI Ant. 6+7	Note	Frequency ( MHz )	Level ( dBμV/m )	Margin ( dB )	Limit Line ( dBμV/m )	Read Level ( dBμV )	Antenna Factor ( dB/m )	Path Loss ( dB )	Preamp Factor ( dB )	Ant Pos ( cm )	Table Pos ( deg )	Peak Avg. ( P/A )	Pol. ( H/V )	
802.11ax HE40 Full CH 134 5670MHz		11340	47.63	-26.37	74	53.32	39.78	10.31	55.78	-	-	P	H	
		17010	47.18	-21.02	68.2	49.87	40.49	12.61	55.79	-	-	P	H	
													H	
													H	
													H	
													H	
													H	
													H	
													H	
													H	
													H	
													H	
													H	
													H	
													H	
													H	
													H	
													H	
	Remark	1. No other spurious found. 2. All results are PASS against Peak and Average limit line. 3. The emission position marked as "-" means no suspected emission found with sufficient margin against limit line or noise floor only.												



**Band 3 5470~5725MHz**  
**WIFI 802.11ax HE80 Full (Band Edge @ 3m)**

WIFI Ant. 6+7	Note	Frequency ( MHz )	Level ( dBμV/m )	Margin ( dB )	Limit Line ( dBμV/m )	Read Level ( dBμV )	Antenna Factor ( dB/m )	Path Loss ( dB )	Preamp Factor ( dB )	Ant Pos ( cm )	Table Pos ( deg )	Peak Avg. ( P/A )	Pol. ( H/V )
802.11ax HE80 Full CH 106 5530MHz		5458.48	61.37	-12.63	74	49.63	31.93	6.36	26.55	272	217	P	H
		5467.84	62.82	-5.38	68.2	51.04	31.97	6.37	26.56	272	217	P	H
		5459.92	51.42	-2.58	54	39.67	31.94	6.36	26.55	272	217	A	H
	*	5530	106.04	-	-	94.17	32.04	6.4	26.57	272	217	P	H
	*	5530	96.23	-	-	84.36	32.04	6.4	26.57	272	217	A	H
		5740.745	56.28	-11.92	68.2	44.02	32.36	6.56	26.66	272	217	P	H
		5447.92	60.74	-13.26	74	49.03	31.9	6.36	26.55	131	325	P	V
		5465.2	61.36	-6.84	68.2	49.59	31.96	6.37	26.56	131	325	P	V
		5459.68	50.91	-3.09	54	39.16	31.94	6.36	26.55	131	325	A	V
	*	5530	105.34	-	-	93.47	32.04	6.4	26.57	131	325	P	V
	*	5530	96.37	-	-	84.5	32.04	6.4	26.57	131	325	A	V
	5728.775	55.79	-12.41	68.2	43.57	32.32	6.55	26.65	131	325	P	V	
802.11ax HE80 Full CH 122 5610MHz		5415.8	61.02	-12.98	74	49.33	31.9	6.34	26.55	280	218	P	H
		5467.25	60.92	-7.28	68.2	49.14	31.97	6.37	26.56	280	218	P	H
		5420	52.6	-1.4	54	40.91	31.9	6.34	26.55	280	218	A	H
	*	5610	109.71	-	-	97.88	31.98	6.45	26.6	280	218	P	H
	*	5610	99.64	-	-	87.81	31.98	6.45	26.6	280	218	A	H
		5725.625	62.57	-5.63	68.2	50.37	32.3	6.55	26.65	280	218	P	H
		5398.65	59.76	-14.24	74	48.09	31.89	6.33	26.55	117	323	P	V
		5464.1	58.93	-9.27	68.2	47.15	31.96	6.37	26.55	117	323	P	V
		5435.4	51.56	-2.44	54	39.86	31.9	6.35	26.55	117	323	A	V
	*	5610	108.8	-	-	96.97	31.98	6.45	26.6	117	323	P	V
	*	5610	99.59	-	-	87.76	31.98	6.45	26.6	117	323	A	V
	5729.09	60.49	-7.71	68.2	48.27	32.32	6.55	26.65	117	323	P	V	
Remark	1. No other spurious found. 2. All results are PASS against Peak and Average limit line.												



Band 3 5470~5725MHz

WIFI 802.11ax HE80 Full (Harmonic @ 3m)

WIFI Ant. 6+7	Note	Frequency ( MHz )	Level ( dBμV/m )	Margin ( dB )	Limit Line ( dBμV/m )	Read Level (dBμV)	Antenna Factor ( dB/m )	Path Loss ( dB )	Preamp Factor ( dB )	Ant Pos ( cm )	Table Pos ( deg )	Peak Avg. (P/A)	Pol. (H/V)
802.11ax HE80 Full CH 106 5530MHz		11060	47.82	-26.18	74	53.01	40.4	10.18	55.77	-	-	P	H
		16590	47.42	-20.78	68.2	50.64	39.81	12.36	55.39	-	-	P	H
													H
													H
													H
													H
													H
													H
													H
													H
													H
													H
													H
													H
													H
													H
													H
			11060	47.22	-26.78	74	52.41	40.4	10.18	55.77	-	-	P
		16590	46.51	-21.69	68.2	49.73	39.81	12.36	55.39	-	-	P	V
													V
													V
													V
													V
													V
													V
													V
													V
													V
													V
													V





WIFI Ant. 6+7	Note	Frequency ( MHz )	Level ( dBμV/m )	Margin ( dB )	Limit Line ( dBμV/m )	Read Level ( dBμV )	Antenna Factor ( dB/m )	Path Loss ( dB )	Preamp Factor ( dB )	Ant Pos ( cm )	Table Pos ( deg )	Peak Avg. ( P/A )	Pol. ( H/V )	
802.11ax HE80 Full CH 122 5610MHz		11220	47.54	-26.46	74	53.28	39.78	10.25	55.77	-	-	P	H	
		16830	46.41	-21.79	68.2	48.99	40.53	12.5	55.61	-	-	P	H	
													H	
													H	
													H	
													H	
													H	
													H	
													H	
													H	
													H	
													H	
													H	
													H	
													H	
													H	
													H	
													H	
			11220	47.21	-26.79	74	52.95	39.78	10.25	55.77	-	-	P	V
			16830	48.24	-19.96	68.2	50.82	40.53	12.5	55.61	-	-	P	V
													V	
													V	
													V	
													V	
													V	
													V	
													V	
													V	
													V	
													V	
													V	
													V	
<b>Remark</b>	<ol style="list-style-type: none"> <li>No other spurious found.</li> <li>All results are PASS against Peak and Average limit line.</li> <li>The emission position marked as "-" means no suspected emission found with sufficient margin against limit line or noise floor only.</li> </ol>													



**Band 3 - Straddle Channel**  
**WIFI 802.11a (Band Edge @ 3m)**

WIFI	Note	Frequency	Level	Margin	Limit	Read	Antenna	Path	Preamp	Ant	Table	Peak	Pol.
Ant.					Line	Level	Factor	Loss	Factor	Pos	Pos	Avg.	
6+7		( MHz )	( dBμV/m )	( dB )	( dBμV/m )	( dBμV )	( dB/m )	( dB )	( dB )	( cm )	( deg )	( P/A )	( H/V )
<b>802.11a CH 144 5720MHz</b>		5352.73	52.16	-21.84	74	40.76	31.62	6.32	26.54	100	1	P	H
		5466.61	51.58	-16.62	68.2	39.8	31.97	6.37	26.56	100	1	P	H
		5458.03	43.95	-10.05	54	32.21	31.93	6.36	26.55	100	1	A	H
	*	5720	117.41	-	-	105.24	32.28	6.54	26.65	100	1	P	H
	*	5720	110.24	-	-	98.07	32.28	6.54	26.65	100	1	A	H
		5871.75	54.22	-13.98	68.2	41.68	32.59	6.66	26.71	100	1	P	H
		5458.81	51.78	-22.22	74	40.03	31.94	6.36	26.55	387	212	P	V
		5466.22	54.01	-14.19	68.2	42.24	31.96	6.37	26.56	387	212	P	V
		5448.28	43.68	-10.32	54	31.97	31.9	6.36	26.55	387	212	A	V
	*	5720	114.43	-	-	102.26	32.28	6.54	26.65	387	212	P	V
	*	5720	106.17	-	-	94	32.28	6.54	26.65	387	212	A	V
			5908.5	53.54	-14.66	68.2	40.86	32.72	6.68	26.72	387	212	P
<b>Remark</b>	1. No other spurious found. 2. All results are PASS against Peak and Average limit line.												



**Band 3 - Straddle Channel**  
**WIFI 802.11a (Harmonic @ 3m)**

WIFI Ant. 6+7	Note	Frequency ( MHz )	Level ( dBµV/m )	Margin ( dB )	Limit Line ( dBµV/m )	Read Level (dBµV)	Antenna Factor ( dB/m )	Path Loss ( dB )	Preamp Factor ( dB )	Ant Pos ( cm )	Table Pos ( deg )	Peak Avg. (P/A)	Pol. (H/V)	
802.11a CH 144 5720MHz		11440	47.03	-26.97	74	52.44	40.02	10.35	55.78	-	-	P	H	
		17160	46.75	-21.45	68.2	49.57	40.46	12.78	56.06	-	-	P	H	
													H	
													H	
													H	
													H	
													H	
													H	
													H	
													H	
													H	
													H	
													H	
													H	
													H	
													H	
													H	
													H	
			11440	47.32	-26.68	74	52.73	40.02	10.35	55.78	-	-	P	V
			17160	46.59	-21.61	68.2	49.41	40.46	12.78	56.06	-	-	P	V
													V	
													V	
													V	
													V	
													V	
													V	
													V	
													V	
													V	
													V	
													V	
													V	
<b>Remark</b>	1. No other spurious found. 2. All results are PASS against Peak and Average limit line. 3. The emission position marked as "-" means no suspected emission found with sufficient margin against limit line or noise floor only.													



**Band 3 - Straddle Channel  
WIFI 802.11ax HE20 Full (Band Edge @ 3m)**

WIFI Ant. 6+7	Note	Frequency ( MHz )	Level ( dBμV/m )	Margin ( dB )	Limit Line ( dBμV/m )	Read Level (dBμV)	Antenna Factor ( dB/m )	Path Loss ( dB )	Preamp Factor ( dB )	Ant Pos ( cm )	Table Pos ( deg )	Peak Avg. (P/A)	Pol. (H/V)
<b>802.11ax HE20 Full CH 144 5720MHz</b>		5409.28	52.8	-21.2	74	41.11	31.9	6.34	26.55	100	1	P	H
		5466.61	53.25	-14.95	68.2	41.47	31.97	6.37	26.56	100	1	P	H
		5459.98	43.3	-10.7	54	31.55	31.94	6.36	26.55	100	1	A	H
	*	5720	118.5	-	-	106.33	32.28	6.54	26.65	100	1	P	H
	*	5720	109.23	-	-	97.06	32.28	6.54	26.65	100	1	A	H
		5877.75	57.26	-10.94	68.2	44.7	32.61	6.66	26.71	100	1	P	H
		5351.56	51.68	-22.32	74	40.29	31.61	6.32	26.54	386	208	P	V
		5463.1	51.95	-16.25	68.2	40.19	31.95	6.36	26.55	386	208	P	V
		5458.42	42.84	-11.16	54	31.1	31.93	6.36	26.55	386	208	A	V
	*	5720	114.47	-	-	102.3	32.28	6.54	26.65	386	208	P	V
	*	5720	105.3	-	-	93.13	32.28	6.54	26.65	386	208	A	V
		5869	56.12	-12.08	68.2	43.6	32.58	6.65	26.71	386	208	P	V
<b>Remark</b>	1. No other spurious found. 2. All results are PASS against Peak and Average limit line.												



**Band 3 - Straddle Channel**  
**WIFI 802.11ax HE20 Full (Harmonic @ 3m)**

WIFI Ant. 6+7	Note	Frequency ( MHz )	Level ( dBµV/m )	Margin ( dB )	Limit Line ( dBµV/m )	Read Level (dBµV)	Antenna Factor ( dB/m )	Path Loss ( dB )	Preamp Factor ( dB )	Ant Pos ( cm )	Table Pos ( deg )	Peak Avg. (P/A)	Pol. (H/V)	
802.11ax HE20 Full CH 144 5720MHz		11440	47.22	-26.78	74	52.63	40.02	10.35	55.78	-	-	P	H	
		17160	46.24	-21.96	68.2	49.06	40.46	12.78	56.06	-	-	P	H	
													H	
													H	
													H	
													H	
													H	
													H	
													H	
													H	
													H	
													H	
													H	
													H	
													H	
													H	
													H	
													H	
			11440	47.18	-26.82	74	52.59	40.02	10.35	55.78	-	-	P	V
			17160	46.62	-21.58	68.2	49.44	40.46	12.78	56.06	-	-	P	V
													V	
													V	
													V	
													V	
													V	
													V	
													V	
													V	
													V	
													V	
													V	
<b>Remark</b>	<ol style="list-style-type: none"> <li>No other spurious found.</li> <li>All results are PASS against Peak and Average limit line.</li> <li>The emission position marked as "-" means no suspected emission found with sufficient margin against limit line or noise floor only.</li> </ol>													



**Band 3 - Straddle Channel**  
**WIFI 802.11ax HE40 Full (Band Edge @ 3m)**

WIFI Ant. 6+7	Note	Frequency ( MHz )	Level ( dBμV/m )	Margin ( dB )	Limit Line ( dBμV/m )	Read Level ( dBμV )	Antenna Factor ( dB/m )	Path Loss ( dB )	Preamp Factor ( dB )	Ant Pos ( cm )	Table Pos ( deg )	Peak Avg. ( P/A )	Pol. ( H/V )
<b>802.11ax HE40 Full CH 142 5710MHz</b>		5455.3	53.71	-20.29	74	41.98	31.92	6.36	26.55	100	10	P	H
		5467	54.27	-13.93	68.2	42.49	31.97	6.37	26.56	100	10	P	H
		5454.13	44.75	-9.25	54	33.02	31.92	6.36	26.55	100	10	A	H
	*	5710	112	-	-	99.87	32.24	6.53	26.64	100	10	P	H
	*	5710	102.73	-	-	90.6	32.24	6.53	26.64	100	10	A	H
		5911	58.38	-9.82	68.2	45.7	32.72	6.68	26.72	100	10	P	H
		5446.33	53.2	-20.8	74	41.49	31.9	6.36	26.55	368	213	P	V
		5465.05	54.28	-13.92	68.2	42.51	31.96	6.37	26.56	368	213	P	V
		5459.2	45.22	-8.78	54	33.47	31.94	6.36	26.55	368	213	A	V
	*	5710	110.23	-	-	98.1	32.24	6.53	26.64	368	213	P	V
*	5710	99.95	-	-	87.82	32.24	6.53	26.64	368	213	A	V	
		5853.5	55.94	-12.26	68.2	43.49	32.51	6.64	26.7	368	213	P	V
<b>Remark</b>	1. No other spurious found. 2. All results are PASS against Peak and Average limit line.												



**Band 3 - Straddle Channel**  
**WIFI 802.11ax HE40 Full (Harmonic @ 3m)**

WIFI Ant. 6+7	Note	Frequency ( MHz )	Level ( dBμV/m )	Margin ( dB )	Limit Line ( dBμV/m )	Read Level ( dBμV )	Antenna Factor ( dB/m )	Path Loss ( dB )	Preamp Factor ( dB )	Ant Pos ( cm )	Table Pos ( deg )	Peak Avg. ( P/A )	Pol. ( H/V )	
802.11ax HE40 Full CH 142 5710MHz		11420	47.48	-26.52	74	52.96	39.96	10.34	55.78	-	-	P	H	
		17130	47.41	-20.79	68.2	50.25	40.43	12.74	56.01	-	-	P	H	
													H	
													H	
													H	
													H	
													H	
													H	
													H	
													H	
													H	
													H	
													H	
													H	
													H	
													H	
													H	
													H	
			11420	47.62	-26.38	74	53.1	39.96	10.34	55.78	-	-	P	V
			17130	46.66	-21.54	68.2	49.5	40.43	12.74	56.01	-	-	P	V
													V	
													V	
													V	
													V	
													V	
													V	
													V	
													V	
													V	
													V	
													V	
<b>Remark</b>	1. No other spurious found. 2. All results are PASS against Peak and Average limit line. 3. The emission position marked as "-" means no suspected emission found with sufficient margin against limit line or noise floor only.													



**Band 3 Straddle Channel  
WIFI 802.11ax HE80 Full (Band Edge @ 3m)**

WIFI Ant. 6+7	Note	Frequency ( MHz )	Level ( dBμV/m )	Margin ( dB )	Limit Line ( dBμV/m )	Read Level (dBμV)	Antenna Factor ( dB/m )	Path Loss ( dB )	Preamp Factor ( dB )	Ant Pos ( cm )	Table Pos ( deg )	Peak Avg. (P/A)	Pol. (H/V)
<b>802.11ax HE80 Full CH 138 5690MHz</b>		5454.52	58.55	-15.45	74	46.82	31.92	6.36	26.55	315	217	P	H
		5467	58.54	-9.66	68.2	46.76	31.97	6.37	26.56	315	217	P	H
		5452.18	50.82	-3.18	54	39.1	31.91	6.36	26.55	315	217	A	H
	*	5690	109.26	-	-	97.24	32.14	6.52	26.64	315	217	P	H
	*	5690	99.33	-	-	87.31	32.14	6.52	26.64	315	217	A	H
		5899.6	59.13	-9.07	68.2	46.48	32.7	6.67	26.72	315	217	P	H
		5449.84	55.99	-18.01	74	44.28	31.9	6.36	26.55	100	321	P	V
		5461.15	57.12	-11.08	68.2	45.37	31.94	6.36	26.55	100	321	P	V
		5459.2	50.32	-3.68	54	38.57	31.94	6.36	26.55	100	321	A	V
	*	5690	108.54	-	-	96.52	32.14	6.52	26.64	100	321	P	V
	*	5690	98.59	-	-	86.57	32.14	6.52	26.64	100	321	A	V
	5856.7	58.09	-10.11	68.2	45.61	32.53	6.65	26.7	100	321	P	V	
<b>Remark</b>	1. No other spurious found. 2. All results are PASS against Peak and Average limit line.												





**Band 3 - Straddle Channel**  
**WIFI 802.11ax HE80 Full (Harmonic @ 3m)**

WIFI Ant. 6+7	Note	Frequency ( MHz )	Level ( dBμV/m )	Margin ( dB )	Limit Line ( dBμV/m )	Read Level (dBμV)	Antenna Factor ( dB/m )	Path Loss ( dB )	Preamp Factor ( dB )	Ant Pos ( cm )	Table Pos ( deg )	Peak Avg. (P/A)	Pol. (H/V)	
802.11ax HE80 Full CH 138 5690MHz		11380	46.79	-27.21	74	52.39	39.86	10.32	55.78	-	-	P	H	
		17070	47.4	-20.8	68.2	50.19	40.43	12.68	55.9	-	-	P	H	
													H	
													H	
													H	
													H	
													H	
													H	
													H	
													H	
													H	
													H	
													H	
													H	
													H	
													H	
													H	
													H	
			11380	47.49	-26.51	74	53.09	39.86	10.32	55.78	-	-	P	V
			17070	47.12	-21.08	68.2	49.91	40.43	12.68	55.9	-	-	P	V
													V	
													V	
													V	
													V	
													V	
													V	
													V	
													V	
													V	
													V	
													V	
													V	
<b>Remark</b>	1. No other spurious found. 2. All results are PASS against Peak and Average limit line. 3. The emission position marked as "-" means no suspected emission found with sufficient margin against limit line or noise floor only.													



<TXBF Mode>

**Band 1 - 5150~5250MHz**  
**WIFI 802.11ax HE20 Full (Band Edge @ 3m)**

WIFI Ant.	Note	Frequency	Level	Margin	Limit Line	Read Level	Antenna Factor	Path Loss	Preamp Factor	Ant Pos	Table Pos	Peak Avg.	Pol.	
6+7		( MHz )	( dBμV/m )	( dB )	( dBμV/m )	( dBμV )	( dB/m )	( dB )	( dB )	( cm )	( deg )	( P/A )	( H/V )	
802.11ax HE20 Full CH 36 5180MHz		5147.16	59.69	-14.31	74	47.8	32.19	6.21	26.51	100	27	P	H	
		5150	50.35	-3.65	54	38.44	32.2	6.22	26.51	100	27	A	H	
	*	5180	112.67	-	-	100.86	32.08	6.25	26.52	100	27	P	H	
	*	5180	103.88	-	-	92.07	32.08	6.25	26.52	100	27	A	H	
													H	
														H
			5147.94	55.92	-18.08	74	44.02	32.2	6.21	26.51	400	219	P	V
			5149.76	47.95	-6.05	54	36.05	32.2	6.21	26.51	400	219	A	V
		*	5180	112.81	-	-	101	32.08	6.25	26.52	400	219	P	V
		*	5180	103.32	-	-	91.51	32.08	6.25	26.52	400	219	A	V
													V	
													V	
802.11ax HE20 Full CH 44 5220MHz		5134.16	53.72	-20.28	74	41.86	32.17	6.2	26.51	101	37	P	H	
		5149.24	45.83	-8.17	54	33.93	32.2	6.21	26.51	101	37	A	H	
	*	5220	113.15	-	-	101.47	31.92	6.28	26.52	101	37	P	H	
	*	5220	103.37	-	-	91.69	31.92	6.28	26.52	101	37	A	H	
			5355.56	52.8	-21.2	74	41.39	31.63	6.32	26.54	101	37	P	H
			5400.08	44.62	-9.38	54	32.94	31.9	6.33	26.55	101	37	A	H
			5074.62	53.34	-20.66	74	41.61	32.1	6.13	26.5	100	123	P	V
			5147.68	45.84	-8.16	54	33.94	32.2	6.21	26.51	100	123	A	V
		*	5220	112.52	-	-	100.84	31.92	6.28	26.52	100	123	P	V
		*	5220	99.84	-	-	88.16	31.92	6.28	26.52	100	123	A	V
		5445.44	52.34	-21.66	74	40.64	31.9	6.35	26.55	100	123	P	V	
		5400.08	43.72	-10.28	54	32.04	31.9	6.33	26.55	100	123	A	V	



<b>802.11ax</b> <b>HE20 Full</b> <b>CH 48</b> <b>5240MHz</b>		5130.78	54.93	-19.07	74	43.09	32.16	6.19	26.51	100	38	P	H
		5148.98	45.54	-8.46	54	33.64	32.2	6.21	26.51	100	38	A	H
	*	5240	113.37	-	-	101.77	31.84	6.28	26.52	100	38	P	H
	*	5240	104.2	-	-	92.6	31.84	6.28	26.52	100	38	A	H
		5386.08	52.63	-21.37	74	41.02	31.82	6.33	26.54	100	38	P	H
		5420.8	44.65	-9.35	54	32.96	31.9	6.34	26.55	100	38	A	H
		5114.4	53.98	-20.02	74	42.18	32.13	6.18	26.51	100	126	P	V
		5149.5	45.37	-8.63	54	33.47	32.2	6.21	26.51	100	126	A	V
	*	5240	111.65	-	-	100.05	31.84	6.28	26.52	100	126	P	V
	*	5240	102.17	-	-	90.57	31.84	6.28	26.52	100	126	A	V
		5352.48	51.68	-22.32	74	40.29	31.61	6.32	26.54	100	126	P	V
		5352.2	43.31	-10.69	54	31.92	31.61	6.32	26.54	100	126	A	V
<b>Remark</b>	1. No other spurious found. 2. All results are PASS against Peak and Average limit line.												



Band 1 5150~5250MHz

WIFI 802.11ax HE20 Full (Harmonic @ 3m)

WIFI Ant. 6+7	Note	Frequency ( MHz )	Level ( dBμV/m )	Margin ( dB )	Limit Line ( dBμV/m )	Read Level (dBμV)	Antenna Factor ( dB/m )	Path Loss ( dB )	Preamp Factor ( dB )	Ant Pos ( cm )	Table Pos ( deg )	Peak Avg. (P/A)	Pol. (H/V)	
802.11ax HE20 Full CH 36 5180MHz		10360	46.82	-21.38	68.2	53.56	39.94	9.78	56.46	-	-	P	H	
		15540	45.37	-28.63	74	50.06	39.44	12.05	56.18	-	-	P	H	
													H	
													H	
													H	
													H	
													H	
													H	
													H	
													H	
													H	
													H	
													H	
			10360	46.61	-21.59	68.2	53.35	39.94	9.78	56.46	-	-	P	V
			15540	45.47	-28.53	74	50.16	39.44	12.05	56.18	-	-	P	V
														V
														V
														V
													V	
													V	
													V	
													V	



WIFI Ant. 6+7	Note	Frequency ( MHz )	Level ( dBμV/m )	Margin ( dB )	Limit Line ( dBμV/m )	Read Level (dBμV)	Antenna Factor ( dB/m )	Path Loss ( dB )	Preamp Factor ( dB )	Ant Pos ( cm )	Table Pos ( deg )	Peak Avg. (P/A)	Pol. (H/V)
802.11ax HE20 Full CH 44 5220MHz		10440	46.48	-21.72	68.2	52.9	40.22	9.82	56.46	-	-	P	H
		15660	44.56	-29.44	74	49.55	38.9	12.04	55.93	-	-	P	H
													H
													H
													H
													H
													H
													H
													H
													H
													H
													H
													H
													H
													H
													H
													H
													H
													H
			10440	46.35	-21.85	68.2	52.77	40.22	9.82	56.46	-	-	P
		15660	44.65	-29.35	74	49.64	38.9	12.04	55.93	-	-	P	V
													V
													V
													V
													V
													V
													V
													V
													V
													V
													V
													V
													V
													V
													V
													V



WiFi Ant. 6+7	Note	Frequency ( MHz )	Level ( dBμV/m )	Margin ( dB )	Limit Line ( dBμV/m )	Read Level (dBμV)	Antenna Factor ( dB/m )	Path Loss ( dB )	Preamp Factor ( dB )	Ant Pos ( cm )	Table Pos ( deg )	Peak Avg. (P/A)	Pol. (H/V)
802.11ax HE20 Full CH 48 5240MHz		10480	47.37	-20.83	68.2	53.64	40.34	9.85	56.46	-	-	P	H
		15720	45.52	-28.48	74	50.59	38.68	12.05	55.8	-	-	P	H
													H
													H
													H
													H
													H
													H
													H
													H
													H
													H
													H
													H
													H
													H
													H
													H
													H
	Remark	1. No other spurious found. 2. All results are PASS against Peak and Average limit line. 3. The emission position marked as "-" means no suspected emission found with sufficient margin against limit line or noise floor only.											



**Band 1 5150~5250MHz**  
**WIFI 802.11ax HE40 Full (Band Edge @ 3m)**

WIFI Ant. 6+7	Note	Frequency ( MHz )	Level ( dBμV/m )	Margin ( dB )	Limit Line ( dBμV/m )	Read Level ( dBμV )	Antenna Factor ( dB/m )	Path Loss ( dB )	Preamp Factor ( dB )	Ant Pos ( cm )	Table Pos ( deg )	Peak Avg. ( P/A )	Pol. ( H/V )	
802.11ax HE40 Full CH 38 5190MHz		5144.82	59.08	-14.92	74	47.19	32.19	6.21	26.51	103	353	P	H	
		5150	52.75	-1.25	54	40.84	32.2	6.22	26.51	103	353	A	H	
	*	5190	108.52	-	-	96.74	32.04	6.26	26.52	103	353	P	H	
	*	5190	98.44	-	-	86.66	32.04	6.26	26.52	103	353	A	H	
		5351.92	54.61	-19.39	74	43.22	31.61	6.32	26.54	103	353	P	H	
		5369	46.23	-7.77	54	34.74	31.71	6.32	26.54	103	353	A	H	
		5145.34	58.2	-15.8	74	46.31	32.19	6.21	26.51	400	220	P	V	
		5150	51.71	-2.29	54	39.8	32.2	6.22	26.51	400	220	A	V	
	*	5190	108.07	-	-	96.29	32.04	6.26	26.52	400	220	P	V	
	*	5190	97.67	-	-	85.89	32.04	6.26	26.52	400	220	A	V	
		5414.36	52.09	-21.91	74	40.4	31.9	6.34	26.55	400	220	P	V	
		5360.88	44.3	-9.7	54	32.85	31.67	6.32	26.54	400	220	A	V	
	802.11ax HE40 Full CH 46 5230MHz		5144.82	57.67	-16.33	74	45.78	32.19	6.21	26.51	100	10	P	H
			5147.68	49.15	-4.85	54	37.25	32.2	6.21	26.51	100	10	A	H
*		5230	112.54	-	-	100.9	31.88	6.28	26.52	100	10	P	H	
*		5230	102.29	-	-	90.65	31.88	6.28	26.52	100	10	A	H	
		5446.56	56.9	-17.1	74	45.19	31.9	6.36	26.55	100	10	P	H	
		5390.28	47.6	-6.4	54	35.97	31.84	6.33	26.54	100	10	A	H	
		5139.62	57.6	-16.4	74	45.73	32.18	6.2	26.51	100	124	P	V	
		5149.76	48.32	-5.68	54	36.42	32.2	6.21	26.51	100	124	A	V	
*		5230	110.84	-	-	99.2	31.88	6.28	26.52	100	124	P	V	
*		5230	100.88	-	-	89.24	31.88	6.28	26.52	100	124	A	V	
	5384.12	55.1	-18.9	74	43.51	31.8	6.33	26.54	100	124	P	V		
	5410.44	46.19	-7.81	54	34.5	31.9	6.34	26.55	100	124	A	V		
Remark	1. No other spurious found. 2. All results are PASS against Peak and Average limit line.													



Band 1 5150~5250MHz

WIFI 802.11ax HE40 Full (Harmonic @ 3m)

WIFI Ant. 6+7	Note	Frequency ( MHz )	Level ( dBμV/m )	Margin ( dB )	Limit Line ( dBμV/m )	Read Level (dBμV)	Antenna Factor ( dB/m )	Path Loss ( dB )	Preamp Factor ( dB )	Ant Pos ( cm )	Table Pos ( deg )	Peak Avg. (P/A)	Pol. (H/V)
802.11ax HE40 Full CH 38 5190MHz		10380	47.59	-20.61	68.2	54.24	40.02	9.79	56.46	-	-	P	H
		15570	46.38	-27.62	74	51.13	39.32	12.05	56.12	-	-	P	H
													H
													H
													H
													H
													H
													H
													H
													H
													H
													H
													H
													H
													H
													H
													H
													H
													H
			10380	47.32	-20.88	68.2	53.97	40.02	9.79	56.46	-	-	P
		15570	46.56	-27.44	74	51.31	39.32	12.05	56.12	-	-	P	V
													V
													V
													V
													V
													V
													V
													V
													V
													V
													V
													V
													V
													V
													V
													V





WIFI Ant. 6+7	Note	Frequency ( MHz )	Level ( dBμV/m )	Margin ( dB )	Limit Line ( dBμV/m )	Read Level (dBμV)	Antenna Factor ( dB/m )	Path Loss ( dB )	Preamp Factor ( dB )	Ant Pos ( cm )	Table Pos ( deg )	Peak Avg. (P/A)	Pol. (H/V)	
802.11ax HE40 Full CH 46 5230MHz		10460	46.54	-21.66	68.2	52.88	40.28	9.84	56.46	-	-	P	H	
		15690	44.62	-29.38	74	49.69	38.75	12.04	55.86	-	-	P	H	
													H	
													H	
													H	
													H	
													H	
													H	
													H	
													H	
													H	
													H	
													H	
													H	
													H	
													H	
													H	
													H	
	Remark	1. No other spurious found. 2. All results are PASS against Peak and Average limit line. 3. The emission position marked as "-" means no suspected emission found with sufficient margin against limit line or noise floor only.												



**Band 1 5150~5250MHz**  
**WIFI 802.11ax HE80 Full (Band Edge @ 3m)**

WIFI Ant. 6+7	Note	Frequency ( MHz )	Level ( dBμV/m )	Margin ( dB )	Limit Line ( dBμV/m )	Read Level (dBμV)	Antenna Factor ( dB/m )	Path Loss ( dB )	Preamp Factor ( dB )	Ant Pos ( cm )	Table Pos ( deg )	Peak Avg. (P/A)	Pol. (H/V)
<b>802.11ax HE80 Full CH 42 5210MHz</b>		5140.4	60.59	-13.41	74	48.72	32.18	6.2	26.51	126	225	P	H
		5150	50.4	-3.6	54	38.49	32.2	6.22	26.51	126	225	A	H
	*	5210	102.21	-	-	90.5	31.96	6.27	26.52	126	225	P	H
	*	5210	91.51	-	-	79.8	31.96	6.27	26.52	126	225	A	H
		5443.48	51.51	-22.49	74	39.81	31.9	6.35	26.55	126	225	P	H
		5437.32	42.86	-11.14	54	31.16	31.9	6.35	26.55	126	225	A	H
		5149.5	61.32	-12.68	74	49.42	32.2	6.21	26.51	100	359	P	V
		5148.72	51.6	-2.4	54	39.7	32.2	6.21	26.51	100	359	A	V
	*	5210	103.26	-	-	91.55	31.96	6.27	26.52	100	359	P	V
	*	5210	93.05	-	-	81.34	31.96	6.27	26.52	100	359	A	V
	5418.28	54.08	-19.92	74	42.39	31.9	6.34	26.55	100	359	P	V	
	5398.4	45.19	-8.81	54	33.52	31.89	6.33	26.55	100	359	A	V	
<b>Remark</b>	1. No other spurious found. 2. All results are PASS against Peak and Average limit line.												



Band 1 5150~5250MHz

WIFI 802.11ax HE80 Full (Harmonic @ 3m)

WIFI Ant. 6+7	Note	Frequency ( MHz )	Level ( dBμV/m )	Margin ( dB )	Limit Line ( dBμV/m )	Read Level (dBμV)	Antenna Factor ( dB/m )	Path Loss ( dB )	Preamp Factor ( dB )	Ant Pos ( cm )	Table Pos ( deg )	Peak Avg. (P/A)	Pol. (H/V)	
802.11ax HE80 Full CH 42 5210MHz		10420	47.23	-20.97	68.2	53.72	40.16	9.81	56.46	-	-	P	H	
		15630	46.71	-27.29	74	51.6	39.05	12.05	55.99	-	-	P	H	
													H	
													H	
													H	
													H	
													H	
													H	
													H	
													H	
													H	
													H	
													H	
													H	
													H	
													H	
													H	
													H	
			10420	47.19	-21.01	68.2	53.68	40.16	9.81	56.46	-	-	P	V
			15630	46.71	-27.29	74	51.6	39.05	12.05	55.99	-	-	P	V
													V	
													V	
													V	
													V	
													V	
													V	
													V	
													V	
													V	
													V	
													V	
													V	
<b>Remark</b>	<ol style="list-style-type: none"> <li>No other spurious found.</li> <li>All results are PASS against Peak and Average limit line.</li> <li>The emission position marked as "-" means no suspected emission found with sufficient margin against limit line or noise floor only.</li> </ol>													



**Band 2 - 5250~5350MHz**

**WIFI 802.11ax HE20 Full (Band Edge @ 3m)**

WIFI Ant. 6+7	Note	Frequency ( MHz )	Level ( dBµV/m )	Margin ( dB )	Limit Line ( dBµV/m )	Read Level (dBµV)	Antenna Factor ( dB/m )	Path Loss ( dB )	Preamp Factor ( dB )	Ant Pos ( cm )	Table Pos ( deg )	Peak Avg. (P/A)	Pol. (H/V)
802.11ax HE20 Full CH 52 5260MHz		5111.18	53.71	-20.29	74	41.93	32.12	6.17	26.51	100	36	P	H
		5078.54	45.34	-8.66	54	33.6	32.1	6.14	26.5	100	36	A	H
	*	5260	113.39	-	-	101.85	31.78	6.29	26.53	100	36	P	H
	*	5260	104.03	-	-	92.49	31.78	6.29	26.53	100	36	A	H
		5386.56	53.39	-20.61	74	41.78	31.82	6.33	26.54	100	36	P	H
		5350.08	44.7	-9.3	54	33.32	31.6	6.32	26.54	100	36	A	H
		5143.14	54.51	-19.49	74	42.62	32.19	6.21	26.51	101	124	P	V
		5078.54	45.57	-8.43	54	33.83	32.1	6.14	26.5	101	124	A	V
	*	5260	112.3	-	-	100.76	31.78	6.29	26.53	101	124	P	V
	*	5260	101.58	-	-	90.04	31.78	6.29	26.53	101	124	A	V
		5354.88	52.92	-21.08	74	41.51	31.63	6.32	26.54	101	124	P	V
		5441.28	43.57	-10.43	54	31.87	31.9	6.35	26.55	101	124	A	V
802.11ax HE20 Full CH 60 5300MHz		5142.12	53.87	-20.13	74	41.99	32.18	6.21	26.51	103	37	P	H
		5117.3	45.4	-8.6	54	33.6	32.13	6.18	26.51	103	37	A	H
	*	5300	113.56	-	-	102.09	31.7	6.3	26.53	103	37	P	H
	*	5300	104.32	-	-	92.85	31.7	6.3	26.53	103	37	A	H
		5360.16	54.51	-19.49	74	43.07	31.66	6.32	26.54	103	37	P	H
		5350.32	46.23	-7.77	54	34.85	31.6	6.32	26.54	103	37	A	H
		5137.36	52.95	-21.05	74	41.09	32.17	6.2	26.51	100	127	P	V
		5117.3	45.43	-8.57	54	33.63	32.13	6.18	26.51	100	127	A	V
	*	5300	110.24	-	-	98.77	31.7	6.3	26.53	100	127	P	V
	*	5300	101.52	-	-	90.05	31.7	6.3	26.53	100	127	A	V
		5356.8	53.54	-20.46	74	42.12	31.64	6.32	26.54	100	127	P	V
		5350.32	45.09	-8.91	54	33.71	31.6	6.32	26.54	100	127	A	V



<b>802.11ax HE20 Full CH 64 5320MHz</b>	*	5320	112.65	-	-	101.21	31.66	6.31	26.53	100	351	P	H
	*	5320	103.35	-	-	91.91	31.66	6.31	26.53	100	351	A	H
		5350.24	58.33	-15.67	74	46.95	31.6	6.32	26.54	100	351	P	H
		5350.08	50.11	-3.89	54	38.73	31.6	6.32	26.54	100	351	A	H
													H
													H
	*	5320	111.36	-	-	99.92	31.66	6.31	26.53	400	216	P	V
	*	5320	101.68	-	-	90.24	31.66	6.31	26.53	400	216	A	V
		5350.56	56.88	-17.12	74	45.5	31.6	6.32	26.54	400	216	P	V
		5350.72	49.68	-4.32	54	38.3	31.6	6.32	26.54	400	216	A	V
												V	
												V	
<b>Remark</b>	1. No other spurious found. 2. All results are PASS against Peak and Average limit line.												



Band 2 5250~5350MHz

WIFI 802.11ax HE20 Full (Harmonic @ 3m)

WIFI Ant. 6+7	Note	Frequency ( MHz )	Level ( dBμV/m )	Margin ( dB )	Limit Line ( dBμV/m )	Read Level (dBμV)	Antenna Factor ( dB/m )	Path Loss ( dB )	Preamp Factor ( dB )	Ant Pos ( cm )	Table Pos ( deg )	Peak Avg. (P/A)	Pol. (H/V)	
802.11ax HE20 Full CH 52 5260MHz		10520	47.54	-20.66	68.2	53.74	40.36	9.87	56.43	-	-	P	H	
		15780	45.64	-28.36	74	50.65	38.62	12.04	55.67	-	-	P	H	
													H	
													H	
													H	
													H	
													H	
													H	
													H	
													H	
													H	
													H	
													H	
													H	
													H	
													H	
													H	
													H	
			10520	48.02	-20.18	68.2	54.22	40.36	9.87	56.43	-	-	P	V
			15780	46.35	-27.65	74	51.36	38.62	12.04	55.67	-	-	P	V
													V	
													V	
													V	
													V	
													V	
													V	
													V	
													V	
													V	
													V	
													V	
													V	



WIFI Ant. 6+7	Note	Frequency ( MHz )	Level ( dBμV/m )	Margin ( dB )	Limit Line ( dBμV/m )	Read Level (dBμV)	Antenna Factor ( dB/m )	Path Loss ( dB )	Preamp Factor ( dB )	Ant Pos ( cm )	Table Pos ( deg )	Peak Avg. (P/A)	Pol. (H/V)	
802.11ax HE20 Full CH 60 5300MHz		10600	46.57	-27.43	74	52.77	40.2	9.92	56.32	-	-	P	H	
		15900	45.93	-28.07	74	50.61	38.7	12.03	55.41	-	-	P	H	
													H	
													H	
													H	
													H	
													H	
													H	
													H	
													H	
													H	
													H	
													H	
													H	
													H	
													H	
													H	
													H	
			10600	45.93	-28.07	74	52.13	40.2	9.92	56.32	-	-	P	V
			15900	45.63	-28.37	74	50.31	38.7	12.03	55.41	-	-	P	V
													V	
													V	
													V	
													V	
													V	
													V	
													V	
													V	
													V	
													V	
													V	
													V	
													V	
													V	



WIFI Ant. 6+7	Note	Frequency ( MHz )	Level ( dBμV/m )	Margin ( dB )	Limit Line ( dBμV/m )	Read Level (dBμV)	Antenna Factor ( dB/m )	Path Loss ( dB )	Preamp Factor ( dB )	Ant Pos ( cm )	Table Pos ( deg )	Peak Avg. (P/A)	Pol. (H/V)	
802.11ax HE20 Full CH 64 5320MHz		10640	46.29	-27.71	74	52.3	40.32	9.94	56.27	-	-	P	H	
		15960	45.29	-28.71	74	50.03	38.52	12.03	55.29	-	-	P	H	
													H	
													H	
													H	
													H	
													H	
													H	
													H	
													H	
													H	
													H	
													H	
													H	
													H	
													H	
													H	
													H	
			10640	47.2	-26.8	74	53.21	40.32	9.94	56.27	-	-	P	V
			15960	44.31	-29.69	74	49.05	38.52	12.03	55.29	-	-	P	V
													V	
													V	
													V	
													V	
													V	
													V	
													V	
													V	
													V	
													V	
													V	
													V	
<b>Remark</b>	<ol style="list-style-type: none"> <li>No other spurious found.</li> <li>All results are PASS against Peak and Average limit line.</li> <li>The emission position marked as "-" means no suspected emission found with sufficient margin against limit line or noise floor only.</li> </ol>													





**Band 2 5250~5350MHz**  
**WIFI 802.11ax HE40 Full (Band Edge @ 3m)**

WIFI Ant. 6+7	Note	Frequency ( MHz )	Level ( dBμV/m )	Margin ( dB )	Limit Line ( dBμV/m )	Read Level ( dBμV )	Antenna Factor ( dB/m )	Path Loss ( dB )	Preamp Factor ( dB )	Ant Pos ( cm )	Table Pos ( deg )	Peak Avg. ( P/A )	Pol. ( H/V )
802.11ax HE40 Full CH 54 5270MHz		5137.36	58.49	-15.51	74	46.63	32.17	6.2	26.51	100	8	P	H
		5143.48	48.06	-5.94	54	36.17	32.19	6.21	26.51	100	8	A	H
	*	5270	112.89	-	-	101.37	31.76	6.29	26.53	100	8	P	H
	*	5270	102.26	-	-	90.74	31.76	6.29	26.53	100	8	A	H
		5350.08	58.93	-15.07	74	47.55	31.6	6.32	26.54	100	8	P	H
		5350.32	48.82	-5.18	54	37.44	31.6	6.32	26.54	100	8	A	H
		5122.74	56.21	-17.79	74	44.38	32.15	6.19	26.51	100	123	P	V
		5147.9	47.57	-6.43	54	35.67	32.2	6.21	26.51	100	123	A	V
	*	5270	110.23	-	-	98.71	31.76	6.29	26.53	100	123	P	V
	*	5270	100.26	-	-	88.74	31.76	6.29	26.53	100	123	A	V
		5352.24	56.24	-17.76	74	44.85	31.61	6.32	26.54	100	123	P	V
		5350.08	47.09	-6.91	54	35.71	31.6	6.32	26.54	100	123	A	V
802.11ax HE40 Full CH 62 5310MHz		5113.9	55.2	-18.8	74	43.4	32.13	6.18	26.51	100	351	P	H
		5126.82	46.68	-7.32	54	34.85	32.15	6.19	26.51	100	351	A	H
	*	5310	107.98	-	-	96.53	31.68	6.3	26.53	100	351	P	H
	*	5310	99.04	-	-	87.59	31.68	6.3	26.53	100	351	A	H
		5351.28	60.09	-13.91	74	48.7	31.61	6.32	26.54	100	351	P	H
		5352	52.65	-1.35	54	41.26	31.61	6.32	26.54	100	351	A	H
		5146.54	54.52	-19.48	74	42.63	32.19	6.21	26.51	381	217	P	V
		5126.82	46	-8	54	34.17	32.15	6.19	26.51	381	217	A	V
	*	5310	107.28	-	-	95.83	31.68	6.3	26.53	381	217	P	V
	*	5310	97.18	-	-	85.73	31.68	6.3	26.53	381	217	A	V
	5354.16	58.68	-15.32	74	47.28	31.62	6.32	26.54	381	217	P	V	
	5350.32	51.11	-2.89	54	39.73	31.6	6.32	26.54	381	217	A	V	
Remark	1. No other spurious found. 2. All results are PASS against Peak and Average limit line.												



Band 2 5250~5350MHz

WIFI 802.11ax HE40 Full (Harmonic @ 3m)

WIFI Ant. 6+7	Note	Frequency ( MHz )	Level ( dBμV/m )	Margin ( dB )	Limit Line ( dBμV/m )	Read Level (dBμV)	Antenna Factor ( dB/m )	Path Loss ( dB )	Preamp Factor ( dB )	Ant Pos ( cm )	Table Pos ( deg )	Peak Avg. (P/A)	Pol. (H/V)	
802.11ax HE40 Full CH 54 5270MHz		10540	47.45	-20.75	68.2	53.65	40.32	9.88	56.4	-	-	P	H	
		15810	44.81	-29.19	74	49.77	38.61	12.04	55.61	-	-	P	H	
													H	
													H	
													H	
													H	
													H	
													H	
													H	
													H	
													H	
													H	
													H	
													H	
													H	
													H	
													H	
													H	
			10540	47.2	-21	68.2	53.4	40.32	9.88	56.4	-	-	P	V
			15810	45.17	-28.83	74	50.13	38.61	12.04	55.61	-	-	P	V
													V	
													V	
													V	
													V	
													V	
													V	
													V	
													V	
													V	
													V	
													V	
													V	



WIFI Ant. 6+7	Note	Frequency ( MHz )	Level ( dBμV/m )	Margin ( dB )	Limit Line ( dBμV/m )	Read Level (dBμV)	Antenna Factor ( dB/m )	Path Loss ( dB )	Preamp Factor ( dB )	Ant Pos ( cm )	Table Pos ( deg )	Peak Avg. (P/A)	Pol. (H/V)
802.11ax HE40 Full CH 62 5310MHz		10620	46.18	-27.82	74	52.28	40.26	9.93	56.29	-	-	P	H
		15930	45	-29	74	49.7	38.61	12.04	55.35	-	-	P	H
													H
													H
													H
													H
													H
													H
													H
													H
													H
													H
													H
													H
													H
													H
													H
													H
													H
			10620	46.46	-27.54	74	52.56	40.26	9.93	56.29	-	-	P
		15930	45.41	-28.59	74	50.11	38.61	12.04	55.35	-	-	P	V
													V
													V
													V
													V
													V
													V
													V
													V
													V
													V
													V
													V
													V
<b>Remark</b>	<ol style="list-style-type: none"> <li>No other spurious found.</li> <li>All results are PASS against Peak and Average limit line.</li> <li>The emission position marked as "-" means no suspected emission found with sufficient margin against limit line or noise floor only.</li> </ol>												



**Band 2 5250~5350MHz**  
**WIFI 802.11ax HE80 Full (Band Edge @ 3m)**

WIFI Ant. 6+7	Note	Frequency ( MHz )	Level ( dBμV/m )	Margin ( dB )	Limit Line ( dBμV/m )	Read Level (dBμV)	Antenna Factor ( dB/m )	Path Loss ( dB )	Preamp Factor ( dB )	Ant Pos ( cm )	Table Pos ( deg )	Peak Avg. (P/A)	Pol. (H/V)
<b>802.11ax HE80 Full CH 58 5290MHz</b>		5106.42	54.93	-19.07	74	43.15	32.11	6.17	26.5	100	226	P	H
		5104.38	45.89	-8.11	54	34.12	32.11	6.16	26.5	100	226	A	H
	*	5290	99.99	-	-	88.5	31.72	6.3	26.53	100	226	P	H
	*	5290	90.05	-	-	78.56	31.72	6.3	26.53	100	226	A	H
		5354.64	54.02	-19.98	74	42.61	31.63	6.32	26.54	100	226	P	H
		5352	47.52	-6.48	54	36.13	31.61	6.32	26.54	100	226	A	H
		5099.96	55.94	-18.06	74	44.18	32.1	6.16	26.5	100	355	P	V
		5107.44	46.87	-7.13	54	35.1	32.11	6.17	26.51	100	355	A	V
	*	5290	103.18	-	-	91.69	31.72	6.3	26.53	100	355	P	V
	*	5290	93.73	-	-	82.24	31.72	6.3	26.53	100	355	A	V
		5355.36	61.06	-12.94	74	49.65	31.63	6.32	26.54	100	355	P	V
		5350.08	52.84	-1.16	54	41.46	31.6	6.32	26.54	100	355	A	V
<b>Remark</b>	1. No other spurious found. 2. All results are PASS against Peak and Average limit line.												



Band 2 5250~5350MHz

WIFI 802.11ax HE80 Full (Harmonic @ 3m)

WIFI Ant. 6+7	Note	Frequency ( MHz )	Level ( dBμV/m )	Margin ( dB )	Limit Line ( dBμV/m )	Read Level (dBμV)	Antenna Factor ( dB/m )	Path Loss ( dB )	Preamp Factor ( dB )	Ant Pos ( cm )	Table Pos ( deg )	Peak Avg. (P/A)	Pol. (H/V)
802.11ax HE80 Full CH 58 5290MHz		10580	47.54	-20.66	68.2	53.74	40.24	9.91	56.35	-	-	P	H
		15870	45.47	-28.53	74	50.25	38.67	12.03	55.48	-	-	P	H
													H
													H
													H
													H
													H
													H
													H
													H
													H
													H
													H
													H
													H
													H
													H
													H
													H
	Remark	1. No other spurious found. 2. All results are PASS against Peak and Average limit line. 3. The emission position marked as "-" means no suspected emission found with sufficient margin against limit line or noise floor only.											



**Band 3 - 5470~5725MHz**

**WIFI 802.11ax HE20 Full (Band Edge @ 3m)**

WIFI Ant. 6+7	Note	Frequency ( MHz )	Level ( dBµV/m )	Margin ( dB )	Limit Line ( dBµV/m )	Read Level (dBµV)	Antenna Factor ( dB/m )	Path Loss ( dB )	Preamp Factor ( dB )	Ant Pos ( cm )	Table Pos ( deg )	Peak Avg. (P/A)	Pol. (H/V)
802.11ax HE20 Full CH 100 5500MHz		5459.12	57.42	-16.58	74	45.67	31.94	6.36	26.55	100	351	P	H
		5469.84	59.95	-8.25	68.2	48.16	31.98	6.37	26.56	100	351	P	H
		5459.92	48.14	-5.86	54	36.39	31.94	6.36	26.55	100	351	A	H
	*	5500	113.05	-	-	101.12	32.1	6.39	26.56	100	351	P	H
	*	5500	104.63	-	-	92.7	32.1	6.39	26.56	100	351	A	H
		5452.72	56.3	-17.7	74	44.58	31.91	6.36	26.55	400	215	P	V
		5469.84	57.3	-10.9	68.2	45.51	31.98	6.37	26.56	400	215	P	V
		5460	46.18	-7.82	54	34.43	31.94	6.36	26.55	400	215	A	V
	*	5500	110.89	-	-	98.96	32.1	6.39	26.56	400	215	P	V
	*	5500	101.56	-	-	89.63	32.1	6.39	26.56	400	215	A	V
													V
													V
802.11ax HE20 Full CH 116 5580MHz		5457.76	52.93	-21.07	74	41.19	31.93	6.36	26.55	100	4	P	H
		5470	51.89	-16.31	68.2	40.1	31.98	6.37	26.56	100	4	P	H
		5458.48	44.67	-9.33	54	32.93	31.93	6.36	26.55	100	4	A	H
	*	5580	115.68	-	-	103.84	32	6.43	26.59	100	4	P	H
	*	5580	105.76	-	-	93.92	32	6.43	26.59	100	4	A	H
		5727.83	54.89	-13.31	68.2	42.68	32.31	6.55	26.65	100	4	P	H
		5454.64	53.92	-20.08	74	42.19	31.92	6.36	26.55	100	125	P	V
		5467.12	51.4	-16.8	68.2	39.62	31.97	6.37	26.56	100	125	P	V
		5387.44	44.5	-9.5	54	32.89	31.82	6.33	26.54	100	125	A	V
	*	5580	112.3	-	-	100.46	32	6.43	26.59	100	125	P	V
	*	5580	101.87	-	-	90.03	32	6.43	26.59	100	125	A	V
		5753.975	53.1	-15.1	68.2	40.79	32.4	6.57	26.66	100	125	P	V



<b>802.11ax HE20 Full CH 140 5700MHz</b>	*	5700	113.73	-	-	101.64	32.2	6.53	26.64	100	5	P	H
	*	5700	104.92	-	-	92.83	32.2	6.53	26.64	100	5	A	H
		5726.52	61.9	-6.3	68.2	49.69	32.31	6.55	26.65	100	5	P	H
													H
													H
													H
	*	5700	111.63	-	-	99.54	32.2	6.53	26.64	350	210	P	V
	*	5700	101.86	-	-	89.77	32.2	6.53	26.64	350	210	A	V
		5725.88	60.56	-7.64	68.2	48.36	32.3	6.55	26.65	350	210	P	V
													V
												V	
												V	
<b>Remark</b>	1. No other spurious found. 2. All results are PASS against Peak and Average limit line.												



Band 3 5470~5725MHz

WIFI 802.11ax HE20 (Harmonic @ 3m)

WIFI Ant. 6+7	Note	Frequency ( MHz )	Level ( dBμV/m )	Margin ( dB )	Limit Line ( dBμV/m )	Read Level (dBμV)	Antenna Factor ( dB/m )	Path Loss ( dB )	Preamp Factor ( dB )	Ant Pos ( cm )	Table Pos ( deg )	Peak Avg. (P/A)	Pol. (H/V)	
802.11ax HE20 Full CH 100 5500MHz		11000	47.74	-26.26	74	52.65	40.7	10.16	55.77	-	-	P	H	
		16500	46.44	-21.76	68.2	49.54	39.9	12.31	55.31	-	-	P	H	
													H	
													H	
													H	
													H	
													H	
													H	
													H	
													H	
													H	
													H	
													H	
			11000	46.94	-27.06	74	51.85	40.7	10.16	55.77	-	-	P	V
			16500	46.23	-21.97	68.2	49.33	39.9	12.31	55.31	-	-	P	V
														V
														V
														V
													V	
													V	
													V	
													V	





WIFI Ant. 6+7	Note	Frequency ( MHz )	Level ( dBμV/m )	Margin ( dB )	Limit Line ( dBμV/m )	Read Level ( dBμV )	Antenna Factor ( dB/m )	Path Loss ( dB )	Preamp Factor ( dB )	Ant Pos ( cm )	Table Pos ( deg )	Peak Avg. ( P/A )	Pol. ( H/V )
802.11ax HE20 Full CH 116 5580MHz		11160	46.59	-27.41	74	52.18	39.96	10.22	55.77	-	-	P	H
		16740	46.66	-21.54	68.2	49.48	40.26	12.45	55.53	-	-	P	H
													H
													H
													H
													H
													H
													H
													H
													H
													H
													H
													H
													H
													H
													H
													H
													H
													H
			11160	46.94	-27.06	74	52.53	39.96	10.22	55.77	-	-	P
		16740	47.13	-21.07	68.2	49.95	40.26	12.45	55.53	-	-	P	V
													V
													V
													V
													V
													V
													V
													V
													V
													V
													V
													V
													V
													V
													V
													V



WIFI Ant. 6+7	Note	Frequency ( MHz )	Level ( dBμV/m )	Margin ( dB )	Limit Line ( dBμV/m )	Read Level ( dBμV )	Antenna Factor ( dB/m )	Path Loss ( dB )	Preamp Factor ( dB )	Ant Pos ( cm )	Table Pos ( deg )	Peak Avg. ( P/A )	Pol. ( H/V )
802.11ax HE20 Full CH 140 5700MHz		11400	47.21	-26.79	74	52.76	39.9	10.33	55.78	-	-	P	H
		17100	48.37	-19.83	68.2	51.21	40.4	12.71	55.95	-	-	P	H
													H
													H
													H
													H
													H
													H
													H
													H
													H
													H
													H
													H
													H
													H
													H
													H
													H
	Remark	1. No other spurious found. 2. All results are PASS against Peak and Average limit line. 3. The emission position marked as "-" means no suspected emission found with sufficient margin against limit line or noise floor only.											



**Band 3 5470~5725MHz**  
**WIFI 802.11ax HE40 Full (Band Edge @ 3m)**

WIFI Ant. 6+7	Note	Frequency ( MHz )	Level ( dBμV/m )	Margin ( dB )	Limit Line ( dBμV/m )	Read Level ( dBμV )	Antenna Factor ( dB/m )	Path Loss ( dB )	Preamp Factor ( dB )	Ant Pos ( cm )	Table Pos ( deg )	Peak Avg. ( P/A )	Pol. ( H/V )
802.11ax HE40 Full CH 102 5510MHz		5456.32	59.83	-14.17	74	48.09	31.93	6.36	26.55	100	356	P	H
		5467.6	65.68	-2.52	68.2	53.9	31.97	6.37	26.56	100	356	P	H
		5458.72	51.01	-2.99	54	39.27	31.93	6.36	26.55	100	356	A	H
	*	5510	110.15	-	-	98.24	32.08	6.39	26.56	100	356	P	H
	*	5510	98.9	-	-	86.99	32.08	6.39	26.56	100	356	A	H
		5764.685	55.34	-12.86	68.2	43.03	32.4	6.58	26.67	100	356	P	H
		5455.6	58.18	-15.82	74	46.45	31.92	6.36	26.55	397	214	P	V
		5469.04	60	-8.2	68.2	48.21	31.98	6.37	26.56	397	214	P	V
		5459.2	48.46	-5.54	54	36.71	31.94	6.36	26.55	397	214	A	V
	*	5510	107.79	-	-	95.88	32.08	6.39	26.56	397	214	P	V
	*	5510	98.08	-	-	86.17	32.08	6.39	26.56	397	214	A	V
	5728.775	53.61	-14.59	68.2	41.39	32.32	6.55	26.65	397	214	P	V	
802.11ax HE40 Full CH 110 5550MHz		5456.08	58.05	-15.95	74	46.32	31.92	6.36	26.55	100	2	P	H
		5467.6	59.98	-8.22	68.2	48.2	31.97	6.37	26.56	100	2	P	H
		5458.96	49.57	-4.43	54	37.82	31.94	6.36	26.55	100	2	A	H
	*	5550	115.38	-	-	103.55	32	6.41	26.58	100	2	P	H
	*	5550	103.87	-	-	92.04	32	6.41	26.58	100	2	A	H
		5736.965	57.62	-10.58	68.2	45.36	32.35	6.56	26.65	100	2	P	H
		5458.48	56.28	-17.72	74	44.54	31.93	6.36	26.55	100	124	P	V
		5464.72	57.25	-10.95	68.2	45.48	31.96	6.37	26.56	100	124	P	V
		5459.44	46.88	-7.12	54	35.13	31.94	6.36	26.55	100	124	A	V
	*	5550	111.2	-	-	99.37	32	6.41	26.58	100	124	P	V
	*	5550	100.66	-	-	88.83	32	6.41	26.58	100	124	A	V
	5732.87	53.91	-14.29	68.2	41.68	32.33	6.55	26.65	100	124	P	V	



<b>802.11ax</b> <b>HE40 Full</b> <b>CH 134</b> <b>5670MHz</b>		5458.15	55.89	-18.11	74	44.15	31.93	6.36	26.55	103	3	P	H
		5464.1	55.84	-12.36	68.2	44.06	31.96	6.37	26.55	103	3	P	H
		5459.9	47.12	-6.88	54	35.37	31.94	6.36	26.55	103	3	A	H
	*	5670	111.86	-	-	99.97	32.02	6.5	26.63	103	3	P	H
	*	5670	102.45	-	-	90.56	32.02	6.5	26.63	103	3	A	H
		5730.98	66.5	-1.7	68.2	54.28	32.32	6.55	26.65	103	3	P	H
		5434.35	55.57	-18.43	74	43.87	31.9	6.35	26.55	392	216	P	V
		5463.75	54.83	-13.37	68.2	43.06	31.95	6.37	26.55	392	216	P	V
		5452.55	46.43	-7.57	54	34.71	31.91	6.36	26.55	392	216	A	V
	*	5670	110.66	-	-	98.77	32.02	6.5	26.63	392	216	P	V
	*	5670	100.72	-	-	88.83	32.02	6.5	26.63	392	216	A	V
		5730.35	61.82	-6.38	68.2	49.6	32.32	6.55	26.65	392	216	P	V
<b>Remark</b>	1. No other spurious found. 2. All results are PASS against Peak and Average limit line.												



Band 3 5470~5725MHz

WIFI 802.11ax HE40 Full (Harmonic @ 3m)

WIFI Ant. 6+7	Note	Frequency ( MHz )	Level ( dBμV/m )	Margin ( dB )	Limit Line ( dBμV/m )	Read Level ( dBμV )	Antenna Factor ( dB/m )	Path Loss ( dB )	Preamp Factor ( dB )	Ant Pos ( cm )	Table Pos ( deg )	Peak Avg. ( P/A )	Pol. ( H/V )	
802.11ax HE40 Full CH 102 5510MHz		11020	47.95	-26.05	74	52.96	40.6	10.16	55.77	-	-	P	H	
		16530	46.69	-21.51	68.2	49.83	39.87	12.33	55.34	-	-	P	H	
													H	
													H	
													H	
													H	
													H	
													H	
													H	
													H	
													H	
													H	
													H	
													H	
													H	
													H	
			11020	48.06	-25.94	74	53.07	40.6	10.16	55.77	-	-	P	V
			16530	47.7	-20.5	68.2	50.84	39.87	12.33	55.34	-	-	P	V
													V	
													V	
													V	
													V	
													V	
													V	
													V	
													V	
													V	
													V	
													V	
													V	



WIFI Ant. 6+7	Note	Frequency ( MHz )	Level ( dBμV/m )	Margin ( dB )	Limit Line ( dBμV/m )	Read Level ( dBμV )	Antenna Factor ( dB/m )	Path Loss ( dB )	Preamp Factor ( dB )	Ant Pos ( cm )	Table Pos ( deg )	Peak Avg. (P/A)	Pol. (H/V)
802.11ax HE40 Full CH 110 5550MHz		11100	46.29	-27.71	74	51.66	40.2	10.2	55.77	-	-	P	H
		16650	46.82	-21.38	68.2	49.92	39.95	12.4	55.45	-	-	P	H
													H
													H
													H
													H
													H
													H
													H
													H
													H
													H
													H
													H
													H
													H
													H
													H
													H
			11100	47.97	-26.03	74	53.34	40.2	10.2	55.77	-	-	P
		16650	46.7	-21.5	68.2	49.8	39.95	12.4	55.45	-	-	P	V
													V
													V
													V
													V
													V
													V
													V
													V
													V
													V
													V
													V
													V
													V



WIFI Ant. 6+7	Note	Frequency ( MHz )	Level ( dBμV/m )	Margin ( dB )	Limit Line ( dBμV/m )	Read Level ( dBμV )	Antenna Factor ( dB/m )	Path Loss ( dB )	Preamp Factor ( dB )	Ant Pos ( cm )	Table Pos ( deg )	Peak Avg. ( P/A )	Pol. ( H/V )	
802.11ax HE40 Full CH 134 5670MHz		11340	46.84	-27.16	74	52.53	39.78	10.31	55.78	-	-	P	H	
		17010	48.82	-19.38	68.2	51.51	40.49	12.61	55.79	-	-	P	H	
													H	
													H	
													H	
													H	
													H	
													H	
													H	
													H	
													H	
													H	
													H	
													H	
													H	
													H	
													H	
													H	
	802.11ax HE40 Full CH 134 5670MHz		11340	46.89	-27.11	74	52.58	39.78	10.31	55.78	-	-	P	V
			17010	48.98	-19.22	68.2	51.67	40.49	12.61	55.79	-	-	P	V
													V	
													V	
													V	
													V	
													V	
													V	
													V	
													V	
Remark	<ol style="list-style-type: none"> <li>No other spurious found.</li> <li>All results are PASS against Peak and Average limit line.</li> <li>The emission position marked as "-" means no suspected emission found with sufficient margin against limit line or noise floor only.</li> </ol>													



**Band 3 5470~5725MHz**  
**WIFI 802.11ax HE80 Full (Band Edge @ 3m)**

WIFI Ant. 6+7	Note	Frequency ( MHz )	Level ( dBμV/m )	Margin ( dB )	Limit Line ( dBμV/m )	Read Level (dBμV)	Antenna Factor ( dB/m )	Path Loss ( dB )	Preamp Factor ( dB )	Ant Pos ( cm )	Table Pos ( deg )	Peak Avg. (P/A)	Pol. (H/V)
802.11ax HE80 Full CH 106 5530MHz		5449.6	56.75	-17.25	74	45.04	31.9	6.36	26.55	100	230	P	H
		5469.04	58.27	-9.93	68.2	46.48	31.98	6.37	26.56	100	230	P	H
		5459.92	47.32	-6.68	54	35.57	31.94	6.36	26.55	100	230	A	H
	*	5530	100.3	-	-	88.43	32.04	6.4	26.57	100	230	P	H
	*	5530	90.9	-	-	79.03	32.04	6.4	26.57	100	230	A	H
		5735.705	54.92	-13.28	68.2	42.67	32.34	6.56	26.65	100	230	P	H
		5459.92	60.62	-13.38	74	48.87	31.94	6.36	26.55	100	351	P	V
		5469.04	63.64	-4.56	68.2	51.85	31.98	6.37	26.56	100	351	P	V
		5459.92	51.26	-2.74	54	39.51	31.94	6.36	26.55	100	351	A	V
	*	5530	104.46	-	-	92.59	32.04	6.4	26.57	100	351	P	V
	*	5530	94.41	-	-	82.54	32.04	6.4	26.57	100	351	A	V
	5731.925	56.58	-11.62	68.2	44.35	32.33	6.55	26.65	100	351	P	V	
802.11ax HE80 Full CH 122 5610MHz		5458.5	60.62	-13.38	74	48.88	31.93	6.36	26.55	296	214	P	H
		5462.7	59.91	-8.29	68.2	48.15	31.95	6.36	26.55	296	214	P	H
		5451.5	52.26	-1.74	54	40.54	31.91	6.36	26.55	296	214	A	H
	*	5610	108.89	-	-	97.06	31.98	6.45	26.6	296	214	P	H
	*	5610	97.79	-	-	85.96	31.98	6.45	26.6	296	214	A	H
		5733.815	62.07	-6.13	68.2	49.83	32.34	6.55	26.65	296	214	P	H
		5445.2	59.6	-14.4	74	47.9	31.9	6.35	26.55	205	90	P	V
		5464.45	59.03	-9.17	68.2	47.26	31.96	6.37	26.56	205	90	P	V
		5449.4	50.46	-3.54	54	38.75	31.9	6.36	26.55	205	90	A	V
	*	5610	108.95	-	-	97.12	31.98	6.45	26.6	205	90	P	V
	*	5610	98.73	-	-	86.9	31.98	6.45	26.6	205	90	A	V
	5726.57	62.58	-5.62	68.2	50.37	32.31	6.55	26.65	205	90	P	V	
Remark	1. No other spurious found. 2. All results are PASS against Peak and Average limit line.												





Band 3 5470~5725MHz

WIFI 802.11ax HE80 Full (Harmonic @ 3m)

WIFI Ant. 6+7	Note	Frequency ( MHz )	Level ( dBμV/m )	Margin ( dB )	Limit Line ( dBμV/m )	Read Level (dBμV)	Antenna Factor ( dB/m )	Path Loss ( dB )	Preamp Factor ( dB )	Ant Pos ( cm )	Table Pos ( deg )	Peak Avg. (P/A)	Pol. (H/V)	
802.11ax HE80 Full CH 106 5530MHz		11060	48.18	-25.82	74	53.37	40.4	10.18	55.77	-	-	P	H	
		16590	47.83	-20.37	68.2	51.05	39.81	12.36	55.39	-	-	P	H	
													H	
													H	
													H	
													H	
													H	
													H	
													H	
													H	
													H	
													H	
			11060	47.63	-26.37	74	52.82	40.4	10.18	55.77	-	-	P	V
			16590	47.66	-20.54	68.2	50.88	39.81	12.36	55.39	-	-	P	V
														V
														V
														V
														V
													V	
													V	
													V	
													V	



WIFI Ant. 6+7	Note	Frequency ( MHz )	Level ( dBμV/m )	Margin ( dB )	Limit Line ( dBμV/m )	Read Level ( dBμV )	Antenna Factor ( dB/m )	Path Loss ( dB )	Preamp Factor ( dB )	Ant Pos ( cm )	Table Pos ( deg )	Peak Avg. ( P/A )	Pol. ( H/V )	
802.11ax HE80 Full CH 122 5610MHz		11220	47.02	-26.98	74	52.76	39.78	10.25	55.77	-	-	P	H	
		16830	48.27	-19.93	68.2	50.85	40.53	12.5	55.61	-	-	P	H	
													H	
													H	
													H	
													H	
													H	
													H	
													H	
													H	
													H	
													H	
													H	
													H	
													H	
													H	
													H	
			11220	47.41	-26.59	74	53.15	39.78	10.25	55.77	-	-	P	V
			16830	47.89	-20.31	68.2	50.47	40.53	12.5	55.61	-	-	P	V
														V
													V	
													V	
													V	
													V	
													V	
													V	
													V	
													V	
													V	
													V	
<b>Remark</b>	1. No other spurious found.													
	2. All results are PASS against Peak and Average limit line.													
	3. The emission position marked as "-" means no suspected emission found with sufficient margin against limit line or noise floor only.													



**Band 3 - Straddle Channel**

**WIFI 802.11ax HE20 Full (Band Edge @ 3m)**

WIFI	Note	Frequency	Level	Margin	Limit	Read	Antenna	Path	Preamp	Ant	Table	Peak	Pol.
Ant.					Line	Level	Factor	Loss	Factor	Pos	Pos	Avg.	
6+7		( MHz )	( dBμV/m )	( dB )	( dBμV/m )	( dBμV )	( dB/m )	( dB )	( dB )	( cm )	( deg )	( P/A )	( H/V )
802.11ax HE20 Full CH 144 5720MHz		5454.13	52.01	-21.99	74	40.28	31.92	6.36	26.55	101	5	P	H
		5468.56	51.57	-16.63	68.2	39.79	31.97	6.37	26.56	101	5	P	H
		5458.42	42.93	-11.07	54	31.19	31.93	6.36	26.55	101	5	A	H
	*	5720	115.95	-	-	103.78	32.28	6.54	26.65	101	5	P	H
	*	5720	106.1	-	-	93.93	32.28	6.54	26.65	101	5	A	H
		5858.5	54.99	-13.21	68.2	42.51	32.53	6.65	26.7	101	5	P	H
		5438.14	51.93	-22.07	74	40.23	31.9	6.35	26.55	100	130	P	V
		5461.15	51.65	-16.55	68.2	39.9	31.94	6.36	26.55	100	130	P	V
		5457.25	42.59	-11.41	54	30.85	31.93	6.36	26.55	100	130	A	V
	*	5720	111.04	-	-	98.87	32.28	6.54	26.65	100	130	P	V
	*	5720	101.87	-	-	89.7	32.28	6.54	26.65	100	130	A	V
		5908	54.21	-13.99	68.2	41.53	32.72	6.68	26.72	100	130	P	V
<b>Remark</b>	1. No other spurious found. 2. All results are PASS against Peak and Average limit line.												



**Band 3 - Straddle Channel**  
**WIFI 802.11ax HE20 Full (Harmonic @ 3m)**

WIFI Ant. 6+7	Note	Frequency ( MHz )	Level ( dBμV/m )	Margin ( dB )	Limit Line ( dBμV/m )	Read Level (dBμV)	Antenna Factor ( dB/m )	Path Loss ( dB )	Preamp Factor ( dB )	Ant Pos ( cm )	Table Pos ( deg )	Peak Avg. (P/A)	Pol. (H/V)	
802.11ax HE20 Full CH 144 5720MHz		11440	47.34	-26.66	74	52.75	40.02	10.35	55.78	-	-	P	H	
		17160	48.88	-19.32	68.2	51.7	40.46	12.78	56.06	-	-	P	H	
													H	
													H	
													H	
													H	
													H	
													H	
													H	
													H	
													H	
													H	
													H	
													H	
													H	
													H	
													H	
													H	
			11440	47.04	-26.96	74	52.45	40.02	10.35	55.78	-	-	P	V
			17160	49.85	-18.35	68.2	52.67	40.46	12.78	56.06	-	-	P	V
													V	
													V	
													V	
													V	
													V	
													V	
													V	
													V	
													V	
													V	
													V	
<b>Remark</b>	<ol style="list-style-type: none"> <li>No other spurious found.</li> <li>All results are PASS against Peak and Average limit line.</li> <li>The emission position marked as "-" means no suspected emission found with sufficient margin against limit line or noise floor only.</li> </ol>													



**Band 3 - Straddle Channel**  
**WIFI 802.11ax HE40 Full (Band Edge @ 3m)**

WIFI Ant. 6+7	Note	Frequency ( MHz )	Level ( dBμV/m )	Margin ( dB )	Limit Line ( dBμV/m )	Read Level ( dBμV )	Antenna Factor ( dB/m )	Path Loss ( dB )	Preamp Factor ( dB )	Ant Pos ( cm )	Table Pos ( deg )	Peak Avg. ( P/A )	Pol. ( H/V )
<b>802.11ax HE40 Full CH 142 5710MHz</b>		5456.47	55.97	-18.03	74	44.23	31.93	6.36	26.55	100	11	P	H
		5470	55.69	-12.51	68.2	43.9	31.98	6.37	26.56	100	11	P	H
		5458.81	45.9	-8.1	54	34.15	31.94	6.36	26.55	100	11	A	H
	*	5710	115.06	-	-	102.93	32.24	6.53	26.64	100	11	P	H
	*	5710	104.15	-	-	92.02	32.24	6.53	26.64	100	11	A	H
		5907.75	58.58	-9.62	68.2	45.9	32.72	6.68	26.72	100	11	P	H
		5417.47	52.92	-21.08	74	41.23	31.9	6.34	26.55	100	129	P	V
		5465.83	54.84	-13.36	68.2	43.07	31.96	6.37	26.56	100	129	P	V
		5459.59	44.57	-9.43	54	32.82	31.94	6.36	26.55	100	129	A	V
	*	5710	109.93	-	-	97.8	32.24	6.53	26.64	100	129	P	V
	*	5710	100.19	-	-	88.06	32.24	6.53	26.64	100	129	A	V
		5856.25	55.43	-12.77	68.2	42.95	32.53	6.65	26.7	100	129	P	V
<b>Remark</b>	1. No other spurious found. 2. All results are PASS against Peak and Average limit line.												



**Band 3 - Straddle Channel**  
**WIFI 802.11ax HE40 Full (Harmonic @ 3m)**

WIFI Ant. 6+7	Note	Frequency ( MHz )	Level ( dBμV/m )	Margin ( dB )	Limit Line ( dBμV/m )	Read Level ( dBμV )	Antenna Factor ( dB/m )	Path Loss ( dB )	Preamp Factor ( dB )	Ant Pos ( cm )	Table Pos ( deg )	Peak Avg. ( P/A )	Pol. ( H/V )	
802.11ax HE40 Full CH 142 5710MHz		11420	46.82	-27.18	74	52.3	39.96	10.34	55.78	-	-	P	H	
		17130	49.42	-18.78	68.2	52.26	40.43	12.74	56.01	-	-	P	H	
													H	
													H	
													H	
													H	
													H	
													H	
													H	
													H	
													H	
													H	
													H	
													H	
													H	
													H	
													H	
													H	
			11420	47.52	-26.48	74	53	39.96	10.34	55.78	-	-	P	V
			17130	49.16	-19.04	68.2	52	40.43	12.74	56.01	-	-	P	V
													V	
													V	
													V	
													V	
													V	
													V	
													V	
													V	
													V	
													V	
													V	
<b>Remark</b>	<ol style="list-style-type: none"> <li>No other spurious found.</li> <li>All results are PASS against Peak and Average limit line.</li> <li>The emission position marked as "-" means no suspected emission found with sufficient margin against limit line or noise floor only.</li> </ol>													



**Band 3 Straddle Channel  
WIFI 802.11ax HE80 Full (Band Edge @ 3m)**

WIFI Ant. 6+7	Note	Frequency ( MHz )	Level ( dBμV/m )	Margin ( dB )	Limit Line ( dBμV/m )	Read Level (dBμV)	Antenna Factor ( dB/m )	Path Loss ( dB )	Preamp Factor ( dB )	Ant Pos ( cm )	Table Pos ( deg )	Peak Avg. (P/A)	Pol. (H/V)
<b>802.11ax HE80 Full CH 138 5690MHz</b>		5457.64	61.21	-12.79	74	49.47	31.93	6.36	26.55	293	213	P	H
		5465.83	61.33	-6.87	68.2	49.56	31.96	6.37	26.56	293	213	P	H
		5459.59	52.33	-1.67	54	40.58	31.94	6.36	26.55	293	213	A	H
	*	5690	110.5	-	-	98.48	32.14	6.52	26.64	293	213	P	H
	*	5690	100.11	-	-	88.09	32.14	6.52	26.64	293	213	A	H
		5866.3	61.32	-6.88	68.2	48.81	32.57	6.65	26.71	293	213	P	H
		5457.64	58.51	-15.49	74	46.77	31.93	6.36	26.55	154	317	P	V
		5463.49	59.48	-8.72	68.2	47.72	31.95	6.36	26.55	154	317	P	V
		5459.98	49.46	-4.54	54	37.71	31.94	6.36	26.55	154	317	A	V
	*	5690	109.8	-	-	97.78	32.14	6.52	26.64	154	317	P	V
*	5690	98.98	-	-	86.96	32.14	6.52	26.64	154	317	A	V	
		5884.3	59.02	-9.18	68.2	46.43	32.64	6.66	26.71	154	317	P	V
<b>Remark</b>	1. No other spurious found. 2. All results are PASS against Peak and Average limit line.												



**Band 3 - Straddle Channel**  
**WIFI 802.11ax HE80 Full (Harmonic @ 3m)**

WIFI Ant. 6+7	Note	Frequency ( MHz )	Level ( dBμV/m )	Margin ( dB )	Limit Line ( dBμV/m )	Read Level (dBμV)	Antenna Factor ( dB/m )	Path Loss ( dB )	Preamp Factor ( dB )	Ant Pos ( cm )	Table Pos ( deg )	Peak Avg. (P/A)	Pol. (H/V)	
802.11ax HE80 Full CH 138 5690MHz		11380	46.35	-27.65	74	51.95	39.86	10.32	55.78	-	-	P	H	
		17070	48.58	-19.62	68.2	51.37	40.43	12.68	55.9	-	-	P	H	
													H	
													H	
													H	
													H	
													H	
													H	
													H	
													H	
													H	
													H	
													H	
													H	
													H	
													H	
													H	
													H	
			11380	46.9	-27.1	74	52.5	39.86	10.32	55.78	-	-	P	V
			17070	48.26	-19.94	68.2	51.05	40.43	12.68	55.9	-	-	P	V
													V	
													V	
													V	
													V	
													V	
													V	
													V	
													V	
													V	
													V	
													V	
<b>Remark</b>	<ol style="list-style-type: none"> <li>No other spurious found.</li> <li>All results are PASS against Peak and Average limit line.</li> <li>The emission position marked as "-" means no suspected emission found with sufficient margin against limit line or noise floor only.</li> </ol>													





Emission below 1GHz  
WIFI 802.11ax HE80 Full (LF @ 3m)

WIFI	Note	Frequency	Level	Margin	Limit	Read	Antenna	Path	Preamp	Ant	Table	Peak	Pol.	
Ant.					Line	Level	Factor	Loss	Factor	Pos	Pos	Avg.		
6+7		( MHz )	( dBμV/m )	( dB )	( dBμV/m )	( dBμV )	( dB/m )	( dB )	( dB )	( cm )	( deg )	( P/A )	( H/V )	
802.11ax HE80 Full LF		83.35	28.91	-11.09	40	46.48	13.76	0.98	32.31	-	-	P	H	
		149.31	27.9	-15.6	43.5	41.82	17.17	1.2	32.29	-	-	P	H	
		351.07	29.33	-16.67	46	39.42	20.34	1.72	32.15	-	-	P	H	
		852.56	30.95	-15.05	46	31.39	28.73	2.6	31.77	-	-	P	H	
		942.77	32.2	-13.8	46	31.01	29.82	2.55	31.18	-	-	P	H	
		969.93	32.39	-21.61	54	29.79	30.93	2.6	30.93	-	-	P	H	
														H
														H
														H
														H
														H
														H
			30.97	22.31	-17.69	40	30.09	23.85	0.72	32.35	-	-	P	V
			120.21	23.57	-19.93	43.5	37.24	17.5	1.13	32.3	-	-	P	V
			334.58	30.31	-15.69	46	40.96	19.83	1.68	32.16	-	-	P	V
			758.47	29.74	-16.26	46	31.81	27.72	2.34	32.13	-	-	P	V
			909.79	31.45	-14.55	46	31.72	28.64	2.54	31.45	-	-	P	V
			974.78	33.17	-20.83	54	30.66	30.8	2.6	30.89	-	-	P	V
														V
														V
													V	
													V	
													V	
													V	

**Remark**

- No other spurious found.
- All results are PASS against limit line.
- The emission position marked as “-” means no suspected emission found and emission level has at least 6dB margin against limit or emission is noise floor only.



**Note symbol**

*	<b>Fundamental Frequency</b> which can be ignored. However, the level of any unwanted emissions shall not exceed the level of the fundamental frequency.
!	Test result is <b>over limit</b> line.
P/A	<b>Peak</b> or <b>Average</b>
H/V	<b>Horizontal</b> or <b>Vertical</b>



A calculation example for radiated spurious emission is shown as below:

WIFI	Note	Frequency	Level	Margin	Limit	Read	Antenna	Path	Preamp	Ant	Table	Peak	Pol.
Ant.		( MHz )	( dBμV/m )	( dB )	( dBμV/m )	( dBμV )	( dB/m )	( dB )	( dB )	( cm )	( deg )	( P/A )	( H/V )
6+7													
802.11a		5150	55.45	-18.55	74	54.51	32.22	4.58	35.86	103	308	P	H
CH 36													
5180MHz		5150	43.54	-10.46	54	42.6	32.22	4.58	35.86	103	308	A	H

1. Path Loss(dB) = Cable loss(dB) + Filter loss(dB) + Attenuator loss(dB)
2. Level(dBμV/m) = Antenna Factor(dB/m) + Path Loss(dB) + Read Level(dBμV) - Preamp Factor(dB)
3. Over Limit(dB) = Level(dBμV/m) – Limit Line(dBμV/m)

**For Peak Limit @ 5150MHz:**

1. Level(dBμV/m)  
= Antenna Factor(dB/m) + Path Loss(dB) + Read Level(dBμV) - Preamp Factor(dB)  
= 32.22(dB/m) + 4.58(dB) + 54.51(dBμV) – 35.86 (dB)  
= 55.45 (dBμV/m)
2. Over Limit(dB)  
= Level(dBμV/m) – Limit Line(dBμV/m)  
= 55.45(dBμV/m) – 74(dBμV/m)  
= -18.55(dB)

**For Average Limit @ 5150MHz:**

1. Level(dBμV/m)  
= Antenna Factor(dB/m) + Path Loss(dB) + Read Level(dBμV) - Preamp Factor(dB)  
= 32.22(dB/m) + 4.58(dB) + 42.6(dBμV) – 35.86 (dB)  
= 43.54 (dBμV/m)
2. Over Limit(dB) = Level(dBμV/m) – Limit Line(dBμV/m)  
= 43.54(dBμV/m) – 54(dBμV/m)  
= -10.46(dB)

**Both peak and average measured complies with the limit line, so test result is “PASS”.**



## Appendix C. Radiated Spurious Emission Plots

Test Engineer :	Yuan Lee, Jacky Hong, Peter Liao and Rain Lee	Temperature :	20~25°C
		Relative Humidity :	40~60%

### Note symbol

-L	Low channel location
-R	High channel location



<CDD Mode>

**Band 1 - 5150~5250MHz**  
**WIFI 802.11a (Band Edge @ 3m)**

WIFI	Band 1 5150~5250MHz Band Edge @ 3m	
ANT	802.11a CH36 5180MHz	
6+7	Horizontal	Fundamental
<b>Peak</b>	<p>Site : 03CH13-HY Condition : PEAK_BE_74 3m HORN_91200_1241 HORIZONTAL : RBW:1000.000KHz VBW:3000.000KHz SWT:Auto</p>	<p>Site : 03CH13-HY Condition : PEAK(FUND) 3m HORN_91200_1241 HORIZONTAL : RBW:1000.000KHz VBW:3000.000KHz SWT:Auto</p>
<b>Avg.</b>	<p>Site : 03CH13-HY Condition : AVG_BE_54 3m HORN_91200_1241 HORIZONTAL : RBW:1000.000KHz VBW:1.000KHz SWT:Auto</p>	Left blank

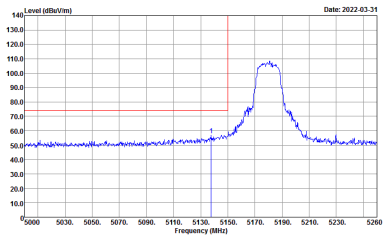
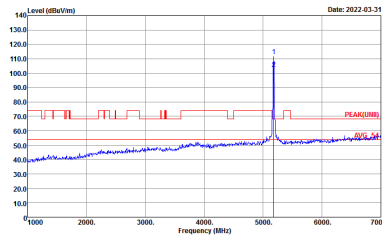
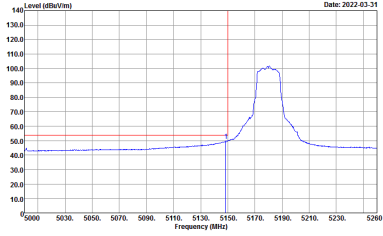

WIFI	Band 1 5150~5250MHz Band Edge @ 3m	
ANT	802.11a CH36 5180MHz	
6+7	Vertical	Fundamental
<p><b>Peak</b></p>	 <p>Site : 03CH13-HY Condition : PEAK_BE_74 3m HORN_91200_1241 VERTICAL : RBW:1000.000KHz VBW:3000.000KHz SWT:Auto</p>	 <p>Site : 03CH13-HY Condition : PEAK(LINE) 3m HORN_91200_1241 VERTICAL : RBW:1000.000KHz VBW:3000.000KHz SWT:Auto</p>
<p><b>Avg.</b></p>	 <p>Site : 03CH13-HY Condition : AV6_BE_54 3m HORN_91200_1241 VERTICAL : RBW:1000.000KHz VBW:1000KHz SWT:Auto</p>	<p><b>Left blank</b></p>

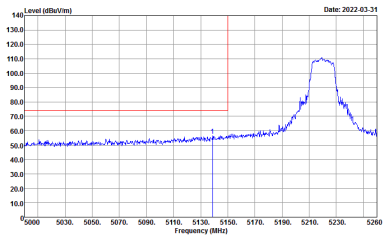
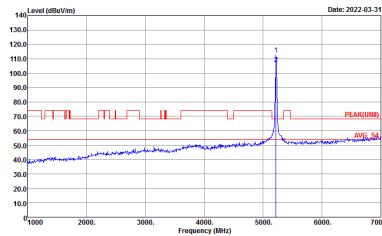
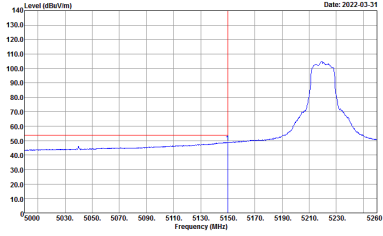

WIFI	Band 1 5150~5250MHz Band Edge @ 3m	
ANT	802.11a CH44 5220MHz - L	
6+7	Horizontal	Fundamental
Peak	 <p>Site : 03CH13-HY Condition : PEAK_BE_74 3m HORN_91200_1241 HORIZONTAL : RBW:1000.000KHz VBW:3000.000KHz SWT:Auto</p>	 <p>Site : 03CH13-HY Condition : PEAK(LINE) 3m HORN_91200_1241 HORIZONTAL : RBW:1000.000KHz VBW:3000.000KHz SWT:Auto</p>
Avg.	 <p>Site : 03CH13-HY Condition : AV6_BE_54 3m HORN_91200_1241 HORIZONTAL : RBW:1000.000KHz VBW:1.000KHz SWT:Auto</p>	Left blank

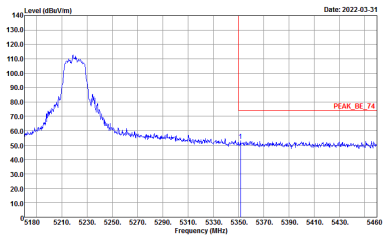
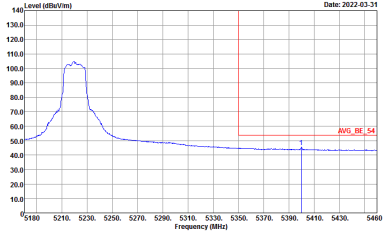

WIFI	Band 1 5150~5250MHz Band Edge @ 3m	
ANT	802.11a CH44 5220MHz - R	
6+7	Horizontal	Fundamental
<p><b>Peak</b></p>	 <p>Site : 03CH13-HY Condition : PEAK_BE_74 3m HORN_91200_1241 HORIZONTAL : RBW:1000.000kHz VBW:3000.000kHz SWT:Auto</p>	<p>Left blank</p>
<p><b>Avg.</b></p>	 <p>Site : 03CH13-HY Condition : AVG_BE_54 3m HORN_91200_1241 HORIZONTAL : RBW:1000.000kHz VBW:10000kHz SWT:Auto</p>	<p>Left blank</p>



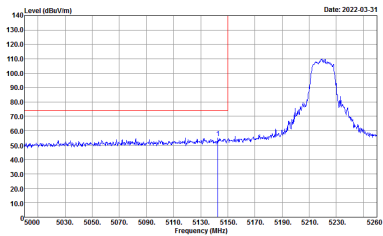
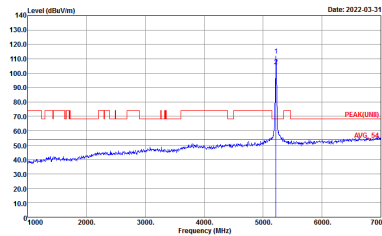
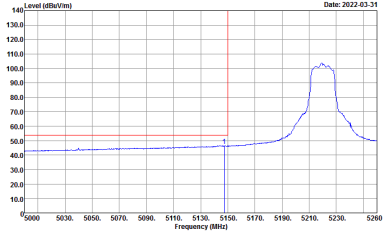

WIFI	Band 1 5150~5250MHz Band Edge @ 3m	
ANT	802.11a CH44 5220MHz - L	
6+7	Vertical	Fundamental
Peak	 <p>Site : 03CH13-HY Condition : PEAK_BE_74 3m HORN_91200_1241 VERTICAL : RBW:1000.000KHz VBW:3000.000KHz SWT:Auto</p>	 <p>Site : 03CH13-HY Condition : PEAK(LINE) 3m HORN_91200_1241 VERTICAL : RBW:1000.000KHz VBW:3000.000KHz SWT:Auto</p>
Avg.	 <p>Site : 03CH13-HY Condition : AV6_BE_54 3m HORN_91200_1241 VERTICAL : RBW:1000.000KHz VBW:1000KHz SWT:Auto</p>	Left blank



WIFI	Band 1 5150~5250MHz Band Edge @ 3m	
ANT	802.11a CH44 5220MHz - R	
6+7	Vertical	Fundamental
<p><b>Peak</b></p>	<p>Site : 03CH13-HY Condition : PEAK_BE_74 3m HORN_91200_1241 VERTICAL : RBW:1000.000kHz VBW:3000.000kHz SWT:Auto</p>	<p>Left blank</p>
<p><b>Avg.</b></p>	<p>Site : 03CH13-HY Condition : AVG_BE_54 3m HORN_91200_1241 VERTICAL : RBW:1000.000kHz VBW:1.000kHz SWT:Auto</p>	<p>Left blank</p>

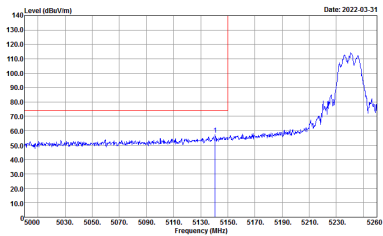
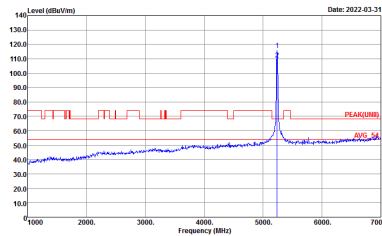
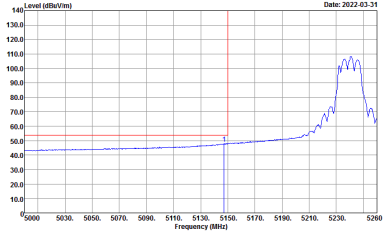

WIFI	Band 1 5150~5250MHz Band Edge @ 3m	
ANT	802.11a CH48 5240MHz - L	
6+7	Horizontal	Fundamental
Peak	 <p>Site : 03CH13-HY Condition : PEAK_BE_74 3m HORN_91200_1241 HORIZONTAL : RBW:1000.000kHz VBW:3000.000kHz SWT:Auto</p>	 <p>Site : 03CH13-HY Condition : PEAK(LINE) 3m HORN_91200_1241 HORIZONTAL : RBW:1000.000kHz VBW:3000.000kHz SWT:Auto</p>
Avg.	 <p>Site : 03CH13-HY Condition : AV6_BE_54 3m HORN_91200_1241 HORIZONTAL : RBW:1000.000kHz VBW:10000kHz SWT:Auto</p>	Left blank



WIFI	Band 1 5150~5250MHz Band Edge @ 3m	
ANT	802.11a CH48 5240MHz - R	
6+7	Horizontal	Fundamental
Peak	<p>Site : 03CH13-HY Condition : PEAK_BE_74 3m HORN_91200_1241 HORIZONTAL : RBW:1000.000kHz VBW:3000.000kHz SWT:Auto</p>	Left blank
Avg.	<p>Site : 03CH13-HY Condition : AVG_BE_54 3m HORN_91200_1241 HORIZONTAL : RBW:1000.000kHz VBW:10000kHz SWT:Auto</p>	Left blank

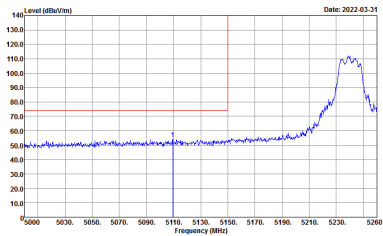
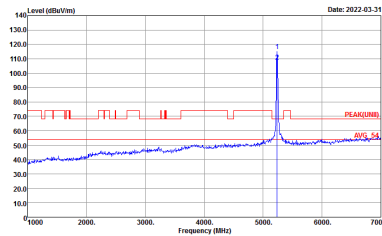
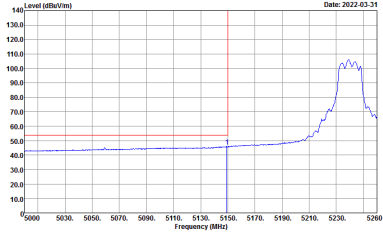

WIFI	Band 1 5150~5250MHz Band Edge @ 3m	
ANT	802.11a CH48 5240MHz - L	
6+7	Vertical	Fundamental
Peak	 <p>Site : 03CH13-HY Condition : PEAK_BE_74 3m HORN_91200_1241 VERTICAL : RBW:1000.000KHz VBW:3000.000KHz SWT:Auto</p>	 <p>Site : 03CH13-HY Condition : PEAK(LINE) 3m HORN_91200_1241 VERTICAL : RBW:1000.000KHz VBW:3000.000KHz SWT:Auto</p>
Avg.	 <p>Site : 03CH13-HY Condition : AV6_BE_54 3m HORN_91200_1241 VERTICAL : RBW:1000.000KHz VBW:1000KHz SWT:Auto</p>	Left blank



WIFI	Band 1 5150~5250MHz Band Edge @ 3m	
ANT	802.11a CH48 5240MHz - R	
6+7	Vertical	Fundamental
<p><b>Peak</b></p>	<p>Site : 03CH13-HY Condition : PEAK_BE_74 3m HORN_91200_1241 VERTICAL : RBW:1000.000KHz VBW:3000.000KHz SWT:Auto</p>	<p>Left blank</p>
<p><b>Avg.</b></p>	<p>Site : 03CH13-HY Condition : AVG_BE_54 3m HORN_91200_1241 VERTICAL : RBW:1000.000KHz VBW:10000KHz SWT:Auto</p>	<p>Left blank</p>

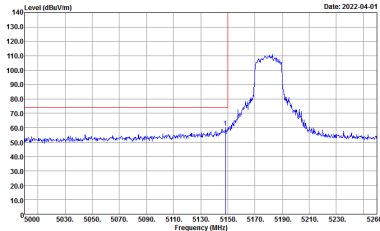
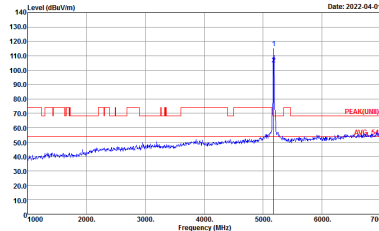
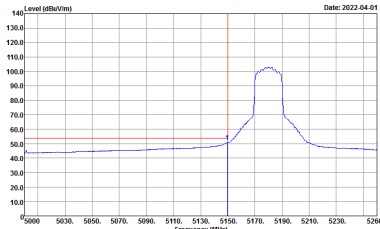

**Band 1 5150~5250MHz**  
**WIFI 802.11ax HE20 Full (Band Edge @ 3m)**

WIFI	Band 1 5150~5250MHz Band Edge @ 3m	
ANT	802.11ax HE20 Full CH36 5180MHz	
6+7	Horizontal	Fundamental
Peak	 <p>Site : 03CH13-HY            Condition : PEAK_BE_74 3m HORN_9120D_1241 HORIZONTAL            : RBW:1000.000KHz VBW:3000.000KHz SWT:Auto</p>	 <p>Site : 03CH13-HY            Condition : PEAK(UWB) 3m HORN_9120D_1241 HORIZONTAL            : RBW:1000.000KHz VBW:3000.000KHz SWT:Auto</p>
Avg.	 <p>Site : 03CH13-HY            Condition : AVG_BE_54 3m HORN_9120D_1241 HORIZONTAL            : RBW:1000.000KHz VBW:0.300KHz SWT:Auto</p>	Left blank

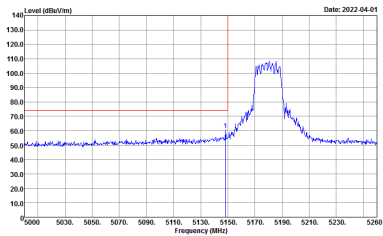
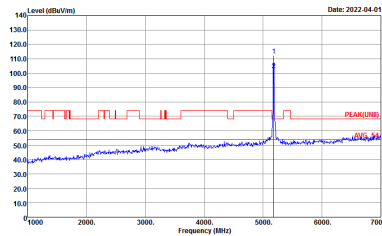
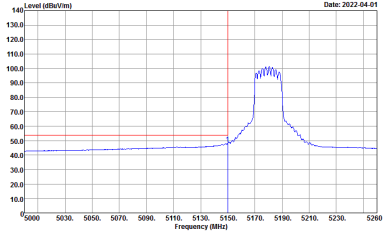

WIFI	Band 1 5150~5250MHz Band Edge @ 3m	
ANT	802.11ax HE20 Full CH36 5180MHz	
6+7	Vertical	Fundamental
Peak	 <p>Date: 2022-04-01</p> <p>Site : 03CH13-HY Condition : PEAK_BE_74 3m HORN_91200_1241 VERTICAL : RBW:1000.000KHz VBW:3000.000KHz SWT:Auto</p>	 <p>Date: 2022-04-01</p> <p>Site : 03CH13-HY Condition : PEAK(LINE) 3m HORN_91200_1241 VERTICAL : RBW:1000.000KHz VBW:3000.000KHz SWT:Auto</p>
Avg.	 <p>Date: 2022-04-01</p> <p>Site : 03CH13-HY Condition : AV6_BE_54 3m HORN_91200_1241 VERTICAL : RBW:1000.000KHz VBW:0.300KHz SWT:Auto</p>	Left blank



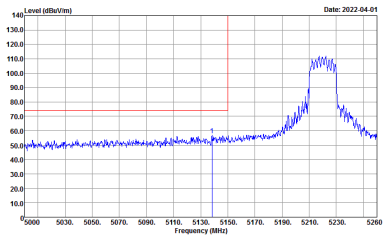
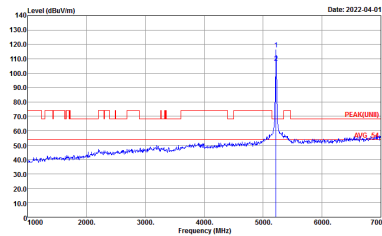
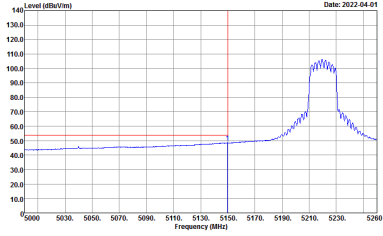

WIFI	Band 1 5150~5250MHz Band Edge @ 3m	
ANT	802.11ax HE20 Full CH44 5220MHz - L	
6+7	Horizontal	Fundamental
Peak	 <p>Site : 03CH13-HY Condition : PEAK_BE_74 3m HORN_91200_1241 HORIZONTAL : RBW:1000.000kHz VBW:3000.000kHz SWT:Auto</p>	 <p>Site : 03CH13-HY Condition : PEAK(LINE) 3m HORN_91200_1241 HORIZONTAL : RBW:1000.000kHz VBW:3000.000kHz SWT:Auto</p>
Avg.	 <p>Site : 03CH13-HY Condition : AV6_BE_54 3m HORN_91200_1241 HORIZONTAL : RBW:1000.000kHz VBW:0.300kHz SWT:Auto</p>	Left blank

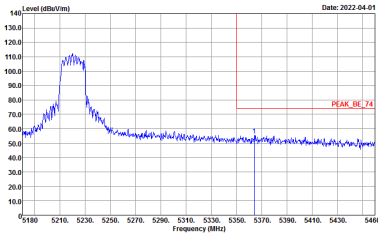
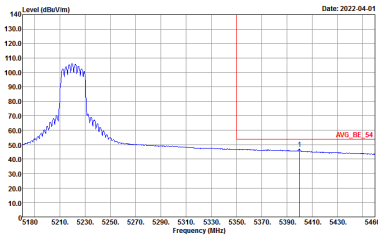

WIFI	Band 1 5150~5250MHz Band Edge @ 3m	
ANT	802.11ax HE20 Full CH44 5220MHz - R	
6+7	Horizontal	Fundamental
<p><b>Peak</b></p>	 <p>Site : 03CH13-HY            Condition : PEAK_BE_74 3m HORN_91200_1241 HORIZONTAL            : RBW:1000.000kHz VBW:3000.000kHz SWT:Auto</p>	<p>Left blank</p>
<p><b>Avg.</b></p>	 <p>Site : 03CH13-HY            Condition : AVG_BE_54 3m HORN_91200_1241 HORIZONTAL            : RBW:1000.000kHz VBW:3000.000kHz SWT:Auto</p>	<p>Left blank</p>

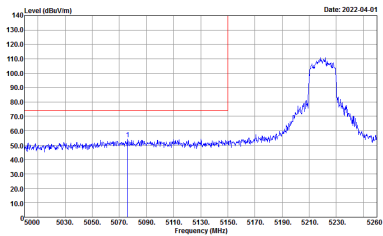
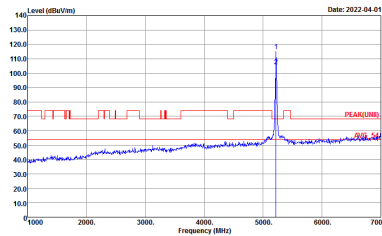
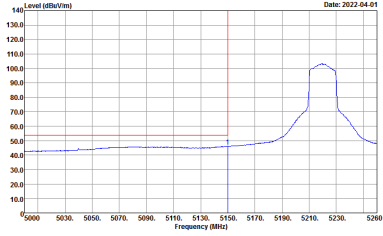

WIFI	Band 1 5150~5250MHz Band Edge @ 3m	
ANT	802.11ax HE20 Full CH44 5220MHz - L	
6+7	Vertical	Fundamental
Peak	 <p>Site : 03CH13-HY Condition : PEAK_BE_74 3m HORN_91200_1241 VERTICAL : RBW:1000.000KHz VBW:3000.000KHz SWT:Auto</p>	 <p>Site : 03CH13-HY Condition : PEAK(LINE) 3m HORN_91200_1241 VERTICAL : RBW:1000.000KHz VBW:3000.000KHz SWT:Auto</p>
Avg.	 <p>Site : 03CH13-HY Condition : AV6_BE_54 3m HORN_91200_1241 VERTICAL : RBW:1000.000KHz VBW:3000.000KHz SWT:Auto</p>	Left blank



WIFI	Band 1 5150~5250MHz Band Edge @ 3m	
ANT	802.11ax HE20 Full CH44 5220MHz - R	
6+7	Vertical	Fundamental
<p><b>Peak</b></p>	<p>Site : 03CH13-HY Condition : PEAK_BE_74 3m HORN_91200_1241 VERTICAL : RBW:1000.000kHz VBW:3000.000kHz SWT:Auto</p>	<p>Left blank</p>
<p><b>Avg.</b></p>	<p>Site : 03CH13-HY Condition : AVG_BE_54 3m HORN_91200_1241 VERTICAL : RBW:1000.000kHz VBW:3000.000kHz SWT:Auto</p>	<p>Left blank</p>

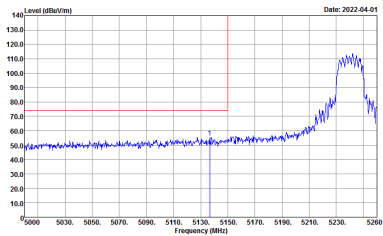
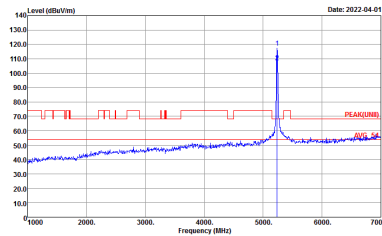
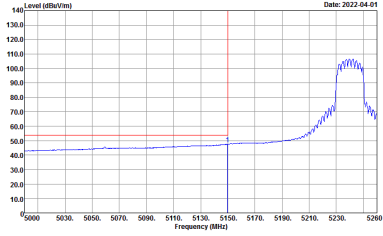

WIFI	Band 1 5150~5250MHz Band Edge @ 3m	
ANT	802.11ax HE20 Full CH48 5240MHz - L	
6+7	Horizontal	Fundamental
Peak	 <p>Site : 03CH13-HY Condition : PEAK_BE_74 3m HORN_91200_1241 HORIZONTAL : RBW:1000.000KHz VBW:3000.000KHz SWT:Auto</p>	 <p>Site : 03CH13-HY Condition : PEAK(LINE) 3m HORN_91200_1241 HORIZONTAL : RBW:1000.000KHz VBW:3000.000KHz SWT:Auto</p>
Avg.	 <p>Site : 03CH13-HY Condition : AV6_BE_54 3m HORN_91200_1241 HORIZONTAL : RBW:1000.000KHz VBW:0.300KHz SWT:Auto</p>	Left blank



WIFI	Band 1 5150~5250MHz Band Edge @ 3m	
ANT	802.11ax HE20 Full CH48 5240MHz - R	
6+7	Horizontal	Fundamental
Peak	<p>Site : 03CH13-HY Condition : PEAK_BE_74 3m HORN_91200_1241 HORIZONTAL RBW:1000.000kHz VBW:3000.000kHz SWF:Auto</p>	Left blank
Avg.	<p>Site : 03CH13-HY Condition : AVG_BE_54 3m HORN_91200_1241 HORIZONTAL RBW:1000.000kHz VBW:0.3000kHz SWF:Auto</p>	Left blank

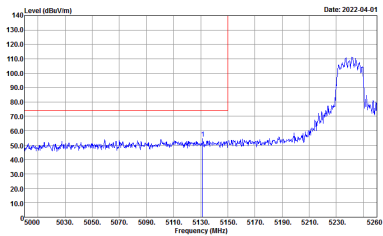
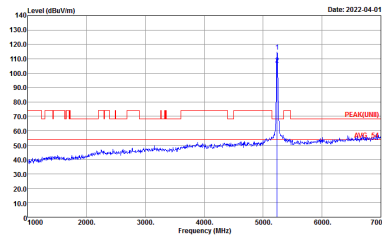
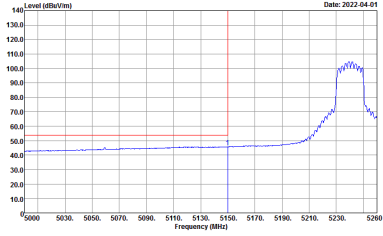

WIFI	Band 1 5150~5250MHz Band Edge @ 3m	
ANT	802.11ax HE20 Full CH48 5240MHz - L	
6+7	Vertical	Fundamental
Peak	 <p>Site : 03CH13-HY Condition : PEAK_BE_74 3m HORN_91200_1241 VERTICAL : RBW:1000.000KHz VBW:3000.000KHz SWT:Auto</p>	 <p>Site : 03CH13-HY Condition : PEAK(LINE) 3m HORN_91200_1241 VERTICAL : RBW:1000.000KHz VBW:3000.000KHz SWT:Auto</p>
Avg.	 <p>Site : 03CH13-HY Condition : AV6_BE_54 3m HORN_91200_1241 VERTICAL : RBW:1000.000KHz VBW:0.300KHz SWT:Auto</p>	Left blank

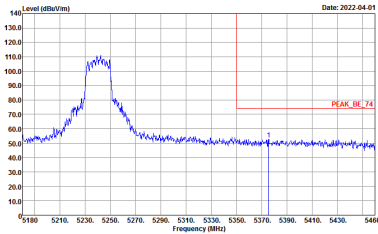
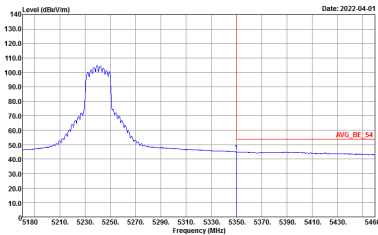

WIFI	Band 1 5150~5250MHz Band Edge @ 3m	
ANT	802.11ax HE20 Full CH48 5240MHz - R	
6+7	Vertical	Fundamental
<p><b>Peak</b></p>	 <p>Site : 03CH13-HY Condition : PEAK_BE_74 3m HORN_91200_1241 VERTICAL : RBW:1000.000kHz VBW:3000.000kHz SWT:Auto</p>	<p>Left blank</p>
<p><b>Avg.</b></p>	 <p>Site : 03CH13-HY Condition : AVG_BE_54 3m HORN_91200_1241 VERTICAL : RBW:1000.000kHz VBW:0.300kHz SWT:Auto</p>	<p>Left blank</p>



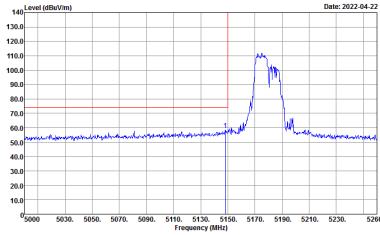
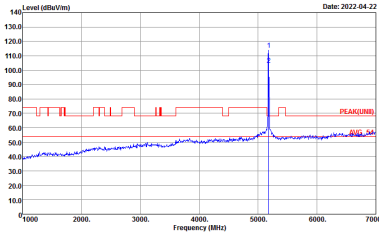
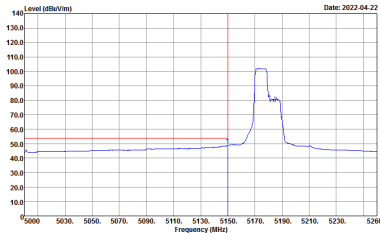

**Band 1 5150~5250MHz**  
**WIFI 802.11ax HE20 Partial 106 (Band Edge @ 3m)**

WIFI	Band 1 5150~5250MHz Band Edge @ 3m	
ANT	802.11ax HE20 Partial 106/53 CH36 5180MHz	
6+7	Horizontal	Fundamental
Peak	 <p>Date: 2022-04-22</p> <p>Site : 03CH13-HY            Condition : PEAK_BE_74 3m HORN_91200_1241 HORIZONTAL            : RBW:1000.000KHz VBW:3000.000KHz SWT:Auto</p>	 <p>Date: 2022-04-22</p> <p>Site : 03CH13-HY            Condition : PEAK(UNII) 3m HORN_91200_1241 HORIZONTAL            : RBW:1000.000KHz VBW:3000.000KHz SWT:Auto</p>
Avg.	 <p>Date: 2022-04-22</p> <p>Site : 03CH13-HY            Condition : AVG_BE_54 3m HORN_91200_1241 HORIZONTAL            : RBW:1000.000KHz VBW:0.010KHz SWT:Auto</p>	Left blank

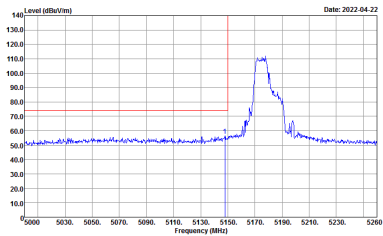
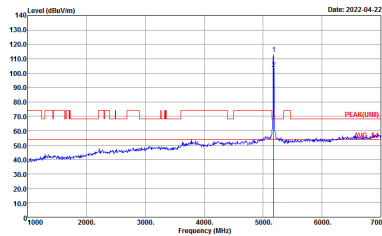
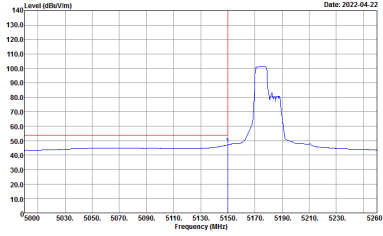

WIFI	Band 1 5150~5250MHz Band Edge @ 3m	
ANT	802.11ax HE20 Partial 106/53 CH36 5180MHz	
6+7	Vertical	Fundamental
Peak	 <p>Site : 03CH13-HY Condition : PEAK_BE_74 3m HORN_91200_1241 VERTICAL : RBW:1000.000KHz VBW:3000.000KHz SWT:Auto</p>	 <p>Site : 03CH13-HY Condition : PEAK(LINE) 3m HORN_91200_1241 VERTICAL : RBW:1000.000KHz VBW:3000.000KHz SWT:Auto</p>
Avg.	 <p>Site : 03CH13-HY Condition : AV6_BE_54 3m HORN_91200_1241 VERTICAL : RBW:1000.000KHz VBW:0.0100KHz SWT:Auto</p>	Left blank

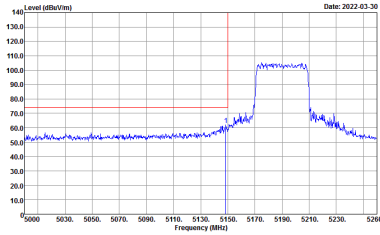
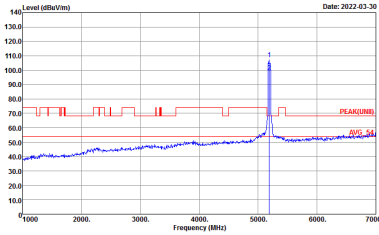
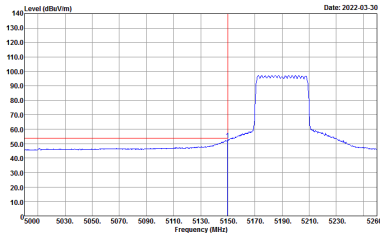

**Band 1 5150~5250MHz**  
**WIFI 802.11ax HE40 Full (Band Edge @ 3m)**

WIFI	Band 1 5150~5250MHz Band Edge @ 3m	
ANT	802.11ax HE40 Full CH38 5190MHz - L	
6+7	Horizontal	Fundamental
Peak	 <p>Site : 03CH13-HY            Condition : PEAK_BE_74 3m HORN_91200_1241 HORIZONTAL            : RBW:1000.000kHz VBW:3000.000kHz SWT:Auto</p>	 <p>Site : 03CH13-HY            Condition : PEAK(UNII) 3m HORN_91200_1241 HORIZONTAL            : RBW:1000.000kHz VBW:3000.000kHz SWT:Auto</p>
Avg.	 <p>Site : 03CH13-HY            Condition : AVG_BE_54 3m HORN_91200_1241 HORIZONTAL            : RBW:1000.000kHz VBW:1.000kHz SWT:Auto</p>	Left blank

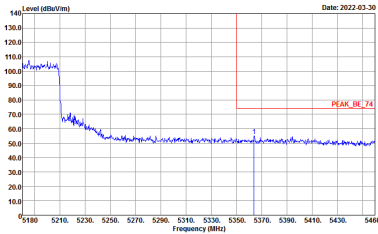
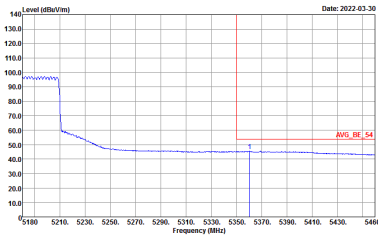

WIFI	Band 1 5150~5250MHz Band Edge @ 3m	
ANT	802.11ax HE40 Full CH38 5190MHz - R	
6+7	Horizontal	Fundamental
<p><b>Peak</b></p>	 <p>Site : 03CH13-HY Condition : PEAK_BE_74 3m HORN_91200_1241 HORIZONTAL : RBW:1000.000kHz VBW:3000.000kHz SWT:Auto</p>	<p>Left blank</p>
<p><b>Avg.</b></p>	 <p>Site : 03CH13-HY Condition : AV6_BE_54 3m HORN_91200_1241 HORIZONTAL : RBW:1000.000kHz VBW:11000kHz SWT:Auto</p>	<p>Left blank</p>

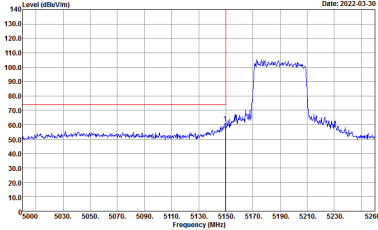
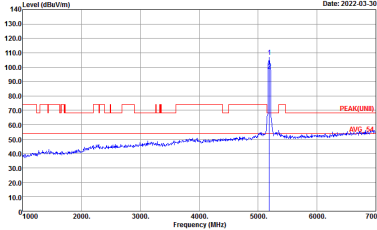
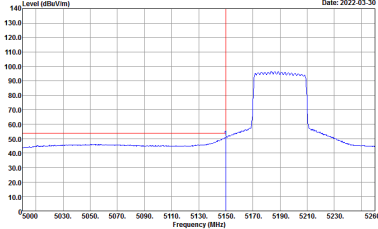

WIFI	Band 1 5150~5250MHz Band Edge @ 3m	
ANT	802.11ax HE40 Full CH38 5190MHz - L	
6+7	Vertical	Fundamental
Peak	 <p>Site : 03CH13-HY Condition : PEAK_BE_74 3m HORN_91200_1241 VERTICAL : RBW:1000.000KHz VBW:3000.000KHz SWT:Auto</p>	 <p>Site : 03CH13-HY Condition : PEAK(LINE) 3m HORN_91200_1241 VERTICAL : RBW:1000.000KHz VBW:3000.000KHz SWT:Auto</p>
Avg.	 <p>Site : 03CH13-HY Condition : AV6_BE_54 3m HORN_91200_1241 VERTICAL : RBW:1000.000KHz VBW:1000KHz SWT:Auto</p>	Left blank

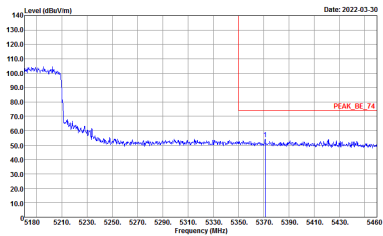
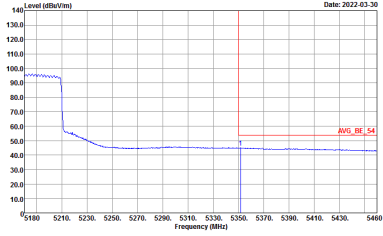

WIFI	Band 1 5150~5250MHz Band Edge @ 3m	
ANT	802.11ax HE40 Full CH38 5190MHz - R	
6+7	Vertical	Fundamental
<p><b>Peak</b></p>	 <p>Site : 03CH13-HY Condition : PEAK_BE_74 3m HORN_91200_1241 VERTICAL : RBW:1000.000kHz VBW:3000.000kHz SWT:Auto</p>	<p>Left blank</p>
<p><b>Avg.</b></p>	 <p>Site : 03CH13-HY Condition : AV6_BE_54 3m HORN_91200_1241 VERTICAL : RBW:1000.000kHz VBW:10000kHz SWT:Auto</p>	<p>Left blank</p>

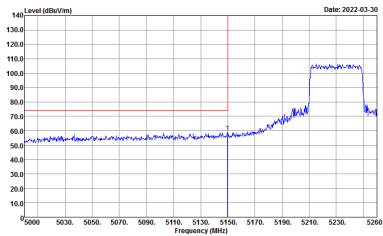
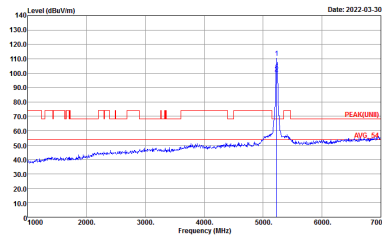
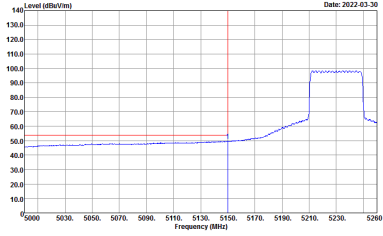

WIFI	Band 1 5150~5250MHz Band Edge @ 3m	
ANT	802.11ax HE40 Full CH46 5230MHz - L	
6+7	Horizontal	Fundamental
Peak	 <p>Site : 03CH13-HY Condition : PEAK_BE_74 3m HORN_91200_1241 HORIZONTAL : RBW:1000.000KHz VBW:3000.000KHz SWT:Auto</p>	 <p>Site : 03CH13-HY Condition : PEAK(LINE) 3m HORN_91200_1241 HORIZONTAL : RBW:1000.000KHz VBW:3000.000KHz SWT:Auto</p>
Avg.	 <p>Site : 03CH13-HY Condition : AV6_BE_54 3m HORN_91200_1241 HORIZONTAL : RBW:1000.000KHz VBW:1000KHz SWT:Auto</p>	Left blank



WIFI	Band 1 5150~5250MHz Band Edge @ 3m	
ANT	802.11ax HE40 Full CH46 5230MHz - R	
6+7	Horizontal	Fundamental
<p><b>Peak</b></p>	<p>Site : 03CH13-HY Condition : PEAK_BE_74 3m HORN_91200_1241 HORIZONTAL : RBW:1000.000kHz VBW:3000.000kHz SWT:Auto</p>	<p>Left blank</p>
<p><b>Avg.</b></p>	<p>Site : 03CH13-HY Condition : AVG_BE_54 3m HORN_91200_1241 HORIZONTAL : RBW:1000.000kHz VBW:10000kHz SWT:Auto</p>	<p>Left blank</p>



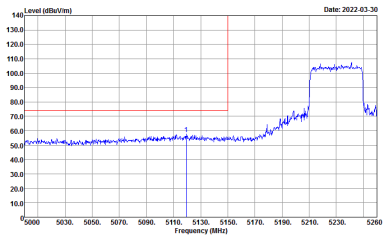
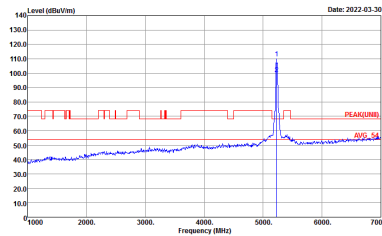
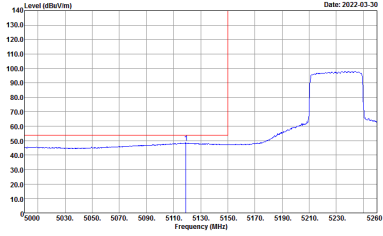

WIFI	Band 1 5150~5250MHz Band Edge @ 3m	
ANT	802.11ax HE40 Full CH46 5230MHz - L	
6+7	Vertical	Fundamental
Peak	 <p>Site : 03CH13-HY Condition : PEAK_BE_74 3m HORN_91200_1241 VERTICAL : RBW:1000.000KHz VBW:3000.000KHz SWT:Auto</p>	 <p>Site : 03CH13-HY Condition : PEAK(LINE) 3m HORN_91200_1241 VERTICAL : RBW:1000.000KHz VBW:3000.000KHz SWT:Auto</p>
Avg.	 <p>Site : 03CH13-HY Condition : AV6_BE_54 3m HORN_91200_1241 VERTICAL : RBW:1000.000KHz VBW:1000KHz SWT:Auto</p>	Left blank



WIFI	Band 1 5150~5250MHz Band Edge @ 3m	
ANT	802.11ax HE40 Full CH46 5230MHz - R	
6+7	Vertical	Fundamental
Peak	<p>Site : 03CH13-HY Condition : PEAK_BE_74 3m HORN_91200_1241 VERTICAL RBW:1000.000kHz VBW:3000.000kHz SWT:Auto</p>	Left blank
Avg.	<p>Site : 03CH13-HY Condition : AV6_BE_54 3m HORN_91200_1241 VERTICAL RBW:1000.000kHz VBW:10000kHz SWT:Auto</p>	Left blank

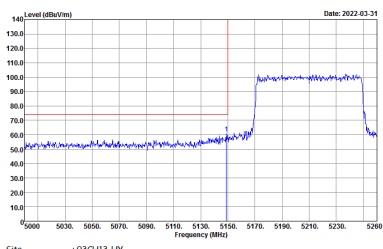
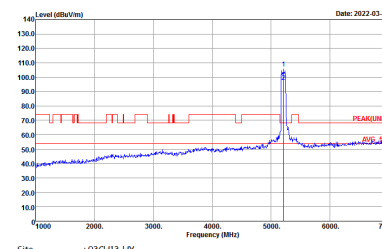
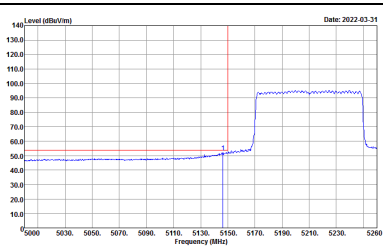

**Band 1 5150~5250MHz**  
**WIFI 802.11ax HE80 Full (Band Edge @ 3m)**

WIFI	Band 1 5150~5250MHz Band Edge @ 3m	
ANT	802.11ax HE80 Full CH42 5210MHz - L	
6+7	Horizontal	Fundamental
<b>Peak</b>	 <p>Site : 03CH13-HY            Condition : PEAK_BE_74 3m HORN_91200_1241 HORIZONTAL            : RBW:1000.000KHz VBW:3000.000KHz SWT:Auto</p>	 <p>Site : 03CH13-HY            Condition : PEAK(UNII) 3m HORN_91200_1241 HORIZONTAL            : RBW:1000.000KHz VBW:3000.000KHz SWT:Auto</p>
<b>Avg.</b>	 <p>Site : 03CH13-HY            Condition : AVG_BE_54 3m HORN_91200_1241 HORIZONTAL            : RBW:1000.000KHz VBW:3.000KHz SWT:Auto</p>	Left blank



WIFI	Band 1 5150~5250MHz Band Edge @ 3m	
ANT	802.11ax HE80 Full CH42 5210MHz - R	
6+7	Horizontal	Fundamental
Peak	<p>Site : 03CH13-HY Condition : PEAK_BE_74 3m HORN_91200_1241 HORIZONTAL : RBW:1000.000kHz VBW:3000.000kHz SWF:Auto</p>	Left blank
Avg.	<p>Site : 03CH13-HY Condition : AV6_BE_54 3m HORN_91200_1241 HORIZONTAL : RBW:1000.000kHz VBW:3.000kHz SWF:Auto</p>	Left blank

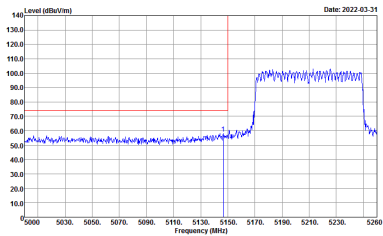
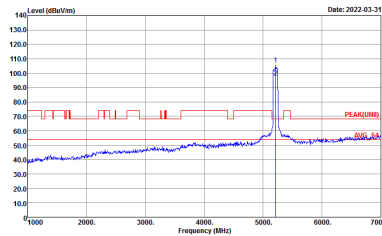
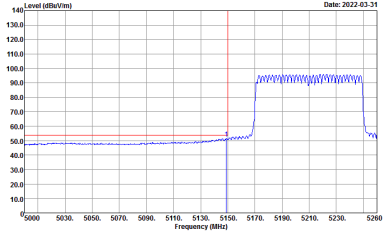

WIFI	Band 1 5150~5250MHz Band Edge @ 3m	
ANT	802.11ax HE80 Full CH42 5210MHz - L	
6+7	Vertical	Fundamental
Peak	 <p>Date: 2022-03-31</p> <p>Site : 03CH13-HY Condition : PEAK_BE_74 3m HORN_91200_1241 VERTICAL : RBW:1000.000KHz VBW:3000.000KHz SWT:Auto</p>	 <p>Date: 2022-03-31</p> <p>Site : 03CH13-HY Condition : PEAK(LINE) 3m HORN_91200_1241 VERTICAL : RBW:1000.000KHz VBW:3000.000KHz SWT:Auto</p>
Avg.	 <p>Date: 2022-03-31</p> <p>Site : 03CH13-HY Condition : AV6_BE_54 3m HORN_91200_1241 VERTICAL : RBW:1000.000KHz VBW:3000.000KHz SWT:Auto</p>	Left blank

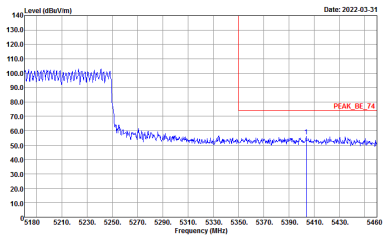
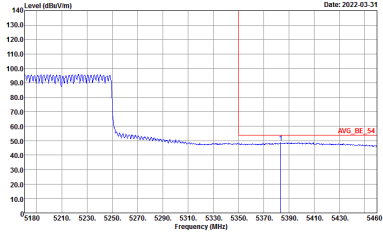

WIFI	Band 1 5150~5250MHz Band Edge @ 3m	
ANT	802.11ax HE80 Full CH42 5210MHz - R	
6+7	Vertical	Fundamental
<p><b>Peak</b></p>	 <p>Site : 03CH13-HY Condition : PEAK_BE_74 3m HORN_91200_1241 VERTICAL : RBW:1000.000kHz VBW:3000.000kHz SWT:Auto</p>	<p>Left blank</p>
<p><b>Avg.</b></p>	 <p>Site : 03CH13-HY Condition : AV6_BE_54 3m HORN_91200_1241 VERTICAL : RBW:1000.000kHz VBW:3.000kHz SWT:Auto</p>	<p>Left blank</p>



**Band 1 - 5150~5250MHz**  
**WIFI 802.11a (Harmonic @ 3m)**

<b>WIFI</b>	<b>Band 1 5150~5250MHz Harmonic @ 3m</b>	
<b>ANT</b>	<b>802.11a CH36 5180MHz</b>	
<b>6+7</b>	<b>Horizontal</b>	<b>Vertical</b>
<b>Peak</b> <b>Avg.</b>	<p>Site : 03CH13-HY          Condition : PEAK(UNII) 3m HORN_91200_1241 HORIZONTAL</p>	<p>Site : 03CH13-HY          Condition : PEAK(UNII) 3m HORN_91200_1241 VERTICAL</p>

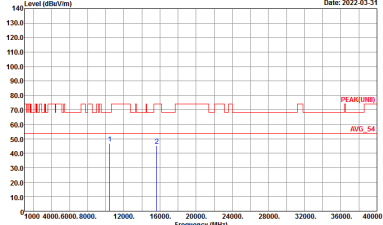
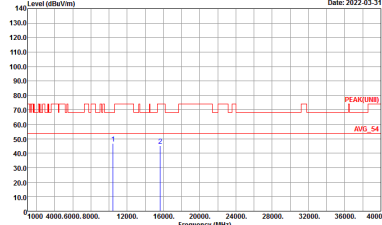

<b>WIFI</b>	<b>Band 1 5150~5250MHz Harmonic @ 3m</b>	
<b>ANT</b>	<b>802.11a CH44 5220MHz</b>	
<b>6+7</b>	<b>Horizontal</b>	<b>Vertical</b>
<p><b>Peak</b></p> <p><b>Avg.</b></p>	 <p>Date: 2022-03-31</p> <p>Site : 03CH13-HY Condition : PEAK(UNII) 3m HORN_91200_1241 HORIZONTAL</p>	 <p>Date: 2022-03-31</p> <p>Site : 03CH13-HY Condition : PEAK(UNII) 3m HORN_91200_1241 VERTICAL</p>





<b>WIFI</b>	<b>Band 1 5150~5250MHz Harmonic @ 3m</b>	
<b>ANT</b>	<b>802.11a CH48 5240MHz</b>	
<b>6+7</b>	<b>Horizontal</b>	<b>Vertical</b>
<b>Peak</b> <b>Avg.</b>	<p>Site : 03CH13-HY Condition : PEAK(UNII) 3m HORN_91200_1241 HORIZONTAL</p>	<p>Site : 03CH13-HY Condition : PEAK(UNII) 3m HORN_91200_1241 VERTICAL</p>



**Band 1 5150~5250MHz  
WIFI 802.11ax HE20 Full (Harmonic @ 3m)**

<b>WIFI</b>	<b>Band 1 5150~5250MHz Harmonic @ 3m</b>	
<b>ANT</b>	<b>802.11ax HE20 Full CH36 5180MHz</b>	
<b>6+7</b>	<b>Horizontal</b>	<b>Vertical</b>
<b>Peak Avg.</b>	<p>Site : 03CH13-14Y Condition : PEAK(UNII) 3m HORN_91200_1241 HORIZONTAL</p>	<p>Site : 03CH13-14Y Condition : PEAK(UNII) 3m HORN_91200_1241 VERTICAL</p>

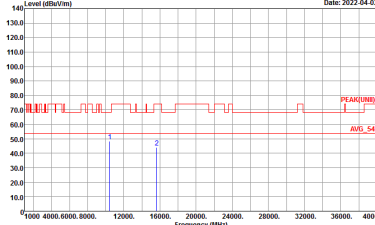
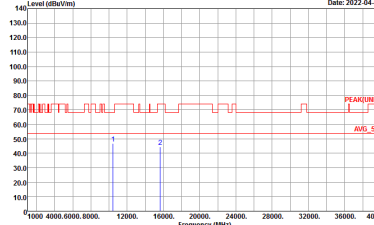

WIFI	Band 1 5150~5250MHz Harmonic @ 3m	
ANT	802.11ax HE20 Full CH44 5220MHz	
6+7	Horizontal	Vertical
<p>Peak</p> <p>Avg.</p>	 <p>Date: 2022-04-02</p> <p>Site : 03CH13-HY Condition : PEAK(UNII) 3m HORN_91200_1241 HORIZONTAL</p>	 <p>Date: 2022-04-02</p> <p>Site : 03CH13-HY Condition : PEAK(UNII) 3m HORN_91200_1241 VERTICAL</p>



<b>WIFI</b>	<b>Band 1 5150~5250MHz Harmonic @ 3m</b>	
<b>ANT</b>	<b>802.11ax HE20 Full CH48 5240MHz</b>	
<b>6+7</b>	<b>Horizontal</b>	<b>Vertical</b>
<b>Peak Avg.</b>	<p>Site : 03CH13-HY Condition : PEAK(UNII) 3m HORN_91200_1241 HORIZONTAL</p>	<p>Site : 03CH13-HY Condition : PEAK(UNII) 3m HORN_91200_1241 VERTICAL</p>



Band 1 5150~5250MHz
WIFI 802.11ax HE40 Full (Harmonic @ 3m)

Table with 3 columns: WIFI, ANT, 6+7. It contains two spectral plots: Horizontal and Vertical. Each plot shows Level (dBuV/m) vs Frequency (MHz) with peak and average markers.



WIFI	Band 1 5150~5250MHz Harmonic @ 3m	
ANT	802.11ax HE40 Full CH46 5230MHz	
6+7	Horizontal	Vertical
Peak Avg.	<p>Site : 03CH13-HY Condition : PEAK(UNII) 3m HORN_91200_1241 HORIZONTAL</p>	<p>Site : 03CH13-HY Condition : PEAK(UNII) 3m HORN_91200_1241 VERTICAL</p>



**Band 1 5150~5250MHz  
WIFI 802.11ax HE80 Full (Harmonic @ 3m)**

<b>WIFI</b>	<b>Band 1 5150~5250MHz Harmonic @ 3m</b>	
<b>ANT</b>	<b>802.11ax HE80 Full CH42 5210MHz</b>	
<b>6+7</b>	<b>Horizontal</b>	<b>Vertical</b>
<b>Peak Avg.</b>	<p>Site : 03CH12-14Y Condition : PEAK(UNII) 3m HORN_91200_1241 HORIZONTAL</p>	<p>Site : 03CH12-14Y Condition : PEAK(UNII) 3m HORN_91200_1241 VERTICAL</p>



**Band 2 - 5250~5350MHz**  
**WIFI 802.11a (Band Edge @ 3m)**

WIFI	Band 2 5250~5350MHz Band Edge @ 3m	
ANT	802.11a CH52 5260MHz - L	
6+7	Horizontal	Fundamental
<b>Peak</b>		
<b>Avg.</b>		<b>Left blank</b>



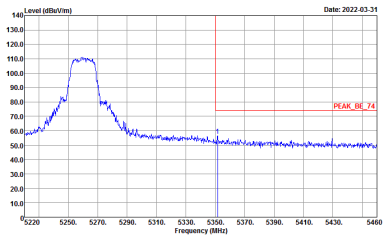
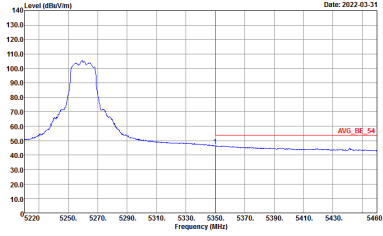

WIFI	Band 2 5250~5350MHz Band Edge @ 3m	
ANT	802.11a CH52 5260MHz - R	
6+7	Horizontal	Fundamental
<p><b>Peak</b></p>	 <p>Site : 03CH13-HY Condition : PEAK_BE_74 3m HORN_91200_1241 HORIZONTAL : RBW:1000.000kHz VBW:3000.000kHz SWT:Auto</p>	<p>Left blank</p>
<p><b>Avg.</b></p>	 <p>Site : 03CH13-HY Condition : AVG_BE_54 3m HORN_91200_1241 HORIZONTAL : RBW:1000.000kHz VBW:10000kHz SWT:Auto</p>	<p>Left blank</p>

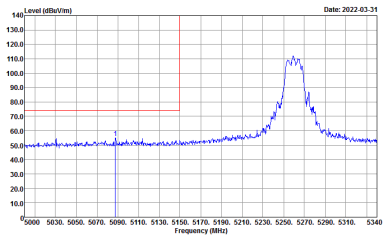
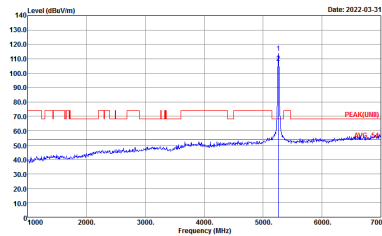
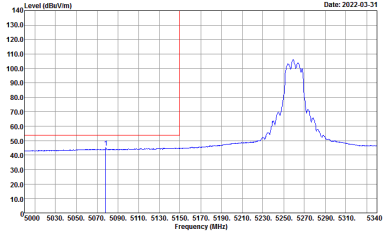

WIFI	Band 2 5250~5350MHz Band Edge @ 3m	
ANT	802.11a CH52 5260MHz - L	
6+7	Vertical	Fundamental
Peak	 <p>Site : 03CH13-HY Condition : PEAK_BE_74 3m HORN_91200_1241 VERTICAL : RBW:1000.000KHz VBW:3000.000KHz SWT:Auto</p>	 <p>Site : 03CH13-HY Condition : PEAK(LINE) 3m HORN_91200_1241 VERTICAL : RBW:1000.000KHz VBW:3000.000KHz SWT:Auto</p>
Avg.	 <p>Site : 03CH13-HY Condition : AV6_BE_54 3m HORN_91200_1241 VERTICAL : RBW:1000.000KHz VBW:1.000KHz SWT:Auto</p>	Left blank

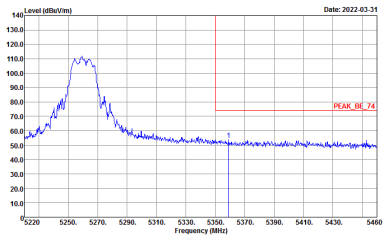
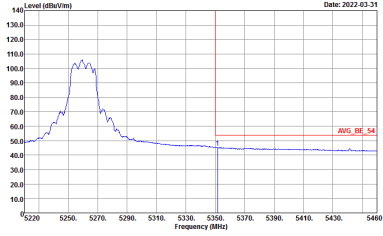

WIFI	Band 2 5250~5350MHz Band Edge @ 3m	
ANT	802.11a CH52 5260MHz - R	
6+7	Vertical	Fundamental
<p><b>Peak</b></p>	 <p>Site : 03CH13-HY Condition : PEAK_BE_74 3m HORN_91200_1241 VERTICAL : RBW:1000.000kHz VBW:3000.000kHz SWT:Auto</p>	<p>Left blank</p>
<p><b>Avg.</b></p>	 <p>Site : 03CH13-HY Condition : AVG_BE_54 3m HORN_91200_1241 VERTICAL : RBW:1000.000kHz VBW:1.000kHz SWT:Auto</p>	<p>Left blank</p>

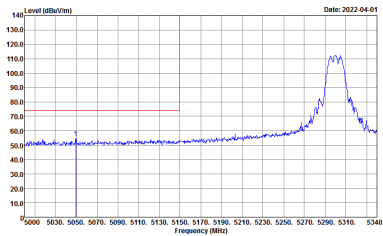
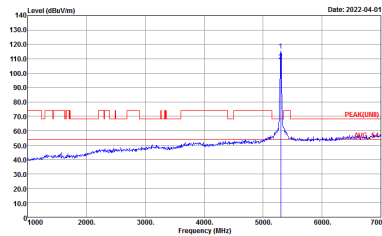
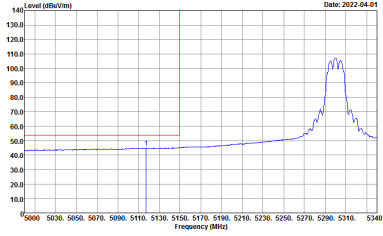

WIFI	Band 2 5250~5350MHz Band Edge @ 3m	
ANT	802.11a CH60 5300MHz - L	
6+7	Horizontal	Fundamental
Peak	 <p>Site : 03CH13-HY Condition : PEAK_BE_74 3m HORN_91200_1241 HORIZONTAL : RBW:1000.000KHz VBW:3000.000KHz SWT:Auto</p>	 <p>Site : 03CH13-HY Condition : PEAK(LINE) 3m HORN_91200_1241 HORIZONTAL : RBW:1000.000KHz VBW:3000.000KHz SWT:Auto</p>
Avg.	 <p>Site : 03CH13-HY Condition : AV6_BE_54 3m HORN_91200_1241 HORIZONTAL : RBW:1000.000KHz VBW:1000KHz SWT:Auto</p>	Left blank



WIFI	Band 2 5250~5350MHz Band Edge @ 3m	
ANT	802.11a CH60 5300MHz - R	
6+7	Horizontal	Fundamental
Peak	<p>Site : 03CH13-HY Condition : PEAK_BE_74 3m HORN_91200_1241 HORIZONTAL : RBW:1000.000kHz VBW:3000.000kHz SWT:Auto</p>	Left blank
Avg.	<p>Site : 03CH13-HY Condition : AVG_BE_54 3m HORN_91200_1241 HORIZONTAL : RBW:1000.000kHz VBW:10000kHz SWT:Auto</p>	Left blank

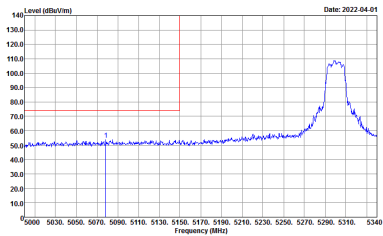
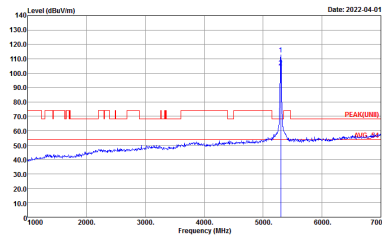
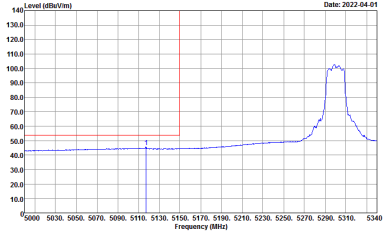

WIFI	Band 2 5250~5350MHz Band Edge @ 3m	
ANT	802.11a CH60 5300MHz - L	
6+7	Vertical	Fundamental
<p><b>Peak</b></p>	 <p>Site : 03CH13-HY Condition : PEAK_BE_74 3m HORN_91200_1241 VERTICAL : RBW:1000.000KHz VBW:3000.000KHz SWT:Auto</p>	 <p>Site : 03CH13-HY Condition : PEAK(LINE) 3m HORN_91200_1241 VERTICAL : RBW:1000.000KHz VBW:3000.000KHz SWT:Auto</p>
<p><b>Avg.</b></p>	 <p>Site : 03CH13-HY Condition : AV6_BE_54 3m HORN_91200_1241 VERTICAL : RBW:1000.000KHz VBW:1.000KHz SWT:Auto</p>	<p><b>Left blank</b></p>



WIFI	Band 2 5250~5350MHz Band Edge @ 3m	
ANT	802.11a CH60 5300MHz - R	
6+7	Vertical	Fundamental
<p><b>Peak</b></p>		<p>Left blank</p>
<p><b>Avg.</b></p>		<p>Left blank</p>



WIFI	Band 2 5250~5350MHz Band Edge @ 3m	
ANT	802.11a CH64 5320MHz	
6+7	Horizontal	Fundamental
<p><b>Peak</b></p>	<p>Site : 03CH13-HY Condition : PEAK_BE_74 3m HORN_91200_1241 HORIZONTAL : RBW:1000.000KHz VBW:3000.000KHz SWT:Auto</p>	<p>Site : 03CH13-HY Condition : PEAK(LINE) 3m HORN_91200_1241 HORIZONTAL : RBW:1000.000KHz VBW:3000.000KHz SWT:Auto</p>
<p><b>Avg.</b></p>	<p>Site : 03CH13-HY Condition : AV6_BE_54 3m HORN_91200_1241 HORIZONTAL : RBW:1000.000KHz VBW:1.000KHz SWT:Auto</p>	<p><b>Left blank</b></p>



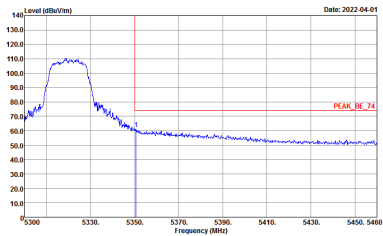
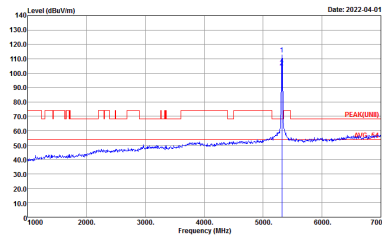
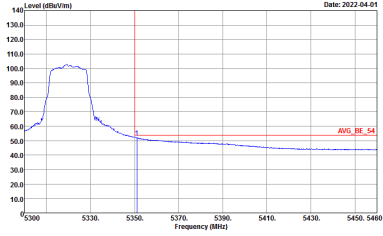

WIFI	Band 2 5250~5350MHz Band Edge @ 3m	
ANT	802.11a CH64 5320MHz	
6+7	Vertical	Fundamental
Peak	 <p>Site : 03CH13-HY Condition : PEAK_BE_74 3m HORN_91200_1241 VERTICAL : RBW:1000.000KHz VBW:3000.000KHz SWT:Auto</p>	 <p>Site : 03CH13-HY Condition : PEAK(LINE) 3m HORN_91200_1241 VERTICAL : RBW:1000.000KHz VBW:3000.000KHz SWT:Auto</p>
Avg.	 <p>Site : 03CH13-HY Condition : AV6_BE_54 3m HORN_91200_1241 VERTICAL : RBW:1000.000KHz VBW:1000KHz SWT:Auto</p>	Left blank



**Band 2 5250~5350MHz**  
**WIFI 802.11ax HE20 Full (Band Edge @ 3m)**

WIFI	Band 2 5250~5350MHz Band Edge @ 3m	
ANT	802.11ax HE20 Full CH52 5260MHz - L	
6+7	Horizontal	Fundamental
Peak	<p>Site : 03CH13-HY            Condition : PEAK_BE_74 3m HORN_9120D_1241 HORIZONTAL            : RBW:1000.000KHz VBW:3000.000KHz SWT:Auto</p>	<p>Site : 03CH13-HY            Condition : PEAK(UWB) 3m HORN_9120D_1241 HORIZONTAL            : RBW:1000.000KHz VBW:3000.000KHz SWT:Auto</p>
Avg.	<p>Site : 03CH13-HY            Condition : AVG_BE_54 3m HORN_9120D_1241 HORIZONTAL            : RBW:1000.000KHz VBW:3000.000KHz SWT:Auto</p>	Left blank

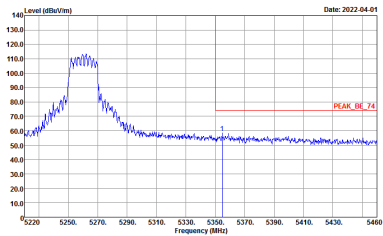
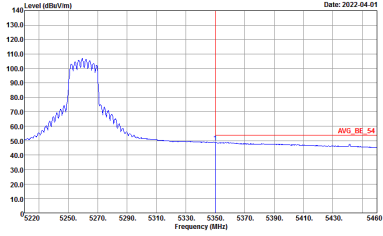

WIFI	Band 2 5250~5350MHz Band Edge @ 3m	
ANT	802.11ax HE20 Full CH52 5260MHz - R	
6+7	Horizontal	Fundamental
<p><b>Peak</b></p>	 <p>Site : 03CH13-HY Condition : PEAK_BE_74 3m HORN_91200_1241 HORIZONTAL : RBW:1000.000kHz VBW:3000.000kHz SWT:Auto</p>	<p>Left blank</p>
<p><b>Avg.</b></p>	 <p>Site : 03CH13-HY Condition : AVG_BE_54 3m HORN_91200_1241 HORIZONTAL : RBW:1000.000kHz VBW:3000.000kHz SWT:Auto</p>	<p>Left blank</p>



WIFI	Band 2 5250~5350MHz Band Edge @ 3m	
ANT	802.11ax HE20 Full CH52 5260MHz - L	
6+7	Vertical	Fundamental
Peak	<p>Site : 03CH13-HY Condition : PEAK_BE_74 3m HORN_9120D_1241 VERTICAL : RBW:1000.000KHz VBW:3000.000KHz SWT:Auto</p>	<p>Site : 03CH13-HY Condition : PEAK(LINE) 3m HORN_9120D_1241 VERTICAL : RBW:1000.000KHz VBW:3000.000KHz SWT:Auto</p>
Avg.	<p>Site : 03CH13-HY Condition : AVG_BE_54 3m HORN_9120D_1241 VERTICAL : RBW:1000.000KHz VBW:3.000KHz SWT:Auto</p>	Left blank



WIFI	Band 2 5250~5350MHz Band Edge @ 3m	
ANT	802.11ax HE20 Full CH52 5260MHz - R	
6+7	Vertical	Fundamental
Peak	<p>Site : 03CH13-HY Condition : PEAK_BE_74 3m HORN_91200_1241 VERTICAL : RBW:1000.000kHz VBW:3000.000kHz SWT:Auto</p>	Left blank
Avg.	<p>Site : 03CH13-HY Condition : AV6_BE_54 3m HORN_91200_1241 VERTICAL : RBW:1000.000kHz VBW:3000.000kHz SWT:Auto</p>	Left blank

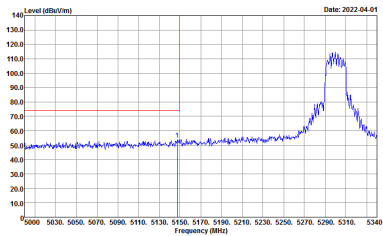
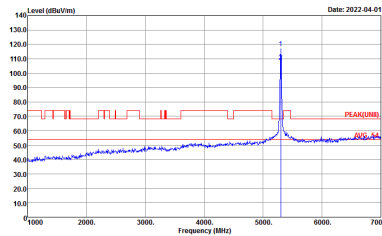
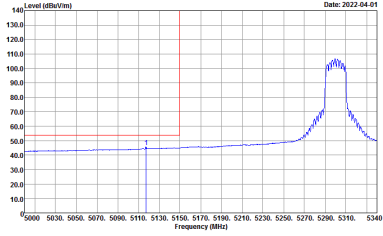

WIFI	Band 2 5250~5350MHz Band Edge @ 3m	
ANT	802.11ax HE20 Full CH60 5300MHz - L	
6+7	Horizontal	Fundamental
Peak	 <p>Site : 03CH13-HY Condition : PEAK_BE_74 3m HORN_91200_1241 HORIZONTAL : RBW:1000.000KHz VBW:3000.000KHz SWT:Auto</p>	 <p>Site : 03CH13-HY Condition : PEAK(LINE) 3m HORN_91200_1241 HORIZONTAL : RBW:1000.000KHz VBW:3000.000KHz SWT:Auto</p>
Avg.	 <p>Site : 03CH13-HY Condition : AV6_BE_54 3m HORN_91200_1241 HORIZONTAL : RBW:1000.000KHz VBW:0.300KHz SWT:Auto</p>	Left blank

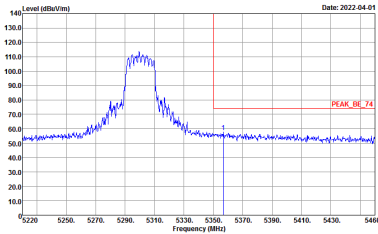
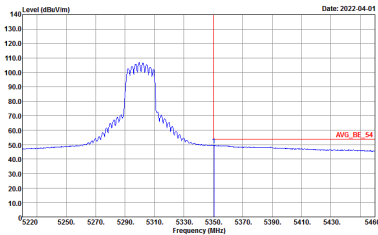

WIFI	Band 2 5250~5350MHz Band Edge @ 3m	
ANT	802.11ax HE20 Full CH60 5300MHz - R	
6+7	Horizontal	Fundamental
<p><b>Peak</b></p>	 <p>Site : 03CH13-HY Condition : PEAK_BE_74 3m HORN_91200_1241 HORIZONTAL : RBW:1000.000kHz VBW:3000.000kHz SWF:Auto</p>	<p>Left blank</p>
<p><b>Avg.</b></p>	 <p>Site : 03CH13-HY Condition : AVG_BE_54 3m HORN_91200_1241 HORIZONTAL : RBW:1000.000kHz VBW:0.300kHz SWF:Auto</p>	<p>Left blank</p>

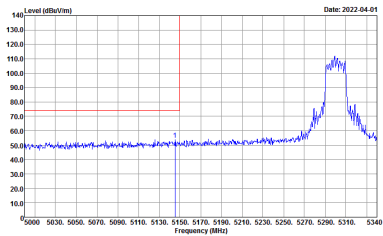
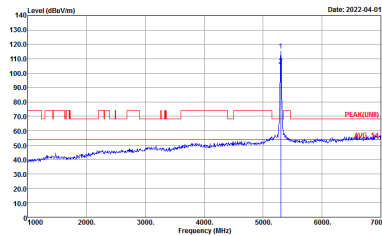
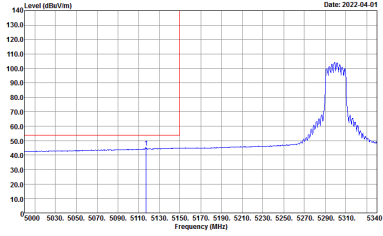

WIFI	Band 2 5250~5350MHz Band Edge @ 3m	
ANT	802.11ax HE20 Full CH60 5300MHz - L	
6+7	Vertical	Fundamental
Peak	 <p>Site : 03CH13-HY Condition : PEAK_BE_74 3m HORN_91200_1241 VERTICAL : RBW:1000.000KHz VBW:3000.000KHz SWT:Auto</p>	 <p>Site : 03CH13-HY Condition : PEAK(LINE) 3m HORN_91200_1241 VERTICAL : RBW:1000.000KHz VBW:3000.000KHz SWT:Auto</p>
Avg.	 <p>Site : 03CH13-HY Condition : AV6_BE_54 3m HORN_91200_1241 VERTICAL : RBW:1000.000KHz VBW:0.300KHz SWT:Auto</p>	Left blank





WIFI	Band 2 5250~5350MHz Band Edge @ 3m	
ANT	802.11ax HE20 Full CH60 5300MHz - R	
6+7	Vertical	Fundamental
Peak	<p>Site : 03CH13-HY Condition : PEAK_BE_74 3m HORN_91200_1241 VERTICAL RBW:1000.000kHz VBW:3000.000kHz SWT:Auto</p>	Left blank
Avg.	<p>Site : 03CH13-HY Condition : AV6_BE_54 3m HORN_91200_1241 VERTICAL RBW:1000.000kHz VBW:0.300kHz SWT:Auto</p>	Left blank

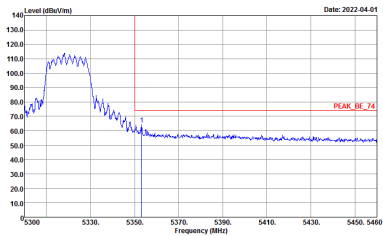
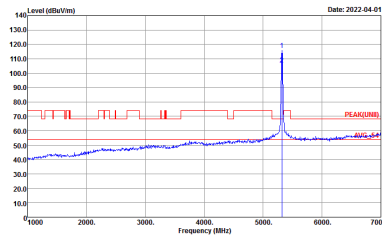
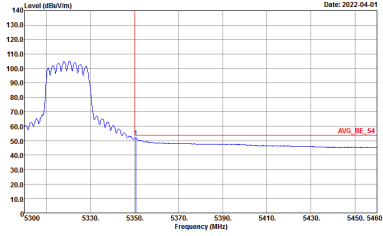

WIFI	Band 2 5250~5350MHz Band Edge @ 3m	
ANT	802.11ax HE20 Full CH64 5320MHz	
6+7	Horizontal	Fundamental
<p><b>Peak</b></p>	 <p>Site : 03CH13-HY Condition : PEAK_BE_74 3m HORN_91200_1241 HORIZONTAL : RBW:1000.000kHz VBW:3000.000kHz SWT:Auto</p>	 <p>Site : 03CH13-HY Condition : PEAK(LINE) 3m HORN_91200_1241 HORIZONTAL : RBW:1000.000kHz VBW:3000.000kHz SWT:Auto</p>
<p><b>Avg.</b></p>	 <p>Site : 03CH13-HY Condition : AVG_BE_54 3m HORN_91200_1241 HORIZONTAL : RBW:1000.000kHz VBW:3000.000kHz SWT:Auto</p>	<p><b>Left blank</b></p>

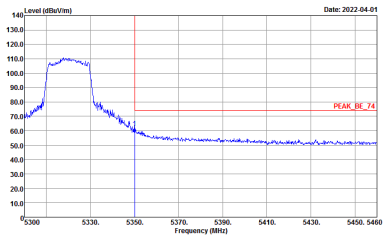
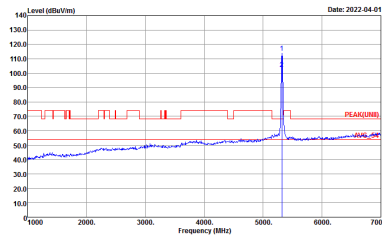
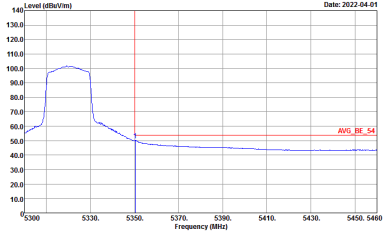

WIFI	Band 2 5250~5350MHz Band Edge @ 3m	
ANT	802.11ax HE20 Full CH64 5320MHz	
6+7	Vertical	Fundamental
Peak	 <p>Date: 2022-04-01</p> <p>Site : 03CH13-HY Condition : PEAK_BE_74 3m HORN_91200_1241 VERTICAL : RBW:1000.000KHz VBW:3000.000KHz SWT:Auto</p>	 <p>Date: 2022-04-01</p> <p>Site : 03CH13-HY Condition : PEAK(LINE) 3m HORN_91200_1241 VERTICAL : RBW:1000.000KHz VBW:3000.000KHz SWT:Auto</p>
Avg.	 <p>Date: 2022-04-01</p> <p>Site : 03CH13-HY Condition : AVG_BE_54 3m HORN_91200_1241 VERTICAL : RBW:1000.000KHz VBW:3000.000KHz SWT:Auto</p>	Left blank

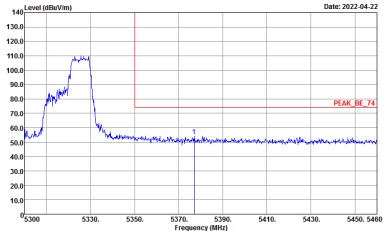
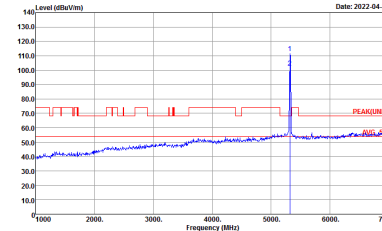
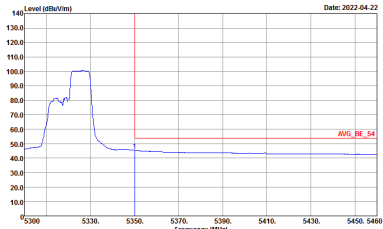

**Band 2 - 5250~5350MHz**  
**WIFI 802.11ax HE20 Partial 106 (Band Edge @ 3m)**

WIFI	Band 2 5250~5350MHz Band Edge @ 3m	
ANT	802.11ax HE20 Partial 106/54 CH64 5320MHz	
6+7	Horizontal	Fundamental
<b>Peak</b>	 <p>Site : 03CH13-HY            Condition : PEAK_BE_74 3m HORN_91200_1241 HORIZONTAL            : RBW:1000.000KHz VBW:3000.000KHz SWT:Auto</p>	 <p>Site : 03CH13-HY            Condition : PEAK(UNII) 3m HORN_91200_1241 HORIZONTAL            : RBW:1000.000KHz VBW:3000.000KHz SWT:Auto</p>
<b>Avg.</b>	 <p>Site : 03CH13-HY            Condition : AVG_BE_54 3m HORN_91200_1241 HORIZONTAL            : RBW:1000.000KHz VBW:0.010KHz SWT:Auto</p>	Left blank

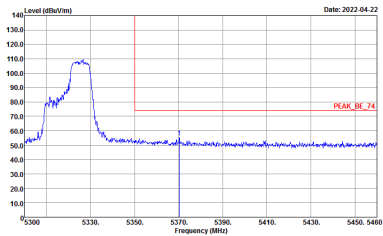
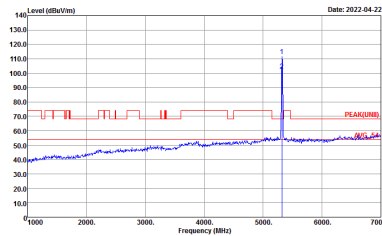
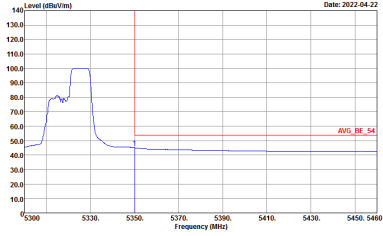

WIFI	Band 2 5250~5350MHz Band Edge @ 3m	
ANT	802.11ax HE20 Partial 106/54 CH64 5320MHz	
6+7	Vertical	Fundamental
Peak	 <p>Site : 03CH13-HY Condition : PEAK_BE_74 3m HORN_91200_1241 VERTICAL : RBW:1000.000KHz VBW:3000.000KHz SWT:Auto</p>	 <p>Site : 03CH13-HY Condition : PEAK(FUND) 3m HORN_91200_1241 VERTICAL : RBW:1000.000KHz VBW:3000.000KHz SWT:Auto</p>
Avg.	 <p>Site : 03CH13-HY Condition : AV6_BE_54 3m HORN_91200_1241 VERTICAL : RBW:1000.000KHz VBW:0.100KHz SWT:Auto</p>	Left blank

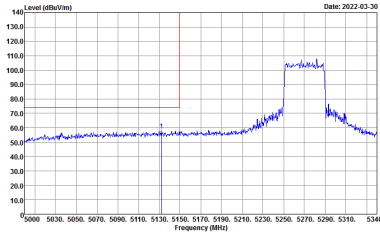
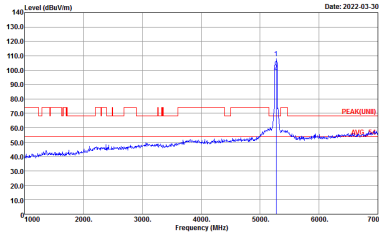
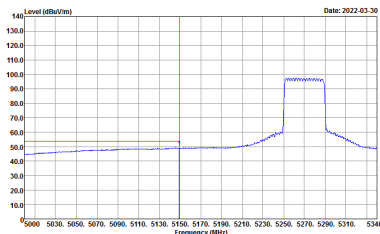

**Band 2 5250~5350MHz**  
**WIFI 802.11ax HE40 Full (Band Edge @ 3m)**

WIFI	Band 2 5250~5350MHz Band Edge @ 3m	
ANT	802.11ax HE40 Full CH54 5270MHz - L	
6+7	Horizontal	Fundamental
Peak	 <p>Site : 03CH13-HY            Condition : PEAK_BE_74 3m HORN_9120D_1241 HORIZONTAL            : RBW:1000.000KHz VBW:3000.000KHz SWT:Auto</p>	 <p>Site : 03CH13-HY            Condition : PEAK(UNII) 3m HORN_9120D_1241 HORIZONTAL            : RBW:1000.000KHz VBW:3000.000KHz SWT:Auto</p>
Avg.	 <p>Site : 03CH13-HY            Condition : AVG_BE_54 3m HORN_9120D_1241 HORIZONTAL            : RBW:1000.000KHz VBW:1.000KHz SWT:Auto</p>	Left blank



WIFI	Band 2 5250~5350MHz Band Edge @ 3m	
ANT	802.11ax HE40 Full CH54 5270 MHz - R	
6+7	Horizontal	Fundamental
<p><b>Peak</b></p>	<p>Site : 03CH13-HY Condition : PEAK_BE_74 3m HORN_91200_1241 HORIZONTAL : RBW:1000.000kHz VBW:3000.000kHz SWT:Auto</p>	<p>Left blank</p>
<p><b>Avg.</b></p>	<p>Site : 03CH13-HY Condition : AVG_BE_54 3m HORN_91200_1241 HORIZONTAL : RBW:1000.000kHz VBW:10000kHz SWT:Auto</p>	<p>Left blank</p>

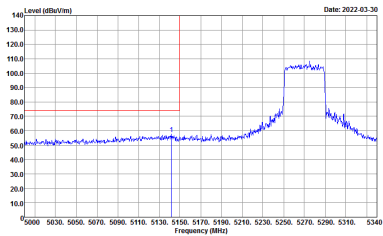
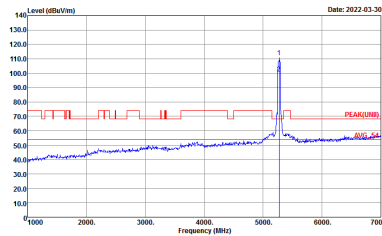
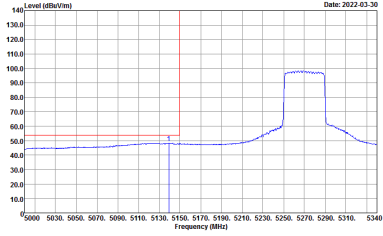

WIFI	Band 2 5250~5350MHz Band Edge @ 3m	
ANT	802.11ax HE40 Full CH54 5270 MHz - L	
6+7	Vertical	Fundamental
Peak	 <p>Site : 03CH13-HY Condition : PEAK_BE_74 3m HORN_91200_1241 VERTICAL : RBW:1000.000KHz VBW:3000.000KHz SWT:Auto</p>	 <p>Site : 03CH13-HY Condition : PEAK(LINE) 3m HORN_91200_1241 VERTICAL : RBW:1000.000KHz VBW:3000.000KHz SWT:Auto</p>
Avg.	 <p>Site : 03CH13-HY Condition : AV6_BE_54 3m HORN_91200_1241 VERTICAL : RBW:1000.000KHz VBW:10000KHz SWT:Auto</p>	Left blank



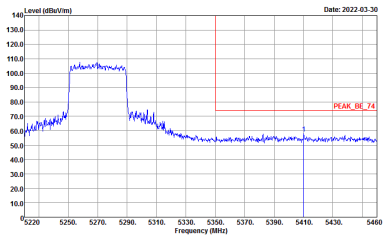
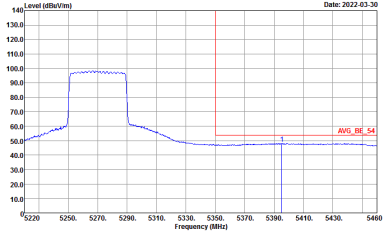

WIFI	Band 2 5250~5350MHz Band Edge @ 3m	
ANT	802.11ax HE40 Full CH54 5270 MHz - R	
6+7	Vertical	Fundamental
<p><b>Peak</b></p>	 <p>Site : 03CH13-HY Condition : PEAK_BE_74 3m HORN_91200_1241 VERTICAL : RBW:1000.000kHz VBW:3000.000kHz SWT:Auto</p>	<p>Left blank</p>
<p><b>Avg.</b></p>	 <p>Site : 03CH13-HY Condition : AV6_BE_54 3m HORN_91200_1241 VERTICAL : RBW:1000.000kHz VBW:10000kHz SWT:Auto</p>	<p>Left blank</p>

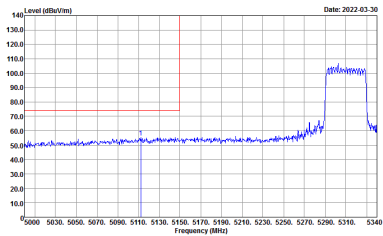
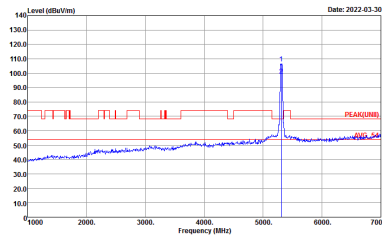
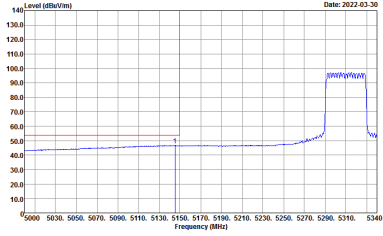

WIFI	Band 2 5250~5350MHz Band Edge @ 3m	
ANT	802.11ax HE40 Full CH62 5310 MHz - L	
6+7	Horizontal	Fundamental
Peak	 <p>Site : 03CH13-HY Condition : PEAK_BE_74 3m HORN_91200_1241 HORIZONTAL : RBW:1000.000KHz VBW:3000.000KHz SWT:Auto</p>	 <p>Site : 03CH13-HY Condition : PEAK(LINE) 3m HORN_91200_1241 HORIZONTAL : RBW:1000.000KHz VBW:3000.000KHz SWT:Auto</p>
Avg.	 <p>Site : 03CH13-HY Condition : AV6_BE_54 3m HORN_91200_1241 HORIZONTAL : RBW:1000.000KHz VBW:1000KHz SWT:Auto</p>	Left blank

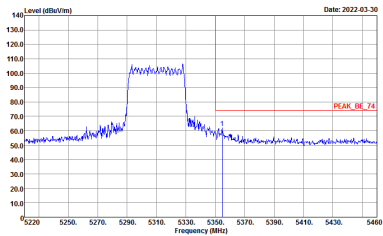
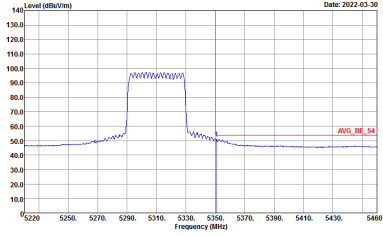

WIFI	Band 2 5250~5350MHz Band Edge @ 3m	
ANT	802.11ax HE40 Full CH62 5310 MHz - R	
6+7	Horizontal	Fundamental
<p><b>Peak</b></p>	 <p>Site : 03CH13-HY Condition : PEAK_BE_74 3m HORN_91200_1241 HORIZONTAL : RBW:1000.000kHz VBW:3000.000kHz SWT:Auto</p>	<p>Left blank</p>
<p><b>Avg.</b></p>	 <p>Site : 03CH13-HY Condition : AV6_BE_54 3m HORN_91200_1241 HORIZONTAL : RBW:1000.000kHz VBW:10000kHz SWT:Auto</p>	<p>Left blank</p>

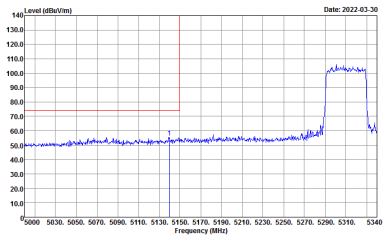
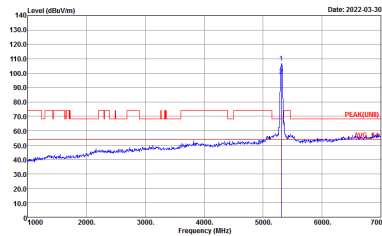
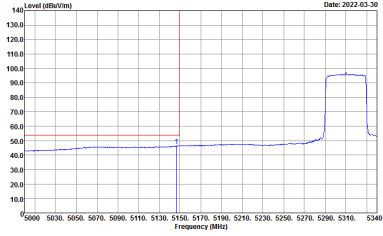

WIFI	Band 2 5250~5350MHz Band Edge @ 3m	
ANT	802.11ax HE40 Full CH62 5310 MHz - L	
6+7	Vertical	Fundamental
Peak	 <p>Site : 03CH13-HY Condition : PEAK_BE_74 3m HORN_91200_1241 VERTICAL RBW:1000.000KHz VBW:3000.000KHz SWT:Auto</p>	 <p>Site : 03CH13-HY Condition : PEAK(LINE) 3m HORN_91200_1241 VERTICAL RBW:1000.000KHz VBW:3000.000KHz SWT:Auto</p>
Avg.	 <p>Site : 03CH13-HY Condition : AV6_BE_54 3m HORN_91200_1241 VERTICAL RBW:1000.000KHz VBW:1000KHz SWT:Auto</p>	Left blank

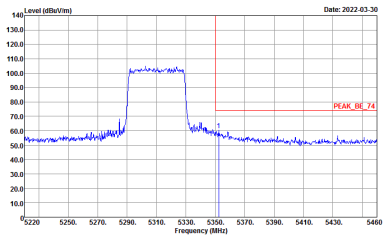
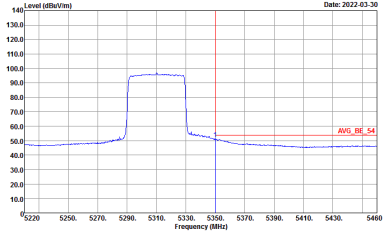

WIFI	Band 2 5250~5350MHz Band Edge @ 3m	
ANT	802.11ax HE40 Full CH62 5310 MHz - R	
6+7	Vertical	Fundamental
<p><b>Peak</b></p>	 <p>Site : 03CH13-HY Condition : PEAK_BE_74 3m HORN_91200_1241 VERTICAL : RBW:1000.000kHz VBW:3000.000kHz SWT:Auto</p>	<p>Left blank</p>
<p><b>Avg.</b></p>	 <p>Site : 03CH13-HY Condition : AVG_BE_54 3m HORN_91200_1241 VERTICAL : RBW:1000.000kHz VBW:10000kHz SWT:Auto</p>	<p>Left blank</p>

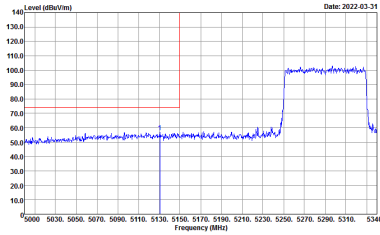
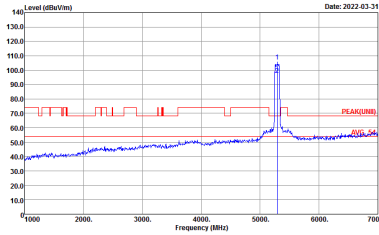
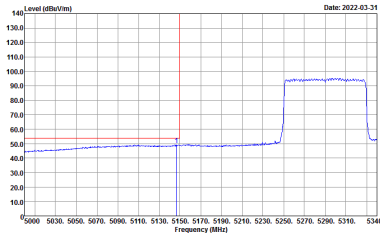

**Band 2 5250~5350MHz**  
**WIFI 802.11ax HE80 Full (Band Edge @ 3m)**

WIFI	Band 2 5250~5350MHz Band Edge @ 3m	
ANT	802.11ax HE80 Full CH58 5290MHz - L	
6+7	Horizontal	Fundamental
Peak	 <p>Site : 03CH13-HY            Condition : PEAK_BE_74 3m HORN_91200_1241 HORIZONTAL            : RBW:1000.000KHz VBW:3000.000KHz SWT:Auto</p>	 <p>Site : 03CH13-HY            Condition : PEAK(UNII) 3m HORN_91200_1241 HORIZONTAL            : RBW:1000.000KHz VBW:3000.000KHz SWT:Auto</p>
Avg.	 <p>Site : 03CH13-HY            Condition : AVG_BE_54 3m HORN_91200_1241 HORIZONTAL            : RBW:1000.000KHz VBW:3.000KHz SWT:Auto</p>	Left blank

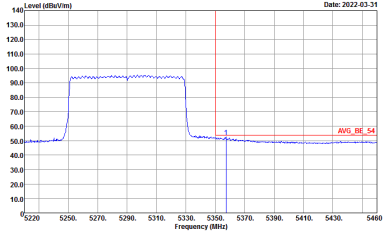

WIFI	Band 2 5250~5350MHz Band Edge @ 3m	
ANT	802.11ax HE80 Full CH58 5290MHz - R	
6+7	Horizontal	Fundamental
<p><b>Peak</b></p>	 <p>Site : 03CH13-HY Condition : PEAK_BE_74 3m HORN_91200_1241 HORIZONTAL : RBW:1000.000kHz VBW:3000.000kHz SWF:Auto</p>	<p>Left blank</p>
<p><b>Avg.</b></p>	 <p>Site : 03CH13-HY Condition : AV6_BE_54 3m HORN_91200_1241 HORIZONTAL : RBW:1000.000kHz VBW:3.000kHz SWF:Auto</p>	<p>Left blank</p>

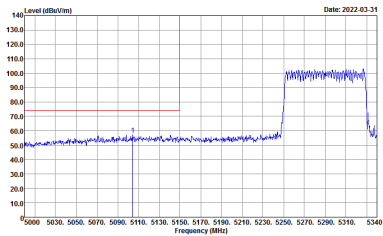
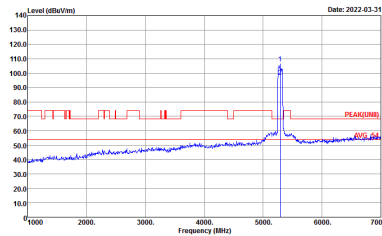
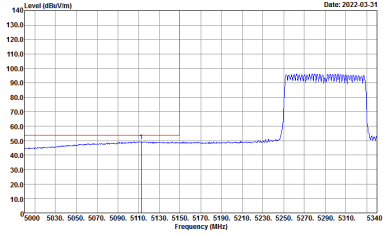

WIFI	Band 2 5250~5350MHz Band Edge @ 3m	
ANT	802.11ax HE80 Full CH58 5290MHz - L	
6+7	Vertical	Fundamental
Peak	 <p>Site : 03CH13-HY Condition : PEAK_BE_74 3m HORN_91200_1241 VERTICAL : RBW:1000.000KHz VBW:3000.000KHz SWT:Auto</p>	 <p>Site : 03CH13-HY Condition : PEAK(LINE) 3m HORN_91200_1241 VERTICAL : RBW:1000.000KHz VBW:3000.000KHz SWT:Auto</p>
Avg.	 <p>Site : 03CH13-HY Condition : AV6_BE_54 3m HORN_91200_1241 VERTICAL : RBW:1000.000KHz VBW:3000.000KHz SWT:Auto</p>	Left blank



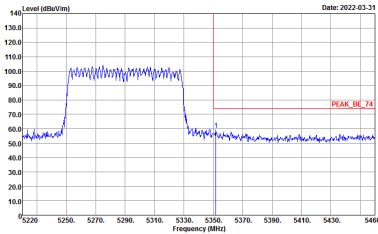
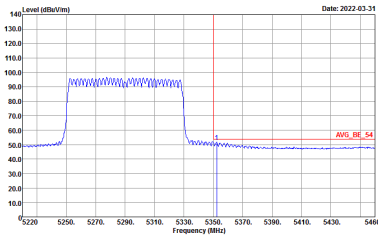

WIFI	Band 2 5250~5350MHz Band Edge @ 3m	
ANT	802.11ax HE80 Full CH58 5290MHz - R	
6+7	Vertical	Fundamental
<p><b>Peak</b></p>	 <p>Site : 03CH13-HY Condition : PEAK_BE_74 3m HORN_91200_1241 VERTICAL : RBW:1000.000kHz VBW:3000.000kHz SWT:Auto</p>	<p>Left blank</p>
<p><b>Avg.</b></p>	 <p>Site : 03CH13-HY Condition : AV6_BE_54 3m HORN_91200_1241 VERTICAL : RBW:1000.000kHz VBW:3.000kHz SWT:Auto</p>	<p>Left blank</p>



**Band 2 - 5250~5350MHz**  
**WIFI 802.11a (Harmonic @ 3m)**

<b>WIFI</b>	<b>Band 2 5250~5350MHz Harmonic @ 3m</b>	
<b>ANT</b>	<b>802.11a CH52 5260MHz</b>	
<b>6+7</b>	<b>Horizontal</b>	<b>Vertical</b>
<b>Peak</b> <b>Avg.</b>	<p>Site : 03CH13-HY          Condition : PEAK(UNII) 3m HORN_91200_1241 HORIZONTAL</p>	<p>Site : 03CH13-HY          Condition : PEAK(UNII) 3m HORN_91200_1241 VERTICAL</p>

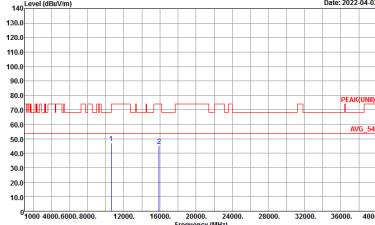
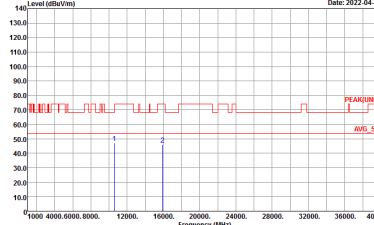

WIFI	Band 2 5250~5350MHz Harmonic @ 3m	
ANT	802.11a CH60 5300MHz	
6+7	Horizontal	Vertical
<p>Peak Avg.</p>	 <p>Site : 03CH13-HY Condition : PEAK(UNII) 3m HORN_91200_1241 HORIZONTAL</p>	 <p>Site : 03CH13-HY Condition : PEAK(UNII) 3m HORN_91200_1241 VERTICAL</p>



<b>WIFI</b>	<b>Band 2 5250~5350MHz Harmonic @ 3m</b>	
<b>ANT</b>	<b>802.11a CH64 5320MHz</b>	
<b>6+7</b>	<b>Horizontal</b>	<b>Vertical</b>
<b>Peak</b> <b>Avg.</b>	<p>Site : 03CH13-HY Condition : PEAK(UNII) 3m HORN_91200_1241 HORIZONTAL</p>	<p>Site : 03CH13-HY Condition : PEAK(UNII) 3m HORN_91200_1241 VERTICAL</p>



**Band 2 5250~5350MHz**  
**WIFI 802.11ax HE20 Full (Harmonic @ 3m)**

<b>WIFI</b>	<b>Band 2 5250~5350MHz Harmonic @ 3m</b>	
<b>ANT</b>	<b>802.11ax HE20 Full CH52 5260MHz</b>	
<b>6+7</b>	<b>Horizontal</b>	<b>Vertical</b>
<b>Peak Avg.</b>	<p>Site : 03CH13-14Y          Condition : PEAK(UNII) 3m HORN_91200_1241 HORIZONTAL</p>	<p>Site : 03CH13-14Y          Condition : PEAK(UNII) 3m HORN_91200_1241 VERTICAL</p>



<b>WIFI</b>	<b>Band 2 5250~5350MHz Harmonic @ 3m</b>	
<b>ANT</b>	<b>802.11ax HE20 Full CH60 5300MHz</b>	
<b>6+7</b>	<b>Horizontal</b>	<b>Vertical</b>
<b>Peak</b> <b>Avg.</b>	<p>Site : 03CH13-HY Condition : PEAK(UNII) 3m HORN_91200_1241 HORIZONTAL</p>	<p>Site : 03CH13-HY Condition : PEAK(UNII) 3m HORN_91200_1241 VERTICAL</p>