



FCC RF Test Report

APPLICANT : Motorola Solutions, Inc.
EQUIPMENT : Enterprise Tablet
BRAND NAME : Motorola
MODEL NAME : ET1N2
FCC ID : UZ7ET1N2
STANDARD : FCC 47 CFR Part 2, 22(H), 24(E), 27(L)
CLASSIFICATION : PCS Licensed Transmitter (PCB)
Tx/Rx FREQUENCY RANGE : GSM850 : 824.2 ~ 848.8 MHz /
869.2 ~ 893.8 MHz
GSM1900 : 1850.2 ~ 1909.8 MHz /
1930.2 ~ 1989.8 MHz
WCDMA Band V : 826.4 ~ 846.6 MHz /
871.4 ~ 891.6 MHz
WCDMA Band IV : 1712.4 MHz ~ 1752.6 MHz
2112.4 MHz ~ 2152.6 MHz
WCDMA Band II : 1852.4 ~ 1907.6 MHz /
1932.4 ~ 1987.6 MHz
CDMA2000 BC0 : 824.70 ~ 848.31 MHz /
869.70 ~ 893.31 MHz
CDMA2000 BC1 : 1851.25 ~ 1908.75 MHz /
1931.25 ~ 1988.75 MHz
MAX. ERP/EIRP POWER : GSM850 (GPRS 8) : 1.0814 W
GSM850 (EDGE 8) : 0.5546 W
GSM1900 (GPRS 8) : 1.1508 W
GSM1900 (EDGE 8) : 0.8472 W
WCDMA Band V (RMC 12.2Kbps) : 0.1734 W
WCDMA Band IV (RMC 12.2Kbps) : 0.3020 W
WCDMA Band II (RMC 12.2Kbps) : 0.2495 W
CDMA2000 BC0 : 0.2046 W
CDMA2000 BC1 : 0.3206 W



The product was received on May 24, 2012 and completely tested on Jun. 02, 2012. We, SPORTON INTERNATIONAL INC., would like to declare that the tested sample has been evaluated in accordance with the procedures given in ANSI / TIA / EIA-603-C-2004 and shown compliance with the applicable technical standards.

The test results in this report apply exclusively to the tested model / sample. Without written approval of SPORTON INTERNATIONAL INC., the test report shall not be reproduced except in full.

Reviewed by:

Jones Tsai / Manager



SPORTON INTERNATIONAL INC.

No. 52, Hwa Ya 1st Rd., Hwa Ya Technology Park, Kwei-Shan Hsiang, Tao Yuan Hsien, Taiwan, R.O.C.

SPORTON INTERNATIONAL INC.

TEL : 886-3-327-3456

FAX : 886-3-328-4978

FCC ID : UZ7ET1N2

Page Number : 2 of 132

Report Issued Date : Jun. 19, 2012

Report Version : Rev. 01



TABLE OF CONTENTS

REVISION HISTORY.....4

SUMMARY OF TEST RESULT5

1 GENERAL DESCRIPTION6

 1.1 Applicant.....6

 1.2 Manufacturer6

 1.3 Feature of Equipment Under Test.....7

 1.4 Emission Designator and Maximum ERP/EIRP Power8

 1.5 Testing Site.....8

 1.6 Applied Standards9

 1.7 Ancillary Equipment List.....9

2 TEST CONFIGURATION OF EQUIPMENT UNDER TEST 10

 2.1 Test Mode.....10

 2.2 Connection Diagram of Test System12

3 TEST RESULT 13

 3.1 Conducted Output Power Measurement.....13

 3.2 Effective Radiated Power and Effective Isotropic Radiated Power Measurement16

 3.3 Occupied Bandwidth Measurement31

 3.4 Band Edge Measurement.....59

 3.5 Conducted Emission Measurement79

 3.6 Field Strength of Spurious Radiation Measurement103

 3.7 Frequency Stability Measurement.....124

4 LIST OF MEASURING EQUIPMENTS.....131

5 UNCERTAINTY OF EVALUATION132

APPENDIX A. PHOTOGRAPHS OF EUT

APPENDIX B. SETUP PHOTOGRAPHS



SUMMARY OF TEST RESULT

Report Section	FCC Rule	IC Rule	Description	Limit	Result	Remark
3.1	§2.1046	N/A	Conducted Output Power	N/A	PASS	-
3.2	§22.913(a)(2)	RSS-132(4.4) SRSP-503(5.1.3)	Effective Radiated Power	< 7 Watts	PASS	-
3.2	§24.232(c)	RSS-133 (6.4) SRSP-510(5.1.2)	Equivalent Isotropic Radiated Power	< 2 Watts	PASS	-
3.2	§27.50(d)(4)	RSS-139 (6.4) SRSP-513(5.1.2)	Equivalent Isotropic Radiated Power	< 1 Watts	PASS	-
3.2	§24.232(d) §27.50(d)(5)	N/A	Peak-to-Average Ratio	< 13 dB	PASS	-
3.3	§2.1049 §22.917(a) §24.238(a) §27.53(g)	N/A	Occupied Bandwidth	N/A	PASS	-
3.4	§2.1051 §22.917(a) §24.238(a) §27.53(g)	RSS-132 (4.5.1) RSS-133 (6.5.1) RSS-139 (6.5)	Band Edge Measurement	< 43+10log10(P[Watts])	PASS	-
3.5	§2.1051 §22.917(a) §24.238(a) §27.53(g)	RSS-132 (4.5.1) RSS-133 (6.5.1) RSS-139 (6.5)	Conducted Emission	< 43+10log10(P[Watts])	PASS	-
3.6	§2.1053 §22.917(a) §24.238(a) §27.53(g)	RSS-132 (4.5.1) RSS-133 (6.5.1) RSS-139 (6.5)	Field Strength of Spurious Radiation	< 43+10log10(P[Watts])	PASS	Under limit 27.67 dB at 3345.000 MHz
3.7	§2.1055 §22.355 §24.235 §27.54	RSS-132 (4.3) RSS-133 (6.3) RSS-139 (6.3)	Frequency Stability for Temperature & Voltage	< 2.5 ppm	PASS	-



1 General Description

1.1 Applicant

Motorola Solutions, Inc.

One Motorola Plaza, Holtsville, NY 11742-1300 USA

1.2 Manufacturer

Motorola Solutions, Inc.

One Motorola Plaza, Holtsville, NY 11742-1300 USA

1.3 Feature of Equipment Under Test

Product Feature & Specification	
Equipment	Enterprise Tablet
Brand Name	Motorola
Model Name	ET1N2
FCC ID	UZ7ET1N2
Tx Frequency	GSM850 : 824 MHz ~ 849 MHz GSM1900 : 1850 MHz ~ 1910 MHz WCDMA Band V : 824 MHz ~ 849 MHz WCDMA Band IV : 1710 MHz ~ 1755 MHz WCDMA Band II : 1850 MHz ~ 1910 MHz CDMA2000 BC0 : 824 MHz ~ 849 MHz CDMA2000 BC1 : 1850 MHz ~ 1910 MHz
Rx Frequency	GSM850 : 869 MHz ~ 894 MHz GSM1900 : 1930 MHz ~ 1990 MHz WCDMA Band V : 869 MHz ~ 894 MHz WCDMA Band IV : 2110 MHz ~ 2155 MHz WCDMA Band II : 1930 MHz ~ 1990 MHz CDMA2000 BC0 : 869 MHz ~ 894 MHz CDMA2000 BC1 : 1930 MHz ~ 1990 MHz
Maximum Output Power to Antenna	GSM850 : 33.02 dBm GSM1900 : 30.61 dBm WCDMA Band V : 24.03 dBm WCDMA Band IV : 22.92 dBm WCDMA Band II : 23.01 dBm CDMA2000 BC0 : 24.13 dBm CDMA2000 BC1 : 24.18 dBm
Antenna Type	Fixed Internal Antenna
HW Version	DV1
SW Version	91-271301-1664-0100-00-D1-051812
FW Version	D3200-ST5UGN-1580 1
Type of Modulation	GSM: GMSK GPRS: GMSK EDGE: GMSK / 8PSK WCDMA: QPSK (Uplink) HSDPA: QPSK (Uplink) HSUPA: QPSK (Uplink) CDMA2000 : QPSK CDMA2000 1xEVDO : 8PSK
EUT Stage	Identical Prototype

Remark: The above EUT's information was declared by manufacturer. Please refer to the specifications or user's manual for more detailed description.

1.4 Emission Designator and Maximum ERP/EIRP Power

FCC Rule	System	Type of Modulation	Emission Designator	Maximum ERP/EIRP
Part 22	GSM850 GPRS 8	GMSK	248KGXW	1.0814 W
Part 22	GSM850 EDGE 8	GMSK / 8PSK	246KG7W	0.5546 W
Part 22	WCDMA Band V RMC 12.2Kbps	QPSK	4M14F9W	0.1734 W
Part 22	CDMA2000 BC0 1xRTT	QPSK	1M28F9W	0.2046 W
Part 24	GSM1900 GPRS 8	GMSK	248KGXW	1.1508 W
Part 24	GSM1900 EDGE 8	GMSK / 8PSK	246KG7W	0.8472 W
Part 24	WCDMA Band II RMC 12.2Kbps	QPSK	4M16F9W	0.2495 W
Part 24	CDMA2000 BC1 1xRTT	QPSK	1M28F9W	0.3206 W
Part 27	WCDMA Band IV RMC 12.2Kbps	QPSK	4M16F9W	0.3020 W

1.5 Testing Site

Test Site	SPORTON INTERNATIONAL INC.		
Test Site Location	No. 52, Hwa Ya 1 st Rd., Hwa Ya Technology Park, Kwei-Shan Hsiang, Tao Yuan Hsien, Taiwan, R.O.C. TEL: +886-3-327-3456 FAX: +886-3-328-4978		
Test Site No.	Sporton Site No.		FCC/IC Registration No.
	TH02-HY	03CH05-HY	722060/4086B-1



1.6 Applied Standards

According to the specifications of the manufacturer, the EUT must comply with the requirements of the following standards:

- Preliminary Guidance for Receiving Applications for Certification of 3G Device. May 9, 2006.
- 47 CFR Part 2, 22(H), 24(E), 27(L)
- ANSI / TIA / EIA-603-C-2004
- FCC KDB 971168 D01 Power Meas. License Digital Systems v01
- IC RSS-132 Issue 2
- IC RSS-133 Issue 5
- IC RSS-139 Issue 2

Remark:

1. All test items were verified and recorded according to the standards and without any deviation during the test.
2. This EUT has also been tested and complied with the requirements of FCC Part 15, Subpart B, recorded in a separate test report.

1.7 Ancillary Equipment List

Item	Equipment	Trade Name	Model No.	FCC ID	Data Cable	Power Cord
1.	System Simulator	R&S	CMU 200	N/A	N/A	Unshielded, 1.8 m
2.	Notebook	DELL	P20G	FCC DoC	N/A	AC I/P: Unshielded, 1.2 m DC O/P: Shielded, 1.8 m
3.	Earpiece	Motorola	21-154925-01R	N/A	N/A	N/A

2 Test Configuration of Equipment Under Test

2.1 Test Mode

During all testing, EUT is in link mode with base station emulator at maximum power level. The spurious emission measurements were carried out in semi-anechoic chamber with 3-meter test range, and EUT is rotated on three test planes to find out the worst emission.

Frequency range investigated for radiated emission is as follows:

1. 30 MHz to 9000 MHz for GSM850, WCDMA Band V and CDMA2000 BC0.
2. 30 MHz to 18000 MHz for WCDMA Band IV.
3. 30 MHz to 19000 MHz for GSM1900, WCDMA Band II and CDMA2000 BC1.

Test Modes		
Band	Radiated TCs	Conducted TCs
GSM 850	<ul style="list-style-type: none"> ■ GPRS 8 Link ■ EDGE 8 Link 	<ul style="list-style-type: none"> ■ GPRS 8 Link ■ EDGE 8 Link
GSM 1900	<ul style="list-style-type: none"> ■ GPRS 8 Link ■ EDGE 8 Link 	<ul style="list-style-type: none"> ■ GPRS 8 Link ■ EDGE 8 Link
WCDMA Band V	<ul style="list-style-type: none"> ■ RMC 12.2Kbps Link 	<ul style="list-style-type: none"> ■ RMC 12.2Kbps Link
WCDMA Band IV	<ul style="list-style-type: none"> ■ RMC 12.2Kbps Link 	<ul style="list-style-type: none"> ■ RMC 12.2Kbps Link
WCDMA Band II	<ul style="list-style-type: none"> ■ RMC 12.2Kbps Link 	<ul style="list-style-type: none"> ■ RMC 12.2Kbps Link
CDMA2000 BC0	<ul style="list-style-type: none"> ■ 1xRTT Link 	<ul style="list-style-type: none"> ■ 1xRTT Link
CDMA2000 BC1	<ul style="list-style-type: none"> ■ 1xRTT Link 	<ul style="list-style-type: none"> ■ 1xRTT Link

Note:

1. The maximum power levels are GPRS multi-slot class 8 mode for GMSK link, EDGE multi-slot class 8 mode for 8PSK link, RMC 12.2Kbps mode for WCDMA band V, RMC 12.2Kbps mode for WCDMA band IV, RMC 12.2Kbps mode for WCDMA band II, 1xRTT mode for CDMA2000 BC0, and 1xRTT mode for CDMA2000 BC1 only these modes were used for all tests.
2. Because there are individual antennas for each WWAN, WLAN, and Bluetooth, the co-location test modes are not required.

The conducted power tables are as follows:

Conducted Power (*Unit: dBm)						
Band	GSM850			GSM1900		
Channel	128	189	251	512	661	810
Frequency	824.2	836.4	848.8	1850.2	1880	1909.8
GPRS 8	33.02	32.98	32.81	30.61	30.40	30.38
GPRS 10	30.58	30.89	30.98	30.55	30.24	30.35
EGPRS 8	26.88	26.89	26.90	26.49	26.33	26.22
EGPRS 10	26.80	26.82	26.85	26.41	23.25	26.17

Conducted Power (*Unit: dBm)									
Band	WCDMA Band V			WCDMA Band II			WCDMA Band IV		
Tx Channel	4132	4182	4233	9262	9400	9538	1312	1413	1513
Rx Channel	4357	4408	4458	9662	9800	9938	1537	1638	1738
Frequency	826.4	836.4	846.6	1852.4	1880	1907.6	1712.4	1732.6	1752.6
RMC 12.2K	24.03	23.97	23.83	22.80	23.01	22.78	22.90	22.92	22.87
HSDPA Subtest-1	23.79	23.72	23.64	22.70	22.73	22.65	22.31	22.36	22.24
HSDPA Subtest-2	23.75	23.68	23.61	22.59	22.64	22.51	22.37	22.40	22.30
HSDPA Subtest-3	23.30	23.25	23.21	22.19	22.22	22.11	22.24	22.29	22.16
HSDPA Subtest-4	23.27	23.23	23.19	22.14	22.18	22.03	21.93	21.97	21.86
HSUPA Subtest-1	23.29	23.49	23.10	22.26	22.29	22.19	22.30	22.35	22.24
HSUPA Subtest-2	22.10	22.14	22.01	21.10	21.14	21.04	21.20	21.26	21.11
HSUPA Subtest-3	22.48	22.54	22.34	21.27	21.31	21.20	21.17	21.21	21.12
HSUPA Subtest-4	22.27	22.33	22.22	21.57	21.59	21.49	21.31	21.35	21.24
HSUPA Subtest-5	23.39	23.45	23.31	22.44	22.48	22.34	22.36	22.38	22.30

Conducted Power (*Unit: dBm)						
Band	CDMA2000 BC0			CDMA2000 BC1		
Channel	1013	384	777	25	600	1175
Frequency	824.7	836.52	848.31	1851.25	1880	1908.75
1xRTT RC1+SO55	24.08	23.98	23.91	23.94	23.98	23.97
1xRTT RC3+SO55	24.05	24.13	23.96	23.95	24.18	23.83
1xRTT RC3+SO32(+ F-SCH)	24.01	23.96	23.88	23.92	23.94	23.80
1xRTT RC3+SO32(+SCH)	23.95	23.91	23.80	23.93	23.96	23.85
1xEVDO RTAP 153.6K	23.73	23.92	23.69	23.95	24.10	23.99
1xEVDO RETAP 4096K	23.85	23.95	23.84	24.06	24.13	23.99

2.2 Connection Diagram of Test System

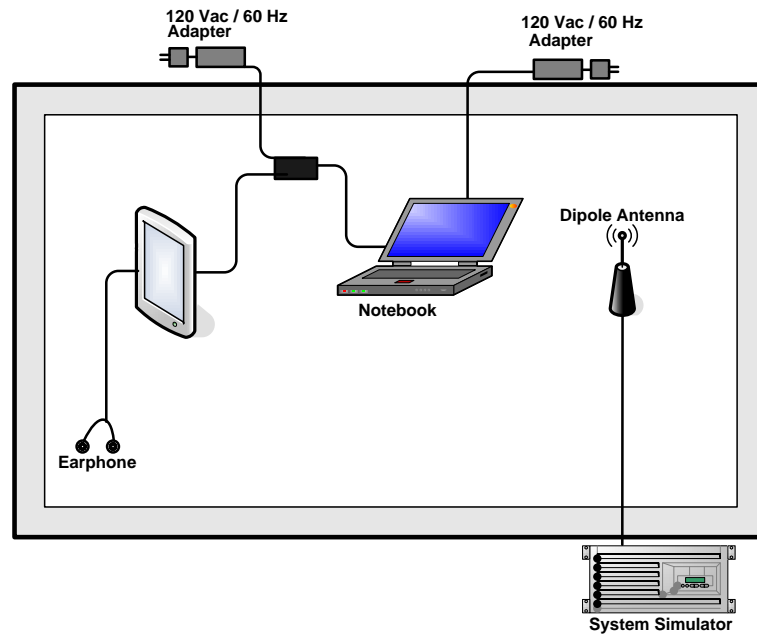

3 Test Result

3.1 Conducted Output Power Measurement

3.1.1 Description of the Conducted Output Power Measurement

A base station simulator was used to establish communication with the EUT. Its parameters were set to transmit the maximum power on the EUT. The measured power in the radio frequency on the transmitter output terminals shall be reported.

3.1.2 Measuring Instruments

See list of measuring instruments of this test report.

3.1.3 Test Procedures

1. The transmitter output port was connected to base station.
2. Set EUT at maximum power through base station.
3. Select lowest, middle, and highest channels for each band and different modulation.

3.1.4 Test Setup

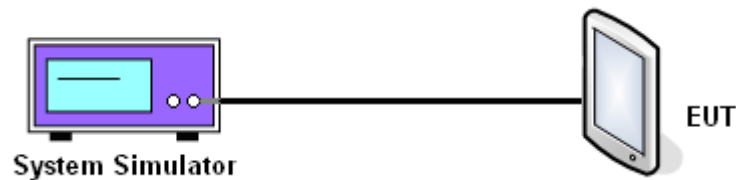



3.1.5 Test Result of Conducted Output Power

Cellular Band									
Modes	GSM850 (GPRS 8)			GSM850 (EDGE 8)			WCDMA Band V (RMC 12.2Kbps)		
Channel	128 (Low)	189 (Mid)	251 (High)	128 (Low)	189 (Mid)	251 (High)	4132 (Low)	4182 (Mid)	4233 (High)
Frequency (MHz)	824.2	836.4	848.8	824.2	836.4	848.8	826.4	836.4	846.6
Conducted Power (dBm)	33.02	32.98	32.81	26.88	26.89	26.90	24.03	23.97	23.83
Conducted Power (Watts)	2.00	1.99	1.91	0.49	0.49	0.49	0.25	0.25	0.24

PCS Band									
Modes	GSM1900 (GPRS 8)			GSM1900 (EDGE 8)			WCDMA Band II (RMC 12.2Kbps)		
Channel	512 (Low)	661 (Mid)	810 (High)	512 (Low)	661 (Mid)	810 (High)	9262 (Low)	9400 (Mid)	9538 (High)
Frequency (MHz)	1850.2	1880	1909.8	1850.2	1880	1909.8	1852.4	1880	1907.6
Conducted Power (dBm)	30.61	30.40	30.38	26.49	26.33	26.22	22.80	23.01	22.78
Conducted Power (Watts)	1.15	1.10	1.09	0.45	0.43	0.42	0.19	0.20	0.19

AWS Band			
Modes	WCDMA Band IV (RMC 12.2Kbps)		
Channel	1312(Low)	1413 (Mid)	1513 (High)
Frequency (MHz)	1712.4	1732.6	1752.6
Conducted Power (dBm)	22.90	22.92	22.87
Conducted Power (Watts)	0.19	0.20	0.19



CDMA2000 BC0			
Test Mode	CDMA 2000 1xRTT		
Test Status	RC3+SO55		
Channel	1013 (Low)	384 (Mid)	777 (High)
Frequency (MHz)	824.70	836.52	848.31
Conducted Power (dBm)	24.05	24.13	23.96
Conducted Power (Watts)	0.25	0.26	0.25

CDMA2000 BC1			
Test Mode	CDMA 2000 1xRTT		
Test Status	RC3+SO55		
Channel	25 (Low)	600 (Mid)	1175 (High)
Frequency (MHz)	1851.25	1880.00	1908.75
Conducted Power (dBm)	23.95	24.18	23.83
Conducted Power (Watts)	0.25	0.26	0.24



3.2 Effective Radiated Power and Effective Isotropic Radiated Power Measurement

3.2.1 Description of the ERP/EIRP Measurement

The substitution method, in ANSI / TIA / EIA-603-C-2004, was used for ERP/EIRP measurement, and the spectrum analyzer configuration follows KDB 971168 D01 Power Meas. License Digital Systems v01. The ERP of mobile transmitters must not exceed 7 Watts and the EIRP of mobile transmitters are limited to 2 Watts.

3.2.2 Measuring Instruments

See list of measuring instruments of this test report.

3.2.3 Test Procedures

1. The EUT was placed on a non-conductive rotating platform with 0.8 meter height in a semi-anechoic chamber. The radiated emission at the fundamental frequency was measured at 3 m with a test antenna and a spectrum analyzer with RBW= 1MHz, VBW= 3MHz for GSM, RBW= 300KHz, VBW= 1MHz for WCDMA, and RMS detector settings per section 4.0 of KDB 971168 D01.
2. During the measurement, the EUT was enforced in maximum power and linked with a base station. The highest emission was recorded from analyzer power level (LVL) from the 360 degrees rotation of the turntable and the test antenna raised and lowered over a range from 1 to 4 meters in both horizontally and vertically polarized orientations.
3. Effective Isotropic Radiated Power (EIRP) was measured by substitution method according to TIA/EIA-603-C. The EUT was replaced by dipole antenna (substitution antenna) at same location, and then a known power from S.G. was applied into the dipole antenna through a Tx cable, and then recorded the maximum Analyzer reading through raised and lowered the test antenna. The correction factor (in dB) = S.G. - Tx Cable loss + Substitution antenna gain - Analyzer reading. Then the EUT's EIRP was calculated with the correction factor, $EIRP = LVL + \text{Correction factor}$ and $ERP = EIRP - 2.15$.

3.2.4 Test Setup

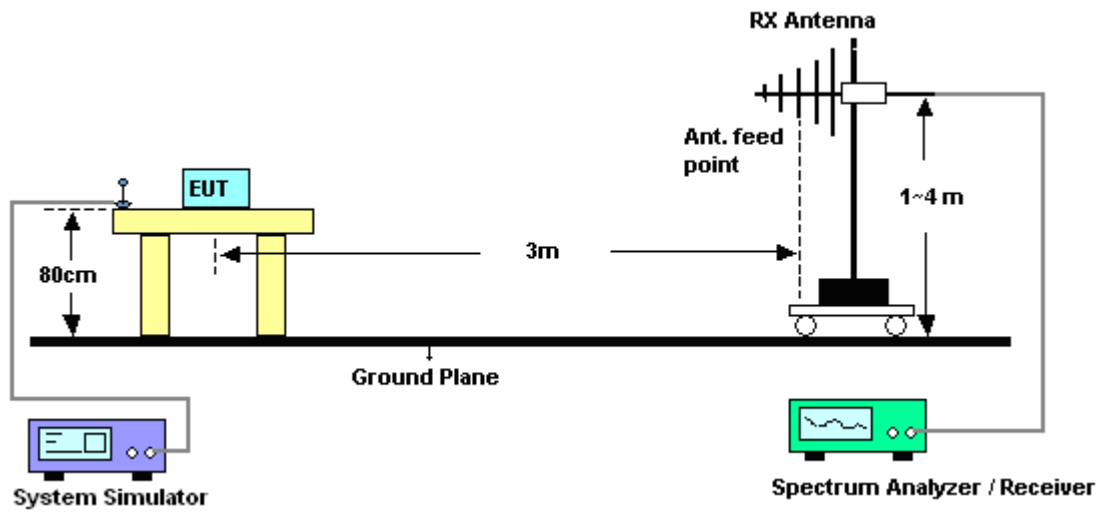

3.2.5 Test Result of ERP

GSM850 (GPRS 8) Radiated Power ERP				
Horizontal Polarization				
Frequency (MHz)	LVL (dBm)	Correction Factor (dB)	ERP (dBm)	ERP (W)
824.2	1.28	30.99	30.12	1.0280
836.4	1.60	30.89	30.34	1.0814
848.8	0.94	31.22	30.01	1.0023
Vertical Polarization				
Frequency (MHz)	LVL (dBm)	Correction Factor (dB)	ERP (dBm)	ERP (W)
824.2	-7.52	34.67	25.00	0.3162
836.4	-7.72	34.88	25.01	0.3170
848.8	-8.45	34.74	24.14	0.2594

* ERP = LVL (dBm) + Correction Factor (dB) – 2.15

GSM850 (EDGE 8) Radiated Power ERP				
Horizontal Polarization				
Frequency (MHz)	LVL (dBm)	Correction Factor (dB)	ERP (dBm)	ERP (W)
824.2	-1.76	30.99	27.08	0.5105
836.4	-1.30	30.89	27.44	0.5546
848.8	-1.87	31.22	27.20	0.5248
Vertical Polarization				
Frequency (MHz)	LVL (dBm)	Correction Factor (dB)	ERP (dBm)	ERP (W)
824.2	-10.47	34.67	22.05	0.1603
836.4	-10.62	34.88	22.11	0.1626
848.8	-11.09	34.74	21.50	0.1413

* ERP = LVL (dBm) + Correction Factor (dB) – 2.15



WCDMA Band V (RMC 12.2Kbps) Radiated Power ERP				
Horizontal Polarization				
Frequency (MHz)	LVL (dBm)	Correction Factor (dB)	ERP (dBm)	ERP (W)
826.4	-6.87	30.74	21.72	0.1486
836.4	-6.35	30.89	22.39	0.1734
846.6	-7.13	31.29	22.01	0.1589
Vertical Polarization				
Frequency (MHz)	LVL (dBm)	Correction Factor (dB)	ERP (dBm)	ERP (W)
826.4	-16.40	34.94	16.39	0.0436
836.4	-15.73	34.88	17.00	0.0501
846.6	-16.01	34.67	16.51	0.0448

* ERP = LVL (dBm) + Correction Factor (dB) – 2.15

CDMA2000 BC0 1xRTT_RC3+SO55 Radiated Power ERP				
Horizontal Polarization				
Frequency (MHz)	LVL (dBm)	Correction Factor (dB)	ERP (dBm)	ERP (W)
824.70	-6.37	31.00	22.48	0.1770
836.52	-5.69	30.95	23.11	0.2046
848.31	-6.01	31.20	23.04	0.2014
Vertical Polarization				
Frequency (MHz)	LVL (dBm)	Correction Factor (dB)	ERP (dBm)	ERP (W)
824.70	-14.77	34.47	17.55	0.0569
836.52	-14.46	34.91	18.30	0.0676
848.31	-14.91	34.76	17.70	0.0589

* ERP = LVL (dBm) + Correction Factor (dB) – 2.15



3.2.6 Test Result of EIRP

GSM1900 (GPRS 8) Radiated Power EIRP				
Horizontal Polarization				
Frequency (MHz)	LVL (dBm)	Correction Factor (dB)	EIRP (dBm)	EIRP (W)
1850.2	-11.61	40.70	29.09	0.8110
1880.0	-11.30	41.91	30.61	1.1508
1909.8	-11.34	41.73	30.39	1.0940
Vertical Polarization				
Frequency (MHz)	LVL (dBm)	Correction Factor (dB)	EIRP (dBm)	EIRP (W)
1850.2	-15.61	42.78	27.17	0.5212
1880.0	-15.96	43.75	27.79	0.6012
1909.8	-16.12	43.06	26.94	0.4943

* EIRP = LVL (dBm) + Correction Factor (dB)

GSM1900 (EDGE 8) Radiated Power EIRP				
Horizontal Polarization				
Frequency (MHz)	LVL (dBm)	Correction Factor (dB)	EIRP (dBm)	EIRP (W)
1850.2	-12.60	40.70	28.10	0.6457
1880.0	-12.68	41.91	29.23	0.8375
1909.8	-12.45	41.73	29.28	0.8472
Vertical Polarization				
Frequency (MHz)	LVL (dBm)	Correction Factor (dB)	EIRP (dBm)	EIRP (W)
1850.2	-16.46	42.78	26.32	0.4285
1880.0	-17.21	43.75	26.54	0.4508
1909.8	-17.19	43.06	25.87	0.3864

* EIRP = LVL (dBm) + Correction Factor (dB)



WCDMA Band IV (RMC 12.2Kbps) Radiated Power EIRP				
Horizontal Polarization				
Frequency (MHz)	LVL (dBm)	Correction Factor (dB)	EIRP (dBm)	EIRP (W)
1712.4	-14.67	39.34	24.67	0.2931
1732.6	-15.76	39.89	24.13	0.2588
1752.6	-15.06	39.86	24.80	0.3020
Vertical Polarization				
Frequency (MHz)	LVL (dBm)	Correction Factor (dB)	EIRP (dBm)	EIRP (W)
1712.4	-24.10	42.85	18.75	0.0750
1732.6	-23.36	42.13	18.77	0.0753
1752.6	-23.25	41.59	18.34	0.0682

* EIRP = LVL (dBm) + Correction Factor (dB)

WCDMA Band II (RMC 12.2Kbps) Radiated Power EIRP				
Horizontal Polarization				
Frequency (MHz)	LVL (dBm)	Correction Factor (dB)	EIRP (dBm)	EIRP (W)
1852.4	-17.53	40.40	22.87	0.1936
1880.0	-17.94	41.91	23.97	0.2495
1907.6	-17.73	41.59	23.86	0.2432
Vertical Polarization				
Frequency (MHz)	LVL (dBm)	Correction Factor (dB)	EIRP (dBm)	EIRP (W)
1852.4	-22.26	42.69	20.43	0.1104
1880.0	-22.90	43.75	20.85	0.1216
1907.6	-21.92	43.02	21.10	0.1288

* EIRP = LVL (dBm) + Correction Factor (dB)



CDMA2000 BC1 1xRTT_RC3+SO55 Radiated Power EIRP				
Horizontal Polarization				
Frequency (MHz)	LVL (dBm)	Correction Factor (dB)	EIRP (dBm)	EIRP (W)
1851.25	-16.31	40.63	24.32	0.2704
1880.00	-17.00	41.91	24.91	0.3097
1908.75	-16.70	41.76	25.06	0.3206
Vertical Polarization				
Frequency (MHz)	LVL (dBm)	Correction Factor (dB)	EIRP (dBm)	EIRP (W)
1851.25	-19.55	42.82	23.27	0.2123
1880.00	-20.70	43.75	23.05	0.2018
1908.75	-20.04	43.33	23.29	0.2133

* EIRP = LVL (dBm) + Correction Factor (dB)



3.2.7 Peak to Average Power Ratio

GSM1900 (GPRS 8) C.C.D.F.

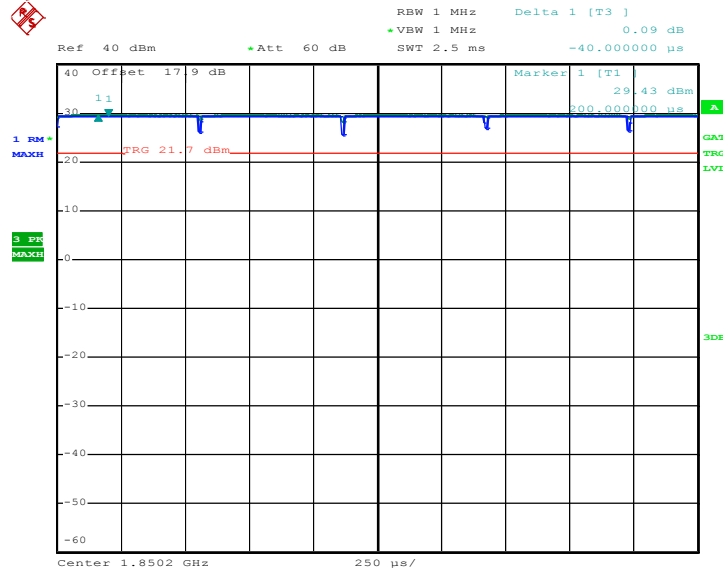

Date: 25.MAY.2012 13:18:13

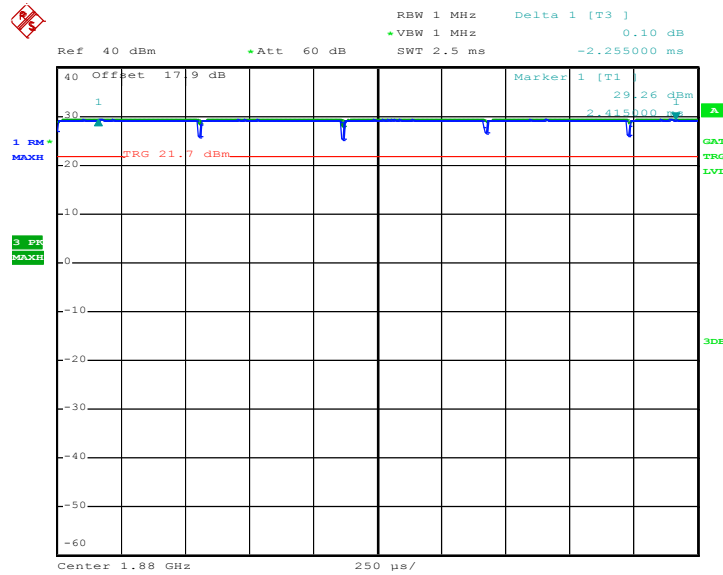

Date: 25.MAY.2012 13:18:38

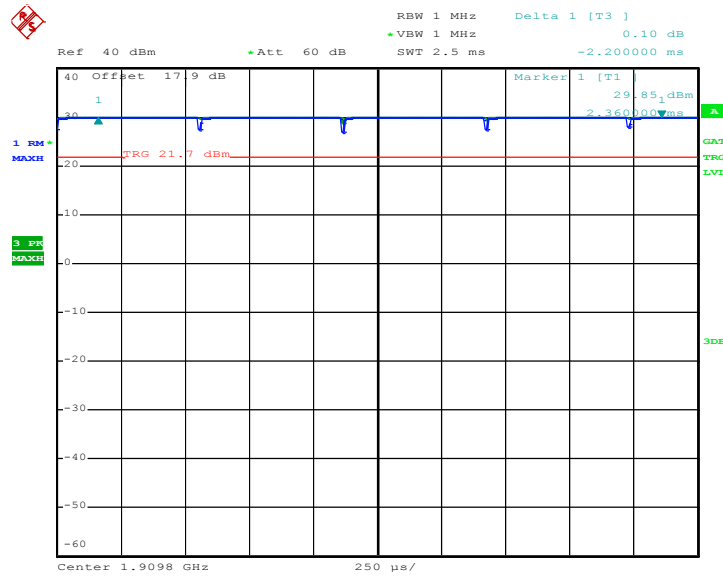

Date: 25.MAY.2012 13:19:02

GSM1900 (EDGE 8) C.C.D.F.

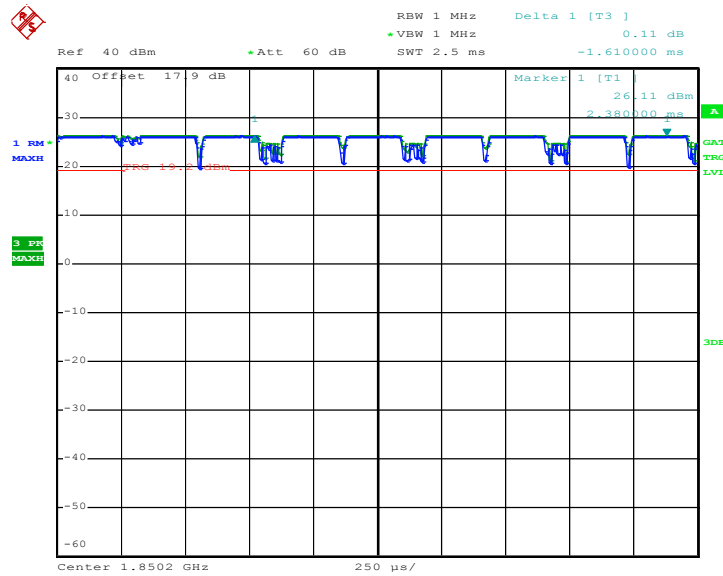

Date: 25.MAY.2012 13:45:51

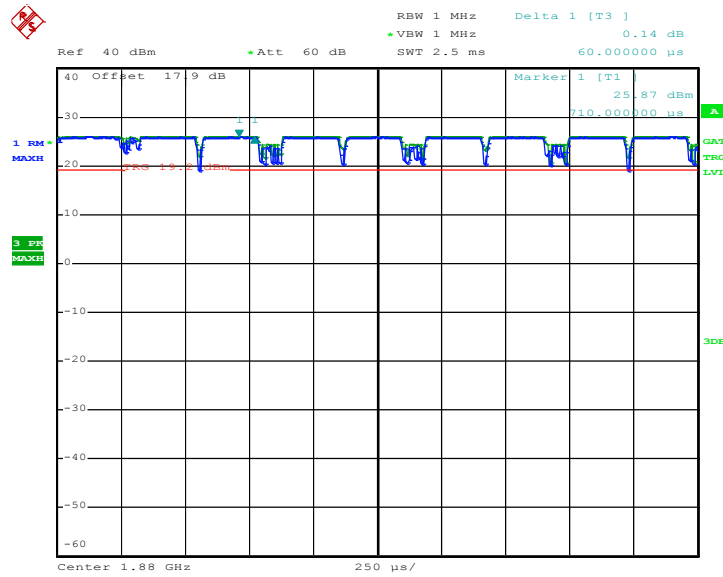

Date: 25.MAY.2012 13:46:49

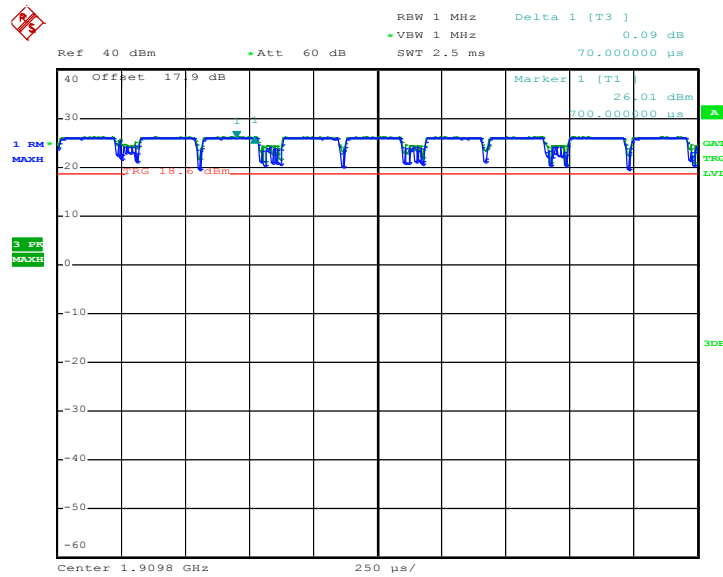

Date: 25.MAY.2012 13:47:30



WCDMA Band II (RMC 12.2Kbps) C.C.D.F.

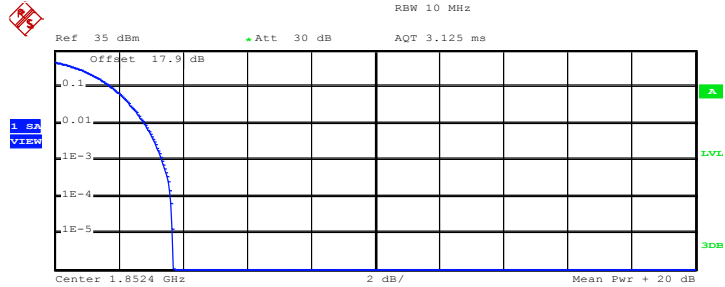

Complementary Cumulative Distribution Function (100000 samples)

Trace 1

Mean 20.49 dBm
 Peak 24.18 dBm
 Crest 3.68 dB

10 % 1.80 dB
 1 % 2.80 dB
 .1 % 3.36 dB
 .01 % 3.64 dB

Date: 25.MAY.2012 12:12:24

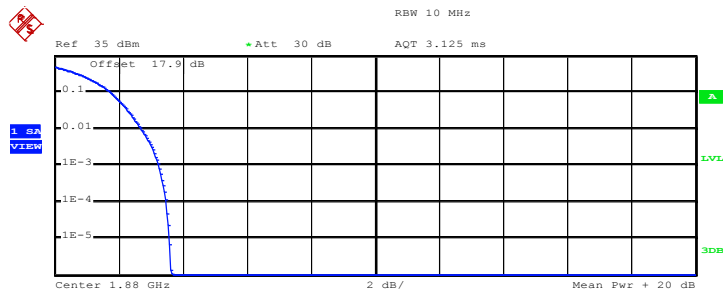

Complementary Cumulative Distribution Function (100000 samples)

Trace 1

Mean 20.96 dBm
 Peak 24.60 dBm
 Crest 3.64 dB

10 % 1.76 dB
 1 % 2.72 dB
 .1 % 3.28 dB
 .01 % 3.48 dB

Date: 25.MAY.2012 12:13:20

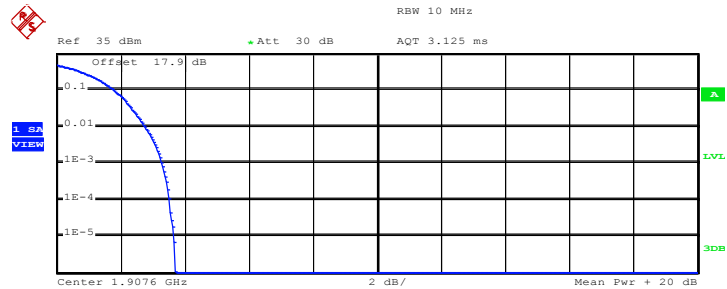

Complementary Cumulative Distribution Function (100000 samples)

Trace 1

Mean 21.25 dBm
 Peak 24.95 dBm
 Crest 3.70 dB

10 % 1.80 dB
 1 % 2.76 dB
 .1 % 3.28 dB
 .01 % 3.52 dB

Date: 25.MAY.2012 12:14:10

WCDMA Band IV (RMC 12.2Kbps) C.C.D.F.

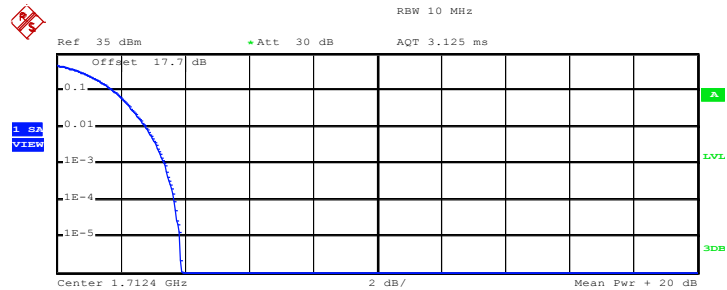

Complementary Cumulative Distribution Function (100000 samples)

Trace 1

Mean 20.22 dBm
 Peak 24.10 dBm
 Crest 3.88 dB

10 % 1.76 dB
 1 % 2.80 dB
 .1 % 3.36 dB
 .01 % 3.68 dB

Date: 25.MAY.2012 11:03:51

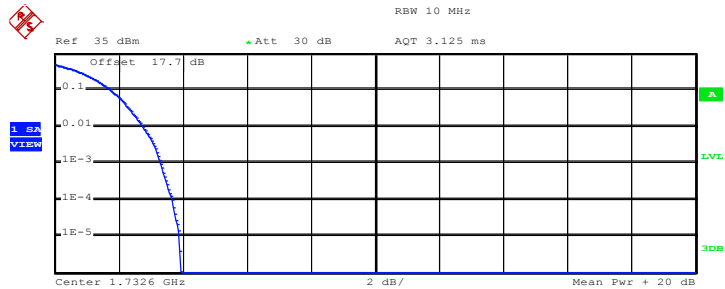

Complementary Cumulative Distribution Function (100000 samples)

Trace 1
Mean 20.95 dBm
Peak 24.88 dBm
Crest 3.93 dB

10 % 1.76 dB
1 % 2.76 dB
.1 % 3.32 dB
.01 % 3.68 dB

Date: 25.MAY.2012 11:04:33

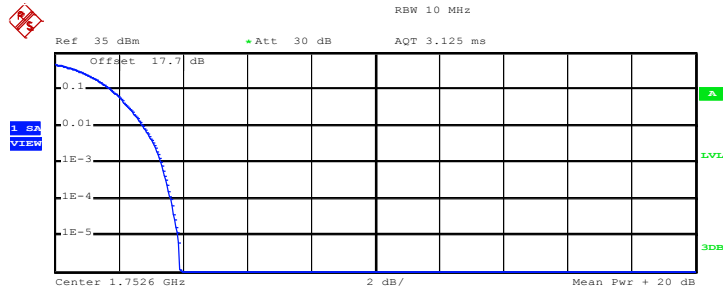

Complementary Cumulative Distribution Function (100000 samples)

Trace 1
Mean 21.17 dBm
Peak 25.09 dBm
Crest 3.92 dB

10 % 1.76 dB
1 % 2.76 dB
.1 % 3.32 dB
.01 % 3.64 dB

Date: 25.MAY.2012 11:05:09



CDMA2000 BC1 (1xRTT RC3+SO55) C.C.D.F.

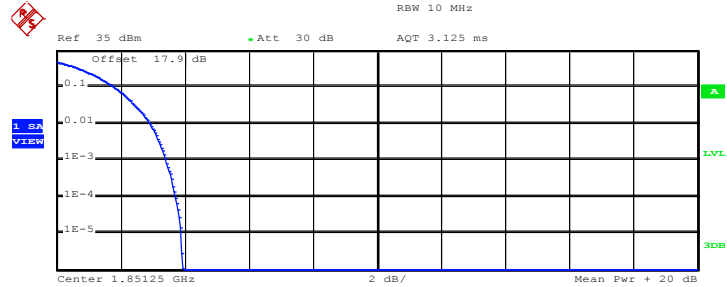

Complementary Cumulative Distribution Function (100000 samples)

Trace 1

Mean 23.71 dBm
 Peak 27.63 dBm
 Crest 3.92 dB

10 % 1.84 dB
 1 % 2.92 dB
 .1 % 3.44 dB
 .01 % 3.72 dB

Date: 25.MAY.2012 16:03:09

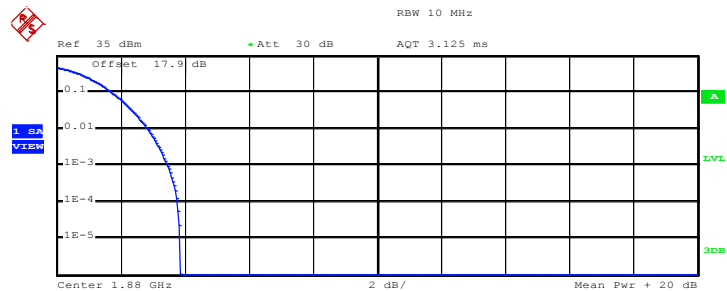

Complementary Cumulative Distribution Function (100000 samples)

Trace 1

Mean 23.49 dBm
 Peak 27.35 dBm
 Crest 3.86 dB

10 % 1.76 dB
 1 % 2.84 dB
 .1 % 3.48 dB
 .01 % 3.76 dB

Date: 25.MAY.2012 16:02:22

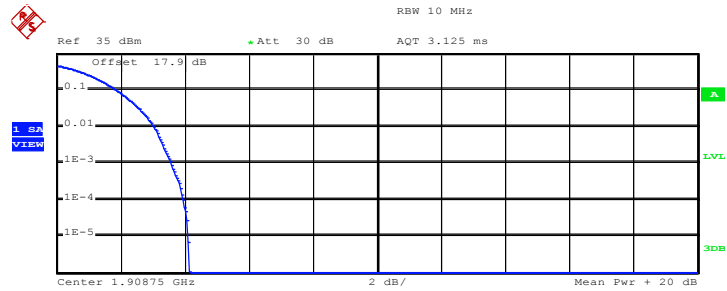

Complementary Cumulative Distribution Function (100000 samples)

Trace 1
Mean 23.23 dBm
Peak 27.35 dBm
Crest 4.12 dB

10 %	1.88 dB
1 %	3.04 dB
.1 %	3.60 dB
.01 %	3.96 dB

Date: 25.MAY.2012 16:02:02

3.3 Occupied Bandwidth Measurement

3.3.1 Description of Occupied Bandwidth Measurement

The emission bandwidth is defined as the width of the signal between two points, located at the 2 sides of the carrier frequency, outside of which all emissions are attenuated at least 26 dB below the transmitter power.

3.3.2 Measuring Instruments

See list of measuring instruments of this test report.

3.3.3 Test Procedures

1. The EUT was connected to Spectrum Analyzer and Base Station via power divider.
2. The 99% and 26 dB occupied bandwidth (BW) of the middle channel for the highest RF powers were measured.

3.3.4 Test Setup

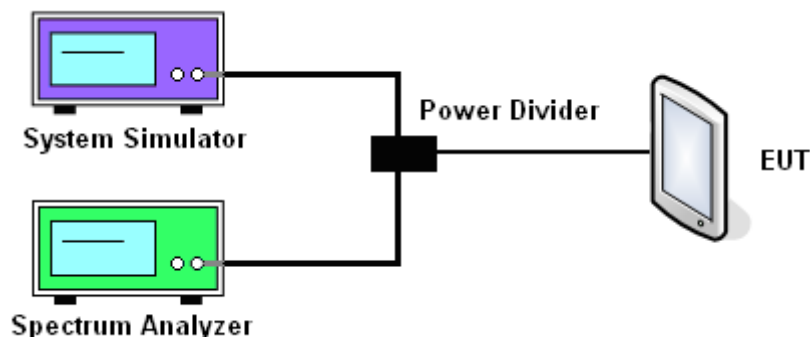



3.3.5 Test Result (Plots) of Occupied Bandwidth

Band :	GSM 850	Power Stage :	High
Test Mode :	GPRS 8 Link		

99% Occupied Bandwidth Plot on Channel 128

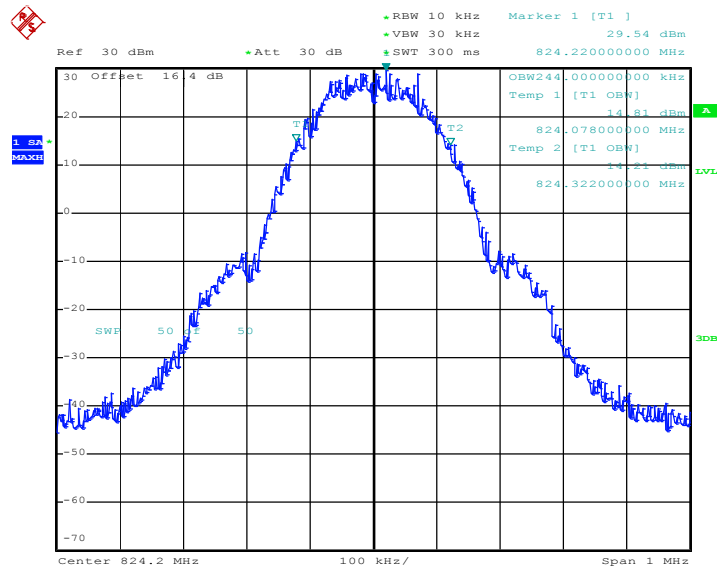

Date: 25.MAY.2012 09:24:17

26dB Bandwidth Plot on Channel 128

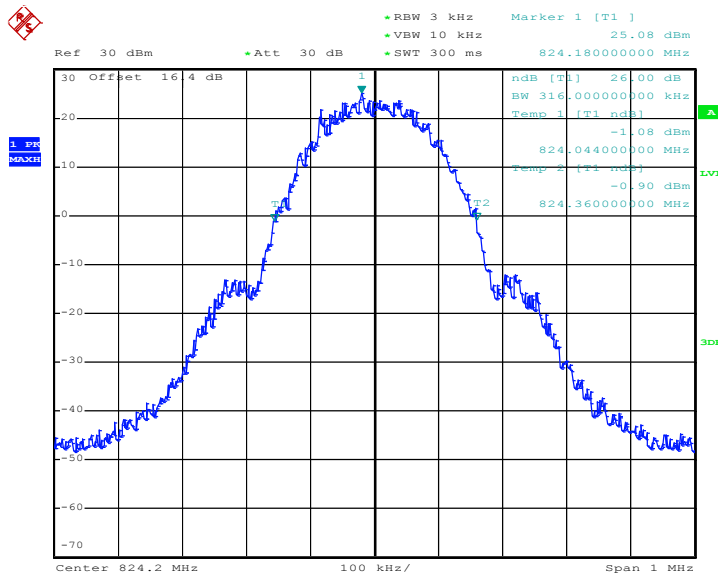

Date: 25.MAY.2012 09:12:50



99% Occupied Bandwidth Plot on Channel 189

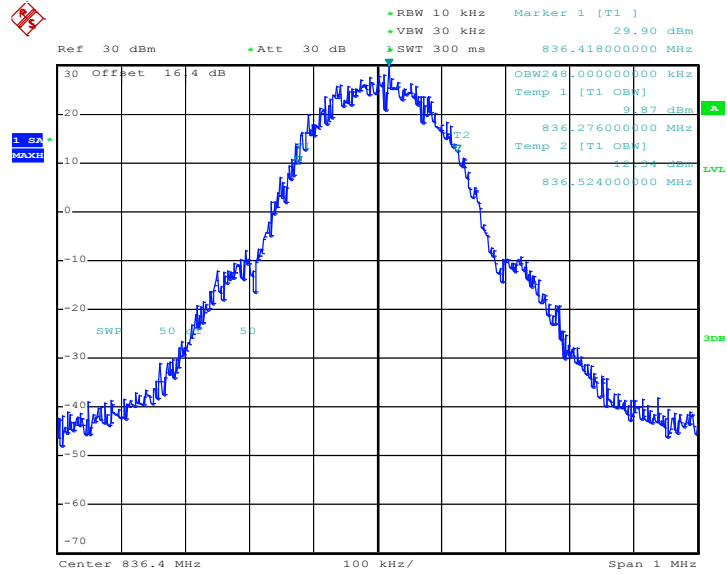

Date: 25.MAY.2012 09:25:09

26dB Bandwidth Plot on Channel 189

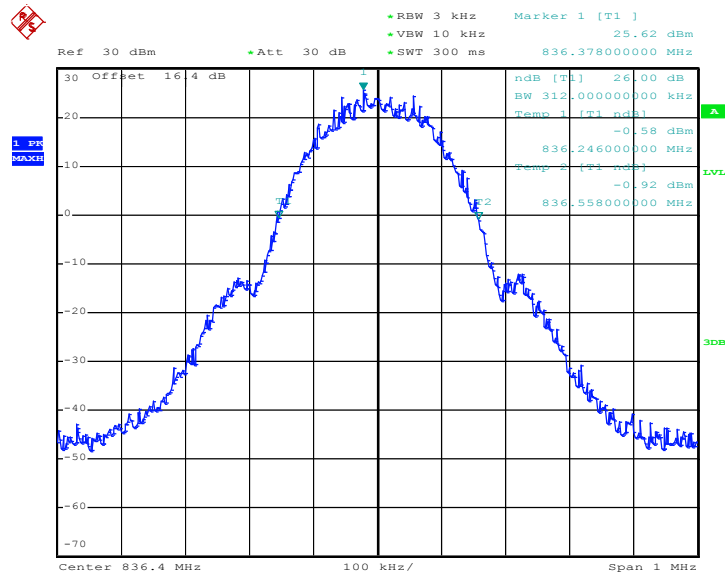

Date: 25.MAY.2012 09:12:09



99% Occupied Bandwidth Plot on Channel 251

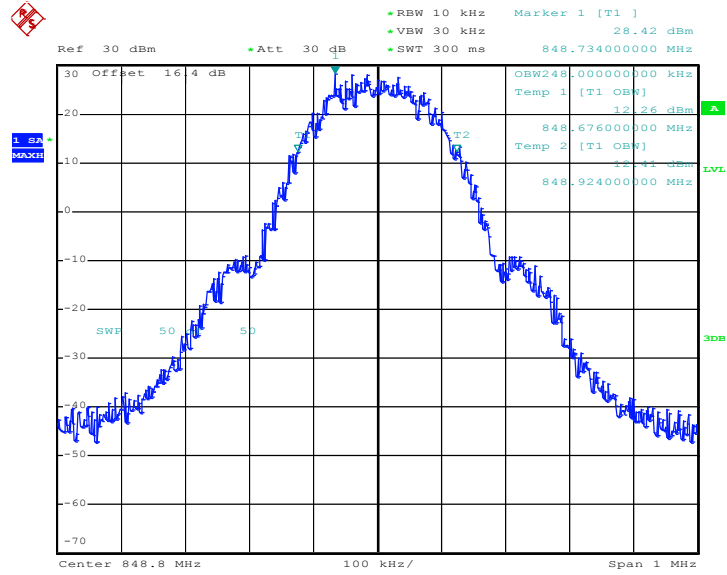

Date: 25.MAY.2012 09:25:58

26dB Bandwidth Plot on Channel 251

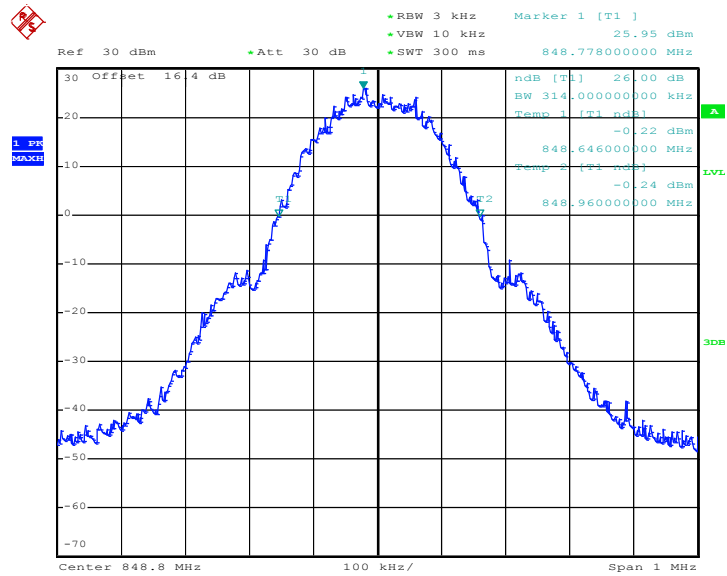

Date: 25.MAY.2012 09:11:16



Band :	GSM 850	Power Stage :	High
Test Mode :	EDGE 8 Link		

99% Occupied Bandwidth Plot on Channel 128

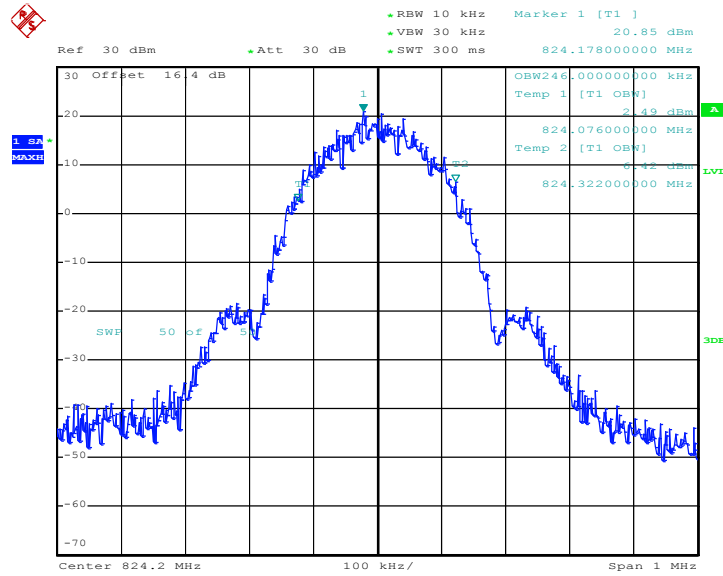

Date: 25.MAY.2012 10:11:55

26dB Bandwidth Plot on Channel 128

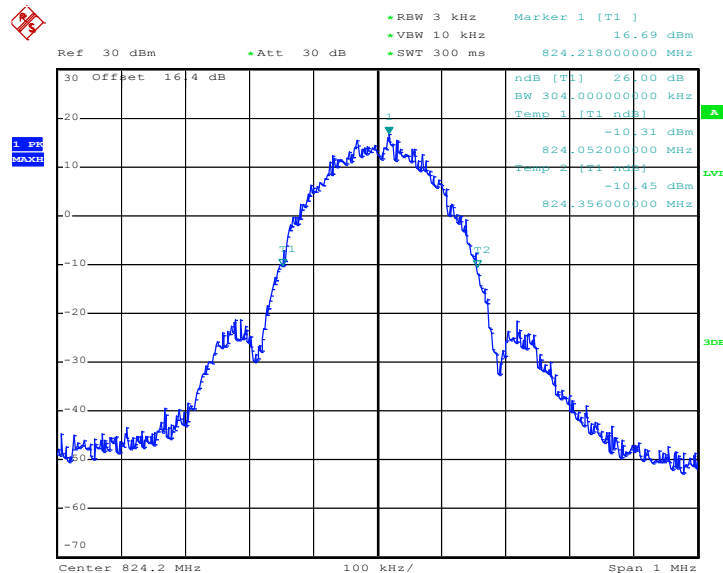

Date: 25.MAY.2012 09:59:13



99% Occupied Bandwidth Plot on Channel 189

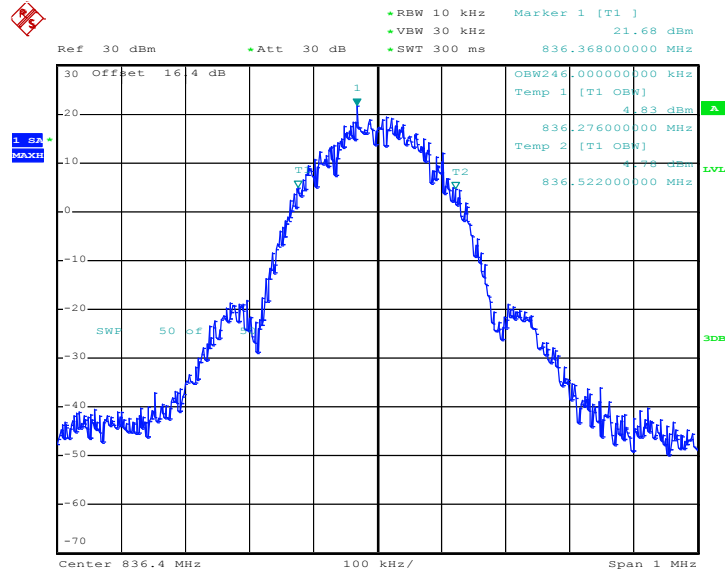

Date: 25.MAY.2012 10:11:04

26dB Bandwidth Plot on Channel 189

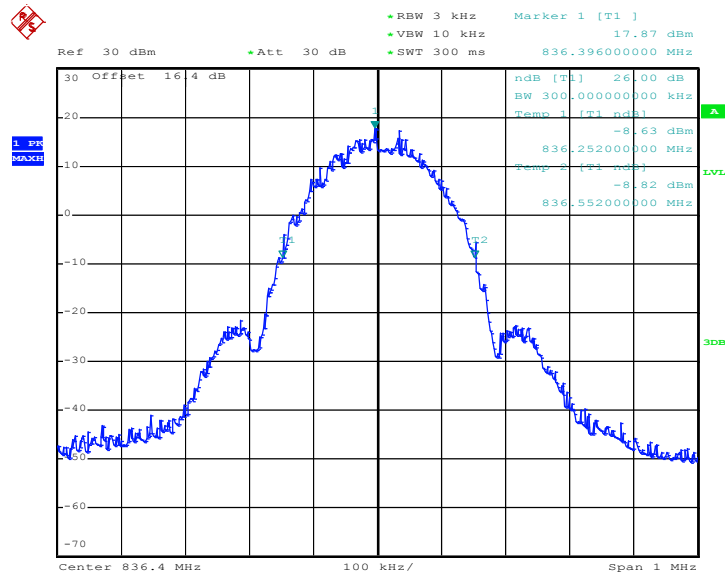

Date: 25.MAY.2012 09:58:32



99% Occupied Bandwidth Plot on Channel 251

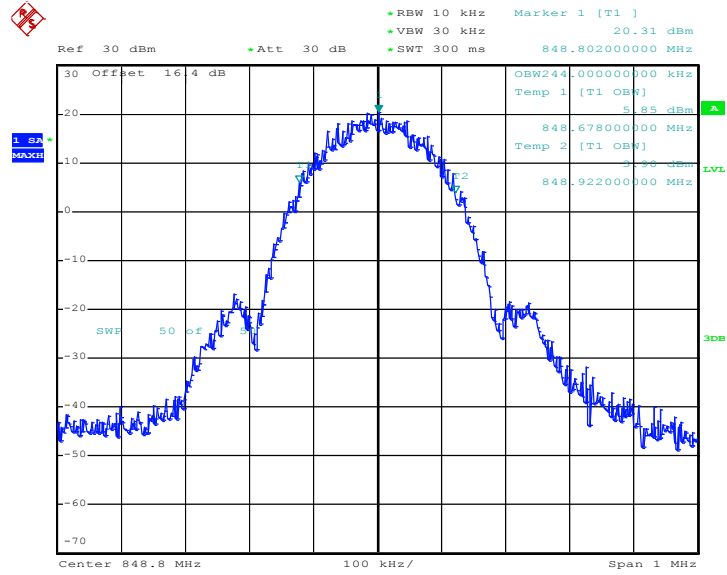

Date: 25.MAY.2012 10:10:12

26dB Bandwidth Plot on Channel 251

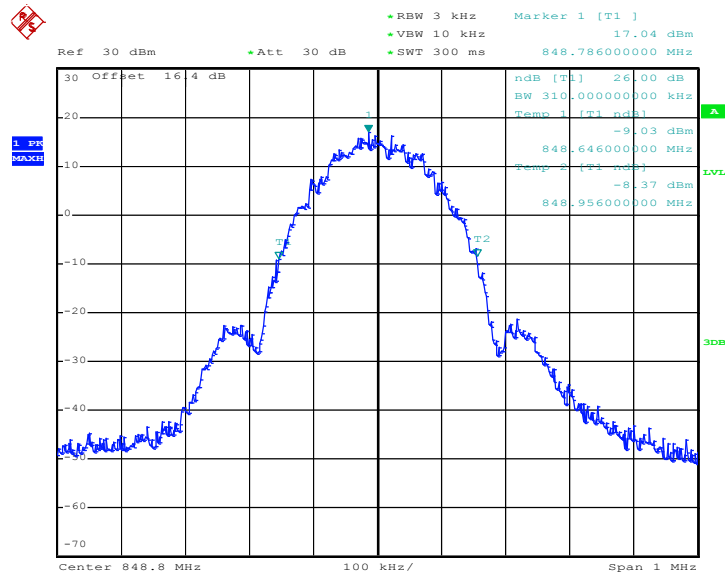

Date: 25.MAY.2012 09:57:19



Band :	GSM 1900	Power Stage :	High
Test Mode :	GPRS 8 Link		

99% Occupied Bandwidth Plot on Channel 512

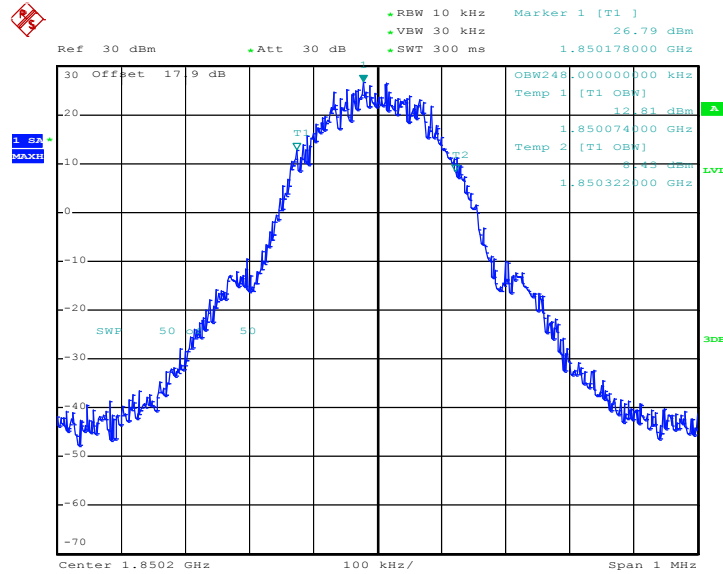

Date: 25.MAY.2012 12:59:30

26dB Bandwidth Plot on Channel 512

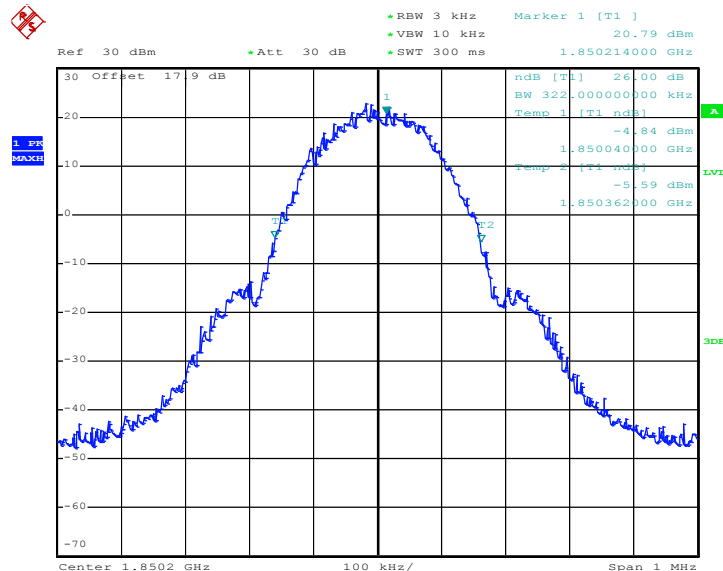

Date: 25.MAY.2012 12:49:40



99% Occupied Bandwidth Plot on Channel 661

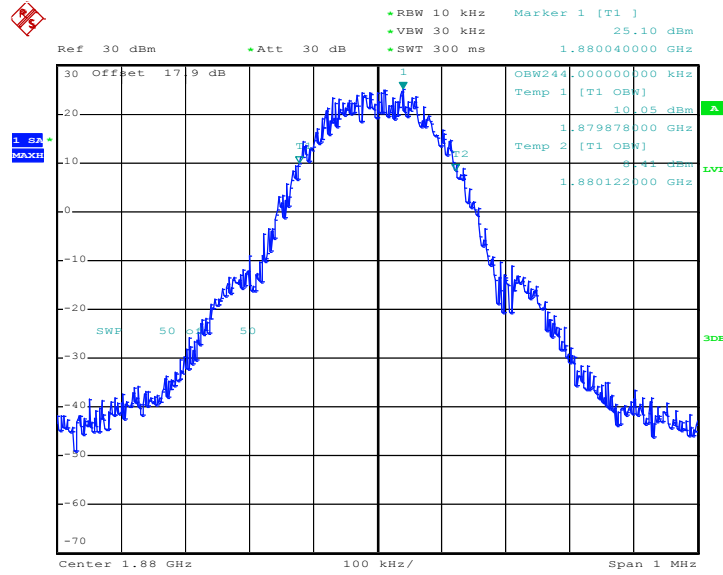

Date: 25.MAY.2012 13:00:17

26dB Bandwidth Plot on Channel 661

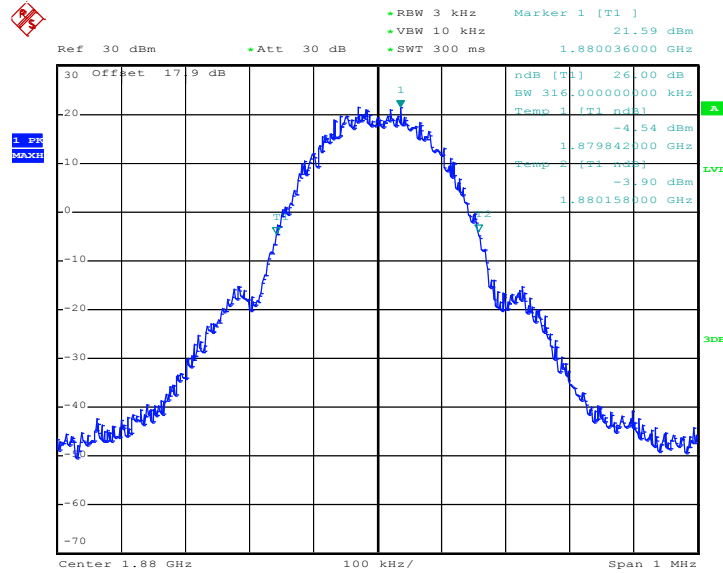

Date: 25.MAY.2012 12:50:22



99% Occupied Bandwidth Plot on Channel 810

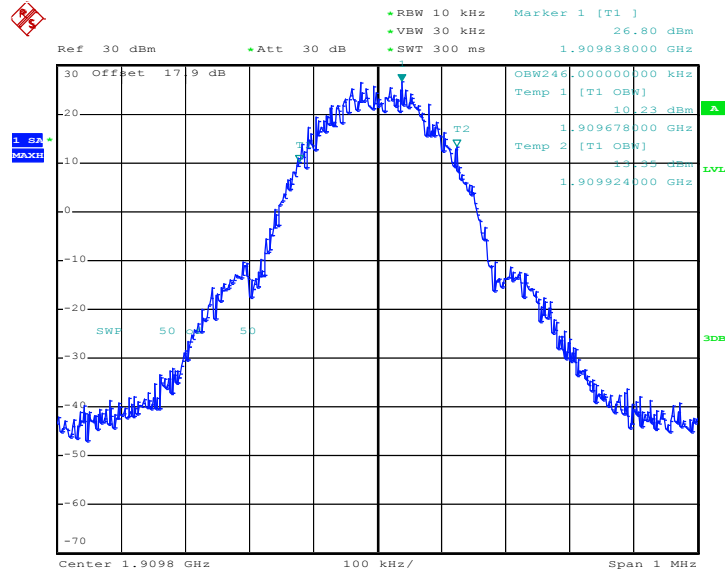

Date: 25.MAY.2012 13:01:18

26dB Bandwidth Plot on Channel 810

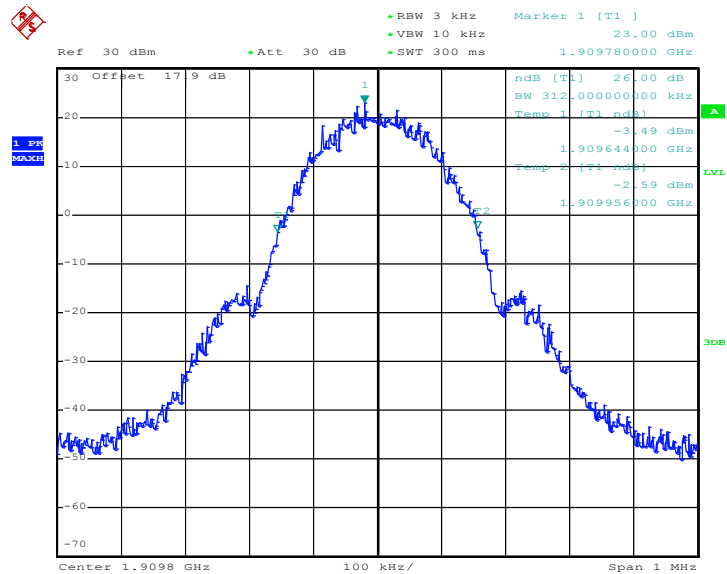

Date: 25.MAY.2012 12:50:58



Band :	GSM 1900	Power Stage :	High
Test Mode :	EDGE 8 Link		

99% Occupied Bandwidth Plot on Channel 512

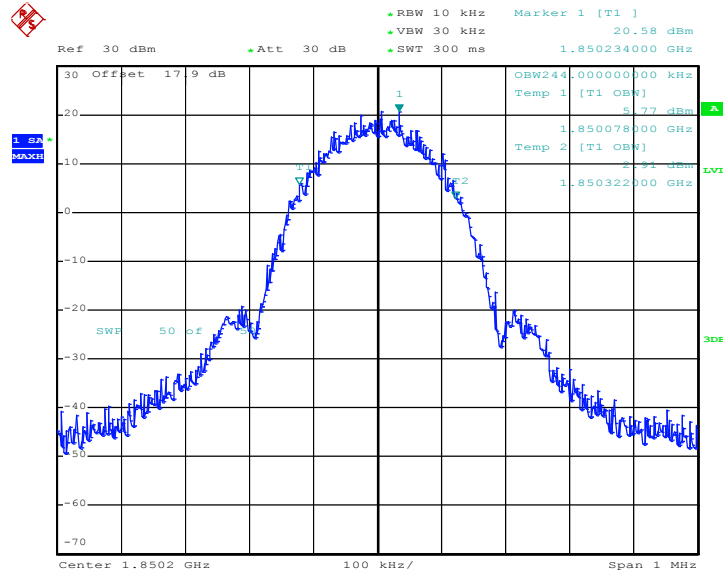

Date: 25.MAY.2012 14:01:26

26dB Bandwidth Plot on Channel 512

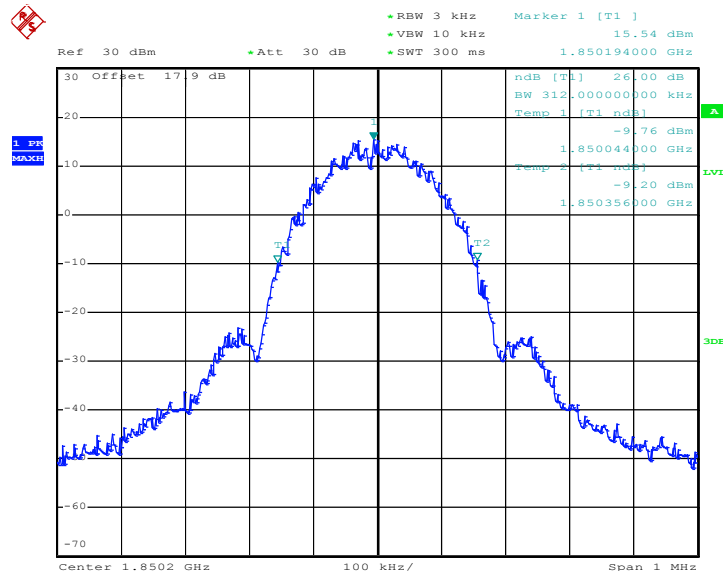

Date: 25.MAY.2012 13:51:43



99% Occupied Bandwidth Plot on Channel 661

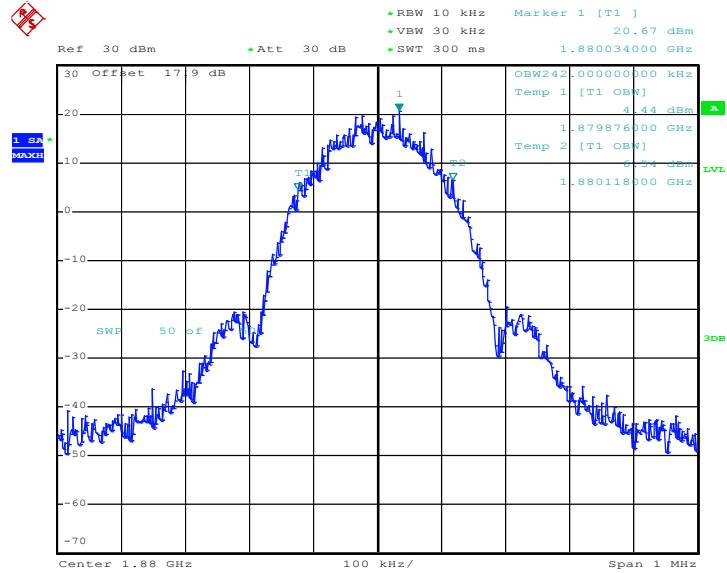

Date: 25.MAY.2012 14:02:19

26dB Bandwidth Plot on Channel 661

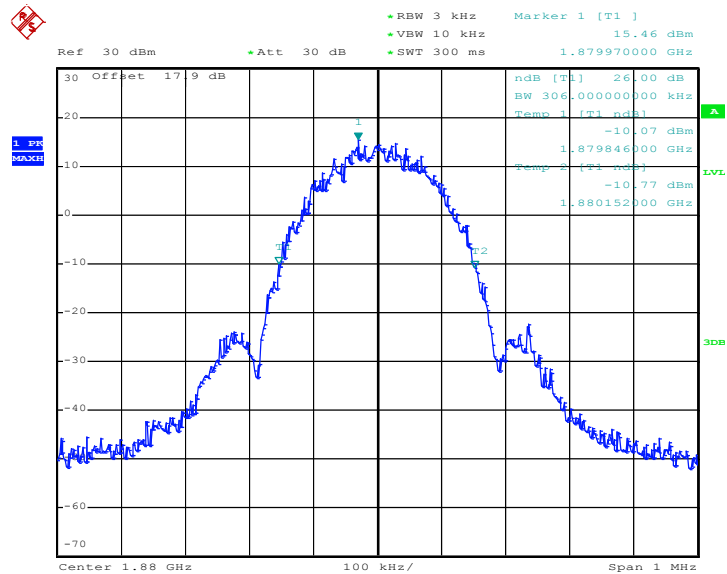

Date: 25.MAY.2012 13:50:55



99% Occupied Bandwidth Plot on Channel 810

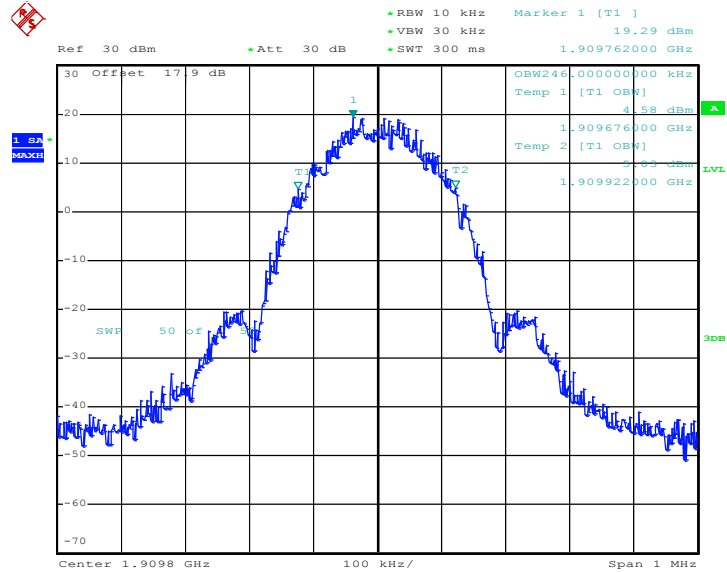

Date: 25.MAY.2012 14:03:16

26dB Bandwidth Plot on Channel 810

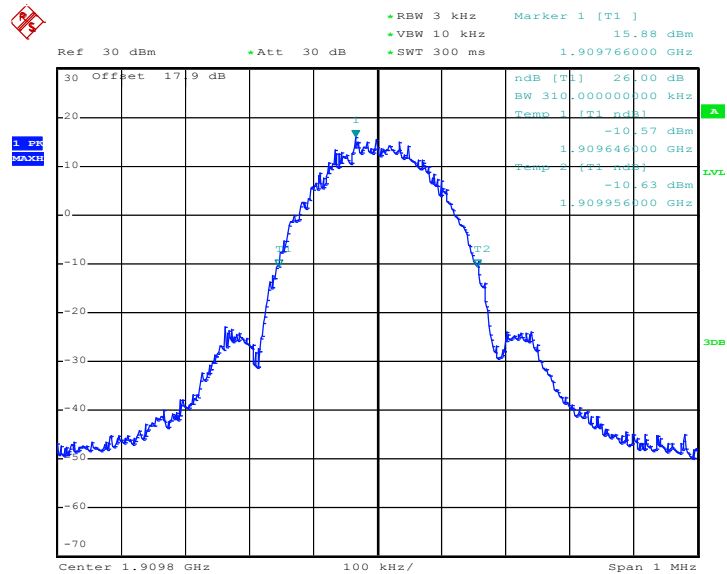

Date: 25.MAY.2012 13:50:12



Band :	WCDMA Band V	Power Stage :	High
Test Mode :	RMC 12.2Kbps Link		

99% Occupied Bandwidth Plot on Channel 4132

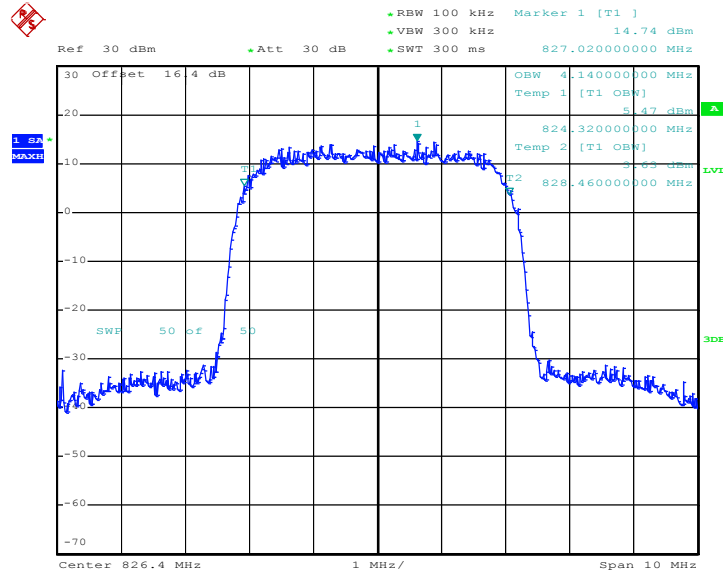

Date: 25.MAY.2012 10:43:10

26dB Bandwidth Plot on Channel 4132

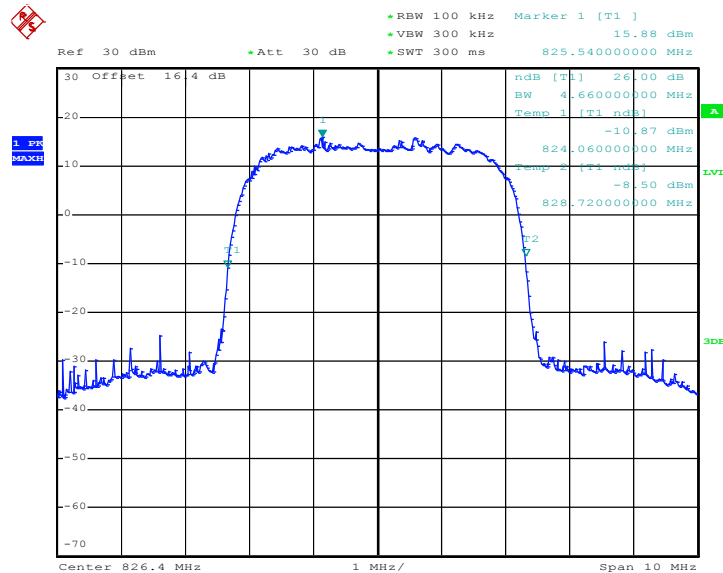

Date: 25.MAY.2012 10:35:31



99% Occupied Bandwidth Plot on Channel 4182

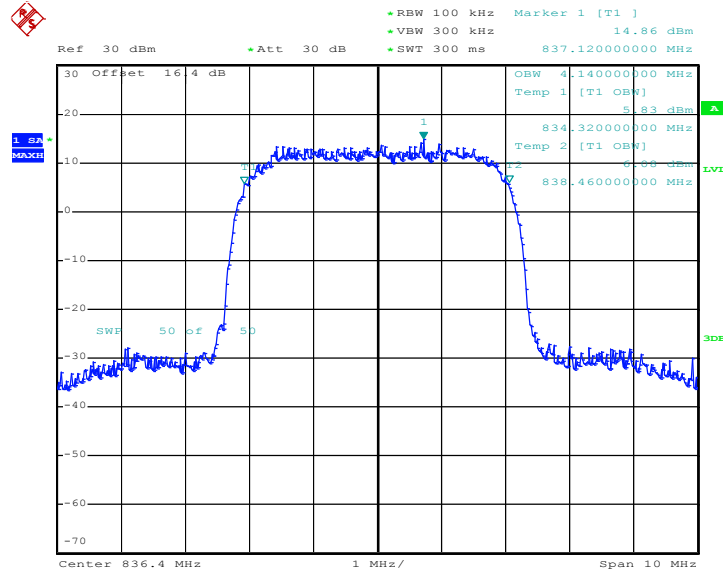

Date: 25.MAY.2012 10:44:10

26dB Bandwidth Plot on Channel 4182

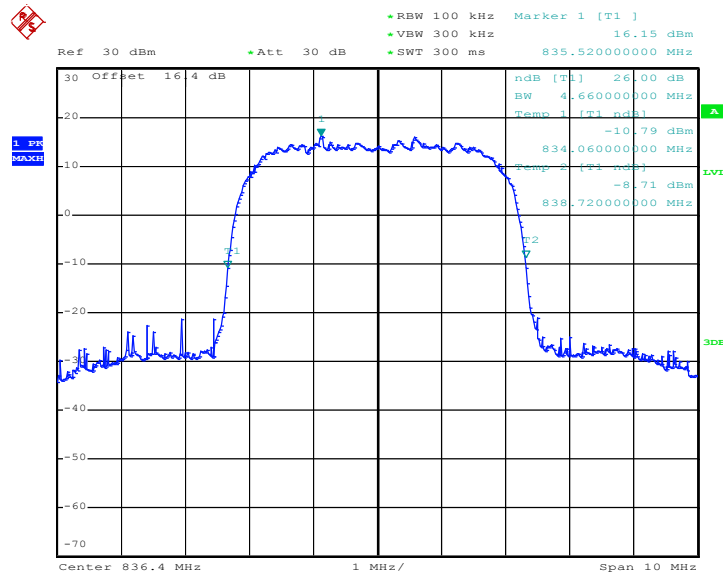

Date: 25.MAY.2012 10:34:51



99% Occupied Bandwidth Plot on Channel 4233

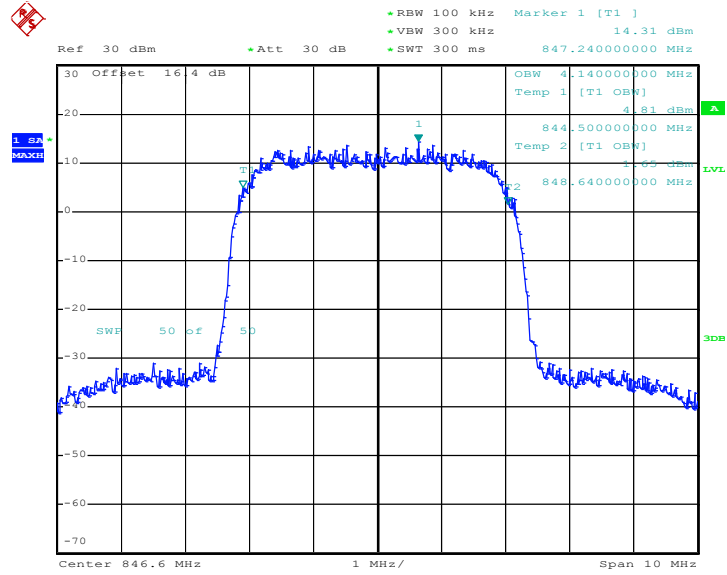

Date: 25.MAY.2012 10:44:51

26dB Bandwidth Plot on Channel 4233

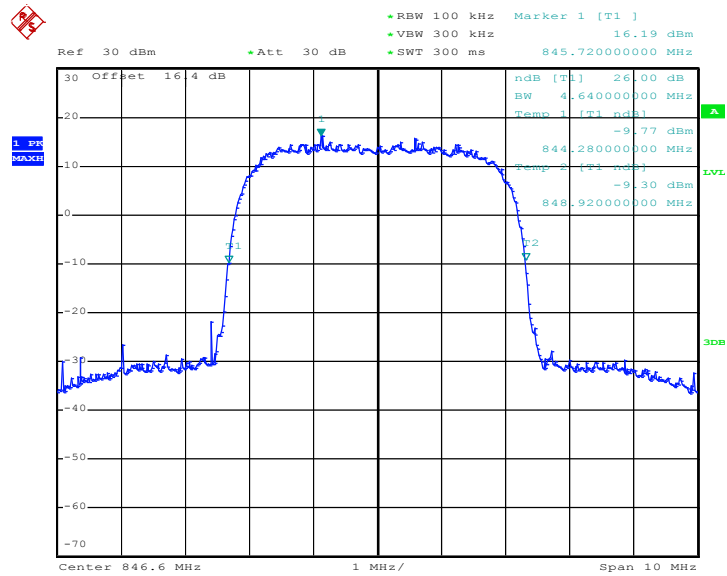

Date: 25.MAY.2012 10:34:14



Band :	WCDMA Band IV	Power Stage :	High
Test Mode :	RMC 12.2Kbps Link		

99% Occupied Bandwidth Plot on Channel 1312

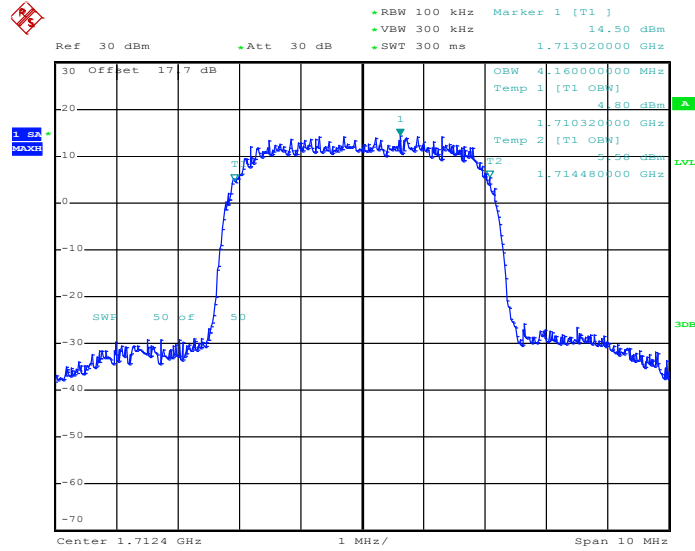

Date: 25.MAY.2012 11:19:55

26dB Bandwidth Plot on Channel 1312

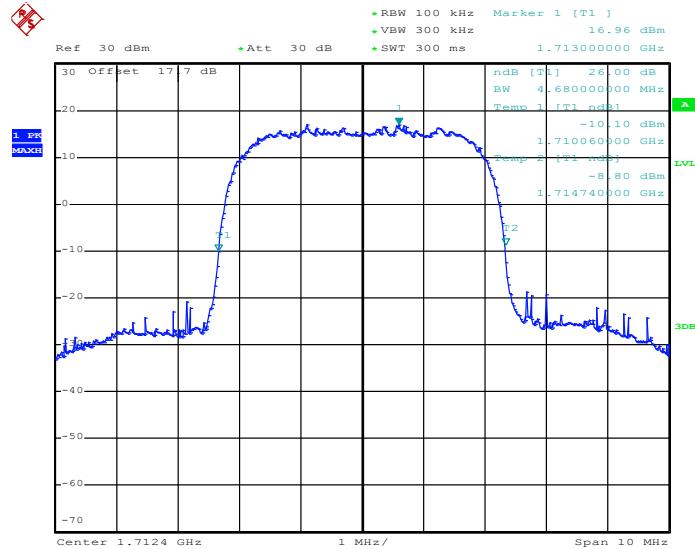

Date: 25.MAY.2012 11:08:54



99% Occupied Bandwidth Plot on Channel 1413

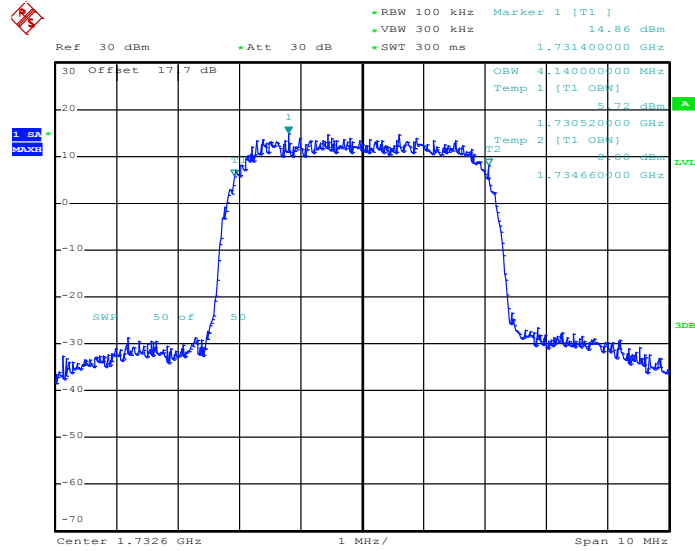

Date: 25.MAY.2012 11:18:45

26dB Bandwidth Plot on Channel 1413

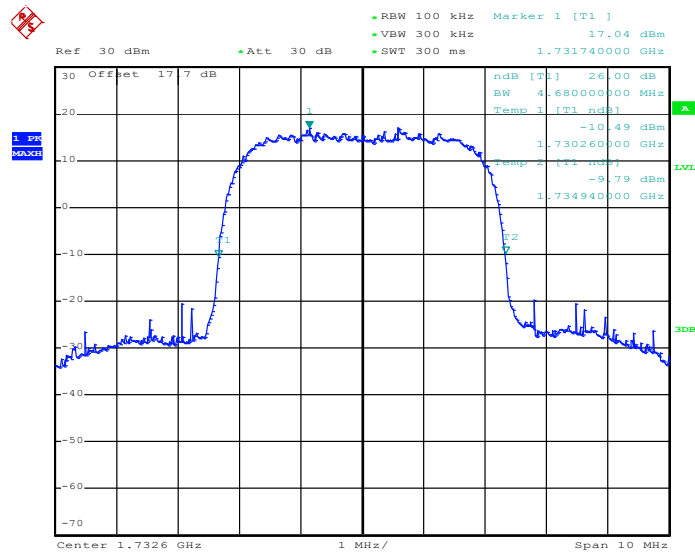

Date: 25.MAY.2012 11:08:20



99% Occupied Bandwidth Plot on Channel 1513

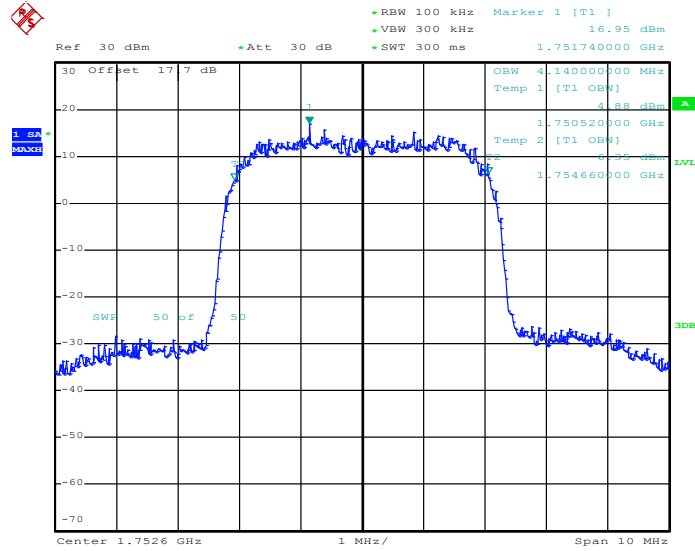

Date: 25.MAY.2012 11:20:36

26dB Bandwidth Plot on Channel 1513

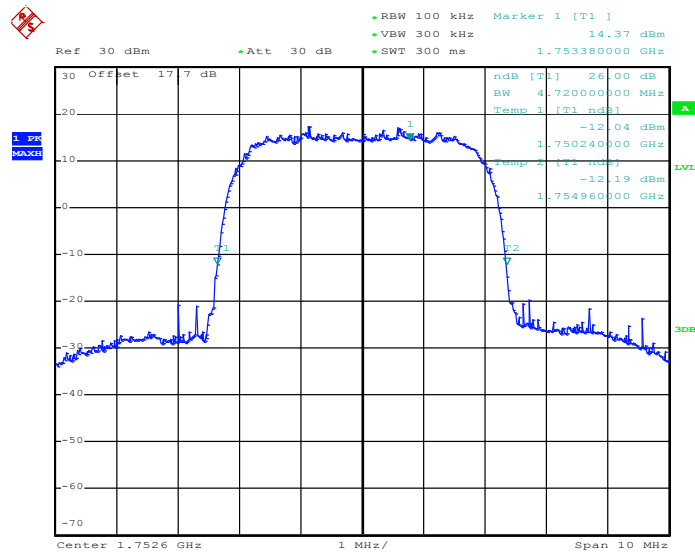

Date: 25.MAY.2012 11:07:43



Band :	WCDMA Band II	Power Stage :	High
Test Mode :	RMC 12.2Kbps Link		

99% Occupied Bandwidth Plot on Channel 9262

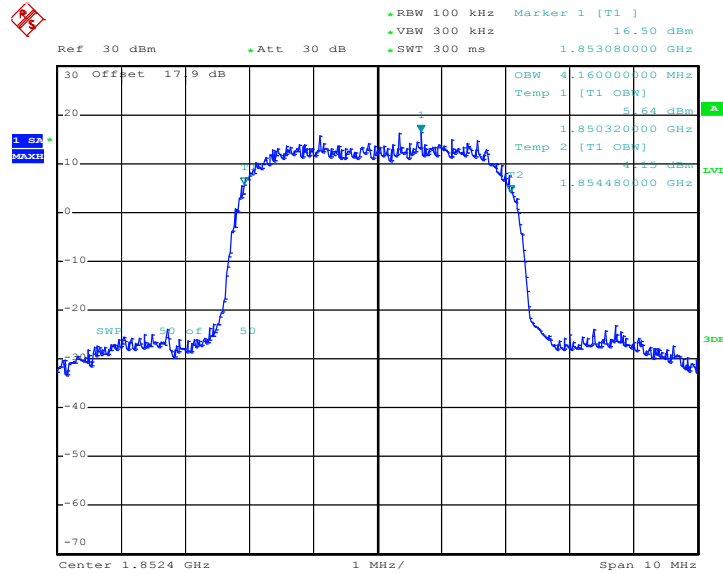

Date: 25.MAY.2012 12:26:13

26dB Bandwidth Plot on Channel 9262

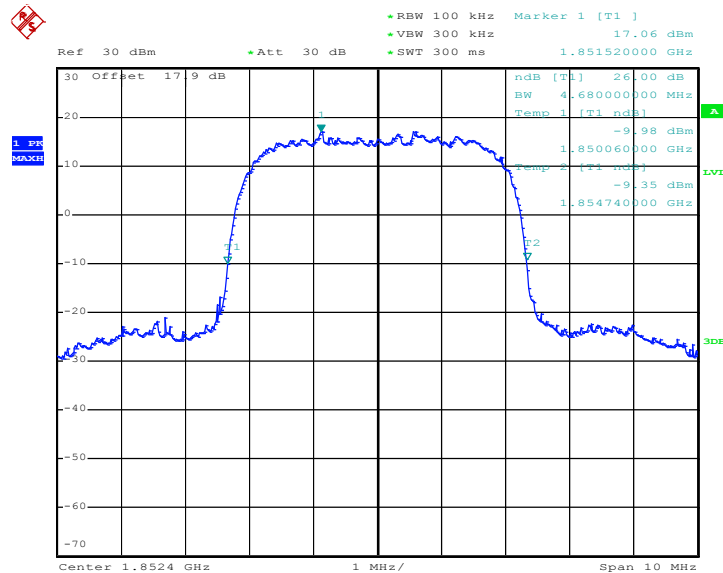

Date: 25.MAY.2012 12:18:36



99% Occupied Bandwidth Plot on Channel 9400

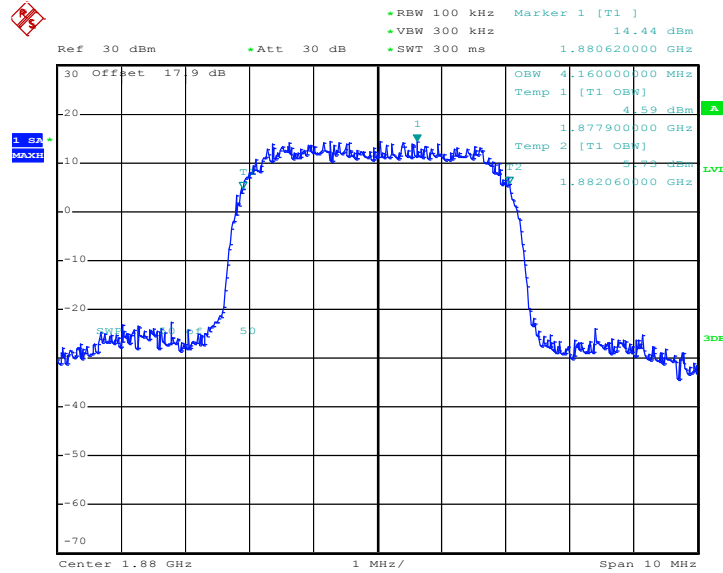

Date: 25.MAY.2012 12:26:46

26dB Bandwidth Plot on Channel 9400

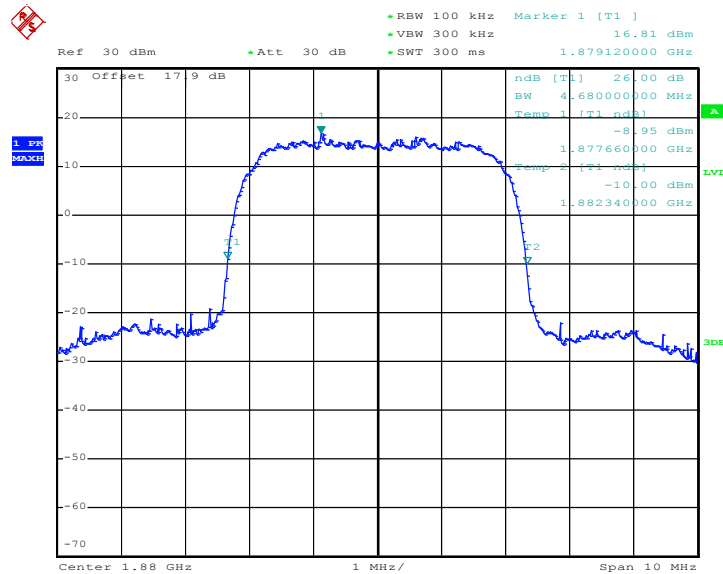

Date: 25.MAY.2012 12:18:05



99% Occupied Bandwidth Plot on Channel 9538

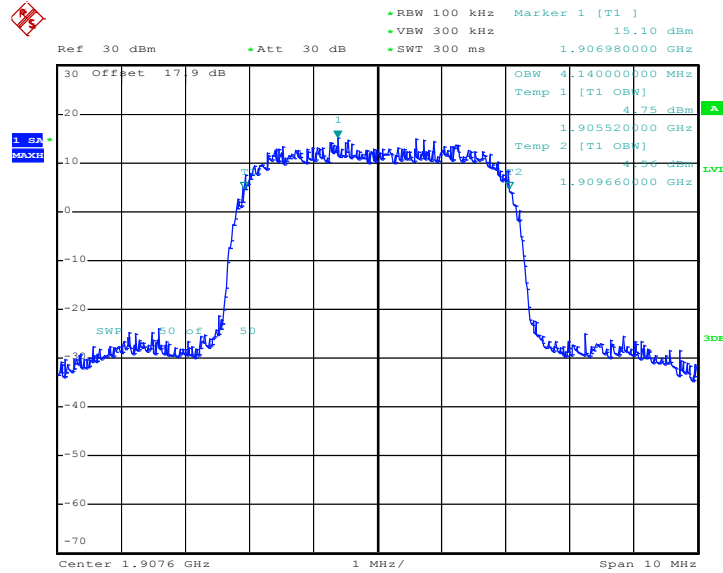

Date: 25.MAY.2012 12:27:47

26dB Bandwidth Plot on Channel 9538

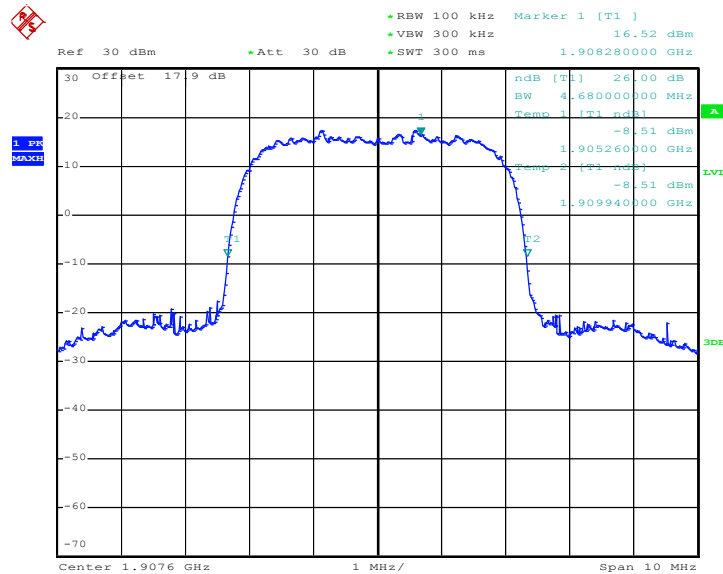

Date: 25.MAY.2012 12:17:26



Band :	CDMA2000 BC0	Power Stage :	High
Test Mode :	1xRTT_RC3+SO55		

99% Occupied Bandwidth Plot on Channel 1013

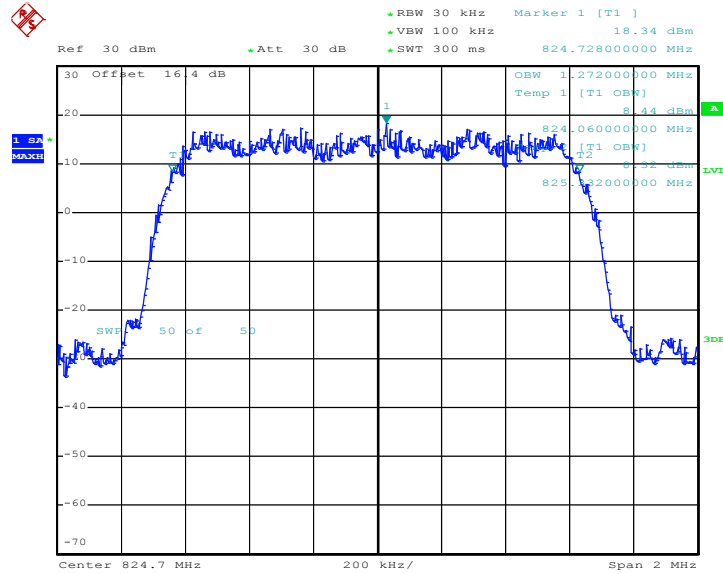

Date: 25.MAY.2012 15:03:36

26dB Bandwidth Plot on Channel 1013

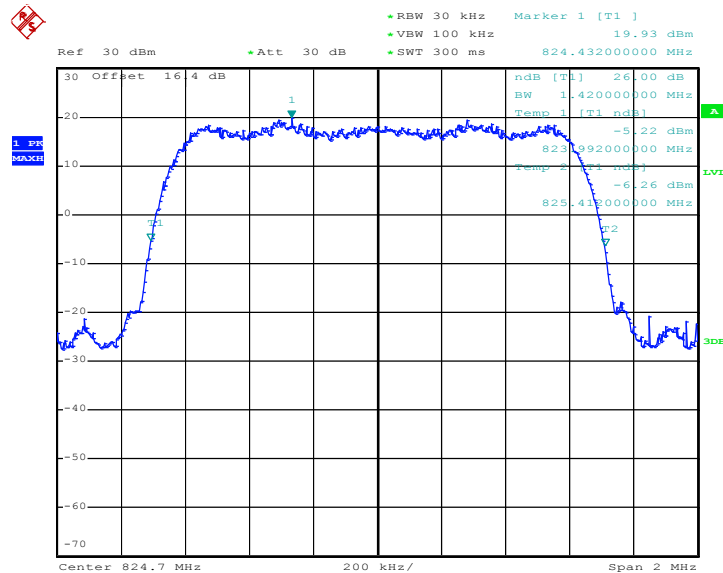

Date: 25.MAY.2012 14:56:07



99% Occupied Bandwidth Plot on Channel 384

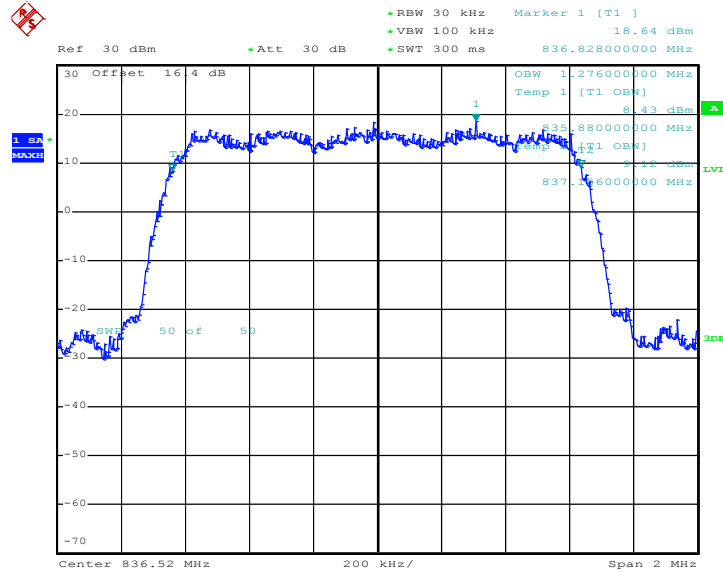

Date: 25.MAY.2012 15:02:05

26dB Bandwidth Plot on Channel 384

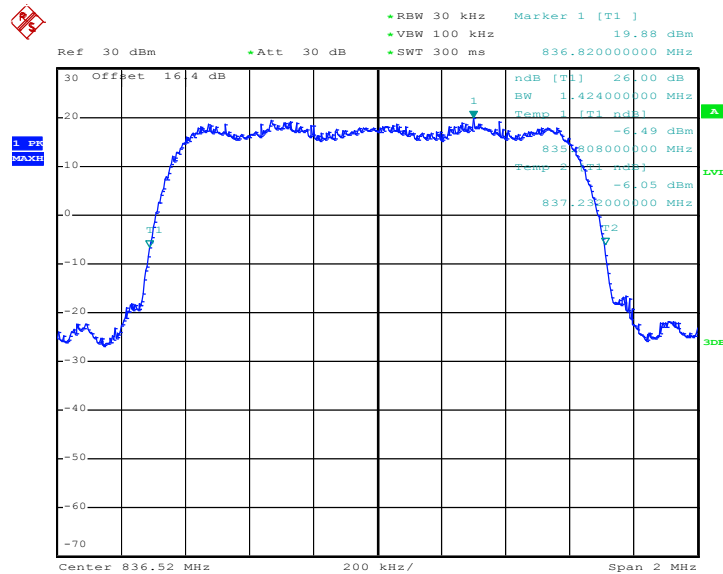

Date: 25.MAY.2012 14:55:31



99% Occupied Bandwidth Plot on Channel 777

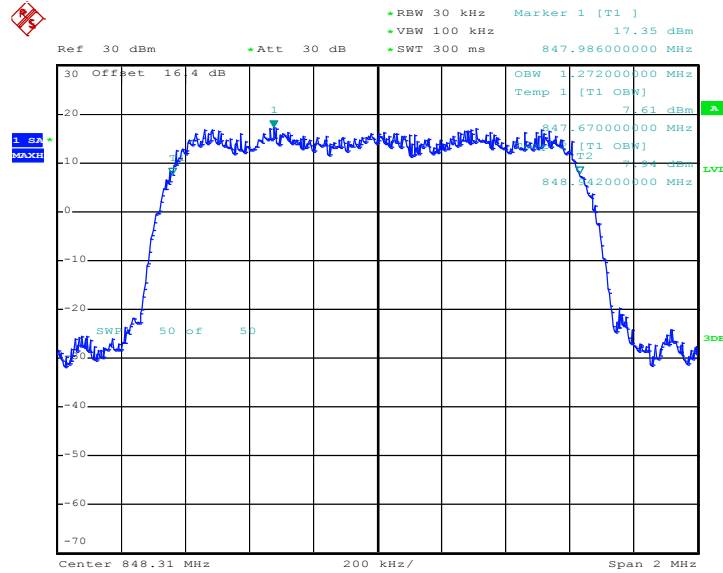

Date: 25.MAY.2012 15:02:47

26dB Bandwidth Plot on Channel 777

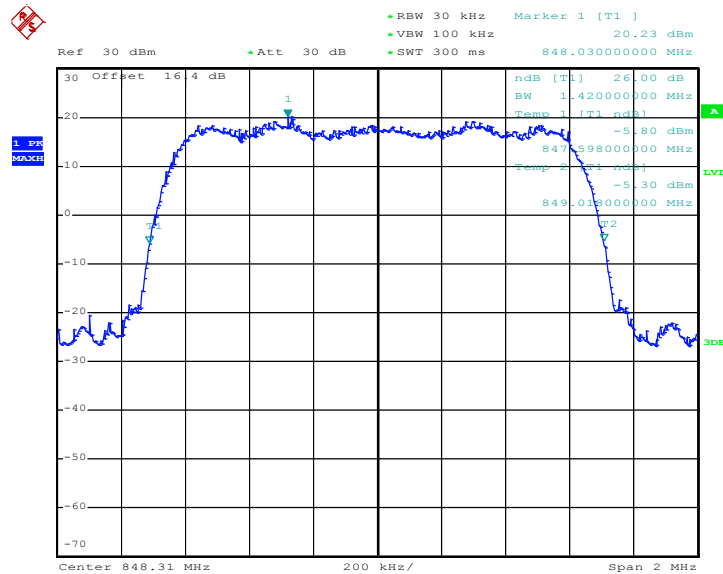

Date: 25.MAY.2012 14:54:56



Band :	CDMA2000 BC1	Power Stage :	High
Test Mode :	1xRTT_RC3+SO55		

99% Occupied Bandwidth Plot on Channel 25

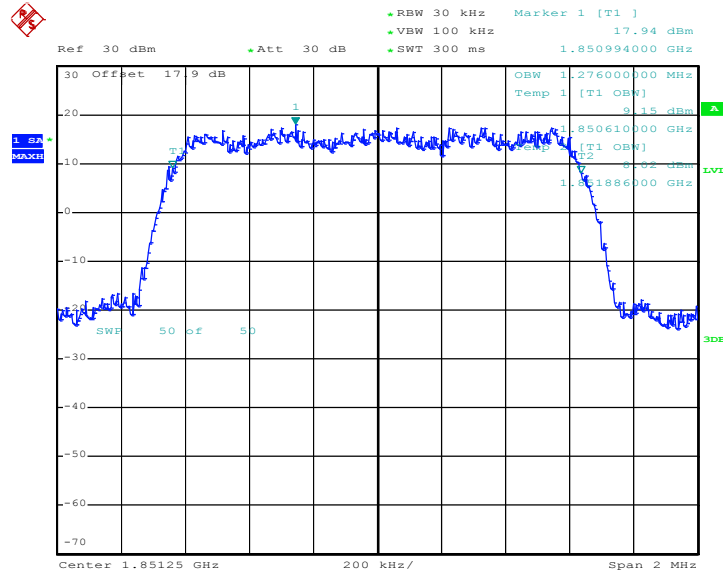

Date: 25.MAY.2012 15:52:07

26dB Bandwidth Plot on Channel 25

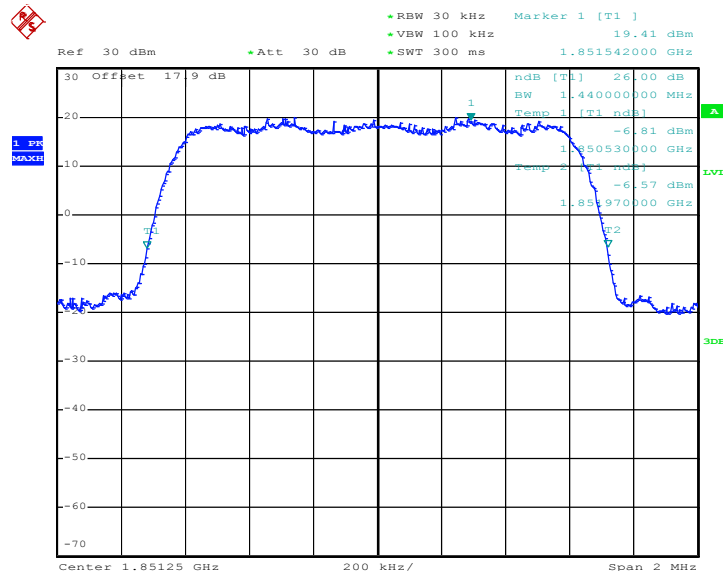

Date: 25.MAY.2012 15:47:18



99% Occupied Bandwidth Plot on Channel 600

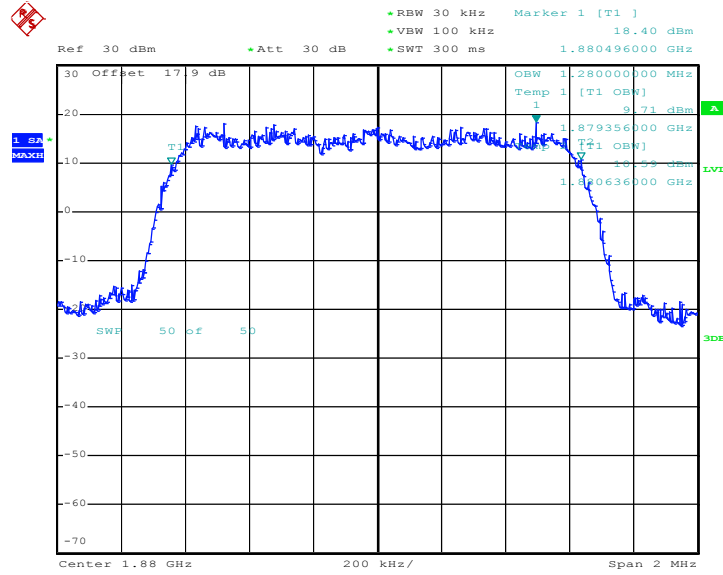

Date: 25.MAY.2012 15:52:51

26dB Bandwidth Plot on Channel 600

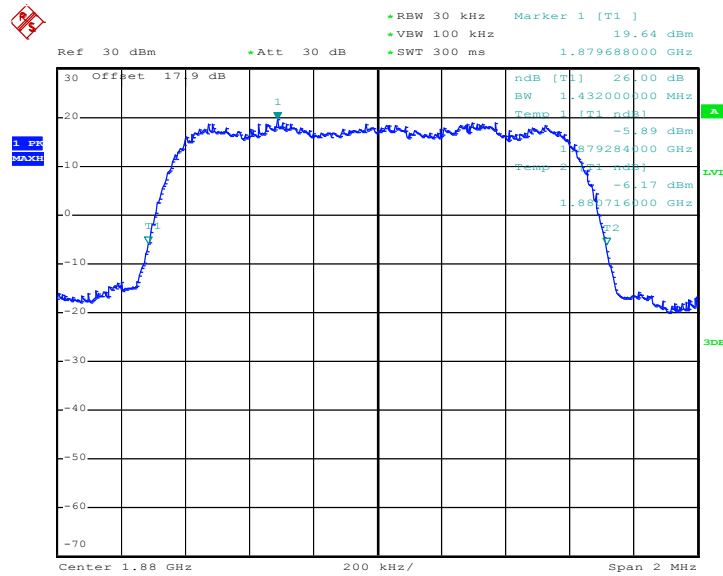

Date: 25.MAY.2012 15:47:58



99% Occupied Bandwidth Plot on Channel 1175

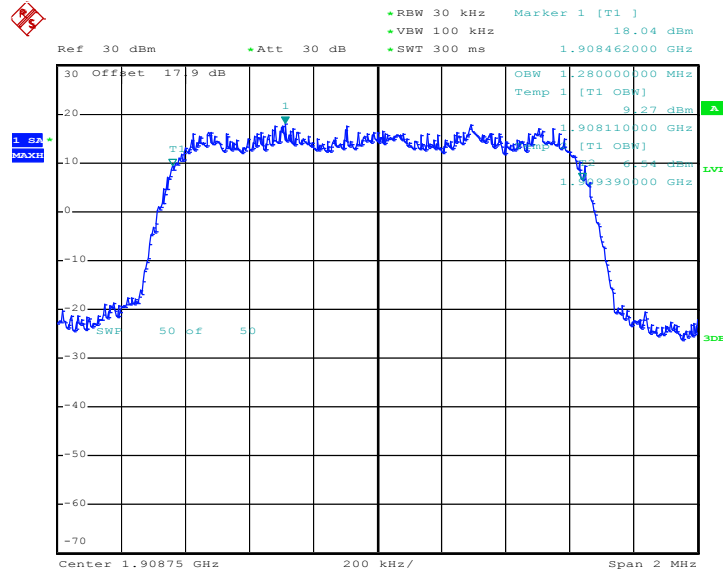

Date: 25.MAY.2012 15:53:41

26dB Bandwidth Plot on Channel 1175

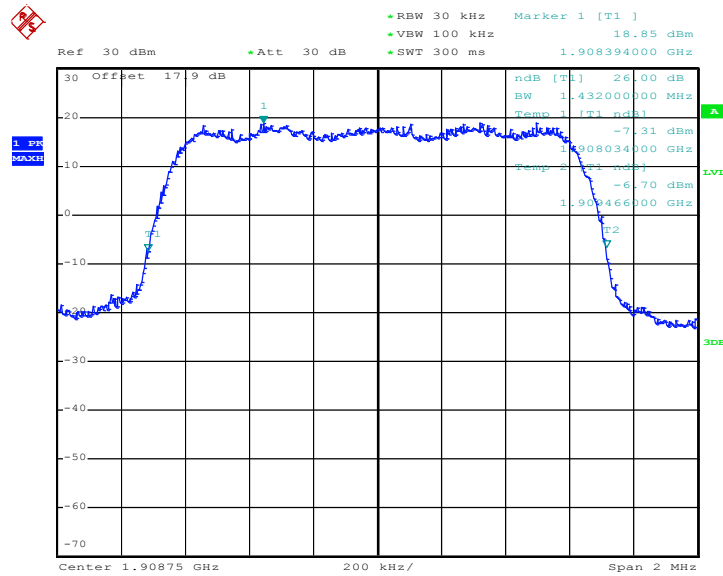

Date: 25.MAY.2012 15:48:31



3.4 Band Edge Measurement

3.4.1 Description of Band Edge Measurement

The power of any emission outside of the authorized operating frequency ranges must be lower than the transmitter power (P) by a factor of at least $43 + 10 \log (P)$ dB.

3.4.2 Measuring Instruments

See list of measuring instruments of this test report.

3.4.3 Test Procedures

1. The EUT was connected to Spectrum Analyzer and Base Station via power divider.
2. The band edges of low and high channels for the highest RF powers were measured. Setting RBW as roughly $BW/100$.
3. The RBW was replaced by 10 kHz, slightly smaller than the value in (2), due to the spectrum analyzer limitation to set the exact value. A worst case correction factor of $10 \cdot \log (1\% \text{ emission-BW/measurement RBW})$ was compensated.

3.4.4 Test Setup

<Conducted Band Edge >

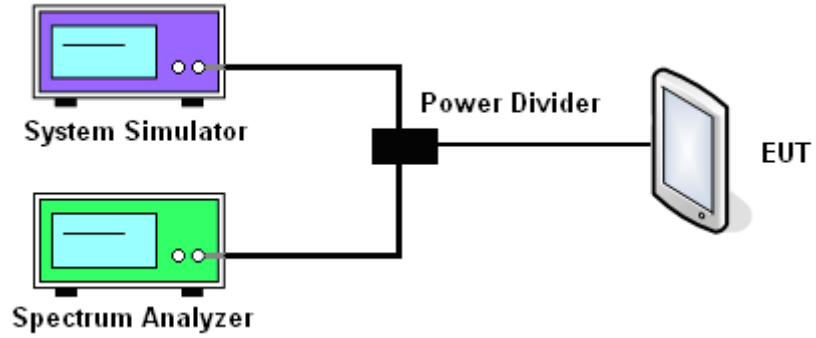

<Radiated Band Edge>

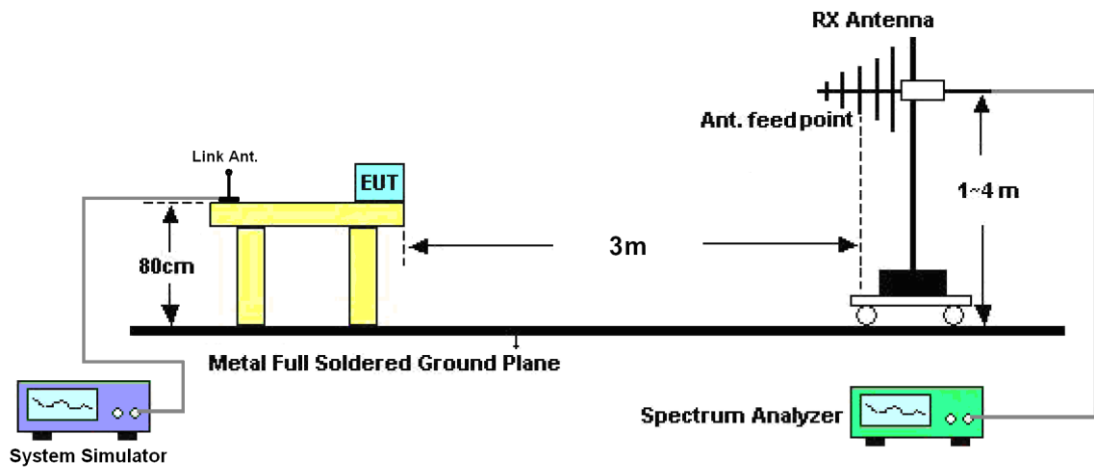

3.4.5 Test Result (Plots) of Conducted Band Edge

Band :	GSM850	Power Stage :	High
Test Mode :	GPRS 8 Link	Maximum 26dB Bandwidth :	0.316MHz
Correction Factor :	0.23dB	Measurement Value :	-16.57dBm
Band Edge :	-16.34dBm		

Lower Band Edge Plot on Channel 128

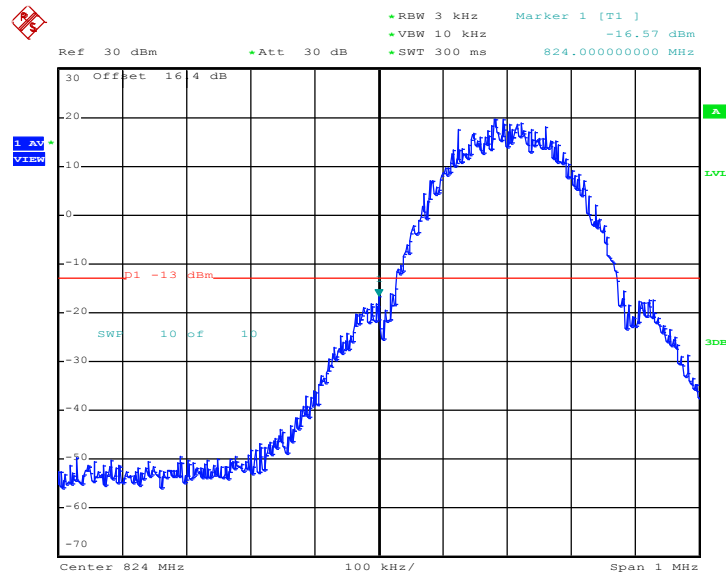

Date: 25.MAY.2012 09:22:07

1. Correction Factor(dB)= $10\log(1\% \text{ Emission BW/RBW})$
2. Band Edge= Measurement Value + Correction Factor(dB)



Band :	GSM850	Power Stage :	High
Test Mode :	GPRS 8 Link	Maximum 26dB Bandwidth :	0.316MHz
Correction Factor :	0.23dB	Measurement Value :	-15.78dBm
Band Edge :	-15.55dBm		

Higher Band Edge Plot on Channel 251

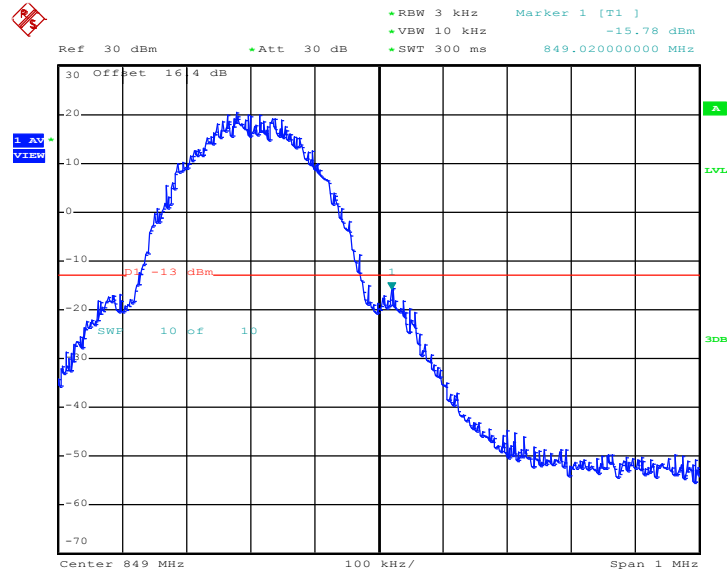

Date: 25.MAY.2012 09:21:13

1. Correction Factor(dB)= $10\log(1\% \text{ Emission BW/RBW})$
2. Band Edge= Measurement Value + Correction Factor(dB)



Band :	GSM850	Power Stage :	High
Test Mode :	EDGE 8 Link	Maximum 26dB Bandwidth :	0.310MHz
Correction Factor :	0.14dB	Measurement Value :	-28.06dBm
Band Edge :	-27.92dBm		

Lower Band Edge Plot on Channel 128

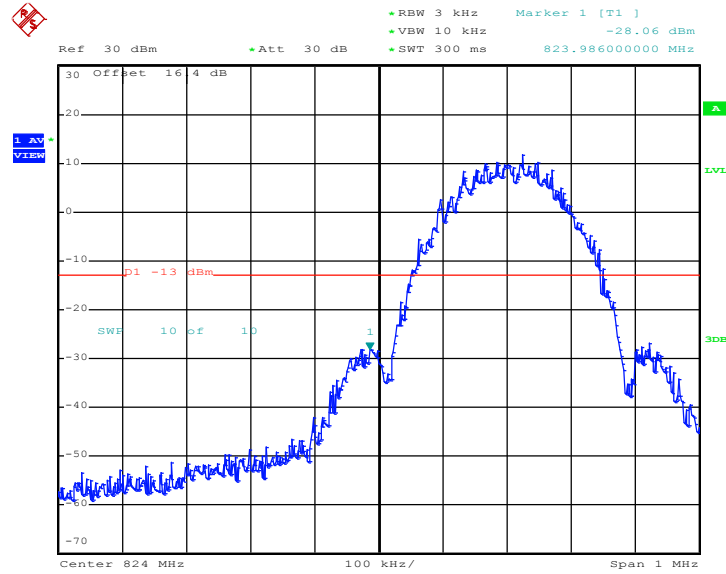

Date: 25.MAY.2012 10:05:53

1. Correction Factor(dB)= $10\log(1\% \text{ Emission BW/RBW})$
2. Band Edge= Measurement Value + Correction Factor(dB)



Band :	GSM850	Power Stage :	High
Test Mode :	EDGE 8 Link	Maximum 26dB Bandwidth :	0.310MHz
Correction Factor :	0.14dB	Measurement Value :	-26.34dBm
Band Edge :	-26.20dBm		

Higher Band Edge Plot on Channel 251

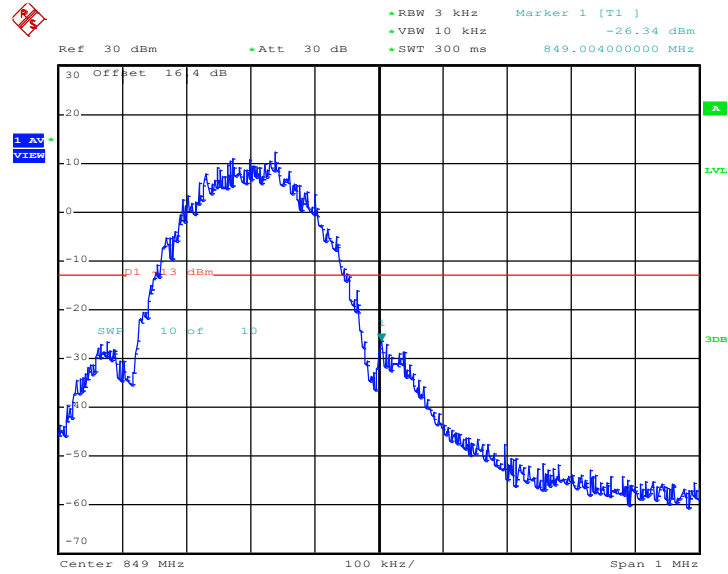

Date: 25.MAY.2012 10:08:18

1. Correction Factor(dB)= $10\log(1\% \text{ Emission BW/RBW})$
2. Band Edge= Measurement Value + Correction Factor(dB)



Band :	GSM1900	Power Stage :	High
Test Mode :	GPRS 8 Link	Maximum 26dB Bandwidth :	0.322MHz
Correction Factor :	0.31dB	Measurement Value :	-21.33dBm
Band Edge :	-21.02dBm		

Lower Band Edge Plot on Channel 512

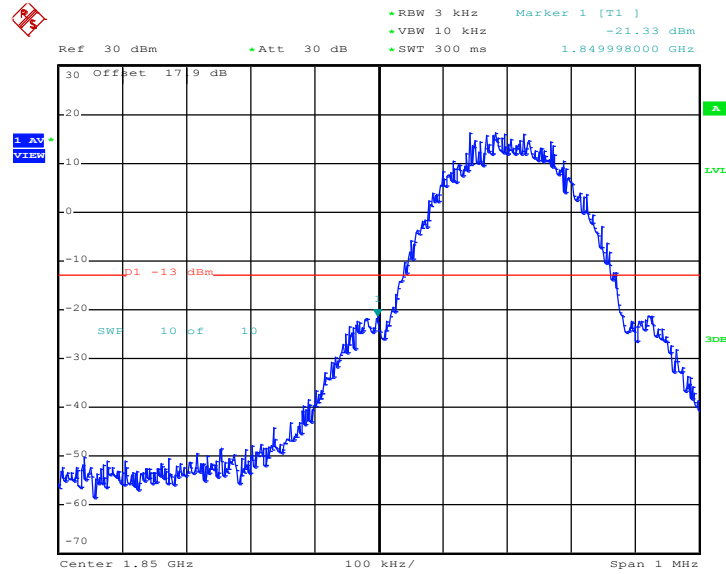

Date: 25.MAY.2012 12:57:40

1. Correction Factor(dB)= $10\log(1\% \text{ Emission BW/RBW})$
2. Band Edge= Measurement Value + Correction Factor(dB)



Band :	GSM1900	Power Stage :	High
Test Mode :	GPRS 8 Link	Maximum 26dB Bandwidth :	0.322MHz
Correction Factor :	0.31dB	Measurement Value :	-19.24dBm
Band Edge :	-18.93dBm		

Higher Band Edge Plot on Channel 810

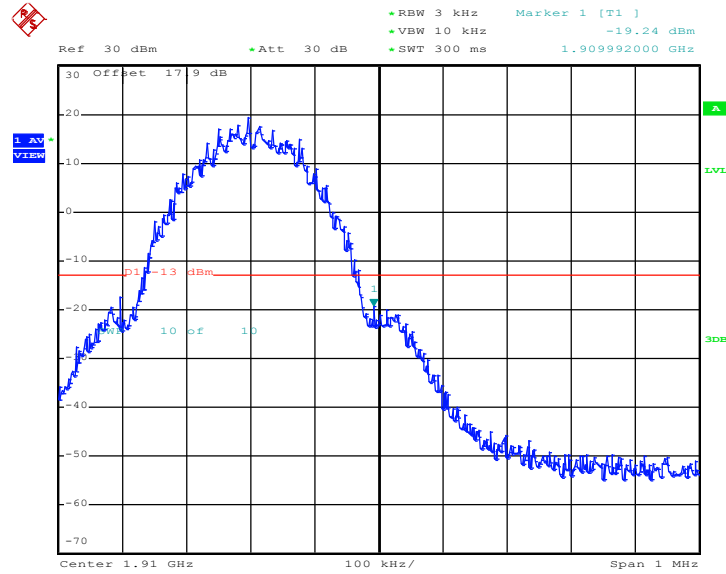

Date: 25.MAY.2012 12:56:47

1. Correction Factor(dB)= $10\log(1\% \text{ Emission BW/RBW})$
2. Band Edge= Measurement Value + Correction Factor(dB)



Band :	GSM1900	Power Stage :	High
Test Mode :	EDGE 8 Link	Maximum 26dB Bandwidth :	0.312MHz
Correction Factor :	0.17dB	Measurement Value :	-28.23dBm
Band Edge :	-28.06dBm		

Lower Band Edge Plot on Channel 512

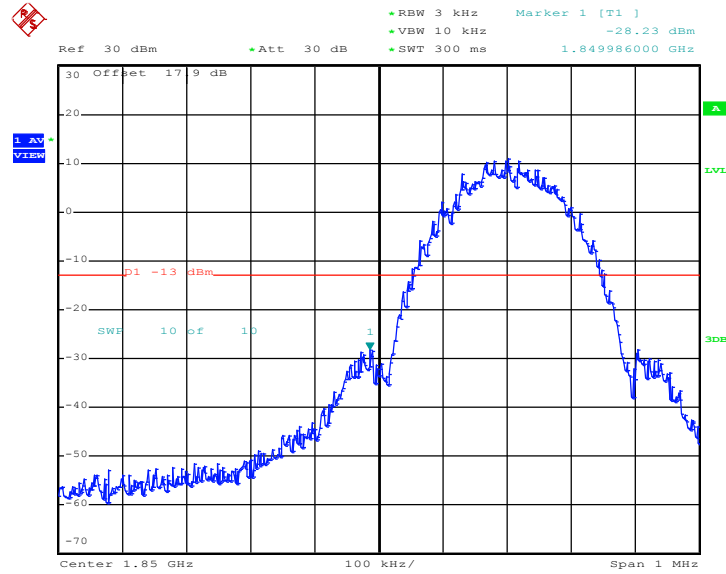

Date: 25.MAY.2012 13:59:27

1. Correction Factor(dB)= $10\log(1\% \text{ Emission BW/RBW})$
2. Band Edge= Measurement Value + Correction Factor(dB)



Band :	GSM1900	Power Stage :	High
Test Mode :	EDGE 8 Link	Maximum 26dB Bandwidth :	0.312MHz
Correction Factor :	0.17dB	Measurement Value :	-27.56dBm
Band Edge :	-27.39 dBm		

Higher Band Edge Plot on Channel 810

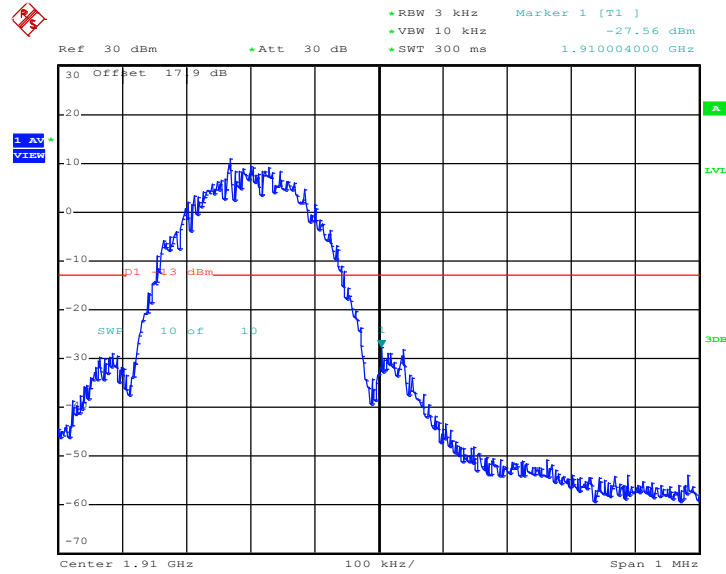

Date: 25.MAY.2012 13:58:12

1. Correction Factor(dB)= $10\log(1\% \text{ Emission BW/RBW})$
2. Band Edge= Measurement Value + Correction Factor(dB)



Band :	WCDMA Band V	Power Stage :	High
Test Mode :	RMC 12.2Kbps Link	Maximum 26dB Bandwidth :	4.660MHz
Correction Factor :	-3.32dB	Measurement Value :	-31.13dBm
Band Edge :	-34.45dBm		

Lower Band Edge Plot on Channel 4132

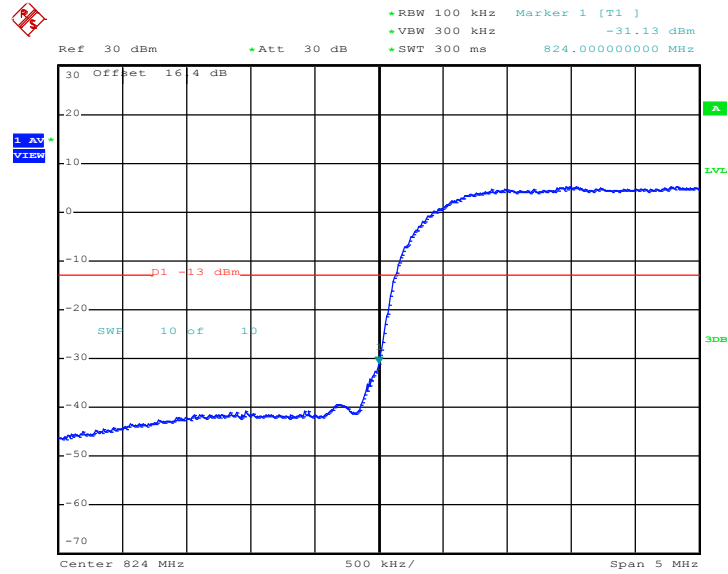

Date: 25.MAY.2012 10:41:08

1. Correction Factor(dB)= $10\log(1\% \text{ Emission BW/RBW})$
2. Band Edge= Measurement Value + Correction Factor(dB)



Band :	WCDMA Band V	Power Stage :	High
Test Mode :	RMC 12.2Kbps Link	Maximum 26dB Bandwidth :	4.660MHz
Correction Factor :	-3.32dB	Measurement Value :	-31.44dBm
Band Edge :	-34.76dBm		

Higher Band Edge Plot on Channel 4233

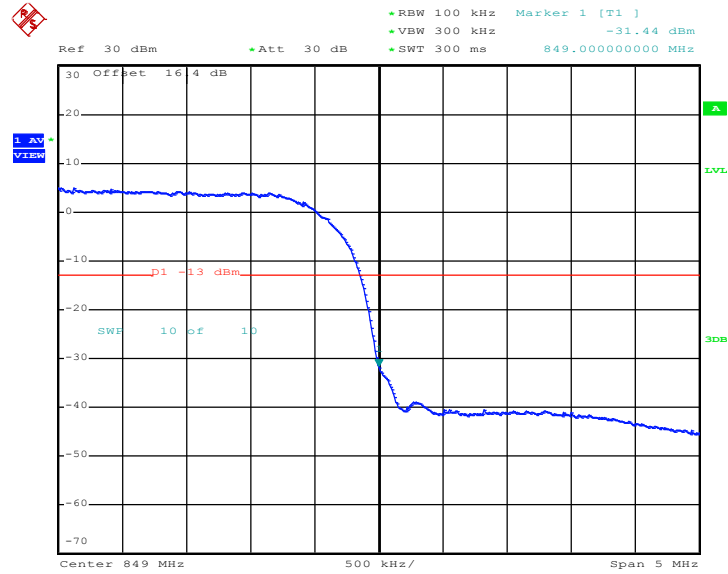

Date: 25.MAY.2012 10:39:58

1. Correction Factor(dB)= 10log(1% Emission BW/RBW)
2. Band Edge= Measurement Value + Correction Factor(dB)



Band :	WCDMA Band IV	Power Stage :	High
Test Mode :	RMC 12.2Kbps Link	Maximum 26dB Bandwidth :	4.720MHz
Correction Factor :	-3.26dB	Measurement Value :	-30.23dBm
Band Edge :	-33.49dBm		

Lower Band Edge Plot on Channel 1312

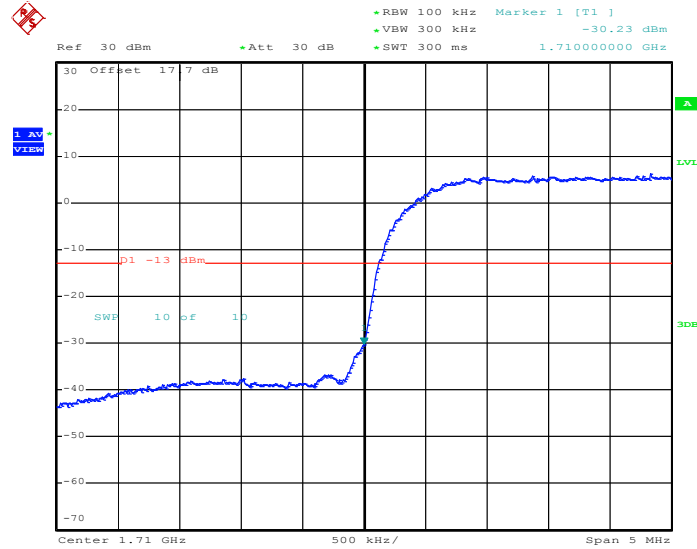

Date: 25.MAY.2012 11:15:18

1. Correction Factor(dB)= $10\log(1\% \text{ Emission BW/RBW})$
2. Band Edge= Measurement Value + Correction Factor(dB)



Band :	WCDMA Band IV	Power Stage :	High
Test Mode :	RMC 12.2Kbps Link	Maximum 26dB Bandwidth :	4.720MHz
Correction Factor :	-3.26	Measurement Value :	-28.61dBm
Band Edge :	-31.87dBm		

Higher Band Edge Plot on Channel 1513

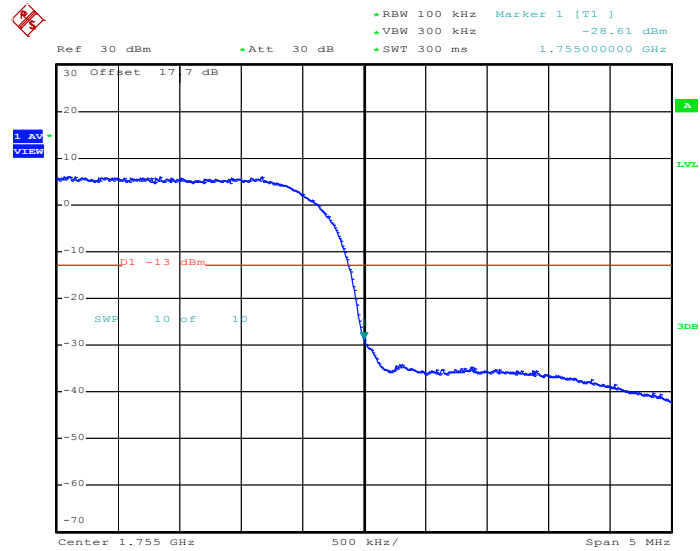

Date: 25.MAY.2012 11:14:18

1. Correction Factor(dB)= $10\log(1\% \text{ Emission BW/RBW})$
2. Band Edge= Measurement Value + Correction Factor(dB)



Band :	WCDMA Band II	Power Stage :	High
Test Mode :	RMC 12.2Kbps Link	Maximum 26dB Bandwidth :	4.680MHz
Correction Factor :	-3.30dB	Measurement Value :	-27.44dBm
Band Edge :	-30.74dBm		

Lower Band Edge Plot on Channel 9262

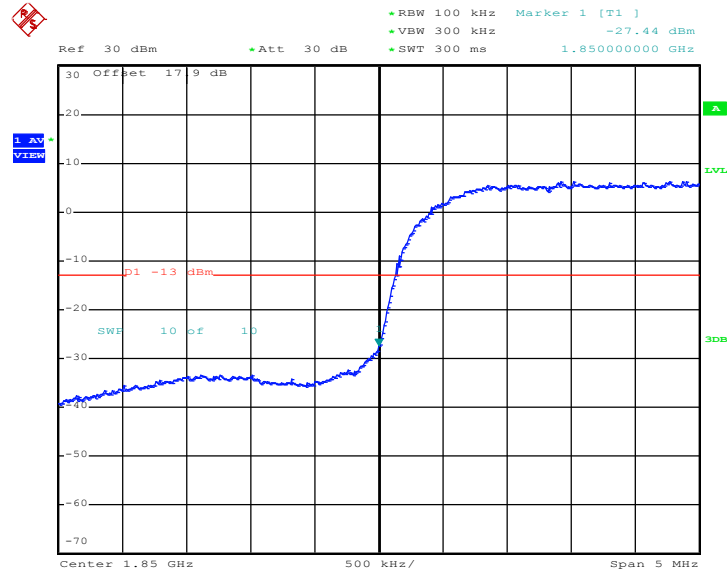

Date: 25.MAY.2012 12:23:53

1. Correction Factor(dB)= $10\log(1\% \text{ Emission BW/RBW})$
2. Band Edge= Measurement Value + Correction Factor(dB)



Band :	WCDMA Band II	Power Stage :	High
Test Mode :	RMC 12.2Kbps Link	Maximum 26dB Bandwidth :	4.680MHz
Correction Factor :	-3.30dB	Measurement Value :	-27.59dBm
Band Edge :	-30.89dBm		

Higher Band Edge Plot on Channel 9538

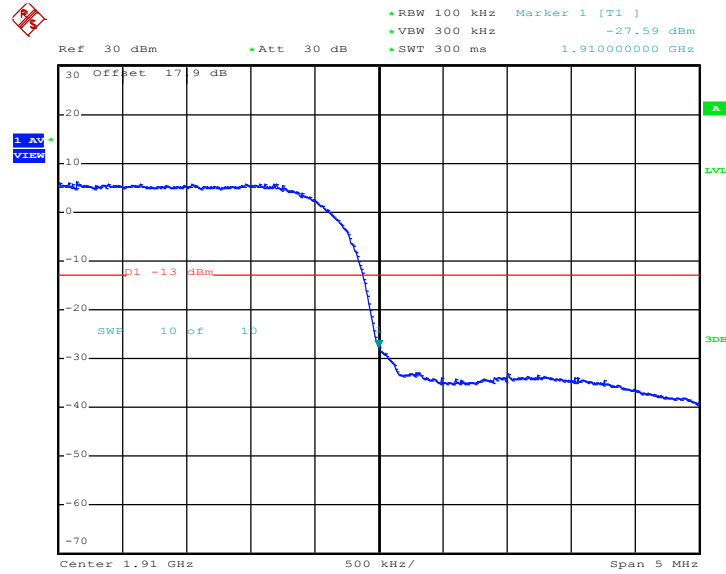

Date: 25.MAY.2012 12:23:15

1. Correction Factor(dB)= 10log(1% Emission BW/RBW)
2. Band Edge= Measurement Value + Correction Factor(dB)



Band :	CDMA2000 BC0	Power Stage :	High
Test Mode :	1xRTT_RC3+SO55	Maximum 26dB Bandwidth:	1.424MHz
Correction Factor :	1.54dB	Measurement Value :	-19.46dBm
Band Edge :	-17.92dBm		

Lower Band Edge Plot on Channel 1013

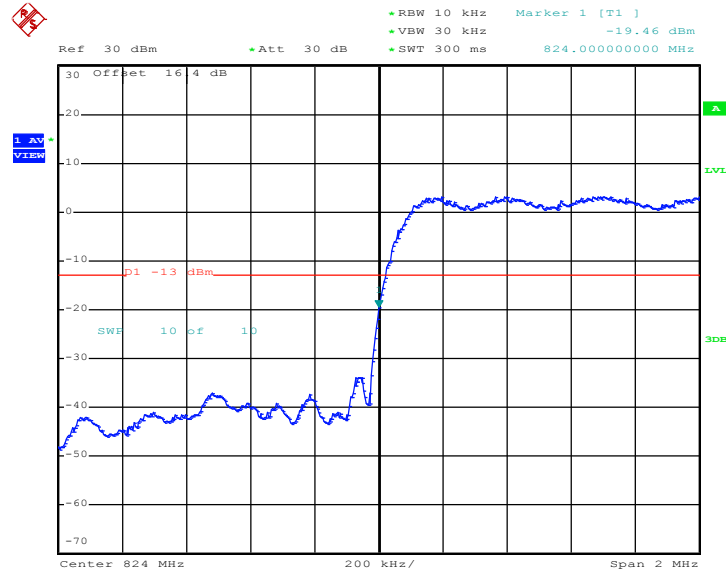

Date: 25.MAY.2012 14:58:24

1. Correction Factor(dB)= 10log(1% Emission BW/RBW)
2. Band Edge= Measurement Value + Correction Factor(dB)



Band :	CDMA2000 BC0	Power Stage :	High
Test Mode :	1xRTT_RC3+SO55	Maximum 26dB Bandwidth:	1.424MHz
Correction Factor :	1.54dB	Measurement Value :	-16.52dBm
Band Edge :	-14.98dBm		

Higher Band Edge Plot on Channel 777

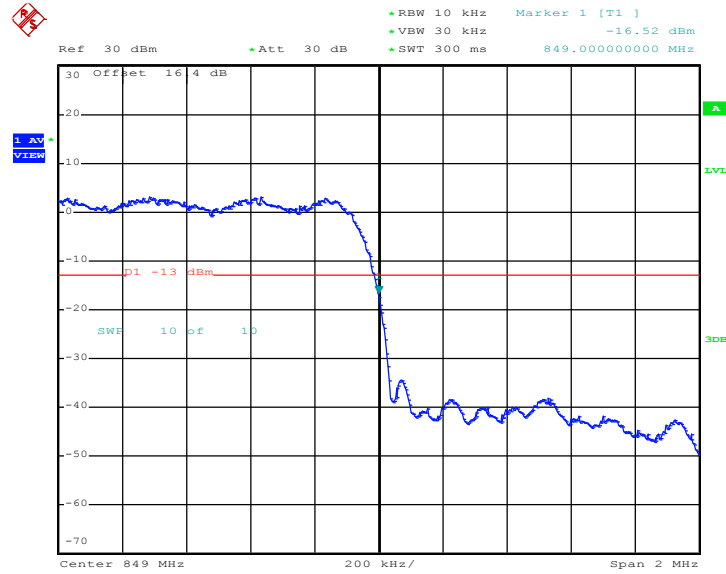

Date: 25.MAY.2012 14:59:27

1. Correction Factor(dB)= $10\log(1\% \text{ Emission BW/RBW})$
2. Band Edge= Measurement Value + Correction Factor(dB)



Band :	CDMA2000 BC1	Power Stage :	High
Test Mode :	1xRTT_RC3+SO55	Maximum 26dB Bandwidth:	1.440MHz
Correction Factor :	1.58dB	Measurement Value :	-33.13dBm
Band Edge :	-31.55dBm		

Lower Band Edge Plot on Channel 25

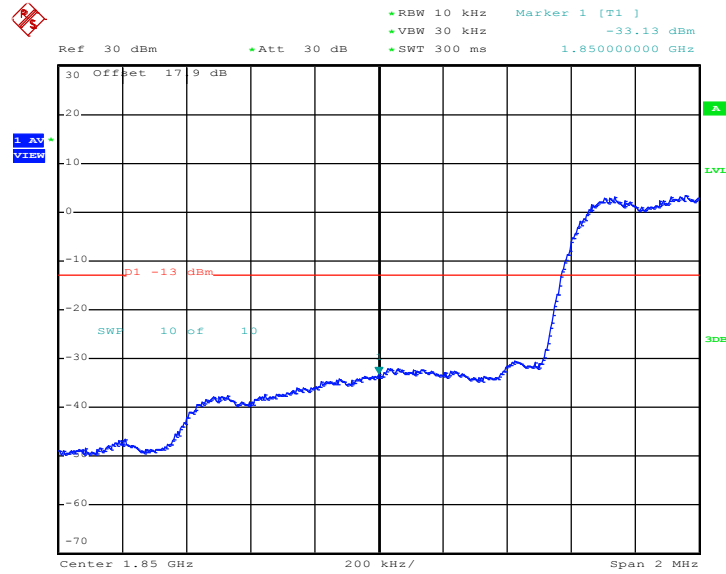

Date: 25.MAY.2012 15:57:47

1. Correction Factor(dB)= 10log(1% Emission BW/RBW)
2. Band Edge= Measurement Value + Correction Factor(dB)



Band :	CDMA2000 BC1	Power Stage :	High
Test Mode :	1xRTT_RC3+SO55	Maximum 26dB Bandwidth:	1.440MHz
Correction Factor :	1.58dB	Measurement Value :	-36.99dBm
Band Edge :	-35.41dBm		

Higher Band Edge Plot on Channel 1175

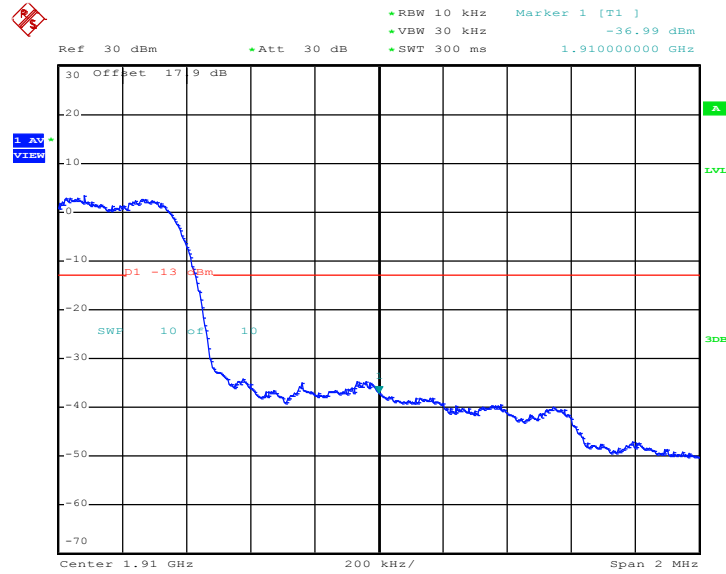

Date: 25.MAY.2012 15:56:38

1. Correction Factor(dB)= $10\log(1\% \text{ Emission BW/RBW})$
2. Band Edge= Measurement Value + Correction Factor(dB)

3.5 Conducted Emission Measurement

3.5.1 Description of Conducted Emission Measurement

The power of any emission outside of the authorized operating frequency ranges must be lower than the transmitter power (P) by a factor of at least $43 + 10 \log (P)$ dB.

It is measured by means of a calibrated spectrum analyzer and scanned from 30 MHz up to a frequency including its 10th harmonic.

3.5.2 Measuring Instruments

See list of measuring instruments of this test report.

3.5.3 Test Procedures

1. The EUT was connected to spectrum analyzer and base station via power divider.
2. The middle channel for the highest RF power within the transmitting frequency was measured.
3. The conducted spurious emission for the whole frequency range was taken.

3.5.4 Test Setup

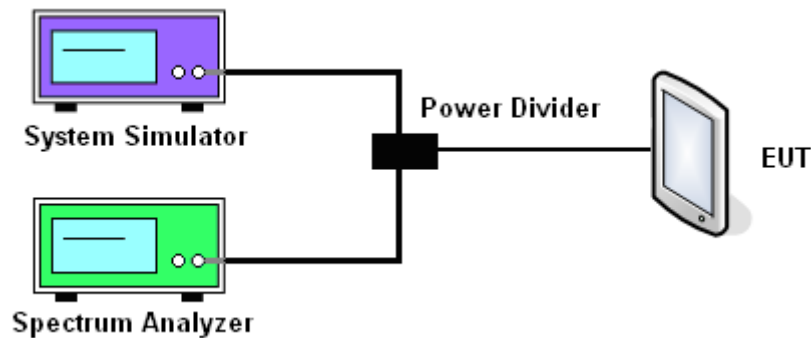

3.5.5 Test Result (Plots) of Conducted Emission

Band :	GSM850	Channel :	CH189
Test Mode :	GPRS 8 Link		

Conducted Emission Plot between 30MHz ~ 1GHz

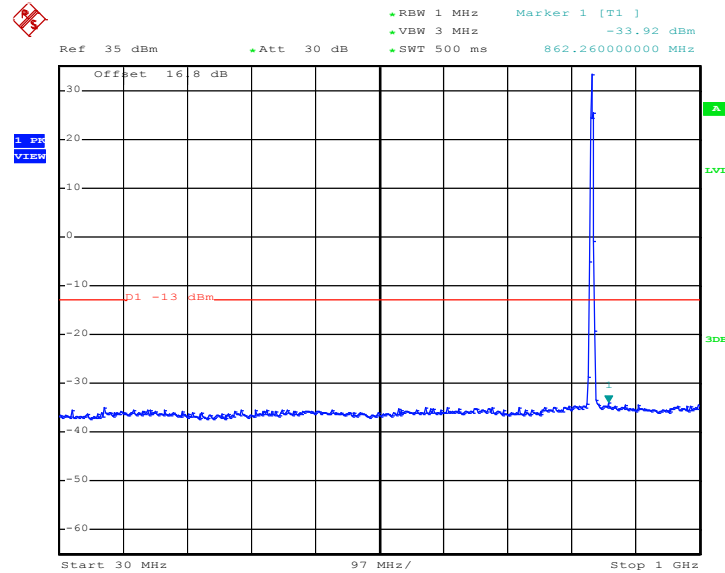

Date: 25.MAY.2012 09:39:17

Conducted Emission Plot between 1GHz ~ 3GHz

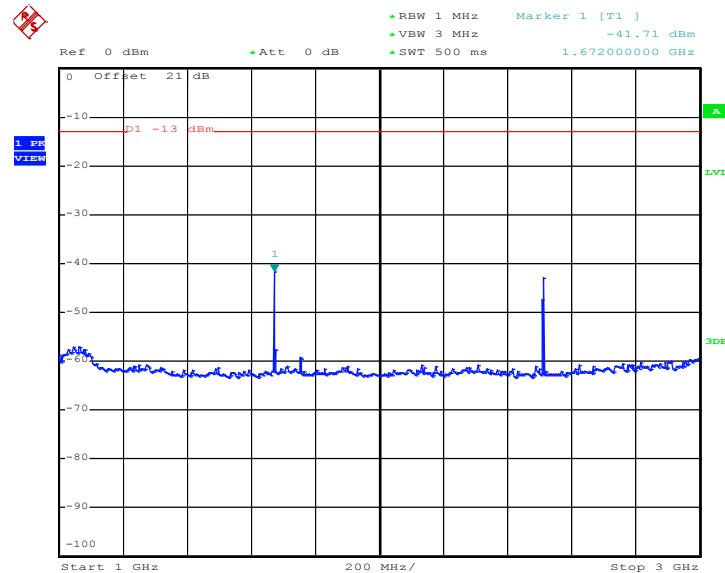

Date: 25.MAY.2012 09:44:44



Conducted Emission Plot between 3GHz ~ 7GHz

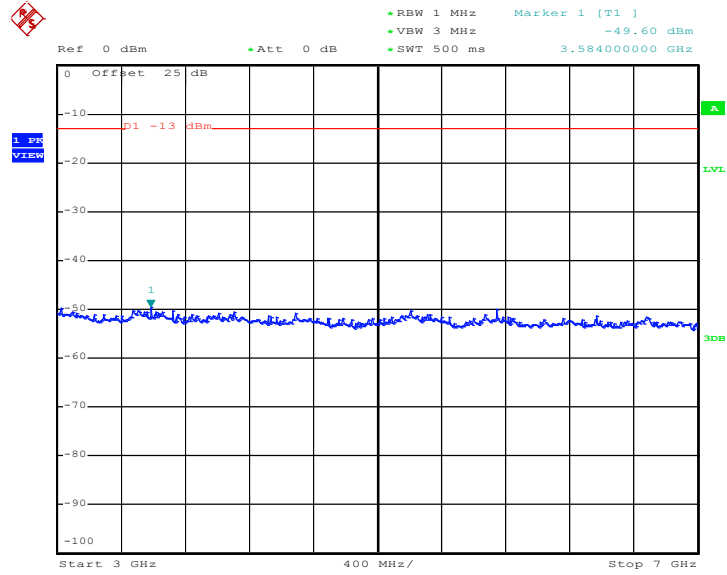

Date: 25.MAY.2012 09:46:39

Conducted Emission Plot between 7GHz ~ 9GHz

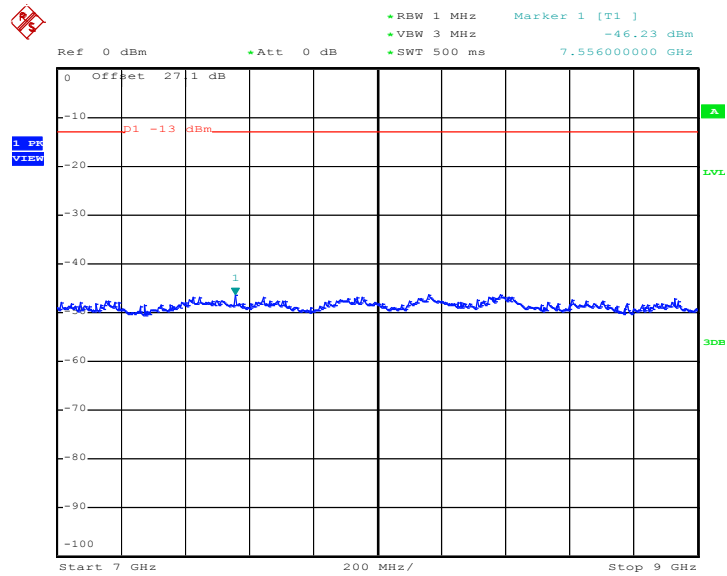

Date: 25.MAY.2012 09:48:18



Band :	GSM850	Channel :	CH189
Test Mode :	EDGE 8 Link		

Conducted Emission Plot between 30MHz ~ 1GHz

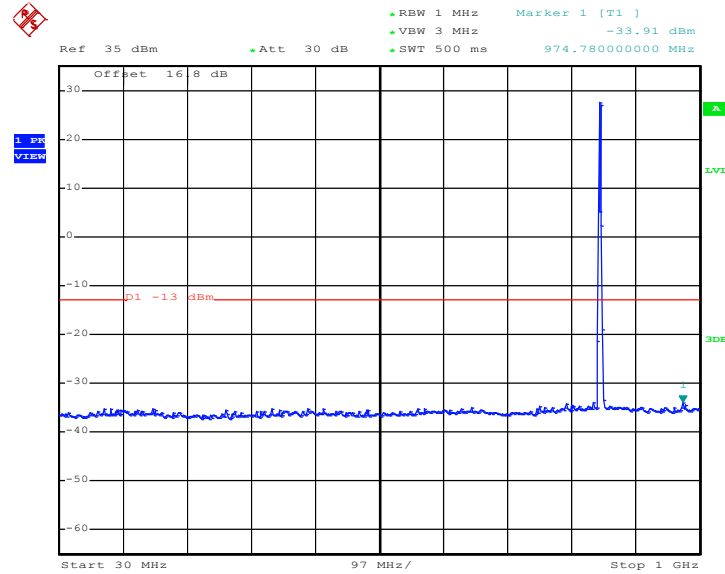

Date: 25.MAY.2012 10:18:23

Conducted Emission Plot between 1GHz ~ 3GHz

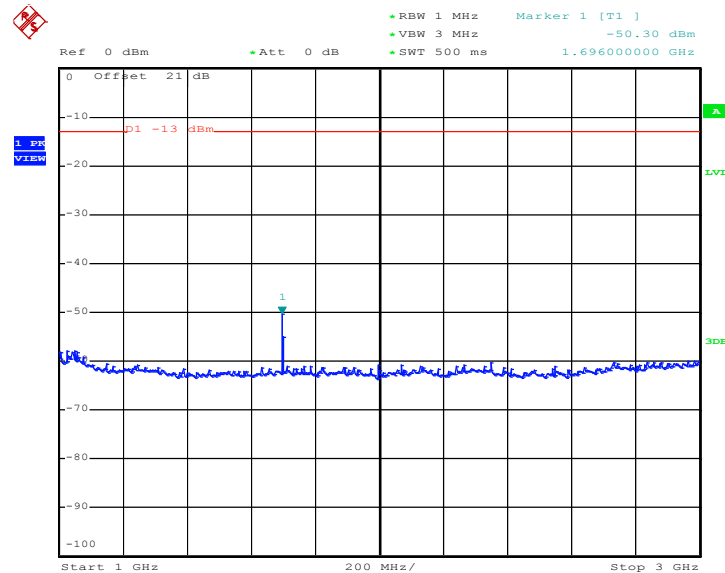

Date: 25.MAY.2012 10:20:41



Conducted Emission Plot between 3GHz ~ 7GHz

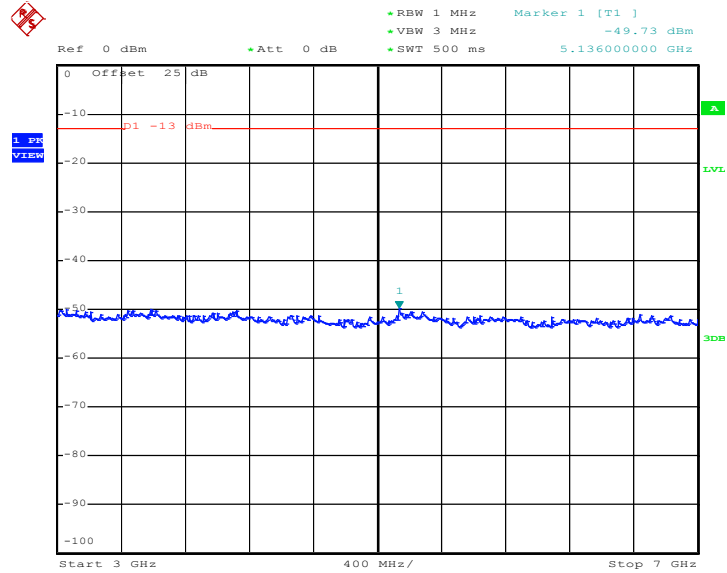

Date: 25.MAY.2012 10:22:16

Conducted Emission Plot between 7GHz ~ 9GHz

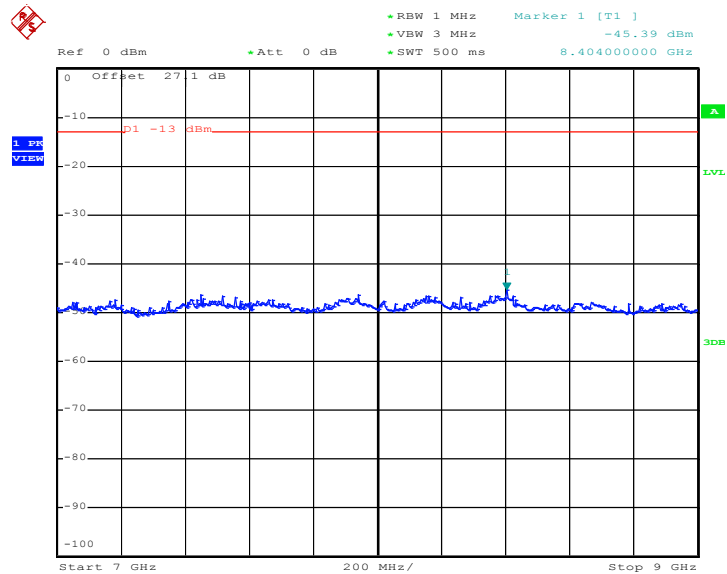

Date: 25.MAY.2012 10:23:33



Band :	GSM1900	Channel :	CH661
Test Mode :	GPRS 8 Link		

Conducted Emission Plot between 30MHz ~ 1GHz

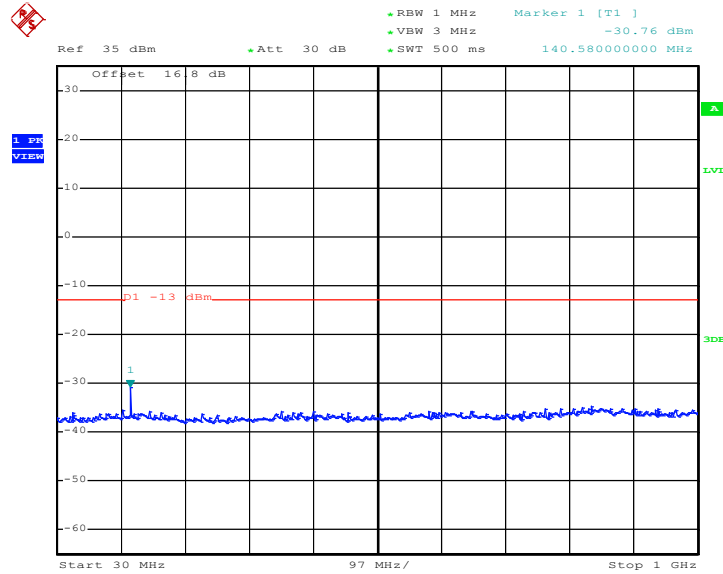

Date: 25.MAY.2012 13:06:58

Conducted Emission Plot between 1GHz ~ 3GHz

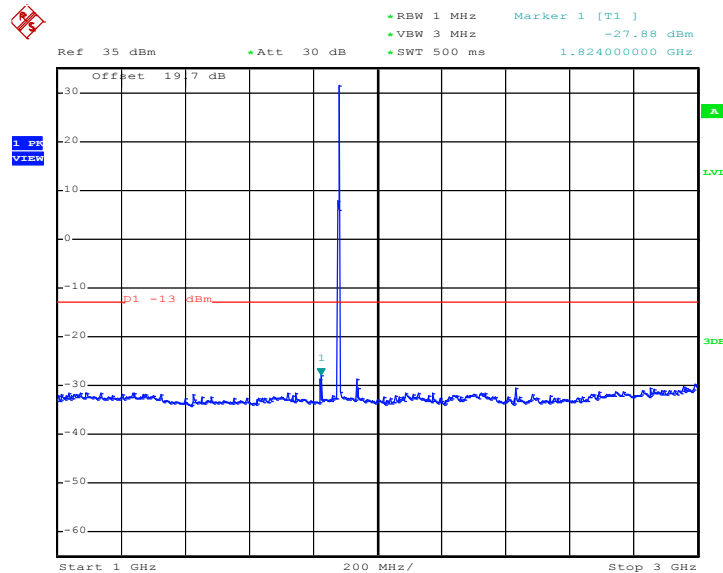

Date: 25.MAY.2012 13:09:01

Conducted Emission Plot between 3GHz ~ 7GHz

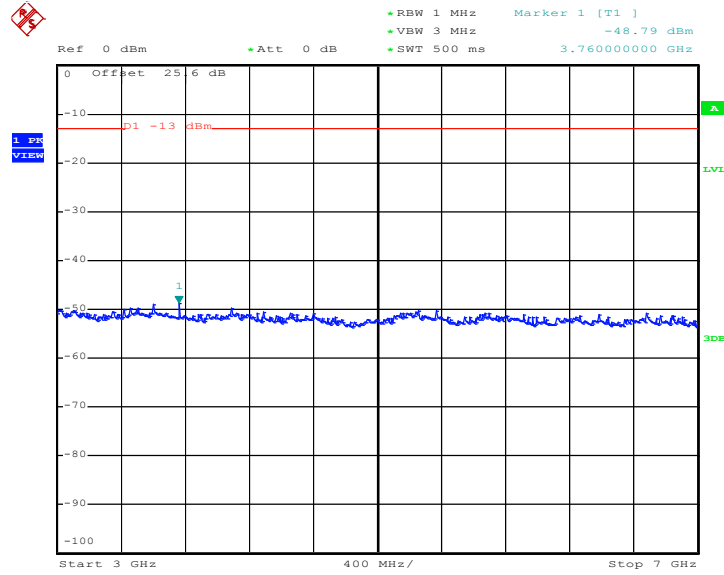

Date: 25.MAY.2012 13:10:13

Conducted Emission Plot between 7GHz ~ 13.6G

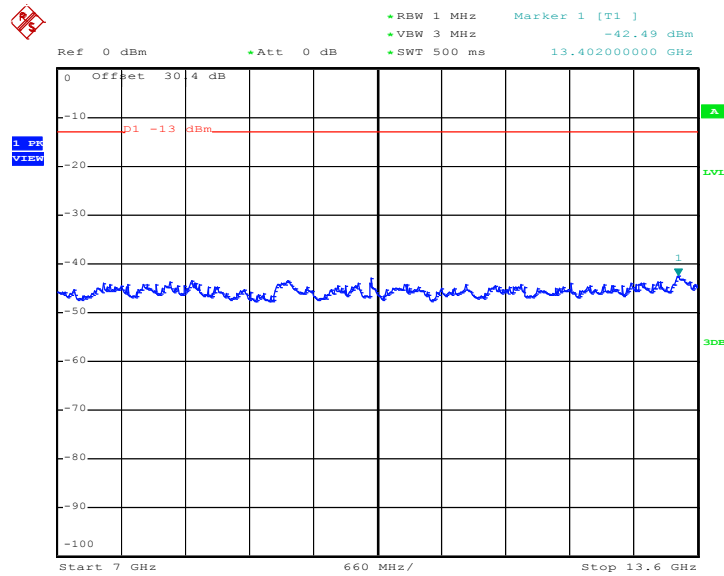

Date: 25.MAY.2012 13:11:41



Conducted Emission Plot between 13.6GHz ~ 19.1GHz

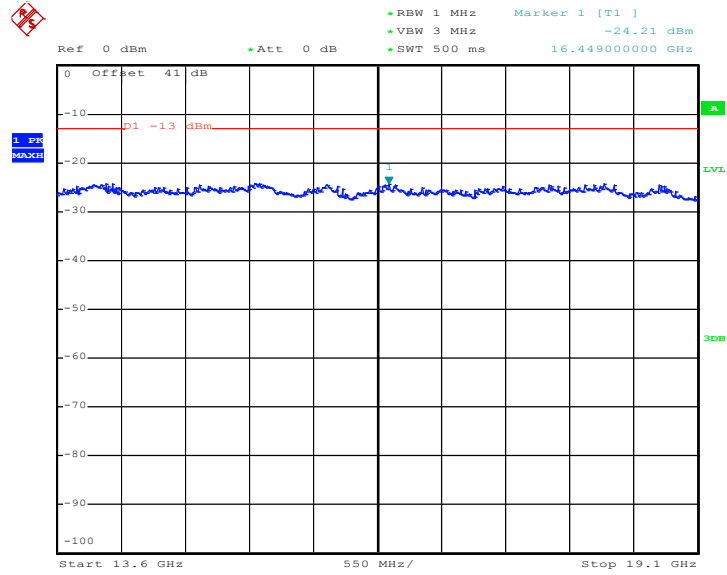

Date: 25.MAY.2012 13:12:54



Band :	GSM1900	Channel :	CH661
Test Mode :	EDGE 8 Link		

Conducted Emission Plot between 30MHz ~ 1GHz

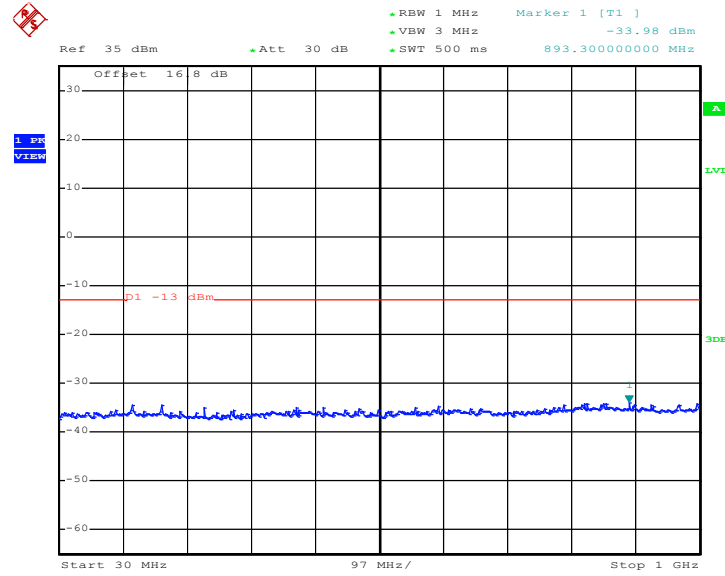

Date: 25.MAY.2012 13:33:00

Conducted Emission Plot between 1GHz ~ 3GHz

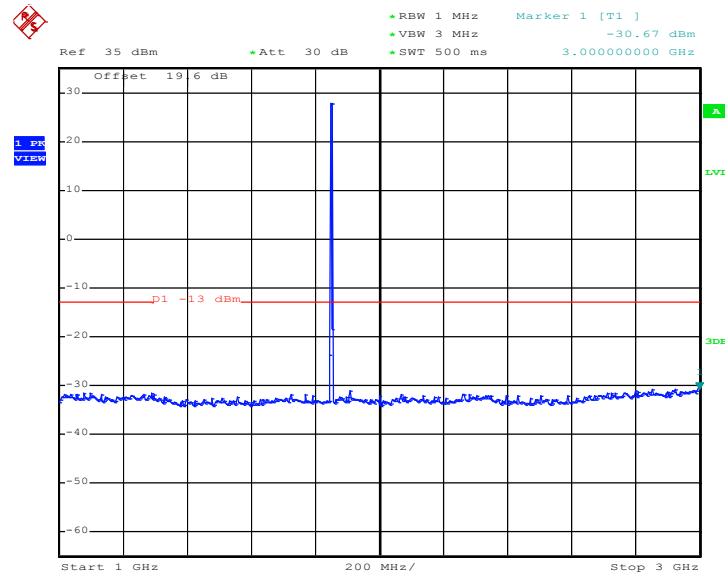

Date: 25.MAY.2012 13:43:47



Conducted Emission Plot between 3GHz ~ 7GHz

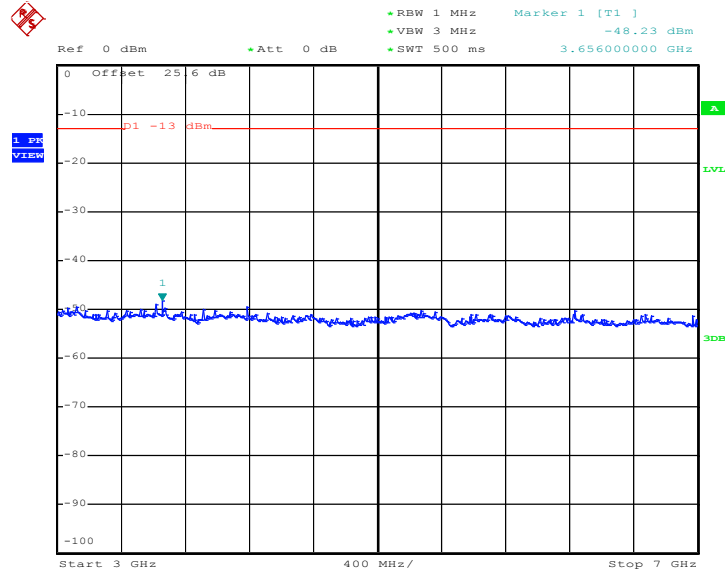

Date: 25.MAY.2012 13:39:17

Conducted Emission Plot between 7GHz ~ 13.6GHz

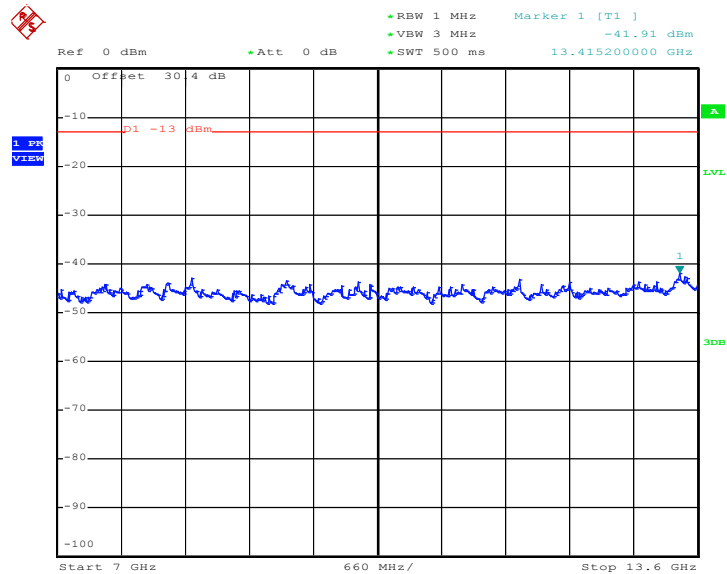

Date: 25.MAY.2012 13:38:01



Conducted Emission Plot between 13.6GHz ~ 19.1GHz

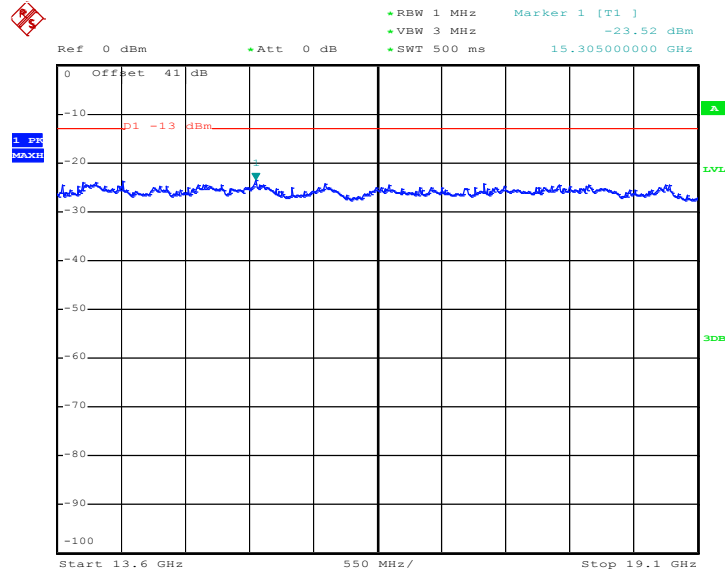

Date: 25.MAY.2012 13:40:37



Band :	WCDMA Band V	Channel :	CH4182
Test Mode :	RMC 12.2Kbps Link		

Conducted Emission Plot between 30MHz ~ 1GHz

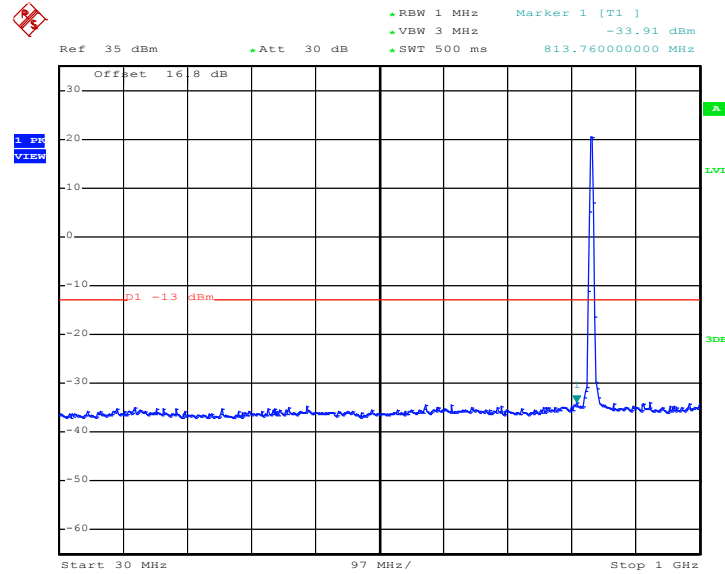

Date: 25.MAY.2012 10:51:00

Conducted Emission Plot between 1GHz ~ 3GHz

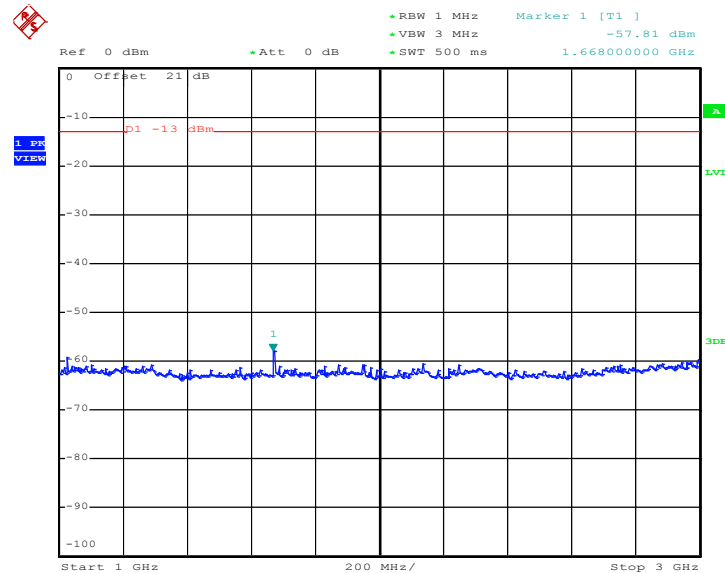

Date: 25.MAY.2012 10:52:35



Conducted Emission Plot between 3GHz ~ 7GHz

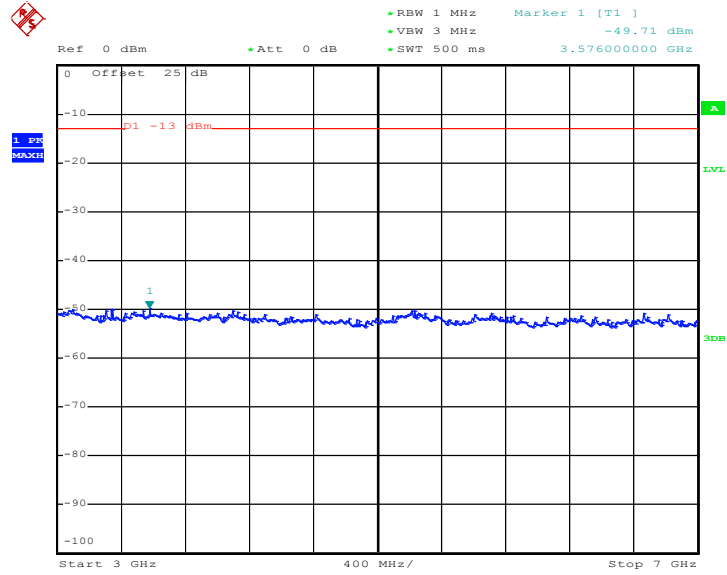

Date: 25.MAY.2012 10:53:52

Conducted Emission Plot between 7GHz ~ 9GHz

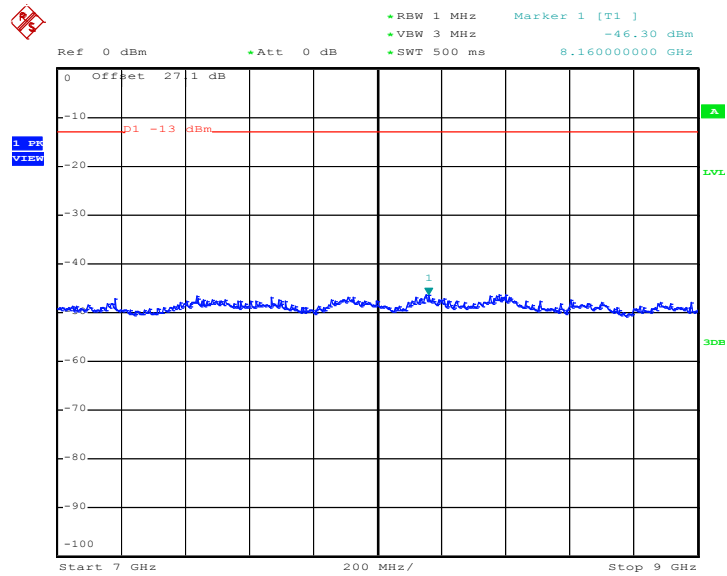

Date: 25.MAY.2012 10:54:53



Band :	WCDMA Band IV	Channel :	CH1413
Test Mode :	RMC 12.2Kbps Link		

Conducted Emission Plot between 30MHz ~ 1GHz

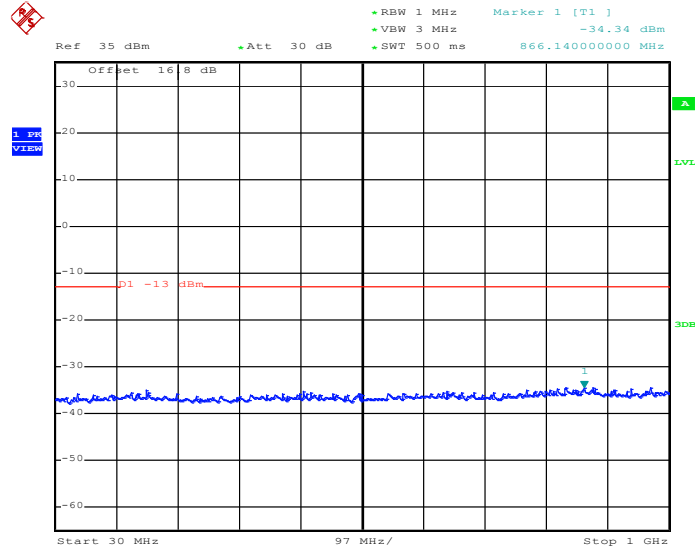

Date: 25.MAY.2012 11:28:33

Conducted Emission Plot between 1GHz ~ 3GHz

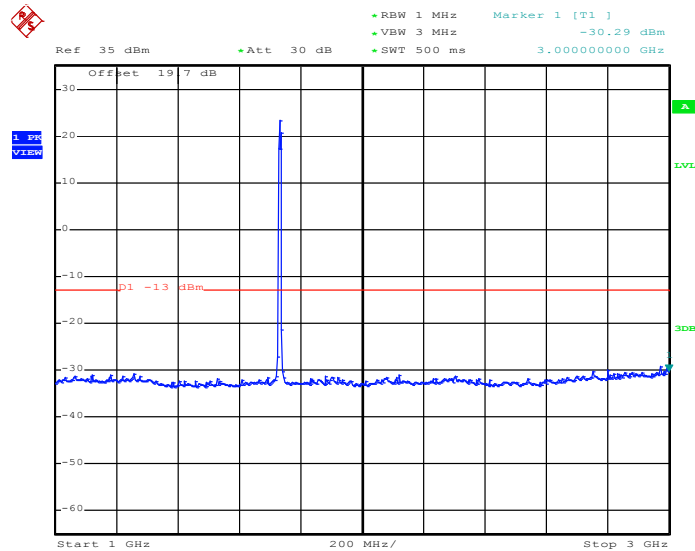

Date: 25.MAY.2012 11:30:28



Conducted Emission Plot between 3GHz ~ 7GHz

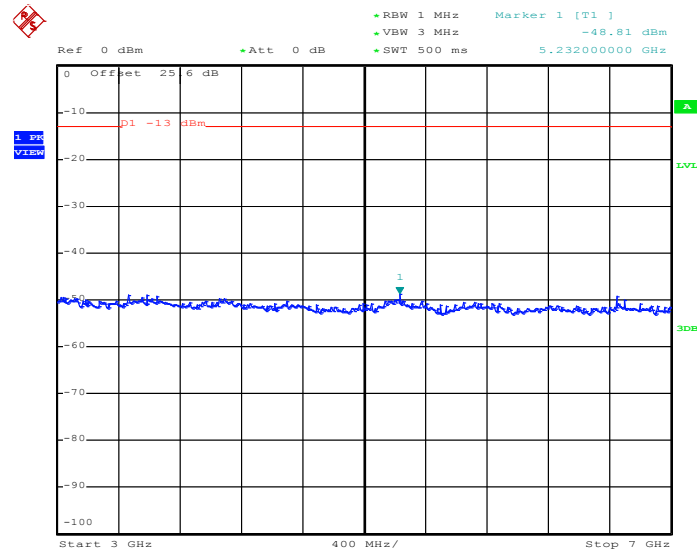

Date: 25.MAY.2012 11:32:43

Conducted Emission Plot between 7GHz ~ 13.6GHz

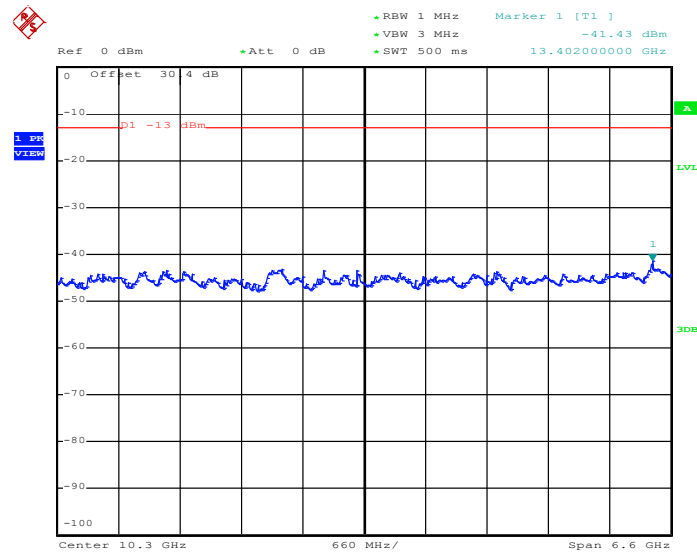

Date: 25.MAY.2012 11:34:35



Conducted Emission Plot between 13.6GHz ~ 18GHz

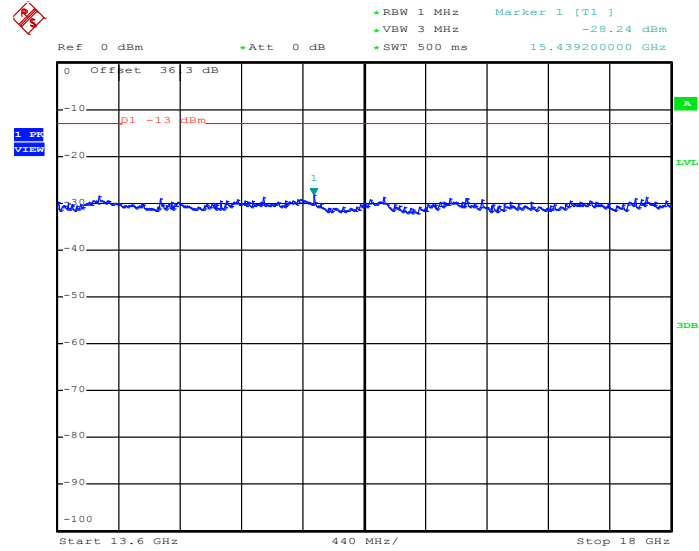

Date: 25.MAY.2012 11:35:50



Band :	WCDMA Band II	Channel :	CH9400
Test Mode :	RMC 12.2Kbps Link		

Conducted Emission Plot between 30MHz ~ 1GHz

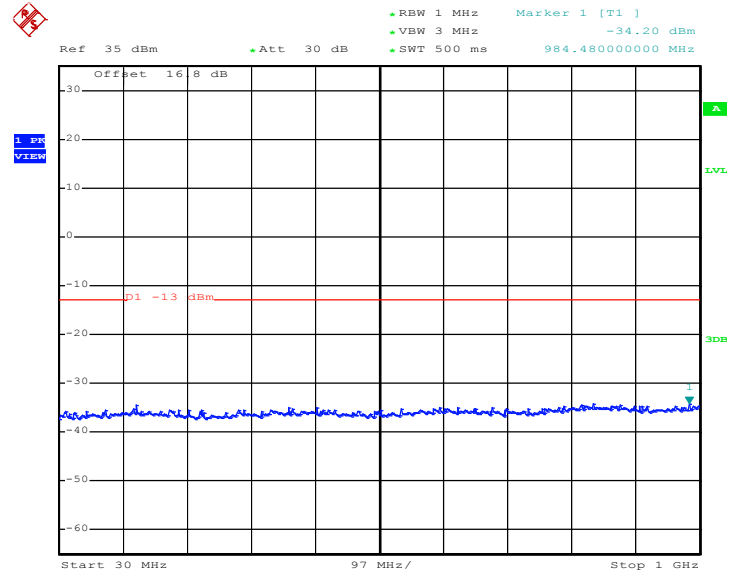

Date: 25.MAY.2012 12:34:13

Conducted Emission Plot between 1GHz ~ 3GHz

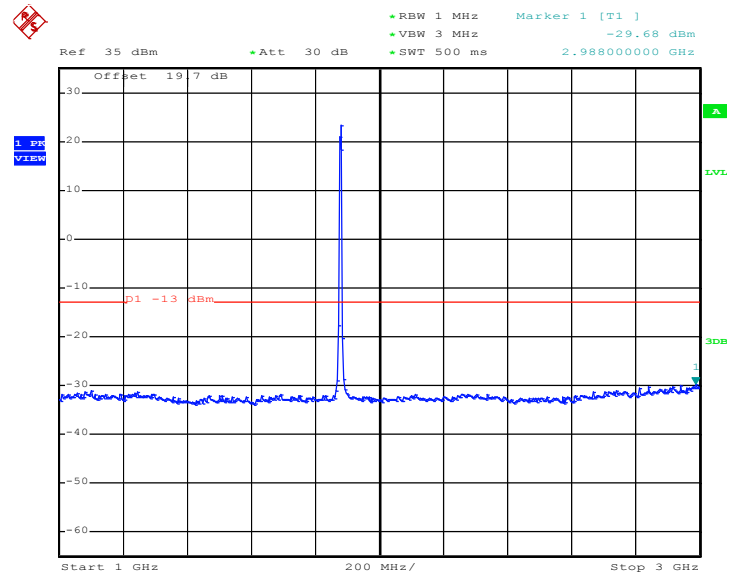

Date: 25.MAY.2012 12:35:58



Conducted Emission Plot between 3GHz ~ 7GHz

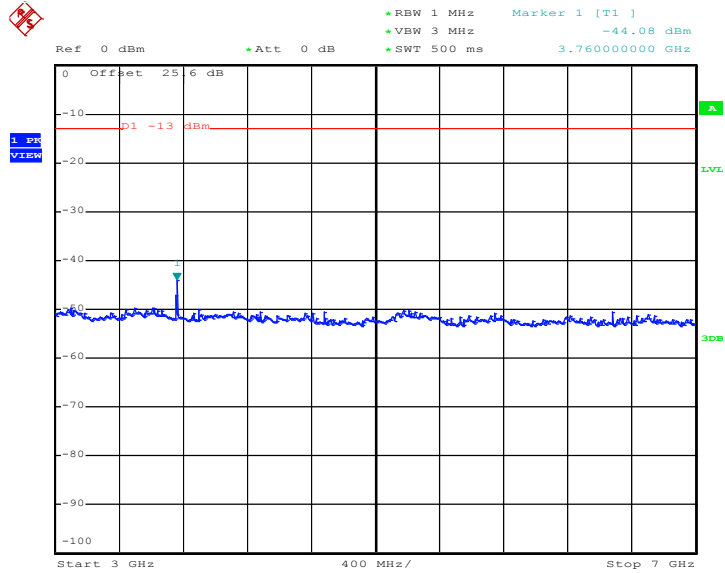

Date: 25.MAY.2012 12:41:22

Conducted Emission Plot between 7GHz ~ 13.6GHz

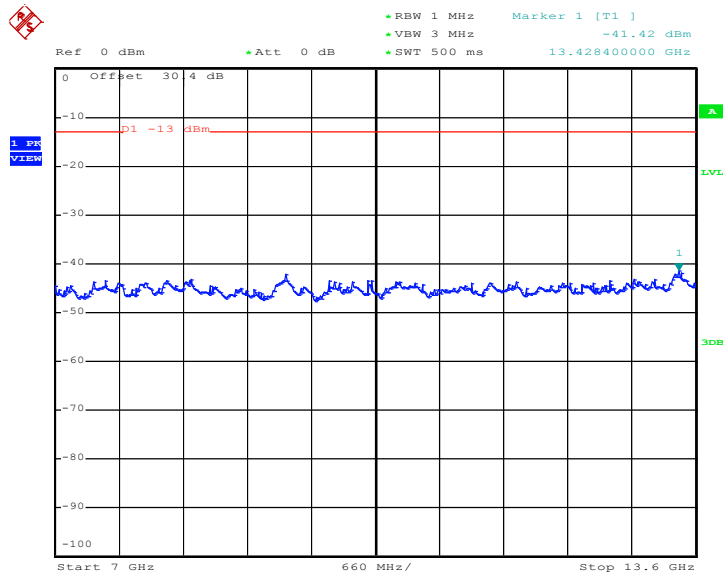

Date: 25.MAY.2012 12:42:29



Conducted Emission Plot between 13.6GHz ~ 19.1GHz

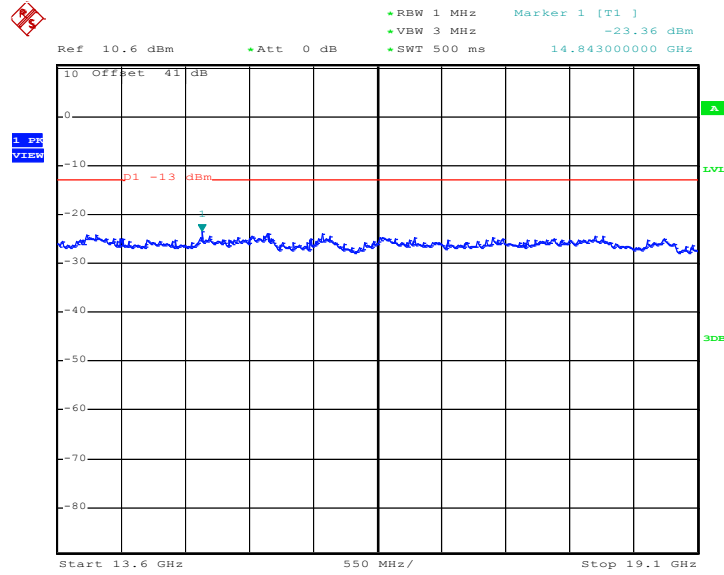

Date: 25.MAY.2012 12:43:39



Band :	CDMA2000 BC0	Power Stage :	High
Test Mode :	1xRTT_RC3+SO55		

Conducted Emission Plot between 30MHz ~ 1GHz

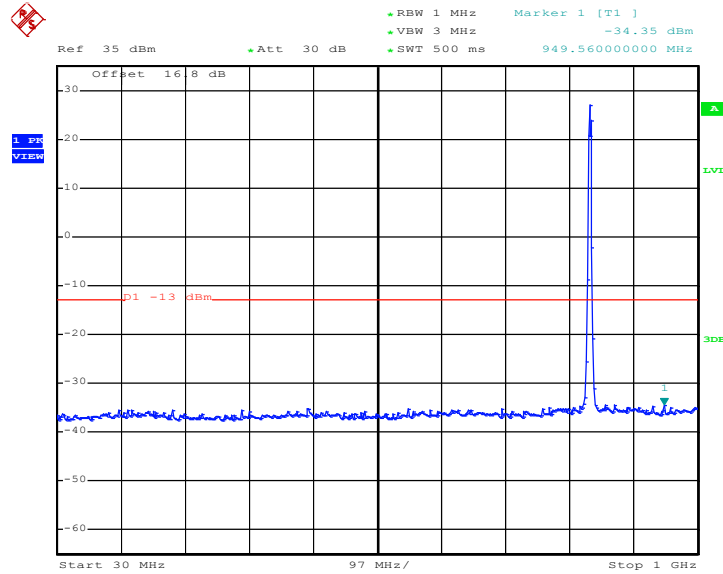

Date: 25.MAY.2012 15:21:14

Conducted Emission Plot between 1GHz ~ 3GHz

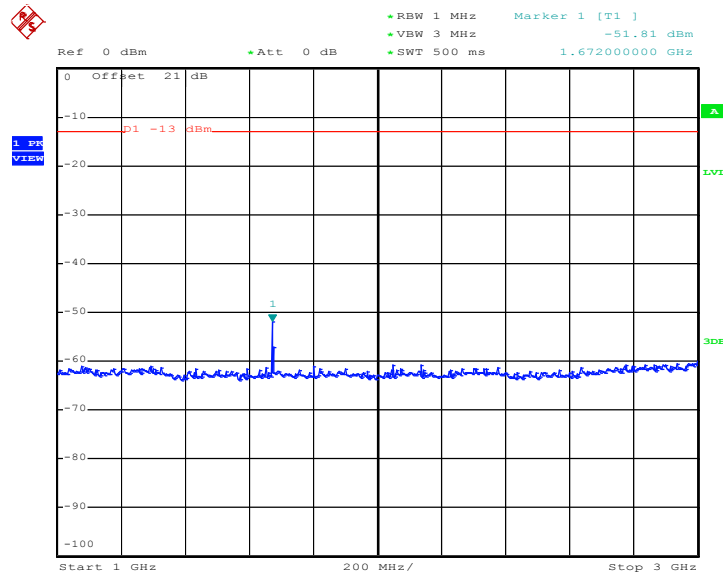

Date: 25.MAY.2012 15:22:43



Conducted Emission Plot between 3GHz ~ 7GHz

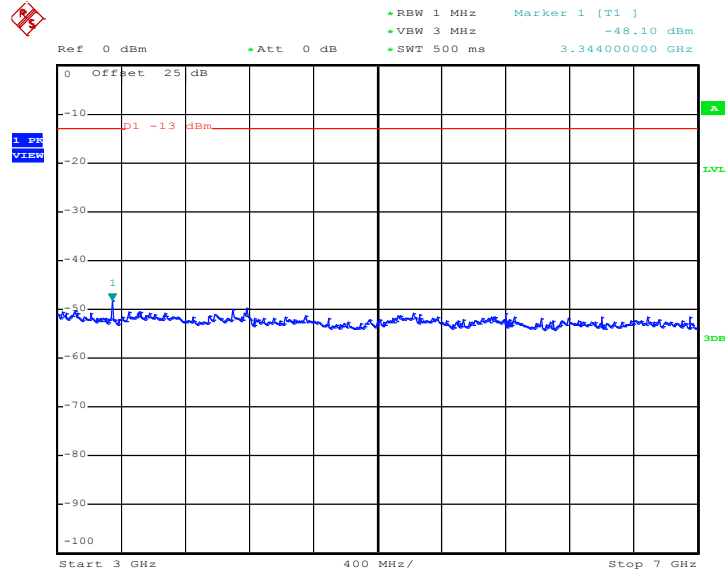

Date: 25.MAY.2012 15:23:34

Conducted Emission Plot between 7GHz ~ 9GHz

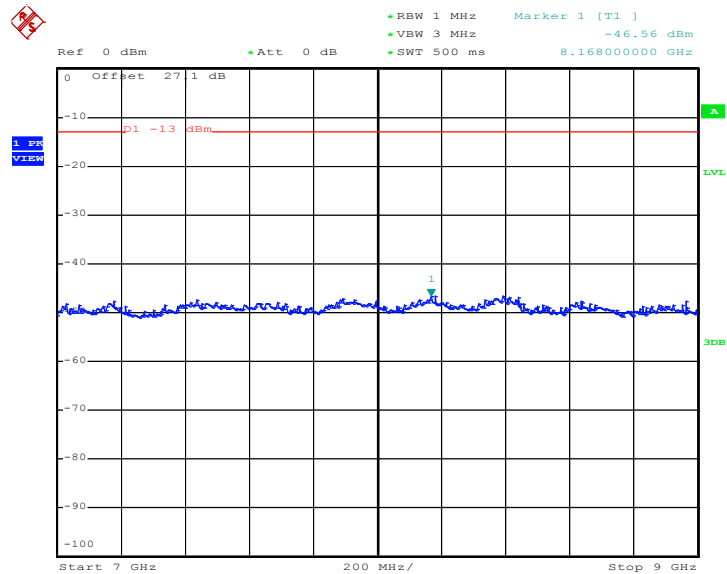

Date: 25.MAY.2012 15:24:30



Band :	CDMA2000 BC1	Power Stage :	High
Test Mode :	1xRTT_RC3+SO55		

Conducted Emission Plot between 30MHz ~ 1GHz

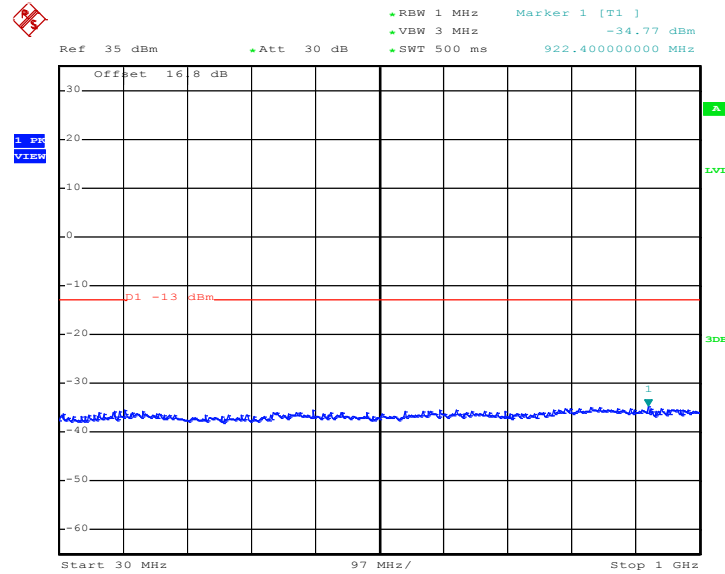

Date: 25.MAY.2012 16:07:14

Conducted Emission Plot between 1GHz ~ 3GHz

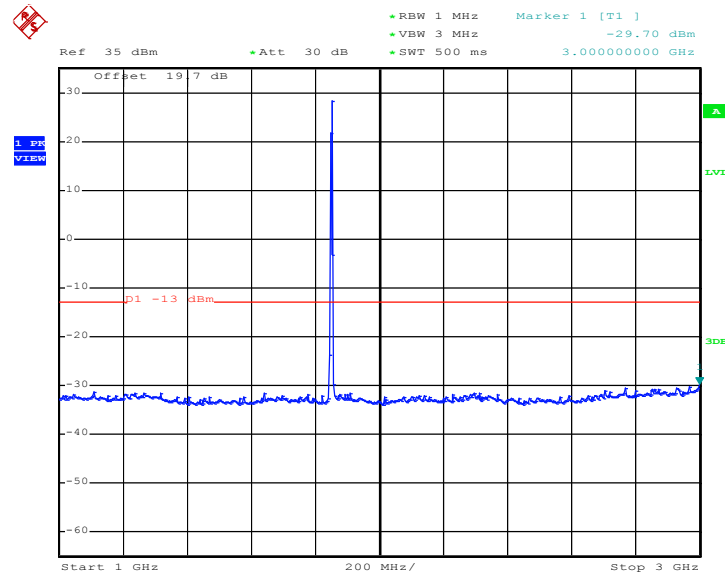

Date: 25.MAY.2012 16:08:56



Conducted Emission Plot between 3GHz ~ 7GHz

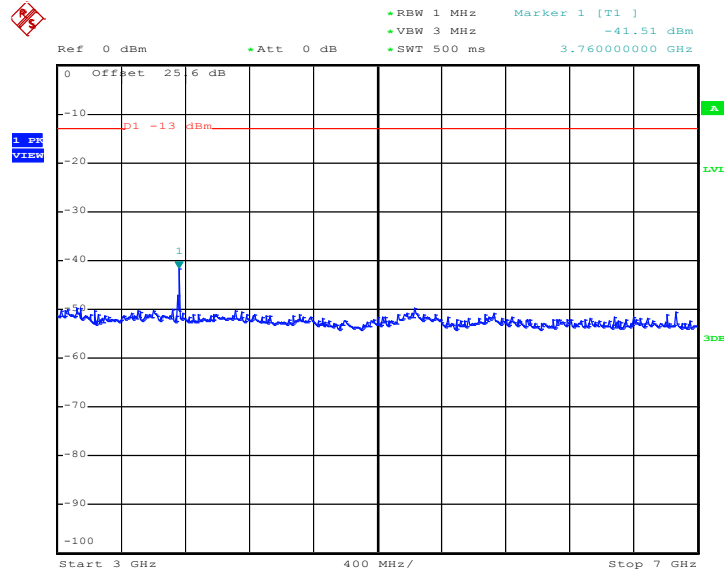

Date: 25.MAY.2012 16:26:22

Conducted Emission Plot between 7GHz ~ 13.6GHz

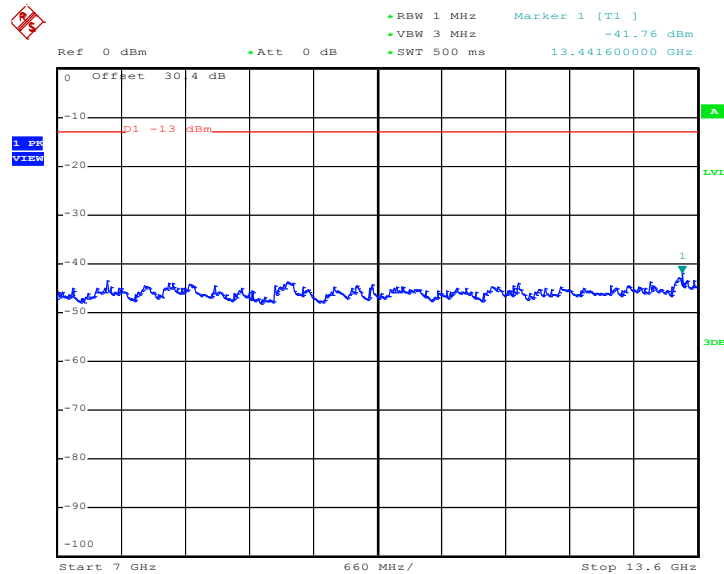

Date: 25.MAY.2012 16:25:28



Conducted Emission Plot between 13.6GHz ~ 19.1GHz

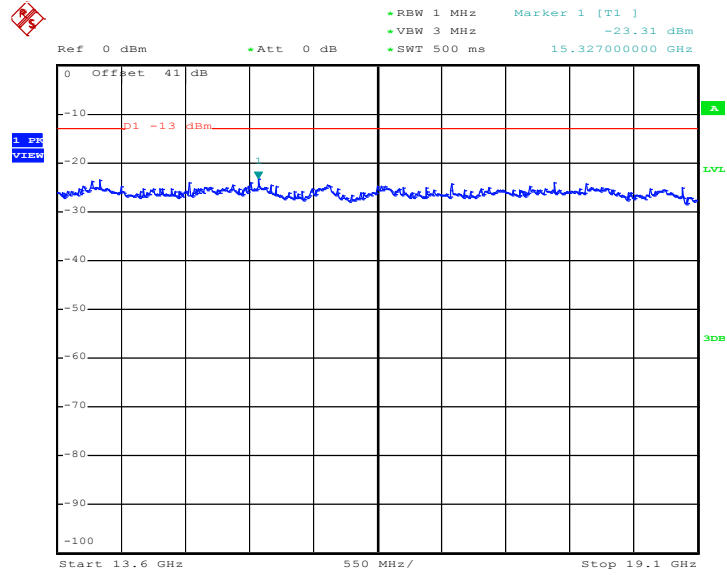

Date: 25.MAY.2012 16:27:21

3.6 Field Strength of Spurious Radiation Measurement

3.6.1 Description of Field Strength of Spurious Radiated Measurement

The radiated spurious emission was measured by substitution method according to ANSI / TIA / EIA-603-C-2004. The power of any emission outside of the authorized operating frequency ranges must be attenuated below the transmitter power (P) by a factor of at least $43 + 10 \log (P)$ dB. The spectrum is scanned from 30 MHz up to a frequency including its 10th harmonic.

3.6.2 Measuring Instruments

See list of measuring instruments of this test report.

3.6.3 Test Procedures

1. The EUT was placed on a rotatable wooden table with 0.8 meter about ground.
2. The EUT was set 3 meters from the receiving antenna, which was mounted on the antenna tower.
3. The table was rotated 360 degrees to determine the position of the highest spurious emission.
4. The height of the receiving antenna is varied between one meter and four meters to search the maximum spurious emission for both horizontal and vertical polarizations.
5. Taking the record of maximum spurious emission.
6. A horn antenna was substituted in place of the EUT and was driven by a signal generator.
7. Tune the output power of signal generator to the same emission level with EUT maximum spurious emission.
8. Taking the record of output power at antenna port.
9. Repeat step 7 to step 8 for another polarization.
10. $EIRP \text{ (dBm)} = S.G. \text{ Power} - Tx \text{ Cable Loss} + Tx \text{ Antenna Gain}$
11. $ERP \text{ (dBm)} = EIRP - 2.15$

3.6.4 Test Setup

For radiated emissions below 30MHz

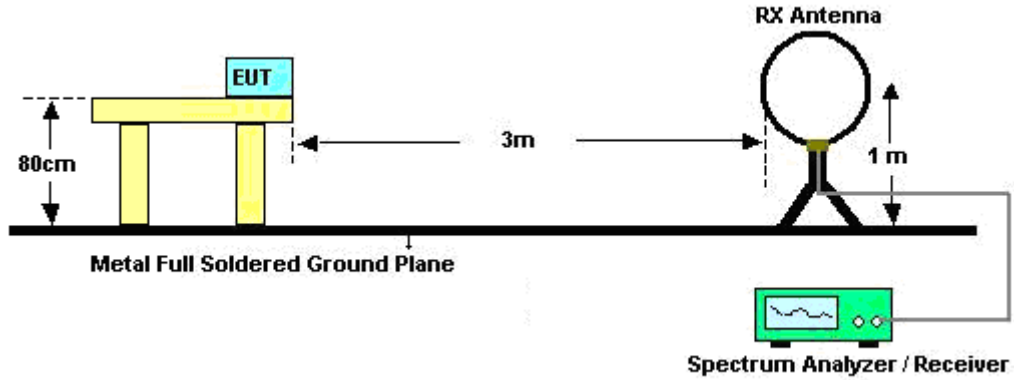

For radiated emissions from 30MHz to 1GHz

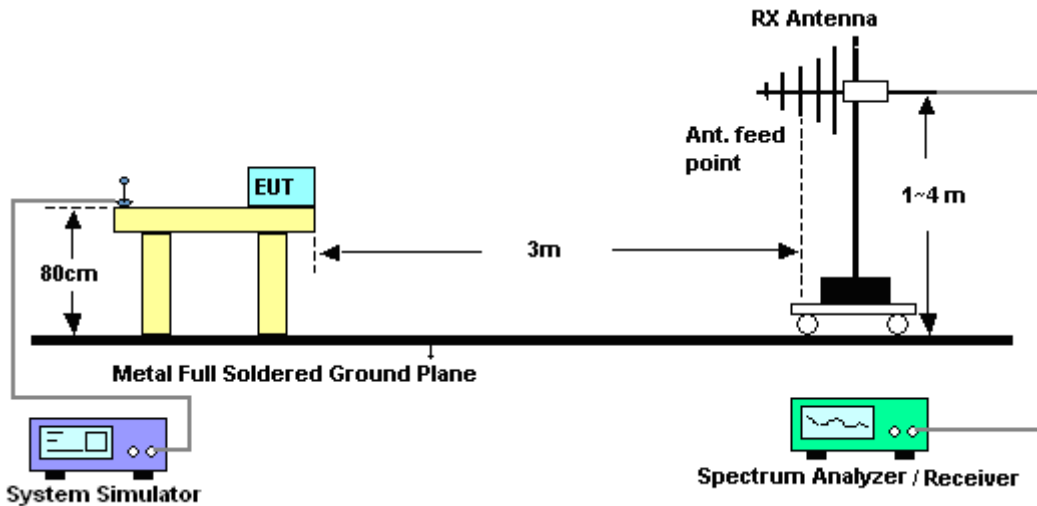

For radiated emissions above 1GHz

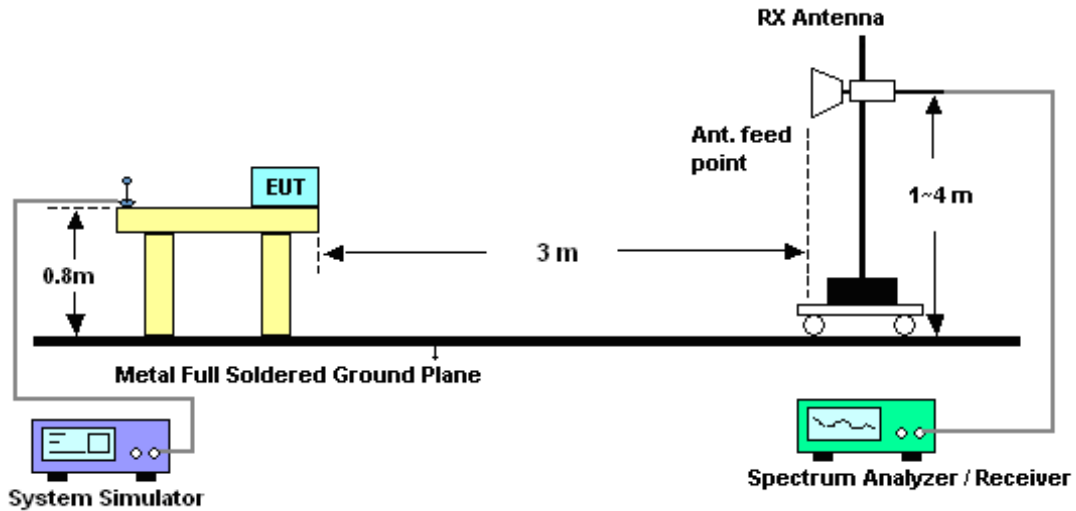

3.6.5 Test Results of Radiated Emissions (9 KHz ~ 30 MHz)

The low frequency, which started from 9 KHz to 30MHz, was pre-scanned and the result which was 20dB lower than the limit line per 15.31(o) was not reported.



3.6.6 Test Result of Field Strength of Spurious Radiated

Band :	GSM850	Temperature :	23~25°C
Test Mode :	GPRS 8 Link	Relative Humidity :	51~53%
Test Engineer :	David Yang	Polarization :	Horizontal
Remark :	Spurious emissions within 30-1000MHz were found more than 20dB below limit line.		

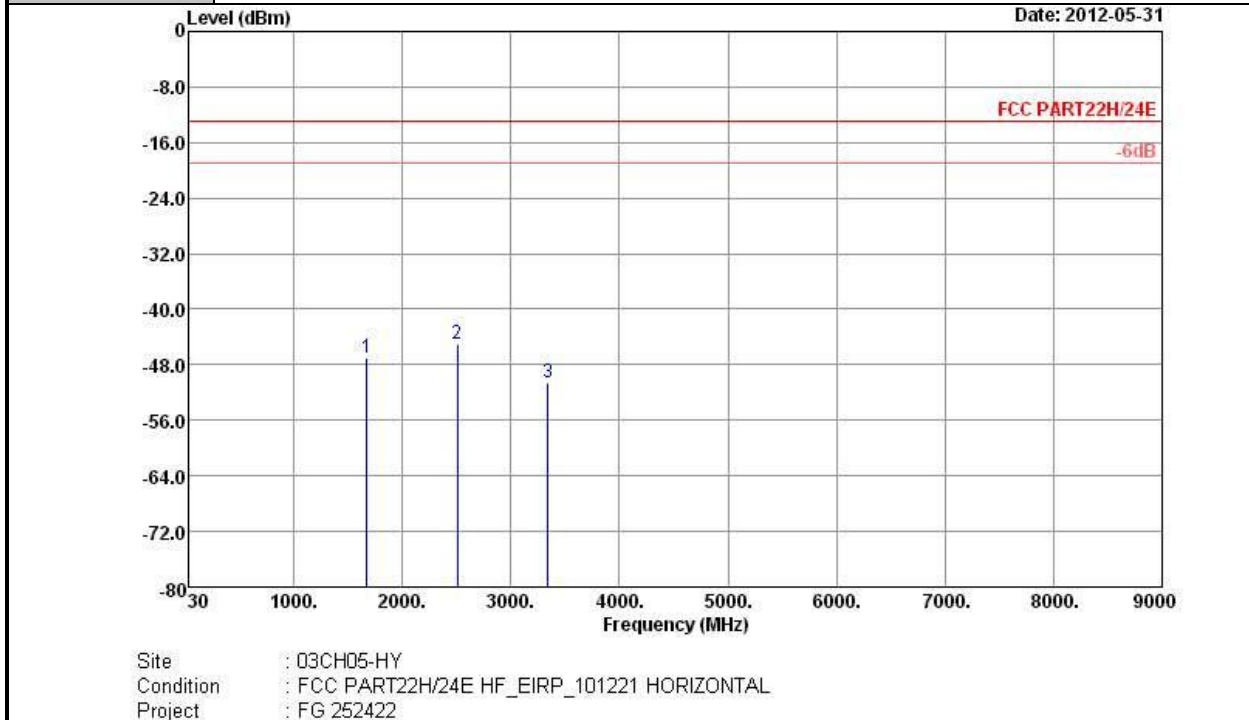

Frequency (MHz)	ERP (dBm)	Limit (dBm)	Over Limit (dB)	SPA Reading (dBm)	S.G. Power (dBm)	TX Cable loss (dB)	TX Antenna Gain (dBi)	Polarization (H/V)	Result
1672	-47.01	-13	-34.01	-52.95	-48.2	2.15	5.49	H	Pass
2509	-45.01	-13	-32.01	-54.3	-46.9	2.38	6.41	H	Pass
3345	-50.57	-13	-37.57	-62.06	-53.9	2.86	8.34	H	Pass



Band :	GSM850	Temperature :	23~25°C
Test Mode :	GPRS 8 Link	Relative Humidity :	51~53%
Test Engineer :	David Yang	Polarization :	Vertical
Remark :	Spurious emissions within 30-1000MHz were found more than 20dB below limit line.		

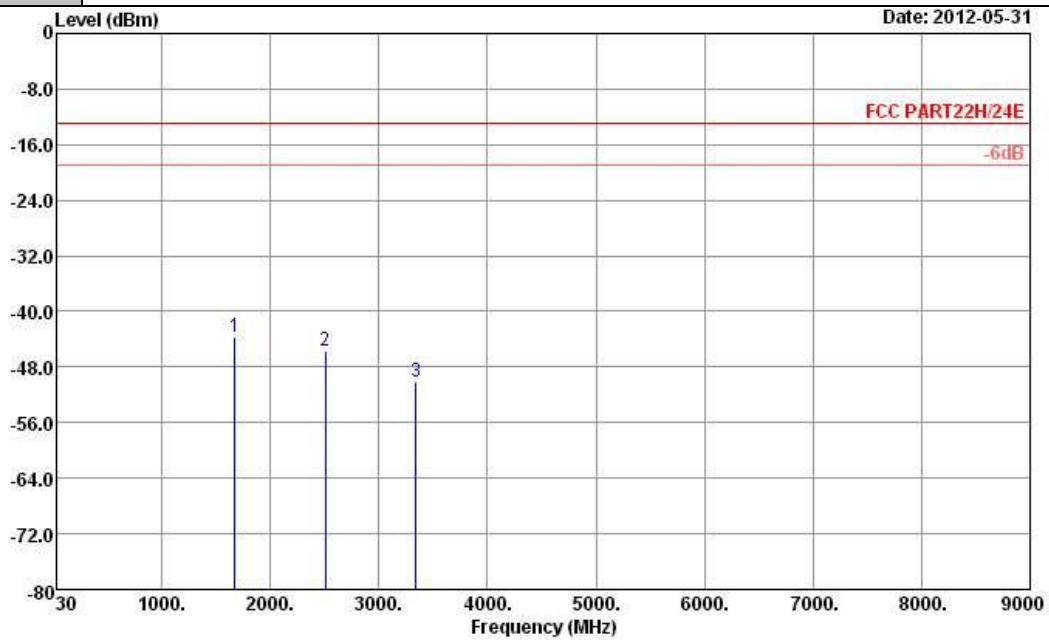

Site : 03CH05-HY
 Condition : FCC PART22H/24E HF_EIRP_101221 VERTICAL
 Project : FG 252422

Frequency (MHz)	ERP (dBm)	Limit (dBm)	Over Limit (dB)	SPA Reading (dBm)	S.G. Power (dBm)	TX Cable loss (dB)	TX Antenna Gain (dBi)	Polarization (H/V)	Result
1672	-43.63	-13	-30.63	-49.56	-44.82	2.15	5.49	V	Pass
2509	-45.61	-13	-32.61	-54.96	-47.5	2.38	6.41	V	Pass
3345	-50.05	-13	-37.05	-61.53	-53.38	2.86	8.34	V	Pass



Band :	GSM850	Temperature :	23~25°C
Test Mode :	EDGE 8 Link	Relative Humidity :	51~53%
Test Engineer :	David Yang	Polarization :	Horizontal
Remark :	Spurious emissions within 30-1000MHz were found more than 20dB below limit line.		

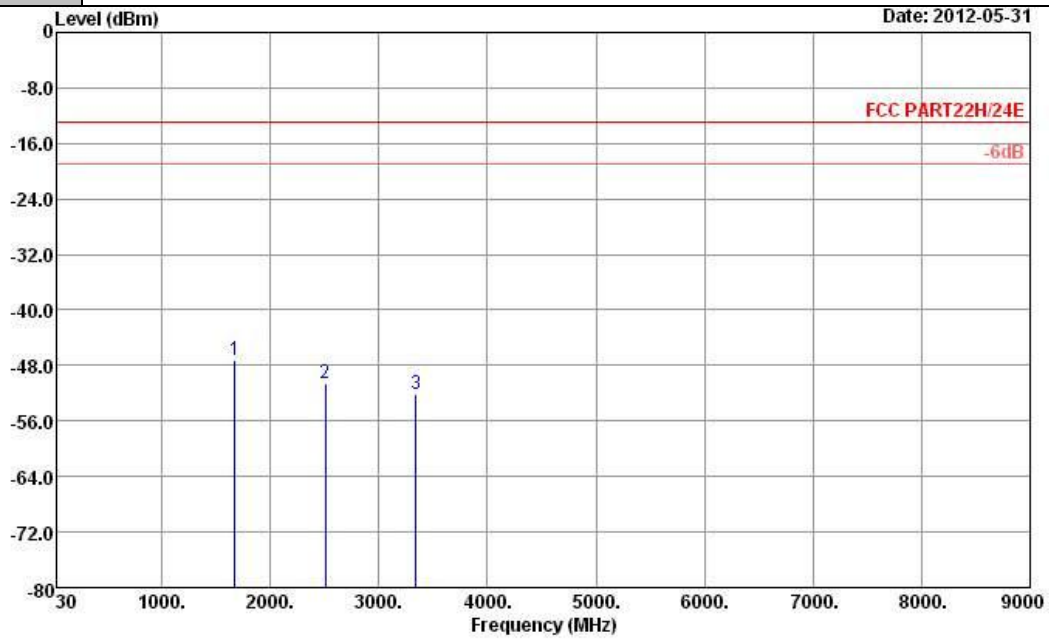

Site : 03CH05-HY
 Condition : FCC PART22H/24E HF_EIRP_101221 HORIZONTAL
 Project : FG 252422

Frequency (MHz)	ERP (dBm)	Limit (dBm)	Over Limit (dB)	SPA Reading (dBm)	S.G. Power (dBm)	TX Cable loss (dB)	TX Antenna Gain (dBi)	Polarization (H/V)	Result
1672	-47.31	-13	-34.31	-53.58	-48.5	2.15	5.49	H	Pass
2509	-50.61	-13	-37.61	-60.17	-52.5	2.38	6.41	H	Pass
3345	-52.17	-13	-39.17	-63.79	-55.5	2.86	8.34	H	Pass



Band :	GSM850	Temperature :	23~25°C
Test Mode :	EDGE 8 Link	Relative Humidity :	51~53%
Test Engineer :	David Yang	Polarization :	Vertical
Remark :	Spurious emissions within 30-1000MHz were found more than 20dB below limit line.		

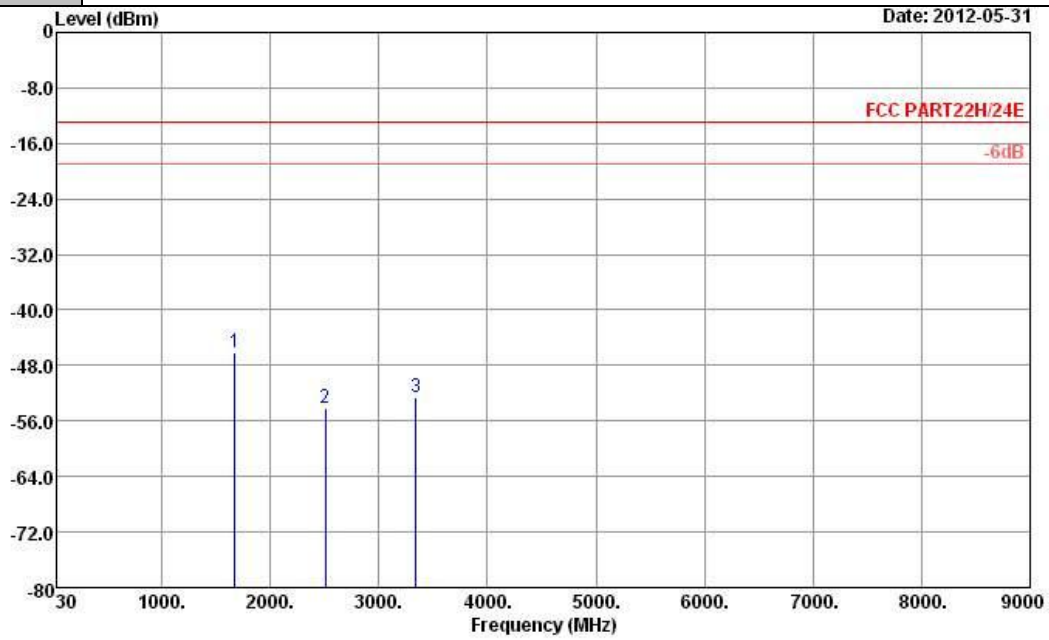

Site : 03CH05-HY
 Condition : FCC PART22H/24E HF_EIRP_101221 VERTICAL
 Project : FG 252422

Frequency (MHz)	ERP (dBm)	Limit (dBm)	Over Limit (dB)	SPA Reading (dBm)	S.G. Power (dBm)	TX Cable loss (dB)	TX Antenna Gain (dBi)	Polarization (H/V)	Result
1672	-46.11	-13	-33.11	-52.24	-47.3	2.15	5.49	V	Pass
2509	-54.11	-13	-41.11	-63.43	-56	2.38	6.41	V	Pass
3345	-52.67	-13	-39.67	-64.16	-56	2.86	8.34	V	Pass



Band :	GSM1900	Temperature :	23~25°C
Test Mode :	GPRS 8 Link	Relative Humidity :	51~53%
Test Engineer :	David Yang	Polarization :	Horizontal
Remark :	Spurious emissions within 30-1000MHz were found more than 20dB below limit line.		

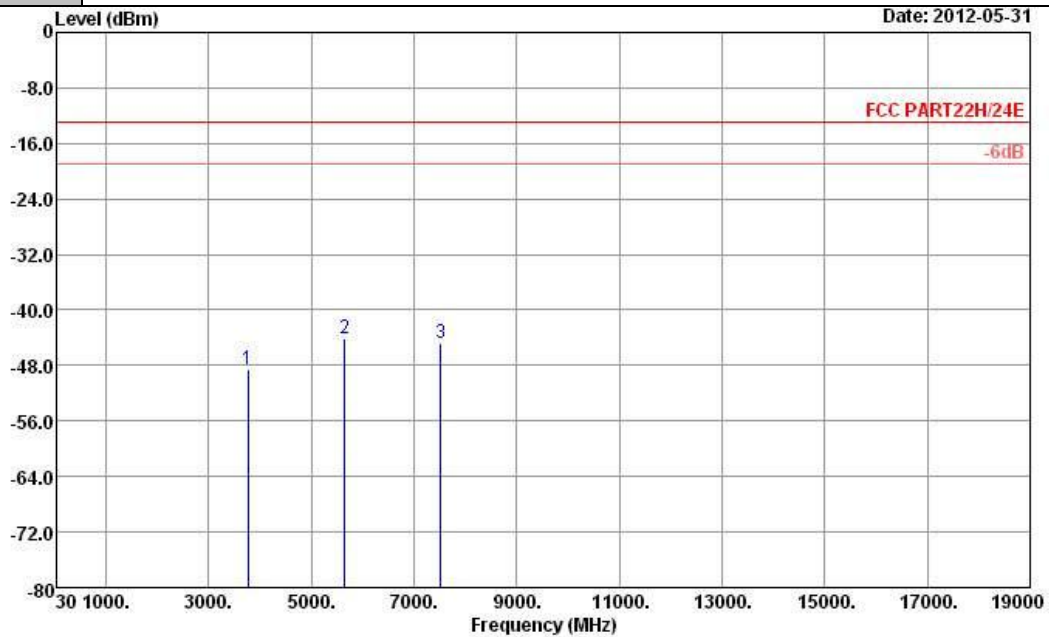

Site : 03CH05-HY
 Condition : FCC PART22H/24E HF_EIRP_101221 HORIZONTAL
 Project : FG 252422

Frequency (MHz)	EIRP (dBm)	Limit (dBm)	Over Limit (dB)	SPA Reading (dBm)	S.G. Power (dBm)	TX Cable loss (dB)	TX Antenna Gain (dBi)	Polarization (H/V)	Result
3760	-48.47	-13	-35.47	-62	-54.6	2.9292	9.06	H	Pass
5640	-44.08	-13	-31.08	-62.97	-51	3.9072	10.83	H	Pass
7520	-44.89	-13	-31.89	-66.8	-52.91	4.5988	12.62	H	Pass



Band :	GSM1900	Temperature :	23~25°C
Test Mode :	GPRS 8 Link	Relative Humidity :	51~53%
Test Engineer :	David Yang	Polarization :	Vertical
Remark :	Spurious emissions within 30-1000MHz were found more than 20dB below limit line.		

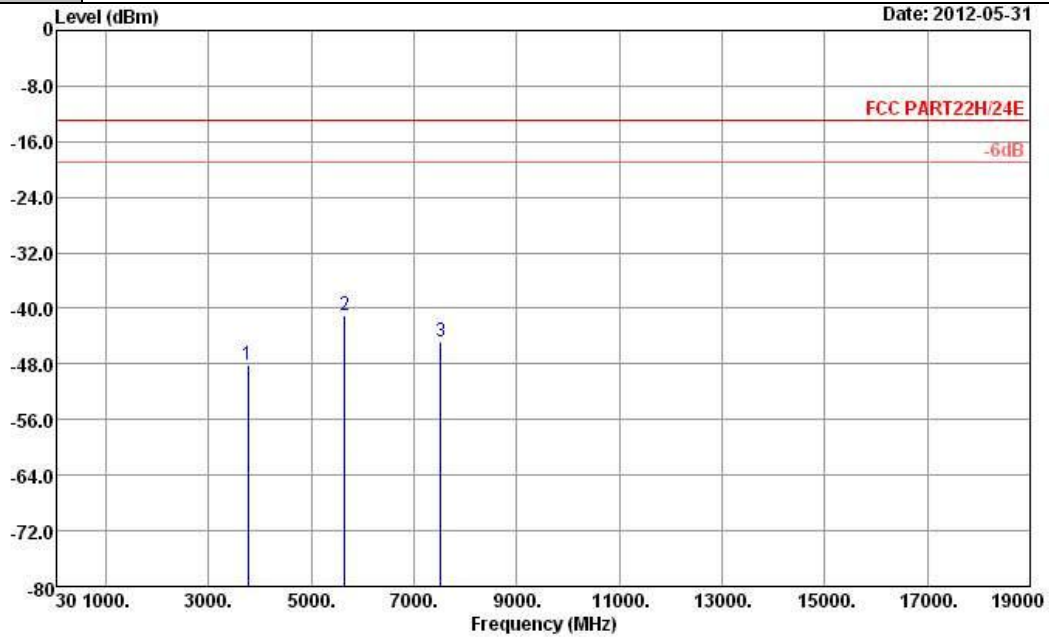

Site : 03CH05-HY
 Condition : FCC PART22H/24E HF_EIRP_101221 VERTICAL
 Project : FG 252422

Frequency (MHz)	EIRP (dBm)	Limit (dBm)	Over Limit (dB)	SPA Reading (dBm)	S.G. Power (dBm)	TX Cable loss (dB)	TX Antenna Gain (dBi)	Polarization (H/V)	Result
3760	-48.17	-13	-35.17	-61.63	-54.3	2.9292	9.06	V	Pass
5640	-41.08	-13	-28.08	-60.07	-48	3.9072	10.83	V	Pass
7520	-44.89	-13	-31.89	-66.85	-52.91	4.5988	12.62	V	Pass



Band :	GSM1900	Temperature :	23~25°C
Test Mode :	EDGE 8 Link	Relative Humidity :	51~53%
Test Engineer :	David Yang	Polarization :	Horizontal
Remark :	Spurious emissions within 30-1000MHz were found more than 20dB below limit line.		

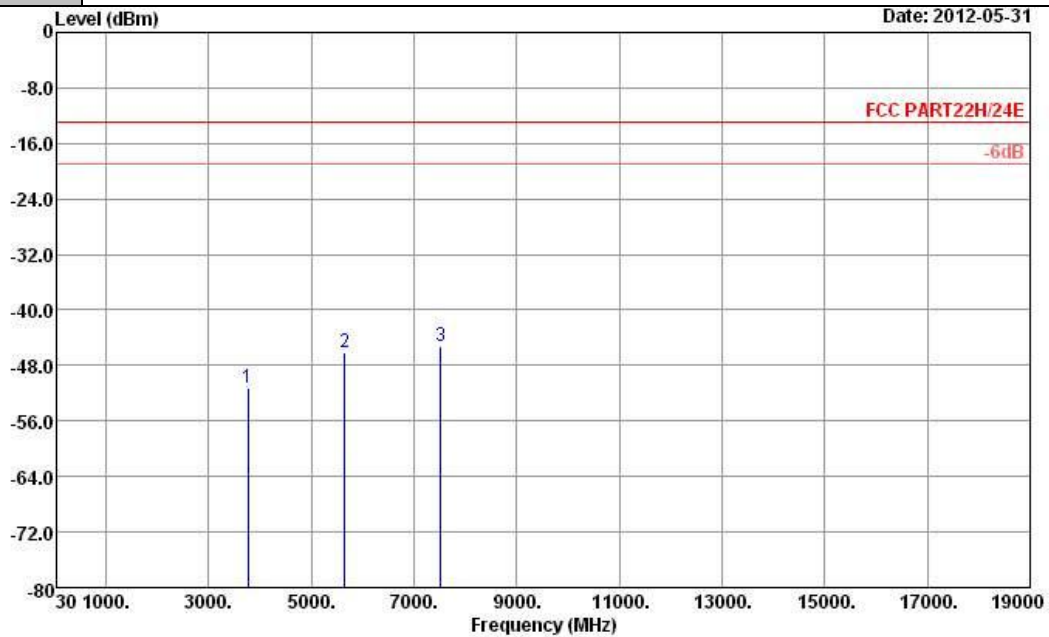

Site : 03CH05-HY
 Condition : FCC PART22H/24E HF_EIRP_101221 HORIZONTAL
 Project : FG 252422

Frequency (MHz)	EIRP (dBm)	Limit (dBm)	Over Limit (dB)	SPA Reading (dBm)	S.G. Power (dBm)	TX Cable loss (dB)	TX Antenna Gain (dBi)	Polarization (H/V)	Result
3760	-51.20	-13	-38.20	-64.72	-57.33	2.9292	9.06	H	Pass
5640	-46.20	-13	-33.20	-65.19	-53.12	3.9072	10.83	H	Pass
7520	-45.24	-13	-32.24	-67.51	-53.26	4.5988	12.62	H	Pass



Band :	GSM1900	Temperature :	23~25°C
Test Mode :	EDGE 8 Link	Relative Humidity :	51~53%
Test Engineer :	David Yang	Polarization :	Vertical
Remark :	Spurious emissions within 30-1000MHz were found more than 20dB below limit line.		

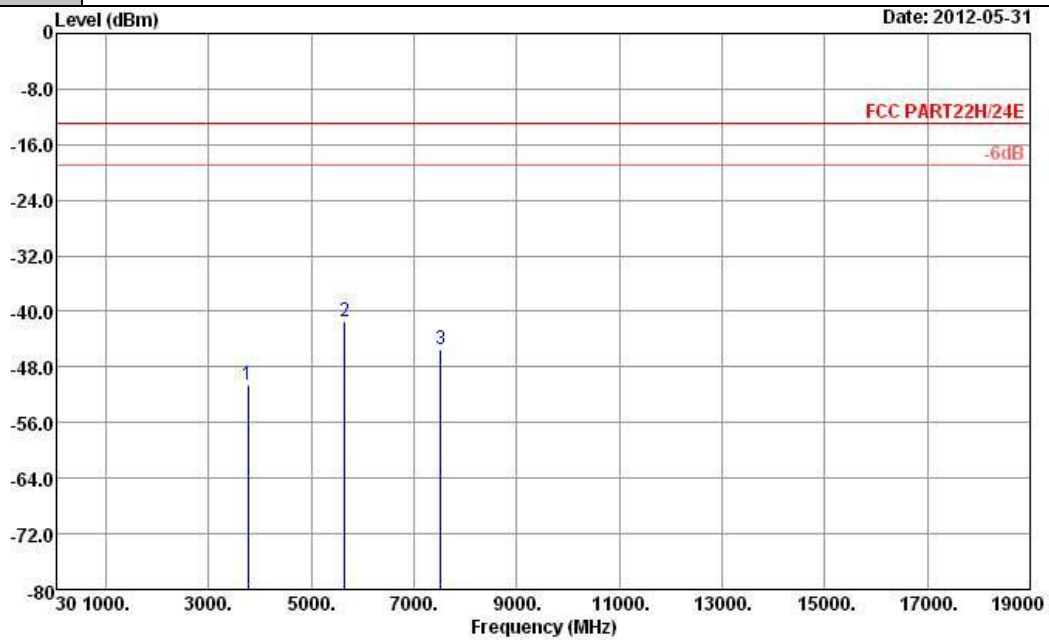

Site : 03CH05-HY
 Condition : FCC PART22H/24E HF_EIRP_101221 VERTICAL
 Project : FG 252422

Frequency (MHz)	EIRP (dBm)	Limit (dBm)	Over Limit (dB)	SPA Reading (dBm)	S.G. Power (dBm)	TX Cable loss (dB)	TX Antenna Gain (dBi)	Polarization (H/V)	Result
3760	-50.48	-13	-37.48	-64.07	-56.61	2.9292	9.06	V	Pass
5640	-41.39	-13	-28.39	-60.26	-48.31	3.9072	10.83	V	Pass
7520	-45.37	-13	-32.37	-67.52	-53.39	4.5988	12.62	V	Pass



Band :	WCDMA Band V	Temperature :	23~25°C
Test Mode :	RMC 12.2Kbps Link	Relative Humidity :	51~53%
Test Engineer :	David Yang	Polarization :	Horizontal
Remark :	Spurious emissions within 30-1000MHz were found more than 20dB below limit line.		

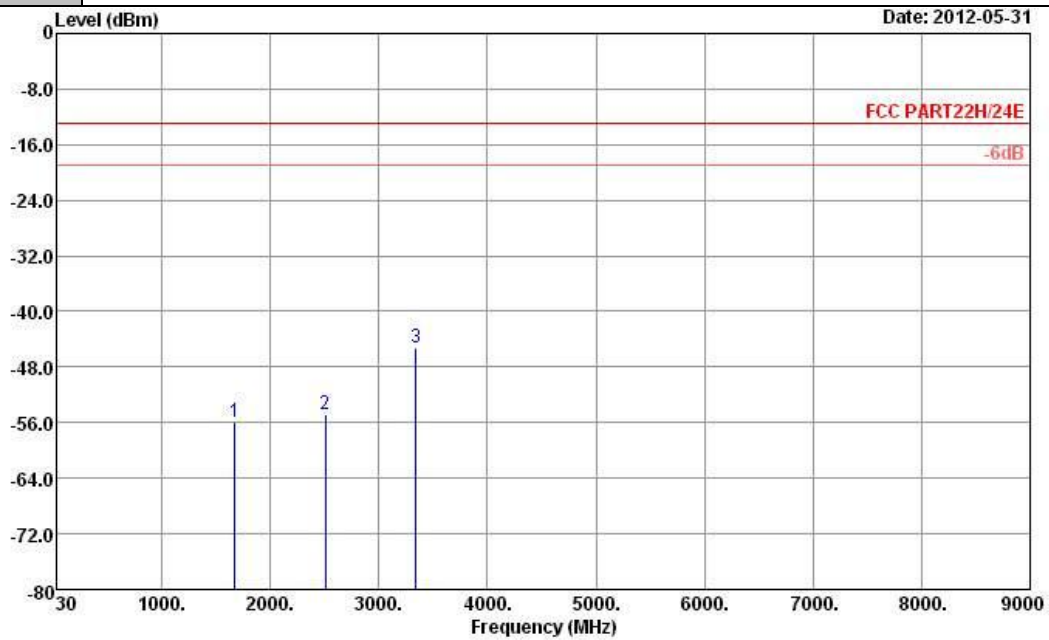

Site : 03CH05-HY
 Condition : FCC PART22H/24E HF_EIRP_101221 HORIZONTAL
 Project : FG 252422

Frequency (MHz)	ERP (dBm)	Limit (dBm)	Over Limit (dB)	SPA Reading (dBm)	S.G. Power (dBm)	TX Cable loss (dB)	TX Antenna Gain (dBi)	Polarization (H/V)	Result
1672	-55.91	-13	-42.91	-61.92	-57.1	2.15	5.49	H	Pass
2509	-54.91	-13	-41.91	-64.58	-56.8	2.38	6.41	H	Pass
3345	-45.23	-13	-32.23	-56.97	-48.56	2.86	8.34	H	Pass



Band :	WCDMA Band V	Temperature :	23~25°C
Test Mode :	RMC 12.2Kbps Link	Relative Humidity :	51~53%
Test Engineer :	David Yang	Polarization :	Vertical
Remark :	Spurious emissions within 30-1000MHz were found more than 20dB below limit line.		

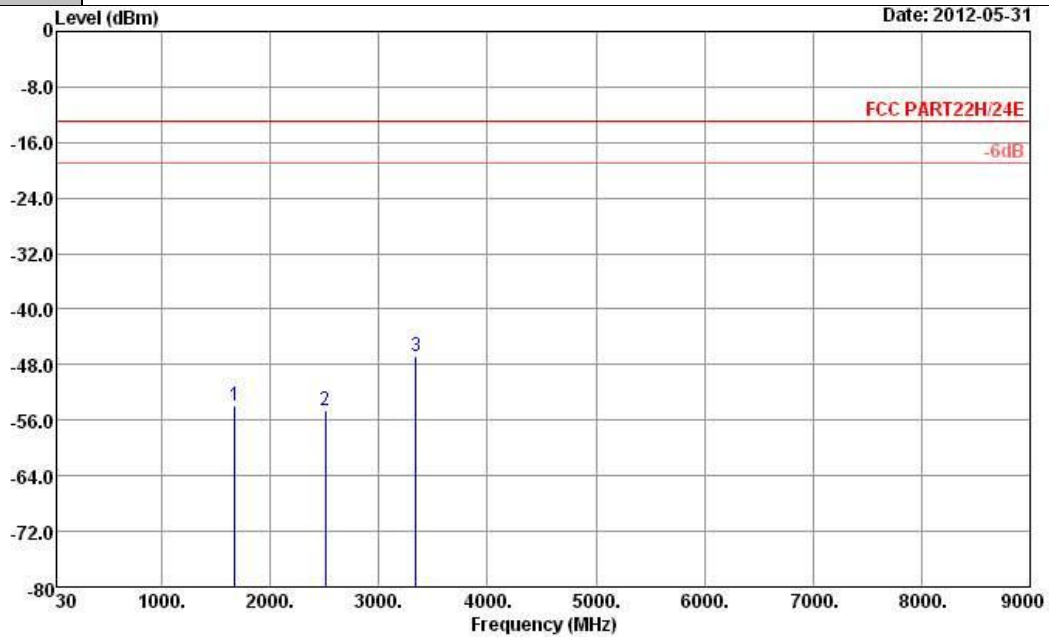

Site : 03CH05-HY
 Condition : FCC PART22H/24E HF_EIRP_101221 VERTICAL
 Project : FG 252422

Frequency (MHz)	ERP (dBm)	Limit (dBm)	Over Limit (dB)	SPA Reading (dBm)	S.G. Power (dBm)	TX Cable loss (dB)	TX Antenna Gain (dBi)	Polarization (H/V)	Result
1672	-53.93	-13	-40.93	-59.9	-55.12	2.15	5.49	V	Pass
2509	-54.66	-13	-41.66	-64.47	-56.55	2.38	6.41	V	Pass
3345	-46.81	-13	-33.81	-59.16	-50.14	2.86	8.34	V	Pass



Band :	WCDMA Band IV	Temperature :	23~25°C
Test Mode :	RMC 12.2Kbps Link	Relative Humidity :	51~53%
Test Engineer :	David Yang	Polarization :	Horizontal
Remark :	Spurious emissions within 30-1000MHz were found more than 20dB below limit line.		

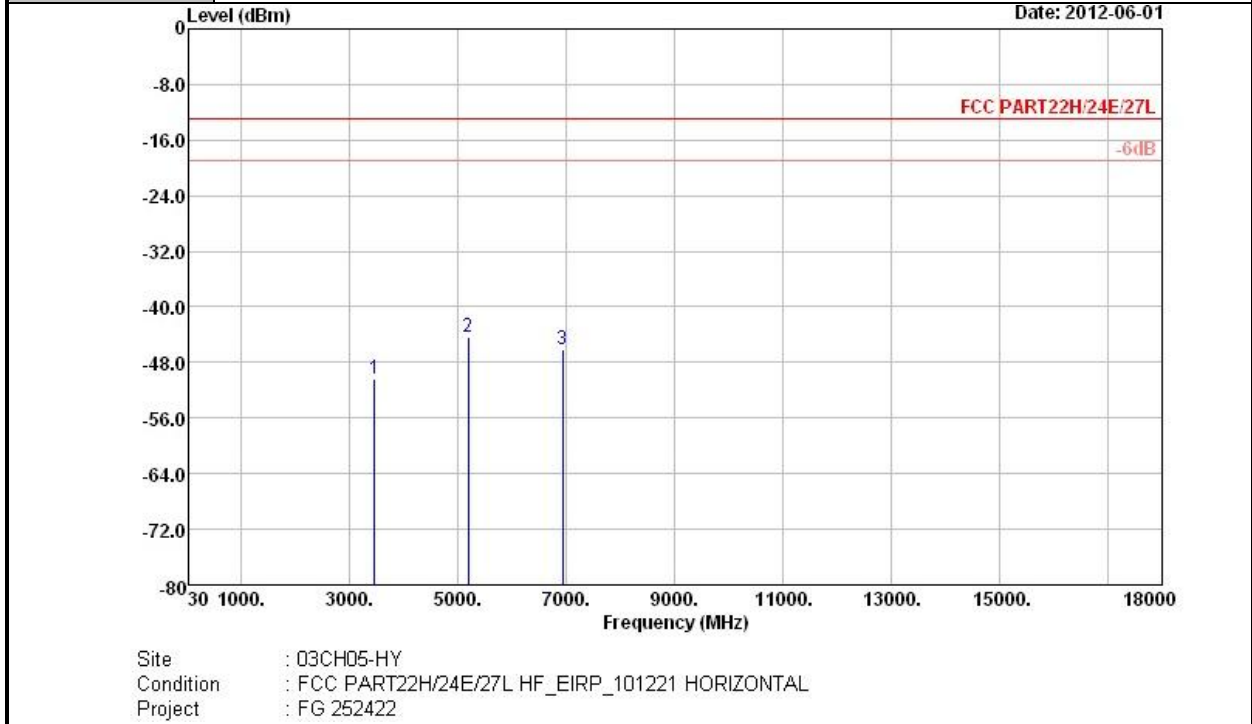

Frequency (MHz)	EIRP (dBm)	Limit (dBm)	Over Limit (dB)	SPA Reading (dBm)	S.G. Power (dBm)	TX Cable loss (dB)	TX Antenna Gain (dBi)	Polarization (H/V)	Result
3465.2	-50.29	-13	-37.29	-62.39	-56.55	2.58	8.84	H	Pass
5197.8	-44.29	-13	-31.29	-62.43	-51.23	3.78	10.72	H	Pass
6930.4	-46.04	-13	-33.04	-67.26	-53.79	4.3	12.05	H	Pass



Band :	WCDMA Band IV	Temperature :	23~25°C
Test Mode :	RMC 12.2Kbps Link	Relative Humidity :	51~53%
Test Engineer :	David Yang	Polarization :	Vertical
Remark :	Spurious emissions within 30-1000MHz were found more than 20dB below limit line.		

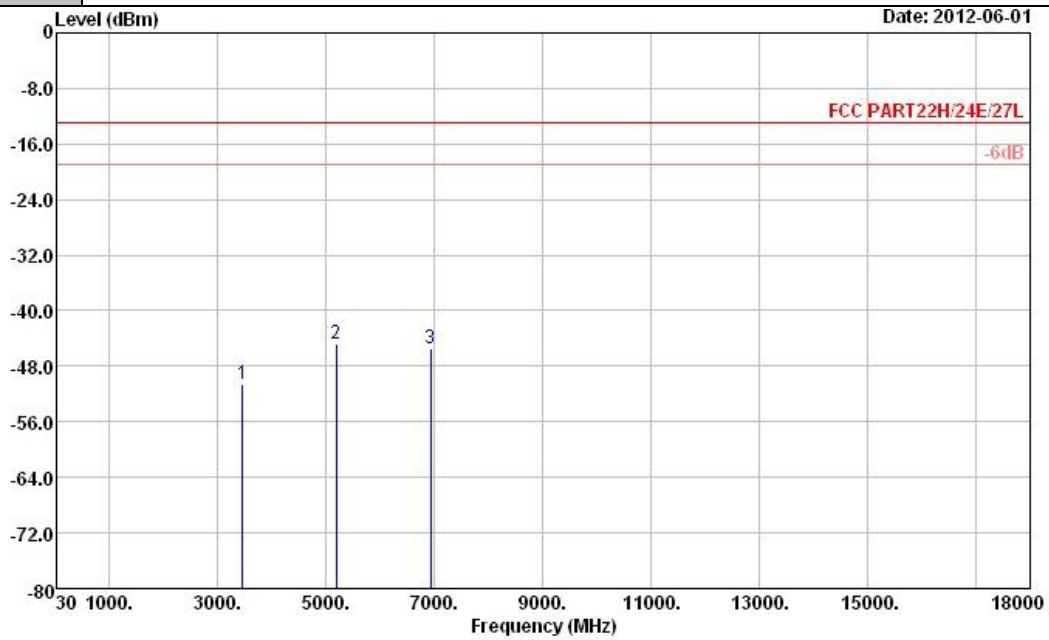

Site : 03CH05-HY
 Condition : FCC PART22H/24E/27L HF_EIRP_101221 VERTICAL
 Project : FG 252422

Frequency (MHz)	EIRP (dBm)	Limit (dBm)	Over Limit (dB)	SPA Reading (dBm)	S.G. Power (dBm)	TX Cable loss (dB)	TX Antenna Gain (dBi)	Polarization (H/V)	Result
3465.2	-50.59	-13	-37.59	-62.64	-56.85	2.58	8.84	V	Pass
5197.8	-44.73	-13	-31.73	-62.69	-51.67	3.78	10.72	V	Pass
6930.4	-45.57	-13	-32.57	-67.24	-53.32	4.3	12.05	V	Pass



Band :	WCDMA Band II	Temperature :	23~25°C
Test Mode :	RMC 12.2Kbps Link	Relative Humidity :	51~53%
Test Engineer :	David Yang	Polarization :	Horizontal
Remark :	Spurious emissions within 30-1000MHz were found more than 20dB below limit line.		

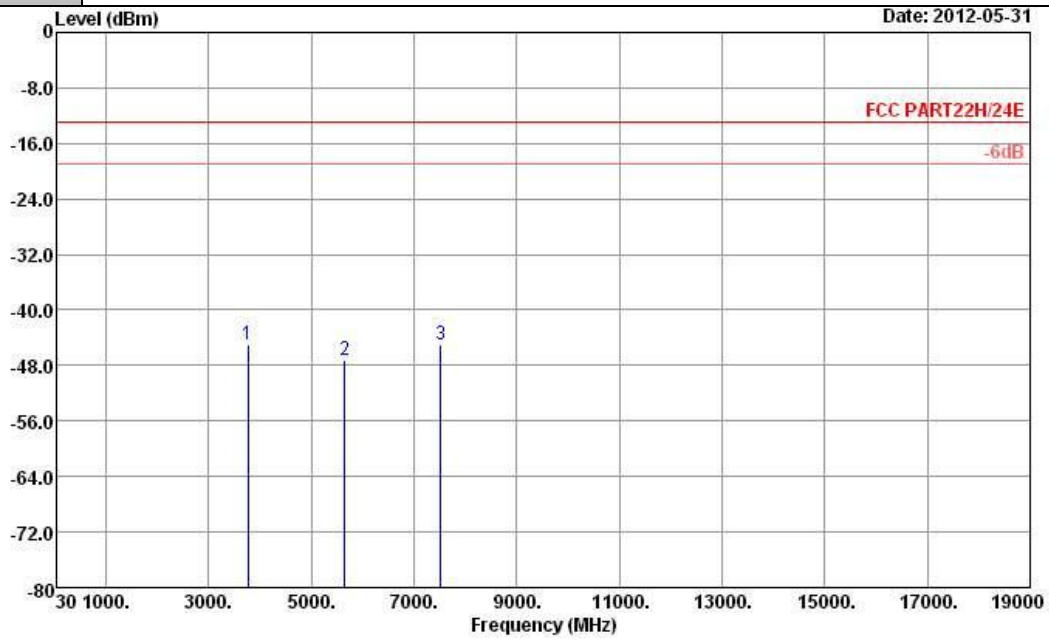

Site : 03CH05-HY
 Condition : FCC PART22H/24E HF_EIRP_101221 HORIZONTAL
 Project : FG 252422

Frequency (MHz)	EIRP (dBm)	Limit (dBm)	Over Limit (dB)	SPA Reading (dBm)	S.G. Power (dBm)	TX Cable loss (dB)	TX Antenna Gain (dBi)	Polarization (H/V)	Result
3760	-44.97	-13	-31.97	-58.51	-51.1	2.9292	9.06	H	Pass
5640	-47.31	-13	-34.31	-66.54	-54.23	3.9072	10.83	H	Pass
7520	-45.08	-13	-32.08	-67.24	-53.1	4.5988	12.62	H	Pass



Band :	WCDMA Band II	Temperature :	23~25°C
Test Mode :	RMC 12.2Kbps Link	Relative Humidity :	51~53%
Test Engineer :	David Yang	Polarization :	Vertical
Remark :	Spurious emissions within 30-1000MHz were found more than 20dB below limit line.		

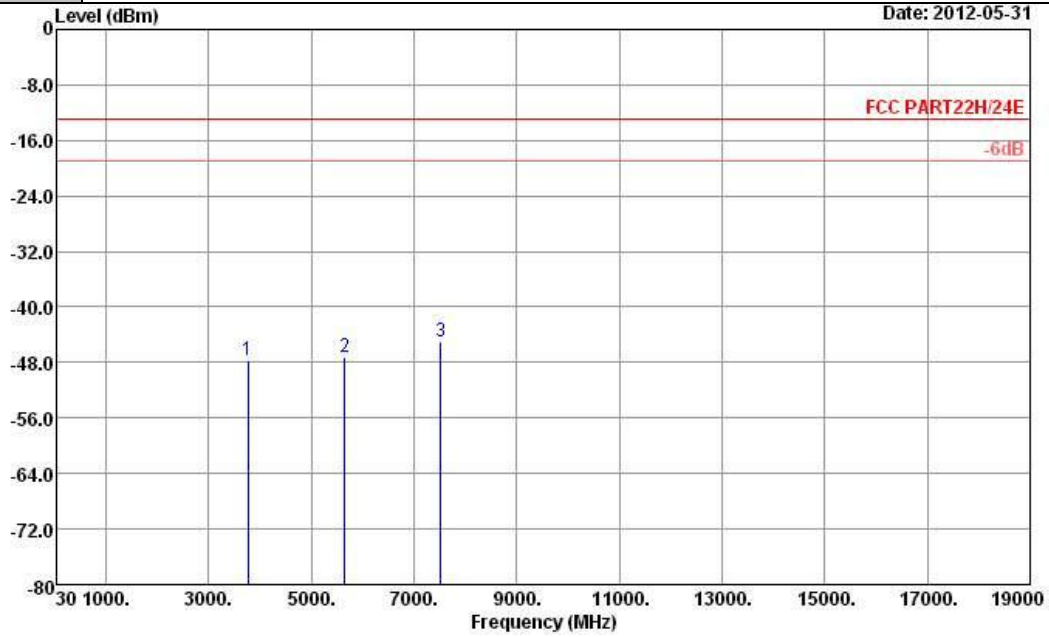

Site : 03CH05-HY
 Condition : FCC PART22H/24E HF_EIRP_101221 VERTICAL
 Project : FG 252422

Frequency (MHz)	EIRP (dBm)	Limit (dBm)	Over Limit (dB)	SPA Reading (dBm)	S.G. Power (dBm)	TX Cable loss (dB)	TX Antenna Gain (dBi)	Polarization (H/V)	Result
3760	-47.77	-13	-34.77	-61.46	-53.9	2.9292	9.06	V	Pass
5640	-47.18	-13	-34.18	-66.55	-54.1	3.9072	10.83	V	Pass
7520	-45.08	-13	-32.08	-67.73	-53.1	4.5988	12.62	V	Pass



Band :	CDMA2000 BC0	Temperature :	23~25°C
Test Mode :	1xRTT_RC3+SO55	Relative Humidity :	51~53%
Test Engineer :	David Yang	Polarization :	Horizontal
Remark :	Spurious emissions within 30-1000MHz were found more than 20dB below limit line.		

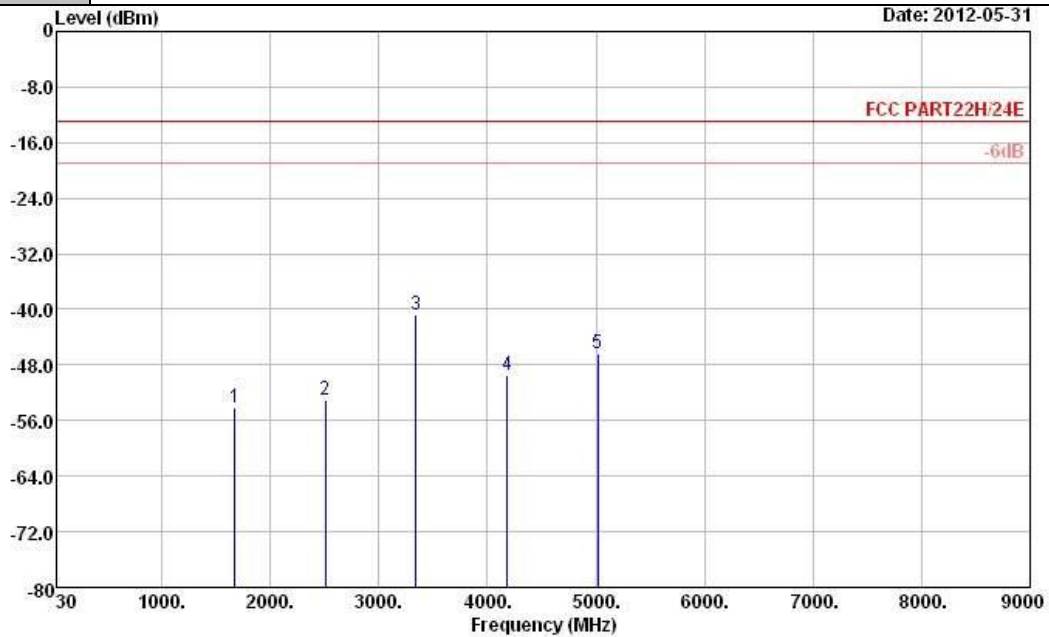

Site : 03CH05-HY
 Condition : FCC PART22H/24E HF_EIRP_101221 HORIZONTAL
 Project : FG 252422

Frequency (MHz)	ERP (dBm)	Limit (dBm)	Over Limit (dB)	SPA Reading (dBm)	S.G. Power (dBm)	TX Cable loss (dB)	TX Antenna Gain (dBi)	Polarization (H/V)	Result
1672	-54.26	-13	-41.26	-60.18	-55.45	2.15	5.49	H	Pass
2509	-53.11	-13	-40.11	-62.53	-55	2.38	6.41	H	Pass
3345	-40.67	-13	-27.67	-52.25	-44	2.86	8.34	H	Pass
4182	-49.56	-13	-36.56	-64.82	-53.5	3.26	9.35	H	Pass
5018	-46.26	-13	-33.26	-63.63	-51	3.62	10.51	H	Pass



Band :	CDMA2000 BC0	Temperature :	23~25°C
Test Mode :	1xRTT_RC3+SO55	Relative Humidity :	51~53%
Test Engineer :	David Yang	Polarization :	Vertical
Remark :	Spurious emissions within 30-1000MHz were found more than 20dB below limit line.		

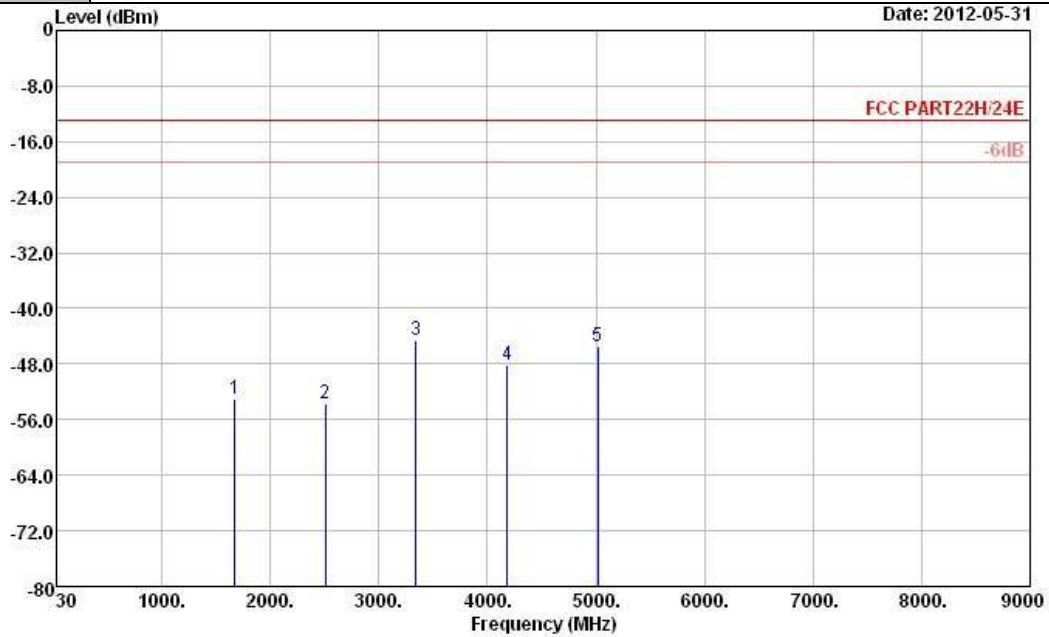

Site : 03CH05-HY
 Condition : FCC PART22H/24E HF_EIRP_101221 VERTICAL
 Project : FG 252422

Frequency (MHz)	ERP (dBm)	Limit (dBm)	Over Limit (dB)	SPA Reading (dBm)	S.G. Power (dBm)	TX Cable loss (dB)	TX Antenna Gain (dBi)	Polarization (H/V)	Result
1672	-53.11	-13	-40.11	-59.03	-54.3	2.15	5.49	V	Pass
2509	-53.71	-13	-40.71	-63.16	-55.6	2.38	6.41	V	Pass
3345	-44.67	-13	-31.67	-56.3	-48	2.86	8.34	V	Pass
4182	-48.21	-13	-35.21	-63.48	-52.15	3.26	9.35	V	Pass
5018	-45.38	-13	-32.38	-62.98	-50.12	3.62	10.51	V	Pass



Band :	CDMA2000 BC1	Temperature :	23~25°C
Test Mode :	1xRTT_RC3+SO55	Relative Humidity :	51~53%
Test Engineer :	David Yang	Polarization :	Horizontal
Remark :	Spurious emissions within 30-1000MHz were found more than 20dB below limit line.		

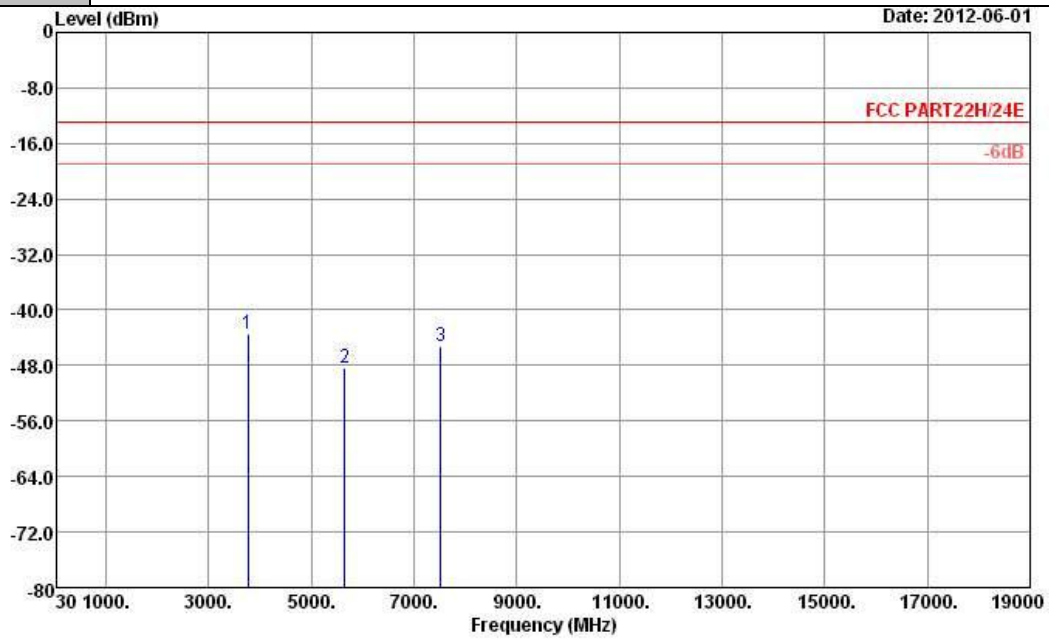

Site : 03CH05-HY
 Condition : FCC PART22H/24E HF_EIRP_101221 HORIZONTAL
 Project : FG 252422

Frequency (MHz)	EIRP (dBm)	Limit (dBm)	Over Limit (dB)	SPA Reading (dBm)	S.G. Power (dBm)	TX Cable loss (dB)	TX Antenna Gain (dBi)	Polarization (H/V)	Result
3760	-43.38	-13	-30.38	-57.02	-49.51	2.9292	9.06	H	Pass
5640	-48.40	-13	-35.40	-67.35	-55.32	3.9072	10.83	H	Pass
7520	-45.29	-13	-32.29	-67.26	-53.31	4.5988	12.62	H	Pass



Band :	CDMA2000 BC1	Temperature :	23~25°C
Test Mode :	1xRTT_RC3+SO55	Relative Humidity :	51~53%
Test Engineer :	David Yang	Polarization :	Vertical
Remark :	Spurious emissions within 30-1000MHz were found more than 20dB below limit line.		

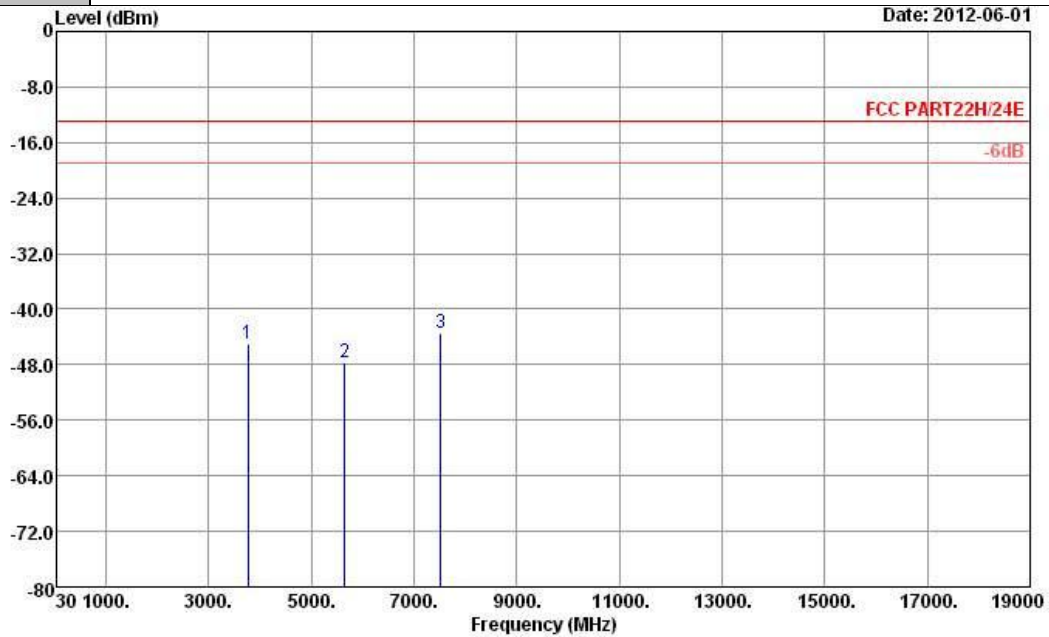

Site : 03CH05-HY
 Condition : FCC PART22H/24E HF_EIRP_101221 VERTICAL
 Project : FG 252422

Frequency (MHz)	EIRP (dBm)	Limit (dBm)	Over Limit (dB)	SPA Reading (dBm)	S.G. Power (dBm)	TX Cable loss (dB)	TX Antenna Gain (dBi)	Polarization (H/V)	Result
3760	-45.06	-13	-32.06	-58.59	-51.19	2.9292	9.06	V	Pass
5640	-47.69	-13	-34.69	-66.69	-54.61	3.9072	10.83	V	Pass
7520	-43.40	-13	-30.40	-65.61	-51.42	4.5988	12.62	V	Pass

3.7 Frequency Stability Measurement

3.7.1 Description of Frequency Stability Measurement

The frequency stability shall be measured by variation of ambient temperature and variation of primary supply voltage to ensure that the fundamental emission stays within the authorized frequency block. The frequency stability of the transmitter shall be maintained within $\pm 0.00025\%$ ($\pm 2.5\text{ppm}$) of the center frequency.

3.7.2 Measuring Instruments

See list of measuring instruments of this test report.

3.7.3 Test Procedures for Temperature Variation

1. The EUT was set up in the thermal chamber and connected with the base station.
2. With power OFF, the temperature was decreased to -30°C and the EUT was stabilized before testing. Power was applied and the maximum change in frequency was recorded within one minute.
3. With power OFF, the temperature was raised in 10°C step up to 50°C . The EUT was stabilized at each step for at least half an hour. Power was applied and the maximum frequency change was recorded within one minute.
4. If the EUT cannot be turned on at -30°C , the testing lowest temperature will be raised in 10°C step until the EUT can be turned on.

3.7.4 Test Procedures for Voltage Variation

1. The EUT was placed in a temperature chamber at $25\pm 5^{\circ}\text{C}$ and connected with the base station.
2. The power supply voltage to the EUT was varied from BEP to 115% of the nominal value measured at the input to the EUT.
3. The variation in frequency was measured for the worst case.

3.7.5 Test Setup

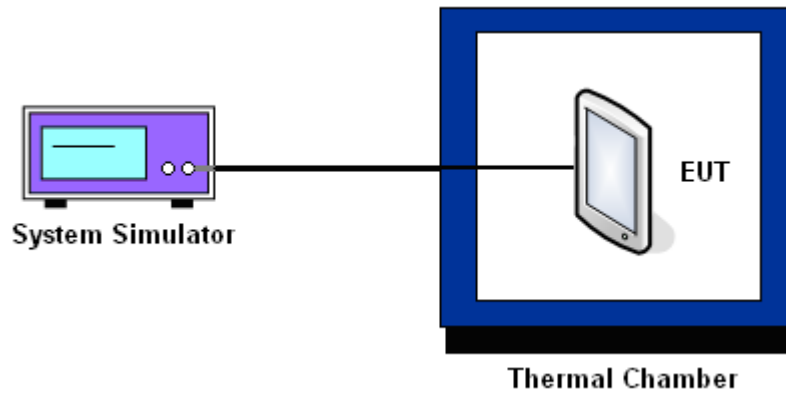



3.7.6 Test Result of Temperature Variation

Band :	GSM 850	Channel :	189
Limit (ppm) :	2.5		

Temperature (°C)	GPRS 8		EDGE 8		Result
	Freq. Dev. (Hz)	Deviation (ppm)	Freq. Dev. (Hz)	Deviation (ppm)	
-30	N/A	N/A	N/A	N/A	PASS
-20	N/A	N/A	N/A	N/A	
-10	N/A	N/A	N/A	N/A	
0	-35	-0.04	-19	-0.02	
10	32	0.04	21	0.02	
20	-41	-0.05	-47	-0.06	
30	-32	-0.04	-49	-0.06	
40	-44	-0.05	-51	-0.06	
50	-37	-0.04	-49	-0.06	

Note: The manufacturer declared that the EUT could work properly between temperatures 0°C~50°C.

Band :	GSM 1900	Channel :	661
Limit (ppm) :	2.5		

Temperature (°C)	GPRS 8		EDGE 8		Result
	Freq. Dev. (Hz)	Deviation (ppm)	Freq. Dev. (Hz)	Deviation (ppm)	
-30	N/A	N/A	N/A	N/A	PASS
-20	N/A	N/A	N/A	N/A	
-10	N/A	N/A	N/A	N/A	
0	48	0.03	-50	-0.03	
10	46	0.02	-53	-0.03	
20	38	0.02	-27	-0.01	
30	24	0.01	28	0.01	
40	-29	-0.02	-30	-0.02	
50	33	0.02	-27	-0.01	

Note: The manufacturer declared that the EUT could work properly between temperatures 0°C~50°C.



Band :	WCDMA Band V	Channel :	4182
Limit (ppm) :	2.5		

Temperature (°C)	RMC 12.2Kbps		Result
	Freq. Dev. (Hz)	Deviation (ppm)	
-30	N/A	N/A	PASS
-20	N/A	N/A	
-10	N/A	N/A	
0	22	0.03	
10	-20	-0.02	
20	-21	-0.02	
30	-19	-0.02	
40	-18	-0.02	
50	-17	-0.02	

Note: The manufacturer declared that the EUT could work properly between temperatures 0°C~50°C.

Band :	WCDMA Band IV	Channel :	1413
Limit (ppm) :	2.5		

Temperature (°C)	RMC 12.2Kbps		Result
	Freq. Dev. (Hz)	Deviation (ppm)	
-30	N/A	N/A	PASS
-20	N/A	N/A	
-10	N/A	N/A	
0	23	0.01	
10	-19	-0.01	
20	24	0.01	
30	28	0.02	
40	-23	-0.01	
50	26	0.02	

Note: The manufacturer declared that the EUT could work properly between temperatures 0°C~50°C.



Band :	WCDMA Band II	Channel :	9400
Limit (ppm) :	2.5		

Temperature (°C)	RMC 12.2Kbps		Result
	Freq. Dev. (Hz)	Deviation (ppm)	
-30	N/A	N/A	PASS
-20	N/A	N/A	
-10	N/A	N/A	
0	35	0.02	
10	38	0.02	
20	41	0.02	
30	33	0.02	
40	28	0.01	
50	28	0.01	

Note: The manufacturer declared that the EUT could work properly between temperatures 0°C~50°C.

Band :	CDMA2000 BC0	Channel :	384
Test Mode :	1xRTT_RC3+SO55	Limit (ppm) :	2.5

Temperature (°C)	Freq. Dev. (Hz)	Deviation (ppm)	Result
-30	N/A	N/A	PASS
-20	N/A	N/A	
-10	N/A	N/A	
0	-7	-0.01	
10	-9	-0.01	
20	9	0.01	
30	8	0.01	
40	-9	-0.01	
50	12	0.01	

Note: The manufacturer declared that the EUT could work properly between temperatures 0°C~50°C.



Band :	CDMA2000 BC1	Channel :	600
Test Mode :	1xRTT_RC3+SO55	Limit (ppm) :	2.5

Temperature (°C)	Freq. Dev. (Hz)	Deviation (ppm)	Result
-30	N/A	N/A	PASS
-20	N/A	N/A	
-10	N/A	N/A	
0	14	0.01	
10	-16	-0.01	
20	-15	-0.01	
30	13	0.01	
40	-11	-0.01	
50	-17	-0.01	

Note: The manufacturer declared that the EUT could work properly between temperatures 0°C~50°C.



3.7.7 Test Result of Voltage Variation

Band & Channel	Mode	Voltage (Volt)	Freq. Dev. (Hz)	Deviation (ppm)	Limit (ppm)	Result
GSM 850 CH189	GPRS 8	3.7	-27	-0.03	2.5	PASS
		BEP	-24	-0.03		
		4.2	-30	-0.04		
	EDGE 8	3.7	-46	-0.05		
		BEP	-51	-0.06		
		4.2	29	0.03		
GSM 1900 CH661	GPRS 8	3.7	29	0.02		
		BEP	40	0.02		
		4.2	40	0.02		
	EDGE 8	3.7	-26	-0.01		
		BEP	-38	-0.02		
		4.2	37	0.02		
WCDMA Band V CH4182	RMC 12.2Kbps	3.7	-16	-0.02		
		BEP	-18	-0.02		
		4.2	-15	-0.02		
WCDMA Band IV CH1413	RMC 12.2Kbps	3.7	23	0.01		
		BEP	18	0.01		
		4.2	-25	-0.01		
WCDMA Band II CH9400	RMC 12.2Kbps	3.7	-31	-0.02		
		BEP	28	0.01		
		4.2	-36	-0.02		
CDMA2000 BC0 CH384	1xRTT RC3+SO55	3.7	12	0.01		
		BEP	12	0.01		
		4.2	10	0.01		
CDMA2000 BC1 CH600	1xRTT RC3+SO55	3.7	-15	-0.01		
		BEP	-16	-0.01		
		4.2	-19	-0.01		

Note:

1. Normal Voltage = 3.7V.
2. Battery End Point (BEP) = 3.4 V.



4 List of Measuring Equipments

Instrument	Manufacturer	Model No.	Serial No.	Characteristics	Calibration Date	Test Date	Due Date	Remark
System Simulator	R&S	CMU200	117995	N/A	Jul. 28, 2011	May 25, 2012	Jul. 27, 2012	Conducted (TH02-HY)
Spectrum Analyzer	R&S	FSP40	100055	9kHz~40GHz	Jun. 13, 2011	May 25, 2012	Jun. 12, 2012	Conducted (TH02-HY)
Thermal Chamber	Ten Billion	TTH-D35P	TBN-930701	N/A	Jul. 27, 2011	May 25, 2012	Jul. 26, 2012	Conducted (TH02-HY)
Spectrum Analyzer	R&S	ESU26	100390	20Hz ~ 26.5GHz	Dec. 22, 2011	May 31, 2012 ~ Jun. 02, 2012	Dec. 21, 2012	Radiation (03CH05-HY)
Bilog Antenna	SCHAFFNER	CBL6111C	2725	30MHz ~ 2GHz	Oct. 22, 2011	May 31, 2012 ~ Jun. 02, 2012	Oct. 21, 2012	Radiation (03CH05-HY)
Turn Table	HD	Deis HD 2000	420/611	0 ~ 360 degree	N/A	May 31, 2012 ~ Jun. 02, 2012	N/A	Radiation (03CH05-HY)
Antenna Mast	HD	MA 240	240/666	1 m ~ 4 m	N/A	May 31, 2012 ~ Jun. 02, 2012	N/A	Radiation (03CH05-HY)
Horn Antenna	ESCO	3117	66584	1GHz ~ 18GHz	Aug. 04, 2011	May 31, 2012 ~ Jun. 02, 2012	Aug. 03, 2012	Radiation (03CH05-HY)
Pre Amplifier	COM-POWER	PA-103A	161075	10Hz ~ 1000MHz Gain:32dB	Feb. 27, 2012	May 31, 2012 ~ Jun. 02, 2012	Feb. 26, 2013	Radiation (03CH05-HY)
Pre Amplifier	MITEQ	AMF-7D-00 101800-30-1	159087	1GHz~18GHz	Feb. 27, 2012	May 31, 2012 ~ Jun. 02, 2012	Feb. 26, 2013	Radiation (03CH05-HY)
Pre Amplifier	Agilent	8449B	3008A01917	1GHz~26.5GHz	Aug. 30, 2011	May 31, 2012 ~ Jun. 02, 2012	Aug. 29, 2012	Radiation (03CH05-HY)
Loop Antenna	R&S	HFH2-Z2	860004/001	9 kHz~30 MHz	Jul. 29, 2010	May 31, 2012 ~ Jun. 02, 2012	Jul. 28, 2012	Radiation (03CH05-HY)
System Simulator	R&S	CMU200	117995	N/A	Jul. 28, 2011	May 31, 2012 ~ Jun. 02, 2012	Jul. 27, 2013	Radiation (03CH05-HY)

5 Uncertainty of Evaluation

Uncertainty of Radiated Emission Measurement (30 MHz ~ 1000 MHz)

Contribution	Uncertainty of X_i		$u(X_i)$
	dB	Probability Distribution	
Receiver Reading	0.41	Normal (k=2)	0.21
Antenna Factor Calibration	0.83	Normal (k=2)	0.42
Cable Loss Calibration	0.25	Normal (k=2)	0.13
Pre-Amplifier Gain Calibration	0.27	Normal (k=2)	0.14
RCV/SPA Specification	2.50	Rectangular	0.72
Antenna Factor Interpolation for Frequency	1.00	Rectangular	0.29
Site Imperfection	1.43	Rectangular	0.83
Mismatch	+0.39 / -0.41	U-Shape	0.28
Combined Standard Uncertainty $U_c(y)$	1.27		
Measuring Uncertainty for a Level of Confidence of 95% ($U = 2U_c(y)$)	2.54		

Uncertainty of Radiated Emission Measurement (1 GHz ~ 40 GHz)

Contribution	Uncertainty of X_i		$u(X_i)$	C_i	$C_i * u(X_i)$
	dB	Probability Distribution			
Receiver Reading	± 0.10	Normal (k=2)	0.10	1	0.10
Antenna Factor Calibration	± 1.70	Normal (k=2)	0.85	1	0.85
Cable Loss Calibration	± 0.50	Normal (k=2)	0.25	1	0.25
Receiver Correction	± 2.00	Rectangular	1.15	1	1.15
Antenna Factor Directional	± 1.50	Rectangular	0.87	1	0.87
Site Imperfection	± 2.80	Triangular	1.14	1	1.14
Mismatch Receiver VSWR $\Gamma_1 = 0.197$ Antenna VSWR $\Gamma_2 = 0.194$ Uncertainty = $20\text{Log}(1-\Gamma_1*\Gamma_2)$	+0.34 / -0.35	U-Shape	0.244	1	0.244
Combined Standard Uncertainty $U_c(y)$	2.36				
Measuring Uncertainty for a Level of Confidence of 95% ($U = 2U_c(y)$)	4.72				



Appendix A. Photographs of EUT

Please refer to Sporton report number EP252422 as below.