



FCC SAR Test Report

APPLICANT : Motorola Solutions, Inc.
EQUIPMENT : Enterprise Tablet
BRAND NAME : Motorola
MODEL NAME : ET1N2
FCC ID : UZ7ET1N2
STANDARD : FCC 47 CFR Part 2 (2.1093)
ANSI/IEEE C95.1-2005
IEEE 1528a-2005
FCC OET Bulletin 65 Supplement C (Edition 01-01)

The product was received on May 25, 2012 and completely tested on Jun. 05, 2012. We, SPORTON INTERNATIONAL INC., would like to declare that the tested sample has been evaluated in accordance with the procedures and shown the compliance with the applicable technical standards.

The test results in this report apply exclusively to the tested model / sample. Without written approval of SPORTON INTERNATIONAL INC., the test report shall not be reproduced except in full.

Reviewed by:

Jones Tsai / Manager



SPORTON INTERNATIONAL INC.

No. 52, Hwa Ya 1st Rd., Hwa Ya Technology Park, Kwei-Shan Hsiang, Tao Yuan Hsien, Taiwan, R.O.C.



Table of Contents

1. Statement of Compliance 4
2. Administration Data 5
2.1 Testing Laboratory..... 5
2.2 Applicant 5
2.3 Manufacturer..... 5
2.4 Application Details..... 5
3. General Information 6
3.1 Description of Equipment Under Test (EUT) 6
3.2 Product Photos..... 7
3.3 Applied Standards..... 7
3.4 Device Category and SAR Limits 8
3.5 Test Conditions..... 8
4. Specific Absorption Rate (SAR)..... 9
4.1 Introduction 9
4.2 SAR Definition..... 9
5. SAR Measurement System10
5.1 E-Field Probe 11
5.2 Data Acquisition Electronics (DAE) 12
5.3 Robot 12
5.4 Measurement Server..... 13
5.5 Phantom..... 13
5.6 Device Holder..... 14
5.7 Data Storage and Evaluation 16
5.8 Test Equipment List..... 18
6. Tissue Simulating Liquids19
7. SAR Measurement Evaluation 21
7.1 Purpose of System Performance check 21
7.2 System Setup..... 21
7.3 Validation Results..... 23
8. EUT Testing Position 24
9. Measurement Procedures 25
9.1 Spatial Peak SAR Evaluation 25
9.2 Area & Zoom Scan Procedures..... 26
9.3 Volume Scan Procedures..... 26
9.4 SAR Averaged Methods 26
9.5 Power Drift Monitoring..... 26
10. SAR Test Configurations..... 27
10.1 Exposure Positions Consideration 27
10.2 Conducted Power (Unit: dBm)..... 29
11. SAR Test Results 35
11.1 Test Records for Body SAR Test 35
11.2 Simultaneous Transmission SAR Analysis 41
11.3 Simultaneous analysis - SPLSR calculation 52
12. Uncertainty Assessment 68
13. References 71

- Appendix A. Plots of System Performance Check
Appendix B. Plots of SAR Measurement
Appendix C. DASYS Calibration Certificate
Appendix D. Product Photos
Appendix E. Test Setup Photos



Revision History

REPORT NO.	VERSION	DESCRIPTION	ISSUED DATE
FA252422	Rev. 01	Initial issue of report	Jun. 19, 2012



1. Statement of Compliance

The maximum results of Specific Absorption Rate (SAR) found during testing for **Motorola Solutions, Inc. Enterprise Tablet ET1N2** are as follows.

<EUT without Hand Strap>

Band	Position	SAR _{1g} (W/kg)
GSM850	Body (0 cm)	0.901
GSM1900	Body (0 cm)	0.944
WCDMA Band V	Body (0 cm)	0.956
WCDMA Band IV	Body (0 cm)	0.964
WCDMA Band II	Body (0 cm)	0.865
CDMA2000 BC0	Body (0 cm)	1.01
CDMA2000 BC1	Body (0 cm)	1.29
802.11 b/g/n	Body (0 cm)	1.4
802.11 a/n	Body (0 cm)	1.38

<EUT with Hand Strap>

Band	Position	SAR _{1g} (W/kg)
GSM850	Body (0 cm)	0.583
GSM1900	Body (0 cm)	0.715
WCDMA Band V	Body (0 cm)	0.595
WCDMA Band IV	Body (0 cm)	1.01
WCDMA Band II	Body (0 cm)	0.756
CDMA2000 BC0	Body (0 cm)	0.649
CDMA2000 BC1	Body (0 cm)	0.875
802.11 b/g/n	Body (0 cm)	0.279
802.11 a/n	Body (0 cm)	0.472

This device is in compliance with Specific Absorption Rate (SAR) for general population/uncontrolled exposure limits (1.6 W/kg) specified in FCC 47 CFR part 2 (2.1093) and ANSI/IEEE C95.1-2005, and had been tested in accordance with the measurement methods and procedures specified in IEEE 1528a-2005 and FCC OET Bulletin 65 Supplement C (Edition 01-01).



2. Administration Data

2.1 Testing Laboratory

Test Site	SPORTON INTERNATIONAL INC.
Test Site Location	No. 52, Hwa Ya 1 st Rd., Hwa Ya Technology Park, Kwei-Shan Hsiang, Tao Yuan Hsien, Taiwan, R.O.C. TEL: +886-3-327-3456 FAX: +886-3-328-4978

2.2 Applicant

Company Name	Motorola Solutions, Inc.
Address	One Motorola Plaza, Holtsville, NY 11742-1300 USA

2.3 Manufacturer

Company Name	Motorola Solutions, Inc.
Address	One Motorola Plaza, Holtsville, NY 11742-1300 USA

2.4 Application Details

Date of Receipt of Application	May 25, 2012
Date of Start during the Test	May 25, 2012
Date of End during the Test	Jun. 05, 2012



3. General Information

3.1 Description of Equipment Under Test (EUT)

Product Feature & Specification	
EUT	Enterprise Tablet
Brand Name	Motorola
Model Name	ET1N2
FCC ID	UZ7ET1N2
Tx Frequency	GSM850: 824.2 MHz ~ 848.8 MHz GSM1900: 1850.2 MHz ~ 1909.8MHz WCDMA Band V: 826.4 MHz ~ 846.6 MHz WCDMA Band II: 1852.4 MHz ~ 1907.6 MHz WCDMA Band IV: 1712.4 MHz ~ 1752.6 MHz CDMA2000 BC0: 824.70 MHz ~ 848.31 MHz CDMA2000 BC1: 1851.25 MHz ~ 1908.75 MHz 802.11b/g/n: 2412 MHz ~ 2462 MHz 802.11a/n: 5180 MHz ~ 5240 MHz; 5260 MHz ~ 5320 MHz; 5500 MHz ~ 5700 MHz; 5745 MHz ~ 5825 MHz Bluetooth: 2402 MHz ~ 2480 MHz
Rx Frequency	GSM850: 869.2 MHz ~ 893.8 MHz GSM1900: 1930.2 MHz ~ 1989.8 MHz WCDMA Band V: 871.4 MHz ~ 891.6 MHz WCDMA Band II: 1932.4 MHz ~ 1987.6 MHz WCDMA Band IV: 2112.4MHz ~ 2152.6 MHz CDMA2000 BC0: 869.70 MHz ~ 893.31 MHz CDMA2000 BC1: 1931.25 MHz ~ 1988.75 MHz 802.11b/g/n: 2412 MHz ~ 2462 MHz 802.11a/n: 5180 MHz ~ 5240 MHz; 5260 MHz ~ 5320 MHz; 5500 MHz ~ 5700 MHz; 5745 MHz ~ 5825 MHz Bluetooth: 2402 MHz ~ 2480 MHz
Maximum Average Output Power to Antenna	GSM850: 33.02 dBm GSM1900: 30.61 dBm WCDMA Band V: 24.03 dBm WCDMA Band II: 23.01 dBm WCDMA Band IV: 22.92 dBm CDMA2000 BC0: 24.13 dBm CDMA2000 BC1: 24.18 dBm 802.11b: 21.21 dBm 802.11g: 20.68 dBm 802.11n (2.4GHz): 20.61 dBm (BW 20MHz) 802.11a: 22.51 dBm 802.11n (5GHz): 22.42 dBm (BW 20MHz) Bluetooth: 1.82 dBm
Antenna Type	WWAN: Fixed Internal Antenna WLAN: PIFA Antenna Bluetooth : PIFA Antenna
HW Version	DV1
SW Version	91-271301-1664-0100-00-D1-051812
FW Version	D3200-STUGN-1580 1

Product Feature & Specification	
Type of Modulation	GSM: GMSK GPRS: GMSK EDGE: GMSK / 8PSK WCDMA: QPSK (uplink) HSDPA: QPSK (uplink) HSUPA: QPSK (uplink) CDMA2000: QPSK CDMA2000 1xEVDO : 8PSK 802.11b: DSSS (BPSK / QPSK / CCK) 802.11a/g/n: OFDM (BPSK / QPSK / 16QAM / 64QAM) Bluetooth (1Mbps): GFSK Bluetooth EDR (2Mbps): $\pi/4$ -DQPSK Bluetooth EDR (3Mbps): 8-DPSK
EUT Stage	Identical Prototype
Remark:	
1. The above EUT's information was declared by manufacturer. Please refer to the specifications or user's manual for more detailed description. 2. Voice call is not supported. DTM not supported.	

3.2 Product Photos

Please refer to Appendix D

3.3 Applied Standards

The Specific Absorption Rate (SAR) testing specification, method and procedure for this device is in accordance with the following standards:

- FCC 47 CFR Part 2 (2.1093)
- ANSI/IEEE C95.1-2005
- IEEE 1528a-2005
- FCC OET Bulletin 65 Supplement C (Edition 01-01)
- FCC KDB 447498 D01 v04
- FCC KDB 616217 D03 v01
- FCC KDB 941225 D01 v02
- FCC KDB 941225 D03 v01
- FCC KDB 248227 D01 v01r02



3.4 Device Category and SAR Limits

This device belongs to portable device category because its radiating structure is allowed to be used within 20 centimeters of the body of the user. Limit for General Population/Uncontrolled exposure should be applied for this device, it is 1.6 W/kg as averaged over any 1 gram of tissue.

3.5 Test Conditions

3.5.1 Ambient Condition

Ambient Temperature	20 to 24 °C
Humidity	< 60 %

3.5.2 Test Configuration

The device was controlled by using a base station emulator. Communication between the device and the emulator was established by air link. The distance between the EUT and the antenna of the emulator is larger than 50 cm and the output power radiated from the emulator antenna is at least 30 dB smaller than the output power of EUT. The EUT was set from the emulator to radiate maximum output power during all tests.

For WLAN SAR testing, WLAN engineering testing software installed on the EUT can provide continuous transmitting RF signal.

4. Specific Absorption Rate (SAR)

4.1 Introduction

SAR is related to the rate at which energy is absorbed per unit mass in an object exposed to a radio field. The SAR distribution in a biological body is complicated and is usually carried out by experimental techniques or numerical modeling. The standard recommends limits for two tiers of groups, occupational/controlled and general population/uncontrolled, based on a person's awareness and ability to exercise control over his or her exposure. In general, occupational/controlled exposure limits are higher than the limits for general population/uncontrolled.

4.2 SAR Definition

The SAR definition is the time derivative (rate) of the incremental energy (dW) absorbed by (dissipated in) an incremental mass (dm) contained in a volume element (dv) of a given density (ρ). The equation description is as below:

$$\text{SAR} = \frac{d}{dt} \left(\frac{dW}{dm} \right) = \frac{d}{dt} \left(\frac{dW}{\rho dv} \right)$$

SAR is expressed in units of Watts per kilogram (W/kg)

SAR measurement can be either related to the temperature elevation in tissue by

$$\text{SAR} = C \left(\frac{\delta T}{\delta t} \right)$$

Where: C is the specific heat capacity, δT is the temperature rise and δt is the exposure duration, or related to the electrical field in the tissue by

$$\text{SAR} = \frac{\sigma |E|^2}{\rho}$$

Where: σ is the conductivity of the tissue, ρ is the mass density of the tissue and E is the RMS electrical field strength.

However for evaluating SAR of low power transmitter, electrical field measurement is typically applied.

5. SAR Measurement System

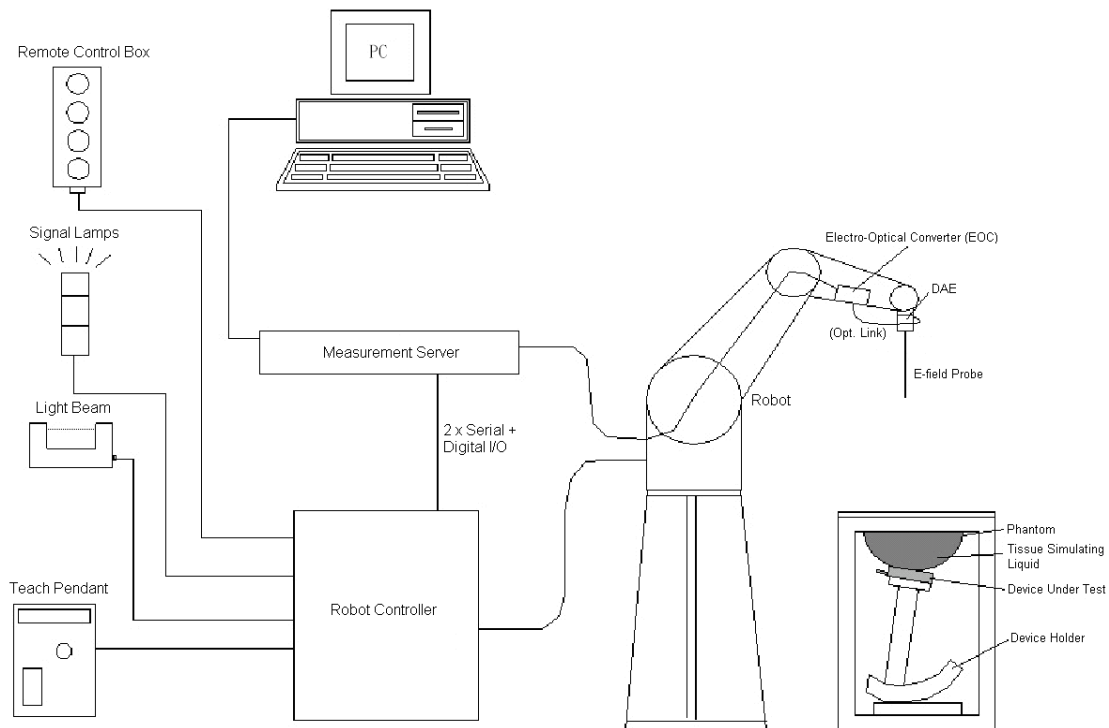

Fig 5.1 SPEAG DASY System Configurations

The DASY system for performance compliance tests is illustrated above graphically. This system consists of the following items:

- A standard high precision 6-axis robot with controller, a teach pendant and software
- A data acquisition electronic (DAE) attached to the robot arm extension
- A dosimetric probe equipped with an optical surface detector system
- The electro-optical converter (ECO) performs the conversion between optical and electrical signals
- A measurement server performs the time critical tasks such as signal filtering, control of the robot operation and fast movement interrupts.
- A probe alignment unit which improves the accuracy of the probe positioning
- A computer operating Windows XP
- DASY software
- Remote control with teach pendant and additional circuitry for robot safety such as warning lamps, etc.
- The SAM twin phantom
- A device holder
- Tissue simulating liquid
- Dipole for evaluating the proper functioning of the system

Some of the components are described in details in the following sub-sections.

5.1 E-Field Probe

The SAR measurement is conducted with the dosimetric probe (manufactured by SPEAG). The probe is specially designed and calibrated for use in liquid with high permittivity. The dosimetric probe has special calibration in liquid at different frequency. This probe has a built in optical surface detection system to prevent from collision with phantom.

5.1.1 E-Field Probe Specification

<ET3DV6 / ET3DV6R Probe >

Construction	Symmetrical design with triangular core Built-in optical fiber for surface detection system. Built-in shielding against static charges. PEEK enclosure material (resistant to organic solvents, e.g., DGBE)
Frequency	10 MHz to 3 GHz; Linearity: ± 0.2 dB
Directivity	± 0.2 dB in HSL (rotation around probe axis) ± 0.4 dB in HSL (rotation normal to probe axis)
Dynamic Range	5 μ W/g to 100 mW/g; Linearity: ± 0.2 dB
Dimensions	Overall length: 330 mm (Tip: 16 mm) Tip diameter: 6.8 mm (Body: 12 mm) Distance from probe tip to dipole centers: 2.7 mm



Fig 5.2 Photo of ET3DV6/ET3DV6R

<EX3DV4 / ES3DV4 Probe>

Construction	Symmetrical design with triangular core Built-in shielding against static charges PEEK enclosure material (resistant to organic solvents, e.g., DGBE)
Frequency	10 MHz to 6 GHz; Linearity: ± 0.2 dB
Directivity	± 0.3 dB in HSL (rotation around probe axis) ± 0.5 dB in tissue material (rotation normal to probe axis)
Dynamic Range	10 μ W/g to 100 mW/g; Linearity: ± 0.2 dB (noise: typically < 1 μ W/g)
Dimensions	Overall length: 330 mm (Tip: 20 mm) Tip diameter: 2.5 mm (Body: 12 mm) Typical distance from probe tip to dipole centers: 1 mm



Fig 5.3 Photo of EX3DV4/ES3DV4

5.1.2 E-Field Probe Calibration

Each probe needs to be calibrated according to a dosimetric assessment procedure with accuracy better than $\pm 10\%$. The spherical isotropy shall be evaluated and within ± 0.25 dB. The sensitivity parameters (NormX, NormY, and NormZ), the diode compression parameter (DCP) and the conversion factor (ConvF) of the probe are tested. The calibration data can be referred to appendix C of this report.

5.2 Data Acquisition Electronics (DAE)

The data acquisition electronics (DAE) consists of a highly sensitive electrometer-grade preamplifier with auto-zeroing, a channel and gain-switching multiplexer, a fast 16 bit AD-converter and a command decoder and control logic unit. Transmission to the measurement server is accomplished through an optical downlink for data and status information as well as an optical uplink for commands and the clock.

The input impedance of the DAE is 200 MOhm; the inputs are symmetrical and floating. Common mode rejection is above 80 dB.



Fig 5.4 Photo of DAE

5.3 Robot

The SPEAG DASY system uses the high precision robots (DASY4: RX90BL; DASY5: TX90XL) type from Stäubli SA (France). For the 6-axis controller system, the robot controller version (DASY4: CS7MB; DASY5: CS8c) from Stäubli is used. The Stäubli robot series have many features that are important for our application:

- High precision (repeatability ± 0.035 mm)
- High reliability (industrial design)
- Jerk-free straight movements
- Low ELF interference (the closed metallic construction shields against motor control fields)



Fig 5.1 Photo of DASY4



Fig 5.2 Photo of DASY5

5.4 Measurement Server

The measurement server is based on a PC/104 CPU board with CPU (DASY4: 166 MHz, Intel Pentium; DASY5: 400 MHz, Intel Celeron), chipdisk (DASY4: 32 MB; DASY5: 128 MB), RAM (DASY4: 64 MB, DASY5: 128 MB). The necessary circuits for communication with the DAE electronic box, as well as the 16 bit AD converter system for optical detection and digital I/O interface are contained on the DASY I/O board, which is directly connected to the PC/104 bus of the CPU board.

The measurement server performs all the real-time data evaluation for field measurements and surface detection, controls robot movements and handles safety operations.



Fig 5.1 Photo of Server for DASY4



Fig 5.2 Photo of Server for DASY5

5.5 Phantom

<SAM Twin Phantom>

Shell Thickness	2 ± 0.2 mm; Center ear point: 6 ± 0.2 mm
Filling Volume	Approx. 25 liters
Dimensions	Length: 1000 mm; Width: 500 mm; Height: adjustable feet
Measurement Areas	Left Hand, Right Hand, Flat Phantom



Fig 5.3 Photo of SAM Phantom

The bottom plate contains three pair of bolts for locking the device holder. The device holder positions are adjusted to the standard measurement positions in the three sections. A white cover is provided to tap the phantom during off-periods to prevent water evaporation and changes in the liquid parameters. On the phantom top, three reference markers are provided to identify the phantom position with respect to the robot.

<ELI4 Phantom>

Shell Thickness	2 ± 0.2 mm (sagging: <1%)
Filling Volume	Approx. 30 liters
Dimensions	Major ellipse axis: 600 mm Minor axis: 400 mm



Fig 5.4 Photo of ELI4 Phantom

The ELI4 phantom is intended for compliance testing of handheld and body-mounted wireless devices in the frequency range of 30 MHz to 6 GHz. ELI4 is fully compatible with standard and all known tissue simulating liquids.

5.6 Device Holder

<Device Holder for SAM Twin Phantom>

The SAR in the phantom is approximately inversely proportional to the square of the distance between the source and the liquid surface. For a source at 5 mm distance, a positioning uncertainty of ± 0.5 mm would produce a SAR uncertainty of ± 20 %. Accurate device positioning is therefore crucial for accurate and repeatable measurements. The positions in which the devices must be measured are defined by the standards.

The DASY device holder is designed to cope with different positions given in the standard. It has two scales for the device rotation (with respect to the body axis) and the device inclination (with respect to the line between the ear reference points). The rotation center for both scales is the ear reference point (EPR). Thus the device needs no repositioning when changing the angles.

The DASY device holder is constructed of low-loss POM material having the following dielectric parameters: relative permittivity $\epsilon = 3$ and loss tangent $\delta = 0.02$. The amount of dielectric material has been reduced in the closest vicinity of the device, since measurements have suggested that the influence of the clamp on the test results could thus be lowered.



Fig 5.5 Device Holder

<Laptop Extension Kit>

The extension is lightweight and made of POM, acrylic glass and foam. It fits easily on the upper part of the mounting device in place of the phone positioned. The extension is fully compatible with the SAM Twin and ELI phantoms.

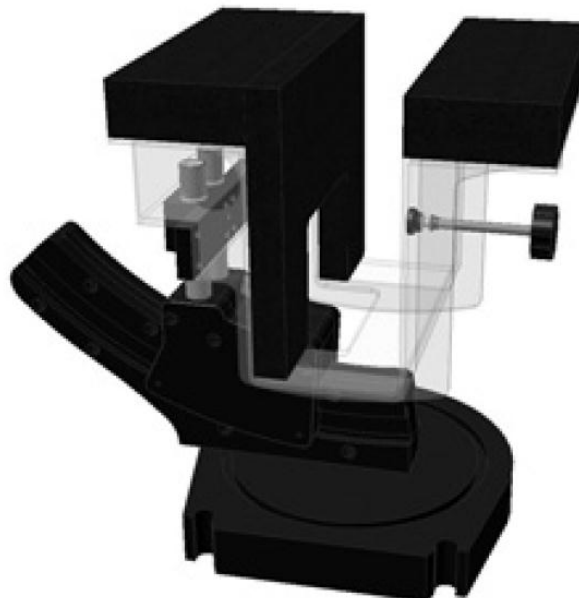

Fig 5.6 Laptop Extension Kit



5.7 Data Storage and Evaluation

5.7.1 Data Storage

The DASY software stores the assessed data from the data acquisition electronics as raw data (in microvolt readings from the probe sensors), together with all the necessary software parameters for the data evaluation (probe calibration data, liquid parameters and device frequency and modulation data) in measurement files. The post-processing software evaluates the desired unit and format for output each time the data is visualized or exported. This allows verification of the complete software setup even after the measurement and allows correction of erroneous parameter settings. For example, if a measurement has been performed with an incorrect crest factor parameter in the device setup, the parameter can be corrected afterwards and the data can be reevaluated.

The measured data can be visualized or exported in different units or formats, depending on the selected probe type (e.g., [V/m], [A/m], [mW/g]). Some of these units are not available in certain situations or give meaningless results, e.g., a SAR-output in a non-lose media, will always be zero. Raw data can also be exported to perform the evaluation with other software packages.

5.7.2 Data Evaluation

The DASY post-processing software (SEMCAD) automatically executes the following procedures to calculate the field units from the microvolt readings at the probe connector. The parameters used in the evaluation are stored in the configuration modules of the software :

Probe parameters :	- Sensitivity	Norm _i , a ₁₀ , a ₁₁ , a ₁₂
	- Conversion factor	ConvF _i
	- Diode compression point	dcp _i
Device parameters :	- Frequency	f
	- Crest factor	cf
Media parameters :	- Conductivity	σ
	- Density	ρ

These parameters must be set correctly in the software. They can be found in the component documents or they can be imported into the software from the configuration files issued for the DASY components. In the direct measuring mode of the multi-meter option, the parameters of the actual system setup are used. In the scan visualization and export modes, the parameters stored in the corresponding document files are used.

The first step of the evaluation is a linearization of the filtered input signal to account for the compression characteristics of the detector diode. The compensation depends on the input signal, the diode type and the DC-transmission factor from the diode to the evaluation electronics. If the exciting field is pulsed, the crest factor of the signal must be known to correctly compensate for peak power.

The formula for each channel can be given as :

$$V_i = U_i + U_i^2 \cdot \frac{cf}{dcp_i}$$

with V_i = compensated signal of channel i, (i = x, y, z)
 U_i = input signal of channel i, (i = x, y, z)
 cf = crest factor of exciting field (DASY parameter)
 dcp_i = diode compression point (DASY parameter)

From the compensated input signals, the primary field data for each channel can be evaluated :

$$\text{E-field Probes : } E_i = \sqrt{\frac{V_i}{\text{Norm}_i \cdot \text{ConvF}}}$$

$$\text{H-field Probes : } H_i = \sqrt{V_i} \cdot \frac{a_{i0} + a_{i1}f + a_{i2}f^2}{f}$$

with V_i = compensated signal of channel i, (i = x, y, z)
 Norm_i = sensor sensitivity of channel i, (i = x, y, z), $\mu\text{V}/(\text{V/m})^2$ for E-field Probes
 ConvF = sensitivity enhancement in solution
 a_{ij} = sensor sensitivity factors for H-field probes
 f = carrier frequency [GHz]
 E_i = electric field strength of channel i in V/m
 H_i = magnetic field strength of channel i in A/m

The RSS value of the field components gives the total field strength (Hermitian magnitude) :

$$E_{\text{tot}} = \sqrt{E_x^2 + E_y^2 + E_z^2}$$

The primary field data are used to calculate the derived field units.

$$\text{SAR} = E_{\text{tot}}^2 \cdot \frac{\sigma}{\rho \cdot 1000}$$

with SAR = local specific absorption rate in mW/g
 E_{tot} = total field strength in V/m
 σ = conductivity in [mho/m] or [Siemens/m]
 ρ = equivalent tissue density in g/cm^3

Note that the density is set to 1, to account for actual head tissue density rather than the density of the tissue simulating liquid.



5.8 Test Equipment List

Manufacturer	Name of Equipment	Type/Model	Serial Number	Calibration	
				Last Cal.	Due Date
SPEAG	Dosimetric E-Field Probe	ET3DV6R	1788	Jan. 26, 2012	Jan. 25, 2013
SPEAG	Dosimetric E-Field Probe	EX3DV4	3792	Jun. 20, 2011	Jun. 19, 2012
SPEAG	Dosimetric E-Field Probe	EX3DV4	3819	Nov. 16, 2011	Nov. 15, 2012
SPEAG	835MHz System Validation Kit	D835V2	499	Mar. 22, 2010	Mar. 21, 2013
SPEAG	1750MHz System Validation Kit	D1750V2	1023	Jun. 16, 2011	Jun. 15, 2012
SPEAG	1900MHz System Validation Kit	D1900V2	5d041	Mar. 23, 2010	Mar. 22, 2013
SPEAG	2450MHz System Validation Kit	D2450V2	736	Jul. 25, 2011	Jul. 24, 2012
SPEAG	5GHz System Validation Kit	D5GHzV2	1006	Jan. 18, 2012	Jan. 17, 2013
SPEAG	Data Acquisition Electronics	DAE4	778	Nov. 22, 2011	Nov. 21, 2012
SPEAG	Data Acquisition Electronics	DAE3	495	Apr. 23, 2012	Apr. 22, 2013
SPEAG	Data Acquisition Electronics	DAE4	1279	May. 03, 2012	May. 02, 2013
SPEAG	Device Holder	N/A	N/A	NCR	NCR
SPEAG	SAM Phantom	QD 000 P40 C	TP-1303	NCR	NCR
SPEAG	SAM Phantom	QD 000 P40 C	TP-1383	NCR	NCR
SPEAG	SAM Phantom	QD 000 P40 C	TP-1446	NCR	NCR
SPEAG	SAM Phantom	QD 000 P40 C	TP-1478	NCR	NCR
SPEAG	SAM Phantom	QD 000 P41 C	TP-1150	NCR	NCR
SPEAG	SAM Phantom	QD 000 P40 CD	TP-1644	NCR	NCR
SPEAG	SAM Phantom	SM 000 T01 DA	TP-1542	NCR	NCR
SPEAG	ELI4 Phantom	QD 0VA 001 BB	1026	NCR	NCR
SPEAG	ELI4 Phantom	QD 0VA 001 BA	1029	NCR	NCR
SPEAG	ELI4 Phantom	QD 0VA 002 AA	TP-1127	NCR	NCR
SPEAG	ELI4 Phantom	QD 0VA 002 AA	TP-1131	NCR	NCR
Agilent	ENA Series Network Analyzer	E5071C	MY46100746	Jun. 10, 2011	Jun. 09, 2012
Agilent	ESG Vector Series Signal Generator	E4438C	MY49070755	Oct. 17, 2011	Oct. 16, 2012
Anritsu	Power Meter	ML2495A	0932001	Sep. 21, 2011	Sep. 20, 2012
Anritsu	Radio Communication Analyzer	MT8820C	6201074414	Dec. 21, 2011	Dec. 20, 2012
Agilent	Wireless Communication Test Set	E5515C	MY48360820	Jan. 05, 2012	Jan. 04, 2014
Agilent	Wireless Communication Test Set	E5515C	GB46311322	Mar. 23, 2011	Mar. 22, 2013
Agilent	Wireless Communication Test Set	E5515C	MY50264370	Apr. 19, 2011	Apr. 18, 2013
Agilent	Wireless Communication Test Set	E5515C	MY50266977	Nov. 13, 2011	Nov. 12, 2013
R&S	Universal Digital Radio communication Tester	CMU200	117995	Jul. 28, 2011	Jul. 27, 2012
R&S	Spectrum Analyzer	FSP7	101131	Jul. 29, 2011	Jul. 28, 2012

Table 5.1 Test Equipment List

Note:

1. The calibration certificate of DASY can be referred to appendix C of this report.
2. Referring to KDB450824 D02, the dipole calibration interval can be extended to 3 years with justification. The dipoles are also not physically damaged, or repaired during the interval.
3. The justification data of dipole D835V2, SN: 499, D1900V2, SN: 5d041 can be found in appendix C. The return loss is < -20dB, within 20% of prior calibration, the impedance is within 5 ohm of prior calibration.

6. Tissue Simulating Liquids

For the measurement of the field distribution inside the SAM phantom with DASY, the phantom must be filled with around 25 liters of homogeneous body tissue simulating liquid. For head SAR testing, the liquid height from the ear reference point (ERP) of the phantom to the liquid top surface is larger than 15 cm, which is shown in Fig. 6.1. For body SAR testing, the liquid height from the center of the flat phantom to the liquid top surface is larger than 15 cm, which is shown in Fig. 6.2.

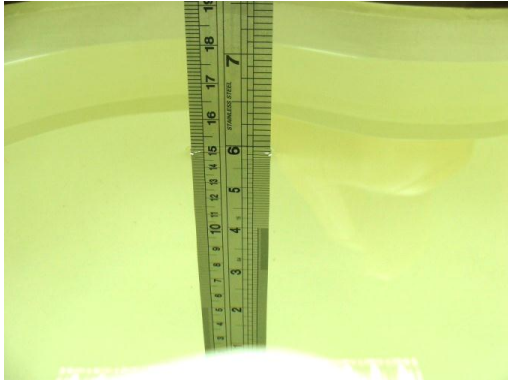

Fig 6.1 Photo of Liquid Height for Head SAR

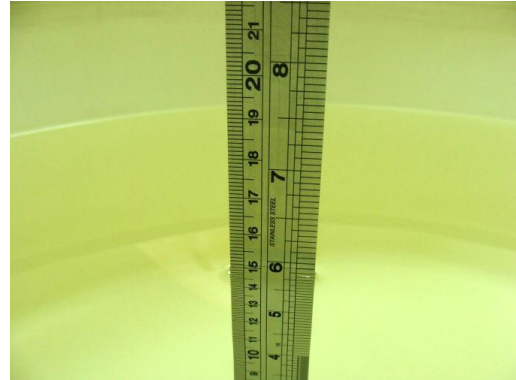

Fig 6.2 Photo of Liquid Height for Body SAR

The following table gives the recipes for tissue simulating liquid.

Frequency (MHz)	Water (%)	Sugar (%)	Cellulose (%)	Salt (%)	Preventol (%)	DGBE (%)	Conductivity (σ)	Permittivity (ϵ_r)
For Head								
750	41.1	57.0	0.2	1.4	0.2	0	0.89	41.9
835	40.3	57.9	0.2	1.4	0.2	0	0.90	41.5
900	40.3	57.9	0.2	1.4	0.2	0	0.97	41.5
1800, 1900, 2000	55.2	0	0	0.3	0	44.5	1.40	40.0
2450	55.0	0	0	0	0	45.0	1.80	39.2
For Body								
750	51.7	47.2	0	0.9	0.1	0	0.96	55.5
835	50.8	48.2	0	0.9	0.1	0	0.97	55.2
900	50.8	48.2	0	0.9	0.1	0	1.05	55.0
1800, 1900, 2000	70.2	0	0	0.4	0	29.4	1.52	53.3
2450	68.6	0	0	0	0	31.4	1.95	52.7

Table 6.1 Recipes of Tissue Simulating Liquid

Simulating Liquid for 5G, Manufactured by SPEAG

Ingredients	(% by weight)
Water	64~78%
Mineral oil	11~18%
Emulsifiers	9~15%
Additives and Salt	2~3%



The dielectric parameters of the liquids were verified prior to the SAR evaluation using an Agilent 85070D Dielectric Probe Kit and an Agilent Network Analyzer.

The following table shows the measuring results for simulating liquid.

Freq. (MHz)	Liquid Type	Temp. (°C)	Conductivity (σ)	Permittivity (ϵ_r)	Conductivity Target (σ)	Permittivity Target (ϵ_r)	Delta (σ) (%)	Delta (ϵ_r) (%)	Limit (%)	Date
835	Body	21.5	0.963	54.5	0.97	55.2	-0.72	-1.27	±5	May 25, 2012
1750	Body	21.6	1.55	51.7	1.52	53.3	1.97	-3.00	±5	May 26, 2012
1900	Body	21.5	1.52	54.6	1.52	53.3	0.00	2.44	±5	May 25, 2012
2450	Body	21.6	1.97	52.7	1.95	52.7	1.03	0.00	±5	Jun. 03, 2012
5200	Body	21.5	5.162	48.492	5.30	49.0	-2.60	-1.04	±5	Jun. 05, 2012
5500	Body	21.4	5.71	47	5.65	48.6	1.06	-3.29	±5	Jun. 02, 2012
5800	Body	21.5	5.976	47.158	6	48.2	-0.40	-2.16	±5	Jun. 05, 2012

Table 6.2 Measuring Results for Simulating Liquid

7. SAR Measurement Evaluation

Each DASY system is equipped with one or more system validation kits. These units, together with the predefined measurement procedures within the DASY software, enable the user to conduct the system performance check and system validation. System validation kit includes a dipole, tripod holder to fix it underneath the flat phantom and a corresponding distance holder.

7.1 Purpose of System Performance check

The system performance check verifies that the system operates within its specifications. System and operator errors can be detected and corrected. It is recommended that the system performance check be performed prior to any usage of the system in order to guarantee reproducible results. The system performance check uses normal SAR measurements in a simplified setup with a well characterized source. This setup was selected to give a high sensitivity to all parameters that might fail or vary over time. The system check does not intend to replace the calibration of the components, but indicates situations where the system uncertainty is exceeded due to drift or failure.

7.2 System Setup

In the simplified setup for system evaluation, the EUT is replaced by a calibrated dipole and the power source is replaced by a continuous wave that comes from a signal generator. The calibrated dipole must be placed beneath the flat phantom section of the SAM twin phantom with the correct distance holder. The distance holder should touch the phantom surface with a light pressure at the reference marking and be oriented parallel to the long side of the phantom. The equipment setup is shown below:

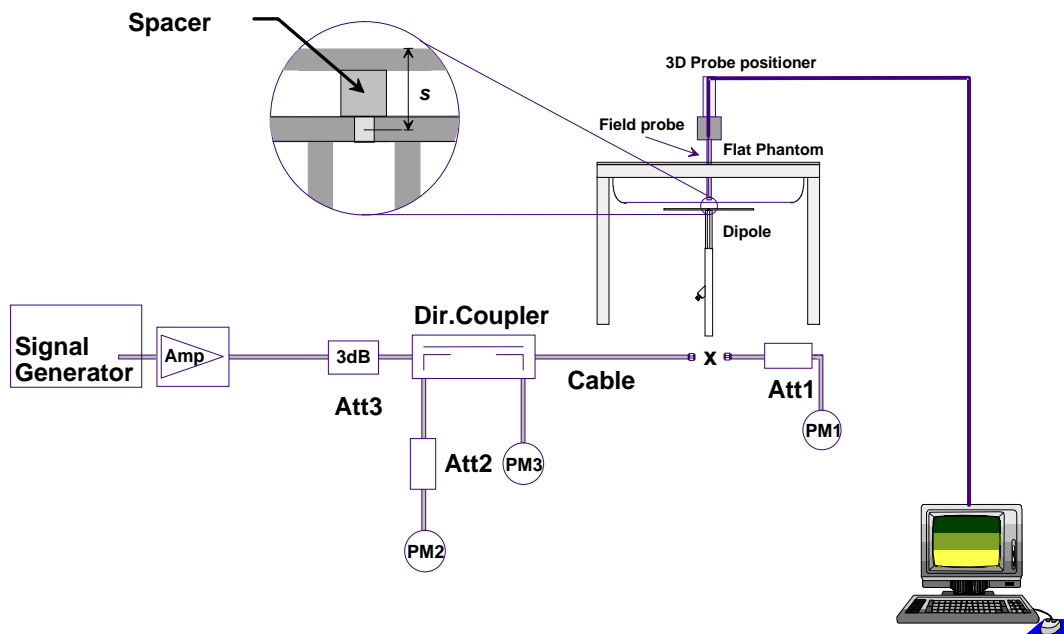

Fig 8.1 System Setup for System Evaluation

1. Signal Generator
2. Amplifier
3. Directional Coupler
4. Power Meter
5. Calibrated Dipole

The output power on dipole port must be calibrated to 24 dBm (250 mW) before dipole is connected.

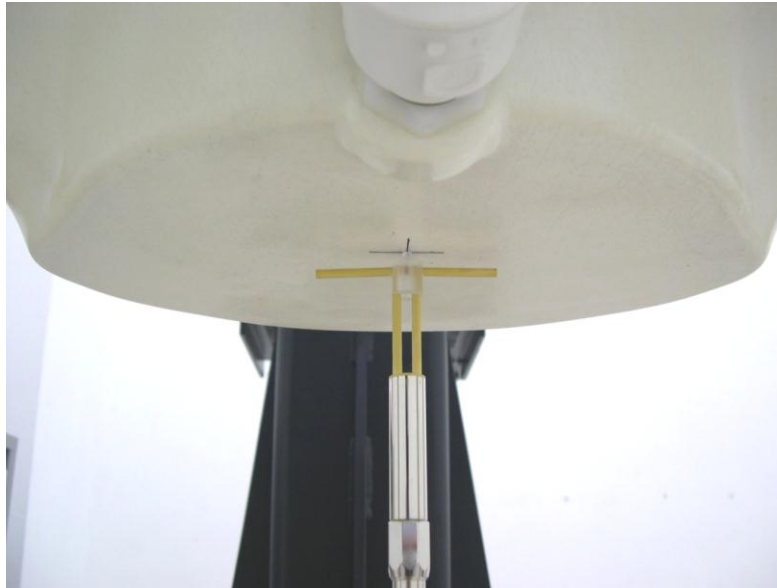

Fig 8.2 Photo of Dipole Setup



7.3 Validation Results

Comparing to the original SAR value provided by SPEAG, the validation data should be within its specification of 10 %. Table 7.1 shows the target SAR and measured SAR after normalized to 1W input power. The table below indicates the system performance check can meet the variation criterion and the plots can be referred to Appendix A of this report.

Measurement Date	Frequency (MHz)	Liquid Type	Targeted SAR _{1g} (W/kg)	Measured SAR _{1g} (W/kg)	Normalized SAR _{1g} (W/kg)	Deviation (%)
May 25, 2012	835	Body	9.82	2.42	9.68	-1.43
May 26, 2012	1750	Body	36.80	8.69	34.76	-5.54
May 25, 2012	1900	Body	40	9.57	38.28	-4.30
Jun. 03, 2012	2450	Body	52.3	13.9	55.60	6.31
Jun. 05, 2012	5200	Body	72.6	18.6	74.40	2.48
Jun. 02, 2012	5500	Body	78.80	20.5	82.00	4.06
Jun. 05, 2012	5800	Body	73.1	17.9	71.60	-2.05

Table 7.1 Target and Measurement SAR after Normalized

8. EUT Testing Position

This EUT was tested in five different positions. They are bottom face of tablet PC, front face, Primary-Landscape, Primary-Portrait, and Secondary-Portrait. In these positions, the surface of EUT is touching with phantom 0 cm gap. Please refer to Appendix E for the test setup photos.

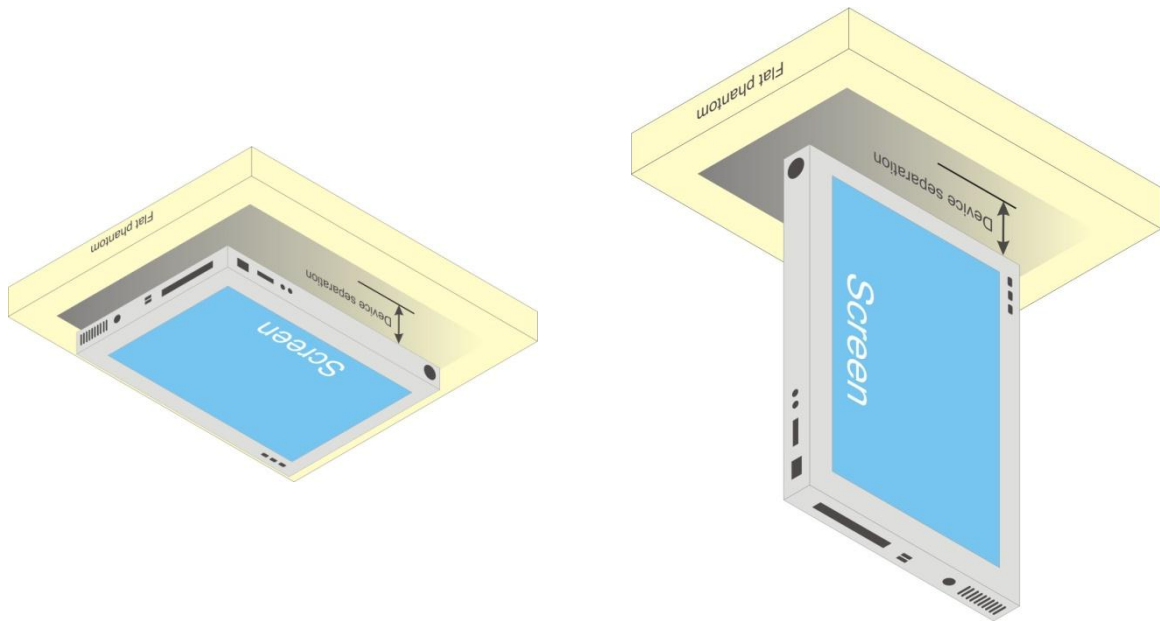

Fig 9.1 Illustration for Lap-touching Position

9. Measurement Procedures

The measurement procedures are as follows:

- (a) Use base station simulator (if applicable) or engineering software to transmit RF power continuously (continuous Tx) in the highest power channel.
- (b) Keep EUT to radiate maximum output power or 100% duty cycle (if applicable).
- (c) Measure output power through RF cable and power meter.
- (d) Place the EUT in the positions as Appendix E demonstrates.
- (e) Set scan area, grid size and other setting on the DASY software.
- (f) Measure SAR results for the highest power channel on each testing position.
- (g) Find out the largest SAR result on these testing positions of each band
- (h) Measure SAR results for other channels in worst SAR testing position if the SAR of highest power channel is larger than 0.8 W/kg

According to the test standard, the recommended procedure for assessing the peak spatial-average SAR value consists of the following steps:

- (a) Power reference measurement
- (b) Area scan
- (c) Zoom scan
- (d) Power drift measurement

9.1 Spatial Peak SAR Evaluation

The procedure for spatial peak SAR evaluation has been implemented according to the test standard. It can be conducted for 1g and 10g, as well as for user-specific masses. The DASY software includes all numerical procedures necessary to evaluate the spatial peak SAR value.

The base for the evaluation is a "cube" measurement. The measured volume must include the 1g and 10g cubes with the highest averaged SAR values. For that purpose, the center of the measured volume is aligned to the interpolated peak SAR value of a previously performed area scan.

The entire evaluation of the spatial peak values is performed within the post-processing engine (SEMCAD). The system always gives the maximum values for the 1g and 10g cubes. The algorithm to find the cube with highest averaged SAR is divided into the following stages:

- (a) Extraction of the measured data (grid and values) from the Zoom Scan
- (b) Calculation of the SAR value at every measurement point based on all stored data (A/D values and measurement parameters)
- (c) Generation of a high-resolution mesh within the measured volume
- (d) Interpolation of all measured values from the measurement grid to the high-resolution grid
- (e) Extrapolation of the entire 3-D field distribution to the phantom surface over the distance from sensor to surface
- (f) Calculation of the averaged SAR within masses of 1g and 10g



9.2 Area & Zoom Scan Procedures

First Area Scan is used to locate the approximate location(s) of the local peak SAR value(s). The measurement grid within an Area Scan is defined by the grid extent, grid step size and grid offset. Next, in order to determine the EM field distribution in a three-dimensional spatial extension, Zoom Scan is required. The Zoom Scan measures 5x5x7 points with step size 8, 8 and 5 mm for 300 MHz to 3 GHz, and 8x8x8 points with step size 4, 4 and 2.5 mm for 3 GHz to 6 GHz. The Zoom Scan is performed around the highest E-field value to determine the averaged SAR-distribution over 10 g.

9.3 Volume Scan Procedures

The volume scan is used for assess overlapping SAR distributions for antennas transmitting in different frequency bands. It is equivalent to an oversized zoom scan used in standalone measurements. The measurement volume will be used to enclose all the simultaneous transmitting antennas. For antennas transmitting simultaneously in different frequency bands, the volume scan is measured separately in each frequency band. In order to sum correctly to compute the 1g aggregate SAR, the EUT remain in the same test position for all measurements and all volume scan use the same spatial resolution and grid spacing (step-size is 4, 4 and 2.5 mm). When all volume scan were completed, the software, SEMCAD postprocessor can combine and subsequently superpose these measurement data to calculating the multiband SAR.

9.4 SAR Averaged Methods

In DASy, the interpolation and extrapolation are both based on the modified Quadratic Shepard's method. The interpolation scheme combines a least-square fitted function method and a weighted average method which are the two basic types of computational interpolation and approximation.

Extrapolation routines are used to obtain SAR values between the lowest measurement points and the inner phantom surface. The extrapolation distance is determined by the surface detection distance and the probe sensor offset. The uncertainty increases with the extrapolation distance. To keep the uncertainty within 1% for the 1 g and 10 g cubes, the extrapolation distance should not be larger than 5 mm.

9.5 Power Drift Monitoring

All SAR testing is under the EUT install full charged battery and transmit maximum output power. In DASy measurement software, the power reference measurement and power drift measurement procedures are used for monitoring the power drift of EUT during SAR test. Both these procedures measure the field at a specified reference position before and after the SAR testing. The software will calculate the field difference in dB. If the power drift more than 5%, the SAR will be retested.

10. SAR Test Configurations

10.1 Exposure Positions Consideration

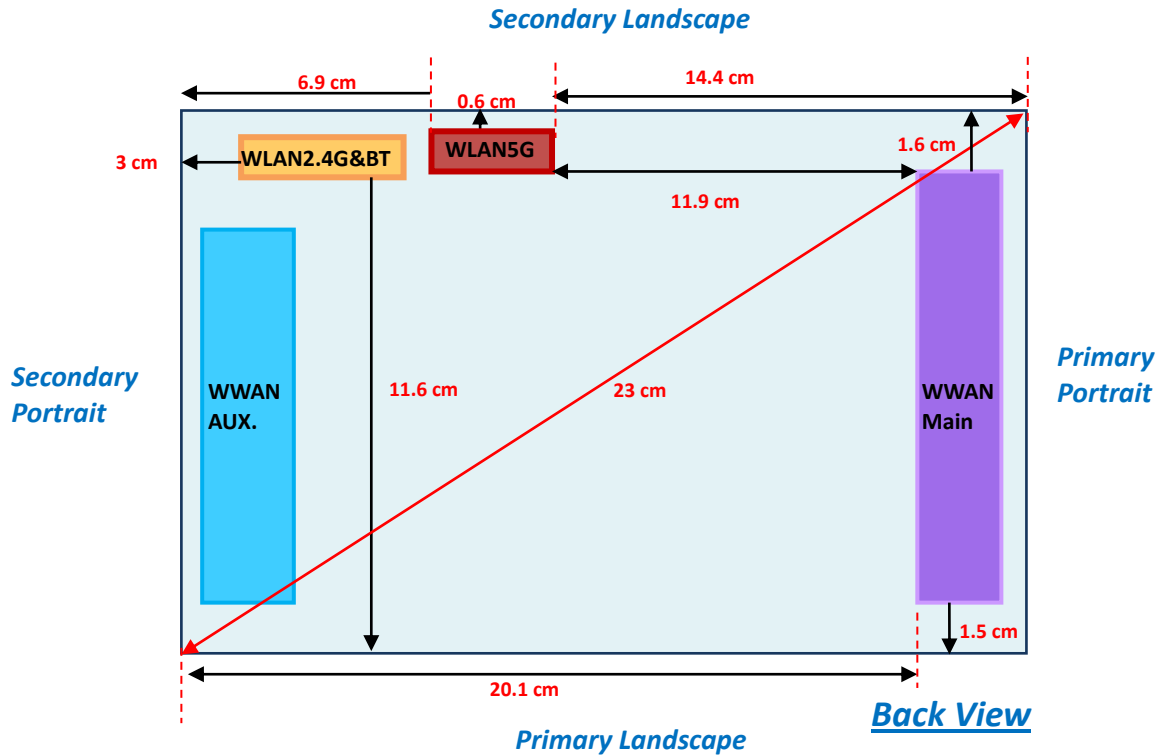

WWAN Main Antenna (Tx/Rx)	GSM850 GSM1900 WCDMA Band II WCDMA Band V WCDMA Band IV CDMA BC0 CDMA BC1
WWAN Aux Antenna (Rx)	GSM850 GSM1900 WCDMA Band II WCDMA Band V WCDMA Band IV CDMA BC0 CDMA BC1
WLAN2.4G/BT Antenna (Tx/Rx)	802.11 b/g/n Bluetooth
WLAN5G Antenna (Tx/Rx)	802.11 a/n



Note:

- 1. Per KDB 941225 D07, the EUT diagonal > 20 cm and Mini-Tablet procedure is not applied. Therefore, SAR tests follow the Tablet Mode in KDB447498.
- 2. There is screen orientation limit at Secondary Landscape; that is only Primary Landscape/Secondary Portrait/Primary Portrait orientations are supported.
- 3. As in (1), the test distance is 0 mm to the flat phantom; SAR evaluation is required for Bottom Face and each applicable Edge with the antenna within 5 cm to the user.
- 4. When EUT is placed within the holster, the front face of EUT is facing to user; therefore, EUT was additionally tested at front face under 0cm separation gap with holster.
- 5. As in (3)(4), the required positions for SAR testing are illustrated below:

Sides for SAR tests; Tablet mode						
Antenna	Bottom Face	Front Face	Secondary Landscape	Primary Landscape	Secondary Portrait	Primary Portrait
WWAN	Yes(0 mm)	Yes(0 mm)	No	Yes(0 mm)	No	Yes(0 mm)
WLAN2.4/BT	Yes(0 mm)	Yes(0 mm)	No	No	Yes(0 mm)	No
WLAN5G	Yes(0 mm)	Yes(0 mm)	No	No	No	No



10.2 Conducted Power (Unit: dBm)

<GSM>

Burst Average Power						
Band	GSM850			GSM1900		
Channel	128	189	251	512	661	810
Frequency (MHz)	824.2	836.4	848.8	1850.2	1880.0	1909.8
GPRS 8 (1 Uplink) – CS1	33.02	32.98	32.81	30.61	30.40	30.38
GPRS 10 (2 Uplink) – CS1	30.58	30.89	30.98	30.55	30.24	30.35
EDGE 8 (GMSK, 1 Uplink) – MCS1	33.00	32.96	32.76	30.58	30.34	30.30
EDGE 10 (GMSK, 2 Uplink) – MCS1	30.56	30.85	30.94	30.51	30.21	30.27
EDGE 8 (8PSK, 1 Uplink) – MCS9	26.88	26.89	26.90	26.49	26.33	26.22
EDGE 10 (8PSK, 2 Uplink) – MCS9	26.80	26.82	26.85	26.41	26.25	26.17

Source-Based Time-Averaged Power						
Band	GSM850			GSM1900		
Channel	128	189	251	512	661	810
Frequency (MHz)	824.2	836.4	848.8	1850.2	1880.0	1909.8
GPRS 8 (1 Uplink) – CS1	24.02	23.98	23.81	21.61	21.40	21.38
GPRS 10 (2 Uplink) – CS1	24.58	24.89	24.98	24.55	24.24	24.35
EDGE 8 (GMSK, 1 Uplink) – MCS1	24.00	23.96	23.76	21.58	21.34	21.30
EDGE 10 (GMSK, 2 Uplink) – MCS1	24.56	24.85	24.94	24.51	24.21	24.27
EDGE 8 (8PSK, 1 Uplink) – MCS9	17.88	17.89	17.90	17.49	17.33	17.22
EDGE 10 (8PSK, 2 Uplink) – MCS9	20.80	20.82	20.85	20.41	20.25	20.17

Remark: The source-based time-averaged power is linearly scaled the maximum burst averaged power based on time slots. The calculated method are shown as below:

Source based time averaged power = Maximum burst averaged power (1 Uplink) - 9 dB

Source based time averaged power = Maximum burst averaged power (2 Uplink) - 6 dB

Note:

1. Following KDB 941225 D03, for Body SAR testing, the EUT was set in GPRS 10 for GSM850 and set in GPRS 10 for GSM1900 due to its highest source-based time-average power.
2. Per KDB 447498, the maximum output power channel is used for SAR testing and for further SAR test reduction.
3. EDGE tests with MCS1 setting, GMSK modulation. Burst average power with MCS9 setting 8 PSK modulation, is provided voluntary for reference.



<WCDMA>

Band	WCDMA Band V			WCDMA Band II			WCDMA Band IV		
Channel	4132	4182	4233	9262	9400	9538	1312	1413	1513
Frequency (MHz)	826.4	836.4	846.6	1852.4	1880.0	1907.6	1712.4	1732.6	1752.6
RMC 12.2K	24.03	23.97	23.83	22.80	23.01	22.78	22.90	22.92	22.87
HSDPA Subtest-1	23.79	23.72	23.64	22.70	22.73	22.65	22.31	22.36	22.24
HSDPA Subtest-2	23.75	23.68	23.61	22.59	22.64	22.51	22.37	22.40	22.30
HSDPA Subtest-3	23.30	23.25	23.21	22.19	22.22	22.11	22.24	22.29	22.16
HSDPA Subtest-4	23.27	23.23	23.19	22.14	22.18	22.03	21.93	21.97	21.86
HSUPA Subtest-1	23.29	23.49	23.10	22.26	22.29	22.19	22.30	22.35	22.24
HSUPA Subtest-2	22.10	22.14	22.01	21.10	21.14	21.04	21.20	21.26	21.11
HSUPA Subtest-3	22.48	22.54	22.34	21.27	21.31	21.20	21.17	21.21	21.12
HSUPA Subtest-4	22.27	22.33	22.22	21.57	21.59	21.49	21.31	21.35	21.24
HSUPA Subtest-5	23.39	23.45	23.31	22.44	22.48	22.34	22.36	22.38	22.30

MPR										
3GPP Requirement	Subtest	WCDMA band V			WCDMA band II			WCDMA band IV		
0	HSDPA Subtest-1	0.00	0.00	0.00	0.00	0.00	0.00	0.00	0.00	0.00
0	HSDPA Subtest-2	0.04	0.04	0.03	0.11	0.09	0.14	-0.06	-0.04	-0.06
0.5	HSDPA Subtest-3	0.49	0.47	0.43	0.51	0.51	0.54	0.07	0.07	0.08
0.5	HSDPA Subtest-4	0.52	0.49	0.45	0.56	0.55	0.62	0.38	0.39	0.38
0	HSUPA Subtest-1	0.10	-0.04	0.21	0.18	0.19	0.15	0.06	0.03	0.06
2	HSUPA Subtest-2	1.29	1.31	1.30	1.34	1.34	1.30	1.16	1.12	1.19
1	HSUPA Subtest-3	0.91	0.91	0.97	1.17	1.17	1.14	1.19	1.17	1.18
2	HSUPA Subtest-4	1.12	1.12	1.09	0.87	0.89	0.85	1.05	1.03	1.06
0	HSUPA Subtest-5	0.00	0.00	0.00	0.00	0.00	0.00	0.00	0.00	0.00

Note:

- For Body SAR, per KDB 941225 D01, RMC 12.2kbps setting is used to evaluate SAR. If HSDPA subset-1 and HSUPA subset-5 output power is < 1/4 dB higher than RMC, or SAR with RMC 12.2kbps setting is $\leq 1.2W/kg$, HSDPA and HSUPA SAR evaluation can be excluded.
- EUT is designed to follow the MPR of 3GPP Table 5.2B.1 specification. In production units, MPR result deviation from 3GPP is expected; the implementation and expected deviation is detailed in tune-up procedure exhibit.



<CDMA2000>

Band	CDMA2000 BC0			CDMA2000 BC1		
	1013	384	777	25	600	1175
Channel	824.70	836.52	848.31	1851.25	1880.00	1908.75
Frequency (MHz)	824.70	836.52	848.31	1851.25	1880.00	1908.75
1xRTT RC1+SO55	24.08	23.98	23.91	23.94	23.98	23.97
1xRTT RC3+SO55	24.05	24.13	23.96	23.95	24.18	23.83
1xRTT RC3+SO32(+ F-SCH)	24.01	23.96	23.88	23.92	23.94	23.80
1xRTT RC3+SO32(+SCH)	23.95	23.91	23.80	23.93	23.96	23.85
1xEVDO RTAP 153.6	23.73	23.92	23.69	23.95	24.10	23.99
1xEVDO RETAP 4096	23.85	23.95	23.84	24.06	24.13	23.99

Note: Referring to KDB 941225 D01, EUT is treated as data device and SAR is tested with RTAP 153.6 kbps (Ev-Do). If RC3+SO32 power is less than 1/4dB higher than Ev-Do, SAR tests with RC3+SO32 setting are not necessary.



<WLAN2.4G>

Mode	Channel	Frequency (MHz)	Average power (dBm)			
			Data Rate (bps)			
			1M	2M	5.5M	11M
802.11b	CH 01	2412	21.13	20.82	20.62	20.60
	CH 06	2437	21.21	21.13	20.98	20.85
	CH 11	2462	20.90	20.78	20.64	20.63

Mode	Channel	Frequency (MHz)	Average power (dBm)							
			Data Rate (bps)							
			6M	9M	12M	18M	24M	36M	48M	54M
802.11g	CH 01	2412	16.00	15.67	15.68	15.52	15.46	15.63	15.70	15.69
	CH 06	2437	20.68	20.64	20.61	20.68	20.56	20.58	20.57	20.56
	CH 11	2462	15.41	15.31	15.24	15.14	15.19	15.06	15.13	15.15

Mode	Channel	Frequency (MHz)	Average power (dBm)							
			Data Rate (bps)							
			MCS0	MCS1	MCS2	MCS3	MCS4	MCS5	MCS6	MCS7
802.11n 20M	CH 01	2412	14.99	14.68	14.87	14.81	15.01	14.94	15.03	14.95
	CH 06	2437	20.61	20.52	20.52	20.51	20.59	20.53	20.59	20.59
	CH 11	2462	15.11	14.90	15.02	15.06	15.11	14.98	14.96	15.15

Note:

1. Per KDB 248227, choose the highest output power channel to test SAR and determine further SAR exclusion
2. For each frequency band, testing at higher data rates and higher order modulations is not requirement when the maximum average output power for each of these configurations is less than 1/4 dB higher than those measured at the lowest data rate.
3. Per KDB 248227, 11g and 11n output power is less than 1/4 dB higher than 11b mode, thus the SAR can be excluded.

<Bluetooth>

Band	Bluetooth		
Channel	0	39	78
Frequency	2402	2441	2480
Average Power	1.80	1.82	1.75

Note: Bluetooth standalone SAR is not required because the Bluetooth highest average power is less than 60/f.



<WLAN 5GHz>

Mode	Channel	Frequency (MHz)	Average Power (dBm)							
			Data Rate (bps)							
			6M	9M	12M	18M	24M	36M	48M	54M
802.11a	CH 036	5180	14.00	13.86	13.84	13.91	13.78	13.80	13.84	13.85
	CH 040	5200	12.38	12.36	13.33	13.37	13.35	13.35	13.36	13.36
	CH 044	5220	14.08	14.02	14.00	14.01	13.90	13.88	13.99	13.96
	CH 048	5240	14.59	14.54	14.56	14.54	14.46	14.54	14.58	14.58
	CH 052	5260	20.44	20.43	20.39	20.42	20.43	20.42	20.38	20.41
	CH 056	5280	18.71	18.67	18.68	18.69	18.68	18.70	18.70	18.70
	CH 060	5300	19.39	19.23	19.22	19.13	19.17	19.16	19.15	19.19
	CH 064	5320	16.64	16.69	16.72	16.73	16.66	16.63	16.63	16.62
	CH 100	5500	15.52	14.78	14.80	14.81	14.78	14.77	14.82	14.82
	CH 104	5520	19.19	18.78	18.76	18.79	18.67	18.68	18.75	18.75
	CH 108	5540	18.83	18.57	18.56	18.50	18.43	18.49	18.49	18.47
	CH 112	5560	18.76	18.33	18.37	18.42	18.29	18.28	18.33	18.35
	CH 116	5580	21.18	21.16	20.11	20.16	20.13	20.15	20.15	20.16
	CH 120	5600	19.60	19.00	18.96	18.99	18.88	18.87	18.92	19.00
	CH 124	5620	19.55	19.27	19.25	19.28	19.13	19.18	19.19	19.18
	CH 128	5640	19.10	18.78	18.85	18.83	18.77	18.74	18.77	18.77
	CH 132	5660	19.52	19.25	19.07	19.12	18.98	18.94	19.03	19.03
	CH 136	5680	19.67	19.65	19.62	19.62	19.61	19.62	19.64	19.63
	CH 140	5700	14.1	13.72	13.86	13.88	13.76	13.76	13.79	13.7
	CH 149	5745	21.41	21.47	21.44	21.42	21.29	21.27	21.34	21.34
CH 153	5765	21.44	21.46	21.45	21.45	21.36	21.36	21.37	21.44	
CH 157	5785	21.70	21.54	21.46	21.48	21.37	21.37	21.41	21.48	
CH 161	5805	21.50	21.12	21.08	21.07	21.00	20.98	20.99	21.05	
CH 165	5825	22.51	22.05	21.98	21.90	21.90	21.95	21.98	22.02	



Mode	Channel	Frequency (MHz)	Average Power (dBm)							
			Data Rate (bps)							
			MCS0	MCS1	MCS2	MCS3	MCS4	MCS5	MCS6	MCS7
802.11n 20M	CH 036	5180	14.43	14.32	14.36	14.41	14.31	14.25	14.36	14.42
	CH 040	5200	12.24	12.21	12.20	12.19	12.20	12.21	12.17	12.17
	CH 044	5220	14.52	14.48	14.48	14.46	14.48	14.39	14.49	14.49
	CH 048	5240	14.50	14.47	14.47	14.44	14.45	14.42	14.46	14.44
	CH 052	5260	20.37	20.32	20.32	20.30	20.29	20.31	20.32	20.33
	CH 056	5280	18.62	18.59	18.59	18.54	18.58	18.58	18.56	18.57
	CH 060	5300	19.74	19.57	19.58	19.54	19.56	19.61	19.45	19.51
	CH 064	5320	15.91	16.05	16.12	16.11	16.11	16.25	16.27	16.29
	CH 100	5500	14.92	14.19	14.23	14.32	14.32	14.23	14.22	14.39
	CH 104	5520	19.09	18.54	18.58	18.59	18.62	18.54	18.58	18.68
	CH 108	5540	18.65	18.26	18.29	18.38	18.40	18.31	18.31	18.44
	CH 112	5560	18.66	18.11	18.14	18.14	18.11	18.16	18.15	18.32
	CH 116	5580	21.09	21.06	21.05	21.06	21.04	21.02	21.04	21.06
	CH 120	5600	19.50	18.79	18.88	18.87	18.89	18.85	18.83	18.94
	CH 124	5620	19.43	19.06	19.09	19.07	19.11	19.08	19.03	19.26
	CH 128	5640	18.98	18.55	18.62	18.66	18.68	18.62	18.64	18.72
	CH 132	5660	18.92	18.28	18.38	18.36	18.42	18.39	18.37	18.49
	CH 136	5680	19.53	18.49	18.48	18.45	18.47	18.47	18.47	18.45
	CH 140	5700	13.40	13.09	12.96	12.96	13.20	13.19	13.19	13.33
	CH 149	5745	21.36	21.33	21.34	21.27	21.28	21.28	21.28	21.48
CH 153	5765	21.40	21.40	21.43	21.41	21.39	21.41	21.35	21.63	
CH 157	5785	21.67	21.36	21.35	21.32	21.36	21.36	21.36	21.59	
CH 161	5805	22.01	21.62	21.61	21.65	21.64	21.64	21.72	21.85	
CH 165	5825	22.42	21.91	21.90	21.97	22.01	22.00	21.99	22.18	

Note:

1. Per KDB 248227, choose the highest output power channel to test SAR and determine further SAR exclusion
2. For each frequency band, testing at higher data rates and higher order modulations is not requirement when the maximum average output power for each of these configurations is less than 1/4 dB higher than those measured at the lowest data rate.
3. Per KDB 248227, 11n output power is less than 1/4 dB higher than 11a mode, thus the SAR can be excluded.

11. SAR Test Results

11.1 Test Records for Body SAR Test

<GSM SAR – EUT without Hand Strap>

Plot No.	Band	Mode	Test Position	Gap (cm)	Ch.	Freq. (MHz)	Output Power	Jelly Sets	Hand Strap	Holster	SAR _{1g} (W/kg)
7	GSM850	GPRS10	Bottom Face	0	251	848.8	30.98	-	-	-	0.856
8	GSM850	GPRS10	Primary Portrait	0	251	848.8	30.98	-	-	-	0.51
9	GSM850	GPRS10	Primary Landscape	0	251	848.8	30.98	-	-	-	0.404
10	GSM850	GPRS10	Front Face	0	251	848.8	30.98	-	-	v	0.342
69	GSM850	GPRS10	Bottom Face	0	251	848.8	30.98	v	-	-	0.901
11	GSM850	GPRS10	Bottom Face	0	128	824.2	30.58	-	-	-	0.777
12	GSM850	GPRS10	Bottom Face	0	189	836.4	30.89	-	-	-	0.894
70	GSM850	GPRS10	Bottom Face	0	128	824.2	30.58	v	-	-	0.773
71	GSM850	GPRS10	Bottom Face	0	189	836.4	30.89	v	-	-	0.877
39	GSM1900	GPRS10	Bottom Face	0	512	1850.2	30.55	-	-	-	0.875
40	GSM1900	GPRS10	Primary Portrait	0	512	1850.2	30.55	-	-	-	0.718
41	GSM1900	GPRS10	Primary Landscape	0	512	1850.2	30.55	-	-	-	0.05
42	GSM1900	GPRS10	Front Face	0	512	1850.2	30.55	-	-	v	0.544
84	GSM1900	GPRS10	Bottom Face	0	512	1850.2	30.55	v	-	-	0.943
43	GSM1900	GPRS10	Bottom Face	0	661	1880	30.24	-	-	-	0.873
44	GSM1900	GPRS10	Bottom Face	0	810	1909.8	30.35	-	-	-	0.725
85	GSM1900	GPRS10	Bottom Face	0	661	1880.0	30.24	v	-	-	0.944
86	GSM1900	GPRS10	Bottom Face	0	810	1909.8	30.35	v	-	-	0.881

<GSM SAR – EUT with Hand Strap>

Plot No.	Band	Mode	Test Position	Gap (cm)	Ch.	Freq. (MHz)	Output Power	Jelly Sets	Hand Strap	Holster	SAR _{1g} (W/kg)
13	GSM850	GPRS10	Bottom Face	0	251	848.8	30.98	-	v	-	0.167
14	GSM850	GPRS10	Primary Portrait	0	251	848.8	30.98	-	v	-	0.51
15	GSM850	GPRS10	Primary Landscape	0	251	848.8	30.98	-	v	-	0.443
16	GSM850	GPRS10	Front Face	0	251	848.8	30.98	-	v	v	0.35
92	GSM850	GPRS10	Primary Portrait	0	251	848.8	30.98	v	v	-	0.583
35	GSM1900	GPRS10	Bottom Face	0	512	1850.2	30.55	-	v	-	0.162
36	GSM1900	GPRS10	Primary Portrait	0	512	1850.2	30.55	-	v	-	0.681
37	GSM1900	GPRS10	Primary Landscape	0	512	1850.2	30.55	-	v	-	0.045
38	GSM1900	GPRS10	Front Face	0	512	1850.2	30.55	-	v	v	0.532
81	GSM1900	GPRS10	Primary Portrait	0	512	1850.2	30.55	v	v	-	0.715

Note:

- Per KDB 447498, if the highest output channel SAR for each exposure position ≤ 0.8 W/kg other channels SAR tests are not necessary.
- "V" mark indicate which accessories were used during the test.

<UMTS SAR – EUT without Hand Strap>

Plot No.	Band	Mode	Test Position	Gap (cm)	Ch.	Freq. (MHz)	Output Power	Jelly Sets	Hand Strap	Holster	SAR _{1g} (W/kg)
1	WCDMA V	RMC12.2K	Bottom Face	0	4132	826.4	24.03	-	-	-	0.833
2	WCDMA V	RMC12.2K	Primary Portrait	0	4132	826.4	24.03	-	-	-	0.542
3	WCDMA V	RMC12.2K	Primary Landscape	0	4132	826.4	24.03	-	-	-	0.31
4	WCDMA V	RMC12.2K	Front Face	0	4132	826.4	24.03	-	-	v	0.338
72	WCDMA V	RMC12.2K	Bottom Face	0	4132	826.4	24.03	v	-	-	0.839
5	WCDMA V	RMC12.2K	Bottom Face	0	4182	836.4	23.97	-	-	-	0.956
6	WCDMA V	RMC12.2K	Bottom Face	0	4233	846.6	23.83	-	-	-	0.932
73	WCDMA V	RMC12.2K	Bottom Face	0	4182	836.4	23.97	v	-	-	0.954
74	WCDMA V	RMC12.2K	Bottom Face	0	4233	846.6	23.83	v	-	-	0.944
96	WCDMA IV	RMC12.2K	Bottom Face	0	1413	1732.6	22.92	-	-	-	0.696
97	WCDMA IV	RMC12.2K	Primary Portrait	0	1413	1732.6	22.92	-	-	-	0.859
100	WCDMA IV	RMC12.2K	Primary Landscape	0	1413	1732.6	22.92	-	-	-	0.08
101	WCDMA IV	RMC12.2K	Front Face	0	1413	1732.6	22.92	-	-	v	0.414
108	WCDMA IV	RMC12.2K	Primary Portrait	0	1413	1732.6	22.92	v	-	-	0.846
98	WCDMA IV	RMC12.2K	Primary Portrait	0	1312	1712.4	22.9	-	-	-	0.881
99	WCDMA IV	RMC12.2K	Primary Portrait	0	1513	1752.6	22.87	-	-	-	0.964
109	WCDMA IV	RMC12.2K	Primary Portrait	0	1312	1712.4	22.9	v	-	-	0.882
110	WCDMA IV	RMC12.2K	Primary Portrait	0	1513	1752.6	22.87	v	-	-	0.916
61	WCDMA II	RMC12.2K	Bottom Face	0	9400	1880	23.01	-	-	-	0.863
62	WCDMA II	RMC12.2K	Primary Portrait	0	9400	1880	23.01	-	-	-	0.619
63	WCDMA II	RMC12.2K	Primary Landscape	0	9400	1880	23.01	-	-	-	0.052
64	WCDMA II	RMC12.2K	Front Face	0	9400	1880	23.01	-	-	v	0.465
78	WCDMA II	RMC12.2K	Bottom Face	0	9400	1880	23.01	v	-	-	0.865
65	WCDMA II	RMC12.2K	Bottom Face	0	9262	1852.4	22.8	-	-	-	0.819
66	WCDMA II	RMC12.2K	Bottom Face	0	9538	1907.6	22.78	-	-	-	0.765
79	WCDMA II	RMC12.2K	Bottom Face	0	9262	1852.4	22.8	v	-	-	0.795
80	WCDMA II	RMC12.2K	Bottom Face	0	9538	1907.6	22.78	v	-	-	0.759

Note:

1. Per KDB 447498, if the highest output channel SAR for each exposure position ≤ 0.8 W/kg other channels SAR tests are not necessary.
2. "V" mark indicate which accessories were used during the test.



<UMTS SAR – EUT with Hand Strap>

Plot No.	Band	Mode	Test Position	Gap (cm)	Ch.	Freq. (MHz)	Output Power	Jelly Sets	Hand Strap	Holster	SAR _{1g} (W/kg)
17	WCDMA V	RMC12.2K	Bottom Face	0	4132	826.4	24.03	-	v	-	0.145
18	WCDMA V	RMC12.2K	Primary Portrait	0	4132	826.4	24.03	-	v	-	0.548
19	WCDMA V	RMC12.2K	Primary Landscape	0	4132	826.4	24.03	-	v	-	0.32
20	WCDMA V	RMC12.2K	Front Face	0	4132	826.4	24.03	-	v	v	0.369
95	WCDMA V	RMC12.2K	Primary Portrait	0	4132	826.4	24.03	v	v	-	0.595
102	WCDMA IV	RMC12.2K	Bottom Face	0	1413	1732.6	22.92	-	v	-	0.124
103	WCDMA IV	RMC12.2K	Primary Portrait	0	1413	1732.6	22.92	-	v	-	0.847
106	WCDMA IV	RMC12.2K	Primary Landscape	0	1413	1732.6	22.92	-	v	-	0.045
107	WCDMA IV	RMC12.2K	Front Face	0	1413	1732.6	22.92	-	v	v	0.471
111	WCDMA IV	RMC12.2K	Primary Portrait	0	1413	1732.6	22.92	v	v	-	0.816
104	WCDMA IV	RMC12.2K	Primary Portrait	0	1312	1712.4	22.9	-	v	-	0.913
105	WCDMA IV	RMC12.2K	Primary Portrait	0	1513	1752.6	22.87	-	v	-	1.01
112	WCDMA IV	RMC12.2K	Primary Portrait	0	1312	1712.4	22.9	v	v	-	0.881
113	WCDMA IV	RMC12.2K	Primary Portrait	0	1513	1752.6	22.87	v	v	-	0.933
55	WCDMA II	RMC12.2K	Bottom Face	0	9400	1880	23.01	-	v	-	0.197
56	WCDMA II	RMC12.2K	Primary Portrait	0	9400	1880	23.01	-	v	-	0.628
57	WCDMA II	RMC12.2K	Primary Landscape	0	9400	1880	23.01	-	v	-	0.063
58	WCDMA II	RMC12.2K	Front Face	0	9400	1880	23.01	-	v	v	0.534
59	WCDMA II	RMC12.2K	Primary Portrait	0	9400	1880	23.01	v	v	-	0.756

Note:

1. Per KDB 447498, if the highest output channel SAR for each exposure position ≤ 0.8 W/kg other channels SAR tests are not necessary.
2. "V" mark indicate which accessories were used during the test.



<CDMA2000 SAR – EUT without Hand Strap>

Plot No.	Band	Mode	Test Position	Gap (cm)	Ch.	Freq. (MHz)	Output Power	Jelly Sets	Hand Strap	Holster	SAR _{1g} (W/kg)
21	CDMA2000 BC0	RTAP153.6	Bottom Face	0	384	836.52	23.92	-	-	-	0.965
22	CDMA2000 BC0	RTAP153.6	Primary Portrait	0	384	836.52	23.92	-	-	-	0.658
23	CDMA2000 BC0	RTAP153.6	Primary Landscape	0	384	836.52	23.92	-	-	-	0.427
24	CDMA2000 BC0	RTAP153.6	Front Face	0	384	836.52	23.92	-	-	v	0.414
75	CDMA2000 BC0	RTAP153.6	Bottom Face	0	384	836.52	23.92	v	-	-	1.01
25	CDMA2000 BC0	RTAP153.6	Bottom Face	0	1013	826.4	23.73	-	-	-	0.867
26	CDMA2000 BC0	RTAP153.6	Bottom Face	0	777	846.6	23.69	-	-	-	0.931
76	CDMA2000 BC0	RTAP153.6	Bottom Face	0	1013	826.4	23.73	v	-	-	0.848
77	CDMA2000 BC0	RTAP153.6	Bottom Face	0	777	846.6	23.69	v	-	-	0.986
45	CDMA2000 BC1	RTAP153.6	Bottom Face	0	600	1880	24.1	-	-	-	1.09
46	CDMA2000 BC1	RTAP153.6	Primary Portrait	0	600	1880	24.1	-	-	-	0.891
47	CDMA2000 BC1	RTAP153.6	Primary Landscape	0	600	1880	24.1	-	-	-	0.07
48	CDMA2000 BC1	RTAP153.6	Front Face	0	600	1880	24.1	-	-	v	0.647
87	CDMA2000 BC1	RTAP153.6	Bottom Face	0	600	1880	24.1	v	-	-	1.29
49	CDMA2000 BC1	RTAP153.6	Bottom Face	0	25	1851.25	23.95	-	-	-	1.08
50	CDMA2000 BC1	RTAP153.6	Bottom Face	0	1175	1908.75	23.99	-	-	-	1.04
51	CDMA2000 BC1	RTAP153.6	Primary Portrait	0	25	1851.25	23.95	-	-	-	0.791
52	CDMA2000 BC1	RTAP153.6	Primary Portrait	0	1175	1908.75	23.99	-	-	-	0.91
88	CDMA2000 BC1	RTAP153.6	Bottom Face	0	25	1851.25	23.95	v	-	-	1.28
89	CDMA2000 BC1	RTAP153.6	Bottom Face	0	1175	1908.75	23.99	v	-	-	1.19

<CDMA2000 SAR – EUT with Hand Strap>

Plot No.	Band	Mode	Test Position	Gap (cm)	Ch.	Freq. (MHz)	Output Power	Jelly Sets	Hand Strap	Holster	SAR _{1g} (W/kg)
27	CDMA2000 BC0	RTAP153.6	Bottom Face	0	384	836.52	23.92	-	v	-	0.153
28	CDMA2000 BC0	RTAP153.6	Primary Portrait	0	384	836.52	23.92	-	v	-	0.649
29	CDMA2000 BC0	RTAP153.6	Primary Landscape	0	384	836.52	23.92	-	v	-	0.374
30	CDMA2000 BC0	RTAP153.6	Front Face	0	384	836.52	23.92	-	v	v	0.413
91	CDMA2000 BC0	RTAP153.6	Primary Portrait	0	384	836.52	23.92	v	v	-	0.638
31	CDMA2000 BC1	RTAP153.6	Bottom Face	0	600	1880	24.1	-	v	-	0.205
32	CDMA2000 BC1	RTAP153.6	Primary Portrait	0	600	1880	24.1	-	v	-	0.813
33	CDMA2000 BC1	RTAP153.6	Primary Landscape	0	600	1880	24.1	-	v	-	0.063
34	CDMA2000 BC1	RTAP153.6	Front Face	0	600	1880	24.1	-	v	v	0.735
90	CDMA2000 BC1	RTAP153.6	Primary Portrait	0	600	1880	24.1	v	v	-	0.741
53	CDMA2000 BC1	RTAP153.6	Primary Portrait	0	25	1851.25	23.95	-	v	-	0.811
54	CDMA2000 BC1	RTAP153.6	Primary Portrait	0	1175	1908.75	23.99	-	v	-	0.875

Note:

1. Per KDB 447498, if the highest output channel SAR for each exposure position ≤ 0.8 W/kg other channels SAR tests are not necessary.
2. "V" mark indicate which accessories were used during the test.



<WLAN SAR – EUT without Hand Strap>

Plot No.	Band	Mode	Test Position	Gap (cm)	Ch.	Freq. (MHz)	Output Power	Jelly Sets	Hand Strap	Holster	SAR _{1g} (W/kg)
145	WLAN2.4G	802.11b	Bottom Face	0	6	2437	21.21	-	-	-	1.06
146	WLAN2.4G	802.11b	Secondary Portrait	0	6	2437	21.21	-	-	-	0.179
147	WLAN2.4G	802.11b	Front Face	0	6	2437	21.21	-	-	v	0.184
149	WLAN2.4G	802.11b	Bottom Face	0	6	2437	21.21	v	-	-	1.09
150	WLAN2.4G	802.11b	Bottom Face	0	1	2412	21.13	-	-	-	0.857
151	WLAN2.4G	802.11b	Bottom Face	0	11	2462	20.9	-	-	-	1.36
152	WLAN2.4G	802.11b	Bottom Face	0	1	2412	21.13	v	-	-	0.825
153	WLAN2.4G	802.11b	Bottom Face	0	11	2462	20.9	v	-	-	1.4
120	WLAN5G	802.11a	Bottom Face	0	48	5240	14.59	-	-	-	0.422
121	WLAN5G	802.11a	Front Face	0	48	5240	14.59	-	-	v	0.103
123	WLAN5G	802.11a	Bottom Face	0	48	5240	14.59	v	-	-	0.474
163	WLAN5G	802.11a	Bottom Face	0	52	5260	20.44	-	-	-	1.38
164	WLAN5G	802.11a	Front Face	0	52	5260	20.44	-	-	v	0.351
166	WLAN5G	802.11a	Bottom Face	0	52	5260	20.44	v	-	-	1.36
167	WLAN5G	802.11a	Bottom Face	0	64	5320	16.64	-	-	-	0.623
168	WLAN5G	802.11a	Bottom Face	0	64	5320	16.64	v	-	-	0.668
132	WLAN5G	802.11a	Bottom Face	0	116	5580	21.18	-	-	-	1.2
133	WLAN5G	802.11a	Front Face	0	116	5580	21.18	-	-	v	0.391
135	WLAN5G	802.11a	Bottom Face	0	116	5580	21.18	v	-	-	1.22
136	WLAN5G	802.11a	Bottom Face	0	104	5520	19.19	-	-	-	0.879
137	WLAN5G	802.11a	Bottom Face	0	136	5680	19.67	-	-	-	1.1
138	WLAN5G	802.11a	Bottom Face	0	104	5580	21.18	v	-	-	0.917
139	WLAN5G	802.11a	Bottom Face	0	136	5680	19.67	v	-	-	1.06
114	WLAN5G	802.11a	Bottom Face	0	165	5825	22.42	-	-	-	1.33
115	WLAN5G	802.11a	Front Face	0	165	5825	22.42	-	-	v	0.25
117	WLAN5G	802.11a	Bottom Face	0	165	5825	22.42	v	-	-	1.32
118	WLAN5G	802.11a	Bottom Face	0	149	5745	21.36	-	-	-	1.02
119	WLAN5G	802.11a	Bottom Face	0	157	5785	21.67	-	-	-	1.19
126	WLAN5G	802.11a	Bottom Face	0	149	5745	21.36	v	-	-	1.08
127	WLAN5G	802.11a	Bottom Face	0	157	5785	21.67	v	-	-	1.13

Note:

- Per KDB 447498, if the highest output channel SAR for each exposure position ≤ 0.8 W/kg other channels SAR tests are not necessary.
- "V" mark indicate which accessories were used during the test.



<WLAN SAR – EUT with Hand Strap>

Plot No.	Band	Mode	Test Position	Gap (cm)	Ch.	Freq. (MHz)	Output Power	Jelly Sets	Hand Strap	Holster	SAR _{1g} (W/kg)
154	WLAN2.4G	802.11b	Bottom Face	0	6	2437	21.21	-	v	-	0.131
155	WLAN2.4G	802.11b	Secondary Portrait	0	6	2437	21.21	-	v	-	0.16
156	WLAN2.4G	802.11b	Front Face	0	6	2437	21.21	-	v	v	0.215
159	WLAN5G	802.11a	Bottom Face	0	48	5240	14.59	-	v	-	0.06
160	WLAN5G	802.11a	Front Face	0	48	5240	14.59	-	v	v	0.134
169	WLAN5G	802.11a	Bottom Face	0	52	5260	20.44	-	v	-	0.189
170	WLAN5G	802.11a	Front Face	0	52	5260	20.44	-	v	v	0.346
140	WLAN5G	802.11a	Bottom Face	0	116	5580	21.18	-	v	-	0.198
141	WLAN5G	802.11a	Front Face	0	116	5580	21.18	-	v	v	0.444
143	WLAN5G	802.11a	Front Face	0	116	5580	21.18	v	v	v	0.472
128	WLAN5G	802.11a	Bottom Face	0	165	5825	22.51	-	v	-	0.23
129	WLAN5G	802.11a	Front Face	0	165	5825	22.51	-	v	v	0.385
131	WLAN5G	802.11a	Front Face	0	165	5825	22.51	v	v	v	0.456

Note:

1. Per KDB 447498, if the highest output channel SAR for each exposure position ≤ 0.8 W/kg other channels SAR tests are not necessary.
2. "V" mark indicate which accessories were used during the test.



11.2 Simultaneous Transmission SAR Analysis

	Applicable Combination
Simultaneous Transmission	WWAN+WLAN
	WWAN+BT

Note:

1. EUT will choose either WCDMA/HSPA or GPRS/EDGE or CDMA2000 according to the network signal condition, therefore, they will not transmit simultaneously.
2. WLAN2.4G and Bluetooth share the same antenna and cannot transmit simultaneously.
3. EUT will choose either WLAN 2.4G or WLAN5G according to the network signal condition, therefore, they will not transmit simultaneously.
4. The maximum SAR summation is calculated based on the same configuration and test position.
5. When stand-alone 1-g SAR is not required for a transmitter or antenna, its SAR is considered zero in the 1-g SAR summing process to determine simultaneous transmission SAR evaluation requirements.
6. If 1g-SAR scalar summation < 1.6W/kg, simultaneous SAR measurement is not necessary.
7. If 1g-SAR summation > 1.6W/kg, SPLSR calculation is necessary.
8. The WWAN scaling factor is calculated according to the difference between measured output power and maximum tolerance power on this device.
9. The SPLSR calculations are based on the scaled WWAN SAR, to show the SAR compliance of the worst conditions among all production units.



<Tablet without Hand Strap>

Position	WWAN							WLAN 2.4G		Max. SAR Summation	Scaled WWAN + WLAN
	WWAN Band	Plot No	Max. WWAN SAR (W/kg)	Output Power (dBm)	Max. Tolerance Power (dBm)	Scaling Factor	Scaled WWAN (W/kg)	Plot No	Max. WLAN SAR (W/kg)		
Front Face	GSM850	10	0.342	30.98	31.1	1.03	0.352	147	0.184	0.53	0.54
	GSM1900	42	0.544	30.55	30.8	1.06	0.576	147	0.184	0.73	0.76
	WCDMA V	4	0.338	24.03	24.7	1.17	0.394	147	0.184	0.52	0.58
	WCDMA IV	101	0.414	22.92	23.7	1.20	0.495	147	0.184	0.60	0.68
	WCDMA II	64	0.465	23.01	23.7	1.17	0.545	147	0.184	0.65	0.73
	CDMA2000 BC0	24	0.414	23.92	25	1.28	0.531	147	0.184	0.60	0.72
CDMA2000 BC1	48	0.647	24.1	24.5	1.10	0.709	147	0.184	0.83	0.89	
Bottom Face	GSM850	12	0.894	30.89	31.1	1.05	0.938	153	1.4	2.29	2.34
	GSM1900	85	0.944	30.24	30.8	1.14	1.074	153	1.4	2.34	2.47
	WCDMA V	74	0.944	23.83	24.7	1.22	1.153	153	1.4	2.34	2.55
	WCDMA IV	96	0.696	22.92	23.7	1.20	0.833	153	1.4	2.10	2.23
	WCDMA II	78	0.865	23.01	23.7	1.17	1.014	153	1.4	2.27	2.41
	CDMA2000 BC0	77	0.986	23.69	25	1.35	1.333	153	1.4	2.39	2.73
CDMA2000 BC1	88	1.28	23.95	24.5	1.14	1.453	153	1.4	2.68	2.85	
Secondary Portrait	GSM850	-	0	-	-	-	-	146	0.179	0.18	0.18
	GSM1900	-	0	-	-	-	-	146	0.179	0.18	0.18
	WCDMA V	-	0	-	-	-	-	146	0.179	0.18	0.18
	WCDMA IV	-	0	-	-	-	-	146	0.179	0.18	0.18
	WCDMA II	-	0	-	-	-	-	146	0.179	0.18	0.18
	CDMA2000 BC0	-	0	-	-	-	-	146	0.179	0.18	0.18
CDMA2000 BC1	-	0	-	-	-	-	146	0.179	0.18	0.18	
Primary Portrait	GSM850	8	0.51	30.98	31.1	1.03	0.524	-	0	0.51	0.52
	GSM1900	40	0.718	30.55	30.8	1.06	0.761	-	0	0.72	0.76
	WCDMA V	2	0.542	24.03	24.7	1.17	0.632	-	0	0.54	0.63
	WCDMA IV	99	0.964	22.87	23.7	1.21	1.167	-	0	0.96	1.17
	WCDMA II	62	0.619	23.01	23.7	1.17	0.726	-	0	0.62	0.73
	CDMA2000 BC0	22	0.658	23.92	25	1.28	0.844	-	0	0.66	0.84
CDMA2000 BC1	52	0.91	23.99	24.5	1.12	1.023	-	0	0.91	1.02	
Secondary Landscape	GSM850	-	0	-	-	-	-	148	0.298	0.30	0.30
	GSM1900	-	0	-	-	-	-	148	0.298	0.30	0.30
	WCDMA V	-	0	-	-	-	-	148	0.298	0.30	0.30
	WCDMA IV	-	0	-	-	-	-	148	0.298	0.30	0.30
	WCDMA II	-	0	-	-	-	-	148	0.298	0.30	0.30
	CDMA2000 BC0	-	0	-	-	-	-	148	0.298	0.30	0.30
CDMA2000 BC1	-	0	-	-	-	-	148	0.298	0.30	0.30	
Primary Landscape	GSM850	9	0.404	30.98	31.1	1.03	0.415	-	0	0.40	0.42
	GSM1900	41	0.05	30.55	30.8	1.06	0.053	-	0	0.05	0.05
	WCDMA V	3	0.31	24.03	24.7	1.17	0.362	-	0	0.31	0.36
	WCDMA IV	100	0.08	22.92	23.7	1.20	0.096	-	0	0.08	0.10
	WCDMA II	63	0.052	23.01	23.7	1.17	0.061	-	0	0.05	0.06
	CDMA2000 BC0	23	0.427	23.92	25	1.28	0.548	-	0	0.43	0.55
CDMA2000 BC1	47	0.07	24.1	24.5	1.10	0.077	-	0	0.07	0.08	



<Tablet with Hand Strap>

Position	WWAN							WLAN 2.4G		Max. SAR Summation	Scaled WWAN + WLAN
	WWAN Band	Plot No	Max. WWAN SAR (W/kg)	Output Power (dBm)	Max. Tolerance Power (dBm)	Scaling Factor	Scaled WWAN (W/kg)	Plot No	Max. WLAN SAR (W/kg)		
Front Face	GSM850	16	0.35	30.98	31.1	1.03	0.360	156	0.215	0.57	0.58
	GSM1900	38	0.532	30.55	30.8	1.06	0.564	156	0.215	0.75	0.78
	WCDMA V	20	0.369	24.03	24.7	1.17	0.431	156	0.215	0.58	0.65
	WCDMA IV	107	0.471	22.92	23.7	1.20	0.564	156	0.215	0.69	0.78
	WCDMA II	58	0.534	23.01	23.7	1.17	0.626	156	0.215	0.75	0.84
	CDMA2000 BC0	30	0.413	23.92	25	1.28	0.530	156	0.215	0.63	0.75
	CDMA2000 BC1	34	0.735	24.1	24.5	1.10	0.806	156	0.215	0.95	1.02
Bottom Face	GSM850	13	0.167	30.98	31.1	1.03	0.172	154	0.131	0.30	0.30
	GSM1900	35	0.162	30.55	30.8	1.06	0.172	154	0.131	0.29	0.30
	WCDMA V	17	0.145	24.03	24.7	1.17	0.169	154	0.131	0.28	0.30
	WCDMA IV	102	0.124	22.92	23.7	1.20	0.148	154	0.131	0.26	0.28
	WCDMA II	55	0.197	23.01	23.7	1.17	0.231	154	0.131	0.33	0.36
	CDMA2000 BC0	27	0.153	23.92	25	1.28	0.196	154	0.131	0.28	0.33
	CDMA2000 BC1	31	0.205	24.1	24.5	1.10	0.225	154	0.131	0.34	0.36
Secondary Portrait	GSM850	-	0	-	-	-	-	155	0.16	0.16	0.16
	GSM1900	-	0	-	-	-	-	155	0.16	0.16	0.16
	WCDMA V	-	0	-	-	-	-	155	0.16	0.16	0.16
	WCDMA IV	-	0	-	-	-	-	155	0.16	0.16	0.16
	WCDMA II	-	0	-	-	-	-	155	0.16	0.16	0.16
	CDMA2000 BC0	-	0	-	-	-	-	155	0.16	0.16	0.16
	CDMA2000 BC1	-	0	-	-	-	-	155	0.16	0.16	0.16
Primary Portrait	GSM850	92	0.583	30.98	31.1	1.03	0.599	-	0	0.58	0.60
	GSM1900	81	0.715	30.55	30.8	1.06	0.757	-	0	0.72	0.76
	WCDMA V	95	0.595	24.03	24.7	1.17	0.694	-	0	0.60	0.69
	WCDMA IV	105	1.01	22.87	23.7	1.21	1.223	-	0	1.01	1.22
	WCDMA II	59	0.756	23.01	23.7	1.17	0.886	-	0	0.76	0.89
	CDMA2000 BC0	28	0.649	23.92	25	1.28	0.832	-	0	0.65	0.83
	CDMA2000 BC1	54	0.875	23.99	24.5	1.12	0.984	-	0	0.88	0.98
Secondary Landscape	GSM850	-	0	-	-	-	-	158	0.279	0.28	0.28
	GSM1900	-	0	-	-	-	-	158	0.279	0.28	0.28
	WCDMA V	-	0	-	-	-	-	158	0.279	0.28	0.28
	WCDMA IV	-	0	-	-	-	-	158	0.279	0.28	0.28
	WCDMA II	-	0	-	-	-	-	158	0.279	0.28	0.28
	CDMA2000 BC0	-	0	-	-	-	-	158	0.279	0.28	0.28
	CDMA2000 BC1	-	0	-	-	-	-	158	0.279	0.28	0.28
Primary Landscape	GSM850	15	0.443	30.98	31.1	1.03	0.455	-	0	0.44	0.46
	GSM1900	37	0.045	30.55	30.8	1.06	0.048	-	0	0.05	0.05
	WCDMA V	19	0.32	24.03	24.7	1.17	0.373	-	0	0.32	0.37
	WCDMA IV	106	0.045	22.92	23.7	1.20	0.054	-	0	0.05	0.05
	WCDMA II	57	0.063	23.01	23.7	1.17	0.074	-	0	0.06	0.07
	CDMA2000 BC0	29	0.374	23.92	25	1.28	0.480	-	0	0.37	0.48
	CDMA2000 BC1	33	0.063	24.1	24.5	1.10	0.069	-	0	0.06	0.07



<Tablet without Hand Strap>

Position	WWAN							WLAN5G Band I		Max. SAR Summation	Scaled WWAN + WLAN
	WWAN Band	Plot No	Max. WWAN SAR (W/kg)	Output Power (dBm)	Max. Tolerance Power (dBm)	Scaling Factor	Scaled WWAN (W/kg)	Plot No	Max. WLAN SAR (W/kg)		
Front Face	GSM850	10	0.342	30.98	31.1	1.03	0.352	121	0.103	0.45	0.46
	GSM1900	42	0.544	30.55	30.8	1.06	0.576	121	0.103	0.65	0.68
	WCDMA V	4	0.338	24.03	24.7	1.17	0.394	121	0.103	0.44	0.50
	WCDMA IV	101	0.414	22.92	23.7	1.20	0.495	121	0.103	0.52	0.60
	WCDMA II	64	0.465	23.01	23.7	1.17	0.545	121	0.103	0.57	0.65
	CDMA2000 BC0	24	0.414	23.92	25	1.28	0.531	121	0.103	0.52	0.63
	CDMA2000 BC1	48	0.647	24.1	24.5	1.10	0.709	121	0.103	0.75	0.81
Bottom Face	GSM850	12	0.894	30.89	31.1	1.05	0.938	123	0.474	1.37	1.41
	GSM1900	85	0.944	30.24	30.8	1.14	1.074	123	0.474	1.42	1.55
	WCDMA V	74	0.944	23.83	24.7	1.22	1.153	123	0.474	1.42	1.63
	WCDMA IV	96	0.696	22.92	23.7	1.20	0.833	123	0.474	1.17	1.31
	WCDMA II	78	0.865	23.01	23.7	1.17	1.014	123	0.474	1.34	1.49
	CDMA2000 BC0	77	0.986	23.69	25	1.35	1.333	123	0.474	1.46	1.81
	CDMA2000 BC1	88	1.28	23.95	24.5	1.14	1.453	123	0.474	1.75	1.93
Primary Portrait	GSM850	8	0.51	30.98	31.1	1.03	0.524	-	0	0.51	0.52
	GSM1900	40	0.718	30.55	30.8	1.06	0.761	-	0	0.72	0.76
	WCDMA V	2	0.542	24.03	24.7	1.17	0.632	-	0	0.54	0.63
	WCDMA IV	99	0.964	22.87	23.7	1.21	1.167	-	0	0.96	1.17
	WCDMA II	62	0.619	23.01	23.7	1.17	0.726	-	0	0.62	0.73
	CDMA2000 BC0	22	0.658	23.92	25	1.28	0.844	-	0	0.66	0.84
	CDMA2000 BC1	52	0.91	23.99	24.5	1.12	1.023	-	0	0.91	1.02
Secondary Landscape	GSM850	-	0	-	-	-	-	122	0.151	0.15	0.15
	GSM1900	-	0	-	-	-	-	122	0.151	0.15	0.15
	WCDMA V	-	0	-	-	-	-	122	0.151	0.15	0.15
	WCDMA IV	-	0	-	-	-	-	122	0.151	0.15	0.15
	WCDMA II	-	0	-	-	-	-	122	0.151	0.15	0.15
	CDMA2000 BC0	-	0	-	-	-	-	122	0.151	0.15	0.15
	CDMA2000 BC1	-	0	-	-	-	-	122	0.151	0.15	0.15
Primary Landscape	GSM850	9	0.404	30.98	31.1	1.03	0.415	-	0	0.40	0.42
	GSM1900	41	0.05	30.55	30.8	1.06	0.053	-	0	0.05	0.05
	WCDMA V	3	0.31	24.03	24.7	1.17	0.362	-	0	0.31	0.36
	WCDMA IV	100	0.08	22.92	23.7	1.20	0.096	-	0	0.08	0.10
	WCDMA II	63	0.052	23.01	23.7	1.17	0.061	-	0	0.05	0.06
	CDMA2000 BC0	23	0.427	23.92	25	1.28	0.548	-	0	0.43	0.55
	CDMA2000 BC1	47	0.07	24.1	24.5	1.10	0.077	-	0	0.07	0.08



<Tablet with Hand Strap>

Position	WWAN							WLAN5G Band I		Max. SAR Summation	Scaled WWAN + WLAN
	WWAN Band	Plot No	Max. WWAN SAR (W/kg)	Output Power (dBm)	Max. Tolerance Power (dBm)	Scaling Factor	Scaled WWAN (W/kg)	Plot No	Max. WLAN SAR (W/kg)		
Front Face	GSM850	16	0.35	30.98	31.1	1.03	0.360	160	0.134	0.48	0.49
	GSM1900	38	0.532	30.55	30.8	1.06	0.564	160	0.134	0.67	0.70
	WCDMA V	20	0.369	24.03	24.7	1.17	0.431	160	0.134	0.50	0.57
	WCDMA IV	107	0.471	22.92	23.7	1.20	0.564	160	0.134	0.61	0.70
	WCDMA II	58	0.534	23.01	23.7	1.17	0.626	160	0.134	0.67	0.76
	CDMA2000 BC0	30	0.413	23.92	25	1.28	0.530	160	0.134	0.55	0.66
	CDMA2000 BC1	34	0.735	24.1	24.5	1.10	0.806	160	0.134	0.87	0.94
Bottom Face	GSM850	13	0.167	30.98	31.1	1.03	0.172	159	0.06	0.23	0.23
	GSM1900	35	0.162	30.55	30.8	1.06	0.172	159	0.06	0.22	0.23
	WCDMA V	17	0.145	24.03	24.7	1.17	0.169	159	0.06	0.21	0.23
	WCDMA IV	102	0.124	22.92	23.7	1.20	0.148	159	0.06	0.18	0.21
	WCDMA II	55	0.197	23.01	23.7	1.17	0.231	159	0.06	0.26	0.29
	CDMA2000 BC0	27	0.153	23.92	25	1.28	0.196	159	0.06	0.21	0.26
	CDMA2000 BC1	31	0.205	24.1	24.5	1.10	0.225	159	0.06	0.27	0.29
Primary Portrait	GSM850	92	0.583	30.98	31.1	1.03	0.599	-	0	0.58	0.60
	GSM1900	81	0.715	30.55	30.8	1.06	0.757	-	0	0.72	0.76
	WCDMA V	95	0.595	24.03	24.7	1.17	0.694	-	0	0.60	0.69
	WCDMA IV	105	1.01	22.87	23.7	1.21	1.223	-	0	1.01	1.22
	WCDMA II	59	0.756	23.01	23.7	1.17	0.886	-	0	0.76	0.89
	CDMA2000 BC0	28	0.649	23.92	25	1.28	0.832	-	0	0.65	0.83
	CDMA2000 BC1	54	0.875	23.99	24.5	1.12	0.984	-	0	0.88	0.98
Secondary Landscape	GSM850	-	0	-	-	-	-	161	0.143	0.14	0.14
	GSM1900	-	0	-	-	-	-	161	0.143	0.14	0.14
	WCDMA V	-	0	-	-	-	-	161	0.143	0.14	0.14
	WCDMA IV	-	0	-	-	-	-	161	0.143	0.14	0.14
	WCDMA II	-	0	-	-	-	-	161	0.143	0.14	0.14
	CDMA2000 BC0	-	0	-	-	-	-	161	0.143	0.14	0.14
	CDMA2000 BC1	-	0	-	-	-	-	161	0.143	0.14	0.14
Primary Landscape	GSM850	15	0.443	30.98	31.1	1.03	0.455	-	0	0.44	0.46
	GSM1900	37	0.045	30.55	30.8	1.06	0.048	-	0	0.05	0.05
	WCDMA V	19	0.32	24.03	24.7	1.17	0.373	-	0	0.32	0.37
	WCDMA IV	106	0.045	22.92	23.7	1.20	0.054	-	0	0.05	0.05
	WCDMA II	57	0.063	23.01	23.7	1.17	0.074	-	0	0.06	0.07
	CDMA2000 BC0	29	0.374	23.92	25	1.28	0.480	-	0	0.37	0.48
	CDMA2000 BC1	33	0.063	24.1	24.5	1.10	0.069	-	0	0.06	0.07



<Tablet without Hand Strap>

Position	WWAN							WLAN5G Band II		Max. SAR Summation	Scaled WWAN + WLAN
	WWAN Band	Plot No	Max. WWAN SAR (W/kg)	Output Power (dBm)	Max. Tolerance Power (dBm)	Scaling Factor	Scaled WWAN (W/kg)	Plot No	Max. WLAN SAR (W/kg)		
Front Face	GSM850	10	0.342	30.98	31.1	1.03	0.352	164	0.351	0.69	0.70
	GSM1900	42	0.544	30.55	30.8	1.06	0.576	164	0.351	0.90	0.93
	WCDMA V	4	0.338	24.03	24.7	1.17	0.394	164	0.351	0.69	0.75
	WCDMA IV	101	0.414	22.92	23.7	1.20	0.495	164	0.351	0.77	0.85
	WCDMA II	64	0.465	23.01	23.7	1.17	0.545	164	0.351	0.82	0.90
	CDMA2000 BC0	24	0.414	23.92	25	1.28	0.531	164	0.351	0.77	0.88
	CDMA2000 BC1	48	0.647	24.1	24.5	1.10	0.709	164	0.351	1.00	1.06
Bottom Face	GSM850	12	0.894	30.89	31.1	1.05	0.938	163	1.38	2.27	2.32
	GSM1900	85	0.944	30.24	30.8	1.14	1.074	163	1.38	2.32	2.45
	WCDMA V	74	0.944	23.83	24.7	1.22	1.153	163	1.38	2.32	2.53
	WCDMA IV	96	0.696	22.92	23.7	1.20	0.833	163	1.38	2.08	2.21
	WCDMA II	78	0.865	23.01	23.7	1.17	1.014	163	1.38	2.25	2.39
	CDMA2000 BC0	77	0.986	23.69	25	1.35	1.333	163	1.38	2.37	2.71
	CDMA2000 BC1	88	1.28	23.95	24.5	1.14	1.453	163	1.38	2.66	2.83
Primary Portrait	GSM850	8	0.51	30.98	31.1	1.03	0.524	-	0	0.51	0.52
	GSM1900	40	0.718	30.55	30.8	1.06	0.761	-	0	0.72	0.76
	WCDMA V	2	0.542	24.03	24.7	1.17	0.632	-	0	0.54	0.63
	WCDMA IV	99	0.964	22.87	23.7	1.21	1.167	-	0	0.96	1.17
	WCDMA II	62	0.619	23.01	23.7	1.17	0.726	-	0	0.62	0.73
	CDMA2000 BC0	22	0.658	23.92	25	1.28	0.844	-	0	0.66	0.84
	CDMA2000 BC1	52	0.91	23.99	24.5	1.12	1.023	-	0	0.91	1.02
Secondary Landscape	GSM850	-	0	-	-	-	-	165	0.394	0.39	0.39
	GSM1900	-	0	-	-	-	-	165	0.394	0.39	0.39
	WCDMA V	-	0	-	-	-	-	165	0.394	0.39	0.39
	WCDMA IV	-	0	-	-	-	-	165	0.394	0.39	0.39
	WCDMA II	-	0	-	-	-	-	165	0.394	0.39	0.39
	CDMA2000 BC0	-	0	-	-	-	-	165	0.394	0.39	0.39
	CDMA2000 BC1	-	0	-	-	-	-	165	0.394	0.39	0.39
Primary Landscape	GSM850	9	0.404	30.98	31.1	1.03	0.415	-	0	0.40	0.42
	GSM1900	41	0.05	30.55	30.8	1.06	0.053	-	0	0.05	0.05
	WCDMA V	3	0.31	24.03	24.7	1.17	0.362	-	0	0.31	0.36
	WCDMA IV	100	0.08	22.92	23.7	1.20	0.096	-	0	0.08	0.10
	WCDMA II	63	0.052	23.01	23.7	1.17	0.061	-	0	0.05	0.06
	CDMA2000 BC0	23	0.427	23.92	25	1.28	0.548	-	0	0.43	0.55
	CDMA2000 BC1	47	0.07	24.1	24.5	1.10	0.077	-	0	0.07	0.08



<Tablet with Hand Strap>

Position	WWAN							WLAN5G Band II		Max. SAR Summation	Scaled WWAN + WLAN
	WWAN Band	Plot No	Max. WWAN SAR (W/kg)	Output Power (dBm)	Max. Tolerance Power (dBm)	Scaling Factor	Scaled WWAN (W/kg)	Plot No	Max. WLAN SAR (W/kg)		
Front Face	GSM850	16	0.35	30.98	31.1	1.03	0.360	170	0.346	0.70	0.71
	GSM1900	38	0.532	30.55	30.8	1.06	0.564	170	0.346	0.88	0.91
	WCDMA V	20	0.369	24.03	24.7	1.17	0.431	170	0.346	0.72	0.78
	WCDMA IV	107	0.471	22.92	23.7	1.20	0.564	170	0.346	0.82	0.91
	WCDMA II	58	0.534	23.01	23.7	1.17	0.626	170	0.346	0.88	0.97
	CDMA2000 BC0	30	0.413	23.92	25	1.28	0.530	170	0.346	0.76	0.88
	CDMA2000 BC1	34	0.735	24.1	24.5	1.10	0.806	170	0.346	1.08	1.15
Bottom Face	GSM850	13	0.167	30.98	31.1	1.03	0.172	169	0.189	0.36	0.36
	GSM1900	35	0.162	30.55	30.8	1.06	0.172	169	0.189	0.35	0.36
	WCDMA V	17	0.145	24.03	24.7	1.17	0.169	169	0.189	0.33	0.36
	WCDMA IV	102	0.124	22.92	23.7	1.20	0.148	169	0.189	0.31	0.34
	WCDMA II	55	0.197	23.01	23.7	1.17	0.231	169	0.189	0.39	0.42
	CDMA2000 BC0	27	0.153	23.92	25	1.28	0.196	169	0.189	0.34	0.39
	CDMA2000 BC1	31	0.205	24.1	24.5	1.10	0.225	169	0.189	0.39	0.41
Primary Portrait	GSM850	92	0.583	30.98	31.1	1.03	0.599	-	0	0.58	0.60
	GSM1900	81	0.715	30.55	30.8	1.06	0.757	-	0	0.72	0.76
	WCDMA V	95	0.595	24.03	24.7	1.17	0.694	-	0	0.60	0.69
	WCDMA IV	105	1.01	22.87	23.7	1.21	1.223	-	0	1.01	1.22
	WCDMA II	59	0.756	23.01	23.7	1.17	0.886	-	0	0.76	0.89
	CDMA2000 BC0	28	0.649	23.92	25	1.28	0.832	-	0	0.65	0.83
	CDMA2000 BC1	54	0.875	23.99	24.5	1.12	0.984	-	0	0.88	0.98
Secondary Landscape	GSM850	-	0	-	-	-	-	171	0.418	0.42	0.42
	GSM1900	-	0	-	-	-	-	171	0.418	0.42	0.42
	WCDMA V	-	0	-	-	-	-	171	0.418	0.42	0.42
	WCDMA IV	-	0	-	-	-	-	171	0.418	0.42	0.42
	WCDMA II	-	0	-	-	-	-	171	0.418	0.42	0.42
	CDMA2000 BC0	-	0	-	-	-	-	171	0.418	0.42	0.42
	CDMA2000 BC1	-	0	-	-	-	-	171	0.418	0.42	0.42
Primary Landscape	GSM850	15	0.443	30.98	31.1	1.03	0.455	-	0	0.44	0.46
	GSM1900	37	0.045	30.55	30.8	1.06	0.048	-	0	0.05	0.05
	WCDMA V	19	0.32	24.03	24.7	1.17	0.373	-	0	0.32	0.37
	WCDMA IV	106	0.045	22.92	23.7	1.20	0.054	-	0	0.05	0.05
	WCDMA II	57	0.063	23.01	23.7	1.17	0.074	-	0	0.06	0.07
	CDMA2000 BC0	29	0.374	23.92	25	1.28	0.480	-	0	0.37	0.48
	CDMA2000 BC1	33	0.063	24.1	24.5	1.10	0.069	-	0	0.06	0.07



<Tablet without Hand Strap>

Position	WWAN							WLAN5G Band III		Max. SAR Summation	Scaled WWAN + WLAN
	WWAN Band	Plot No	Max. WWAN SAR (W/kg)	Output Power (dBm)	Max. Tolerance Power (dBm)	Scaling Factor	Scaled WWAN (W/kg)	Plot No	Max. WLAN SAR (W/kg)		
Front Face	GSM850	10	0.342	30.98	31.1	1.03	0.352	133	0.391	0.73	0.74
	GSM1900	42	0.544	30.55	30.8	1.06	0.576	133	0.391	0.94	0.97
	WCDMA V	4	0.338	24.03	24.7	1.17	0.394	133	0.391	0.73	0.79
	WCDMA IV	101	0.414	22.92	23.7	1.20	0.495	133	0.391	0.81	0.89
	WCDMA II	64	0.465	23.01	23.7	1.17	0.545	133	0.391	0.86	0.94
	CDMA2000 BC0	24	0.414	23.92	25	1.28	0.531	133	0.391	0.81	0.92
	CDMA2000 BC1	48	0.647	24.1	24.5	1.10	0.709	133	0.391	1.04	1.10
Bottom Face	GSM850	12	0.894	30.89	31.1	1.05	0.938	135	1.22	2.11	2.16
	GSM1900	85	0.944	30.24	30.8	1.14	1.074	135	1.22	2.16	2.29
	WCDMA V	74	0.944	23.83	24.7	1.22	1.153	135	1.22	2.16	2.37
	WCDMA IV	96	0.696	22.92	23.7	1.20	0.833	135	1.22	1.92	2.05
	WCDMA II	78	0.865	23.01	23.7	1.17	1.014	135	1.22	2.09	2.23
	CDMA2000 BC0	77	0.986	23.69	25	1.35	1.333	135	1.22	2.21	2.55
	CDMA2000 BC1	88	1.28	23.95	24.5	1.14	1.453	135	1.22	2.50	2.67
Primary Portrait	GSM850	8	0.51	30.98	31.1	1.03	0.524	-	0	0.51	0.52
	GSM1900	40	0.718	30.55	30.8	1.06	0.761	-	0	0.72	0.76
	WCDMA V	2	0.542	24.03	24.7	1.17	0.632	-	0	0.54	0.63
	WCDMA IV	99	0.964	22.87	23.7	1.21	1.167	-	0	0.96	1.17
	WCDMA II	62	0.619	23.01	23.7	1.17	0.726	-	0	0.62	0.73
	CDMA2000 BC0	22	0.658	23.92	25	1.28	0.844	-	0	0.66	0.84
	CDMA2000 BC1	52	0.91	23.99	24.5	1.12	1.023	-	0	0.91	1.02
Secondary Landscape	GSM850	-	0	-	-	-	-	134	0.418	0.42	0.42
	GSM1900	-	0	-	-	-	-	134	0.418	0.42	0.42
	WCDMA V	-	0	-	-	-	-	134	0.418	0.42	0.42
	WCDMA IV	-	0	-	-	-	-	134	0.418	0.42	0.42
	WCDMA II	-	0	-	-	-	-	134	0.418	0.42	0.42
	CDMA2000 BC0	-	0	-	-	-	-	134	0.418	0.42	0.42
	CDMA2000 BC1	-	0	-	-	-	-	134	0.418	0.42	0.42
Primary Landscape	GSM850	9	0.404	30.98	31.1	1.03	0.415	-	0	0.40	0.42
	GSM1900	41	0.05	30.55	30.8	1.06	0.053	-	0	0.05	0.05
	WCDMA V	3	0.31	24.03	24.7	1.17	0.362	-	0	0.31	0.36
	WCDMA IV	100	0.08	22.92	23.7	1.20	0.096	-	0	0.08	0.10
	WCDMA II	63	0.052	23.01	23.7	1.17	0.061	-	0	0.05	0.06
	CDMA2000 BC0	23	0.427	23.92	25	1.28	0.548	-	0	0.43	0.55
	CDMA2000 BC1	47	0.07	24.1	24.5	1.10	0.077	-	0	0.07	0.08



<Tablet with Hand Strap>

Position	WWAN							WLAN5G Band III		Max. SAR Summation	Scaled WWAN + WLAN
	WWAN Band	Plot No	Max. WWAN SAR (W/kg)	Output Power (dBm)	Max. Tolerance Power (dBm)	Scaling Factor	Scaled WWAN (W/kg)	Plot No	Max. WLAN SAR (W/kg)		
Front Face	GSM850	16	0.35	30.98	31.1	1.03	0.360	143	0.472	0.82	0.83
	GSM1900	38	0.532	30.55	30.8	1.06	0.564	143	0.472	1.00	1.04
	WCDMA V	20	0.369	24.03	24.7	1.17	0.431	143	0.472	0.84	0.90
	WCDMA IV	107	0.471	22.92	23.7	1.20	0.564	143	0.472	0.94	1.04
	WCDMA II	58	0.534	23.01	23.7	1.17	0.626	143	0.472	1.01	1.10
	CDMA2000 BC0	30	0.413	23.92	25	1.28	0.530	143	0.472	0.89	1.00
	CDMA2000 BC1	34	0.735	24.1	24.5	1.10	0.806	143	0.472	1.21	1.28
Bottom Face	GSM850	13	0.167	30.98	31.1	1.03	0.172	140	0.198	0.37	0.37
	GSM1900	35	0.162	30.55	30.8	1.06	0.172	140	0.198	0.36	0.37
	WCDMA V	17	0.145	24.03	24.7	1.17	0.169	140	0.198	0.34	0.37
	WCDMA IV	102	0.124	22.92	23.7	1.20	0.148	140	0.198	0.32	0.35
	WCDMA II	55	0.197	23.01	23.7	1.17	0.231	140	0.198	0.40	0.43
	CDMA2000 BC0	27	0.153	23.92	25	1.28	0.196	140	0.198	0.35	0.39
	CDMA2000 BC1	31	0.205	24.1	24.5	1.10	0.225	140	0.198	0.40	0.42
Primary Portrait	GSM850	92	0.583	30.98	31.1	1.03	0.599	-	0	0.58	0.60
	GSM1900	81	0.715	30.55	30.8	1.06	0.757	-	0	0.72	0.76
	WCDMA V	95	0.595	24.03	24.7	1.17	0.694	-	0	0.60	0.69
	WCDMA IV	105	1.01	22.87	23.7	1.21	1.223	-	0	1.01	1.22
	WCDMA II	56	0.756	23.01	23.7	1.17	0.886	-	0	0.76	0.89
	CDMA2000 BC0	28	0.649	23.92	25	1.28	0.832	-	0	0.65	0.83
	CDMA2000 BC1	54	0.875	23.99	24.5	1.12	0.984	-	0	0.88	0.98
Secondary Landscape	GSM850	-	0	-	-	-	-	142	0.433	0.43	0.43
	GSM1900	-	0	-	-	-	-	142	0.433	0.43	0.43
	WCDMA V	-	0	-	-	-	-	142	0.433	0.43	0.43
	WCDMA IV	-	0	-	-	-	-	142	0.433	0.43	0.43
	WCDMA II	-	0	-	-	-	-	142	0.433	0.43	0.43
	CDMA2000 BC0	-	0	-	-	-	-	142	0.433	0.43	0.43
	CDMA2000 BC1	-	0	-	-	-	-	142	0.433	0.43	0.43
Primary Landscape	GSM850	15	0.443	30.98	31.1	1.03	0.455	-	0	0.44	0.46
	GSM1900	37	0.045	30.55	30.8	1.06	0.048	-	0	0.05	0.05
	WCDMA V	19	0.32	24.03	24.7	1.17	0.373	-	0	0.32	0.37
	WCDMA IV	106	0.045	22.92	23.7	1.20	0.054	-	0	0.05	0.05
	WCDMA II	57	0.063	23.01	23.7	1.17	0.074	-	0	0.06	0.07
	CDMA2000 BC0	29	0.374	23.92	25	1.28	0.480	-	0	0.37	0.48
	CDMA2000 BC1	33	0.063	24.1	24.5	1.10	0.069	-	0	0.06	0.07



<Tablet without Hand Strap>

Position	WWAN							WLAN5G Band IV		Max. SAR Summation	Scaled WWAN + WLAN
	WWAN Band	Plot No	Max. WWAN SAR (W/kg)	Output Power (dBm)	Max. Tolerance Power (dBm)	Scaling Factor	Scaled WWAN (W/kg)	Plot No	Max. WLAN SAR (W/kg)		
Front Face	GSM850	10	0.342	30.98	31.1	1.03	0.352	115	0.25	0.59	0.60
	GSM1900	42	0.544	30.55	30.8	1.06	0.576	115	0.25	0.79	0.83
	WCDMA V	4	0.338	24.03	24.7	1.17	0.443	115	0.25	0.59	0.64
	WCDMA IV	101	0.414	22.92	23.7	1.20	0.495	115	0.25	0.66	0.75
	WCDMA II	64	0.465	23.01	23.7	1.17	0.545	115	0.25	0.72	0.80
	CDMA2000 BC0	24	0.414	23.92	25	1.28	0.531	115	0.25	0.66	0.78
	CDMA2000 BC1	48	0.647	24.1	24.5	1.10	0.709	115	0.25	0.90	0.96
Bottom Face	GSM850	12	0.894	30.89	31.1	1.05	0.938	114	1.33	2.22	2.27
	GSM1900	85	0.944	30.24	30.8	1.14	1.074	114	1.33	2.27	2.40
	WCDMA V	74	0.944	23.83	24.7	1.22	1.153	114	1.33	2.27	2.48
	WCDMA IV	96	0.696	22.92	23.7	1.20	0.833	114	1.33	2.03	2.16
	WCDMA II	78	0.865	23.01	23.7	1.17	1.014	114	1.33	2.20	2.34
	CDMA2000 BC0	77	0.986	23.69	25	1.35	1.333	114	1.33	2.32	2.66
	CDMA2000 BC1	88	1.28	23.95	24.5	1.14	1.453	114	1.33	2.61	2.78
Primary Portrait	GSM850	8	0.51	30.98	31.1	1.03	0.524	-	0	0.51	0.52
	GSM1900	40	0.718	30.55	30.8	1.06	0.761	-	0	0.72	0.76
	WCDMA V	2	0.542	24.03	24.7	1.17	0.632	-	0	0.54	0.63
	WCDMA IV	99	0.964	22.87	23.7	1.21	1.167	-	0	0.96	1.17
	WCDMA II	62	0.619	23.01	23.7	1.17	0.726	-	0	0.62	0.73
	CDMA2000 BC0	22	0.658	23.92	25	1.28	0.844	-	0	0.66	0.84
	CDMA2000 BC1	52	0.91	23.99	24.5	1.12	1.023	-	0	0.91	1.02
Secondary Landscape	GSM850	-	0	-	-	-	-	116	0.256	0.26	0.26
	GSM1900	-	0	-	-	-	-	116	0.256	0.26	0.26
	WCDMA V	-	0	-	-	-	-	116	0.256	0.26	0.26
	WCDMA IV	-	0	-	-	-	-	116	0.256	0.26	0.26
	WCDMA II	-	0	-	-	-	-	116	0.256	0.26	0.26
	CDMA2000 BC0	-	0	-	-	-	-	116	0.256	0.26	0.26
	CDMA2000 BC1	-	0	-	-	-	-	116	0.256	0.26	0.26
Primary Landscape	GSM850	9	0.404	30.98	31.1	1.03	0.415	-	0	0.40	0.42
	GSM1900	41	0.05	30.55	30.8	1.06	0.053	-	0	0.05	0.05
	WCDMA V	3	0.31	24.03	24.7	1.17	0.362	-	0	0.31	0.36
	WCDMA IV	100	0.08	22.92	23.7	1.20	0.096	-	0	0.08	0.10
	WCDMA II	63	0.052	23.01	23.7	1.17	0.061	-	0	0.05	0.06
	CDMA2000 BC0	23	0.427	23.92	25	1.28	0.548	-	0	0.43	0.55
	CDMA2000 BC1	47	0.07	24.1	24.5	1.10	0.077	-	0	0.07	0.08



<Tablet with Hand Strap>

Position	WWAN							WLAN5G Band IV		Max. SAR Summation	Scaled WWAN + WLAN
	WWAN Band	Plot No	Max. WWAN SAR (W/kg)	Output Power (dBm)	Max. Tolerance Power (dBm)	Scaling Factor	Scaled WWAN (W/kg)	Plot No	Max. WLAN SAR (W/kg)		
Front Face	GSM850	16	0.35	30.98	31.1	1.03	0.360	131	0.456	0.81	0.82
	GSM1900	38	0.532	30.55	30.8	1.06	0.564	131	0.456	0.99	1.02
	WCDMA V	20	0.369	24.03	24.7	1.17	0.431	131	0.456	0.83	0.89
	WCDMA IV	107	0.471	22.92	23.7	1.20	0.564	131	0.456	0.93	1.02
	WCDMA II	58	0.534	23.01	23.7	1.17	0.626	131	0.456	0.99	1.08
	CDMA2000 BC0	30	0.413	23.92	25	1.28	0.530	131	0.456	0.87	0.99
	CDMA2000 BC1	34	0.735	24.1	24.5	1.10	0.806	131	0.456	1.19	1.26
Bottom Face	GSM850	13	0.167	30.98	31.1	1.03	0.172	128	0.23	0.40	0.40
	GSM1900	35	0.162	30.55	30.8	1.06	0.172	128	0.23	0.39	0.40
	WCDMA V	17	0.145	24.03	24.7	1.17	0.169	128	0.23	0.38	0.40
	WCDMA IV	102	0.124	22.92	23.7	1.20	0.148	128	0.23	0.35	0.38
	WCDMA II	55	0.197	23.01	23.7	1.17	0.231	128	0.23	0.43	0.46
	CDMA2000 BC0	27	0.153	23.92	25	1.28	0.196	128	0.23	0.38	0.43
	CDMA2000 BC1	31	0.205	24.1	24.5	1.10	0.225	128	0.23	0.44	0.46
Primary Portrait	GSM850	92	0.583	30.98	31.1	1.03	0.599	-	0	0.58	0.60
	GSM1900	81	0.715	30.55	30.8	1.06	0.757	-	0	0.72	0.76
	WCDMA V	95	0.595	24.03	24.7	1.17	0.694	-	0	0.60	0.69
	WCDMA IV	105	1.01	22.87	23.7	1.21	1.223	-	0	1.01	1.22
	WCDMA II	59	0.756	23.01	23.7	1.17	0.886	-	0	0.76	0.89
	CDMA2000 BC0	28	0.649	23.92	25	1.28	0.832	-	0	0.65	0.83
	CDMA2000 BC1	54	0.875	23.99	24.5	1.12	0.984	-	0	0.88	0.98
Secondary Landscape	GSM850	-	0	-	-	-	-	130	0.292	0.29	0.29
	GSM1900	-	0	-	-	-	-	130	0.292	0.29	0.29
	WCDMA V	-	0	-	-	-	-	130	0.292	0.29	0.29
	WCDMA IV	-	0	-	-	-	-	130	0.292	0.29	0.29
	WCDMA II	-	0	-	-	-	-	130	0.292	0.29	0.29
	CDMA2000 BC0	-	0	-	-	-	-	130	0.292	0.29	0.29
	CDMA2000 BC1	-	0	-	-	-	-	130	0.292	0.29	0.29
Primary Landscape	GSM850	15	0.443	30.98	31.1	1.03	0.455	-	0	0.44	0.46
	GSM1900	37	0.045	30.55	30.8	1.06	0.048	-	0	0.05	0.05
	WCDMA V	19	0.32	24.03	24.7	1.17	0.373	-	0	0.32	0.37
	WCDMA IV	106	0.045	22.92	23.7	1.20	0.054	-	0	0.05	0.05
	WCDMA II	57	0.063	23.01	23.7	1.17	0.074	-	0	0.06	0.07
	CDMA2000 BC0	29	0.374	23.92	25	1.28	0.480	-	0	0.37	0.48
	CDMA2000 BC1	33	0.063	24.1	24.5	1.10	0.069	-	0	0.06	0.07

11.3 Simultaneous analysis - SPLSR calculation

Position	Plot No	Band/CH	SAR peak location (m)			SAR (W/kg)	Gap (cm)	Peak distance (cm)	Pair SAR sum (W/kg)	SPLSR
			X	Y	Z					
Bottom Face w/o Hand strap	12	GSM850 CH189	-0.035	-0.081	-0.176	0.938	0	17.9	2.34	0.13
	153	WLAN2.4G CH11	0.053	0.079	-0.175	1.4	0			

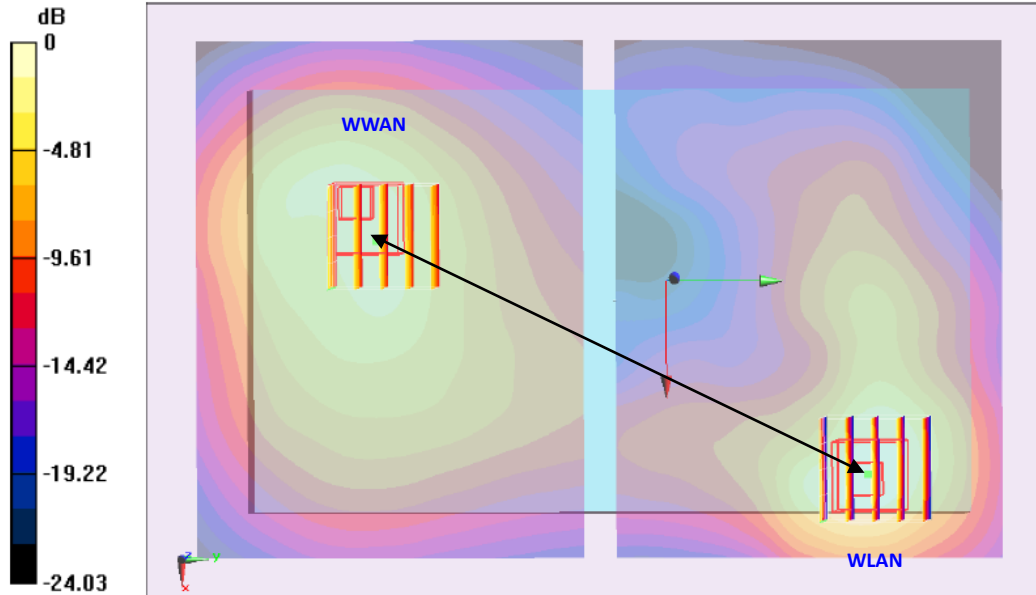

Position	Plot No	Band/CH	SAR peak location (m)			SAR (W/kg)	Gap (cm)	Peak distance (cm)	Pair SAR sum (W/kg)	SPLSR
			X	Y	Z					
Bottom Face w/o Hand strap	85	GSM1900 CH661	0.049	-0.081	-0.174	1.074	0	16.0	2.47	0.15
	153	WLAN2.4G CH11	0.053	0.079	-0.175	1.4	0			

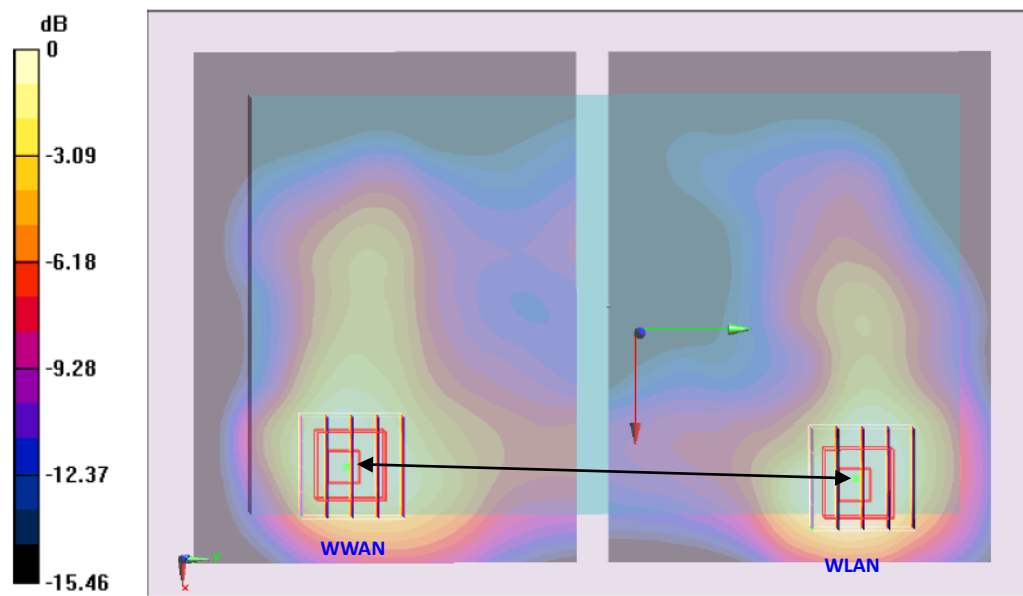

Position	Plot No	Band/CH	SAR peak location (m)			SAR (W/kg)	Gap (cm)	Peak distance (cm)	Pair SAR sum (W/kg)	SPLSR
			X	Y	Z					
Bottom Face w/o Hand strap	74	WCDMA V CH4233	-0.027	-0.077	-0.176	1.153	0	17.5	2.55	0.15
	153	WLAN2.4G CH11	0.053	0.079	-0.175	1.4	0			

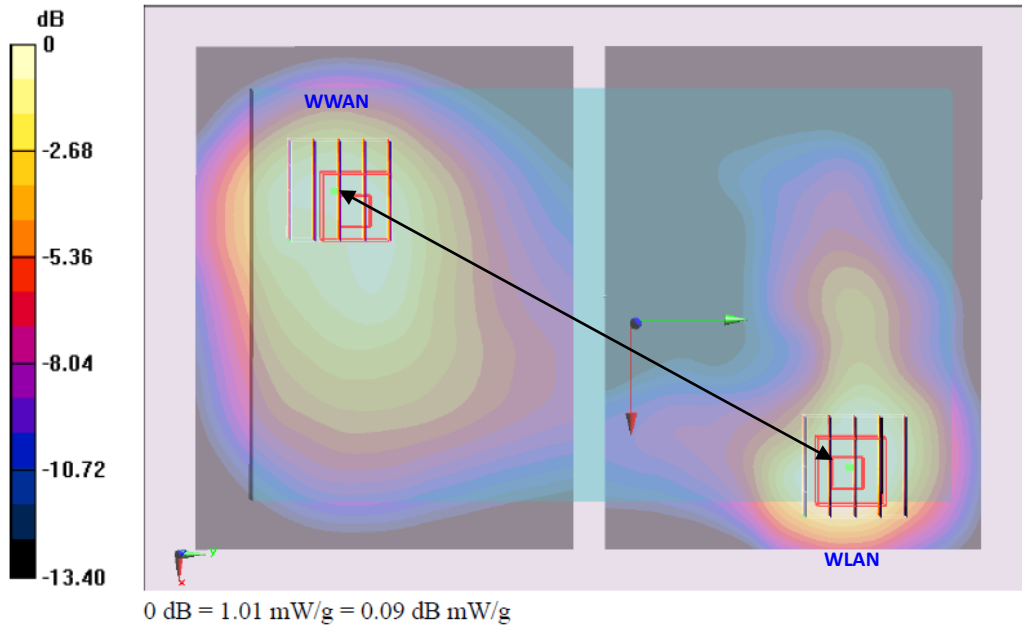

Position	Plot No	Band/CH	SAR peak location (m)			SAR (W/kg)	Gap (cm)	Peak distance (cm)	Pair SAR sum (W/kg)	SPLSR
			X	Y	Z					
Bottom Face w/o Hand strap	96	WCDMA IV CH1413 Cube 0	0.049	-0.083	-0.175	0.833	0	16.2	2.23	0.14
	153	WLAN2.4G CH11	0.053	0.079	-0.175	1.4	0			
	96	WCDMA IV CH1413 Cube 1	-0.029	-0.105	-0.176	0.765	0	20.1	2.17	0.11
	153	WLAN2.4G CH11	0.053	0.079	-0.175	1.4	0			

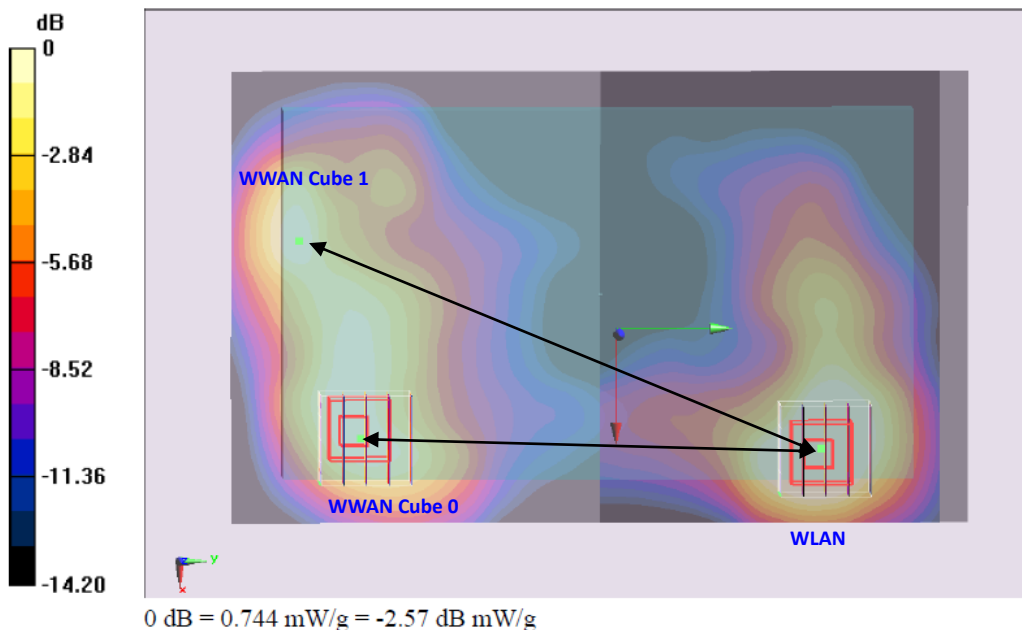

Position	Plot No	Band/CH	SAR peak location (m)			SAR (W/kg)	Gap (cm)	Peak distance (cm)	Pair SAR sum (W/kg)	SPLSR
			X	Y	Z					
Bottom Face w/o Hand strap	78	WCDMA II CH9400	0.051	-0.083	-0.175	1.014	0	16.2	2.41	0.15
	153	WLAN2.4G CH11	0.053	0.079	-0.175	1.4	0			

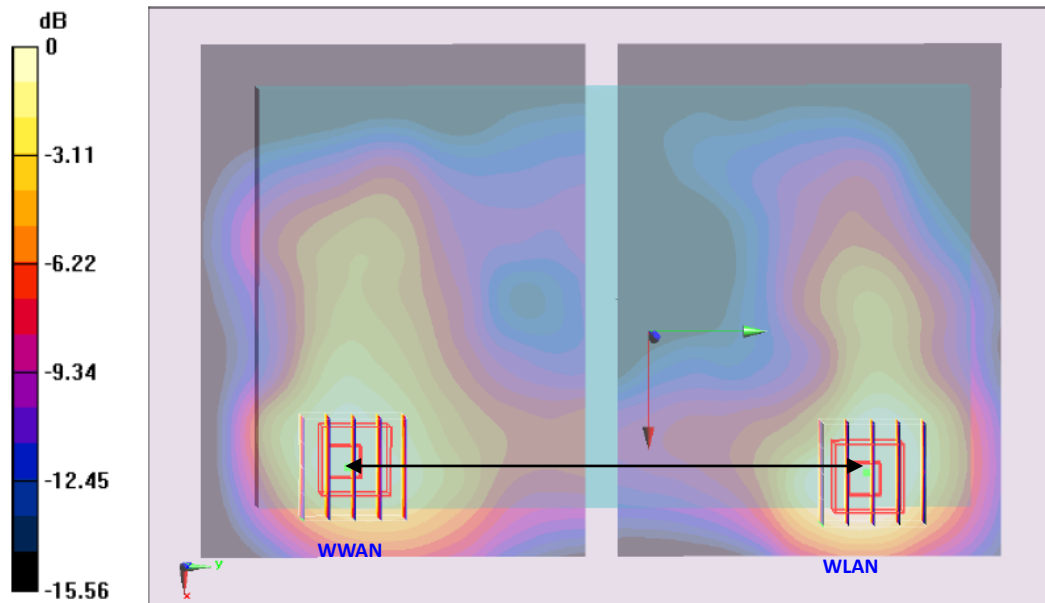

0 dB = 0.946 mW/g = -0.48 dB mW/g

Position	Plot No	Band/CH	SAR peak location (m)			SAR (W/kg)	Gap (cm)	Peak distance (cm)	Pair SAR sum (W/kg)	SPLSR
			X	Y	Z					
Bottom Face w/o Hand strap	77	CDMA2000 BC0 CH777	-0.019	-0.079	-0.176	1.333	0	17.4	2.73	0.16
	153	WLAN2.4G CH11	0.053	0.079	-0.175	1.4	0			

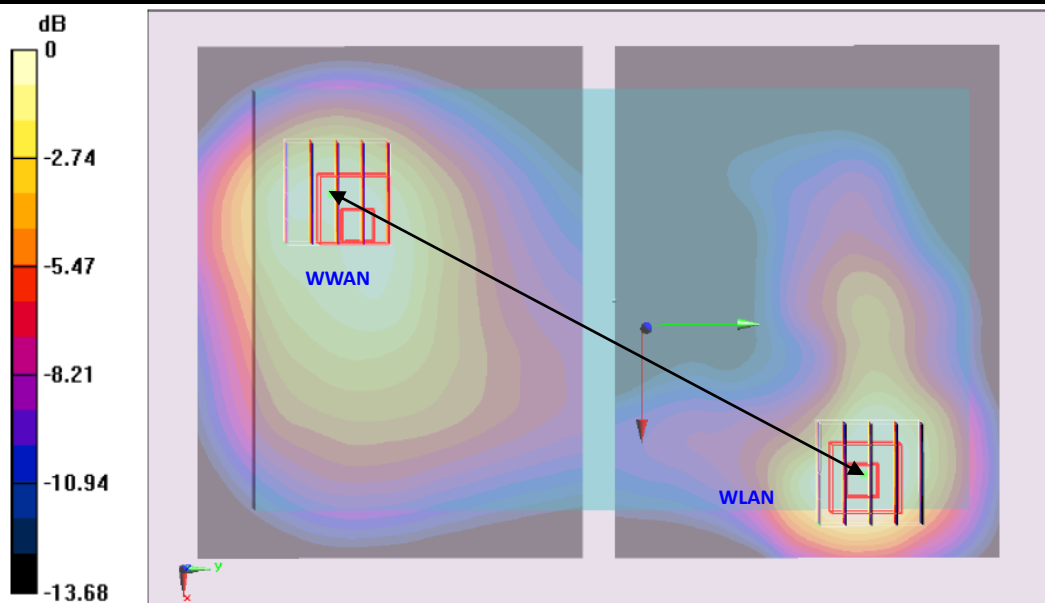

0 dB = 1.05 mW/g = 0.42 dB mW/g

Position	Plot No	Band/CH	SAR peak location (m)			SAR (W/kg)	Gap (cm)	Peak distance (cm)	Pair SAR sum (W/kg)	SPLSR
			X	Y	Z					
Bottom Face w/o Hand strap	88	CDMA2000 BC1 CH25	0.049	-0.091	-0.174	1.453	0	17.0	2.85	0.17
	153	WLAN2.4G CH11	0.053	0.079	-0.175	1.4	0			

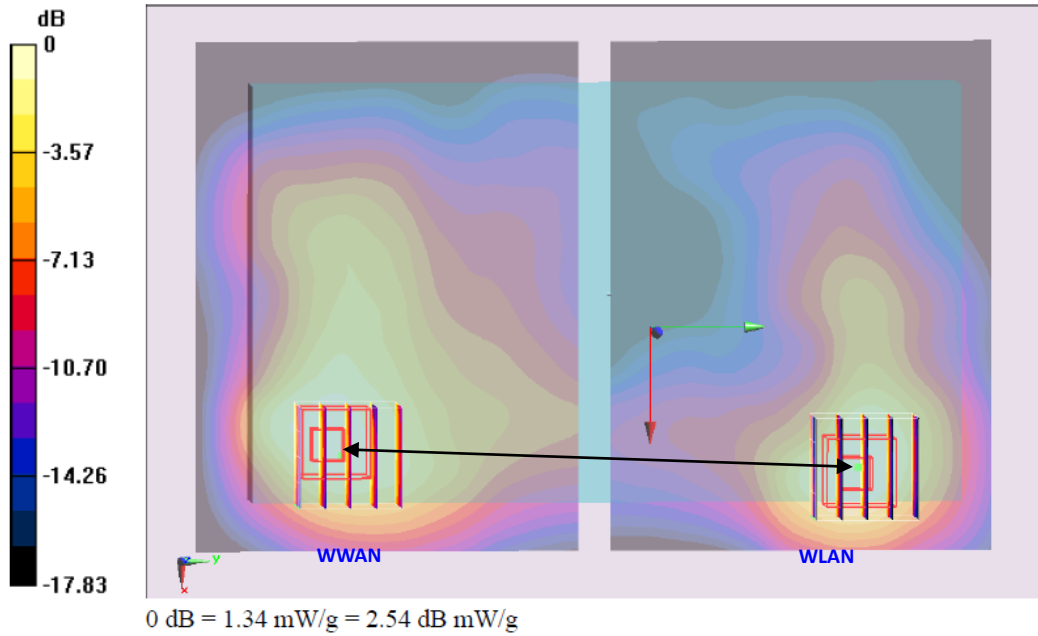

Position	Plot No	Band/CH	SAR peak location (m)			SAR (W/kg)	Gap (cm)	Peak distance (cm)	pair SAR sum (W/kg)	SPLSR
			X	Y	Z					
Bottom Face w/o Hand strap	74	WCDMA V CH4233	-0.027	-0.077	-0.176	1.153	0	14.5	1.63	0.11
	123	WLAN5G CH48	0.057	0.041	-0.18	0.474	0			

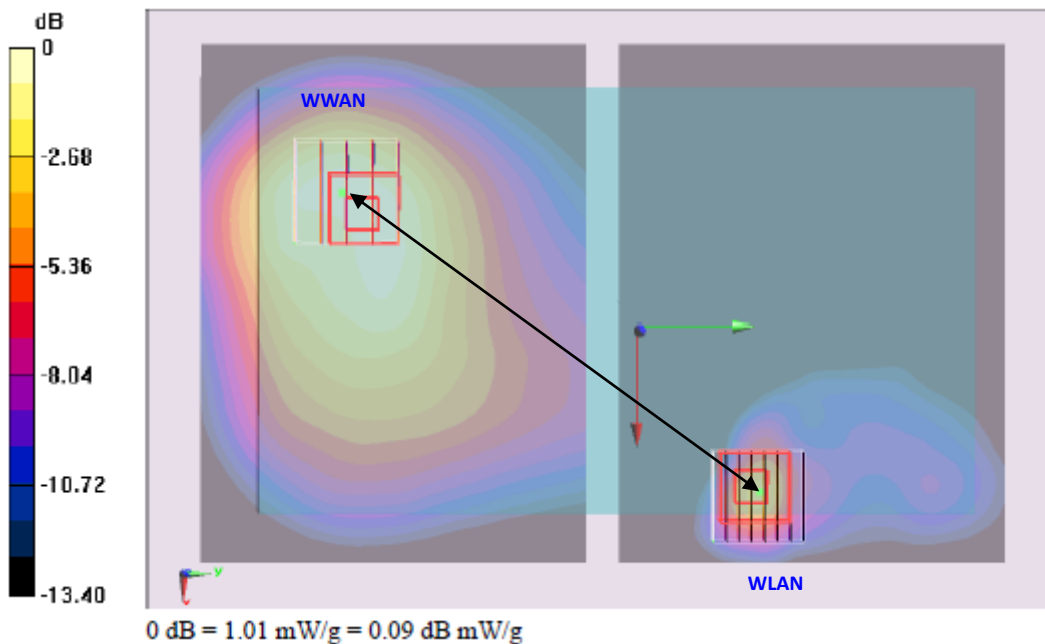

Position	Plot No	Band/CH	SAR peak location (m)			SAR (W/kg)	Gap (cm)	Peak distance (cm)	Pair SAR sum (W/kg)	SPLSR
			X	Y	Z					
Bottom Face w/o Hand strap	77	CDMA2000 BC0 CH777	-0.019	-0.079	-0.176	1.333	0	14.2	1.81	0.13
	123	WLAN5G CH48	0.057	0.041	-0.18	0.474	0			

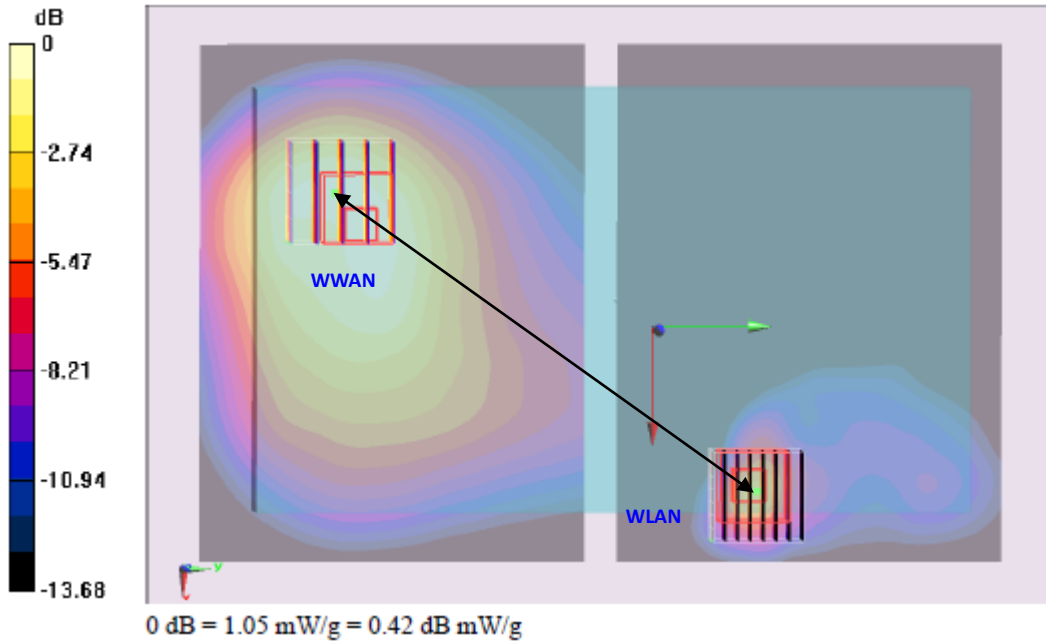

Position	Plot No	Band/CH	SAR peak location (m)			SAR (W/kg)	Gap (cm)	Peak distance (cm)	Pair SAR sum (W/kg)	SPLSR
			X	Y	Z					
Bottom Face w/o Hand strap	88	CDMA2000 BC1 CH25	0.049	-0.091	-0.174	1.453	0	13.2	1.93	0.15
	123	WLAN5G CH48	0.057	0.041	-0.18	0.474	0			

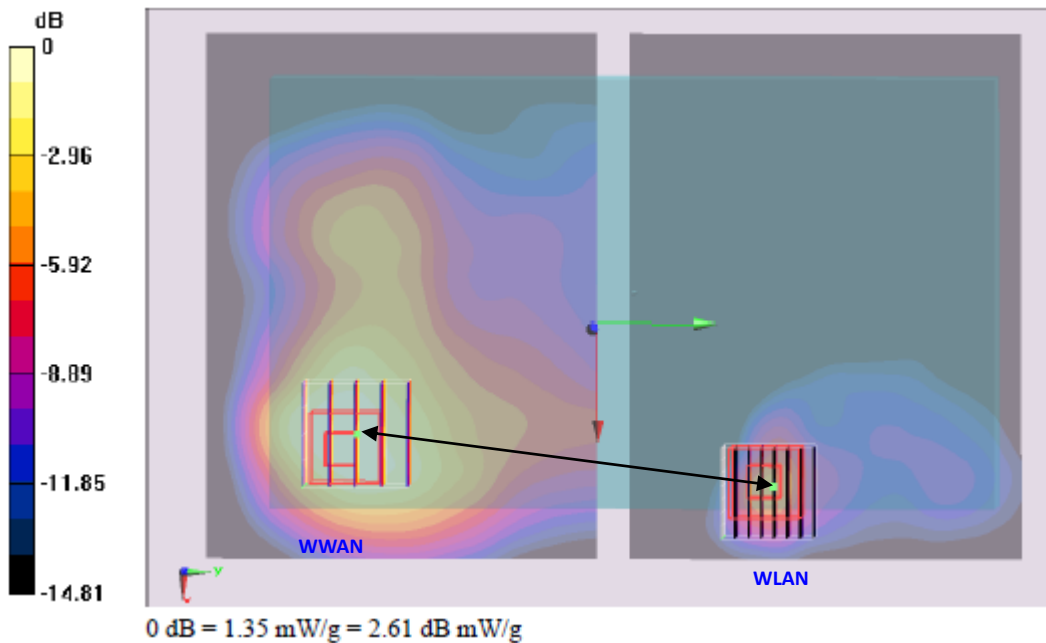

Position	Plot No	Band/CH	SAR peak location (m)			SAR (W/kg)	Gap (cm)	Peak distance (cm)	pair SAR sum (W/kg)	SPLSR
			X	Y	Z					
Bottom Face w/o Hand strap	12	GSM850 CH189	-0.027	-0.081	-0.176	0.938	0	14.1	2.32	0.16
	163	WLAN5G CH52	0.053	0.035	-0.181	1.38	0			

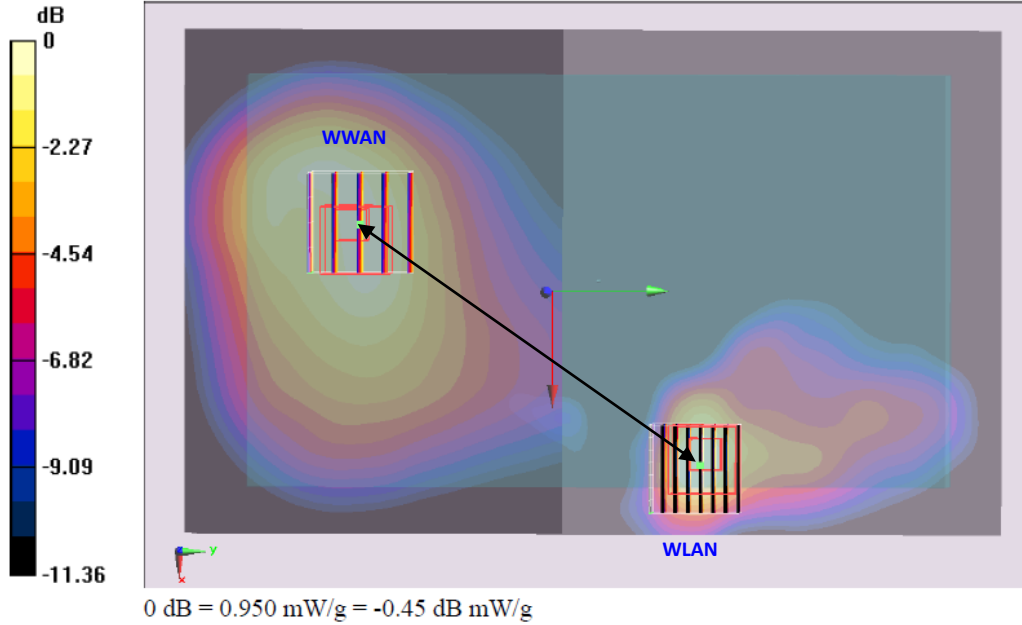

Position	Plot No	Band/CH	SAR peak location (m)			SAR (W/kg)	Gap (cm)	Peak distance (cm)	pair SAR sum (W/kg)	SPLSR
			X	Y	Z					
Bottom Face w/o Hand strap	85	GSM1900 CH661	0.049	-0.081	-0.174	1.074	0	11.6	2.45	0.21
	163	WLAN5G CH52	0.053	0.035	-0.181	1.38	0			

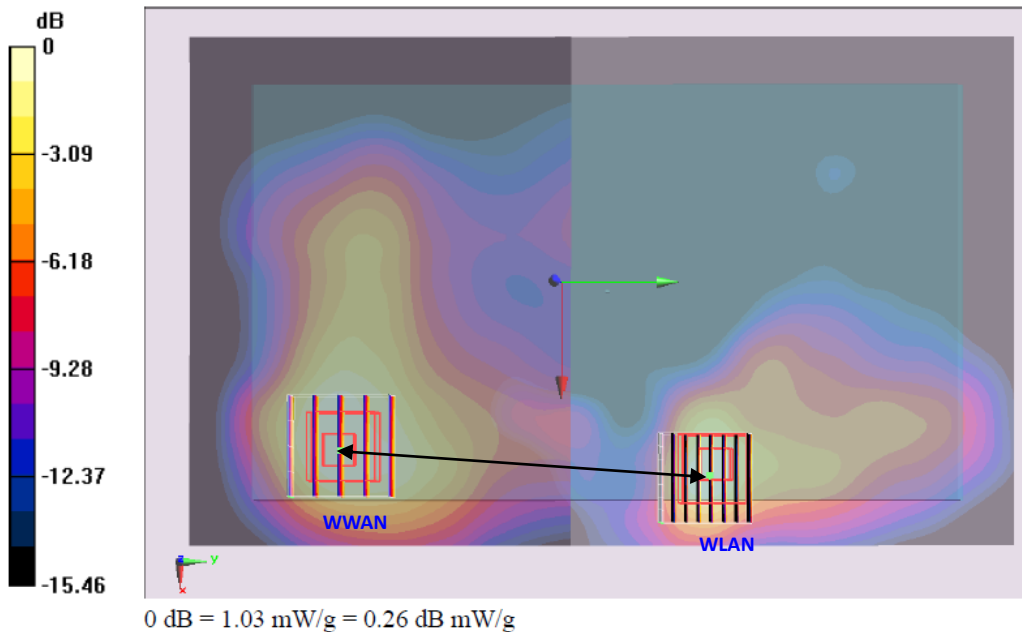

Position	Plot No	Band/CH	SAR peak location (m)			SAR (W/kg)	Gap (cm)	Peak distance (cm)	pair SAR sum (W/kg)	SPLSR
			X	Y	Z					
Bottom Face w/o Hand strap	74	WCDMA V CH4233	-0.027	-0.077	-0.176	1.153	0	13.8	2.53	0.18
	163	WLAN5G CH52	0.053	0.035	-0.181	1.38	0			

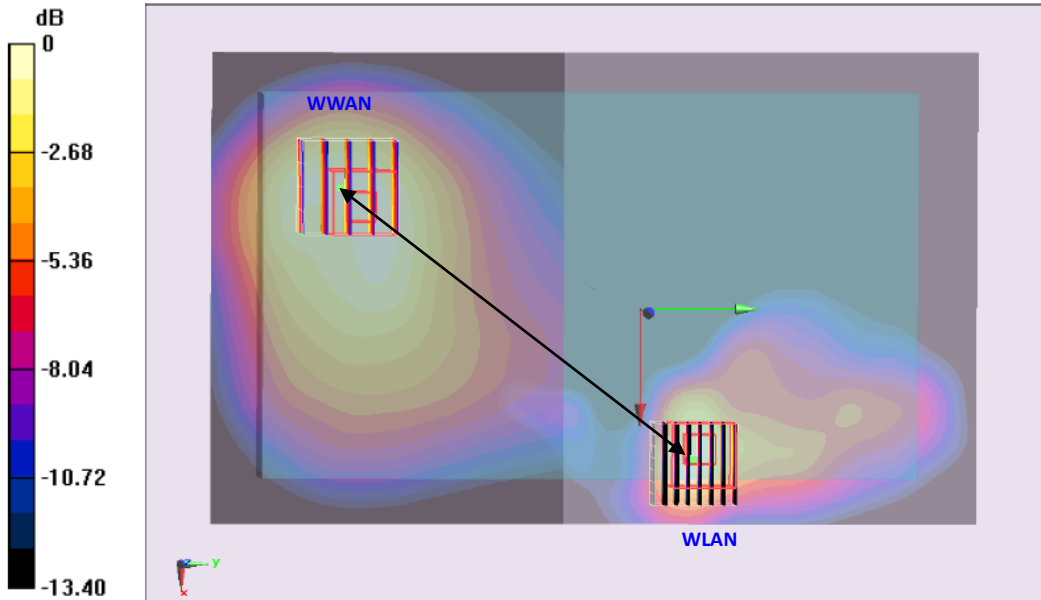

0 dB = 1.01 mW/g = 0.09 dB mW/g

Position	Plot No.	Band/CH	SAR peak location (m)			SAR (W/kg)	Gap (cm)	Peak distance (cm)	pair SAR sum (W/kg)	SPLSR No
			X	Y	Z					
Bottom Face w/o Hand strap	96	WCDMA IV CH1413 Cube 0	0.049	-0.083	-0.175	0.833	0	11.8	2.21	0.19
	163	WLAN5G CH52	0.053	0.035	-0.181	1.38	0			
Bottom Face w/o Hand strap	96	WCDMA IV CH1413 Cube 1	-0.029	-0.105	-0.176	0.765	0	16.2	2.15	0.13
	163	WLAN5G CH52	0.053	0.035	-0.181	1.38	0			

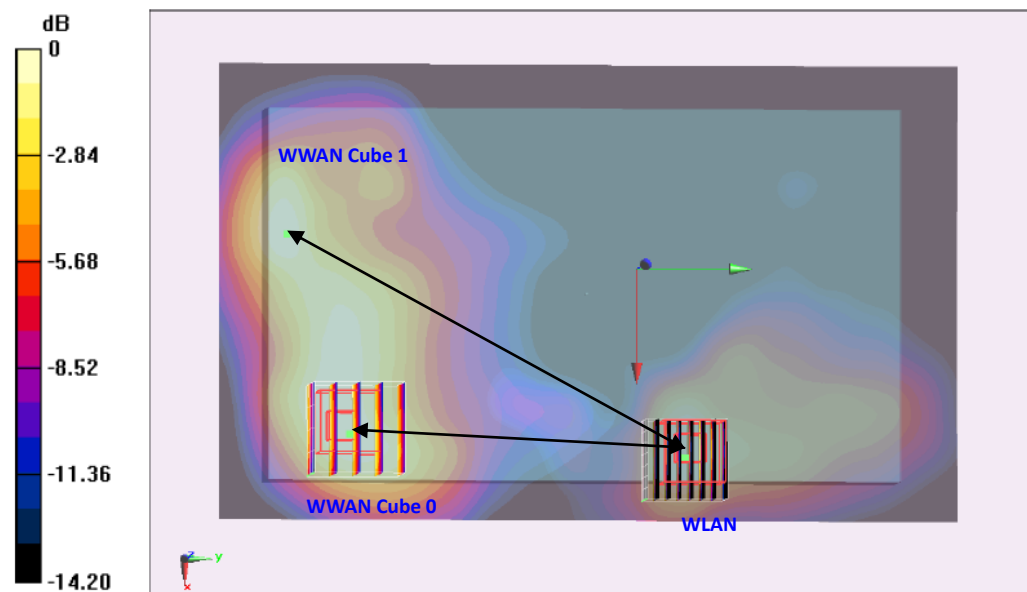

0 dB = 0.744 mW/g = -2.57 dB mW/g

Position	Plot No	Band/CH	SAR peak location (m)			SAR (W/kg)	Gap (cm)	Peak distance (cm)	pair SAR sum (W/kg)	SPLSR
			X	Y	Z					
Bottom Face w/o Hand strap	78	WCDMA II CH9400	0.051	-0.083	-0.175	1.014	0	11.8	2.39	0.2
	163	WLAN5G CH52	0.053	0.035	-0.181	1.38	0			

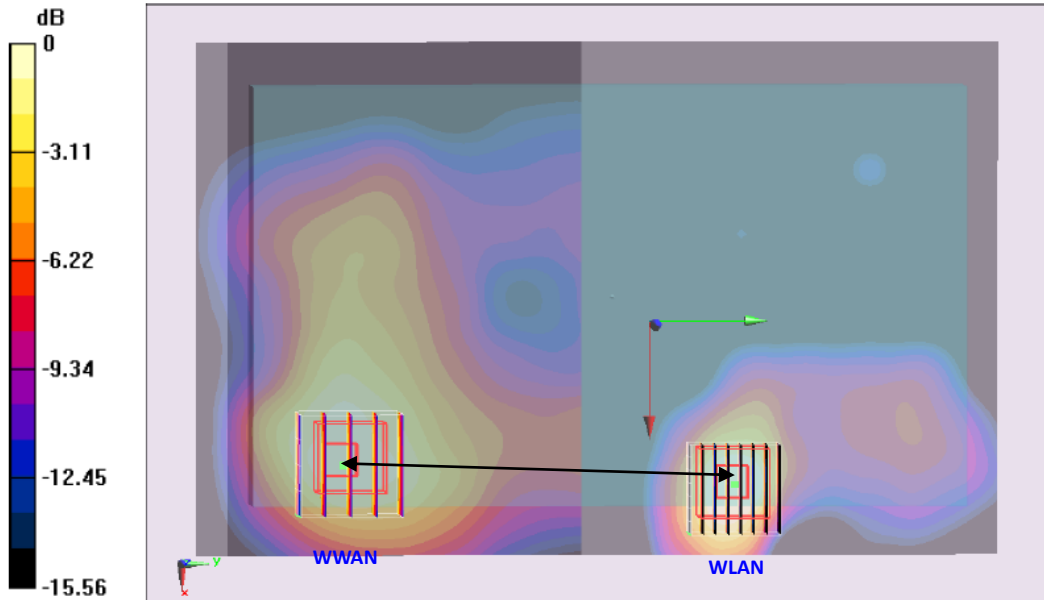

0 dB = 0.946 mW/g = -0.48 dB mW/g

Position	Plot No	Band/CH	SAR peak location (m)			SAR (W/kg)	Gap (cm)	Peak distance (cm)	pair SAR sum (W/kg)	SPLSR
			X	Y	Z					
Bottom Face w/o Hand strap	77	CDMA2000 BC0 CH777	-0.019	-0.079	-0.176	1.333	0	13.5	2.71	0.2
	163	WLAN5G CH52	0.053	0.035	-0.181	1.38	0			

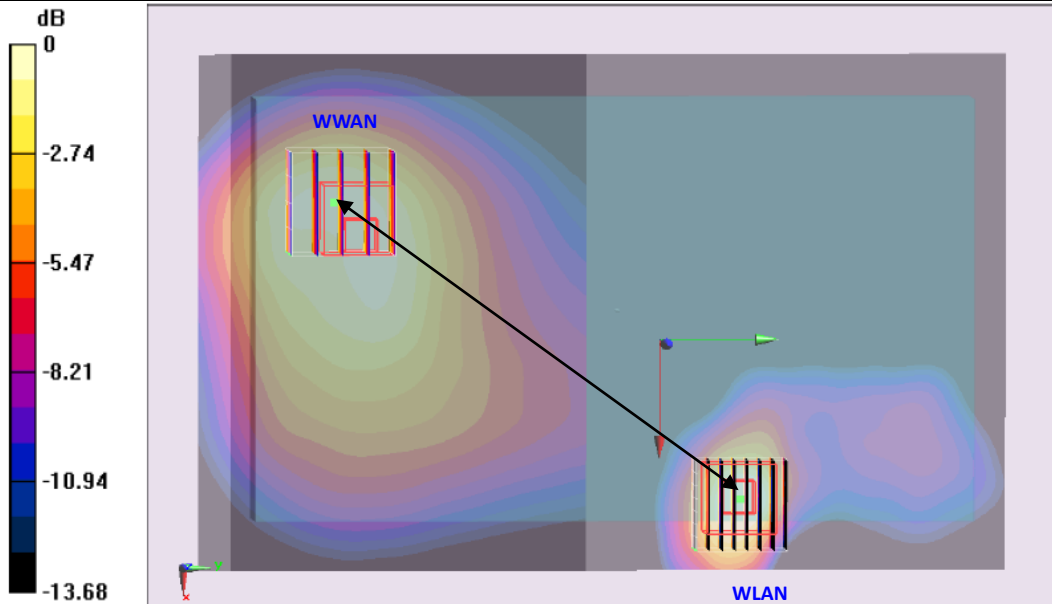

0 dB = 1.05 mW/g = 0.42 dB mW/g

Position	Plot No	Band/CH	SAR peak location (m)			SAR (W/kg)	Gap (cm)	Peak distance (cm)	pair SAR sum (W/kg)	SPLSR
			X	Y	Z					
Bottom Face w/o Hand strap	88	CDMA2000 BC1 CH25	0.049	-0.091	-0.174	1.453	0	12.6	2.83	0.22
	163	WLAN5G CH52	0.053	0.035	-0.181	1.38	0			

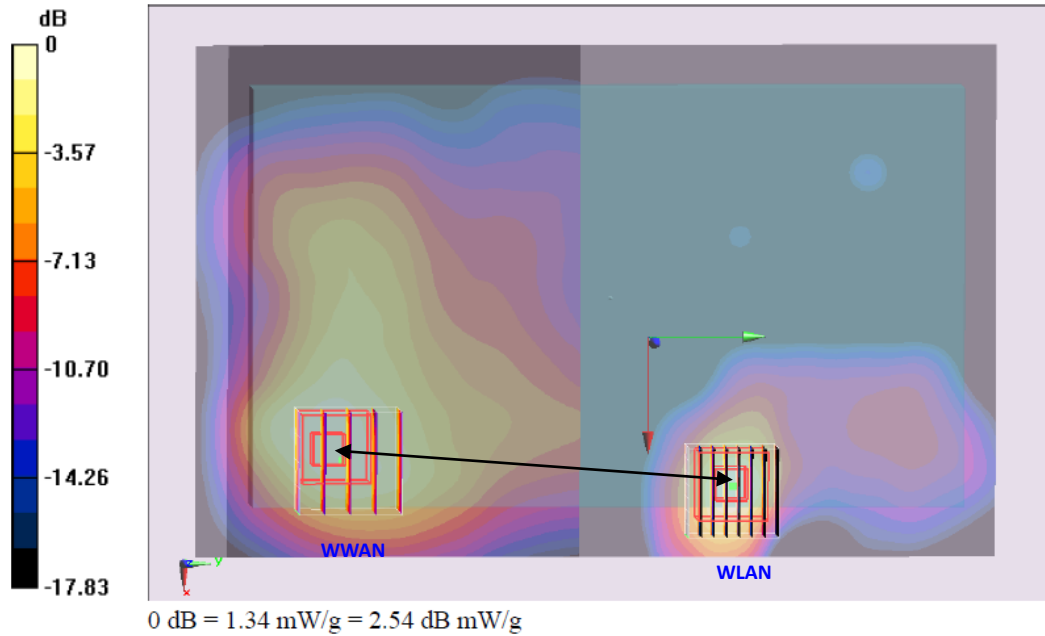

Position	Plot No	Band/CH	SAR peak location (m)			SAR (W/kg)	Gap (cm)	Peak distance (cm)	pair SAR sum (W/kg)	SPLSR
			X	Y	Z					
Bottom Face w/o Hand strap	12	GSM850 CH251	-0.027	-0.081	-0.176	0.938	0	15	2.16	0.14
	135	WLAN5G CH116	0.057	0.037	-0.181	1.22	0			

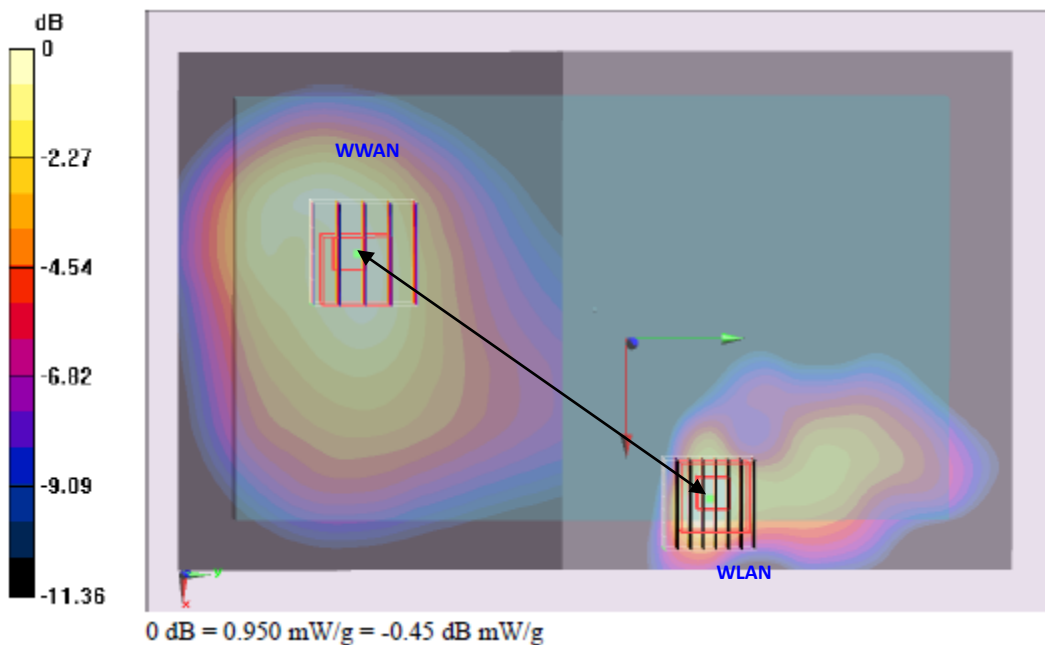

Position	Plot No	Band/CH	SAR peak location (m)			SAR (W/kg)	Gap (cm)	Peak distance (cm)	pair SAR sum (W/kg)	SPLSR
			X	Y	Z					
Bottom Face w/o Hand strap	85	GSM1900 CH661	0.049	-0.081	-0.174	1.074	0	11.8	2.29	0.19
	135	WLAN5G CH116	0.057	0.037	-0.181	1.22	0			

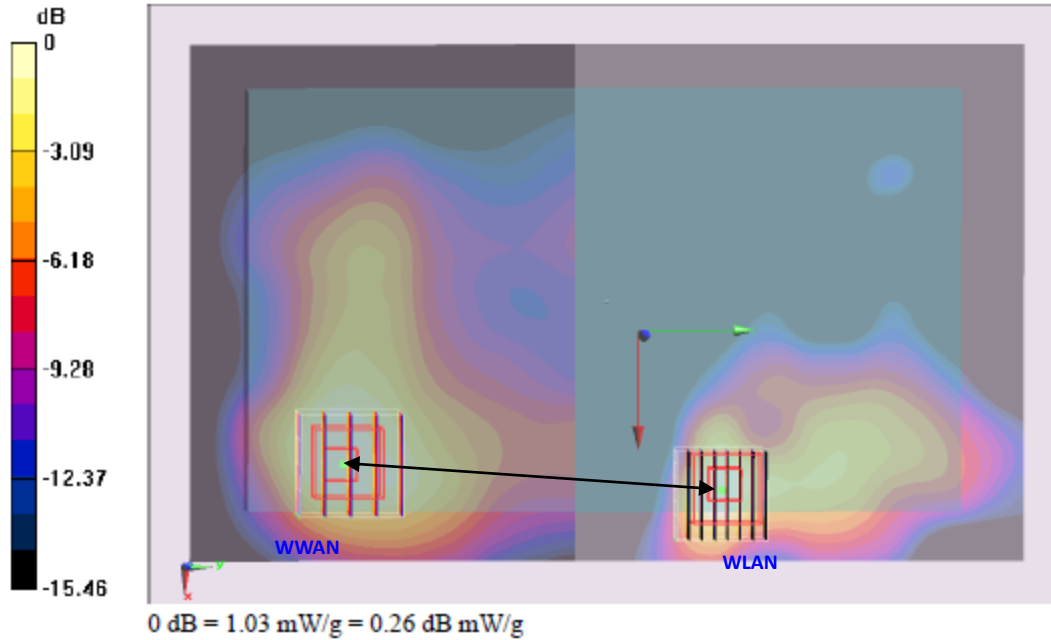

Position	Plot No	Band/CH	SAR peak location (m)			SAR (W/kg)	Gap (cm)	Peak distance (cm)	pair SAR sum (W/kg)	SPLSR
			X	Y	Z					
Bottom Face w/o Hand strap	74	WCDMA V CH4233	-0.027	-0.077	-0.176	1.153	0	14.2	2.37	0.17
	135	WLAN5G CH116	0.057	0.037	-0.181	1.22	0			

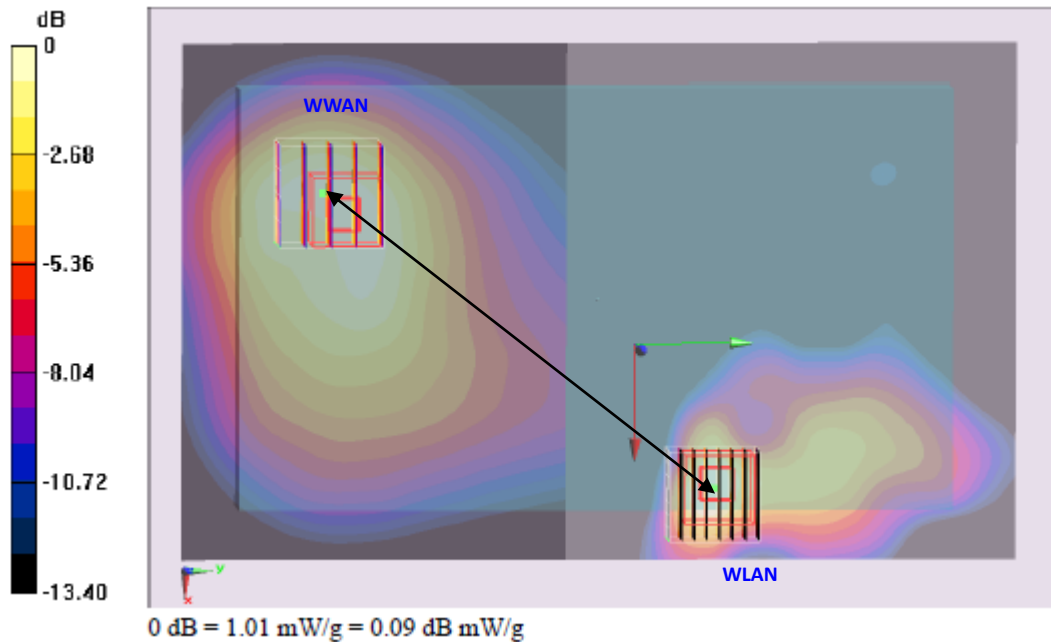

Position	Plot No.	Band/CH	SAR peak location (m)			SAR (W/kg)	Gap (cm)	Peak distance (cm)	pair SAR sum (W/kg)	SPLSR No
			X	Y	Z					
Bottom Face w/o Hand strap	96	WCDMA IV CH1413	0.049	-0.083	-0.175	0.833	0	12	2.05	0.17
	135	WLAN5G CH116	0.057	0.037	-0.181	1.22	0			
Bottom Face w/o Hand strap	96	WCDMA IV CH1413	-0.029	-0.105	-0.176	0.765	0	16.6	1.99	0.12
	135	WLAN5G CH116	0.057	0.037	-0.181	1.22	0			

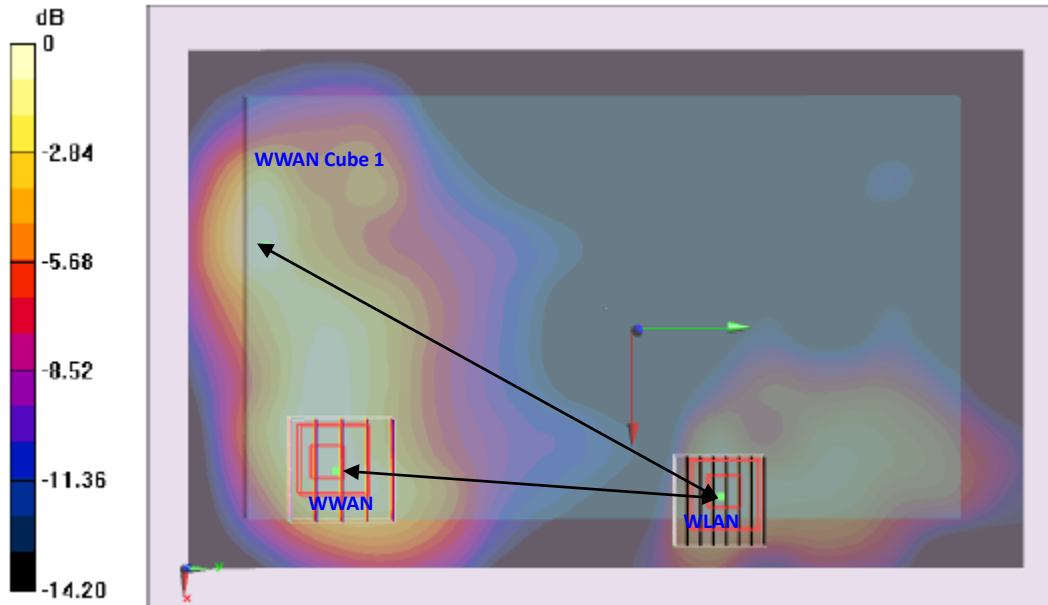

0 dB = 0.744 mW/g = -2.57 dB mW/g

Position	Plot No	Band/CH	SAR peak location (m)			SAR (W/kg)	Gap (cm)	Peak distance (cm)	pair SAR sum (W/kg)	SPLSR
			X	Y	Z					
Bottom Face w/o Hand strap	78	WCDMA II CH9400	0.051	-0.083	-0.175	1.014	0	12	2.23	0.19
	135	WLAN5G CH116	0.057	0.037	-0.181	1.22	0			

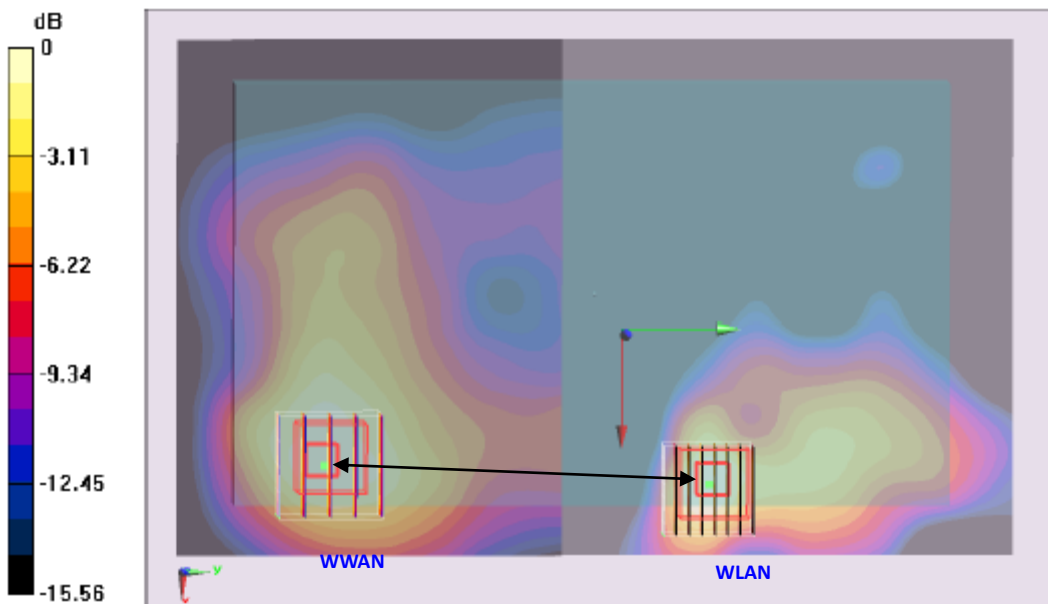

0 dB = 0.946 mW/g = -0.48 dB mW/g

Position	Plot No	Band/CH	SAR peak location (m)			SAR (W/kg)	Gap (cm)	Peak distance (cm)	pair SAR sum (W/kg)	SPLSR
			X	Y	Z					
Bottom Face w/o Hand strap	77	CDMA2000 BC0 CH777	-0.019	-0.079	-0.176	1.333	0	13.9	2.55	0.18
	135	WLAN5G CH116	0.057	0.037	-0.181	1.22	0			

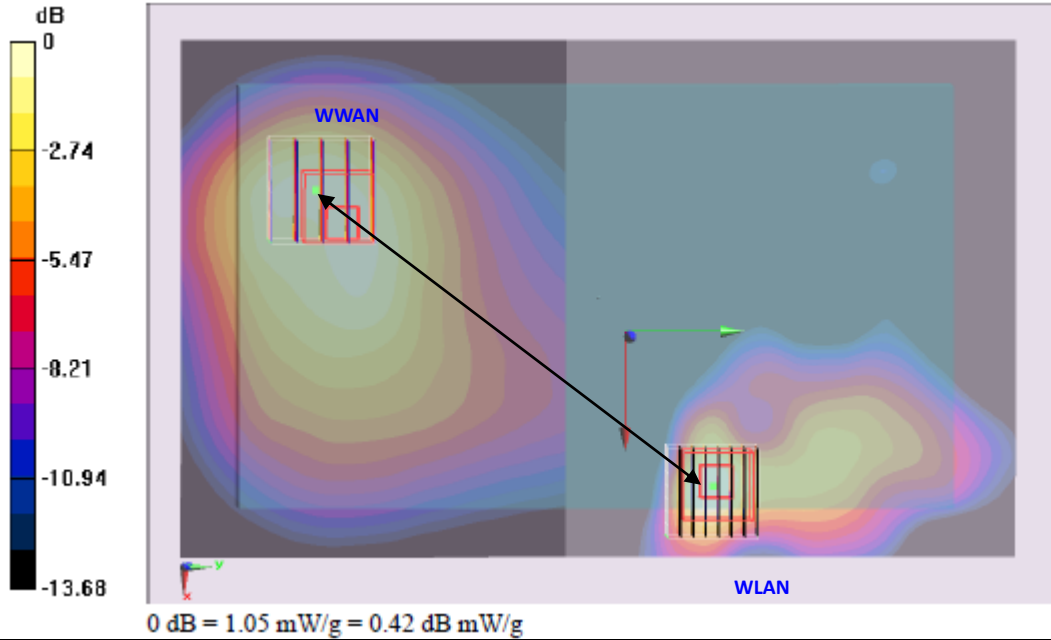

Position	Plot No	Band/CH	SAR peak location (m)			SAR (W/kg)	Gap (cm)	Peak distance (cm)	pair SAR sum (W/kg)	SPLSR
			X	Y	Z					
Bottom Face w/o Hand strap	88	CDMA2000 BC1 CH25	0.049	-0.091	-0.174	1.453	0	12.8	2.67	0.21
	135	WLAN5G CH116	0.057	0.037	-0.181	1.22	0			

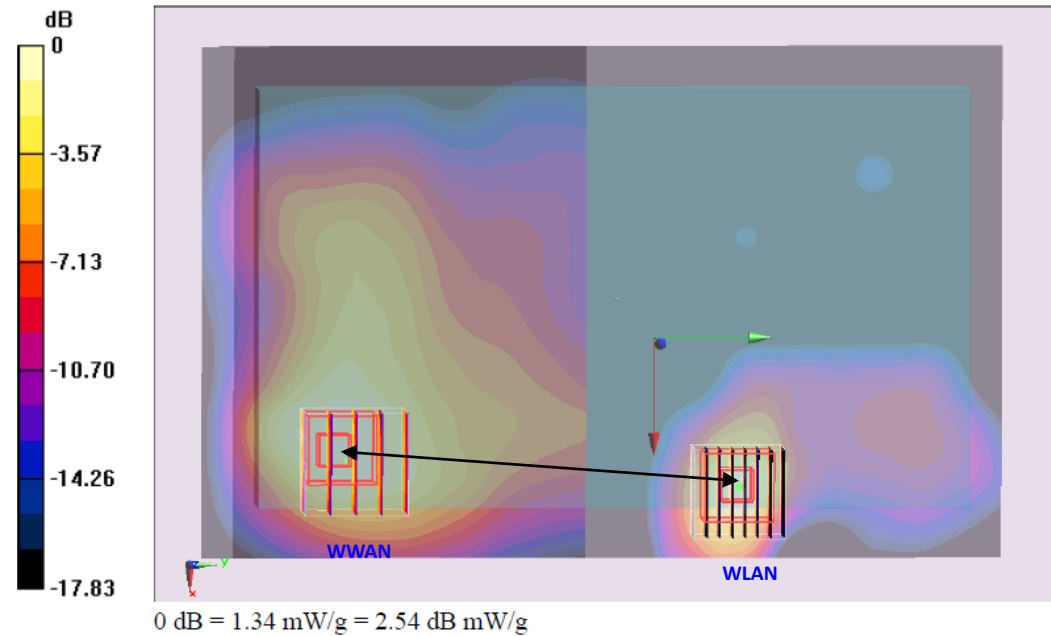

Position	Plot No	Band/CH	SAR peak location (m)			SAR (W/kg)	Gap (cm)	Peak distance (cm)	pair SAR sum (W/kg)	SPLSR
			X	Y	Z					
Bottom Face w/o Hand strap	12	GSM850 CH251	-0.027	-0.081	-0.176	0.938	0	15.1	2.27	0.15
	114	WLAN5G CH165	0.057	0.039	-0.18	1.33	0			

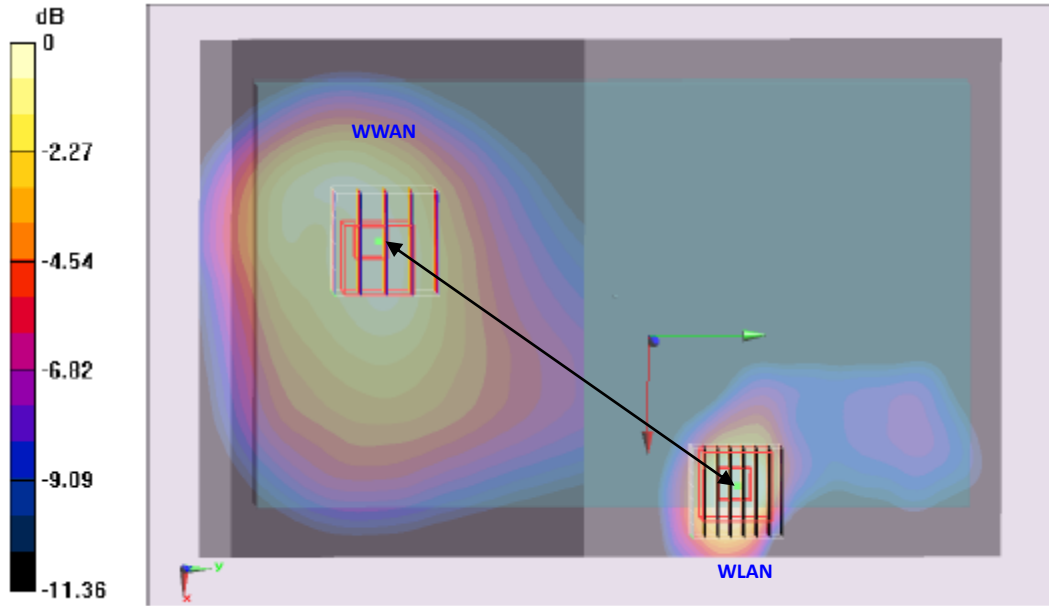

0 dB = 0.950 mW/g = -0.45 dB mW/g

Position	Plot No	Band/CH	SAR peak location (m)			SAR (W/kg)	Gap (cm)	Peak distance (cm)	pair SAR sum (W/kg)	SPLSR
			X	Y	Z					
Bottom Face w/o Hand strap	85	GSM1900 CH661	0.049	-0.081	-0.174	1.074	0	12	2.4	0.2
	114	WLAN5G CH165	0.057	0.039	-0.18	1.33	0			

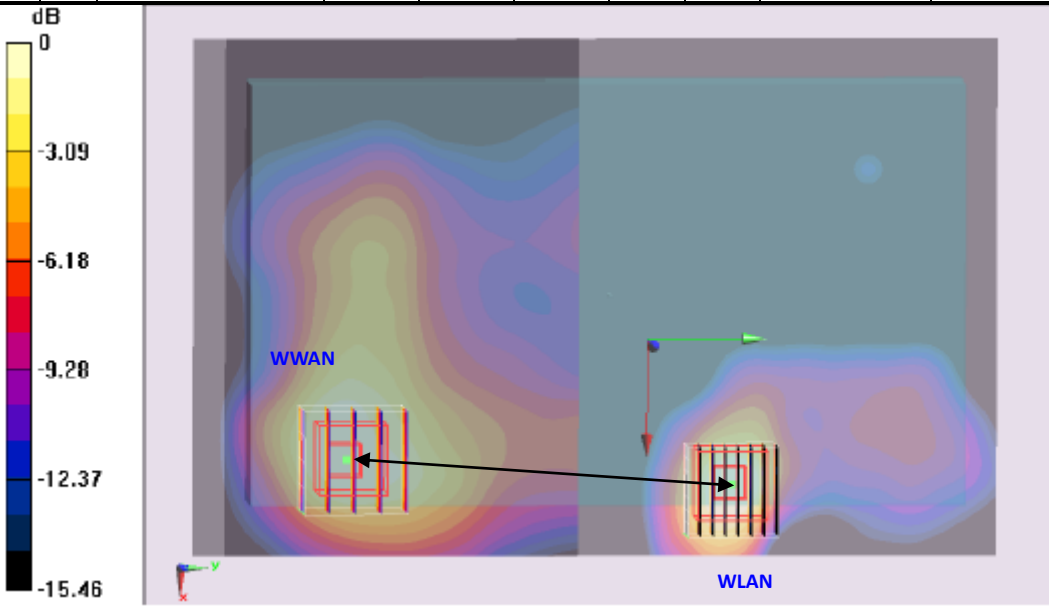

0 dB = 1.03 mW/g = 0.26 dB mW/g

Position	Plot No	Band/CH	SAR peak location (m)			SAR (W/kg)	Gap (cm)	Peak distance (cm)	pair SAR sum (W/kg)	SPLSR
			X	Y	Z					
Bottom Face w/o Hand strap	74	WCDMA V CH4233	-0.027	-0.077	-0.176	1.153	0	14.3	2.48	0.17
	114	WLAN5G CH165	0.057	0.039	-0.18	1.33	0			

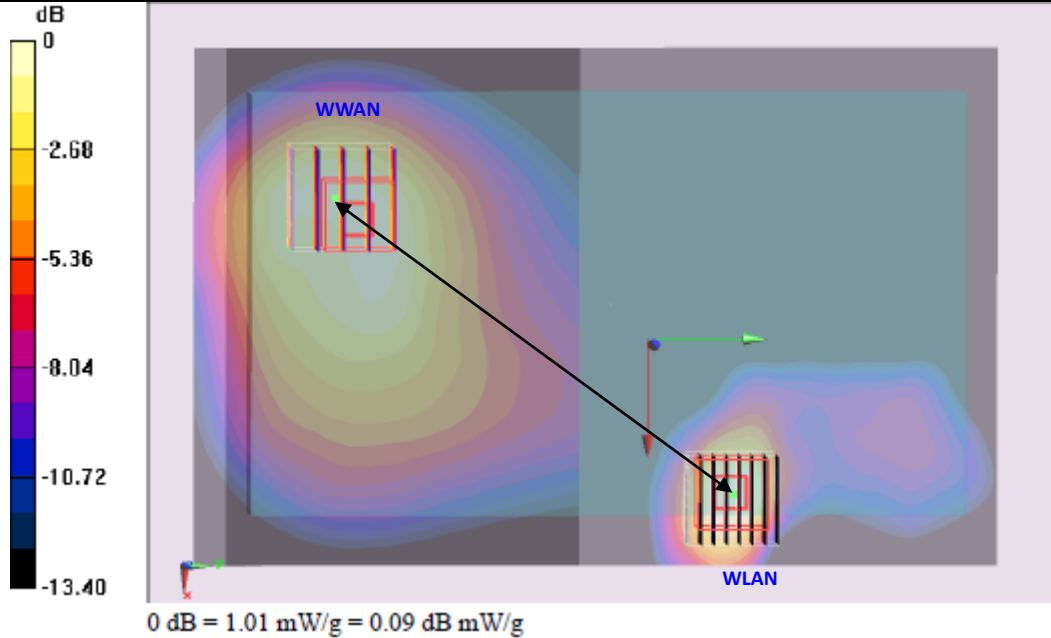

Position	Plot No.	Band/CH	SAR peak location (m)			SAR (W/kg)	Gap (cm)	Peak distance (cm)	pair SAR sum (W/kg)	SPLSR No
			X	Y	Z					
Bottom Face w/o Hand strap	96	WCDMA IV CH1413 Cube 0	0.049	-0.083	-0.175	0.833	0	12.2	2.16	0.18
	114	WLAN5G CH165	0.057	0.039	-0.18	1.33	0			
Bottom Face w/o Hand strap	96	WCDMA IV CH1413 Cube 1	-0.029	-0.105	-0.176	0.765	0	16.8	2.1	0.12
	114	WLAN5G CH165	0.057	0.039	-0.18	1.33	0			

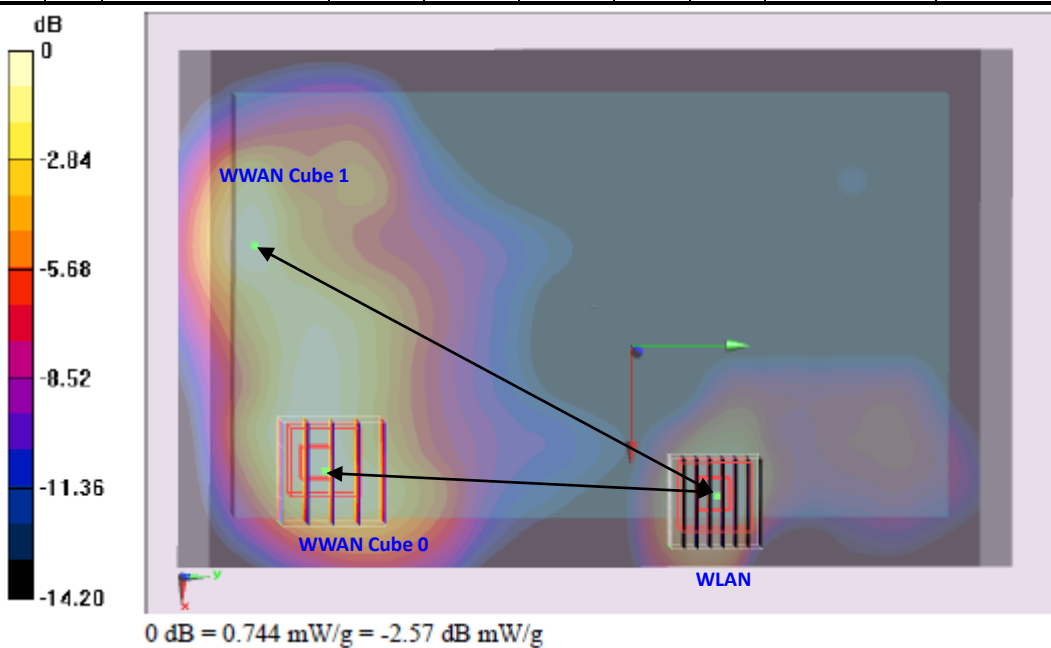

Position	Plot No	Band/CH	SAR peak location (m)			SAR (W/kg)	Gap (cm)	Peak distance (cm)	pair SAR sum (W/kg)	SPLSR
			X	Y	Z					
Bottom Face w/o Hand strap	78	WCDMA II CH9400	0.051	-0.083	-0.175	1.014	0	12.2	2.34	0.19
	114	WLAN5G CH165	0.057	0.039	-0.18	1.33	0			

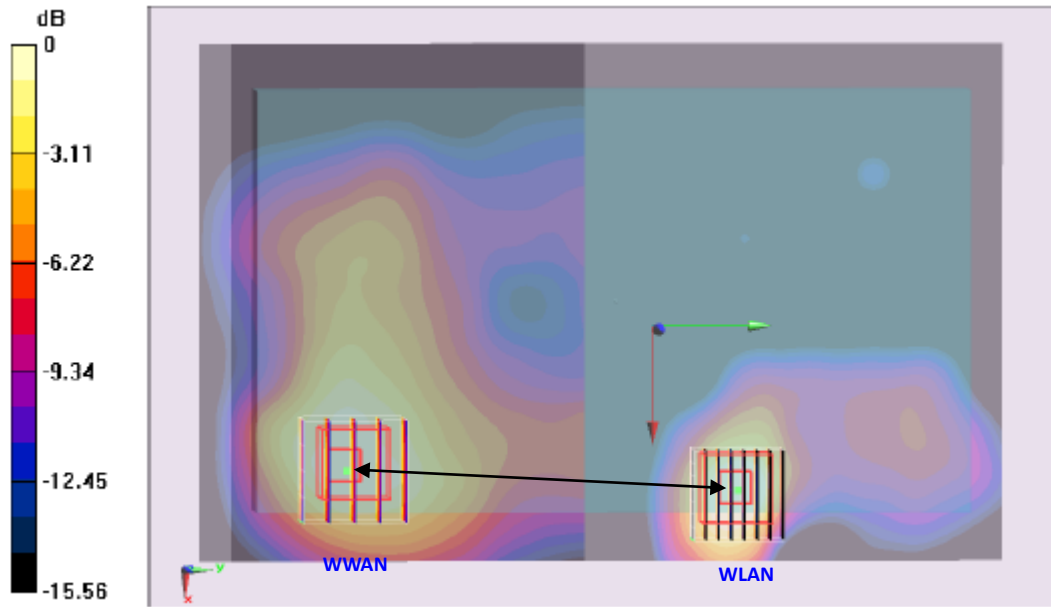

0 dB = 0.946 mW/g = -0.48 dB mW/g

Position	Plot No	Band/CH	SAR peak location (m)			SAR (W/kg)	Gap (cm)	Peak distance (cm)	pair SAR sum (W/kg)	SPLSR
			X	Y	Z					
Bottom Face w/o Hand strap	77	CDMA2000 BC0 CH777	-0.019	-0.079	-0.176	1.333	0	14	2.66	0.19
	114	WLAN5G CH165	0.057	0.039	-0.18	1.33	0			

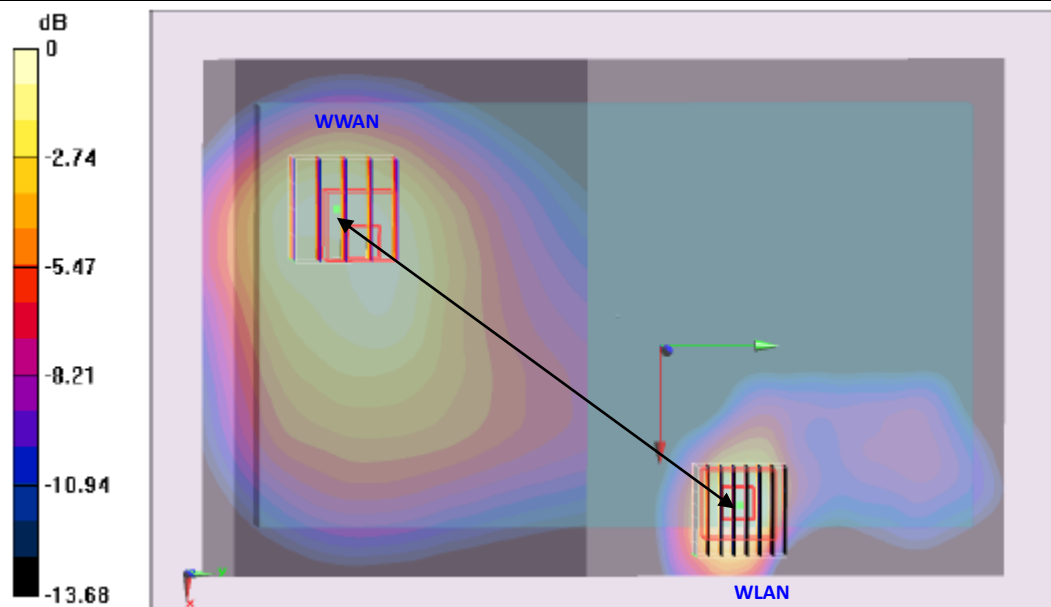

0 dB = 1.05 mW/g = 0.42 dB mW/g

Position	Plot No	Band/CH	SAR peak location (m)			SAR (W/kg)	Gap (cm)	Peak distance (cm)	pair SAR sum (W/kg)	SPLSR
			X	Y	Z					
Bottom Face w/o Hand strap	88	CDMA2000 BC1 CH25	0.049	-0.091	-0.174	1.453	0	13	2.78	0.21
	114	WLAN5G CH165	0.057	0.039	-0.18	1.33	0			

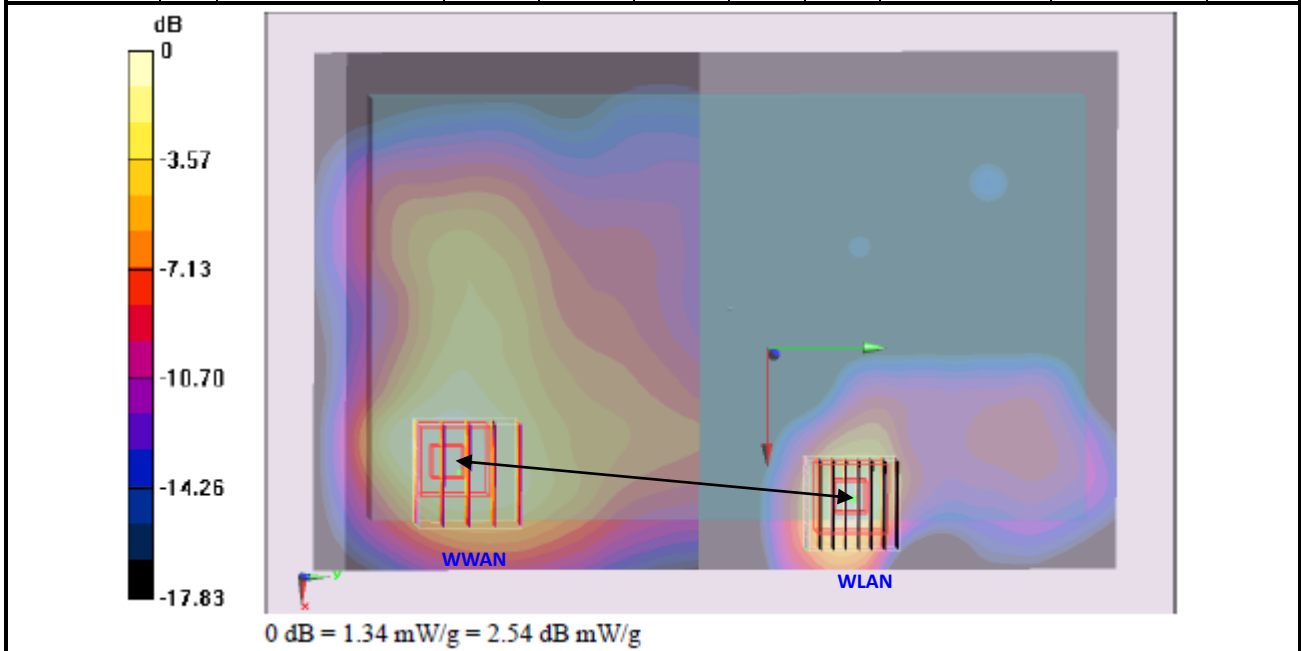

Test Engineer : Aaron Chang and Nick Yu

12. Uncertainty Assessment

The component of uncertainty may generally be categorized according to the methods used to evaluate them. The evaluation of uncertainty by the statistical analysis of a series of observations is termed a Type A evaluation of uncertainty. The evaluation of uncertainty by means other than the statistical analysis of a series of observation is termed a Type B evaluation of uncertainty. Each component of uncertainty, however evaluated, is represented by an estimated standard deviation, termed standard uncertainty, which is determined by the positive square root of the estimated variance.

A Type A evaluation of standard uncertainty may be based on any valid statistical method for treating data. This includes calculating the standard deviation of the mean of a series of independent observations; using the method of least squares to fit a curve to the data in order to estimate the parameter of the curve and their standard deviations; or carrying out an analysis of variance in order to identify and quantify random effects in certain kinds of measurement.

A type B evaluation of standard uncertainty is typically based on scientific judgment using all of the relevant information available. These may include previous measurement data, experience and knowledge of the behavior and properties of relevant materials and instruments, manufacture’s specification, data provided in calibration reports and uncertainties assigned to reference data taken from handbooks. Broadly speaking, the uncertainty is either obtained from an outdoor source or obtained from an assumed distribution, such as the normal distribution, rectangular or triangular distributions indicated in Table 12.1

Uncertainty Distributions	Normal	Rectangular	Triangular	U-Shape
Multi-plying Factor ^(a)	$1/k^{(b)}$	$1/\sqrt{3}$	$1/\sqrt{6}$	$1/\sqrt{2}$

(a) standard uncertainty is determined as the product of the multiplying factor and the estimated range of variations in the measured quantity

(b) κ is the coverage factor

Table 12.1 Standard Uncertainty for Assumed Distribution

The combined standard uncertainty of the measurement result represents the estimated standard deviation of the result. It is obtained by combining the individual standard uncertainties of both Type A and Type B evaluation using the usual “root-sum-squares” (RSS) methods of combining standard deviations by taking the positive square root of the estimated variances.

Expanded uncertainty is a measure of uncertainty that defines an interval about the measurement result within which the measured value is confidently believed to lie. It is obtained by multiplying the combined standard uncertainty by a coverage factor. Typically, the coverage factor ranges from 2 to 3. Using a coverage factor allows the true value of a measured quantity to be specified with a defined probability within the specified uncertainty range. For purpose of this document, a coverage factor two is used, which corresponds to confidence interval of about 95 %. The DASY uncertainty Budget is showed in Table 12.2.



Error Description	Uncertainty Value (±%)	Probability Distribution	Divisor	Ci (1g)	Standard Uncertainty (1g)
Measurement System					
Probe Calibration	6.0	Normal	1	1	± 6.0 %
Axial Isotropy	4.7	Rectangular	√3	0.7	± 1.9 %
Hemispherical Isotropy	9.6	Rectangular	√3	0.7	± 3.9 %
Boundary Effects	1.0	Rectangular	√3	1	± 0.6 %
Linearity	4.7	Rectangular	√3	1	± 2.7 %
System Detection Limits	1.0	Rectangular	√3	1	± 0.6 %
Readout Electronics	0.3	Normal	1	1	± 0.3 %
Response Time	0.8	Rectangular	√3	1	± 0.5 %
Integration Time	2.6	Rectangular	√3	1	± 1.5 %
RF Ambient Noise	3.0	Rectangular	√3	1	± 1.7 %
RF Ambient Reflections	3.0	Rectangular	√3	1	± 1.7 %
Probe Positioner	0.4	Rectangular	√3	1	± 0.2 %
Probe Positioning	2.9	Rectangular	√3	1	± 1.7 %
Max. SAR Eval.	1.0	Rectangular	√3	1	± 0.6 %
Test Sample Related					
Device Positioning	2.9	Normal	1	1	± 2.9 %
Device Holder	3.6	Normal	1	1	± 3.6 %
Power Drift	5.0	Rectangular	√3	1	± 2.9 %
Phantom and Setup					
Phantom Uncertainty	4.0	Rectangular	√3	1	± 2.3 %
Liquid Conductivity (Target)	5.0	Rectangular	√3	0.64	± 1.8 %
Liquid Conductivity (Meas.)	2.5	Normal	1	0.64	± 1.6 %
Liquid Permittivity (Target)	5.0	Rectangular	√3	0.6	± 1.7 %
Liquid Permittivity (Meas.)	2.5	Normal	1	0.6	± 1.5 %
Combined Standard Uncertainty					± 11.0 %
Coverage Factor for 95 %					K = 2
Expanded Uncertainty					± 22.0 %

Table 12.2 Uncertainty Budget of DASY for frequency range 300 MHz to 3 GHz



Error Description	Uncertainty Value (±%)	Probability Distribution	Divisor	Ci (1g)	Standard Uncertainty (1g)
Measurement System					
Probe Calibration	6.55	Normal	1	1	± 6.55 %
Axial Isotropy	4.7	Rectangular	√3	0.7	± 1.9 %
Hemispherical Isotropy	9.6	Rectangular	√3	0.7	± 3.9 %
Boundary Effects	2.0	Rectangular	√3	1	± 1.2 %
Linearity	4.7	Rectangular	√3	1	± 2.7 %
System Detection Limits	1.0	Rectangular	√3	1	± 0.6 %
Readout Electronics	0.3	Normal	1	1	± 0.3 %
Response Time	0.8	Rectangular	√3	1	± 0.5 %
Integration Time	2.6	Rectangular	√3	1	± 1.5 %
RF Ambient Noise	3.0	Rectangular	√3	1	± 1.7 %
RF Ambient Reflections	3.0	Rectangular	√3	1	± 1.7 %
Probe Positioner	0.8	Rectangular	√3	1	± 0.5 %
Probe Positioning	9.9	Rectangular	√3	1	± 5.7 %
Max. SAR Eval.	4.0	Rectangular	√3	1	± 2.3 %
Test Sample Related					
Device Positioning	2.9	Normal	1	1	± 2.9 %
Device Holder	3.6	Normal	1	1	± 3.6 %
Power Drift	5.0	Rectangular	√3	1	± 2.9 %
Phantom and Setup					
Phantom Uncertainty	4.0	Rectangular	√3	1	± 2.3 %
Liquid Conductivity (Target)	5.0	Rectangular	√3	0.64	± 1.8 %
Liquid Conductivity (Meas.)	2.5	Normal	1	0.64	± 1.6 %
Liquid Permittivity (Target)	5.0	Rectangular	√3	0.6	± 1.7 %
Liquid Permittivity (Meas.)	2.5	Normal	1	0.6	± 1.5 %
Combined Standard Uncertainty					± 12.8 %
Coverage Factor for 95 %					K = 2
Expanded Uncertainty					± 25.6 %

Table 12.3 Uncertainty Budget of DASY for frequency range 3 GHz to 6 GHz



13. References

- [1] FCC 47 CFR Part 2 "Frequency Allocations and Radio Treaty Matters; General Rules and Regulations"
- [2] ANSI/IEEE Std. C95.1-2005, "IEEE Standard for Safety Levels with Respect to Human Exposure to Radio Frequency Electromagnetic Fields, 3 kHz to 300 GHz", October 2005"
- [3] IEEE Std. 1528a-2005, "Recommended Practice for Determining the Peak Spatial-Average Specific Absorption Rate (SAR) in the Human Head from Wireless Communications Devices: Measurement Techniques", February 2006
- [4] FCC OET Bulletin 65 (Edition 97-01) Supplement C (Edition 01-01), "Evaluating Compliance with FCC Guidelines for Human Exposure to Radiofrequency Electromagnetic Fields", June 2001
- [5] SPEAG DASY System Handbook
- [6] FCC KDB 248227 D01 v01r02, "SAR Measurement Procedures for 802.11 a/b/g Transmitters", May 2007
- [7] FCC KDB 447498 D01 v04, "Mobile and Portable Device RF Exposure Procedures and Equipment Authorization Policies", November 2009
- [8] FCC KDB 616217 D03 v01, "SAR Evaluation Considerations for Laptop/Notebook/Netbook and Tablet Computers", November 2009
- [9] FCC KDB 941225 D01 v02, "SAR Measurement Procedures for 3G Devices – CDMA 2000 / Ev-Do / WCDMA / HSDPA / HSPA", October 2007
- [10] FCC KDB 941225 D03 v01, "Recommended SAR Test Reduction Procedures for GSM / GPRS / EDGE", December 2008
- [11] FCC KDB 941225 D04 v01, "Evaluating SAR for GSM/(E)GPRS Dual Transfer Mode", January 27 2010
- [12] FCC KDB 941225 D07 01, "SAR Evaluation Procedure for UMPC Mini-Tablet Devices", April 2011
- [13] FCC KDB 388624 D02, "Permit But Ask List", December 2011.



Appendix A. Plots of System Performance Check

The plots are shown as follows.



Appendix B. Plots of SAR Measurement

The plots are shown as follows.



Appendix C. DAS Y Calibration Certificate

The DAS Y calibration certificates are shown as follows.